

Electronics World

MAY, 1966
60 CENTS

WILL SATELLITES BE USED FOR HOME TV?

HOW TO SELECT ATTENUATORS AND PADS

CHOOSING THE RIGHT R.F. CHOKE

ULTRASONICS IN MEDICINE

TV TAPE RECORDERS

*—for Home
and Industry*

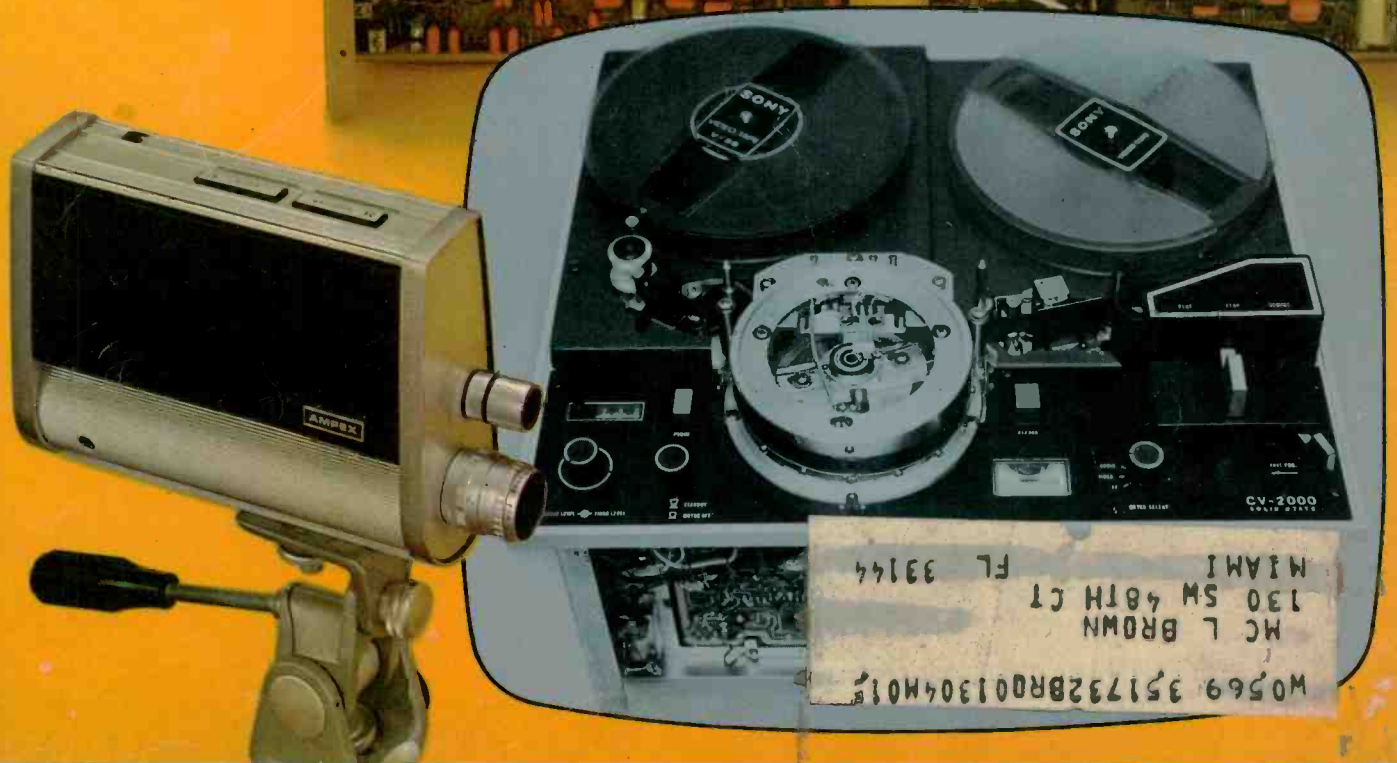

You call it tiny.
We call it progress!



 This is the new E-V 1177. An FM stereo tuner and 50 watt stereo amplifier. All in one neat package.

Don't let its calm exterior fool you. The inside is packed with action. Solid-state circuitry born of our lengthy experience in aerospace electronics. Nothing wasted. Every ounce contributes to superb sound reproduction.

You can tackle the biggest musical sounds on record with the 1177. It's more than equal to the challenge.

When teamed with a pair of famed Electro-Voice speakers, you've achieved a matched high fidelity system of rare excellence. And the E-V approach to high fidelity design makes installation easy and operation effortless.

Oh. One other thing about the E-V 1177. The price. It's right in line with the size. Small. Just \$280.00, including the walnut-paneled case. See your E-V dealer for a demonstration. Or write for our complete high fidelity catalog. *It's big!*

ELECTRO-VOICE, INC., Dept. 564N
629 Cecil Street, Buchanan, Michigan 49107

Electro-Voice®

high fidelity systems and speakers • tuners, amplifiers, receivers • public address loudspeakers • microphones • phonograph needles and cartridges • organs • space and defense electronics

CIRCLE NO. 117 ON READER SERVICE CARD

ARE YOU NEXT?



HOW MUCH WOULD YOU LOSE IF BURGLARS STRUCK TONIGHT?

TECHNICAL INFORMATION

The RADAR SENTRY ALARM is a complete U.H.F. Doppler Radar System which saturates the entire protected area with invisible r.f. microwaves. It provides complete wall to wall—floor to ceiling protection for an area of up to 5,000 square feet. Without human movement in the protected area, the microwave signal remains stable. Any human movement (operation is unaffected by rodents and small animals) in the area causes the doppler signal to change frequency approximately 2 to 4 cps. An ultra-stable low frequency detector senses this small frequency change, amplifies it and triggers the police type siren—which is heard up to a half mile away.

In addition, the RADAR SENTRY ALARM's protection can be extended to other areas with the use of the following optional accessories:

- remote detectors for extending coverage to over 10,000 sq. ft.
- rate of rise fire detector U.L. approved for 2,500 sq. ft. of coverage each (no limit on the number of remote detectors that can be used)
- hold-up alarm
- central station or police station transmitter and receiver (used with a leased telephone line)
- relay unit for activating house lights
- battery operated horn or bell which sounds in the event of: powerline failure; equipment malfunction or tampering

Cash? Color Sets? Stereos? Portables? Consoles? Tubes? Test Equipment?

Add it up. What's the total? . . . \$1,000.00? . . . \$5,000.00? . . . \$10,000.00? . . . more?

Can you afford a loss like that?

Can you afford to be out of work for two or three weeks because your test equipment was stolen? Or smashed? Because if a burglar isn't satisfied with your haul . . . he'll smash everything in sight.

And don't count on insurance to cover your losses . . . At best, you'll get only partial restitution . . . and nothing for all the time you lose.

When will your time come?

We hope . . . never.

Install a "RADAR SENTRY ALARM" security system . . .

And we know never!

But there's another reason why you should install "RADAR SENTRY ALARM" in your business. Before you know it you'll be installing them all over town. Because everyone needs protection. Of the more than 100 million buildings . . . stores, offices, factories, schools, churches and homes . . . only a small percentage are protected by an effective security system.

You can sell them! And you don't have to be a super salesman either. For hundreds of electronics professionals like yourself are selling them . . . all across the country. All you have to do is demonstrate it. It sells itself. A glance at the technical information shows why. It's the most unique, effective and advanced security system available.

Here is a list of just some customers who are protected by RADAR SENTRY ALARMS: U.S. Government; U.S. Air Force; Detroit Board of Education; Catholic Diocese of North Carolina and Detroit; Hundreds of Businesses, homes and factories.

You, too, can protect your possessions and property . . . the same way you earn them . . . ELECTRONICALLY . . . with a "RADAR SENTRY ALARM". And at the same time expand your business in a totally new area that yields high profits.

Don't wait.

Write today for complete details.

**RADAR SENTRY ALARMS
BY DAY . . . PROFITS
BY NIGHT . . . PROTECTION**

RADAR SENTRY ALARM

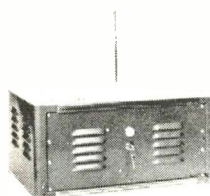

Mail to: RADAR DEVICES MANUFACTURING CORP.
22003 Harper Ave., St. Clair Shores, Michigan 48080



Please tell me how I can protect and expand my business with Radar Sentry Alarm. I understand there is no obligation.

Name

Address

City State & Code EW-5



new
8290
Shielded Permohm*
 Shown Actual Size



82 Channel TV lead-in for the strongest, cleanest picture signal and best color... ever!

- Provides 82 channel color reception
- Less installation time and cost
- Eliminates transmission line pick-up of noise and ghost signals
- No expensive matching transformers required
- Can be installed anywhere

Photos courtesy of WGN-TV.



Unshielded twin-lead
 Severe picture disturbance
 due to ignition noise.



Coaxial Cable
 Ignition noise minimized—
 but not eliminated.



* Shielded Permohm
 Eliminates automobile
 ignition noise.

■ New 8290 Shielded Permohm TV Lead-in combines the strong signal strength of twin-lead with the clean signal protection of shielded cable. Because it is a balanced line for 300 Ohm TV antennas and receivers, *costly matching transformers and connectors are eliminated.*

8290 is specifically designed for superior color reception on all 82 channels. The twin-lead is encapsulated in low-loss cellular polyethylene insulation, Beldfoil** shielded against all outside disturbances, and protected with a weatherproof

*Belden Trademark—Reg. U.S. Pat. Off.

jacket. A drain wire is provided for grounding the shield to the chassis. The need for stand-offs, twisting or routing of lead-in is eliminated. 8290 can be taped directly to a mast or tower, routed through metal pipe, buried underground, or even installed in rain filled gutters to reduce installation time and cost.

Ask your distributor about 8290 Shielded Permohm TV Lead-in cable, today! Or, write P. O. Box 5070-A for complete information.

*Belden U.S. Patent 2,782,251

**Belden U.S. Patent 3,032,604

BELDEN MANUFACTURING COMPANY

Belden

P. O. Box 5070-A · Chicago, Illinois 60680



THIS MONTH'S COVER shows two home video tape recorders along with a camera designed for home use. The unit at the top is the tape-deck portion of the Ampex recorder while the unit shown in the inset below is the Sony home video machine. We have removed the tape-head covers along with the front covers and shields in order to show some of the internal components. The Ampex camera at the lower left is for use with the manufacturer's home video machine. Technical articles in this issue cover both recorders and compare the various techniques employed for video tape recording. Color photo by J. R. McKenney; inset photo by Bakalar-Cosmo Photographers.



Publisher
PHILLIP T. HEFFERNAN

Editor
WM. A. STOCKLIN

Technical Editor
MILTON S. SNITZER

Associate Editors
LESLIE SOLOMON
P. B. HOEFER

Assistant Editor
MARSHA JACOBS

Contributing Editors
WALTER H. BUCHSBAUM
Prof. ARTHUR H. SEIDMAN

Art Editor
RICHARD KELLY

Art and Drafting Dept.
J. A. GOLANEK

Advertising Sales Manager
LAWRENCE SPORN

Advertising Service Manager
ARDYS C. MORAN

May, 1966

Electronics World

MAY 1966

VOL. 75, No. 5

CONTENTS

- 25 Ultrasonics in Medicine** *Abraham Kagan*
"Silent-sound" waves are now being increasingly used for physiotherapy, as a diagnostic tool, and to destroy malignant or unwanted tissues. This article describes the techniques employed and results obtained.
- 30 Recent Developments in Electronics**
- 32 Video Tape Recording Methods** *Leon Wortman*
There are three basic techniques used to put TV pictures on tape—transverse, helical, and longitudinal. Here is a comparison of the methods, along with the specific advantages and disadvantages, especially for home video recording.
- 35 Resistive Attenuators and Pads** *Chester F. Scott*
Do you know all the important factors to consider in selecting a variable attenuator? This article covers the circuitry, the design, and MIL specs.
- 38 Automatic TV Brightness Control** *Stu Hoberman*
- 39 Home TV Via Satellite** *Bradford B. Underhill*
When can we expect direct TV broadcasts to our individual homes? Not within our lifetimes, according to this authoritative article.
- 42 Sony Home Video Recorder** *C. H. Fields & Saburo Oniki*
- 45 Chroma Demodulation in Color Sets: RCA** *Walter H. Buchsbaum*
- 48 How to Select R.F. Chokes** *Joseph Tartas*
- 52 Ampex Home Video Recorder** *Joseph Roizen*
- 66 Soviet "Polar-Modulation" Stereo**
- 74 Airlines Plan Communications Satellites**
- 82 Semiconductor Interval Timer** *Donald E. Lancaster*
- 85 TV Disc Recorder**

-
- 6 For the Record (Editorial)**
CATV—A Booming New Industry
- 12 EW Lab Tested**
Harman-Kardon SC-440 "Stratophonic" System
- 60 The Technician and the Youngster** *John Frye*
- 75 Test Equipment Product Report**
Cohu 510 Series Digital Voltmeter-Ratiometer
Hewlett-Packard Model 427A Multi-Purpose Voltmeter
Electro PS-3A Transistor Regulated Power Supply

MONTHLY FEATURES

- 4** Coming Next Month
- 22** Letters from Our Readers
- 64** Book Reviews
- 78** Radio & TV News
- 86** New Products & Literature

Electronics World: Published monthly by Ziff-Davis Publishing Company at 307 North Michigan Ave., Chicago, Illinois 60601. One year subscription \$5.00. Second Class Postage paid at Chicago, Illinois and at additional mailing offices. Subscription service: Portland Place, Boulder, Colorado 80311. Copyright © 1966 by Ziff-Davis Publishing Company. All rights reserved.

color coded nutdrivers

now in new, handy kits
FOR BENCH, WALL OR TOOL BOX

Sturdy, new pebble-grain plastic cases provide handy means for keeping nutdrivers in good order on the workbench or in tool box for service calls. Lids snap shut, lock tight to protect tools. No. 77 case has hole in lid lock for wall hanging . . . molded compartments keep tools from tumbling out.



No. 77
SOLID SHAFT
NUTDRIVER KIT

7 Hex Openings: 3/16", 7/32", 1/4", 9/32", 5/16", 11/32", 3/8"



No. HS6-18
HOLLOW
SHAFT
NUTDRIVER KIT

10 Hex Openings: 3/16", 7/32", 1/4", 9/32", 5/16", 11/32", 3/8", 7/16", 1/2", 9/16"

PROFESSIONAL QUALITY

Precision fit, case-hardened sockets; polished and plated steel shafts; shockproof, breakproof, color coded plastic (UL) handles.

WRITE FOR CATALOG 162



XCELITE, INC., 12 BANK ST., ORCHARD PARK, N. Y.
In Canada Contact Charles W. Pointon, Ltd.

CIRCLE NO. 88 ON READER SERVICE CARD

COMING NEXT MONTH

Special Feature Articles on: PUBLIC-ADDRESS SYSTEMS

Our June issue will carry three important features of special interest to all those involved in planning, installing, and maintaining public-address systems.

Abraham B. Cohen, manager of engineering of University, tells how to select the proper speaker, how to obtain correct sound coverage, and how to connect such transducers.

M. S. Sumberg of Bogen's Sound Products Division explains how to pick the right p.a. amplifier. He covers various types of p.a. installations and makes recommendations about equipment to handle each particular type of job.

Paul K. Franklin of Electro-Voice emphasizes how important the proper selection of a p.a. microphone and its correct placement are in obtaining the required frequency response, directivity, and output level in the system.

SEALED LEAD-ACID BATTERIES

This newest advance in sealed, compact power sources which offers the highest cell voltage, heavy drain capability, and maximum watt-hour capacity at extreme temperatures is discussed in depth by **E. T. DeBlock** and **John R. Thomas** of Globe-Union's Battery Division.

VARACTOR DIODE APPLICATIONS

These special semiconductor diodes which operate as "high-Q" electronically variable capacitors are finding increasing use in a.f.c. circuits, FM modulators, harmonic generators, and parametric

amplifiers. Includes a list of firms that make such units and the types they sell.

CHROMA SYNC IN COLOR SETS: RCA

This second article in the current series on the specialized circuitry to be found in color television receivers, covers the sync circuits of RCA's sets.

SAMPLING OSCILLOSCOPES

Signal sampling techniques permit laboratory-type scopes to extend their vertical-bandpass capability up to the equivalent of 1000 MHz—allowing the measurement of very rapid waveforms.

All these and many more interesting and informative articles will be yours in the June issue of *ELECTRONICS WORLD* . . . on sale May 19th.

ZIFF-DAVIS PUBLISHING COMPANY

William B. Ziff
Chairman of the Board (1946-1953)

William Ziff
President

W. Bradford Briggs
Executive Vice President

Hershel B. Sarbin
Vice President and General Manager

Philip Sine
Financial Vice President

Walter S. Mills, Jr.
Vice President, Circulation

Stanley R. Greenfield
Vice President, Marketing

Phillip T. Heffernan
Vice President

Frank Pomerantz
Vice President, Creative Services

Arthur W. Butzow
Vice President, Production

Editorial and Executive Offices
One Park Avenue
New York, New York 10016 212 ORegon 9-7200

NEW YORK OFFICE 212 ORegon 9-7200
James J. Sullivan
Joseph E. Halloran

MIDWESTERN OFFICE
307 North Michigan Avenue
Chicago, Illinois 60601 312 726-0892
Midwestern Advertising Manager, Royce Richard

WESTERN OFFICE
9025 Wilshire Boulevard
Beverly Hills, California 90211
213 CResview 4-0265; BRadshaw 2-1161
Western Advertising Manager, Bud Dean

JAPAN
James Yagi
c/o Sekihara
1, Sakamachi, Shinjuku-ku
Tokyo, Japan

CIRCULATION OFFICE
Portland Place, Boulder, Colorado 80311



Member
Audit Bureau of
Circulations

Radio & TV News • Radio News • Radio-Electronic Engineering Trademarks Reg. U.S. Pat. Off.
SUBSCRIPTION SERVICE: All subscription correspondence should be addressed to Electronics World, Circulation Department, Portland Place, Boulder, Colorado 80311. Please allow at least six weeks for change of address. Include your old address, as well as new—enclosing if possible an address label from a recent issue.
EDITORIAL CONTRIBUTIONS must be accompanied by return postage and will be handled with reasonable care; however publisher assumes no responsibility for return or safety of art work, photographs, or manuscripts.

ELECTRONICS WORLD (May, 1966, Vol. 75, No. 5) is published monthly by Ziff-Davis Publishing Company at 307 North Michigan Avenue, Chicago, Illinois 60601. (Ziff-Davis also publishes Skiing, Flying, Business/Commercial Aviation, Boating, Car and Driver, Popular Photography, HiFi/Stereo Review, Popular Electronics, Modern Bride, Skiing Trade News and Skiing Area News.) One year subscription rate for U.S., U.S. Possessions, and Canada, \$5.00; all other countries, \$6.00. Second Class postage paid at Chicago, Illinois and at additional mailing offices. Authorized as second class mail by the Post Office Department, Ottawa, Canada and for payment of postage in cash.

ELECTRONICS WORLD

LOOK!

A New Electronics Slide Rule with Instruction Course

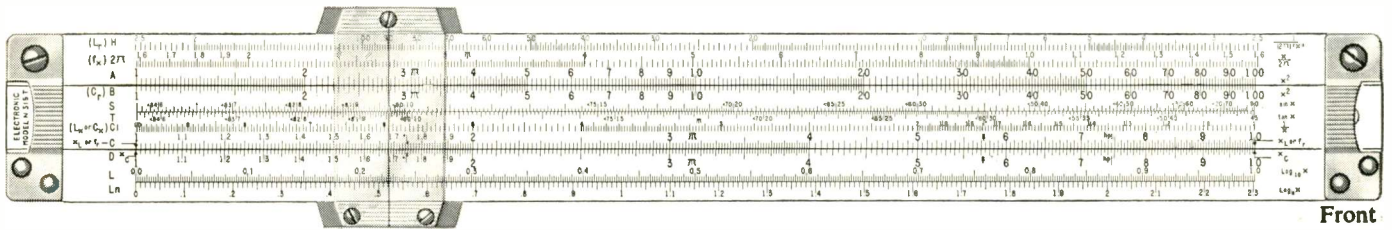

Front

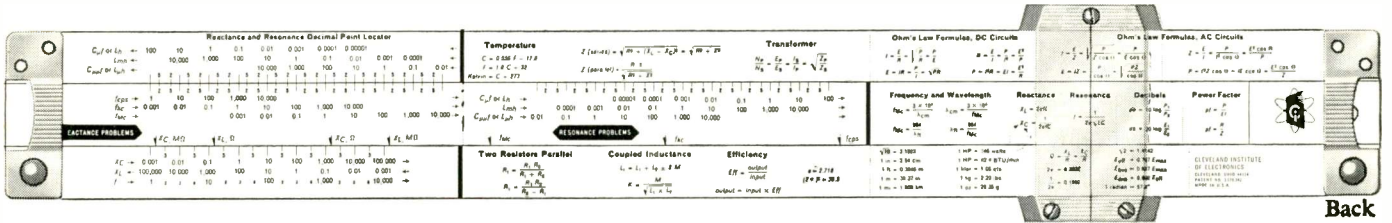

Back

This amazing new "computer in a case" will save you time the very first day. CIE's patented, all-metal 10" electronics slide rule was designed *specifically* for electronic engineers, technicians, students, radio-TV servicemen and hobbyists. It features special scales for solving reactance, resonance, inductance and AC-DC circuitry problems . . . an exclusive "fast-finder" decimal point locator . . . widely-used formulas and conversion factors for instant reference. And there's all the standard scales you need to do multiplication, division, square roots, logs, etc.

Best of all, the CIE Slide Rule comes complete with an Instruction Course of four **AUTO-PROGRAMMED*** lessons. It includes hundreds of illustrations, diagrams and practice problems. You'll learn ingenious short cuts . . . whip through exacting electronics problems quickly and accurately. This course alone is worth far more than the price of the entire package!

Electronics Slide Rule, Instruction Course, *and* handsome, top-grain leather carrying case . . . a \$50 value for less than \$20. Send coupon for FREE illustrated booklet and FREE Pocket Electronics Data Guide, without obligation. Cleveland Institute of Electronics, 1776 E. 17th St., Dept. EW-121, Cleveland, Ohio 44114.

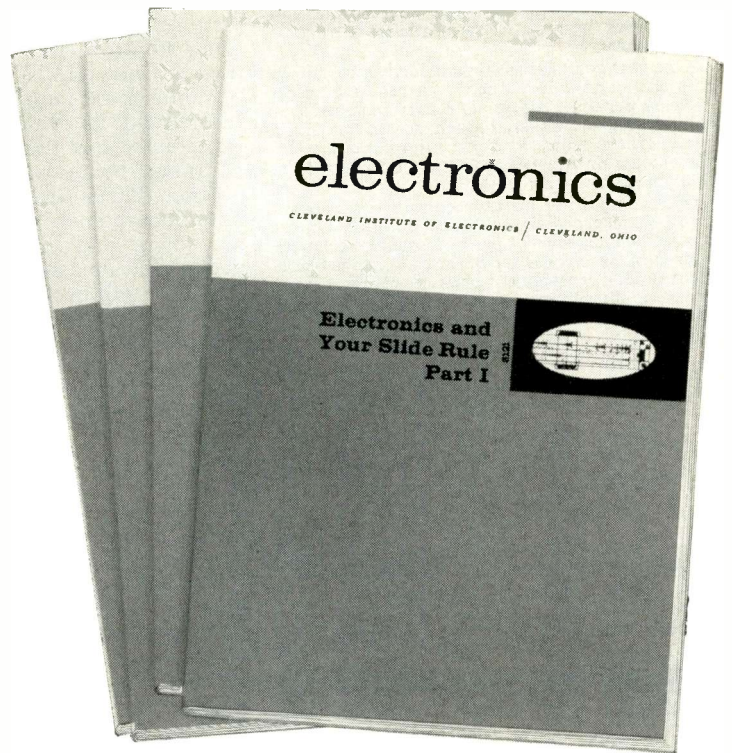

*TRADEMARK

GET BOTH FREE!

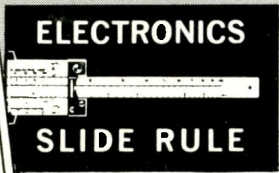
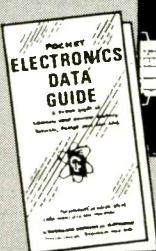

Send coupon today →

Cleveland Institute of Electronics

1776 E. 17th St., Dept. EW-121, Cleveland, Ohio 44114

Please send FREE Illustrated Booklet describing your Electronics Slide Rule and Instruction Course.

SPECIAL BONUS! Mail coupon promptly . . . get FREE Pocket Electronics Data Guide too!

Name _____ (PLEASE PRINT)
 Address _____ County _____
 City _____ State _____ Zip _____

A leader in Electronics Training . . . since 1934.

Complete TUNER REPAIR

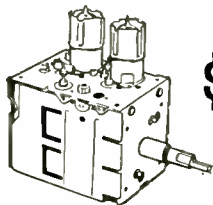

ONLY
\$950
INCLUDING

Includes ALL parts (Except tubes) . . .
ALL Labor on ALL makes. Fast, 24-hour
service with 1 year warranty.

Sarkes Tarzian, Inc. maintains two complete, well-equipped Factory Service Centers—assisted by Engineering personnel—and staffed by specialized technicians who handle ONLY tuner repairs on ALL makes and models. Tarzian-made tuners received one day will be repaired and shipped out the next. Allow a little more time for other tuners.

One year guarantee against defective workmanship and parts failure due to normal usage. Cost—\$9.50 per unit. \$15 for UV combinations. Absolutely no additional, hidden charge for ANY parts, except tubes. You pay shipping costs. Replacements on tuners beyond practical repair are available at low cost.

When inquiring about repair service, always give TV make, chassis and Model number. Tuners repaired on approved, open accounts. Check with your local distributor for Sarkes Tarzian replacement tuners, replacement parts, or repair service. See your distributor, or use the address nearest you for fast factory repair service:

TUNER SERVICE  CORPORATION

(Factory-supervised tuner service
authorized by Sarkes Tarzian)

MIDWEST—817 N. Pennsylvania St.,
Indianapolis, Ind. Box 1642
Tel: 317-632-3493

EAST—547-49 Tonnele Ave.,
Jersey City, New Jersey • Tel: 201-792-3730

WEST—SARKES TARZIAN, Inc.,
Tuner Service Division
10654 Magnolia Blvd., N. Hollywood, Calif.
Tel: 213-769-2720

CIRCLE NO. 97 ON READER SERVICE CARD

GET INTO **ELECTRONICS**



V.T.I. training leads to success as technicians, field engineers, specialists in communications, guided missiles, computers, radar and automation. Basic & advanced courses in theory & laboratory. Electronic Engineering Technology and Electronic Technology curricula both available. Assoc. degree in 29 mos. B. S. also obtainable. G.I. approved. Graduates in all branches of electronics with major companies. Start September, February. Dorms, campus. High school graduate or equivalent. Write for catalog.

VALPARAISO TECHNICAL INSTITUTE
Dept. RD, Valparaiso, Indiana



For the record

WM. A. STOCKLIN, EDITOR

CATV—A BOOMING NEW INDUSTRY

THE birth of community antenna television systems occurred over 15 years ago, in 1950, when the first commercial installation was made in Lansford, Pa. It was an insignificant beginning and few people at that time could have anticipated its potential growth.

In just over 15 years CATV systems have been connected to 2 million homes. Today some 1600 systems are in operation, covering all 50 states and the Virgin Islands. As of January 1st, there were approximately 250 systems in various stages of installation, about 600 additional communities had issued permits but construction had not yet started, and approximately 1200 applications were pending before local governing bodies. Each month there are some 90 applications for new CATV installations.

While these facts are impressive, the future holds an even greater potential. It is predicted that this year some 1 million additional homes will have a CATV connection. The ultimate potential is some 52 million homes. Some day every hamlet, town, and city will be interconnected like a massive spider web.

CATV will become as common as the telephone connection and each home will receive, on one or more sets, dozens of channels providing education, cultural material, and entertainment.

For those who have not been convinced as to the need for cable systems, let us refer to the often-quoted Seiden Report. According to this report, there are nine states that do not have a single 3-station market, and in 14 other states there is only one 3-station market each.

For those who believe that cable systems are confined to rural areas, let us note that New York City has issued franchises for several companies to do CATV installations. Construction has started and it is hoped that it will be completed by the end of the year.

The successes of CATV to date have not been achieved without problems. There were roadblocks no matter which way the CATV operators turned, but they met each challenge successfully and today they are operating without control by any state or federal agency. This certainly is not objectionable since it has encouraged a new and budding industry to bloom, and we are firm believers in the free-enterprise system. For many manufacturers in the electronics industry, this has meant new customers. Thousands of dollars are spent daily for cable and electronic equipment, not to mention all the miscellaneous items required for such a system.

But, a day of reckoning must come,

certainly not to curtail CATV, but to set operating ground rules for free television and CATV. Up to several weeks ago, both Congress and the FCC had turned their attention elsewhere. Even the Public Utility Commissions have declared that CATV does not come under their jurisdiction. There have been many court encounters but only one state—Connecticut—has indicated that such service comes under the jurisdiction of its PUC.

Not too long ago, FCC Chairman E. William Henry announced that the FCC would study all of the problems and shortly thereafter, on Feb. 15, he announced that CATV does come under FCC jurisdiction, and immediately proceeded to set regulations. In addition, he made major requests to Congress.

1. That CATV systems be required to get the consent of originating stations for re-transmitting their signals over CATV. This implies that a copyright fee might be imposed on CATV operators.

2. That CATV systems should be classified as public utilities.

3. That CATV operators be prohibited from originating programs of their own, thereby automatically blocking the development of CATV into a form of pay-TV.

This is the start of another series of court battles. FCC member Robert B. Bartley said that he did not agree that the Communications Act confers jurisdiction over CATV to the FCC. Even Chairman Henry said the question of jurisdiction probably will be decided by the Supreme Court.

If past performance of Congressional and Supreme Court actions is any criterion, it will be a long time before any regulations will be enforced.

Getting back to the items listed above, we believe the first should be enacted only to conform to present copyright laws. We believe item 2 will become a reality, but that item 3 is unrealistic in the broad sense. We do not believe there is any organization, including the FCC, that really wants to stifle CATV progress. There is a definite need for cable systems and eventually CATV will provide additional services now unknown to us and in a way free TV cannot.

We feel sure that a set of rules and regulations will emerge that will neither hinder the continued growth of cable systems nor permit the demise of free TV broadcasting. The decisions will set ground rules so that both can operate free of legal problems and prosper side by side. Harmonious cooperation between the two must be the eventual goal. ▲



BREAKTHROUGH...

TALK RIGHT THROUGH SKIP AND NOISE INTERFERENCE WITH THE NEW JOHNSON MESSENGER "350" SINGLE SIDEBAND CB TRANSCEIVER.

The Strategic Air Command, U.S. Signal Corps and overseas telephone companies pioneered single sideband because they required dependable, long range communications, particularly when operating conditions were at their worst. They proved that single sideband penetrated jumbled skip signals, atmospheric noise and other interference with clean, sharp clarity.

Now this "talk power" is yours for CB communication with the new Johnson Messenger "350" single sideband transceiver. The Messenger "350" will give you up to 30% more range than ordinary CB communication. Under severe skip and noise conditions, the "350" can deliver up to 3 times the range previously possible.

Maximum legal power input with single sideband provides output equivalent to 3 times ordinary AM talk power.

Johnson engineering superiority gives you these features in the Messenger "350": Automatic level control that lets you talk as loudly as you like without exceeding legal power limits—and with no speech clipping

- Adjacent channel interference virtually eliminated
- Crystal stability of .001%
- 3-watt audio output on receive or P.A.
- Dependable operation from -20° to +140° F.
- Solid state circuitry throughout—no tubes, no mechanical relays
- Optional plug-in AC power supply for base operation
- Optional Power Pack for high-power, hand carried field operation.

All these and more are yours when you move up to single sideband with the Johnson Messenger "350". Ask your authorized Johnson Dealer to demonstrate it today!



E. F. JOHNSON COMPANY

1121 10TH AVENUE S. W., WASECA, MINNESOTA 56093

Please send me my FREE booklet—Why Single Sideband?

Name _____

Street _____

City _____ State _____ Zip _____

CIRCLE NO. 108 ON READER SERVICE CARD

Electronics comes alive with NRI Training Kits

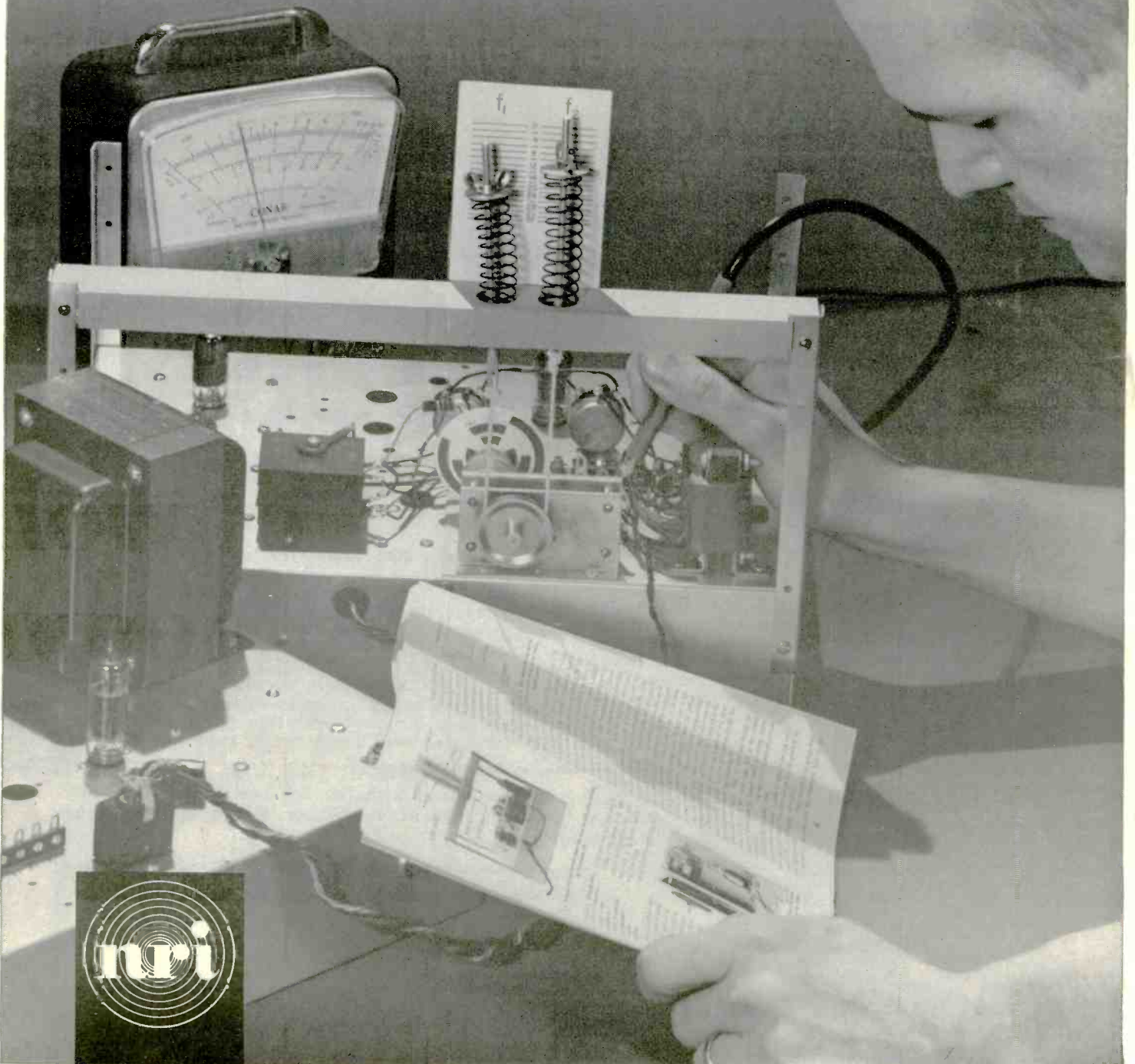

DISCOVER THE EASE AND EXCITEMENT OF TRAINING AT HOME THE NRI WAY

New Achievement Kit—Custom Training Kits—"Bite Size" Texts

Only NRI offers you this pioneering method of simplified "3 Dimensional" home-study training in Electronics, TV/Radio and Broadcasting/Communications. It's a remarkable teaching idea unlike anything you have ever encountered, the result of more than half a century of simplifying, organizing and dramatizing learning-at-home techniques. If you are an ambitious man—regardless of your education—you can effectively learn the Electronics field of your choice the NRI way.

NRI has *simplified* Electronics by producing "bite size" lesson texts averaging only 40 pages each. Dozens of illustrations open wide a picture window through which you'll see and understand practical uses of Electronics. You start out with NRI's exclusive Achievement Kit, containing everything you need to get started fast. (Illustrated at right.)

NRI has *organized* Electronics training to take you step-by-step from the first stages into more intriguing areas. Once you know the fundamentals thoroughly, it's easy to grasp more advanced theory and techniques. You move with confidence and enthusiasm into a new adventure filled with the excitement of discovery.

NRI has *dramatized* Electronics through the careful development of special training equipment that is *programmed* into your training systematically . . . beginning with your first group of lessons. Things you read about come alive in your hands as you build, experiment, purposely cause "problems" in circuits—and solve them. You learn to use test equipment, to build radios and TV sets, transmitter, or computer circuits. It's the priceless "third dimension" in NRI training . . . practical experience.



YOU GET MORE FOR YOUR MONEY FROM NRI

Mail the postage-free card now for your free NRI catalog. Then, compare if you like. You'll find—as have so many thousands of others—that NRI training can't be beat. Read about your first lessons in the attractive new Achievement Kit sent the day we receive your enrollment; about "bite size," easily read texts and carefully designed custom training equipment. See why NRI gives you more value. Whatever your reason for wanting more knowledge of Electronics, you'll find NRI has an instruction plan for you. Choose from three major training programs in TV/Radio Servicing, Industrial Electronics and Complete Communications. Or select from specialized courses for men with specific wants or needs. Check the course of most interest to you on the postage-free card and mail today for your free NRI catalog. No obligation. No salesman will call. NATIONAL RADIO INSTITUTE, Electronics Div., Washington, D.C. 20001.

More than 50 years of leadership
in Electronics Training



Career? Part-Time Earnings? Hobby? Choose From 10 Training Plans

1. TELEVISION-RADIO SERVICING

Complete training from basic fundamentals of electricity to home entertainment equipment. You learn how to fix radios, hi-fi and stereo sets, black-and-white and color TV, PA systems, etc. A profitable field full or part-time.

2. COMPLETE COMMUNICATIONS*

Designed to teach and provide you with actual practice in operation, service and maintenance of AM, FM and TV broadcasting stations. Also covers marine, aviation, mobile radio, facsimile, microwave, radar.

3. INDUSTRIAL-MILITARY ELECTRONICS

From basic principles to computers. A comprehensive training plan that teaches you the fundamentals, then takes you into such modern-day miracles as servos, telemetry, multiplexing, pulse circuitry, data processing, other career-building subjects.

4. FCC LICENSE*

Specifically designed short course to prepare you for your First Class FCC Radio-telephone License examinations. You begin

with a thorough background in fundamental Electronic principles, advance to required subjects covering equipment and procedures.

5. BASIC ELECTRONICS

A concise course to teach modern Electronics terminology and components. A wealth of practical, useful information to help you better understand the field, to give you some technical knowledge. For anyone who wants a basic understanding of Radio-TV Electronics.

6. MATH FOR ELECTRONICS

A brief course for engineers and technicians who need a quick review of the essential mathematics used in industry, in communications, in government jobs. Basic arithmetic review, short-cut formulas, modern digital numbers systems, much, much more.

7. ELECTRONICS FOR AUTOMATION

This course not for beginners. Offered for men with some fundamental knowledge of Electronics who want a better understanding of Automation in current use. Covers process control, ultrasonics, telemetering and remote control, electromechanical measurements, other key subjects.

8. AVIATION COMMUNICATIONS*

This course prepares you to install, maintain, service aircraft communications equipment. Covers direction finders, ranges, markers, Loran, Shoran, radar, landing systems. Earn your First Class FCC License with Radar Endorsement.

9. MOBILE COMMUNICATIONS*

Learn to install and maintain mobile equipment and associated base stations. Covers transmitters and receivers used by police and fire departments, public utilities, construction projects, taxis, etc. Prepares you for a First Class FCC License.

10. MARINE COMMUNICATIONS*

Covers transmitters, direction finders, depth indicators, radar, Sonar, other equipment used on commercial ships and thousands of pleasure boats. Prepares you for your First Class FCC License with Radar Endorsement.

* You must pass your FCC License exam (any Communications course) or NRI refunds in full the tuition you have paid.

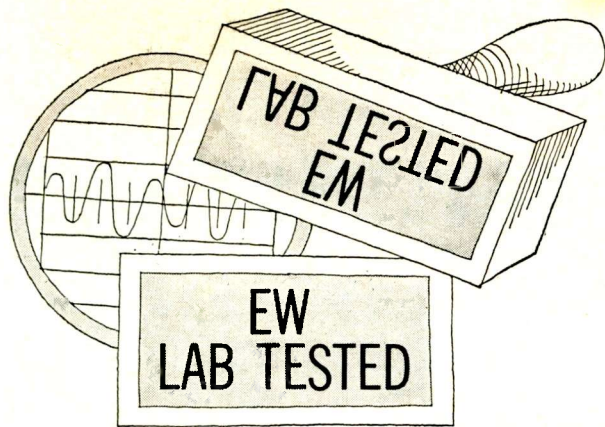

HI-FI PRODUCT REPORT

TESTED BY HIRSCH-HOUCK LABS

Harman-Kardon SC-440 "Stratophonic" System

Harman-Kardon SC-440 "Stratophonic" System

For copy of manufacturer's brochure, circle No. 27 on Reader Service Card.



DESPITE the numerous advantages of component high-fidelity systems over ordinary packaged radio/phonographs, the complexity (real or imagined) of assembling one's own system has kept many from enjoying the benefits of high fidelity. The integrated stereo receiver represented a giant step toward simplifying system planning and, understandably, has captured a large share of the component market.

Nevertheless, for many people, the selection of a record player, cartridge, and speaker system is so confusing that they are not tempted by the availability of integrated receivers. For them, the compact, integrated system may well be the ideal solution. This offers, under the control and warranty of one manufacturer, a record changer, cartridge, amplifier, and speakers, attractively packaged for installation without additional cabinetry. Some models are also available with built-in tuners, forming a complete high-fidelity system.

The new Harman-Kardon SC-440 "Stratophonic" system is perhaps the most complete integral system we have seen, for it includes an AM tuner and FM-stereo tuner in addition to the other essential components. The walnut cabinet base houses a solid-state receiver similar to the firm's SR-400 "Stratophonic" receiver. On top of the base is

a Garrard AT-60 automatic turntable fitted with an ADC 770 cartridge.

On the sloping front panel of the receiver are the input switch (which also serves as a stereo/mono mode selector), the volume control and "on-off" switch, bass and treble tone controls, balance control, and tuning knob. The edge-lighted slide-rule dial has AM, FM, and logging scales. An automatic stereo indicator light and tuning meter are lo-

cated on the dial scale. Switching between mono and stereo FM reception is automatic. Two slide switches control the loudness contour and cut off the speakers for headphone listening via the front-panel phone jack.

In the rear of the control unit are inputs for a high-level auxiliary source or tape recorder, and tape recording outputs which are unaffected by the tone and volume-control settings. The unit has a built-in AM antenna, although a longer wire can be connected where needed. A 48-inch wire is supplied for an FM antenna and conventional FM antennas may be used in weaker signal areas.

The system is supplied with its own speakers and the usual screw terminals at the amplifier and speakers have been replaced by ordinary phono jacks. A pair of 24-foot cords is supplied, giving the user a wide choice of speaker locations.

The speakers of the SC-440, more than anything else, distinguish it from other compact music systems. They are not in any sense miniature, but rather are full-sized, heavy "bookshelf" (23" x 13½" x 10") units weighing about 30 pounds each. Low frequencies are han-

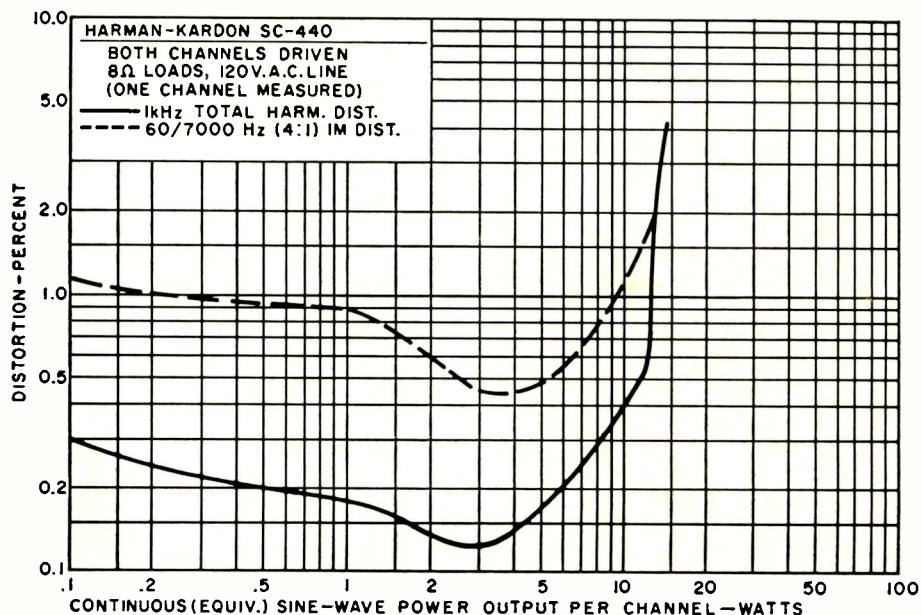

FINCO-AXIAL[®]

COLOR-KIT

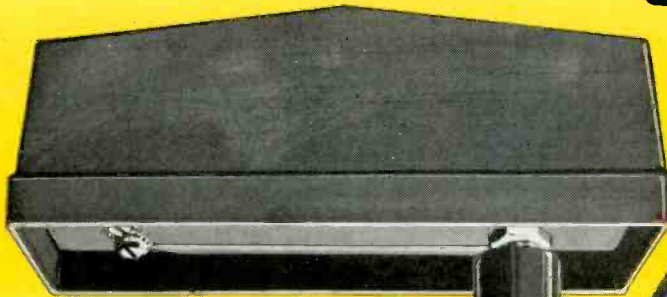

FINCO-AXIAL COLOR-KIT, Model 7512 AB

High performance Indoor and Outdoor Matching Transformers convert old-fashioned and inefficient 300 ohm hook-ups to the new Finco-Axial 75 ohm color reception system.

List price for complete kit . . .
7512AB \$8.95

7512-A Mast mounted matching transformer . . . list \$5.40

7512-B TV Set mounted matching transformer . . . list \$4.15

FINCO-AXIAL SHIELDED COLOR CABLE, CX Series

Highest quality, 75 ohm swept coaxial cable (RG 59/U) complete with Type F fittings, weather boot ready for installation.

Available in 25, 50, 75 and 100 foot lengths. List price . . . \$5.55, \$8.65, \$11.50 and \$14.20.

Write for Color Brochure # 20-349

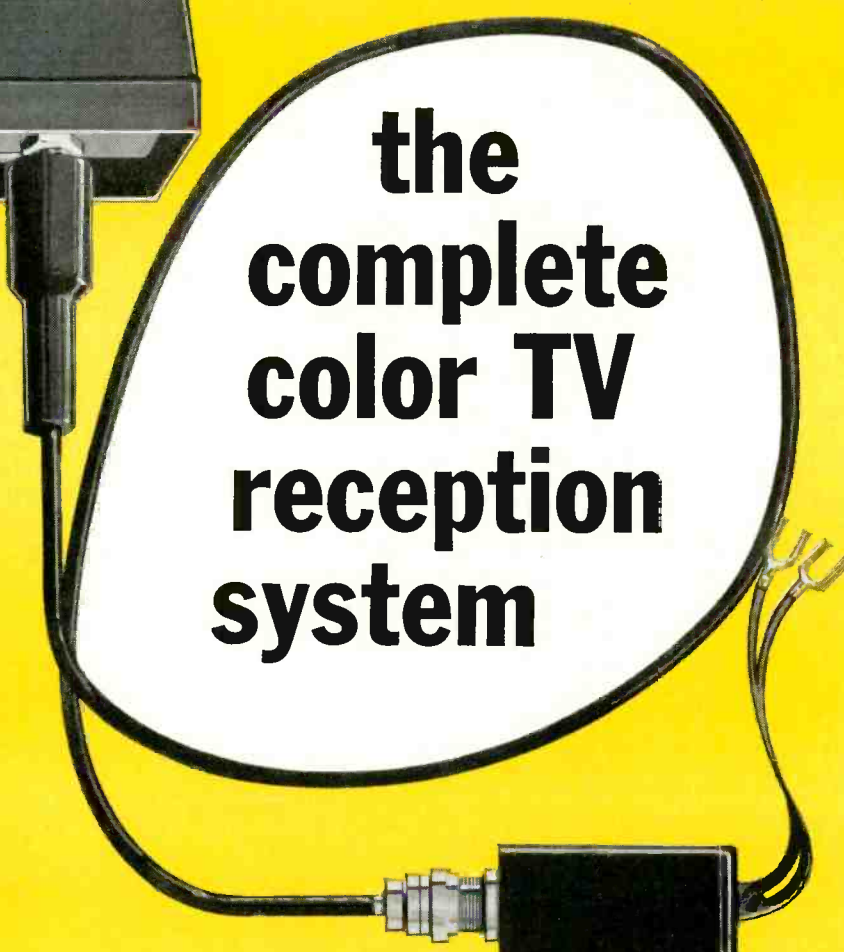

**the
complete
color TV
reception
system**

For the best color TV picture

*eliminates color-fade, ghosting and smearing!
Improves FM and Stereo, too!*

QUICK, EASY INSTALLATION

ENJOY brilliant "TV-Studio" color reception today by changing over to the new Finco-Axial Color Reception System. NOW, color fade, ghosts and smears are a thing of the past. Finco-Axial shields color sets against signal loss . . . eliminates outside interference and mismatch problems.

THE FINNEY COMPANY 34 WEST INTERSTATE STREET, DEPT. 410, BEDFORD, OHIO

ASSEMBLE YOUR OWN ALL-TRANSISTOR *Schober* ELECTRONIC ORGAN



3 NEW MODELS
Recital \$1500
Console II \$850
Spinet \$550

This is the all-new, all-transistor Schober

Recital Model...the most versatile electronic organ available today. Its 32 voices (plus amazing "Library of Stops"), 6 couplers and 5 pitch registers delight professional musicians...make learning easy for beginners. Comparable to ready-built organs selling from \$5000 to \$6000.

The pride and satisfaction of building one of these most pipe-like of electronic organs can now be yours...starting for as low as \$550. The Schober Spinet, only 39¼ inches wide, fits into the smallest living room. The new, all-transistor Schober Console II is the aristocrat of "home-size" organs...with two full 61-note manuals, 17 pedals, 22 stops and coupler, 3 pitch registers and authentic theatre voicing.

AND YOU SAVE 50% OR MORE BECAUSE YOU'RE BUYING DIRECTLY FROM THE MANUFACTURER AND PAYING ONLY FOR THE PARTS, NOT COSTLY LABOR.

It's easy to assemble a Schober Organ. No special skills or experience needed. No technical or musical knowledge either. Everything you need is furnished, including the know-how. You supply only simple hand tools and the time.

You can buy the organ section by section...so you needn't spend the whole amount at once.

You can begin playing in an hour, even if you've never played before—with the ingenious Pointer System, available from Schober.

Thousands of men and women—teenagers, too—have already assembled Schober Organs. We're proud to say that many who could afford to buy any organ have chosen Schober because they preferred it musically.

Send for our free Schober Booklet, describing in detail the exciting Schober Organs and optional accessories; it includes a free 7-inch "sampler" record so you can hear before you buy.

THE Schober Organ CORPORATION

43 West 61st Street, New York, N.Y. 10023

Also available in Canada, Australia, Hong Kong, Mexico, Puerto Rico, and the United Kingdom

THE SCHOBER ORGAN CORP., DEPT. RN-43
43 West 61st Street, New York, N.Y. 10023

- Please send me FREE Schober Booklet and free 7-inch "sampler" record.
- Enclosed find \$2.00 for 10-inch quality LP record of Schober Organ music. (\$2.00 refunded with purchase of first kit.)

Name _____
Address _____
City _____ State _____ Zip No. _____

CIRCLE NO. 96 ON READER SERVICE CARD

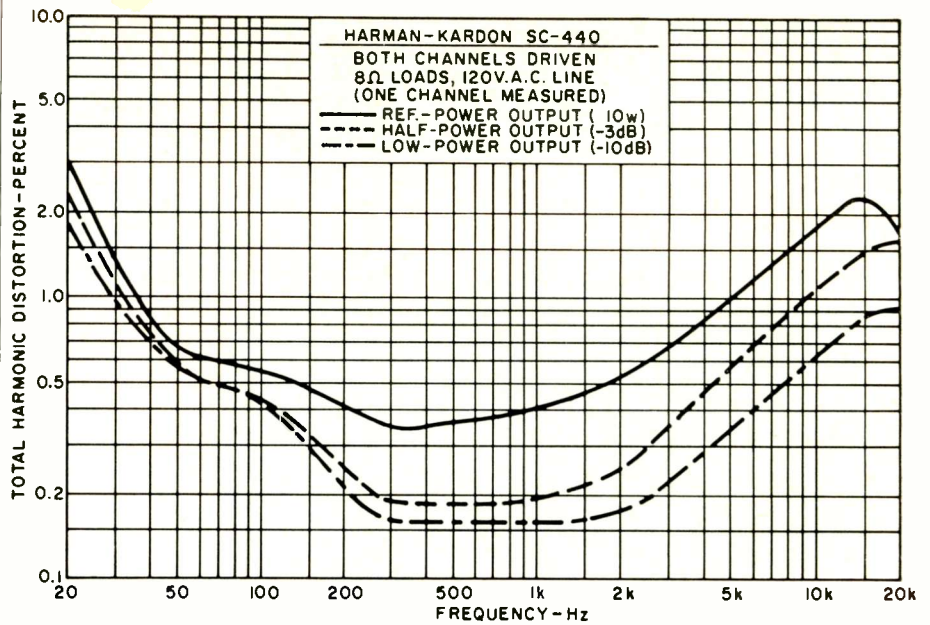

ded by a 10" acoustic-suspension woofer, with a highly compliant cone surround. High frequencies are radiated by a 3½" cone tweeter, with a level control for the tweeter on the back of the speaker cabinet.

In testing the unit we measured the receiver performance as though it were a separate unit, driving 8-ohm resistive loads. Since the frequency response is not shaped in any way to compensate for speaker response, we felt justified in testing the speakers independently. The record player and cartridge were not tested, other than by normal use and listening since they are standard commercial units and are not peculiar to

this particular integrated stereo system.

The receiver is a simple, yet effective design. The FM front-end has a tuned r.f. stage, mixer, and separate oscillator. The AM tuner has no r.f. stage. Four i.f. stages are used for FM followed by a ratio detector. In AM reception, three of them are used, with a separate diode detector. The multiplex circuit is unusually simple, with only two transistors (plus another to operate the stereo indicator lamp) and a four-diode balanced modulator.

The audio section has feedback-equalized phono preamplifiers. The driver transistors are transformer-coupled to the output stages, which are directly coupled to the speakers. The power supply provides five positive voltages and four negative voltages, individually filtered for maximum decoupling.

The manufacturer does not supply any performance specifications with the SC-440. We measured a continuous power output of about 13 watts per channel (by the new IHF measurement standard) at 2% distortion (either harmonic or IM). The 1-kHz harmonic distortion was very low, under 0.3% up to 8 watts output. The IM was in the vicinity of 1% below 1 watt, falling to less than 0.5% and reaching 1% again

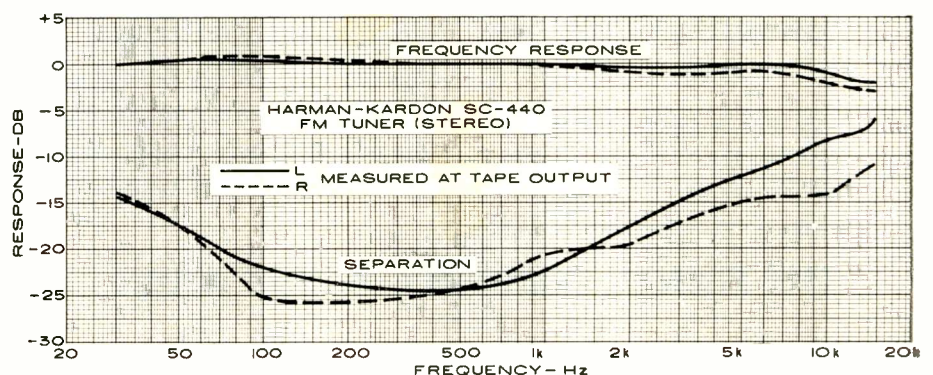
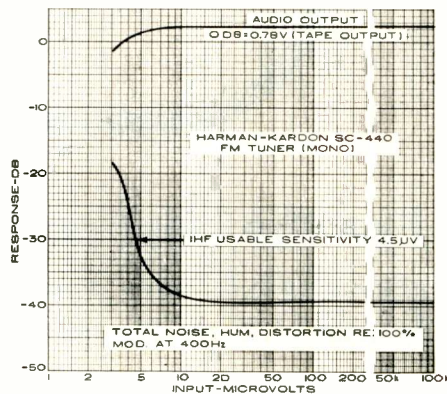

Engineered for Professional Quality and savings up to 50%

Whether you want the creative pleasure and thrift of build-it-yourself, or factory-assembled professional quality equipment ready-to-use—you save up to 50% with EICO

no-compromise engineering. Be super-critical. Compare EICO with anybody else. The more critically you judge, the more you'll see for yourself that your best buy is EICO.



COLOR TV LAB

Three compact portable instruments for shop or home Color TV servicing. Add one more and you're set for FM-MPX stereo.

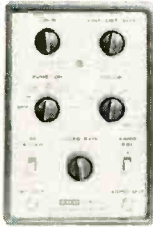

New Model 380 Solid State NTSC Color Generator generates exact NTSC color signals individually and all required dot-bar patterns. Super-compact, 4 pounds light, instant operation. **\$159.95 wired only.**

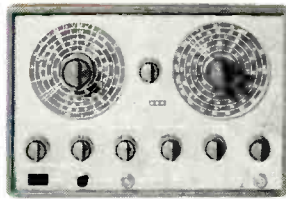

Model 369 Sweep/Marker Generator for easiest, fastest visual alignment of color or B&W TV and FM RF and IF circuits. Five sweep ranges from 3-220mc. Four marker ranges from 2-225mc. Crystal marker oscillator. Post injection of markers. **\$99.95 kit, \$149.95 wired.**



New Model 435 Direct-Coupled Wideband Scope. Top-quality DC-4.5mc scope with 3" flat-face CRT. Zener calibrator. Outperforms 5" scopes three times its size, facilitates on-location color TV and other servicing. **\$99.95 kit, \$149.95 wired.**



New Model 342 FM Multiplex Signal Generator. Design lab quality. Both composite audio and FM RF outputs. Inputs for stereo audio source for store demonstrations, critical A/B listening tests. **\$149.95 wired.**



New Model 1030 Regulated Power Supply. Speeds troubleshooting, design work, production line testing, electronics teaching. Variable bias and plate sources regulated to 1/3 of 1%: 0-150V @ 2ma; 0-400V @ up to 150ma. Ripple less than 3mv rms. Unregulated fil. volts of 6.3V & 12.6V, @3A. Switchable, monitoring milliammeter and voltmeter. **\$59.95 kit, \$99.95 wired.**



New Model 378 Audio Generator. Near-distortionless sine wave generator (<0.1% 20-20,000c) providing fast, convenient switch-selection of frequencies from 1c to 110kc (1c steps 1c-100c, 10c steps 100c-1kc, 100c steps 1kc-10kc, 1kc steps 10kc-110kc), 8-pos. 10db/step output attenuator & fine attenuator. Output meter (4 1/2" 200ua) with 8 voltage ranges & db scale. **\$49.95 kit, \$69.95 wired.**



New Model 965 FaradOhm Bridge/Analyzer. "Unusually versatile" — Electronics World. 9-range, low-voltage capacitance-resistance bridge safely measures even 1-volt electrolytics. Metered bridge balance, leakage test voltage (6 DC VTVM ranges 1.5-500V), leakage current (11 DC VTAM ranges 0.15ua-15ma). DC VTVM & VTAM external-ly usable. **\$129.95 wired.**



Model 460 Wideband Direct-Coupled 5" Oscilloscope. DC-4.5mc for color and B&W TV service and lab use. Push-pull DC vertical amp., bal. or unbal. input. Automatic sync limiter and amp. **\$89.95 kit, \$129.50 wired.**



Model 232 Peak-to-Peak VTVM. A must for color or B&W TV and industrial use. 7-non-skip ranges on all 4 functions. With Uni-Probe.® **\$29.95 kit, \$49.95 wired.**



New Model 779 Sentinel 23 CB Transceiver. 23-channel frequency synthesizer provides crystal-controlled transmit and receive on all 23 channels. No additional crystals to buy ever! Features include dual conversion, illuminated S/Rf meter, adjustable squelch and noise limiter, TVI filter, 117VAC and 12VDC transistorized dual power supply. Also serves as 3.5 watt P.A. system. **\$169.95 wired.**



New Model 3566 All Solid-State Automatic FM MPX Stereo Tuner/Amplifier. "Very satisfactory product, very attractive price" — Audio Magazine. No tubes, not even nuvistors. Delivers 112 watts IHF total to 4 ohms, 75 watts to 8 ohms. Completely pre-wired and pre-aligned RF, IF and MPX circuitry, plus plug-in transistor sockets. **\$219.95 kit (optional walnut cabinet \$14.95), \$325.00 wired including walnut cabinet. UL approved.**



New Model 753 The one and only SSB/AM/CW Tri-Band Transceiver Kit. "The best ham transceiver buy for 1966" — Radio TV Experimenter Magazine. 200 watts PEP on 80, 40 and 20 meters. Receiver offset tuning, built-in VOX, high level dynamic ALC. Unequaled performance, features and appearance. Sensationally priced at **\$189.95 kit, \$299.95 wired.**

FREE 1966 CATALOG

EICO Electronic Instrument Co., Inc. EW-5
131-01 39th Ave., Flushing, N.Y. 11352

Send me FREE catalog describing the full EICO line of 200 best buys, and name of nearest dealer. I'm interested in:

- test equipment ham radio
 stereo/hi-fi Citizens Band radio

Name _____
Address _____
City _____ State _____

1945-1965: TWENTY YEARS OF LEADERSHIP IN CREATIVE ELECTRONICS

VALUABLE books from E. & E.

great "how-to-build" data in the famous

RADIO HANDBOOK (16th Ed.)

Tells how to design, build, and operate the latest types of amateur transmitters, receivers, transceivers, and amplifiers. Provides extensive, simplified theory on practically every phase of radio. Broadest coverage; all original data, up-to-date, complete. 816 pages. Order No. 166, only... \$9.50

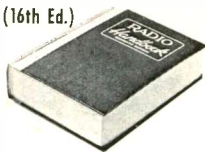

RADIOTELEPHONE LICENSE MANUAL

Helps you prepare for all commercial radiotelephone operator's license exams. Provides complete study-guide questions and answers in a single volume. Helps you understand fully every subject you need to know to obtain an operator's license. 200 pp. Order No. 030, only \$5.75

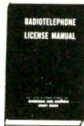

LEADING BOOK ON TRANSISTORIZED COMMUNICATIONS EQUIPMENT

TRANSISTOR RADIO HANDBOOK, by Donald L. Stoner, W6TNS, Lester A. Earnshaw, ZL1AAX. Covers a wide range of communication uses for both amateur and commercial applications. Includes audio and speech amplifiers, VHF transmitting and receiving equipment, SSB excitors, and complete SSB transceivers. 180 pages. Order No. 044, only... \$5.00



Order from your electronic parts distributor or send coupon below.

EDITORS and ENGINEERS, Ltd.

P.O. Box 68003, New Augusta, Indiana, Dept. EWE-5

Ship me the following books:

No. 166 No. 030 No. 044 \$_____encl.

Name _____

Address _____

City _____ State _____ Zip _____

CIRCLE NO. 120 ON READER SERVICE CARD

Meet Winegard Chroma-Tel

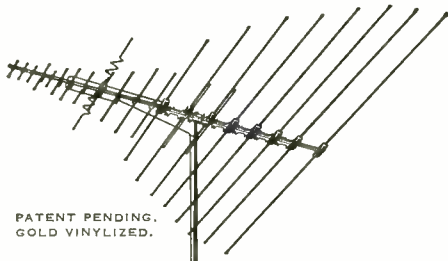

PATENT PENDING. GOLD VINYLIZED.

First 1/2 size all-band (UHF, VHF, FM) antenna with full size power

- Delivers Brilliant Color, Beautiful Black and White, Full-Tone FM Sound
- Brings in All the UHF, VHF and FM Stations in Your Area

Now there's an All-Band (UHF, VHF, FM) antenna that is actually half the size of most other all-band antennas. It eliminates half the bulk, half the wind loading, half the storage space, half the truck space and half the weight of ordinary all-band antennas... without sacrificing one bit of performance! Features Winegard's new Chroma-Lens Director System and impedance correlators.

Compare size, cost and performance... you'll choose Winegard Chroma-Tel every time. Ask your distributor or write for Fact-Finder #242

3 Models from \$17.50 list.

Winegard Co. ANTENNA SYSTEMS

3000 Kirkwood • Burlington, Iowa

CIRCLE NO. 89 ON READER SERVICE CARD

at 9 watts output. Referred to 10 watts and 2% distortion, the power bandwidth (at -3 dB) was 22 to over 20,000 Hz. (We subsequently learned that the loudspeakers employed are 4-ohm units. If we had used 4-ohm rather than 8-ohm loads, power output would be greater than the figures given above.—Editor)

With the tone controls centered, the over-all frequency response was within ±1 dB from 20 to 20,000 Hz. The tone controls cover a range of +8.5, -6.9 dB at 50 Hz and +17.7, -8.0 dB at 10,000 Hz. The loudness compensation boosts only the low frequencies at reduced volume control settings.

The FM tuner had an IHF usable sensitivity of 4.5 microvolts with limiting essentially complete at 10 microvolts. Its frequency response was ±1 dB from 30 to 15,000 Hz. Stereo separation was 25 dB at middle frequencies, reducing to 14 dB at 30 Hz and 6 to 11 dB at 15,000 Hz. (The model tested was an early unit that had a low-"Q" multiplex coil. According to the manufacturer, later versions have better stereo separation, especially at the higher frequencies.—Editor)

The speaker system (designated Model HK-40) had an exceptionally smooth over-all frequency response, with a middle and high range as smooth as we have ever measured on a dynamic speaker. From 1000 to 15,000 Hz the response followed our microphone calibration curve within about 1 dB. The smoothness we measured, averaging nine sets of data made with different microphone positions in a "live" room, was further confirmed by the excellent tone-burst response. The tone burst taken at 1.6 kHz is typical of the speaker's performance over most of its range. The only point of significant ringing was at about 800 Hz.

Below 1000 Hz, we usually apply a corrective curve, based on many speaker tests in the same environment, which corrects for much of the effect of the room on the speaker's low-end response. The resulting response curve shows a

rise below 200 Hz, amounting to about 10 dB between 40 and 60 Hz. Some of this undoubtedly was the result of low-frequency room resonances as indicated on the curve. However, the very low bass distortion (only 5% at 30 Hz with 1-watt input) makes the low-frequency output of the HK-40 true and usable over its entire range.

From the moment we turned on the SC-440 system, it was apparent that this was no ordinary "compact" music system. The over-all sonic balance was extremely pleasing. In particular, the bass performance was far beyond what we would have expected from a system of such a moderate price. The low bass can actually be felt rather than heard—and the clarity and smoothness of the speakers' response makes them the equal of almost any speaker we know of in the \$100 to \$150 bracket.

The FM receiver delivered excellent performance using only the 48-inch wire supplied as an antenna. In fact, we never felt the need for a better antenna in our suburban New York location. The tuner was drift-free, tuned easily, and sounded fine. The audio power was more than sufficient for the speakers, which evidently are relatively efficient. The AM tuner, which we did not measure, sounded as good as we would expect of any AM receiver, and is adequate for its intended purpose.

The record player and cartridge sounded fine on stereo records, tracking at 3 grams. On some older mono LP's, we observed some distortion, which may have been due to the stylus radius being too small for their grooves.

The components of the SC-440, if purchased separately, would cost about \$525, assuming a price of \$100 each for the speakers (and they would be a good value at that price). Obviously, the complete price of \$429.00 for the system makes it an outstanding value. We have no hesitation in recommending it to anyone who wants true high-fidelity performance in a moderate-priced integrated system. ▲

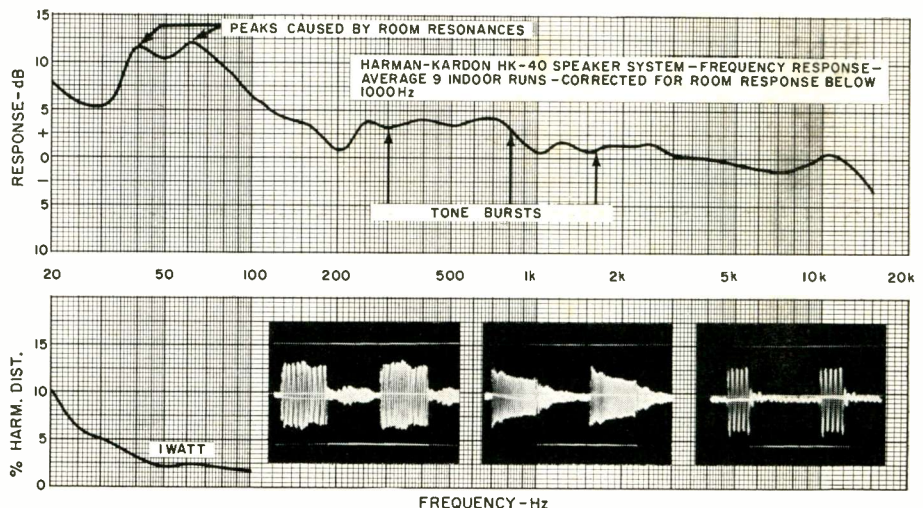

\$1 FIELD-EFFECT TRANSISTOR OFFER

The true semiconductor equivalent of a pentode tube...
... voltage controlled, high input Z, now available at experimenter prices!

How the FET works:

The field-effect transistor may be described as a semiconductor resistor whose channel conductance is controlled by one or more applied voltages. That's how the tube behaves—plate current changing with applied grid voltage. Consequently, there is a close resemblance between the output plate characteristic of a pentode tube and the FET's drain voltage/drain current characteristic. The FET's terminals, labeled gate, drain, and source, are analogous to the tube's grid, plate, and cathode. N-channel FETs require the same voltage polarities as the tube, i.e., positive drain voltage and negative bias on the gate. P-channel FETs, on the other hand, use the opposite voltage polarities. For amplifier design, note the transconductance, g_{fs} , since it controls the gain. Impedance matching can be accomplished with a source follower circuit. Voltage gain is almost unity and $Z_{out} \approx 1/g_{fs}$. The real advantage of the FET is its high input impedance; cascading stages presents no measurable loading on previous stages. Where the bipolar transistor's input emitter-base circuit is a low impedance, forward-biased diode, the FET offers the same design thinking as the tube. Other advantages: No power wasted on heaters, low power consumption, and solid state reliability. The \$1 and \$3 packages described below contain a full discussion of FET operation, how they compare with tubes, and complete data on the devices you order.

6 practical circuits you can build:

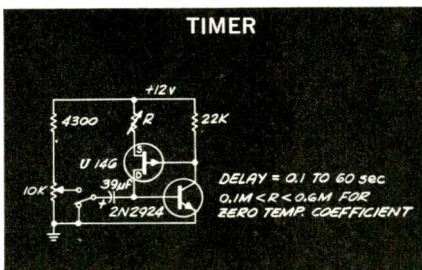

This basic circuit can be used for an enlarger timer, metronome, or other timing device.

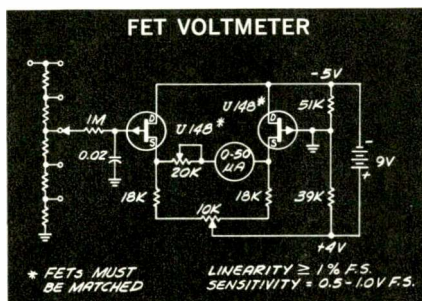

Here is a DC voltmeter with an input impedance that competes with any good VTVM, full scale sensitivity of 0.5 volts max. Add a diode and recalibrate for AC.

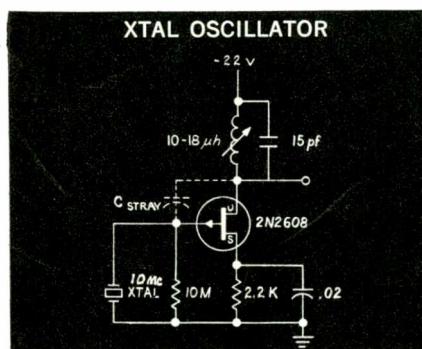

The high impedance of a crystal works hand-in-hand with the high-Z FET.

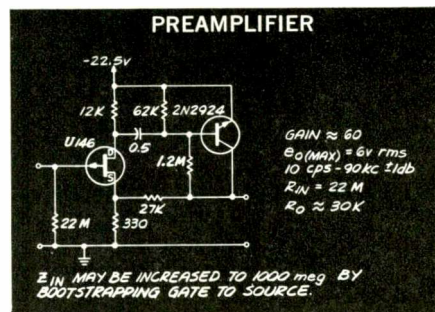

This mike preamp could be built into the mike's case, complete with battery operated by the PTT switch. A FET source-follower stage would provide a low-Z output to long mike lines.

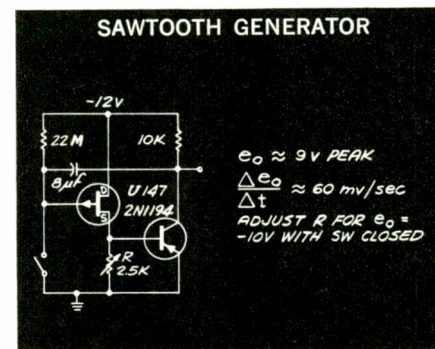
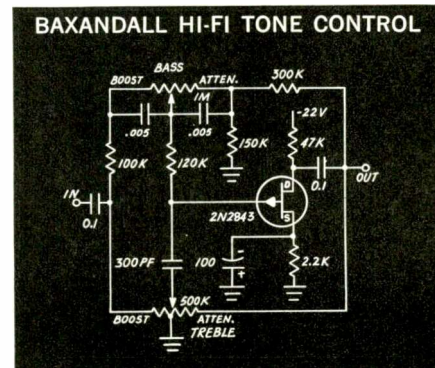

Siliconix assumes no responsibility for circuits shown, nor does it represent or warrant that they do not infringe any patents.

GET TO WORK WITH FETs FOR AS LITTLE AS \$1.00!

Here are the principal parameters (and their tube equivalents) of the two low-priced FETs available from Siliconix.

FET Parameter	I_{DSS}	V_p	BV_{GDS}	g_{fs} (Min.)
Tube Equivalent Parameter	Zero Bias Plate Current	Grid Cutoff Voltage	Max. Plate Voltage	Minimum Transconductance
U110	0.1-1.0 ma	-6 V	20 V	110 μmho
U112	0.9-9.0 ma	-6 V	20 V	1000 μmho

Offer #1—\$1.00 A Siliconix U-110 field-effect transistor, data sheet with complete specification, applications notes, and a detailed discussion of FET operations. \$1.

Offer #2—\$2.00. The U-112 FET, plus all of the circuit and device information noted above. \$2.

Offer #3—Both FETs, plus all data above at a special combination price of just \$2.75.

NOTE: California residents add 4c, 8c, or 11c sales tax. Clip the coupon and mail today, please send check or money order; no purchase orders, please!

Siliconix incorporated
1140 W. Evelyn Avenue • Sunnyvale, California 94086
Phone 245-1000 • Area Code 408 • TWX 408-737-9949

To: SILICONIX INCORPORATED
1140 W. Evelyn Ave., Sunnyvale, Calif. 94086

Enclosed is: \$1 for U-110 FET and data
 Check or \$2 for U-112 FET and data
 Money Order \$2.75 for both FETs and data

Name _____
 Address _____
 City _____ State _____ Zip _____

Please check one: Engineer Ham
 Hobbyist Serviceman

This is a limited offer, for experimenters only, one order to a customer. Offer closes June 30, 1966

In today's electronics boom, the demand for men with technical education is far greater than the supply of graduate engineers. Thousands of real engineering jobs are being filled by men without engineering degrees—provided they are thoroughly trained in basic electronic theory and modern application. The pay is good, the future is bright...and the training can now be acquired at home—on your own time.

How to become a “Non-Degree Engineer”

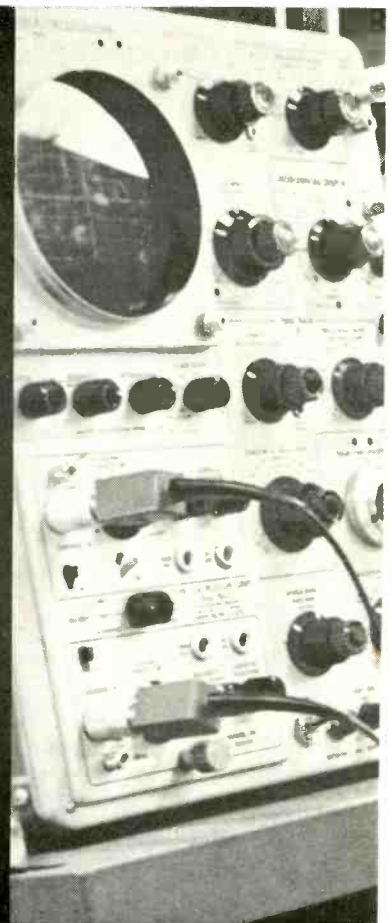

The electronics boom has created a new breed of professional man—the non-degree engineer. Depending on the branch of electronics he's in, he may "ride herd" over a flock of computers, run a powerful TV transmitter, supervise a service or maintenance department, or possibly work side by side with distinguished scientists at the frontier of a new discovery.

In military-connected work alone, 80% of the field engineers are not college trained. Yet they enjoy officer status and receive generous *per diem* allowances in addition to salaries up to \$11,000 a year.

In TV and radio, the Broadcast Engineer is the man with a 1st Class FCC License, whether he has a college diploma or not.

But even though you don't need a college education to become one of these non-degree engineers, you do need to know more than soldering connections, testing circuits and replacing components. You need to really know your electronics theory—to be able to calculate such things as resonance, reactance, inductance... and to know what to do with the numbers after you've figured them.

How can you pick up this necessary knowledge? Many of today's non-degree engineers learned their electronics at home. In fact, some authorities feel that a home study course is the *best* way to study Electronics. *Popular Electronics* said:

"By its very nature, home study develops your ability to analyze and extract information as well as to strengthen your sense of responsibility and initiative. Electronics technicians, even though they do not intend to work for themselves, must be 'self-starters.' Anyone who can satisfactorily

complete a home study course in electronics need have no worry about his initiative."

Cleveland Method Makes It Easy

If you decide to advance your career through home study, it's best to pick a school that *specializes* in the home study method. Electronics is complicated enough without trying to learn it from texts and lessons that were designed for the classroom instead of the home.

The Cleveland Institute is such a specialist. It concentrates on home study exclusively. Over the last 30 years it has developed techniques that make learning at home easy, even if you once had trouble studying. Your instructor gives the lessons and questions you send in his undivided personal attention—it's like being the only student in his "class." He not only grades your work, he analyzes it. Even your correct answers can reveal misunderstandings he will want to clear up. And he mails back his corrections and comments the same day he gets your lessons, so you read his notations while everything is still fresh in your mind.

Students who have taken other courses often comment on how much more they learn from CIE. For example, here's what Mark E. Newland of Santa Maria, California says:

"Of 11 different correspondence courses I've taken, CIE's was the best prepared, most interesting, and easiest to understand. I passed my 1st Class FCC exam after completing my course, and have increased my earnings by \$120 a month."

CIE Assures You A FCC License

The Cleveland method of training is so successful that better than *9 out of 10 CIE*

men who take the FCC exam pass it—and on their first try. This is despite the fact that, among non-CIE men, 2 out of every 3 who take the exam fail! That's why CIE can promise in writing to refund your tuition in full if you complete one of its FCC courses and fail to pass the licensing exam.

This Book Can Help You

Thousands who are advancing their electronics careers started by reading our famous book, "How To Succeed in Electronics." It tells of many non-degree engineering jobs and other electronics careers open to men with the proper training. And it tells which courses of study best prepare you for the work you want.

If you would like to cash in on the electronics boom, let us send you this 40-page book free. You are under no obligation to buy anything. But you do owe it to yourself to read it carefully.

Just fill out and mail the attached card. Or, if the card is missing, write to:

CIE Cleveland Institute of Electronics

1776 E. 17th St., Dept. EW-17
Cleveland, Ohio 44114

The only home study school to provide complete coverage of electronics fundamentals plus such up-to-date applications as: Microminiaturization • Laser Theory and Application • Suppressed Carrier Modulation • Single Sideband Techniques • Logical Troubleshooting • Boolean Algebra • Pulse Theory • Timebase Generators ... and many more.

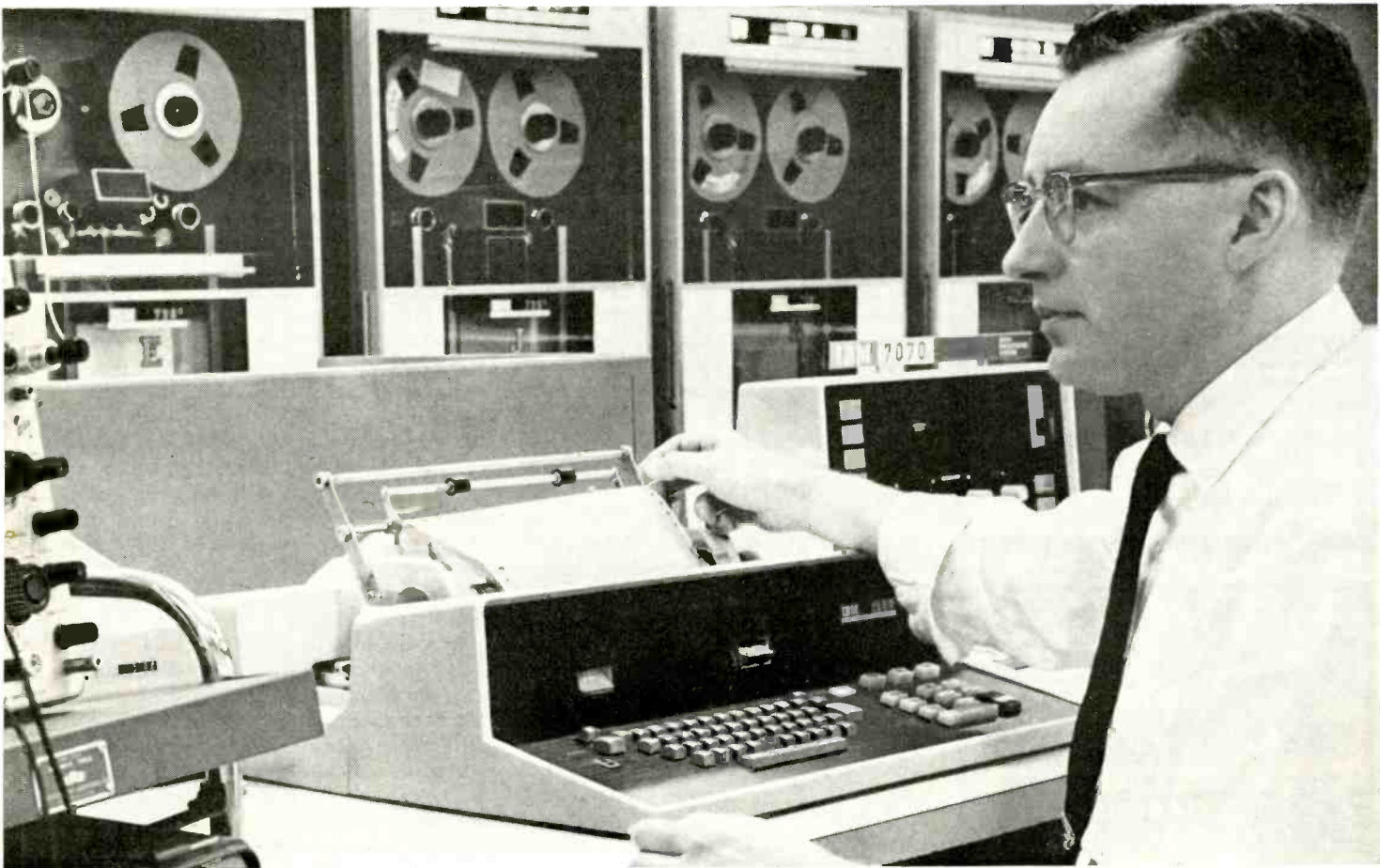

Get Your First Class Commercial

F. C. C. LICENSE QUICKLY!

We specialize in communications-electronics training. We prepare you to PASS F.C.C. license exams—and to succeed in the positions which require greater knowledge and ability.

Get your first class F.C.C. license in 4 months of resident classes, or at your own pace by correspondence. Grantham training leads you step-by-step to your third, second, and first class license—and to success in your electronics career.

Resident courses (day or evening) are available in the cities listed below. These courses include valuable laboratory training for those who need it, or may be taken without lab by those who already have practical experience.

Correspondence instruction is available for those who cannot or do not wish to attend classes. The correspondence course is especially designed (programmed) for home study.

Grantham lessons are constantly revised and updated to keep up with the latest F.C.C. changes—and are written so you can understand them. For our free brochure which covers both resident classes and home study instruction, write or phone any of the schools listed below. Ask for "Brochure 66-E."

Grantham School of Electronics

1505 N. Western Av., Hollywood, Cal. 90027

(Phone: HO 9-7878)

408 Marion Street, Seattle, Wash. 98104

(Phone: MA 2-7227)

818-18th St., NW, Washington, D.C. 20006

(Phone: 298-7460)

CIRCLE NO. 113 ON READER SERVICE CARD

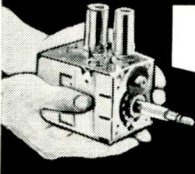

COMPLETE TUNER OVERHAUL

ALL MAKES
ALL LABOR
AND PARTS
(EXCEPT TUBES
& TRANSISTORS)

995

Send complete tuner now ... or write for full information and mailing labels. Exchanges on tuners unfit for overhaul from \$12.95

CASTLE TV TUNER SERVICE

MAIN PLANT: 5717 N. Western Ave., Chicago 45, Illinois
EAST: 41-94 Vernon Blvd., Long Island City 1, New York
Castle TV Services, Ltd. Nation-wide service.
CANADA: For service in Canada write to Chicago for details, Canadian address, and mailing kit.
*Major parts are charged extra in Canada

361C AUDIO EQUALIZER

Variable Equalizer necessary for professional quality recording or playback. Ideal for use between mixer and tape recorder or tape to tape, etc. Write for details or send \$2.00 for LP demonstration record. Covers tape and disc recording techniques. Refunded with purchase.

361C
\$44⁹⁵



Order Direct or Write for information.

KUHN ELECTRONICS

CINCINNATI 17, OHIO

LETTERS FROM OUR READERS

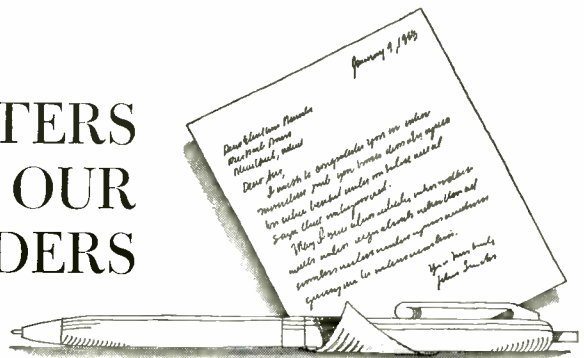

TIME MEASUREMENTS

To the Editors:

I am giving a series of noontime lectures in astronomy for our astronomy club at the office (*Bell Telephone Labs.*). We recently covered astronomical time measurements. Consequently, my attention was attracted by your "Time Scales & Time Measurements" article in *ELECTRONICS WORLD* for January, 1966. Before I condemn the article, I want to say that I actually did learn something from it. And now for the points of criticism.

Regarding the variations between lengths of apparent solar days, even if the earth's orbit were perfectly circular and there were no eccentricities in the axis, the apparent solar days would *not* be of uniform length. Variations would exist because of the inclination between the orbital plane and the equatorial plane. However, a solar day in November is never more than seconds different in length from a day in June, and certainly nothing like the 16 minutes stated by the author.

Consider the following statement in the "Ephemeris Time" section. "Due to the tremendous distances, these celestial bodies, except for the nearer planets, appear to be motionless in space." Truth of the matter is that all celestial bodies appear to be moving in space and this is regardless of distance. Stars exhibit motions such as proper motion, aberration, and parallax. These motions must be accounted for in coordinate measurements. There is apparently nothing fixed in the heavens.

Under the heading "Sidereal Time," the author states "... if the earth is going away from the sun, it must rotate more than 360 degrees to present the same point to the sun as shown in Fig. 1. The opposite is true when the motion of the earth is toward the sun." That is patently untrue. The excess rotation beyond 360 degrees is required because the earth is revolving about the sun, and this excess rotation is required whether the earth is going toward or away from the sun. The picking of a reference point farther from the sun does not lessen the effect, as the author stated. It eliminates the effect, as such. Of course, the orbital motion still causes

problems, but not that one. The author now gets involved with the subject of sidereal time.

Sidereal time is more important than one is led to believe. It is really one of the most basic times measured. Most other times are derived from it or corrected by measurement of it. Sidereal time is defined in terms of the interval between transits of the vernal equinox—a point, not a body. And there are two sidereal times, apparent and mean, just as there are apparent solar time and mean solar time. The difference between them is not caused by the same thing, however. Sidereal time is actually measured by observing the transits of various stars whose positions relative to the vernal equinox are accurately known.

As for the eastward motion of the sun in the sky, I, in contrast to the author, have no doubt that most people have *never* noticed such an eastward motion. Most probably have never even heard of it. After all, when you are looking at the sun in the sky, there is nothing else there to relate its position to. How can you see any eastward motion by looking at it at the same time each day? When you compare its position with terrestrial objects there is certainly no progressive eastward motion. I don't say such a motion does not exist; it does. It is just not that apparent, and is in fact most easily discovered by noting that it is the stars that are in a different position at the same time on successive nightly observations. Then, by inference, one decides the sun must have moved eastward. I can only guess at what the author meant by the statement, "At the end of a year's time the sun, in its apparent orbit around the earth, will have then added one extra day."

There is nothing curious about there being one more sidereal day in a sidereal year than solar days in the solar year. That statement includes four time units, and the relationships among them have not been given. The reader is thus in no position to come to such a conclusion. I assume the author meant the term solar year to be a tropical year, the one we use for our calendars. Maybe another reason for the statement not being curi-

ous is that it just is not really true in the first place.

KENNETH E. STONE
Marlboro, N.J.

Following is a portion of Author Wilson's reply to Reader Stone's letter.—
Editors

To the Editors:

My thanks to Reader Stone for pointing out the mistake in the second paragraph under "Sidereal Time." It should be noted that there is always some additional amount of rotation because of the orbital motion. The amount of additional rotation increases or decreases as the earth moves away from or toward the sun, respectively. This is why the apparent solar days are of unequal duration when compared to a more accurate reference.

Let me repeat and emphasize the difference between an apparent solar day and a mean solar day. An apparent solar day is the duration of time required for one rotation of the earth placing the sun back in its apparent position in the sky. A mean solar day is the average of all the apparent solar days in one solar year. Because of this, an apparent solar day is different at different times of the year. In November, this difference is at its greatest due to the earth's being near its aphelion of orbit (most distant point from the sun).

With regard to the section on ephemeris time, an extension of the context would include the next sentence, "Therefore, at regular intervals of ephemeris years, these celestial bodies appear to return to the same relative positions in the heavens." This regular interval is the ephemeris year and is, as stated, constant enough to be a reference.

I have only suggested that the distant stars appear motionless. I didn't say they did not move. The important point is that they regularly return to the same relative positions, thus offering an accurate reference.

My mention of sidereal time was not intended to belittle it. I repeat that sidereal time is of little use in the majority of measurements in electronics, just the same as solar time and in contrast to the UT-2 scale. As to how to reference sidereal time, although I did not use the imaginary point that Reader Stone knows as the vernal equinox, common sense requires that there be some point of reference.

As to the remainder of the disagreements, Reader Stone has pointed out only one possible misstatement in the article and is, instead, taking issue with the conciseness with which the story was written.

EDWARD C. WILSON III
Rialto, Calif. ▲

The ideal base/mobile combination for CB radio

FOR BASE STATIONS where 117V 60 cycle AC current is available...

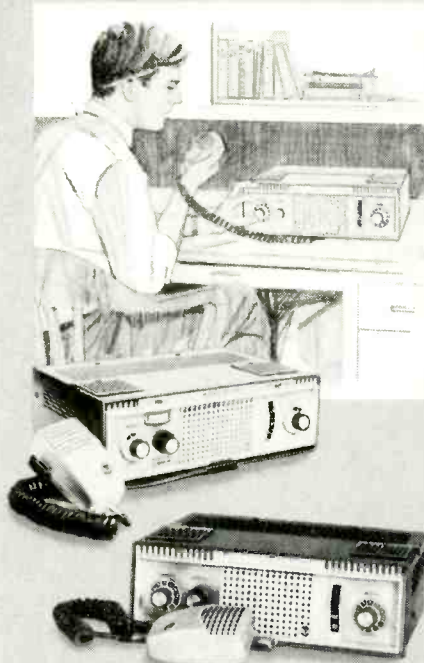

The Low-Cost RCA Mark VIII and Mark NINE

- 9 crystal-controlled transmit and receive channels.
- Tunable receiver for reception of 23 C-B channels; dial marked in both channel numbers and frequency.
- Exceptionally good voice reproduction.
- Highly selective superheterodyne receiver with one RF and two IF amplifier stages.
- Electronic switching—no relay noise or chatter.
- Illuminated "working channel" feature.
- Light and compact—only 3¾ inches high, weighs only 9 pounds with mike.
- Improved Automatic Noise Limiter.

Plus these EXTRA features in the Mark NINE

- Combination "S" Meter (indicates the relative strength of incoming signal) and Relative RF Output Meter (indicates relative strength of signal being transmitted).
- Spotting Switch. Permits precise manual tuning of receiver without use of receiver crystals.
- External Speaker Jack. Lets you connect an external speaker to set, so that incoming calls can be heard in remote locations.

Mark VIII: \$99.95* Mark NINE: \$114.50*

*Optional distributor resale price.

FOR MOBILE UNITS where low power consumption is important...

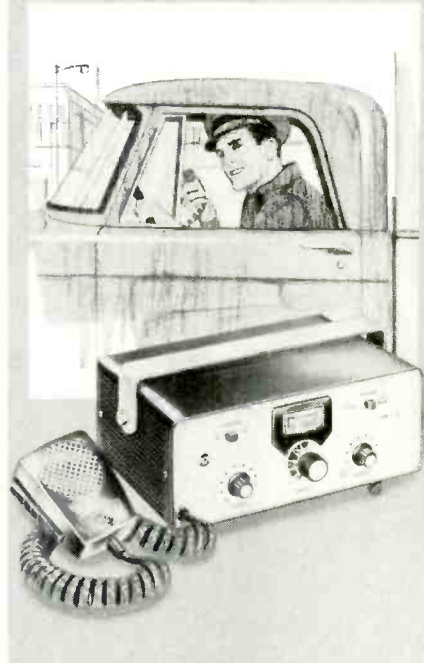

The all-solid state MARK 10

- All silicon transistors assure low power consumption, dependable communication at temperatures from -23° to +130° F.
- Compact, lightweight. Fits easily under dash of any car or truck. Only 3¾" high, 5¾" deep, 8½" wide. Weighs less than 4½ pounds.
- 12 crystal-controlled transmit and receive channels with illuminated channel selector.
- Combination "S" Meter and Relative RF Output Meter.
- Operates from 12-volts DC power source (positive or negative ground).
- Crystal-controlled double conversion, superheterodyne receiver provides frequency accuracies greater than 0.004%.
- Separate AGC amplifier eliminates blasting and overloading, minimizes fading.
- Six-stage IF bandpass filter for maximum selectivity without ringing.
- Low-distortion, series-type noise limiter with automatic threshold adjustment.
- Receiver power regulated for maximum stability.
- Acoustically designed cabinet with audio characteristics shaped for maximum intelligibility.
- External speaker jack (de-activates internal speaker).

Mark 10: \$189.95*

*Optional distributor resale price.

See them at your
Authorized RCA CB
Radio Distributor.
Look for stores
displaying
this symbol.



RCA ELECTRONIC COMPONENTS AND DEVICES, HARRISON, N. J.

The Most Trusted Name in Electronics

**Where
will you stand
10 years from today,
when half
of what you now
know becomes
obsolete?**

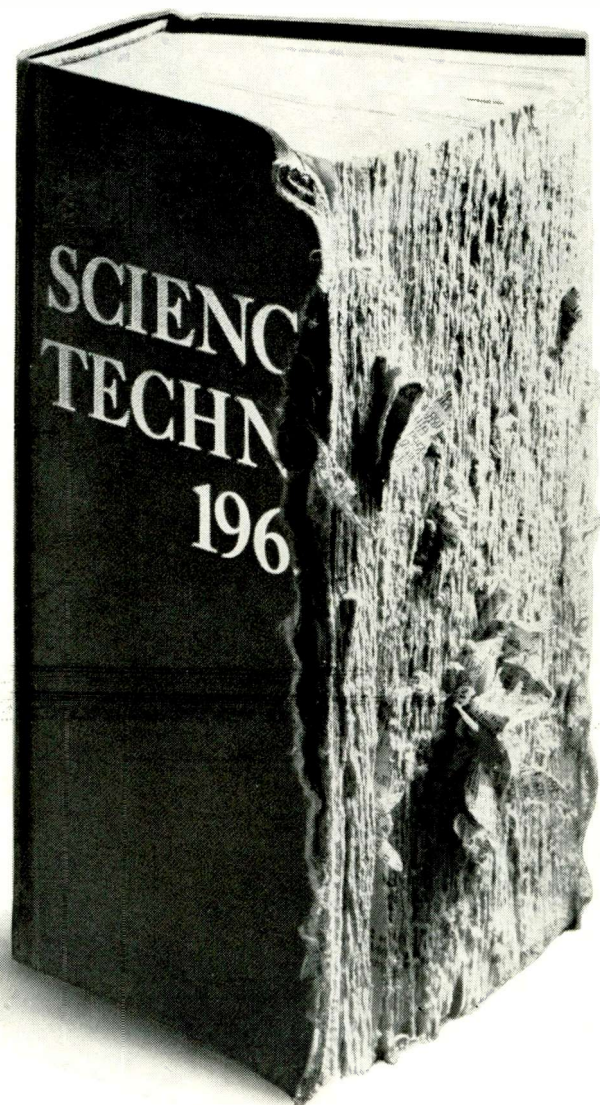

Right now you're steeped in the latest technologies. But 10 years from now half of this knowledge will be obsolete. And half of what you will need to know isn't even available today.

To keep up, you'll have to spend an increasing amount of your time in professional study.

Many concerned technicians realize this fact. And it's one reason they've joined the IBM team.

They know that today IBM is a leader in science and technology. A dynamic company whose people and systems are at work on almost everything new in the world today. The discovery of new knowledge. The design of new products. The development of new solutions to a host of problems. IBM is an exciting company. It enables you to stay technologically "hot" throughout your career—and provides you with real opportunity for advancement.

So why don't you keep abreast of the times—and your technology? To see how IBM can help you keep technologically "hot" and your career "going," please write, outlining your qualifications, to M. A. Haeussler, Dept. 650S, IBM Corporate Headquarters, Armonk, New York 10504.

IBM is an Equal Opportunity Employer (M/F).

IBM®

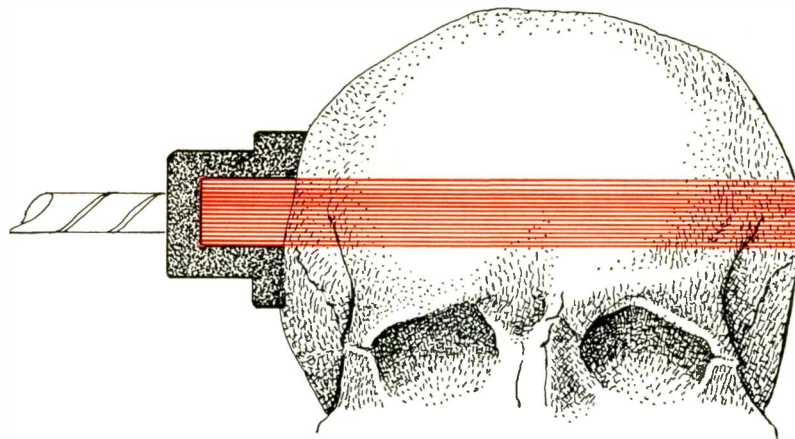

ULTRASONICS in Medicine

By ABRAHAM KAGAN

Survey of increasing use of "silent-sound" waves for physiotherapy, as a diagnostic tool, and to destroy malignant or unwanted tissues.

THE application of ultrasonics to medicine is over twenty years old, but recent years have seen a remarkable quickening of both the scope and the pace of the development of this medical tool. Today there are significant advances that may revolutionize medical diagnostic procedures. As Dr. Joseph H. Holmes of the University of Colorado Medical Center and one of the leading researchers in this field puts it: "We may well visualize the patient of the future systematically scanned by ultrasound while electronic recorders feed the information into computers which process the data and arrive at a diagnosis."

While such computerized patient management is still admittedly in the realm of scientific imagination, sufficient real progress in research, instrumentation, and interpretation has taken place to move the concept out of the area of science-fiction and into the realm of science-fact.

Ultrasonics has been used in three well-defined medical areas: for physiotherapy of numerous skeletomuscular and neuro-muscular disorders; for diagnostic purposes to depict anatomical structures and pathological processes; and surgically, for destruction of malignant or unwanted tissues. In this article we will not be concerned with the common uses of ultrasonics for dental drilling and cleaning surgical tools.

Frequencies, Power Loads, Transducers

Any sound wave, whether sonic or ultrasonic, is produced by actual mechanical motion of the particles of the material through which it passes. The energy of the wave is propagated longitudinally—in the direction of the wave motion—resulting in a series of alternate compressions and rarefactions in the propagating medium. The two principal characteristics of such a wave are frequency and intensity.

The ultrasonic range includes sound waves with a frequency greater than the normally audible limit of 20,000 Hz, but the frequencies used for most medical applications are much higher—from just below 1 MHz for physiotherapy to as high as 15 MHz for diagnostic applications. The reason for this is that the best resolution is provided by the shortest wavelengths (from about 1.5 mm to about 0.10 mm in fluids and soft tissues, corresponding to 1 to 15 MHz). The upper

limit of the usable frequencies, however, is determined by the absorption of ultrasound by the tissues. Soft tissues attenuate the sound-wave power or intensity by about 1 dB (or 25%) per cm per MHz. Thus, the most useful diagnostic frequencies range from approximately 2 MHz for applications where bone penetration is involved to 10-15 MHz for applications involving soft external organs such as the eye or the breast.

While the *frequency* of medical ultrasound varies only by a factor of 10, the *intensity* of the applied waves may vary by a factor of 10^2 or more, depending on their medical application. The power levels used for diagnostic studies are the lowest, ranging from 0.001 to 0.04 watt per cm^2 . Recent improvements in ability to measure intensity of sound actually entering tissue show that most routinely performed diagnostic procedures expose tissue to no more than 0.01 watt/ cm^2 . Intensities from 0.1 watt to 1.5 watts per cm^2 are used for physiotherapy. Surgical applications entailing destruction of tissues require intensities ranging from 4 watts to as high as 1500 watts per cm^2 .

The transducers which convert electrical to sound energy and *vice versa* are usually piezoelectric crystals or ceramics of barium titanate, lithium sulphate, or lead zirconate-titanate. Crystal size varies because there is a predictable relationship between the dispersion of the sound beam and the number of wavelengths across the crystal face. Crystals from about $\frac{1}{8}$ in to 1 in in diameter have been used with the most common diameter of commercial diagnostic crystals being about $\frac{3}{4}$ in. The problem of improving lateral discrimination for diagnostic and surgical application has also been approached by acoustic converging lens directly in front of the crystal or by bowl-shaped focusing transducers. Ceramic transducers have also employed small liquid-filled coupling chambers in order to obtain improved efficiency.

Physical Therapy

Of the three broad areas of application mentioned, probably the most widely practiced is that of physical therapy. According to Dr. John H. Aldes, executive director of the American Institute of Ultrasonics in Medicine, some 50,000 doctors and therapists in the United States are now employing ultrasonic

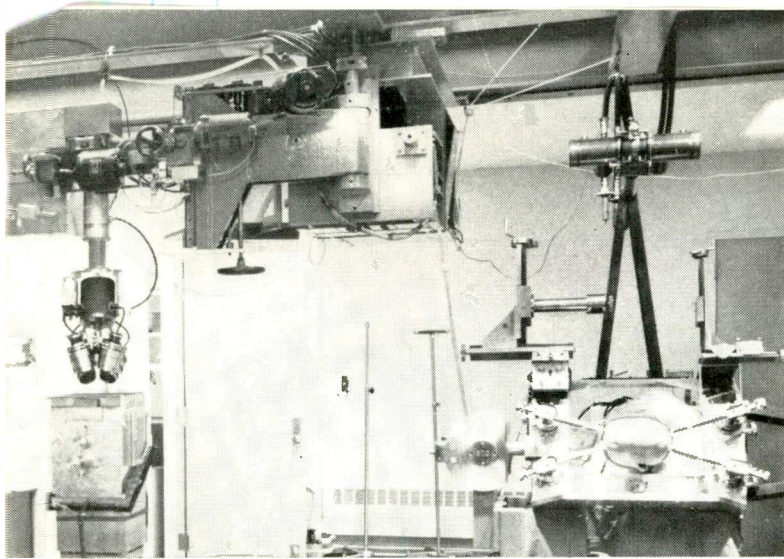

Equipment for ultrasonic surgery at Biophysical Research Lab at Univ. of Illinois. At left are four focused transducers suspended from massive overhead track. To right is operating platform with four steel pins holding skull model. Equipment is rigid enough to assure repeatability of location of focused ultrasonic beams in tissue to within a thousandth of an inch.

energy for the treatment of a wide variety of conditions ranging from athletic injuries such as the familiar "charley horse" to bursitis, various types of arthritic, rheumatoid, and gouty conditions and joint pathologies and a variety of neuromuscular and vasomotor disturbances. Clinical usage of ultrasonic energy is already taught in every school of physical medicine approved by the American Medical Association.

For therapy, a continuous ultrasonic beam is used. The transducer can be held in direct contact with the patient's skin which is coated with mineral oil or a similar acoustic coupling material. When more convenient, the part to be treated is immersed in water and the transducer held about an inch away from the area to be treated. The dosage is a product of the intensity of the sound beam and the length of time it is applied to a particular area. The equipment manufactured for ultrasonic therapy is generally calibrated and may be preset in terms of these two parameters. The duration of a single treatment generally does not exceed several minutes with a series of treatments usually being required. According to Dr. Edwin Matlin, secretary of the AIUM, ultrasonic physical treatment is self-protecting since any excessive dosage makes itself self-evident, before any damage can be caused, through a characteristic cramping sensation experienced by the patient.

Although the exact physiological mechanism of the effects of ultrasound upon living tissues is not yet thoroughly under-

stood, it has been determined that in addition to generating deep-seated heat similar to that produced by conventional diathermy, ultrasound produces certain mechanical and chemical effects on cell molecules. The results include a decomposition of some macromolecules, increased vascular and fluid circulation, and an increase in membrane permeability. The effects of this ultrasonic "micromassage" add up to frequent relief from soreness and pain, improvement in joint motion, healing of skin ulcers, elimination of phantom limb pain, and stretching and softening of scar tissue.

A recently developed adaptation of ultrasonic physiotherapy technique takes advantage of the ability of ultrasound to force certain steroids through the intact skin. In this technique, hydrocortisone, which is conventionally injected into the joint area by means of a hypodermic needle, is simply applied to the affected areas in the form of an ointment. The ointment serves as an acoustical coupling agent and at the same time is ultrasonically "pumped" through the skin into the underlying tissues. In another variation, the hydrocortisone is injected just under the skin surface and is then diffused deeper into the tissues ultrasonically.

Diagnostic Ultrasound

The history of ultrasonics for medical diagnosis bears an interesting contrast to the use of x-rays for the same purpose. While x-ray photography was used to diagnose bone fractures within a year of Roentgen's discovery in 1895, Galton's invention of the ultrasonic dog whistle remained merely a scientific curiosity for almost 60 years. It was only with World War II developments in radar and sonar that the basic tools for the application of ultrasound for medical diagnosis became available.

Analysis is made possible by the following facts. Various tissues have specific acoustic impedances which depend on their density and elasticity. Whenever the ultrasonic wave encounters an interface between two media differing in either of these two characteristics, part of the wave is reflected. The greater the mismatch, the larger the reflection. A wave in a homogeneous medium may be attenuated by absorption which depends on the molecular constitution of the material and, in case of liquids, on their viscosity. In relatively non-homogeneous media another phenomenon encountered by the ultrasonic wave is scattering. This is due to multiple reflections from many small random interfaces. To sum up, an ultrasonic wave is modulated by, and thus can be used to depict, several mechanical properties of biological tissues such as their density, elasticity, viscosity, molecular structure, and in-

A number of A-scan displays from Smith Kline diagnostic ultrasonic equipment. (A) Brain midline displacement of 8 mm to left indicating presence of space-occupying lesions. (B) Echoes from posterior wall of the heart's left ventricle are separated from pericardial echoes, indicating that fluid is present. (C) The

width of a fetal head within the uterus can be measured. (D) A brass fragment in the eye is located with great accuracy. (E) A stone, located 20 mm from the probe being held against the surface of kidney, is indicated. (F) In various soft-tissue sites, equipment has been used to locate foreign objects (such as needle).

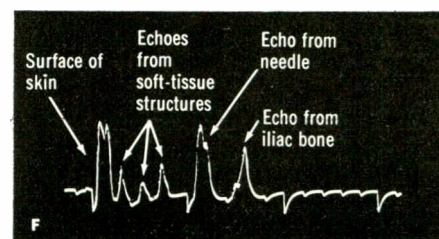
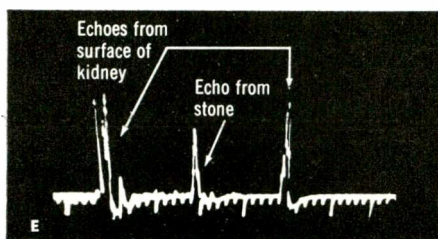
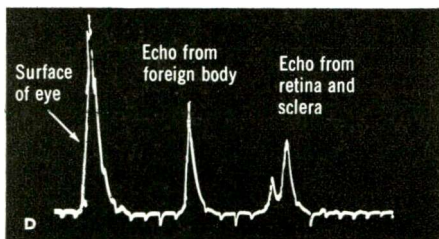
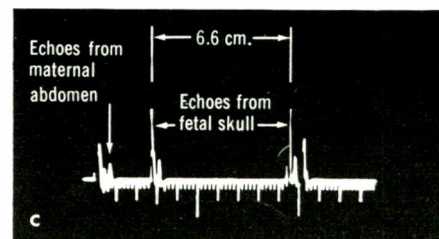
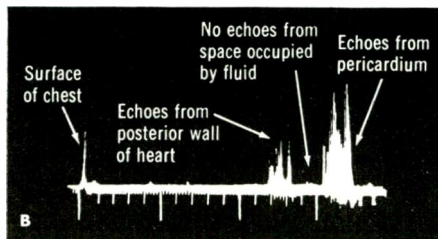
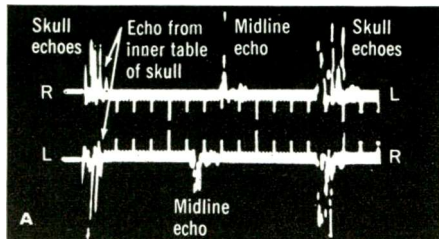

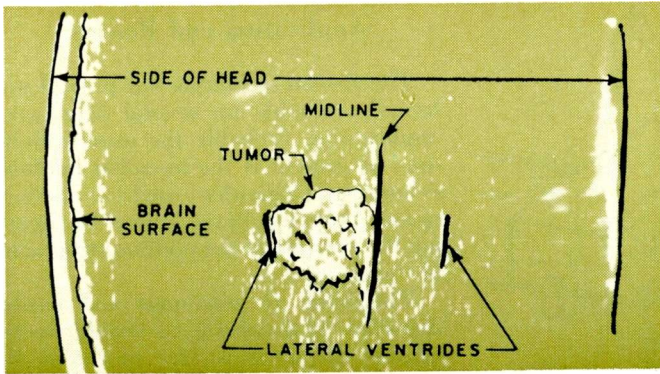

B-scan display showing a 2-cm brain tumor. Notice the midline displacement toward the right in this photograph.

terfaces. Identifying anatomical structures in terms of these properties and relating them to the presence or absence of pathology are the fundamental problems of medical diagnostic ultrasonography.

In the earliest ultrasonic diagnostic experiments, performed in 1942, visualization of the head was attempted with a continuous acoustic wave. By using a transmitting transducer on one side of the head and a receiving transducer on the other side, it was hoped to plot the regions with different sound transmission characteristics and thus to localize the position of liquid-filled brain ventricles. The ventricles can be visualized with x-rays only if they are drained through a spinal tap and injected with air to provide sufficient x-ray contrast—a procedure which entails some pain and risk to the patient. However, variation in the strength of the received signal due to absorption and refraction of the sound energy from the bones of the skull was so large as to mask the variation due to the ventricles.

Much greater success was achieved by the adaptation of the pulse-echo technique developed at that time for the detection of flaws in metal. In this system a pulsed beam of ultrasound is directed into the structure to be examined and the echoes, reflected from discontinuities or interfaces between media of varying acoustic impedances, are detected and displayed on the screen of a cathode-ray tube.

In the human body strongest echoes are reflected from relatively hard structures such as bone, stone-like deposits or formations, or foreign bodies. However, the ultrasonic pulse apparatus has been refined to the point where signal voltages about 100 dB below the transmitted pulse (or in the ratio of 1 to 100,000) can be detected. Thus echoes can be received not only from soft-tissue-to-bone interfaces, but also from many soft-tissue-to-soft-tissue and soft-tissue-to-fluid interfaces, which are usually not detectable by x-rays. This sensitivity, plus the ability to detect and localize radiolucent objects such as stones composed of uric or xanthic acids, wood splinters, etc., give ultrasonography a unique diagnostic capability. Also, unlike x-rays, the very low intensity sound waves used for diagnostic applications are completely harmless and have no restrictions with respect to the number of examinations or the areas which may be examined.

Ideally, this exploratory pulse signal is a single half-cycle of approximately one microsecond duration. In practice, the ultrasonic "bang" consists of a few rapidly decaying half-cycles. The pulses are produced at a repetition rate which may be varied from 200 to 1000 per second. Pulsing voltage, too, is variable from 1000 to below 200 volts, depending on the frequency used and on the material of the transducer.

To compensate for the attenuation of the signal caused by scattering and absorption in the tissues, an automatic sweep gain is usually employed so that the amplitude of the displayed echo signal is unchanged by the distance of the echo-producing structure from the skin surface.

Among the refinements introduced by manufacturers of ultrasonic diagnostic equipment is an electronic gating method

which accepts echo signals only within a selected time span, thus controlling the depth of observation from the total thickness of the organism to a "slice" as thin as 2 mm anywhere along the beam's line of sight.

An exciting area for future development may lie in combining ultrasonic sonar techniques with color television. Interfaces reflect different ultrasonic frequencies to a different degree. If three different ultrasonic frequencies are directed at the same structure and pulsed in rapid sequence, echoes corresponding to the three frequencies and differing in their intensities can be used to modulate the three beams of a color television tube. The resultant color would be a visual representation of the reflectance of the scanned structure to the three selected ultrasonic frequencies. This technique, it is hoped, will produce an electronic "staining" which will allow interfaces of different structures to take on different colors depending on their nature.

In the main, two principal ultrasonic diagnostic techniques have been developed: A-scan and B-scan (derived from designations of radar equipment adapted for the early experiments). The best-documented and the most widely used is the A-scan or time-amplitude ultrasonography. Another term suggested but not yet widely accepted is *stykographic* (from Greek "stykos," a line). In this type of examination the positions of the transmitting-receiving transducer and the echo-producing structure are fixed relative to each other. Echoes appear on the screen of a cathode-ray tube as vertical spikes along a horizontal time trace. Since the two-way speed of sound transmission through various tissues is known (about 13 $\mu\text{sec/cm}$ in soft tissues), the horizontal trace can be calibrated in terms of the exact distance in tissue. A block diagram of a typical apparatus is given in Fig. 1.

In an adaptation of the A-scan technique used for observing moving or pulsating organs, such as the heart valves or blood vessels, the echoes produced by the moving structure are displayed as an array of scattered spots whose position corresponds to the motion of the structure. The addition of a slow 10-25 mm/sec vertical sweep converts the display to a waveform where the displacement is shown as a function of time.

The second major category of ultrasonic diagnostic techniques produces a B-scan. In this procedure the ultrasonic probe is moved in relation to the organ or area being examined

Fig. 1. Block diagram of ultrasonic pulse (A-scan) equipment.

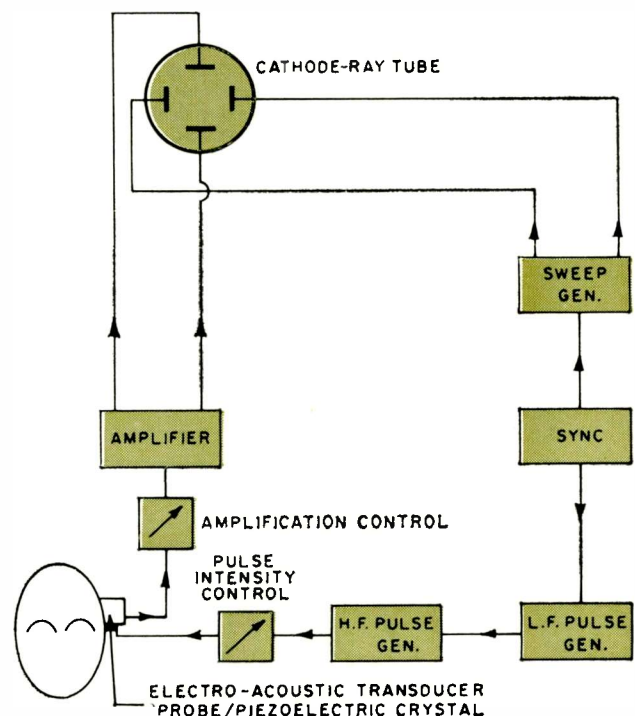

Application and Results

The A-scan technique has proved extremely valuable for several diagnostic applications. Probably the most widely used at present is the so-called midline echoencephalography used to detect space-occupying brain lesions by locating the position of the midline structures of the brain.

The brain is gelatinous and easily distorted. It is capable of sliding freely against the inner surface of the skull. Thin, strong membranes partly separate the two cerebral hemispheres and the cerebellum and restrain their movement. However, when a space-occupying mass such as an accumulation of blood (hematoma) or a tumor appears in one of the compartments, the brain is pushed away and herniates into one of the other compartments, carrying with it the internal blood vessels and displacing the mid-brain structures. The direction and degree of this displacement are quickly

measured by the displacement of the midline echo. This provides strong evidence of the existence of a space-occupying mass. Over 200 hospitals in this country and abroad are already equipped for this procedure. In several, echoencephalography is used as a routine screening of all suspected cases of head injury to determine whether a further and more elaborate study is indicated. Over-all accuracy in indicating the position of the cerebral midline for several thousand cases has averaged almost 95%.

A rapidly growing application of echoencephalography is the diagnosis of hydracephalus. The swollen fluid-filled brain ventricles are easily measured with ultrasound and the condition of the patient can be conveniently checked by periodic examinations.

Experts foresee a military application of echoencephalography which will permit all cases of head wounds to be rapidly screened at the battle-line aid station with lightweight transistorized ultrasonic equipment to determine the seriousness and the subsequent management of the injury. Military medical researchers have also been successful in detecting and locating bone fragments by introducing a small ultrasonic probe into the wound itself.

A quite different use of the time-amplitude echoscan of the skull is to measure the diameter of the head of an unborn child. Measurements obtained by this method correlate within 2 mm with caliper measurements made after birth. The size of the fetal skull is important as a measure of fetal maturation and in cases of breech presentation. The amniotic fluid which surrounds the unborn child is a good acoustic medium. After the position of the fetal head is determined by palpation, the acoustic transducer is applied to the mother's abdomen. The position and direction of the sound beam is then adjusted until the echogram shows the echo of the infant's midbrain as well as the two stronger echoes of the two parietal bones. This assures that an exact right-angle measurement has been accomplished. X-ray measurements of the fetal head are not accurate because it cannot be determined with certainty whether a right-angle roentgenogram has been made. Also, because fetal tissues are particularly sensitive to ionizing radiation, repeated exposures to x-rays cannot be made with the same freedom as repeated ultrasonic scans.

One of the earliest applications of the x-ray was the location of kidney and gall stones. This can be done even more successfully with ultrasound, first, because ultrasound can detect stones which are composed of materials transparent to x-rays and, second, because ultrasound can be used both

A transverse B-scan display of the head is being made here with Hoffrel Instruments equipment. The support bridge over the patient's head permits the ultrasonic transducer to be moved across head. Image is photographed from the CRT.

so that the array of echoes, displayed by intensity modulation on the long-persistence phosphor screen of a cathode-ray tube or integrated photographically, coalesces into an anatomical cross-section or "tomogram" in the plane sectioned by the sound beam. To obtain a more detailed anatomic outline, a so-called compound-scan technique has been developed where the transducer is moved in a combination of circular and rocking motion up to 360 degrees around the part being examined.

In the original compound scan experiments, the patients were immersed in a tub—part of a converted B-29 gun turret—of saline solution which acted as an acoustic coupling medium while the transducer carriage was rotated around the patient on a circular ring, at the same time oscillating in a 4-inch horizontal motion. This awkward technique placed a severe limitation on the usefulness of the procedure, but subsequently developed apparatus using portable mechanized scanners permits bedside examination of even very sick patients.

A pencil-type probe for surface application to the eye is shown being demonstrated. The left-hand pip on the scope is caused by the sound energy being reflected from the surface of the eyelid. The second pip is the echo from the back surface of the eyeball. The exact diameter of the eye can be measured from the horizontal scale. Clamped to the vertical standard is a 1-in monitor scope that duplicates the picture.

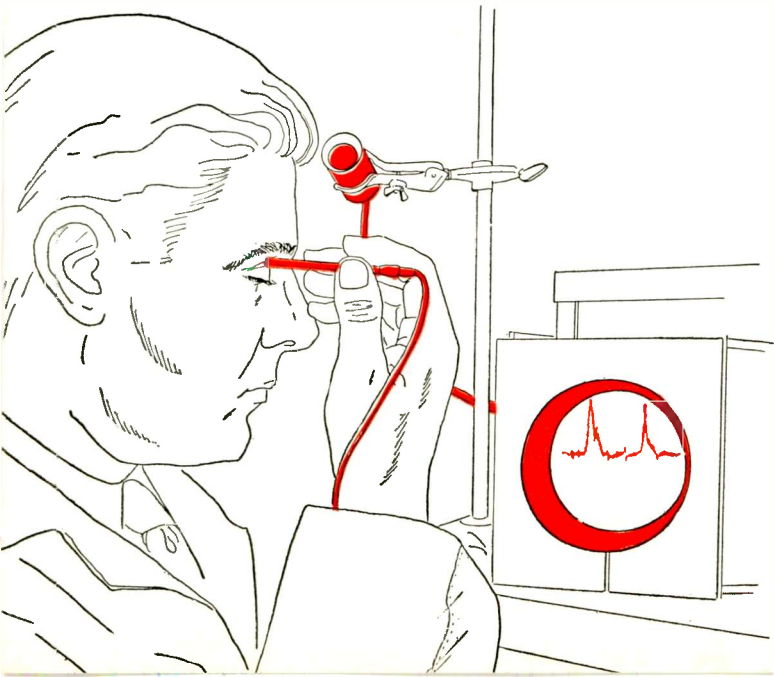



B-scan ultrasonic examination can provide evidence of pregnancy. The outline of the fetal head is clearly shown here.

before and continuously during surgery. Using a variety of small transducers built into long thin probes and into flexible catheters, or clipped to the end of his finger, the operating surgeon can localize small stones hidden within ducts or on the underside of an exposed organ. In this way the located stones can be removed with the smallest possible incision and the least amount of damage to the tissues.

One of the first applications of an ultrasonic probe during an operation for the removal of an externally introduced foreign body took place in 1963. The case, described by Dr. Nathaniel R. Bronson of the Manhattan Eye and Ear Hospital, involved a four-year-old boy who had fallen on a pencil point so that a piece of graphite became imbedded in the upper cheek and remained there after the wound had healed. The case presented a special problem because the scar and the nature of the foreign body made it impossible to locate it precisely either with x-rays or by palpation. It was, of course, highly desirable to minimize surgical exploration and subsequent scarring.

After the piece of graphite was located approximately with an ultrasonic probe, an elliptical incision was made to include the scar. A one-eighth-inch diameter ultrasonic probe was then introduced into the incision and angled until an echo from the graphite located its position precisely and kept it in view during the operation. This proved a simple and easy method of maintaining visualization of the foreign body during surgery.

A very fruitful application of diagnostic ultrasound has been found for the examination of the eye. Ultrasound up to 15 MHz has been used by Scandinavian and American researchers to detect retinal and choroidal detachment in eyes obscured by cataracts or internal bleeding, to locate intraocular tumors, to measure the front-to-back diameter of the eyeball, and even to prescribe corrective lenses for aphakic (lensless) eyes of young children. A special ultrasonic transducer equipped with an acoustic lens can produce a sound wave beam less than 1 mm in diameter which is able to define intraocular structures less than 0.001 mm in diameter.

One of the most ingenious instruments recently developed for the extraction of foreign bodies from the eye is an intraocular forceps equipped with a needle-thin ultrasonic transducer. After the tiny instrument (originated by Bronson) is introduced into the eye, its position in relation both to the foreign body and to the back of the eye is continuously indicated on a one-inch display tube within the surgeon's field of view. In the first attempt last year to use the ultrasonically guided forceps, the time required to remove a piece of a brass cartridge from the eye of an 11-year-old boy was less than 40 seconds.

Many other applications of the ultrasonic A-scan include measurements of the diameters of the liver, spleen, and the bladder, the latter useful for the determination of the bladder

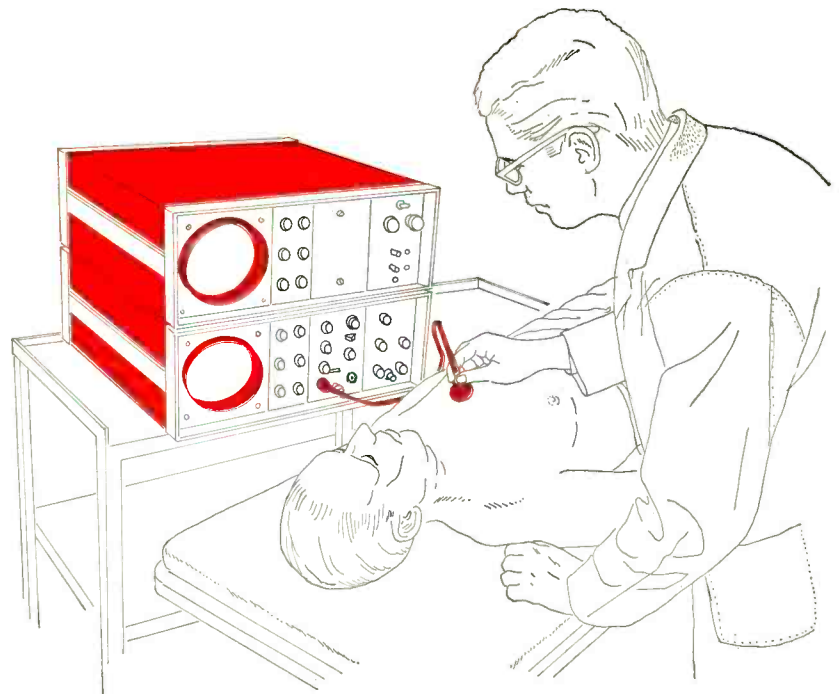

In this illustration, an ultrasonic heart examination is being performed with the aid of the diagnostic "Reflectoscope" manufactured by Sperry.

capacity and amount of residual urine. Ultrasonic study of the heart has been used to obtain motion patterns of normal and diseased valves and blood vessels and also to diagnose pericardial effusion—a dangerous condition where fluid accumulates between the heart and the pericardium, the thin strong sack which encloses and protects the heart.

The B-scan technique, which produces cross-sectional tomograms, gives more definitive information of anatomical structures within the body but requires a much more sophisticated interpretation. A considerable number of animal and human studies have been performed to develop the technique and to relate the ultrasonic indications to actual anatomic conditions. Encouraging results have been obtained with examinations of the liver, kidney, and spleen. The normal tissue of these organs transmits sound well so that any pathological structure within them produces echoes, frequently characteristic of the type

(Continued on page 62)

The Bronson foreign body locator and extractor used to remove piece of brass cartridge from eye of an 11-year-old boy.

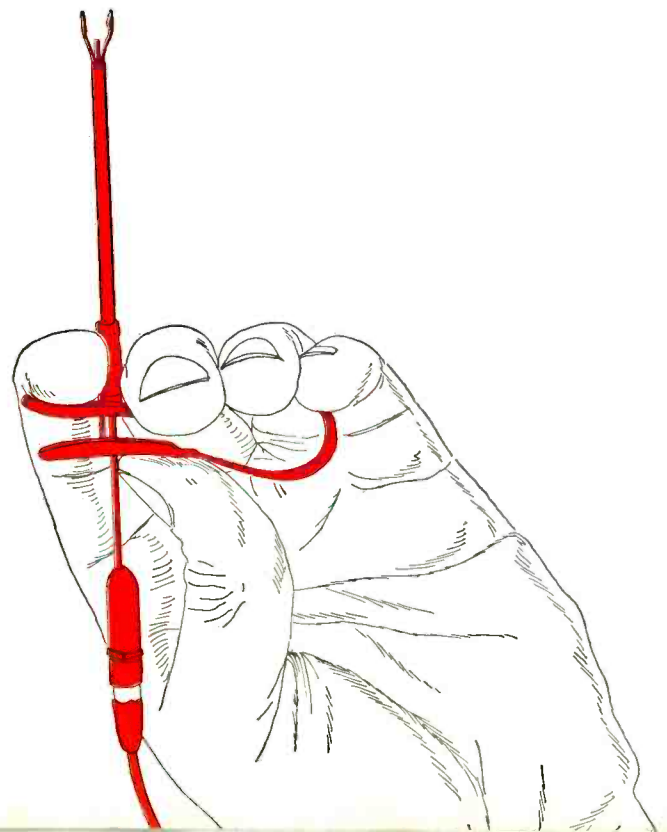

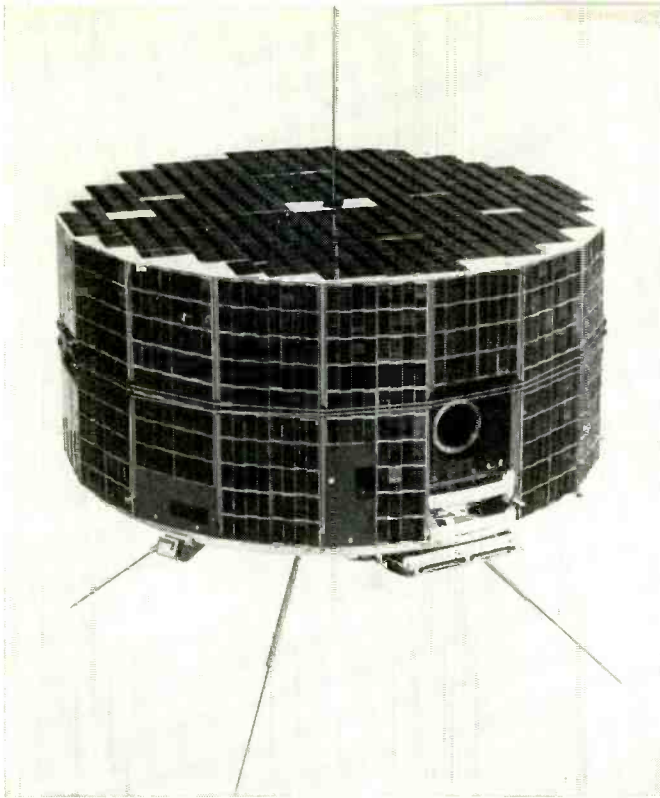

RECENT DEVELOPMENTS IN ELECTRONICS

First Global Operational Weather Satellite. (Above) Two Tiros operational system weather satellites have been launched for ESSA (Environmental Science Service Administration). One of these provides full coverage of the earth every day with weather TV pictures. The other provides local weather pictures to inexpensive receiving stations located throughout the world. Many nations will share the use of this satellite by employing simple, one-man ground stations. Any nation using one of these ground stations will receive two or three pictures of the user's local area per orbit on one to three orbits daily. Each picture embraces more than one million square miles. Integrated circuitry is used throughout the command system aboard the latter satellite, and it is believed to be the most extensive use of such circuitry in space to date. Ten previous Tiros weather satellites, all built by RCA, have been experimental or developmental in nature, but all have supplied useful weather data for many months. The last four satellites are still in operation.

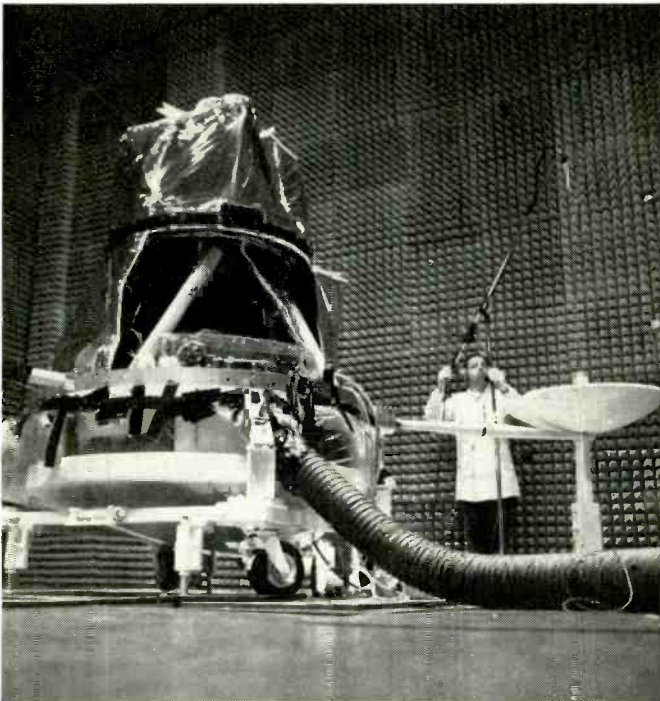

Lunar Orbiter Electronics Tested. (Center) A Lunar Orbiter test spacecraft is shown here being tested in a microwave anechoic room at the Goldstone tracking station in the Mojave Desert. Later this year a flight version of the spacecraft will orbit the moon taking high-resolution photographs of possible landing sites for Apollo astronauts. A Boeing Co. engineering aide is shown picking up signals from the craft's antenna. These signals will be attenuated and transmitted several miles to an 85-foot antenna, where they are converted into light and recorded on film. The attenuation simulates the signal loss that would occur over the 240,000-mile moon-to-earth distance. The rubber spikes on the wall prevent unwanted reflection of signals. The 850-pound spacecraft is designed to dip within 29 miles of the moon's surface and take photos showing objects a yard square.

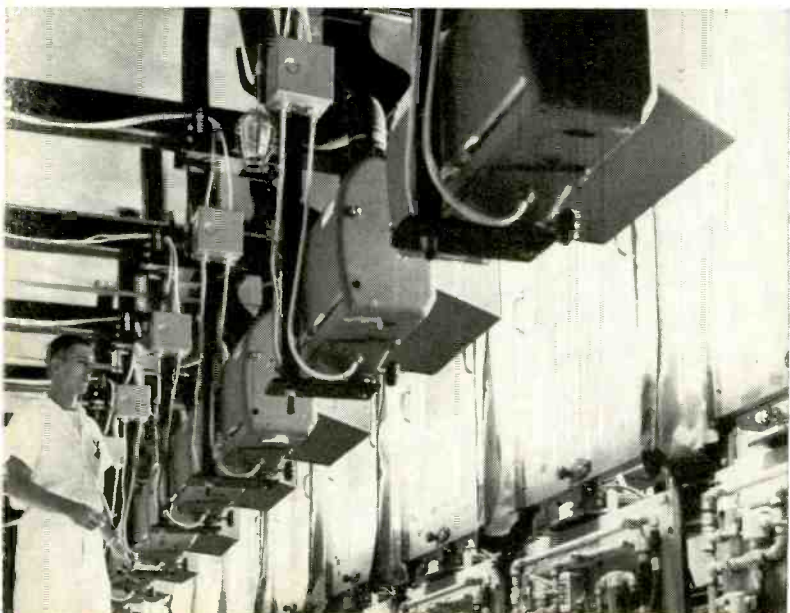

Color-TV Aperture Mask Production Tripled. (Left) The production of shadow masks for color-TV picture tubes is being tripled by Sylvania in order to meet the growing demands for this important component. A technician is shown monitoring a battery of printer units used for photographically imprinting patterns of the aperture mask on specially coated steel. This step in the manufacture of aperture masks precedes the chemical etching of up to 440,000 cone-shaped holes in each mask. The mask is later located just behind the phosphor-dot screen of the color tube. For each hole in the mask, there are three corresponding dots on the face of the picture tube consisting of red, blue, and green phosphors. The great public demand for color receivers is expected to continue in the future. In 1965, about 2.7 million color sets were sold to the public and it is expected that 4.5 million sets will be sold this year. In 1967, this figure is expected to increase to about 7.8 million sets, while over 8 million sets per year are expected to be sold through 1970.

New Beacon Tracking Radar. (Right) Enclosed in the near pod under the fuselage of the aircraft shown here is a new K-band beacon tracking radar system. The system is designed to track and provide distance and angular measurements between aircraft carrying the radars and those carrying transponders. The radar uses all solid-state components with the exception of the transmitting magnetron and the local-oscillator tubes. Maximum range is 50 nautical miles, range-measuring accuracy is better than $\pm 0.1\%$ of true range, and angle-measuring accuracy is better than $\pm 0.25^\circ$. The system was built for the Instrumentation Laboratory at Eglin Air Force Base by Airborne Instruments Lab.



Lightweight Microwave TV System. (Center) A laboratory model of a lightweight microwave communications system capable of short-range transmission of TV signals is shown. The low-power microwave beam is generated by a tiny microwave oscillating diode which is powered by a standard 30-volt battery. Together they represent about 1/50th the weight of comparable equipment presently used in commercial systems. The tiny gallium arsenide diode will provide at least one milliwatt of output power in the X and K microwave bands. It presently costs \$150 each. The system was developed at the GT&E Laboratories.



Computer Interconnects Integrated Circuits. (Below left) Interconnections among the eighty circuits on this silicon wafer were produced automatically under computer control, in a new technique described by an IBM scientist at the recent International Solid State Circuits Conference in Philadelphia. After the circuits, each containing five transistors, have been formed on the wafer, an automatic device tests each of them and punches out results on punched cards. The cards are then fed into a computer which calculates an interconnection pattern that avoids any faulty circuits on the wafer and connects good circuits to perform the desired function. The actual connections are then "drawn" directly on the silicon wafer itself completely automatically under control of the computer.

First Apollo Instrument Ship. (Below right) Vanguard, the first of the Apollo Instrument Ships, recently completed her initial builder's trials in the Atlantic Ocean off Boston. The 595-foot vessel and her sister ships, Mercury and Redstone, will complement land-based tracking stations in our manned lunar exploration program. The three ships, created by cutting apart three World War II tankers and fitting them with new midbodies as well as the latest electronic tracking equipment, are being converted by General Dynamics. The dish-shaped antennas that are located on the deck include (left to right) one for C-band and two larger ones for unified S-band and telemetry work.

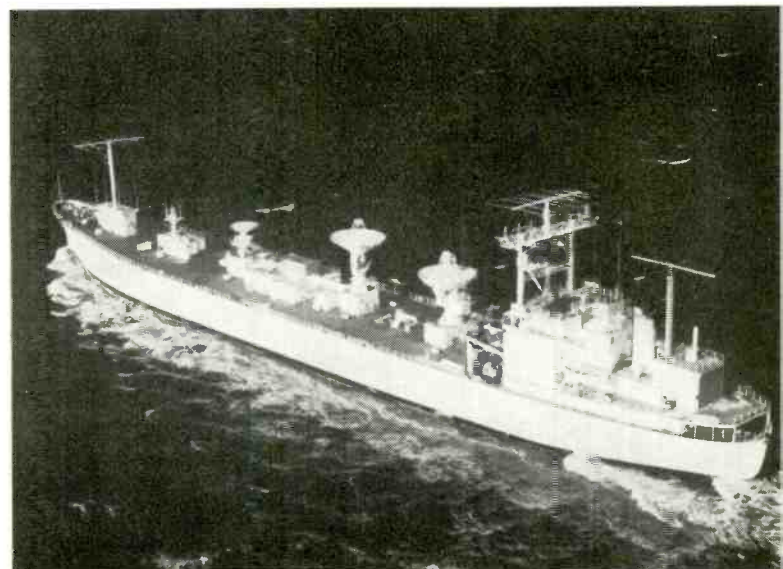
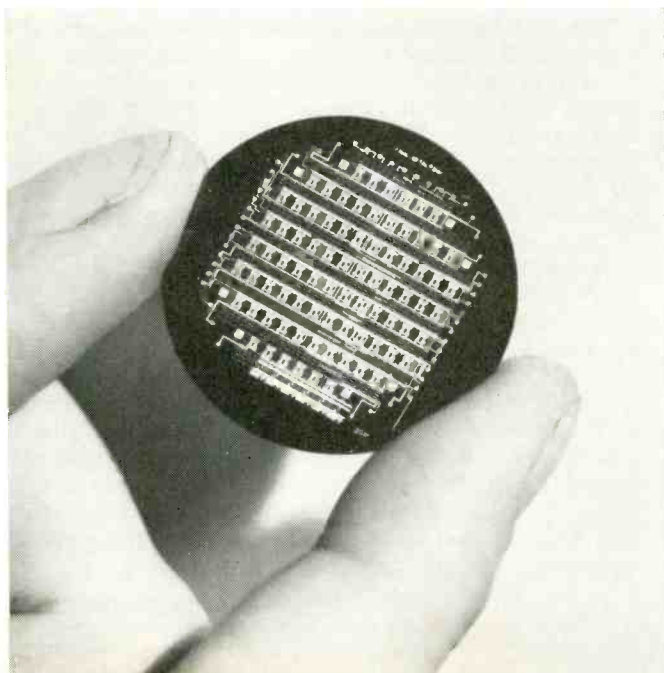

Comparison among the transverse, helical, and longitudinal techniques of recording TV signals with emphasis on the method used for home video recording.

By LEON WORTMAN / Ampex Corporation



The single-head full-helical video tape recorder may be employed to prepare training tapes for industry or for schools.

Video Tape Recording Methods

THERE are two basic formulas in the magnetic recording field which represent the major stumbling blocks against storing television signals on tape. The first formula has to do with the recorded wavelengths which are proportional to the velocity of the tape over the frequency to be recorded (Fig. 1A).

With normal audio signals, which extend to 15 or 20 kHz, the recorded wavelength on tape turns out to be a reasonably manageable dimension, but television frequencies extend more than a hundred times beyond. Something must be changed to accommodate this spectrum of frequencies, and the original approach was simply to increase the velocity of the tape so that the wavelength on the tape remained a workable magnitude. The early experiments conducted in the late 1940's by RCA and others were in this direction. Huge reels spewing incredible amounts of tape past stationary heads yielded the first visible images, but the efficiency of such systems was too low to make them practical.

The second formula has to do with signal level in relation to head-to-tape contact. This one says that signal loss is proportional to 54 dB per wavelength separation between

the head and the tape (Fig. 1B). If the wavelengths are very small, then the head had better remain in more intimate contact with the tape to retain the few millivolts available in playback.

The logical solution to these two dilemmas is first to achieve the high writing speed necessary by rotating the head assembly, rather than accelerating the tape and, second, allowing the head to penetrate or intimately contact the tape (which should be free from imperfections) as it scans the video tracks. Having met these requirements, we are now faced with the problem of how to physically scan the tape.

Transverse System

There are a great number of recording techniques which must be considered before a commercially acceptable system is adopted. Each method yields some measure of performance and each has advantages and disadvantages. Some of the methods which have been attempted include small arcuate, large arcuate, spiral, full-helical, half-helical, and transverse.

The first commercially successful video recorder, which employed the transverse system (Fig. 2), was introduced by Ampex in 1956 at the National Association of Broadcasters Convention in Chicago. This recorder utilized a rotating head assembly (14,400 rpm) approximately 2" in diameter, with four transducers peripherally displaced by 90 degrees. The 2"-wide tape moved at 15 ips and the transverse tracks laid down were 10 mils wide at an angle of 89.7 degrees, virtually perpendicular to the edge of the tape. Audio and control-track signals were recorded along the edges of the tape in normal longitudinal fashion.

This transverse system has since been developed into the most sophisticated technique for recording monochrome and color-TV signals on tape. Accessories to the system permit its use for complex program production, editing, animation, and dubbing. Color recording of NTSC signals (the most difficult to handle) can be made, dubbed, or reproduced with a quality virtually indistinguishable from a live color program. The standards adopted for this system were universally accepted. Virtually all 4-head transverse recorders make interchangeable tapes.

Fig. 1. (A) Response of a tape playback head at various tape speeds, assuming equal recorded flux density on tape at all frequencies. When head gap is equal to one-half the recorded wavelength, output is maximum; when gap width equals recorded wavelength, output drops to zero. (B) The effect of tape-surface imperfections preventing intimate contact of tape head is to produce drop-outs or substantial loss of signal output.

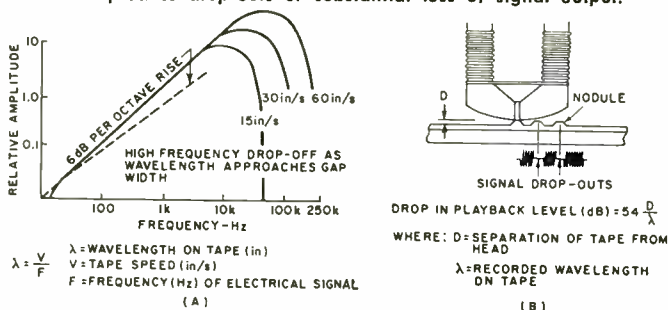

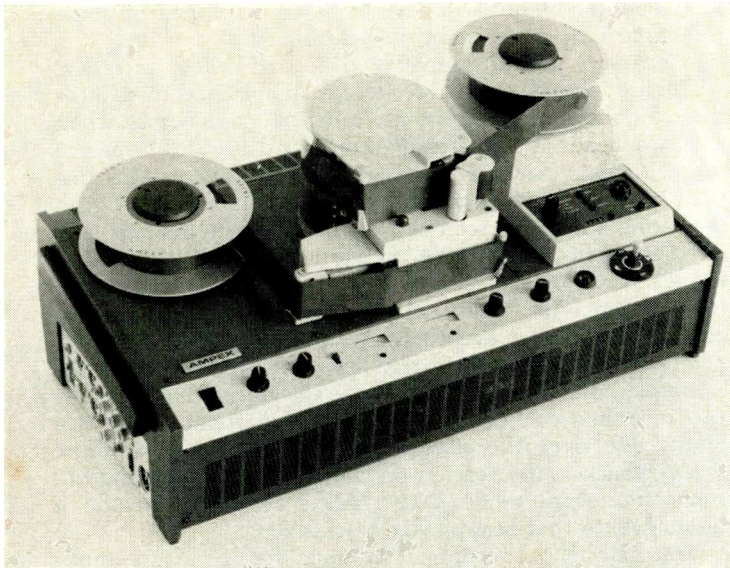

A typical two-head half-helical scan video tape recorder.

The major drawback to this system is its complexity and price. All of these recorders, even in their simplest configuration, lie above the \$20,000 mark and a fully equipped color machine runs closer to \$100,000.

Once the feasibility of committing video signals to tape was established, laboratories throughout the world started attacking the problem with new vigor in an effort to reduce the size, complexity, and cost of this type of equipment.

From the early 1960's, there has been a continual parade of new entries into the field and a proliferation of standards that eliminated interchangeability among manufacturers as a basic requirement. The systems that have emerged are the full-helical, the half-helical, and the longitudinal.

Full-Helical System

The full-helical system utilizes a single transducer on a drum around which tape is wrapped on a scanning assembly (Fig. 3). The tracks are laid down at a slight angle to the edge of the tape, running from one edge to the other. Audio and control tracks (not shown) occupy narrow spaces near the edges of the video tape. The tape may be wrapped around the helical assembly in three ways.

At the crossover point, where the rotating head completes one track at the bottom edge and starts the next track at the top, the tape may be either overlapped, butted, or separated in an *omega* form. All of the methods will work. However, the *omega* appears to be the most practical since the entry and exit gates support and position the tape more accurately and the crossover period may be kept to a minimum. The simplicity of the full-helical system is in its need for only a single transducer to perform the video recording

Fig. 2. The transverse recorder uses four rapidly rotating video heads producing nearly perpendicular tracks on 2-in video tape.

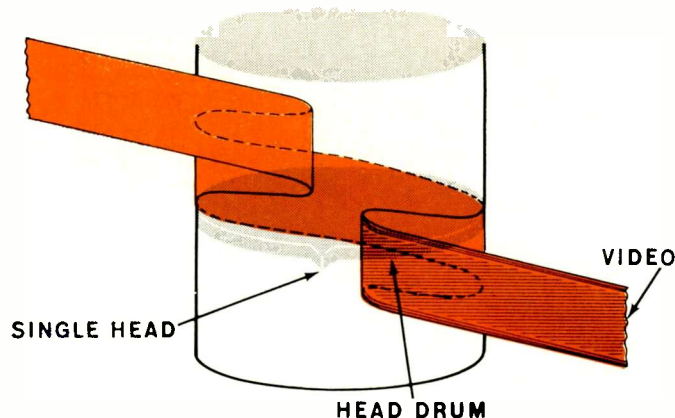
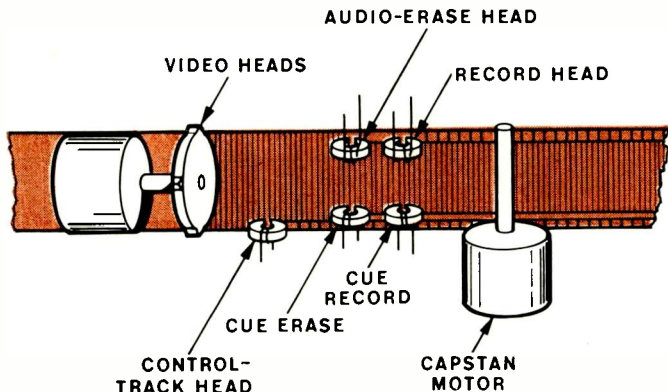

Fig. 3. In the full-helical recorder, a single rotating head is used and tape is wrapped almost completely around drum.

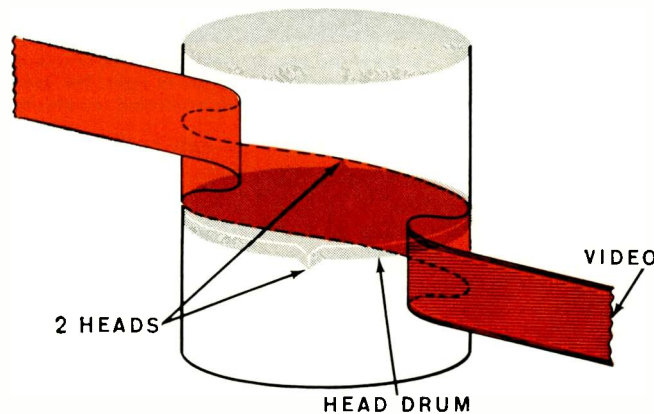

Fig. 4. In the half-helical recorder, two rotating heads are used and tape is wrapped a little over half way around drum.

function. In this way, there is no necessity to match heads, to worry about relative electrical characteristics, and geometric displacement.

It does, however, have one major drawback. No matter what technique is used, the head must leave the tape for a short instant of time and during that period no signal will be available. This is known as the drop-out period and is usually located somewhere near or in the vertical interval so that it will disturb the image as little as possible. The signal, of course, may be blanked during this time by applying some sort of clamp, but if the television system requires continuous availability of synchronizing and blanking pulses, then some complex regeneration is necessary to reintroduce such pulses during this drop-out period. If the phase of the incoming signal changes during recording, then a black bar will run through the picture until the recorder catches up with the new phase. This would almost preclude such a recorder being used for any broadcast applications without a processing amplifier. This is the system employed in the manufacturer's home video tape recorder.

Half-Helical System

On the principle that two heads are better than one, the half-helical system retains some of the simplicity and eliminates many of the drawbacks of the single-headed arrangement (Fig. 4).

As implied by the name, the half-helical wraps the tape around the scanning assembly for a little more than 180°. Two head transducers on the drum now scan the video signal with sufficient overlap so that electronic switching will permit sequencing the signals from tape into continuous form with only the switching time transient from one head to the next. The switching transfer can be inserted during vertical blanking and would be invisible on a normal monitor.

There are some peripheral advantages. The tape is in

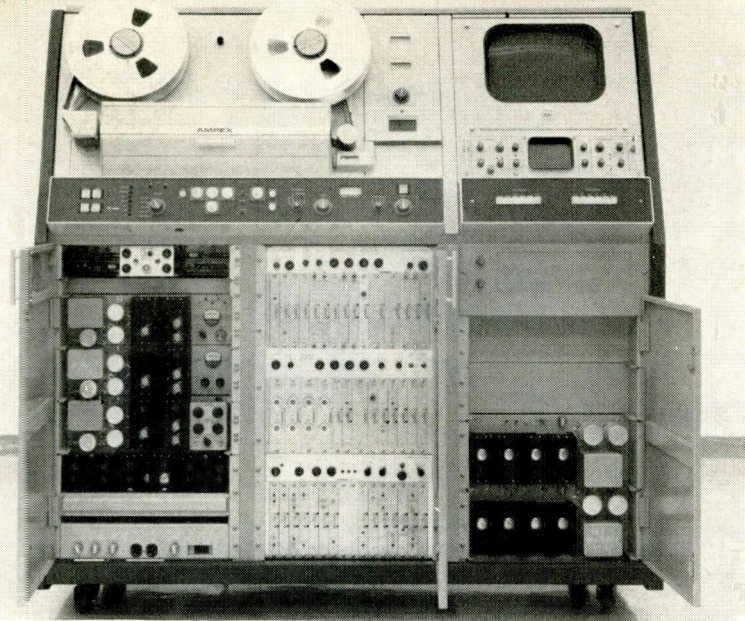

Video tape recorder for broadcast use, employing transverse recording system. Waveform and picture monitors are at right. The doors have been opened to show modular construction and complexity.

contact with the scanning assembly for only half the distance, thereby reducing the effects of "sticktion," a term describing the cohesion between the surface of the scanning assembly and the face of the tape. The differential stretch is kept to a minimum and the scanning angle is increased to accommodate the shorter path.

These recorders can be broadcast-stabilized and some have been fitted with versions of electronic editing that permit inserting or assembling sequenced video information without disturbances to the playback image. The best time-base stability of both types of helical recorders is limited by the inertia of the larger drums and the complexity of attempting to control such a mass of moving metal. Recording and playback color signals (requiring high time-base stability) cannot

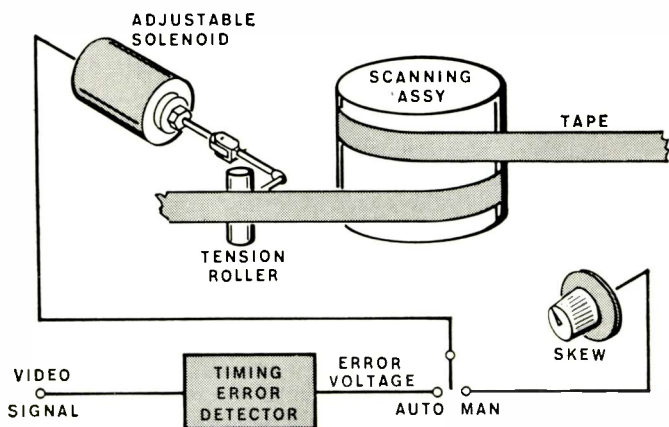
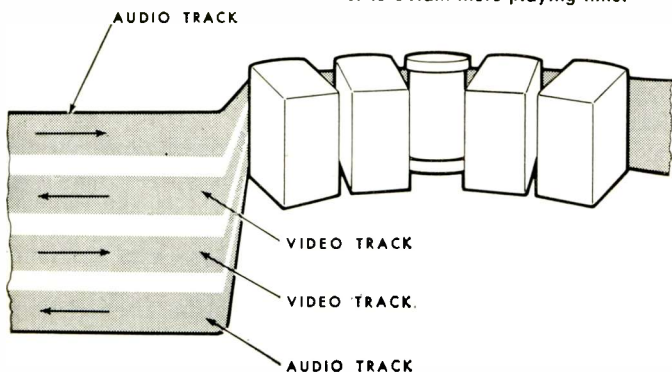

Fig. 5. Automatic tension servo employed when the half-helical video tape recorder is designed for broadcasting applications.

Fig. 6. Longitudinal recorder uses stationary video heads and records in both directions in order to obtain more playing time.



be done directly, but will have to be accomplished by some electronic time-based stabilizing accessory.

There are several problems with half-helical recorders which are inherent whenever more than one head transducer is used. The first is known as "dihedral" and occurs when the two heads are not displaced by exactly 180° on the drum. An interchanged tape being played back will be misread in time by the alternate head assemblies, one scan appearing a little too soon and the other a little too late. The effect is the displacement of any vertical line to the right and the left of where it should be at the top of the image on the television monitor. The flywheel effect of the horizontal circuit on the monitor eventually averages out the line, so the defect is only visible for a few lines after vertical blanking. A simple adjustment of the head transducer position and a test recording can correct this fault. Temperature and humidity effects on the elasticity of the tape will also affect the playback if the tension on the tape has varied slightly from the record mode. Most helical recorders include a tension control for best playback conditions.

The half-helical recorders designed for broadcast applications require an automatic system to do this and a tension servo (Fig. 5) is used. This device develops an error voltage from the timing error between alternate fields and applies this error voltage as a correction to a solenoid controlling a tension roller against the tape. It is possible to achieve a degree of correction which limits the transfer time-based displacement to less than approximately 0.25 microsecond, a figure well within broadcast requirements.

Longitudinal Recorders

There has been a great deal of publicity about the advent of a longitudinal video recorder which would be cheaper and simpler than a machine with the rotating-head approach. These recorders all work on the principle of an audio recorder, using extremely narrow-gap heads with very rapidly moving quarter-inch tape. Tape speed is on the order of 100 ips and even at this great velocity, only 1.5-MHz bandwidth is achieved.

The thinnest tape on the largest practical size reel will only yield about 30 minutes of playing time per direction. Both forward and reverse tracks are recorded, doubling the playing time with the reversal of the tape. Audio tracks are also recorded longitudinally along with the video signal.

There are a number of inherent drawbacks in this type of approach. Primarily, the picture quality is poorer than that of the helical recorders because the active read/write speed is limited by the tape-handling capabilities of the transport. At 100 ips, the problems of spooling tape, handling it safely, and avoiding tape throw are severe. Small discontinuities on the oxide cause tape lift with subsequent streaking in the picture. Special pains must be taken to keep the tape surface very smooth.

Although the longitudinal recorder would seem to be the simplest approach, it still represents a considerable degree of complexity over an ordinary audio recorder and the results obtained usually fall below those required for most picture image storage purposes. (In spite of this limitation, picture quality may be adequate for non-critical home use, especially in view of the fact that such units may be made at a lower price than rotating-head machines.—Editor)

Video recording on magnetic tape divides into three levels at the present time: home recorders, ranging in price up to \$1500; industrial and educational recorders up to \$15,000; and a fully broadcast-compatible transverse machine that was previously described, at up to \$100,000. The application of the small recorders is virtually limitless for in-home entertainment, sports, education, medicine, and travel. Magnetic TV recording represents, at the present time, one of the greatest potential fields for electronic equipment and, in a few years, will be almost as universal as television itself. ▲

Circuitry, design, and selection of these devices which vary signal levels without disturbing the impedance, frequency response, or other system characteristics.

By CHESTER F. SCOTT
Chief Engineer
Daven Division, McGraw-Edison Co.

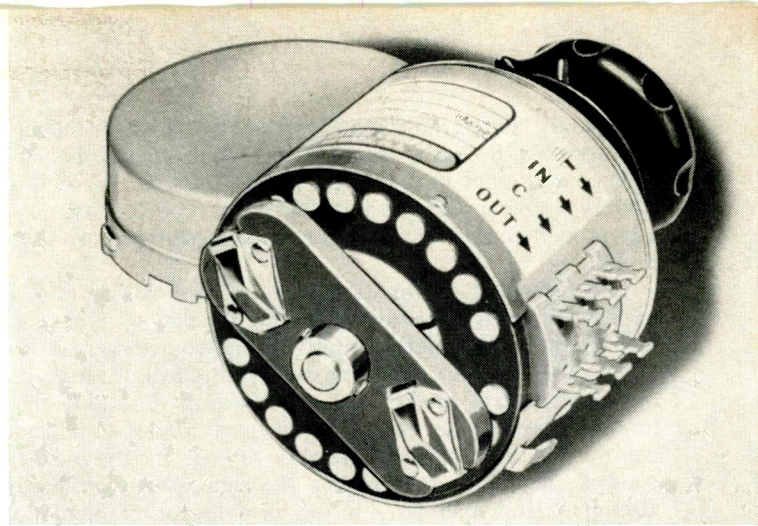

A typical unbalanced bridged-T variable resistive a.f. attenuator.

RESISTIVE ATTENUATORS and PADS

THIS article covers the circuitry and design of resistive attenuator networks. These are used to vary signal levels without disturbing the impedance, frequency response, or other characteristics of the system. They are referred to by many names such as faders, pads, mixers, masters, pots, etc., but the basic function remains the same.

Attenuator Classifications

Attenuators are divided into two main classifications: *fixed* and *variable*. Fixed attenuators are used where the level of a signal must be reduced by a known number of decibels which will not have to be changed. Variable attenuators are used where rapid or frequent changes in signal level are required. They are also used when the required amount of signal reduction must be determined at the time of system installation. Where frequent variations in level are necessary, an attenuator which is variable by a rotary or a straight-line switch is used. When the level can be adjusted and set with a minimum of future changes, a type that is variable by means of soldered interconnections is normally used.

The basic circuits for both the variable and fixed types are the same and the formulas for resistor values are equally applicable to both. In variable attenuators which are controlled by a switch, the variation is generally accomplished by adding or subtracting resistors in the series and shunt circuits. The exceptions are the ladder and π types. In the ladder type, all resistors are fixed and the series resistor tapped at correct intervals. The π operation is covered later. (*Inexpensive variable attenuators are also available in which the various series and shunt elements consist of volume-control-type potentiometers that are ganged together to produce the proper resistance changes as the control is operated—Ed.*) Attenuators that are variable by means of changing soldered interconnections consist of a group of fixed pads with different attenuations. The attenuation variation is accomplished by connecting attenuators with the correct losses in series to provide the required total attenuation.

Electrically, attenuators are divided into two main classifications: *balanced* and *unbalanced*. A balanced attenuator control is one where equal resistance is inserted in each side of the circuit and where the center point of any shunt resistance can be grounded or left floating depending upon the other circuit characteristics. An unbalanced control is one where the resistance is added in only one side of the line and where the other side of the line is "common" or grounded.

In designing the equipment where attenuators are to be

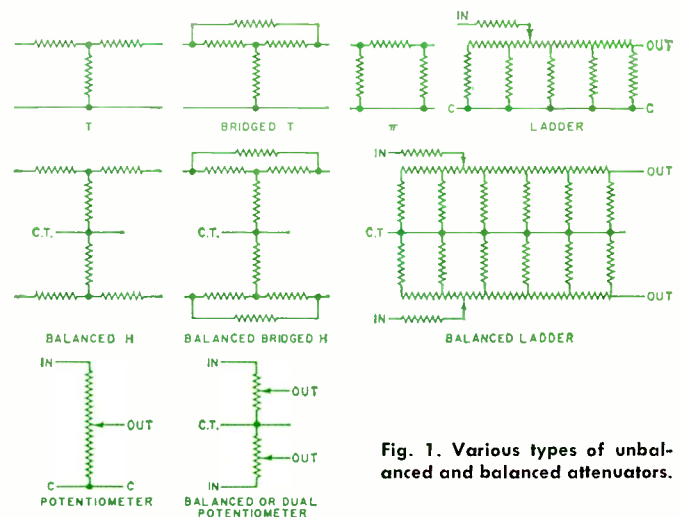

Fig. 1. Various types of unbalanced and balanced attenuators.

used, there are two schools of thought as to whether balanced or unbalanced controls are more satisfactory. One group claims that balanced circuitry is better because hum and noise due to ground loops and improper grounding is done away with. The other group contends that unbalanced circuitry is better because, with proper grounding, stray capacities are overcome and better control is obtained. This article will not attempt to deal with the merits of over-all system design. There are instances where economics will be a determining factor in system design, and we will only indicate that balanced controls are usually approximately twice as expensive as their unbalanced counterpart since twice the number of resistors and twice the switch facility are required.

An unbalanced control cannot be used where other circuitry is balanced because, to operate correctly throughout the required frequency range, an unbalanced control must have one side of the line grounded. A balanced control cannot be used in an unbalanced circuit since ground on one side of the unbalanced circuit would affect the control operation. One-half of a balanced control, *i.e.*, one input terminal, one output terminal, and the center-tap terminal, can be employed in an unbalanced circuit but only if the particular circuit impedance is one-half that of the balanced control.

The most frequently used attenuator circuits are the T,

bridged-T, ladder, and potentiometer types or their balanced counterparts, the balanced-H, balanced bridged-H, balanced ladder, and dual or balanced potentiometers. In high-frequency applications, the unbalanced π type is most generally used. The schematic diagrams for these types are shown in Fig. 1.

The following information covering the design and use of the various styles is given for the unbalanced types only. The formulas for determining the resistance values in a balanced control are the same as those indicated for the unbalanced control except that, in inserting the value for Z in the formula, the full value is used for an unbalanced control but only one-half the value is used for the balanced control. Thus, in determining the values for a 600-ohm attenuator, the value for Z in the formulas for an unbalanced control is 600 ohms, but that for a balanced control is 300 ohms.

The T attenuator is generally the most stable and, within reasonable limits of terminal impedance and range of attenuation, can be made the most accurate through fairly wide frequency ranges. Since it requires three variable resistors and their associated switching, it is generally the most expensive of the unbalanced types used at frequencies up to 1 MHz. Both the input and output impedances remain constant, within the specified resistor accuracy, throughout the attenuation range. The insertion loss of this type control is zero dB when the input and output impedances are equal.

These characteristics make the T attenuator especially useful as controls in instruments and other applications where accuracy and constant impedance are required. The formulas for determining the resistance values required are shown in Fig. 2A.

Where equal input and output impedances are involved, Z_{in} and Z_{out} are equal and the resulting values for R1 and R2 are also equal. For a fixed-loss attenuator with either equal or unequal input and output impedance, and for a variable loss attenuator with equal input and output impedance, the formulas are used without further consideration. For a variable loss attenuator with unequal input and output impedance, the resistor values are normally determined for one impedance, and an impedance-matching network is used to match the impedance at the other end. The resistance values for this impedance-matching network are determined as indicated later in this article.

The bridged-T network is a variation of the T network which requires the use of only two variable resistors. It is thus somewhat less expensive than the T but has practically

Typical fixed attenuator T pad for 600-ohm audio lines.

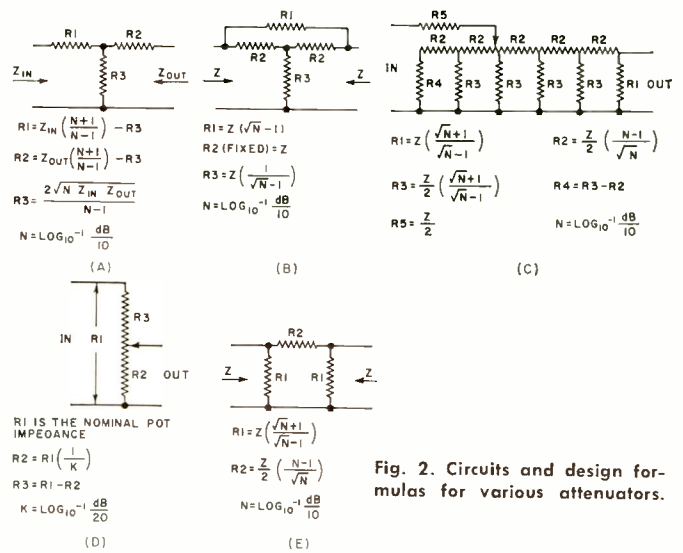
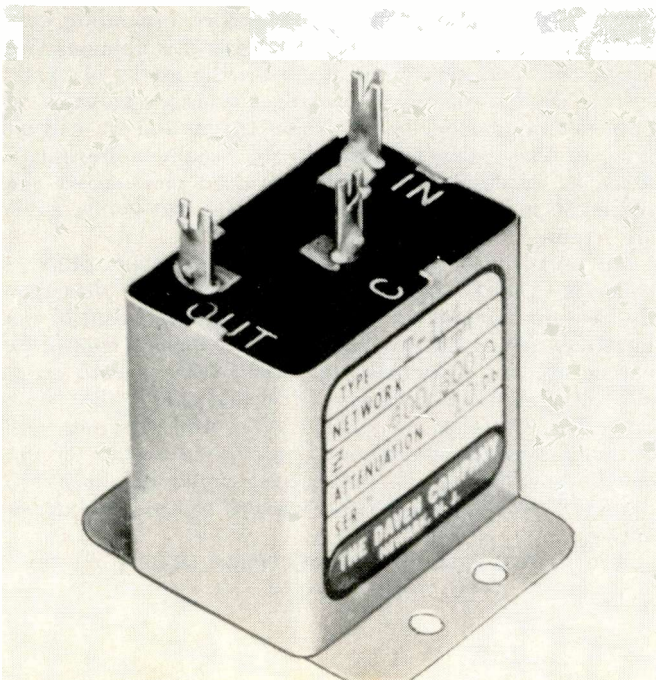

Fig. 2. Circuits and formulas for various attenuators.

equal characteristics up to somewhat lower attenuation values. The bridged-T has a constant input and output impedance throughout the attenuation range and has a zero dB insertion loss when the input and output impedances are equal. In the higher losses above 30 to 40 dB, the value for R1 (see Fig. 2B) becomes so high that it is more susceptible to the effect of any stray capacitance across it.

The bridged-T attenuator is normally used only for attenuators which are variable by means of rotary or linear switching. They are normally used between equal input and output impedances but, with the use of an impedance-matching network at one end, they can be used between unequal impedances with the necessary insertion loss due to the impedance match. They are used mainly in instruments or in communications equipment where constant impedance and zero insertion loss is important and where the attenuation range is not too great. The formulas for determining resistance values are shown in Fig. 2B.

Ladder Attenuators

The ladder type attenuator is actually a variation of the π type and is used only in the variable loss styles. It requires the use of only one variable resistor and is the least expensive of all the types except the potentiometer. Ladder attenuators are most generally used as mixer controls in public address systems and broadcast consoles, and also as controls in audiometers.

The circuitry is such that the output impedance falls to about two-thirds of the nominal value at the low loss end and the input impedance falls to approximately the same amount at the high attenuation end. The curves for a 30-step, $1\frac{1}{2}$ dB/step ladder with a 600-ohm input and output impedance are shown in Fig. 3. Throughout the mid-attenuation range, where the control is normally operated in mixing applications, both the input and output impedance are fairly constant and practically nominal.

The resistor values in a ladder attenuator are such that they remain within practical limits throughout the attenuation range. Thus, the high attenuation values required for audiometer applications are obtainable in a single control. With an equal input and output impedance, the ladder attenuator has an insertion loss of 6 dB. This is partially due to the fact that, unlike a T or bridged-T attenuator, all the resistors of the ladder attenuator are in the circuit at all times and control is obtained by connecting to various taps on the series resistor by means of the switch. The remainder of the insertion loss is due to the fact that a resistor, equal in value to one-half of the input impedance, is connected in series with the input to provide a more constant impedance. When the input impedance of a ladder att-

tenuator is one-half of the output impedance, the resistor in series with the input is omitted and the insertion loss is approximately 2dB.

The ladder attenuator is unique because its circuit is such that any possible switching noise is attenuated along with the signal. This feature is helpful in mixer applications where the signal-to-noise ratio is especially important. The formulas for the resistor values in the ladder attenuator are shown in Fig. 2C.

For optimum decibel and impedance accuracy, dB in the formula is normally selected as 6 dB. For a 2 dB per step control, R_2 is tapped for three equal sections and for $1\frac{1}{2}$ dB per step it is tapped for four equal sections.

Potentiometers and π Networks

The potentiometer is a simple potential divider and is designed to operate into a very high impedance such as the grid circuit of a vacuum-tube amplifier. It is used to control voltage in specific decibel steps or in special voltage ratio steps. It has the simplest construction and is therefore the least expensive of any of the attenuators. The formulas for determining the resistor values for this attenuator are shown in Fig. 2D.

The formulas are for potentiometers calibrated in decibel steps. When voltage ratios are required, the ratio of R_2 to R_1 is the same as the ratio of the required output voltage to the input voltage. Again, $R_3 = R_1 - R_2$.

The π network is comparable to the T network in stability and accuracy. It is also a network which requires three variable resistors. It is not generally used in low- and medium-frequency variable attenuator applications because the switching is somewhat more complicated than that for the T network. It is more generally used in high-frequency attenuators because it is easier to shield and the resistor values are in a range more readily adaptable for the lower impedances used.

In the high-frequency variable attenuators, the variation in attenuation is accomplished by switching π attenuators of the correct loss in and out of the circuit. For this type of switching, the resistors values in a π network remain within a range which is not overly affected by stray capacitance. The formulas for the π network are shown in Fig. 2E.

Attenuation Per Step & Matching

The selection of the dB per step of any attenuator depends upon the usage. For controls used in instruments, the dB per step can be any value up to 10 dB, and sometimes more, depending upon the instrument requirements. In broadcast and recording operations, the normal maximum dB per step is 2.

In the higher quality recordings, no switching noise can be tolerated. If the dB per step is too high, there will be a noticeable "pop" if the control is switched between steps during a sustained note. The lower the dB per step, the more steps are required to obtain a comparable total attenuation and more steps means higher cost. Thus, economics enters into the choice, but in recording applications, steps of 1.5 dB or less, if practical, are commonly used.

For optimum over-all operation, the impedance of all portions of a system should match. Thus, with the exception of the potentiometer, the input impedance of the attenuator should equal the impedance of the source and the output impedance of the attenuator should be equal to that of the load.

When the source and load impedances are unequal, a resistive network can be utilized to match them. This impedance-matching network is generally a T network or its counterpart, the balanced-H. Where a resistive network is used to match unequal impedances, some loss is necessary. The amount of this loss is dependent upon the ratio of the higher impedance to the lower impedance being matched.

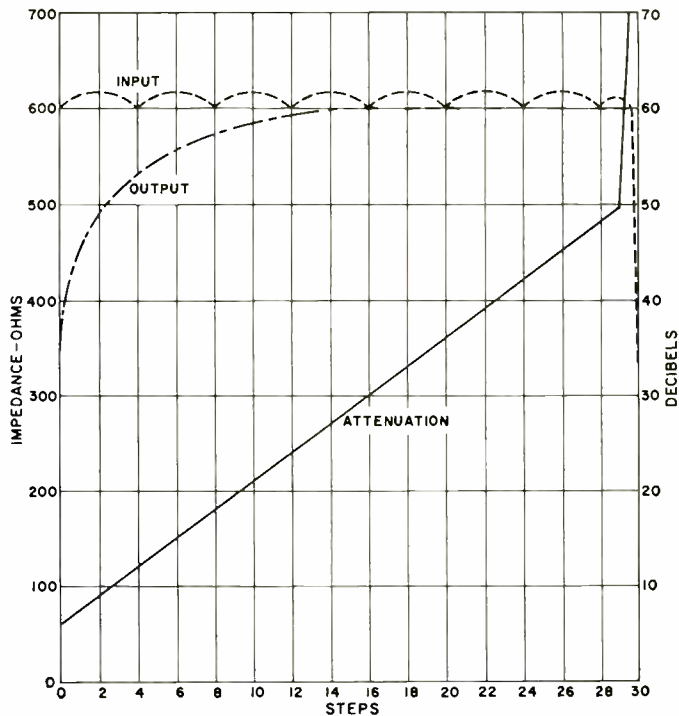

Fig. 3. Characteristics of a 30-step ladder attenuator.

Power & Impedance Available

The normal power dissipation of most attenuators is 0.5 or 0.6 watt continuous. Such attenuators will handle up to approximately 2.5 watts peak in audio circuits where the level fluctuates considerably. Attenuators with continuous power rating up to 20 watts and, in special cases, higher are available. Attenuators which have a low dB loss, such as decade T types with 10 steps of 0.1 dB per step, can be used in circuits where the wattage is considerably above the normal rating of the control. This is due to the fact that only a relatively small portion of the power is dissipated in the attenuator whereas most of the power is dissipated in the load.

In general, balanced-H, T, and ladder attenuators are available with impedances up to about 1000 or 2000 ohms. For special applications, controls with higher impedances are obtainable but attenuation and frequency ranges must be considered since internal capacitance and capacitance in the external wiring will have greater effect on the attenuator accuracy. The attenuators used in high-frequency applications generally have an impedance of 50, 52, 73, or 75 ohms. Attenuators with 93- and 125-ohm impedances can be made but, for a specified accuracy, the frequency range is limited by capacitance effects. Potentiometers normally are made with impedances in the range from 1000 ohms to 1 megohm. Lower impedances are available with a somewhat reduced attenuation range due to resistance values becoming too low for practical manufacture. Capacitance effect becomes a limiting factor for impedances over 1 megohm.

Attenuation & Frequency Range

The attenuation range available in an attenuator depends upon impedance, circuit type, and frequency range. In bridged-T and bridged balanced-H attenuators the variable series resistor becomes exceedingly high at the higher losses and the variable shunt resistor becomes too low for practical manufacture. Thus the highest loss normally supplied in the bridged-T and bridged balanced-H types is approximately 40 dB. This is not a firm figure because impedance and dB per step must be taken into consideration.

In T and balanced-H attenuators the limiting factor on the dB range is the resistor value between steps in both the series and the shunt arms.

(Continued on page 79)

AUTOMATIC TV Brightness Control

By STU HOBERMAN

A photocell can be used to control the bias on the CRT to change TV picture brightness with room light changes.

AUTOMATIC brightness control circuits that monitor the ambient room lighting and adjust the cathode-ray tube brightness accordingly are being used in a number of black-and-white sets.

The heart of these circuits is a tiny device called a photocell. It can be considered as a variable resistor that changes its resistance value in proportion to the amount of light striking its sensitive surface. When the photocell is in darkness, its resistance may reach several megohms, while under a bright light, the resistance can drop down to about 100 ohms. These values depend largely on the construction of the cell, the size of the sensitive surface, and the chemical composition of the cell.

Fig. 1A shows the response of a typical cell to the light spectrum. Note that, like the human eye, this particular cell is responsive to the visible portion of the light spectrum from about 5000 to 7000 Å. Specially designed photocells that peak in the infrared or ultraviolet regions of the spectrum are available.

How the photocell responds to varying degrees of light intensity is shown in Fig. 1B. The photocell used here is an *Amperex* type RPY-17 that varies its resistance from almost 100,000 ohms at .1 footcandle to about 100 ohms at 1000 footcandles.

Because of the response characteristics, photocells may be used in many applications where control circuits must imitate the response of the human eye. One such application is in the automatic brightness circuits where the photocell will control the brightness of the CRT in response to changes in the viewing room illumination.

Fig. 2 illustrates basic operation of the automatic brightness circuit. The photocell (*PC1*) and the range adjust (*R6A*) are added for automatic operation. The contrast control is shown as part of the video amplifier circuit, with the video signal applied through a voltage-divider network to the cathode of the CRT. The d.c. level of the signal at the cathode is determined by the brightness control. Decreasing the level results in a brighter picture, while increasing the level results in a darker picture.

To modify the basic circuit, the photocell and range adjust are added as shown in Fig. 2. Photocell *PC1* is part of a voltage-divider network that includes *R6* and *R6A*. The voltage applied to this network is tapped off by the wiper arm of *R6* and applied to the cathode of the CRT through *R5*. Rotating *R6* wiper towards *R6A* lowers the cathode bias to increase brightness. Moving *R6* wiper the other way makes the cathode more positive and lowers the CRT brightness.

Potentiometer *R6A* functions as the range adjust control and limits the maximum resistance of the circuit. The voltage at the lower end of *R6* is then a function of the setting

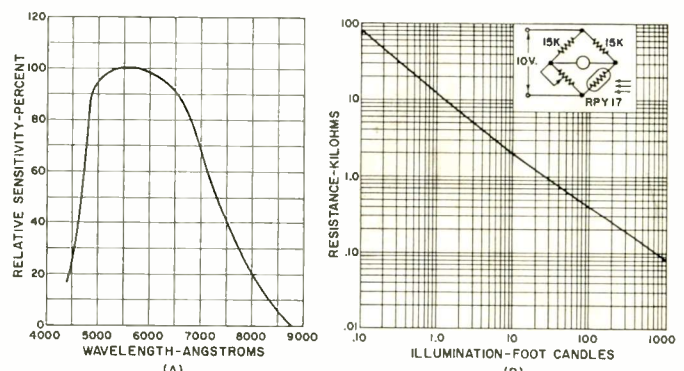

Fig. 1. (A) Plot of typical photocell response across the light spectrum. (B) Photocell resistance varies with light.

of *R6A* and the resistance of *PC1*. If the room illumination increases, the resistance of *PC1* decreases, lowering the d.c. level and increasing CRT brightness. The reverse situation occurs when the room is darkened.

To make the modification, disconnect the ground side of the brightness control and connect a 100,000-ohm potentiometer (*R6A*) between the open leg of the control and ground. Clockwise rotation of *R6* and *R6A* must result in an increase in CRT brightness. Wire one leg of *R6A* to the wiper arm so that clockwise rotation brings *R6* closer to ground.

Connect the photocell (*PC1*) across *R6A* as shown, and mount the cell through a cutout in the front of the TV set so that the cell can monitor the room illumination. ▲

Fig. 2. TV set modifications to include automatic brightness.

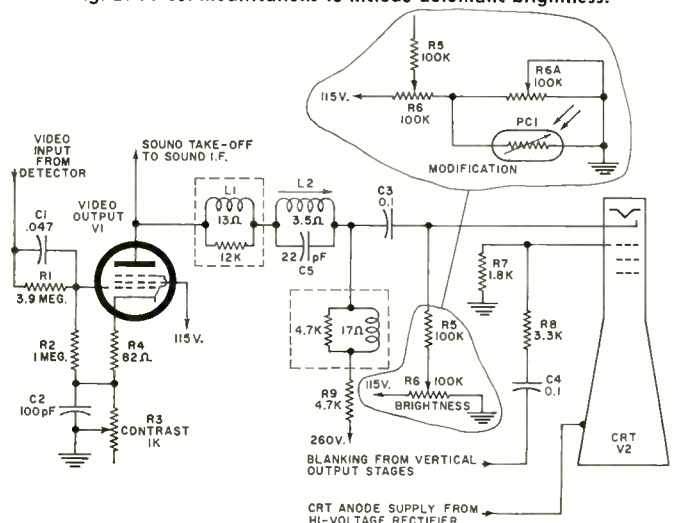



Our author began his professional career at the Harvard Underwater Sound Laboratory in 1943. From the end of the war until 1949 he was Assistant Professor of Engineering Research at the Pennsylvania State Univ. and a Group Leader of Electronic Research at the Ionospheric Research Lab. From 1949 to 1959, he was with RCA engaged in the development of advanced military systems using color television. Since 1959, Mr. Underhill has been a Senior Staff Member of Arthur D. Little, Inc., an industrial research company with headquarters in Cambridge, Massachusetts. There he has participated in and directed studies aimed at assessing the technical-economic constraints on CATV, pay television, and ETV, and has provided consulting services in management, marketing, engineering, company policy, and corporate assessment to many companies.

HOME TV VIA SATELLITE

By BRADFORD B. UNDERHILL / Arthur D. Little, Inc.

Can we use space satellites to broadcast TV directly to individual homes? What are the problems and can they be solved in the immediate future? Here are authoritative answers to these and other important questions.

Editor's Note: We recently attended a financial seminar presented by the National Community Television Association, Inc. in New York City. During the all-day session over a dozen papers were presented dealing mainly with the financial aspects of CATV. Included were papers by Milton J. Shapp, president of Jerrold Corp., on the history, size, and relationship of CATV to the broadcasting industry; by Willard E. Walbridge, representing the National Association of Broadcasters, on the broadcaster's viewpoint; by Frederick W. Ford, former chairman of the FCC and now president of NCTA, on industry relationship with FCC and Congress; by E. William Henry, chairman of FCC, on the FCC view of CATV; and others. Among the most interesting and important was the talk on satellite broadcasting by Bradford B. Underhill. A portion of Mr. Underhill's presentation dealt with the possible use of satellites in connection with a CATV system. Of more general interest, however, were his remarks on the feasibility of using satellites to broadcast TV programs directly to our homes. This is a subject of widespread and increasing interest today, especially in view of the successful use of Telstar, Syncom, Relay, and Early Bird communications satellites. Because of its importance to our readers, we have excerpted below a large portion of Mr. Underhill's remarks.

IN discussing the impact of space satellites on the future of world-wide television programming, we will consider the technical-economic feasibility of a satellite system that could, conceivably, transmit 8 to 12 channels of TV to individual homes. (Ideally, we would, of course, like to postulate over 100 channels which would allow a wide choice for the individual television viewer; but a discussion of 8 to 12 channels will, I believe, adequately demonstrate the overall situation.)

Clearly, if a television set coupled with a relatively simple, unobtrusive, and cheap antenna system at each home could, at any one time, pick up over 100 different TV programs ranging from comedy through education, news, serious plays, and do-it-yourself material, we would have reached a very advanced state of communications. Even the ability to select 8 to 12 different and interesting programs would provide a new dimension to television, particularly if the selection were on a national or even international basis.

Let's consider the practicality of the idea of using space satellites to broadcast TV directly to individual homes. Any communications system requires a source or transmitter and a receiver. In a satellite system, whether located on the ground or in the air, the satellite performs two functions; that is, it must receive signals from the primary transmitter or transmitters and then amplify and repeat selected signals to selected audiences.

Conceptually, a space satellite can distribute signals on a grand scale. Consider a high-altitude space satellite that hov-

ers over essentially the same spot on earth 24 hours per day, 365 days per year. It could receive signals from anywhere on almost one-half of the world and repeat this to the same portion of the world. One such satellite could cover *all* of North America, South America, and much of Europe and Africa. Two more could cover 95% of the populated world. Compare this with the 35- to 40-mile television reception available today. The comparison is staggering.

Such a satellite, operating at an altitude of about 22,300 nautical miles, is called "synchronous" since it keeps pace with the earth's rotation. Another possibility imagines non-synchronous satellites operating at a much lower altitude—say, 300 miles—which move with respect to the transmitter and receiving stations. In order to keep each satellite in view of its neighbors and the ground, at least *ten* such satellites would be required. Each would have to be tracked by appropriate ground stations and each would have to transmit to the ground as well as to its neighbors. In addition, each receiving station would have to track the satellites as they move across the zenith and acquire the next one as it becomes visible. We do not believe that such a system will prove feasible for home use, but concede that COMSAT or some such organization might be able to develop a base for non-synchronous satellite global communications with heavy government support.

Assuming you will accept the loosely supported contentions as far as non-synchronous satellites are concerned, let us examine the case for synchronous satellites. Remember that this is a satellite that remains over essentially the same spot on earth and can receive signals from anywhere in its field of view and retransmit to that same wide area; roughly one-half of the world can be seen from such a satellite. A synchronous orbit is operationally desirable in order to avoid problems of pointing antennas toward the satellite and making contact with (acquiring) the satellite as it rises over the horizon.

The satellite must contain a source of electrical power. At the present time, photovoltaic cells which draw power from sunlight are the commonest source of satellite power. Conventional batteries are nearly useless for long-time activity. In the future, nuclear devices capable of generating a substantial amount of electric power for long periods of time may be generally available for communications satellites. Until nuclear power supplies are available, transmitted power from a satellite will be severely limited, for a solar-battery power supply weighs about one pound per watt of continuous available power.

The satellite platform will contain the receiving antenna and amplifier, modulator, a rebroadcasting transmitter, and a transmitting antenna. As these antennas must have high gain and correspondingly narrow beams, the attitude

Antenna Diameter

Freq. (MHz)	19-dB Gain (covering approx. a hemisphere)	29-dB Gain (covers 2500 × 4000 nautical-mile oval)	39-dB Gain (covers 800 × 1200 nautical-mile oval)
60	18.5 m (61 ft)	58.5 m (193 ft)	185 m (610 ft)
200	5.55 m (18.2 ft)	17.6 m (57.6 ft)	55.5 m (182 ft)
600	1.85 m (6.1 ft)	5.85 m (19.3 ft)	18.5 m (61 ft)

where: dB = 10 log₁₀ P₁/P₂ or 2 × power = 3 dB; 10 × power = 10 dB; 100 × power = 20 dB.

Table 1. Diameter of various high-gain transmitting antennas.

Table 2. Effective capture area of omnidirectional antenna.

Freq. (MHz)	Effective Area (sq meters)	Gain (dB) Relative to one sq meter
60	1.99	3
200	.179	-7.5
600	.0199	-17

control of the platform must be sufficiently precise to aim the antennas within appropriate tolerances. This problem is not insurmountable, but every sharpening of the attitude tolerances increases the complexity of the attitude sensor and control system and adds to the amount of energy which must be available for attitude control.

The receiving ground complex consists of receiving antennas and receivers, that is, an amplifier and demodulator to convert the signal back to the preferred usable form. With the satellite in a practically stationary orbit, a complex control system is not needed to aim the ground antenna.

Down-Link Power Computations

At first sight, the transmission properties of the link from the ground to the satellite look very much like those of the link from the satellite to the ground. The principal asymmetry is that in the up-link the transmitter is on the ground and the receiver is in orbit, whereas in the down-link the transmitter is in orbit and the receiver is on the ground. The state of our technology is such that we can install more powerful elements on the ground than we can in orbit. Practically speaking, this usually makes up-link performance easier to achieve than down-link performance, for a ground transmitter can be vastly more powerful than an orbiting transmitter, whereas a ground receiver can only be a little more sensitive than an orbiting receiver. Consequently, we shall examine the power budget for the down-link only.

Frequency Assumptions: We will confine our discussion primarily to the existing television broadcast frequency bands at 54 to 88, 174 to 216, and 470 to 890 MHz. For specific numerical examples, we chose frequencies of 60, 200, and 600 MHz as representative of these three bands. Still higher frequencies, *i.e.*, 2000-7000 MHz might be used but these would require expensive conversion equipment at each home.

Radiated Power Assumptions: Where there is dependence on solar power, it is likely that the maximum continuous radiated power will not exceed a few watts, perhaps 10 watts at most. When nuclear or other power supplies are available, the primary power limitation is removed and the significant

limit will arise from constraints on dissipation and life-time in the power output stages of the transmitter. We believe 100 watts radiated power will represent a likely maximum for the next decade. Under extreme conditions, power of 1000 watts may be attained. However, even with ground-based equipment, current technology does not attempt to achieve long life-time and high reliability in electronic circuit elements operating at power levels of even one kilowatt; reliability relies on replacement. The ordinary techniques of enhancing reliability by overdesign and derating are ineffective where high power throughout is required. These suggested limits are consistent with the guidelines cited by G. M. Northrup in a paper prepared for the *Rand Corporation* in 1963. Accordingly, I shall assume a total radiated power from the satellite of 100 watts except where otherwise stated.

Satellite Transmitting Antenna Directivity: The effective radiated power from the satellites can be enhanced 80 times (19 dB) with a directional antenna whose beam just illuminates the near-hemisphere visible from the satellite. An antenna 10 times as large will illuminate, in the temperate zone, an oval about 2500 × 4000 nautical miles, and will have a gain of 800 (29 dB). An antenna 10 times larger yet will have a gain of 8000 (39 dB) and illuminate an oval about 800 × 1200 nautical miles. At the frequencies under consideration, however, these antennas are quite large, as shown in Table 1.

Although very large antennas have been considered, we have as yet no experience in the erection and operational use of antennas even as large as 60 feet, to say nothing of antennas 10 times this diameter. Furthermore, a 29-dB antenna has a beamwidth of about 6°, and a 39-dB antenna has a beam width of less than 2°. The pointing of such a sharp beam adds a burden to the attitude control system of the platform.

For the moment, let us assume the 19-dB antenna on the satellite and defer consideration of higher gain antennas until later.

Path Loss: Because of the way certain standards of television signal strength have been developed, comparisons are facilitated by computing signal strength at the earth's surface directly in terms of received power density per unit area for one channel. Let us assume that the 100 watts which is radiated through a 19-dB gain antenna is equally divided among 12 channels, each having a bandwidth of 6 MHz. The slant range from the satellite to the temperate zones is approximately 45,000 kilometers. On the ground the power density is: $PD = 2.6 \times 10^{-11}$ watt per square meter or 26/-1000th of a microwatt/meter².

Receiver Antenna Directivity: The effective capture area of an omnidirectional antenna is shown in Table 2 for the various frequencies under consideration. A half-wave dipole antenna has 1.6 times (2 dB) more directivity, provided it is appropriately aimed. Combinations of reflectors and multiple dipoles can give gains of several decibels, but more substantial gains require structures whose size is comparable to those shown in Table 1.

An antenna with more than a few dB gain is likely to be large and expensive. Such antennas will probably be ruled out in applications where one would be required for each home television user. For the sake of comparison, further

Table 3. Grades of television service and the FCC regulations governing them.

Freq. (MHz)	Local Community Service		Grade A Service		Grade B Service	
	Field Strength (μV/m)	Power Density (watts/m ²)	Field Strength (μV/m)	Power Density (watts/m ²)	Field Strength (μV/m)	Power Density (watts/m ²)
54-88	5,010	6.66×10^{-8}	2510	1.67×10^{-8}	224	1.33×10^{-10}
174-216	7,080	1.33×10^{-7}	3550	3.34×10^{-8}	631	1.06×10^{-9}
470-890	10,000	2.65×10^{-7}	5010	6.66×10^{-8}	1580	6.61×10^{-9}

From: "Television Engineering Handbook," Donald G. Fink, ed.; McGraw-Hill, N.Y. 1957, pp. 2-35.

computations are based on the use of a non-directional receiving antenna. This factor can easily be modified by assuming some other antenna gain figures.

Noise assumptions: We have two bases for estimating noise limitation. On the one hand, we can use the grades of television service from the FCC regulations, as quoted in Table 3.

For convenience, the power density in watts per square meter has been computed and exhibited alongside of the field strength. On the other hand, we can base signal-to-noise relationships on thermal noise and an assumption about the noise temperatures of the receiver and the associated environment. A set of such assumptions is shown in Table 4.

In order for the television receiver to function properly, the signal strength must exceed the noise by a substantial margin. The exact amount depends on the grade of service required and on the character of the noise. It will be assumed that a signal-to-noise ratio of 26 dB is required for satisfactory service and that 5 dB additional margin is required to allow for system degradation other than that arising in the down-link from the satellite. If the noise is white thermal noise, this will result in a high-quality black-and-white television picture but one that is not totally free from visible noise effects. The sensitivity of color television to noise interference is somewhat greater.

Resulting Margins: Table 5 compares the received signal strength, as computed above, with the FCC standards and with the performance of a low-noise receiver with a 1000°K effective noise temperature connected through a non-directional antenna. The resulting figures are expressed in decibels and are all negative, showing the deficit in dB between the signal as it would be received from the satellite and the desired grade of service indicated at the head of the column.

It is easy to see that the FCC Grade B Service is closely parallel in signal strength requirements to that required by a low-noise 1000°K receiver with an isotropic antenna. Those of you who have ever tried to operate a television receiver in an area with Grade B Service, so-called fringe-area reception, know that with off-the-shelf home television receivers, the performance is very unsatisfactory without a directional antenna.

In one way or another, the deficit of 33 to 70 dB must be made good. If a 1000-watt transmitter can be used aboard the satellite, 10 dB can be gained at once.

The transmitting antenna gain may possibly be increased 20 dB at 600 MHz and 10 dB at 200 MHz. At 60 MHz it is hard to see how this could be increased at all.

A receiving antenna six feet in diameter will have a gain of 20 dB at 600 MHz and 10 dB at 200 MHz. At 60 MHz it is fruitless to attempt antenna directivity because galactic noise at 60 MHz is greatly in excess of 1000°K noise assumed for the receiver. The highly directive antenna would focus on sources of high galactic noise periodically during the earth's rotation and nullify the desired improvement.

The receiver noise figure could be reduced somewhat provided a high-gain, low-side-lobe receiving antenna were used. This leads to a complex and expensive system, and would probably be useful only at the 600-MHz frequency; for even at 200 MHz, galactic noise is a significant source of interference. Let us assume a possible 5-dB improvement at 600 MHz. Table 6 shows the total improvement achievable by these means. It is clear that success is possible only at 600 MHz and that the margin is slim. Even this success is bought at the cost of a 1000-watt transmitter, a 60-ft diameter antenna on the satellite, a 6-ft diameter receiving antenna with low side lobes, and a receiving system operating at an effective noise temperature of 300°K on the ground. We believe that such a low-noise receiver antenna system would add a minimum of \$200 to the homeowner's cost. Even if we are overly conservative, a home conversion cost of at least \$6 billion is indicated to convert current TV

Equivalent-Noise Assumptions	Noise Temperatures	Watts in a 6-MHz Band
Sky noise at 60 MHz (galactic noise, ctr. of galaxy)	10,000°K	8.28×10^{-13}
Sky noise at 200 MHz (galactic noise, ctr. of galaxy)	1,000°K	8.28×10^{-14}
Sky noise at 600 MHz (galactic noise, ctr. of galaxy)	100°K	8.28×10^{-15}
Typical vacuum-tube TV receiver	3,000°K	2.48×10^{-13}
Low-noise vacuum-tube receiver	1,000°K	8.28×10^{-14}
Typical uncooled parametric amp.	300°K	2.48×10^{-14}
Typical cooled parametric amp.	100°K	8.28×10^{-15}

Sources: "A Study of the Sources of Noise in Centimeter-Wave Antennas," D. C. Hogg, 1961. "Aids for the Gross Design of Satellite Communication Systems," G. M. Northrop, Rand Corporation.

Table 4. Equivalent-noise assumptions for various sources.

Freq. (MHz)	FCC "Local Community Service"	FCC Grade A Service	FCC Grade B Service	Isotropic Receiving Antenna*
60	-64 dB	-58 dB	-37 dB	-33 dB
200	-67 dB	-61 dB	-46 dB	-43.5 dB
600	-70 dB	-64 dB	-54 dB	-53 dB

Synchronous-altitude satellite radiating 100 watts divided equally among 12 channels through a 19-dB gain (full-earth coverage) antenna. (assumes 2.6×10^{-14} watt/m² available; Table 3 power required, and Table 2 antenna gain)
*19-dB transmitting antenna—26 dB S/N into 1000°K receiver, 5-dB margin.

Table 5. Deficit received power from a satellite system. Received power density in dB relative to various service grades.

households to satellite receivers. Without further analysis, it appears that this is hopelessly expensive for the ultimate users of such television signals.

Although the technical problem is made easier by going to frequencies above 2000 MHz, this would add the burden of conversion cost to the individual home owner and would still provide only marginal signal strength unless only a small portion of the earth were covered by the satellite.

The 9-dB deficit at 600 MHz could be made up by reducing the number of channels transmitted to only one or by increasing the power to 10,000 watts. The first is not attractive and the second is beyond our capability at this time.

Conclusions

There is no doubt that television transmission *via* satellite relay is technically feasible with a larger permanent ground antenna and receiver installation, but such installations cost many millions of dollars to build and hundreds of thousands of dollars per year to staff and maintain.

Such installations would allow economic world-wide transmission and reception of a single TV channel and several radio channels and would be attractive to the broadcasters. Retransmission to homes would be achieved by relaying the received information to the individual homes *via* cable or local transmitters. Certainly governments might find such a system valuable for

(Continued on page 90)

Table 6. Additional system improvements that are available. Frequency in MHz

	60	200	600
Transmitting Power	10 dB	10 dB	10 dB
Transmitting Antenna Gain	0 dB	10 dB	20 dB
Receiving Antenna Gain	0 dB	10 dB	20 dB
Receiver Noise Figure	0 dB	0 dB	5 dB
Total Improvement	10 dB	30 dB	55 dB
Required Grade B	37 dB	46 dB	54 dB
Required Grade A	58 dB	61 dB	64 dB
Local	64 dB	67 dB	70 dB
Grade A Deficit	48 dB	31 dB	9 dB

SONY HOME VIDEO RECORDER

By C. H. FIELDS, Manager Technical Services
and SABUROU ONIKI, Staff Engineer
Sony Corp. of America

Technical description and design of a thousand-dollar,
two-rotary-head machine for home and industrial uses.

Editor's Note: Just after the following article was received, we attended a demonstration of the first home video tape recorder that records and plays back color-TV pictures. The quality of the pictures played back on a conventional color-TV receiver was just about on a par with the original color pictures on the same receiver. The recorder, made by Sony, uses the same basic design as the black-and-white home video machine described below. It does, however, employ a somewhat higher tape speed (12 ips rather than 7½ ips), it uses four rotating heads rather than two, and it has additional circuitry for color-signal processing. The color home video tape recorder is expected to be available in the fall of 1967. Its price will be established after production starts. The company is also developing a color-TV camera for home use.

LAST September when Sony Corporation of America placed its home video tape recorder on the U.S. market for \$995, it stirred up considerable interest. Prior to introducing its home machine, the company had been marketing a professional video tape recorder for medical, broadcast, sports, and transportation applications. The

Over-all view of recorder (Model TCV-2010) and monitor.

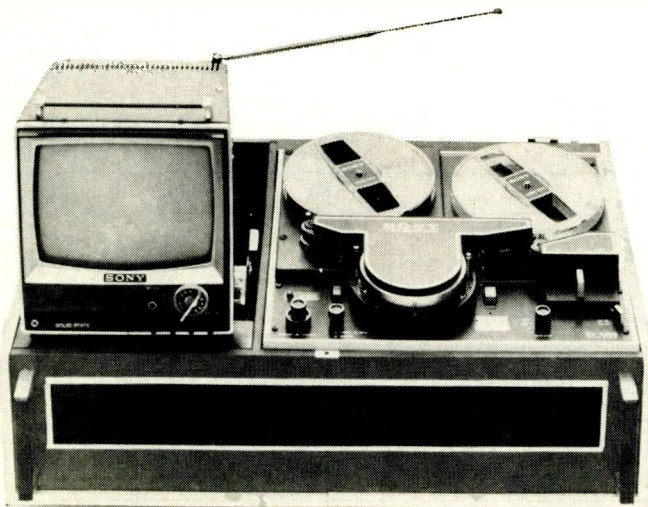

larger and more expensive professional equipment is still marketed for the fields for which it was designed, but the home unit is now attracting the bulk of the attention. This is because this new unit has so many uses with which the public can relate.

An amateur golfer sees it as a means for improving his swing. The optometrist believes he can sell more framed glasses if he can show patients how they will look. The politician thinks of it in terms of improving his "image" if he has a chance to practice his speeches with the video tape recorder before going on the air. The entertainer sees it as a rehearsal aid to get ready for an actual performance or a tryout. While doting parents consider it in the light of a "living record" of their children's antics, their best parties, and family weddings, reunions, and holiday get-togethers.

To meet the needs of such diverse customers, the unit has been designed to be simple to use and capable of being operated without the need for mechanical adjustments. It works on regular house current and can be transported for use wherever a.c. current is available. It weighs 66 pounds and is approximately the size of a man's suitcase.

The Sony "Videocorder," with its tape deck, 9-inch monitor, and separately available camera (\$350) is literally a home television studio. Its basic use in the home is with the camera for home movies or for recording favorite TV programs off-the-air. It is possible, using a timer switch, to record TV programs automatically for later viewing. Tapes can be erased and used again. A one-hour, ½" tape costs \$39.95. (A tape made on one unit, however, must be played back on the same type of unit.—Ed.) Tape head life is 1000 hours and a replacement head costs in the neighborhood of \$90.00.

Preliminary Relationships

Even though we are only going to discuss the recorder in terms of a block diagram, some preliminary relationships must be made clear first. Although the built-in 9-inch monitor may be switched on independently, no picture will be present on the screen since all video must go through the recording circuits of the tape deck. Operating the "power on/off" and the "record" push-buttons activates these circuits.

In this mode, the monitor is used to set up audio and video levels before the synchronous motor, which drives the tape transport and the rotary heads, is turned on.

When a satisfactory picture is obtained and the recording

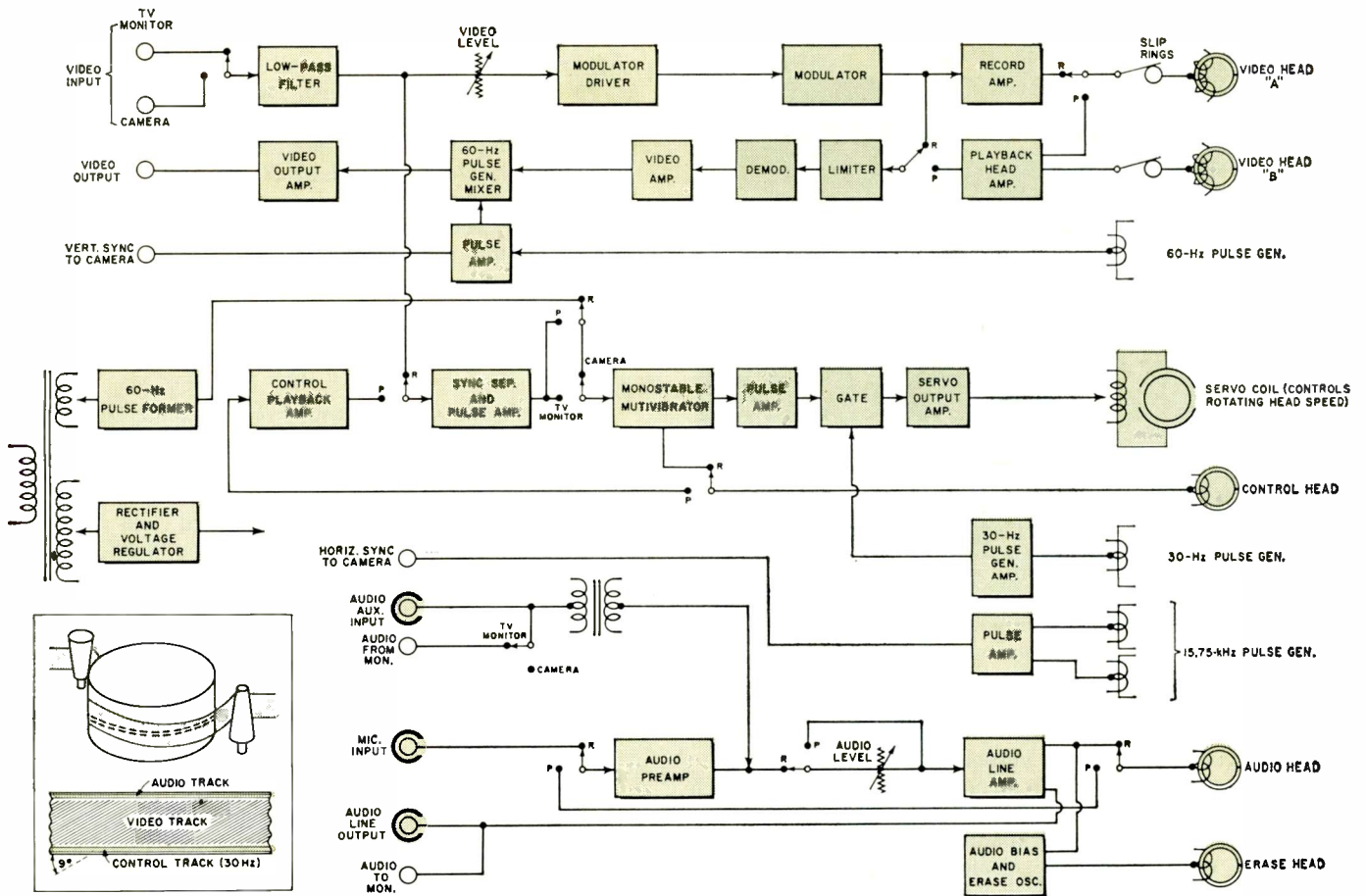

Fig. 1. Complete block diagram of the video tape recorder. Inset shows tape travel around drum and tracks on the half-inch tape.

levels are correct as read on the meter, the main motor is switched on, starting the tape drive and video head assembly. Within six seconds the servo system locks the video head assembly rotation to the synchronizing signal so that, during playback, the rotating video heads will track exactly over the recorded signal.

The tape path, as can be seen in the photo and in the Fig. 1 inset, is at an angle across the head drum. Thus, since the video heads are rotating in the horizontal plane, each head will follow a slanted track across the tape.

The inset diagram also shows the tracks laid down during recording. The top track is sound, recorded as in a normal audio tape recorder. The middle portion of the tape is video, each slanted line representing one field of the TV picture. The lower track is the control track which is recorded in the same manner as the audio track, but is a special signal controlling the angular position of the video heads to the tape so that during playback the heads will follow the slanted video track in an exact manner.

Video Recording Circuitry

Two inputs are provided to the tape deck (see Fig. 1). One is for use during camera recording while the other is for recording off-the-air TV programs. The operation is essentially the same for TV video or camera video, but the control-track signal is originated in a slightly different manner.

Video from either camera or off-the-air TV is applied to a low-pass filter which eliminates the higher frequencies, such as color burst and 4.5-MHz audio i.f. The full-composite video signal is applied to both the "Video Level" control and the sync separator.

The "Video Level" control is an operator's control and provides a simple meter method of setting the optimum recording level. The modulator driver section provides pre-emphasis, clamping, and white clipping automatically, as well as imped-

ance matching to the modulator. The composite video signal drives a modulator whose output is an FM signal. The output of this modulator is fed to the record amplifier and the limiter section. At the limiter section, any amplitude modulation is removed before the FM is demodulated. Output from the demodulator is again composite video.

The video amplifier, which also provides de-emphasis, feeds the mixer stage where a 60-Hz pulse is inserted just before the vertical blanking pulse of the composite video. The purpose of this short pulse will be explained later. The final stage provides output level and matching to the monitor.

At this point we have followed the composite video path from the monitor (or camera) through the recording stages in the tape deck, and back to the monitor.

Returning to the modulator, the other path for the FM is through the record amplifier which provides FM recording current to the video head "A" only, through the brush and the slip-ring assembly. The record amplifier also compensates for the magnetic characteristic between tape and the "A" head.

Using only one head for recording takes advantage of the fact that there is very little difference in the video signal between one field and the next.

Therefore, in the "Videocorder," during "Record" (R), only every second field is recorded. One field is recorded during each pass the "A" video head makes on the tape, the speed of rotation of the head assembly being 30 revolutions per second. In this way, during recording, the slanted video tracks may be "packed" closer together, in effect doubling the length of the tape. The effective writing speed is 433 inches per second.

The "B" head is so positioned that it must follow the "A" track exactly. Further, the "B" head starts at the beginning of the track just before the "A" head leaves the end of the same track. This overlap of the output of the two heads occurs during the vertical blanking period since the angular

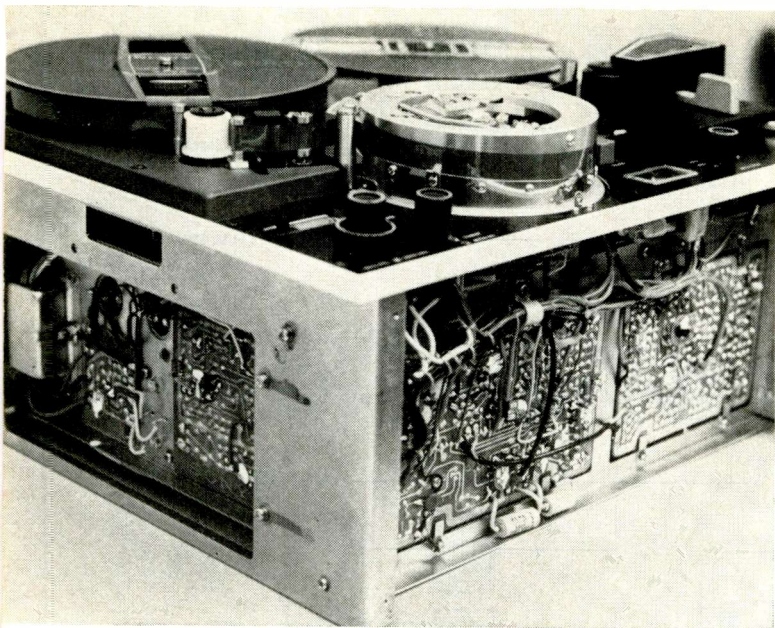

Recorder is shown here with outer drum cover removed. Note particularly the tape travel path around tape drum.

displacement of the head assembly, in relation to the tape, is rigidly controlled by the vertical sync pulse.

By recording 30 fields per second and playing back each field twice per second, in succession, the total effect is as though both fields were originally recorded and 30 full frames are reproduced. The resolution is greater than 180 lines as observed on a standard EIA test-pattern chart.

The method of overlapping the video head outputs during the vertical blanking period is much simpler than the highly complex, expensive method of switching from head to head. However, this overlap produces spurious pulses which tend to mask the vertical sync pulse itself and produce an unstable vertical condition in the monitor picture, as the vertical oscillator in the monitor will be triggered at random by these pulses. To eliminate this condition and supply an unobscured, clear sync pulse for the monitor's vertical oscillator, a narrow 60-Hz pulse is inserted a few horizontal lines before vertical blanking. This 60-Hz pulse generator is a coil whose field is cut by two iron bars located precisely on the head drum (which is rotating at 30 rps). The resulting 60-Hz pulse is amplified by the pulse amplifier and mixed with the composite video. This provides the necessary clean pulse for vertical synchronization.

During playback, both heads provide signal to the playback amplifier which combines the two signals, ensuring that the level of each is uniform and correct to prevent saturation of the limiter stages.

The FM output of the limiters is demodulated, the composite video being amplified by the video amplifier section, and after the 60-Hz mixer stage, the video output section provides the gain and impedance matching to the monitor.

Servo Control Synchronization

The single hysteresis synchronous motor drives the capstan of the recorder at a constant speed, ensuring a tape speed of $7\frac{1}{2}$ ips. The head assembly, however, is belt driven from the same motor by a special pulley at a rotation of slightly more than 30 revolutions/sec. The servo system and magnetic servo brake serve two functions: (a) By continuous, controlled braking, they guarantee that the head assembly rotates at exactly 30 rps; and (b) At the same time, they ensure that the "A" record head will assume the same instantaneous positions and thus follow the recorded track exactly. Without this close control, very poor and distorted video will occur on playback.

Synchronization for off-the-air TV is accomplished in a slightly different manner than for camera operation. Off-the-air TV will be considered first. During "Record," the vertical sync pulse is separated from the composite signal, integrated and amplified, before being coupled to the monostable multivibrator. The first of these 60-Hz pulses produces one usable pulse from the multivibrator. The second 60-Hz pulse is ignored by the multivibrator. The resultant pulse output after integration is applied to the gate circuit.

A 30-Hz reference pulse is generated by the pulse generator, is amplified, and is then used to "open" the gate. This pulse generator, like the 60-Hz generator, produces one pulse each time its field is cut by an iron bar on the rotating head drum.

The amplitude of the output from the gate, after integration and wave-shaping, is proportional to the difference in phase between the 30-Hz pulse generator output and the leading edge of a 30-cycle pulse generated by the extremely stable vertical sync pulses from the TV station.

The natural rate of rotation of the video head assembly is slightly higher than 30 rps. This would produce more than 30 Hz from the pulse generator. Since this pulse would, in effect, arrive too early in relation to the leading edge of the pulse from the monostable multivibrator, a longer, higher output would result. After integration, shaping, and amplification by the servo output amplifier, this waveform produces sufficient braking to reduce the speed of the head assembly to exactly 30 rps.

The physical position of all components is such that the two video heads must be held to extremely close limits in order to always retrace video information that had been previously recorded.

A second output of the monostable multivibrator stage is recorded by the control head on the tape. During playback, this pulse is picked up by the control head and, after amplification by the control playback amplifier, is fed to the sync separator/pulse amplifier. Here, after integration, it serves to trigger the monostable multivibrator which, as before, will produce braking by the servo coil. Since the recorded signal was produced by the off-the-air TV vertical sync pulse through this same path, the resultant amount of braking will ensure correct head rotation speed and position.

When the associated camera is used, a reasonably stable 60-Hz pulse is required to take the place (and provide the same function) as the vertical sync pulse. The 60-Hz a.c. provided by the electric utilities is held to close enough tolerance in the U.S. to suffice. A 6.3-volt winding on the power transformers supplies this signal to the 60-Hz pulse former which, after clipping, shaping, and forming is used during camera operation to trigger the monostable multivibrator. From this point to the servo coil the same sequence of events occurs as during TV operation.

To synchronize the camera accurately, trigger pulses generated in the tape deck are used. The camera vertical oscillator is locked by the 60-Hz pulse generator already discussed. The camera's horizontal oscillator is triggered, at 15 kHz, by pulses produced by two coils in close proximity to a wheel having 525 serrations in its circumference. As each serration passes through the fields of these coils a pulse is produced. Since the serrated wheel is mounted on the rotating head drum shaft, and revolves at 30 revolutions per second, each coil produces 30×525 or 15,750 pulses per second. The output level of the coils is balanced and then amplified by the pulse amplifier before being fed to the camera's horizontal oscillator.

Recording cannot be accomplished from standard TV receivers. The built-in monitor must be used for off-the-air recording. Playback may be accomplished through this monitor or through standard TV receivers whose video, audio, and horizontal a.f.c. circuits have been modified by means of a special video adapter to be marketed by Sony. ▲

Chroma Demodulation in Color Sets: RCA

By WALTER H. BUCHSBAUM

First of a series of articles covering modern color-TV theory. This portion includes details on the bandpass amplifier, the chroma demodulator, and matrixing used in the latest RCA sets.

MANY portions of a color-TV receiver perform the same functions as in a black-and-white set, but three groups of circuits—the chroma demodulator, the color sync, and convergence—are unique to color sets. The chroma demodulator circuits are often considered the most complex since they transform the chroma signal into the red, green, and blue information that creates the color picture on the CRT screen. To perform this function, the demodulators must receive the correct phase of color sync signal controlled by the 8-cycle burst transmitted immediately following the horizontal sync pulse. The color video signals are the product of the demodulator section and the color sync section, but the convergence section is needed to operate the color picture tube. This latter section determines CRT convergence not only for color but also for black-and-white transmissions.

This article covers the chroma demodulator and matrixing section of the new line of RCA color sets. The color sync and convergence sections will be covered in future articles.

Basic Operation

The entire process of converting the subcarrier information into the red, green, and blue video signals consists of three distinct steps. First the subcarrier is amplified and limited in its frequency response. Then phase and amplitude demodulation takes place and, finally, the demodulated video signals are mixed in the proper amplitudes and polarities to produce the three color video signals. This sequence and the parameters associated with each step are illustrated in Fig. 1. From the 0- to 4-MHz over-all video signal, the 3.58-MHz subcarrier and its sidebands are selected by the chroma bandpass amplifier. The signal obtained from its output is a 3.58-MHz carrier which varies both in phase and amplitude, in accordance with the chroma information generated at the transmitter.

To detect the chroma component, it must be remembered that any color is specified by three quantities: brightness, hue, and saturation. The brightness component is the video, or *Y*, signal which has full 4-MHz bandwidth and which furnishes the monochrome picture. Only hue and saturation

are encoded on the subcarrier. If hue is considered as phase angle and saturation as amplitude, any resultant vector can be composed of different amplitudes of two reference vectors with fixed phase angles. In the RCA models, these are called the *X* and *Z* axes, with their phase angles shown in Fig. 2A. In the demodulator, the color subcarrier is then compared against these two phase angles, and the resultant amplitudes constitute the *X* and *Z* video signals. These two signals can be matrixed into the red, green, and blue color-difference signals as illustrated for the *R-Y* axis shown in Fig. 2B. They are called color-difference signals because they lack the *Y*, or brightness signal component, which is transmitted as a normal monochrome signal.

Bandpass Amplifier

In the RCA Model CTC19, two stages of video amplification are used for the *Y* signal. The first stage, as shown in Fig. 3, is a cathode-follower that drives the *Y* delay line. A separate pentode is used to amplify the color subcarrier. This stage contains a peaking coil (*L1*) and a small-valued coupling capacitor (*C3*) to emphasize the higher video frequencies but is not tuned specifically to the color subcarrier.

Fig. 1. Block diagram of a typical chroma demodulator section.

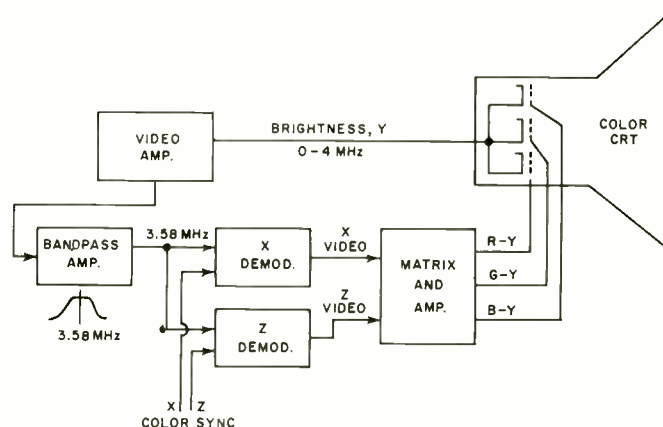

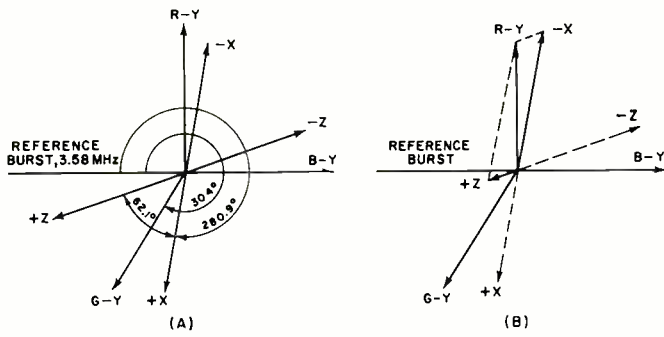

Fig. 2. (A) Color axes phase relation. (B) How R-Y is formed.

At the grid of the bandpass amplifier, a tapped coil (L_2) resonates with the grid capacitance at 3.58 MHz, while the plate circuit uses a double-tuned transformer (T_1), with R_8 loading the secondary to assure broad bandpass. The over-all response curve of the bandpass amplifier stage, as shown in Fig. 4A, is made up of the frequency response of the tapped grid coil (Fig. 4C) and the double-tuned output transformer response of Fig. 4B. Note that the bandwidth is 0.5 MHz on either side of the 3.58-MHz subcarrier and that a much greater tolerance is permitted on the high-frequency side of the response curve. The information contained in the upper and lower sidebands of the subcarrier is identical and will appear redundant to the demodulator.

The chroma amplifier must provide enough gain to drive the two demodulators. Since in this model the demodulator screen grids receive the chroma signal, sufficient power must be developed in the chroma bandpass stage. The circuit of Fig. 3 will provide 25 volts peak-to-peak across R_8 , or about 1.1 watts peak when the grid signal is 9 volts peak-to-peak.

In the RCA CTC16 and CTC17 models, three stages of video (Y signal) amplification are used, with the second stage driving the delay line. Here, the color subcarrier is obtained at the plate of the first video amplifier and then amplified in a circuit which is almost identical to the one shown in Fig. 3 and which results in the same response curve. In all RCA models, the grid of the bandpass amplifier gets a d.c. bias from the plate of the color-killer stage. When a monochrome signal is received, there will be no color sync burst on the horizontal interval blanking pulse, and the color killer generates a high bias which cuts off the bandpass amplifier thus removing the color signal.

Chroma Demodulators

From the chroma bandpass transformer, the signal goes to the color control potentiometer. This control determines the amplitude of the color subcarrier which will be applied to the two demodulators and therefore controls the intensity of the colors on the CRT screen. As illustrated in Fig. 5, both demodulator tubes receive the chroma signal on their screen

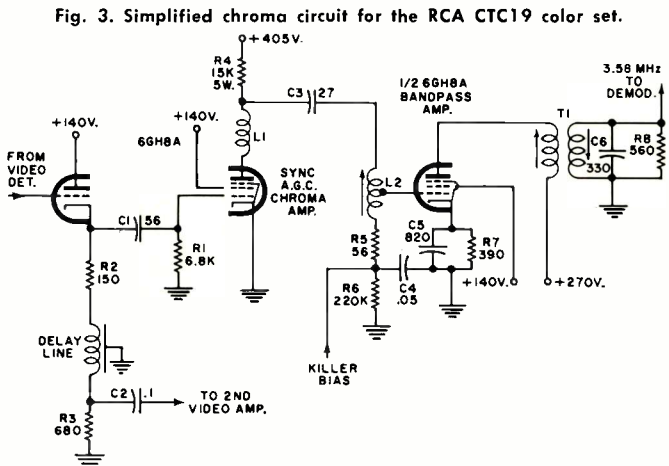

Fig. 3. Simplified chroma circuit for the RCA CTC19 color set.

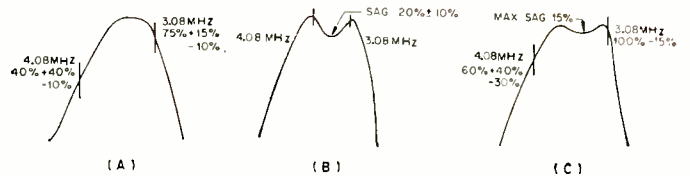

Fig. 4. (A) Over-all chroma bandpass. (B) Transformer response. (C) Grid coil response. These are for the circuit of Fig. 3.

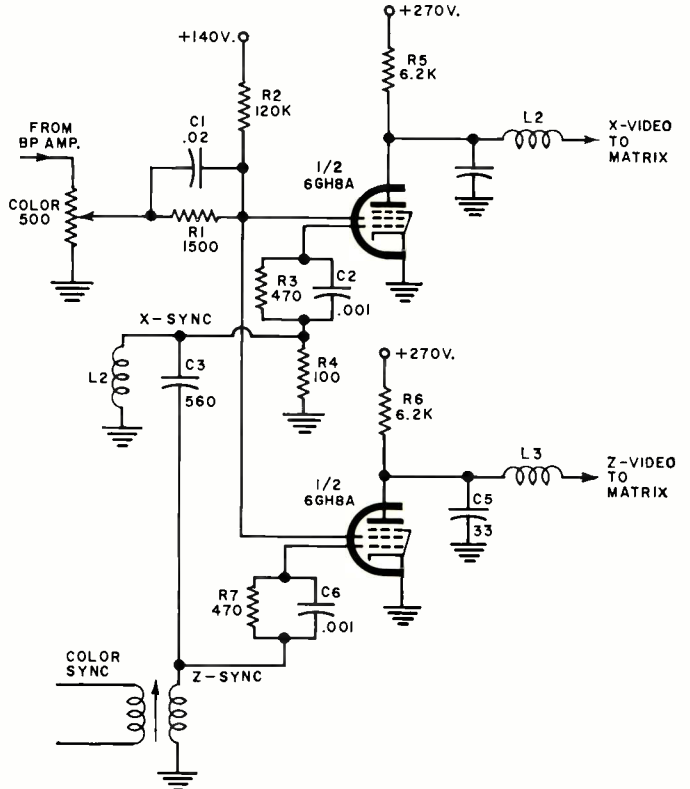

Fig. 5. Simplified chroma demodulators as used in RCA sets.

grids. The d.c. level at both screen grids is partly determined by the setting of the color control potentiometer, since it forms a voltage divider with resistors R_1 and R_2 . Variation of the potentiometer setting can change the screen grid voltage from about 1.6 to 1.2 volts. At any of these values, the screen voltage is so low that it permits very little current to flow through the tube. Both demodulators operate in exactly the same manner; the only difference between them is the phase of their color sync signals.

To understand the operation of the pentode demodulator, all of the voltages on the tube must be considered. The plate goes to +270 volts through R_5 (R_6) and, with normal screen grid voltage, the tube would act as a high-gain video amplifier. During each positive portion of the applied color sync, the tube is turned on and, depending on the level of the signal at the screen grid at that instant, more or less current will flow from cathode to plate. In other words, the color subcarrier is sampled during the positive peaks of color sync, and the amplitude of the output signal will then depend on the amplitude and phase of the chroma subcarrier when compared with the amplitude and phase of the signal applied to the control grid. The true effect of the phase variation becomes apparent when a detailed analysis of the demodulating process is made and both the X and Z color sync phases are considered.

Fig. 6 (left) illustrates a typical portion of a 3.58-MHz phase- and amplitude-modulated subcarrier (A). Below this, the X color sync signal with the cut-off bias of the tube indicated by a horizontal line is shown (B). If the tube can conduct only during the short intervals when the color sync signal goes above the cut-off bias, the resultant plate voltage

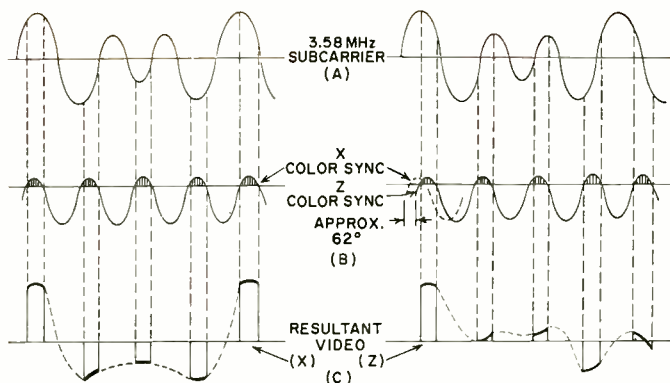

Fig. 6. (A) Modulated color subcarrier. (B) 3.58-MHz oscillator signal. (C) Resultant video for X channel (left) and Z (right).

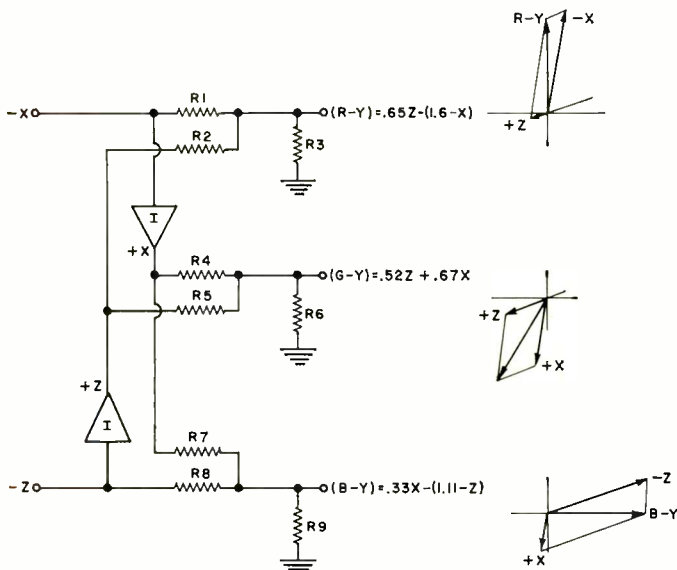

Fig. 7. Principle of matrixing X and Z into R-Y, G-Y, and B-Y.

will be very much like the short pulses shown at (C). The output of the demodulator consists of a series of short pulses, occurring at the 3.58-MHz rate, and varying in amplitude according to the phase and amplitude relationship of the subcarrier to the color sync. The video signal is obtained by integrating these pulses, using a capacitor, to produce a waveform as indicated by the dotted lines connecting the individual pulses of (C). To illustrate the effect of the approximate 62° phase delay between the X and Z color sync signals, Fig. 6 (right) shows operation of the Z signal, the only difference being the relative phase between the subcarrier and the color sync signal. Note that the two resultant video signals are different from each other. At the output of the X and Z demodulators (Fig. 5), a capacitor and peaking coil provide the integration and also act as a filter for the 3.58-MHz color subcarrier. As a result, the output of the X and Z demodulators will be a completely integrated, smooth video signal whose highest frequency is about 500 kHz.

In the RCA CTC16 and CTC17 series models, the demodulators are 6HZ6 pentodes with the screen grids operated at d.c. Here, the color subcarrier is applied to the control grids and the color synchronizing signal is applied to the respective suppressor grids. The 6HZ6 has a characteristic permitting the suppressor grid to cut the tube off. Because the color subcarrier is applied to the control grid, less power is required as compared with the signals on the screen grid of the CTC19 model. In all other respects, the X and Z demodulators in the CTC16 and 17 series are identical to those in the CTC19. After demodulation, the signals are then matrixed to form the color difference signals.

The red, green, and blue color-difference signals can be

obtained from the X and Z video by adding the relative amplitudes and polarities, and Fig. 2B illustrates how the -X and +Z vectors could be used to produce the R-Y signal.

Matrixing

The principles of the complete matrixing process are illustrated in Fig. 7 where it is assumed that the -X and -Z signals, rather than the +X and +Z, are developed by the demodulators because this simplifies the explanation. If the X and Z signals were positive, the connections of the inverters in the circuit of Fig. 7 would change, but the relative amplitudes would remain the same.

In the matrixing process, only signal polarities and amplitudes are used. As shown in Fig. 7, both X and Z signals are combined in a matrix to produce the three color-difference signals. In this RCA set, for example, the angle between R-Y and the -X vector is 10.9° and the angle between R-Y and the +Z vector is 107°. Based on these angles, trigonometry allows us to calculate the lengths of -X and +Z to produce an R-Y of unity length. As shown in Fig. 7, this turns out to be 1.6 for -X and .65 for +Z.

The -X signal is applied through R1 and the +Z signal is obtained from an inverter and applied through R2 across R3. With the correct resistor relationship, the resultant signal can be made equal to R-Y. The G-Y and B-Y signals are constituted of their respective components of X and Z in the same manner. Note that both polarities of X and Z are required to produce the three color-difference signals. Fig. 7 shows the relative amplitudes of X and Z required to produce the color-difference signals with unity amplitude. In analyzing the actual receiver circuitry, however, it must be remembered that unity amplitude of all three colors rarely occurs. White is shown on the screen when 0.30 red, 0.59 green, and 0.11 blue components (Continued on page 67)

Fig. 8. Matrix and color-difference amplifiers used by RCA.

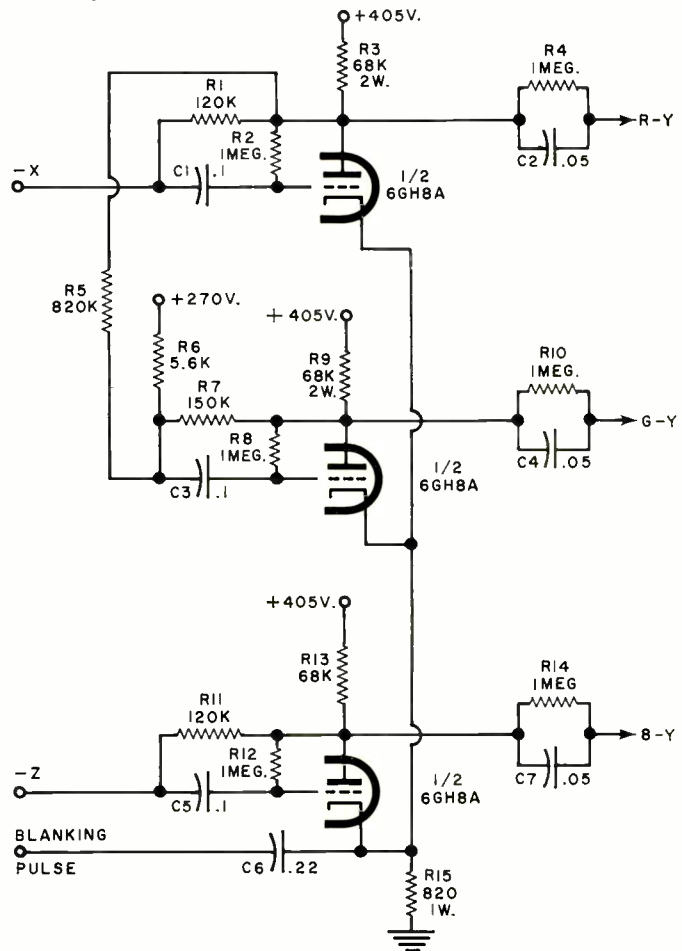

How to select R. F. Chokes

By JOSEPH TARTAS

There is more to an r.f. choke than some wire wound about a form. When all its characteristics are known, it can prove useful as a tuned circuit, transformer, low-or high-pass filter, as well as an r.f. isolator.

NOT so many years ago, the selection of an r.f. choke was not a difficult problem. You simply asked for a Z-50, if you were working in the 50-MHz area, or a Z-14 if your circuitry was in the 10- to 15-MHz range. Chances were, you didn't know anything about the choke itself, other than taking the manufacturer's word that it was designed to work in that range.

For very-low-frequency work, the selection of a choke usually depended more on the inductive reactance and hence was usually some arbitrarily selected value of high inductance. If you were really designing, you might make a lot of calculations and measurements, throw in a few rules of thumb, and come up with the right value.

Today, the picture has changed considerably and instead of two or three makes of chokes and a dozen or so values to select from, there are hundreds of sizes and shapes as well as specific characteristics to meet extreme temperature, moisture, or other environmental requirements. In a single manufacturer's line, there are several physical sizes designed to fit requirements of current-carrying capabilities and space limitations; and in cases of extremely small volume, there are non-insulated chokes to reduce the physical size but retain the same electrical characteristics.

The most important improvement in the RFC field in the past few years is the information made available to the user through manufacturers' literature. This information includes inductance; minimum "Q" (although often misleading—this will be discussed farther on); approximate resonant frequency, perhaps the most important item; the approximate distributed capacitance; the minimum parallel resistance

at two widely separated frequencies; the maximum d.c. resistance; the maximum current rating; and in the case of one manufacturer, incremental current rating. Because of extreme environmental requirements in military and industrial equipment these days, many chokes are also rated for maximum temperatures ranging from 85° to 500°C and power dissipations that depend upon body sizes, covering materials and core materials.

In spite of all this information, it often requires a bit of reading between the lines before you can make a sensible selection of the correct RFC to use in your particular circuit. Before you can do this, however, you must have a thorough understanding of the various characteristics and circuit requirements that go into such a selection.

Why a Choke Is Used

Basically, an r.f. choke is nothing more than an inductance that, because of its own distributed capacitance, forms a parallel-resonant circuit. This distributed capacitance (Fig. 1) is a multiplicity of small capacitances existing between adjacent turns and from any one turn to all the others, as well as to a shield if one is used, and to a ground if one exists

Fig. 1. Besides inductance, an RFC, like any other coil has some distributed capacitance between turns and to chassis.

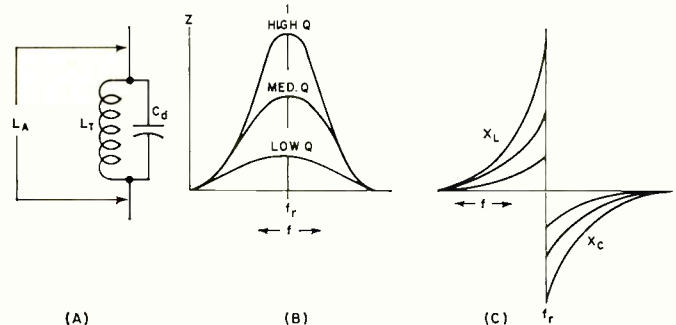
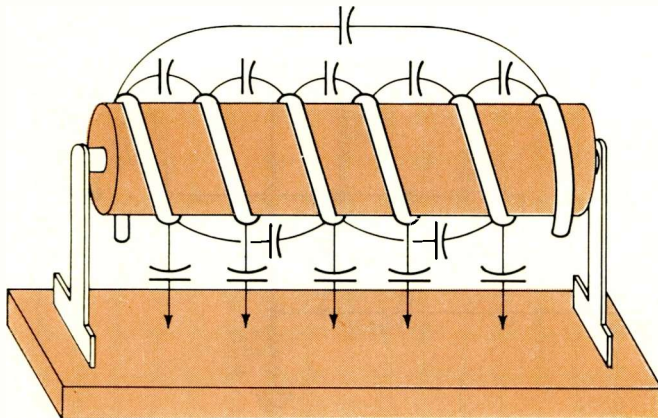

Fig. 2. (A) How an RFC looks electrically. (B) and (C) show "Q" and reactance, respectively, for different values of "Q."

in the vicinity of the choke when it is installed in the equipment. For the moment, consider the self-capacitance, or distributed capacitance itself (without the choke-to-ground capacitance), as being in parallel with the pure inductance of the coil and having a resistance equivalent to the resistive component of the choke. A choke would then appear schematically as in Fig. 2A, and its impedance and reactance as in Figs. 2B and 2C, respectively.

As in all parallel-resonant circuits, the maximum impedance at resonance will depend upon the "Q" and this, in turn, will

be the deciding factor as to how effective the choke will be at its self-resonant frequency and over how wide a frequency range it will still be effective. The impedance depends upon the amount of self-capacitance that exists in the choke and the equivalent parallel resistance. A good approximation of the impedance of a parallel-resonant circuit is $Z_p = L/CR$ as long as the circuit "Q" is at least 10. The value of R is normally the sum of the series resistances of the inductance and capacitance, but in a choke the resistance involved in the distributed capacitance is practically non-existent. This, then, boils down to the inductance, the distributed capacitance, and the resistance of the winding (d.c. + r.f. resistance as frequency goes higher) as affecting the over-all performance of the choke; that is, the resonant impedance, the self-resonant frequency, the "Q" and hence the bandwidth of the choke, and its effectiveness on the r.f. voltages it is being used to suppress. Thus, it is obvious that the value of inductance of a choke is not as important as the self-resonant frequency and impedance, although the inductance does have some bearing on these factors.

Chokes come in many forms, the particular type depending upon the frequency involved, the inductance necessary to achieve it, and the distributed capacitance that results from the particular form factor and winding method. Many are simple single-layer solenoids with or without powdered-iron cores; others are multi-layer coils of various configurations; still others are single or multiple honeycomb windings with one or more sections combined in series.

A single-layer solenoid has the lowest distributed capacitance, and this capacitance is proportional to the diameter of the winding and to a smaller degree is affected by the length and number of turns and, where only a few turns are in-

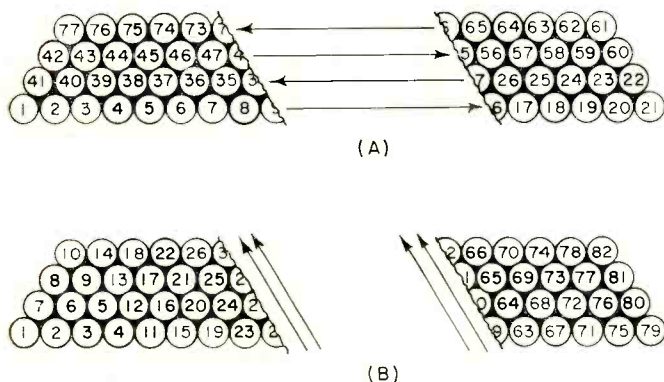

Fig. 3. Two different methods of winding multi-turn coils. Note winding arrangement difference between (A) and (B).

involved, the spacing between turns. For a single-layer, close-wound choke, the distributed capacitance is approximated by $C_d = .75 \text{ diameter (in inches), with } C \text{ in pF.}$

In a multi-layer coil (Fig. 3A), the capacitance is considerably greater, not only because of the greater number of turns but also because of the relative capacitances between layers and nearby turns. If the layers are wound so that the difference of potential between any two adjacent turns is small, then the capacitance is small; if the layers are wound in such a way as to have adjacent turns non-parallel to each other, as in the honeycomb or universal winding, the capacitance is at a minimum between those adjacent turns. The total distributed capacitance may be further reduced by the use of powdered-iron or ferrite cores which reduce the number of turns of wire necessary to obtain the desired inductance value. However, other problems enter when cores are used, since the core losses, the capacitance effects due to the dielectric material used in making the cores, and the useful temperature range and effective permeability of the core which affect the "Q" must be considered, as well as a factor that is often ignored in r.f. chokes, the temperature coefficient of the core,

which also affects the temperature coefficient of the choke.

In multi-section chokes, the individual sections may be alike or may be designed so that the over-all choke appears as a broadband filter. In most cases, the choke is not like a single resonant circuit but appears electrically as a multi-element bandpass filter.

When a large inductance is required and the use of a single-layer coil is prohibitive because of its size, the multi-layer coil becomes necessary. This, in turn, means a larger distributed capacitance which is no longer directly related to the diameter or coil size. One method of reducing capacitance is to wind the coil in such a way that the high-numbered turns do not lie next to low-numbered turns (the condition for greatest capacitance). Early attempts to reduce capacitance by means of "bank-winding" (Fig. 3B) resulted in expensive chokes, since this method required great skill by the winder and it could not be done by machine. The coil could not be held to the production tolerances then required (and completely unusable with today's close-tolerance requirements), and when large inductances were needed, the coil was so large physically as to be almost impractical.

The development of the universal coil winder provided the designer with a new and extremely useful tool that allowed him to repeatedly produce a mechanically stable, relatively low capacitance coil with a fairly large inductance. This type of winding, while not having the lowest attainable capacitance, was better than a "happy medium" between the excessive capacitance of the layer-wound and the great expense of the bank-wound coil.

The "universal" layer-wound coil, more commonly known as "pie-wound" because of its resemblance to a pie, is a compromise between the bank-wound coil of Fig. 3B and the slot-wound coil of Fig. 4A.

The slot-wound coil has a distributed capacitance equal to a two-plate capacitor, each plate consisting of rings the width of the slot with one plate having the inner coil diameter A (see Fig. 4B) and the other plate the outer diameter B . Since a two-plate capacitor of two greatly different areas depends to a large extent on the area of the smaller plate, the smaller the diameter of the inside ring (or the winding form in this case) the smaller the distributed capacitance, and conversely, the greater the inductance the pie will have for a given width and outer diameter.

The universal-wound pie of Fig. 4C is simply a free-stand-

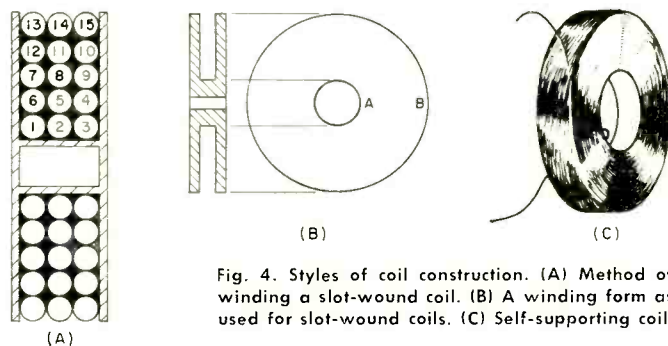

Fig. 4. Styles of coil construction. (A) Method of winding a slot-wound coil. (B) A winding form as used for slot-wound coils. (C) Self-supporting coil.

ing, self-supporting, slot-wound coil with a winding similar to the bank-wound coil, although restricted because of the narrow cross-section of the slot.

As the art progressed, powdered-iron cores were developed, and their use as forms or cores for universal-wound r.f. chokes allowed a great reduction in over-all size.

Like all new materials, powdered iron had its own limitations. If the permeability (μ , the ratio of inductance with the core, to the inductance without the core) was low, and the losses resulting from the insertion of the core in the coil (eddy losses) were kept to a minimum (resulting in a reasonably high "Q"), the size of the coil was not reduced greatly. In-

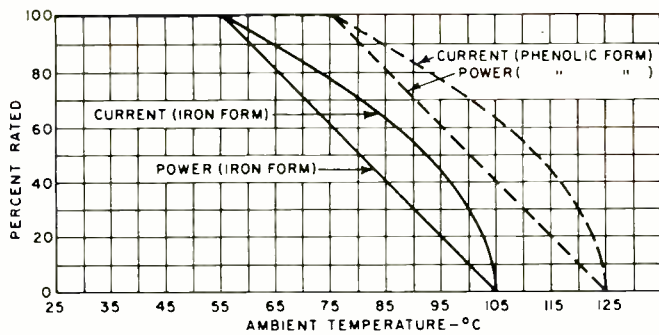

Fig. 5. Derating curve for one type of miniature r.f. choke.

creasing the μ of the core material reduced the choke size, but often it was found that the "Q" suffered greatly due to core losses so that the series impedance (QX) was inadequate to warrant the use of a costly and bulky component.

Eventually, new ferrite materials (ceramic materials with magnetic qualities) were developed which allowed for great reduction in the size of an r.f. choke, but as environmental temperature specifications for equipment were raised above the usual 85°C, the temperature capabilities of the ferrites fell apart. Either the temperature coefficient was poor, causing excessive change in effective inductance with change in environmental temperature, or the permeability decreased so rapidly above 85°C that the resulting inductance became too low to be effective long before the maximum temperature requirements were met.

This led to further improvements in the capabilities of ferrite core materials, and we now have extremely large inductances in very tiny packages with excellent temperature and mechanical stability, and because of the extremely high permeability of the cores, the distributed capacitance or "self-capacitance" of the choke remains quite low.

Examples of this size reduction are a miniature 1000- μ H choke with a molded phenolic form having a distributed capacitance of 5 to 10 pF for several makes, and a ferrite-bodied choke with the same effective inductance yet having less than 1-pF capacitance.

Chokes having an iron core, for the same inductance, run somewhere in between, with a maximum capacitance of 7 pF.

In large chokes using non-miniature techniques, the capacitance is usually not given, and often the self-resonant frequency is ignored as well. Because these chokes are usually wound with larger wire to accommodate high currents, the capacitance of these chokes would be even higher than that of the miniature types.

The current rating of a choke will often depend upon the ambient temperature and will have to be derated. Fig. 5

shows a curve for derating one type of miniature choke. If the current rating is given at the maximum temperature to be encountered, then only the *incremental current* is of interest. This is the current necessary to reduce the effective choke inductance by 5% due to the magnetization of the iron core that effectively lowers the permeability and hence the inductance.

Chokes are normally used to prevent coupling of r.f. power (microwatts or megawatts) from one circuit to another in a piece of equipment. Any wires that lead from stage to stage, circuit to circuit, or from one sub-unit to another are potential conductors of undesired r.f.

In r.f. circuitry in particular, there is usually a series of cascaded amplifier or multiplier stages, and more often than not, an oscillator or two. Furthermore, mixers, detectors, and other associated circuits are commonly involved in such circuitry, and each is a source or terminus for leads that might conduct unwanted r.f. These leads can be any or all of the following: "B+," "B-," a.g.c., filament leads, fixed bias leads, leads to panel controls, and video or audio input and output.

Carefully selected, the proper choke can be an r.f. isolator; a shunt trap; a tuned circuit either at its self-resonant frequency or, by means of additional shunt capacitance, at some lower frequency; or can be combined with other components to make a low-pass, high-pass, or bandpass filter.

A recently introduced innovation is a series-resonant trap that is in appearance an r.f. choke. Utilizing the capacitance between turns as a series-coupling element, it can be made in a wide range of series self-resonant frequencies. Like the parallel-resonant choke, the series trap will probably find applications that formerly required an external capacitor in conjunction with an RFC to make a series-resonant trap.

How to Use Chokes

Because a choke is composed largely of distributed inductance and capacitance rather than lumped inductance and capacitance, it appears electrically as a transmission line rather than as a tuned circuit. Depending upon the values of these constants and the terminating impedance of this transmission line, a choke can act as an impedance varying from extremely high to almost a perfect short.

At the fundamental (self-resonant) frequency and at all odd multiples of this frequency, a choke appears as a parallel-resonant circuit. At even multiples, the same choke acts as a series-resonant circuit with the lowest impedance limited only by the series-resonant resistance, or essentially the resistance of the coil itself. This phenomenon occurs because a choke does act as a transmission line and is *not terminated in its characteristic impedance*. If it were so terminated, a choke would be little more than a straight conductor or lossless transmission line for the r.f. currents.

Fig. 6. Various uses for r.f. chokes. (A) R.f. suppressor. (B), (C), (D) Used as a tank coil. (E) Tuned circuit with tap. As a transformer, an RFC can be used with (F) mutual, (G) top C, (H) top L, (I) bottom C, (J) bottom L coupling.

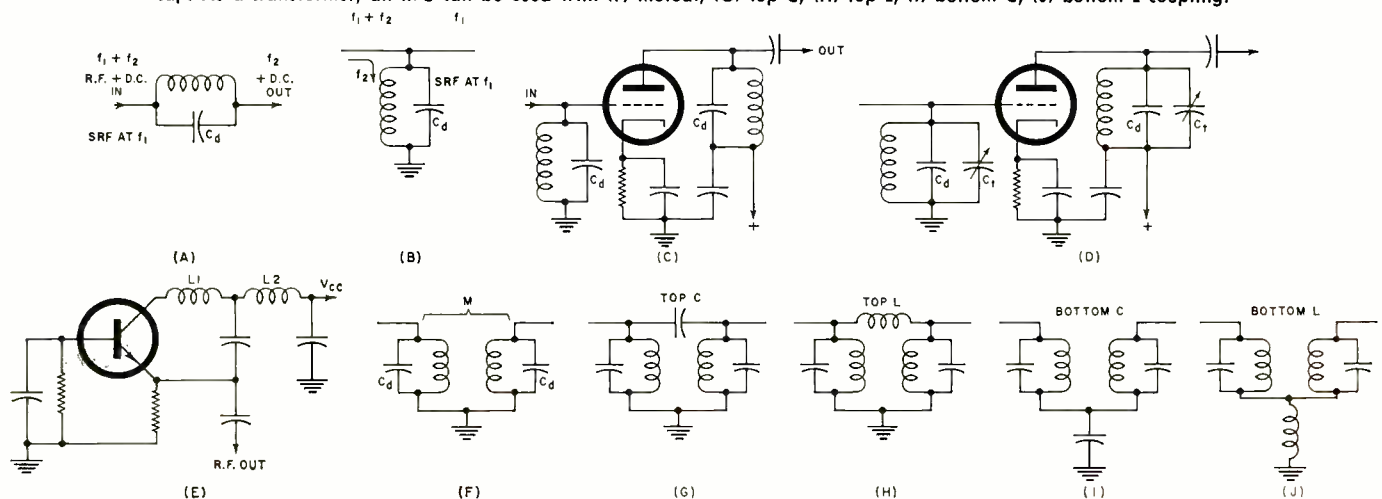

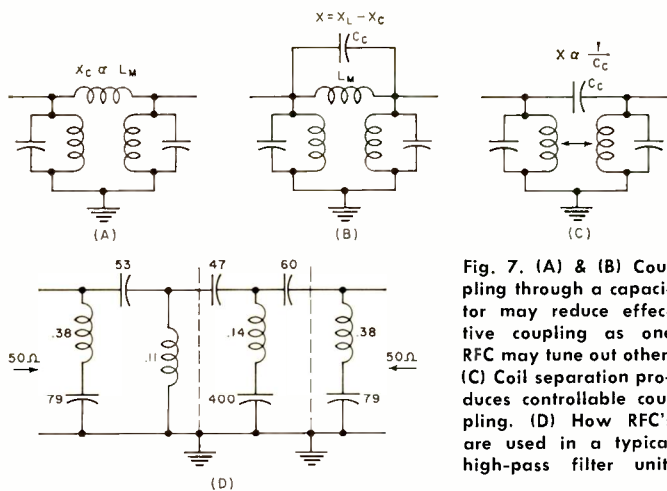

Fig. 7. (A) & (B) Coupling through a capacitor may reduce effective coupling as one RFC may tune out other. (C) Coil separation produces controllable coupling. (D) How RFC's are used in a typical high-pass filter unit.

Because of the distributed elements, a choke may be thought of as a series circuit composed of a number of elements, each element consisting of several small inductances and capacitances in parallel; as two parallel branches, with one leg a series of small coils and the other leg a series of small capacitors; or even as a combination of the two, which would make it the equivalent of multi-element filter circuits. Hence, at any given frequency, a choke can appear as almost anything from a high parallel-resonant impedance to a very low series-resonant impedance.

It is customary, however, to select a choke having its highest parallel-resonant impedance when it is to be used as an r.f. suppression element in a supply line (in series with a "B+" line, for example), as shown in Fig. 6A. If a choke is selected having the same self-resonant frequency (SRF) as the frequency it is desired to suppress, then the choke must have the *highest series impedance* at that frequency. And because a choke is a completely self-contained high-impedance element, its SRF is not affected by external elements connected from either end to ground, and further attenuation is achieved by bypassing either or both ends of the choke. It is, however, affected by any parallel elements, and hence its SRF, "Q," or parallel-resonant impedance can be lowered.

Because it can be altered, such a choke may be utilized as a tank coil and tuned by a fixed or variable capacitor connected across the choke (Figs. 6B, 6C, and 6D) and have its loaded "Q" adjusted by adding a parallel resistor (or tube or transistor circuit). Two chokes in series, with the combination shunted by a capacitor, provides a tuned circuit with a tap (or an autotransformer), as shown in Fig. 6E. The tap can be adjusted by the proper selection of the inductance ratio or impedance ratio desired. Because of the extremely wide range of available chokes (0.10 μH to many millihenrys) in small increments, almost any ratio is obtainable.

It is also possible to use two chokes as primary and secondary of a transformer (Fig. 6F). Again, the wide range of values can be utilized for almost any transformation ratio. Depending upon the size and type selected (magnetically shielded types would not be suitable), the degree of coupling can be varied over a considerable range by adjusting the relative separation between the two choke bodies. If greater coupling is desired than can be obtained by mutual coupling, the usual methods of top C, top L, bottom C, or bottom L, as shown in Figs. 6F through 6J, can be utilized. However, because of the mutual inductance that exists between two chokes in close proximity to each other, additional coupling through a physical capacitance may actually reduce the effective coupling because one effectively tunes out the other (Figs. 7A and 7B). To prevent this from occurring, sufficient separation to minimize mutual coupling will give better control through the coupling elements, as indicated by Fig. 7C.

It is just this capability of being coupled to a coil or an-

other choke that often requires that a choke be connected so that such coupling is at a minimum. Contrary to the usual v.h.f. and u.h.f. wiring practices, it is often necessary to use maximum lead lengths on chokes so that they may be placed away from tuned circuits or supply lines containing similar or different chokes. And because of the peculiarities of the distributed constants that make the choke what it is, the extra lead length has little effect on its performance. Furthermore, placing a choke near the chassis, although increasing the effective distributed capacitance somewhat, will provide a certain degree of shielding.

If the choke is magnetically shielded, so much the better, for such a choke will not only have little or no coupling to circuits but will also not radiate any r.f. to surrounding circuits as is possible with unshielded chokes. However, a note of caution is necessary. If a magnetically shielded coil is placed too close to a tuned circuit, it can effectively load, or lower, the "Q" of that circuit considerably because the closed ferrite body of the choke acts as if a shorted turn were coupled to it.

As a series element, a choke may also be used as a trap, either at its SRF or at some other frequency, by tuning it as a parallel circuit with additional capacitance. As such, it may be coupled to a circuit either magnetically or capacitively. As a series-tuned trap, the tuning capacitance should be large relative to the distributed capacitance of the choke so that the effect of the distributed capacitance is minimized. If the choke inductance is small, its effective inductance may be adjusted by the length of its leads, as much as 10%.

Chokes may also be used, because of the small physical sizes and wide range of inductances available, in the construction of miniature filters. A typical high-pass filter is shown in Fig. 7D. In a majority of cases, the capacitance required is large, the inductance values small, and the mutual coupling must be at a minimum. Magnetically shielded microminiature chokes, combined with miniature ceramic capacitors, can produce a high-pass, low-pass, or bandpass filter of incredibly small size yet with extremely sharp bandpass characteristics and large off-frequency attenuations.

Reliability

R.f. chokes, like all other components, must be selected with a bit of wisdom and a lot of understanding. In general, most standard makes of chokes will give satisfactory results even beyond their rated capabilities, although this is not a recommendation to use them in that way.

As long as chokes are operated within their intended ratings, and their specifications and intended applications are considered wisely, there should be no problems either in experimental use or in production.

Recent impartial tests indicate that potted, cement-coated, or otherwise encapsulated coils tend to have a higher rate of failure as wire diameter is decreased. (Continued on page 68)

Inductance	Test Frequency (MHz)	SRF (approximate) (MHz)
.1-1.0 μH	25	500-164
1-10 μH	7.9	164-52
10-100 μH	2.5	52-15
.1-1 mH	.79	15-5.6
1-10 mH	.25	5.6-4.7
10-100 mH	.079	4.7-1.15

Table 1. Self-resonant frequency is higher than test frequency.

Table 2. The relationship between choke and "Q" meter tuning.

Frequency Condition	Choke Reactance	Capacitance Dial
Below SRF	Inductive	Increase for resonance
At SRF	Resistive (Resonant)	No change
Above SRF	Capacitive	Decrease for resonance

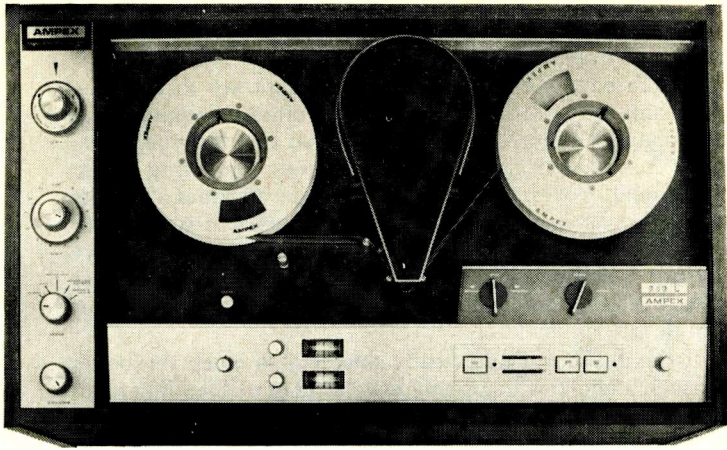

Top view of the recorder. Control center is at extreme left.

Ampex Home Video Recorder

By JOSEPH ROIZEN / International Video Consultant, Ampex Corporation

Design and operation of this manufacturer's lowest priced full helical scan recorder for in-home, educational, and industrial uses.

VIDEO recorders utilizing magnetic tape as a storage medium are beginning to rival the already familiar audio tape units in size, price, and simplicity. The Ampex VR-6000 series, designed for home use, is an example of such a device. Its cubic dimensions, weight, and cost are roughly double that of a good-quality audio recorder.

The Model 6200 console, which includes deck, base, and video control center, costs \$1495; the price of the Model 6100 basic deck alone is \$1095. The control center contains TV receiver front-end circuits for making a recording but no display monitor. The center also permits the recorder to be connected to any TV set's antenna terminals to allow the set to be used as a monitor during playback. A separately available camera and microphone kit sells for \$580. The recorder weighs just under a hundred pounds and will record and play back a 1-hour program using special 1-inch video

tape. A 10-inch reel of this tape (3000 feet) costs \$59.95, while a lighter duty tape is expected to cost \$39.95 a roll. The video head used is expected to have a minimum life of 500 hours with a replacement cost of under \$35. A tape made on one of these recorders can be played back on another similar Ampex recorder.

The VR-6000 uses the helical-scan principle with a single rotating head assembly (Fig. 1), laying down the 3° 6' angled tracks containing the picture signal. Two stationary heads record the control and audio track signals in normal longitudinal fashion along the top and bottom edges of the one-inch-wide tape (Fig. 2). Although the tape moves from reel to reel at only 9.6 inches per second, the effective writing speed of the 3600 rpm video head is 1000 ips.

The tape is guided around the helical scanning assembly by entry and exit guides that can be opened to facilitate threading (Fig. 3). When the guides are in the closed position, the video head is out of contact with the tape for only

Fig. 1. A single rotating video head lays down very slightly slanted (3° 6') video tracks on the 1-in tape. Fixed heads record and play back control and audio tracks near tape edges.

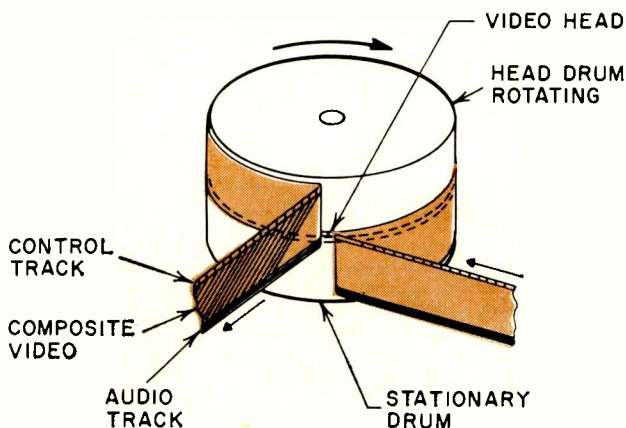
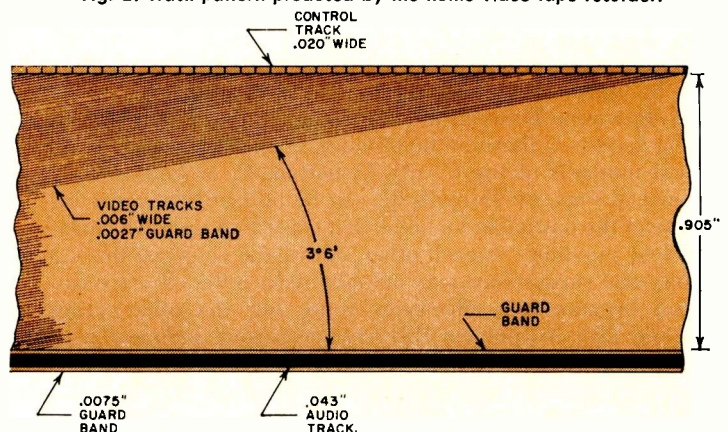

Fig. 2. Track pattern produced by the home video tape recorder.



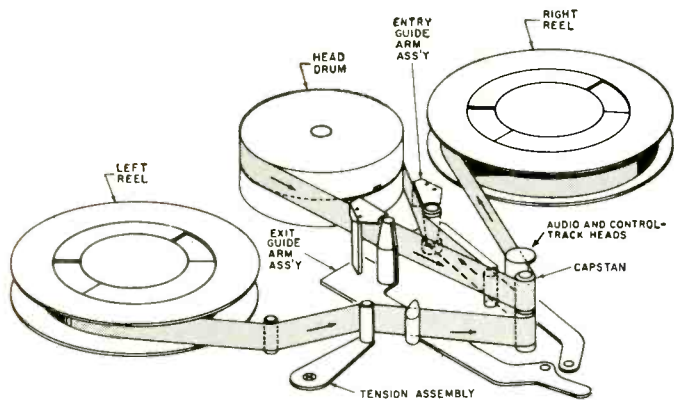

Fig. 3. During tape threading the guides are opened as shown.

a short time (a few horizontal lines) and this drop-out period is timed to occur just before vertical sync at the bottom of the picture where it is relatively invisible on the normally over-scanned monitor.

The only unusual controls on this recorder have to do with threading the tape and controlling its tension. A "Ready/Thread" knob opens the gates mentioned earlier. In the "Ready" position, the tape is tensioned by the holdback torque of the supply reel, but this may require slight changes to accommodate different tapes. A separate tension control knob actuates a pressure arm against the tape and varies the tape tension to optimize playback scanning of the video tracks. In the "Record" mode this tension arm is de-activated by a solenoid.

Although no specific control is provided for it, a feature not required on an audio machine is brought into play when the stop button is depressed. This is known as a "still-frame" presentation and presents a stop-motion image on the monitor screen whenever the recorder is in the play mode and as long as the "Ready/Thread" knob remains in the "Ready" position. The rotating video head then continues to scan the track representing a single TV field on the stationary tape. A slight pressure on the take-up reel will yield the best image, or permit moving slowly from track to track as the operator requires. In this way it is possible to pick out a single specific field that may be desired. The counter on the unit will permit rough location of any pre-recorded portion of the tape.

Signal System

Like most video recorders, the VR-6000 series utilizes a form of FM modulation which alters the character of the signal to be recorded from an amplitude varying one to a constant amplitude frequency variation. This greatly reduces the ratio between the highest and the lowest frequency to be recorded, thereby making the spectrum of recorded frequencies well within the read/write wavelength capabilities of the transducer. (The horizontal resolution of the played back picture is better than 250 lines while the video bandwidth is 20 Hz to 2.5 MHz.) The video input signal is applied through a video level pot which allows adjustment to a range of amplitudes normally encountered on a vidicon camera (Fig. 4).

The signal is pre-emphasized to improve signal-to-noise ratio and this pre-emphasized signal is then applied to a modulator operating between 3.0 and 5.0 MHz. A clamp in the circuit serves to maintain d.c. balance and to eliminate hum or tilt in the incoming signal. The output of the modulator is amplified and controlled so that the proper record current may be applied to the head. A final amplifier, known as a record driver, supplies the head current. The signal from the record driver is fed back to the playback circuitry so that monitoring of the incoming signal is actually done through most of the electronics of the recorder. This is known as the electronics-to-electronics signal and indicates that the system is functioning in the record mode.

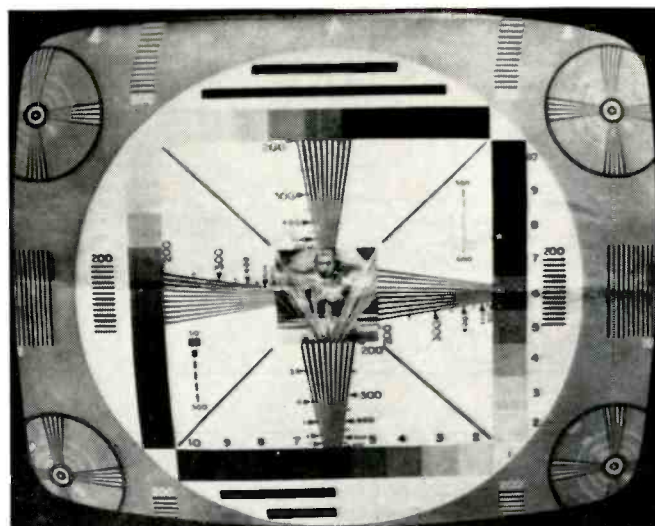

Off-the-screen monitor photo showing played back test pattern.

In playback, the video head output is connected to a high-gain preamplifier with equalization control. This is then fed to a series of limiters that maintain a constant amplitude output, even though the actual head output may be varying, due to changes in head-to-tape contact, drop-outs on the tape, etc. The output is detected and applied to a low-pass filter, which eliminates most of the FM carrier components and yields a video signal which is further amplified and applied to an r.f. modulator which can be adjusted to put out a composite television signal between channels 2 and 5 on a normal home receiver. The user selects an unused channel in his particular locality and he may then view the playback of his video-tape machine by switching his television receiver to that same channel.

Servo System

In order to control the timing of the television signal and the proper tracking of the rotating head on the video tracks, it is necessary to have a servo system in a video recorder. The function of the servo is to position the video head drum so that the tracks are written across the tape to some specific timing reference.

The vertical synchronizing signal is used as the reference and it is applied in the record mode to a pulse amplifier whose output is the sampling time for a signal derived from a tachometer head on the head drum (Fig. 5). The tachometer signal is delayed by a multivibrator and formed into a ramp

With the tape stationary, the rotating head scans the magnetic track corresponding to a single TV field. In the original photo scanning lines are clearly visible on close examination.

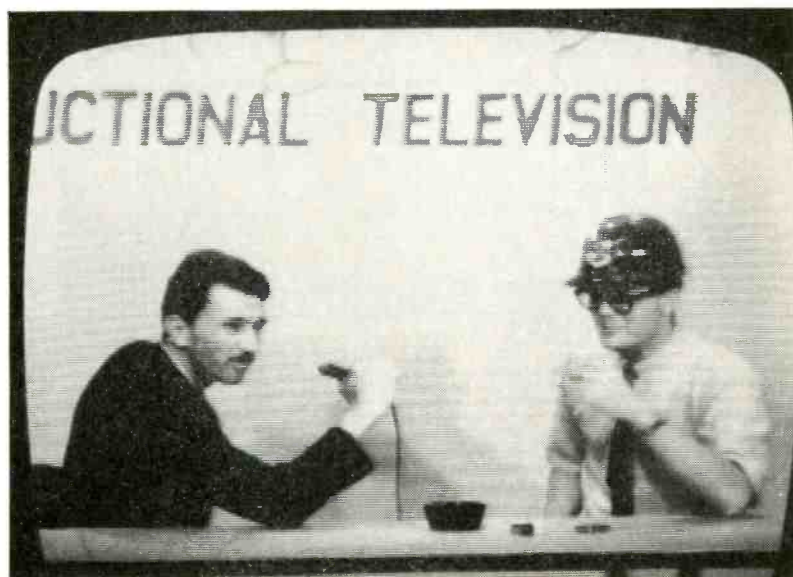

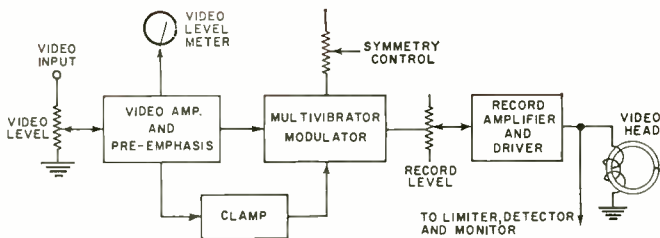

Fig. 4. Video signal circuits to the rotating video head.

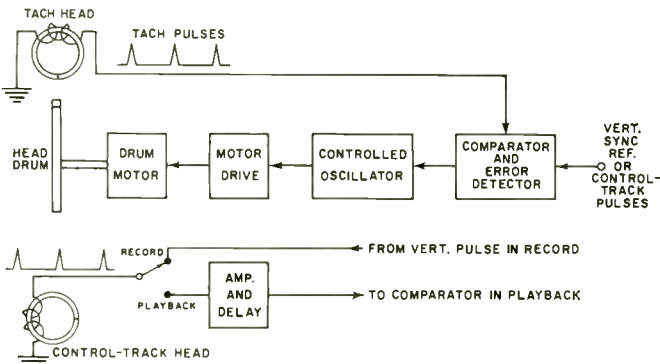

Fig. 5. Block diagram of the servo system which is employed to maintain proper speed so that video head tracks properly.

whose sloping gradient is proportional to the angular position of the drum motor. The ramp is sampled by the pulse derived from vertical sync and an error signal having the following characteristic is developed: the polarity of the error signal is the direction of the error and its amplitude is the magnitude. This voltage error then controls an oscillator which actually drives the drum motor through a binary counter and a power amplifier.

When the drum is in the wrong position, *i.e.*, the vertical pulse is not exactly at the right point on the tape, the sample pulse occurs too low or too high on the ramp signal (Fig. 6). Since the ramp evaluation at its center is zero volts, the sampling below or above this point applies a positive or negative voltage to the drum oscillator and the oscillator increases or decreases frequency proportionately. The drum motor accelerates or decelerates to minimize this error and when it achieves equilibrium, the sample pulses are centered on the ramp and the drum is now running at the right speed, properly positioned, and should continue to do so. This "lock-up" is achieved in a matter of a few seconds and a recording should not be initiated before this condition occurs. In the playback mode, the monitor image serves to indicate when the system is in synchronism.

While the recording is being made, the vertical sync signal is also being utilized to lay down an additional track along the top edge of the tape, referred to as the control track. This timing signal will be used in the playback mode to

Fig. 6. Operating waveforms of recorder's servo system.

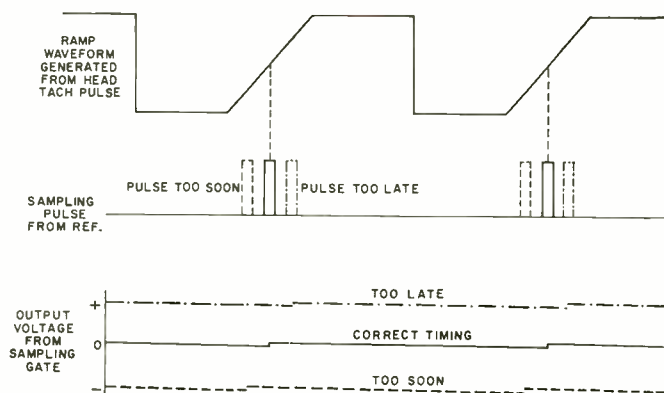

assure that the video head tracks accurately on the recorded signal. In playback, the control track head output is amplified and properly delayed through an adjustable multivibrator. This signal now becomes the sampling pulse for the drum phase comparator and the external reference is switched out of the circuit. The drum motor position is now being controlled by the coincidence between the control track and its own tachometer head. To adjust to optimum picture quality and minimum noise, a tracking control is included which alters the delay of the multivibrator driven by the control-track signal. If the delay is altered, the drum motor timing is changed until the playback signal quality is maximized. The capstan is locked to the power-line frequency since it is driven by 117-volt, 60-Hz a.c. power.

A single channel of audio is recorded simultaneous with the video signal, but displaced from it by the distance between the video-recording head and the stationary audio-head assembly. Since this distance is always fixed, synchronism is constantly maintained between the sound and picture.

The video recorder requires a low-impedance video signal at its input to provide the necessary electrical information. This is usually obtained from a camera if the recordings to be made are of local origination. However, for use in the home it is obvious that some means of taping shows off the air must be included so that the home viewer may record his favorite program while he is away, through the use of a pre-set timer. There is also the possibility that two desirable

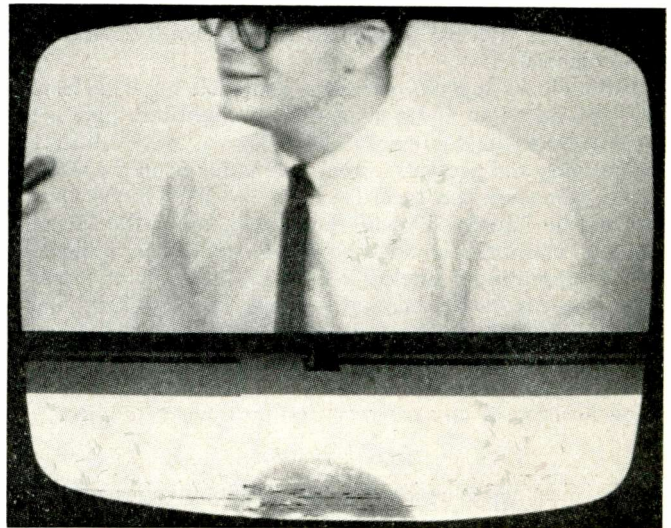

Still-frame display with the vertical interval intentionally rolled up into view to show the dropout at the bottom of the picture while the rotating video head is leaving the tape.

programs may occur simultaneously and it would be useful to record one while watching the other. The recorded program can then be replayed at a more convenient time. To accommodate this, the system includes a video control center, which has a built-in tuner and a switching arrangement that permits input selection. The tuner is then set to the alternate channel and that signal is recorded while the desired channel is being watched. No modifications are necessary to the television set and the playback of the recorder is available on the selected channel, which is not in public use.

When the camera input is being used, the television receiver acts as a monitor and it is possible to carefully set up the home video recorder for optimum results. Switching the recorder into the play mode then provides an instantaneous replay showing that the television image has been properly transferred to the tape. In due time, tape libraries will carry pre-recorded video tapes which can be used for entertainment or information with the recorder. Especially in the educational field, this should be of great advantage for home-study courses of various kinds. ▲

No Waiting In This Line



Kit GR-53A **\$375⁰⁰** (less cabinet)

Step Right Up And Enjoy The True-To-Life Pictures Of A HEATHKIT® 21" COLOR TV... Now Available For Immediate Delivery!

Supply Catches Demand. Until recently, this unique color TV kit has been on a reservation basis due to the nation-wide shortage of color tubes. However, at the moment we have them in stock for immediate right-to-your-front door delivery.

The Only 21" Color TV You Can Align & Maintain! You degauss, converge and adjust the picture . . . *anytime* you decide color purity needs it. Exclusive "built-in self-servicing facilities" coupled with simple-to-follow instructions and detailed color photos show you exactly what to do and how to do it. Results? Clean, beautifully sharp color pictures day in and day out.

Only 21" Color TV You Can Install 3-Ways! Mount it in a wall, your own or either Heath cabinet. Picture tube is warranted for a year, all other parts for 90 days.

From Parts To Pictures In Just 25 Hours! As easy to build as an audio amplifier. And you enjoy the savings (quality compares to sets costing up to \$200 more). Easy credit terms available, too. Get the full story in your FREE Heathkit catalog!

Kit GR-53A, all parts except cabinet for wall mounting, 125 lbs. . . . **\$375.00**
 Assembled GRA-53-7, walnut wood cabinet (illustr.), 82 lbs. . . . **\$108.00**
 Assembled GRA-53-6, walnut-finished hardboard cabinet, 51 lbs. . . . **\$46.50**

Heathkit®/Thomas "Coronado" Transistor Organ!

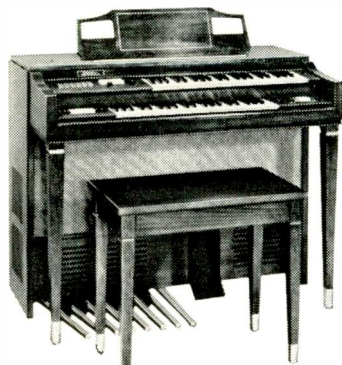

Kit GD-983
\$799⁰⁰

All Genuine Thomas Factory-Fabricated Parts! Boasts 17 organ voices, two 44-note keyboards, rotating Leslie plus 2-unit main speaker system, 28-notes of chimes, 13-note heel & toe pedalboard, color-tone attack & repeat percussion, all-transistor 75-watt EIA peak power amplifier, luxurious hand-crafted walnut cabinet with matching bench. Liberal credit terms available. 245 lbs.

Play In Minutes Instead Of Months...

With This New
 Heathkit®/Thomas
COLOR-GLO
 Organ



Kit GD-325
\$349⁹⁵
 (less bench)

Just Match Up The Colors With Your Left Hand, the letters with your right hand . . . and you play complete songs with melody, harmony and bass . . . even if you've never played an organ before! When you're finished, just flip a switch and the Color-Glo key lights disappear, leaving a beautiful spinet organ. Includes 10 organ voices, two 37-note keyboards and more! 153 lbs. Matching walnut bench, 18 lbs. \$24.95



FREE!

**World's Largest
 Kit Catalog!**

108 pages! Over 250 easy-to-build kits for stereo/hi-fi, amateur radio, shortwave, test, marine, CB, educational. Mail coupon or write Heath Company, Benton Harbor, Michigan 49022.



Heath Company, Dept. 15-5
 Benton Harbor, Michigan 49022

Enclosed is \$ _____, plus shipping.

Please send model (s) _____.

Please send FREE Heathkit Catalog.

Name _____

Address _____

City _____

State _____

Zip _____

Prices & specifications subject to change without notice.

CL-241

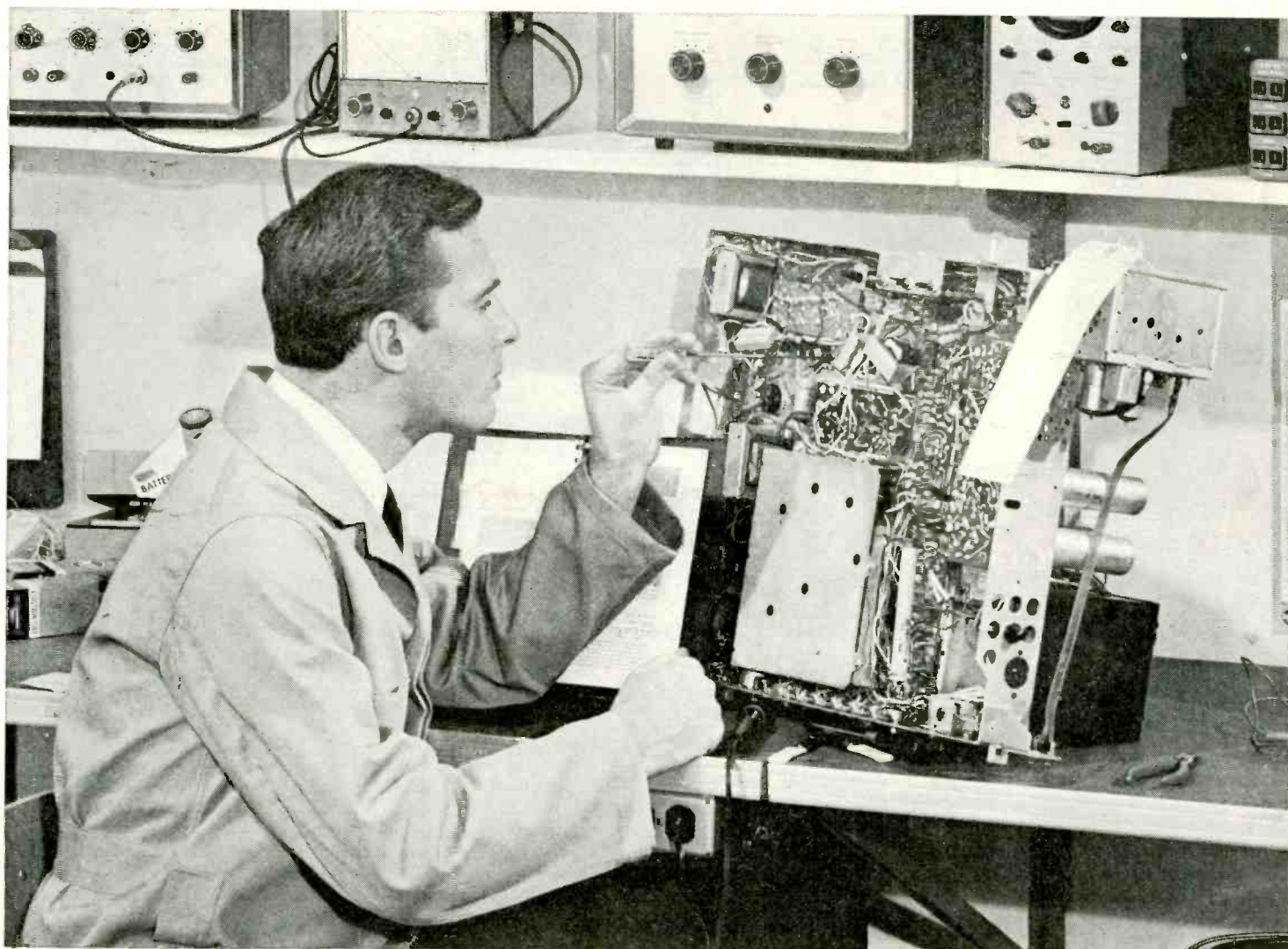

RCA TRAINING can be the smartest investment you ever made!

**Start building a profitable career in electronics now!
New RCA "AUTOTEXT" programmed instruction will help you
learn faster and easier!**

If you're considering a future in electronics, now is the time to start! A great new teaching aid—"AUTO-TEXT" programmed instruction developed by RCA and introduced by RCA Institutes will help you master the fundamentals of electronics almost automatically. Even people who have had trouble with conventional home training methods are finding it easier and more fun to start their training in Electronics Fundamentals the RCA way. Prove

it to yourself as others throughout the country are now doing. An interest or inclination in electronics is what you need. RCA "Autotext" helps you to do the rest. You'll be ready to go on to advanced training sooner than you ever thought possible! The future is unlimited; the jobs are available. The important thing is to get started now.

Founded in 1909, RCA Institutes is one of the largest technical schools in the United States devoted princi-

pally to electronics. The very name "RCA" means dependability, integrity, and scientific advance. RCA Institutes offers the finest facilities of home training. A Service of the Radio Corporation of America, RCA Institutes gives you the technical instruction you need to plan, build and realize the career you want in today's fastest growing field.

Investigate your future now at RCA Institutes. It can be the smartest investment you ever made.

HOME TRAINING COURSES

RCA Institutes offer this complete selection of Home Training Courses

- Electronic Fundamentals
- Electronic Fundamentals (in Spanish)
- TV Servicing
- Color TV Servicing
- Transistors

- Communications Electronics
- FCC License Preparation
- Mobile Communications
- Automation Electronics
- Automatic Controls

- Industrial Applications
- Nuclear Instrumentation
- Digital Techniques
- Computer Programming
- Drafting

Liberal Tuition Plan. All RCA Institutes Home Study courses are available under a Liberal Tuition Plan. This plan affords you the most economical possible method of home study training. You pay for lessons only as you order them. If, for any reason, you should wish to interrupt your training, you can do so and you will not owe a cent until you resume the course. No other obligations! No installment payments required.

RCA Personal Instruction. With RCA Home Study training you set your own pace in keeping with your own ability, finances and time. RCA Institutes allows you ample time to complete the course. Your lesson assignments are individually graded by technically trained personnel, and helpful comments are added where required. You get theory, experiment, and service practice beginning with the very first lesson. All lessons are profusely illustrated. You get a complete training package throughout the entire course.



You Get Prime Quality Equipment. All kits furnished with the course are complete in every respect, and the equipment is top grade. You keep all the equipment furnished to you for actual use on the job... and you never have to take apart one piece to build another.

CLASSROOM TRAINING IN NEW YORK CITY

No previous training required. You are eligible even if you haven't completed high school.

RCA Institutes Resident School in New York City offers training that will prepare you to work in rewarding positions on research and production projects in fields such as automation, transistors, communications, technical writing, television, computers, and other industrial and advanced electronics applications. If you did not complete high school, RCA will prepare you for such training with courses specially designed to provide the basic math and physics required for a career in electronics. Check classroom training on attached card, and full information will be rushed to you.

Free Placement Service. RCA Institutes graduates are now employed in important jobs at military installations with important companies such as IBM, Bell Telephone Labs, General Electric, RCA, and in radio and TV stations all over the country. Many other graduates have opened their own businesses. A recent New York Resident School class had 93% of the graduates who used the FREE Placement Service accepted by important electronics companies... and had their jobs waiting for them on the day they graduated!



Coeducational Day and Evening Courses. Day and Evening Courses are available at RCA Resident Schools in New York City. You can prepare for a career in electronics while continuing your normal full-time or part-time employment. Regular classes four times each year.

**SEND POSTCARD FOR FREE ILLUSTRATED BOOK TODAY!
SPECIFY HOME TRAINING OR CLASSROOM TRAINING.**

RCA INSTITUTES, INC. Dept. EW-56 SERVICE OF RADIO CORPORATION OF AMERICA, 350 WEST 4TH ST., NEW YORK, N.Y. 10014



The Most Trusted Name in Electronics



JOHN FRYE

Encouraging a boy's interest in electronics always carries with it the responsibility of stressing potential hazards

THE TECHNICIAN AND THE YOUNGSTER

BARNEY pretended to be aligning the portable TV set on the service bench, but he was really cocking an ear to the conversation between Mac, his employer, and a freckled, shorts-clad boy holding a bulky radio in his thin arms and looking earnestly up into the face of the shop owner.

"Okay, kid," Mac said with assumed gruffness; "you told the office girl this was an urgent matter and that you had to see me personally right away. What's all this about?"

"Mr. McGregor," the boy said, "I'm in big trouble and I need help."

"What kind of trouble?"

"It's like this: I like to mess around with electricity and radio and stuff like that. Last night I got this bright idea—at least it seemed a bright idea then—of running a couple of wires from the voice coil of the speaker in this radio Dad keeps in his den down through the cold air register to another speaker above my workbench in the basement. Soldering on the wires was no sweat, and both speakers worked fine when I plugged in the radio; but when I tried to turn the radio off, the switch had no effect. The radio kept right on playing.

"What's more, when I moved the wires coming from the speaker, they made sparks where they touched the metal air duct, and this made a heck of a noise in the radio. I pulled the plug, cut off the wires going to my speaker, and sneaked out the back door with the radio. My dad will really clobber me if he finds out I've messed up this particular radio. You see, he's real proud of it because my big brother—he's in Vietnam now—bought it several years ago for Dad's birthday with the very first money he ever earned."

"A father *would* be pretty proud of something like that," Mac agreed, examining the thin cotton insulation on the two stiff wires sticking out through a hole in the cardboard back of the set. "What do you want me to do?"

"I want you to find what I did to the radio and fix it—no matter what it costs!" the boy blurted. "I've only got a dollar and thirty-five cents now, but I'll give you every penny of my allowance until I pay all of it—that is, if you'll trust me."

"I don't know about that," Mac demurred with pretended seriousness. "We don't do any credit work here. However," he went on hastily as he saw tears welling in the boy's eyes, "we may be able to work something out. First, let's find out how much damage you did."

He put an ohmmeter across the prongs of the line plug and clicked the switch on and off several times. With the switch on the meter indicated around 100 ohms; but each time the switch clicked off, the meter pointer fell back to an infinite resistance reading. Next, the switch still on, Mac checked for resistance between each of the line-plug prongs and one of the stiff wires coming from the speaker coil. One prong gave a reading of about 100 ohms; the other, zero resistance. Finally he plugged in the receiver. In a few seconds it began to play normally, and when the switch was turned off it quit playing. After waiting half a minute for the filaments to cool down, Mac turned the set back on and then off with the same results.

"Hm-m-m-m," he said, a twinkle in his eye that only Barney noticed, "I thought you told me the radio wouldn't turn off. By the way, boy, what's your name?"

"It's Tommy, and the radio *wouldn't* turn off. Honest it wouldn't. I wasn't lying to you."

"I know you weren't Tommy, and I also know you are a very lucky boy. This funny-acting radio could easily have killed you. Why do you think this notice is printed on the back of the set?"

"Warning: this receiver is equipped with an interlock switch for your protection. The back should be entirely removed before an attempt is made to change tubes," Tommy read aloud. "I suppose they don't want you burning yourself on hot tubes."

"Huh-uh," Mac replied, shaking his head. "They don't want you electrocuting yourself. This is what we call a 'hot chassis' receiver. One of these line-cord wires goes through the switch directly to the metal chassis of the set. The speaker frame is bolted to the chassis, and one side of the voice coil is connected to the speaker frame; so, when the radio is playing, one of these wires you soldered to the voice coil is actually connected to one side of the 120-volt a.c. line. Do you know one side of that line is connected to the earth, both at the point where it enters your house and at the pole transformer out in the alley?"

"I know one wire is called a 'hot' wire and the other a 'ground' wire," Tommy admitted guardedly.

"Good. Now you know why. When you pulled the wire through the furnace duct, this cheesy insulation scraped off and made a connection from the radio chassis to ground through the wire, the metal duct, and the grounded furnace. Then you got lucky and inserted the plug in the wall socket so the wire leading through the switch to the chassis was connected to the grounded side of the line. That meant when the switch was on current could flow back to the pole transformer through either the ground wire or through the earth. Turning the switch off merely opened the wire circuit. Enough current still flowed through the earth circuit to keep the radio playing. Moving the speaker wires disturbed the electrical connection between the wires and the duct, producing the sparks and making the noise in the radio.

"Had you, while standing on the cement floor of the basement, touched the speaker wire and moved it so that it broke connection with the duct, the current would have flowed to ground through your body instead of through the furnace. That could have very easily been fatal."

Tommy's shoulders hunched together in a little shiver. "What would have happened if I had put the plug into the wall socket so that the hot wire went to the switch?" he asked.

"Well, as soon as you turned on the switch, the 120-volt line would have been short-circuited back through the earth circuit. A fuse would probably have blown, but before that happened you could have ruined the speaker or the switch in the radio."

While talking, Mac had been busy taking the back off the set, cutting loose the wires from the voice-coil terminals,

and then buttoning the receiver back up. He arranged the line cord in a neat hank and handed the radio to the boy.

"How much do I owe you?" Tommy asked.

"I believe a dollar would be about right," Mac replied.

The boy fished a crumpled dollar bill from the pocket of his shorts and handed it to Mac. "I sure do thank you, Mr. McGregor," he called over his shoulder as he headed for the door. "This has really taught me a lesson I'll remember."

"Good kid," Barney commented when the boy was gone; "but I'd have bet you wouldn't charge him anything."

"That would have robbed him of his dignity," Mac explained. "He realized he'd made a mistake and was doing his best to rectify it like a man. Seeing this, I treated him like a man—as he wanted and deserved to be treated."

"You know," Barney observed, "for a man who never had a son you're a pretty understanding cuss. You make me a little ashamed of something I did last week. Three kids came to the house and wanted me to help them work out an electronic method for keeping tab on the flight of an experimental rocket they were building. They had some kind of a hazy notion about building a radar system to do this. Naturally, I told them this was out of the question, and I really gave them the old brush-off. My conscience has been pricking me about this ever since; and just now, when I saw you handling that youngster, it gave me a real jab. I'm going to get in touch with those kids tonight and see what we can work out that they can build themselves."

"Fine! I've always felt a man fortunate enough to acquire a fund of technical knowledge has a sort of obligation to share that knowledge with youngsters who seek and need his help. You might call it a kind of intellectual *noblesse oblige*. I never forget that if one man hadn't been kind and understanding to me when I was a kid I'd probably not be in electronics."

"Who was that?" Barney asked.

"He operated a combination garage and one-horse motion picture show back in the little Arkansas town where I was born. I was fascinated by the 32-volt Delco system he used to charge storage batteries and to furnish power for the theater house lights and the carbon-arc light in the projector. I kept pestering him until he finally showed me how to care for the two-volt glass cells and to operate that Delco d.c. generator. I think the proudest moment of my whole life was the first time he let me press that little black tongue that actuated the starter of the gas-driven generator."

Mac paused a few seconds to enjoy the fond memory and then continued. "He always had several spare cells, and

he'd let me take two or three of these home at a time for my experimenting. When they were exhausted, I'd simply exchange them for freshly charged cells. You can't imagine what it meant to have an unlimited supply of electricity with which to experiment back in those days of coal-oil lamps. I built my own electric magnets, motors, bells, induction coils, and even a telephone. After that, electricity and I were married for life."

"I know what you mean," Barney said. "When I was a kid I haunted the home of a radio ham who lived just behind us. He used to say jokingly that he expected to find me sitting on his doorstep when he took in the milk and when he put out the cat. But he took the time and trouble to answer my questions, to lend me books, and to help me learn the code. That man helped me find what I wanted to do for my life's work."

"There's a lot of satisfaction and a lot of responsibility in encouraging a youngster to become involved in electronics," Mac mused. "The satisfaction is pretty well wrapped up in that remark that a man never stands so tall as when he stoops to help a child. As for the responsibility, you have to begin with, and keep harping on, the dangers of electricity. As we just saw, a little knowledge is truly a dangerous thing in this business, and it is not in the natural disposition of a youngster to worry about what *might* happen; yet that is precisely what a person must do constantly when he's working around electricity. When you're working with something that moves 186,000 miles a second, anticipation of trouble is your only protection."

"Hey, Boss, I just happened to think that I am a good example of what you have been talking about. If course I'm not a kid any longer, but you have certainly spent a lot of time and patience on me over the years. Just about everything I know about electronics you've taught me. I hope that gives you a little satisfaction."

"Oh I'm not *too* ashamed of you," Mac said with a teasing grin. "Considering what I had to work with, I've done fairly well!" ▲



"It seems her telephone and TV both went out at the same time."

FAMOUS WALKIE-TALKIE KNIGHT KIT



\$5.88
each Postpaid

Buy a pair for two-way fun.

- Tens of thousands sold at \$8.88 each!
- No license needed; operates hours on one battery.
- Complete with Ch. 7 transmit crystal.
- Fun to build yourself.

Even Allied has never before offered such value in a walkie-talkie kit! Sends and receives messages up to ¼ mile with 3-transistor circuit. Takes just a few hours to assemble. Sensitive super-regenerative receiver, push-to-talk transmitter. Telescoping antenna. Blue case 5½ x 2½ x 1¾". Add 27c for each battery.

- Use coupon below to order your kit now.
- Check box to receive latest Allied catalog.

Allied Radio, Dept. 1E
100 N. Western Avenue
Chicago, Ill. 60680 Yes, send new free catalog!

Please send me.....Knight walkie-talkie kits (83 PR 804 RPW). I enclose \$5.88 for each unit. Also send.....batteries (83 PR 005 RPW). I enclose 27c for each battery. Satisfaction guaranteed or money back.

NAME..... (please print)

ADDRESS.....

CITY, STATE..... ZIP.....

CIRCLE NO. 125 ON READER SERVICE CARD

**WORLD'S FINEST
5-CORE SOLDER**

**ERSIN
MULTICORE**

**NEW EASY
DISPENSER
PAK ONLY 69¢**

BUY IT AT RADIO-TV PARTS STORES

MULTICORE SALES CORP. WESTBURY, N.Y. 11590
CIRCLE NO. 104 ON READER SERVICE CARD

THE 1966 PHOTOGRAPHY ANNUAL



PHOTOGRAPHY ANNUAL—the favorite photographic showcase of camera enthusiasts the world over! It's an issue you'll enjoy and learn from...one you'll want to add to your collection of valuable photographic editions! To receive your copy by mail, thereby avoiding any chance of disappointment, be sure to send your order today!

PARTIAL CONTENTS include these portfolios

- Ralph Morse—"Biographer of the Space Age."
- Book Preview! John Rawlings' figure studies.
- Gary Winogrand's amusing "Look at the Animals."
- Story of the Year—dramatic Civil Rights photos.
- An extensive International Portfolio.
- Best News Pictures of the Year...and more!

PLUS...the full story behind each photo

Enjoy the convenience of having this year's edition delivered directly to your home!

\$1.25
only

GET THE EXQUISITE
LEATHERFLEX-COVERED
EDITION
for just \$3.00—POSTPAID!

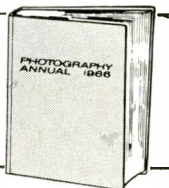

FILL IN, DETACH & MAIL

THIS FORM TODAY!

ZIFF-DAVIS SERVICE DIVISION • Dept. PA
589 Broadway • New York, N.Y. 10012

Please send my copy of the 1966 PHOTOGRAPHY ANNUAL as I've indicated below:

- Send me the regular edition. My \$1.25, plus 15¢ for shipping and handling (25¢ outside U.S.), is enclosed.
- Send me the Deluxe Leatherflex-Covered edition, postpaid. My \$3.00 is enclosed. (Orders outside U.S. add 75¢ to partially defray postage and handling costs.) Allow three weeks additional for binding and mailing.

name please print EW-56

address

city state zip-code

(Payment must be enclosed with order.)

Ultrasonics in Medicine

(Continued from page 29)

of lesion which produced them. Tomograms have successfully differentiated among several different types of benign and malignant breast tumors and some researchers feel that it is quite possible that the not too distant future will see ultrasound used for routine diagnostic screening of the breast in the same manner that chest x-rays are now used for mass screening for tuberculosis.

Systematic ultrasonic studies of the extremities have revealed that it is possible to depict and identify the skin surface, the fatty layers, the muscle groups and their fibrous sheaths, the blood vessels and even thickness of their walls. An interesting application of ultrasonic tomography not directly connected with medicine has been the evaluation of the quality (*i.e.*, fat content and distribution) of the flesh of animals selected for breeding purposes.

The development of convenient, portable contact scanners has greatly simplified the application of area B-scans to obstetrics. Excellent visualizations have been obtained of the fetus and its position in the uterus and these ultrasonic tomograms have been used to demonstrate the presence of multiple pregnancies and of several types of abnormalities.

Recent improvements in the sensitivity and convenience of ultrasonic transducers and scanning apparatus, as well as improvements in the technique and greater sophistication of the interpretations have made it possible to extend the use of ultrasonic tomography to the direct visualization of intracranial tumors. In this technique, described by Dr. Adapon of the New York University Medical Center and Dr. Grossman of the University of Pittsburgh School of Medicine, a motorized scanning bridge moves a transducer at a predetermined rate on the surface of the skull. As in all B-scans, display apparatus is switched to the intensity modulation mode which produces a signal whose brightness is proportional to echo amplitude. As the transducer moves along the surface of the head, a corresponding line of dots moves vertically over the screen of the

oscilloscope. Position of the transducer is displayed on the vertical axis and the distance of the echo from the skin surface on the horizontal axis. The shutter of the recording camera is left open throughout the scan and results in a two-dimensional image of a cross-section of the head in the plane of the moving transducer. On these images normal and abnormal intracranial masses have been visualized directly and not merely by inference as they are in the time-amplitude scans of the midbrain structures. This technique is new and most American research up to now has been done on *known* lesions. However, clinical researchers are hopeful that enough studies on unknowns will be done in the next few years to yield diagnostic results acceptable to the medical profession.

Surgical Application of Ultrasonics

The third major area of medical ultrasonics—that of the destruction of diseased or unwanted tissues—is still further from broad medical utilization but is already being used in certain specific procedures. One of these is the selective destruction of the vestibular function of semicircular canals of the inner ear in the treatment of acute forms of Meniere's disease. This disorder is characterized by severe ringing of the ears, vertigo, and nystagmus—an uncontrollable side-to-side motion of the eyes.

In this treatment a special focused transducer is placed directly on the surgically exposed semicircular canal and driven at 3 MHz. This frequency produces rapid attenuation of the signal and thus limits its penetration to the desired area. Ultrasonic energy, applied at intensities of 3 to 8 watts per cm², destroys the diseased or malfunctioning epithelial cells in the labyrinth without damage to the hearing. This treatment has had a high percentage of success in thousands of cases in Italy, where the technique has been pioneered by Dr. M. Arslan, of Padua, as well as in the Presbyterian Hospital in New York.

A considerable amount of experimental data has already been accumulated at the University of Illinois and several other biomedical research centers on the selective destruction of small volumes of tissue within the brain. Using focused multiple ultrasonic radiators and

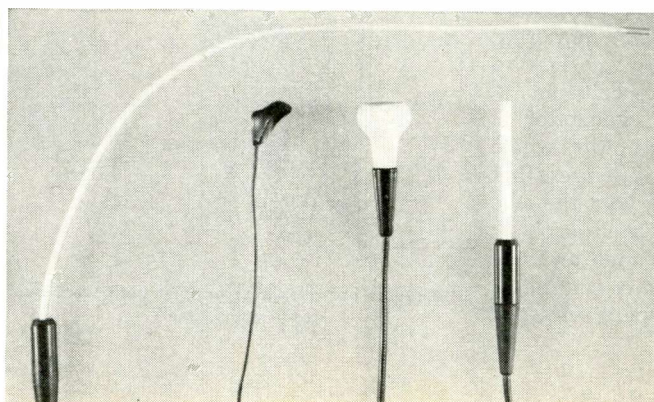

Various types of ultrasonic transducers. From left to right: transducer mounted at end of long, flexible probe; finger-tip transducer for examination of exposed organs; general-purpose 2-MHz transducer for external examinations; pencil-type 7.5-MHz transducer to provide narrow beam to locate foreign bodies.

intensities of 50 to 1500 watts per cm², researchers have been able to produce precisely placed lesions as small as one mm³ at 1 MHz and as small as 0.02 mm³ at 2.7 MHz.

Such minute and precisely positioned brain lesions have been produced for treatment and relief of intractable pain, the tremors and rigidity of Parkinson's disease, and the involuntary athetoid movements associated with cerebral palsy. Prefrontal ultrasonic irradiation has been used as a substitute for lobotomy and further possible application is indicated for the treatment of psychomotor epilepsy.

The specific and particular advantages of high-intensity ultrasonic neurosurgery are varied. The precise location of the unwanted tissue can be checked by the disappearance of the symptoms at lower sonic intensities—before ultrasonic energy of sufficient intensity to destroy the tissue permanently is applied. Precisely controlled ultrasound is able to destroy brain tissue without affecting any of the surrounding or even contained blood vessels and, of course, to reach deep-seated internal areas without damaging the intervening tissues. However, although ultrasonic energy will penetrate the skull for ordinary diagnostic purposes, precise surgical procedures on the brain require the removal of portions of the bone through which sound beams are to pass in order to minimize scattering and obtain more precise control. To obtain accuracy within a few thousandths of an inch, human neurosurgical apparatus possesses extreme rigidity. To prevent motion during the irradiation procedure the skull of the patient is held by stainless steel pins with hemispherical ends which fit into shallow hemispherical depressions drilled in the skull.

While the most dramatic applications of ultrasonics to medicine have been in the areas described, these by no means exhaust its usefulness. Among the ancillary medical and biological applications are several ultrasonic methods for measurement of blood flow and viscosity.

It has been pointed out that the comparative rates of the growth of our population and of the production of physicians make it inevitable that the present ratio of one doctor to every 790 persons will decrease to one to a thousand by 1980.

However, this decreasing ratio of doctors to patients does not mean a decline in the adequacy or quality of medical care. On the contrary, there is every indication that the improvement in medical technology, the development of new drugs, and the utilization of advanced electronic systems and devices will provide even better medical care. Ultrasonics in its many applications will certainly provide an important modality to make this possible. ▲

WHY bother with makeshift twist-prong capacitor replacements?

When you substitute capacitor sizes and ratings, you leave yourself wide open for criticism of your work . . . you risk your reputation . . . you stand to lose customers. It just doesn't pay to use makeshifts when it's so easy to get the exact replacement from your Sprague distributor!

Get the right SIZE,
right RATING every time
with improved



**SPRAGUE
TWIST-LOK®
CAPACITORS!**

1,863 different capacitors to choose from!

The industry's most complete selection of twist-prong capacitors, bar none. Greater reliability, too. Exclusive Sprague cover design provides a leak-proof seal which permits capacitors to withstand higher ripple currents.

GET YOUR COPY of Sprague's comprehensive Electrolytic Capacitor Replacement Manual K-107 from your Sprague Distributor, or write Sprague Products Co., 51 Marshall Street, North Adams, Mass.



WORLD'S LARGEST MANUFACTURER OF CAPACITORS

65-126-03 R1

BOOK REVIEWS

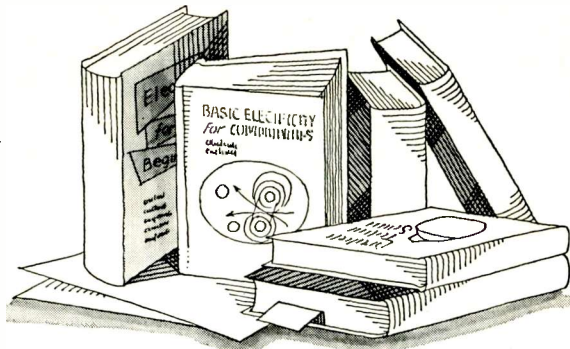

"DICTIONARY OF ELECTRONICS" by Harley Carter. Published by *Hart Publishing Company, Inc.*, 510 Sixth Ave., New York, N.Y. 10011. 410 pages. Price \$2.65. Soft cover.

In order to meet the needs of students and engineers in the fast-changing field of electronics, this concise, illustrated, and inexpensive dictionary has been prepared.

The terminology is British, but American users should experience little difficulty in making the transition. Priority has been given to the inclusion of fundamental facts and terms and the other entries follow on from these. Also listed are familiar terms and descriptions of many electronic instruments. Definitions cover many branches of electronics, including radio, television, communications, radar, electronic instrumentation, and industrial electronics.

A rather extensive appendix includes circuit symbols, abbreviations, color codes, conversion tables, and tube basing diagrams.

"TRANSISTORS: PRINCIPLES AND APPLICATIONS" by R. G. Hibberd. Published by *Hart Publishing Company, Inc.*, 510 Sixth Ave., New York, N.Y. 10011. 297 pages. Price \$5.95 cloth bound, \$2.45 soft cover.

The author, manager of the R&D Department of *Texas Instruments Ltd.*, offers a comprehensive guide to the characteristics and uses of the various types of transistors that have been developed in recent years. Included is information on the junction transistor, the epitaxial planar, the field-effect, metal-oxide silicon, and thin-film types. He discusses the principles of operation, transistor characteristics, equivalent circuits and parameters, and how to establish suitable d.c. operating conditions. There is even a chapter devoted to the manufacture of transistors so that the effects of the basic methods of fabrication and types of junction on transistor characteristics can be easily understood.

The operation and characteristics of associated semiconductor devices used in conjunction with transistors, such as the junction rectifier, the silicon controlled rectifier, the zener diode, the tunnel diode, the varactor diode, and the phototransistor are also covered.

The book also includes notes on handling and testing transistors and a chapter on solid-state circuit techniques.

The lavish use of line drawings, partial schematics, graphs, and charts helps to explain the text material. While the author is associated with *Texas Instruments Incorporated's* British affiliate, most of the information and circuitry will be easily recognized by American engineers and students.

"THE RADIO AMATEUR'S HANDBOOK" compiled and published by the *American Radio Relay League, Inc.*, Newington 11, Conn. 602 pages plus 32-page tube section, index, and 56-page catalogue section. Price \$4.00 in U.S. Soft cover.

This is the forty-third consecutive edition of the "amateur's bible" and represents a veritable treasure trove of useful information for the ham, engineer, and student of radio and electronics.

The chapters on the theory of radio communications have been updated to keep abreast of all phases of the art while material on equipment construction has been revised to take advantage of new design techniques. There are transmitter and receiver circuits for every amateur frequency range, and for special purposes such as mobile and portable operation. Theory and construction material is included for other important ham station equipment such as test and measuring instruments and antennas.

The chapter on vacuum tubes and semiconductor characteristics and tube basing diagrams has been brought up-to-date and provides one of the most complete such listings to be found within a single book.

"1966 WORLD RADIO TV HANDBOOK" compiled and published by *World Radio-Television Handbook Co. Ltd.*, Denmark. Available in the U.S. from *Gilfer Associates*, P.O. Box 239, Park Ridge, N.J. 07656. 304 pages. Price \$4.95 postpaid. Soft cover.

Another harbinger of Spring is the appearance of the new annual edition of WRH. This is the 20th such edition and includes a complete listing of medium- and short-wave stations (including TV), frequencies, broadcast

schedules, interval signals, addresses, station personnel, etc.

Of interest to SWL's is information regarding verification of reception reports, or lack of verification, for the various stations, what form verification takes, and correct mailing addresses of the various stations.

Maps, musical intervals for identification purposes, world time schedules, abbreviations used, etc. are extras which make the handbook especially useful. Incidentally, television stations (including location, call letters, and channel) are listed for the U.S., Canada, and Mexico.

"TRANSISTOR ELECTRONICS" by Karl-Heinz Rumpf & Manfred Pulvers. Published by *Pergamon Press Inc.*, 122 E. 55th St., New York, N.Y. 10022. 282 pages. Price \$10.00.

Subtitled "Use of Semiconductor Components in Switching Operations," this book is devoted almost exclusively to applications in digital systems and, as such, is designed primarily for design and development engineers and students of advanced electronic techniques.

The book contains extensive circuit and logic diagrams as well as many practical, worked examples. A large part of the book is devoted to semiconductor data, including standardization, rationalization, life-expectancy, and serviceability of components.

Since the authors have addressed this book to fellow engineers, they have assumed that their readers have the requisite background in mathematics and circuit theory. The translation from the German by Werner Stohl is excellent.

"DAVID SARNOFF" by Eugene Lyons. Published by *Harper & Row*, New York. 359 pages. Price \$6.95.

This is an "in depth" portrait of one of the electronics industry's best known figures. The author traces Mr. Sarnoff's life and works from his birth in Uzlian, a tiny isolated village in Russia, his emigration to the United States, his life in the ghetto of New York's Lower East Side and then Hell's Kitchen, and his struggle upward to head one of the largest electronic firms in the world.

The eldest child in his family, young David had to take over as the head of the house when his father died not long after the family emigrated. The range and variety of the jobs he tackled is impressive and gives some clue to the man to come.

There are long and detailed accounts of litigations, suits, countersuits, and contract negotiations which may be of less interest to the general reader than the details of Mr. Sarnoff's life and accomplishments but are a necessary part of the well-rounded picture of the man and his creation, RCA. ▲

NOW! ADD TO OR COMPLETE YOUR PHOTOFACT® LIBRARY AT PRESENT LOW PRICES!

UNTIL JULY 1, 1966—
SAVE
\$123⁷⁵
on your purchase
of a 225-Set
PHOTOFACT LIBRARY
ORDER NOW!



Until July 1, 1966, you can buy a PHOTOFACT LIBRARY (minimum of 60 Sets) at the present low Easy-Buy contract price of \$1.95 per Set—you save 55¢ per Set—you save over \$120.00 on a 225-Set Library purchase!

(After July 1, 1966, PHOTOFACT prices go up: Single Sets 1 through 200 go to \$3.00 each; Single Sets 201 through current issues go to \$2.50 each)

ACT NOW! THERE'S NEVER BEEN A DEAL LIKE THIS:

**NO INTEREST, NO CARRYING CHARGE
LIBRARY EASY-BUY PLAN**

- Yes—no interest—no carrying charge—no other deal like it!
- Only \$10 down—30 months to pay while the Library earns for you!
- Prepaid transportation to your shop.
- Add-on privilege of a year's advance subscription to current PHOTOFACT Sets on same contract.

4 WAYS TO SELECT YOUR LIBRARY

1. Complete your present PHOTOFACT Library.
2. Order a "Starter" Library of 225 Sets. (Sets 451-675—coverage from 1959 to 1964—only \$14.29 per month).
3. Order by brand name and year—see the handy selection chart at your Sams distributor.
4. Order a *complete* PHOTOFACT Library.

FREE

the famous
14-volume



NEW STANDARD ENCYCLOPEDIA!

RETAIL
VALUE
\$149⁵⁰

FREE with the purchase of a
PHOTOFACT LIBRARY consisting
of 225 or more Sets... an invaluable
TREASURY OF KNOWLEDGE for your family—a complete, authoritative, indispensable reference library for your home!

ACT NOW!
Offer ends
June 30, 1966

SAVE OVER \$120.00! Order your Photofact Library today!

See your Sams Distributor, or write for Easy-Buy Library details to Howard W. Sams & Co., Inc., 4300 W. 62nd St., Indianapolis, Indiana 46206

Back Issues Available

Use this coupon to order
back issues of
ELECTRONICS WORLD

We have a limited supply of back issues that can be ordered on a first-come, first-served basis. Just fill in the coupon below, enclose your remittance in the amount of 65¢ each and mail.

ZIFF-DAVIS SERVICE DIVISION
Dept. BCEW, 589 Broadway
New York 12, New York

Please send the following back issues of ELECTRONICS WORLD. I am enclosing _____ to cover the cost of the magazine, shipping and handling.

Month _____ Year _____

Month _____ Year _____

Month _____ Year _____

Name _____

Address _____

City _____ Zone _____ State _____

No charge or C.O.D. orders please. EW

GAS WELDING TORCH



Uses **OXYGEN**
and **LP GAS**

- Completely self-contained.
- Produces 5000° pin-point flame.
- Welds, brazes, solders.
- Hundreds of lightweight uses.
- Suggested list - \$19.95.



GET COMPLETE DETAILS AT MOST INDUSTRIAL DISTRIBUTORS, OR WRITE TO MICROFLAME, INC.

MICROFLAME, INC.
7800 COMPUTER AVENUE
MINNEAPOLIS, MINNESOTA 55424

SOVIET "POLAR-MODULATION" STEREO

A simple demodulator, reduced costs, and extra subcarriers are claimed for system.

USING a technique very similar to the American pilot-tone system of transmitting and receiving stereo broadcasts, Soviet engineers have been testing what they call the "polar-modulation" system of compatible stereo.

The basic difference between the two systems is that while the American method completely suppresses the 38-kHz modulated subcarrier, and transmits a 19-kHz pilot tone, the Soviet system does not transmit a pilot tone and only suppresses its 31.25-kHz subcarrier by 14 dB.

Both systems are capable of reproducing 30 to 15,000 Hz on either channel. Crosstalk attenuation above 300 Hz is better than 25 dB. Deterioration in the S/N ratio with A=B for mono transmission is 2 dB while for stereo reception it is 22 dB (compared with the 1 and 19 dB for the American system).

The Soviets also point out that in countries where a frequency deviation of ± 75 kHz is in force, their system can also permit (besides stereo) another subcarrier at 55 ± 5 kHz, and an SCA-type service at 67 ± 7 kHz, while still staying within the allowed 75 kHz.

The polar-modulation system modulates the subcarrier such that the positive half cycles of the subcarrier are modulated by one channel while the negative half cycles are modulated by the other channel (see insert in Fig. 1). At the polar-modulation receiver, the composite signal is detected and passed on to a stereo adapter such as shown in Fig. 1. Here, the incoming signal is passed through a filter peaked at the subcarrier frequency, amplified, and then passed through a cathode follower to a simple polarity detector. The output from the detector is then passed to external audio amplifiers.

Because the polar-modulation subcarrier is twice the frequency of the European TV horizontal line frequency, Soviet engineers point out that their system can easily be put to use in broadcasting stereo signals over a TV sound transmitter. In this case, the subcarrier itself does not have to be transmitted because it can be regenerated from the TV set line oscillator. The reduction in S/N ratio (with A = B) in the stereo channel is 0 dB in mono and 16.4 dB in the stereo mode. ▲

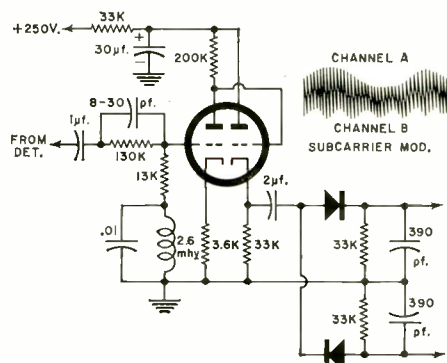

Fig. 1. Simple stereo adapter uses polarity detectors. The insert shows method of subcarrier modulation.

Chroma Demodulation

(Continued from page 47)

are simultaneously present at the three electron guns.

The actual circuitry used in all recent RCA color sets performs exactly the same functions as required by the matrixing principles but appears much more complex. As shown in Fig. 8, the matrixing circuits consist of three triode amplifiers which have their cathodes connected together. To make sure that no color signals appear during the retrace period, a blanking pulse is applied through C6 to the junction of the cathodes, cutting all three triodes off.

The exact amplitudes and components of X and Z at the various tube elements are quite complex to analyze because both signals are present at cathodes and plates. The important point is the principle of adding signals of various amplitudes and polarities.

In the R-Y stage, the -X signal is applied to the grid, but a portion of the plate signal is fed back, through R1, slightly reducing the amplification. The R-Y signal requires a large -X and a much smaller +Z signal. Looking at the B-Y amplifier, note that the -Z signal is applied at the grid, making the Z signal at the cathode positive. Because the cathodes are connected together, the R-Y amplifier will have a small +Z signal at the cathode which is then added to the -X signal applied at the grid.

As shown in Fig. 7, G-Y is made up of +X and +Z signals. The G-Y amplifier then receives a +Z signal on its cathode, but it also receives a +X signal on its cathode since all three cathodes are tied together. Note that the +X is larger than the +Z, and therefore a portion of the +X from the plate of the R-Y amplifier is applied to the grid of the G-Y stage through R5 and R6, which act as a voltage divider. At the B-Y amplifier, the -Z signal must be considerably larger than the +X and the -Z is therefore applied to the grid, while +X appears at the common cathodes.

Another way of analyzing the operation of the matrixing amplifiers would be to think of signals applied at the grid as having more amplitude, because of the gain inherent in the control grid, while those signals applied at the cathode would have a lower amplitude. We can say that +X and +Z appear at the cathode while -X and -Z appear at the grids of the R-Y and B-Y stages. The G-Y amplifier receives both +X and +Z at its cathode, but since the +X must be larger, an additional component is fed to the grid from the R-Y amplifier which acts as an inverter for the -X signal. ▲

*Installs
instantly!*

Hy-gain's new CITIZENS BAND "Magna-Topper"

- Alnico Magnet mount provides vise-like grip to any vehicle
- Easily moved from vehicle to vehicle
- Topper designed for maximum "Talk Power"

Now... excitingly different... highly practical... a superior performance Hy-Gain "Topper" with an Alnico base mount that allows instant installation on any car, truck, tractor, or other vehicle. No holes to drill, no special tools required... simply hook up the feedline to your CB transceiver, and you're ready to communicate loud and clear on any or all 23 channels. Unique base plate forms capacity connection to vehicle body to provide performance efficiency equal to that of permanently mounted antennas.

"Magna-Topper"... the most versatile mobile antenna ever! Superior performance top-loading design - exclusive Hy-Q loading coil - lifetime adjustable tuning rod - comfortable 29" overall height. Comes complete with 16 feet of coaxial cable and connector. Get yours today... Model TQRMB... \$14.95 Net



Powerful Alnico magnet in base mount holds antenna securely in place... even at speeds of over 80 MPH.



Available NOW from your
Hy-Gain distributor or dealer, or write...
HY-GAIN ELECTRONICS CORPORATION
8474 N. E. Highway 6 - Lincoln, Nebraska 68501

CIRCLE NO. 109 ON READER SERVICE CARD

Hy-gain "TOPPERS" FOR ANY MOBILE INSTALLATION

DX "ROOF TOPPER"
For biggest TALK POWER. 59" overall. \$16.95 Net.

SHORTY "ROOF TOPPER"
Powerful 19" model ignores low garaging... \$15.50 Net

"JIFFY TOPPER"
Mounts in trunk lip. No exterior holes to drill. \$13.95 Net

AM-CB "DUO-TOPPER"
Replaces AM whip. Outstanding on both AM & CB. \$14.95 Net

"MARINE TOPPER"
Delivers 1.5db gain. Mounts on any wooden or fiberglass hull. \$19.95 Net

All "Topper" models complete with mount, coaxial cable and connectors.

PUT **ZIP**
in
your mail

Include
**ZIP CODE NUMBERS
IN ALL ADDRESSES**

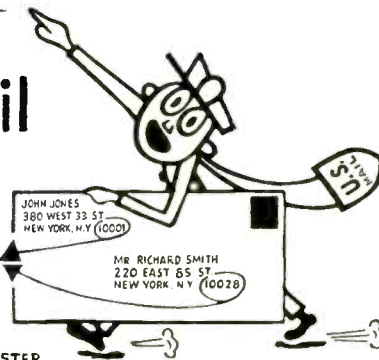

POSTMASTER

if you
snap
with
this...

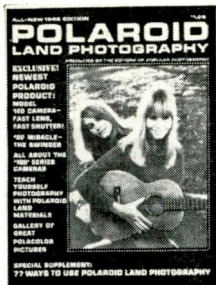
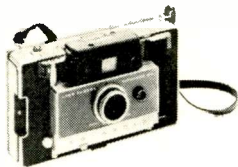

it's a
snap
with
this!

1966 POLAROID LAND PHOTOGRAPHY

If you own a Polaroid Land camera, or are in the market for one, sign up now for the most important "excursion" of your picture-taking career. An exciting tour through the miraculous world of "instant" pictures.

Your guide is the all-new 1966 edition of POLAROID LAND PHOTOGRAPHY — the only comprehensive and up-to-date handbook on the subject. The one knowledgeable guide that delivers the skill and know-how for the most rewarding Polaroid Land photographs you've ever taken!

Your tour begins the moment you open your copy... with a detailed inspection of every Polaroid Land camera in existence, including the swingin' "Swinger" and the fabulous, new Model 180, plus the complete line of accessories and film... next, a valuable course in photography basics and technique... an important discussion on amazing Polacolor... followed by 77 fascinating uses for Polaroid Land photography.

PLUS—gallery after gallery of masterful, enchanting Polaroid Land photographs — including 16 eye-opening pages in glorious color.

All in all, 116 fact-and-photo-packed pages of the most extensive, authoritative, important-to-you information available. **Sign up today.** Just clip the coupon below and return it with your remittance. **\$1.25**

Also Available —AN EXQUISITE LEATHERFLEX-BOUND EDITION... for just \$3 POSTPAID!

Ziff-Davis Service Division • Dept. PLP
589 Broadway • New York, N.Y. 10012

YES! Send me a copy of the 1966 POLAROID LAND PHOTOGRAPHY, as checked below:

\$1.25 enclosed, plus 15¢ for shipping and handling. Send me the regular edition. (\$1.50 for orders outside the U.S.A.)

\$3.00 enclosed. Send me the DeLuxe Leatherflex-bound edition, postpaid. (\$3.75 for orders outside the U.S.A.) Allow three additional weeks for delivery. EW-56

name _____ please print _____
address _____
city _____ state _____ zip code _____

PAYMENT MUST BE ENCLOSED WITH ORDER.

R.F. Chokes
(Continued from page 51)

Encapsulation tends to restrict the thermal expansion of the windings due to the different expansion rate of the encapsulating material. These tests indicate that such a restriction causes the wires to bite through the insulating coating and short adjacent turns together. However, these tests also show that the failure rate only increases rapidly above #34 AWG and at temperatures in excess of 150°C. Furthermore, most encapsulated chokes use materials that do not hinder expansion of the windings since the materials are, to a wide degree, either compatible in expansion coefficients or are thermosetting and tend to soften slightly with elevated heat.

How to Measure

Any of several instruments may be used to determine the various characteristics of r.f. chokes. The necessity for doing so, however, will depend upon what kind of information is made available by the manufacturer and just what interpretation can be made of this information.

The approximate SRF (self-resonant frequency) may be found quite simply with a grid-dip oscillator, provided the choke is not completely magnetically shielded. If more than one dip is observed, the lowest frequency indicated will be the fundamental SRF. With this set-up, you can then alter this frequency with additional shunt capacitance, meanwhile monitoring the change until the desired frequency has been reached.

For any type of choke, shielded or not, a "Q" meter can be used to determine the SRF and, simultaneously, the distributed capacitance and the "Q" at the SRF. This last point is often overlooked in the application of a choke and the use of the available data. A careless reading will lead the user to believe that the "Q" shown is at the SRF, when it is actually the "Q" that is obtained at the frequency of measurement at which the inductance measurement is made on the "Q" meter. Only at the given test frequency does the "Inductance" dial read correctly, but the test frequencies for the various inductance ranges differ from the SRF by a factor of 2 to 20 in the normal range of miniature choke values. The differences for one make of choke are shown in Table 1. It is obvious from this table and from the vast differences in "Q" for the same coil at various frequencies that one measurement cannot substitute for the other. Of course, the "Q" may not be important in many applications, but where it plays a significant part, it must be determined for the SRF or the frequency at which it is to be used.

The SRF is measured on the "Q" meter by the following procedure. Con-

nect the test leads to the "Cap" terminals. With the choke disconnected and the leads in place, connect to the "Coil" terminals a relatively high "Q" work coil that will resonate in the region of the expected SRF of the choke. The choke is then connected to the test leads on the "Cap" terminals and the "Capacitance" dial is tuned to re-resonate the combination. If no change is necessary, then that frequency is the SRF of the choke. If the "Capacitance" dial must be shifted to re-resonate, then the entire procedure must be repeated, but at a higher or lower frequency until the SRF is found. As a guide, Table 2 shows the relationships among the various indications.

The effective parallel resistance R_p and effective parallel reactance X_p at any frequency may be found by a similar method, except that the process used to pinpoint the SRF is not necessary.

Adjust the "Q" meter for resonance at the test frequency F and record the indicated "Q" as Q_1 and capacitance as C_1 . Remove the test leads from the "Cap" terminals and record the increase in capacitance needed to re-resonate the "Q" meter as C_2 . Reconnect the leads and the choke to be measured, and re-resonate at F . Call the new reading Q_2 .

The effective parallel resistance is found from $R_p = [(1.59 \times 10^3) (Q_1 Q_2)] / [f(C_1 + C_2)(Q_1 - Q_2)]$ and the effective parallel reactance is found from $X_p = (1.5 \times 10^3) / f(C_2 - C_1)$ where f is in MHz and C is in pF. The impedance is $Z = \sqrt{R_p^2 + X_p^2}$ at any frequency, and $Z = R_p$ at the SRF since $X_p = 0$ and $R_p = \sqrt{R_p^2}$.

Under some conditions ($C_2 - C_1$) may be negative, indicating a capacitive reactance for the choke at that frequency.

The "Q" is found from $Q = [(C_2 - C_1)(Q_1 Q_2)] / [C_1(Q_1 - Q_2)]$ and is the "Q" of the unknown impedance, or in this case the choke being tested. This is obtained from the relation $Q = R_p / X_p$.

The distributed capacitance may be measured with the "Q" meter by the two-measurement method when the distributed capacitance, C_d , is 10 pF or less, as follows.

Connect the choke to the "Coil" terminals and resonate the choke by varying the "Frequency" dial, with the capacitance set at a low value (30 to 50 pF). Note the frequency and call this capacitance C_1 . Change the frequency setting to one-half the previous frequency setting and re-resonate the coil by varying the "Capacitance" dial. The new value is called C_2 . The distributed capacitance, within 20%, is found by $C_d = (C_2 - 4C_1) / 3$.

A much simpler method of determining the approximate value of C_d is from a resonance chart, where frequency, inductance, and capacitance are

shown. As long as C_d is small, it has a negligible effect on all but very small values of inductance. For this reason, the *apparent inductance* will be close to the *true inductance*, and the chart would probably show the required capacitance to resonate the apparent inductance with as good an accuracy as the "Q" meter.

For example, a $10\text{-}\mu\text{H} \pm 10\%$ choke measured by the above method had an *apparent inductance* of $10.7\ \mu\text{H}$ and a distributed capacitance of $0.67\ \text{pF}$. The "Q" at SRF was not measured because the SRF was above the range of the "Q" meter.

From a resonance chart, the apparent inductance given in the manufacturer's data sheet gives a capacitance value slightly higher.

The actual inductance that would be measured if the choke had no distributed capacitance at all is found from the value obtained in the C_d measurement.

The true inductance is $L_T = L_1 [C_1 / (C_1 + C_d)]$. In the case of the $10\text{-}\mu\text{H}$ choke just mentioned, $L_T = 10.7 [38 / (38 + .67)] = 9.83\ \mu\text{H}$ where C_1 is the capacitance required to measure the apparent inductance, $38\ \text{pF}$ in this case; and L_1 is the apparent inductance.

Thus, the SRF can be determined from the values of L_T and C_d , or the approximate C_d can be obtained from the approximate SRF and a resonance chart. Because of the nature of r.f. chokes and their various circuit requirements, these approximations will quite often be adequate. ▲

FILAMENT SHUNT

By CHARLES C. MORRIS

QUITE often the filament string of 12-v. d.c. mobile equipment requires the use of series-parallel wiring and filament shunt resistors. A typical circuit might use a 6CX8, 6AQ5, and 6AN8. These tubes cannot be wired for 12-volt operation without filament shunting provisions.

A simple solution is shown in the illustration. This makes use of a standard pilot lamp that can also serve as a panel light. For example; a #47 lamp (6.3-v., .15 a.) can be wired in parallel with the 6CX8 making that combination operate at 6.3-v., .90 a. The 6AQ5 and 6AN8 tubes are connected in parallel making that combination also operate at 6.3-v., .90 a. The two combinations are wired in series for 12-v. operation. The lamp could be used as a panel lamp (power-on indicator). Many other combinations are possible. ▲

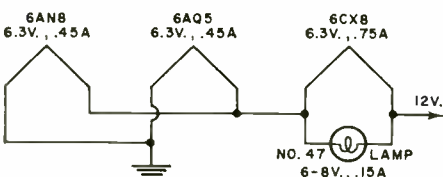

Look what's happened to the RCA WR-51A FM Stereo Signal Simulator

...it got to be the WR-52A...

NEW, REDESIGNED AND IMPROVED

Last year we decided to make a few improvements in our WR-51A Stereo FM Signal Simulator...for two years THE established test instrument for multiplex stereo servicing. We intended to call it the WR-51B.

But one thing led to another and we made so many extensive improvements that we virtually had a new instrument on our hands. You're looking at it: the NEW RCA WR-52A STEREO FM SIGNAL SIMULATOR. We've added an RF Deviation Meter to measure the modulation level of both stereo and monaural FM signals. The meter is also used to accurately establish the level of the 19 Kc subcarrier.

We've included provisions for modulating left or right stereo signals with an external monaural source.

We've added a switch to disable the 19 Kc oscillator to provide a low-distortion monaural FM output.

We've added a new frequency (72 Kc)...required, along with the 67 Kc frequency, for trap alignment in some sets.

These features, together with numerous internal circuit design changes have resulted in a vastly improved, almost completely new instrument. And, the RCA WR-52A includes all those features that made its predecessor such a valuable servicing tool.

COMPOSITE STEREO OUTPUT—for direct connection to multiplex circuit

Choice of left stereo and right stereo signals

RF OUTPUT—for connection to receiver antenna terminals

100 Mc carrier, tuneable
Choice of FM signals—left stereo, right stereo, monaural FM, internal test and 60 cycle FM sweep
FM stereo deviation adjustable from 0-100%
100 Mc sweep signal adjustable from 0 to more than 750 Kc at a 60 cps rate
RF output attenuator

CRYSTAL-CONTROLLED 19 Kc SUBCARRIER ($\pm 0.1\%$)

SINE WAVE FREQUENCIES

Three low-distortion frequencies—400 cps, 1 Kc, 5 Kc

Two crystal-controlled frequencies—19 and 38 Kc
Additional frequencies—67 and 72 Kc for trap alignment

READILY PORTABLE—weighs only 12¾ pounds, measures 13½" by 10" by 8"

COMPLETE WITH WIRED-IN CONNECTING CABLES

We also raised the price...just 50 cents. The WR-52A is now \$250.00.* Ask to see it at your Authorized RCA Test Equipment Distributor.

*Optional distributor resale price, subject to change without notice. May be slightly higher in Hawaii and the West.

RCA ELECTRONIC COMPONENTS & DEVICES, HARRISON, N.J.



The Most Trusted Name in Electronics

**“Get more
education
or
*get out of
electronics***

...that's my advice.”

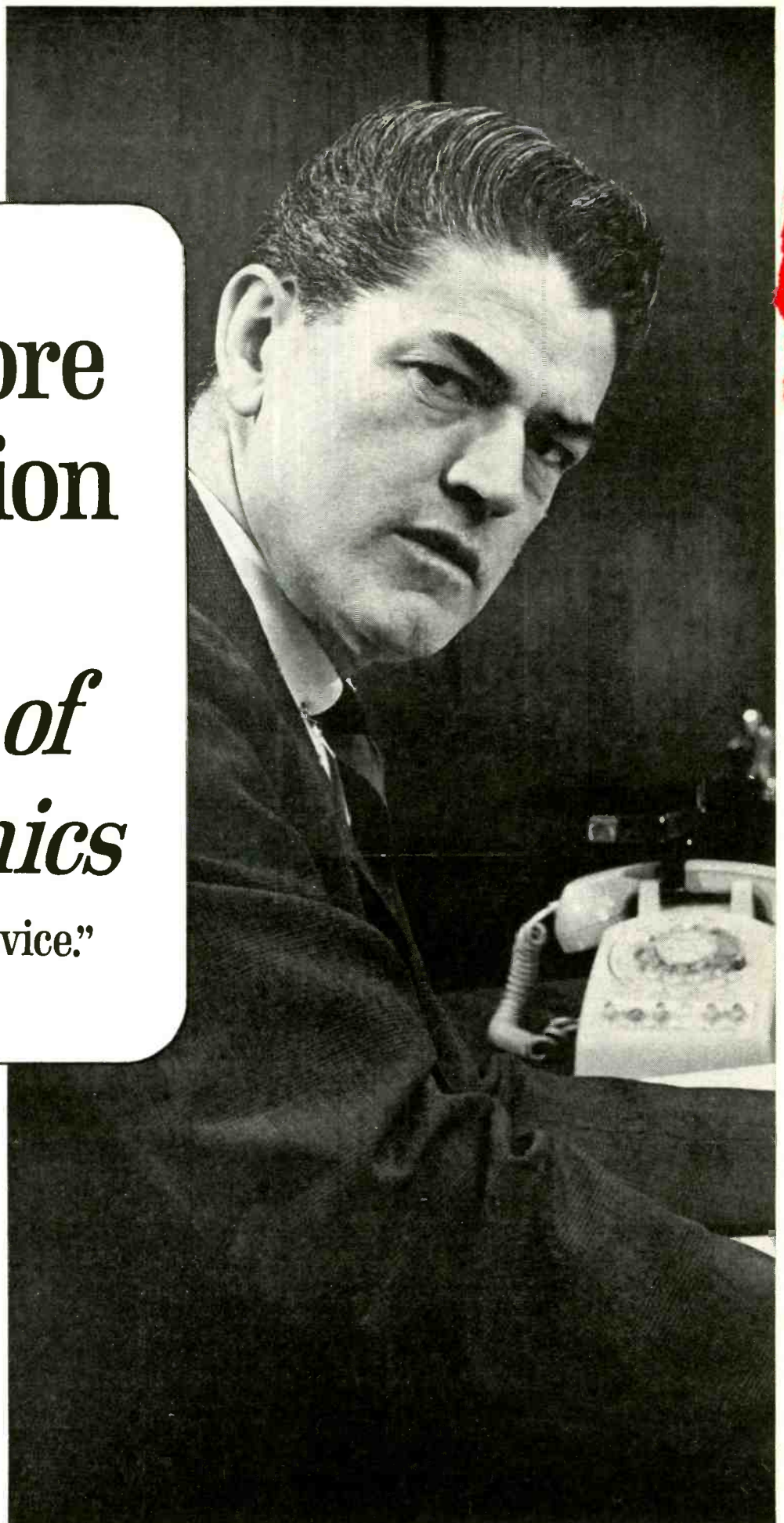

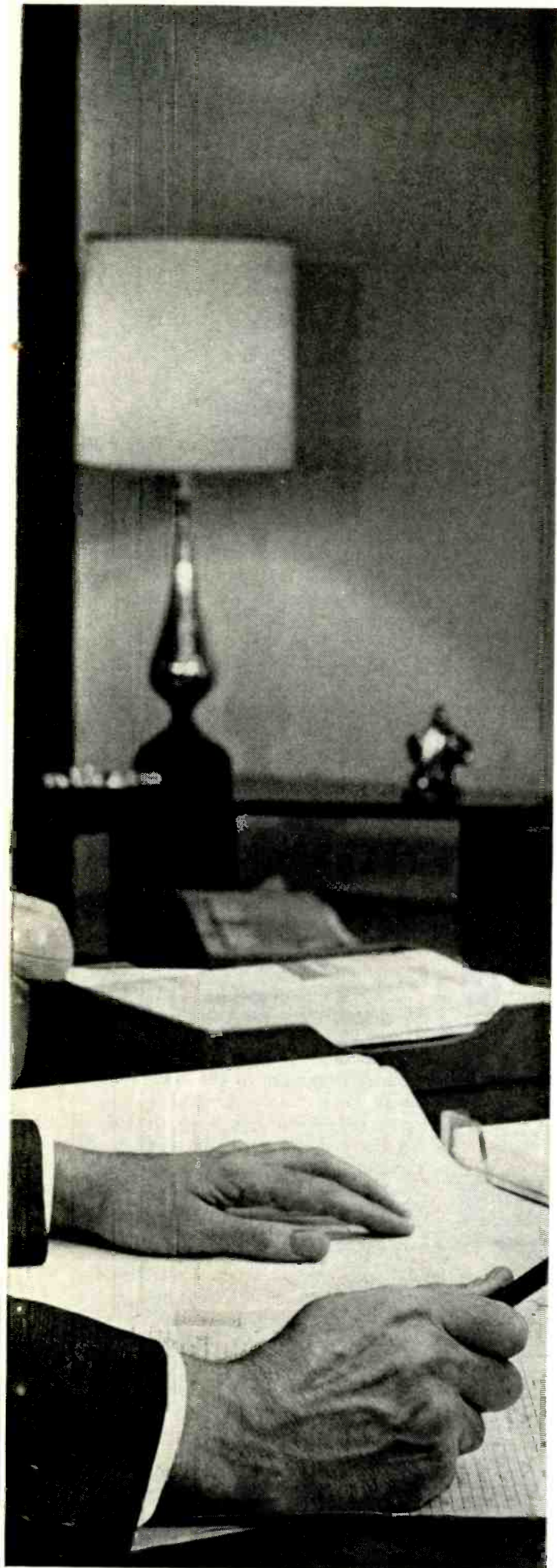

May, 1966

Ask any man who really knows the electronics industry.

Opportunities are few for men without advanced technical education. If you stay on that level, you'll never make much money. And you'll be among the first to go in a layoff.

But, if you supplement your experience with more education in electronics, you can become a specialist. You'll enjoy good income and excellent security. You won't have to worry about automation or advances in technology putting you out of a job.

How can you get the additional education you must have to protect your future—and the future of those who depend on you? Going back to school isn't easy for a man with a job and family obligations.

CREI Home Study Programs offer you a practical way to get more education without going back to school. You study at home, at your own pace, on your own schedule. And you study with the assurance that what you learn can be applied on the job immediately to make you worth more money to your employer.

You're eligible for a CREI Program if you work in electronics and have a high school education. Our FREE book gives complete information. For your copy, airmail postpaid card or write: CREI, Dept. 1105 D 3224 Sixteenth Street, N.W., Washington, D.C. 20010



- NOW!**
TWO NEW PROGRAMS!
- Industrial Electronics for Automation
 - Computer Systems Technology

Let's Look Inside The Dynamic Microphone

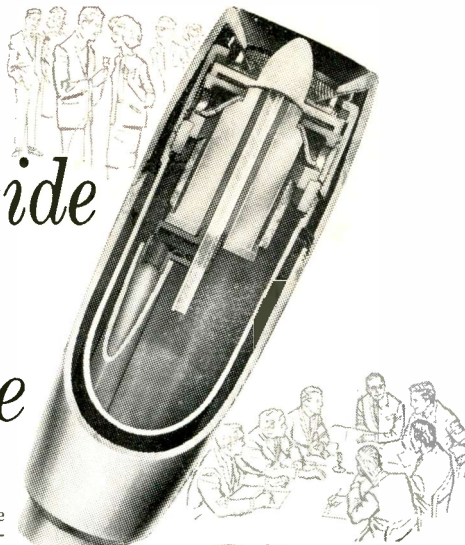

THIS is no ordinary microphone. It's a University Dynamic. Its manner of working is no less complex than a modern day computer. Its system of elements is a carefully integrated electromechanical network in a critical acoustical area. Without showing it, it's really quite a bit more than it appears to be — you have to listen to know the results of its performance.

For example—you move toward a flurry of activity on a busy street corner and witness a man-on-the-street interview. To you and other observers the conversation is barely audible above the noise of people and traffic. But to radio listeners the conversation is clear and unaffected by the sounds of the city . . . They are remote . . . in the background where they belong. This is the distinct advantage of a microphone with a good directional pick-up pattern.



Model 8000 Directional (Cardioid) Shock Mounted

To demonstrate another case in point — Imagine yourself an unseen observer in a conference room of a large organization. A tape recorder, fed by a single microphone in the center of the conference table, is in use to store all that is said. Many speak at once; some face away from the microphone; it appears that all that is said may never be recorded, but every word is captured on the magnetic tape for later review.



Model 8100 Directional (Cardioid) With Switch Shock Mounted

Microphones, but they are different in design, to serve different applications. The first is a highly directional (cardioid) dynamic microphone, sensitive only to the areas of sound intended for radio transmission or recording . . . proportionally attenuating sounds emanating from adjacent unwanted areas. The second is a highly omnidirectional dynamic microphone sensitive to sounds in all surrounding areas, specifically designed to pick up all sounds.

University makes only dynamic microphones, and they have the precision and reliability of modern day computers. Look at the inside to confirm this. The bullet shaped dome of the directional cardioid is a precise and significant component of the system. It smoothes the vital mid-range to provide a more dynamic, natural quality of sound. Filters, in a special configuration, soften sudden bursts of sound, minimize sibilants and protect the inner components from dust, dirt and the elements. A series of ducts further extends the performance of the microphone's transducer element providing gross and fine tuning (similar to the bass ducts of a speaker system) to sharpen the directional characteristics and reinforce the bass response.



Model 2040 Omni-Directional With Switch



Model 2000 Omni-Directional



Model 2050 Omni-Directional With Swivel & Switch

The unusual, rugged, yet highly sensitive characteristics of the exclusive University UNILAR diaphragm are responsible for the remarkable high frequency performance of the University Dynamic Microphone — sharp, bright, clear and transparent. The UNILAR diaphragm is not easily seen in the precision cut-away shown above. It is extremely light and slender thin, rugged and virtually indestructible. It could easily withstand torturous bursts of sound and vibration, even without the "extra-measure-of-protection" blast filter screen in the assembly. This feature alone guarantees continued distortion-free and trouble-free performance . . . and, it is only one of many features that make the University Dynamic Microphone the choice of professionals and recording buffs. No matter what the nature of sound, University captures the live natural quality that makes the difference right from the start . . . better than other microphones costing \$10, \$15 or even \$20 more. And, the exclusive University warranty gives you five times as long to enjoy this "lively sound." Stop at a franchised University Dealer today and try for yourself. Get more info too! Write to Desk E-65, UNIVERSITY SOUND, P. O. Box 1056, Oklahoma City, Oklahoma 73101 . . . we'll send you a FREE copy of "MICROPHONES 66."



Attache' 6000 Miniature Directional (Cardioid) With Swivel

AIRLINES PLAN COMMUNICATIONS SATELLITES

World-wide v.h.f. coverage is envisioned in this approach.

THE Air Transport Association of America, representing the interests of American commercial aviation, has been conducting a number of experiments using communications satellites for signaling between high-flying aircraft and their base stations.

The airlines are interested in the possibility of using satellites for air-to-ground communications because this offers the most promising way to get reliable static-free v.h.f. communications over vast ocean areas. V.h.f. is used for communications with aircraft in flight over the U.S. and within line-of-sight range of coastal or island stations for transoceanic flights. At the altitudes of 30,000 to 40,000 feet commonly used by jets, line-of-sight distance is not usually more than 250 miles (less than a half-hour's flying time) but can be extended to about 350 miles using increased transmitter power.

With the introduction of supersonic transports, contact time between stations may amount to only a few minutes. When it is considered that an enormous amount of information (usual communications, navigation data, and telemetry) will have to flow between the SST and the base station, then a very reliable means of long-distance, interference-free communications must be used.

Beyond the range of v.h.f. stations, the aircraft presently relies on high-frequency (h.f.) communications which are more severely affected by sunspots and other disturbances in the earth's ionosphere. H.f. achieves its range by bouncing signals off the ionosphere; thus, daily and seasonal changes in the position and intensity of the ionosphere affect such communications. The difference in communications quality between h.f. and v.h.f. is considerable.

By providing a stationary satellite radio-relay link, such as a synchronous satellite, more than one-third of the earth's surface becomes line-of-sight.

In a series of tests initiated by the ATAA, using the Syncom III satellite over the Pacific Ocean, teletypewriter transmissions between 6 1/4 and 50 words per minute were exchanged between an aircraft and ground station.

In one test, a Pan American aircraft climbing out of Hong Kong successfully maintained v.h.f. contact with a base station in California, better than 6000 miles away. ▲

CIRCLE NO. 90 ON READER SERVICE CARD

SEND ELECTRONICS WORLD REGULARLY EACH MONTH, FOR:

5 years \$20 3 years \$13 1 year \$5

NAME _____ PLEASE PRINT _____
ADDRESS _____
CITY _____
STATE _____ ZIP CODE _____ NEW RENEWAL

EXTRA BONUS! Payment enclosed. (We will add 2 EXTRA ISSUES, at no extra cost, for each year of your order! For example, if you order a five-year subscription you'll receive the regular sixty issues PLUS ten bonus issues — almost a full extra year — for the same price!) Bill me. I'll pass up the bonus.

Additional postage outside the U.S., its possessions and Canada: Add \$1 per year for all other countries.

Mail to: ELECTRONICS WORLD, Dept. 0138, Portland Place, Boulder, Colo. 80302



A NEW family of highly accurate, solid-state digital voltmeter-ratiometers, the 510 Series, has been developed by *Cohu Electronics, Inc.* combining the d.v.m.'s inherent superiority for making rapid, precise, accurate measurements free of interpolation errors with the flexibility of general-utility bench meters. The addition of a digital coupler creates an inexpensive digital data-logging system for recording on typewriters, tape punches, or standard office adding machines.

First to be introduced in this new series is the Model 511. It is designed to be used as a general-purpose d.c. voltmeter and d.c./d.c. ratiometer. Its high accuracy (0.01% of reading, ± 1 digit) and wide measurement range (100 microvolts to 1000 volts and 0:1 to 1000:1 ratios) make this instrument suitable for use in R&D, calibration, and test laboratories; in repair and maintenance facilities; and in any other application where the resolution and accuracy are needed or where a clear numerical display will eliminate reading errors and reduce test time. Specific applications include low-voltage measurements where loading effects cause excessive errors. The meter has virtually infinite input resistance on the lowest voltage range. The floating input reduces possibilities for error due to grounding currents.

A front-panel switch selects both the measurement range and function (voltage or ratio), and a sensitivity control stabilizes measurements in the presence of noisy input signals and permits use of external reference voltages greater than one volt. Four decades ranges for each function enable measurement of d.c. voltages from .0000 to ± 999.9 volts and d.c./d.c. ratios from .0000:1 to $\pm 999.9:1$. Accuracy is 0.01% of reading, ± 1 digit for both voltage and ratio measurement. Input resistance is 10 megohms on all but the 1-volt and 1:1-ratio ranges where a choice is provided of either 10 megohms or greater than 1000 megohms.

Principal design characteristics (see

TEST EQUIPMENT PRODUCT REPORT

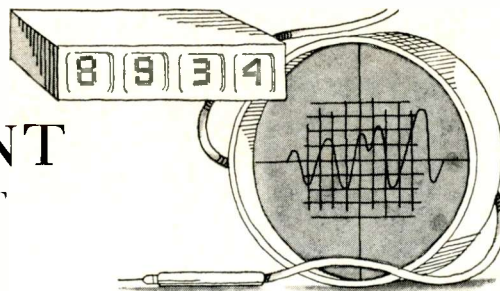

Cohu 510 Series Digital Voltmeter-Ratiometer

For copy of manufacturer's brochure, circle No. 156 on Reader Service Card.



block diagram) include a bidirectional, tracking-type logic which balances faster for small signal changes than most d.v.m.'s having a single-pass logic system. Biquinary logic is used for both the digital potentiometer and the readout indicator switching and results in a reduction of components. Use of plug-in printed-circuit relays in the logic circuitry further reduces component count because each multi-pole relay performs simultaneous logic, digital potentiometer switching, and readout control functions. Conversion from the biquinary code used in the 511 to commonly used BCD codes requires only simple decoding matrices.

Precision low-temperature-coefficient wirewound resistors are used in the range divider and in the digital potentiometer to achieve very high accuracy and stability of both voltage and ratio

measurements. A stable solid-state reference voltage source provides an accurate reference for voltmeter operation. The visual display uses biquinary-input, glow-discharge numerical indicators. These have a wide viewing angle (approximately 150°) and a bright red neon glow.

In operation, voltages present at the input divider and digital potentiometer outputs are sampled in a comparator circuit. Any difference in the two potentials appears at the input to the error amplifier as an error pulse. The error amplifier is a low-noise, solid-state circuit. An error amplifier sensitivity control allows use of external reference voltages from ± 1 volt to ± 100 volts.

Power consumption is only 15 watts. Dimensions are $5\frac{1}{4}'' \times 10\frac{1}{2}'' \times 15''$, and weight is just 12 pounds. The price is \$995. ▲

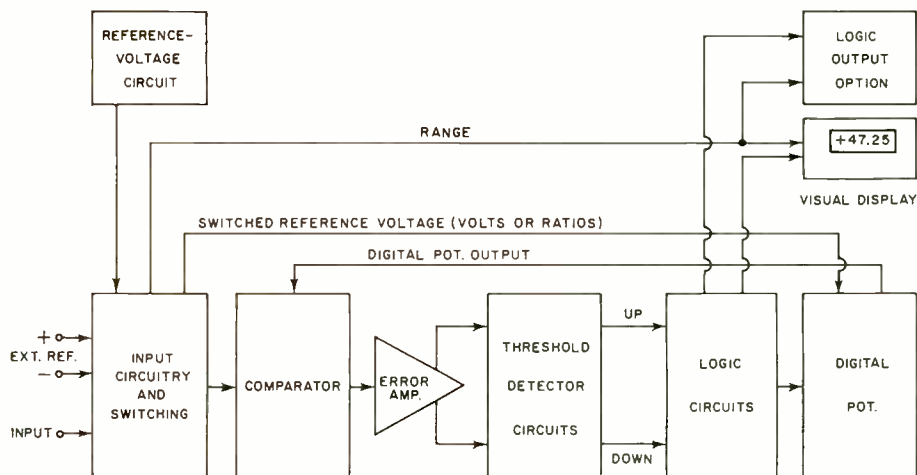

Hewlett-Packard Model 427A Multi-Purpose Voltmeter

For copy of manufacturer's brochure, circle No. 157 on Reader Service Card.

A NEW high-impedance multi-function meter, with all solid-state circuitry, battery-operated, with a mirror-backed, individually calibrated taut-band meter movement, has been introduced by *Hewlett-Packard* at just under \$200.

The Model 427A is a d.c. voltmeter (full-scale ranges: 100 mV to 1000 V), and an a.c. voltmeter for the frequencies from 10 Hz to 1 MHz (full-scale ranges: 10 mV to 300 V), with $\pm 2\%$ full-scale

A PUBLISHING FIRST



only \$1.25

... THE ONLY COMPLETE GUIDE FOR SERVICEMEN AND HOBBYISTS TO EVERY MAJOR PHASE OF CONSUMER ELECTRONICS SERVICING!

ELECTRONICS INSTALLATION & SERVICING HANDBOOK - 1966

For the progressive serviceman who wants to service better and faster . . . and expand his business by handling a wider variety of equipment —

For the "do-it-yourself" hobbyist who wants to save money by servicing his own equipment —

The 1966 ELECTRONICS INSTALLATION & SERVICING HANDBOOK has arrived! The only comprehensive and authoritative guide to consumer electronics servicing available anywhere! A handy, on-the-bench reference volume containing 128 pages—over 150 illustrations, charts and tables—on how to spot, analyze and correct trouble . . . quickly, efficiently and economically!

Coverage includes: the basics of servicing • servicing b/w & color TV • AM-FM household radios • stereo/hifi • CB equipment • intercoms and PA systems • antennas • transistorized ignition systems

Hundreds of money-saving techniques and shortcuts. Every up-to-date method and procedure.

You'd have to purchase several expensive manuals to equal this kind of incisive, all-inclusive coverage. But now you get it all in the 1966 ELECTRONICS INSTALLATION & SERVICING HANDBOOK for just \$1.25!

GET THE EXQUISITE LEATHERFLEX-BOUND EDITION for just \$3 POSTPAID!

--- fill in, clip & mail this form today! ---

Ziff-Davis Service Division • Dept. IS
589 Broadway • New York, N.Y. 10012
YES! Send me a copy of the 1966 ELECTRONICS INSTALLATION & SERVICING HANDBOOK, as checked below:
 \$1.25 enclosed, plus 15¢ for shipping and handling. Send me the regular edition. (\$1.50 for orders outside the U.S.A.)
 \$3.00 enclosed. Send me the Deluxe Leatherflex-bound edition, postpaid. (\$3.75 for orders outside the U.S.A.) Allow three additional weeks for delivery.

NAME _____ EW-56

ADDRESS _____

CITY _____ STATE _____ ZIP CODE _____

--- Payment must be enclosed with order. ---

accuracy. The a.c. response is proportional to average, and the meter is calibrated in r.m.s. values. Ohms ranges, $\pm 5\%$ accurate, are 10 ohms center-scale to 10 megohms center-scale.

The heart of the meter is a new d.c. amplifier using a field-effect transistor both for high input impedance conversion and, through a balancing circuit, for temperature compensation. Input resistance is above 10 megohms. The d.c. drift with temperature is typically under 0.5 millivolt per degree centigrade.

Battery power makes possible complete isolation from power-line ground. The common signal ground is floated and may be operated as much as 500 V d.c. off ground. A single 22.5-V internal dry battery, inexpensive and readily available, is the normal power source. The instrument's low power consumption (400 milliwatts) gives the battery typical continuous-operating life of more than 300 hours. Built-in facility to operate also from the a.c. power line is an option. With this option, the instrument may be switched instantly from a.c. to battery, or *vice versa*, while in use.

Both a.c. and d.c. volts are measured

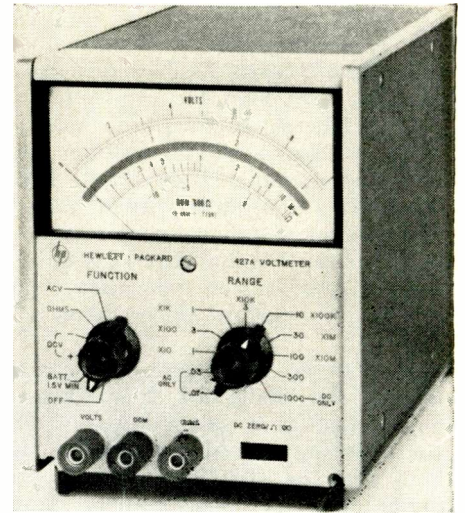

from the same terminals. Since the d.c. mode strongly rejects a.c., separate measurements of a.c. and d.c. voltages at a common point may be made at the flick of the function knob. Overloads are well tolerated: 1200 V d.c. causes no harm on any d.c. range setting; 300 V r.m.s. a.c. are withstood without damage even on the most sensitive a.c. ranges, while 425 V are withstood on ranges above 1 V. ▲

Electro PS-3A Transistor Regulated Power Supply

For copy of manufacturer's brochure, circle No. 158 on Reader Service Card.

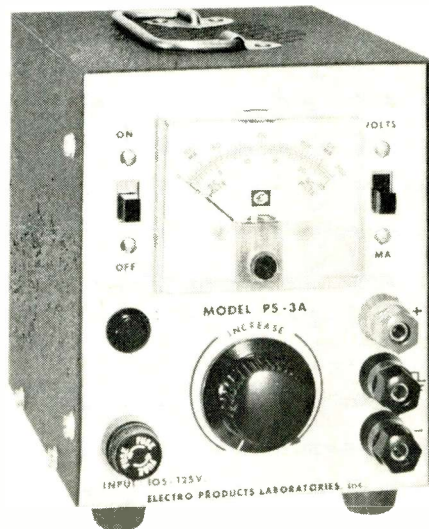

vides an adjustable source of ripple-free, stable d.c. power from 0 to 25 volts at up to 200 mA. The output-voltage adjustment resistor (R_{12} in diagram) is a 12-turn potentiometer that permits very accurate setting of the output voltage and prevents serious disturbance of the output setting if the adjustment knob is accidentally touched. The unit has an output ripple of 0.5 mV and a line or load regulation of 0.02%.

The supply has many industrial laboratory applications and can be used for classroom demonstrations and for battery substitution. Both positive and negative output terminals are "floating" so that either may be connected to the chassis ground terminal. The isolation of the output terminals permits series operation of two or more supplies for higher output voltage.

The supply uses a basic series transistor voltage regulator and a regenerative feedback amplifier. This combination

THE Model PS-3A power supply, manufactured by Electro Products Laboratories, Inc., is a general-purpose, low-power laboratory supply that pro-

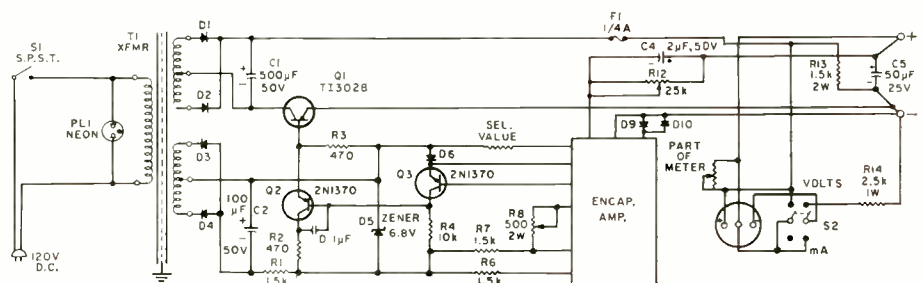

NOTE: D1, 2, 3, 4, 6, 9 AND 10 ARE 100 p.i.v.
ENCAP. AMP. (INCLUDES Q4, Q5, Q7, Q8, R9, THERMISTOR)

forms a closed-loop current amplifier. By changing the impedance of Q1 inversely with the load current, a constant voltage is maintained across the output terminals. Instead of using a zener diode as the main reference element, a conventional silicon diode (D8), operated well into its characteristic "knee" in the forward direction, is used. This results in a low temperature coefficient and a low dynamic impedance, equaling or exceeding the performance obtained from a considerably more expensive zener regulating diode.

Transistors Q2 and Q4 are used for current amplification. The error-sensing amplifier is a differential amplifier consisting of Q4 and Q5. This latter circuit, along with the reference diode and a thermistor, are encapsulated within a single epoxy block. The increased thermal capacity of the epoxy reduces the effects of temperature "spikes" so that the amplifier and thermistor respond evenly without overshooting or hunting. Silicon diodes D9 and D10 prevent overdriving the differential amplifier during sudden load changes in excess of ratings by clamping the input to the forward drop across the diodes.

The built-in meter can be switched to monitor either output voltage or current. The price of the power supply is \$99.50. ▲

SOLID-STATE TWEETER

THE usual high-frequency loud-speaker (tweeter) uses a fine wire coil mounted on the piston of a horn, placed in a magnetic field, and excited by passing an electric current through the coil.

In a newly designed horn by Motorola, a piezoelectric ceramic element powers a driver piston that "kicks" small pulses of air through the horn. A cross-section of the new loudspeaker is shown in the illustration.

One end of the piezoelectric ceramic element (developed by Clevite Corp.) is cemented to the apex of a flower-shaped aluminum diaphragm. The other end is connected to two wires, one on the outside and the other on the inside surface of the ceramic tube.

As voltage is applied and removed from the ceramic, it expands and contracts over its entire length to act as a power driver pumping the diaphragm back and forth. This action drives pulses of air through the horn. ▲

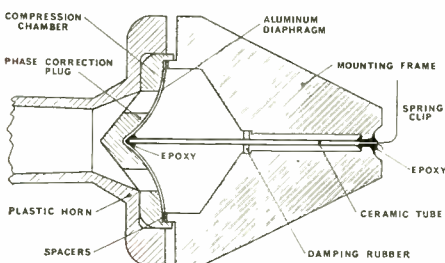

May, 1966

R FOR "DOCTORS
OF SERVICING"



For handy guidebook to better servicing, write Channel Master Corp., Ellenville, N.Y.

Where there's a contact... or a relay...

Service with Contact Shield! Protective! Corrective! It not only cleans and safeguards contacts better on TV, radio, and hi-fi sets; on all relay-operated electrical equipment, regular protective maintenance with this versatile cleaner prevents sticky relays—while corrective servicing unsticks them... in seconds. Promotes greater conductivity, keeps relays working smoother, longer. Contact Shield—the professional service man's cleaner.

APPLICATIONS INCLUDE:

- Bowling Alley Automatic Pin Spotters
- Vending Machines • Pinball Machines
- Slot Machines • Telephone Switchboards
- IBM Computers and other data processing equipment
- Industrial Equipment using relays, such as welding machines, etc.

MOVING?

**ATTACH
LABEL HERE**

If you've recently changed your address or plan to in the near future, be sure to notify us at once. Affix address label showing old address here, and print new address below.

My New Address is:

name please print

address

city state

zip-code date at new address

Notify us of your address change as far in advance as possible—it takes about 2 months for a change to become effective. (Eg. A notice received in May becomes effective with the August issue.)

Mail to: ELECTRONICS WORLD
1255 Portland Pl., Boulder, Colo. 80302

Enjoy the "music-only" programs now available on the FM broadcast band from coast to coast.

- NO COMMERCIALS •
- NO INTERRUPTIONS •



It's easy! Just plug Music Associated's Sub Carrier Detector into multiplex jack of your FM tuner or easily wire into discriminator. Tune through your FM dial and hear programs of continuous, commercial-free music you are now missing. The Detector, self-powered and with electronic mute for quieting between selections, permits reception of popular background music programs no longer sent by wire but transmitted as hidden programs on the FM broadcast band from coast to coast. Use with any FM tuner. Size: 5½" x 6". Shipping weight approx. 7 lbs.

KIT \$4950

(with pre-tuned coils, no alignment necessary)

WIRED \$7500

COVER \$4.95 EXTRA

Current List of FM Broadcast Stations with SCA authorization \$1.00

MUSIC ASSOCIATED

65 Glenwood Road, Upper Montclair, New Jersey
Phone: (201)-744-3387

CIRCLE NO. 103 ON READER SERVICE CARD

Discover all those places
you never knew existed!

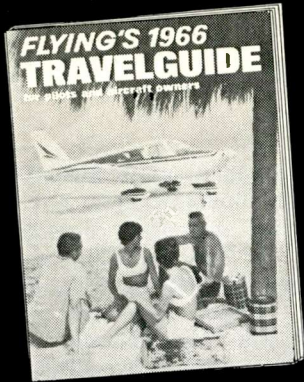

Get more fun out of flying
with the new **FLYING
TRAVELGUIDE**

The first really useful guide to flying vacations! Everything you need to know about: lodgings, restaurants, resorts, sightseeing, recreation, sports activities, airport facilities, children's fun, price information, special information for the gals.

Published by the editors of FLYING Magazine, the FLYING TRAVELGUIDE brings you complete information, organized into easy to follow form, that will make every flying trip a wonderful experience.

■ **Complete area descriptions!**

Airport facilities, nearby hotels, motels, resorts, restaurants, sightseeing highlights—complete with price information!

■ **Handy geographical breakdown!**

Listings are divided into 6 geographical sections, covering the U.S. and Bahamas!

■ **Quick-reference symbols!**

Listings show symbols denoting the type (and quality) of recreation and special interests at each area.

■ **Fun for the youngsters, too!**

Special listings of children's attractions.

■ **Special information for the Gals!**

Ideas on food and clothing suited to flying trips.

So, whether you own a plane, rent, or fly with others . . . the FLYING TRAVELGUIDE is for you!

Don't miss out! Order your copy now!



**DELUXE LEATHERFLEX-
BOUND EDITION —**

\$3.00 Handsome and permanent. Keeps the FLYING TRAVELGUIDE neat and attractive even after constant use.

FILL IN AND MAIL THIS COUPON TODAY!

Ziff-Davis Service Division / Dept. FT
589 Broadway / New York, N.Y. 10012

Roger! Send my copy of FLYING's 1966 TRAVELGUIDE right away!

\$1.25 (plus 15¢ for shipping and handling, 25¢ outside U.S.A.) is enclosed. Send me the regular edition.

\$3.00 enclosed. Send me the Deluxe Leatherflex-Bound edition, postpaid. (Allow two extra weeks for delivery.)

NAME _____ EW 56

ADDRESS _____

CITY _____ STATE _____ ZIP _____

PAYMENT MUST BE ENCLOSED WITH ORDER.

RADIO & TV NEWS

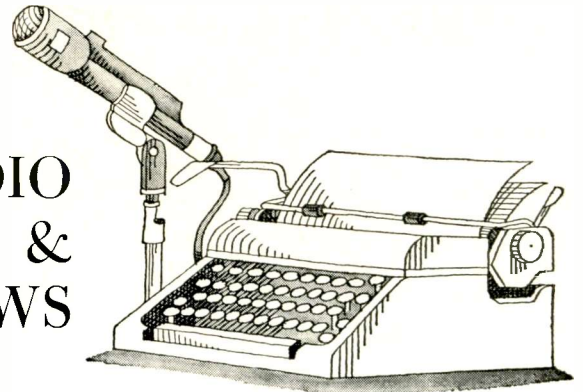

THE development of the techniques of creating integrated circuits may lead to a small-sized, portable electronic device that will enable the blind to tactually "read" any printed material rather than conventional Braille only.

Basically, the system suggested by J. G. Linvill of Stanford University and J. C. Bliss of the Stanford Research Institute consists of a finger-tip-sized dense array of tiny photocells, each coupled to its own transistor amplifier and each fed to an independent piezoelectric bimorph reed that can produce tactile stimulation. The internal circuit is arranged so that a darkened photocell gates the output of a tiny oscillator to the corresponding reed. Thus, the plane of reed tips, some stationary and some vibrating depending on whether each photocell receives light or not, generates a tactile image of the material being "read."

The blind person, acquainted with the physical formation of the printed letters and numbers, places a finger tip over the plane of reed tips and moves the reading aid over the printed material.

As the various reed tips come into play with the changes in color density between the background and printing, the user can sense a vibrating and grainy facsimile of the material being read.

Successful reading tests with blind subjects have been made using a computer to simulate the reading aid. These tests showed that the tactile images presented on a field of 96 piezoelectrically driven pins have been readable by three tested subjects at rates of about 30 correct words per minute.

Present photocell sensitivities and integrated circuit techniques appear to be adequate for a convenient microminiature realization of this arrangement, although several technical problems remain to be solved.

Time Signals

The high accuracy of the WWV-type time signals is very useful in precision laboratory work. However, for the general public, the time signals transmitted by various radio and TV stations suffice.

A check of the timing systems used

by the New York area network stations showed that *NBC* uses a system of three coincident gates (one for hours, one for minutes, and one for seconds), all driven from a precision clock checked to WWV twice a day. When the three gates are coincident (on the hour), a relay closes to place the time tone on the line. *CBS* uses an audio oscillator triggered by a precision clock which in turn is compared and corrected to WWV. *ABC* radio uses a *Western Union* clock correction signal, sent each hour, to close a relay that puts their tone on the line. Most of the local radio stations also use the *Western Union* correction signal for initiating their tone, chime, or gong.

Single-Slot Telephone

A new coin telephone, completely new in appearance and with a single-slot coin entrance, is going into service in many parts of the country. Developed at *Bell Labs.*, the new unit should save time for the customer by eliminating any possible fumbling in getting the right coin in the right slot. Unlike previous coin telephones, there are no gongs or chimes as the coins are deposited. Instead, electronic signals, not heard by the customer, indicate the number and type of coins deposited. This system also permits future automation of the telephone system.

The coin chute accepts non-mutilated U.S. coins, including the new laminated types, and will reject fraudulent ones. As each coin enters the chute, it is tested for ferromagnetic properties, maximum diameter, minimum diameter, maximum thickness, weight, density, and resistivity.

Electronic Match

A novel use for an SCR was recently unveiled by the *Wilcolator Co.* The pilot light of a gas range is removed, and the SCR-controlled "electronic match" substituted. Operating like an automobile transistor ignition system, when a push-button is depressed, a spark jumps across a gap located in the burner's gas flow igniting the gas. According to the manufacturer, this new system enables cold operation of a gas range without the danger of a pilot light blowing out with possible resulting damage. ▲

Resistive Attenuators

(Continued from page 37)

At the higher losses these become too low for practical manufacture. The approximate maximum loss normally supplied in the T and balanced-H attenuators is 60 dB but here again the actual maximum depends upon impedance and dB per step.

In the above types the total attenuation range of a variable attenuator may be increased by combining two or more attenuators on the same shaft and connecting them in series. For example, a 100-dB attenuator can be made by connecting two 50-dB attenuators in series. In operation, the first group of steps varies the first 50 dB and the second group of steps varies the second 50 dB. Up to 50 dB, the attenuation is varied in one section while the second section remains at zero dB. Above 50 dB the first section remains at 50 dB while the second section inserts the remainder of the attenuation.

In ladder and balanced ladder attenuators the circuitry is such that the resistor values do not get too high or too low as loss is increased and therefore they are not a limiting factor in the dB range. Thus, in these types, attenuation ranges of somewhat over 100 dB are obtainable.

Attenuators are available covering the frequency range from d.c. to 10 GHz. So-called audio-frequency attenuators will operate satisfactorily up to at least 100 kHz and in some instances, depending upon the decibel range and impedance, much higher. Video-frequency attenuators generally operate at frequencies up to 10 MHz and radio-frequency attenuators cover the remainder of the range to 10 GHz.

Attenuator accuracy is dependent upon the accuracy of the resistors used in their construction. At audio frequencies, the attenuation accuracy is the same as the resistor accuracy. Thus, if resistors with a 5% accuracy are used, the attenuation will be within 5% of nominal. Actually the attenuation accuracy will probably be much closer than 5%.

Attenuators used in broadcasting and recording operations normally have a 5% accuracy while those used in instruments and in measuring applications generally have a 1% accuracy and frequently have tolerances as close as 0.1%. The higher frequency attenuators normally have the accuracy specified in dB through a range of operating frequencies. Since this accuracy depends upon the amount of loss, impedance, and frequency range, a general statement of available accuracies is not feasible. For these applications the manufacturer should be consulted before completing an equipment design.



The Heart of your Radio is Its

TEXAS CRYSTALS

INSIST ON CQC*

If your dealer can't supply your needs, send his name with your request for catalog to our plant nearest you.

TEXAS CRYSTALS

1000 Crystal Drive
Fort Myers, Fla. 33901
Phone: 813-936-2109

4117 W. Jefferson Blvd.
Los Angeles, Calif. 90016
Phone: 213-731-2258

Division of Whitehall Electronics Corp.

* Controlled Quality Crystals available only from Texas Crystals dealers. Extensive precision testing throughout manufacture enables Texas Crystals to unconditionally guarantee their frequency control crystals. Use of Texas Crystals in space program and by other governmental agencies is evidence of the quality you can count on.

CIRCLE NO. 93 ON READER SERVICE CARD

Your Postmaster Suggests:

Always Include

Your (ZIP CODE) Number

in your

Return Address

LEARN Electronics Engineering AT HOME

Fix TV, design automation systems, learn transistors, complete electronics, College level Home Study courses taught so you can understand them. Earn more in the highly paid electronics industry. Computers, Missiles, theory and practical. Kits furnished. Over 30,000 graduates now employed. Resident classes at our Chicago campus if desired. Founded 1934. Catalog.

American Institute of Engineering & Technology
1141 West Fullerton Parkway Chicago, Ill. 60614

LARGEST SELECTION in United States
AT LOWEST PRICES—48 hr. delivery

JAN
CRYSTALS

Thousands of frequencies in stock. Types include HC6/U, HC18/U, FT-241, FT-243, FT-171, etc. SEND 10¢ for catalog with oscillator circuits. Refunded on first order. 2400D Crystal Dr. Ft. Myers, Fla. 33901

NUMERIC READOUT 9⁹⁵

MINIATURE SIZE, compact, incandescent numeric readouts have new-type, long-life, 30,000 hour lamps. Machined aluminum stack-plate design permits close side-by-side mounting. Digit size 3/4" high. Specify 6V or 14V model.

SHIPPED PREPAID WHEN CHECK ACCOMPANIES ORDER
ORDER FROM **ALCO ELECTRONIC PRODUCTS, INC.**
LAWRENCE, MASSACHUSETTS



WE DON'T CLAIM
OUR ELECTRONIC
IGNITION SYSTEM
IS BEST ...

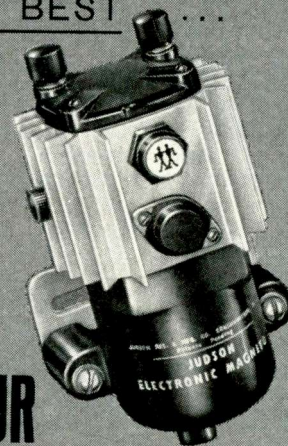

OUR CUSTOMERS DO!

WRITE TODAY FOR FREE LITERATURE

JUDSON

RESEARCH AND MFG. CO.
CONSHOHOCKEN, PA., U.S.A.



CIRCLE NO. 107 ON READER SERVICE CARD

“One of the finest examples of solid-state integrated-amplifier kit design, packaging and performance we have seen...”

Electronics Illustrated, May 1966

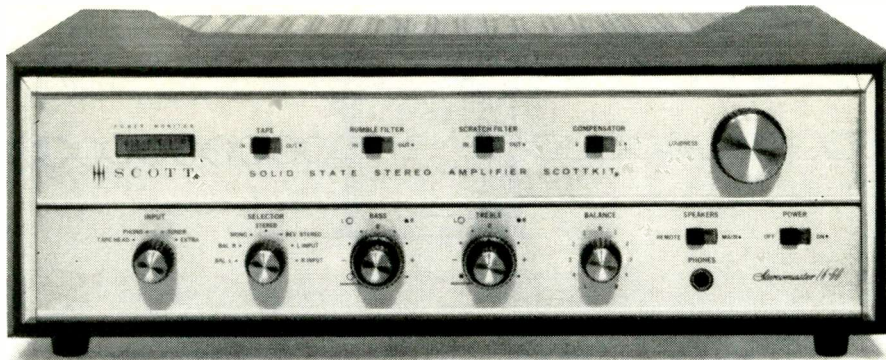

“The LK-60 has practically every operating feature you’d want. There are inputs for tape heads, FM tuner, tape recorder playback preamps, AM tuner or TV sound and magnetic-cartridge record player. And there are switched and unswitched AC outlets that can handle 250 watts.”

At \$189.95, Scott’s 120-watt LK-60 solid-state stereo amplifier kit gives you the same features, performance, quality, and reliability you’d expect from the Scott 260, its factory-wired counterpart costing ninety dollars more. Scott’s full-color, life-size construction manual makes the LK-60 a cinch to assemble . . . according to Electronics Illustrated, “. . . the manual is the most complete, foolproof one we’ve seen in a long time.”



For complete information on the Scott LK-60 120-watt solid state stereo amplifier kit, write: H. H. Scott, Inc., Dept. 160-05, 111 Powdermill Road, Maynard, Mass. Export: Scott International, Maynard, Mass. Prices and specifications subject to change without notice. Prices slightly higher west of Rockies.

CIRCLE NO. 95 ON READER SERVICE CARD

ITC

KNOWN THE WORLD OVER FOR
ELECTRONIC VALUES

**NORTRONICS
TAPE HEAD**

LATEST TYPE
8 POLE — ¼ TRACK
STEREO “COMBO”
RECORD — PLAY & ERASE

Medium-impedance
for vacuum-tube or transistor circuits.

400 mhy 1 kc ind
2500 ohm 1 kc imp
100 kc max bias
freq
390 ohm dc res
0.1 mil gap spacer
.043 track width
55 db 1 kc
crosstalk rej

MODEL
UA2Q47K2

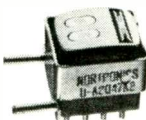

ITC

SPECIAL SALE PRICE

Calif. customers add 4% sales tax. **\$8.95** Add 40 Cents for postage and handling

Check or M.O. must accompany order. No C.O.D.

**INTERNATIONAL
TELEVISION CORP.**

2772 WEST OLYMPIC BLVD.
LOS ANGELES, CALIF. 90006

CIRCLE NO. 86 ON READER SERVICE CARD

80

PERMANENT PROTECTION!

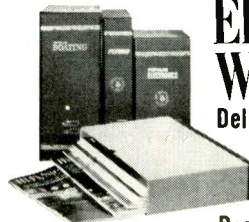

**Electronics
World**

Deluxe Magazine Files
that hold a full
year’s copies!

Designed to keep your periodicals orderly and easy to refer to. These durable files guard against soiling, tearing, wear or misplacement of issues. They look, feel like leather and are washable! 23kt. gold lettering and exquisite 2-color binding make them highly-decorative additions to your bookshelves.

Shipped POSTPAID! FULLY GUARANTEED!

Only \$3.50 each—3 for \$10, 6 for \$19

Order several today—for ELECTRONICS WORLD
and all your other favorite magazines.

Jesse Jones Box Corp., Box 5120, Dept. EW
Philadelphia 41, Pa.

Enclosed is \$_____ Please send me _____
Electronics World Magazine Files in the colors checked
below:

- Black backing/maroon sides
 Maroon backing/black sides

NAME _____

ADDRESS _____

CITY _____ STATE _____ ZIP CODE _____

Orders outside U.S.A. please add \$1 additional for
each file ordered.

(Payment must accompany order)

With the exception of a few covering fixed high-frequency types and two or three covering attenuation networks (two or more attenuators connected in series and mounted in a portable case or on a relay rack panel), there are no MIL-Specs on attenuators. However, attenuators are available which will meet most of the military environmental requirements such as: temperature extremes, humidity, shock, vibration, and salt spray. For detailed information, the manufacturer should be consulted.

Attenuator Ordering Information

Most attenuator manufacturers have catalogues which show the electrical and mechanical specifications of their “standard” attenuators. When items are required which are not included in the catalogue, the information supplied to the manufacturer should be as complete as possible to avoid delay or misunderstanding. As much as possible of the following information should be included.

1. *Complete electrical specifications* including whether the attenuator is to be fixed or variable. If fixed, include type of circuit, decibel loss, impedance (both input and output), required accuracy, frequency range, and operating level (power).

If variable, include type of circuit, impedance (both input and output), required accuracy, frequency range, operating level (power), number of steps and dB per step, linear or tapered, are “off” or “cue” positions required? (both input and output terminated but no signal goes through).

2. *Mechanical specifications.* If fixed, include maximum physical size (if space is important), and type of terminals and connectors.

If variable, include physical size or manufacturer’s basic type, with or without detents (indexing device), any required shaft deviations from manufacturer’s standard, and type of terminals or connectors.

Finally, specify any military requirements which must be met. ▲

QUICK AND EASY BREADBOARD

By CHARLES C. MORRIS

A NOVEL breadboard circuit idea is to use squares of soft pine wood and unpainted thumbtacks for mounting the experimental circuit. The thumbtacks can be soldered very easily, making excellent terminals and component tie-points.

The thumbtacks have the added advantage that they can be used over and over again and, by using soft pine wood, many multi- or odd-circuit arrangements can be made up—a thing not always possible with commercial breadboard components.

Another idea is to use the thumbtacks simply as component hold-down devices if for some reason direct soldering would be undesirable. ▲

ELECTRONICS WORLD

New Professional DC 'Scope Heathkit® IO-14

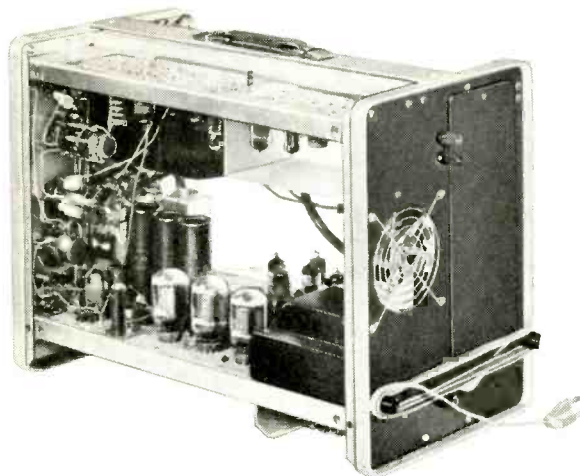

Kit **\$299**
Factory Assembled **\$399**

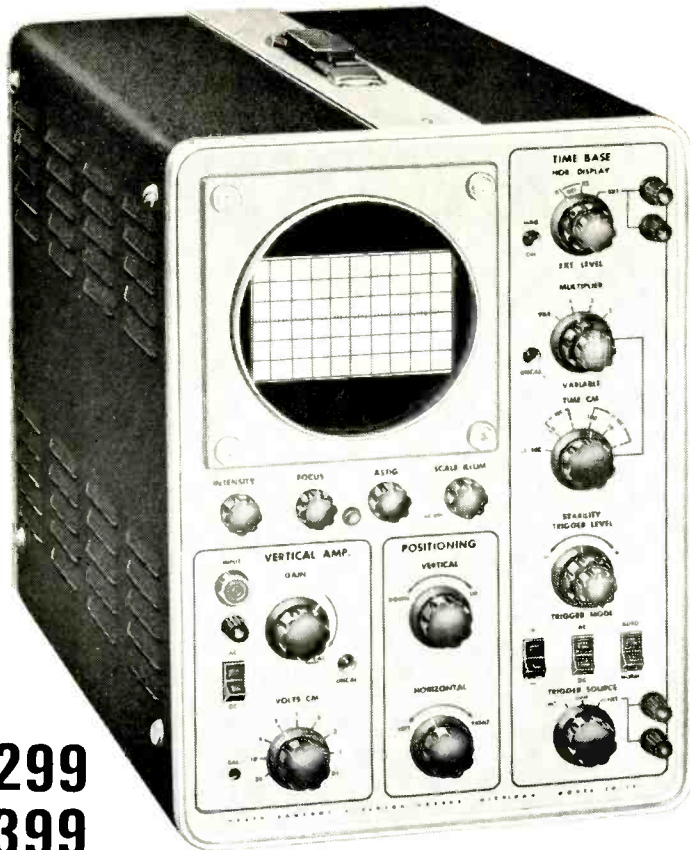

Eighteen Years Ago Heath Broke The Price Barrier On Oscilloscopes With A Low-Cost Scope For Hams, Hobbyists, And Service Technicians. Now Heath Breaks The Price Barrier Again! . . . With A Precision, Fast-Response, Triggered Sweep, Delay Line Oscilloscope For The Serious Experimenter, Industrial Or Academic Laboratory, And Medical Or Physiology Research Laboratory.

- A high stability 5" DC oscilloscope with triggered sweep • DC to 8 mc bandwidth and 40 nanosecond rise time • Vertical signal delay through high linearity delay lines—capable of faithful reproduction of signal waveforms far beyond the bandwidth of the additional circuitry • Calibrated vertical attenuation—from 0.05 v/cm to 600 volts P-P maximum input • Calibrated time base • 5X sweep magnifier • Forced air cooling • Input for Z axis modulation • Input for direct access to vertical deflection plates • Easy circuit-board construction & wiring harness assembly • Components are packaged separately for each phase of construction • Easy to align • Fulfills many production and laboratory requirements at far less cost than comparable equipment—particularly scopes capable of fast-rise waveform analysis • No special order for export version required—wiring options enable 115/230 volt, 50-60 cycle operation

Here Is A Truly Sophisticated Instrument . . . designed with modern circuitry, engineered with high quality, precision-tolerance components, and capable of satisfying the most critical demands for performance. The IO-14 features precision delay-line circuitry to allow the horizontal sweep to trigger "ahead" of the incoming vertical signal. This allows the leading edge of the signal waveform to be accurately displayed after the sweep is initiated.

The IO-14 Provides Features You Expect Only In High Priced Oscilloscopes. For example, switches are quality, ball-detent type; all major control potentiometers are precision, high-quality sealed components; all critical resistors are 1% precision; and circuit boards are low-loss fiber glass laminate. The IO-14's cabinet is heavy gauge aluminum. Its CR tube is shielded against stray magnetic fields, and forced air ventilation allows the IO-14 to be operated under the continuous demands of industrial and laboratory use.

Kit IO-14, 45 lbs. **\$299.00**
Assembled IO-14, 45 lbs. **\$399.00**

IO-14 SPECIFICATIONS—(Vertical) Sensitivity: 0.05 v/cm AC or DC. **Frequency response:** DC to 5 mc, —1 db or less; DC to 8 mc, —3 db or less. **Rise time:** 40 nsec (0.04 microseconds) or less. **Input impedance:** 1 megohm shunted by 15 uuf. **Signal delay:** 0.25 microsecond. **Attenuator:** 9-position, compensated, calibrated in 1, 2, 5 sequence from 0.05 v/cm. **Accuracy:** ±3% on each step with continuously variable control (uncalibrated) between each step. **Maximum input voltage:** 600 volts peak-to-peak; 120 volts provides full 6 cm pattern in least sensitive position. **(Horizontal) Time base:** Triggered with 18 calibrated rates in 1, 2, 5 sequence from 0.5 sec/cm to 1 microsecond/cm with ±3% accuracy or continuously variable control position (uncalibrated). **Sweep magnifier:** X5, so that fastest sweep rate becomes 0.2 microseconds/cm with magnifier on. (Overall time base accuracy ±5% when magnifier is on.) **Triggering capability:** Internal, external, or line signals may be switch selected. Switch selection of + or — slope. Variable control on slope level. Either AC or DC coupling. "Auto" position. **Triggering requirements:** Internal; 1/2 cm to 6 cm display. External: 0.5 volts to 120 volts peak-to-peak. **Horizontal input:** 1.0 v/cm sensitivity (uncalibrated) continuous gain control. **Bandwidth:** DC to 200 kc ±3 db. **General** 5ADP31 or 5ADP2 Flat Face C.R.T. interchangeable with any 5AD or 5AB series tube for different phosphor characteristics. 4250 V. accelerating potential. 6 x 10 cm edge lighted graticule with 1 cm major divisions & 2 mm minor divisions. **Power supply:** All voltages electronically regulated over range of 105-125 VAC or 210-250 VAC 50/60 cycle input. (Z Axis) Input provided. DC coupled CRT unblanking for complete retrace suppression. **Power requirements:** 285 watts. 115 or 230 VAC 50-60 cps. **Cabinet dimensions:** 15" H x 10 1/2" W x 22" D includes clearance for handle and knobs. **Net weight:** 40 lbs.

FREE! 1966 Heathkit Catalog

HEATHKIT 1966

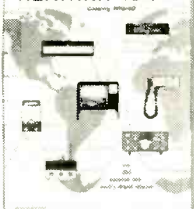

108 pages . . . many in full color . . . describe over 250 Heathkits for the lab, hobbyist, and industry.

Heath Company, Dept. 15-5
Benton Harbor, Michigan 49022

Enclosed is \$ _____, plus shipping for model (s) _____
 Please send FREE Heathkit Catalog & full IO-14 specifications.

Name _____

Address _____

City _____ State _____ Zip _____

Prices & specifications subject to change without notice.



TE-142

SEMICONDUCTOR INTERVAL TIMER

By DONALD E. LANCASTER

Semiconductor gate-controlled switch makes practical an all-electronic timer that can be set from 1 to 100 seconds in discrete 1-second steps.

THERE have long been available simple, low-cost timing devices of various types, ranging from mechanical egg timers, neon and thyratron devices, simple RC relay and SCR circuits, to others. Practically all of these devices leave much to be desired in the areas of convenience of operation, repeat accuracy, timing precision, life, resettability, and ease of external connections.

The new semiconductor gate controlled switch (GCS) makes practical an all-electronic digital timer capable of 1 to 100 second timing in discrete one-second intervals, to an over-all accuracy of better than 2 percent. The device is self-resetting, and has very quick recovery. It can be operated, read, and cycled in total darkness either manually or via external foot switches. There are no relays or other mechanical components in this circuit which will directly control 25 to 500 watts of 117-volt incandescent lamp load. Simple modifications allow the control of any load, either all-electronically or via an external relay. Operation is absolutely silent. No warm-up time is required and only a brief half-second recovery time is required for high repeat accuracy.

This timer was specifically designed for use as an enlarger control center for a custom photo finisher and thus lends itself well to most darkroom applications. There are many non-photographic applications for this device, ranging from sequence timers for displays, electronic automatic checkout equipment, process control, to other applications requiring the accuracy and ease of operation not found in many other control devices.

Parts cost should not exceed \$45 and no special tools or components are needed to build this unit.

Operation

The basic circuit consists of a bridge rectifier, a gate controlled switch, and a zener-stabilized transistor-unijunction timing circuit. This is combined with suitable switching that provides for momentary or sustained load power in addition to the normal time cycle.

A gate controlled switch is the new SCR-like device with the added advantage that the GCS may be turned off, as well as on, by gate pulses of the proper polarity. Since these are unilateral devices, a full-wave bridge rectifier is required for the GCS and the load. Fig. 1A shows the simplified power-control circuit, while Fig. 1B shows the timing circuit. The output of the rectifier is filtered only enough to provide holding current for the GCS during the zeros of the a.c. line. This produces the waveform shown in Fig. 1A across the load. Once the GCS is pulsed on, it latches on, and stays on cycle after cycle until a negative gate turn-off pulse appears. The amount of filtering used must be a compromise between providing enough holding current at high loads, and the rising output voltage that will be provided under light load operation. (With very small loading, the output would be pure d.c. at 1.41 times the normal line voltage.) When a 20- μ F filter capacitor is used, loads of between 25 and 500 watts may be accommodated by the timer. The output voltage varies somewhat with large changes in load, as shown in the regulation curve of Fig. 2.

In operation, a "Time-Start" pulse turns on the GCS and the load. The GCS turn-on also provides power for the timing circuitry. At the end of the time interval, the timing circuit produces a turn-off pulse, shutting down the GCS, load, and timing power supply.

The timing circuit (Fig. 1B), consists of a zener-regulated power supply and a unijunction transistor. An RC network between the -20V line, the emitter of the UJT, and the circuit common provides the time function. In operation, the charge across C1 (Fig. 1B) is zero at the start of the time period. Resistor R starts charging C1 and the emitter voltage of the UJT gradually becomes more and more positive. When a critical emitter voltage is exceeded (the intrinsic stand-off ratio), the UJT abruptly turns on. This also turns on the gating transistor (Q1) which "dumps" the charge on C2

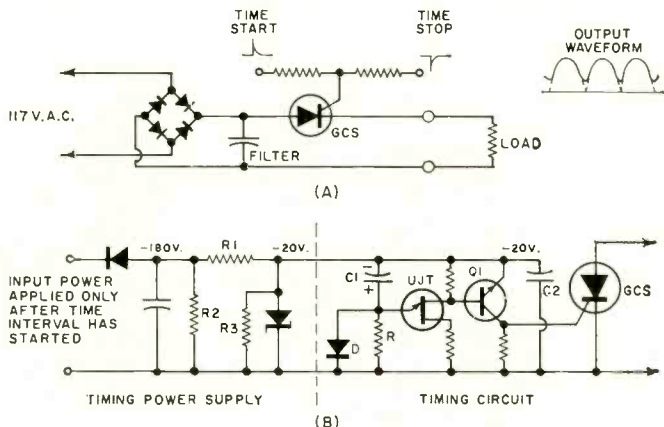

Fig. 1 (A) In simplified circuit, GCS is turned on by a positive and off by a negative pulse. (B) Basic timing circuit.

Fig. 2. The timer output voltage varies with the applied load. The minimum recommended load for proper operation is 25 watts.

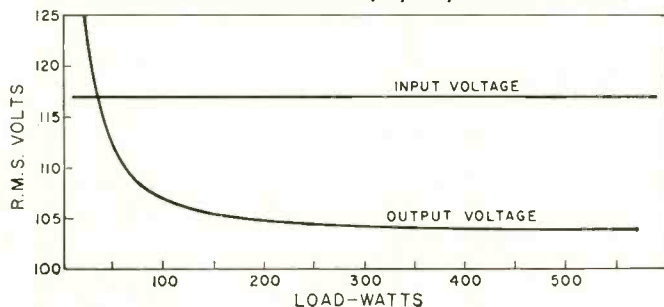
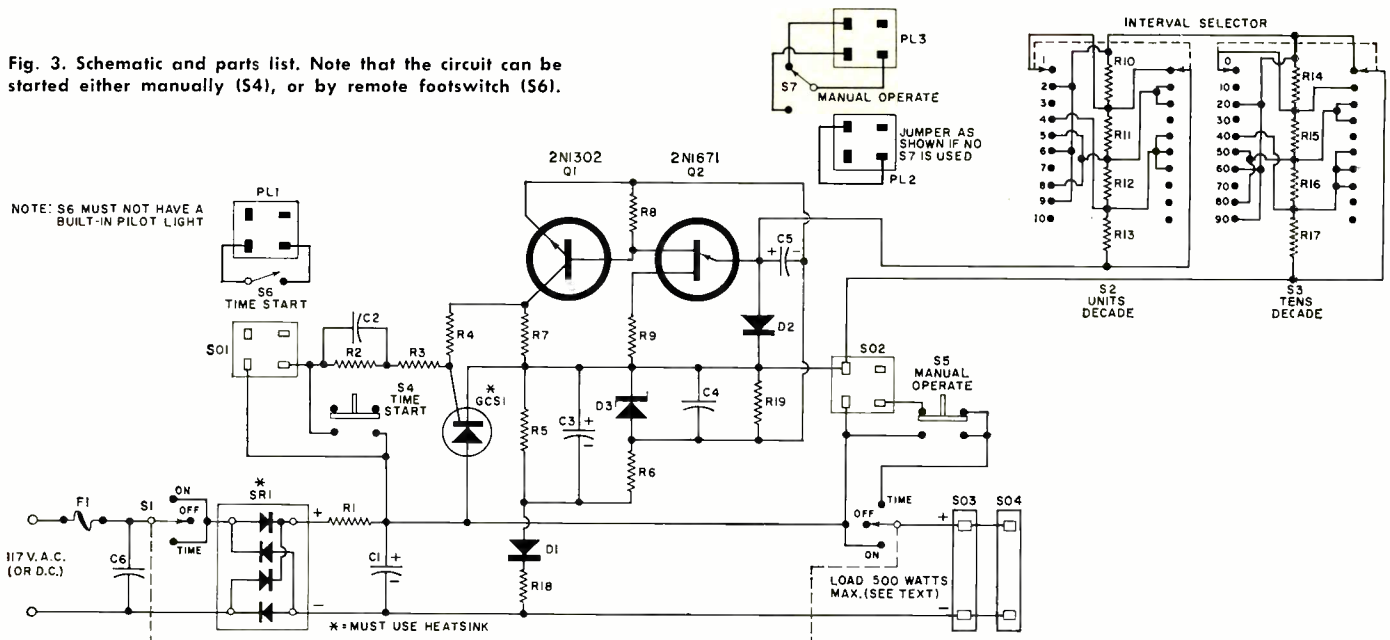

Fig. 3. Schematic and parts list. Note that the circuit can be started either manually (S4), or by remote footswitch (S6).



- NOTE: S6 MUST NOT HAVE A BUILT-IN PILOT LIGHT
- R1—1 ohm, 5 W wirewound power res.
 - R2—2.2 megohm, 1/2 W res.
 - R3—3300 ohm, 1/2 W res.
 - R4, R18—47 ohm, 1/2 W res.
 - R5—18,000 ohm, 2 W res.
 - R6—5000 ohm, 5 W res.
 - R7—470 ohm, 1/2 W res.
 - R8—39 ohm, 1/2 W res.
 - R9—510 ohm, 1/2 W res.
 - R10—Selected value to give exactly 1-sec time interval (approx. 17,000 ohms, 1/2 W, see text)
 - R11—2 × R10, 1/2 W res. ±1%, see text
 - R12—4 × R10, 1/2 W res. ±1%, see text
 - R13—3 × R10, 1/2 W res. ±1%, see text

- R14—10 × R10, 1/2 W res. ±1%, see text
- R15—20 × R10, 1/2 W res. ±1%, see text
- R16—40 × R10, 1/2 W res. ±1%, see text
- R17—30 × R10, 1/2 W res. ±1%, see text
- R19—2400 ohm, 1/2 W res.
- C1—20 μF, 250 V elec. capacitor
- C2—0.1 μF, 200 V Mylar capacitor
- C3—10 μF, 250 V elec. capacitor
- C4—3 μF, 100 V Mylar capacitor
- C5—68 μF, 15 V, 10% high-quality tantalum capacitor
- C6—0.02 μF, 600 V disc ceramic capacitor
- S1—D.p.d.t., 10A center-off toggle sw.
- S2, S3—D.p. 10-pos. non-shorting selector sw.
- S4, S5—Two-circuit, 5A push-button sw.

- S6—S.p.s.t. footswitch
- S7—S.p.d.t. 5A footswitch
- SO1, SO2—4-prong Jones socket
- SO3, SO4—Chassis-mounting a.c. outlet
- PL1, PL2, PL3—4-prong Jones plug
- F1—1A fuse (for 100 W or less load) 2A fuse (200 W or less load), etc., see text
- SR1—18A, 200 V press-fit bridge rectifier, 1N4436 or 4 3A, 200 V silicon diodes (Motorola MR1032B)
- GCS1—Gate controlled switch (Motorola MGCS 924-4, 5A @ 200 V) or Texas Inst. TIC-12
- D1, D2—750-mA, 200-V silicon power diode
- D3—22V, 1W zener diode (Motorola 1N3028B)
- Q1—2N1302 transistor
- Q2—2N1671 unijunction transistor

into the GCS gate. This turns off the GCS, the timing circuit, and the load.

By switch-selecting R in a digital manner, the time interval may be selected. A "units" and a "tens" decade is used to give incremental one-second intervals between one and 100 seconds.

There is a major problem inherent in UJT timers that is eliminated in this upside-down circuit configuration. In a normal UJT, after turn-on and capacitor discharge, there is still a charge remaining on the timing capacitor. This charge slowly bleeds off and ultimately reaches zero after a long time period. The timing error introduced between starting with no charge and starting with some charge is considerable and can approach 40% of the time cycle. To overcome this problem, a set of mechanical contacts is almost always used to reset the UJT and its capacitor to zero charge. While this method is widely used, it is neither convenient nor practical to have to reset a timer mechanically each time cycle.

The fact that the supply voltage, but not the supply impedance, disappears at the end of the time cycle is used to automatically reset the timer. This is a function of diode D (Fig. 1B). When the -20-volt supply is operative, D is reverse biased and does not interfere with the normal time cycle. When the time cycle ends, the supply voltage disappears. Any charge remaining on $C1$ now forward biases diode D , providing a discharge path through resistors $R1$, $R2$, and $R3$. Note that this is independent of the timing resistor, giving an equal recovery time regardless of the setting of the time interval selectors. The recovery time of the circuit is on the order of a half second to give a repeat accuracy error of less than 2 percent.

By careful selection of R resistance values, use of high-quality timing capacitors and zeners, and by waiting only a few seconds between cycles, this timer may be made to have an accuracy of better than 0.5 percent, and perhaps

as good as 0.2 percent. This figure includes both repeat accuracy and long-time stability.

Final Circuit Arrangement

Fig. 3 shows the final circuit. The input power may be either conventional power line or d.c. between 100 and 130 volts. Fuse $F1$ is rated slightly above the load power to protect the circuit. Capacitor $C6$ is a filter to reduce AM radio noise during turn-on and turn-off of the time cycle. Switch $S1$

Fig. 4. Additional driver circuits may be added for loads that will not operate on inverted a.c. supply. (A) All-electronic approach using a bilateral SCR. (B) Using an external relay.

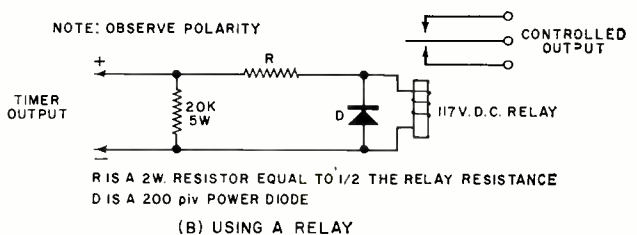
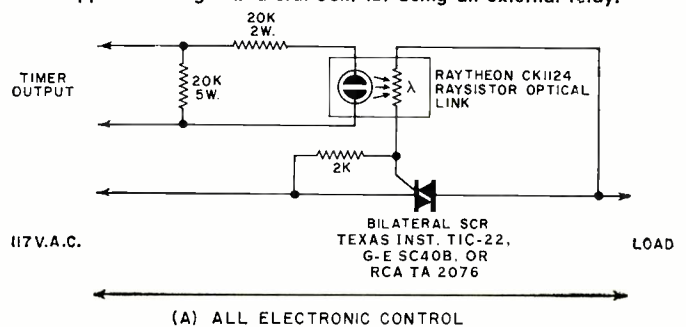

Don't Buy a 1966 Car!

... unless you've read the 1966 Car and Driver Yearbook. It's got the answer to every automotive question you can think of . . .

- All new road tests of 60 models — economy cars; compact, intermediate and full-size sedans; sports sedans; sports and GT cars; luxury cars.
- A buyer's guide to more than 100 other models, covering virtually every car available in the U.S.A.
- A comprehensive analysis of what's happening in the automobile industry — styling, engineering, safety, prices and predictions.
- Technical specifications of all domestic and imported cars.
- A spectator's guide to racing, with action-packed photos.
- 16 pages of accessories and performance equipment.

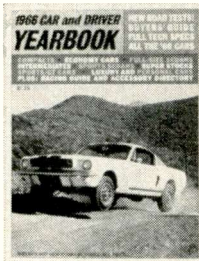

8-COLOR ANTIQUE CAR CHART

—ready for framing—printed in Sweden. Regularly \$2.95. Save \$1 by ordering now with 1966 Yearbook—both for just \$3.35!

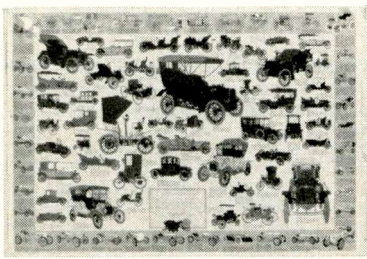

— Fill in Detach and Mail Coupon Today —

Ziff-Davis Service Division/Dept. CDY
589 Broadway/New York, N.Y. 10012

- Send me the Yearbook only. \$1.25 enclosed, plus 15¢ for shipping and handling. (\$1.50 for orders outside the U.S.A.)
- Please send me the 1966 Car and Driver Yearbook plus the Antique Car Chart. \$3.35 enclosed. (\$4.00 for orders outside the U.S.A.) Allow three additional weeks for delivery.

print name EW-56

address

city state zip code

PAYMENT MUST BE ENCLOSED WITH ORDER

is the power switch which also selects between timed and sustained (“on”) operation of the devices.

The GCS used is the *Texas Instruments TIC-12* rated at 5 amperes and 200 volts. (*Editor's Note: As this is written, the TIC-12 costs \$9.60.*) It is in a diamond-shaped power transistor package and mounts in the usual manner. Both SR1 and the GCS must be mounted on a heatsink, with the GCS insulated from the heatsink.

The network consisting of C2, R2, and R3 provides the GCS positive gate pulse required for turn-on. This is a one-shot network, required to make the time cycle independent of the length of time the “Time-Start” push-button (S4) or foot switch (S6) is depressed.

The timer power supply consists of R5, R6, R18, D1, D3, C3, and C4. Unless GCS1 is conducting, there is no voltage drop across the load and no voltage across this power supply. This is a conventional zener supply except for its negative output. Unijunction transistor Q2 provides the time function when its emitter voltage exceeds the value required for breakdown. Timing is provided by a selected interval resistor charging up C5. A high-quality capacitor with low leakage must be used here; otherwise leakage and time degradation will affect timer performance.

The obvious way to select a time interval would be to use twenty precision resistors in values of 1, 2, . . . 10 and 10, 20, 30 . . . 90, and switch these one at a time to obtain the desired time interval. By adding a second deck to each switch, and using the switching scheme shown in Fig. 3, only eight resistors are required. Note that at least one resistor must always be in the circuit. It is quite important that non-shorting selector switches are used.

The exact value of the resistors is determined by using an oscilloscope whose time base may be used for calibration. The one-second resistor value is then determined experimentally. All the other resistors are precision multiples of this original value. Once the “tens” decade series of resistors have been determined approximately, a conventional electric clock, equipped with a second hand, can be used to accurately trim the resistor values. Set the clock's second hand to 12, plug the clock into the timer output, and select the time values with the “tens” decade switch. Each “tens” decade switch position should cause the clock to indicate the correct number of seconds. The pertinent resistors can be trimmed as required.

The actual resistance may be obtained by several means. The simplest is to use all one-percent resistors. A second alternative is to use one- or two-watt carbon resistors and a file to raise them to the exact value. (Start with a resistor that

gives you a time somewhat shorter than that desired.) The resistors must be resealed after filing to make them humidity and time stable. A third method is to use a large number of half-watt resistors and keep trying parallel combinations until the exact values are obtained. In all these cut and try methods, an accurate timing device (oscilloscope or other accurate timer) is required.

The final circuitry consists of gating transistor Q1 which is used to discharge capacitor C5 into the gate of the GCS via current-limiting resistor R4.

Two two-circuit push-buttons are used to provide the “Time-Start” and momentary bypass controls. Four-prong connectors bring these connections to the rear of the timer, allowing footswitch control. The “Time-Start” footswitch (S6) is in parallel with the “Time-Start” push-button (S4) while the momentary bypass footswitch (S7) is in series with the “Manual-Operate” push-button (S5).

Footswitch S7 must be a s.p.d.t. switch having heavy enough contacts to handle the load power. A jumper must be substituted for the normally closed connection of this switch if footswitch operation is not to be used. S6 is a s.p.s.t. footswitch and need only have a contact rating of half an ampere. This switch must not have a built-in neon pilot light because this type will not allow proper operation of the turn-on pulse network.

Reasonable size wire, at least #20, should be used for all internal connections that must carry the load current.

The timer is intended for use only with loads which will operate off inverted a.c. This includes all incandescent lamps, heaters, and most universal motors (motors with brushes). If a highly inductive load is used, a diode or varistor should be added to the output as a surge eliminator. The timer will not operate a fluorescent lamp directly or the “cold boxes” occasionally found on enlargers. The timer will not directly control an a.c. induction motor of any type.

Additional Drivers

If fluorescent lamp or induction motor operation is required, additional circuitry will be required to provide a switched a.c. output. Two possibilities are shown in Fig. 4. In Fig. 4A, the timer output actuates an optical link (“Raysistor”) which in turn gates a bilateral SCR. Loads of between 10 and 600 watts may be switched with the bilateral SCR. The output waveform of this circuit is identical to the input powerline waveform, except for a drop of about one volt. Fig. 4B shows how a conventional mechanical relay may be coupled to the timer and used for special switching requirements. ▲

TV DISC RECORDER

By recording on a high-speed magnetic disc rather than on a length of magnetic tape, short time interval color and monochrome signals may be stored and played back.

THE conventional method for the recording and playback of TV video signals on tape has been with the use of a special tape recorder using a length of tape transported past the rapidly revolving heads. To insure good high-frequency response, the head-to-tape speed has to be very high and even for a still picture, which consists of a large number of redundant frames, a considerable amount of tape is required.

Engineers of the *Sony Corp.* have developed a method that eliminates the bulky reels and awkward threading and setup of conventional video tape recorders with the introduction of their disc color video playback system shown in Fig. 1.

The video disc itself consists of an aluminum ring, approximately 10 inches in diameter, having a magnetic-oxide-coated plastic sheet covering its interior area. When the disc is mounted on its drive mechanism, it can be made to rotate at 1800 rpm. This will produce a head-to-disc speed of approximately 1000 ips.

Three closely adjacent pickup heads are mounted on a cantilever arm and make contact with the disc surface. In this color version, each color signal (red, green, and blue) is individually recorded on a separate track, and a special pulse generator driven by the rotating disc produces the necessary sync signals. By mechanically moving the cantilever arm carrying the three heads towards the disc center in discrete steps, up to 40 different still color pictures may be played back off the disc. Resolution is in excess of 350 lines. The cost of the suitcase-size device is expected to be about \$2000.

Another version of the disc device, the "Videomat," is built into a 62-inch high, 22-inch wide, 23-inch deep package resembling an automatic soft-drink vending unit.

This version is equipped with a built-in monochrome TV camera and spot lighting system. With the insertion of a coin, or the operation of a remote control, this unit records a 30-second scene on a video disc. The recorded scene is then played back twice on a built-in 19-inch monochrome monitor. A system of front-panel illuminated instruction panels indicates when the machine is in the record or playback mode. The disc is automatically erased after the second playback.

No price has been established for the "Videomat" but production is expected to start in late summer.

No further details, including availability of the disc color playback system, are available at the moment. ▲

Fig. 1. The disc can carry up to 40 prerecorded color stills.

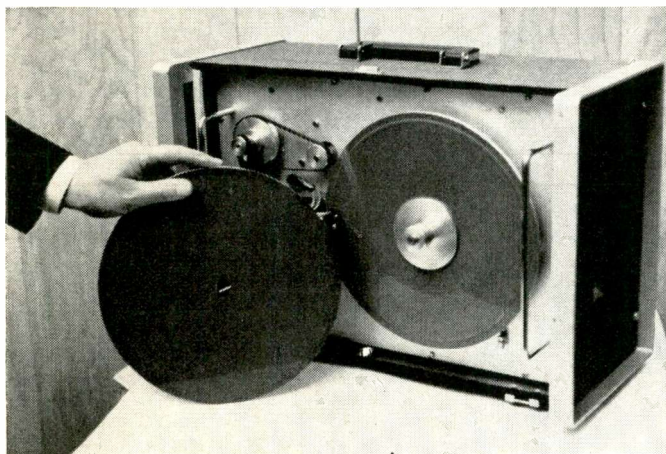

May, 1966

RECOMMEND THE TURNER 500 CARDIOID

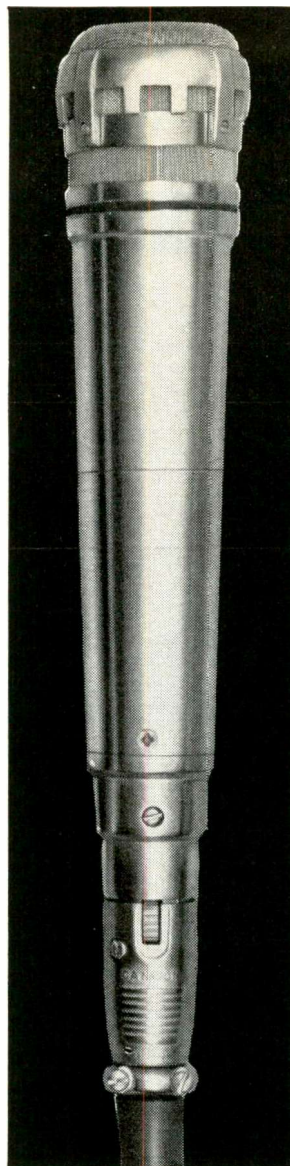

In your business, your reputation depends on your recommendation. Don't risk either — always recommend the high-performing, trouble-free Turner 500 Cardioid. Most problems in PA or sound applications — extraneous noises, poor acoustics, etc. — can be successfully solved by incorporating Turner 500's into the system. So before you make your next installation, check the Reader Service card for the complete Turner catalog. Get details on the Model 500 — list price \$84.00 — and the rest of the Turner line, including:

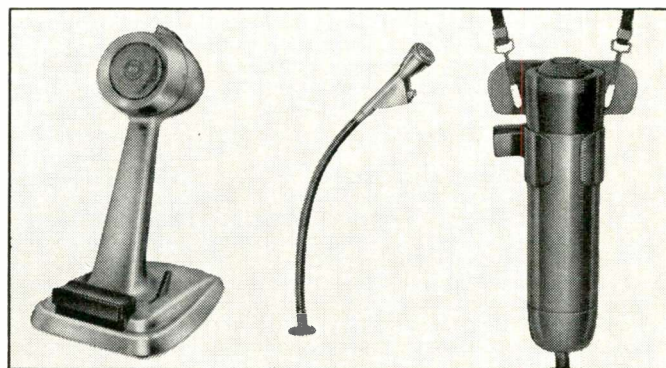

MODEL 251

Low cost, high performance paging microphone with Turner's unique lift-to-talk feature. List price \$49.50.

MODEL SR585D

Fixed mounted microphone conveniently mounted on a flexible 16" gooseneck. List price \$40.

MODEL 58

A natural for any application requiring freedom and mobility... does double-duty on desk stand. List price \$57.

THE  MICROPHONE COMPANY
918 17th Street N.E.
Cedar Rapids, Iowa

In Canada: Tri-Tel Associates, Ltd.
Export: Ad Auriema Inc., 85 Broad Street, New York, N.Y. 10004

CIRCLE NO. 92 ON READER SERVICE CARD

85

NEW PRODUCTS & LITERATURE

Additional information on the items covered in this section is available from the manufacturers. Each item is identified by a code number. To obtain further details, fill in coupon on the Reader Service Card.

COMPONENTS • TOOLS • TEST EQUIPMENT • HI-FI • AUDIO • CB • HAM • COMMUNICATIONS

SINGLE-TURN POT

A new servo-mounted precision potentiometer that meets the specifications of MIL-R-12931D. style RR1100 is being marketed as the 2550. The 1 $\frac{1}{8}$ " diameter potentiometer has a power rating of 1 $\frac{1}{2}$ watts at 85°C derated to zero at 150°C. It is a wirewound single-turn pot offering $\pm 0.5\%$ independent linearity.

The precision card-wound element is welded directly to the turret lugs to prevent "floating"



when soldering into a circuit. The terminals are gold-plated for easy soldering and corrosion-free shelf life. Color-coded Teflon insulators identify terminal functions and assure humidity-proof performance. Insulated resistance wire prevents all shorting between turns.

The new 2550 pot is available in a resistance range from 10 to 100,000 ohms. Resistance tolerance is as low as $\pm 3\%$. Resolution runs from 0.338% down to 0.068%. Amphenol Controls

Circle No. 126 on Reader Service Card

COLOR-TV RECTIFIER KIT

In order to handle problems involved in color-TV repair, a new "universal" color-TV rectifier replacement kit has been put on the market. The kit contains one focus rectifier, one booster rectifier, one convergence rectifier, and two power-supply rectifiers. The kit is suitable for making rectifier replacements in color sets manufactured by such firms as Admiral, Emerson, G.E., Magnavox, Motorola, Philco, Zenith, Semitronics

Circle No. 1 on Reader Service Card

DIGITAL PANEL METER

A new digital panel meter, the Model DM-25, offers a simple, inexpensive means of incorporating digital readout into any equipment where accuracy and readability are important.

The "Digimeter" requires less front-panel space than an ordinary 3 $\frac{1}{2}$ " d'Arsonval meter, but is capable of at least 20 to 30 times better accuracy, linearity, and resolution, according to the manufacturer. One model provides direct-reading digital measurement of a.c. or d.c. voltage and current and of temperature, strain, displacement, pressure, or any other parameter for which suitable transducers exist.

Complete electrical and mechanical specifications on the Model DM-25 will be supplied by the manufacturer on request. Abbey Electronics

Circle No. 127 on Reader Service Card

AIR VARIABLE CAPACITORS

Extremely high "Q" and greater capacitance values are featured in the new VAM series of miniature air variable capacitors now available. The small, rugged units have a "Q" factor of greater than 2000, measured at 100 MHz and 10 pF. They offer extremely low losses at higher frequencies.

Capacitance range is from 0.8 to 10 pF measured at 1 MHz. They are designed for panel mounting or printed-circuit use. Insulation resistance is 10⁴ megohms at 100 volts d.c. and 25°C. Units are gold plated to prevent corrosion damage and for high surface conductivity. A high-density insulator between rotor and stator provides excellent structural strength as well as electrical characteristics. JFD Electronics

Circle No. 128 on Reader Service Card

H.F. TRANSMISSION LINES

A series of dual high-frequency transmission lines, which are designed for such applications as transmission of digital data in computers, are available as complete cable assemblies with connectors. They can also be used in any application where high-frequency transmission and consistent impedance characteristics are considerations. The 93-ohm dual lines have 20 pairs of conductors, terminated in a double row of 0.050" center-distance connectors.

The cable assemblies are constructed of #33 gauge round, silver-plated, copper wire insulated with homogeneous TFE Teflon. The dual-line assemblies are 0.028" thick by 1" wide. Digital Sensors

Circle No. 129 on Reader Service Card

UNWRAP/REWRAP HAND TOOL

A new hand tool, on which a patent is pending, has been developed for removing and replacing coiled wire connections on solderless (wire wrap) type terminals. The unwrap end of the tool slightly loosens the wire coil so that it may be removed intact from the terminal. When located on another terminal the rewrap tool tightens the wire coil to its original four-pound strength or greater. Time involved is seconds and no damage to the coil results.

The tool is made to fit wire sizes #18 AWG or smaller. A data sheet giving complete information on the new tool will be forwarded on request. McCallus Industries

Circle No. 130 on Reader Service Card

WIREWOUND TRIMMING POTS

A new series of rugged trimming potentiometers, tradenamed "Nu-Frim," is on the market. These units are designed with a ring of multiple contacts around the resistance element to provide smooth, light, and even contact pressure in all directions. During adjustment, the unit's spring ring makes many sequential contacts on each turn of resistance wire as the line of contact moves in a spiral motion. As a result of this concept, resolution is increased and the wiper contact noise is less than 20 ohms at vibration levels in excess of 100 G's.

Other features include resolution better than 0.1%, welded lead construction, reliable all-metal

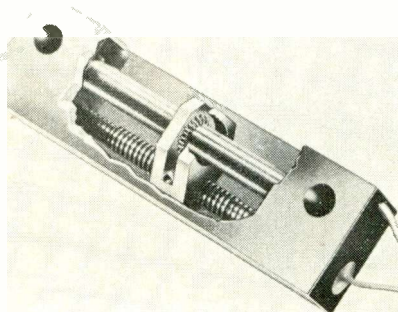

clutch, rugged diallyl phthalate glass-filled housing, no exposed metal, 2-watt power rating, and 50 ppm temperature coefficient. Available resistance ranges are from 10 ohms to 100,000 ohms. Newport Instrument

Circle No. 131 on Reader Service Card

SOLDERING-IRON CONTROL UNIT

A compact, 1 $\frac{3}{4}$ " cube unit has been developed which will convert any soldering iron currently in use into a high-reliability instrument. The new control unit permits a reliable temperature setting from 400° to 1000° at the turn of the dial from position 1 to position 7. The control takes all the guesswork out of determining correct soldering temperature.

The control unit, if plugged into an outlet, still permits full use of the outlet. The right side of the control is a straight-through plug, while the outlet on the left is the controlled plug for the iron. Hunter Tools

Circle No. 2 on Reader Service Card

CERAMIC BANDPASS FILTERS

New miniature low-frequency ceramic bandpass filters, at frequencies from 9 kHz to 50 kHz are now on the market. The filters are suitable for use in either military or commercial applications. Typical characteristics of the filters include 3 dB bandwidth of 1%, a 20 dB/3 dB bandwidth ratio of 13, and a mid-band insertion loss of less than 3 dB. Filters over the entire frequency range are hermetically sealed in HC-6/U crystal cans and weigh a total of less than $\frac{1}{4}$ ounce.

Impedance characteristics vary with frequency from 56,000 ohms at 10 kHz, 47,000 ohms at 20 kHz, 33,000 ohms at 30 kHz, to 22,000 ohms at 50 kHz. Center frequency of the filter changes less than 0.25% in 5 years and varies less than .3% over the temperature range of -40 to +85°C. Clevite

Circle No. 132 on Reader Service Card

SERVICE-TYPE V.T.V.M.

The Model 905 vacuum-tube voltmeter is a general-purpose unit which is suitable for radio and TV service work, school and home laboratories, production lines, and industrial maintenance applications. The unit is supplied with a fully assembled single a.c./d.c./ohms probe. It features a 0.5-volt d.c. range and also provides peak-to-peak a.c. measurement facilities. Other features include a 200- μ A meter electronically protected against overload and burnout, separate scales to indicate true peak-to-peak a.c. voltages, zero-center-scale for FM detector alignment and null detection, precision multiplier resistors with a tolerance of 1%, and an ohmmeter circuit with internal 1 $\frac{1}{2}$ -volt source for all resistance ranges to protect delicate equipment under test. Precise Electronics

Circle No. 3 on Reader Service Card

SHRINKABLE TUBING KIT

A kit containing a complete selection of six-inch lengths of all types of "Fit" heat-shrinkable tubing is now being offered to engineers, lab workers, and designers of prototype models.

Packaged in a compartmented clear plastic box, the kit includes samples of Fit-105 irradiated PVG tubing, Fit-221 irradiated polyolefin tubing, Fit-295 semi-rigid irradiated polyolefin tubing, Fit-300 surface irradiated polyolefin tubing, Fit-350 irradiated high-temperature Kynar tubing, and samples of Fit caps and markers.

The kit comes with an 8-page brochure which gives complete specifications and dimensions of the shrinkable tubing line. Alpha Wire

Circle No. 133 on Reader Service Card

"N"-CHANNEL FET'S

A new series of "n"-channel FET's, the 2N4117, 2N4118, 2N4119, is now available for low-power audio applications. The series offers tight 3-to-1 range of low I_{DSS} , a 2½-to-1 g_{fs} range, low C_{iss} , and 10 picoamp max I_{GSS} . The very low input current and low capacitance (3 pF) make these units suitable for high input impedance a.c. or d.c. amplifiers, storage circuits, choppers, and electrometers. The FET's are packaged in the TO-72 can. Siliconix

Circle No. 4 on Reader Service Card

TIME/FREQUENCY METER/COUNTER

A fully transistorized, compact time/frequency meter/counter is now on the market. Based on a 1 MHz oven-controlled crystal, the instrument offers three gating times: 0.1 sec, 1 sec, and 10 secs, providing a frequency measuring range

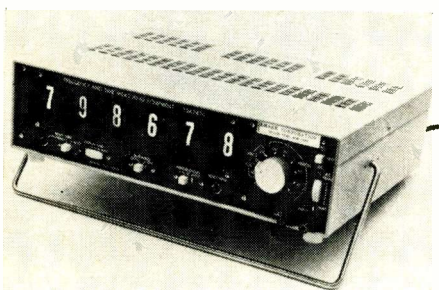

from d.c. to 1.2 MHz. Accuracy is ± 1 count \pm crystal stability of 1 part in one million. The period measurement with its three gating times of 1, 10, and 100 cycles allows measurements from d.c. to 100 kHz. A six-place digital in-line read-out is legible from any angle. Full details on the instrument are available on request. Amark

Circle No. 134 on Reader Service Card

PREFABRICATED HEAD ENDS

A new concept of factory fabricated head ends designed to increase the sales of master antenna television equipment has been announced. The prefabricated head end is designed to add sales appeal to MATV systems and to make it possible for the installer/distributor to install home systems with minimum expenditure of manpower. The head end is tested and aligned for specified channels and delivered to the distributor ready for installation. No costly labor is necessary to assemble component parts. The head end is installed, the distribution cables are hooked to the output, the antenna cables are connected to the input, and the system becomes operative. Blonder-Tongue

Circle No. 5 on Reader Service Card

SILICON RECTIFIER KIT

A practical solution to the problem of stocking rectifiers for prototyping is offered by the new rectifier kit now available. The kit is designed to provide the engineer and lab technician with a convenient stock of rectifiers and molded rectifier bridges, eliminating costly delays for ordering needed, but out-of-stock, components.

A total of 13 premium silicon rectifier types and 8 types of molded full-wave rectifier bridges is included in the kit to meet a wide variety of rectification requirements. Rectifier current ratings range from 0.25 to 35 amperes with voltage ratings from 200 to 3000 volts. All of the rectifiers and full-wave bridges included in the kit are standard items in the company's distributor line. Motorola

Circle No. 135 on Reader Service Card

22-AMP SCR LINE

A 22-ampere series of silicon controlled rectifiers with p.r.v. ratings from 25 to 700 volts (800-volt non-repetitive transient rated) is now avail-

able. The series has a maximum current rating of 22.3 amps average (35 amps r.m.s.) at up to 70°C case temperature and a junction temperature capability of 150°C. The maximum operating temperature of 150°C permits significant current ratings in higher ambient temperatures than with conventional 125°C maximum devices of identical physical size.

Further information on this new series is included in Bulletin A-117 which will be forwarded upon request. International Rectifier

Circle No. 136 on Reader Service Card

MOLDED MICA CAPACITORS

A new line of molded mica capacitors, designated HTCM, has been developed for applications requiring reliable operation at the higher operating temperatures. According to the company, the new units have approximately the same low failure rate as dipped mica capacitors and are obtainable for operation at 125°C and 150°C per the requirements of MIL-C-5.

At present, the line includes case size 15 but will soon include case sizes 20, 30, and 35. Electro Motive Mfg.

Circle No. 137 on Reader Service Card

ADJUSTABLE AND TAPPED RESISTORS

Two new commercial resistor styles—adjustable and tapped power wirewounds—are now in production as the HLA (adjustable) series and the HLT (tapped) series. The new models have the added precision and load-life stability made possible by a multilayer silicone coating. They are direct replacements for vitreous enamel tapped and adjustable types.

All models in both series are wound on hollow, tubular ceramic cores and are of the type used in voltage dividing applications. Made according to MIL-R-19365C, the HLA series includes 12 models with power ratings from 12 to 225 watts and a resistance range from 1 ohm to 100,000 ohms. The HLT series includes 13 models in sizes ranging from 11 to 225 watts with a resistance range from 1 ohm to 1.1 megohms. Dale

Circle No. 138 on Reader Service Card

FIXED PAD ATTENUATORS

A new line of low-cost fixed pad attenuators for pulse, video, and r.f. applications is now available. Fully enclosed, ruggedized metal construction provides shielding and protects the low noise, 1% tolerance resistors used in the attenuation networks.

Attenuators are available in any desired dB value from 1 through 60 dB in 1 dB steps. Standard impedances are 50, 75, and 93 ohms. Standard connectors are u.h.f., N, and BNC. The u.h.f. and BNC attenuators are rated at ½ watt while the type N is rated at 1 watt. Holland Electronics

Circle No. 139 on Reader Service Card

MINIATURE PANEL INSTRUMENT

The Model 120-G has been added to the G-Series panel instrument line and features a "bar-ring" d.c. movement which provides exact, reliable readings and is inherently self-shielded from stray magnetic fields. A special flat insert for the masked portion of the meter front may be painted any color the customer desires and can be imprinted with company logos, instructions, or names for personalizing the meter.

The Model 120-G measures only 1¾" square and extends 1½" behind the panel. A special short-barrel model is available on special order. Instrument movements range from 10 μ A d.c. up. Triplett

Circle No. 6 on Reader Service Card

THERMAL SWITCH

A new thermal switch, Series 4300, is now available as a snap-acting, heavy-duty bimetal actuated unit. Contacts are single-pole, single-throw, available either normally open or normally closed and are capable of switching up to a 30 amp resistive load or a 1500 watt tungsten load.

Units are available with delay times ranging from 5 seconds to 4 minutes and, because of its

thermal action, the switch will integrate pulses or intermittent current to eliminate short cycling or chatter. Hart Mfg.

Circle No. 140 on Reader Service Card

VECTOR VOLTMETER

The new vector voltmeter, Model 8405A, is a dual-channel, wideband r.f. millivoltmeter and phase meter. It has a frequency range of 1 MHz to 1 GHz, a maximum sensitivity of 100 microvolts full scale, and ± 180 -degree phase measurement range with resolution to 0.1 degree.

The unit reads voltage directly with one of two pencil-size high-impedance probes. With a second, elsewhere in the circuit under measurement, it reads phase angle relative to the first



probe. The second probe and its meter may be switched to read voltage, giving direct and simultaneous reading of gain between points.

The 8405A automatically tunes when a single knob is set anywhere within an octave of the signal frequency being measured. The instrument finds and phase-locks to the fundamental signal at the first of the two probes in 10 milliseconds. Hewlett-Packard

Circle No. 141 on Reader Service Card

LOW-NOISE R.F. AMPLIFIER

A MOSFET low-noise r.f. amplifier, which offers low cross-modulation distortion, is being marketed as the FT57. The unit is an "n"-channel depletion model MOSFET which offers the high stability and reliability of the firm's patented "Planar II" epitaxial process, features a low noise figure, low reverse capacity, and high power gain, making it suitable for use in FM and v.h.f. television applications.

The FT57 is available in a four-lead TO-72 package. Fairchild Semiconductor

Circle No. 142 on Reader Service Card

KITS FOR V.S.W.R. MEASUREMENTS

A series of complete, pre-packaged kits for making v.s.w.r. measurements has been introduced. Utilizing a "Rho-Tector" v.s.w.r. detector, the kits contain everything necessary for making the impedance comparisons basic to v.s.w.r. measurements in r.f. and microwave devices.

Besides the detector, which comes in any one of five models operating in a frequency range from 1 MHz to 4 GHz, each kit contains two standard matched terminations and two mismatches. All five items are packed in a fitted wooden instrument case. Telonic

Circle No. 143 on Reader Service Card

INSTRUMENTATION COOLING FANS

Designed for cooling low-profile instrumentation and measuring only 3¼ inches square, the new "Sprite" fan delivers 35 cubic feet of air per minute at free delivery.

The new fan was designed for general-purpose cooling and ventilation applications where small size and low cost are important requirements. The fan is recommended for applications requiring pressures of .05 inch of water to 0.75 inch of water at 25 to 3 cubic feet per minute. A double-flange construction provides universal mounting. Rotron

Circle No. 7 on Reader Service Card

METALLIZED-POLYCARBONATE CAPACITOR

A metal cased miniature metallized-poly-carbonate capacitor designed to meet the requirements of miniaturized production has been released as the K323Z.

Featuring excellent stability at higher voltages, the metallized-polycarbonate film used as the dielectric in this new unit provides maximum stability, low dissipation factor, low dielectric absorption, and high insulation resistance. The capacitors have a standard tolerance of $\pm 20\%$. Units with $\pm 10\%$, $\pm 5\%$, and lower can be supplied. Voltage ratings are 100, 200, 300, 400, and 600 volts d.c. with capacities from $0.01 \mu\text{F}$ to $5 \mu\text{F}$. Aerovox

Circle No. 144 on Reader Service Card

FUSE EXTRACTOR POSTS

Two new waterproof r.f. shielded fuse extractor posts that eliminate possible transmission or reception of stray r.f. signals through the hole in the chassis used for the fuse post mounting are now available.

They are designed to take 3AG and 8AG size fuses and for use in such applications as military ground support test equipment and commercial and industrial computers. The shielded fuse ex-

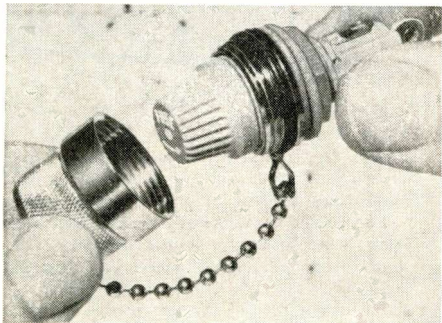

tractor post for the 3AG fuses ($1\frac{1}{4} \times \frac{1}{4}$ diameter) is Part #340225 while for the 8AG fuses ($1 \times \frac{1}{4}$) the part is #370011. They are ruggedly constructed to withstand environmental conditions such as salt spray, vibration, shock, and water immersion. Littelfuse

Circle No. 145 on Reader Service Card

DESOLDERING KIT

A nine-piece desoldering kit which comes in a handy steel storage box is now being marketed as the Model 300-K. The kit contains a Model 300 pencil-style desoldering iron, six tips of different sizes from 0.038 to 0.090, a metal stand for the iron, and a tip cleaning tool. Included is a new 0.063 industrial-type tip with premium alloy. The iron is used to remove defective soldered components and to resolder replacements. The box for the kit is $10 \times 3\frac{1}{4} \times 1\frac{3}{4}$ and has a rugged hammertone finish. Enterprise Development

Circle No. 8 on Reader Service Card

HI-FI—AUDIO PRODUCTS

RIGHT-ANGLE AUDIO PLUG

A unique right-angle, 8-position plug which eliminates cable entry and routing problems in compact electronic equipment is now on the market. The miniature plug is adjustable so that cabling can be routed through the integral rubber strain relief in any of eight directions. Entry routes are spaced every 45° in a circle on a plane parallel with the panel or chassis-mounting position of the plug. Only $\frac{3}{8}$ " movement along the axis of the plug is required to connect or disconnect and less than $1\frac{1}{2}$ " total distance is needed to mount the plug (this includes length of plug and connect-disconnect travel). Full engineering specifications on this and other plugs and receptacles in the company's line will be supplied on request. Switchcraft/Preh

Circle No. 9 on Reader Service Card

80-WATT STEREO AMPLIFIER

The LRE-80 solid-state stereo amplifier utilizes 29 semiconductors and features instant operation, without hum, noise, or microphonics and sufficient power to drive any stereo speaker to its full capacity.

Controls and inputs include: bass, treble, dual volume, 5-position mode, 5-position input, 4-position output including power/off, speaker phase, and headphone switch. There are rocker switches for low filter, high filter, loudness, tape monitor, and a special stereo headphone jack for tape head or phono input. There are also stereo inputs for tuner, tape recorder and aux. ± 1 and aux. ± 2 . There are two convenience outlets, one switched.

Power output is 80 watts IHF (40 watts per channel) and response is 22-24,000 Hz ± 1 dB. The unit has an extruded aluminum, gold-finished panel and measures $13\frac{3}{8}$ " wide $\times 4\frac{1}{2}$ " high $\times 10\frac{1}{2}$ " deep. It is designed to operate on 110-120 volts, 60-cycle a.c. Lafayette

Circle No. 10 on Reader Service Card

DYNAMIC MICROPHONE LINE

A new line of dynamic microphones, offered in a choice of impedances and designed for use with transistorized solid-state and tube equipment, is now on the market. Impedance range is 200, 600, 10,000, and 50,000 ohms. Diaphragms are made of rugged polyester film and can withstand high temperature and humidity conditions. A unique method of encasing the cartridge cups in rubber sleeves offers the user a shock-resistant mike and helps cut to a minimum handling and clothing noises.

The microphones are made of die-cast metal and finished in brushed chrome. Seven basic models are currently available and the manufacturer will supply full specifications on this new line upon request. Sonotone

Circle No. 11 on Reader Service Card

CABINET SPEAKER SYSTEM

A new convertible speaker, the "Grenadier" 8400, features louvered front panels and a hand-rubbed satin walnut finish. It is designed for standard shelf placement or on its own custom-made walnut bench.

Additional features include a low-frequency hyperbolic horn; a mid-range direct radiator, and ultrasonic domed tweeter, both coupled to die-cast acoustic lenses; frequency response of

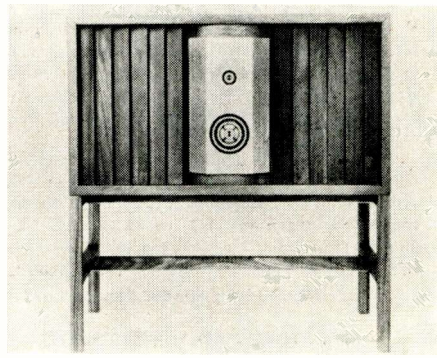

25 to 20,000 Hz; nominal impedance of 8 ohms; and power handling capacity of 100 watts maximum undistorted. Empire Scientific

Circle No. 12 on Reader Service Card

P.A. AMPLIFIER

The new model "Twenty Three" amplifier incorporates many built-in features for a more effective background music/paging system or portable p.a. applications. There are three microphone inputs with separate gain controls; phono input and auxiliary input for tuner, tape recorder preamp, or radio output; 70-volt line output; and convenience a.c. outlet.

A paging switch automatically mutes other microphone, phono, and auxiliary inputs. A five-step tone control and master power switch are also provided. The amplifier has a full 20 watts power output and a frequency response of 20 to 20,000 Hz ± 2 dB. Bell

Circle No. 13 on Reader Service Card

AM-FM STEREO RECEIVER

The all-transistor "Stratophonic B" Model SR-100B is an AM-FM stereo receiver with 60

watts IHF music power output. A precision styled front panel includes a new two-system speaker selector, improved d'Arsonval tuning meter, headphone jack, positive-action multiplex indicator, and new rocker switches for tape monitor and contour.

Performance features include a 2.9 μV front end, 6 to 50,000 Hz bandwidth, frequency response of 5-60,000 Hz at normal listening levels and 8-40,000 Hz at full 60 watts. Harman-Kardon

Circle No. 14 on Reader Service Card

COMPACT RECORD PLAYER

A four-speed manual player, designated the Model SP20, has recently been put on the



market. Incorporating many high-fidelity features including a semi-counterbalanced arm with adjustable stylus pressure, a trip built of DuPont "Delrin" which will allow the unit to track as light as 2 grams, a full-sized weighted turntable, and interchangeable plug-in head which will accommodate any cartridge, the unit measures $14\frac{3}{8}$ " left to right, $12\frac{1}{2}$ " front to rear, and $3\frac{1}{2}$ " above and $2\frac{1}{8}$ " below the motorboard. Garrard

Circle No. 15 on Reader Service Card

HEADSET-MICROPHONE ASSEMBLIES

By using standard components and subassemblies in a new series of lightweight headset-microphone assemblies, a broad line of essentially custom-made headsets to meet varying communications problems is available.

The headsets are designed to offer maximum comfort. Circumaural earcups surround the ear instead of pressing against it. Soft, vinyl-covered, foam-filled earcushions form an acoustical seal against the head without excessive pressure. Materials and construction meet military and telephone standards of quality.

The miniature dynamic earphone elements are supplied in impedances of 20, 150, and 300 ohms. Sensitivity is 105 dB at 1000 Hz re: 0 dB 0.0002 dyne/cm^2 with input of 1 mW. Frequency range is 100 to 4500 Hz with harmonic distortion less than 2% with 1 mW applied. Roanwell

Circle No. 16 on Reader Service Card

CAPACITOR MICROPHONE

A new pressure gradient type capacitor microphone, the S-10, which operates on a single TR-126 mercury battery and employs a field-effect transistor, has been announced. Permanent polarization is supplied at 62 volts and the Mylar diaphragm gives the unit excellent response.

Frequency range is 40 to 20,000 Hz with a deviation of less than 3 dB. The cardioid pattern gives effective front-to-back discrimination of approximately 20 dB. Sensitivity is rated at -53



dBm re: 10 dyne/cm² at 200-ohm load. The XLR-type 4-pin connector serves as an "on-off" switch, eliminating unnecessary battery drain.

The microphone has a satin nickel finish and measures 7³/₈" long. Diameter is ⁷/₈" and the unit weighs only 9 ounces with battery. The S-10 comes with 20 feet of cable, swivel mount, battery, and carrying case. Synchron Corp.

Circle No. 17 on Reader Service Card

SOLID-STATE STEREO AMP

A solid-state stereo amplifier which provides 30 watts music power (1HF) output per channel at 4, 8, and 16 ohms impedance has been put on the market as the Model "Sixty." Frequency response is 10 to 100,000 Hz ± 2 dB; stereo separation at 1 kHz is 65 dB; and THD is 0.5% at rated power. The treble tone control provides 10 dB boost and 15 dB cut at 10 kHz while the bass control offers 15 dB boost and cut at 50 Hz.

The unit measures 15¹/₄" wide x 3¹/₄" high x 8¹/₂" deep, including knobs, dress panel, and



fuses. An optional walnut cabinet is available at additional cost. Audio Dynamics

Circle No. 18 on Reader Service Card

PROFESSIONAL RECORDER

A new line of solid-state professional audio recorder/reproducers for studio use by recording companies and radio stations has been introduced as the Series AG-300.

In addition to solid-state electronics for greater reliability and performance, the new AG-300 offers an improved tape transport and console

design improvements featuring modern functional styling and simulated walnut side panels.

The console has overhead electronics and a transport that can be tilted to various operating angles for user convenience. The transport may be turned over for servicing without dismantling. Other new electronic features include tweaking adjustments on the front panel, plug-in equalizers for maximum flexibility, new locking-type level set knobs, and new "ready to record" light to permit visual confirmation of proper settings from remote locations.

The series includes one-, two-, three-, and four-channel models, either mounted or unmounted. Speeds are 15 and 7¹/₂ ips. with frequency response ± 2 dB from 30 to 18,000 Hz at 15 ips. Ampex

Circle No. 146 on Reader Service Card

CB-HAM-COMMUNICATIONS

PRINTED-CIRCUIT CB TRANSCEIVER

The new Model 650 is an 18-transistor, 9-diode CB transceiver which contains a crystal correlated tunable receiver, adding the stability of a crystal oscillator to a high-"Q" tuned circuit. Seven panel controls plus an easily read output/"S" meter permit a high degree of regulation and monitoring of transmitted and received signal. A switch mounted on the squelch control converts the 650 to a p.a. system when used with an external speaker.

The dual-conversion superhet receiver in the Model 650 uses a crystal-controlled first oscillator and a tuned second oscillator. The first i.f. is 4.3 MHz and the second is 455 kHz, offering a high conversion frequency and hence freedom from images.

The unit has a 10-channel crystal switch for selecting transmitting and receiving frequencies when the transceiver is completely crystal controlled and for selecting the transmitting frequency alone when the tuner is used. It comes factory equipped with channel 11 crystals.

With self-contained 12-volt d.c. and 117-volt a.c. power supplies, the unit measures only 3³/₄" high x 6³/₄" wide x 9¹/₂" deep. Amphenol

Circle No. 19 on Reader Service Card

12-CHANNEL CB TRANSCEIVER

The Model 712 "Sentinel 12" is a 12-channel, dual-conversion, 5-watt CB transceiver which provides twelve crystal-controlled transmit and receive channels and complete tunable reception of all 23 CB channels. It features adjustable squelch and noise limiter and switches for 3.5-



watt p.a. use, spotting, and Part 15 operation. The integral transistorized dual power supply operates from 12-volt d.c. or 117-volt a.c.

The unit comes with a channel 9 transmit crystal, mobile mounting brackets, a.c. and d.c. power cords, noise canceling push-to-talk ceramic microphone and measures 4³/₄" x 12" x 7¹/₂". It is available only in wired form. Eico

Circle No. 20 on Reader Service Card

SSB CITIZENS BAND UNIT

The greater performance of single sideband has been made available to users of CB equipment with the introduction of the "350."

The SSB mode of transmission furnishes up to 30% greater range over ordinary 5-watt AM Citizens Band transmitters when operating conditions are ideal. Under actual use during periods of high noise, severe skip interference, and other atmospheric interference, the new unit can deliver up to three times the range of other CB units.

ZENITH LOG PERIODIC ANTENNAS

offer high
signal gain and
ghost rejection

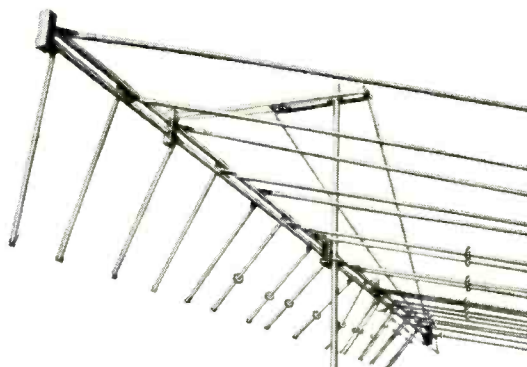

All-channel VHF/UHF/FM and FM Stereo

Developed by the University of Illinois antenna research laboratories, each Zenith log periodic antenna works like a powerful multi-element Yagi . . . not on just one or a few channels, but across the entire band it's designed for.

Order Zenith antennas and all genuine Zenith replacement parts and accessories from your Zenith distributor.

BUILT TO THE QUALITY STANDARDS OF ZENITH ORIGINAL PARTS

Also Zenith periodic antennas for

- UHF • VHF
- FM AND FM STEREO
- PLANAR HELICAL UHF

ZENITH

The quality goes in
before the name goes on

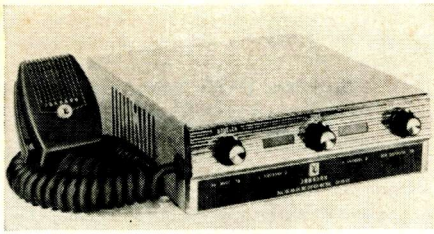

The "350" can operate on any of 46 different frequencies without adjacent channel interference. The unit is all-solid-state. Mechanical relays have been eliminated by a diode switching system, yielding complete reliability.

The unit weighs 6 pounds for 12-volt operation and comes in a cabinet 8" wide x 2½" high x 9½" long. An optional a.c. power supply for base-station use is available. E. F. Johnson

Circle No. 21 on Reader Service Card

FIVE-BAND TRANSCEIVER

A new 80, 40, 20, 15, 10 meter transceiver has been introduced as the SR-2000. Transmitter power input is 2000 watts p.e.p. on SSB and 1000 watts on c.w. Despite the high power, the unit measures only 7½" high x 16½" wide x 15" deep.

The transmit section has two 8122 output tubes and a variable pi network. Carrier and unwanted sideband suppression is rated at 50 dB and distortion products are 30 dB. The audio

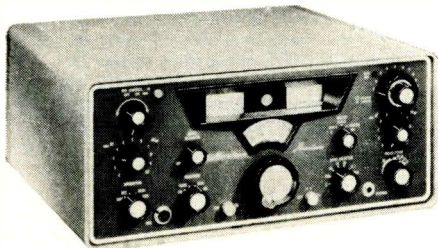

output is measured at 500 to 2600 Hz at 6 dB. Cooling of the section is handled by a two-speed blower.

Sensitivity of the receive section is less than 1 μV for a 20 dB signal-to-noise ratio. The audio output for driving a speaker is 2 watts and overall gain is 1 μV for ½-watt output. The receiver first i.f. is 6.0-6.5 and the second i.f. is 1650 kHz. Hallicrafters

Circle No. 22 on Reader Service Card

25-CHANNEL TRANSCEIVER

A 25-channel CB transceiver which provides coverage of the 23 CB channels plus two emergency "H.E.L.P." channels has been introduced as the Stock No. 99-3064WX.

The unit is a dual-conversion transceiver; has a full-wave range-boost circuit; uses 13 tubes, 2 transistors, and 9 diodes; offers 0.3-μV sensitivity and adjacent channel rejection. Receiver selectivity is 8 kHz at 31 dB down. Other features include a combination "S" and power output meter; 100 mW and 5-watt power input switch; variable ANL and squelch; p.a. switch with front-panel volume control; and built-in 117-volt a.c. and transistorized 12-volt d.c. power supply.

The unit measures 12" wide x 5" high x 8¾" deep. It comes complete with mobile mounting bracket, cables, and ceramic push-to-talk microphone. Lafayette

Circle No. 23 on Reader Service Card

MANUFACTURERS' LITERATURE

DIGITAL READOUTS

A new and enlarged 1966 catalogue listing a full line of incandescent lamps and digital readouts is now available. Featured in the booklet are "Midgi-Lite" digital readout heads; "Midgi-Mate" miniature drivers and encoders with rugged epoxy encapsulation and brightness adjustability; and the multi-filament "Alpha-Lite," an alpha-numeric microminiature readout dis-

play with variable brightness, modular plug-in construction, and a life expectancy exceeding 50,000 hours. Pinites

Circle No. 147 on Reader Service Card

ELECTRONIC COMPONENTS

A full line of precision electronic components, including batteries, capacitors, resistors, semiconductors, switches, and controls, is offered in a new 1966 44-page illustrated general catalogue. Mallory

Circle No. 24 on Reader Service Card

PROXIMITY SWITCHES

A new 16-page illustrated catalogue (85d) covering proximity switch systems has been issued. All-metals sensitive systems, which respond to all electroconductive metals, and ferromagnetic-metals sensitive systems, responding to ferrous metals only, are described in detail.

In addition, the booklet supplies mounting dimensions, application data, and a listing of accessories. Micro Switch

Circle No. 148 on Reader Service Card

SEMICONDUCTOR CATALOGUE

Semiconductors, metal-film resistors, wire and cable products, and precision connectors are among the products listed in a new 60-page, short-form catalogue.

Convenient cross-reference information, selection charts, and outline drawings are included. Transitron

Circle No. 149 on Reader Service Card

FILTER NETWORKS

Data useful in specifying custom electronic filters is contained in a new 6-page brochure. Response curves, specification tables, and block diagrams are included, as well as a number of typical filter-network installations. Triad Transformer

Circle No. 150 on Reader Service Card

RADIO INTERFERENCE

A special 18-page report dealing with all phases of radio interference related to the operation of engine generators has been published. Entitled "Radio Frequency Interference," the study discusses causes of r.f. interference and methods of locating, measuring, and suppressing it.

Multi-colored charts outline radio suppression classifications and control limits issued by the Army, Navy, and Air Force. Onan

Circle No. 151 on Reader Service Card

TAPE RECORDERS

Two new, fully transistorized tape recorders for commercial applications are presented in a 6-page illustrated folder.

Model 1021 is a monaural recorder with tape speeds of 3¾ ips for AM broadcasts and 7½ ips for FM. Model 1022 is a stereophonic recorder that operates at 15 ips with wide flat frequency response, good signal-to-noise ratio, and low distortion that are ideal for cutting master tapes. Model 1022 also operates at 7½ ips for general recording requirements. Magnecord

Circle No. 25 on Reader Service Card

TUBE RATINGS

A new mobile communications tube reference guide which contains the basic specifications and "Push-To-Talk-Service (PTTS)" ratings for eleven popular tubes is now available.

The PTTS rating system, developed by the company for its own tubes, is based on an operating cycle of 1 minute on (maximum) and 4 minutes off (minimum). This cycle also permits continuous operation for extended periods to allow circuit alignment and tune-up. AmpereX

Circle No. 26 on Reader Service Card

INDICATOR LIGHTS

A new 12-page illustrated catalogue (L-178A) describing a complete line of two-terminal, fully insulated, subminiature indicator lights has been issued.

Both incandescent and neon types are offered

in a wide choice of lens-cap shapes, finishes, and colors with hot-stamped or engraved legends. Dialight

Circle No. 152 on Reader Service Card

LEVER SWITCHES

A new 4-page engineering specification catalogue (No. S-309) covering four series of new lever-type switches has been issued. Fully illustrated, the bulletin supplies complete mounting information and operating details. A wide selection of colors, knob shapes, illumination, and application tips is offered. Switchcraft

Circle No. 153 on Reader Service Card

PRECISION POTENTIOMETERS

A complete line of microminiature and sub-miniature, ganging, sine-cosine, high-resolution, sleeve and ball-bearing, linear and non-linear, and fully enclosed, precision-ganging potentiometers is presented in a new 24-page illustrated catalogue. Samarius

Circle No. 154 on Reader Service Card

PRODUCT BROCHURE

Illustrations and descriptions of a wide variety of "Scotch" electrical products for the communications industry are provided in a new 8-page booklet. Included are electrical tapes, connectors, splicing kits, sealers, flat cable systems, and mounting plates and cable clips. 3M

Circle No. 155 on Reader Service Card

Home TV Via Satellite

(Continued from page 41)

transporting information to other world centers or to developing nations.

To sum up, we at Arthur D. Little, Inc. believe that:

- Non-synchronous satellites would require trackers at each home. Large-scale CATV operators could conceivably develop a receiving system to track multiple satellites, but this would be an expensive undertaking.

- Synchronous satellites broadcasting twelve channels to the home are not technically feasible below 200 MHz and are only marginally feasible at 600 MHz. Here expensive receiving equipment is required.

- At frequencies between 2000 and 7000 MHz, trunking is possible but this would require expensive ground equipment that only the most affluent CATV systems could afford.

- A feasible system would require at least a 20,000-watt continuous power source (more probably 30,000 to 40,000 watts of prime power would be required) and the development of high-power transmitting equipment that could operate reliably for many years. Neither development appears possible for many, many years. ▲

PHOTO CREDITS

Page	Credit
12	Harman-Kardon
26	Dr. F. J. Fry, University of Illinois
32, 33, 34, 52	Ampex Corporation
35, 36	Daven Div.
42, 44, 85	Sony Corp. of America
62	Smith Kline Instrument Co.

ELECTRONICS MARKET PLACE

COMMERCIAL RATE: For firms or individuals offering commercial products or services. 70¢ per word (including name and address). Minimum order \$7.00. Payment must accompany copy except when ads are placed by accredited advertising agencies. Frequency discount: 5% for 6 months; 10% for 12 months paid in advance. **READER RATE:** For individuals with a personal item to buy or sell. 40¢ per word (including name and address). No Minimum! Payment must accompany copy. **GENERAL INFORMATION:** First word in all ads set in bold caps at no extra charge. Additional words may be set in bold caps at 10¢ extra per word. All copy subject to publisher's approval. **Closing Date:** 1st of the 2nd preceding month (for example, March issue closes January 1st.) Send order and remittance to: Hal Cymes ELECTRONICS WORLD, One Park Avenue, New York, New York 10016

FOR SALE

JUST starting in TV service? Write for free 32 page catalog of service order books, invoices, job tickets, phone message books, statements and file systems. Oelrich Publications, 6556 W. Higgins Rd. Chicago, Ill. 60656.

GOVERNMENT Surplus Receivers, Transmitters, Snooperscopes, Radios, Parts, Picture Catalog 25¢. Meshna, Nahant, Mass. 09108.

INVESTIGATORS, FREE BROCHURE, LATEST SUBMINIATURE ELECTRONIC SURVEILLANCE EQUIPMENT, ACE ELECTRONICS, 11500-J NW 7TH AVE., MIAMI, FLA. 33168.

CANADIANS—Giant Surplus Bargain Packed Catalogs. Electronics. Hi-Fi, Shortwave, Amateur, Citizens Radio. Rush \$1.00 (Refunded). ETCO. Dept. Z, Box 741, Montreal, Canada.

RESISTORS precision carbon-deposit. Guaranteed 1% accuracy, 1/2 watt 8¢. 1 watt 12¢. 2 watt 15¢. Rock Distributing Co., 902 Corwin Road, Rochester 10, N.Y.

NEW supersensitive transistor locators detect buried gold, silver, coins. Kits, assembled models. \$19.95 up. Free catalog. Relco-A22, Box 10563, Houston 18, Texas.

JAPAN & Hong Kong Electronics Directory. Products, components, supplies. 50 firms—just \$1.00. Ippano Kaisha Ltd., Box 6266, Spokane, Washington 99207.

ELECTRONIC Ignition Kits, Components. Free Diagrams. Anderson Engineering, Epsom, New Hampshire 03239.

WEBBER Labs. Transistorized converter kit \$5.00. Two models using car radio 30-50Mc or 100-200Mc, one Mc spread. Easily constructed. Webber, 72 Cottage, Lynn, Mass.

SAVE ON DIODES. If you use Germanium or Silicon Diodes in quantities of 5000 to a million, get our low, low prices. Send specs or request samples. **RULAND MANUFACTURING CO.,** Watertown, Mass. 617-924-8000.

TEST equipment, transmitters, receivers, antennas, parts. Picture catalog 20¢. Parramore Surplus Co., Dept. E-1, Mount Pleasant, Fla. 32352.

RECORDS

DISCOUNT Records, All Labels—Free Lists. Write Cliff House, Box 42-E, Utica, N.Y.

RENT STEREO RECORDS, \$1.00 three days. FREE offer, write: DISCO-TAPE, P.O. Box 5202-EM, Sta. #4, North Hollywood, Calif. 91604.

CANADIANS, transistors, all semiconductors and components. Free catalogue contains reference data on 300 transistor types. J.&J. Electronics (Dept. EW), P.O. Box 1437 Winnipeg, Manitoba, Canada.

TRANSISTORS—Miniature Electronic Parts. Send for Free Catalog. Electronic Control Design Company, P. O. Box 1432M, Plainfield, N.J.

ELECTRONIC Bargains—Free Catalog, Tubes, Diodes, CRT's Tuner Cleaner, etc. Cornell, 4213-W University, San Diego, Calif. 92105.

METERS—Surplus, new, used, panel and portable. Send for list. Hanchett, Box 5577, Riverside, Calif. 92507.

TRANSISTORIZED Products Importers catalog. \$1.00. Intercontinental. CPO 1717, Tokyo, Japan.

MESHNA'S TRANSISTORIZED CONVERTER KIT \$4.50 Two models—converts car radio to receive 30-50 mc or 100-200 mc (one mc tuning). Meshna, Lynn, Mass. 01901.

SECURITY ELECTRONICS introduces its NEW 1966 line of SURVEILLANCE EQUIPMENT. Improved NEW designs for maximum performance and greater value. FREE DETAILS. Security Electronics-EW, 11 East 43rd St., New York, N.Y. 10017.

R.F. CONVERTERS \$10 up. World's largest selection. Also CCTV cameras, transmitters, etc. Lowest factory prices. Catalog 10¢. Vanguard, 196-23 Jamaica Ave., Hollis, N.Y. 11423.

SAFEGUARD PRIVACY! New instrument detects electronic "bugs," wire-tapping and snooping devices. Free information. Dee Equipment, Box 7263-7, Houston 8, Texas.

CONVERT any television to sensitive big-screen oscilloscope. Only minor changes required. No electronic experience necessary. Illustrated plans, \$2.00. Relco-A22, Box 10563, Houston 18, Texas.

SCHEMATICS For Professional Sub miniature surveillance equipment. Send for Free Brochure. Tri Tron, Inc., 7800 Phoenix NE, Dept. A, Albuquerque, New Mexico 87110.

GIANT TESLA COIL—FORTY-INCH SPARKS! Complete plans, \$5.00. Details, color photo 50¢. Huntington Electronics, Inc., Dept. B, Box 9, Huntington Station, Shelton, Conn. 06484.

SMALL Nickel Cadmium Batteries. Low Priced. Electro-Matic Control Co., Iron Mountain, Mich. 49801.

AMAZING ELECTRONIC GAMES, fascinating tabletop experiments, exciting electronic toys and transistor gadgets. Build them all at a bargain with clearly illustrated "how-to" hobby manuals. Free catalog: Capstone, W-56, Cannondale, Conn. 06806.

ELECTRO-MECHANICAL, instrumentation, electronics. Parts, supplies and components. Timers, recorders, counters. Latest parts from missile control systems. Send 10¢ for catalog. TEXAS VALTRONICS, P.O. Box 2563, Freeport, Texas.

OCTOPULSE electronic ignition, Silicon reliability! Fail safe! Simplest installation yet! Positive, negative ground models, same low price \$24.95. Money back guarantee! Handebois, Inc., 4371 W. 138th St., Hawthorne, Calif. 90250.

HARD-TO-GET TUBES IN STOCK BRAND NEW—1 YR. GUARANTEE

Type	Price	Type	Price	Type	Price	Type	Price
200-00A	3.50	6AU5	1.75	6U8	1.18	12SQ7	1.35
01A	2.75	6AU6	1.74	6V6GT	.76	12SR7	1.79
1A7	1.75	6AU8	1.68	6W4	.86	12W6	1.35
1AX2	.95	6AW8	1.35	6W6GT	1.02	12W6	1.35
1B3	.95	6AX4	.96	6X4	.59	13GF7	1.76
1N5	1.50	6AX5	1.33	6XSGT	.75	14A4	1.45
1L6	2.75	6AX7	1.25	6XA8	1.20	14A5	1.35
1LA4	1.30	6B4	5.95	6Y6GA	1.45	14A7	1.85
1LA6	1.98	6B8	2.66	7A4	2.25	14B6	1.90
1LC6	1.89	6BA6	1.70	7A5	2.05	14B8	1.95
1LD5	1.95	6BA8	1.48	7A6	2.69	14C5	1.75
1LE3	1.25	6BE6	1.81	7A7	1.70	14C7	2.33
1LH4	2.80	6BH6	.95	7AD7	2.95	14E6	1.39
1LH5	1.89	6BH8	1.54	7AD7	1.25	14E7	1.39
1N5	1.85	6BK7	1.38	7AG7	2.85	14F7	3.10
1P5	2.00	6BQ6	1.59	7AH7	1.95	14F8	2.23
1R4	1.89	6BQ7	1.43	7AU7	.93	14G7	1.95
1R5	1.10	6B7	2.10	7B7	1.25	14H7	1.95
1S5	1.10	6C4	.64	7B8	3.00	14Q7	2.25
1T5	1.05	6CSM	1.95	7B6	1.90	14W7	1.85
1U5	.98	6C8G	2.95	7B7	1.85	14X7	1.85
1V2	2.00	6C7	2.20	7C4	1.15	19	1.00
2A3	3.75	6C8	1.95	7C5	1.25	2A	1.50
2A6	4.50	6C8	1.95	7C6	1.25	2A	1.50
2A5	1.49	6C8	1.29	7C7	1.28	25C5	.75
2A2A	1.95	6C8A	1.10	7F7	2.94	25D6	1.40
3A3	1.18	6C7A	1.35	7F7	1.95	25D6	1.40
3A5	1.10	6C8X	1.42	7G7	2.25	26	1.60
3B7	2.39	6CZ5	1.48	7H7	1.95	27	1.75
3BM4	1.58	6D6	2.50	7J7	1.75	28	1.50
3BZ6	.83	6D6	2.50	7K7	1.05	30	1.25
3CB6	.82	6DA4	1.03	7L7	1.99	33	1.15
3D6	1.48	6DN6	3.05	7M7	2.71	34	1.25
3D7	1.88	6D8	1.45	7Q5	1.45	35A5	2.10
3Q5	2.00	6DQ4	.96	7R7	2.25	35L6	.92
4B7	1.52	6DQ5	3.10	7S7	1.79	35W4	.79
4B8	1.39	6E5	2.25	7T7	2.49	35Z3	1.74
4BZ7	1.45	6F4	4.75	7X6	1.35	35Z5	.72
4CB6	.82	6F6	1.75	7Y7	1.79	35Z6	1.75
5AM8	1.50	6FGC	1.95	7Y8	2.95	37	1.25
5AN8	1.64	6F7	3.95	7Y7	1.79	38	1.25
5A8	1.64	6F8	3.08	7Z4	2.35	39/44	1.25
5A58	1.64	6F8	3.08	7Z4	2.35	39/44	1.25
5AT8	1.44	6H28	2.10	8B05	1.03	42	1.94
5AZ4	2.00	6J5C	1.34	8C67	.86	43	2.75
5B7	1.45	6J5F	1.13	8D06	1.95	45/2A3	3.50
5BR8	1.59	6J7	1.88	8J7	1.28	46	.95
5CG8	1.19	6J7G	1.75	8G8	1.42	47	3.50
5J6	1.25	6J8	2.50	8J8	1.38	48	4.00
5U4	1.73	6K6GT	.93	10DE7	2.23	49	3.50
5U8	1.19	6K7	1.90	12A8	2.95	50	1.75
5V4	1.35	6L6G	1.10	12AH7	1.99	50A5	2.20
5X8	1.40	6L6G	1.65	12AT6	.63	50C5	.74
5Y3	.61	6L7M	2.58	12AT7	1.05	50L6	.88
5Y4	1.45	6N7M	1.85	12AU6	.74	50X6	2.10
5Z3	3.00	6P5	1.25	12AU7	.66	50Y6	1.55
5Z4	3.00	6Q7	2.05	12AV6	.58	50Y7	1.52
6A7	3.05	6S7	1.95	12AX4	.92	53	3.50
6A8	2.45	6S8GT	1.95	12AX6	1.95	53	3.50
6AB4	.92	6S7M	1.60	12BA6	.59	56	1.45
6AB7	2.50	6S87	2.25	12BE6	.61	57	1.75
6AC	2.24	6SD7	1.42	12BH7	1.04	58	1.75
6AC7	1.75	6SH7	1.10	12CK7	1.58	59	1.75
6AF3	1.18	6SF7	2.40	12BR7	1.14	70L7	.99
6AC5	1.03	6SG7	1.69	12BY7	1.15	71A	1.25
6AT6	2.75	6SH7	1.50	12K7	1.52	71B	1.25
6AM4	1.25	6SJTGT	1.48	12K8M	2.95	76	1.75
6AK5	1.69	6SJT7M	1.65	12L6	1.32	77	2.00
6AL7	1.50	6S7M	1.50	12L8	1.50	78	1.75
6AM8	1.25	6SK7M	1.58	12Q7	1.50	80	1.75
6AN8	1.43	6SL7GT	1.25	12S7	1.59	83	1.75
6AR5	1.59	6SNTGT	.90	12SC7	1.92	83V	3.00
6ARS	1.45	6SOTGT	1.33	12SF7	2.32	88	3.00
6A55	.99	6SR7	1.50	12SG7	1.72	6146	2.75
6AS7	2.85	6S7M	1.88	12SH7	1.85	6336	4.75
6AT8	1.49	6T8	1.20	12SJ7	1.30	6500	4.00
6AU4	1.28	6U5	2.75	12SK7	1.40	807	.95
				12SL7	1.33	KT-88	4.95

OUR MINIMUM ORDER \$5.00

SEND FOR COMPLETE TUBE CATALOG OF OVER 3500 ADDITIONAL TYPES

UNITED RADIO CO.

EW-5, P.O. BOX—1000 A5, NEWARK, N.J.
CIRCLE NO. 91 ON READER SERVICE CARD

GET IT from GOODHEART!

EVERYTHING UNCONDITIONALLY GUARANTEED!

DOES LOW OR CHANGING LINE VOLTAGE ANNOY?

Featured for May are **Line Voltage Regulators**. They hold line to 115 or 120 v. for full rating. Automatically! CV types are tuned saturating isolating transformers. hold to 1%. have 14% harmonics. CVH are same but only 3% harm. CM are servo-system, hold 1% to 1%. have ZERO harm. SEI are Electronic, hold to 0.1%. have max. 3% harm. MFRs. are Sola, Raytheon, General Radio, Sorensen, Superior, Electric. ALL AT LOW SURPLUS BARGAIN PRICES! *Items are SPECIAL VALUES!

CV: 250 VA, \$22.50, 500 VA \$ 37.50
1 KVA, \$69.50, 2 KVA (230v) 99.50
CVH: 250 VA, \$29.50, 1 KVA 89.50
EM: 6 KVA, \$279.50.

(Includes G.R. #1570AL.)
S/EL: 500 VA, \$99.50, 1 KVA 129.50
2 KVA *129.50, 2 KVA "S" 199.50
2 1/2 KVA *199.50, 3 KVA 279.50
5 KVA (230v) \$350.00, 10 KVA 595.00

HIGH-POWER SIGNAL GENERATORS

Can be used normally because they have accurately-calibrated attenuators & freq. calibration, very low leakage, high stability AM or CW. Additionally, the high power enables use to measure effectiveness of RF filters with atten. over 100 db. to provide known radiation fields to measure susceptibility, leakage, screen rooms, etc. to plot antenna radiation patterns and to measure VSWR.

TS-606/U (Borg-Warner, Byron-Jackson, Rollin Model 20): 85 kc to 40 mc. Output across a 20 ohm external load (making a 10 ohm source impedance) is variable from 0.1 v to 10 v AM or CW and for CW only, will put out up to 15 v at most freq. in its range. When we use a 50 ohm wattmeter as a load, we read from 10 to 12 watts. Vo is read on a panel meter, with step and variable atten. With book, fob Los Angeles. . . . \$995.00

TS-608/U (Borg-Warner, Byron-Jackson, Rollin Model 30-1): Very similar to above, except output designed for a 50 ohm load, and freq. range 11 to 400 mc. We read outputs (at high-level CW only) of 7 to 10 watts on a 50 ohm wattmeter used as a load. On AM/CW Low output use, puts out 10 v across 50 ohms. Step and variable attenuators down to 0.1 v. With book, fob Los Angeles. . . . \$1295.00 (Note: last factory price was \$14,750.00!)

SLRD (Rohde & Schwarz): 275 to 2,750 mc in 2 overlapping bands calibrated on long scale with readability of 1 part in 10,000 and accuracy of 2%. Max. power output into external 50 ohm load is more than 10 w from 275-500 mc; more than 20 w from 500-1700 mc; more than 5 w from 1700-2400 mc; more than 1 w from 2400-2750 mc. Output controllable adjustably down to about 10 to the minus 10th w. CW or AM pulse at 1 kc 100% modulated. Overhauled and certified by the factory branch, with book. Regular price is over \$4000.00. From us, only \$1995.00

WE RENT TO YOU! WE BUY FROM YOU!

R. E. GOODHEART CO., INC.

Box 1220-A, Beverly Hills, Calif. 90213
Phones: Area 213, office 272-5707, messages 275-5342
CIRCLE NO. 114 ON READER SERVICE CARD
May, 1966

RECTIFIERS & TRANSISTORS

Silicon Diodes

Amps	100 PIV	200 PIV	400 PIV	600 PIV
.75*	.07	.10	.14	.21
3	.14	.22	.28	.40
15	—	.75	1.20	1.55
35	—	1.30	2.00	2.70

Amps	700 PIV	800 PIV	900 PIV	1000 PIV
.75*	.25	.32	.40	.55
3	.49	.58	.67	.78
15	1.70	1.85	2.25	2.50
35	3.15	3.60	4.50	4.80

1100 PIV 70c, 1200 PIV 85c, .75 amp
* TopHat, Epoxy, or Flameless

10 Watt Sil. Zener Stud 20%, 12-200V. .95¢ ea.
1 Watt Zener, axial 20%, 8-200V. .50¢ ea.
Sil. diode Stud, 1500 piv, 300 ma. .50¢ ea.
Sil. diode, 1500 PIV, 50 ma. axial. .3/\$1.00
Hoffman Sil. Epoxy diodes, 200 ma.
3000 PIV. .98¢ 6000 PIV. \$2.49
Thermistor bead, 900 or 1200 ohm, 600° F. 2/\$1.00

Silicon Power Transistors

4W, 2n498 TO-5	.50c
15W, 2n2989, TO-5	.75c
30W, 2n2151, TO-60	\$1.25
40W, 2n1047, TO-57	\$1.40
50W, 2n1022, TO-53	\$1.50
50W, 2n1724, TO-61	\$1.50

2n1300 series, NPN or PNP. .6/\$1.00
Sil. Junction diodes, 1N200 series. .15/\$1.00
70 amp. stud, 50 PIV—\$2.50, 100 PIV. \$3.50
Amplifier, 6 Tubes, new, 3 lbs. \$1.49
Nickel Cadmium Battery, 9 1/2 oz. 8 amp hr. \$1.95
10 Lbs. Power Resistors, 5-60W. \$1.98
10 Lbs Oil Capacitors, assorted. \$1.98
Radio Knobs for 1/4" shafts. 120/\$1.98
2 Watt Pots, assorted. .15/\$1.00
Mercury Batteries, 5.4V, 5/8"x1" .4/\$1.00
Precision Resistors, assorted. 120/\$1.98
200—1/2 w resistors, assorted. \$1.98
130—1 W resistors, assorted. \$1.98

Varicap-Voltage Variable Capacitor

27, 47, or 100 pf at 4V. 4:1. \$1.25

150 W Germanium Power (Diamond Case)

2n1021...\$1.00 2n1022...\$1.25 2n511...\$1.50
20 W Germanium Power (internal heat sink)
2n1038 4/\$1.00 2n1039 3/\$1.00 2n1040 2/\$1.00
2n1041 60¢ Add 10¢ ea. for external heat sink

SILICON CONTROLLED RECTIFIERS

PRV	.75A	7A	16A	PRV	.75A	7A	16A
25	—	.48	300	1.20	1.80	2.20	2.20
50	—	.45	.70	400	1.70	2.20	2.70
100	—	.70	1.20	500	1.95	3.00	3.30
200	.80	1.15	1.70	600	2.30	3.20	3.90

Money back guarantee, \$2.00 min. order, include postage. Write For Free Catalog.

Electronic Components Co.
Box 2902, Baton Rouge, La. 70821

CIRCLE NO. 118 ON READER SERVICE CARD

BIG CATALOG
World's "BEST BUYS"
in GOV'T. SURPLUS
Electronic Equipment

100 NEW ITEMS

INCLUDED IN OUR NEWEST
SPRING-SUMMER '66 CATALOG
SEND FOR YOUR COPY NOW!

SP-600 Super Pro Receiver	\$349.95
MICROSCOPE PROJECTOR 75X Comparator	99.50
ELECTROFAX SIGNAL GUARD	34.95
READOUT BOARD—30 Lights, 110 Volts	1.95
COMPUTER MEMORY CORE MATRIX	24.95
AN/PDR-8B RADIATION DETECTOR	29.95
BOMB DIRECTOR COMPUTER	7.95
SUPERSONIC SELECTOR, 10 Channel	8.95
AUDIO BOOSTER AMPLIFIER	12.95
TN-1/APR-1 TUNING UNIT	
30-90 MC. W/Case (New)	24.95
MILLIVAC D.C. MILLIVOLTMETER	
1 MV. To 1000 V.	115.00
BALLATINE VOLTMETER No. 300—	
1 MV. To 100 V.	85.00
CEDCO CRYSTAL CALIBRATOR—Model C-5	39.95
POWER SUPPLY For Transistors, Voltage Regulated	29.95
FR-24 WAVEMETER	
12,400 To 15,000 MC.	150.00
BC-221 FREQUENCY METER	
Used: \$79.50—New: 125.00	
OS-26/OS-S1 OSCILLOSCOPE	
(See Catalog) \$44.95 To \$9.50	
AN/UPM-8 RADAR TEST SET	39.95
TS-414 DYNAMOTOR TEST SET	79.50
AN/UPM-11 RANGE CALIBRATOR	100.00

FOR BIG CATALOG—SEND 25¢ (stamps or coin) and receive 50¢ CREDIT on your order!

Address Dept. EW • Prices F.O.B. Lima, O. •
25% Deposit on C.O.D.'s • Minimum Order \$5.00

FAIR RADIO SALES
2133 ELIDA RD. • BOX 1105 • LIMA, OHIO

ELECTRONICS ENGINEERING AND INSTRUCTION

FCC LICENSE in six weeks. First class radio telephone. Results guaranteed. Elkins Radio School, 2603C, Inwood, Dallas, Texas.

ELECTRONICS! Associate degree—29 months. Technicians, field engineers, specialists in communications, missiles, computers, radar, automation. Start September, February. Valparaiso Technical Institute, Dept. N, Valparaiso, Indiana.

ELECTRONICS—F.C.C. License Training—correspondence. or resident classes. Free details, Write: Dept. 6, Grantham, 1505 N. Western, Hollywood, Calif. 90027.

REI First Class Radio Telephone License in (5) weeks Guaranteed. Tuition \$295.00. Job placement free. Radio Engineering Institute, 1336 Main Street, Sarasota, Fla.

HIGHLY—effective home study review for FCC commercial phone exams. Free literature! COOK'S SCHOOL OF ELECTRONICS, Craigmont, Idaho 83523.

LEARN ELECTRONIC ORGAN SERVICING at home. All Makes including transistors. Experimental kit—

NATIONAL TECHNICAL RESEARCH LABS, 6422 S. Westrell Ave., Whittier, Calif.

TUBES

BEFORE you buy receiving tubes, Transistors, Diodes, Electronic Components and Accessories... send for Giant Free Zalytron Current Catalog, featuring Standard Brand Tubes; RCA, GE, etc.—all Brand new premium quality individually boxed. One year guarantee—all at biggest discounts in America! We serve professional servicemen, hobbyists, experimenters, engineers, technicians. Why pay more? Zalytron Tube Corp., 469-W Jericho Turnpike, Mineola, N.Y. 11502.

TUBES—33¢ each. One year guaranteed. Complete stock. Free list. Cornell, 4215—W University, San Diego, Calif. 92105.

FREE Catalog. Electronic parts, tubes, Wholesale. Thousands of items. Unbeatable prices. Arcturus Electronics ZD, 502-22 St., Union City, N. J. 07087.

TUBES, SEMICONDUCTORS, ELECTRONIC EQUIPMENT & COMPONENTS. Quality merchandise only! Serving engineers, purchasing agents TV/HiFi servicemen and hams for 16 years. Write for catalog or call WA 5-7000, BARRY ELECTRONICS, 512 Broadway, New York, N.Y. 10012.

PATENTS

INVENTIONS: Ideas developed for Cash Royalty sales. Raymond Lee, 130-G West 42nd, N.Y.C. 10036.

WANTED

QUICKSILVER. Platinum, Silver, Gold. Ores Analyzed. Free Circular. Mercury Terminal, Norwood, Mass.

CASH Paid! Sell your surplus electronic TUBES. (Want UNUSED, clean Radio/TV Receiving, Transmitting, Special Purpose, Magnetrons, Klystrons, Broadcast Types.) Want military and commercial Lab/Test Equipment. Want commercial Ham Receivers and Transmitters. For a Fair Deal Write: BARRY Electronics, 512 Broadway, New York, N.Y. 10012 (WA 5-7000.)

TV SETS Wanted! "As Is." T.V., 467 Columbus Ave., N.Y., N.Y. TR 3-9400.

GOLD, Silver, Platinum (Any Form) Diamonds Bought, Information Free. Wilmot's, 1067V Bridge, Grand Rapids, Mich. 49504.

URGENTLY NEED MILITARY SURPLUS, ARC-27, ARC-34, ARC-38, ARC-44, ARC-52, ARC-73, ARC-84, COLLINS 51X-2, 17L-7, 51V-3, 618S-1, 18S-4, 618T. ARMY GROUND RT-66 THRU RT-70/GRC, GRR-5, R-109/GRC, AM-65/GRC, RT-77/GRC-9, GRC-10, GRC-19, PRC-25, TRC-1, TRC-7, TRC-24, TCC-7. TEST EQUIPMENT WITH ARM, SG, PRM, URM, UPM PREFIXES. ELECTRONIC TECH MANUALS. TOP CASH DOLLAR PAID, PLUS SHIPPING. SLEP ELECTRONICS COMPANY, DRAWER 178-EW, ELLENTON, FLA. 33532.

TOP CASH PAID for Electronic Test Equipment as Hewlett-Packard, Tektronix, General Radio, Dumont, Boonton. All types of tubes Special Purpose and Receiving, Transistors, Allen-Bradley resistors. Bring your gear, Plenty of FREE Parking. Open 6 days weekly 9-5:30. Rex Industrial Electronics, 759 10th Avenue, New York, N.Y. 10019 (nr. 51 st.) Telephone 757-1361.

REPAIRS AND SERVICES

TV Tuners Rebuilt and Aligned per manufacturers specification. Only \$9.50. Any Make UHF or VHF. We ship COD Ninety day written guarantee. Ship complete with tubes or write for free mailing kit and dealer brochure. JW Electronics, Box 51B, Bloomington, Indiana.

METERS—TEST EQUIPMENT REPAIRED—CALIBRATED. Free catalog. Bigelow Electronics, Bluffton, Ohio 45817.

EMPLOYMENT OPPORTUNITIES

INSTRUCTORS wanted—Experienced instructors to teach in the area of Electronics and Radio-Television Servicing. Age open—salary open—Prefer individual with an EE Degree with Electronics option for the Electronics positions—Year round employment in South-eastern United States—Excellent opportunity with growing institution. Send complete resume of education, personal background, and experience to Robert E. Paap, President, Catawba Valley Technical Institute, Hickory, North Carolina.

RUBBER STAMPS

RUBBER ADDRESS STAMP \$1.00. Signature \$2.88. Free catalog. Jackson Products, 1433 Winnemac, Chicago, Ill. 60640.

ELECTRONICS WORLD CLASSIFIED ADVERTISING CONTINUES #1 IN THE FIELD

Just as ELECTRONICS WORLD is the leading magazine for electronics professionals, the ELECTRONICS MARKET PLACE is the outstanding medium for mail order advertisers aiming for a selective audience.

The electronics professional looks to the pages of the ELECTRONICS MARKET PLACE for information as to where products and services may be obtained by him... and he's interested in products for his business as well as his personal interests.

The mail order advertising which now appears in these columns is placed by businessmen who are interested in investing their advertising dollars wisely. Therefore, as most of them are back with us month after month... you know they're achieving results! Results that can be obtained by you, too, if your classified advertising appears regularly in the ELECTRONICS MARKET PLACE, at the low rate of 70¢ per word—minimum \$7.00.

Plan now to get your classified advertising in the next available issue—July—on sale June 16th. Deadline is May 5th, so write today to: Hal Cymes, Classified Advertising Manager, ELECTRONICS WORLD, One Park Avenue, New York, New York 10016.

DO-IT-YOURSELF

PROFESSIONAL ELECTRONIC PROJECTS—\$1.00 up. Catalog 25¢, refundable. PARKS, Box 25565, Seattle, Wash. 98125.

TAPE AND RECORDERS

RENT Stereo Tapes—over 2,500 Different—all major labels—free brochure. Stereo-Parti, 1616—E. W. Terrace Way, Santa Rosa, California.

BEFORE renting Stereo Tapes, try us. Postpaid both ways—no deposit—immediate delivery. Quality—Dependability—Service—Satisfaction—prevail here. If you've been dissatisfied in the past, your initial order will prove this is no idle boast. Free Catalog, Gold Coast Tape Library, Box 2262, Palm Village Station, Hialeah, Fla. 33012.

TAPE RECORDER SALE. Brand new, latest models, \$10.00 above cost. Arkay Sales, 1028-B Commonwealth Ave., Boston, Mass. 02215.

STEREO TAPES. Save up to 60% (no membership fees, postpaid anywhere USA). Free 60-page catalog. We discount batteries, recorders, tape accessories. Beware of slogans "not undersold," as the discount information you supply our competitor is usually reported to the factory. **SAXITONE**, 1776 Columbia Rd., Washington, D. C. 20009.

HI-FI components, tape recorders, sleep learn equipment, tapes. Unusual Values. Free Catalog. Dressner, 1523 Jericho Turnpike, New Hyde Park 10, N.Y.

TAPE-MATES now offers **ALL TAPES—ALL LABELS** at **TREMENDOUS SAVINGS** plus **FREE** Tape-Mates membership. For **FREE** brochure write **TAPE-MATES**, 5280-EW W. Pico Blvd., Los Angeles 90019.

TAPES, TAPE RECORDERS—sold, exchanged. Free catalog. Tower, Lafayette Hill, Pa. 19444.

HIGH FIDELITY

LOW, LOW quotes: all components and recorders. Hi-Fi, Roslyn 9, Penna

HI-FI Components, Tape Recorders, at guaranteed "We Will Not Be Undersold" prices. 15-day money-back guarantee. Two-year warranty. No Catalog. Quotations Free. Hi-Fidelity Center, 239 (L) East 149th Street, New York 10451.

FREE! Send for money saving stereo catalog #E5W and lowest quotations on your individual component, tape recorder or system requirements. Electronic Values Inc., 200 West 20th Street, N.Y., N.Y. 10011.

FREE—\$1.00 Value "Miracle" Record cleaning cloth with every quotation on **HIFI EQUIPMENT.** Our "**ROCK BOTTOM**" prices on **NAME BRAND** amplifiers—tuners—taperecorders—speakers—**FRANCHISED—59 YEARS IN BUSINESS.** Write for this month's specials—**NOW!** Rabsons 57th St., Inc., Dept. 569, 119 W. 57th St., New York, New York 10019.

BRITISH High Fidelity 6" Woofer, 5" Tweeter. Exceptional Performance. 11,500 gauss, 30-20,000 cps., \$14.95. Enclosure Plans \$2.50. C-T Acoustic Laboratories, Box 543, Newark, Calif.

GOVERNMENT SURPLUS

JEEPS FROM—\$52.50 Typewriters From—\$4.15, Cars From—\$31.50, Walkie-Talkies, Guns, Airplanes, Boats. Typical "As Is" Bid Bargains From Uncle Sam. Tremendous Variety. Exciting Free List. Write: Enterprises, Box 402-B-9, Jamaica, N.Y. 11430.

JEEPS Typically From \$53.90... Trucks From \$78.40... Boats, Typewriters, Airplanes, Electronics Equipment, Photographic Equipment, used. 100,000 Bargains Direct From Government. Complete Sales Directory and Surplus Catalog \$1.00 (Deductible First \$10.00 Order). Surplus Service, Box 820-K, Holland, Mich. 49424.

TOOLS

TOOL CATALOG Send 25¢. Silvo Hardware, 107 Ziff, Walnut, Phila., Penna. 19106.

HYPNOTISM

FREE Hypnotism, Self-Hypnosis, Sleep Learning Catalog! Drawer H400, Ruidoso, New Mexico 88345.

GREGORY ELECTRONICS
Reconditioned & Used FM
2-WAY RADIO SAVINGS
Partial list—Send for New '66 catalog

Voice Commander

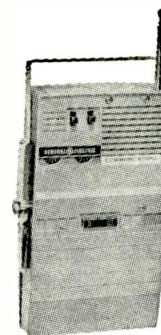

132 to 172 MC, 1W 9.5" x 5.3" x 1.7" Reduced price including brand New Rechargeable Nickel Cadmium Battery Pack

Lowest Price Ever!

\$148

If crystal & tuning is desired add \$40.00
Battery charger for these units \$16.00

WRITE FOR QUANTITY PRICES

RCA 25-54mc CMF40
6/12v 40 watts

Vibrator power supply. Fully narrow banded. Complete with all accessories, less crystals and antenna.

\$178

(Same unit without accessories \$148)

Same unit tuned to your frequency including brand new antenna, ready for installation

\$223

MOTOROLA P 11

Dry Battery Operated Pack Sets, less batteries & crystals
40-50 MC.....

\$48

DUMONT 101A 30-50MC

12 Volt 30 Watts complete accessories ideal for Monitor Receiver.....
Less crystals & antenna

\$68

GE TX 4ET5

6 v 30 watt 40-50mc.....

\$10

GE TX 4ET5

12 v 30 watt 40-50mc.....

\$15

We Buy Late Model Equipment for Cash
—Write; Wire or Phone!



GREGORY ELECTRONICS CORPORATION

249 RT. 46, Saddle Brook, N.J., 07662

Phone: (201) 489-9000

CIRCLE NO. 112 ON READER SERVICE CARD



WE DON'T HAVE \$1,000,000!

But we have enough cash to pay you the most for all your late model equipment! We want to buy ground and air communication equip., tele-type, GRC, PRG, ARC, AIN, & test equipment. WE PAY FREIGHT! Tell us what you have... what you want... and we'll give you the best deal in the country—**TODAY!**
COLUMBIA ELECTRONICS
Dept. EW
4365 W. Pico Blvd.
Los Angeles, Calif. 90019

EDUCATIONAL OPPORTUNITIES

LEARN While Asleep, hypnotize with your recorder, phonograph. Astonishing details, sensational catalog free! Sleep-Learning Association, Box 24-2D, Olympia, Washington.

LEARN while asleep. Remarkable, scientific, 92% effective. Details free. ASR Foundation, Box 721, Dept. e.g., Lexington, Kentucky.

USED Correspondence Courses and Books sold and rented. Money back guarantee. Catalog free. (Courses Bought). Lee Mountain, Pisgah, Alabama.

MICRO SPECIAL TO ELECTRONICS WORLD READERS ONLY!

M I C R O SINCE 1957 **M I C R O**

EVERY DEAL A FAIR DEAL

LARGE, SELECT STOCK! DEPENDABLE, FAST SERVICE!

- Every tube tested in our own laboratory for mutual conduction and life test.
- We guarantee **FREE** replacement for one year of any tube purchased from us which fails to function efficiently under any or all operating conditions. Prompt refunds on any defective merchandise.
- Advertised tubes not necessarily new, but may be electrically perfect factory seconds or used tubes—each clearly so marked.

New at MICRO!
25-WATT POWER TRANSISTORS
YOUR CHOICE **79¢** ea. **3 for \$2**

MICRO TUBE FABULOUS LOW PRICES!

0A2
024
1A7GT
1B3GT
1H4G
1H5GT
1L4
1L6
1NSGT
1QSST
1R5
6AW8
6AN8
174
104
1U5
1V2
1X2
2A3
2AF4
3BC5
3BN6
3BZ6
3CB6
3CF6
3CA6
3F4
3Q4
4BZ7A
4BZ7
5A7B
5A7C
5A7D
5A7E
5A7F
5A7G
5A7H
5A7J
5A7K
5A7L
5A7M
5A7N
5A7P
5A7Q
5A7R
5A7S
5A7T
5A7U
5A7V
5A7W
5A7X
5A7Y
5A7Z
5A7AA
5A7AB
5A7AC
5A7AD
5A7AE
5A7AF
5A7AG
5A7AH
5A7AI
5A7AJ
5A7AK
5A7AL
5A7AM
5A7AN
5A7AO
5A7AP
5A7AQ
5A7AR
5A7AS
5A7AT
5A7AU
5A7AV
5A7AW
5A7AX
5A7AY
5A7AZ
5A7BA
5A7BB
5A7BC
5A7BD
5A7BE
5A7BF
5A7BG
5A7BH
5A7BI
5A7BJ
5A7BK
5A7BL
5A7BM
5A7BN
5A7BO
5A7BP
5A7BQ
5A7BR
5A7BS
5A7BT
5A7BU
5A7BV
5A7BW
5A7BX
5A7BY
5A7BZ
5A7CA
5A7CB
5A7CC
5A7CD
5A7CE
5A7CF
5A7CG
5A7CH
5A7CI
5A7CJ
5A7CK
5A7CL
5A7CM
5A7CN
5A7CO
5A7CP
5A7CQ
5A7CR
5A7CS
5A7CT
5A7CU
5A7CV
5A7CW
5A7CX
5A7CY
5A7CZ
5A7DA
5A7DB
5A7DC
5A7DD
5A7DE
5A7DF
5A7DG
5A7DH
5A7DI
5A7DJ
5A7DK
5A7DL
5A7DM
5A7DN
5A7DO
5A7DP
5A7DQ
5A7DR
5A7DS
5A7DT
5A7DU
5A7DV
5A7DW
5A7DX
5A7DY
5A7DZ
5A7EA
5A7EB
5A7EC
5A7ED
5A7EE
5A7EF
5A7EG
5A7EH
5A7EI
5A7EJ
5A7EK
5A7EL
5A7EM
5A7EN
5A7EO
5A7EP
5A7EQ
5A7ER
5A7ES
5A7ET
5A7EU
5A7EV
5A7EW
5A7EX
5A7EY
5A7EZ
5A7FA
5A7FB
5A7FC
5A7FD
5A7FE
5A7FF
5A7FG
5A7FH
5A7FI
5A7FJ
5A7FK
5A7FL
5A7FM
5A7FN
5A7FO
5A7FP
5A7FQ
5A7FR
5A7FS
5A7FT
5A7FU
5A7FV
5A7FW
5A7FX
5A7FY
5A7FZ
5A7GA
5A7GB
5A7GC
5A7GD
5A7GE
5A7GF
5A7GG
5A7GH
5A7GI
5A7GJ
5A7GK
5A7GL
5A7GM
5A7GN
5A7GO
5A7GP
5A7GQ
5A7GR
5A7GS
5A7GT
5A7GU
5A7GV
5A7GW
5A7GX
5A7GY
5A7GZ
5A7HA
5A7HB
5A7HC
5A7HD
5A7HE
5A7HF
5A7HG
5A7HH
5A7HI
5A7HJ
5A7HK
5A7HL
5A7HM
5A7HN
5A7HO
5A7HP
5A7HQ
5A7HR
5A7HS
5A7HT
5A7HU
5A7HV
5A7HW
5A7HX
5A7HY
5A7HZ
5A7IA
5A7IB
5A7IC
5A7ID
5A7IE
5A7IF
5A7IG
5A7IH
5A7II
5A7IJ
5A7IK
5A7IL
5A7IM
5A7IN
5A7IO
5A7IP
5A7IQ
5A7IR
5A7IS
5A7IT
5A7IU
5A7IV
5A7IW
5A7IX
5A7IY
5A7IZ
5A7JA
5A7JB
5A7JC
5A7JD
5A7JE
5A7JF
5A7JG
5A7JH
5A7JI
5A7JJ
5A7JK
5A7JL
5A7JM
5A7JN
5A7JO
5A7JP
5A7JQ
5A7JR
5A7JS
5A7JT
5A7JU
5A7JV
5A7JW
5A7JX
5A7JY
5A7JZ
5A7KA
5A7KB
5A7KC
5A7KD
5A7KE
5A7KF
5A7KG
5A7KH
5A7KI
5A7KJ
5A7KK
5A7KL
5A7KM
5A7KN
5A7KO
5A7KP
5A7KQ
5A7KR
5A7KS
5A7KT
5A7KU
5A7KV
5A7KW
5A7KX
5A7KY
5A7KZ
5A7LA
5A7LB
5A7LC
5A7LD
5A7LE
5A7LF
5A7LG
5A7LH
5A7LI
5A7LJ
5A7LK
5A7LL
5A7LM
5A7LN
5A7LO
5A7LP
5A7LQ
5A7LR
5A7LS
5A7LT
5A7LU
5A7LV
5A7LW
5A7LX
5A7LY
5A7LZ
5A7MA
5A7MB
5A7MC
5A7MD
5A7ME
5A7MF
5A7MG
5A7MH
5A7MI
5A7MJ
5A7MK
5A7ML
5A7MN
5A7MO
5A7MP
5A7MQ
5A7MR
5A7MS
5A7MT
5A7MU
5A7MV
5A7MW
5A7MX
5A7MY
5A7MZ
5A7NA
5A7NB
5A7NC
5A7ND
5A7NE
5A7NF
5A7NG
5A7NH
5A7NI
5A7NJ
5A7NK
5A7NL
5A7NM
5A7NN
5A7NO
5A7NP
5A7NQ
5A7NR
5A7NS
5A7NT
5A7NU
5A7NV
5A7NW
5A7NX
5A7NY
5A7NZ
5A7OA
5A7OB
5A7OC
5A7OD
5A7OE
5A7OF
5A7OG
5A7OH
5A7OI
5A7OJ
5A7OK
5A7OL
5A7OM
5A7ON
5A7OO
5A7OP
5A7OQ
5A7OR
5A7OS
5A7OT
5A7OU
5A7OV
5A7OW
5A7OX
5A7OY
5A7OZ
5A7PA
5A7PB
5A7PC
5A7PD
5A7PE
5A7PF
5A7PG
5A7PH
5A7PI
5A7PJ
5A7PK
5A7PL
5A7PM
5A7PN
5A7PO
5A7PP
5A7PQ
5A7PR
5A7PS
5A7PT
5A7PU
5A7PV
5A7PW
5A7PX
5A7PY
5A7PZ
5A7QA
5A7QB
5A7QC
5A7QD
5A7QE
5A7QF
5A7QG
5A7QH
5A7QI
5A7QJ
5A7QK
5A7QL
5A7QM
5A7QN
5A7QO
5A7QP
5A7QQ
5A7QR
5A7QS
5A7QT
5A7QU
5A7QV
5A7QW
5A7QX
5A7QY
5A7QZ
5A7RA
5A7RB
5A7RC
5A7RD
5A7RE
5A7RF
5A7RG
5A7RH
5A7RI
5A7RJ
5A7RK
5A7RL
5A7RM
5A7RN
5A7RO
5A7RP
5A7RQ
5A7RR
5A7RS
5A7RT
5A7RU
5A7RV
5A7RW
5A7RX
5A7RY
5A7RZ
5A7SA
5A7SB
5A7SC
5A7SD
5A7SE
5A7SF
5A7SG
5A7SH
5A7SI
5A7SJ
5A7SK
5A7SL
5A7SM
5A7SN
5A7SO
5A7SP
5A7SQ
5A7SR
5A7SS
5A7ST
5A7SU
5A7SV
5A7SW
5A7SX
5A7SY
5A7SZ
5A7TA
5A7TB
5A7TC
5A7TD
5A7TE
5A7TF
5A7TG
5A7TH
5A7TI
5A7TJ
5A7TK
5A7TL
5A7TM
5A7TN
5A7TO
5A7TP
5A7TQ
5A7TR
5A7TS
5A7TT
5A7TU
5A7TV
5A7TW
5A7TX
5A7TY
5A7TZ
5A7UA
5A7UB
5A7UC
5A7UD
5A7UE
5A7UF
5A7UG
5A7UH
5A7UI
5A7UJ
5A7UK
5A7UL
5A7UM
5A7UN
5A7UO
5A7UP
5A7UQ
5A7UR
5A7US
5A7UT
5A7UU
5A7UV
5A7UW
5A7UX
5A7UY
5A7UZ
5A7VA
5A7VB
5A7VC
5A7VD
5A7VE
5A7VF
5A7VG
5A7VH
5A7VI
5A7VJ
5A7VK
5A7VL
5A7VM
5A7VN
5A7VO
5A7VP
5A7VQ
5A7VR
5A7VS
5A7VT
5A7VU
5A7VV
5A7VW
5A7VX
5A7VY
5A7VZ
5A7WA
5A7WB
5A7WC
5A7WD
5A7WE
5A7WF
5A7WG
5A7WH
5A7WI
5A7WJ
5A7WK
5A7WL
5A7WM
5A7WN
5A7WO
5A7WP
5A7WQ
5A7WR
5A7WS
5A7WT
5A7WU
5A7WV
5A7WW
5A7WX
5A7WY
5A7WZ
5A7XA
5A7XB
5A7XC
5A7XD
5A7XE
5A7XF
5A7XG
5A7XH
5A7XI
5A7XJ
5A7XK
5A7XL
5A7XM
5A7XN
5A7XO
5A7XP
5A7XQ
5A7XR
5A7XS
5A7XT
5A7XU
5A7XV
5A7XW
5A7XX
5A7XY
5A7XZ
5A7YA
5A7YB
5A7YC
5A7YD
5A7YE
5A7YF
5A7YG
5A7YH
5A7YI
5A7YJ
5A7YK
5A7YL
5A7YM
5A7YN
5A7YO
5A7YP
5A7YQ
5A7YR
5A7YS
5A7YT
5A7YU
5A7YV
5A7YW
5A7YX
5A7YY
5A7YZ
5A7ZA
5A7ZB
5A7ZC
5A7ZD
5A7ZE
5A7ZF
5A7ZG
5A7ZH
5A7ZI
5A7ZJ
5A7ZK
5A7ZL
5A7ZM
5A7ZN
5A7ZO
5A7ZP
5A7ZQ
5A7ZR
5A7ZS
5A7ZT
5A7ZU
5A7ZV
5A7ZW
5A7ZX
5A7ZY
5A7ZZ

Jan Surplus Tubes
32¢ ea.
\$29 PER HUNDRED ASSTD
for ANY TUBE LISTED

6BZ7
6CA6
6CB6
6CG6
6CW6
6DE6
6EQ6
6F6
6GH6
6GJ6
6GK6
6GL6
6GM6
6GN6
6GP6
6GQ6
6GR6
6GS6
6GT6
6GU6
6GV6
6GW6
6GX6
6GY6
6GZ6
6HA6
6HB6
6HC6
6HD6
6HE6
6HF6
6HG6
6HH6
6HI6
6HJ6
6HK6
6HL6
6HM6
6HN6
6HO6
6HP6
6HQ6
6HR6
6HS6
6HT6
6HU6
6HV6
6HW6
6HX6
6HY6
6HZ6
6IA6
6IB6
6IC6
6ID6
6IE6
6IF6
6IG6
6IH6
6II6
6IJ6
6IK6
6IL6
6IM6
6IN6
6IO6
6IP6
6IQ6
6IR6
6IS6
6IT6
6IU6
6IV6
6IW6
6IX6
6IY6
6IZ6
6JA6
6JB6
6JC6
6JD6
6JE6
6JF6
6JG6
6JH6
6JI6
6JJ6
6JK6
6JL6
6JM6
6JN6
6JO6
6JP6
6JQ6
6JR6
6JS6
6JT6
6JU6
6JV6
6JW6
6JX6
6JY6
6JZ6
6KA6
6KB6
6KC6
6KD6
6KE6
6KF6
6KG6
6KH6
6KI6
6KJ6
6KK6
6KL6
6KM6
6KN6
6KO6
6KP6
6KQ6
6KR6
6KS6
6KT6
6KU6
6KV6
6KW6
6KX6
6KY6
6KZ6
6LA6
6LB6
6LC6
6LD6
6LE6
6LF6
6LG6
6LH6
6LI6
6LJ6
6LK6
6LM6
6LN6
6LO6
6LP6
6LQ6
6LR6
6LS6
6LT6
6LU6
6LV6
6LW6
6LX6
6LY6
6LZ6
6MA6
6MB6
6MC6
6MD6
6ME6
6MF6
6MG6
6MH6
6MI6
6MJ6
6MK6
6ML6
6MN6
6MO6
6MP6
6MQ6
6MR6
6MS6
6MT6
6MU6
6MV6
6MW6
6MX6
6MY6
6MZ6
6NA6
6NB6
6NC6
6ND6
6NE6
6NF6
6NG6
6NH6
6NI6
6NJ6
6NK6
6NL6
6NM6
6NN6
6NO6
6NP6
6NQ6
6NR6
6NS6
6NT6
6NU6
6NV6
6NW6
6NX6
6NY6
6NZ6
6OA6
6OB6
6OC6
6OD6
6OE6
6OF6
6OG6
6OH6
6OI6
6OJ6
6OK6
6OL6
6OM6
6ON6
6OO6
6OP6
6OQ6
6OR6
6OS6
6OT6
6OU6
6OV6
6OW6
6OX6
6OY6
6OZ6
6PA6
6PB6
6PC6
6PD6
6PE6
6PF6
6PG6
6PH6
6PI6
6PJ6
6PK6
6PL6
6PM6
6PN6
6PO6
6PP6
6PQ6
6PR6
6PS6
6PT6
6PU6
6PV6
6PW6
6PX6
6PY6
6PZ6
6QA6
6QB6
6QC6
6QD6
6QE6
6QF6
6QG6
6QH6
6QI6
6QJ6
6QK6
6QL6
6QM6
6QN6
6QO6
6QP6
6QQ6
6QR6
6QS6
6QT6
6QU6
6QV6
6QW6
6QX6
6QY6
6QZ6
6RA6
6RB6
6RC6
6RD6
6RE6
6RF6
6RG6
6RH6
6RI6
6RJ6
6RK6
6RL6
6RM6
6RN6
6RO6
6RP6
6RQ6
6RR6
6RS6
6RT6
6RU6
6RV6
6RW6
6RX6
6RY6
6RZ6
6SA6
6SB6
6SC6
6SD6
6SE6
6SF6
6SG6
6SH6
6SI6
6SJ6
6SK6
6SL6
6SM6
6SN6
6SO6
6SP6
6SQ6
6SR6
6SS6
6ST6
6SU6
6SV6
6SW6
6SX6
6SY6
6SZ6
6TA6
6TB6
6TC6
6TD6
6TE6
6TF6
6TG6
6TH6
6TI6
6TJ6
6TK6
6TL6
6TM6
6TN6
6TO6
6TP6
6TQ6
6TR6
6TS6
6TT6
6TU6
6TV6
6TW6
6TX6
6TY6
6TZ6
6UA6
6UB6
6UC6
6UD6
6UE6
6UF6
6UG6
6UH6
6UI6
6UJ6
6UK6
6UL6
6UM6
6UN6
6UO6
6UP6
6UQ6
6UR6
6US6
6UT6
6UU6
6UV6
6UW6
6UX6
6UY6
6UZ6
6VA6
6VB6
6VC6
6VD6
6VE6
6VF6
6VG6
6VH6
6VI6
6VJ6
6VK6
6VL6
6VM6
6VN6
6VO6
6VP6
6VQ6
6VR6
6VS6
6VT6
6VU6
6VV6
6VW6
6VX6
6VY6
6VZ6
6WA6
6WB6
6WC6
6WD6
6WE6
6WF6
6WG6
6WH6
6WI6
6WJ6
6WK6
6WL6
6WM6
6WN6
6WO6
6WP6
6WQ6
6WR6
6WS6
6WT6
6WU6
6WV6
6WW6
6WX6
6WY6
6WZ6
6XA6
6XB6
6XC6
6XD6
6XE6
6XF6
6XG6
6XH6
6XI6
6XJ6
6XK6
6XL6
6XM6
6XN6
6XO6
6XP6
6XQ6
6XR6
6XS6
6XT6
6XU6
6XV6
6XW6
6XX6
6XY6
6XZ6
6YA6
6YB6
6YC6
6YD6
6YE6
6YF6
6YG6
6YH6
6YI6
6YJ6
6YK6
6YL6
6YM6
6YN6
6YO6
6YP6
6YQ6
6YR6
6YS6
6YT6
6YU6
6YV6
6YW6
6YX6
6YY6
6YZ6
6ZA6
6ZB6
6ZC6
6ZD6
6ZE6
6ZF6
6ZG6
6ZH6
6ZI6
6ZJ6
6ZK6
6ZL6
6ZM6
6ZN6
6ZO6
6ZP6
6ZQ6
6ZR6
6ZS6
6ZT6
6ZU6
6ZV6
6ZW6
6ZX6
6ZY6
6ZZ6

12BY7
12CA5
12AX7
12AU7
12AV7
12B7
12C7
12D7
12E7
12F7
12G7
12H7
12I7
12J7
12K7
12L7
12M7
12N7
12O7
12P7
12Q7
12R7
12S7
12T7
12U7
12V7
12W7
12X7
12Y7
12Z7
12AA
12AB
12AC
12AD
12AE
12AF
12AG
12AH
12AI
12AJ
12AK
12AL
12AM
12AN
12AO
12AP
12AQ
12AR
12AS
12AT
12AU
12AV
12AW
12AX
12AY

UNUSUAL BARGAINS

... MANY U. S. GOV'T SURPLUS

Brand New, Quick-Charge, Industrial Surplus
NICKEL-CADMIUM BATTERY
Unparalleled Value



For the first time a 6-volt light-weight nickel-cadmium battery in stainless steel, strap type-casting, 4-amp hour capacity. Almost unlimited life—thousands of discharge-charge cycles with minute deterioration—charges fully in approx. 1 hr. with Edmund charger kit. Just a few drops of water per year provide full maintenance. Hundreds of uses for hobbyists, amateur photographers, campers, model builders, etc. Unequaled for rechargeable lanterns, cycle scooters, and boat lights; portable fluorescent, and ultraviolet lights; electronic flash units. Battery requires minimum of electrolyte; is sealed to prevent loss; delivers nearly 100% of output at below freezing temperatures compared to 50% by lead-acid batteries. No corrosive fumes under any stage of recharge. Stud type terminals on top 1/8" apart, marked for polarity: 6-32 thread, nuts and lock washers. 6" x 2" x 4". Wt. 2 lbs. 12 ounces.

Stock No. 70,776-AK \$15.00 Ppd.
CHARGER KIT FOR 6-VOLT BATTERY. Charges in approx. 1 hr. Shuts off automatically, attaches to Stock No. 70,776 battery case. Includes transformer, resistors, charger circuit board, mounting hardware, 8-ft. cord plug, switch, assembly instr.

Stock No. 70807-AK \$8.00 Ppd.
ONE 1.2 VOLT NICKEL-CADMIUM CELL \$3.95 Ppd.
Stock No. 40,798-AK

"Balls of Fun" for Kids ...
Traffic Stoppers for Stores ...
Terrific for Amateur Meteorologists ...
SURPLUS GIANT WEATHER BALLOONS



At last... available again in big 8-ft. diameter. Create a neighborhood sensation. Great backyard fun. Exciting beach attraction. Blow up with vacuum cleaners or auto air hose. Sturdy enough for hard play; all other uses. Filled with helium (available locally) use balloons high in the sky to attract crowds, advertise store sales, announce fair openings, etc. Amateur meteorologists use balloons to measure cloud heights, wind speeds, temperature, pressure, humidity at various heights. Photographers can take low-cost aerial photos. Recent Gov't. surplus of heavy, black, neoprene rubber.

Stock No. 60,568-AK \$2.00 Ppd.
SLIGHTLY HEAVIER RUBBER-LATER MANUFACTURE!
Stock No. 60,562-AK 4 ft. diam. size \$2.00 Ppd.
Stock No. 60,564-AK 8 ft. diam. size \$4.00 Ppd.

Send Check or M.O.—Money-Back Guarantee
EDMUND SCIENTIFIC CO., BARRINGTON, N. J. 08007

SEND FOR NEW 148-PAGE FREE CATALOG—"AK"
Completely new 1966 edition. New items, categories, illustrations, 148 easy-to-read pages packed with nearly 4000 unusual items. Dozens of electrical and electronic parts, accessories. Enormous selection of Astronomical Telescopes, Microscopes, Binoculars, Magnifiers, Stigmets, Lenses, Prisms. Many war surplus items for hobbyists, experimenters, workshop, factory. Write catalog "AK."

EDMUND SCIENTIFIC CO., BARRINGTON, NEW JERSEY 08007
CIRCLE NO. 119 ON READER SERVICE CARD

AUTHORS' SERVICES

AUTHORS! Learn how to have your book published, promoted, distributed. FREE booklet "ZD," Vantage, 120 West 31 St., New York 1.

POEMS or new songs wanted. Tin Pan Alley, Inc., 1650 Broadway, New York, N.Y. 10019.

PHOTOGRAPHS

PHOTOGRAPHS and transparencies wanted, to \$500.00 each. Valuable information free—Write Intrapphoto-EW, Box 74607, Hollywood 90004.

PLANS AND KITS

TRIGGER SWEEP—Accurate time base duplicates laboratory instruments. Transistorized. Add to your scope. Plans and instructions \$1.00. SSS, 1720 Kimberly Dr., Sunnyvale, Calif. 94087.

EXPERIMENTERS—Latest transistorized projects Catalog 10¢. Hazelton Scientific, Box 163C, Hazel Park, Mich.

PERSONALS

GET out of debt—clear credit, immediate relief. Advisor, Box 48337-EW1, Los Angeles 90048.

LOW-COST Loans By Mail. \$6.00 monthly repays \$104.50; \$56 monthly repays \$1,321.39. Borrow any amount. Guaranteed fast, confidential. Write today! Bankers Investment, 92-B, Box 1648, Hutchinson, Kansas 67501.

REAL ESTATE

FREE!—SPRING CATALOG Giant 180 pages! Thousands of properties described, pictured—Land, Farms, Homes, Businesses—Waterfront, Recreation, Retirement. Selected Best Buys from The World's Largest. 489 Offices, 36 states Coast to Coast. Mailed FREE! **STROUT REALTY**, 60-ZD East 42nd St., New York, N.Y. 10017.

PHOTOGRAPHY—FILM, EQUIPMENT, SERVICES

MEDICAL FILM—Adults only—"Childbirth" one reel, 8mm \$7.50; 16mm \$14.95. International W, Greenvale, Long Island, New York.

SCIENCE Bargains—Request Free Giant Catalog "CJ"—148 pages—Astronomical Telescopes, Microscopes, Lenses, Binoculars, Kits, Parts, War surplus bargains. Edmund Scientific Co., Barrington, New Jersey.

EMPLOYMENT INFORMATION

FOREIGN Employment. Construction, other work projects. Good paying overseas jobs with extras, travel expenses. Write only: Foreign Service Bureau, Dept. D, Bradenton Beach, Florida.

FOREIGN Employment: South America, Africa, Europe, Australia, USA. Earnings to \$2,000.00 monthly. Construction, all trades, professions, occupations. Many companies pay fare, housing, benefits, bonuses. Write: Universal, Dept. B-8, Woodbridge, Conn. 06525.

"EMPLOYMENT RESUME GUIDE", EXAMPLED WRITING INSTRUCTIONS PLUS ACTUAL EXEMPLARS NUMEROUS TYPICAL RESUMES—\$2.00. BONUS "APPLICATION LETTER WRITING" (DOLLAR VALUE) INCLUDED FREE. MAGNETIC, Box 3677-EWW, WASHINGTON 20007.

SAVE your pay free meals and lodging. Technicians needed, Caribbean Island Tracking Stations. And Cape Kennedy, Information. \$1.00. Research, Box 334L, Cape Canaveral, Fla. 32920.

INVENTIONS WANTED

IMMEDIATE cash, for Patent Applications, free Patent Searches. Write for details. Universal Patents, 184-Y, Marion, Ohio.

INVENTORS. We will develop, help sell your idea or invention, patented or unpatented. Our national manufacturer clients are urgently seeking new items for outright cash sale or royalties. Financial assistance available. 10 years proven performance. For free information, write Dept. 42, Wall Street Invention Brokerage, 79 Wall Street, New York 5, N.Y.

NEON AC/DC ELECTRIC TESTER
FOR HOME AUTO SHOP
Special! 59¢

Prestige & Success are yours as an ELECTRONIC EXPERT
FOR CORNELL CUSTOMERS ONLY by special arrangement with the publisher, these amazing bargains are available.

COMPLETE RADIO SERVICING AND BASIC ELECTRONICS COURSE ONLY \$3.00 (\$3.50 - 50 packaging charge)

NEW PRACTICAL TV TRAINING COURSE ONLY \$3.50 (\$3.70 - 50 packaging charge)

Both above courses **\$6.00**

NEW! EASY TO USE! RADIO-TV/TUBE TESTER
TEST and REPAIR TV & RADIO SETS APPLIANCES
\$2.89 plus 30¢ shipping

CORNELL TUBES

1 YR. GUARANTEED

Mutual Conductance Lab-tested, Individually Boxed, Branded and Code Dated Tubes are new, or used and so marked.

OZ4	6A55	6CD6	6K6	6X4	12BF6
1B3	6AT6	6CF6	6K7	6X8	12BH7
1J3/1K3	6AT8	6CG7	6Q7	7A7	12BL6
1H5	6AU4	6CG8	654	7A8	12BY7
1L4	6AU5	6CM7	65A7	786	12C5
1T4	6AU6				12CA5
1U4	6AV6				12SN7
1X2	6AW8				12SQ7
3BZ6	6AX4				25L6
3DG4	6BA6				25Z6
5U4	6BC5	6CZ5	6SH7	7C5	35W4
5U8	6BD6	6D6	65J7	7N7	35Z3
5V4	6BG6	6DA4	65K7	7Y4	50L6
5Y3	6BJ6	6DA6	65L7	12AD6	24
6A6	6BL7	6DE6	65N7	12AE6	27
6A8	6BN4	6DQ6	65Q7	12AF6	77
6B4	6BN6	6EA7	65R7	12AT7	78
6AC7	6BQ6	6E6	6U7	12AU7	84/6Z4
6AG5	6BQ7	6EM5	6U8	12AX7	5687
6AK5	6BQ7	6F6	6V6	12BA6	6350
6AL5	6BZ6	6GH8	6V8	12BD6	6463
6AN8	6C4	6H6	6V6	12BE6	7044
6AQ5	6C6	6J5	6W4		
	6CB6	6J6	6W6		

Other tubes at low prices—send for free list

NO SUBSTITUTIONS WITHOUT YOUR PERMISSION

21 PICTURE TUBES
\$1395
* Administered Pay Dtd Deposit CDD or Send Dtd * with Order

all purpose ELECTRONIC CLEANER
ELECTRONIC CLEANER
LUBRICATES RESTORES
89c plus 30¢ shipping

SILICON RECTIFIERS
750 MA 400 P.I.V.
69¢ PAIR

DIODES / RECTIFIERS
sensational **39¢** per pack
KIT VALUE!

SOLDERING GUN
EASY TO HANDLE
HOT SHOT
THE ALL PURPOSE ELECTRIC SOLDERING GUN
\$2.99 plus 30¢ shipping

Electronic SOLDER
SOLDER
Sensational **VALUE! 29¢**

CORNELL ELECTRONICS CO.

Dept. EW 5 4217 University Ave., San Diego, Calif. 9 2 1 0 5

**AN/APR-4Y FM & AM RECEIVER
"FB" FOR SATELLITE TRACKING!**



High precision lab instrument suitable for monitoring and measuring frequency and relative signal strength of signals from 38 to 1000 Mc. in 5 tuning ranges. Pos. 110 Volt ac cycle 3C operation, built-in power supply. Original circuit diagram included. Checked out perfect. LIKE NEW \$88.50

TN-19 TUNING UNIT for above. continuous tuning 975 to 2300 Mc. Just right for 1200 Mc. Satellite. Frequency and other current Ham activity. Checked out perfect \$69.50
Other tuning units for above. TN-16, TN-17, TN-18, TN-34 in stock P.U.R. \$88.50

ARR-15 Collins Receiver, 1.5 to 18.5 Mc. Tunable, with Collins PTO and calibrator (written up in manual). Complete with tubes. \$65.00 exc. used

LORAN R-65/APN-9 RECEIVER & INDICATOR

Used in ships and aircraft. Determines position by radio signals from known xmitters. Accurate to within 1% of distance. Complete with tubes and crystal. IN LIKE NEW Condition \$79.50



Used, with all parts, less tubes, crystal and visor Special \$29.50

Shock Mount for above \$2.95
Circuit diagram and connecting plugs available.



LORAN APN-4 FINE QUALITY NAVIGATIONAL EQUIPMENT

Determine exact geographic position of your boat or plane. Indicator and receiver complete with all tubes and crystal.
INDICATOR ID-6B/APN-4, and RECEIVER R-9B/APN-4, complete with tubes. Exc. Used \$88.50

NEW! APN-4A Receiver-Indicator as above, changed to operate same as APN-4B for improved performance. NEW \$88.50
Shock Mount for above \$2.95

We carry a complete line of replacement parts and accessories for above.

AN ARR-2 Receiver, 234-258 Mc. Complete with 11 tubes. Brand New \$10.95
Exc. Used \$7.95

SCR-625 MINE DETECTOR

Complete portable outfit in original packing, with all accessories. Excellent. Used \$29.50



BC-929 3-Inch Scope, with all tubes, LIKE NEW \$16.50

Conversion instructions, with diagram, for 110 V AC operation \$.65

LM Freq. Meter, Modulated, 125 Kc to 20,000 Kc. With Calibration Book, Like New \$34.50
As above, less Calif. Book, exc. used \$34.50

BC1206-C BEACON RECEIVER 193 to 420 Kc. made by Satchel Carlson. Works on 24-240 volts. 1.35 Mc. IF. Complete with 5 tubes. Size 4" x 4" x 6". Wt. 4 lbs. LIKE NEW \$11.95
USED less tubes \$ 6.95

SCR-274 COMMAND EQUIPMENT

Type	Description	Used	Like New	BRAND NEW
BC-453	Receiver			
190-550	Kc.	\$14.95	\$18.95	P.U.R.
BC-454	Receiver 3-6 Mc.	\$15.95	\$24.50	
BC-455	Receiver 6-9 Mc.	\$13.95	\$19.50	\$24.50
BC-946	Receiver, 5.0 to 10.0 Mc. Complete with all tubes. Brand New, in original packing	\$48.50		
1.5 to 3 MC. Receiver Brand New		\$22.50		

110 Volt AC Power Supply for all 274-N and ARC-5 Receivers, complete with metal case, instructions. Factory wired, tested, ready to use \$12.50

SPLINED TUNING KNOB for 274-N and ARC-5 Receivers. Fits BC-453, BC-454 and others. Only 49¢

2.1 to 3 Mc. Transmitter. Brand New \$12.95
BC-458 TRANSMITTER—3.3 to 7 Mc. Complete with all tubes and crystal \$13.95

BRAND NEW \$8.95
Like New \$19.50

BC-459 TRANSMITTER—7 to 9 Mc. Complete with all tubes & crystal \$19.50

Like New \$16.95

BC-696 TRANSMITTER 3-4 Mc. Complete with All Tubes & Crystal. Brand New \$12.95
Like New \$12.95

BC-456 Modulator USED \$3.45 NEW \$5.95

ALL ACCESSORIES AVAILABLE FOR ABOVE

2 VOLT BATTERY "PACKAGE"

1—2V, 20 Amp. Hr. Willard Storage Battery—Model = 20-2, 3" x 4" x 5 1/2" high \$2.79
1—2V, 7 prong Synchronous Plug-in Vibrator 1.49
1—Quartz Bottle (Electrolyte for 2 cells) 1.45
ALL BRAND NEW! Combination Price \$5.45

Willard 6V Midget Storage Battery \$2.95

SEND FOR BIG NEW G&G CATALOG

Military & Electronic Surplus—Sensational Bargains!

Include 25¢ (Returned with First Order)

Please include 25¢ Deposit with order—Balance C.O.D., or Remittance in Full. 50¢ Handling Charges on all orders under \$5.00. All shipments F.O.B. Our Warehouse, N.Y.C. All Merchandise subject to Prior Sale and Price Change.

G & G RADIO SUPPLY CO.
Telephone: (212) CO 7-4605
77 Leonard St. New York, N.Y. 10013

CIRCLE NO. 115 ON READER SERVICE CARD
May, 1966

COINS

DOLLARS 1878, 1879, 1880 S \$3.00 Each; Uncirculated. SHULTZ, Salt Lake City, Utah 84110.
100 BUFFALO Nickels Clear Dates. Many Different, (Scarce). Only \$10.95. Van's Coins B-1, Walworth, Wisconsin 53184.

KENNEDY LIMITED SILVER MEMORIAL MEDALLION Issue. Only 15,000 will be minted and sold, in ALL THE WORLD. 1 1/2" diameter, serially numbered; beautifully sculptured high-relief. Become one of the lucky 15,000 owners of this rare solid silver masterpiece for only \$15.00. Also in unlimited solid bronze for \$5.00. Satisfaction guaranteed. Erie Publishers, P.O. Box 453F, Buffalo, N.Y. 14205.

BUSINESS OPPORTUNITIES

INVESTIGATE Accidents—Earn \$750 to \$1,400 monthly. Men urgently needed. Car furnished. Business expenses paid. No selling. No college education necessary. Pick own job location. Investigate full time. Or earn \$6.44 hour spare time. Write for Free Literature. No obligation. Universal, CZ-5, 6801 Hillcrest, Dallas, Texas 75205.

EARN extra money selling advertising book matches. Sample kit furnished. Match Corp, Dept. MO-56C, Chicago, Ill. 60632.

CITIZENS Band Radio Dealerships Available. Sell Full or Part Time. Knox Electronic, Dept. 274, Galesburg, Ill. 61401.

FREE BOOK "990 Successful, Little-Known Businesses." Work Home! Plymouth-945-Y, Brooklyn, New York 11218.

I MADE \$40,000.00 YEAR by mailorder! Helped others make money! Start with \$10.00—Free proof. Torrey, Box 63566-N, Oklahoma City, Oklahoma 73106.

FREE "Franchise Profit Letter" tells how unique NFR service is helping thousands seeking profitable businesses. Write today. National Franchise Reports, D-528, 333 North Michigan, Chicago 60601.

RAISE Capital fast—easy proven sources—Free information—Advisor, Box 48337-EW2, Los Angeles 90048.

FREE Facts and descriptive bulletin. Be an Air Conditioning, Refrigeration, and Heating Serviceman. High pay, jobs open everywhere, operate your own service business, no school or correspondence necessary. Instructions on all systems. Write Doolco Trouble Shooter, 2018 Canton, Dallas, Texas 75201.

STAMPS

COLLECT POSTAGE STAMPS in Beautiful White Ace Albums. Send for Color Booklet. Washington Press, Maplewood, New Jersey 07040.

FREE 25 Egypt, 10¢ handling, Approvals, Bellet Z-D, Hazel Park, Mich. 48030.

TERRIFIC 1¢ and 2¢ approvals. Thousands available. Thom's Stamps, P.O. Box 456, Richmond, Ind. 47374.

COLORFUL Israel Ambulance, 10¢ with Approvals. Iray, Box 114, Allston, Mass. 02134.

ADVANCED Collectors!!! Foreign Stamp Approvals 1/2 catalogue! Roth, Walker, W. Va. 26180.

MALAYSIA: 100 different \$1.00! (Catalogued \$5.00). CKLeong, POB 2617, Singapore 1.

MAGNETS

MAGNETS — Alnico—Ceramic—Flexible—Assemblies. What you need, we have. Special Powerful Pocket magnets, \$1.00. Maryland Magnet, 5412-E Gist, Baltimore, Md. 21215.

MISCELLANEOUS

WINEMAKERS: Free illustrated catalog of yeasts, equipment. Semplex, Box 7208, Minneapolis, Minn. 55412.

CASH REWARD!!!

YOU will be rewarded with cold, hard cash by selling us your new, used, excess or unwanted electronic equipment. **WE WANT TO BUY YOUR:** AN/ARN-21, AN/ARC-34, AN/ARC-52, -55, any ARN or ARC equipment, ID indicators, Military Type Test Equipment, Collins and Bendix equip., instruments and instrumentation. Tell us what you have—collect the reward!

J. J. CANDEE CO. Dept. EW
2525 W. Burbank Blvd., Burbank, Calif. 91505

FREE! PLUS CHOOSE ANY \$100 ITEM FREE

\$25 WORTH OF TRANSISTORS, RECTIFIERS, RESISTORS, CONDENSERS, DIODES, ETC.

Both FREE WITH ANY \$10 ORDER

DAP 198

IGNITION TRANSISTOR

TO-41

2N1073A
2N1073B
10 Amps
60-120 V

750 MIL TOP HAT AND EPOXIES

1000 PRV 3 for \$1.29

ZENER VOLTAGE REGULATORS 1 WATT

3 For \$1

Volts	6.8	10	15	22	33	47	68	100	150
Volts	7.5	11	16	24	36	51	75	110	160
Volts	8.2	12	18	27	39	56	82	120	180
Volts	9.1	13	20	30	43	62	91	130	200

LOW NOISE FETS FROM CRYSTALONIC

WORTH \$24

Vacuum Tube Equivalent

\$1.95 ELEC. WORLD November, for use in hook-ups.

N-channel

- 60 CERAMIC CONDENSERS, discs, npo's, to .05 \$1
- 10 TRANSISTOR ELECTROLYTICS: 10mf to 500mf \$1
- 50 COILS & CHOKES, if, rf, ant, osc, & more \$.1
- 10 ELECTROLYTICS, to 500mf, asst FW & tubulars \$1
- 10 VOLUME CONTROLS, to 1 meg, switch too! \$1
- 60 HI-O RESISTORS, 1/2, 1, 2W, 1% & 5% values \$1
- 60 TUBULAR CONDENSERS, to .5mf, to 1Kv, asst \$1
- 40 DISC CONDENSERS, 27mf to .05mf to 1KV \$1
- \$25 SURPRISE PAK: transistors, rect, diodes, etc. \$1
- 30 POWER RESISTORS, 5 to 50W, to 24 Kohms. \$1

"ONE PRICE" SCRS!

Imagine 7-amp, 16-amp and 25-amp at one price! Just check the proper amp and PRV blocks.

7-Amps	16-Amps	25-Amps			
PRV	Sale	PRV	Sale	PRV	Sale
25	.25	150	.80	300	1.75
50	.45	200	1.15	400	2.25
100	.70	250	1.35	500	2.50
				600	2.95

- 2—500MC 2N708 NPN Silicon planar TO16 \$1
- 25 GERMANIUM & SILICON DIODES, no test \$.1
- 25 TOP HAT RECTIFIERS, silicon, 750ma, no test \$1
- 3 2-WATT PLANAR TRANSISTRS, 2N697, 100mc \$1
- 25 "EPOXY" SILICON RECTIFIERS no test \$.1
- 10 2-6AMP RECT's, studs, silicon, 5.0 to 400V \$1
- 10 PHILCO MAT HI-FREQ. TRANSISTRS, untested \$1
- 3 2N706 500MW, 300MC NPN PLANAR, TO16 \$1

750 MIL TOP HAT AND EPOXIES

PIV	50	100	200	400	Sale PIV	5¢ 400	7¢ 800	14¢ 1000	13¢ 1200	Sale PIV	19¢ 1400	29¢ 1600	51¢ 1800	69¢ 2000
-----	----	-----	-----	-----	----------	--------	--------	----------	----------	----------	----------	----------	----------	----------

- 15 PNP TRANSISTORS, CK722, 2N35, 107 no test \$1
- 15 NPN TRANSISTORS 2N35, 170, 440, no test \$1
- 30 TRANSISTORS, rf, if, audio osc-ifs, TO5 no test \$1
- 10 FAMOUS CK722 TRANSISTORS, pnp no test \$1
- 5 2N107 TRANSISTRS, by GE, pnp, dop, audio pak \$1
- 3 40-WATT TRANSISTORS PNP, stud, 80V Volts \$1
- 4 2N123 TRANSISTORS, mixer-conv, TO22 \$.51
- 85 WATT 2N1212 PLANAR, drift, 10mc, npn \$1
- 85 WATT 2N424 PLANAR, silicon, TO-53, npn \$1

10¢ FOR OUR "SUMMER" BARGAIN CATALOG ON: Semiconductors Poly Paks Parts

POLY PAKS

TERMS: Send check, money order. Add postage—avg. wt. per pak 1 lb. Rate d net 30 days. COD 25% deposit.

P.O. BOX 942W
50. LYNNFIELD, MASS.
"PAK-KING" of the world

CIRCLE NO. 102 ON READER SERVICE CARD



Dollar s-t-r-e-t-c-h-e-r ...1966 edition!

If you're in the market for photography equipment and you want to get the most for your money, send for the 1966 PHOTOGRAPHY DIRECTORY & BUYING GUIDE right now!

Then just sit back and be as choosy as you like!

You'll have access to over a thousand different items—with complete, point-by-point information on manufacturer, model number, size, special characteristics and price.

And the 1966 edition of this big, valuable factbook is more comprehensive than ever before. A large, new 8½" x 11" format now brings you virtually every category of photo gear you want to know about... 160 pages of all the latest equipment!

Expert tips on how to buy and what to look for in... still cameras, flash equipment, exposure meters, lenses, movie cameras, projectors, super-8, sound, titlers, editors, slide equipment, tape recorders, enlargers, films, filters... and more!

The 1966 PHOTOGRAPHY DIRECTORY & BUYING GUIDE has been compiled by the editors of POPULAR PHOTOGRAPHY. That means authoritative, precise information. Dollar-stretching data that will help you select the best equipment in your price range, consistently, all through the next twelve months!

This year, play it smart. Shop before you buy, confidently, with the up-to-the-minute 1966 PHOTOGRAPHY DIRECTORY & BUYING GUIDE.

First Time Ever Offered!
A DELUXE, GOLD-EMBOSSED
LEATHERFLEX-BOUND EDITION
... just \$3.00 postpaid.



Ziff-Davis Service Division
Dept. PD, 589 Broadway · N.Y., N.Y. 10012
YES! Send me a copy of the 1966 PHOTOGRAPHY DIRECTORY & BUYING GUIDE, as checked below:

- \$1.25 enclosed, plus 15¢ for shipping and handling. Send me the regular edition. (\$1.50 for orders outside the U.S.A.)
- \$3.00 enclosed. Send me the Deluxe Leatherflex-bound edition, postpaid. (\$3.75 for orders outside the U.S.A.) Allow three additional weeks for delivery.

name _____ EW-56
address _____
city _____ state _____ zip code _____

—PAYMENT MUST BE ENCLOSED WITH ORDER.—

ELECTRONICS WORLD MAY 1966 ADVERTISERS INDEX

READER SERVICE NO.	ADVERTISER	PAGE NO.	READER SERVICE NO.	ADVERTISER	PAGE NO.
	Alco Electronic Products, Inc.	79		Kuhn Electronics	22
125	Allied Radio	61			
	American Institute of Engineering & Technology	79	106	Micro Electron Tube Co.	93
			105	Microflame, Inc.	66
124	Belden Manufacturing Company..	2	104	Multicore Sales Corp.	61
			103	Music Associated	77
	Candee Co., J. J.	95		National Radio Institute... 8, 9, 10, 11	
	Capitol Radio Engineering Institute, The	70, 71, 72, 73	102	Poly Paks	95
	Castle TV Tuner Service	22			
	Channel Master Corp.	77		RCA Electronic Components and Devices	FOURTH COVER
123	Cleveland Institute of Electronics..	5	100	RCA Electronic Components and Devices	23
	Cleveland Institute of Electronics	18, 19, 20, 21	99	RCA Electronic Components and Devices	69
122	Columbia Electronics	93		RCA Institutes, Inc.	56, 57, 58, 59
	Cornell Electronics Co.	94	98	Radar Devices Manufacturing Corp.	1
121	EICO Electronic Instrument Co., Inc.	15	85	Sams & Co., Inc., Howard W.	65
120	Editors and Engineers, Ltd.	16	96	Schober Organ Corporation, The..	14
119	Edmund Scientific Co.	94	95	Scott Inc., H. H.	80
117	Electro-Voice, Inc.	SECOND COVER		Siliconix, Inc.	17
118	Electronic Components Co.	92	94	Sprague Products Co.	63
	Fair Radio Sales	92			
116	Finney Company, The	13	93	Texas Crystals	79
			101	Triplett Electrical Instrument Company	THIRD COVER
115	G & G Radio Supply Co.	95	97	Tuner Service Corporation	6
114	Goodheart Co. Inc., R. E.	91	92	Turner Microphone Company, The.	85
113	Grantham School of Electronics..	22			
112	Gregory Electronics Corporation..	93		Valparaiso Technical Institute....	6
111	Heath Company	55	91	United Radio Co.	91
110	Heath Company	81	90	University Sound	74
109	Hy-Gain Electronics Corporation..	67			
	I B M Corporation	24			
86	International Television Corp.	80	89	Winegard Co. Antenna Systems..	16
	Jan Crystals	79	88	Xcelite, Inc.	4
108	Johnson Company, E. F.	7			
107	Judson Research and Mfg. Co.	79	87	Zenith	89

CLASSIFIED ADVERTISING 91, 92, 93, 94, 95

PROTECTS AGAINST • Bent Pointers • Burned-Out Resistors
 • Damaged Pivots • Overheated Springs • Burned-Out Meter
 • Changes in Accuracy Due to Overheating



Model 630-PLK

BURNOUT PROOF V-O-M

\$85.00

Suggested U.S.A., User Net

USES UNLIMITED

School Classrooms • Field Engineers • Application Engineers
 • Electrical, Radio, TV, and Appliance Servicemen • Electrical Contractors • Factory Maintenance Men • Industrial Electronic Maintenance Technicians • Home Owners, Hobbyists

FACTS MAKE FEATURES:

- 1** Comprehensive overload protection.
- 2** One selector switch minimizes chance of incorrect settings
- 3** Polarity reversing switch

Additional protection is provided by Model 630-PLK's new transistorized relay circuit. Transistorized overload sensing device does not load circuit under test, eliminating the possibility of damaging circuit components. A special meter shorting feature on "off" position offers high damping when moving tester. The exclusive patented Bar Ring Movement provides self-shielding and is not affected by stray magnetic fields. Wider spread scales, and unbreakable clear plastic window assure maximum readability. Diode network across meter protects against instantaneous transient voltage.

TRIPLETT ELECTRICAL INSTRUMENT COMPANY, BLUFFTON, OHIO

RANGES

DC Volts:	0-2.5-10-50-250-1,000-5,000 at 20,000 ohms/volt. 0-0.25 at 100 microamperes.
AC Volts:	0-3-10-50-250-1,000-5,000 at 5,000 ohms/volt.
Decibels:	-20 to +11, +21, +35, +49, +61, +75; "0" DB at 1 MW on 600 ohm line.
DC Microamperes:	0-100 at 250 Mv.
DC Milliamperes:	0-10-100-1,000 at 250 Mv.
DC Amperes:	0-10 at 250 Mv.
Ohms:	0-1,000-10,000 (4.4-44 at center scale).
Megohms:	0-1-100 (4,400-440,000 at center scale).

Output Volts (AC): 0-3-10-50-250-1,000 at 5,000 ohms/volt; jack with condenser in series with AC ranges.

CARRYING CASE

Model 639-OS black leather carrying case, built-in stand, flaps open to permit use of tester in the case. Suggested U.S.A., User Net.....\$13.00

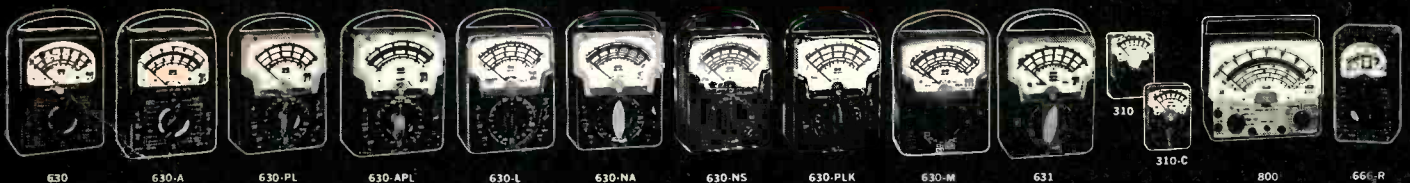

THE WORLD'S MOST COMPLETE LINE OF V-O-M'S. AVAILABLE FROM YOUR TRIPLETT DISTRIBUTOR'S STOCK.

CIRCLE NO. 101 ON READER SERVICE CARD

Indispensable!

*The brand-new
RCA RC-24
receiving tube
manual*

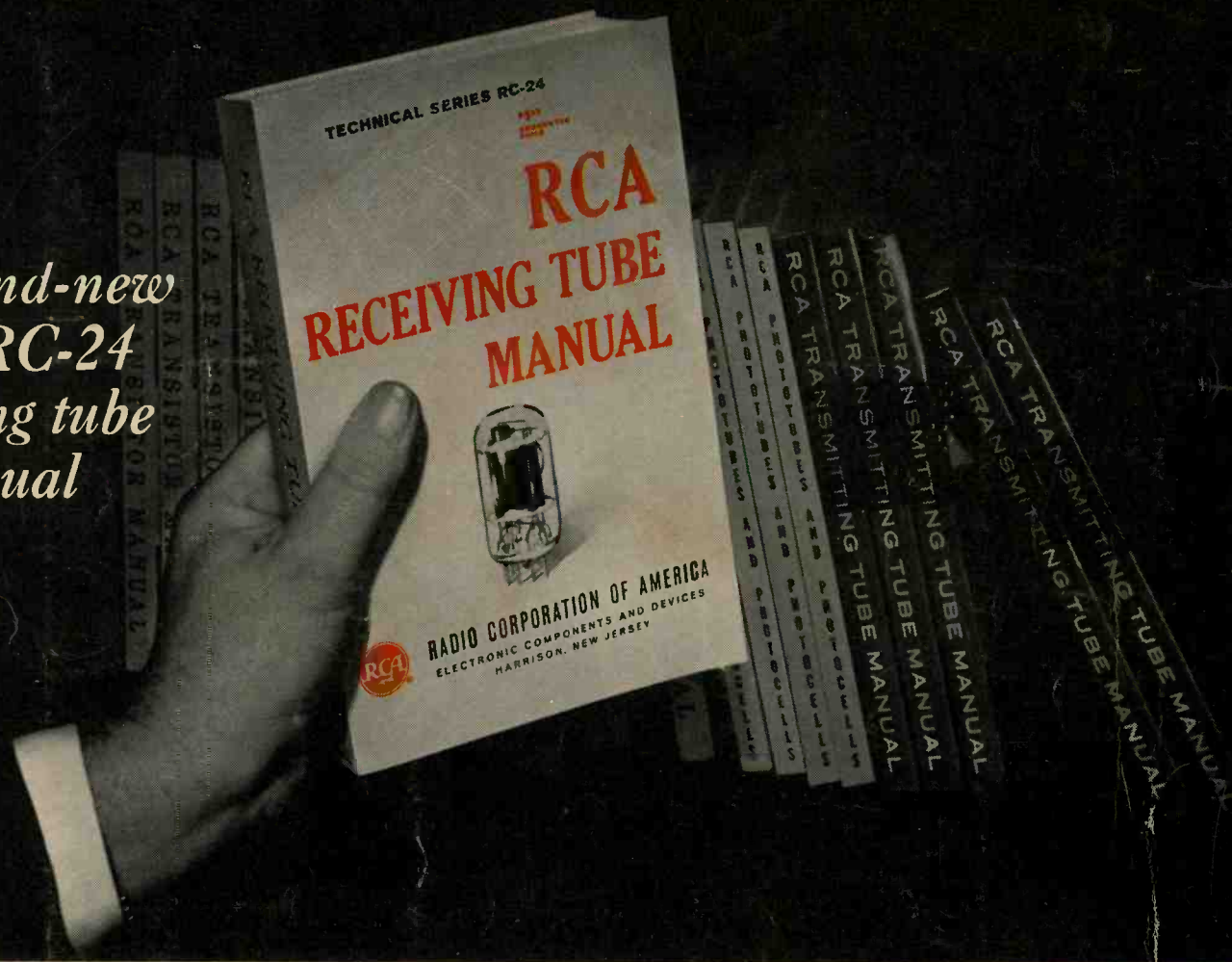

*Complete-authoritative
A must in every
technical library
A must on every work bench
More compact and easier
to read than ever before*

Technical design and applications data on more than 1200 receiving tubes. Check these NEW features and improvements not included in previous editions:

- ✓ Additional data on 100 new tube types
- ✓ Revised circuits section with new, simple format
- ✓ Updated picture tube characteristics chart
- ✓ Revised and updated Applications Guide
- ✓ New tube index section for ready reference
- ✓ Data section on active types only. (Discontinued and replacement types appear in a separate section.)
- ✓ Additional text material on TV in the tube applications section

Everyone concerned with electronics needs this manual... service technicians, engineers, radio amateurs and hobbyists. Order yours today from your nearest Authorized RCA Distributor.

Only \$1.25*
*Suggested Price

RCA Electronic Components and Devices, Harrison, N.J.



The Most Trusted Name in Electronics