

Electronics World

MARCH, 1966
50 CENTS

FUNCTIONAL DESIGNING—A Revolutionary Trend That Will Affect Future of Passive Components

METER-RELAY DEVICES

ORBITING ASTRONOMICAL
OBSERVATORY

USING NEW LOW-COST
INTEGRATED
CIRCUITS

SUBSTITUTING FET'S
FOR TUBES IN HI-FI
AMPLIFIERS

SPECIAL FEATURE

NEW G-E IN-LINE COLOR-TV PICTURE TUBE



Conventional RCA
Color-Tube Gun



New G-E In-Line
Color-Tube Gun

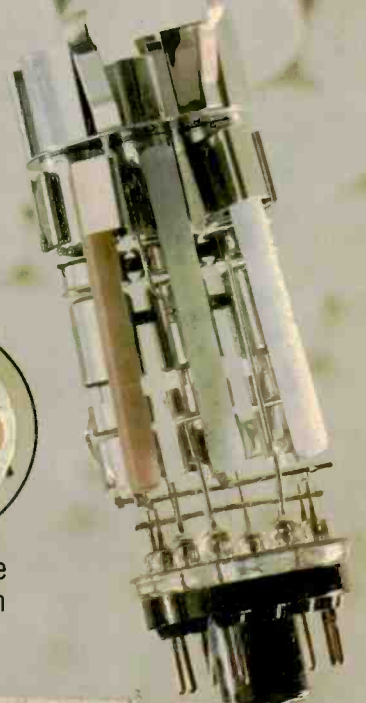

M0466 3517328RD01304M013
MC L BROWN
130 SW 48TH CT
MIAMI FL 33144



**This was the E-V Model 635.
It started a tradition
of excellence in
dynamic microphones.**

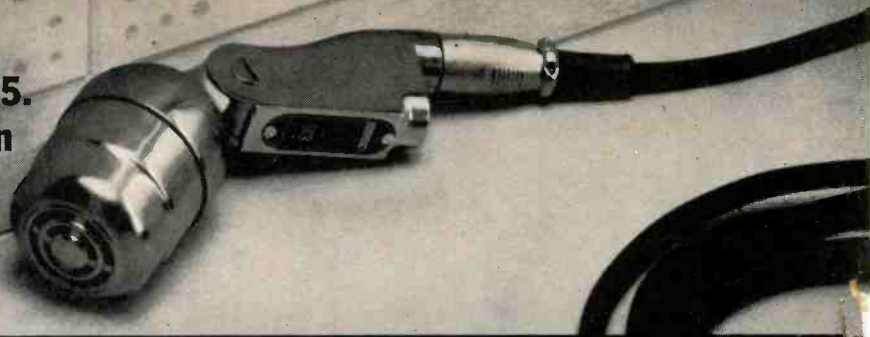

**This is the new
E-V Model 635A.
It's better
in every way!**



Model 635A Dynamic Microphone \$82.00 List. (Normal trade discounts apply.)

E-V How can a microphone as good as the E-V Model 635 be made obsolete? By making it better! It wasn't easy. After all, professional sound engineers have depended on the 635 since 1947.

During this time, the 635 earned a reputation for toughness and dependability that was unrivalled by other omnidirectional dynamics. And internal changes through the years have kept the 635 well in the forefront of microphone design.

But now the time has come for an all new 635: the Electro-Voice Model 635A. It's slimmer, for easier hand-held use. Lighter, too. With a slip-in mount (or accessory snap-on Model 311 mount) for maximum versatility on desk or floor stands. The new, stronger steel case re-

duces hum pickup, and offers a matte, satin chromium finish perfect for films or TV.

The new 635A is totally new inside, too—and all for the best. A new four-stage filter keeps “pops” and wind noise out of the sound track, while guarding against dirt and moisture in the microphone, completely eliminating any need for external wind protection. Of course you still get high output (—55db) and smooth, crisp response. And you can still depend on the exclusive E-V Acustalloy® diaphragm that is guaranteed against failure for life* (it's that tough)!

We expect to see plenty of the “old” 635's in daily use for years. But more and more, the new 635A will take over as the new standard. It's easy to find out

why: just ask your E-V Professional Microphone distributor for a free demonstration in your studio. Or write us today for complete data. We'll be proud to tell you how much better the new Model 635A really is!

*The E-V Professional Microphone Guarantee: All E-V professional microphones are guaranteed UNCONDITIONALLY against malfunction for two years from date of purchase. Within this period, Electro-Voice will repair or replace, at no charge, any microphone exhibiting any malfunction, regardless of cause, including accidental abuse. In addition, all E-V microphones are GUARANTEED FOR LIFE against defects in the original workmanship and materials.

ELECTRO-VOICE, INC., Dept. 361N
629 Cecil Street, Buchanan, Michigan 49107

Electro-Voice®
SETTING NEW STANDARDS IN SOUND

Crime does pay!



Every 40 seconds a burglary takes place in the United States.

TECHNICAL INFORMATION

The RADAR SENTRY ALARM is a complete U.H.F. Doppler Radar System which saturates the entire protected area with invisible r.f. microwaves. It provides complete wall to wall—floor to ceiling protection for an area of up to 5,000 square feet. Without human movement in the protected area, the microwave signal remains stable. Any human movement (operation is unaffected by rodents and small animals) in the area causes the doppler signal to change frequency approximately 2 to 4 cps. An ultra-stable low frequency detector senses this small frequency change, amplifies it and triggers the police type siren—which is heard up to a half mile away.

In addition, the RADAR SENTRY ALARM's protection can be extended to other areas with the use of the following optional accessories:

- remote detectors for extending coverage to over 10,000 sq. ft.
- rate of rise fire detector U.L. approved for 2,500 sq. ft. of coverage each (no limit on the number of remote detectors that can be used)
- hold-up alarm
- central station or police station transmitter and receiver (used with a leased telephone line)
- relay unit for activating house lights
- battery operated horn or bell which sounds in the event of: powerline failure; equipment malfunction or tampering

At that rate, it's a multi-million dollar a year business...for burglars.

And an even better business opportunity for you.

Why? Because burglary can be stopped...with an effective alarm system.

In fact, police and insurance officials have proved that an alarm system reduces, and in many cases, eliminates losses—even helps police apprehend the criminal.

Here's where you come in.

Only a small percentage of the more than 100 million buildings—stores, offices, factories, schools, churches and homes are protected by an effective alarm system.

That means virtually every home, every business is a prospect.

You can sell them!

And you don't have to be a super-salesman to sell the best protection available—a Radar Sentry Alarm unit. All you have to do is demonstrate it...it sells itself.

A glance at the technical information shows why.

It's the most unique and effective alarm system ever invented.

And here's the proof.

In the past six years, thousands of RADAR SENTRY ALARM units have been sold in the Detroit, Michigan area alone—sold by men like yourself on a part-time and full-time basis.

Here are just a few customers who are protected by RADAR SENTRY ALARMS:

- U. S. Government
- U. S. Air Force
- Detroit Board of Education
- Hundreds of Churches,
- Banks, Businesses and
- Homes.

Everyone is a prospect.

So take advantage of your profession! Put your technical knowledge and experience to work for you in a totally new area—an area that will make money for you!

Don't wait!

Let us prove that crime does pay.

Become a distributor.

Write now for free details.

RADAR SENTRY ALARM



.....
Mail to: RADAR DEVICES MANUFACTURING CORP.
22003 Harper Ave., St. Clair Shores, Michigan 48080



Please tell me how I can have a business of my own distributing Radar Sentry Alarm Systems. I understand there is no obligation.

Name _____
Address _____
City _____ State & Code _____

EW-3

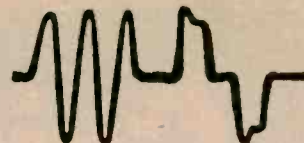

What you should know about wet-slug tantalum capacitors

COMPARATIVE SIZES TANTALUM CAPACITORS

FOR 6.8 Mfd. 50 VOLTS

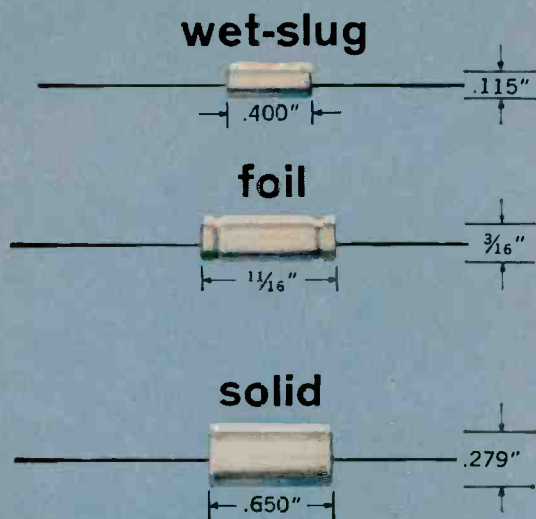

FOR 100 Mfd. 30 VOLTS

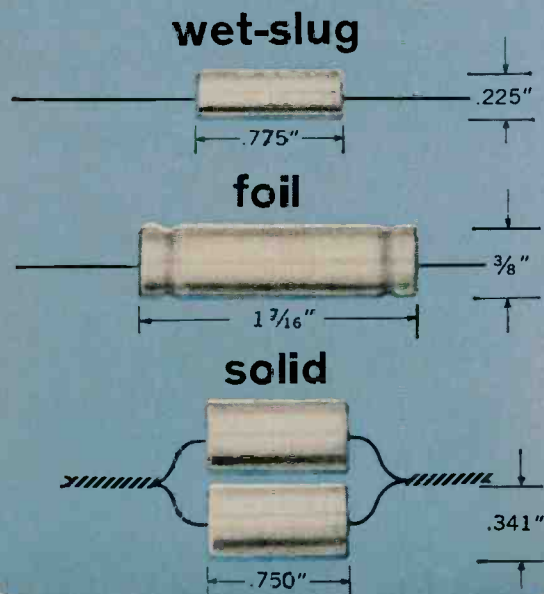

When you're bread-boarding a piece of high-reliability equipment, you'll probably consider tantalum capacitors. They'll do things that you can't do with aluminum electrolytics. Run at higher temperatures—up to 200°C. Put a lot of rating in minimum size. And most of all, operate with extreme reliability under extreme environmental conditions.

There are three basic types of tantalum capacitors—wet-slug, foil, and solid electrolyte. How do you know which kind to use? Here are some facts about wet-slug types which are worth knowing. And we at Mallory aren't prejudiced, because we make *all* tantalum types—the widest line in the industry, in fact.

Wet-slug tantalum capacitors are smallest; rating for rating, about 20% the size of solid electrolyte types. The newest Mallory wet-slug models, the MTP for instance, has up to 170,000 mfd-volts per cubic inch—almost 5 times what you can get in a solid electrolyte counterpart.

DC leakage of the wet-slug models is as low as 10% that of comparable solid types. This can be important in an RC timing circuit, where you need to maintain charge on a capacitor.

In the language of reliability engineers, wet-slug capacitors are inherently free from catastrophic failure. Pin-point failures of the dielectric film are self-healing, because there's wet electrolyte present to permit re-forming when voltage is applied. When a solid electrolyte capacitor fails, it's gone for good (or for bad).

If you need voltage ratings over 100 WVDC, you can get them only in foil or wet-slug models—the latter going all the way to 630 volts. Solid tantalum ratings in standard types go up to 100 volts.

How good is the case seal on wet-slug capacitors? Good enough to pass the toughest MIL tests, including those for the Minuteman II project which are about as tough as they come.

What about cost? All tantalum capacitors are relatively expensive, and solids usually are lowest in price. *But* when you need fairly high capacitance, wet-slug types often turn out to be the best buy!

A Mallory Industrial Distributor near you can supply all Mallory wet-slug, foil and solid tantalum capacitors, including many MIL types. Mallory Distributor Products Company, a division of P. R. Mallory & Co. Inc., Indianapolis, Indiana 46206.

50th
ANNIVERSARY



THIS MONTH'S COVER shows the three-gun in-line arrangement as used in the new G-E 11-inch color CRT (right) compared with a conventional RCA color gun arrangement. Note that the three beams of the in-line guns cross over to illuminate their respective phosphors in a straight line compared with the triangle pattern found in presently used three-gun arrangements. Because of this mechanical approach, coupled with the small size of the CRT, convergence is greatly simplified, and the need for complex high-voltage regulation is avoided. (Photograph by Bruce Pendleton)

Electronics World

MARCH 1966

VOL. 75, No. 3

CONTENTS

- 27** **The Orbiting Astronomical Observatory** *Donald A. Imgram*
Using some new electronic applications to astronomy, this soon-to-be launched scientific satellite promises spectacular views of the universe around us.
- 31** **T and H Attenuator Pad Nomograms** *Max H. Applebaum*
- 32** **Recent Developments in Electronics**
- 34** **Line-Operated Transistor TV Sets: Westinghouse** *Walter H. Buchsbaum*
- 36** **Meter-Relay Devices** *Sidney L. Silver*
- 39** **G-E 11-inch Color TV: New Look in Color Receivers** *W. H. Buchsbaum*
- 42** **Substituting FET's for Tubes in Hi-Fi Amplifiers** *W. A. Rheinfelder*
- 44** **New U.H.F. TV Antenna Design** *Harold Harris*
- 46** **Functional Designing** *J. J. Suran*
Conventional circuit-design techniques using discrete passive components may soon be obsolete. Engineers will have to learn a new functional approach involving integrated circuitry, a batch-fabrication method.
- 50** **Using New Low-Cost Integrated Circuits** *Donald E. Lancaster*
- 53** **Non-Destructive Testing (Part 2)** *John R. Collins*
- 68** **New Approach to Educational TV**
- 85** **Measuring Length with a Laser**
- 88** **Power-Line Spike Absorber** *Ronald L. Ives*
- 94** **Square-Wave Testing** *James F. Kennedy*

-
- 6** **For the Record (Editorial)**
Man's Limitless Mind
 - 12** **EW Lab Tested**
*Sonotone RM-2 Speaker System
Shure Model 580 Microphone*
 - 59** **Electronics in the Hospital** *John Frye*
 - 76** **Test Equipment Product Report**
*Hewlett-Packard Model 141A Oscilloscope
B&K Model 606 Tube Tester
Electro Scientific Model 300 Voltmeter Bridge*

MONTHLY FEATURES

- | | |
|---|--|
| 4 Coming Next Month | 82 Electronic Crosswords |
| 22 Letters from Our Readers | 86 Book Reviews |
| 70 Radio & TV News | 96 New Products & Literature |
-



Publisher
PHILLIP T. HEFFERNAN

Editor
WM. A. STOCKLIN

Technical Editor
MILTON S. SNITZER

Associate Editors
LESLIE SOLOMON
P. B. HOEFER

Assistant Editor
MARSHA JACOBS

Contributing Editors
WALTER H. BUCHSBAUM
Prof. ARTHUR H. SEIDMAN

Art Editor
RICHARD KELLY

Art and Drafting Dept.
J. A. GOLANEK

Advertising Sales Manager
LAWRENCE SPORN

Advertising Service Manager
ARDYS C. MORAN

March, 1966

Electronics World: Published monthly by Ziff-Davis Publishing Company at 307 North Michigan Ave., Chicago, Ill. 60601. One year subscription \$5.00. Second Class Postage paid at Chicago, Ill. and at additional mailing offices. Subscription service: Fortland Place, Boulder, Colo. 80311
Copyright © 1966 by Ziff-Davis Publishing Company. All rights reserved.

for successful
COLOR TV servicing
own these **SAMS BOOKS**



Color TV Training Manual, New Second Edition.
by C. P. Oliphant & Verne M. Ray. This newly revised comprehensive manual is the most up-to-date guide available for technicians preparing to service color TV receivers. Full information on: Colorimetry; Requirements of the Composite Color Signal; Make-up of the Color Picture Signal; RF and IF Circuits; Video, Sync & Voltage-Supply Circuits; Bandpass Amplifier, Color-Sync and Color-Killer Circuits; Color Demodulation; Matrix Section; Color Picture Tube & Associated Circuits; Setup Procedure; Aligning the Color Receiver; Troubleshooting. Includes full-color illustrations invaluable for setup, alignment, and troubleshooting. 224 pages; 8½ x 11". **\$5.95**
Order TVC-2, only.

Color TV Servicing Made Easy
by Wayne Lemons. Written in "made easy" style. Takes the mystery out of color TV servicing. Familiarizes you with color principles and setup adjustments; thoroughly covers color circuitry, adjustments, and servicing of all color TV sets produced to date. This book will help to put you into this fast-growing, profitable service work. 128 pages; **\$2.50**
5½ x 8½". Order CSL-1, only.

Know Your Color-TV Test Equipment
by Robert G. Middleton. Explains clearly and easily the function and circuit action of each color TV test instrument. Covers: White-Dot and Cross-Hatch Generators, Color-Pattern and Color-Bar Generators, Rainbow and NTSC Generators, Principles of Video-Frequency Sweep Generators and Testing, Lab-type equipment, and valuable setup information. Profusely illustrated. 160 pages; **\$2.50**
5½ x 8½". Order KOC-1, only.

Color TV Trouble Clues
Invaluable field-tested guide to trouble clues and procedures for color TV receiver repair. Describes types of troubles encountered, troubleshooting techniques, alignment and sync problems, convergence, etc. Includes data on use of test equipment to speed color TV servicing. Fully illustrated with photographs and schematics. A "must" for color TV service technicians. 96 pages; 5½ x 8½". **\$1.95**
Order COL-1, only.

101 Ways to Use Your Color TV Test Equipment
by Robert G. Middleton. Written in the time-tested formula acclaimed by thousands of TV technicians. Shows you practical uses for your test equipment to diagnose color TV circuit troubles quickly and easily. Describes proper equipment hookups, how to evaluate test results, how to check instruments; includes time-saving techniques. 144 pages; **\$2.50**
5½ x 8½". Order TEM-9, only.

Color TV Guidebook
A special Howard W. Sams publication about color TV servicing techniques, equipment required, and related subjects. General information includes outlook for color TV manufacturers, broadcasting networks, and technicians. Specific sections deal with starting a color TV service business, troubleshooting and repair techniques, antennas, color tube stocking, transistorized color TV, small-town color TV problems, new circuits and developments. **\$1.00**
8½ x 11". Order PFR-1, only.

HOWARD W. SAMS & CO., INC.

Order from your Sams Distributor today, or mail to Howard W. Sams & Co., Inc., Dept. EW-3
4300 W. 62nd Street, Indianapolis, Ind. 46206

- Send me the following books:
- TVC-2 KOC-1 TEM-9
 - CSL-1 COL-1 PFR-1
- Send FREE Sams Booklist. \$_____ enclosed

Name _____
Address _____
City _____ State _____ Zip _____

My Distributor is _____

CIRCLE NO. 92 ON READER SERVICE CARD

COMING
NEXT MONTH
SPECIAL ISSUE



Variable Resistors—An information-packed, 24-page section with eight authoritative articles on potentiometers, trimmers, and rheostats with both general-purpose and precision devices covered. Such authorities as William Murphy & Robert D. Hostetler of CTS Corp.; Herb Levy of Ohmite; R. L. Frey & James A. Fred of Malory Controls; George Raeburn of Centralab; George Boyd of Clarostat; Howard A. Morrison of Computer Instruments Corp.; Gary Kounkel of Bourns' Trimpot Div.; and James R. Taylor of IRC are represented. In addition, the section will include a comprehensive tabulation of variable resistor sources.

and ordinary transistor circuits, although at present the cost is higher.

REVERBERANT ROOMS: THEIR DESIGN & USE
Loudspeaker and microphone evaluations, acoustic absorption data, transmission loss of materials, subjective listening tests, noise measurements, and fatigue tests are some of the operations performed in this type of chamber.

AUTOMATIC BRIGHTNESS CONTROLS
A unique photocell circuit which can adjust TV set brightness to compensate for ambient light changes.

WEST COAST ELECTRONICS INDUSTRY
Another of EW's up-to-the-minute surveys—this one on the products, people, and employment possibilities in the West Coast electronics industry. This is a companion piece to our earlier surveys on the East Coast and Middle West industry status.

HIGH-QUALITY PHONO EQUALIZER USING FET'S
W. A. Rheinelder, applications consultant for Dickson Electronics Corp., describes the design of a hi-fi circuit, using new field-effect transistors, which is said to surpass the performance of both tube

All these and many more interesting and informative articles will be yours in the APRIL issue of ELECTRONICS WORLD... on sale March 17th.

ZIFF-DAVIS PUBLISHING COMPANY

William B. Ziff
Chairman of the Board (1946-1953)

William Ziff
President

W. Bradford Briggs
Executive Vice President

Hershel B. Sarbin
Vice President and General Manager

Philip Sine
Financial Vice President

Walter S. Mills, Jr.
Vice President, Circulation

Stanley R. Greenfield
Vice President, Marketing

Phillip T. Heffernan
Vice President

Frank Pomerantz
Vice President, Creative Services

Arthur W. Butzow
Vice President, Production

Editorial and Executive Offices
(212 ORegon 9-7200)
One Park Avenue, New York, N.Y. 10016

NEW YORK OFFICE (212 ORegon 9-7200)
James J. Sullivan
Joseph E. Halloran

MIDWESTERN OFFICE (312 726-0892)
307 North Michigan Avenue, Chicago, Ill. 60601
Midwestern Advertising Manager, Rayce Richard

WESTERN OFFICE (213 CRestview 4-0265)
9025 Wilshire Boulevard, Beverly Hills, Cal. 90211
Western Advertising Manager, Bud Dean

JAPAN
James Yagi, c/o Sekihara,
1, Sakamachi, Shinjuku-ku, Tokyo, Japan

CIRCULATION OFFICE
Portland Place, Boulder, Colorado, 80311



Member
Audit Bureau of
Circulations

Radio & TV News • Radio News • Radio-Electronic Engineering Trademarks Reg. U.S. Pat. Off.
SUBSCRIPTION SERVICE: All subscription correspondence should be addressed to Electronics World, Circulation Dept., Portland Place, Boulder, Colorado 80311. Please allow at least six weeks for change of address. Include your old address as well as new—enclosing if possible an address label from a recent issue.

EDITORIAL CONTRIBUTIONS must be accompanied by return postage and will be handled with reasonable care; however publisher assumes no responsibility for return or safety of art work, photographs, or manuscripts.

ELECTRONICS WORLD (March, 1966, Vol. 75, No. 3) is published monthly by Ziff-Davis Publishing Company at 307 North Michigan Avenue, Chicago, Ill. 60601. (Ziff-Davis also publishes Skiing, Flying, Business/Commercial Aviation, Popular Boating, Car and Driver, Popular Photography, HiFi/Stereo Review, Popular Electronics, Modern Bride, Skiing Trade News and Skiing Area News.) One year subscription rate for U.S., U.S. Possessions and Canada, \$5.00; all other Foreign, \$6.00. Second class postage paid at Chicago, Illinois and at additional mailing offices. Authorized as second class mail by the Post Office Department, Ottawa, Canada and for payment of postage in cash.

NEW from

FINCO



BOOSTER-COUPLER

Model No. 65-1 List \$29.95



UHF CONVERTERS

Model U-Vert 300 List \$39.95

Model U-Vert 200 List \$26.90

Model U-Vert 100 List \$19.95

ALL FINCO PRODUCTS ARE ENGINEERED FOR **"COLOR"**

The BOOSTER-COUPLER

"for Deluxe Home and Commercial Use"

Two tube, 4 set VHF-TV or (FM) Distribution Amplifier for home and small commercial distribution systems . . . with low loss splitters (FINCO #3001 or #3003) can feed 16 or more sets, depending on signal level and line length losses. FEATURES:

- On-Off Switch
- AC convenience receptacle
- Ventilated perforated steel cabinet 6 $\frac{1}{16}$ " x 3 $\frac{3}{16}$ " x 3 $\frac{3}{16}$ "
- Metal enclosed to eliminate shock hazard
- Easy access for tube servicing
- Convenient, easy mounting . . . bracket and screws supplied
- UL listed AC cord
- 117 Volts, 60 cycles
- Attractive appearance with rugged commercial construction
- No strip terminals
- Minimum "snow" (very low noise figure)
- 100% test for all electronic characteristics

The CONVERTERS

"That challenge all competition"

FEATURES:

- Drift free fine tuning
- Post conversion signal amplification
- Solid state chassis — shockproof
- Convenient AC outlet on converter
- Exact input-output impedance match
- Lighted dial tuning
- Full color and black-white signal conversion
- High gain — low noise
- Conforms to FCC radiation specifications
- Easy installation — UL approved
- Instant warm-up — Operates at Channel 5 or 6
- A model for every reception area

Write for beautiful color brochures — Numbers 20-338 and 20-377

Atlanta
Fort Worth
Kansas City
Chicago
Cleveland
Detroit

THE FINNEY COMPANY

34 West Interstate Street Bedford, Ohio 44014 Dept. 410

New York
Pittsburgh
San Francisco
Los Angeles
Boston
Albany

ASSEMBLE YOUR OWN ALL-TRANSISTOR *Schober* ELECTRONIC ORGAN



3 NEW MODELS
Recital \$1500
Console II 850
Spinet 550

This is the new, all-transistor Schober Console II... the most luxurious

"home-size" organ available today.

Full 61-note manuals, 17 pedals, 22 stops and coupler, 3 pitch registers, and authentic theatre voicing leave little to be desired. Comparable to ready-built organs selling from \$1800 to \$2500.

The pride and satisfaction of building one of these most pipe-like of electronic organs can now be yours... starting for as low as \$550. The Schober Spinnet, only 38 inches wide, fits into the smallest living room. The all-new, all-transistor Schober Recital Model actually sounds like the finest pipe organ; its 32 voices, 6 couplers, 5 pitch registers delight professional musicians... making learning easy for beginners.

AND YOU SAVE 50% OR MORE BECAUSE YOU'RE BUYING DIRECTLY FROM THE MANUFACTURER

AND PAYING ONLY FOR THE PARTS, NOT COSTLY LABOR.

It's easy to assemble a Schober Organ. No special skills or experience needed. No technical or musical knowledge either. Everything you need is furnished, including the know-how. You supply only simple hand tools and the time.

You can buy the organ section by section... so you needn't spend the whole amount at once.

You can begin playing in an hour, even if you've never played before—with the ingenious Pointer System, available from Schober.

Thousands of men and women—teen-agers, too—have already assembled Schober Organs. We're proud to say that many who could afford to buy any organ have chosen Schober because they preferred it musically.

Send for our free Schober Booklet, describing in detail the exciting Schober Organs and optional accessories; it includes a free 7-inch "sampler" record so you can hear before you buy.

IN OUR 10TH YEAR

THE *Schober Organ* CORPORATION

43 West 61st Street, New York, N. Y. 10023

Also available in Canada, Australia, Hong Kong, Mexico, Puerto Rico, and the United Kingdom

THE SCHOBER ORGAN CORP., DEPT. RN-42

43 West 61st Street, New York, N. Y. 10023

Please send me FREE Schober Booklet and FREE 7-inch "sampler" record.

Enclosed find \$2.00 for 10-inch quality LP record of Schober Organ music. (\$2.00 refunded with purchase of first kit.)

Name _____

Address _____

City _____ State _____ Zip No. _____

CIRCLE NO. 90 ON READER SERVICE CARD



For the record

WM. A. STOCKLIN, EDITOR

MAN'S LIMITLESS MIND

IT is the responsibility of all editors of science-oriented publications to present ideas—to get their readers to think—not of the past or present, but of the future. Actually, there is no present. It is simply a fine line between the past and what is ahead.

Responsible engineers—those who are leaders in their field—are actually visionaries in that they think only of the future. It has such great potential; it is limitless and exciting—but only to those who make an active effort to train their minds to think ahead.

These thoughts were expressed so well by Edmund B. Fitzgerald, president of *Cutler-Hammer, Inc.*, at a recent symposium held in connection with the dedication of the firm's new corporate headquarters building and Research Center in Milwaukee, that we wish to devote the balance of our space to excerpts from his comments.

"We have all come to refer to our times as the Space Age. At least we can agree that we are at the beginning of the Space Age. We have taken our first tottering steps away from Mother Earth. In years to come, the steps will become stronger, surer, bolder. And probably there is not one among us who doubts that some day our children or their children or their grandchildren will be able, literally, to reach other worlds almost as easily as we today reach other continents. In so doing man will be reaching for the stars which have beckoned to him since the beginning of history—the stars which have become a dream and a goal. And now they draw nearer.

"But you and I probably will not travel to other planets. We will remain on earth. Does this mean that the great Space Age means nothing to us? Is there nothing in this great explosion of scientific knowledge which will make earth a better place to live, which will change our lives, even though we don't make the trip into space? Of course not. Perhaps, in fact, the changes will be even more startling here on our own planet. Already we are seeing the changes. By means of communication satellites, our ability to talk with men in other countries is speeded and made easier.

"Already we are seeing advances in medicine such as heart stimulators, made possible by tiny microcircuits. We are seeing the dream of limitless power come to life through control of nuclear fission and fusion, freeing man of dependence upon falling water, coal, or oil deposits as sources of energy. This abundance of energy will, if properly used, forever eliminate the "have-not" nations, for with abundant power all the nations of

the world will be able to produce the goods which permit rising standards of living.

"But these are only the beginning. The real promise of the future is even more exciting than these examples.

"But let me dwell for a moment upon a facet of our time which is, it seems to me, most important. It is easy to become awed by talk of space and trips to the distant planets. These are exciting topics and much in the news.

"Yet there is something even more exciting.

"Space, it is believed, is infinite, without beginning and without end. It staggers the imagination. In fact I doubt that any of us here can truly comprehend the dimensions of space. And yet even more startling, even more limitless is man's mind. It is only a few moments in time since man was huddling around a fire in a cave. Yet here we are challenging limitless space, a few hundred generations later. This is the real wonder of the age. For to date no one has defined the limit of man's imagination and dreaming. And it is imagination and dreaming—combined with the means and fortitude to bring a dream to reality—which precede all new advances. From the dream springs the investigation, the theory, the techniques and finally the accomplishment. It has been so throughout man's history. It will be so in the future. And, one dream fulfilled, man dreams another dream, and again the process starts.

"Here lies the true wonder of our age and every other age which has preceded it. For if man did not dream and yearn for his distant goals, we would still be huddled around that fire, in that cave.

"Similarly, we would not now be on the threshold of space nor would we have electricity, motor cars, airplanes, telephones, and all those things which were not even dreams to many of our ancestors. This same process will create a new world tomorrow. The most stimulating concept of all is that beyond that new world of tomorrow lies another new world of another tomorrow, and then yet another and another. For this is the history of man, and I am pleased to believe it is also his future."

We hope that all of our readers have enjoyed Mr. Fitzgerald's comments as much as we have. Certainly it should make everyone stop and think, and wonder what the future holds.

Jerry Suran's article, "Functional Designing," in this same issue is a good example of how the electronics engineer should be planning ahead. His article specifically covers a more modern approach to designing. Don't miss it. ▲

SONY[®]

CAPTURES THE TOTAL DIMENSION OF SOUND

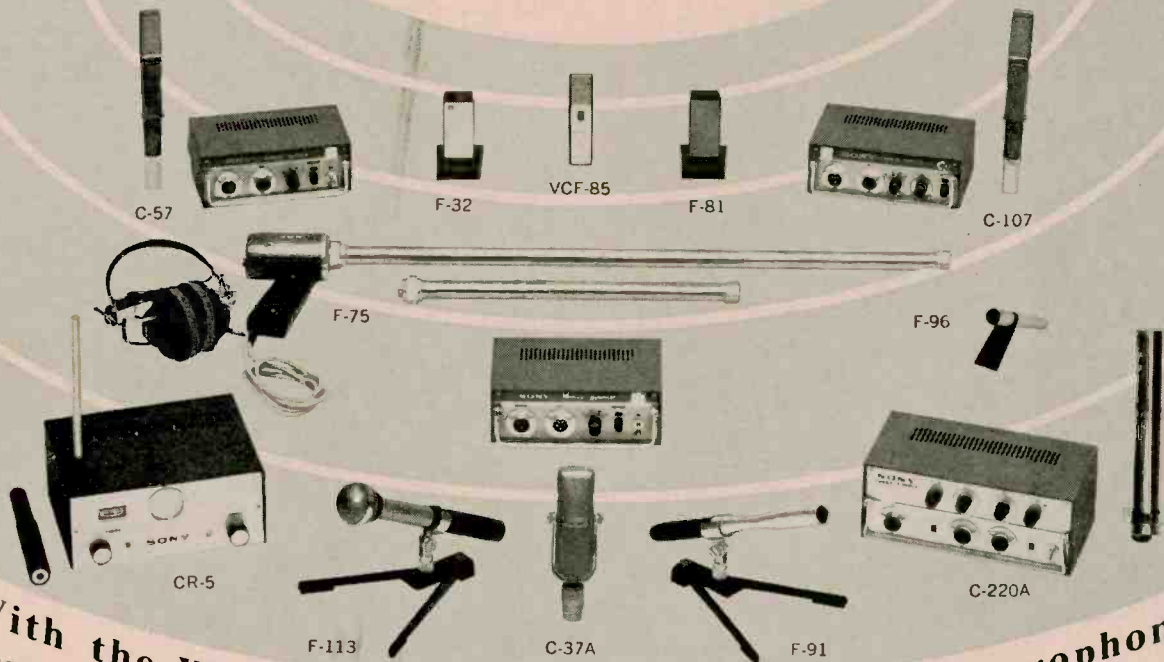

With the World's Most Complete Line of Microphones

Once again, Sony concentration on research and design establishes product leadership. Sony microphones are universally preferred for their capability of transmitting the full natural range of the sounds of music and the human voice. No other manufacturer offers Sony's breadth of selection. Whether Professional or Consumer, there is a Sony microphone for every requirement, priced lower than any other comparable instrument.

PROFESSIONAL MICROPHONES—designed for use in TV and radio stations, recording studios and theatres.

Model C-37A Variable Directivity Condenser Microphone: The standard within the broadcasting and recording industry. \$295.

Model C-57 Variable Directivity Condenser Microphone: Wide frequency response, low distortion and rapid selection of directional characteristics. \$375.

Model C-107 Continuously Variable Polarization Condenser Microphone: Ideal for recording studios or broadcast requiring remote control, exceptional uniformity and high front to back rejection. \$525.

Model C-220A Uni-axial Stereo/Monaural Condenser Microphone: 2 complete microphones contained within a single case, independent selection of each polar pattern. \$625.

Model F-75 Super Directional Telemicrophone: 18" probe for use up to 75 feet, 34" probe for use up to 150 feet, \$395.

Model CR-5 Wireless Microphone: Consists of FM transmitter and receiver, mike

hand-held or lavalier-worn, operates up to 300-foot radius, \$365.

Model F-91 Slim Styled Dynamic Microphone: Ideal for TV staging. "on-the-spot" interviews, audience participation. \$149.50.

Model F-113 Uni-directional Dynamic Microphone: For difficult acoustical environments where feedback or background noise are a problem. \$249.50.

CONSUMER MICROPHONES—developed for the home recording enthusiast.

Model F-81: Premium quality, high impedance, cardioid dynamic microphone, less than \$29.50.

Model F-32: Same as F-81 but incorporates bass attenuation switch for Voice Public Address, less than \$27.50.

Model VCF-85: Cardioid dynamic microphone with voice activating feature, less than \$22.00.

Model F-96: General purpose, dynamic microphone, ideal for instrumentalists, singers, public address, less than \$17.50.

For literature or nearest franchise dealer, write to Superscope, Inc., Sun Valley, California, Dept. 25

SONY SUPERSCOPE The Tapeway to Stereo[®]
 8150 VINELAND AVENUE • SUN VALLEY, CALIFORNIA • 91353

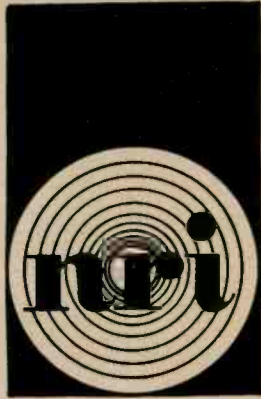

Learning electronics at home is faster, easier, more interesting with new achievement kit

Only NRI offers you this pioneering method of "3 Dimensional" home-study training in Electronics, TV-Radio . . . a remarkable teaching idea unlike anything you have ever encountered. Founded more than half a century ago—in the days of wireless—NRI pioneered the "learn-by-doing" method of home-study. Today, NRI is the oldest, largest home-study Electronics school. The NRI staff of more than 150 dedicated people has made course material entertaining and easy to grasp. NRI has simplified, organized and dramatized subject matter so that any ambitious man—regardless of his education—can effectively learn the Electronics course of his choice.

DISCOVER THE EXCITEMENT OF NRI TRAINING

Whatever your reason for wanting knowledge of Electronics, you'll find the NRI "3 Dimensional" method makes learning exciting, fast. You build, test, experiment, explore. Investigate NRI training plans, find out about the NRI Achievement Kit. Fill in and mail the postage-free card. No salesman will call. NATIONAL RADIO INSTITUTE, Electronics Division, Washington, D. C. 20016

GET A FASTER START IN THE COURSE YOU CHOOSE WITH NRI'S REMARKABLE ACHIEVEMENT KIT

When you enroll with NRI we deliver to your door everything you need to make a significant start in the Electronics field of your choice. This remarkable, new starter kit is worth many times the small down payment required to start your training. And it is only the start . . . only the first example of NRI's unique ability to apply 50 years of home-study experience to the challenges of this Electronics Age. Start your training this exciting, rewarding way. No other school has anything like it. What do you get? The NRI Achievement Kit includes: your first set of easy-to-understand "bite-size" texts; a rich, vinyl desk folder to hold your training material in orderly fashion; the valuable NRI Radio-TV Electronics Dictionary; important reference texts; classroom tools like pencils, a ball-point pen, an engineer's ruler; special printed sheets for your lesson answers—even a supply of pre-addressed envelopes and your first postage stamp.

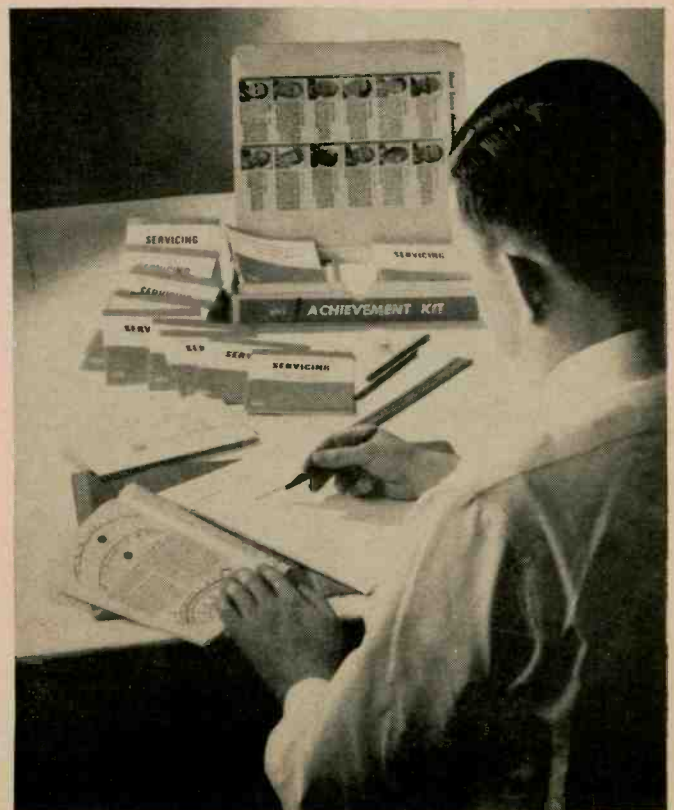

ELECTRONICS COMES ALIVE AS YOU LEARN BY DOING WITH CUSTOM TRAINING EQUIPMENT

Nothing is as effective as learning by doing. That's why NRI puts so much emphasis on equipment, and why NRI invites comparison with equipment offered by any other school, at any price. NRI pioneered and perfected the use of special training kits to aid learning at home. You get your hands on actual parts like resistors, capacitors, tubes, condensers, wire, transistors and diodes. You build, experiment, explore, discover. You start right out building your own professional vacuum tube voltmeter with which you learn to measure voltage and current. You learn how to mount and solder parts, how to read schematic diagrams. Then, you progress to other experimental equipment until you ultimately build a TV set, an actual transmitter or a functioning computer unit (depending on the course you select). It's the practical, easy way to learn at home—the priceless “third dimension” in NRI's exclusive Electronic TV-Radio training method.

SIMPLIFIED, WELL-ILLUSTRATED “BITE-SIZE” LESSON TEXTS PROGRAM YOUR TRAINING

Certainly, lesson texts are a necessary part of training . . . but only a part. NRI has reduced reading matter to “bite-size,” programmed texts as simplified, direct and well-illustrated as half a century of teaching experience can make them. The best scientific techniques and extensive study have gone into each book. The amount of material in each text, the length and design, is precisely right for home-study. NRI texts are programmed with NRI training kits to make things you read about come alive. As you learn, you'll experience all the excitement of original discovery. Texts and equipment vary with the course you select. Choose from three major training programs in TV-Radio Servicing, Industrial Electronics and Complete Communications. Or select one of seven specialized courses for men with specific wants or needs. Check the courses of most interest to you on the postage-free card and mail it today for your free catalog.

custom training kits “bite-size” texts

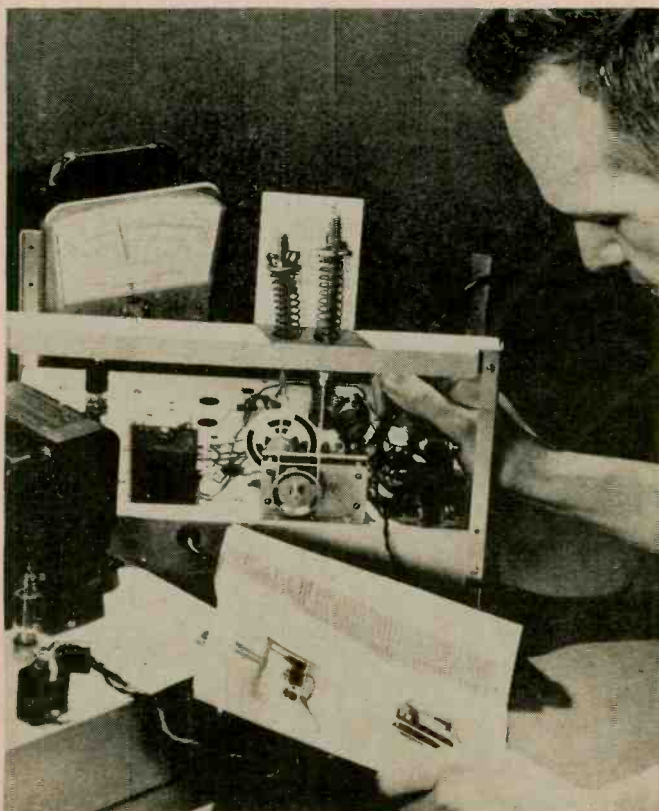

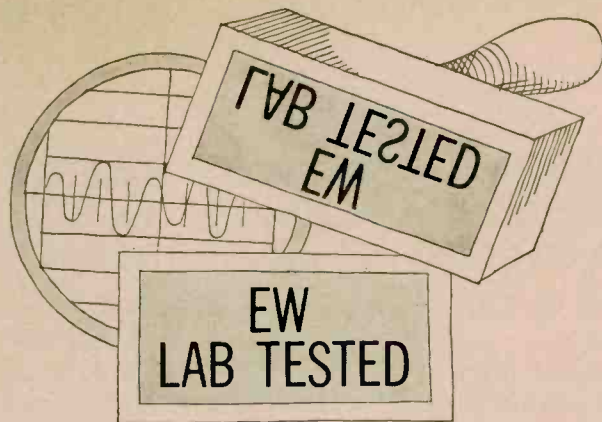

HI-FI PRODUCT REPORT

TESTED BY HIRSCH-HOUCK LABS

Sonotone RM-2 Speaker System
Shure Model 580 Microphone

Sonotone RM-2 Speaker System

For copy of manufacturer's brochure, circle No. 28 on Reader Service Card.

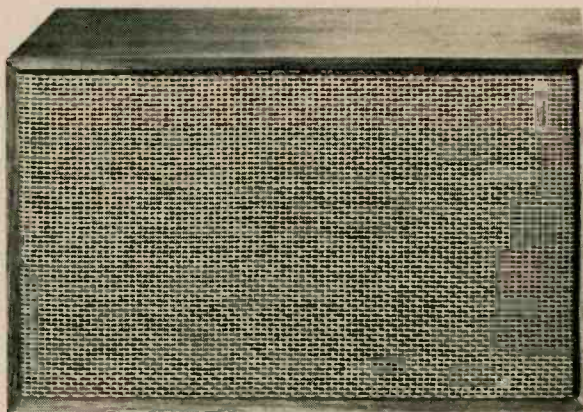

MANY "compact" speakers appear to be evolving into medium-size, heavy enclosures that are hardly suitable for bookshelf mounting. Fortunately, this evolution is simultaneously proceeding in the opposite direction toward true "bookshelf" proportions.

The Sonotone "Sonomaster" Model RM-2 is ideally proportioned for bookshelf mounting, measuring 19" wide x 11½" high x 8½" deep, and weighing only 22 pounds. It does not require oversized or reinforced shelves for safe mounting.

The speaker is constructed of ¾" thick material, with an attractive oiled-walnut veneer finish. It contains an 8-inch ceramic-magnet woofer with a high-compliance, long-throw voice coil and a 3½-inch cone tweeter, plus a crossover network. The woofer resonance in the enclosure is 50 cps and the crossover to the tweeter occurs at 4500 cps. A continuously adjustable level control on the rear of the box allows frequencies higher than 5000 cps to be boosted up to 5 db over the normal level, or to be attenuated completely. The system impedance is 8 ohms and it is rated to handle up to 50 watts of program material. Its efficiency is high enough for operation with any amplifier rated at 10 watts or more.

We mounted the RM-2 on a shelf a few feet off the floor, simulating a normal bookshelf installation, and measured its frequency response at eight different

points in the room. Averaging the data produced a single composite response curve, which was corrected for the known response of the room below 1000 cps and for the microphone response at high frequencies. The final curve, in our estimation, is a reasonable indication of the speaker's performance in a typical room environment.

Making allowance for the irregularities below 200 cps, which are probably due in some measure to room resonances, the over-all response of the RM-2 is very smooth over the entire audio range. Its freedom from peaks and holes and lack

of undue emphasis on any part of the spectrum imply an easy, musical sound character, and this was confirmed by our listening tests.

The low-frequency response appears to be unusually good, but this must be evaluated together with the low-frequency distortion curve, which shows a rapid increase in distortion below 50 cps. At frequencies of 40 cps and below, a large part of the speaker's acoustic output is not of fundamental frequency, so that the effective lower frequency limit is between 40 and 50 cps, depending on how much harmonic distortion one is willing to tolerate. (Sonotone rates the low-frequency limit of the RM-2 as 40 cps.) Above 90 cps, where the bulk of program material is concentrated, the distortion is negligible.

The highs roll off smoothly, but are present in usable degree to well beyond 10,000 cps. This curve was taken with the tweeter level set at the recommended "normal" point and it can be seen that adding 5 db to the response curve above 5000 cps results in a very nearly flat response. We found that the best over-all balance between highs and lows occurred with the normal setting, however.

The tone-burst response of the speaker system was uniformly good. The pictures taken at 150, 450, and 1000 cps typify its performance throughout its range.

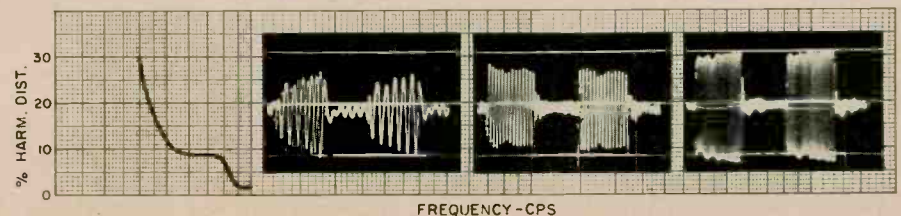
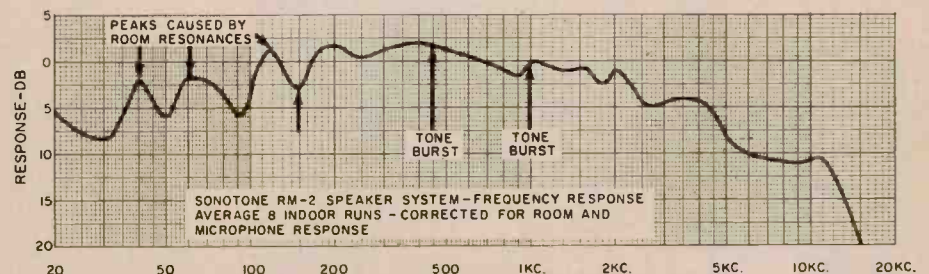

GET SUPERIOR 82-CHANNEL COLOR TV RECEPTION WITH NEW BELDEN 8290

**SHIELDED PERMOHM*
LEAD-IN**

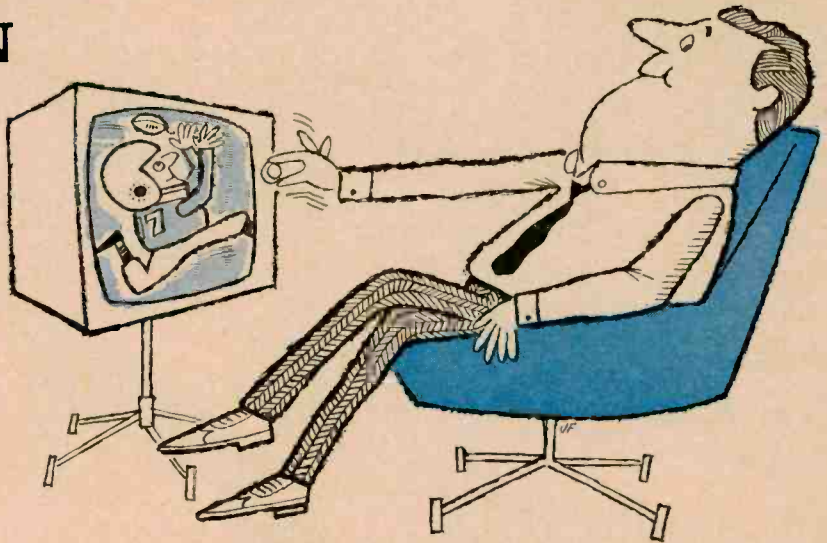

Until the introduction of Belden 8290 Shielded Permohm TV lead-in cable, there were serious limitations in the effectiveness of the various lead-in cables available, whether twin lead or coaxial.

Here Roland Miracle, electronic engineer of the Belden Manufacturing Company, discusses the problems and the reasons why Belden 8290 Shielded Permohm is the all-purpose answer for 82-channel and color TV reception.

Q. *What problems have been experienced in using twin lead cables other than 8290?*

A. Most installers have found out that using flat ribbon or tubular 300 ohm line for UHF and color installations is unsatisfactory. When these lines encounter dirt, rain, snow, salt, smog, fog, or industrial deposits, the impedance drops abruptly, the attenuation soars and the picture is lost.

To overcome this problem, Belden developed its 8285 Permohm line which encapsulates the flat twin lead in a low loss cellular polyethylene jacket. This keeps all of the surface deposits out of the critical signal areas—regardless of weather conditions.

Although this was a major improvement, there still remained the problem of electrical interference signals from automotive ignition systems, reflected TV signals and extreme electrical radiation which could be picked up by the lead-in to create ghosts and static lines in the picture.

Q. *Then, is this why many people recommend coaxial cable as TV lead-in?*

A. Yes. Because of the incorporation of a shield, coaxial cable has an advantage over unshielded twin lead.

Q. *Then, why isn't coaxial the total answer?*

A. Coaxial cable has much higher db losses per hundred feet than twin lead. Although the shield in coaxial cable does reduce lead-in pick-up of interference signals, it is not as effective as a 100% Beldfoil* shield.

Another way to put this is that 8290 delivers approximately 50% of the antenna signal through 100 feet of transmission line at UHF while coaxial cable can deliver only 15% to 20%, frequently not enough for a good picture. Even at VHF, the higher losses of a coaxial cable may be intolerable, depending on the signal strength and the length of the lead-in.

The following chart spells this out conclusively. We have compared RG 59/U Coax to the new Belden 8290 Shielded Permohm. All 300 ohm twin leads, under ideal weather conditions, have db losses similar to 8290.

CHANNEL	MC	db LOSS/100' 8290	db LOSS/100' COAX (RG 59 Type)
2	57	2.1	2.8
6	85	2.6	3.5
7	177	3.7	5.2
13	213	4.1	5.9
14	473	6.1	9.2
47	671	7.3	11.0
83	887	8.3	13.5

Capacitance: 8290—8.3 mmf/ft. between conductors

Coax—21 mmf/ft.

Velocity of Propagation: 8290—71.2%

Coax—65.9%

Q. *Won't the use of matching transformers improve the efficiency of a coaxial cable system?*

A. No! The efficiency is further reduced. Tests show that a pair of matching transformers typically contribute an additional loss of two db, or 20% over the band of frequency for which they are designed to operate. Incidentally, transformer losses are not considered in the chart.

Q. *How does 8290 Shielded Permohm overcome the limitations of other lead-ins?*

A. 8290 is a twin lead with impedance, capacitance, velocity of propagation and db losses which closely resemble the encapsulated Permohm twin lead so that a strong signal is delivered to the picture tube. At the same time, 8290 has a 100% Beldfoil shield which prevents line pick-up of spurious interference signals. In short, 8290 combines the better features of twin lead and coaxial cable into one lead-in.

Q. *What about cost?*

A. In most cases, 8290 is less expensive than coax since matching transformers are not required. The length of the lead-in is also a factor in the price difference. The cost of coaxial cable installations can vary tremendously, depending upon the type and quality of matching transformers used. If UHF reception is desired, very high priced transformers are required.

Q. *Is 8290 Shielded Permohm easy to install?*

A. Yes! Very! It can be stripped and prepared for termination in a manner similar to 300 ohm line without the use of expensive connectors. It also can be taped to masts, gutters or downspouts, thus reducing the use of standoffs. There is no need to twist 8290 as the shield eliminates interference problems. It is available from your Belden electronic distributor in 50, 75, and 100 foot lengths, already prepared for installation, or 500' spools.



Belden

BELDEN MANUFACTURING COMPANY
P. O. Box 5070-A · Chicago, Ill. 60680
*Belden Trademark Reg. U.S. Pat. Off.

Thinking of college and a space age career in electronics?

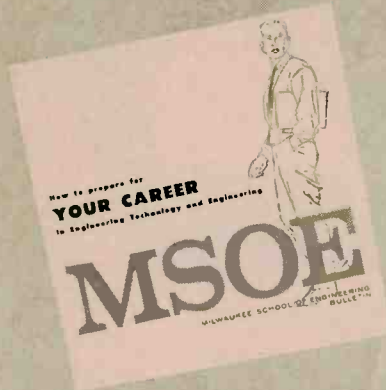

Send for this booklet on ENGINEERING TECHNOLOGY AND ENGINEERING

Learn how you can prepare for a dynamic career as an electrical or mechanical engineering technician or engineer in such exciting, growing fields as avionics, missiles, reliability control, fluid mechanics, data processing, metallurgy, microelectronics, and advanced aerospace research.

MSOE offers residence study programs leading to these degrees in engineering technology and engineering:

2 years—Associate in Applied Science
4 years—Bachelor of Science

Also get facts about scholarships and financial aids, job placement and other student services, plus photographs of MSOE technical laboratories and student activities. For your copy, just mail the coupon — no obligation.

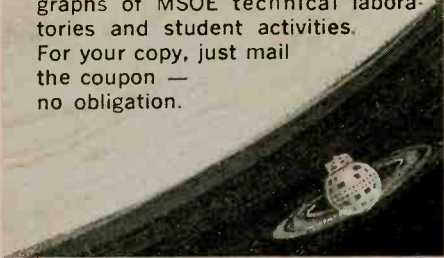

MSOE

Milwaukee School of Engineering
Dept EW-366 1025 N. Milwaukee St.,
Milwaukee, Wisconsin 53201

Please send the "Your Career" booklet.
I'm interested in

Electrical fields Mechanical fields

Name..... Age.....

Address.....

City..... State..... ZIP.....

MS-227A

CIRCLE NO. 100 ON READER SERVICE CARD

14

No significant ringing or spurious response was encountered at any frequency.

We doubt that the unit would deliver pleasing sound when driven with 50 watts of program material, but few speakers would. On the other hand, it is not likely to be damaged by brief high-power peaks and is, therefore, well

suitable for use with practically any amplifier.

The speaker has a thoroughly musical, satisfying sound which is comparable to that of any speaker in its price class, to say nothing of some costing considerably more. It sounds open and unrestricted, belying its small size. The RM-2 sells for \$56.50. ▲

Shure Model 580 Microphone

For copy of manufacturer's brochure, circle No. 29 on Reader Service Card.



IN sound reinforcement and public-address applications, acoustic feedback often limits the amount of useful amplification. When the speaker is at a distance of several feet from the microphone, turning up the amplifier gain frequently results in "howling" or a boomy echoing which reduces intelligibility.

One technique for minimizing acoustic feedback is to use a directional microphone which discriminates against sound arriving from its rear and sides. A cardioid (heart-shaped) polar response is commonly used since it offers a fairly wide angle front response, together with a high rejection from the rear and sides.

The cardioid pattern is obtained by providing openings at the rear of the microphone diaphragm. Sound arriving from the rear or sides drives both sides of the diaphragm in the same phase, causing a partial cancellation of output. Sound arriving from the front, however, is unable to affect the rear of the diaphragm because of the design of the openings and baffles in the microphone case, and a normal output is obtained.

Some cardioid microphones are quite bulky and heavy and do not have a uniform polar response. For example, the response in the horizontal plane

might be a cardioid, but the vertical response might be omnidirectional, or have some other less desirable pattern. The Shure "Unidyne" series of microphones are designed to have a polar response symmetrical about their major axis.

The new 580 series "Unidyne A" microphones are low-cost dynamic types, with the same symmetrical cardioid pattern featured in more expensive Shure models. The 580 series microphones are 7" long, with a tapered cylindrical case 1 3/16" in diameter at the grille and slightly under 1" in diameter at the other end. The grille is made of stainless steel. The microphone weighs 1 pound, 6 ounces.

The 580 series comes in two versions: the high-impedance Model 580SA, for use with amplifier inputs of 100,000 ohms or more, and the low-impedance Model 580SB, for 150- to 250-ohm inputs. They are fitted with 15-foot integral shielded cable. Swivel adapters allow a tilt of up to 90 degrees, with instant removal of the microphone for hand-held use. The microphone cartridge is shock-mounted within the case to minimize extraneous noises when it is hand held. An "on-off" switch on the side of the case has a lock plate for keeping it permanently on.

We tested a low-impedance Model 580SB microphone. It was placed 10" in front of a loudspeaker and a response curve was plotted. Then a calibrated reference microphone was placed in the same position and a similar curve plotted. The difference between the two curves can be considered as the response of the 580SB, since the reference microphone is flat within 1 db in the frequency range of interest. This method of measurement, while subject to some errors because of a lack of a uniform sound field and dissimilar polar patterns for the two microphones, gives a

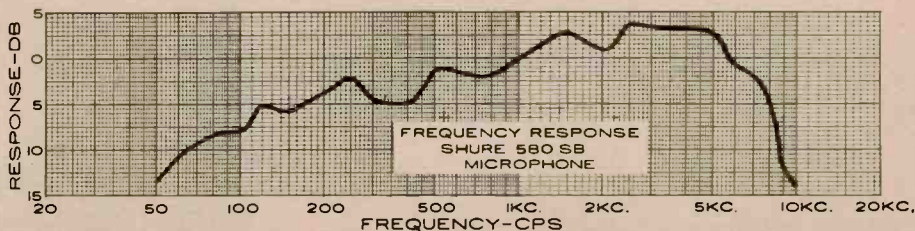

A New Electronics Slide Rule with Self-Training Course

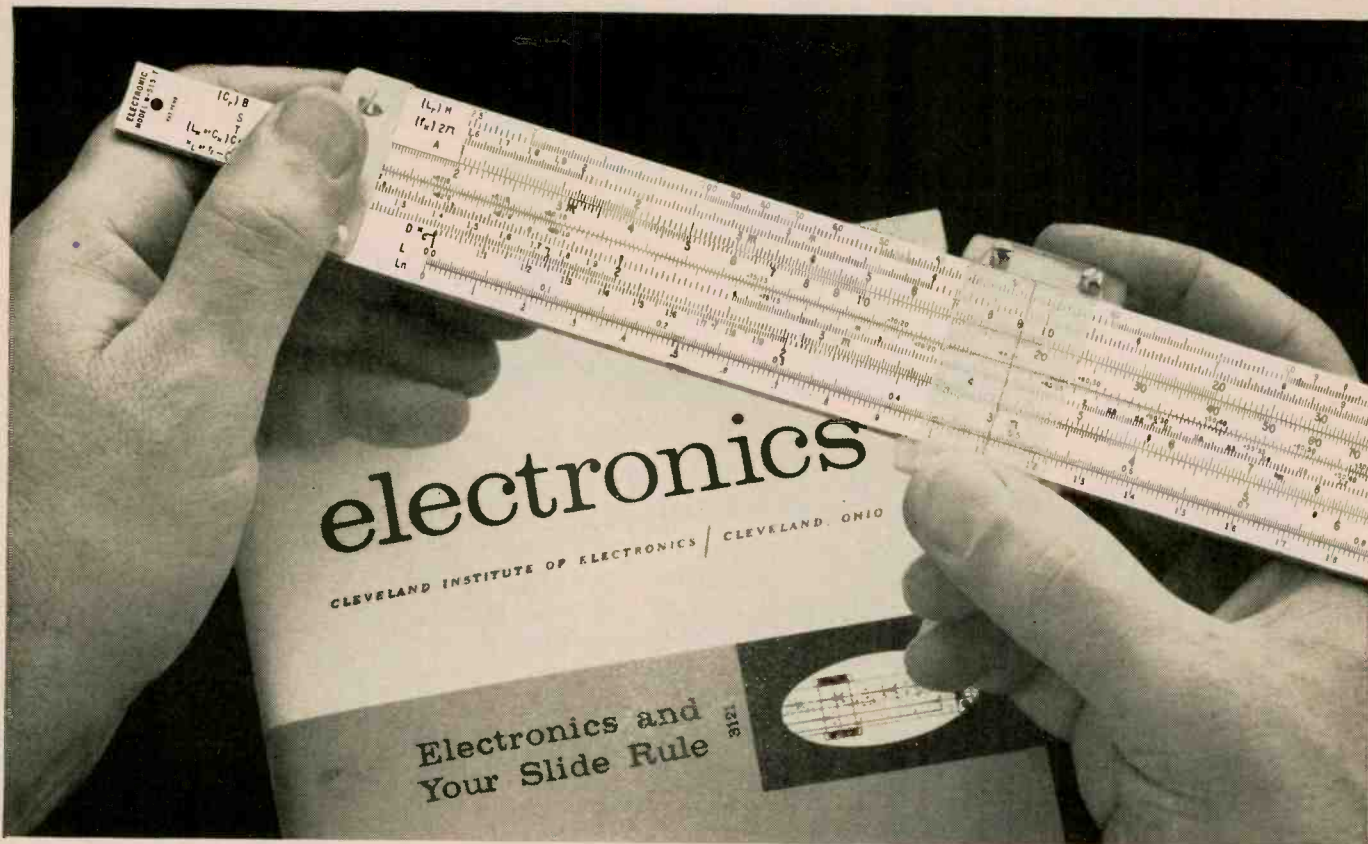

Why didn't someone think of this before?

Here's a great *new* way to solve electronic problems accurately . . . easily. The Cleveland Institute Electronics Slide Rule* is the only rule designed specifically for the exacting requirements of electronics computation. It comes complete with an illustrated Instruction Course consisting of four AUTO-PROGRAMMED* lessons . . . each with a short quiz you can send in for grading and consultation by CIE's expert instructors. With this personal guidance, you'll soon be solving complex electronics problems in seconds while others still struggle along with pad and pencil.

Here's what Mr. Joseph J. DeFrance, Head of the Electrical Technology Dept., New York City Community College, has to say about it:

"I was very intrigued by the 'quickie' electronics problem solutions. It is an ingenious technique. The special scales should be of decided value to any technician, engineer, or student. The CIE slide rule is a natural."

See for yourself. Learn how to whip through all kinds of reactance, resonance, inductance, AC and DC circuitry problems in seconds . . . become a whiz at conventional computations too!

This all-metal 10" rule is made to our tough specs by Pickett, Inc. . . . comes complete with top grain leather carrying case and Instruction Course. A \$50 value for less than \$20. Send coupon for FREE illustrated booklet and FREE Pocket Electronics Data Guide. Cleveland Institute of Electronics, 1776 E. 17th St., Dept. EW-119, Cleveland, Ohio 44114.

*TRADEMARK

GET BOTH FREE!



Cleveland Institute of Electronics

1776 E. 17th St., Dept. EW-119 • Cleveland, Ohio 44114

Please send FREE Electronics Slide Rule Booklet.
SPECIAL BONUS: Mail coupon promptly . . . get FREE Pocket Electronics Data Guide too!

Name _____ (Please Print)

Address _____ County _____

City _____ State _____ Zip _____

A leader in Electronics Training . . . since 1934

KWIKETTE[®] SOLDERING AIDS...

the revolutionary new connectors that make **QUICK** work of parts replacement!

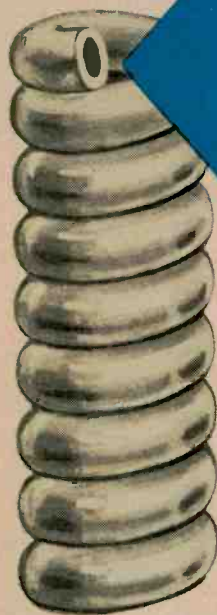

Ten times actual size

WIRE + FLUX + SOLDER, ALL in One!

The 3-in-1 KWIKETTE is *not just another wire spring connector...Copperweld wire inner core, a layer of flux, and an outer jacket of solder... all you need is heat!*

Once again, Sprague helps the TV-radio service industry by solving difficult servicing problems... parts replacement on printed wiring boards, in "inaccessible" chassis nooks, and on crowded terminal lugs. Mechanically sturdy and electrically reliable, the KWIKETTE provides *quick*, expert, "one-handed" soldered connections as easy as A-B-C!



NOBODY ELSE HAS KWIKETTE CONNECTORS... YOU GET 'EM ONLY FROM SPRAGUE PRODUCTS!

KWIKETTES are now being packed with Sprague Atom[®] Capacitors *at no extra cost to you!* Whenever you need tubular electrolytics, insist on pre-packaged Sprague Atoms from your parts distributor and you'll automatically get your KWIKETTE component connectors... the biggest boon to the service technician since the soldering gun!

* Trademark



WORLD'S LARGEST MANUFACTURER OF CAPACITORS

ES-5316

reasonably valid picture of a microphone's over-all range and smoothness.

The Model 580SB had a very smooth response, free from appreciable peaks and holes, from 50 to 10,000 cps. The maximum output was between 1000 and 6000 cps, with a gradual reduction in bass output to -13 db at 50 cps. The highs fell off more rapidly, to -14 db at 10,000 cps. This portion of the curve is most subject to error since the reference microphone was omnidirectional and responded to sounds arriving from the sides, while these produced less output from the 580SB.

The manufacturer rates the 580SB as having a "shaped frequency range" from 50 to 12,000 cps. Since no response curve is included in the specification sheet, we cannot compare our curve with theirs. Previous experience has shown that the correlation should be quite good.

The microphone has a clear, natural quality. We made voice recordings with it and several other microphones, and it proved to have an excellent balance between high and low frequencies. The cardioid response was very effective in reducing rear and side pickup. Shure specifies the side cancellation as approximately 6 db and the rear cancellation as approximately 15 to 20 db. Rough checks with a vu meter confirmed these claims.

Although the microphone was designed primarily for p.a. and other sound-reinforcement applications, it makes an excellent microphone for amateur radio operation. We used it "on the air" with uniformly complimentary reports, and with complete freedom from unwanted tripping of our "VOX" (voice-operated transmission) circuits by the receiver output.

The 580SB has a list price of \$52. The 580SA lists for \$59. A pair of 580SA's, matched to within 1 db for output and 1.5 db for frequency response, is available for stereo recording as the 580SA-MP, for \$118. ▲



"I think that one is the high-voltage rectifier!"

ELECTRONICS WORLD



Why does Arco wind all its tv-replacement capacitors with computer-grade 99.99% pure aluminum foil?

To help cure that pain in your neck.

Impurities in aluminum foil can lead to deterioration, premature failures, lost customer confidence—and call-back time you can't charge for. Big pains in the neck.

So we wind every Arcolytic® electrolytic capacitor with the purest aluminum foil available: 99.99% pure. It meets computer manufacturer standards. And exceeds those of radio-tv manufacturers.

Result: Arcolytic capacitors last longer in your customer's set. In fact, they won't deteriorate even at high operating temperatures of 85° C.

And while we wind them with computer-grade foil, we price them for home-entertainment service. You pay no premium.

You'll find whatever discrete capacitance value you need at your Arco Distributor's. And in your choice of single- and multiple-section tubular, or twist-mount designs. (You'll also find a complete line of equivalent-quality miniature ceramic disc capacitors up to 6000 VDCW.)

Start using Arcolytic capacitors. And the next call from your customer will be because he likes your kind of reliability, and wants more of your service.



Arco Electronics

A DIVISION OF LORAL CORPORATION

COMMUNITY DRIVE, GREAT NECK, N.Y. DALLAS, TEX. PASADENA, CALIF. WRITE FOR FREE CATALOG.

You can earn more money if you get an FCC License

...and here's our famous CIE warranty that you will get your license if you study with us at home

NOT SATISFIED with your present income? The most practical thing you can do about it is "bone up" on your electronics, pass the FCC exam, and get your Government license.

The demand for licensed men is enormous. Ten years ago there were about 100,000 licensed communications stations, including those for police and fire departments, airlines, the merchant marine, pipelines, telephone companies, taxicabs, railroads, trucking firms, delivery services, and so on.

Today there are over a million such stations on the air, and the number is growing constantly. And according to Federal law, no one is permitted to operate or service such equipment without a Commercial FCC License or without being under the direct supervision of a licensed operator.

This has resulted in a gold mine of new business for licensed service technicians. A typical mobile radio service contract pays an average of about \$100 a month. It's possible for one trained technician to maintain eight to ten such mobile systems. Some men cover as many as fifteen systems, each with perhaps a dozen units.

Coming Impact of UHF

This demand for licensed operators and service technicians will be boosted again in the next 5 years by the mushrooming of UHF television. To the 500 or so VHF television stations now in operation, several times that many UHF stations may be added by the licensing of UHF channels and the sale of 10 million all-channel sets per year.

Opportunities in Plants

And there are other exciting opportunities in aerospace industries, electronics manufacturers, telephone companies, and plants operated by electronic automation. Inside industrial plants like these, it's the licensed technician who is always considered first for promotion and in-plant training programs. The reason is simple. Passing the Federal government's FCC exam and getting your license is widely accepted proof that you know the fundamentals of electronics.

So why doesn't everybody who "tinkers" with electronic components get an FCC License and start cleaning up?

The answer: it's not that simple. The government's licensing exam is tough. In fact, an average of two out of every three men who take the FCC exam fail.

There is one way, however, of being pretty certain that you will pass the FCC exam. And that is to take one of the FCC home study courses offered by the Cleveland Institute of Electronics.

CIE courses are so effective that better than 9 out of every 10 CIE-trained men who take the exam pass it...on their very first try! That's why we can afford to back our courses with the iron-clad Warranty shown on the facing page: you get your FCC License or your money back.

There's a reason for this remarkable record. From the beginning, CIE has specialized in electronics courses designed for home study. We have developed techniques that make learning at home easy, even if you've had trouble studying before.

In a Class by Yourself

Your CIE instructor gives his undivided personal attention to the lessons and questions you send in. It's like being the only student in his "class." He not only grades your work, he analyzes it. Even your correct answers can reveal misunderstandings he will help you clear up. And he mails back his corrections and comments the same day he receives your assignment, so you can read his notations while everything is still fresh in your mind.

It Really Works

Our files are crammed with success stories of men whose CIE training has gained them their FCC "tickets" and admission to a higher income bracket.

Mark Newland of Santa Maria, Calif., boosted his earnings by \$120 a month after getting his FCC License. He says: "Of 11 different correspondence courses I've taken, CIE's was the best prepared, most interesting, and easiest to understand."

Once he could show his FCC License, CIE graduate Calvin Smith of Salinas, California, landed the mobile phone job he'd been after for over a year.

Mail Card for Two Free Books

Want to know more? The postpaid reply card bound-in here will bring you free copies of our school catalog describing opportunities in electronics, our teaching methods, and our courses, together with our special booklet, "How to Get a Commercial FCC License." If card has been removed, just send your name and address to us.

THESE CIE MEN PASSED... NOW THEY HAVE GOOD JOBS

Matt Stuczynski,
Senior Transmitter
Operator, Radio
Station WBOE



"I give Cleveland Institute credit for my First Class Commercial FCC License. Even though I had only six weeks of high school algebra, CIE's AUTO-PROGRAMMED™ lessons make electronics theory and fundamentals easy. After completing my CIE Course, I took and passed the 1st Class FCC Exam. I now have a good job in studio operation, transmitting, proof of performance, equipment servicing. Believe me, CIE lives up to its promises. I really enjoy my work and I'm on my way up."



Chuck Hawkins,
Chief Radio
Technician, Division
12, Ohio Dept.
of Highways

"My CIE Course enabled me to pass both the 2nd and 1st Class License Exams on my first attempt...I had no prior electronics training either. (Many of the others who took the exam with me were trying to pass for the eighth or ninth time!) I'm now in charge of Division Communications. We service 119 mobile units and six base stations. It's an interesting, challenging and rewarding job. And incidentally, I got it through CIE's Job Placement Service...a free lifetime benefit for CIE graduates."

Glenn Horning,
Local Equipment
Supervisor, Western
Reserve Telephone
Company



"There's no doubt about it. I owe my 2nd Class FCC License to Cleveland Institute. Their FCC License Course really teaches you theory and fundamentals and is particularly strong on transistors, mobile radio, troubleshooting and math. Do I use this knowledge? You bet. We're installing more sophisticated electronic gear all the time and what I learned from CIE sure helps. Our Company has 10 other men enrolled with CIE and take my word for it, it's going to help every one of them just like it helped me."

CIE Cleveland Institute of Electronics
1776 E. 17th St., Dept. EW-13, Cleveland, Ohio 44114

Accredited by the Accrediting Commission of the National Home Study Council, and the only home study school to provide complete coverage of electronics fundamentals plus such up-to-date applications as: Microminiaturization • Laser Theory and Application • Suppressed Carrier Modulation • Single Sideband Techniques • Logical Troubleshooting • Boolean Algebra • Pulse Theory • Timebase Generators...and many more.



Better than
9 out of 10
CIE men win
their "ticket"
the very first
time they try
(NATIONAL AVERAGE
IS ONLY 1 OUT OF 3)

Cleveland Institute of Electronics
WARRANTY
 of success in obtaining a
Government FCC License

The Cleveland Institute of Electronics hereby warrants that upon completion of the Electronics Technology, Broadcast Engineering, or First-Class FCC License course, you will be able to pass the FCC examination for a First Class Commercial Radio Telephone License (with Radar Endorsement);

OR upon completion of the Electronic Communications course you will be able to pass the FCC examination for a Second Class Commercial Radio Telephone License;

AND in the event that you are unable to pass the FCC test for the course you select, on the very first try, you will receive a FULL REFUND of all tuition payments.

This warranty is valid for the entire period of the completion time allowed for the course selected.

G. O. Allen

G. O. Allen
 President

FIRST AND ONLY compact scrulox screwdriver sets

Increasing use of Scrulox square recess screws in appliances, radios, TV sets, electronic instruments... even the control tower at Cape Kennedy... has created a need. A need for compact, versatile driver sets. Small enough to tuck in a pocket. Complete enough to be practical on shop bench or assembly line.

Now, here they are... from Xcelite, of course.



PS44
COMPACT
CONVERTIBLE SET

Five color coded midget Scrulox drivers—#00 thru #3

One midget nutdriver—1/4" hex
"Piggyback" torque amplifier handle increases reach and driving power
See-thru plastic case doubles as bench stand

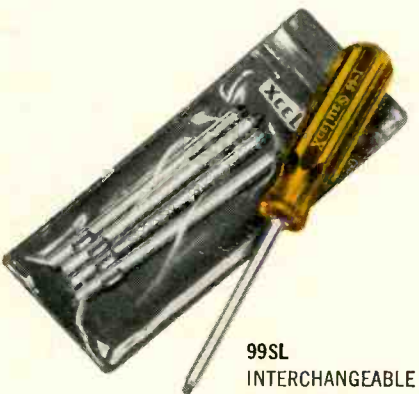

99SL
INTERCHANGEABLE
BLADE KIT

Five Scrulox blades—#00 thru #3
Shockproof, breakproof, Service Master handle
Durable, see-thru plastic case



XCELITE, INC., 12 BANK ST., ORCHARD PARK, N. Y.
CIRCLE NO. 82 ON READER SERVICE CARD

LETTERS FROM OUR READERS

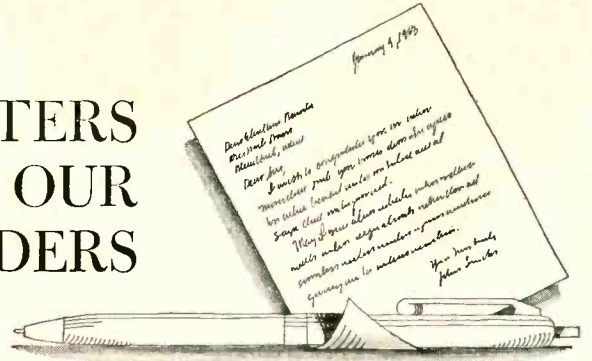

CRYOGENICS IN ELECTRONICS

To the Editors:

Mr. William Nelson's article "Cryogenics in Electronics" (December issue) proved to be of considerable interest to me. I am presently working toward an MSEE at the University of Nevada, and my thesis topic is concerned with the area of superconductivity.

I therefore have an interest in articles on cryogenics. Though I cannot say that Mr. Nelson's article helped me directly, it is the first article I have read of a general nature that did not make errors when the author tried to simplify the subject matter. Neither did Mr. Nelson make the article so detailed that it could not be understood by persons outside the field.

Generally, then, I feel that Mr. Nelson is to be complimented on his presentation of a potentially complex subject so that it could be understood by most workers in the electronics field.

ROGER L. PETERSON
Reno, Nev.

PRODUCT TEST REPORTS

To the Editors:

I have been reading your magazine for several months now and find it to be very informative and containing something of interest for everyone in electronics.

I was wondering if your lab-tested department could provide me with some information on a product in which I am interested. It is a Japanese product under the brand name of "Delmonico." The particular item I am interested in is their FM/FM-AM table radio with multiplex reception. I would appreciate any knowledge of this product you might have, along with possible technical data and where I might be able to purchase it. If you have any information or suggestions on other radios of this type, I would appreciate them.

LAWRENCE P. WARREN
Keesler AFB, Miss.

The above letter is typical of many we get requesting lab-tested information on specific products. Our lab is currently quite overloaded with products waiting to be tested so that it is impossible for us to run special tests for our

readers. Therefore, the only information we have on specific products and their performance is the information that appears regularly from month to month. A listing of the products tested appears in our annual index (December issues). In addition, our testing is strictly confined to component high-fidelity equipment.

—Editors

FRYE'S "ELECTRIC SHOCK"

To the Editors:

Have just completed rereading your excellent article in December, 1965 edition titled "Electric Shock" by John Frye. This is one of the most interesting and concise articles I have ever had the pleasure of reading on this subject, and it really drives home its point.

As safety chairman of the Bureau of Electricity, City of Alameda, I would like to procure an additional 50 copies of this article for distribution to our linemen and other electrical workers.

We certainly enjoy ELECTRONICS WORLD and always find many items of worthwhile reading.

ARTHUR L. BERG
Operations Office Mgr.
Bureau of Electricity
Alameda, Calif.

WVW GEOALERTS

To the Editors:

Just prior to 20 minutes after each hour, station WVW transmits some letters and numbers in slow Morse code. What is the significance of this transmission?

E. L. SINGER
Bronx, N.Y.

These transmissions are geoalerts and time corrections. A geoalert identifies days on which outstanding solar or geophysical events are expected or have occurred during the previous 24 hours. The geoalert is identified by the letters "GEO" followed by one of the following letters repeated five times:

M—magnetic storm	C—cosmic ray event
N—magnetic quiet	W—stratospheric warming
S—solar activity	E—no geoalert issued
Q—solar quiet	

Immediately following this transmission, the UT2 (Universal Time) time cor-

1. With 1 Finger Of Your Right Hand, Pick Out Key A, Key F, Etc.

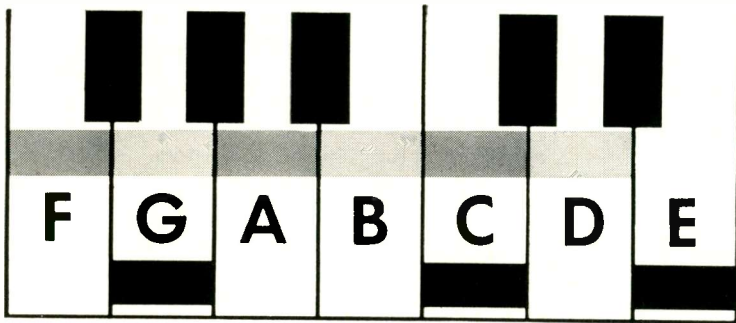
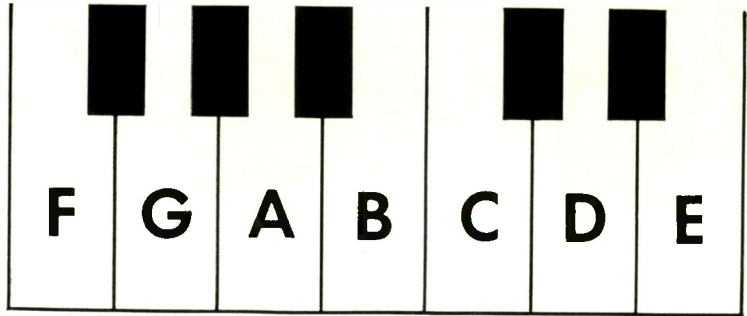

2. Now Put 2 Fingers And A Thumb Of Your Left Hand On The Red Keys... The Green Keys... Or The Black Keys.

3. That's All It Takes To Play Complete Songs On The New Heathkit®/Thomas COLOR-GLO Organ

Play Complete Songs In Minutes . . . Instead Of Months! Color-Glo key lights on this new Heathkit/Thomas Transistor Organ show you the correct notes and chords. You play melody, harmony and bass notes *instantly* . . . even if you've never played an organ before!

Switch On The Color-Glo, And You're Ready To Play! Each key on the upper keyboard lights up with a letter. You simply match the key's letters with the letters on the music to play melody. For harmony, there are 3 red keys, 3 black keys and 3 green keys on the lower keyboard. Just press and hold the notes that match the background color in the Thomas Color-Glo music book (included). To add the bass, press the pedal that's marked with the same color as the harmony notes. That's all there is to it. Touch the switch again, and the Color-Glo keys disappear, leaving a beautiful spinet organ.

All Genuine Thomas Factory-Fabricated Parts! Other features include ten organ voices; repeat percussion; two 37-note keyboards; 13-note heel & toe bass pedals; variable expression pedal; 2 levels of vibrato; balance control; 12" speaker; 50-watt EIA peak music power amplifier; and hand-crafted walnut cabinet. The transistorized tone generators, the heart of the organ, are warranted for 5 years.

Build It In About 50 Hours! Takes no special skills or knowledge . . . you even tune the organ with a pretuned tone generator. Easy credit terms available, too. Get the full story . . . use the coupon to send for demonstration record and the FREE Heathkit catalog.

Kit GD-325 Organ, 153 lbs. \$349.95
GDA-232-1, matching walnut bench, 18 lbs. \$ 24.95



Kit GD-325
\$349⁹⁵
(less bench)

Hear It Perform Yourself!



Send 50c for 7", 33 1/3 rpm demonstration record (see coupon). For full details on this, plus over 250 other Heathkits, mail coupon or write Heath Company, Benton Harbor, Michigan 49022 for FREE Heathkit Catalog.



Heath Company, Dept. 15-3
Benton Harbor, Michigan 49022

Enclosed is \$ _____, plus shipping.

Please send model(s) _____

Enclosed is 50c. Please send Organ Demonstration Record No. GD-232-5.

Please Send FREE 1966 Heathkit Catalog.

Name _____

Address _____

City _____

State _____

Zip _____

Prices and specifications subject to change without notice.

CL-238

HERE IT IS... ONLY \$15⁹⁵



The
Revolutionary
Adjustatone

...ALL NEW FROM TELEX

Never before such fine performance at such a low price. This all new stereo beauty from Telex has big 3½ inch speakers with over 7 square inches of cone area. They deliver a terrific bass response down to 10 cycles and reproduce highs clearly up to 15,000 cycles. Sound impedance 3-16 ohms.

Forward Sound

You get the aural perspective of an audience seat with the exclusive "forward sound" acoustic effect that puts stereo sound *out front*. You adjust to normal "in-head" stereo effect by reversing phones.

Comfort

Soft foam cushions combine with light weight to assure effortless listen-

ing, even over long periods. Stereo pleasure the way it should be enjoyed—in solid comfort.

Rich new styling

The all new Adjustatone complements the decor of any room, any stereo set. Inset panels and silver trim accent the smooth line styling. Construction is of stainless steel and injection molded high impact plastic.

Try the sensational new Adjustatone at your dealer. No stereo set should be without one. See also the three other great Telex stereo headsets—the Stereo Twin ST-10 and ST-20 and the ultimate of all stereo headsets—the new Serenata. All made in U.S.A.

Products of Sound Research

TELEX

DEPARTMENT 29C, 3054 EXCELSIOR BLVD., MINNEAPOLIS, MINNESOTA
CIRCLE NO. 87 ON READER SERVICE CARD



COMPLETE TUNER OVERHAUL

9⁹⁵

ALL MAKES ALL LABOR AND PARTS (EXCEPT TUBES & TRANSISTORS)

Send complete tuner now... or write for full information and mailing labels. Exchanges on tuners unfit for overhaul from \$12.⁹⁵

CASTLE TV TUNER SERVICE

MAIN PLANT: 5717 N. Western Ave., Chicago 45, Illinois
EAST: 41-54 Vernon Blvd., Long Island City 1, New York
Castle TV Services, Ltd., Nationwide service.

CANADA: For service in Canada write to Chicago

*Major parts are charged extra in Canada

SAY YOU SAW IT IN

Electronics World

361C AUDIO EQUALIZER

Variable Equalizer necessary for professional quality recording or playback. Ideal for use between mixer and tape recorder or tape to tape, etc. Write for details or send \$2.00 for LP demonstration record. Covers tape and disc recording techniques. Refunded with purchase.

361C

\$44⁹⁵ 

Order Direct or Write for information.

KUHN ELECTRONICS
CINCINNATI 17, OHIO

rections are transmitted. These are corrections to be applied to time signals for obtaining actual UT2 within ±3 msec. Corrections, given in Morse code, begin with "UT2" followed by either "AD" (for add) or "SU" (for subtract), in turn followed by the number of milliseconds to be added or subtracted from the time as broadcast.—Editors

MULTIPLEX ADAPTER FOR FM STEREO

To the Editors:

Your October issue contained an article on "A Multiplex Adapter for FM Stereo" (p. 74). After I built the unit, I found that the output was extremely low so that I had to operate my amplifier with its gain wide open. Also, I noted about the same voltage (-4.5 volts) on all electrodes of Q4 and Q5, the output transistors. What's wrong with this circuit?

EDWIN T. MARTIN
Newark, N.J.

Several readers have reported these same symptoms. The trouble is in the bias networks for the two output transistors. Resistors R16 and R23 should be 180,000 ohms rather than 18,000 ohms as shown. When this change is made, the negative bias will be reduced to its proper value, output transistor collector current will fall, and the circuit should operate with considerably greater output.—Editors

COLOR-TV SET-UP PROBLEMS

To the Editors:

An engineer from our tube division found the last two sentences of the top righthand paragraph on p. 25 in my December article ("Color-TV Set-Up Problems & Adjustments") in error. Published manufacturing specifications are greater than the value given as minimal, and many tubes in the field have dot separations greater than ¼".

The effect of inherent dot separation in the tube upon dot shape and size is dependent upon direction as well as separation magnitude. Dot distortion is further dependent upon the amount of purity correction required and upon the neck components' quality. Therefore, it is difficult to establish dot separation standards which cause excessive dot distortion.

Service technicians should not reject a tube on the basis described in the aforementioned section of my article. High magnet strength requirements on any magnet or purity magnet are grounds for suspecting the tube. The actual problem cause can best be finalized by substituting a new tube or new neck components, including the deflection yoke.

VIC BELL, Chief Service Engr.
Entertainment Products Div.
Sylvania Electric Products Inc.
Batavia, N.Y. ▲

new!

Low cost—all solid-state CITIZENS RADIO TRANSCEIVER



MESSENGER "100"

Check the performance features—then take a look at the price tag! You won't find a CB unit on the market that gives you as much value and reliability for your two-way radio dollar. The same highly competent engineering team that designed the famous Messenger III now brings you this low cost, compact, 5 channel transceiver for Mobile, Base or Portable field use! Delivers maximum power from legal input. High performance noise limiting for "whisper quiet" operation. Adjustable "squelch" control. Receiver is both sensitive and selective—unique speech compression circuit prevents overmodulation and delivers a crisp, clean signal without adjacent channel "splatter"... boosts average transmitted power for maximum readability at extended ranges.

Circuitry Features of the "100" include:

- *Narrow bandwidth receiver* for excellent selectivity!
- *High receiver sensitivity* for maximum range!
- *Unique speech compression circuit* which prevents overmodulation and helps deliver a clean, crisp signal without adjacent channel "splatter"! Three types of usage from one unit—Mobile, Base or Portable.

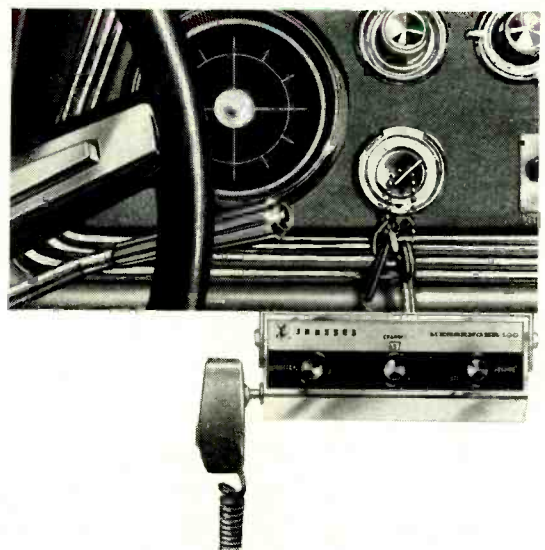

CALL OR WRITE TODAY
for complete information!
E. F. JOHNSON COMPANY

1016 10th Ave. S.W. • Waseca, Minn. 56093

\$129⁹⁵

NET
(Mobile Unit)

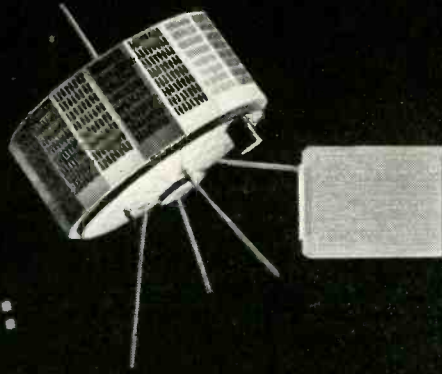

Tiros uses Solid RCA Circuits

**The entire RCA Victor line
uses RCA Solid Copper Circuits
Why?**

**RCA Solid Copper Circuits won't come loose.
Won't short circuit. Won't go haywire. They're the
Space Age advance over old-fashioned "hand wiring."**

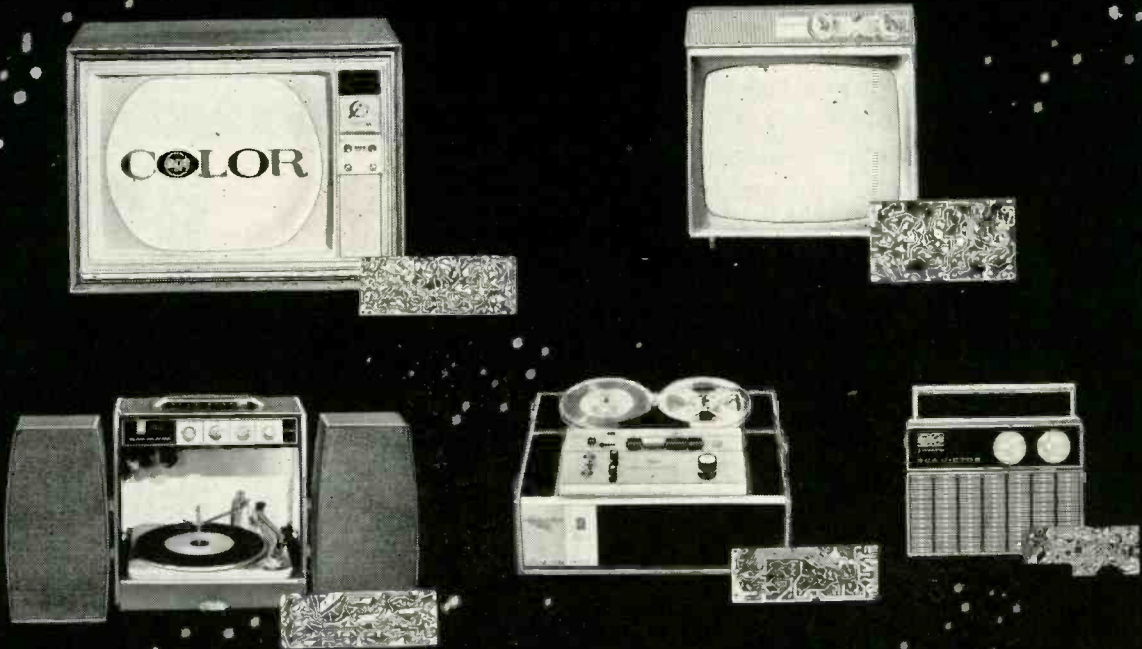

SHOWN AT TOP: SOLID RCA CIRCUIT DESIGNED FOR NASA'S TIROS



THE ORBITING ASTRONOMICAL OBSERVATORY

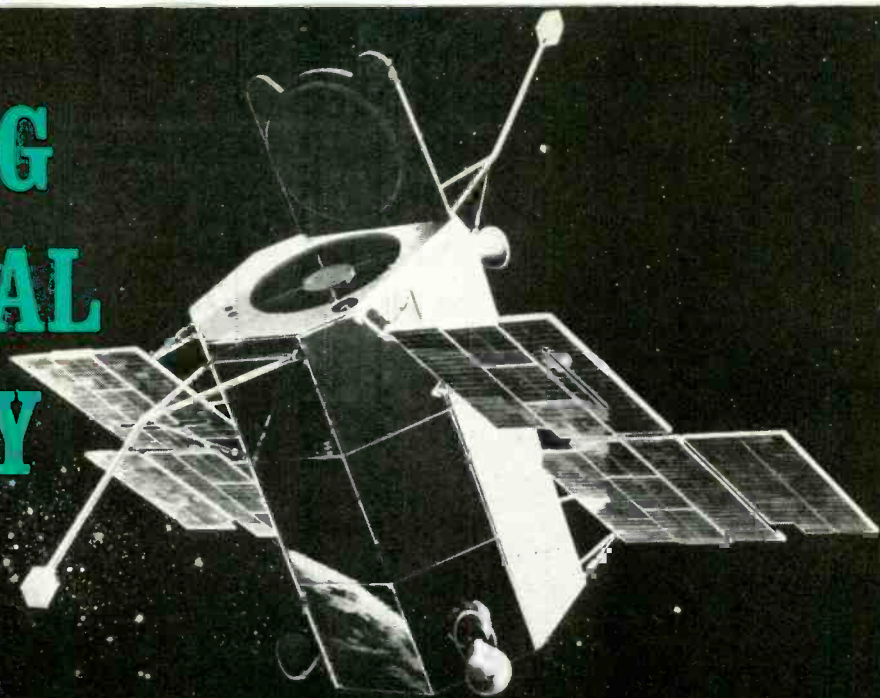

By DONALD A. IMGRAM
OAO Project Engineer, Grumman Aircraft Engineering Corp.

Probably the most complex satellite built to date, the Orbiting Astronomical Observatory uses the latest electronic techniques to enable scientists to see the universe without interference.

THE Orbiting Astronomical Observatory (OAO) is the largest, heaviest, and most electronically complex satellite being built under NASA's unmanned observatory program. Astronomy is the OAO's mission, and why NASA should be willing to invest over one hundred million dollars, literally in pursuit of the stars, is not too difficult to understand. All heavenly bodies emit energy at frequencies spanning the electromagnetic spectrum. But the atmosphere which surrounds the earth is a hazy, shimmering veil which absorbs much of the radiation which reaches us from outer space, and only a small portion of the incident radiation is unaffected as it attempts to penetrate the atmospheric barrier. Hence, all current astronomical theories are based almost exclusively on information received by ground observers through a narrow optical "window." Just how much present concepts will be shaken when man can observe the entire universe from an unobstructed vantage point high above the atmosphere is a matter of speculation, but who amongst us could have imagined the contrast between the two photographs making up Fig. 1? Similar revelations undoubtedly await the scientists preparing experiments for use on board the OAO, once detection equipment is placed outside the earth's atmosphere where the view will be unobstructed compared with terrestrial observation as shown in Fig. 2.

The OAO

Each OAO, and it is expected that as many as ten launches will be made over the course of the next decade, is composed of two main elements. These are the spacecraft itself and the associated experimental package.

The spacecraft system consists of four electronic subsystems. These are the stabilization and control, data-processing, communications, and power supply subsystems. The functional interplay of each can best be understood by detailing the operation of the satellite after it is inserted into its intended orbit. Immediately following booster separation, the stabilization and control system halts the tumbling motion induced by separation forces and begins the initial stabilization and orientation process by seeking and acquiring the sun. Both of these functions are accomplished simultaneously by two different kinds of sensors. The first is a system of

three rate gyros that senses tumbling rates about the three spacecraft control axes (pitch, yaw, and roll). In the second system, error signals are generated by a system of eight "coarse" solar sensors. These are silicon solar cells which when illuminated produce an output that is a cosine function of the angle of incident sunlight on the cell. The eight cells have hemispherical fields of view and are installed such that four provide pitch axis error information while the other four sense yaw motion. No roll control data is provided by the solar sensors. Two of the four eyes for each axis are paired on the front (anti-sun) and rear (sun-pointing) faces of the satellite. The polarity of one cell in each pair is reversed with respect to that of its mate, and the outputs of each pair are summed algebraically. The resultant composite signals are roughly sinusoids with the zero (null) crossing points corresponding to zero displacement of the spacecraft from the sun line. Driving signals in the form of error rate and error displacement are hence available and can be used to position the observatory so that at the conclusion of the coarse solar sensing and the rate stabilization phase, the spacecraft is aligned with the sun line. All spacecraft torquing during this phase is accomplished using the high-thrust gas-jet system whose operation is similar to those used in the Mercury and Gemini spacecraft.

Ultimately, the error angle will be reduced to zero and the spacecraft will eventually approach a limit cycle motion of ± 2 degrees with a residual rate less than .03 degree per second. At this time the spacecraft will have its rear face pointing towards the sun.

Mounted on the rear face of the observatory is a solar-cell "disable" eye having a restricted field of view (± 10 degrees). Also affixed to a common fine-pointing assembly are eight additional solar cells. Their function is to provide finer solar-sensing control signals which are used until the spacecraft alignment to the sun line is maintained at $\pm .25$ degree. Upon achieving the fine solar pointing, the spacecraft begins one of the more challenging stabilization operations that the OAO will be called upon to perform. Termed the "roll search" maneuver, its success depends upon proper functioning of the spacecraft's star trackers, the most critical components on board the OAO.

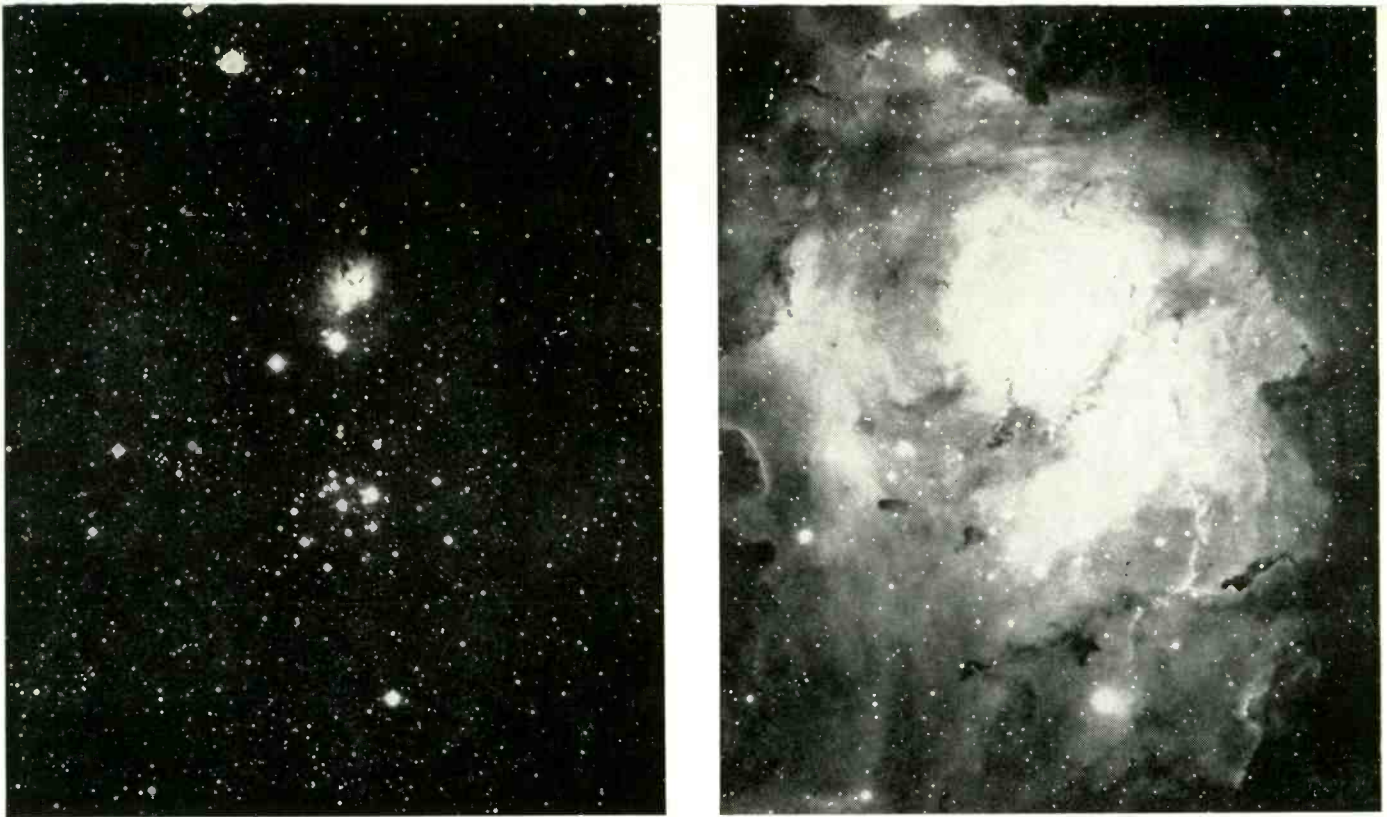

Fig. 1. A hint of things to come is shown in this pair of photographs of the Sagittarius Constellation. The two pictures are identical except the one made using near ultraviolet light (right) discloses considerable detail not recorded by the visible light emanating from the same source. Many similar spectacular pictures will be made by OAO.

Six gimballed star trackers are employed on the OAO, and each is an electro-mechanical/optical device used for the detection, acquisition, and tracking of selected "guide" stars. Guide stars chosen for the OAO total 31 in number, all having an apparent brightness (S-4 response) of second magnitude or brighter. Operation of a tracker is shown in Fig. 3. The heart of the device is a 3.5-inch-diameter aluminized beryllium mirror with a focal length of 5 inches. Light entering the telescope-like barrel is reflected off the main mirror onto a prism beam splitter having two secondary plane mirrors offset at an angle of 45 degrees with respect to each other. The offset arrangement permits splitting the incident light into two beams, each of which is used to provide error data about a specific spacecraft control axis (*i.e.*, pitch and roll). The two beams subsequently pass through slits in two orthogonal vibrating reeds and illuminate the cathode surface of a ten-stage photomultiplier. Since one reed vibrates at 350 cps and the other at 450 cps, appropriate circuitry can be used to obtain two-axis control information which facilitates automatic tracking of the guide stars. Filtered outputs from the photomultiplier are synchronously demodulated to yield d.c. voltages whose polarity is a function of phase (direction of displacement of the star image) and whose amplitude is a function of the displacement of the star from the center of the tracker's one-square-degree field of view.

Star-tracker usage begins immediately upon the completion of the fine sun-pointing mode. After the observatory settles into the $\pm .25$ degree limit cycle, the roll gyro output is biased to induce a roll search motion about the sun line. While the OAO is rolling, each tracker sweeps out a one-degree-wide circle on the celestial sphere. Careful preselection of gimbal angles—each tracker can be gimballed through 45 degrees on each axis—is performed before launch on ground computers such that at a specific and unique roll angle, all non-occulted star trackers simultaneously detect guide stars. When this occurs, the trackers generate star-presence signals which cause the gyro bias to be removed and allow the trackers to lock onto and track the stars. Subsequent observatory control is accomplished using stellar control, the solar sensors and gyros serving no further purpose.

All experimentation will obviously not be done with the

OAO aligned with the sun line; hence, the observatories are provided with a capability for "slewing" to any arbitrary position in space. Imagine that the spacecraft is aligned with the sun line and that it is desired to reorient the OAO to a position 30 degrees away, say to point the main experiment telescope at a star in the region of Orion. The first required operation is that ground operators at the OAO Central Control Station at Goddard Space Flight Center in Greenbelt, Maryland develop a series of spacecraft commands on a digital computer. These commands will be sent by teletypewriter to one of the three OAO remote-control stations located at Rosman, North Carolina; Quito, Ecuador; and Santiago, Chile. These sites were chosen and equipped with special OAO ground-support equipment because at least one of these stations has a 10-minute r.f. contact with the satellite once every 100-minute orbit. In turn, the remote stations relay the appropriate commands to the observatory. When received on board the spacecraft, the commands are routed to the data-processing subsystem.

The means by which the OAO slews from one region of the sky to another are three "coarse" inertia wheels. Inertia wheels, positioned one on each control, are simple a.c. motors which are accelerated and braked as a result of commands sent from the ground. When, for example, the pitch wheel is accelerated, the spacecraft will be caused to rotate about its pitch axis but in an opposite direction in accordance with the principle of conservation of angular momentum. Braking the wheel will cause the spacecraft to cease rotation. By careful calibration of the wheel's inertia properties, acceleration, and braking characteristics, it is possible to accurately predict the slewing actions of the spacecraft in response to wheel motion and hence to orient the OAO to any desired position in space.

The observatory is also equipped with a set of three "fine" inertia wheels which are used to maintain the satellite in a stabilized attitude once the experiment is pointed at the region of interest in the celestial sphere. When supplied with signals directly from the star trackers, the wheels can stabilize the spacecraft to any arbitrary position in inertial space with an accuracy of ± 1 minute of arc and restrict drift off this pointing to rates less than 15 arc seconds in 50 minutes of

time. Some later spacecraft will be equipped with a "fine error sensor" as part of the main experiment optics. Use of this device will enable future OAO's to be accurately attitude stabilized to less than $\pm .1$ second of arc.

Spacecraft Commands

Commands may be sent to the OAO as either "real-time" or "delayed-mode" (stored) commands. Real-time commands are used when the observatory is within line-of-sight of a ground station and are executed immediately. Delayed-mode commands may also be executed during line-of-sight contacts (at some time after their initial decoding on board the spacecraft), but generally the delayed commands are placed into memory storage for subsequent execution after the satellite terminates its ground contact. The recognition by the spacecraft as to what type of command has been received is accomplished in the command decoder and distributor portion of the primary processor. A unique feature of the OAO is its ability to verify commands transmitted from the ground. To understand how this operation takes place, it is necessary to review the OAO's command format. The entire OAO data-processing system is digital in nature. Commands are sent to the OAO as a series of four 32-bit command messages. The four words consist of the first and second command words, and the first and second verification words. Verification words are the "ones" complement of the command words, meaning that, for example, if the first command word began its message by the binary bits "11010," the first verification word would be registered as "00101." This format is employed so that on-board verification of received commands can be accomplished by comparing the command word and the verification word on a bit-by-bit basis. Only if an exact comparison of the bits can be made is the command acted upon by the satellite.

Commands are received by the OAO's command receiver at a 1-kc. rate. The spacecraft's system clock, which is a crystal-controlled sine-wave oscillator supplying a fundamental clock frequency of 1.6 mc., provides the basic observatory timing reference. A shaper-driver network forms the clock signal into a square wave and transfers the resultant waveform to a ten-stage frequency divider. Outputs from the frequency divider are decoded to provide clock pulses and bit gate for use by all OAO equipments. Received commands are synchronized to the primary processor's 50-kc. bit time rate and are verified on board as well as retransmitted to the ground for a further verification (or "echo check"). When it is desired to store a command for later use, the message is entered into the OAO's command-storage unit. Command-storage capability is included to facilitate quad redundant storage of 128 two-word commands (verification words are not stored since they are of no further use after a command has been validated). The storage medium consists of the MARS (Multi-Aperture Reluctance Switch) devices. These are tiny ferrite cores which allow random-access, non-destructive readout capability. The observatory also incorporates a 200,000-bit data-storage unit which is used to record both spacecraft as well as experiment data. Again, the MARS devices are utilized. The entire data memory can be used to store information in a non-redundant fashion, or the memories can be "halved" to permit redundant storage of 100,000 bits of data. The Gemini computer was derived from the OAO data-processing unit.

Spacecraft Electronics

As in all spacecraft, data transmission is vital. In the OAO, the spacecraft's command receiver (CRE) is part of the

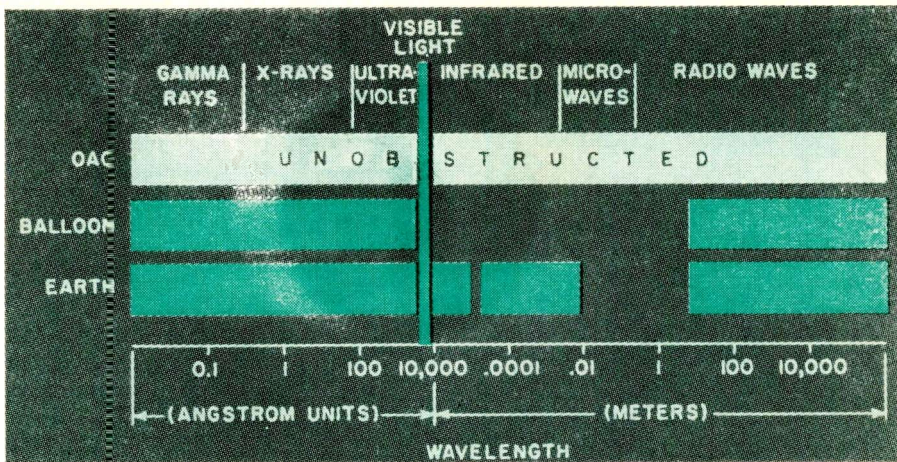
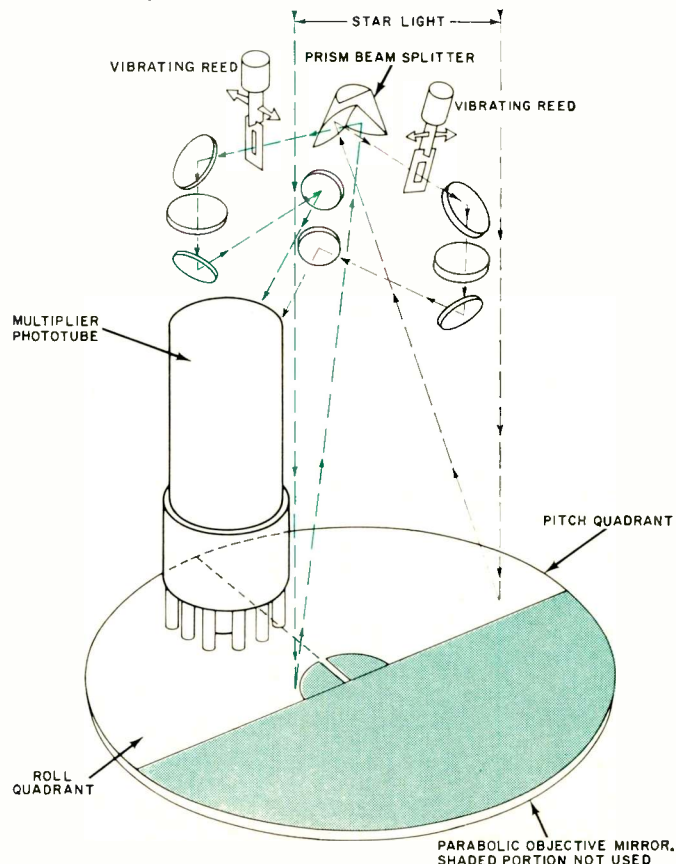

Fig. 2. The earth's atmosphere absorbs certain portions of the electromagnetic spectrum. Once above this medium with the OAO, total spectrum observation is very easily attained.

communications subsystem, a block diagram of which is shown in Fig. 4. R.f. signals are received in two channels, corresponding to the two v.h.f. slot antennas. The command signal sent to the CRE is a 148,260-mc. v.h.f. carrier, amplitude-modulated by the command modulation. Command modulation consists of the superposition of two subcarriers. One subcarrier, known as the command-message modulation, is frequency-shift keyed (FSK) in accordance with the sequence of "1's" and "0's" in the message. The other, known as the message rate clock modulation, is a sinusoid at 1042 cps. The FSK subcarrier may be considered to consist of the alternate existence of two audio tones of equal amplitude, referred to as the "1" tone and the "0" tone. The command modulation is formally known as pulse-code modulation, non-return-to-zero, frequency-shift keyed, amplitude modulation or [PCM (NRZ)/FSK/AM]. Also part of the communica-

Fig. 3. The star tracker splits incident starlight into two beams, each modulated at a different frequency by the vibrating reeds to provide error data about a specific axis.



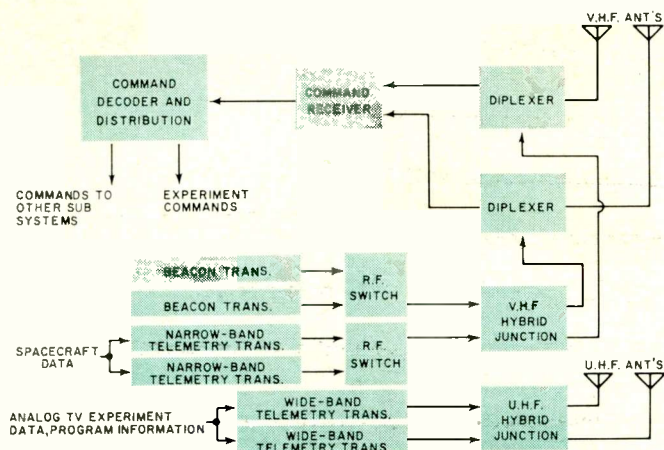
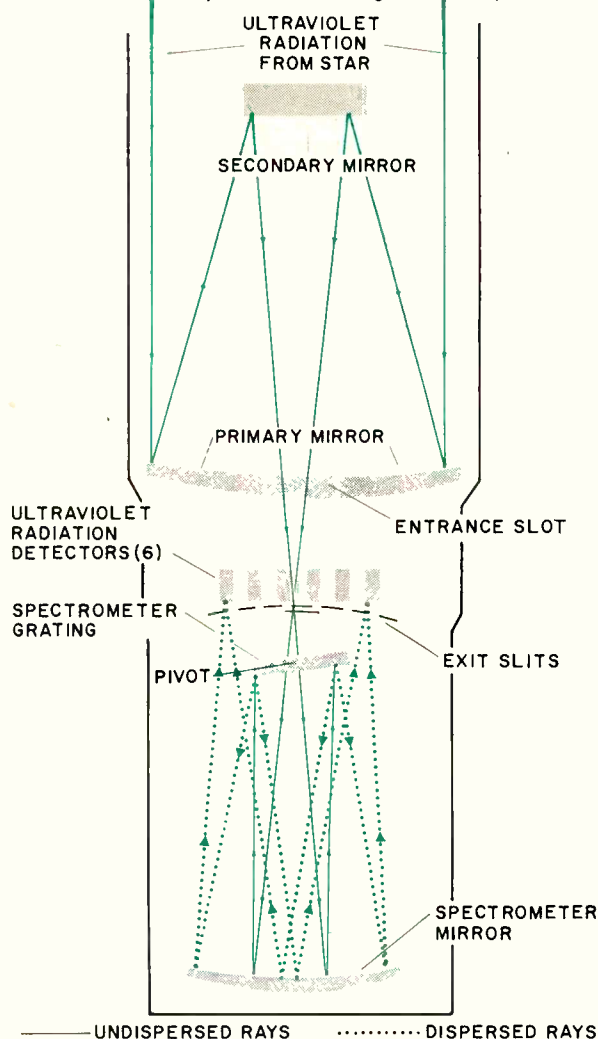

Fig. 4. Block diagram of the spacecraft communications system.

tions system are the radio-tracking beacon and the wide- and narrow-band telemetry transmitters. Operating at 136.440 mc., the beacon permits accurate orbital tracking of the spacecraft. The narrow-band transmitter (NBT) is used for spacecraft telemetry data and for the echoing of commands for ground verification. In addition, although it is not a primary mode, the narrow-band transmitter can be used for experiment-data transmission. The output of the NBT is PCM (split-phase) phase-shift keyed (PSK) and is sent at a rate of 1042 bits per second. The NBT, like the wide-band transmitter (WBT), is a completely solid-state unit. Each NBT consists

Fig. 5. This special telescope permits detailed observation of the ultraviolet spectrum in two-angstrom-wide portions.



of a crystal-controlled oscillator, a phase-shift keying modulator, an FM isolation and amplification stage, three stages of class-C amplification, a driver stage, a power output stage, a varactor doubler stage, RFI filter, and telemetry output circuitry. The WBT is capable of transmitting either analog or digital data. A video bandwidth of 62.5 kc. is used for analog information, with a total transmission bandwidth of 250 kc. Digital data can be transmitted as PCM/NRZ at a rate of 1042 bits per second in real time if it is received from experimenter's data-handling equipment, or at 50,000 bits per second from the data-storage unit or directly from the experiment. Power output of the WBT is eight watts over temperatures ranging between 0 and 130°F. The transmitting frequency is 400.550 mc.

Completing the spacecraft's electronic subsystems is the power supply subsystem. All power used on board the spacecraft is generated by the satellite's solar array, which is capable of generating approximately 1000 watts under the most favorable conditions with respect to incident sunlight. The array employs *p-n* cell types of between 13% and 14% efficiency, and the total area devoted to solar cells is approximately 114 square feet. Each of the three OAO batteries consists of 22 series-connected, sealed nickel-cadmium cells of the 20-amp. hour size. Each battery is capable of supplying approximately 535 watt-hours of energy. Control of the battery during recharging is a critical operation and is performed by the battery-charge and sequence controller. A regulator-converter, which provides regulated d.c. outputs of several voltages, accepts unregulated 23 to 34 volts d.c. from either the array, if the spacecraft is in the sunlight, or the batteries if the spacecraft is occulted from the sun. Two multivibrator-type power oscillators (master and slave) convert the unregulated d.c. inputs to square-wave pulses at 2 kc. The combined outputs of the master and slave oscillators are added in an autotransformer connection in the slave oscillator and a secondary connection in the master unit. The resulting output is full-wave rectified and filtered through diode rectifiers and LC section respectively. Voltage regulation is achieved by varying the phase angle between the master and slave oscillators. The a.c. demands of the inertia wheels as well as the gyros are supplied by an inverter.

All spacecraft electronics are mounted peripherally around the central structural cylinder which houses the main experiment package. By employing this structural arrangement, it is possible for the OAO to accommodate a variety of experiment packages without substantial changes to the basic spacecraft design. Hence, we find that the spacecraft is often referred to as one of the family of "streetcar" satellites, meaning that it accepts a variety of "passengers."

Experiment Packages

All current experiments are intended to explore regions of the electromagnetic spectrum that are essentially invisible to earthbound observers. A total of nine experiments will be included on board the first four OAO launches. A few of the key experiments will be discussed here. The initial OAO will have an experiment whose function will be to gather spectral energy distribution information on selected stars and nebulae in the ultraviolet range (100 to 4000 Å). As a secondary function, the experiment will measure time-varying spectral-intensity data on particular stars. A total of seven observing instruments will be used to take these measurements. Four stellar photometers, each of which covers a bandwidth of approximately 1000 Å, are used. In turn, each photometer is equipped with a programmable filter to further subdivide the coverage into 250-Å bands. Also provided in the first OAO will be two scanning spectrometers. One covers the range of 1000 Å to 2000 Å while the other scans between 2000 Å and 4000 Å. A unique cycling device permits scanning the range in 100 steps, yielding intensity bandwidth of 10Å to 20 Å wide. The final instrument (Continued on page 87)

T and H ATTENUATOR PAD NOMOGRAMS

By MAX H. APPLEBAUM/Warwick Electronics Inc., Pacific Mercury Div.

Values of resistors employed in unbalanced T and balanced H pads with different input and output impedances for r.f. and a.f. use.

THE use of this nomogram provides a simplified and rapid means of calculating component values for unbalanced T and balanced H non-symmetrical attenuator pads for audio or r.f. applications. These pads have different values of impedances looking into and out of the circuit. Schematics of the pads are shown at right. The formulas used for the nomograms are adaptations of standard equations. The method of using the nomograms is illustrated in the following example.

Example: Design a 12-db pad which will match a 75-ohm coaxial cable from a distribution amplifier to a receiver having a 50-ohm input unbalanced to ground.

Solution: In nomogram 1, extend a straightedge from 50 on the Z2 scale to 12 on the attenuation scale. Rotate the straightedge about the point where it crosses the pivot line to 75 on the Z1 scale. The straightedge is found to cross the R3 scale at about 33 ohms.

In nomogram 2, extend the straightedge from 12 on the at-

tenuation scale to 75 on the Z1 scale. It is found to cross the R1+R3 scale at 85. Subtracting R3 from this number, we get a value of about 52 ohms for R1. Now extend the straightedge from 12 on the attenuation scale to 50 on the Z2 scale. It is found to cross the R2+R3 scale at about 56. Subtracting R3 from this number, we get a value of 23 ohms for R2. To summarize, R1≈52 ohms, R2≈23 ohms, and R3≈33 ohms. For a balanced H pad, the values of R1 and R2 are halved.

Note: In nomogram 2, the Z1 scale is used in conjunction with the R1+R3 scale, and the Z2 scale with the R2+R3 scale. ▲

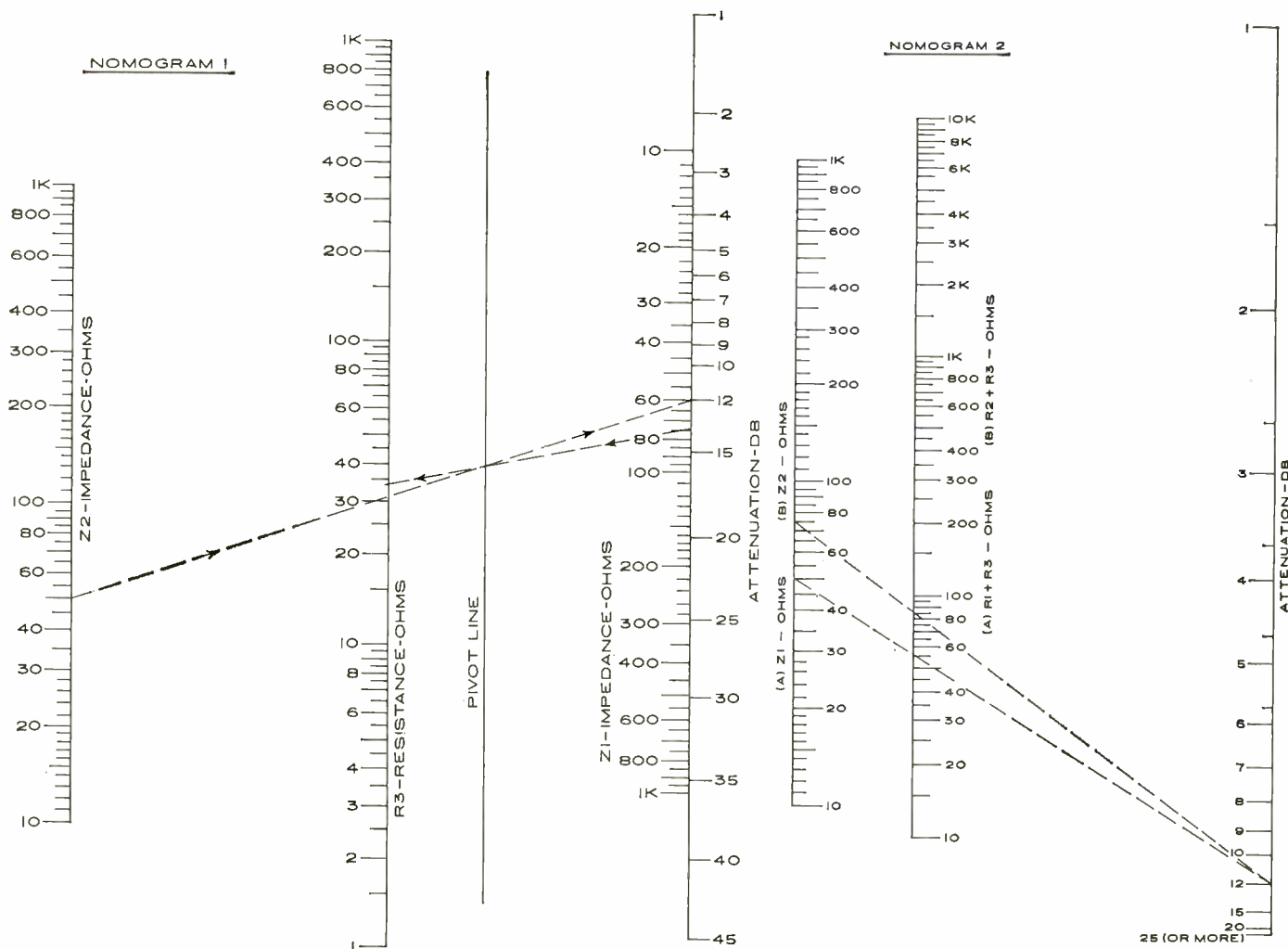
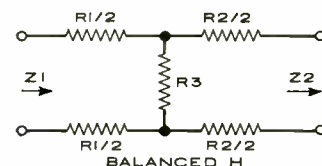
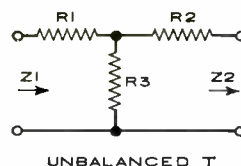

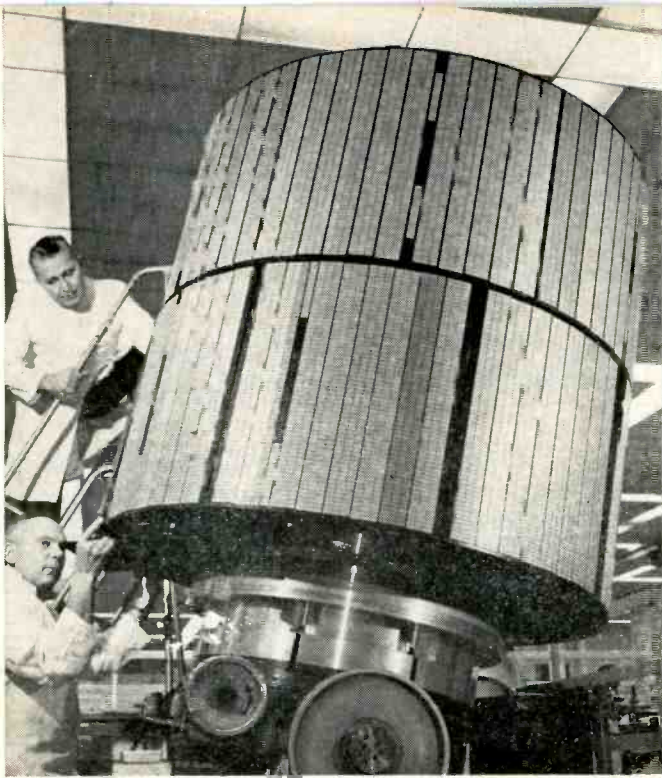

RECENT DEVELOPMENTS IN ELECTRONICS

New Scientific Satellites. (Above) A new family of scientific satellites, called ATS for Applications Technology Satellites, is being built for NASA by Hughes under \$39 million contract. Five such spacecraft will be launched beginning late this year to conduct about 20 scientific experiments in space. Shown here in final assembly is a structural model of a synchronous-altitude spacecraft that will be spin-stabilized by gas jets. Such a satellite will appear to remain fixed in space above a given location on earth. Later ATS versions will uncoil four 130-foot weighted booms as a "gravity-gradient" experiment to keep the satellite's antenna continually facing earth while in its orbit.

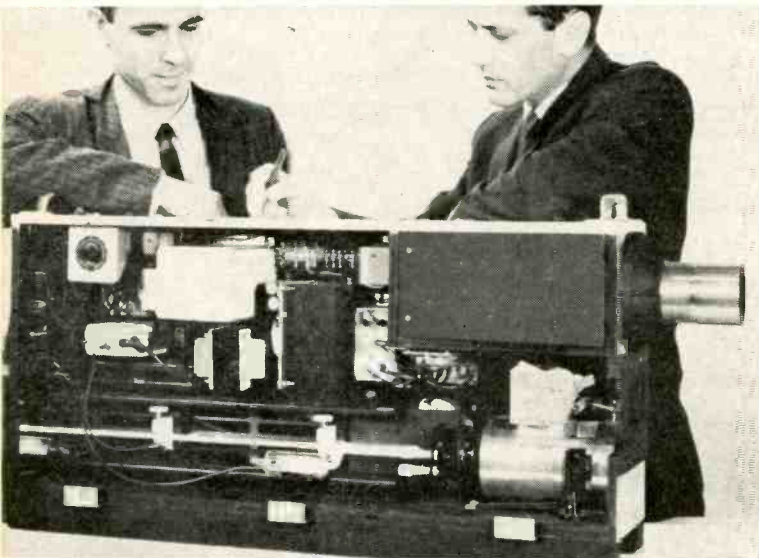

Lightless, Lensless Laser TV Camera. (Center) A laboratory model of a laser television camera which needs no studio lights or other external sources of illumination is shown here with its side cover removed. Scanned by a rapidly moving narrow beam of red laser light, subjects even in complete darkness appear on the TV monitor screen as if in daylight brightness. Picture quality is sharp and clear. The intensity of the laser beam is far below an amount that would endanger human vision and, when the beam is scanning, it is completely invisible. The extremely sharp laser beam strikes a polygon prism rotating at almost 60,000 rpm. This causes the beam to scan horizontally at the rate of 15,750 lines per sec. The beam is then reflected from a slower speed multi-sided mirror resulting in 60 vertical scans per sec. Energy reflected from the target is sensed by a photomultiplier and used to intensity modulate the CRT in a TV monitor whose beam is scanning in sync with the laser beam. Camera was developed by Perkin-Elmer. The camera can be considerably reduced in size.

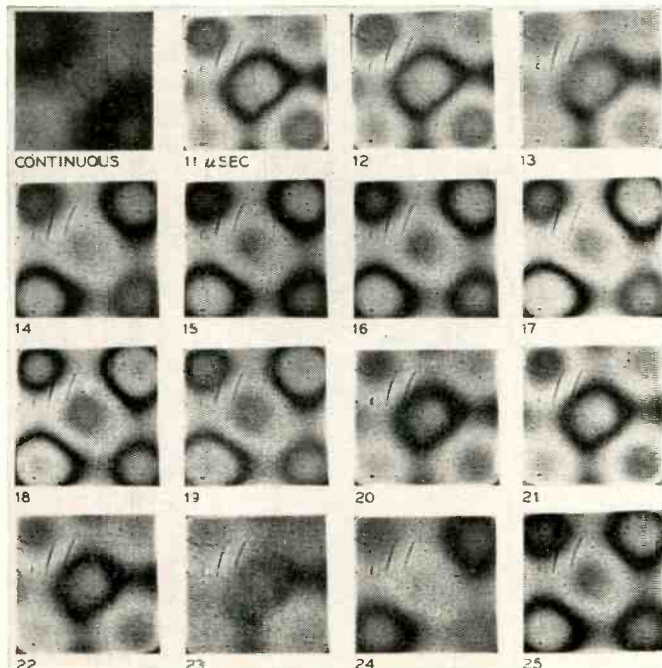

Crystal Sound Patterns. (Left) These photographs taken at intervals of one millionth of a second show how the structure of a crystal changed when it was made to oscillate by an ultrasonic sound wave at a frequency of 100 kHz (kc.). The technique of photographing sounds in a crystal was developed at Bell Telephone Laboratories. The crystal used in this experiment was potassium dihydrogen phosphate (KDP). The crystal was sandwiched between two glass electrodes. While the crystal was vibrating, bursts of polarized light, synchronized with the acoustic vibrations, were directed through the crystal and focused onto a camera. This technique provides an almost continuous picture of the crystal's acoustic strain at intervals as short as a fraction of a microsecond. Previous methods of observing acoustic strain, such as sprinkling powder on the crystal surface or using x-ray diffraction, did not provide the time-resolved patterns or the complete amount of detail now possible.

Transportable Station Shows Gemini Recovery. (Right) A transportable satellite communication ground station aboard the aircraft carrier Wasp beamed the first live TV pictures of the Gemini 6 and 7 astronauts when they arrived aboard the carrier after splashdown. The station sent signals from on-board TV cameras up to the Early Bird satellite. From the satellite, the signals went to COMSAT's Andover, Me. station and then via land facilities to the networks for distribution to viewers across the country. The station, designed by ITT Federal Labs, consists of a 30-foot diameter antenna secured to the aircraft carrier's flight deck, and a 30-foot long communications van stowed one deck below. The automatic tracking antenna is capable of being steadily aimed at the Early Bird satellite although the carrier may roll and pitch as it maintains its cruise speed.

Laser-Pierced Diamond Wire-Drawing Dies. (Center) A laser beam is being used by Western Electric to pierce diamonds in wire-drawing dies. This is said to be the first known application of the laser for mass-production purposes. The diamond dies are used to precisely draw copper into wire half the thickness of a human hair. Previously, holes were made in diamonds by steel pins and diamond dust, a method requiring 2 to 3 days. Rough piercing with the laser beam takes about 2 minutes. The photo shows a closeup of a diamond die as it appears on a CCTV position monitor. The tiny tip at the bottom of the pierced hole is the result of a single laser shot. Multiple shots are employed to produce an opening having the required diameter.

Solid-State Display Panel. (Below left) Development of a solid-state display panel which is the first of its kind designed to vary the time that images from sonar signals can be retained was announced by GT&E Laboratories. Advantages of the new light-amplifier display panel over conventional displays which utilize cathode-ray tubes are its compact size and its adjustable persistency which prevents fading and smudging of the image. The photo shows an early model of panel developed for the Navy.

Computer-Directed Traffic. (Below right) A new experimental system is now automatically controlling traffic signals at 32 intersections along a major three-mile highway and adjacent streets leading into the downtown section of San Jose, Calif. The system uses 400 vehicle-detecting devices that feed information to the computer about the speed and density of traffic. Preliminary results show a significant improvement in the methods of handling the flow of 35,000 cars that use the highway daily. Subsequently, some 28 traffic signals in the downtown area will be controlled by the IBM control system that is used.

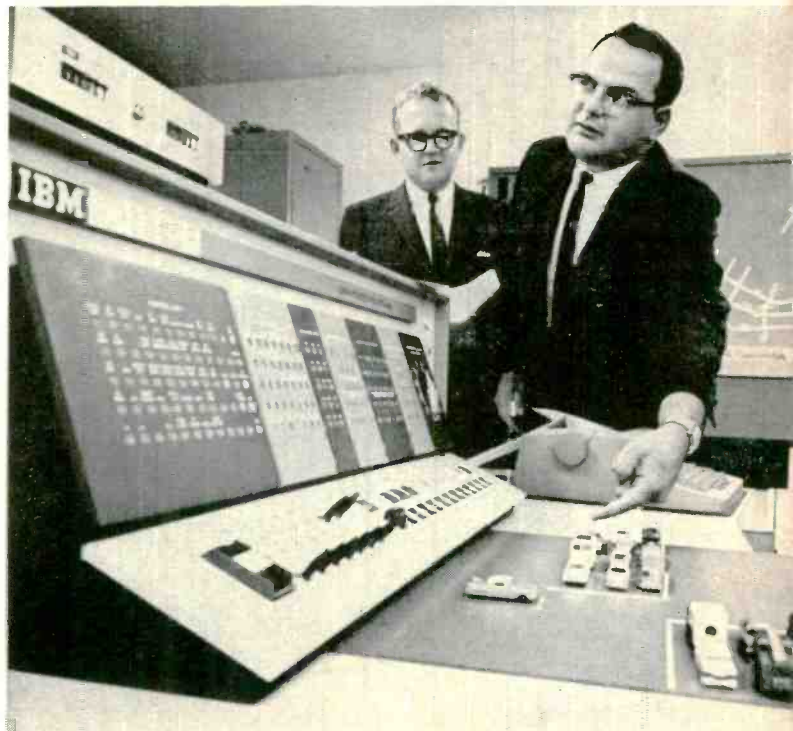
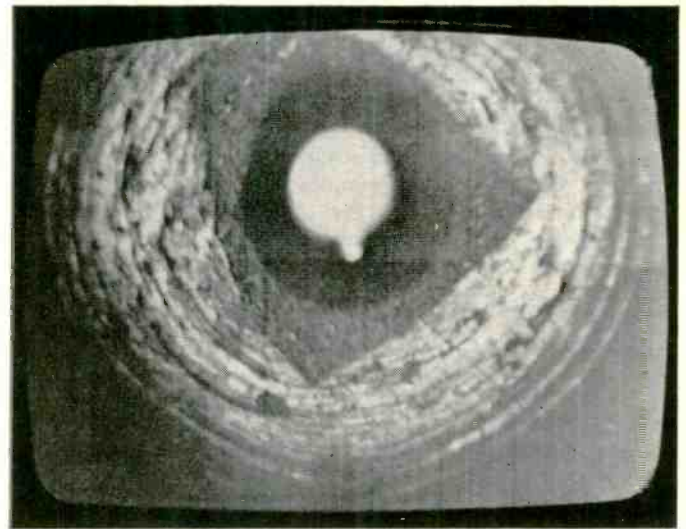
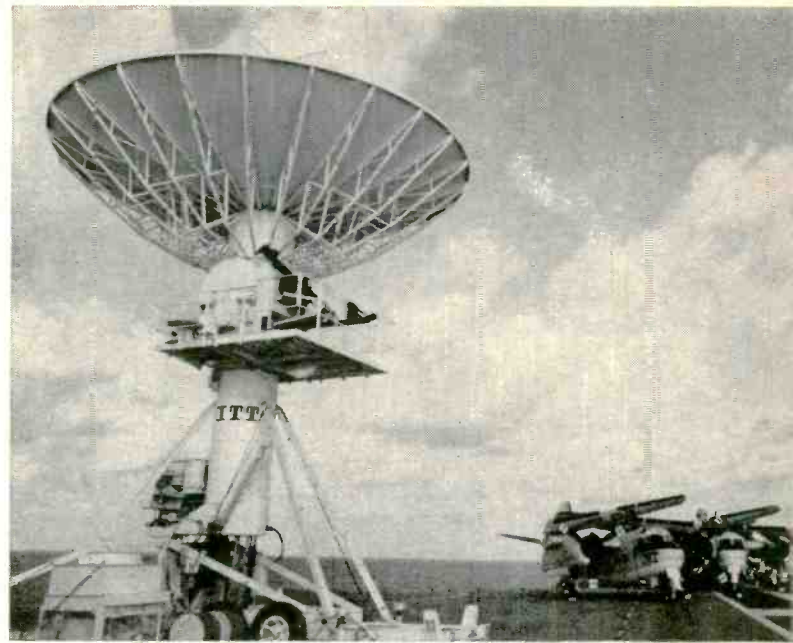

Line-Operated Transistor TV Sets: *Westinghouse*

By WALTER H. BUCHSBAUM

Another in a series of articles covering unique circuit details of line-operated, large-screen transistor TV sets. This article covers the 27-transistor, 19-inch, 114° CRT Westinghouse model.

THE *Westinghouse Electric Corp.*'s transistorized 19-inch, a.c.-operated TV receiver uses 27 transistors, a vacuum-tube high-voltage rectifier, and a 114° deflection-angle CRT. As illustrated in Fig. 1, the viewing screen is covered by a low-reflectivity type of black glass which, according to the manufacturer, provides glare-free reception and greatly enhanced contrast. As with most modern portable receivers, removal of the back cover gives the technician access to practically all of the circuitry. Separate v.h.f. and u.h.f. tuners are used, and a special crossover network is provided to permit both v.h.f. and u.h.f. operation with the same antenna. As shown in Fig. 1, most of the circuitry is contained on a single printed wiring assembly.

Among the transistor circuits of this receiver, we have selected three relatively unusual circuits which appear for the first time in this *Westinghouse* model and which will be discussed in detail.

Probably the most unusual is the power supply, which uses a voltage regulator similar to those found in transistorized power supplies for laboratory or experimental use. As shown in Fig. 2, a full-wave rectifier, *D1*, and *D2*, provide approximately 75 volts to the input filter capacitor *C1*. A portion

of the B+ current goes through *R1*, a 47-ohm resistor, while another portion passes through *R2* and *Q1*. This transistor controls the current and acts both as a filtering and a regulating element. Capacitor *C5* is the output filter. A portion of the full-wave rectified signal is filtered by *R4*, *C2*, *R5*, and *C3* and is applied to the base of *Q2*. This voltage appears as a well-filtered d.c. signal which regulates the gain of *Q2*, which, in turn, directly drives the base of *Q1* to approximately set the 60-volt output level. In addition to providing the filtering, the combination of *Q2* and *Q1* also assures constant output voltage, regardless of a.c. line voltage, or B+ drain variation. This is accomplished by the sensing circuit of *Q3*. The emitter of *Q3* is regulated by means of the zener diode. The base of *Q3* is connected to a portion of the voltage between +60 volts and ground and is adjustable to provide the correct regulated voltage of +60 volts. Any change in the 60-volt output results in a corresponding change in the voltage on the base of *Q3*, which affects the current through *Q3* and thereby varies the current at the base of *Q2*. As in vacuum-tube voltage-regulating schemes, *Q2* controls the resistance, or current-carrying capability, of *Q1* and thereby the +60 volt output voltage. *Q1* is fuse-

Fig. 1. Exterior (left) and interior (right) of the Westinghouse 19-inch transistor TV set. According to the manufacturer, the black glass reduces glare and improves contrast.

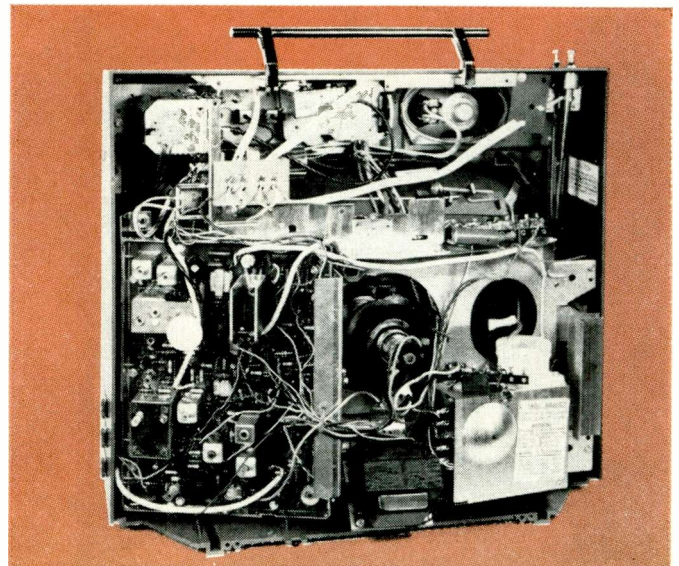
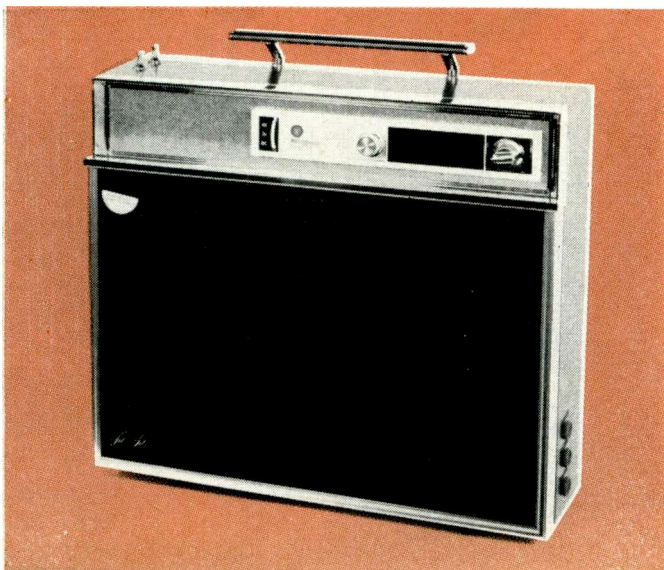

protected against an output short circuit. Since Q1 has to dissipate a fair amount of power, it is mounted on a heat-dissipation shelf.

The circuit shown in Fig. 2 provides adequate filtering and excellent regulation for the 60- and 12-volt supplies. The 60-volt supply is used for the audio output amplifier and both vertical and horizontal sweep sections. The 12-volt supply is used for practically all the other circuits as well as for biasing in many circuits using +60 volts.

Another circuit deserving some description is the noise-canceling circuit shown in Fig. 3. This circuit consists essentially of a single transistor, Q3, which acts as an inverter across the first video amplifier Q1.

The voltage at the base of Q1 is determined by the setting of R3, the white level control. This control is factory-set to produce the best white screen picture. The output of the two-stage video amplifier is coupled to the CRT.

Noise canceler Q3 is normally cut off because of reverse bias between base and emitter. This bias is set by R4, the noise-adjust potentiometer. Diode D2 is also cut off due to reverse bias. Under these conditions, the noise canceler is inoperative until a negative-going pulse of sufficient amplitude to overcome the reverse bias on D2 comes along. When this occurs, Q3 conducts for the duration of the noise pulse. The pulse spikes are then inverted, amplified, and coupled via C3 to the second video amplifier where they cancel the original noise spikes. Because D2 is reverse-biased when no noise spikes are received, it represents a high impedance and does not influence operation of the video amplifier.

The third circuit, the vertical oscillator, is also not entirely new when compared with vacuum-tube receivers, but it has not previously been shown in transistor sets. As illustrated in Fig. 4, the vertical oscillator circuit is the transistor equivalent of the vacuum-tube blocking oscillator circuit used in the earliest TV receivers. T1 is the blocking-oscillator transformer, coupling the signal from the collector to the base of Q1, similar to the vacuum-tube version operating between plate and grid. Sync pulses pass through a conventional integrator, R1, R2, C1, and C2 and are applied to the base of Q1 through C3 and the primary of T1. D1 applies the sync pulses to the collector of Q1 as well, while blocking the oscillator pulses. D2, connected across the secondary of T1, acts as damping diode to eliminate ringing. The frequency of the blocking-oscillator circuit is controlled by R9 (hold control) and R8 which determine the d.c. bias on the base of Q1, again similar to the technique used in vacuum-tube blocking oscillators. D3 acts as coupling between the output of Q1 and the input of Q2 and assures that only the desired polarity pulse, without the overshoot portion, is sent to Q2, the driver stage for the output amplifier. Height control R12 determines the bias on the base of Q2 and therefore its amplification, while R11, the linearity control, in conjunction with C5, affects the waveshape of the pulse applied to the base of Q2.

In addition to the three unusual circuits just described, the receiver contains a number of other features. One of these is the use of +240 volts d.c. as collector supply for the video output amplifier. This, according to the manufacturer, is necessary to provide a sufficiently large voltage swing at the output of the video amplifier to drive the cathode of the picture tube. As a result, the video output transistor is a power type, having +12 volts on the emitter and +150 volts on the collector. It is mounted on the printed wiring board but contains its own finned heat radiator. The horizontal output transformer and high-voltage section are protected against damage from arcing by a special clamping diode which, in the event of large current surge, discharges into a 10- μ f. capacitor. This circuit is credited with preventing the burnout trouble in horizontal output transistors which seems to have plagued earlier transistor TV receivers.

As in all Westinghouse TV receivers featuring "Instant-

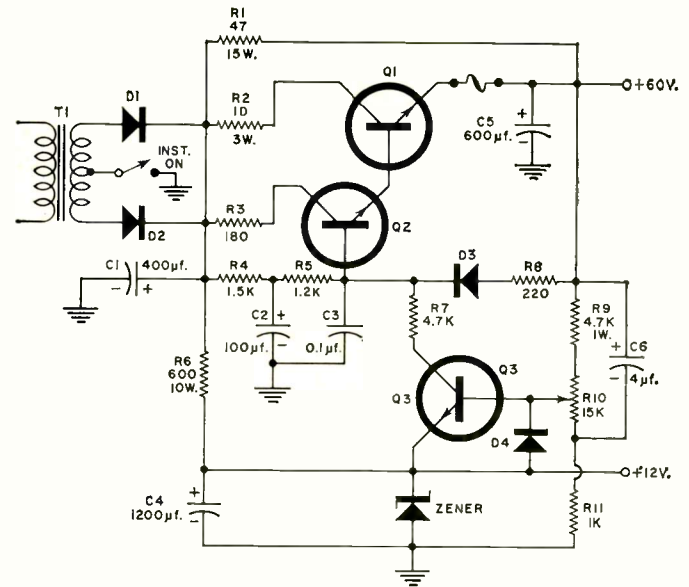

Fig. 2. The power supply for this receiver is relatively complex and features a zener-controlled voltage regulator.

On," the filaments of the picture tube and the primary of the power transformer are connected to the a.c. power line at all times. While the entire receiver requires 75 watts during operation, a total of approximately 7 watts is dissipated when the receiver is turned off.

This Westinghouse 19-inch transistorized TV receiver is another interesting entry into the rapidly growing field of line-operated, large-screen transistor TV sets.

While the use of transistors does not necessarily mean a reduction in cost, or a serious reduction in the set's physical size, it does seem to mean a more trouble-free receiver. Westinghouse is so sure of the reliability of the transistor circuit that, in addition to the one-year guarantee on the picture tube, a two-year guarantee on the various component parts is also made.

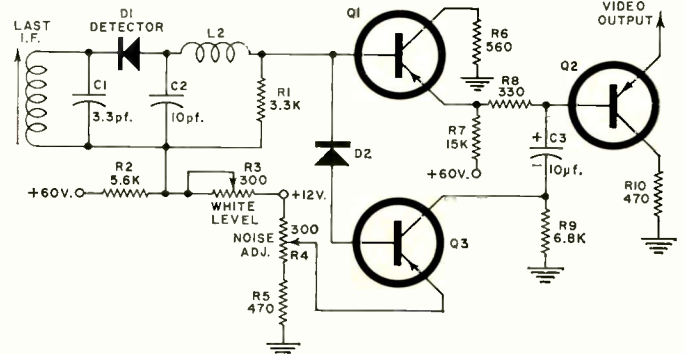

Fig. 3. The noise-canceler stage inverts the noise peaks so that they cancel at the input of the second video amplifier.

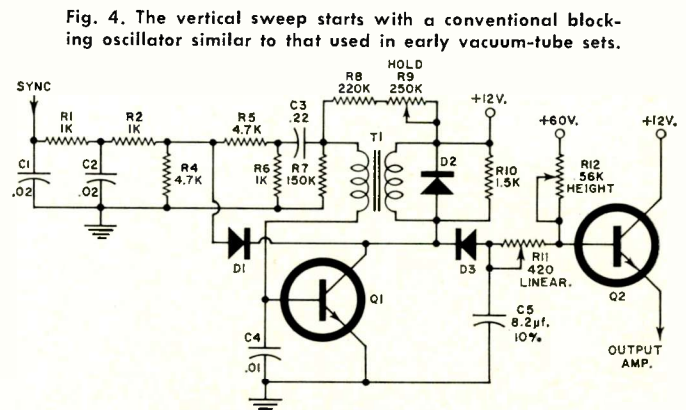

Fig. 4. The vertical sweep starts with a conventional blocking oscillator similar to that used in early vacuum-tube sets.

Meter-Relay Devices

By SIDNEY L. SILVER

These important components are widely used in industry for indicating small changes in voltage and current, and operating control circuits when preset values are reached.

IN the field of automation there is an increasing need for simple, inherently stable control-system components to perform the various process functions with a high degree of reliability. One of the most useful and versatile of these components is the meter relay, which combines the functions of both an indicating meter and a control relay. Meter relays are electro-mechanical devices which are capable of detecting and indicating extremely small changes in current or voltage; and when these measured quantities reach preset limits as determined by adjustable control points, a set of built-in relay contacts effect the opening and closing of auxiliary circuits.

These instruments are sensitive enough to respond directly to low-level signals (without need for any further amplification) from any process variable that can be measured electrically through the use of a suitable transducer. They are widely employed to monitor and control such variables as temperature, radiation level, pressure, moisture content, pH,

motor speed, and a multitude of other physical and chemical phenomena.

Meter relays can function as limit-control devices in which control action is initiated when the safe operating limit of a measured variable is reached. In this mode of operation, associated equipment is shut down and protective warning devices are actuated. The unit is then reset manually each time the variable reaches a predetermined control point.

In a programmed operation, meter relays can maintain an automated process at a given level by automatic "on-off" control. In this mode of operation, the desired control action occurs at a preset limit, but the device continues to sample the variable periodically without interrupting the load circuitry. Under these conditions, corrective control action ceases when the measured variable returns to the proper level.

Meter relays may be broadly classified into three categories according to their contact arrangement: the *nonlocking*, *locking*, and *continuous-reading* types. In addition, a new

Fig. 1. Typical current-sensitive meter relay. This particular unit incorporates two screw-adjustable contact pointers.

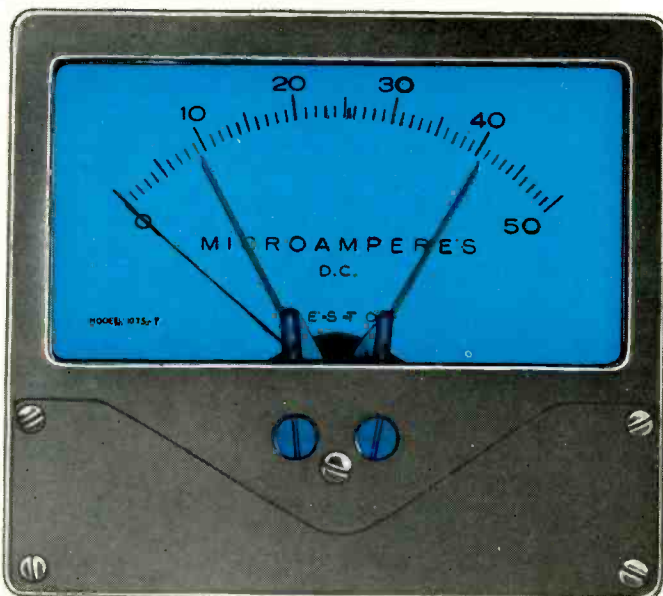
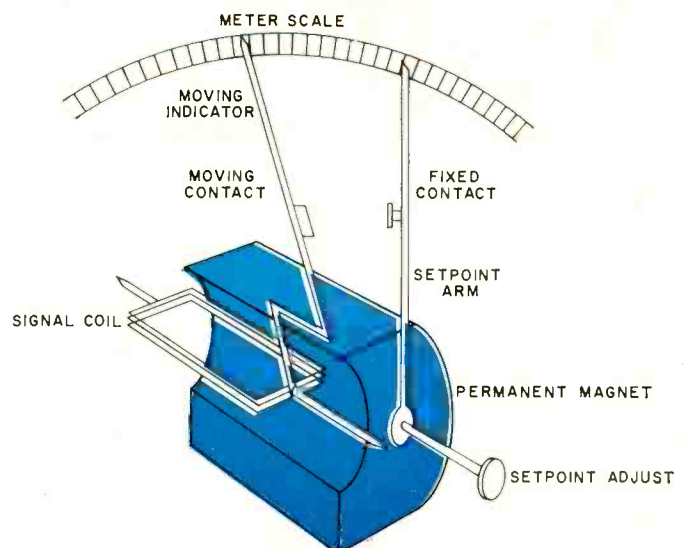

Fig. 2. Cutaway diagram of non-locking meter relay. The various leads for control signal and load relay are not shown.



concept in meter-relay design is the optical type which incorporates solid-state switching to eliminate the usual physical contacts. A typical, commercially available meter relay with two setpoint arms is shown in Fig. 1.

Nonlocking Meter Relays

The nonlocking meter relay is a sensitive contact device which depends solely upon the current flowing through a moving coil for maintaining contact pressure. Operating on the d'Arsonval principle, as shown in Fig. 2, the moving coil is attached to an indicating pointer and suspended on jeweled pivots in the flux gap of a permanent magnet. When the coil is energized by a signal current, a torque is produced which rotates the coil and causes the pointer assembly to move across a meter scale in direct proportion to the signal passed through the coil. The indicating pointer is restrained by a pair of control springs (not shown) which serve as current leads to the coil and restore the pointer to zero when the signal current is removed.

In addition, the instrument has an adjustable setpoint arm which is rotatable along the same axis as the moving indicator and which may be manually adjusted to any desired point on the meter dial. A moving contact is carried by the indicating pointer and a fixed mating contact is mounted on the setpoint arm. Some types are provided with two setpoint arms (each carrying a stationary contact) which are adjustable for high and low operating values.

Fig. 3A shows the basic circuit of a nonlocking meter relay in which the moving contact and the fixed contact form a series circuit with an external load relay that is energized by a d.c. source. When a control signal applied to the moving coil causes the indicating pointer to reach a predetermined setpoint, the contacts are forced together, thus closing the load circuit. If, however, the signal level falls below the setpoint, the meter relay resets itself automatically, and the signal coil restores the moving element to a position relative to the amount of current in the coil.

One of the basic problems of the nonlocking arrangement is the small force applied to the moving coil element to close the relay contacts. Since only a few milligrams of pressure exist at the point of contact, it is necessary to employ a high-torque meter movement in order to produce a reliable and definite contact action. To increase contact reliability, a suitable contact material such as platinum, is generally used because of its extremely low contact resistance and its relatively high resistance to oxide film formation. In addition, one of the contacts is made flexible in order to provide a wiping action which keeps the contacts clean. To avoid arcing which may produce contact corrosion, the open-circuit voltage across the contacts is limited to about 6 volts d.c. Generally, the use of nonlocking meter relays is restricted to applications where the control signal abruptly rises or falls below a predetermined setpoint so that the make or break period of the contacts occurs quite rapidly.

Locking Meter Relays

To offset the disadvantage of low contact pressure imposed by the nonlocking arrangement, locking meter relays were developed to provide additional torque to the signal coil. In this configuration, an auxiliary winding, referred to as a locking or aiding coil, is integrally wound on the same form as the signal coil. As shown in Fig. 3B, the locking coil is connected in series with the load relay circuit across the d.c. power source. When the indicating pointer reaches setpoint, sufficient current flows through the locking coil to boost the signal coil rotation, thus maintaining firm contact pressure (on the order of 2 grams).

Once the load relay is pulled in by the meter-relay contact action, it remains energized irrespective of the signal current value, so that the pointer no longer responds to input signals. To reset the device, a push-button switch, in this case man-

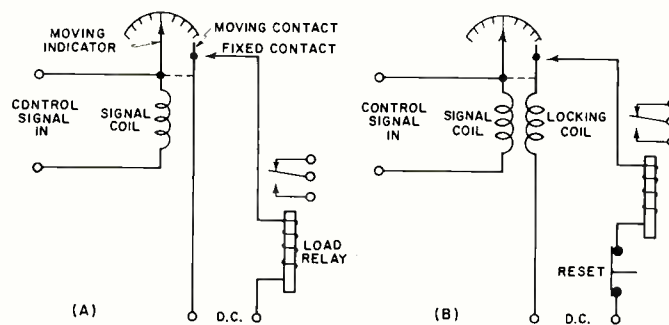

Fig. 3. (A) Basic circuit diagram of the nonlocking type, (B) Locking meter relay circuit shown here with manual reset.

ually operated, interrupts the d.c. circuit and opens the locked meter-relay contacts. If the input signal has fallen below the lock-in value, the meter-relay contacts remain separated and the load relay drops out. However, if the signal level is above the preset level, the contacts promptly close again.

Since the moving contact is spring loaded, the contacts are kicked apart forcefully when the load circuit is broken, thus overcoming any tendency for the contacts to stick. The spring pressure allows operation of locking meter relays at contact ratings up to 25 ma. at 125 volts d.c. For this reason, these devices are particularly adaptable to slowly changing input signals.

In applications where both upper and lower limits for a specific current are required, a double-contact meter relay is employed. This unit is provided with two setpoint arms whose contacts are adjustable for high- and low-level operating points. Thus, when an input signal rises or falls to either of the predetermined control points, a load relay is tripped and control action is initiated.

In the double-contact arrangement shown in Fig. 4A, both a positive and negative d.c. power source are required. By this means, the voltages applied to the fixed contacts are of

Fig. 4. (A) Double-contact type using a three-terminal power supply. (B) Dual locking-coil arrangement with 2 moving contacts.

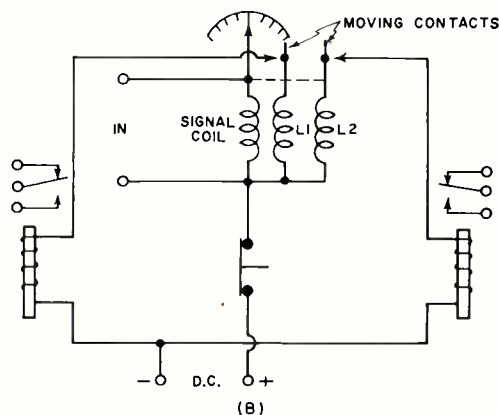
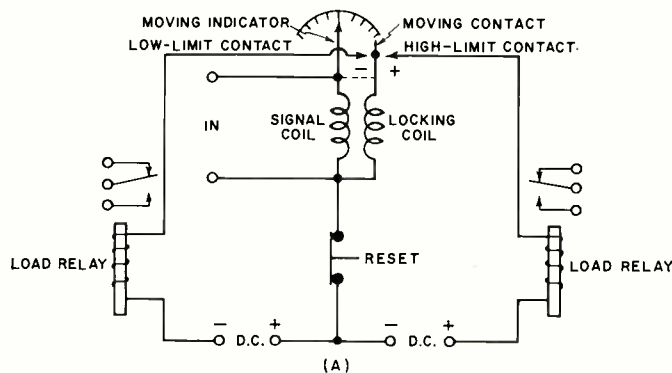

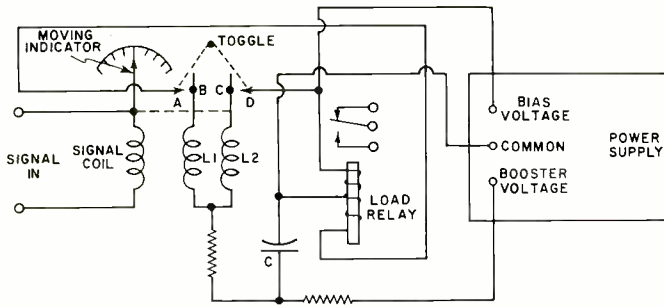

Fig. 5. Continuous-reading type with automatic-reset feature.

opposite polarity, so that the locking-coil torque is properly directed to maintain pressure on either contact. To lock the high-limit contact upscale, for example, a positive polarity must be applied to the high-limit contact to permit current to flow up through the locking coil. Conversely, current must flow through the coil in a reverse direction to lock the low-limit contact downscale.

Fig. 4B shows an alternate arrangement which employs a single d.c. power supply but requires dual locking coils. In this circuit, the meter relay contacts lock with the same polarity on both high- and low-level limits. The locking coils are wound in opposite directions in order to maintain the proper direction of force. Since a voltage of the same polarity appears on each of the fixed contacts, the coil L2 locks in an upscale direction and the coil L1 locks downscale.

Continuous-Reading Meter Relays

A unique arrangement which combines both the high contact pressure of the locking meter relay and the instantaneous reset of the nonlocking type, is the continuous-reading device shown in Fig. 5. The resetability feature of this unit eliminates the need for interruption circuits and provides a continuous indication of the monitored variable both above and below setpoint.

In the continuous-reading design, a V-shaped toggle arm is mounted on the setpoint arm in such a way that it pivots behind the indicating pointer. The toggle carries a pair of contacts (A and D) which form two separate circuits through a center-tapped load relay. In addition, the moving pointer has two isolated contacts (B and C) positioned so that moving contact C touches toggle contact D when the pointer reaches setpoint in the upscale direction; and contact A

touches contact B as the meter moves downscale. A d.c. power source is connected to the load relay which provides a biasing current of sufficient amplitude to hold the load relay in, but not enough to energize it initially.

When the moving pointer reaches setpoint in the upscale direction, capacitor C discharges through one half of the load relay and the resultant current surge pulls the relay in. Simultaneously, booster coil L2 is energized and drives the pointer further upscale so that enough torque is added to the pointer to trip the toggle. This action opens the booster circuit to the load relay, but the biasing current holds the relay in.

When the pointer returns downscale, contacts A and B close, and capacitor C discharges through the other half of the load relay, thus bucking the biasing current. At the same time, booster coil L1 is energized, which drives the pointer further downscale, snaps the toggle back to its original position, and opens the bucking circuit. By this particular sequence of action, the moving pointer indicates input signal values continuously while the booster circuits provide positive make and break action of the associated circuits.

Optical Meter Relays

A recent development in meter-relay design is the optical or contactless type which provides continuous indication above and below setpoint without the use of physical contacts. Fig. 6 illustrates a typical optical meter relay which

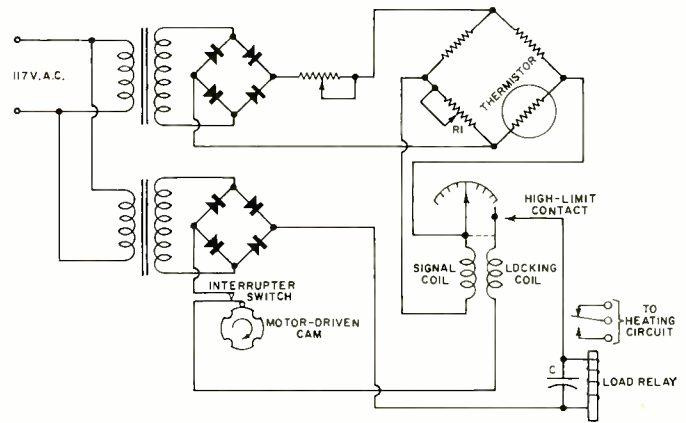
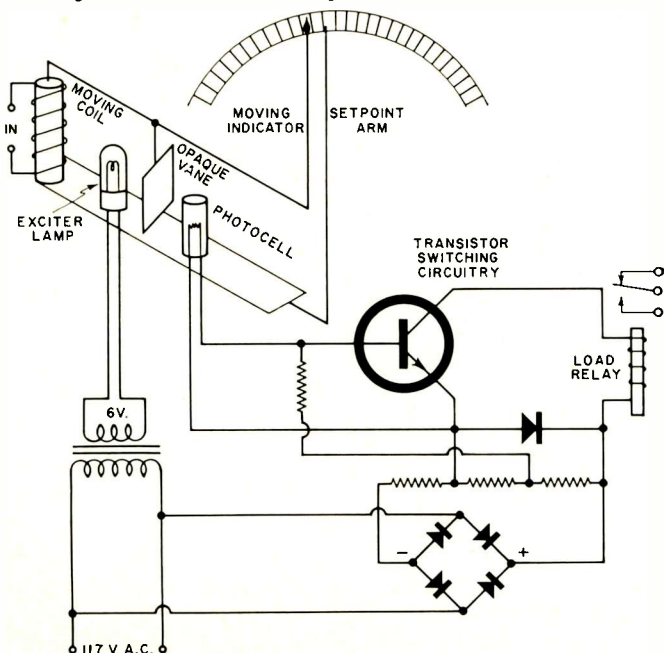

Fig. 7. Automatic temperature controller with high-limit relay.

Fig. 6. Pictorial-schematic diagram of an optical meter relay.



achieves its non-physical contact action through the use of a light beam and photoresistive cell. In this configuration, the setpoint arm carries both an exciter lamp and photoconductive cell arranged so that the light source is projected on the sensitive surface of the photocell.

When the moving pointer is below setpoint, the light beam falling on the cell causes its resistance to drop, which cuts off the transistor switching circuitry and maintains the load relay in an unenergized state. When the pointer reaches setpoint, a low-mass aluminum vane carried by the indicator interrupts the beam of light illuminating the cell. The resulting increase in cell resistance allows the transistor switch to conduct, which pulls in the load relay and initiates control action. To obtain a high/low setpoint meter relay, a separate light source and photocell are provided for each setpoint arm that is employed in the device.

Automatic Control Applications

In many complex automation processes, it is necessary to maintain a variable, such as temperature, at a given level by "on-off" control of associated circuitry. Since meter relays of the locking type do not drop out when current through the signal coil is reduced, an automatic interrupter circuit may replace the manual reset button to periodically separate the locking contacts. This "on-off" action allows the meter relay to intermittently sample the process (Continued on page 84)

A new approach to small screen color CRT's, coupled with greatly simplified chroma, convergence, and high voltage circuits, produces a different type of color-TV receiver.

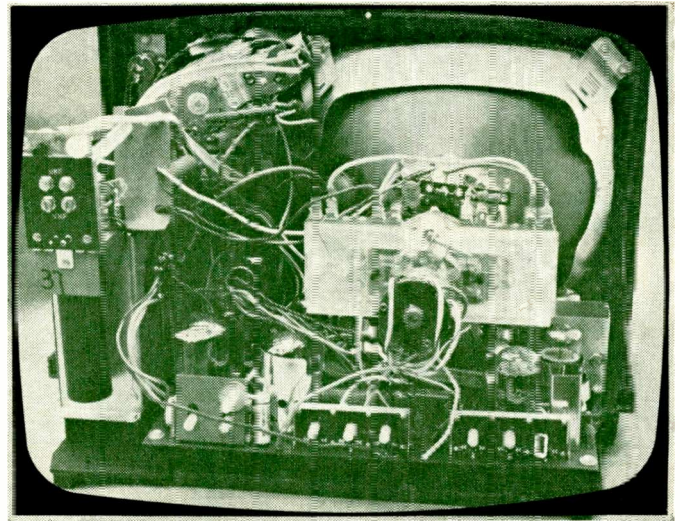

Fig. 1. Chassis view of the 11-inch color set. The convergence assembly is the white plastic structure mounted on the CRT neck.

G-E 11-inch Color TV: the new look in color receivers

By WALTER H. BUCHSBAUM

THE current flood of new color-TV receivers contains many variations of receiver design, all based on the same type of shadow-mask picture tube. With the introduction of a new type of picture tube, the 11SP22, the G-E "Porta-Color" is the smallest of all color-TV sets and differs in many important respects from conventional color sets. Much of the circuitry is quite unusual and contains many novel features. Even the method of mounting components, the accessibility of the chassis components, and the over-all construction are quite different from previous designs. As will be illustrated in this article, the major innovations are in the mechanical construction; the 11-inch picture tube; and in the new and simplified circuits used in the chroma section, the color sync, and the convergence circuits. While the G-E "Porta-Color" receiver still uses a shadow-mask tube with three electron guns and a phosphor dot screen, demodulates the B-Y and R-Y chroma signal, and still uses horizontal and vertical convergence coils, the detailed circuits and components are quite different from any previous receiver.

Mechanical Innovations

As shown in Fig. 1, the entire receiver, with the picture tube, becomes accessible by removing the one-piece cabinet body and back. The bottom of the cabinet consists of cross-mounted channels which directly support the printed-circuit assembly. Louvered panels protect the bottom of the printed circuits and can be removed for testing. A single etched circuit board contains the majority of the receiver circuitry and the high-voltage compartment. A small sub-chassis, containing the power-supply components and the tuner assembly, is mounted separately, as shown at the left of the photograph. The picture tube is clamped directly against the front panel and mounts the deflection yoke and convergence assembly on its neck. In addition to the picture tube, the set uses 13 tubes, one transistor, and 13 diodes. The tubes are of the multi-ele-

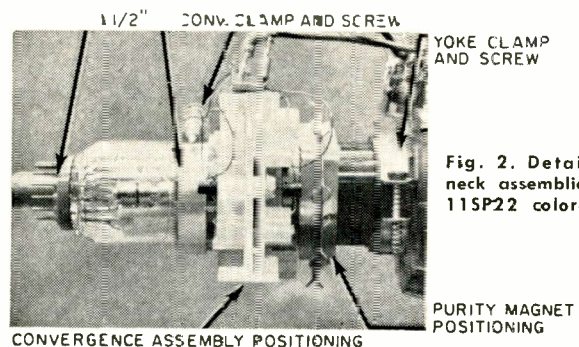

Fig. 2. Details of the neck assemblies for the 11SP22 color-TV tube.

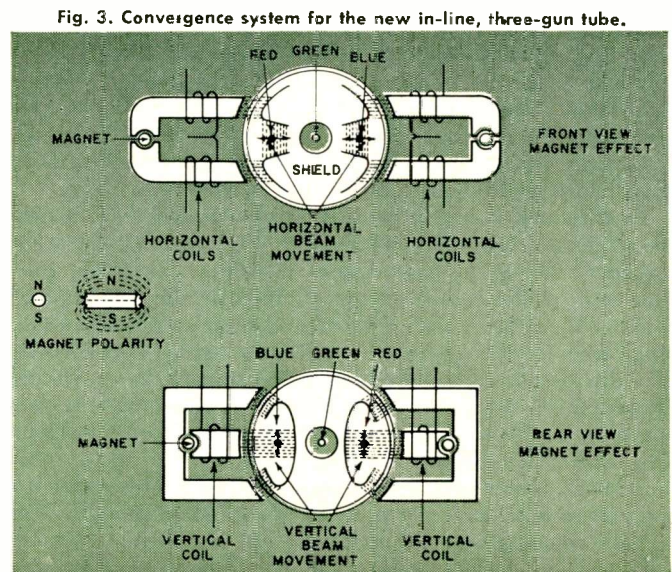

Fig. 3. Convergence system for the new in-line, three-gun tube.

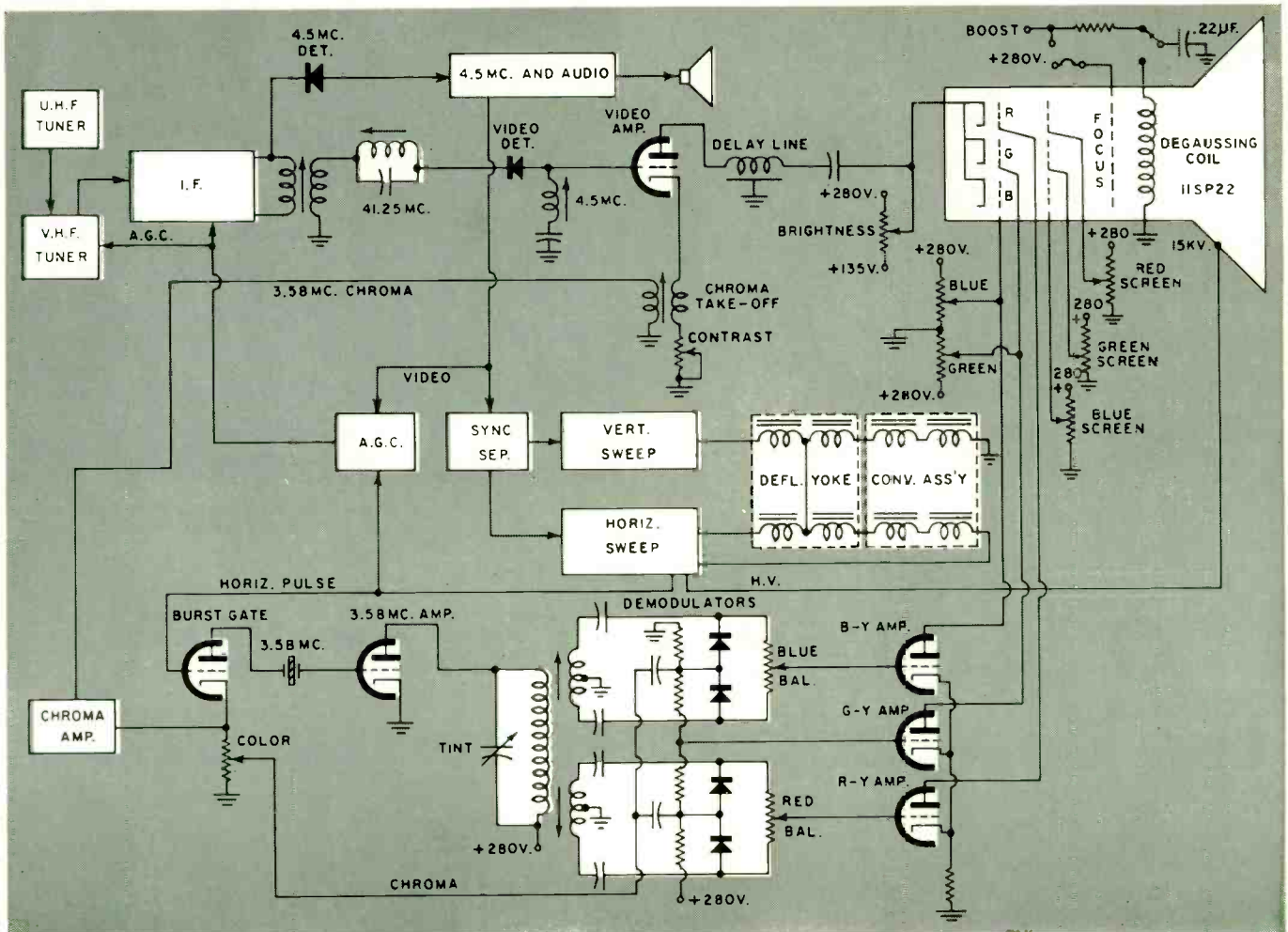

Fig. 4. The basic circuit of the "Porta-Color" set shows the simplicity of chroma, convergence, and high-voltage sections.

ment Compactron type used in many previous *G-E* receivers and actually represent many more functional stages.

The Picture Tube

The 11SP22 is a shadow-mask tube, differing primarily from its predecessors in that the electron guns are horizontally in line and their beams hit the phosphor dot screen in a horizontal rather than a triangular configuration. This is illustrated on the front cover of this issue. In the conventional triangular electron-beam configuration, each electron beam must be aligned in a number of different directions, while in the horizontal in-line arrangement used in this new tube, the center electron beam is used as a reference with the other two being aligned with respect to it. This is apparent from the convergence assembly itself which contains convergence coils and magnets only for two electron beams. The separate vertical and horizontal convergence coils are mounted on a plastic assembly as shown in Fig. 2. A purity magnet assembly is used, but its action is not as critical as in other color tubes.

To illustrate the operation of the horizontal and vertical convergence adjustment, refer to Fig. 3 which shows the front and rear view of the convergence assembly. The green electron gun (at the center) is not affected by the convergence fields of the other guns. The red and blue guns contain two separate pole pieces to interact with the vertical and horizontal coils respectively. Note that in the case of the horizontal convergence, shown in the front view, the magnetic flux passes vertically across the path of the electron beam, causing it to move in a horizontal direction. For the vertical case, the horizontal magnetic field does not have any effect because the coil and internal pole piece are displaced longitudinally. For vertical convergence, the magnetic flux is oriented horizontally, causing vertical beam movement. One result of the sim-

plified convergence design is that there are no adjustments and waveshaping circuits for vertical and horizontal convergence amplitude and tilt. The only adjustment that is required is setting the magnet on each of the horizontal and vertical coils for optimum convergence. Each set of convergence coils is connected in series with its respective deflection-yoke winding, as shown in the basic circuit of Fig. 4.

Circuit Innovations

The various circuit innovations of this set can be illustrated by the simplified diagram of Fig. 4. Both the v.h.f. and the u.h.f. tuner are conventional, with the latter using a transistor as the local oscillator and a diode as the mixer. The i.f. amplifier section is also conventional and uses three stages, followed by two separate detectors, as shown. A 41.25-mc. trap is connected before the video detector to reduce the amplitude of any 4.5-mc. component in the video. To further reduce the 4.5-mc. intercarrier signal, a series trap is located in the output of the video detector. A single video amplifier is used for the brightness signal, with a delay line in its output

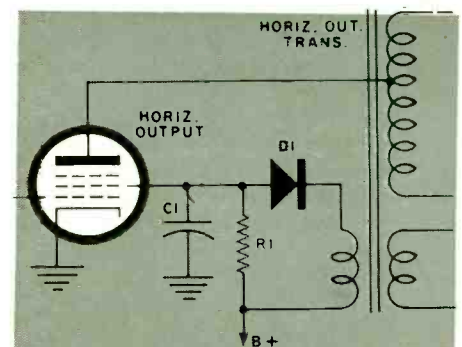

Fig. 5. This simple circuit eliminates the separate high-voltage regulator yet maintains a close degree of voltage regulation.

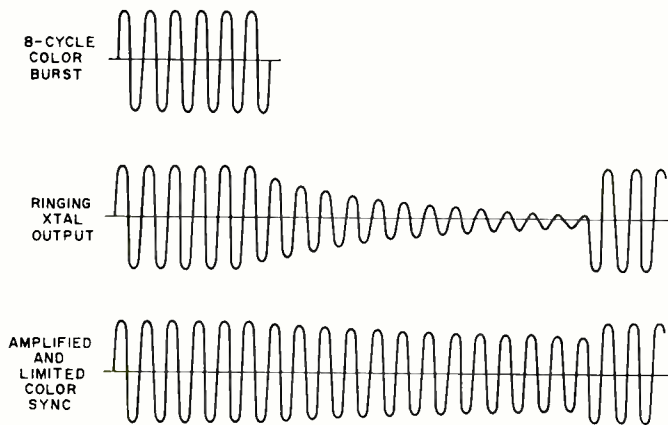

Fig. 6. The eight-cycle color burst (top, only six are shown) causes the crystal to ring (center). The limiter circuit acts to maintain crystal oscillation at a reasonable level.

to assure proper coincidence between the Y (brightness) and the chroma signals at the picture tube. As in many black-and-white receivers, the contrast control is part of the cathode circuit of the video amplifier, which also contains a bifilar transformer tuned to 3.58 mc., the color subcarrier frequency. By this arrangement, the contrast control also affects the chroma signal amplitude, and this reduces the viewer's problem of setting contrast and chroma gain to the right balance.

The 4.5-mc. audio detector is tuned primarily for the inter-carrier sound signal, but enough video information is amplified in the 4.5-mc. sound i.f. to drive the sync separator and a.g.c. stages. The audio section itself is conventional. Neither the sync separator nor the vertical sweep section contain any radically new circuitry.

While the horizontal a.f.c. oscillator and flyback appear conventional, the horizontal output amplifier uses a novel arrangement to provide some regulation of the high voltage and the horizontal sweep signal. In practically all color sets, the high-voltage section contains a shunt regulator because variations in high voltage can show up as color errors; however, no regulator as such appears in this model. The regulation scheme in this set is shown in simplified form in Fig. 5 and consists of resistor R_1 , capacitor C_1 , diode D_1 , and the blanking winding of the flyback transformer connected to the screen grid of the output amplifier. Without the pulse from the transformer winding, diode D_1 is reverse-biased by the voltage drop across R_1 . The transformer pulse (which is also the blanking pulse) is normally about 150 volts, causing the diode to conduct and charge screen-grid capacitor C_1 . Since the pulse amplitude varies with the transformer loading, it controls the screen-grid voltage and thereby the gain of the output amplifier. Transformer loading depends on both the sweep amplitude and the high voltage, but, under normal operation, only the high voltage varies with beam current. While this scheme may not provide as close a regulation as the usual shunt regulator, it permits elimination of the separate high-voltage regulator and the usual width-control coil as well.

The deflection yoke contains toroidally wound coils, and, as mentioned before, the convergence coils are simply connected in series with their respective deflection coils. Because toroidal deflection yokes require a larger current at lower voltages, it is possible to use this current directly in the convergence coils without the usual arrangements of separate transformer windings, waveshaping circuits, and amplitude and tilt controls.

Most previous color receivers have used a 3.58-mc. oscillator controlled by a phase detector that compares the phase of the color oscillator with the incoming color sync burst. In this new set, an entirely different scheme using a crystal ringing circuit is employed. As shown in Fig. 4, the chroma signal is picked off the video amplifier cathode and gated in the burst gate by the horizontal pulse so that only the 3.58-mc. color

sync burst passes through to the crystal ringing circuit. This circuit consists of a crystal and an impedance-matching, tuned LC circuit and is based on the principle that a crystal, excited by a signal of its own resonant frequency, will continue to oscillate for a short period of time. Fig. 6 illustrates the waveforms for the circuit. The 8-cycle burst (top) transmitted from the TV station excites the crystal to ring. This ringing, after the first 8 cycles are over, exponentially decreases in amplitude but starts again at a high amplitude when the next burst comes in (center). The 3.58-mc. amplifier following the ringing crystal amplifies and limits the signal so that a relatively constant amplitude 3.58-mc. sine wave reaches the output transformer (bottom). The variable capacitor connected across the primary of the color sync output transformer acts as the tint control because it varies, to some extent, the phase of the color sync signal in the primary. Each of the two secondaries is tuned to provide the desired phase shift, thus generating the color sync signals necessary for demodulation. In addition to the obvious simplicity of this circuit, it also has the advantage of greatly simplified alignment.

The chroma signal is taken from the cathode of the burst gate through the color gain control and is applied to two balanced-diode demodulators. This type of demodulator has been used previously only in military applications and requires a relatively high amplitude of sync signal as well as a low-impedance chroma signal to operate properly. Detailed circuit operation of the diode demodulator circuit can be understood from the simplified circuit and its waveforms shown in Fig. 7. The color subcarrier is applied through capacitor C_3 to diodes D_1 and D_2 and appears across the three series resistors, R_1 , R_2 , and R_3 . Potentiometer R_2 is set to produce zero volts d.c. from the output of the detectors regardless of the presence or absence of the color sync signal. This feature overcomes any amplitude variations of the color sync signals and also eliminates the need for a color killer because, in the absence of both chroma and color sync (during monochrome transmission), the output of the balanced detector will be zero. Each of the two diodes functions as a peak detector. When no chroma signal is present, C_1 and C_2 are charged up to their peak value by the reference signal, and, with the diodes cut off, both capacitors discharge in series across the three resistors. Diode conduction then occurs only at the peak of each reference signal. Diode D_1 conducts when a negative signal is present at its cathode, but, at the same instant, a positive signal is presented at the other end of the transformer, and diode D_2 conducts in the opposite direction. These opposite and equal currents produce zero output at the center of the balanced potentiometer.

During the period when the diodes are conducting, the chroma signal is detected. D_1 will develop a positive voltage proportional to the sum of the chroma and its respective reference signal, while D_2 will develop a negative voltage proportional to the sum of the chroma and the 180° out-of-phase reference signal. This is the same effect as the operation of the gating elements in a synchronous demodulator. When the reference signal causes conduction of the diodes, they become a low-impedance path and allow the chroma information to pass. in the voltage waveforms (Continued on page 65)

Fig. 7. Basic circuit (left) and waveforms (right) of the color demodulators. With no chroma signal, the detectors have zero output, thus eliminating color-killer circuit.

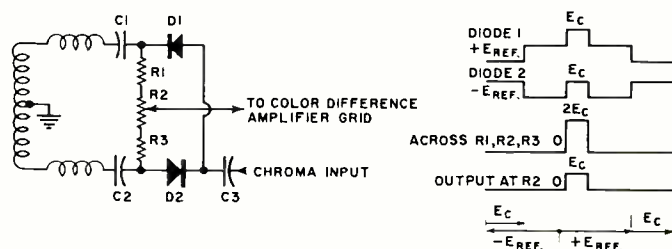

SUBSTITUTING FET'S FOR TUBES IN HI-FI AMPLIFIERS

By W. A. RHEINFELDER
Applications Consultant, Dickson Electronics Corp.

Steps taken in converting low-level stages of power amplifiers to field-effect transistors. Comparative measurements show superior performance of FET unit.

IN high-fidelity equipment, generally a much higher level of performance and quality is required than for most standard consumer electronic products. Such high standards often lead to hand-trimmed cathode resistors in professional vacuum-tube equipment, as well as the use of extensive feedback for both a.c. and d.c. stabilization. The main difficulty with tubes lies in their parameter drift with aging. This may cause a problem, for example, in the push-pull output stage, where d.c. currents must be perfectly balanced in the output transformer to insure low distortion, particularly at low frequencies. Other stages, especially pentode circuits, are equally critical. Parameter changes include decreased input impedance (due to gas), parasitic generation, low-frequency sputtering, and filament leakage.

Solid-state devices should maintain their parameters over a very long period of time. Hence, solid-state amplifiers should have high reliability and be free from maintenance. Other factors favoring solid-state designs are reduced current drain and with it, generated heat, no warm-up, smaller size, and reduced weight. Most of these advantages are of lesser importance in line-operated equipment, possibly with the exception of easier elimination of hum in solid-state equipment due to the lack of filaments.

The first approaches to solid-state hi-fi circuits were of necessity based upon standard bipolar transistors since FET's had not become available as yet. The use of standard transistors led to numerous difficulties which were overcome, however, more or less ingeniously by circuit designers.

The low input impedance of transistor circuits is, for ex-

ample, readily compensated for by negative series feedback. The noise level of transistors generally is lower than that of tubes due to the lower temperature of transistors. Distortion in normal transistors is a more difficult problem due to the fact that a forward-biased diode (base to emitter) is inherently non-linear, particularly in low-impedance circuits. This problem has been reduced by careful optimization of bias, special high- and low-level biasing circuits, temperature compensation with thermistors, and large d.c. feedback. Many of the transistor circuits designed for extreme quality of performance appear to use brute-force methods rather than elegant engineering solutions. In other cases, quality has been sacrificed, particularly in the area of low-level crossover distortion, in order to arrive at an all-solid-state design with a reasonably small number of stages.

While excellent performance is possible with present-day solid-state designs, the simplicity and quality at a given price of an ultra-linear Williamson-type power amplifier still remains to be matched with standard transistor units.

Recent improvements in field-effect transistors (FET's) have, however, opened a whole new field of applications. For the first time devices are now becoming available which are superior to conventional transistors and vacuum tubes as far as distortion, output capability, gain, noise, and current drain are concerned. Power FET's will become available shortly, and this will lead to a superior type of hi-fi equipment.

Illustrated in Fig. 1 is a typical circuit of a high-quality power amplifier. The question might be asked, "Why convert to solid state at all, as long as power FET's are not available

Fig. 1. A typical circuit diagram of a ten- to fifteen-watt vacuum-tube high-fidelity power amplifier.

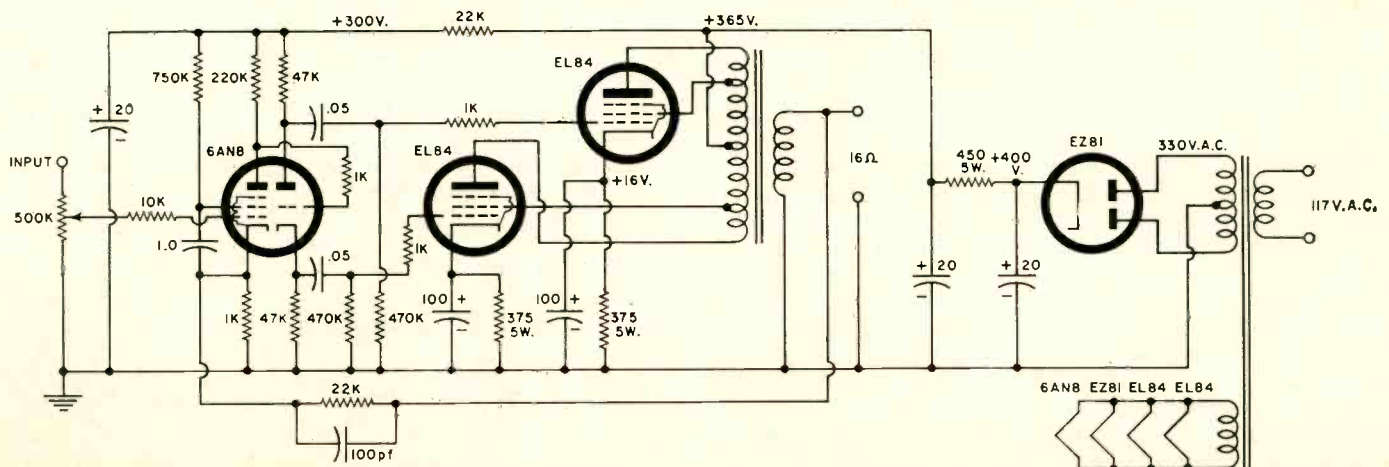

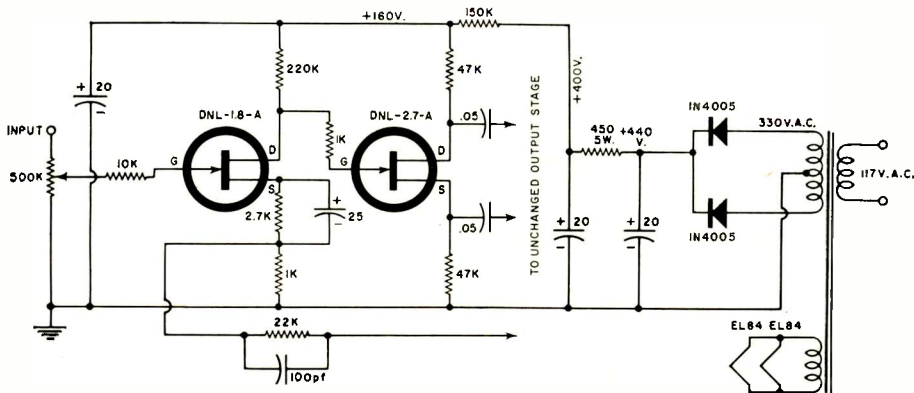

Fig. 2. Circuit of Fig. 1 modified for FET's and silicon diodes.

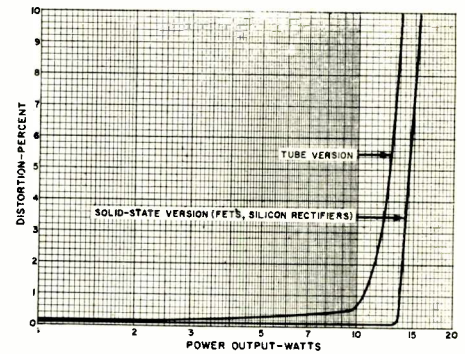

Fig. 3. Distortion and overload characteristics of both the original and converted amplifiers.

as yet?" The answer is that in the circuit shown, serious problems of parameter drift exist. In the author's unit, which uses a similar circuit to the one shown in Fig. 1, over a period of time distortion becomes excessive, that is, audible at normal listening levels. Measurements indicated at one time a distortion level as high as 5% at 5 watts, while normally the amplifier would handle better than 10 watts at 0.6% distortion with the over-all feedback loop connected.

Tracing this condition led to the input stage. Drift in screen-grid parameters caused actual overload of the first stage. In any case, distortion could be brought down all the way by readjusting the screen-grid resistor. Optimum values ranged all the way from 150,000 ohms to 2 megohms, depending on tube and age. Tests made with fresh tubes showed great variations also. Other triode-pentodes had higher distortion even under optimum conditions.

When FET's for large-signal voltage amplifiers became available recently, a direct conversion was attempted, with the exception of the output stage which is to be converted at some future date. Fig. 2 shows the modified circuit.

The modification is as follows:

1. Drop the supply voltage for the voltage-amplifier/phase-splitter combination to +160 volts from the former 300 volts. This is accomplished by changing the 22,000-ohm dropping resistor to 150,000 ohms.

2. Add the resistor-capacitor combination shown in the source circuit of the first FET. Due to their lower current drain, FET's require larger self-bias resistors for proper gate bias than vacuum tubes. The values as given are correct for the transistor shown.

3. As an optional change, replace the EZ81 rectifier with low-cost silicon diodes.

All changes are easily made, and the FET's and silicon diodes are wired directly to the pins of the tube sockets.

Improvement in Performance

The improvement in performance of the FET circuit is shown in Table 1 and Fig. 3. Also, there was no change in performance with different FET's of the same type. Temperature stability of the circuit is excellent. FET's tested in a similar circuit performed without change in distortion or gain from temperatures of -50°C to $+150^{\circ}\text{C}$, a considerably larger range than would be encountered in practice.

The cost of FET's is at the present time quite a bit higher than that of vacuum tubes, but this is offset by the cost of tube replacement and maintenance. For example, the author in three years went through six 6AN8's and two EZ81's plus the time spent in readjusting circuit values. In a new design, a further cost reduction is possible due to a less expensive power transformer (a saving of approximately 10 watts in filament power), a smaller, more efficient chassis, and lower assembly costs.

In going over the improvements in detail, the increased power output shown in Fig. 3 is mainly due to the better

Table 1. Comparison between vacuum-tube and FET versions.

	Tube Version	FET Version	
Output for 1% Dist.			
1 kc.	10.5	13.7	w.
100 cps	7.0	13.5	w.
10 kc.	8.5	12.5	w.
Gain at 1 kc.	26	26	db
Input for 10-w. out.	.64	.64	v.
Noise and hum	5.3 (0.7*) at 60 cps	.35 at 120 cps	mv.
Drive into EL84's for 10-w. out	11.5	11.0	v.
Drive available from phase-splitter	10 (26*)	20	v.
Bandwidth at .3 db	11 cps, 20 kc.	11 cps, 20 kc.	
Bandwidth at 3.0 db	7 cps, 93 kc.	7 cps, 93 kc.	

*fresh-tube optimized

rectifiers resulting in an increased supply voltage. Dissipation of the output stage had to be checked for this condition. The measured plate and screen dissipations are well within ratings. Also, the filament voltage was rechecked to make sure that it was not excessive for the EL84's. The decreased distortion below the overload point is due to the FET's. The FET circuit delivered nearly twice the voltage into the output stage than the tube circuit. While a fresh optimized tube produced 26 volts, this performance was achieved for only about one month of operation. Also, the tube needs a supply voltage of 300 volts, while the far more efficient FET produces more than 20 volts with only 160 volts.

If a higher output were needed, this could be achieved with a larger supply voltage (and special higher breakdown FET's). However, there is little need for a higher output voltage from the phase splitter even in high-power amplifiers. For example, a pair of EL34's delivers 100 watts of audio power in class-B push-pull (with a plate supply voltage of 800 volts) for a drive signal of only 23.4 volts. This level is available directly from the FET circuit of Fig. 2. Typical commercial circuits have also been using a 6AN8 tube for this high-power application.

This change to FET's can be fully recommended and results in a superior power amplifier. Incidentally, in Fig. 1, the output stage uses individual cathode resistors. This leads to a much better balance during the life of the output tubes and is preferable to the common resistor often found.

The conversion of existing preamplifiers is more complicated, and often it is more advantageous to construct a completely new circuit. The use of FET's in such an application results in less noise and distortion together with a higher overload level. A typical high-quality circuit of this type will be described in a forthcoming issue. ▲

Editor's Note: The FET's described in this article range in price from \$3 to \$10 depending on quantity and type. They are available from stock from Dickson Electronics Corp., 310 South Wells Fargo Avenue, Scottsdale, Arizona 85252.

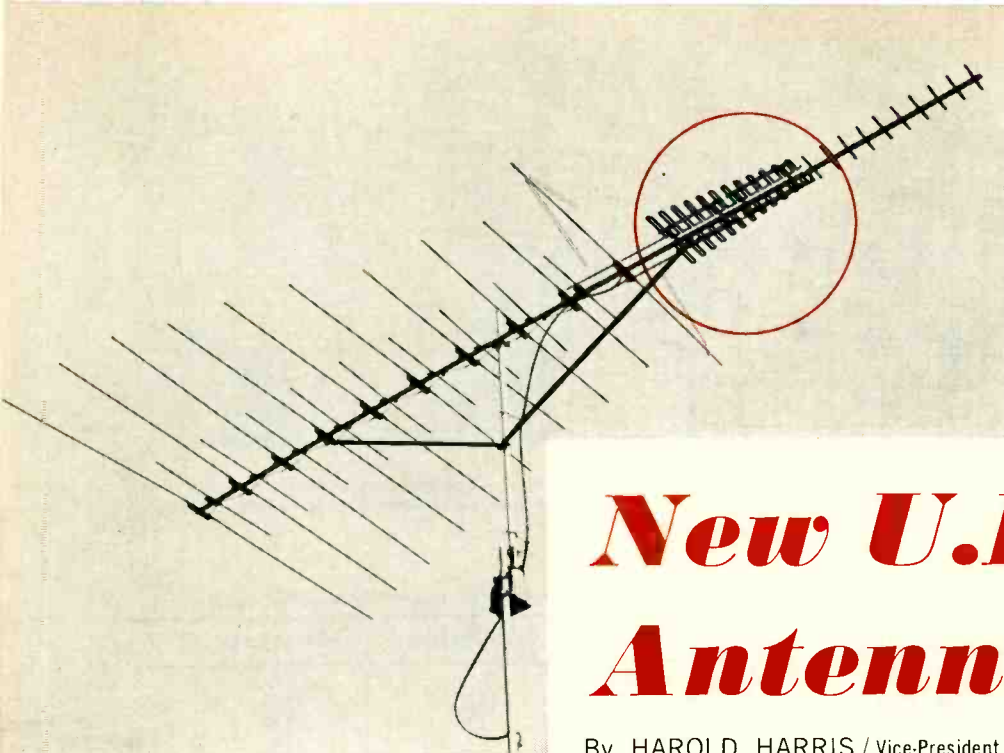

The new u.h.f. array is shown here mounted in front of a conventional "Color Crossfire" v.h.f. TV and FM antenna. An additional array of directors is mounted at the very front of the antenna for still more u.h.f. gain in fringe areas. A rotator is used to change the antenna orientation. The u.h.f. portion of the antenna can also be separately mounted on the mast and oriented in a different direction for u.h.f. TV stations.

New U.H.F. TV Antenna Design

By HAROLD HARRIS / Vice-President, Engineering, Channel Master Corp.

Impedance-controlled end-fire folded-dipole array may be connected to v.h.f. antenna without need for u.h.f.-v.h.f. coupler, permitting use of one download.

THE all-channel receiver law, effective April 30, 1964, requiring that all new television receivers be capable of both u.h.f. and v.h.f. reception, has caused a great renaissance in u.h.f. In addition to such major markets as New York, Los Angeles, Chicago, Philadelphia, and Detroit, an ever-growing number of important reception areas are being provided with both u.h.f. and v.h.f. reception. In addition to this constantly broadening TV service, the rate of growth of FM and FM-stereo has dominated the recent radio and hi-fi industry. It has, therefore, become highly desirable from the standpoint of appearance and ease of installation to develop single antennas which will cover these three bands.

A number of antennas have appeared on the market which

cover v.h.f. TV and FM with varying degrees of success. But now it is necessary to incorporate a means of receiving u.h.f. as well. One such technique is by the use of a new u.h.f. array called the "Ultradyne." This array can be connected directly to the v.h.f. antenna without the use of a splitter so that a single download may be employed. Such a splitter is still required at the receiver, which has separate v.h.f. and u.h.f. antenna terminals.

The new u.h.f. antenna is an impedance-controlled end-fire series-fed folded-dipole array. This antenna (Fig. 1) functions as a high-gain broadband u.h.f. antenna, having a well-controlled 300-ohm impedance. The antenna, when used alone, has gains from 9 to 12 db. In fringe areas, a director

Fig. 1. Basic "Ultradyne" u.h.f. TV antenna array.

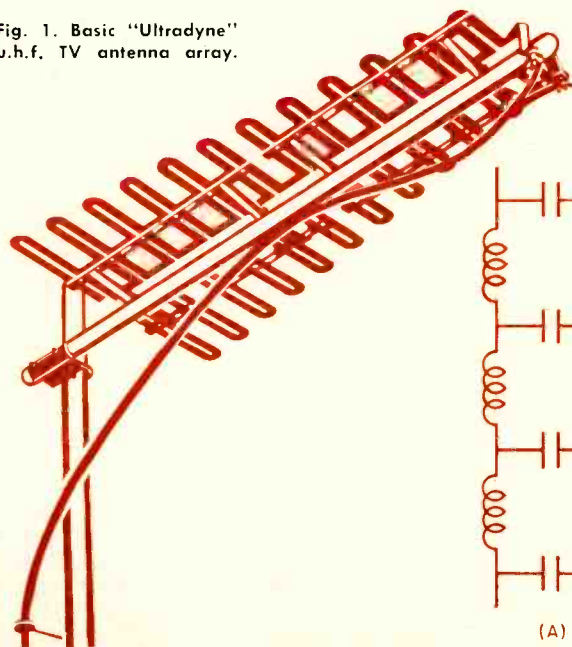
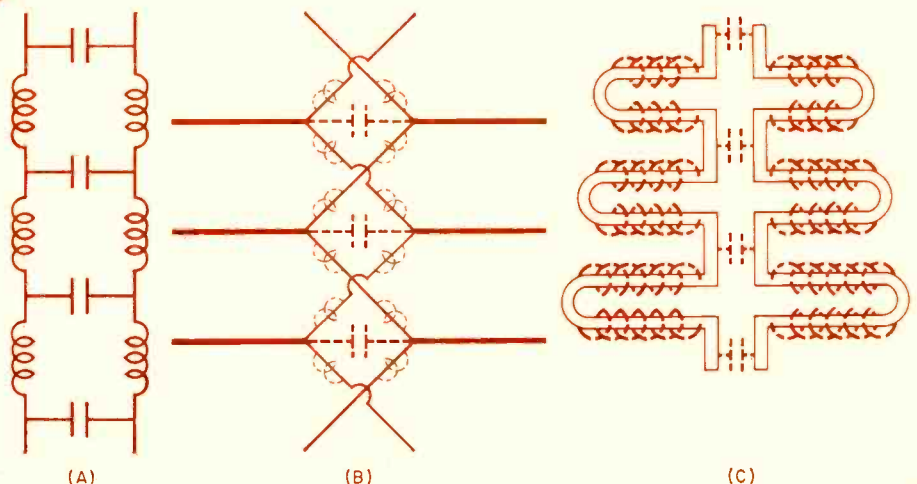

Fig. 2. (A) Distributed capacitance and inductance of twin-lead. (B) Conventional feed harness has relatively high distributed capacitance and low distributed inductance resulting in fairly low characteristic impedance. (C) The "Ultradyne" feeder has relatively high distributed inductance and capacitance. The construction is such that a 300-ohm impedance is the result.



train added to the front increases the gain from 2 to 3 db. Before discussing how this antenna can be combined with a v.h.f. antenna, an explanation of the technical features and characteristics of the antenna would be in order.

Technical Features & Characteristics

At v.h.f., the u.h.f. antenna appears as a section of 300-ohm line. A review of transmission-line theory will explain how this is possible. Fig. 2A shows a schematic representation of twin-lead. This type of transmission line has a certain distributed capacitance between conductors and a certain distributed inductance along the length of the conductors. The combination of these two effects gives rise to a characteristic impedance which is independent of length. This impedance can be varied by changing the diameter or spacing between conductors.

Fig. 2B shows the feed harness of a common type of straight dipole antenna. This is equivalent to a length of twisted transmission line. Other similar antennas do not actually use the twist but feed the straight dipoles by means of a transmission-line pair in which one conductor is placed above the other and the dipoles are fed alternately. Due to the diameter of the wire rod used in these types as well as the spacing between the conductors, the impedance cannot be brought up a 300-ohm level.

The "Ultradyn" antenna overcomes this problem by making both the interconnecting transmission line and the dipoles out of two identical continuous one-piece stamped aluminum strips. The spacing, width of the strips, and thickness of the strips have been carefully chosen so that in combination with the dipole elements, the impedance is 300 ohms, the same as a straight length of twin-lead or a conventional well-made v.h.f. antenna. As a result, this antenna eliminates the need for a u.h.f.-v.h.f. coupler when connected to a v.h.f. and FM antenna.

While the above explains the impedance characteristics of the antenna, it does not alone account for the high gain. The gain of an antenna is a function of several factors, among the most important of which is capture area. Due to the distributed capacitance and inductance inherent in the construction of the antenna, a longer element is required to resonate at any given frequency. The result is that the antenna is, on the average, about 50% wider from tip to tip across the band than many u.h.f. types using straight rod elements (Fig. 3). This larger capture area, or space aperture, means that the antenna intercepts more energy. It is this factor, plus the good impedance match, that accounts for the high gain of the antenna. Front-to-back ratios average more than 10:1 over the entire band. Even higher ratios occur when the director train is used.

Antennas of this type must have their dipole elements fed 180° out of phase with each other. When straight rod elements are used, this requirement is met by transposing the harness leads. With this new u.h.f. antenna, the phase reversal is accomplished by the use of folded-dipole elements. Each element can be considered to be made up of two shorted quarter-wave stubs. The voltage at the input end of one of the conductors forming such a shorted quarter-wave stub is 180° out of phase with the voltage at the input end of the other conductor of the stub.

Connecting the Antenna

The new antenna is a front-fed type, and when it is used for u.h.f. alone the last (longest) dipole is shorted. The lead-in to the TV receiver is connected to the shortest element, which is directed toward the transmitting antenna of the u.h.f. station to be received.

When the new u.h.f. antenna is used in conjunction with any 300-ohm v.h.f. antenna, the shorting link is removed and a length of 300-ohm transmission line is simply run from the back end of the u.h.f. antenna to the feed points of the v.h.f.

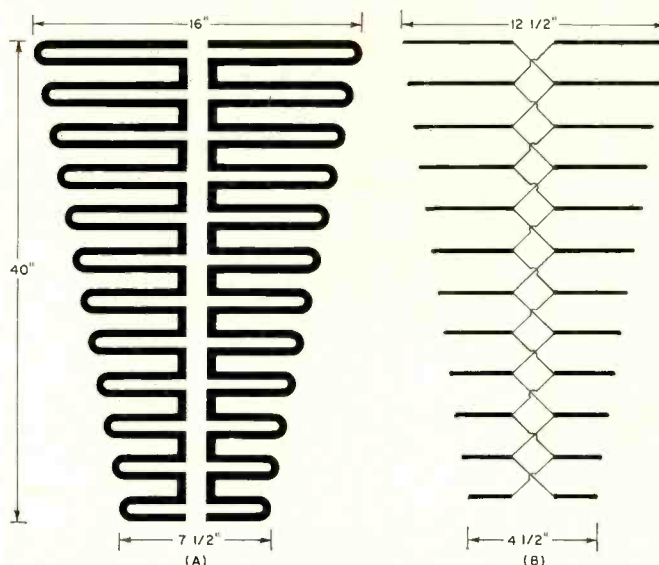

Fig. 3. Elements in the antenna at (A) are about 50 percent longer than those shown at (B). This increases capture area.

antenna. The lead-in to the TV set remains connected to the shortest element of the u.h.f. antenna. At v.h.f., the entire u.h.f. antenna appears merely as a length of 300-ohm transmission line, and therefore a u.h.f.-v.h.f. antenna coupler is not needed.

It is important to bear in mind an often overlooked consideration in comparing u.h.f. and v.h.f. antenna characteristics. The laws of electromagnetic propagation discriminate against u.h.f. In recognition of this fact, the FCC permits u.h.f. stations to operate at a maximum effective radiated power of one megawatt, while allowing high-band v.h.f. stations to operate at 300 kilowatts and low-band v.h.f. stations to operate at only 100 kilowatts maximum.

One reason for this is that the higher the frequency, the greater the propagation losses, and the less diffraction or bending occurs, permitting the signal to follow the earth's curvature. A second consideration is that most antennas get smaller as frequencies go higher, thereby intercepting less energy.

Table 1 shows the number of microvolts present at the terminals of antennas having gains of 10 db in a field strength of 1000 microvolts per meter on channels 4, 10, 14, and 83. It also shows the gain required of an antenna to deliver 1380 microvolts at the channels specified. This table demonstrates why higher gain is required on u.h.f. than on v.h.f. in areas of approximately equal field strength. It also points out why, in designing combination u.h.f.-v.h.f. antennas, a higher-gain u.h.f. section is almost always necessary.

All of these considerations were carefully weighed in the design of the new u.h.f. antenna array described above. ▲

Table 1. Signal strengths for antennas with 10-db gain in a field strength of 1000 microvolts per meter. Also antenna gain needed to deliver a certain signal strength at various channels. Lengths shown are for free-space half-wavelength. Antenna elements are usually made 5% shorter to take into account "end effect."

CHANNEL	FREQUENCY	FREE-SPACE HALF-WAVELENGTH IN INCHES	MICROVOLTS DELIVERED BY ANTENNA WITH 10-db GAIN	ANTENNA GAIN NEEDED TO DELIVER 1380 MICROVOLTS AT SPECIFIED CHANNEL
4	66-72 mc.	85.7	4350	0 db
10	192-198 mc.	30.3	1560	9 db
14	470-476 mc.	12.5	635	16.7 db
83	884-890 mc.	6.6	335	22.3 db

Functional Designing

By J. J. SURAN

Manager, Electronic Applications and Devices Laboratory
General Electric Company, Syracuse, New York

A revolutionary functional design philosophy may soon obsolete discrete components in electronic circuits.

Editor's Note: Recently we attended a seminar sponsored by JFD Electronics Corp. on "The Future of Passive Components in Microelectronics." The first three speakers, Dr. John J. Bohrer, Vice-President, Research and Development, International Resistance Co.; Bruce R. Carlson, Treasurer and Director, Sprague Electric Company; and Jack Goodman, Vice-President, Components Division, JFD Electronics Corporation; covered resistive, capacitive, and inductive components and their role in our industry both now and in the immediate future. They agreed that the passive-component industry is presently strong and would continue to grow in the future. The final speaker summarized many of the points made by the previous speakers, but he also expressed a somewhat different viewpoint. Because of the importance of his remarks, we are presenting pertinent excerpts here.

THE changes brought about by integrated-circuit technology or microcircuits or, as I prefer to call it, batch fabrication technology, are so profound and so subtle that the full impact of this new and changing electronic technology has still not been realized by many people in the field.

One of the most immediate and profound changes is the very definite alteration in trade-off considerations in circuit design. For example, in the days of "bliss"—and I will define "bliss" as before learning of integrated solid-state—the circuit designer had several simple rules to follow.

Rule 1 was that the most expensive and at the same time unreliable component was the active device. Therefore, if you designed a circuit and wanted it cheap and reliable, you reduced the number of active devices required to a minimum.

This is no longer true. As a matter of fact, the reverse is now true. This is due to batch fabrication of solid-state devices. The transistor is now the cheapest and most reliable element in the arsenal of integrated or discrete electronic components.

The second rule was that the more complex a circuit looked, the more expensive it was likely to be; and the more discrete components in it, the more expensive and less reliable it was.

This has changed too. As a matter of fact, it is turning out that you really can't predict by looking at a complex circuit whether it is going to be more expensive or less

THE AUTHOR is responsible for technical and financial program planning, project organization, integration with product departments, and evaluation of laboratory effectiveness. Before joining G-E, he held engineering positions at J. W. Meaker Co. and Motorola. Between 1959 and 1963, he also served as a non-resident member of the MIT faculty. He is a Fellow of the IEEE, holds a BSEE degree from Columbia University and did graduate work at both Columbia and IIT. He is co-author of two books, co-author of 35 papers, and the holder of 18 patents in the field.



expensive than a much simpler looking circuit or whether it will be more reliable or less reliable.

These are profound changes in circuit design. But there is another change involving the approach to circuit design from a systems point of view. We no longer ask ourselves, "What are the required characteristics of a specific circuit?" when we try to visualize a black box fitting into a system. Instead, we ask, "What are the functional desires of the system's designer with regard to these black boxes?"

In other words, we are taking a functional design approach to circuits rather than a terminal specification approach as was done in the days of "bliss."

I know that there are many circuit designers who are still not doing this, and don't be too surprised if within a few years their circuits, unless they change their present design philosophy very soon, will be obsolete.

Capacitors

The functional properties of a capacitor are diagrammed in Fig. 1, and we might ask "What does a capacitor do?"

It is quite possible that there is a planet in our universe that boasts a highly advanced civilization—an electronics civilization—where they have never heard of capacitors. Chances are, however, they are probably using some component or some functional block to provide the capacitor function.

Basically, a capacitor is a differentiator if it is used as a series element or an integrator if it is used in a shunt mode. It provides phase lead or phase lag in control systems, d.c. de-coupling, and storage charge. These are a capacitor's functions.

If we could find other ways of providing these same functions in electronic circuits, then it is obvious we would not need capacitors. We use capacitors for these jobs because capacitors are inexpensive. As long as manufacturers supply inexpensive and reliable capacitors we will undoubtedly use them. But as soon as there is a breakthrough in the batch fabrication approach which will make such functions available at lower cost, capacitor manufacturers will feel the pinch.

Now let me show you how we can replace capacitors in circuits by using the functional approach.

Fig. 2A is a very simple example—a conventional flip-flop with conventional capacitors cross-coupling from collector to base of the flip-flop. If we ask ourselves, "Why were capacitors used?" we would have to answer that, basically, what the design engineer wanted was a certain function. The

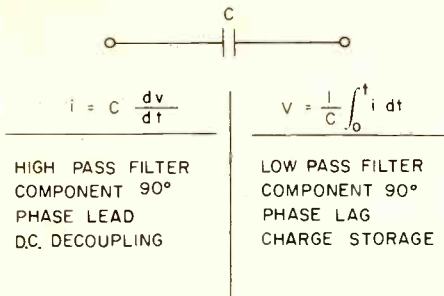

Fig. 1. Functional properties of capacitor.

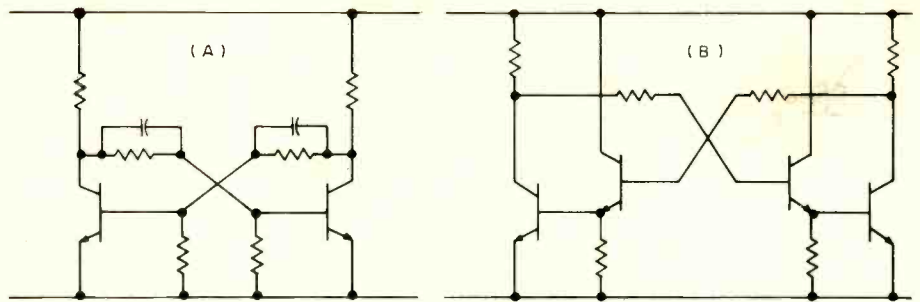

Fig. 2. How capacitors can be replaced by using functional approach. (A) capacitively coupled flip-flop, and (B) a regenerative-boost flip-flop circuit.

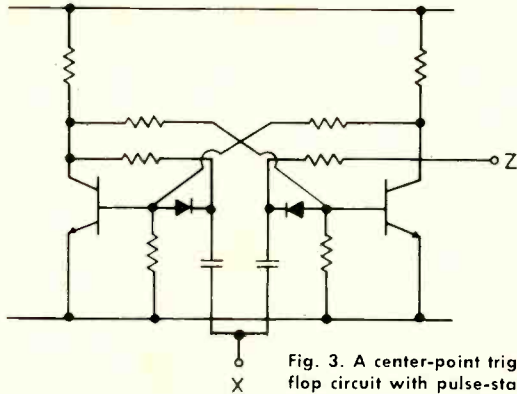

Fig. 3. A center-point triggered flip-flop circuit with pulse-starting gate.

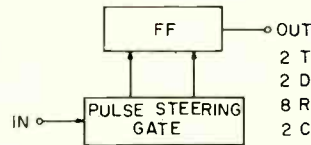
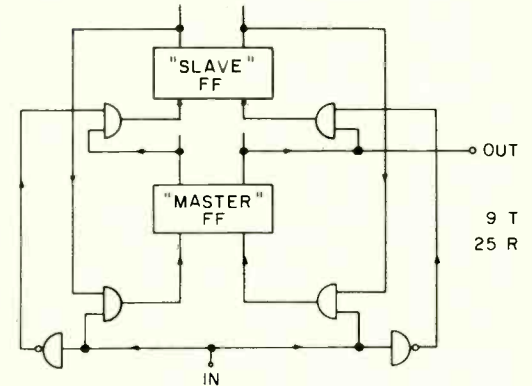

Fig. 4. Master-slave versus pulse-steered flip-flops.



function wanted from the capacitors in that flip-flop was to give the regenerative action of the circuit a boost during the transition stage; in other words, when the flip-flop changes states, to short-circuit the resistors in order to get more regenerative gain.

As soon as an engineer uses that functional definition for these capacitors, he says, "Well, if all we need is more gain, why not put transistors in the cross-coupling loop?"

It wasn't done in the days of "bliss" because transistors were more expensive than capacitors. But in these days of batch fabrication techniques, integrated circuits, and microelectronics, the transistor is cheaper than the capacitor. It is, then, quite obvious that we can make such a substitution (Fig. 2B). As a matter of fact, if you examine available integrated flip-flops, you will find that most of them have regenerative boosts being provided by transistors instead of capacitors, in the coupling networks.

Let us take another example where we have a much more difficult function to perform because, in this case, the capacitor does more than just provide a differentiating function. In Fig. 3 the capacitor also provides a delay. This is the well-known pulse-steering gate. This was the classical work-horse flip-flop in the days of "bliss." It is a very simple circuit and one that worked well over the years. It is to be found in all the textbooks.

These capacitors are difficult to replace because they provide three functions which are hard to duplicate by other means—although not impossible.

In these days of integrated circuits, they have been replaced by an awkward-looking circuit—one which often turns out to be less expensive than one using capacitors.

Let's see just what these capacitors do: first they serve a d.c. isolation function, isolating one part of the circuit from another. Second, they supply a differentiating function, that is, they allow energy to pass into the flip-flop only during the leading or trailing edge of the trigger pulse. Finally, they provide the logic delay or storage required to prevent a race condition.

The energy-storage function is the one most difficult to replace. Fig. 4 shows one of the classical ways of doing it, however. Engineers have known this configuration for quite a long time.

You use two flip-flops—one, a master flip-flop and the other a slave. This slave flip-flop is basically a storage circuit that provides the logic delay that capacitors could supply. If you try to implement this, you get a pretty complicated circuit.

Fig. 5 shows an RTL (resistor transistor logic) realization of that scheme. Looking at this, you might say, "Is someone going to tell me this is a better circuit than the simple pulse steering-gate flip-flop?"

In the days of "bliss," the answer was obviously "no." It was more expensive and much less reliable. Look at all the interconnections and look at all the components. But in the days of integrated circuits, the answer is "yes." It is a more feasible circuit, it is a more reliable circuit, and it is a more economical circuit because a transistor is much cheaper and much less area-consuming than a capacitor.

Resistors

Let us now turn our attention to resistors. There are a lot of unnecessary resistors in these circuits. All resistors that feed into the bases of transistors are performing isolation functions.

If transistors are cheaper than resistors, let's replace these resistors with transistors. If you do that you get the DCTL integrated flip-flop, first introduced by Fairchild, with 18 transistors and 8 resistors instead of the "bliss" circuit which had two transistors, two diodes, eight resistors, and two capacitors.

An economic evaluation ultimately boils down to whether two capacitors are worth 14 transistors or whether one capacitor is worth 7 transistors in an integrated structure. With today's economic, integrated technology, the answer to that question, unreasonable as it may sound to some, is "yes," under many conditions.

Many manufacturers are selling these circuits cheaper than we can make the classic simpler circuit of discrete components. Furthermore, these circuits are much more reliable because their internal interconnections are much more reliable than the solder connection, the wire-wrap connection, or the welded connection.

We can now provide circuits of this complexity which approach, in reliability, the lifetime of a single transistor.

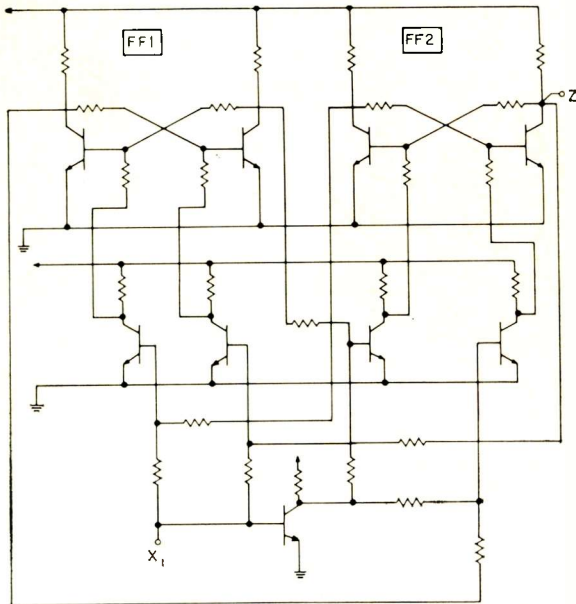

Fig. 5. A center-point triggered master-slave flip-flop.

All of the data that I have seen shows that this trend is, in fact, a real trend; that is, you no longer can say that because Circuit A has 18 transistors and Circuit B has only 2 transistors, Circuit A is less reliable than Circuit B.

This is a fundamental and profound change in electronics. It is leading us, at least in the laboratories, to make a fundamental and profound change in the way we design equipment. We no longer count active components. We no longer count components of any kind.

As a matter of fact, some of our systems look so fantastically complex, if you consider them from the components level, you would say that we, as researchers, are awfully idiotic to even dream up such systems and they will never work. But, hopefully, we are not idiotic—we are simply being foresighted.

The fact is that batch fabrication techniques—the ability to put down literally hundreds of thousands of components interconnected in systems or subsystems, is a profound, important, and completely different approach to electronic technology.

Incidentally, it all started with the transistor. There is nothing revolutionary about integrated circuits. It has been one processing step advance after another which has made this possible. And the advances in materials and processing are by no means slowing down.

Consider next the matter of high-value resistors for high-speed computers. We are designing computer circuits now capable of operating at 200 MHz. The circuit delay times

are on the order of one nanosecond, which is the time it takes light to travel about one foot. Such circuits can handle 200 million bits of information per second. While this is accomplished circuit work, there are some problems in their system use.

One of the things you have to do in the high-speed computer is provide a distributed electrical structure. In other words, you have to go to transmission line connections. This poses the problem of how to put a transmission line on an integrated substrate. This is a vital problem in high-speed computers, because of noise and reflection considerations.

In other words, the impedance levels of high-speed circuits can never really get beyond 100 ohms. Bill Piel of our Laboratory has calculated, for example, that if you wanted a 2000-ohm coaxial cable, the inner conductor would be the size of an electron and the outer sheath would be the size of the known universe. So, we will probably stick to an impedance of about 100 ohms.

It is interesting to note that the high-speed computer is one example of equipment which requires the size reduction

Fig. 8. Triggered pulse-line drivers. (A) Blocking oscillator, (B) Schmitt trigger.

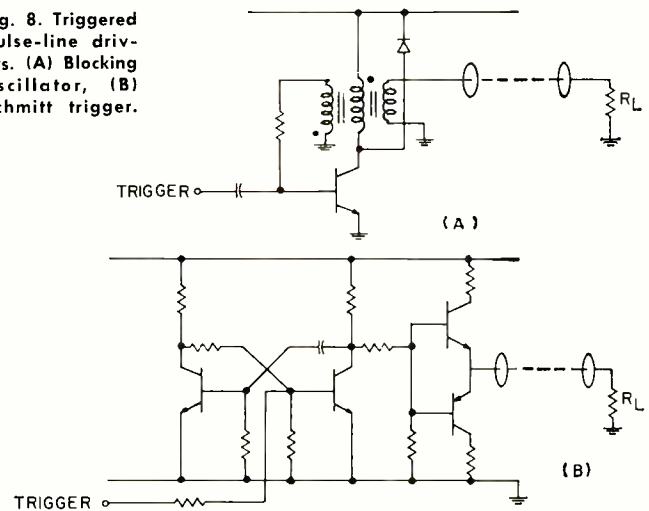

integrated circuits offer because of speed-of-light considerations. However, we are not going to use nanowatt circuits which employ billion ohm or million ohm resistors because they are incompatible with the high speed that is required.

Transformers & Inductors

Before we stop with these examples, let's consider transformer and inductor problems. We have been charged with failing to do much about inductors or transformers because they can't be made in integrated circuit form.

This is true. On the other hand, we may not have to use transformers or inductors if we can provide equivalent functions by other means.

One of the main functions of the transformer in the simple circuit of Fig. 6A is isolation. We can provide even more isolation between input and output in the opto-electronic circuit shown in Fig. 6B.

It is true that the circuit of Fig. 6B is a less efficient way of providing isolation because as yet we haven't learned to make the opto-electronic circuit with high efficiency. On the other hand, active devices are so cheap that we can make up for losses in the circuit element by introducing more gain in the output. For example, we can use two transistors, instead of one, thus making up much of the loss of the opto-electric transfer process.

Transformers are also used for phase inversion. Fig. 7A is a conventional transistor circuit using transformers for decoupling and phase inversion. By using complementary symmetry transistors (Fig. 7B) we can provide the same function without the use of the transformer.

This, incidentally, is why people are so interested in mak-

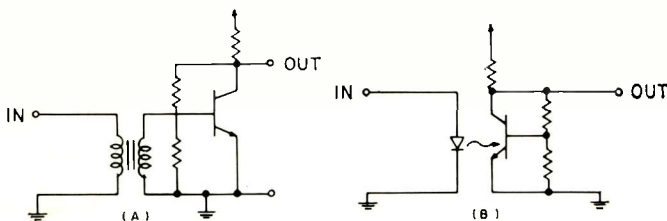

Fig. 6. Replacing a transformer in circuit. (A) Standard isolation transformer hookup and (B) opto-electronic isolation.

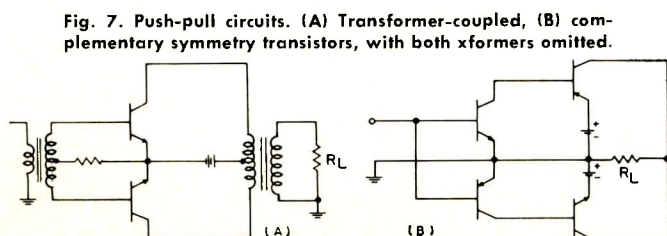

Fig. 7. Push-pull circuits. (A) Transformer-coupled, (B) complementary symmetry transistors, with both xformers omitted.

ing *p-n-p* as well as *n-p-n* transistors in microelectronic or monolithic form. Because we are able to put down these elements on the same substrate, we can use complementary symmetry principles to do the job of transformers.

Many radios being produced today are using this kind of output to speakers instead of transformers.

Other functions of transformers include impedance matching and energy storage. Again, these functions are hard to duplicate by other means. One good example of how this might be done is demonstrated in Fig. 8, if we compare the blocking oscillator of Fig. 8A with the one shown in Fig. 8B. Both are classic circuits and both do the same thing, but one looks more complicated than the other.

Fig. 8A is a fairly simple circuit. The transformer is performing four functions: phase inversion, isolation, energy storage, and impedance matching.

In Fig. 8B we have had to separate the functions and, consequently, we are using more components, but the same functional job is being done by the circuit of (B) as by the circuit of (A). We have replaced the transformer, but we haven't eliminated the capacitor.

One of the reasons is that it is still more economical to use a capacitor in a pulse circuit to provide long time delays. This becomes a film capacitor on the silicon substrate, part of the monolithic or integrated structure.

We can apply this same sort of design technique to linear circuits although we have heard that linear circuits are not yielding very well to integrated circuit technology.

I believe that the reason for this is that some of the problems *are* more difficult and also because an economic cross-over is yet to be reached. Linear circuits of a standard type are not produced in mass quantities like digital circuits.

Although the mass production possibilities don't exist as yet, as soon as the economics catch up with technology we are going to be using integrated circuits in analog applications.

Filter Design

Now let us consider how we can overcome some of the problems of filter design by using active techniques. Fig. 9 shows a second-order Butterworth filter response which would normally be realized by the *LC* circuit on the left. Notice that we need a 1.8-henry coil and an 8000-pF capacitor.

Shown at the right is an active circuit implementation of the same filter, designed by Gordon Danielson of *G-E*, wherein the inductor has been eliminated.

The filter can now be integrated, whether you do it on a monolithic silicon substrate or whether you do it with thin films and discrete transistor chips and then call it a hybrid.

Batch fabrication techniques can be used to make even more complicated filters such as the Chebyshev type shown in Fig. 10. Here we have a response with more critical specifications. Compare the active *RC* network with the passive *LC* circuit. Does the circuit look more complicated? Yes, it does. It is much more complicated, but with batch fabrication techniques, the cost may actually be lower, not higher.

We should understand that the subtleties go even further. Even the design approach is different. We no longer ask ourselves how to build a filter, but "How do you provide a filter-like function? What is the function of a filter in this system? Are there other ways of providing this function?"

Let me cite just one example of the kind of things we have been cooking in the laboratories.

Fig. 11 diagrams a transformer-filter combination which is made from a single bar of piezoelectric material—one of the barium titanate family. This bulk device is doing the same thing as that combination of transistors, resistors, and capacitors that we have illustrated in monolithic integrated form which, in turn, was doing the same job that the combination of discrete components—inductors, capacitors, and resistors—was

(Continued on page 83)

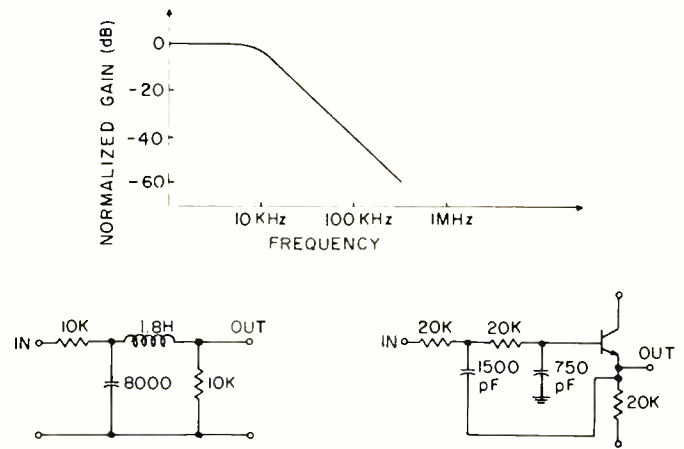
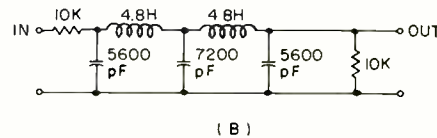
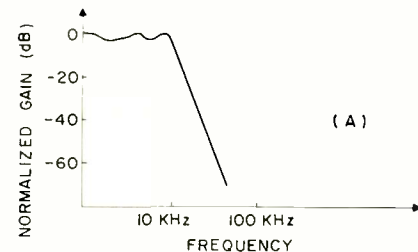
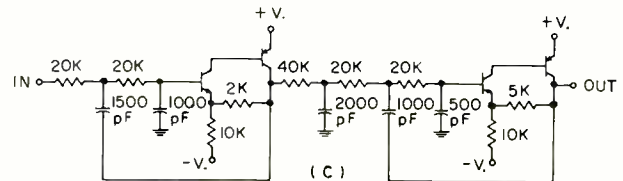

Fig. 9. Passive and active filters. Butterworth second-order filter response with *LC* and active *RC* implementation.



(B)



(C)

Fig. 10. (A) The frequency response of a Chebyshev fifth-order filter. (B) *LC* and (C) active *RC* filter network implementation.

Fig. 11. The response characteristics of a double-transverse ceramic transformer. (A) With a conventional double-transverse ceramic transformer, and (B) using a cross-coupled design.

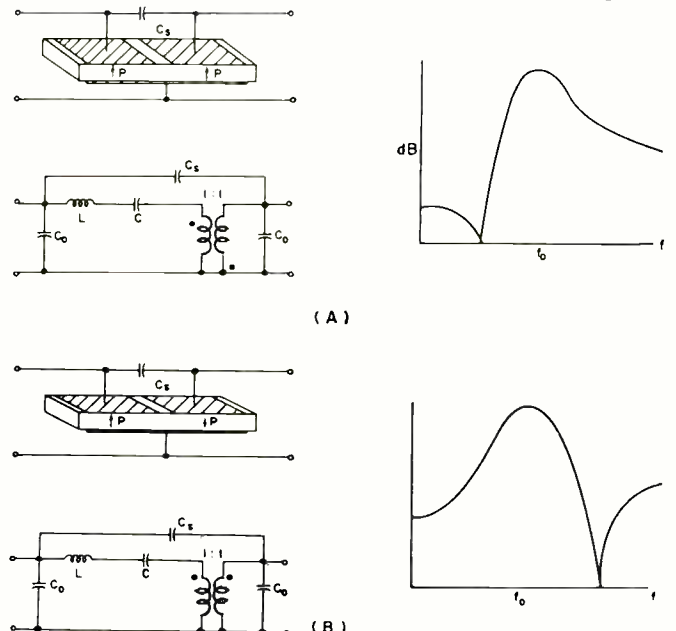

(A)

(B)

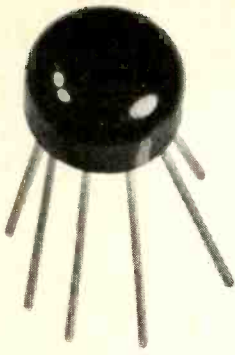

A pair of the new epoxy IC's. Units have eight leads and are about the same size as a TO-5 transistor case.

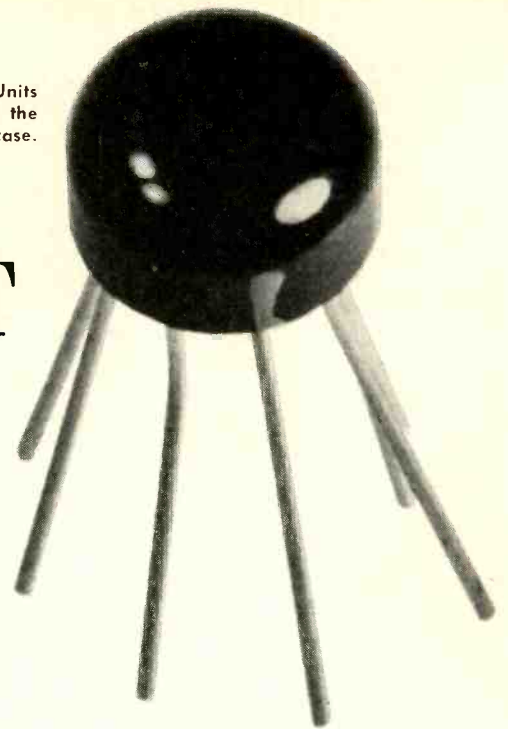

USING NEW LOW-COST INTEGRATED CIRCUITS

By DONALD E. LANCASTER

Some of the new integrateds have come way down in price and have many uses outside of computers. Here are techniques and circuits for these new IC devices.

THERE are two myths prevailing in regard to today's integrated circuitry. "Too expensive" and "only good for special computer circuits," are the hue and cry of many who simply do not yet realize the tremendous potential of in-stock integrateds applied to everyday circuits.

The facts are the exact opposite. Today there are very few basic circuits that cannot be fully integrated while substantially reducing the total cost, complexity, and assembly

time. Improved reliability, temperature performance, and ruggedness are gained in the bargain. For instance, about \$1.60 spent at a distributor's will buy the equivalent of three or four 2N708 transistors and five or six resistors, which separately might cost over five dollars, not counting the extra assembly time. For the same price, you also get an all-silicon circuit fully guaranteed and tested to operate over a specified temperature range into fully specified loads. This eliminates a large measure of the normal environmental testing, "burning in" of components, marginal resistance values, and expensive testing.

Of the twenty or so major integrated-circuit (IC) manufacturers, six have widely distributed, low-cost lines. Of these, the epoxy micrologic series of *Fairchild Semiconductor* lends itself well to our purpose of developing a number of basic integrated circuits that can be used for both commercial and experimental purposes. By obvious changes in supply voltages, impedance levels, and pin connections, these same basic circuits are pretty much applicable to other manufacturers' IC lines.

The *Fairchild* series consists of three integrateds packaged in eight-lead epoxy packages, the same size as a TO-5 case transistor. As a family, the units may be directly connected to each other. One supply voltage of +3.6 volts is specified, but any voltage from 3 to 4.5 should suffice for many applications. The latter is easily obtained from two or three pen-light cells.

The pin connections are numbered *counterclockwise from the top*, with a color-coded dot directly beside lead 8. The units are specified over a +15° to +55° C interval, useful for both room temperature and laboratory environments. Identical, wider-temperature units are available at premium cost. Although sockets are readily obtainable, the breadboarding technique shown in the photo is a good means of mounting experimental circuitry. This technique makes all connections readily accessible and well separated. To mount the IC, eight Teflon press-fit terminals are pressed into holes forming a circle 3/8" in diameter. The leads of the IC are all bent radially outward and soldered directly to the tips of the terminals. Printed circuits are impractical with integrateds unless two-sided or multi-layer board is used; otherwise too many jumpers are required.

Rather than specify an input requirement as so many ohms or so many ma., and output requirements similarly, a much

Fig. 1. Internal circuit of the three IC's described in text.

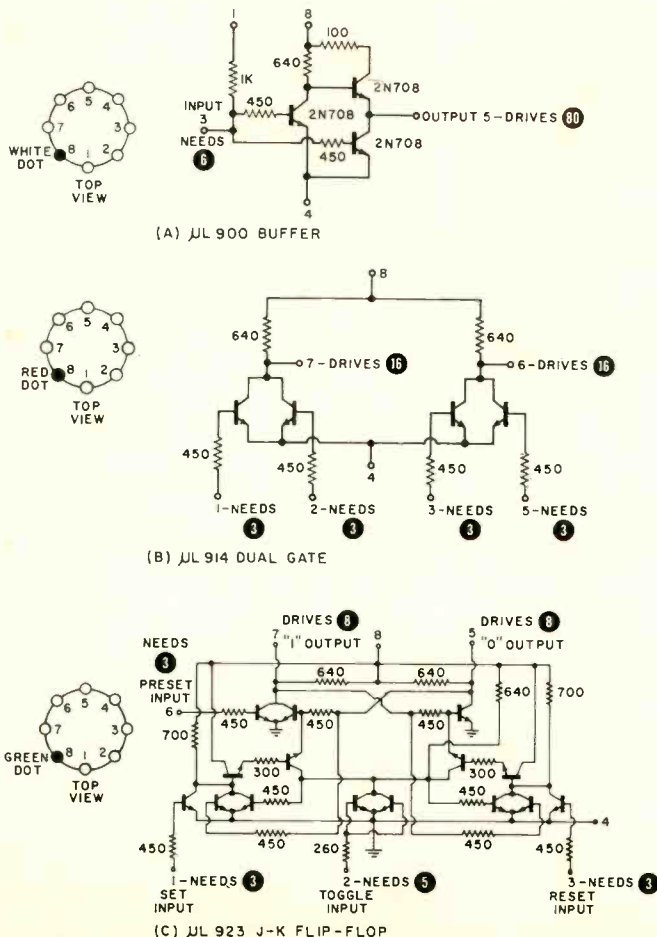

easier method is used on this IC line. Both input requirements and output drive capability are specified as so many "units," as indicated in the circles in the circuit diagrams. Any combination of inputs can be driven by an output whose drive capability exceeds the *sum* of the input units required. For instance, we will see that a μ L914 requires "3" units of drive at an input and delivers "16" units of drive at an output. Thus one μ L914 output can drive five μ L914's inputs, with "1" to spare. All other requirements are determined in a similar manner, simply adding up the loads and keeping the load units equal to or less than the drive capability.

The three IC's are compared in Fig. 1. The μ L900 (about \$1.60 each) is a buffer element designed to provide inversion and a high drive capability. This circuit finds use whenever a large number of inputs (up to a load factor of "80" units) is to be driven from a single circuit or when a low-impedance output is required for external circuitry. This three-transistor, five-resistor circuit operates as a switch. Ground the input and the top transistor saturates, connecting the output load to +3.6 volts which is tied to lead 8. Connect the input to a positive voltage between 1 and 3.6 volts and the top transistor goes off and the bottom two saturate, connecting the load to ground (tied to lead 4) through a low impedance.

The μ L914 is called a dual two-input gate, but is far more useful than the name implies. It consists of two pairs of transistors sharing common collector loads. Outside of the supply and emitter connections, both halves of the circuit are completely separate. Considering one side, in the absence of any input, both transistors remain off, and the output voltage is equal to the supply voltage (connected to lead 8). If either (or both) inputs go positive, the driven transistor(s) saturates, and the output is connected to ground (connected to lead 4) *via* the low impedance of a saturated transistor. This IC is the workhorse of the line, for it readily forms all the logic circuits, all multivibrators, a host of linear amplifiers, level detectors, and some others that we will shortly examine.

Fanciest of the three integrateds is the μ L923—at about \$4.00—a full-counting flip-flop. The IC is the equivalent of fifteen transistors and seventeen resistors. It singlehandedly counts by two, automatically steering its own input to the proper side every count, even at push-button speeds. This IC

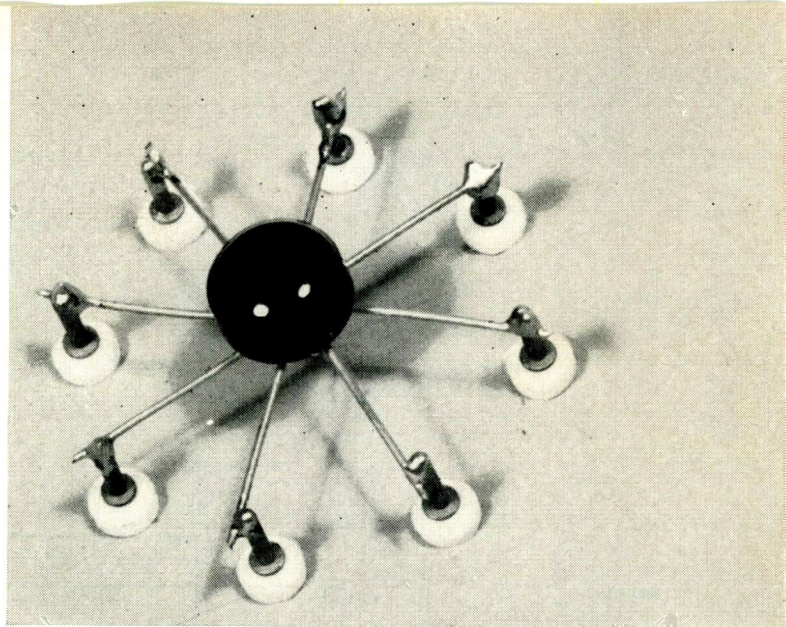

A convenient method of mounting for breadboarding circuits.

is also useful as a shift register or memory element and replaces some complicated binary and ring-counter circuitry.

Inverter and Gate Circuits

In all the circuits, we have purposely left out the inner connections of the IC's to emphasize the external system connections and the simplicity of using integrated circuitry. To study the circuits from a discrete equivalent standpoint, refer back to Fig. 1.

The simplest circuit is the inverter of Fig. 2A. Here a binary "1" input produces a "0" output and *vice versa*. Use this one to invert any digital pulse or generate a complementary digital signal. The circuit functions on the presence or absence of base current in one transistor. A positive input signal saturates the transistor and grounds the output. A grounded input signal turns the transistor off and the output goes positive. If desired, the other half of the μ L914 may be used elsewhere in the circuit.

Using both inputs produces the disabling gate of Fig. 2B. Here the IC inverts the digital signal on lead 1 only if the input to lead 2 is grounded. A positive input at lead 2 grounds the output irrespective of the condition of lead 1, disabling the circuit.

If the opposite effect is desired, an inverter may be added to the gate input. Now, as in Fig. 2C, a grounded-gate input prevents any signal inputs on lead 1 from being inverted and appearing at the output. If the gate input, lead 3, is made positive, the inverter stage makes leads 6 and 2 grounded and thus passes the input signal. This is then an enabling gate.

Logic Circuits

There is always so much confusion over just what constitutes and "and," an "or," a "nand," or a "nor" circuit for, depending on how things are defined, one circuit can perform any two functions. In binary arithmetic, there are only two possible system states, the "one" state and the "zero" state. The rules for logic are simply:

If *any* "one" input produces a "one" output, the circuit is an "or" circuit.

If *any* "one" input produces a "zero" output, the circuit is a "nor" circuit.

If *all* input "one's" have to be present to produce a "one" at the output, the circuit is an "and" circuit.

If *all* input "one's" have to be present to produce a "zero" at the output, the circuit is a "nand" circuit.

Note that all the rules are defined in accordance with the presence or absence of "one" inputs. There is nothing in the rules that concerns itself with "zero" inputs.

The trouble comes in when a "one" and a "zero" are defined in a system. Circuit people will usually define a "one" as a

Fig. 2. Basic inverter and disabling and enabling gates.

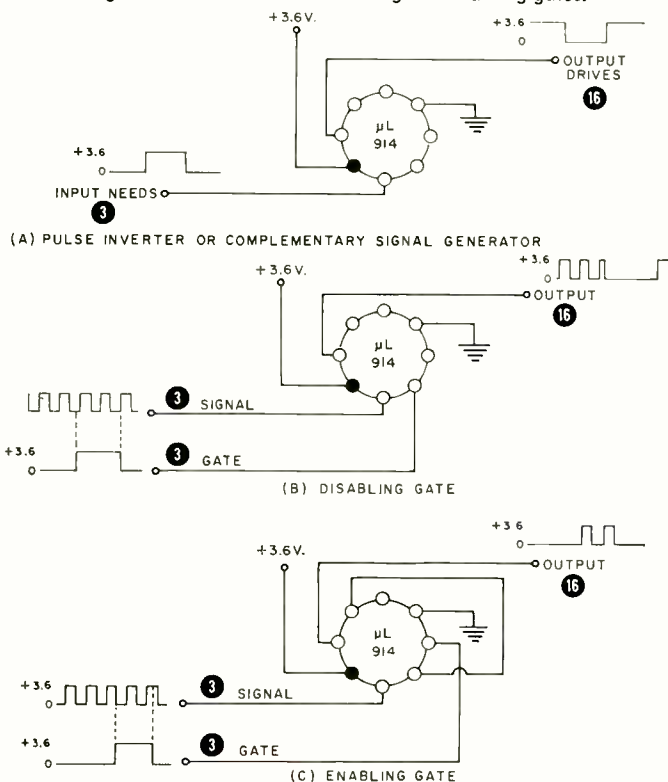

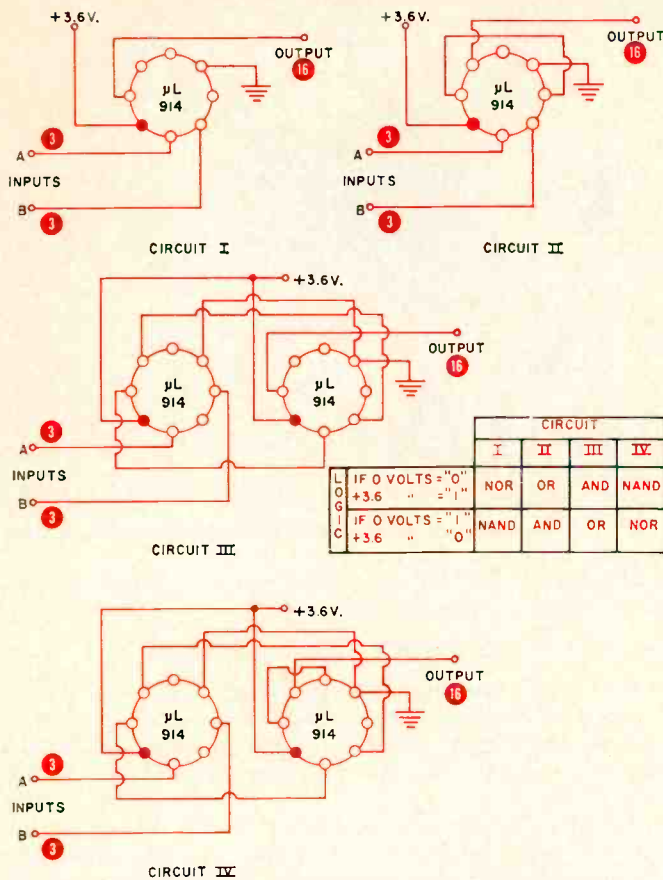

Fig. 3. Logic circuits along with their various designations.

positive input and a "zero" as a grounded input; the computer people will often do the exact opposite. Four basic logic circuits are shown in Fig. 3 along with a chart which defines the logic operations in terms of your choice of what a "one" or a "zero" is.

Circuit I produces a grounded output if either input is positive and a positive output only if both inputs are grounded.

Circuit II produces a positive output if either input is positive and a grounded output only if both inputs are grounded.

Circuit III produces a positive output if both inputs are positive and a grounded output if either input is grounded.

Circuit IV produces a grounded output if both inputs are positive and a positive output if either input is grounded.

Fig. 4. (A) Set-reset flip-flop, latch, or memory. (B) Monostable, delay, or gate generator. (C) Bounceless, noiseless push-button. (D) Astable oscillator or square-wave generator.

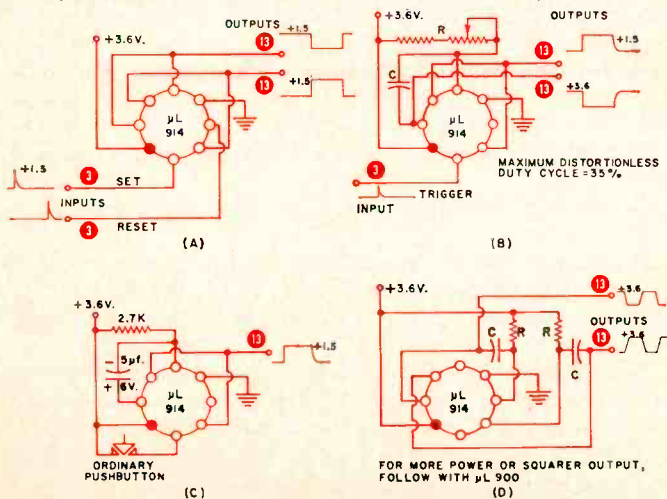

These logic circuits are the very basis of all digital computer circuitry and other areas where particular sequences or coincidences must be detected.

Multivibrators

All the conventional multivibrators (flip-flops) are easily built using the connections of Fig. 4. In 4A, the output of one half of a μ L914 is connected to one input on the other half and *vice versa*. The two remaining inputs, one on either side, are brought out for external connections. This produces a bistable multivibrator or a set-reset flip-flop. A momentary set pulse consists of a positive signal briefly applied to lead 1. This momentarily grounds lead 7, the output of the set inverter. The grounding of lead 7 grounds lead 3 which lets lead 6 go positive. The positive output of lead 6 is connected to lead 2 which holds the multivibrator in the set state after the input trigger disappears. A reset pulse applied to the opposite input will transfer the output to the reset side, again holding itself in the new state until the next arrival of a set pulse. This circuit is useful as a latch or memory as well as a gate or interval generator.

If one of the feedback connections is broken and a capacitor and recharging resistor are inserted in its place, the

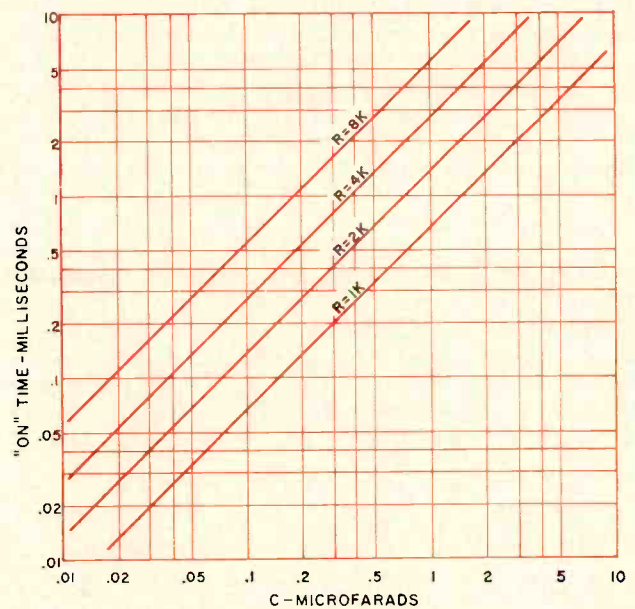

Fig. 5. Performance of the monostable circuit in Fig. 4B.

monostable multivibrator of Fig. 4B results. Here a set or trigger input pulse changes the state of the flip-flop, but it changes state back again after a time delay determined by the recharging time of capacitor C . When the input trigger arrives, lead 7 immediately goes to ground. The charge on C cannot instantaneously change, so C drives lead 5 negative, turning off the other side of the flip-flop and providing feedback to hold the output in the set state. R then slowly recharges C , making lead 5 more and more positive until finally lead 5 is positive enough to turn on its transistor and revert the state of the monostable back to normal. The net effect is a constant time interval or delay, in the form of a rectangular pulse, produced every time an input trigger pulse arrives.

Fig. 5 includes a family of curves that lets you choose values of C and R for required time delays. Varying R with a potentiometer gives control over the delay interval. The delay is largely independent of the supply voltage. The circuit will only operate on a 75% maximum duty cycle, and the duty cycle should be held to less than 30-35% if timing accuracy is important. For instance, a 300-microsecond monostable must have at least 100 microseconds to recover. If timing accuracy is important, it should have at least 700 microseconds; otherwise the earlier

(Continued on page 80)

NON-DESTRUCTIVE TESTING

This second part of a two-part series covers various types of ultrasonic flaw-detection devices, ultrasonic thickness gages, eddy-current instruments, Hall-effect instruments, and the various types of infrared techniques used in modern NDT tests.

By JOHN R. COLLINS

THE increasing interest in non-destructive testing in recent years can be attributed not only to the demand for near-perfect equipment for vital military and space programs, but also to simple economic considerations. Components can be produced more economically if flaws or impurities in materials are detected at an early stage. By locating defective components before they are incorporated into end products, wasted effort can be eliminated. Finally, a continuing program of equipment overhaul and inspection by non-destructive methods can prevent dangerous failures and expensive plant shutdowns.

Much equipment and many techniques have been developed for NDT. Nevertheless, the field is growing. Problems are increasing as fast as solutions. There is every reason to expect that non-destructive testing will become even more important in the years ahead.

Ultrasonic Methods

The use of x-ray apparatus for radiographic and fluoroscopic inspection of materials and components was discussed in Part 1 (February issue). Although quite effective for many applications, x-rays have notable limitations. Sufficient contrast for good definition is difficult to obtain when small defects are located deep in a metal. Penetrating capabilities are confined, for practical purposes, to several inches of steel. X-ray equipment for deep penetration (such as linear accelerators and Van de Graaff generators) is heavy and relatively immobile. It is inconvenient to use for inspecting equipment already installed.

These limitations are largely overcome through the use of

ultrasonic testing methods. Mechanical vibrations at frequencies above the audible range can readily penetrate beams 40 feet long without severe attenuation. By using very short

Fig. 1. A portable ultrasonic instrument is used to check an aircraft landing gear outer cylinder for fatigue cracks.

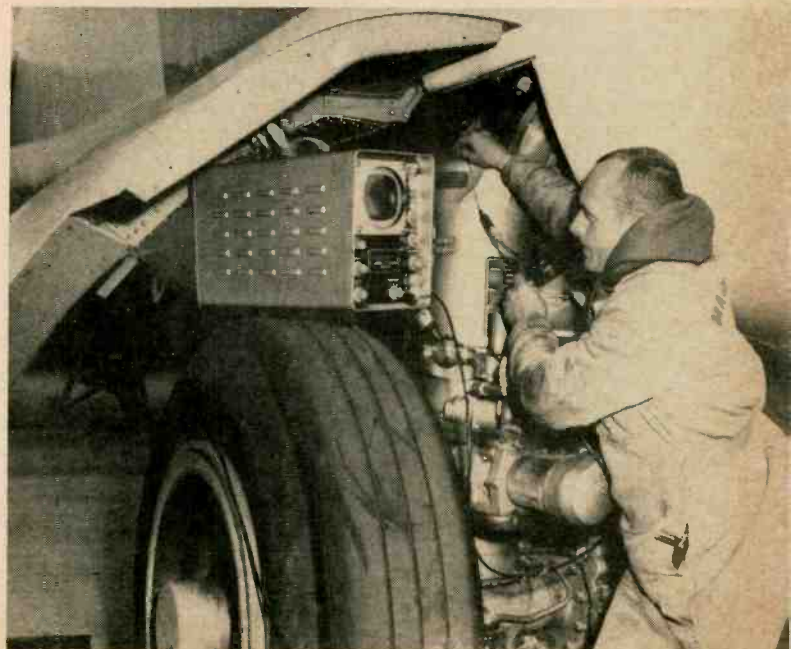

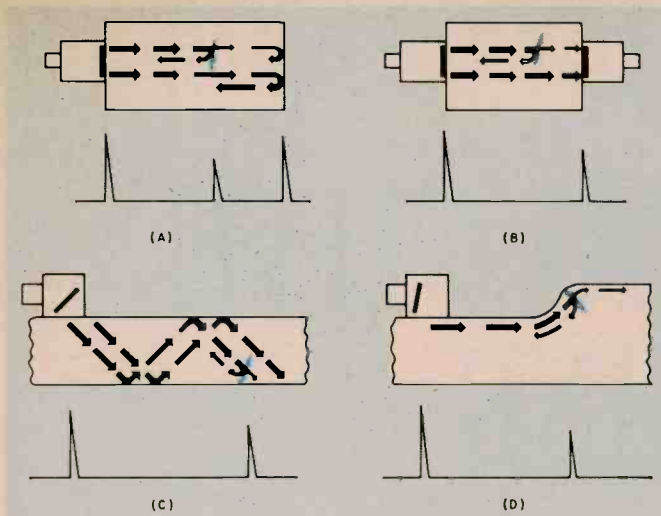

Fig. 2. Four methods of using ultrasonic pulses for flaw detection. (A) Longitudinal waves. (B) Two-transducer through transmission. (C) Transverse or shear waves. (D) Surface waves.

wavelengths, small defects can be detected. Furthermore, light, portable equipment can readily be built which is suitable for field use (Fig. 1).

A typical ultrasonic test instrument uses an oscillator to provide electrical energy which can be adjusted to any frequency in a range between 0.5 mc. and 15 mc., and at a pulse repetition rate ranging from 100 to 5000 pulses per second. This electrical energy is converted to ultrasonic energy by means of a piezoelectric transducer. Vibrations are transmitted through the transducer to the piece to be inspected. Energy reflected back from flaws or discontinuities is converted by the transducer to electrical signals which are displayed on the cathode-ray tube. By studying these reflections, the condition of the test piece can be determined.

Quartz crystals or barium-titanate ceramics are generally used for transducers, since these materials are efficient at converting electrical impulses into mechanical vibrations, and *vice versa*. Unless good contact is made with the surface of the test piece, most of the ultrasonic energy will be reflected back from the surface and only a small portion will enter the test piece itself. To assure good contact, a couplant such as oil, glycerine, or soap film is normally used.

Effective coupling may also be obtained by immersing the test piece and the transducer in a liquid bath of oil or water. Since the density of these liquids approaches that of the test piece, there is little tendency for energy to be reflected back from the surface. Immersion techniques are useful in testing materials having irregular shapes or rough surfaces. Crystals for high-frequency use are quite thin, and the immersion method reduces wear on the crystal surface.

Fig. 3. Special TV camera-like image converter and closed-circuit TV monitor produce a high-definition picture of flaw.

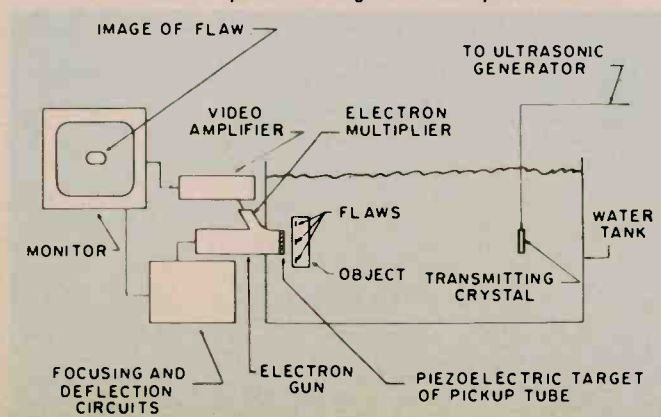

The various ways of utilizing ultrasonic energy for flaw detection are illustrated in Fig. 2. Although only direct contact between the test piece and the transducer is shown, immersion techniques are applicable in each instance. Probably the most common method involves the longitudinal wave which is projected in a straight line through the material, as in Fig. 2A. Pulses will appear on the cathode-ray tube to indicate the points at which energy is reflected: at the contact junction between the transducer and test piece, and at the far side of the test piece. Since these are the two chief reflection points, the pulses will be highest there. If there is any flaw or discontinuity in between, some energy will also be reflected back from it. The height of the reflected pulse provides an indication of the size of the flaw, and its position between the two main pulses indicates its location.

A different longitudinal wave method is shown in Fig. 2B. Two transducers are located on opposite sides of the test piece. Ultrasonic waves are projected by one transducer and picked up by the second. Both transducers, of course, must be coupled to the test piece so that no air gaps exist. If there is no flaw, the received pulse should be the same height as the transmitted pulse. A smaller received pulse indicates the loss of energy due to a discontinuity in the path.

This method has the disadvantage that it does not give an indication of the location of the defect. It is useful, however, for such purposes as determining faulty bonding in laminated structures. One of the most important applications of the through-transmission method is to check the walls of space capsules, which are constructed of honeycomb covered with light sheet metal. It is essential that the bond between the skin and the honeycomb be perfect and that there be no internal flaw at any point. An elaborate test setup has been devised in which two transducers are precisely positioned, one inside and one outside, and move together in a pre-arranged program that is controlled by tape, covering the entire surface. The transducers are coupled to the walls by means of jets of water.

Through the use of a special probe in which the crystal is set at an angle of 45° to the surface, transverse or shear waves can be projected into the test piece, as in Fig. 2C. Ultrasonic energy is reflected from surface to surface and, if it encounters a flaw, some of it is reflected back, showing up as a pip on the cathode-ray tube. This method is useful for testing welds and for subsurface defects. Waves of this kind can probe test specimens of various odd shapes and configurations. The data may be difficult to interpret, however, and it may be necessary to use other methods to pinpoint the location of a defect after its presence has been detected.

When the crystal is placed at an angle of 60° or 70° to the horizontal, surface waves may be generated, as in Fig. 2D. In this case, the beam is projected along and slightly below the surface of materials and will follow irregular shapes, reflecting from defects in the usual way. Similar transducers are used to produce so-called Lamb waves in thin materials. Lamb waves resemble ripples that travel down the surface and are reflected back to the transducer. They are especially useful for detecting unbonded areas in thin laminations and are more sensitive than shear waves for detecting very small defects on or near the surface.

For good definition, the wavelength of the ultrasonic pulse should be short compared to the defect. It is important to note that the wavelength at a given frequency does not remain constant for all materials, being far shorter in a dense material, such as lead, than in a light material, such as aluminum.

Because of the number of variables involved, a skilled operator is needed to perform other than routine tests with ultrasonic equipment and to evaluate results. However, ultrasonic methods provide a powerful tool for non-destructive testing and are having a remarkable influence in many fields.

A new approach to ultrasonic non-destructive testing is the

"Ultra Scan" system developed by *James Electronics, Inc.*

Using a special TV camera-like image converter submerged in a tank of water, the object to be tested is placed in the water between the image converter and a source of ultrasonic waves as shown in Fig. 3.

Unlike the single trace displays commonly found in pulse echo systems, this new system operates with a TV-like raster on a high-resolution, closed-circuit TV monitor.

The object undergoing test can be rotated in all directions to find the physical shape of any defect, its dimensions, and its orientation within the test piece. Strip stock and seam welds can be continuously inspected by moving the material past the transducer. Defects as small as .010-inch can be detected.

The system will operate with living tissue as well as metals and many non-metallic materials such as plastic or rubber. It also permits examination of porosity in cast parts, laminar flow in fluids, and homogeneity of potted assemblies.

Ultrasonic Thickness Gages

In a different kind of operation, ultrasonic energy is used as an effective device for determining the thickness of materials—not only metals of all kinds but also other solid materials, such as glass, plastics, and hard rubber. For gaging purposes, the instrument is provided with a tuning capacitor which permits the continuous tuning of the oscillator over a wide range. The transducer is placed against the wall of the test object and coupled to it by means of grease or soap in the usual way. When the frequency of the oscillator coincides with the resonant frequency of the test piece, a standing wave is set up, as shown in Fig. 4. This point can be detected by the fact that the transducer draws more energy at resonance. The instrument is calibrated to permit the resonant frequency to be interpreted in terms of sample thickness.

An ultrasonic thickness gage made by *Magnaflux Corporation* is shown in Fig. 5 being used to determine wall thickness of a 36-inch Inconel liner used for wind tunnels. For work of this kind, portability is essential. The instrument will measure thicknesses from .025 to 3.0 inches and is accurate to .014 inch. Both flat and curved transducers are available to fit objects of different shapes.

Among the uses for ultrasonic thickness gages are maintenance examinations to find areas of corrosion or wear on tanks, pipes, ship hulls, airplane wing skins, and other structures accessible from one side only. In addition, they are used to check thickness of products during manufacture and to detect core shift in heavy castings.

Eddy-Current Instruments

Most electronics technicians have observed that the effective impedance of a coil carrying a high-frequency current undergoes a change if the coil is brought close to a conductor. This can be explained by the fact that the magnetic field surrounding the coil induces eddy currents in the conductor, and the magnetic field associated with the eddy currents affects the magnetic field of the coil. The situation is like the influence of a transformer secondary on the primary.

Because eddy currents result in power loss, reduction in the magnetic field, and heating, they are normally considered undesirable and steps are taken to minimize their effect. It is interesting to note, therefore, that a new and important category of NDT instruments utilizes eddy currents to analyze substances and to detect flaws.

The basic theory is not difficult to understand. A coil carrying a high-frequency current is placed close to the part to be inspected, inducing eddy currents which, in turn, reflect energy back to the coil. This affects the current flow through the coil and the voltage across it. Obviously, anything that affects the induced eddy currents will also affect the reflected energy and the coil voltage.

Eddy currents are affected primarily by the permeability

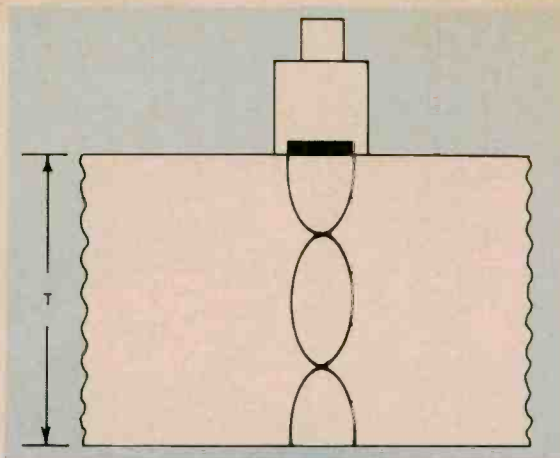

Fig. 4. Measuring material thickness using standing waves.

of the test piece and its resistance. Many factors influence permeability and resistivity: flaws, discontinuities, chemical composition, condition of heat treatment, dimensions, temperature, etc. This means that eddy-current instruments can test not only for flaws but also for other factors which may be important for quality-control purposes.

One of the difficulties is the fact that while a number of variables affect the reflected energy, the information is conveyed only as a change in voltage. It may be difficult, therefore, to determine whether a measured voltage change has resulted from a crack in the test material or, say, a difference in heat treatment or thickness. Elaborate techniques for interpreting the data have therefore been devised. It has been noted that changes in eddy currents resulting from different conditions produce variations in the phase angle of the coil voltage. This can be explained by the fact that currents within a conductor lag surface currents, and a defect at a given depth will result in a phase angle different from that

Fig. 5. Portable ultrasonic thickness gage in use. Note the grease couplers placed at the desired pipe testing locations.





Fig. 6. Test probe locates cracks in a non-magnetic gear.

produced by a surface flaw. Conductivity changes affect currents at all depths and result in a different phase angle than a flaw at only a single point in the test piece. Changes in permeability influence magnetic flux rather than the induced current directly, and since the two are out of phase, still a different phase angle is noted. Changes in dimensions also have a distinct effect.

For analytical work, eddy-current instruments are usually equipped with cathode-ray tubes or some other device for determining the phase angle of the voltage across the coil. Within limits, it is thus possible to distinguish between flaws at different depths, flaws of different shapes, variations in conductivity, variations in permeability, and differences in dimensions.

Instruments are usually designed to supply any of a number of frequencies to the output coil. For high-conductivity materials, low coil frequencies provide the best separation, and *vice versa*. Fifty cycles is common for examining ferrous parts, but as low as one cycle may be employed to permit penetration to one-half inch or more in ferrous materials. Several megacycles may be used for inspection of high-resistivity non-magnetic materials, such as stainless steel, or for measuring very thin plating.

The configuration of the coil depends on the job to be done. An encircling coil is normally used for testing rods or pipe, and inspection is possible at speeds of 300 feet per

minute or more. Since any transverse motion of the pipe in the coil would cause a change in the apparent impedance, such movements are rigidly controlled to .05 inch or less in any direction from the true center. The system detects scabs, slivers, or other rolled-in materials, open or spotty welds, splits, blisters, etc. A number of different readout devices may be supplied, including a pen recorder and an audible alarm, but the most common device is a paint spray that is triggered by the flaw and marks the defective section of pipe.

A point probe (Fig. 6) is used to inspect material directly under the probe. The instrument shown is compact, operates at a single fixed frequency, and is used to locate and determine the severity of cracks in non-magnetic metals. It may also be used to sort non-magnetic materials according to conductivity or alloy variations and to measure the thickness of both conductive and non-conductive coatings. Special probes are usually designed for particular applications.

Operation is quite simple. The probe is placed on a defect-free test sample, and the balance control is adjusted until the needle of the meter is centered on the scale. As the probe passes over a defect, the needle deflects downscale, and the amount of deflection indicates the severity of the flaw. Coating-thickness measurements and sorting applications are performed in the same way, by recording meter readings on known samples and observing any differences that occur on unknown parts.

Some probes are equipped with differential coils—two coils, side by side, which interrogate adjacent areas on the test piece and provide an output signal equal to the difference between the two voltages. In a differential system, the output is zero when the adjacent areas have the same properties, and an indication appears only when there is a flaw.

Eddy-current testing is comparatively new, and more applications of the technique are constantly being developed. It has great promise. It permits detection of flaws invisible to the finest x-ray radiography. Since its output is a voltage, it is well-adapted to automatic control.

Hall-Effect Instruments

When a conductor carrying a current is subjected to a magnetic field perpendicular to the direction of current flow, a difference of potential will appear across opposite edges of the conductor. This is known as the Hall effect. Although the effect is quite small in metallic conductors, voltages that are easily measurable can be produced through the use of flat strips of new semiconductor materials, especially indium arsenide and indium antimonide. If the current through the strip is maintained at a constant level, any change in the measured voltage will be due to a change in the magnetic field. Since a very high degree of sensitivity is possible, Hall-effect devices permit great accuracy in measuring tiny variations in a magnetic field. This factor is extremely valuable in eddy-current testing.

A Hall-effect, eddy-current device called a "Magnetic Reaction Analyzer," made by *F. W. Bell, Inc.*, is shown in the block diagram of Fig. 7. The excitation coil in the probe is supplied by a variable-frequency oscillator, which permits the generation of any frequency from 20 cycles to 100 kc., and a constant-current amplifier which maintains the energizing field H_o at a constant level regardless of the frequency. When the probe is placed in close proximity to the test object, the H_o field penetrates into the material and generates eddy currents within it. The eddy currents, a function of the material properties, produce a reaction-field H_r , which adds vectorially to H_o , producing a net field H_n at the Hall-effect device ($H_o + H_r = H_n$).

The Hall device is mounted in the probe as shown and, when fed from the d.c. constant-current supply, produces a voltage that is proportional to the net field H_n . This voltage is then amplified, detected, and fed to a panel meter for direct reading of the net field H_n as a percentage of H_o .

Fig. 7. Hall-effect instrument used in non-destructive tests.

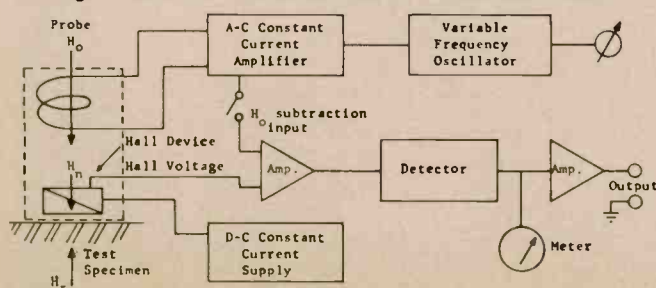

NOW YOU CAN EASILY ADD
SOUND TO YOUR SLIDE
OR FILM SHOWS WITH
POPULAR PHOTOGRAPHY'S
EXCITING NEW
"SOUND FOR A
PICTURE EVENING"
RECORD ALBUM



"Sound For A Picture Evening"
Consists of selections from the music masters
of the Capitol Record Hollywood Library
High Fidelity 12-inch vinyl album—33½ RPM
Playing time: 40 minutes
AVAILABLE IN MONAURAL OR STEREO
AT NO EXTRA COST

EXPRESSLY CREATED FOR FILM
AND SLIDE SHOWS

No matter how good your film and slide shows are, sound will make them better... more entertaining and certainly more professional. But, it has to be the right kind of sound. Although any musical record can be used as a background for your film and slide shows, few, if any, can match the variety of actions, situations, and scenes inherent in most shows. That's why Popular Photography created this album. It's ideal for almost every mood captured by your camera. Whether your show is simple, elaborate or somewhere in-between—"SOUND FOR A PICTURE EVENING" provides a final, professional touch to make it a complete success.

A POPULAR PHOTOGRAPHY
EXCLUSIVE

The "Sound For A Picture Evening" album has been produced by the editors of Popular Photography exclusively for our readers and is prepared by the Custom Services Division of Capitol Records. This outstanding album cannot be purchased in any store and is available by mail only to the readers of Popular Photography and other Ziff-Davis magazines.

ALBUM CONTENTS:
17 SPECIFIC MOOD MUSIC
BACKGROUNDS
8 TRACKS FOR SPECIAL
SOUND EFFECTS

THEMES TO MATCH YOUR
SUBJECTS... PERFECTLY!

3 FILM OPENINGS: Grandiose, Sweet and Gentle and Dramatic • 3 FILM CLOSINGS: Epic Finale, Hollywood Style and Gentle • 11 THEMES: Happy-Go-Lucky • Gay Party • Vacation Tempo • Traveling • Happy Birthday Party • Pomp of a Parade • Sound of a Carousel • Circus Time • Sentimental Moments • Children's Playtime • Christmas Time

DON'T MISS OUT ON THIS OUTSTANDING OFFER.
FILL IN AND MAIL TODAY

FOR SPECIAL SITUATIONS,
THESE WONDERFULLY REALISTIC
SOUND EFFECTS

Ocean Waves • Train • Jet Planes • Baby Crying • Crowd In Stadium • Traffic • Dog Barking • Thunder And Rain

FREE! WITH YOUR ALBUM
PURCHASE — IF YOU ORDER NOW

Complete Instruction Booklet—Here, in one comprehensive booklet, is all the information you need to make your film or slide show a resounding success. You will find helpful tips on how to build an effective sound track, choosing the right background selections and sound effects, synchronization, taping, organizing your show, editing and much more.

BAND POINTER—Fits on the top of your record and tells you where to find the exact band you want. Eliminates guesswork, fumbling and wasted time. Lights... Projector... Action!

This wonderful 12" long-playing album
(a must for every slide and film show impressario)
can be yours for

ONLY \$3.98 POSTPAID

MONAURAL OR STEREO

... a small price to pay for an album you will enjoy
and treasure for many years. ORDER NOW.

"Sound For A Picture Evening"
POPULAR PHOTOGRAPHY—Dept. SD
One Park Avenue, New York, N.Y. 10016

Please send me _____ albums at \$3.98 each. My check (or money order) for \$ _____ is enclosed. I understand that you will pay the postage. (Add 75¢ to partially defray postage costs outside U.S.A.)

N.Y. State residents please add local sales tax.

CHECK ONE: MONO STEREO

Name _____

Address _____ EW-66

City _____ State _____ Zip Code _____

Sorry—No charges or C.O.D. Orders

Olson

FREE

Fill in coupon for a FREE One Year Subscription to OLSON ELECTRONICS' Fantastic Value Packed Catalog—Unheard of LOW, LOW PRICES on Brand Name Speakers, Changers, Tubes, Tools, Stereo Amps, Tuners, CB, Hi-Fi's, and thousands of other Electronic Values. Credit plan available.

NAME _____
ADDRESS _____
CITY _____ ZONE _____ STATE _____

If you have a friend interested in electronics send his name and address for a FREE subscription also.

OLSON ELECTRONICS, INC.

464 S. Forge Street Akron, Ohio 44308

CIRCLE NO. 95 ON READER SERVICE CARD

Every No-Noise Aerosol Product

Guaranteed

Non-Flammable Non-Toxic and Won't Affect Plastics

"NO NOISE"

Insist On This Trusted
NAME BRAND
Avoid Risky "Private Labels"

"No Noise" PRODUCTS ARE
PERFECT FOR COLOR TV

- Volume Control & Contact Restorer
- Tuner-Tonic with Perma-Film
- EC-44 For Electrical Contacts
- Tape-Reco Head Cleaner

FREE 5" plastic extender push-button assembly for pin-point application with all No-Noise products.

ELECTRONIC CHEMICAL CORP.
813 Communipaw Avenue, Jersey City 4, N. J.

CIRCLE NO. 113 ON READER SERVICE CARD

The instrument is also equipped to permit a signal proportional to H_o to be subtracted from the Hall voltage H_n . The difference is then proportional to H_r , thus providing a direct measurement of the reaction field ($H_n - H_o = H_r$). Since both H_n and H_r can be read, it is possible to make a complete phase analysis of the eddy-current field.

The fact that the magnetic excitation field is constant at all frequencies permits analysis of ferromagnetic materials at different frequencies under standard conditions, so that comparisons can readily be made of results. The use of a Hall device to detect the magnetic field simplifies phase analysis, extends the usable frequencies to a very low value without loss of sensitivity, and permits deep penetration as well as measurements in very high conductivity materials.

Infrared Techniques

The use of infrared methods for NDT is increasing because some defects can be found faster by infrared applications than by any other method. In other instances, infrared permits the detection of flaws that cannot be detected by any of the usual testing procedures.

The basic device for infrared testing is the infrared radiometer, an optical instrument which collects radiation within a restricted field of view and converts that energy into an electrical signal. All objects at temperatures above absolute zero radiate energy, most of which is in the infrared region. The wavelength of the radiation is a function of the temperature of the radiator; hence, the electrical signal provided by the radiometer gives an accurate measurement of the temperature of the area surveyed.

Location of imperfect bonding is an almost universal problem because so many laminated materials are now used. If the surface of a laminated structure is heated, the heat will not be absorbed to the interior as fast at an imperfectly bonded area, and the surface temperature will be higher than in surrounding areas. The difference can be detected by scanning the heated surface with a radiometer.

This method is used for testing nuclear fuel elements where proper operation demands a perfect bond between

the fuel and the walls of the container. In practice, the entire surface is scanned by heating a spot on the surface with a torch and rotating the element to permit the spot to be scanned with a radiometer. Hot spots detected in this manner indicate improper bonds.

Infrared scanning can detect poorly soldered or welded connections which exhibit discontinuous thermal conductivity even though electrical conductivity is normal. Fig. 8A shows a thermal scan of a good, 10-watt, wirewound resistor, made with infrared equipment manufactured by *Barnes Engineering Company*. Note that temperature is highest at the center and decreases in a symmetrical manner towards both ends. In contrast, Fig. 8B shows a variation in the temperature to the right of center, revealing that the right terminal metal cup is in poor thermal, although perfect electrical, contact. A defect of this particular kind would shorten the life of the unit.

An infrared radiometric microscope, also developed by *Barnes*, permits the detailed scanning of integrated and thin-film circuits. The temperature of each microscopic area is measured and recorded as it is positioned under the cross hairs of the microscope. Any small temperature rise above the ambient may indicate a faulty unit. In the design of monolithic circuits, this permits an accurate measure of how much power can be dissipated per unit area. During manufacture of microcircuitry, infrared microscopy can detect voids in deposited elements, improper connections, and bonding defects.

Infrared techniques are also adapted to fast checking of crowded printed-circuit boards or components that are inaccessible when in operation. By photographing a circuit board with an infrared scanning camera, overheated components can be detected within 10 to 60 seconds. The camera incorporates a radiometer which converts the infrared energy into an electrical signal. The electrical signal, in turn, modulates a glow lamp, providing an output in the visible light range which is proportional to temperature. As the surface is scanned, the results are recorded on *Polaroid* film for a permanent record. ▲

Fig. 8. (A) Thermal scan of good 10-w. resistor shows highest temperature at the center. (B) Same resistor with right terminal making a poor thermal contact.

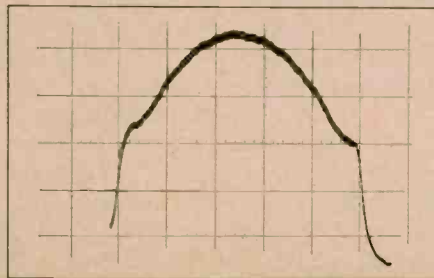

(A)



(B)



J OHN FRYE

Greatly expanded use of electronic devices offers the best hope of relieving heavily overtaxed medical institutions.

ELECTRONICS IN THE HOSPITAL

IT was Mac's first day back at work after a three-week siege with a kidney stone, and Barney was genuinely glad to find the boss sitting at his accustomed spot at the service bench. He said as much. "Don't think I'm not glad to be back," Mac admitted with a rather wan smile lighting his drawn face. "Those six days I spent in the hospital were especially unpleasant. Of course, a retrograde pyelogram and cystoscopy accompanied by the removal of a stone are not exactly conducive to a happy, contented hospital visit; but there was more to it than that.

"The hospital was terribly overcrowded. When I left, several patients were out in the halls with screens around their beds. I was lucky to get a bed in a four-bed ward in the old wing of the hospital. But that meant I occupied an old-fashioned bed which, since I was forbidden to get out of bed, had to be cranked up and down by a nurse every time I wanted it changed. There was no intercom for talking to the desk or for summoning help. You pushed a button that lighted a bulb over the ward door and then waited for up to a half hour until an overtaxed nurse, orderly, or aide came to see what you wanted. And this part of the hospital was not wired so a patient could use a telephone from his bed, no matter how urgently he needed to do so.

The Old and the New

"I could not resist comparing these conditions with my previous stay in the new wing of this same hospital three years ago. There I had an electric bed I could control completely with a touch of my finger. Only a person who has spent several days in a hospital bed knows how much it rests a tired, aching body to be able to raise or lower the head or foot a few inches whenever you want to do so. And by pushing a button I had immediate communication with the desk. I could ask a question directly of the nurse in charge, or I could request specific help. There was no time wasted trotting back and forth relaying information, locating and sending the specific kind of help needed, etc. Furthermore, the urgency of the calls could be evaluated, and they could be handled accordingly. I remembered three years ago when a man in our ward suffered a sudden and unexpected heart attack. We other three were helplessly bedfast after operations, but we were able to summon the nurses immediately over the intercom. I do not know what we would have done if this had happened in the old wing of the hospital. Finally, a telephone could be plugged in at the patient's bedside whenever he needed it."

"I'd guess the electric and electronic gadgets in that new wing not only contribute to the comfort and peace of mind of the patients; they must surely make things a lot easier for the nurses."

"Precisely! When patients are rendered more self-sufficient and communications between nurses and patients are improved, fewer nurses can more easily care for a given number of patients. Hold that thought while I go on to another area.

"I also had an intravenous pyelogram in the hospital, and

that meant a trip to the x-ray department. The man in charge there is an electronics buff, and every time I fall into his clutches he tries to pump me about gadgets he wants to build and I try to pry information out of him about what he is doing to me and what he sees on those x-ray plates. This particular test is not painful, but it takes considerable time; so the x-ray technician and I had quite an opportunity to chat. I got him talking about electric and electronic equipment used in hospital laboratories—not just in our modest hospital but also in much larger institutions. I particularly sought information about equipment that enabled tests to be run automatically, quickly, and accurately.

Electronic Lab Equipment

"He first described a machine that prepares tissue specimens for microscopic examination. These have to go through variously timed staining processes and immersions in different concentrations of alcohol. The whole thing, from microtome to microscope slide is handled automatically by this electrically operated machine. Another instrument called the Coleman photometer does 90% of the chemistry tests for sugar, non-protein nitrogen, blood urea nitrogen, and cholesterol by electronic color-determination testing. Another instrument called a fibrometer determines the density of the blood for evaluating the prothrombin rate, a test important in determining the clotting factor. And then there is the electrophoresis tester that automatically and electronically analyzes serum. The auto analyzer does the same thing for blood. This instrument is so useful that even our hospital has two of them: one in the hematology section of the lab and the other in the chemistry section. A Colter counter is used to count rapidly the red and white blood cells in a specimen of blood. Water baths, refrigerators, and culture-growing ovens have their temperatures maintained precisely with electronic temperature controls.

"But this barely scratches the surface of how electronics is helping out in hospitals. An electronic 'reader' is said to analyze electrocardiograms faster and more accurately than a jury of physicians. A similar device in connection with an electroencephalograph, is claimed to be able to automatically analyze a brain malfunction as well as a highly trained doctor can. We already have computer-like instruments that can compare a patient's heart sounds with a storage bank of normal and abnormal heart recordings and come up with a quick diagnosis of the heart's condition. In fact, it takes little imagination to foresee the feeding of a patient's symptoms into a computer in which are stored hundreds of thousands of case histories against which the patient's symptoms can be matched for a readout diagnosis."

"A friend of mine just returned from a big clinic," Barney interrupted, "and he was telling me that when a nurse wanted to take an electrocardiogram she simply plugged a set of electrodes into a wall receptacle beside his bed from which a cable led to a permanently mounted machine at a remote monitoring position. The nurse and the operator at the monitoring position talked back and forth on the intercom until

Earn Extra Income in MOBILE-RADIO MAINTENANCE!



CITIZENS BAND
AIRCRAFT . . . MARINE
. . . PUBLIC SAFETY . . .
BUSINESS AND INDUSTRIAL
RADIO

961,000 new transmitters added
last year, with the curve still
going upward!

MEASURE FREQUENCY with the LAMPKIN 105-B

- Just this ONE instrument . . . with no extra crystals or factory adjustments . . . will measure ALL channels from 100 KC to 175 MC. Only \$295 00.
- Ample accuracy for all mobile transmitters except for split-channels above 50 MC—for these use inexpensive accessory PPM Meter.
- Pin-point signal generator for receiver final alignment.
- Internal quartz crystal standard . . . correctable to WWV.

MEASURE FM DEVIATION with the LAMPKIN 205-A

- Just this ONE meter measures all mobile channels, 25 MC to 500 MC.
- Reads instantaneous true peak swing due to FM modulation.
- Set selective-calling tone signals using 0-1.25 KC or 0-2.5 KC ranges of 205-A Quad Scale, \$340.00. Dual Scale model, 12.5 KC and 25 KC ranges, only \$290.00.
- Oscilloscope jack for true wave form.
- 3-inch meter indicates directly in peak KC.



105-B 205-A

FREE BOOKLET!

Send for "HOW TO MAKE
MONEY IN MOBILE-RADIO
MAINTENANCE".

MAIL COUPON TODAY!

At no obligation to me, please send free booklet and information on Lampkin meters.

Name _____
Address _____
City _____ State _____ Zip _____

LAMPKIN LABORATORIES, INC.
MFM Div., Bradenton, Fla. 33505

CIRCLE NO. 102 ON READER SERVICE CARD

GET INTO ELECTRONICS



V.T.I. training leads to success as technicians, field engineers, specialists in communications, guided missiles, computers, radar and automation. Basic & advanced courses in theory & laboratory. Electronic Engineering Technology and Electronic Technology curricula both available. Assoc. degree in 29 mos. B. S. also obtainable. G.I. approved. Graduates in all branches of electronics with major companies. Start September, February. Dorms, campus. High school graduate or equivalent. Write for catalog.

VALPARAISO TECHNICAL INSTITUTE
Dept. RD, Valparaiso, Indiana

the electrodes were all satisfactorily positioned; then the operator took the recording. Without moving from his chair, he could take an electrocardiogram of any patient in his area with only the help of a nurse's aid to place the electrodes.

"Another hospital provides a central monitoring console for keeping a constant check on patients in the intensive care ward. Sensors for temperature, blood pressure, respiration, and pulse are attached to every critical patient, and information from each set of sensors is fed to an individual panel of the monitoring console where each parameter is recorded on a chart. Upper and lower limits can be set for each function being recorded so that an alarm will sound if these limits are exceeded. In addition, a scope can be switched on to monitor information coming in on any panel for immediate observation of a critical body function. One operator sitting at that console can keep a very close check on the condition of several patients simultaneously—a far closer and more meaningful check than could be made by a nurse actually in the ward."

"Let me underscore just one more point," Mac said, "and then we'll try to pull all this together into an idea that has been gnawing at me. Overcrowding at our local hospital is not an exception; it is typical of conditions in practically every part of the country. A few months ago, 1600 people queued up in front of a major hospital in our state capital. Each person represented a patient waiting to get into that hospital. It was stated that some would have to wait more than a year for a hospital bed. While this was a publicity stunt aimed at raising funds for new hospital construction, it revealed the desperately overcrowded conditions in a great many of our hospitals. They are short of beds, short of nurses, short of orderlies, and short of trained laboratory technicians.

What About Medicare?

"But think how much worse things are going to get when Medicare goes into effect July 1st. At that time, millions of people in an age group with a high incidence of illness are going to have a right to hospital care they could not previously afford. For the first time, many of these people will have hospital insurance, and they are going to expect to be able to use it when they need it. It seems reasonable to expect that hospitals that are floundering now will be swamped unless something is done quickly.

"But it takes a long time to build new hospitals and equip them, and it takes several years to train new doctors, new nurses, and new laboratory technicians. For the next few critical years we are not going to have those new hospitals, doctors, nurses, or technicians. We must 'make do' with what we have. That

means everything possible must be done to increase the efficiency of those people dedicated to healing the sick, and patients must be rendered as self-sufficient as possible."

"Hey! I get what you're driving at!" Barney exclaimed. "You think the best way to take up the immediate slack is through electronics! You think installing new electric beds, new intercom equipment, new patient-monitoring equipment, and new up-to-date automatic laboratory equipment in all hospitals—not just the big clinics—is the best way to cope with the expected flood of Medicare patients."

"Right. An electric bed is expensive, but it is cheap when you think of it in nurse-hours saved. The same goes for an intercom installation. Automatic diagnostic equipment will make quicker and more accurate diagnoses possible. That means quicker cures and shorter stays in the hospital. Much of this equipment, because it is automatic, can be used by less highly trained personnel, leaving the trained technicians free to supervise and do work that instruments still cannot perform."

"All this is going to cost a wad of dough," Barney observed. "Where's it going to come from?"

"I believe local communities will raise funds to help their hospitals when they grasp the enormity of the problem," Mac answered, "but these funds very probably are going to be supplemented by grants from the same government that is providing Medicare. If Medicare beneficiaries cannot obtain benefits to which they are entitled and for which they are paying because hospital facilities simply are not available, a terrific howl is going to be heard in Congress.

"And we do have a War on Ill Health as well as a War on Poverty. While most of the big guns of this war are presently trained on distant, long-term objectives, such as the establishment of new medical schools and the development of new clinics for the treatment of major killers, I think expediency is going to dictate lowering the sights of some of these guns to provide much-needed immediate help to hospitals, large and small. And if it comes to a question of priority between the needs of the War on Ill Health and the War on Poverty, the former wins hands down. If you doubt it, ask any ill person, be he wealthy or poor, which should be first."

Barney had been sketching on a pad while his employer talked, and now he showed the latter what he had been drawing. Around the winged, snake-twined staff of the caduceus were very carefully drawn the circular orbits of the electron.

"I gather that's how you think the medical symbol of the future should look," Mac said with a grin as he turned back to the service bench. ▲

G-E 11-Inch Color TV

(Continued from page 41)

of Fig. 7, the E_c signal indicates the chroma signal and the bottom line is a vector presentation, showing the reference signal 180° out of phase.

Two identical diode demodulators are used to produce a signal 8.1° out of phase with the R-Y and 4.6° out of phase with the B-Y chroma signals respectively. The phase angle is determined by the electrical position of the two secondaries with respect to the primary. These phase-angle relations cannot be changed without changes in the transformer, and any variation of the primary tuning capacitor (tint control) will affect both demodulated signals to the same extent.

The blue and red color difference signals are applied to the grids of three triode amplifiers that drive the respective grids in the picture tube. The G-Y signal is obtained, as in many conventional color receivers, by combining the cathodes of the three amplifiers and by adding a small video component from the resistor network common to the two demodulators, as illustrated in Fig. 4. The outputs of the three color difference amplifiers are d.c.-coupled to their respective picture-tube grids, and, in the case of the blue and green, a d.c. bias setting determines the blue and green amplitudes.

The picture tube is not too different from other shadow-mask picture tubes in its over-all operation. Three separate screen-grid adjustments are available to obtain proper black-and-white balance. Focusing is accomplished by a common low-voltage electrostatic focus element which can be jumped either to +280 volts or to the horizontal boost voltage. A degaussing coil is permanently mounted around the screen of the 11SP22 and is actuated by a manual switch which discharges a normally charged capacitor through the degaussing coil. The rapidly decaying current through the coil performs the demagnetization.

The receiver uses a transformerless voltage-doubler silicon rectifier circuit to generate +280 volts and a half-wave rectifier to provide +135 volts. All the tube filaments, including those of the color picture tube, are in series. In servicing this receiver, it is essential that an isolating transformer be used to avoid accidental shock.

Editor's Note: The latest version of the G-E 21-inch color set uses a similar approach to chroma demodulation. In these sets, tint control is via a voltage-variable capacitor in the subcarrier amplifier and a third secondary (for G-Y, including its own diodes) is added to the demodulator transformer. Also, a separate shunt regulator is used. ▲



Your new copy is waiting

FREE! For fun and pride in assembly, for long years of pleasure and performance, for new adventures in creative electronics mail the coupon below and get Conar's brand new catalog of quality do-it-yourself and assembled kits and equipment. Read about items from TV set kits to transistor radios . . . from VTVM's to scopes . . . from tube testers to tools. And every item in the Conar catalog is backed by a no-nonsense, no-loopholes, money-back guarantee! See for yourself why Conar, a division of National Radio Institute, is just about the fastest growing entry in the quality kit and equipment business.

CONAR

MAIL THIS COUPON NOW

CONAR 3939 Wisconsin Ave., Washington 16, D.C.

CB6C

Please send me your new catalog.

Name _____

Address _____

City _____

State _____

Z-Code _____

CIRCLE NO. 119 ON READER SERVICE CARD



SUBSCRIPTION OFFER

SAVING UNDER SINGLE-COPY PRICE

3 Years \$12 YOU SAVE \$6

2 Years \$9 YOU SAVE \$3

1 Year \$5 YOU SAVE \$1

New Renewal Extension

**SEND ELECTRONICS WORLD
REGULARLY EACH MONTH, FOR:**

name _____ please print

address _____

city _____

state _____

zip code _____

Payment enclosed. (We will add 2 EXTRA ISSUES at no extra cost, for each year of your order!)

Bill me. I'll pass up the bonus.

initial _____

Additional postage: Add \$1 per year for Pan-Am and all other foreign countries.

Mail to: ELECTRONICS WORLD

Dept. 0136, Portland Place, Boulder, Colo. 80302

for PROFITABLE,
TIME-SAVING
SERVICING

OF: Black & White TV
Color TV

AM and FM, Tube or
Transistor Home, Portable
and Auto Radios

Communications
equipment &
Home
Appliances

Hi-Fi
Components

**B & K PROFESSIONAL
TEST EQUIPMENT**

WITH SIGNAL INJECTION AND IN-AND-OUT OF CIRCUIT
MEASURING TECHNIQUES

Send today for your free copy of Catalog AP22

B&K
DIVISION OF
DYNASCAN

DS-602

1801 WEST BELLE PLAINE AVENUE, CHICAGO, ILL. 60613
Telephone: (312) 327-7270 • Cable Address: BANDKOC

CIRCLE NO. 123 ON READER SERVICE CARD

How To Have Fun While You Save . . .

Something For Everyone . . . In This Vast Heathkit Selection!

Kit GR-43
\$159⁹⁵



New Heathkit 10-Band Transistor Portable!

10 bands tune Longwave, Standard Broadcast, FM and 2-22.5 mc Shortwave. 16 transistors, 6 diodes, and 44 factory assembled and pretuned circuits. Two separate AM & FM tuners and IF strips. FM tuner & IF strip are same components used in deluxe Heathkit FM stereo gear. 2 built-in antennas. Battery saver switch cuts current drain up to 35%. Rotating tuning dial. Dial light. 4 simple controls for tuning, volume, tone, AFC and band switching. 4" x 6" PM speaker. Earphone & built-in jack. Optional 117 v. AC converter/battery charger available @ \$6.95. Time zone map & "listener's guide." Man size: 13½" W x 5¼" D x 10%¹⁶" H. 17 lbs.

Kit GW-14
\$89⁹⁵

Assembled GWW-14
\$124⁹⁵



New 23-Channel, 5-Watt, Transistor CB Transceiver!

Your best 23-channel CB buy—bar none! Compare! 23 crystal-controlled transmit & receive channels for the utmost reliability . . . at lowest cost. All-transistor circuit for instant operation, low battery drain . . . only .75 A transmit, .12 A receive. Compact . . . 3" H x 7" W x 10½" D . . . ideal for car, boat, and 12 v. neg. gnd. mobile use. ½ uv sensitivity for 10 db signal plus noise-to-noise ratio. Includes "S" meter, adjustable squelch, automatic noise limiter, built-in speaker, ceramic PTT mike, gimbal mounting bracket, aluminum cabinet with die-cast chrome-plated front panel. 8 lbs. Kit GWA-14-1, optional power supply for AC operation, 5 lbs. . . \$14.95. GWA-14-2, complete 23 channel crystal package (46 CB crystals)—\$135.70 value. . . only \$79.95

Can You Match A Color With A Color, And A Letter With Another Letter? That's All It Takes To Make Music On This NEW Heathkit®/Thomas COLOR-GLO Organ!

Play complete songs in *minutes* instead of months! Color-Glo key lights show you the correct notes and chords . . . you and every member of your family can play melody, harmony and bass notes *instantly*. Just match up the colors with your left hand, the letters with your right hand . . . and you play complete songs . . . even if you've never played an organ before! And when you're finished, just flip a switch and the Color-Glo keys disappear, leaving a beautiful spinet organ console. Other features include 10 true organ voices; variable repeat percussion; 13-note heel and toe bass pedals; 2 overhanging 37-note keyboards; 50-watt EIA peak music power amplifier; 12" speaker; vibrato . . . all genuine Thomas factory-fabricated parts! Plug-in tone generators, the heart of the organ, warranted for 5 years. Fully transistorized. Handcrafted walnut cabinet. 153 lbs. GDA-232-1, matching walnut bench, 18 lbs. \$24.95

Kit GD-325
\$349⁹⁵
(less bench)

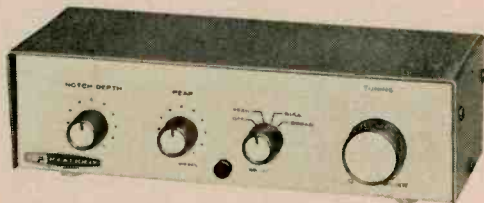

New Heathkit "Q" Multiplier

Ideal for use with SWL & Ham receivers with IF circuits from 450 to 460 kc such as the matching low cost Heathkit GR-64 shortwave radio (\$37.95). Creates extra sharp selectivity through an efficient "Q" of 4000, and provides a notch for adjacent signal attenuation. Includes built-in power supply. Attractive "low boy" charcoal cabinet with gray front panel. 3 lbs.

Kit GD-125
\$14⁹⁵



Kit HD-10
\$39⁹⁵

New Heathkit Solid-State Electronic Keyer

All solid-state circuitry. Speed range—15 to 60 words per minute. Solid-state switching—no relays to stick or clatter. Adaptable to either right or left handed operators. Convertible to semi-automatic operation. Variable dot-space ratio. Self-completing dashes. Sealed switches on paddle—no exposed contacts to clean or adjust. Built-in paddle—"feel" is adjustable to your fist during assembly. "Hold" switch for transmitter tuning. Transformer-operated power supply isolates keyer from line power. Fused for protection. 6 lbs.

... Build A Heathkit®!

Now Choose From 2 Heathkit® Transistor Stereo Receivers!



**New 30-Watt Transistor FM Stereo Receiver . . .
Less Than \$100!**

Features 31 transistors, 11 diodes for cool, natural transistor sound; 20 watts RMS, 30 watts IHF music power @ ±1 db, 15 to 60,000 cps; wideband FM/FM stereo tuner plus two preamplifiers & two power amplifiers; front panel stereo headphone jack; compact 3 7/8" H x 15 1/4" W x 12" D size. Assembles in 20 hours or less. Custom mount it in a wall, or optional Heath cabinets (walnut \$9.95, beige metal \$3.95) 16 lbs.

Kit AR-14
\$99⁹⁵
(less cabinet)



66-Watt Transistor AM/FM Stereo Receiver

Just add 2 speakers for a complete stereo system. Boasts AM/FM/FM Stereo tuning; 46-transistor, 17-diode circuit for cool, instant operation and natural transistor sound; 66 watts IHF music power (40 watts RMS) at ±1 db from 15 to 30,000 cps; automatic switching to stereo; preassembled & aligned "front-end" & AM-FM IF strip; walnut cab. 35 lbs.

Kit AR-13A
Now Only
\$184⁰⁰

Best Hi-Fi News Of '66 . . . New Low-Cost Transistor Stereo Twins!

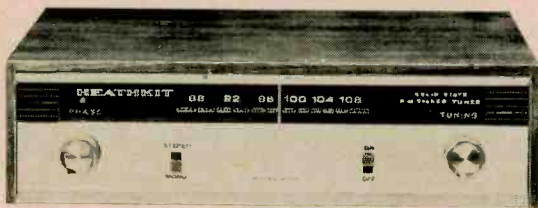

New Transistor FM/FM Stereo Tuner

Heath's easiest to build stereo/hi-fi kit . . . takes only 4 to 6 hours! 14 transistor, 5 diode circuit for cool instant operation, transparent transistor sound. Phase control assures best stereo performance. 3 transistor "front-end" plus 4-stage IF section. Filtered outputs for direct stereo recording. Automatic stereo indicator light. Preassembled & aligned "front-end." Install in a wall or either Heath cabinet (walnut \$7.95, beige metal \$3.50). 6 lbs.

Kit AJ-14
\$49⁹⁵
(less cabinet)

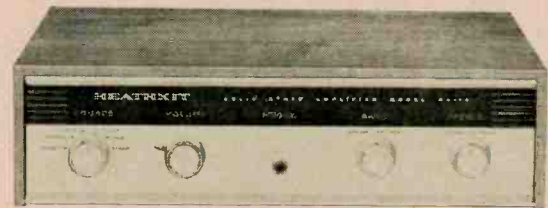

Matching 30-Watt Transistor Stereo Amplifier

Assembles in 10 hours or less! 17 transistors, 6 diodes. 20 watts RMS, 30 watts IHF music power @ ±1 db, 15 to 60,000 cps. No audio transformers . . . assures minimum phase shift, extended response, lower distortion. Solid-state power supply plus electronic filter for regulation within 10%. Accommodates phono, tuner, auxiliary . . . 4, 8, 16 ohm speaker impedances. Lighted panel. Installs in wall, or Heath cabinets (walnut \$7.95, metal \$3.50). 10 lbs.

Kit AA-14
\$59⁹⁵
(less cabinet)

FREE 1966 CATALOG!



108 pages . . . many in full color . . . describe these and over 250 easy-to-build Heathkits. Save up to 50%. Mail coupon or write Heath Company, Benton Harbor, Michigan 49022 for your FREE copy.

Buy Now—Use This Order Blank

Heath Company, Dept. 15-3
Benton Harbor, Michigan 49022



Please send FREE Heathkit Catalog

Model Description Weight Price

Name _____ (Please Print)

Address _____

City _____ State _____ Zip _____

SHIP VIA:
 Parcel Post Express Collect Freight 20% Included, C.O.D. Best Way
 Prices & Specifications subject to change without notice. CL-236

SELLING THAT RECORDER? BUYING A RECEIVER?

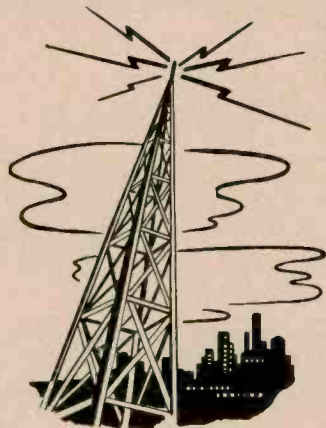

ELECTRONICS WORLD runs a Hot Line into the 197,524 electronics professionals who buy the magazine each month. And, for only 40¢ a word, a personal classified ad will help you make your connection.

ELECTRONICS WORLD has the largest audience of its kind in the world, and this creates an ideal market place for you. Actually, when you get together with your co-professionals, you may find that many are near neighbors. Yet your mutual needs may be met only through the medium of our classified columns.

Take advantage of our special personal rate of 40¢ a word (including name and address)

NO MINIMUM REQUIRED

a saving of 30¢ a word from our commercial rate of 70¢.

A small investment can bring quick results, and complete data is printed in the Classified Advertising Section. Write your ad and mail it today, with your payment to:

HAL CYMES
Classified Advertising Manager
ELECTRONICS WORLD
One Park Ave., N. Y., N. Y. 10016
MAY ISSUE CLOSES MARCH 1st.

NEW APPROACH TO EDUCATIONAL TV

Four channels of multiplexed audio and a video special-effects circuit are used to make students play an active role in educational-TV courses.

BECAUSE they felt that students taking conventional educational-TV courses were playing too passive a role, the *Educating Systems Inc.* of New York, in cooperation with *ICS Services* of Scranton, Pa., have developed a different approach to educational TV in which the viewer can participate to his advantage.

Unlike conventional educational TV in which a remote instructor conducts a one-way program, the new technique is a completely integrated system of teaching, testing, and immediate student response to the testing, where the teacher presents material, then tests the students on what they have learned.

In this system, the student, wearing earphones (Fig. 1) watches a TV monitor (or receiver) to follow program continuity. Periodically throughout the session, the action on the TV screen is stopped and up to four multiple-choice questions are flashed on the screen. Each question has a number associated with it, and the student is asked to choose the one he feels is the correct answer.

Choice is made by depressing one of four numbered buttons mounted in a box connected to the TV set. When the chosen button is depressed, the selected answer remains on the screen while the others disappear. The audio portion of the system then tells the student if he has chosen the correct answer or not and explains why the answer is correct or incorrect. After a few minutes, the picture and sound resume. Arrangements can be made so that when a button is depressed, a permanent record is made so that students' progress can be charted.

At present, the four audio channels are carried by a commercial FM station as subcarriers at 30, 40, 52.5, and 70 kHz with each channel ± 3 kHz wide.

In the video portion, shown in Fig. 2, the incoming horizontal sync pulses are fed to a pair of cascaded delay multivibrators. Each of these delay circuits can deliver an output blanking pulse half a horizontal line long (37 μ secs.). The first multivibrator is triggered by the horizontal sync while the second is triggered by the trailing edge of the first multivibrator output. The blanking output is fed to the CRT gun so that if

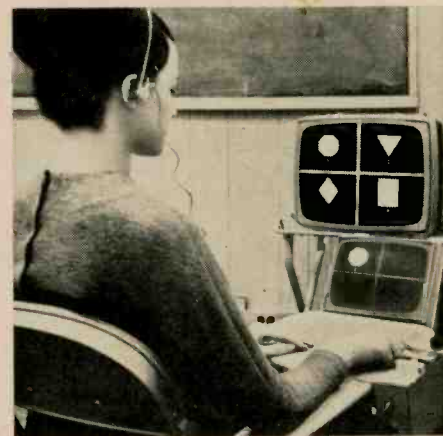

Fig. 1. Student can select one of four answers for display on the TV monitor.

the first delay is selected, the left-hand side of the screen is displayed while the other half is blanked out. If the second delay is chosen, the right-hand portion is displayed while the left-hand portion of the screen is blanked.

The vertical circuit consists of a 1/120-second multivibrator triggered by the vertical sync pulse. The output blanking pulse from this circuit is selected so that if the top half of the picture is chosen, the bottom half is blanked out, and conversely, if the bottom half of the picture is chosen, the top half will be blanked out.

By combining the two circuits in a selector switch, it becomes possible to select any quadrant for display while blanking the others out.

In a variation of the video display, the delay multivibrators are used to drive special sweep circuits so that the selected quadrant will fill the entire screen. ▲

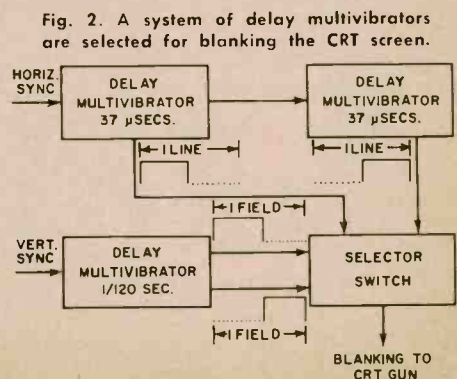

WANTED

A COMPLETE SELECTION OF ANNUALS, YEAR-BOOKS, DIRECTORIES AND HANDBOOKS from the world's largest publisher of special interest magazines. They're all editions that have escaped many of our readers in past years and are still on their most wanted list. Take a moment to review the titles still available. You're sure to find many of your favorites.



PHOTOGRAPHY ANNUAL

A selection of the World's finest photographs compiled by the editors of Popular Photography. All editions \$1.25 each:

- | | |
|-------------|-------------|
| 1966.....#1 | 1961.....#6 |
| 1965.....#2 | 1959.....#7 |
| 1964.....#3 | 1958.....#8 |
| 1963.....#4 | |
| 1962.....#5 | |



ELECTRONIC EXPERIMENTER'S HANDBOOK

Many challenging projects for the electronics hobbyist.

- | | |
|--------------------------------|-----|
| 1965 — Fall Edition — \$1.25 | #9 |
| 1961 — \$1.00 | #10 |
| 1962 — \$1.00 | #11 |
| 1963 — \$1.00 | #12 |
| 1964 — \$1.00 | #13 |
| 1965 — Spring Edition — \$1.25 | #14 |



CAR & DRIVER YEARBOOK

A complete buyers guide covering virtually every car available in the United States . . . Road tests . . . Technical specifications . . . Accessories and performance equipment buying guide . . . Guide to racing with action-packed photos.

- | | |
|---------------|-----|
| 1966 — \$1.25 | #15 |
| 1964 — \$1.00 | #16 |
| 1965 — \$1.25 | #17 |



COMMUNICATIONS HANDBOOK

The most complete and up-to-date guide to the exciting world of specialized radio communications.

- | | |
|---------------|-----|
| 1966 — \$1.25 | #18 |
| 1965 — \$1.00 | #19 |
| 1964 — \$1.00 | #20 |
| 1963 — \$1.00 | #21 |



PHOTOGRAPHY DIRECTORY

World's most complete photographic buying guide.

- | | |
|---------------|-----|
| 1966 — \$1.25 | #22 |
| 1965 — \$1.00 | #23 |



POLAROID LAND PHOTOGRAPHY

Complete guide and only comprehensive and up-to-date handbook on Polaroid Land Photography.

- | | |
|---------------|-----|
| 1966 — \$1.25 | #24 |
| 1963 — \$1.00 | #25 |

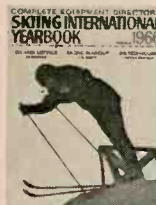

SKIING INTERNATIONAL YEARBOOK

A luxuriously illustrated compendium of 1965's important events . . . A timely forecast of the excitement-packed 1966 season—by the editors of Skiing Magazine.

- | | |
|---------------|-----|
| 1966 — \$1.25 | #26 |
|---------------|-----|

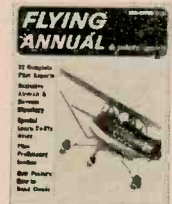

FLYING ANNUAL

The most valuable aviation yearbook ever compiled . . . Pilot reports . . . Aircraft directory . . . How to buy a used airplane . . . Navcom directory . . . Learn to fly section.

- | | |
|---------------|-----|
| 1966 — \$1.25 | #27 |
| 1965 — \$1.25 | #28 |



STEREO/HI FI DIRECTORY

Complete buyers guide for virtually every Hi Fi component manufactured.

- | | |
|---------------|-----|
| 1966 — \$1.25 | #29 |
|---------------|-----|



TAPE RECORDER ANNUAL

Everything you need to know about tape recording including a complete directory of mono and stereo recorders.

- | | |
|---------------|-----|
| 1966 — \$1.25 | #30 |
| 1965 — \$1.00 | #31 |



ELECTRONICS INSTALLATION AND SERVICING HANDBOOK

The only complete guide for servicemen and hobbyists to every major phase of consumer electronics servicing.

- | | |
|---------------|-----|
| 1966 — \$1.25 | #32 |
|---------------|-----|



COLOR PHOTOGRAPHY ANNUAL Special

Only 200 copies available (#33)—an international treasury of the year's best color pictures selected by the editors of Popular Photography. 162 pages, 64 in full color. This valuable "collectors edition" will be shipped to the first 200 persons ordering—

- | | |
|--------|-----|
| \$1.25 | #33 |
|--------|-----|

TO PLACE YOUR ORDER, circle the numbers of the annuals you wish to receive on the coupon, clearly print your name and address and enclose your remittance. Please be sure to enclose an additional 15¢ shipping and handling for each copy ordered. Add 50¢ per copy for orders outside U.S.A.

Ziff-Davis Publishing Co.—Dept. SD
One Park Avenue, New York, N.Y. 10016

I am enclosing \$_____ for the annuals circled below. My remittance includes an additional 15¢ per copy for shipping and handling (50¢ for orders outside U.S.A.). I understand quantities are limited and orders will be filled on a first come-first served basis.

- | | | | | | | | | | | | | | | | | |
|----|----|----|----|----|----|----|----|----|----|----|----|----|----|----|----|----|
| 1 | 2 | 3 | 4 | 5 | 6 | 7 | 8 | 9 | 10 | 11 | 12 | 13 | 14 | 15 | 16 | 17 |
| 18 | 19 | 20 | 21 | 22 | 23 | 24 | 25 | 26 | 27 | 28 | 29 | 30 | 31 | 32 | 33 | |

Name _____

Address _____ EW-36

City _____ State _____ Zip Code _____

Payment must be enclosed with order.

PERMANENT PROTECTION!



Electronics World

Deluxe Magazine Files that hold a full year's copies!

Designed to keep your periodicals orderly and easy to refer to. These durable files guard against soiling, tearing, wear or misplacement of issues. They look, feel like leather and are washable! 23kt. gold lettering and exquisite 2-color binding make them highly-decorative additions to your bookshelves.

Shipped POSTPAID! FULLY GUARANTEED!

Only \$3.50 each—3 for \$10, 6 for \$19

Order several today—for ELECTRONICS WORLD and all your other favorite magazines.

Jesse Jones Box Corp., Dept. EW
 Box 5120
 Philadelphia 41, Pa.

Please send me:

TITLE	QTY.	BLACK BACKING/ MAROON SIDES	MAROON BACKING/ BLACK SIDES
Electronics World	_____	<input type="checkbox"/>	<input type="checkbox"/>
_____	_____	(Other publications shipped in colors available.)	

Total amount enclosed \$ _____

name _____

address _____

city _____ state _____ zip-code _____

--- (Payment Must Accompany Order) ---

WORLD'S FINEST
5-CORE SOLDER

ERSIN MULTICORE
NEW EASY DISPENSER PAK
ONLY 69¢

BUY IT AT RADIO-TV PARTS STORES

MULTICORE SALES CORP. WESTBURY, N.Y. 11591
 CIRCLE NO. 98 ON READER SERVICE CARD

RADIO & TV NEWS

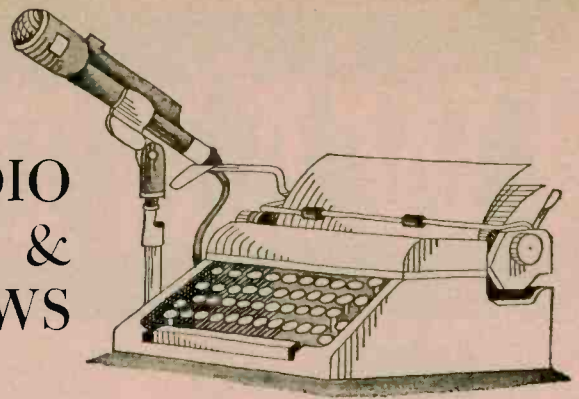

ALTHOUGH all the electronic circuits of color TV have been explained in detail, both in this and other electronics publications, there are some nuances that are often overlooked. One of these, in the color demodulator system, seems to be of interest according to our mail.

Most color-TV sets use either the I and Q, or the R-Y, B-Y axes in their color demodulators. In these cases, the two axes are 90° (quadrature) apart and located in their NTSC-designated angle positions. Due to certain patent claims, some receiver manufacturers use neither of these two axes, and the ones that they do use are not in quadrature.

Most use a pair of axes with one in the neighborhood of R-Y, some degrees to either side, while the partner axis lies somewhere in the B-Y sector, at some angle other than 90° from the first.

RCA, for example, places its X axis 10.9° off the R-Y angle, with the associated Z axis 62.5° from this towards the B-Y axis. Other companies use somewhat different axes angles and angular relationships.

Regardless of the demodulation axes used, the outputs of these color demodulators invariably work into a matrix whose values are arranged to produce the correct B-Y, R-Y, and G-Y signals to the guns of the color CRT. Thus, all transmitted colors fall into their correct relationships.

Blackboard by Wire

A Columbia University professor is teaching a course in contemporary mathematics simultaneously to 300 senior students at 10 colleges in eight mid-western and southern states through a communications system that simultaneously transmits both his voice and handwriting over conventional telephone circuits using a new approach to educational electronics developed by the General Telephone and Electronics Corp.

In this blackboard-by-wire system, the written material is transmitted in the form of a sequence of audio tones to a receiving unit in each of the 10 college classrooms.

These units then convert the tones to a large-screen display of the original

handwriting. Conventional two-way voice circuits, operating through amplifiers at each end, enable the students to comment or ask questions.

Currently, Texas A & M University is using this new remote teaching aid to conduct a series of graduate-level chemistry courses in two cities, some 200 miles from the university.

Man-Made Sun

Scientists at the General American Transportation Corp. Research Division have built a sun-like device that can produce a sunburn on a human being within five seconds.

Called a high-intensity monochromator, the device can project light at any wavelength of the sun's visible and near-visible spectrum at intensities greater than those found outside the earth's atmosphere. It can project three different wavelengths ranging from ultraviolet to infrared simultaneously.

The device is not designed to produce tans on humans, although some research is being directed in this way, but to investigate the effects of intense sunshine on plant growth and eye sensitivity, and the effects of strong sunlight on astronauts and space vehicles.

Color Up; Mono Down

Distributor sales of color-TV receivers to dealers during the first six months of 1965 totaled 839,000 units, up 83.3 percent from sales during the same period last year. During the same interval, monochrome-TV receiver sales were off 1.6 percent, at 3,387,000 units.

According to the Electronics Industries Association, distributors suffered sales declines of monochrome-TV sets in six out of the nine geographical regions.

Of the three regions (New England, East North Central, and South Atlantic) which registered increases, the East North Central area showed a sharp rise of nearly 9 percent in distributor sales.

All nine U.S. geographic areas registered sales increases in color-TV sets during the first half of the year. The West Central, East South Central, and South Atlantic regions set the pace with increases of 111 percent, 109 percent, and 100 percent, respectively. ▲

Engineered for Professional Quality and savings up to 50%

Whether you want the creative pleasure and thrift of build-it-yourself, or factory-assembled professional quality equipment ready-to-use—you save up to 50% with EICO

no-compromise engineering. Be super-critical. Compare EICO with anybody else. The more critically you judge, the more you'll see for yourself that your best buy is EICO.

EICO

KITS & WIRED

COLOR TV LAB

Three compact portable instruments for shop or home Color TV servicing. Add one more and you're set for FM-MPX stereo.

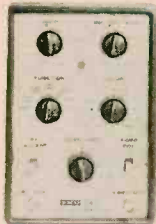

New Model 380 Solid State NTSC Color Generator generates exact NTSC color signals individually and all required dot-bar patterns. Super-compact, 4 pounds light, instant operation. \$159.95 wired only.

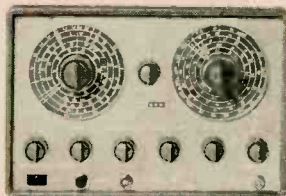

Model 369 Sweep/Marker Generator for easiest, fastest visual alignment of color or B&W TV and FM RF and IF circuits. Five sweep ranges from 3-220mc. Four marker ranges from 2-225mc. Crystal marker oscillator. Post Injection of markers. \$89.95 kit, \$139.95 wired.

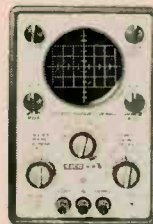

New Model 435 Direct-Coupled Wideband Scope. Top-quality DC-4.5mc scope with 3" flat-face CRT. Zener calibrator: Outperforms 5" scopes three times its size, facilitates on-location color TV and other servicing. \$99.95 kit, \$149.95 wired.



New Model 342 FM Multiplex Signal Generator. Design lab quality. Both composite audio and FM RF outputs. Inputs for stereo audio source for store demonstrations, critical A/B listening tests. \$149.95 wired.



New Model 1030 Regulated Power Supply. Speeds troubleshooting, design work, production line testing, electronics teaching. Variable bias and plate sources regulated to 1/4 of 1%: 0-150V @ 2ma; 0-400V @ up to 150ma. Ripple less than 3mv rms. Unregulated fil. volts of 6.3V & 12.6V. @3A. Switchable, monitoring milliammeter and voltmeter. \$59.95 kit, \$99.95 wired.



New Model 378 Audio Generator. Near-distortionless sine wave generator (<0.1% 20-20,000c) providing fast, convenient switch-selection of frequencies from 1c to 110kc (1c steps 1c-100c, 10c steps 100c-1kc, 100c steps 1kc-10kc, 1kc steps 10kc-110kc), 8-pos. 10db/step output attenuator & fine attenuator. Output meter (4 1/2" 200ua) with 8 voltage ranges & db scale. \$49.95 kit, \$69.95 wired.



New Model 965 FaradOhm Bridge/Analyzer. "Unusually versatile" — Electronics World. 9-range, low-voltage capacitance-resistance bridge safely measures even 1-volt electrolytics. Metered bridge balance, leakage test voltage (6 DC VTAM ranges 1.5-500V), leakage current (11 DC VTAM ranges 0.15ua-15ma). DC VTVM & VTAM externally usable. \$129.95 wired.



Model 460 Wideband Direct-Coupled 5" Oscilloscope. DC-4.5mc for color and B&W TV service and lab use. Push-pull DC vertical amp., bal. or unbal. input. Automatic sync limiter and amp. \$89.95 kit, \$129.50 wired.



Model 232 Peak-to-Peak VTVM. A must for color or B&W TV and industrial use. 7-non-skip ranges on all 4 functions. With Uni-Probe.® \$29.95 kit, \$49.95 wired.



New Model 779 Sentinel 23 CB Transceiver. 23-channel frequency synthesizer provides crystal-controlled transmit and receive on all 23 channels. No additional crystals to buy ever! Features include dual conversion, illuminated S/R/F meter, adjustable squelch and noise limiter, TVI filter, 117VAC and 12VDC transistorized dual power supply. Also serves as 3.5 watt P.A. system. \$169.95 wired.



New Model 3566 All Solid-State Automatic FM MPX Stereo Tuner/Amplifier. "Very satisfactory product, very attractive price" — Audio Magazine. No tubes, not even novistors. Delivers 112 watts IHF total to 4 ohms, 75 watts to 8 ohms. Completely pre-wired and pre-aligned RF, IF and MPX circuitry, plus plug-in transistor sockets. \$219.95 kit (optional walnut cabinet \$14.95), \$325.00 wired including walnut cabinet. UL approved.



New Model 753 The one and only SSB/AM/CW Tri-Band Transceiver Kit. "The best ham transceiver buy for 1966" — Radio TV Experimenter Magazine. 200 watts PEP on 80, 40 and 20 meters. Receiver offset tuning, built-in VOX, high level dynamic ALC. Unequaled performance, features and appearance. Sentionally priced at \$179.95 kit, \$299.95 wired.

FREE 1966 CATALOG

EICO Electronic Instrument Co., Inc. EW-3
131-01 39th Ave., Flushing, N.Y. 11352

Send me FREE catalog describing the full EICO line of 200 best buys, and name of nearest dealer. I'm interested in:

- test equipment ham radio
 stereo/hi-fi Citizens Band radio

Name _____
Address _____
City _____ State _____

1945-1965: TWENTY YEARS OF LEADERSHIP IN CREATIVE ELECTRONICS

MALE

career opportunities

with

**Programmers
SYSTEMS & APPLICATIONS**

Professional programmers with college degrees and 2 or more years of experience on large-scale computers are needed to participate in the specifications and implementa-

MALE HELP WANTED
CIANS

MAINTENANCE
TECHNICIANS

For

Commercial
communications
Equipment

are immediate openings for technical school graduates with related experience with equivalent training experience. Must have had class FCC radio telegraph and telecommunication experience. Actual experience in data communications, telephone systems and in transmission systems will be helpful.

LABORATORY TECHNICIAN

High school graduate with good technical ability and high intelligence to train for photographic and high intelligence to train for photographic resist application of precision patterns in metal and on glass.

Complete benefit program including profit sharing.

**ELECTRONIC TEST
TECHNICIANS**

Production testing and trouble-shooting of VHF and UHF aviation radio equipment. Exceptional opportunity for permanent first and second shift positions with AAA standing profit-sharing program. Male and female.

**MECHANICAL
DRAFTSMEN**

Male openings for first and second shift positions. High school graduates with advanced training in drafting. These

**DATA REDUCTION
TECHNICIANS**

LOCAL

Enter large-scale scientific and business data into a computer. Work with the computer operator to process data into usable form. Show of data to be processed. Show of data to be processed. Show of data to be processed. Show of data to be processed.

TECHNICIANS

FOR ANALOG
DIGITAL AND
HYBRID COMPUTERS
& CALIBRATION

**ELECTRON
TECHNICIA**

Permanent positions offering excellent working conditions. For more information, fill out and return this coupon to:

**ELECTRONICS
TECHNICIAN**

With experience in transmitter or entry level electro-mechanical devices wanted as engineering assistant for development of data communications equipment. Excellent technical background and familiar with radio-

**ELECTRONIC WIRING
& SOLDERING**

We are looking for an entry level position in our electronics department. You must have a high school diploma and be able to read and understand electronic schematics.

**RADAR
SYSTEMS**

Seeking experienced radar technicians for our radar systems department. Must have a high school diploma and 2 years of experience in radar systems.

WANTED:

half a million

**INSTRUMENTATION
TECHNICIANS**

**RESEARCH
TECHNICIANS**

RCA HOME TRAINING CAN PREPARE YOU FOR THE BIGGEST CAREER OPPORTUNITIES IN HISTORY! NEW 'CAREER PROGRAMS' POINT THE WAY!

Electronics Jobs Expanding Every Day; Trained Technicians in Demand; RCA Institutes "Space Age" Methods make learning faster, easier!

Government reports have indicated the increasing demands for manpower in the electronics fields.* New developments in modern technology, automation, the growth of new areas of work, such as atomic energy, earth satellites and other space programs, and data systems analysis and processing are changing the occupational picture daily. To help meet this need, RCA Institutes offers a wide variety of Home Training Courses, all geared to a profitable, exciting electronics career in the shortest possible time.

New Career Programs right on target

RCA Institutes new "Career Programs" are complete units that train you for the specific job you want. And each of them starts with the amazing "AUTOTEXT" Programmed Instruction Method—the new scientific way to learn. RCA "AUTOTEXT" helps even those who have had trouble with ordinary home training methods in the past. Learn faster and easier than ever before!

Valuable Equipment Included

With each RCA Institutes Career Program, you receive valuable equipment to keep and use on the job. You'll get the new Programmed Electronics Breadboard which provides limitless

laboratory type experimentation, from which you construct a working signal generator and a superheterodyne AM Receiver. And as a special bonus, you get valuable Multimeter and Oscilloscope Kits—all at no additional cost!

Liberal Tuition Plan Ideal for Today's Budgets

RCA Institutes offers you this most economical way to learn. You pay for lessons only as you order them. No long term contracts. You can stop your training at any time and you will not owe one cent! Compare this with any other home training plan!

Choose from these Job-Directed Programs.

- TELEVISION SERVICING
- FCC LICENSE PREPARATION
- AUTOMATION ELECTRONICS
- AUTOMATIC CONTROLS
- DIGITAL TECHNIQUES
- TELECOMMUNICATIONS
- INDUSTRIAL ELECTRONICS
- NUCLEAR INSTRUMENTATION
- SOLID STATE ELECTRONICS
- ELECTRONICS DRAFTING
- plus a wide variety of separate courses from Electronics Fundamentals to Computer Programming.

technicians!

CLASSROOM TRAINING ALSO AVAILABLE

You may also learn electronics at one of the most modern laboratory and classroom electronics schools in the country—RCA Institutes Resident School in New York City. Day and Evening Courses start four times a year—and courses are planned so as not to interfere with your job or social life. No previous technical training needed for admission. You are eligible even if you haven't completed high school.

SEND NOW FOR NEW VALUABLE FREE CAREER BOOK—YOURS WITHOUT COST OR OBLIGATION. SEND POSTAGE PAID CARD TODAY. CHECK HOME TRAINING OR CLASSROOM TRAINING.

Free Placement Service For all Students

Recently, RCA Institutes Free Placement Service has placed 9 out of 10 Resident School graduates in jobs before or shortly after graduation! And, many of these jobs are with top companies—like IBM, Bell Telephone Labs, General Electric, RCA, and radio and TV stations throughout the country. This service is now available to Home Study students as well.

RCA INSTITUTES, Inc. Dept. EW-36

350 West 4th St., New York, N. Y. 10014

A Service of Radio Corporation of America



The Most Trusted Name in Electronics

*"Scientists, Engineers, and Technicians in the 1960's" U.S. Dept. of Labor Bureau of Labor Statistics, 1964.

TEST EQUIPMENT

PRODUCT REPORT

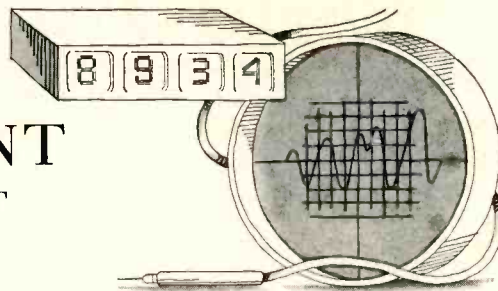

Hewlett-Packard Model 141A Oscilloscope

For copy of manufacturer's brochure, circle No. 160 on Reader Service Card.



THE Model 141A oscilloscope is said to be the first variable-persistence instrument; it performs scope functions that previously were impossible. The unit behaves just like its conventional counterpart until its "Persistence" or "Store" knobs are operated. Then the new Model 141A will produce gradually decaying traces whose persistence may be continuously varied from about $1/5$ second to more than one minute. When switched to the "Store" mode, the unit becomes a storage scope, yet it retains the advantages of conventional scopes: dark background for contrast, long tube life, and non-glare internal graticule screen with no-parallax display. Waveforms may be observed up to one hour without degradation and stored for days with the instrument turned off.

The unit is actually an oscilloscope main-frame, and it accepts all plug-ins previously offered by H-P for its Model 140A, including its 20-mc. amplifiers, high-sensitivity guarded amplifiers, time-domain reflectometer, and swept-frequency indicator.

With continuous variability of trace fade-time, slowly swept traces may be continuously on display by adjusting per-

sistence to match sweep time. Annoying flicker is removed from slow sweeps; the trend of changing waveforms can be followed by superimposing successive traces with rate-of-fade adjusted to prevent confusion from the accumulation of too many traces; meaningless random deviations from sweep to sweep may be rejected, since successive repetitive traces will add in brightness.

Many biological phenomena occur at low rates; observing them with the variable-persistence screen, the traces may be made to linger long enough so that the entire wave is constantly on the screen, set to fade fast enough so that successive traces are not confused with their predecessors. Continuous swept-frequency displays may be made slowly for maximum resolution, with adequate visibility at all times. Successive sweeps may be superimposed to observe trends in the behavior of the subject through a series of adjustments.

The heart of the instrument is a newly designed CRT with pulsed persistence-controlling circuitry. Storage is on a storage mesh, not on the screen, so the phosphor was selected for optimum visibility, and an internal graticule was employed. The pattern is etched on the dielectric storage mesh by secondary emission as the writing electron beam dislodges electrons from it (see diagram). Flood guns now spray low-velocity electrons toward the screen. Near the stored positive charge on the storage mesh, the screen's positive field pulls flood electrons through the mesh. These stroke the phosphor, producing the visible trace. The background remains dark.

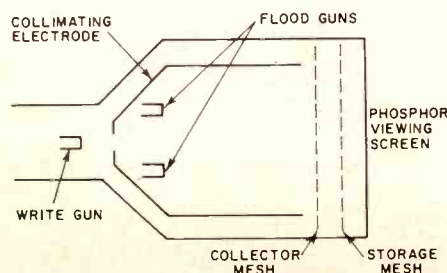

To erase the pattern on the mesh, its static voltage is reduced all over. If the erase voltage is pulsed in successive small increments, the pattern will slowly fade. Erasure may be accelerated by widening the pulses. Variable persistence, then, is achieved by the pulse-width control on the erase pulse generator. Storage is accomplished by holding off the erase voltage.

The new instrument is priced at \$1275 without plug-ins. ▲

B&K Model 606 Tube Tester

For copy of manufacturer's brochure, circle No. 30 on Reader Service Card.

THE Model 606 "Dyna-Jet" tube tester has been designed for fast testing of the newest color, Compactron, and other receiving tubes. It tests for shorts, grid emission (in a unique 100-megohm-sensitive circuit), leakage, gas, and cathode emission under simulated load conditions.

The sensitive grid-emission and gas-test circuit is shown here. The tube under test has its normal plate-to-grid voltage applied, but the grid is biased beyond cut-off so that no plate current flows. This bias is applied through the 5.6-meg resistor. The same resistor is also in the grid circuit of the triode section of a 6BN8 d.c. amplifier. This tube is also



biased just beyond cut-off. Under these conditions, no plate current flows and no reading is obtained on the meter in the plate circuit.

However, if the tube under test is gaseous, or if its grid is contaminated with some of the cathode coating, then current will flow from grid to plate and through the 5.6-meg. resistor back to the grid again. This will result in a voltage drop across the resistor as shown in the diagram, lifting the cut-off bias on the 6BN8 and producing a meter deflection. Upon seeing this deflection, which reveals as little as 2 to 3 micromperes of grid current, the technician immediately knows that the tube under test is defective and should be replaced.

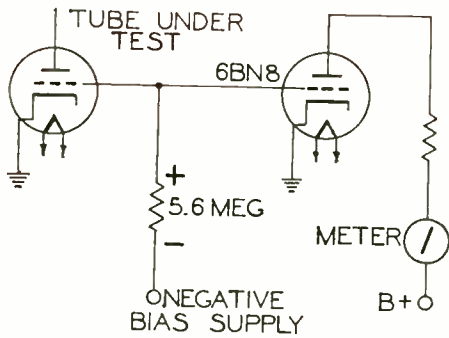

The tube tester is housed in a sturdy, leatherette-covered carrying case that is small enough to fit into a tube caddy. A reference index supplied with the unit contains a complete tube listing. The tester is priced at \$79.95. ▲

**Electro Scientific
Model 300 Voltmeter Bridge**

For copy of manufacturer's brochure,
circle No. 161 on Reader Service Card.



THIS new Model 300 potentiometer voltmeter bridge provides a complete five-dial d.c. measurement facility in one convenient battery-operated portable package. It combines the functions of a potentiometer voltmeter, a picoammeter, a wide-range guarded Wheatstone bridge, a four-terminal Kelvin bridge, a resistance comparison bridge, a ratiometer, and a high-sensitivity electronic null detector in a single instrument.

Applications include potentiometric temperature measurement with base- or noble-metal thermocouples, calibration of potentiometric indicating recorder controllers, d.c. voltmeters and ammeters, x-y recorders, analog computing elements involving linear or non-linear d.c. voltage functions, checking of d.c. power supplies, measurement of Redox and other chemically generated potentials, and calibration of resistance thermometers and thermocouples. Accurate four-terminal measurements of the low resistance of switch contacts, wires, rods, carbon brushes, windings of motors, generators, transformers, and other electrical conductors can be made.

First One-Piece All-Channel Antenna with Individual UHF and VHF Orientation

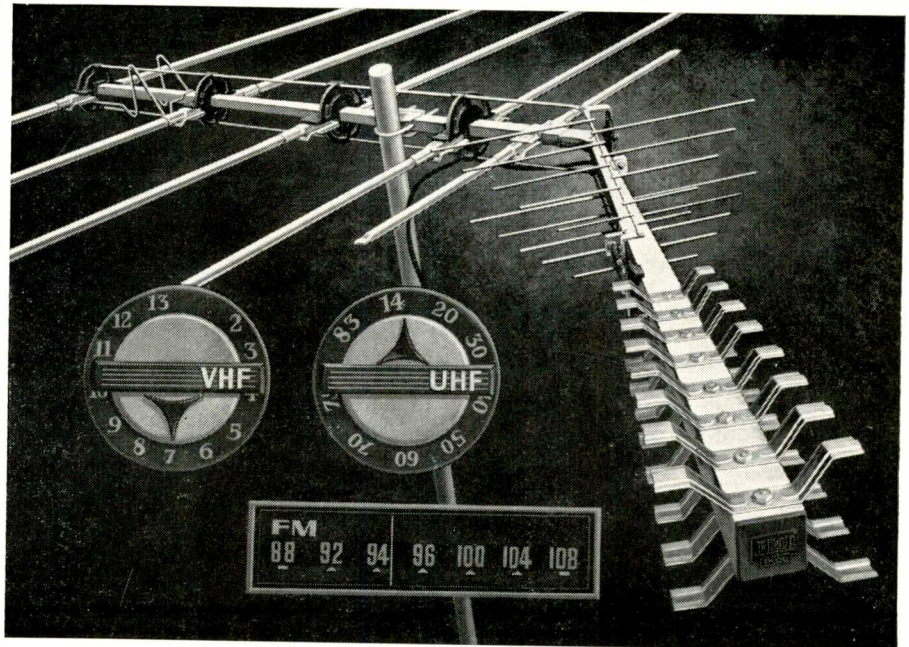

New JERROLD Coloraxial™ Pathfinder™

Now you can pull in strong VHF, UHF, and FM signals all from a single antenna, with the assurance that all three bands are properly oriented for best reception.

The new PATHFINDER offers this all-channel versatility plus a choice of 75-ohm coaxial or 300-ohm standard outputs. Prices are as low as \$21.95 list.

Note from the illustration that the UHF section is hinged for individual orientation and maximum directivity. You get all the flexibility of separate antennas, without the losses from coupling separate antennas to a common downlead. Rugged square-boom construction and Golden Armor corrosion-resistant finish assure long life. Flat response across all 82 channels, low VSWR, excellent front-to-back ratio make PATHFINDER the antenna to answer every TV and FM reception need. Send for complete information.



JERROLD ELECTRONICS CORPORATION
Distributor Sales Division, Dept. EW-3
15th & Lehigh Ave., Philadelphia, Pa. 19132

Please send me complete information on
PATHFINDER all-channel TV and FM antennas.

Name _____
Address _____
City _____ State _____ Zip _____

CIRCLE NO. 104 ON READER SERVICE CARD

PUT **ZIP**
in
your mail

Include
ZIP CODE NUMBERS
IN ALL ADDRESSES

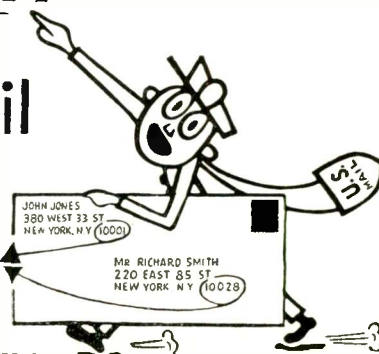

POSTMASTER

whether you operate
a space
rocket... ..or a radio rig...

YOU NEED
TEXAS CRYSTALS
to control frequency!

Why TEXAS CRYSTALS? Simply because you can be sure of their doing the job perfectly, just as they have in numerous space projects. And, TEXAS CRYSTALS are unconditionally guaranteed! Regardless of your crystal needs—CB, amateur, commercial 2-way, low frequency, marine, aircraft, etc.—see your parts dealer for TEXAS CRYSTALS.

If your dealer can't supply your needs, send his name with your request for catalog to our plant nearest you.



- CB • AMATEUR
- COMMERCIAL
- RADIO CONTROL
- MILITARY
- MINIATURE
- LOW FREQUENCY
- AIRCRAFT

TEXAS CRYSTALS

1000 Crystal Drive
Fort Myers, Florida 33901
Phone 813 — WE 6-2109

4117 W. Jefferson Blvd.
Los Angeles, California 90016
Phone 213 — 731-2258

A Division of Whitehall Electronics Corp.

CIRCLE NO. 86 ON READER SERVICE CARD

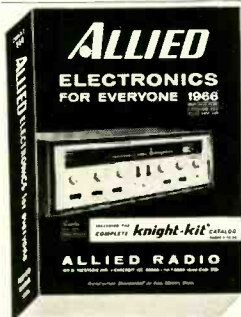

FREE

send for your
MONEY-SAVING
508-page

1966 **ALLIED** CATALOG

SAVE MOST ON:

Stereo Hi-Fi
Tape Recording
CB 2-Way Radio
Shortwave & Ham Gear
Automotive Electronics
FM-AM & AM Radios
Portable TV & Phonos
Test Instruments
TV Tubes & Antennas
Power Tools, Hardware
Parts, Tubes, Transistors

See the world's largest selection of top money-saving buys, including exclusive Knight-Kits and products available only from ALLIED. Get fastest service, easy-pay terms, satisfaction guaranteed or your money back. Send coupon today for your FREE 1966 ALLIED Catalog.

EASY TERMS: Use the Allied Credit Fund Plan.

ALLIED RADIO

free
catalog

ALLIED RADIO, Dept. 1-C
100 N. Western Ave., Chicago, Ill. 60680

Send FREE 1966 ALLIED Catalog.

Name

PLEASE PRINT

Address

City

State

Zip

CIRCLE NO. 125 ON READER SERVICE CARD
78

MOVING?

ATTACH
LABEL HERE

If you've recently changed your address or plan to in the near future, be sure to notify us at once. Affix address label showing old address here, and print new address below.

My New Address is:

name please print

address

city

state

zip-code

date at new address

Notify us of your address change as far in advance as possible—it takes about 2 months for a change to become effective. (Eg. A notice received in May becomes effective with the July issue.)

Mail to: ELECTRONICS WORLD
1255 Portland Pl., Boulder, Colo. 80302

A modulator-type detector with an integral high-gain solid-state amplifier provides better than 5-mv. d.c. sensitivity with an input impedance of one meg. Battery life is over one year of forty hours per week use with "D"-size cells.

Five voltage ranges (from 50 mv. full-scale to 500 volts), eight current ranges (from 0.5 μ a. full-scale to 5 amp.), and ten resistance ranges (0.5 ohm full-scale to 500 meg.) are provided. Accuracy is $\pm 0.02\%$ of reading or one switch step for essentially all functions.

The instrument is priced at \$750. ▲

FIELD-EFFECT LIGHT METER

THE photosensitive field-effect transistor is a special unipolar field-effect device that receives illumination through a lens in the top of its header can.

Incident radiant energy within the wavelength band of 1.1 to 0.4 microns (near infrared to blue) will generate a current across the gate channel junction of the device. This photodiode action is amplified by the internal equivalent of a high-impedance, low-noise amplifier.

The photometer shown in the diagram uses a Siliconix P-102 device and can be used to measure optical density changes in a sample with a minimum full-scale reading of 4.0 (.01% transmission). The voltage developed across the "Range" resistor is applied to the microammeter by source follower action. ▲

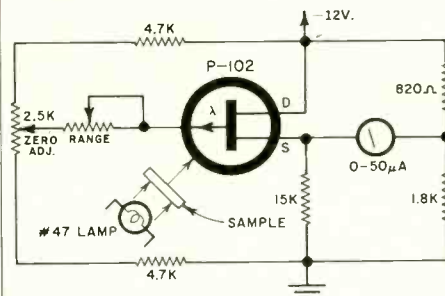

RANGE RESISTOR VALUE (OHMS)	FULL-SCALE OPTICAL DENSITY CALIBRATION
10K	0.0 (100% TRANSMISSION)
100K	1.0 (.10% ")
1 MEG.	2.0 (.1% ")
10 MEG.	3.0 (.1% ")
100 MEG.	4.0 (.01% ")

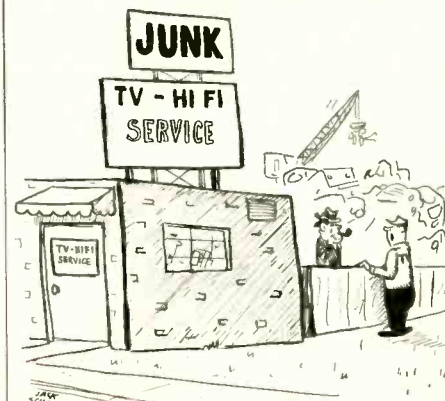

"..... about your new sign"

ELECTRONICS WORLD

A PUBLISHING FIRST

... THE ONLY COMPLETE GUIDE FOR SERVICEMEN AND HOBBYISTS TO EVERY MAJOR PHASE OF CONSUMER ELECTRONICS SERVICING!



For the progressive serviceman who wants to find out how to service better and faster ... how to expand his business by handling a wider variety of electronics equipment —

For the "do-it-yourself" hobbyist who wants to save hundreds of dollars by installing and repairing his own equipment —

The 1966 ELECTRONICS INSTALLATION & SERVICING HANDBOOK has arrived! The only comprehensive and authoritative guide to every major phase of consumer electronics servicing. There's nothing like it anywhere!

A handy, on-the-bench reference volume containing 128 pages—over 150 illustrations, charts and tables—on how to spot, analyze and correct trouble ... quickly, efficiently and economically!

Complete, in-depth coverage of: the fundamentals of servicing • servicing b/w & color TV • AM-FM household radios • stereo/hifi • CB equipment • intercoms and PA systems • antennas • transistorized ignition systems.

Hundreds of money-saving techniques and shortcuts. Every up-to-date method and procedure. All in easy-to-understand language for the novice...yet thorough enough to answer the professional's most complex question!

You'd have to purchase several expensive manuals to equal this kind of incisive, all-inclusive coverage. But now you get it all in the 1966 ELECTRONICS INSTALLATION & SERVICING HANDBOOK. A small investment that will pay for itself many times over with just one practical application. **only \$1.25**

**GET THE EXQUISITE
LEATHERFLEX-BOUND EDITION
for just \$3 POSTPAID!**

The 1966 ELECTRONICS INSTALLATION & SERVICING HANDBOOK is also available in an attractive, gold-embossed, Leatherflex-bound edition — a superb addition to your library of permanent reference books. This deluxe volume will be mailed to your home, postpaid, for just \$3.00, when you check the appropriate box on the order form.



--- FILL IN, CLIP & MAIL THIS FORM TODAY! ---

Ziff-Davis Service Division • Dept. IS
589 Broadway • New York, N.Y. 10012

YES! Send me a copy of the 1966 ELECTRONICS INSTALLATION & SERVICING HANDBOOK, as checked below:

\$1.25 enclosed, plus 15¢ for shipping and handling. Send me the regular edition. (\$1.50 for orders outside the U.S.A.)

\$3.00 enclosed. Send me the DeLuxe Leatherflex-bound edition, postpaid. (\$3.75 for orders outside the U.S.A.) Allow three additional weeks for delivery.

name _____ please print _____ EW-36

address _____

city _____ state _____ zip code _____

--- PAYMENT MUST BE ENCLOSED WITH ORDER. ---

Using Integrateds

(Continued from page 52)

arrival of new trigger pulses will affect the timing interval.

One example of a monostable application is the noiseless push-button circuit of Fig. 4C. Ordinary push-buttons are both bouncy and noisy. In the first few milliseconds of contact, the contacts may alternately make and break as many as several hundred times. This is detrimental to any high-speed electronic circuit that faithfully follows every input pulse. With the monostable, the first bounce triggers the circuit and produces a single 15-millisecond pulse. Only one output pulse is produced for every depression of the push-button.

If both multivibrator sides are capacitively coupled and resistor-recharged, an astable or free-running circuit results (Fig. 4D). This one is useful as an oscillator or square-wave generator. It may be synchronized to external signals by applying sync pulses to leads 1 or 5. Fig. 6 gives the period and frequency of the astable circuit for various R and C values. Again, the timing is largely independent of supply

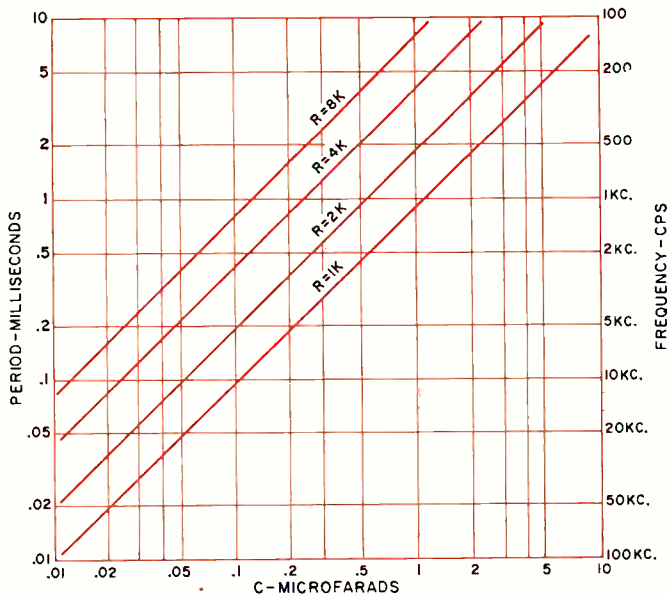

Fig. 6. Performance of the astable circuit in Fig. 4D.

voltage, for an increasing supply voltage simultaneously increases the stored charge and recharging rate.

For a squarer output or a lower output impedance, a $\mu\text{L}900$ may be added to Fig. 4D. Another possibility is to start with two $\mu\text{L}900$'s and two capacitors and use the internal 1000-ohm recharging resistors by jumpering leads 1 and 8.

Special Circuits

A Schmitt trigger or level detector is made using the circuit of Fig. 7A. This one has the interesting property that the output abruptly snaps from a grounded to a positive output or *vice versa* the instant a slowly varying input voltage exceeds a critical value. The circuit is essentially an emitter-coupled multivibrator with emitter-current feedback provided by an external 27-ohm resistor. For the circuit to possess snap action, the voltage drop across this resistor should be less after triggering than before. This is brought about by unbalancing the collector loads with an external 820-ohm collector resistor. With this resistor, the voltage required to trip the trigger is somewhat above the voltage required to keep the trigger in the "on" state. This feature, called "hysteresis," prevents the trigger from "chattering." Changing the values of the external resistors will vary the amount of hysteresis and the trip points.

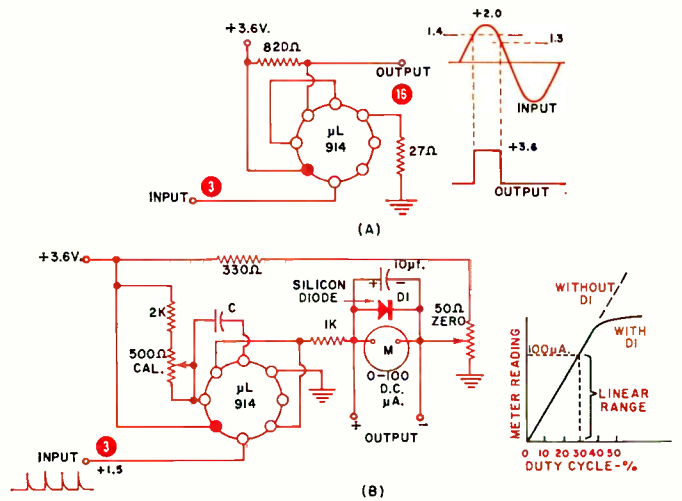

Fig. 7. (A) Schmitt trigger, level detector, or squaring circuit. (B) Frequency-to-voltage converter, tach, or frequency meter.

Another interesting variant is the frequency-to-voltage converter of Fig. 7B which consists of a monostable followed by an integrating capacitor. This circuit makes an excellent tachometer or pulse counter and, when preceded by the Schmitt circuit, a very useful analog frequency meter at low cost.

The converter is always run at less than about 30% duty cycle to give a linearity of better than 2%. Each input pulse trips the monostable. The meter is selected so that it reads full scale when the ratio of monostable "on" time to total interval time is 30%. If the total interval time were doubled, the duty cycle would be only 15%, the meter would only read half scale, and so on. The choice of C and the meter determines the range of operation. Calibration is achieved by using the 500-ohm calibration potentiometer. A zero adjuster serves to buck out the slight zero offset of the saturated IC. Diode D1 protects the meter from damage should a pulse rate higher than full scale appear at the input. If desired, the integrated output voltage may be amplified and then employed for additional purposes.

Binary Counters

A divide-by-two or binary scaler is shown in Fig. 8A. Here a single $\mu\text{L}923$ is used as a counting flip-flop. No additional circuitry is required to properly steer the input pulses to the correct side of the flip-flop. The pulses at the input may be any waveshape and can appear any time from one per hour

Fig. 8. (A) Divide-by-two, binary scaler, or counting flip-flop. (B) A self-indicating, resettable binary counter.

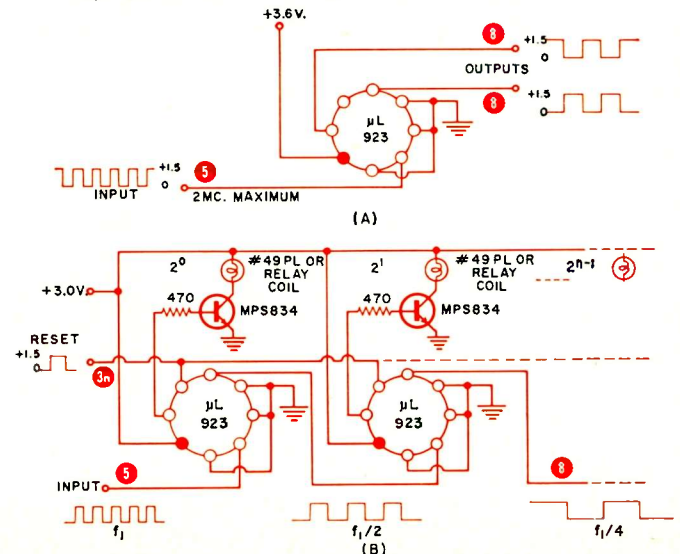

up to 2,000,000 pulses per second. The fast response of this circuit makes noiseless push-button operation (as in Fig. 4C) mandatory when operating off mechanical contacts.

These IC's may be cascaded to form a counting chain, frequency divider, or binary counter simply by connecting output to input down the line. This produces a series of output square waves whose repetition rates are $\frac{1}{2}$, $\frac{1}{4}$, $\frac{1}{8}$, $\frac{1}{16}$, etc. of the input. Driver transistors and either pilot lights or relay coils may be added in order to indicate the condition of each stage, as shown in Fig. 8B.

Linear Circuits

Many digital integrated circuits make fine linear amplifiers. The basic circuit is the differential amplifier or "long-tail pair," formed out of a single $\mu\text{L}914$, as shown in Fig. 9A. The emitter resistor and the negative supply voltage form a current source that splits its current to either side as the difference of input signals. Signal A sees an emitter-follower working into a grounded-base amplifier to arrive at the output; signal B sees only a common-emitter stage. The output of B is inverted, but that of A is not, so the difference (A-B) appears at output.

This amplifier configuration is one of the most reliable and stable, but is not used too often with discrete circuitry for two reasons. First, two transistors are required per stage. Second, and more important, the forward voltage characteristics of the two transistors must be closely matched and held at exactly the same temperature, otherwise the bias points will shift with temperature and the differential amplifier will become unbalanced. This requires a controlled environment and expensive matched pairs of transistors. With integrateds, this is no problem at all. Both transistors are

of identical geometry side by side on the same slab of silicon. They must always be at an identical temperature and must be nearly matched.

For instance, Fig. 9B shows a wide-band amplifier, useful from d.c. to 7 megacycles. Input B is grounded. The output consists of input A amplified by approximately 26 decibels and in phase with the input. Adjusting the bias potentiometer establishes the d.c. operating point at the output and sets the stage gain. The output impedance is less than 1000 ohms; the input is greater than 3000 ohms, so stages may be cascaded for more gain. If capacitor coupling is used, resistors must be added shunting each input (at most 1000 ohms) to keep the non-linear input impedance from charging the coupling capacitor and improperly biasing the circuit. Transformer coupling is preferable.

If tuned transformers are used, the selective r.f. amplifier of Fig. 9C results. Here the gain is 30 decibels and the center frequency may be anything from audio to above 20 mc. (with gain falling off somewhat above 10 mc.). The value of the LC ratio and the tuning capacitors will determine the bandwidth, selectivity, and the center frequency. Stages may be cascaded for more gain. It is desirable to invert the phase every stage with the transformer connections to minimize the possibility of oscillation. The gain is controllable by an a.g.c. voltage input of 0 to -3 volts from a source impedance of 1000 ohms or less. This gives the astonishing gain-control range of 30 db of gain to 50 db of loss for a total of 80 db.

Inputs less than 150 millivolts will be linearly amplified; above this level the amplifier limits sharply. This property makes this circuit very attractive for self-limiting 10.7-mc. i.f. amplifiers. ▲

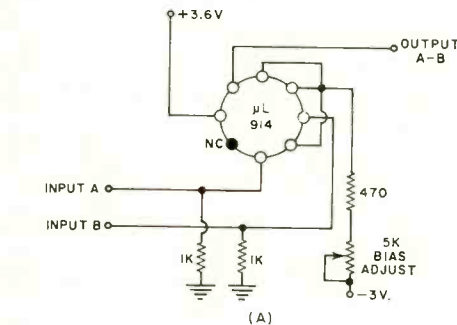

(A)

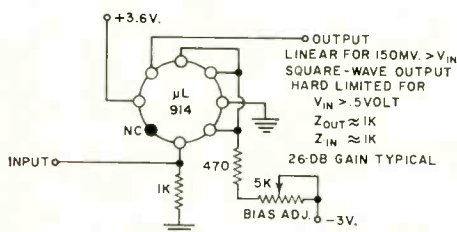

(B)

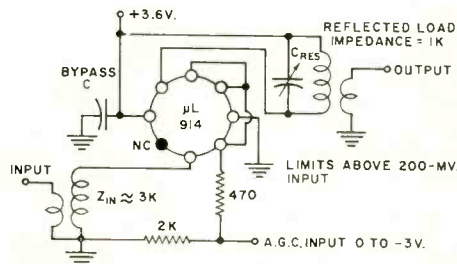

(C)

Fig. 9. (A) Differential amplifier or signal comparator. (B) D.c. to 7-mc. amplifier, limiter, or square-wave generator. (C) R.f. amplifier or FM limiter useful to 20 mc., with a 30-decibel gain figure.

Get Your First Class Commercial F. C. C. LICENCE or Your Money Back!

The Grantham F. C. C. License Course by correspondence will prepare you to pass the F.C.C. examination for your first class radiotelephone license. We know this, but of course you do not really know if it is true. Therefore, we make this offer: After completing this course if you should fail to pass the F.C.C. exam for this license, Grantham will refund all of your tuition payments!

Read complete details in our new 1966 catalog of courses. For this free catalog, write:

Desk 66-C
Grantham School of Electronics
1505 N. Western Ave.
Hollywood, Calif. 90027

CIRCLE NO. 108 ON READER SERVICE CARD

Enjoy the "music-only" programs now available on the FM broadcast band from coast to coast.

- NO COMMERCIALS •
- NO INTERRUPTIONS •

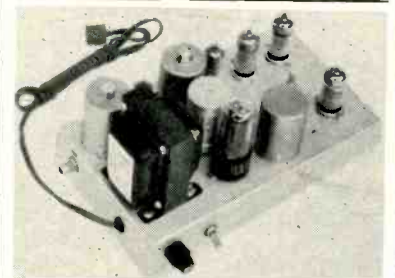

It's easy! Just plug Music Associated's Sub Carrier Detector into multiplex jack of your FM tuner or easily wire into discriminator. Tune through your FM dial and hear programs of continuous, commercial-free music you are now missing. The Detector, self-powered and with electronic mute for quieting between selections, permits reception of popular background music programs no longer sent by wire but transmitted as hidden programs on the FM broadcast band from coast to coast. Use with any FM tuner. Size: 5½" x 6". Shipping weight approx. 7 lbs.

KIT \$4950

(with pre-tuned coils, no alignment necessary)

WIRED \$7500

COVER \$4.95 EXTRA

Write to:

MUSIC ASSOCIATED

65 Glenwood Road, Upper Montclair, New Jersey
Phone: (201)-744-3387

CIRCLE NO. 96 ON READER SERVICE CARD

Hi-Performance Space-Saving Twins

from

BIRNBACH

Amazing features, sophisticated solid state design

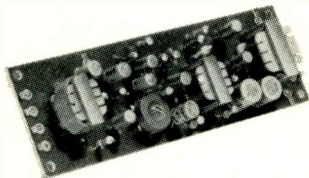

Compact Transistor Audio Amplifier

- 5 Transistors and 1 Thermistor
- Shielded Input Transformer with 2 PRIMARY WINDINGS... 50 ohms and High Impedance
- Output Transformer with 2 SECONDARY WINDINGS... 8 ohms (for speakers), 500 ohms (for modulation and high impedance loads)
- Volume Control included and mounted on Circuit Board
- Low Distortion... 300 Milliwatt Push-Pull Output
- Extremely high gain... 80 db! Handles low level mikes, phono pickups, telephone pickups, etc.
- Sturdy Printed Circuit Board only 5½" long x 1¾" wide
- Weighs only 3½ ounces
- Power Supply: Any 9 Volt DC source.

\$9.95 each*

*Add 55¢ per unit for postage and handling

Complete instructions with hook-up diagram sent with each unit.

Use Amplifier for following, or combine with Transmitter for wireless:

- PA System
- Hi-Fi System (use 2 for Stereo)
- Guitar Amplifier
- Surveillance Listening System
- Electronic Stethoscope
- Intercom Amplifier
- Modulation for Transmitter
- Phono Amplifier
- Utility Amplifier
- Science Projects

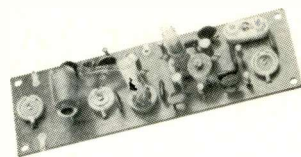

Compact RF Transmitter

- No license required for operation
- Full 100 milliwatt output
- Pie Network — loads into almost any antenna
- Crystal controlled oscillator transistor, buffer transistor, final amplifier transistor
- Heat sink on final RF amplifier
- Solid state, printed circuit
- Plug-in crystal (not supplied)
- Solder lugs for all connections
- Effective range of ½-mile radius
- Standard 90-day warranty
- 9 Volt Power Supply
- Only 2" x 5"

\$14.95 each*

Fill in this order blank and mail to
BIRNBACH RADIO CO., INC.
435 Hudson Street / New York, N. Y. 10014

Please send me _____ (quantity) TR-100 transmitters
at \$14.95 each (subtotal _____)
Please send me _____ (quantity) A-300 amplifiers
at \$9.95 each (subtotal _____)
I am including in my check 55¢ per unit for handling and postage
(subtotal _____)

My check for (grand total _____)
is enclosed. Sorry, No COD's.

Name _____

Address _____

City _____ State _____ Zip _____

ELECTRONIC CROSSWORDS

By JAMES R. KIMSEY

(Answer on page 102)

ACROSS

- To vary the amplitude, frequency, or phase of an oscillation, usually at a signal frequency rate.
- The fixed voltage applied between grid and cathode elements of an electron tube.
- Aerial.
- A buried object that serves as an anchor for a guy wire or rope.
- Rodent.
- Here (Fr.).
- Hackneyed by constant repetition.
- Switch position.
- Dry seed fruit.
- Type of communications system (abbr.).
- Didn't work.
- Timid.
- An inert gas often used in discharge tubes and as a lamp filling.
- American Indian.
- A system of challenge and response developed for use with radar equipment (abbr.).
- A bow of flame formed between two electrodes.
- Unit of current (abbr.).
- The thing mentioned.
- Electrical current such as usually supplied by power lines (abbr.).
- Confronted.
- Some.
- Crystal cut. Used extensively in r.f. transmitters from 4500 to 10,000 kc.
- Linear measure (abbr.).
- Widening of the volume range of an a.f. signal so that weak passages become weaker and loud passages become louder.
--loss insulator.
- Shade tree.
- compensation, a control device that compensates for voltage drop due to current flow.

- In electron optics a hole in a plate electrode which separates two fields (2 words).

DOWN

- Microwave term specifying the type of oscillation occurring in a line, waveguide, tube, or cavity.
- Term used to indicate that current is being taken from a voltage source.
- Amount of radiant energy emitted from a source.
- Refractory metal used for grids and plates of power tubes.
- Printer's measure.
- Regularly recurring pulsation of amplitude resulting from the combination of two tones or electric waves of different frequencies.
- General term used to signify the strength or value of a current.
- Indefinite article.
- The load, above the normal operating rating, to which a device can be subjected without failure (2 words).
- A three-electrode vacuum tube.
- Type of current (abbr.).
- Paddle.
- Television band (abbr.).
- Curve formed by the intersection of a cone and a plane.
- A thin, enamel-like insulation of high tenacity.
- The seventh letter of the Greek alphabet.
- Southern state (abbr.).
- Money received from labor or services.
- Crystal cut.
- Beverage.
- Female sheep.
- Place.
- Observe.
- Sick.
- Radioman (slang).
- Part of "to be."

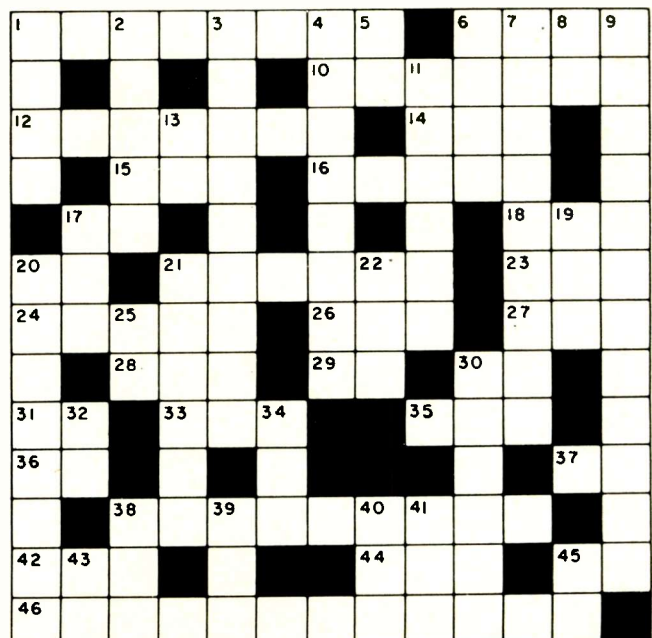

Functional Designing

(Continued from page 49)

doing in the days of "bliss." It may soon be possible to deposit such bulk-effect functional elements continuously with batch fabricated semiconductor networks.

We have heard, too, that variable resistors and variable capacitors are components which can never be displaced by integrated circuits. Here, again, our thinking is blocked by the fact that because variable resistors or variable capacitors have been used for a long time their use is therefore inviolate.

I think this is a wrong assumption. We must ask ourselves, "What is the function of these variable elements?" Their functions may, for example, be assumed by phase-locked loops; in other words, feedback systems or servos that will do the tuning automatically.

The real question is, "When do such subsystems become economically competitive with present systems?"

As batch fabrication evolves, such techniques will become directly competitive with present systems.

Finally, I would like to make passing reference to high power. While it is true that high-power devices appear to be untouchable from an integrated-circuit viewpoint, in the laboratories we are

now asking the same questions about such power devices as we asked about other devices in the past.

We are asking, "What functions are we trying to provide and are there other ways of doing the job?"

Within a year you will undoubtedly find power devices that look pretty integrated—integrated structures that have, in fact, control circuits adjacent to the power element in integrated form.

As time goes on, the integrated or batch fabrication techniques will be applied to the power field in the same way as it is being used in the low-level computer business today.

Since these predictions are being made by an R&D man, you might discount them because we have been unduly optimistic in the past. I will have to admit that in 1951-52 I was one of those who predicted that transistors would eliminate tubes because transistors had infinite life and were failure-proof. The tube manufacturers are still in business!

The previous distinguished speakers (see Editor's Note) have raised the question, "Why hasn't the discrete-component manufacturer been replaced by the integrated-circuit manufacturer?"

We might riposte, "Why hasn't the tube manufacturer been replaced by the transistor manufacturer?"

Let's consider this for a moment be-

cause the transistor is about 15 years old, yet the tube manufacturer is still in business.

My answer would be that, in effect, the tube manufacturer *has* been replaced by the transistor manufacturer because if it hadn't been for transistors, the tube industry would, no doubt, be very much bigger than it is today.

Also, if it hadn't been for the transistor, several electronic industries that exist today would never have come into being. For example, the modern computer industry is based on the transistor. This is literally true. Without the transistor, modern computers simply would not be economically feasible.

The space industry also depends on the transistor. Without it, our various space ventures might never have gotten off the ground.

Perhaps if tubes had been able to keep up, technologically, with transistors, they would have been used in computer and space application but the fact is that tube manufacturers have lost virtually all of this potential market and, as a result, have ceased to expand.

As time goes on we will see a still further decline in the percentage of tube manufacturers when compared with the total components industry.

We might ask, therefore, "How far wrong were we in our original prediction?" ▲

Back Issues Available

Use this coupon to order
back issues of
ELECTRONICS WORLD

We have a limited supply of back issues that can be ordered on a first-come, first-served basis. Just fill in the coupon below, enclose your remittance in the amount of 65¢ each and mail.

ZIFF-DAVIS SERVICE DIVISION
Dept. BCEW, 589 Broadway
New York 12, New York

Please send the following back issues of **ELECTRONICS WORLD**. I am enclosing _____ to cover the cost of the magazine, shipping and handling.

Month _____ Year _____

Month _____ Year _____

Month _____ Year _____

Name _____

Address _____

City _____ Zone _____ State _____

No charge or C.O.D. orders please. EW

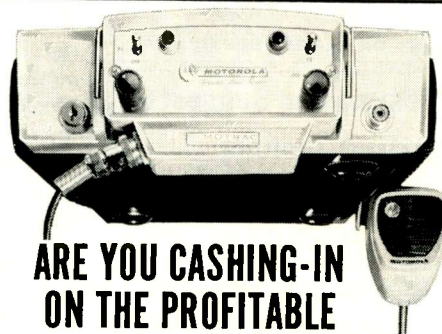

ARE YOU CASHING-IN ON THE PROFITABLE 2-WAY RADIO SERVICE BUSINESS?

- ★ Motorola will train you for this rewarding, elite profession
- ★ Send for our **FREE EVALUATION EXAM**. Prove to yourself that you are ready to learn FM 2-way radio servicing.

Opportunities in 2-way radio servicing are virtually unlimited. ■ Just one of the hundreds of successful Motorola Service Stations writes, "we would be pleased to interview any graduate of your school that has received some training in 2-way radio maintenance. We are an established firm, 10 years old, with a promise of expansion governed by our ability to obtain competent technicians." ■ Get all the facts today. There is no obligation and no salesman will call.



MOTOROLA TRAINING INSTITUTE

4545 West Augusta Blvd. • Chicago 51, Illinois • Dept. AEF611

- Send me **FREE** entrance exam.
- Send full details on Home Study Course on **FM 2-way Radio Servicing**
- Send me details on how you can help me prepare for an **FCC License**.

Name _____ Occupation _____

Address _____

City _____ Zone _____ State _____

CIRCLE NO. 99 ON READER SERVICE CARD



POTENT NEW PRE-AMPS FROM WINEGARD

- First Pre-Amps That Have Same Gain on Both TV Bands plus FM
- Will Take Highest Signal Input of Any Twin Transistor Antenna Amplifiers Made
- Have Lowest Noise Figure Ever Obtained on TV Antenna Pre-Amps
- Can Be Used on Any TV Antenna for Black and White, Color or FM

AP75T SPECIFICATIONS: GAIN: flat 33DB per band. SIGNAL OUTPUT: 2,000,000 MV. INPUT IMPEDANCE: 300 ohm. DOWNLEAD IMPEDANCE: 75 ohm. OUTPUT IMPEDANCE: 75 ohm, 117V 60CPS, 1.8 watts. List price only \$79.95.

AP220T (300 ohm) and AP275T (75 ohm). SPECIFICATIONS: GAIN flat 18DB per band. BANDPASS: 54MC-108MC, 174MC-216MC. INPUT IMPEDANCE: 300 ohm. OUTPUT IMPEDANCE: AP-220T—75 or 300 ohm, AP275T—300 ohm input, 75 ohm output. 117V, 60 CPS, 1.8 watts. List prices: AP220T only \$44.95, AP275T only \$49.95. Ask your distributor or write today for spec. sheets.

Winegard Co. ANTENNA SYSTEMS

3000 Kirkwood, Burlington, Iowa
CIRCLE NO. 81 ON READER SERVICE CARD

Your Postmaster Suggests:
Always Include
Your (ZIP CODE) Number
in your
Return Address

BARGAIN HUNTING? FREE! GIANT SENSATIONAL ELECTRONICS CATALOG HENSHAW TV SUPPLY 3617 TROOST, KANSAS CITY, MO.

LARGEST SELECTION in United States
AT LOWEST PRICES—48 hr. delivery

JAN CRYSTALS

Thousands of frequencies in stock. Types include HC6/U, HC18/U, FT-241, FT-243, FT-171, etc. SEND 10¢ for catalog with oscillator circuits. Refunded on first order. 2400D Crystal Dr. Ft. Myers, Fla. 33901

LEARN Electronics Engineering AT HOME

Fix TV, design automation systems, learn transistors, complete electronics. College level Home Study courses taught so you can understand them. Earn more in the highly paid electronics industry. Computers, Missiles, theory and practical. Kits furnished. Over 30,000 graduates now employed. Resident classes at our Chicago campus if desired. Founded 1934. Catalog.

American Institute of Engineering & Technology
1141 West Fullerton Parkway Chicago, Ill. 60614

Meter-Relay Devices

(Continued from page 38)

being controlled in order to determine whether further control action is required.

Fig. 7 shows a temperature control unit utilizing a locking meter relay, in which the contact action provides high-limit automatic control and the indicating element gives direct readings in both Fahrenheit and centigrade. In this circuit, a thermistor sensing element (designed for negative-temperature coefficient) forming one arm of a d.c.-energized bridge, is mounted near the source of heat to be controlled.

Initially, the bridge is balanced by $R1$ to provide the desired operating point and the setpoint arm is adjusted for the required high-temperature limit. Control action begins when an increase in temperature (as small as $.075^{\circ}\text{F}$) unbalances the bridge and causes a current flow through the meter relay signal coil. This action causes the load relay to pull in and switch off the heating circuit. When the temperature drops below the control point, the load relay drops out and the heat is switched on again.

To test the temperature periodically, the sampling interrupter switch is actuated by a notched cam which, in turn, is continuously driven by a small synchronous motor. The frequency of interruption is determined by the speed of the motor (usually 1 rpm) and the number of notches on the cam. To avoid breaking the load relay circuit during the brief periods of interruption, capacitor C is placed across the relay coil to hold in the relay when the sampling switch is open.

A common application of meter relays in industrial automation is the control of positioning devices as a function of motor current. During an automatic grinding operation, for example, a meter relay can utilize the fluctuating load current of a drive motor to precisely regulate the grind-pressure applied to a workholding fixture. The fixture is positioned by a feed motor which, in turn, is driven by a pair of load relays ($RL1$ and $RL2$ in Fig. 8) which operate from a low-limit and high-limit contact, respectively.

In this application, an a.c. signal derived from the current drawn by the grinding wheel drive motor is rectified to d.c. and fed to the signal coil of a double-contact meter relay. Initially, the meter-relay setpoint arms are adjusted for minimum and maximum drive currents. In normal operation, with the proper drive motor current applied to the rotary grinding wheel, the correct pressure is applied to the workpiece and no control action occurs.

However, when the drive motor current decreases below the normal range

(indicating that grinding pressure is too light), the moving indicator and the low-limit contact lock downscale and load relay $RL1$ is energized. The load contacts start the feed motor in a direction which advances the fixture toward the grinding wheel. Simultaneously, the normally closed pulsing contacts of $RL1$ intermittently make and break the low-limit locking circuit so that continuous sampling of the drive motor current occurs. This "on-off" pulsing action continues as long as the meter relay is at or below the low setpoint; and the resultant corrective action ceases when the signal is restored to normal range.

Conversely, when the drive motor current increases above normal value (indicating that grinding pressure is too heavy), the high-limit contact locks upscale and load relay $RL2$ is pulled in. The feed motor now retracts the fixture from the grinding wheel. At the same time, the pulsing contacts of $RL2$ sample the input signal until the drive motor current again reaches normal value.

Ordinarily, the opening of the pulsing contacts would result in de-energizing the relay coils so that the load contacts would be released instantly. Load relays $RL1$ and $RL2$, however, are kept energized during each pulsing cycle for a period of time determined by the $RC1$ time constant in the low-limit circuit and the $R2C2$ combination in the high-limit circuit. $R1$ and $R2$ must be sufficiently high (on the order of 3000 ohms) to limit the peak current in the locking coils which otherwise may cause arcing of the meter-relay contacts. Pulsing rate is also a function of the characteristics of the load relays and is generally designed so that interruptions occur two times per second. The overall effect of the holding action is to keep the feed motor operating steadily during pulsing periods in order to apply corrective positioning of the fixture and, at the same time, to allow the meter-relay contacts to respond to drive-motor current changes.

Meter relays are now being assigned more and more critical tasks in the field of automation. ▲

Fig. 8. Pulsing meter relay for automatic machining process.

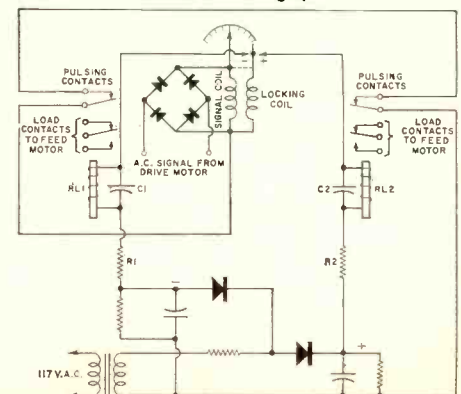

MEASURING LENGTH WITH A LASER

New use for laser permits length measurements having an extremely high order of accuracy.

THE successful measurement of length with a laser has just been completed at the National Bureau of Standards (U.S. Department of Commerce). By the use of a laser beam as an interferometric light source, Bureau scientists have measured the length of a meter bar with an accuracy better than one part in ten million.

Conventional light sources, such as krypton-86 or mercury-198 lamps, do not permit direct interferometric measurements of lengths greater than a few decimeters. Hence, successive determinations have to be made to measure longer lengths, requiring tedious and time-consuming procedures. A helium-neon laser of improved stability was designed and built, and the performance of this laser was tested in actual length measurements by means of an automatic fringe-counting interferometer that had been developed at NBS for measuring line standards up to one meter lengths.

The laser was kept in single-mode operation by adjustment of its r.f. power supply and was made to function at or near the center of the red neon spectral line at a wavelength of approximately 632.8 nanometers (6328 Å) by tuning the laser cavity.

Since the neon wavelength produced in the laser was not known with sufficient accuracy, it was determined in comparative interferometric measurements. Interference fringe counts were obtained over various portions of a decimeter line standard, first by use of a standard mercury-198 lamp and then with the laser. The neon wavelength of this laser was then calculated by use of the accepted value for the mercury-198 wavelength at 436 nanometers.

This calculation showed the neon wavelength to be 632.81983 nm, under standard meteorological conditions, that is, in air at 20°C containing .03% carbon dioxide at standard atmospheric pres-

sure and at 1330 N/m² (10 mm. of mercury) water-vapor pressure.

The automatic fringe-counting interferometer, with the laser as a light source, was then used to measure the length of the meter bar in terms of this wavelength. As the meter bar inside the interferometer was moved over its entire length, interference fringes produced by the laser were automatically counted. From the total count of 3,160,460.33 fringes, or half-wavelengths, the length of the meter bar was determined to be 1.00000098 meters. This length agreed to within 7 parts in 100 million with an independent measurement of 1.00000105 meters for this bar. In addition, measurements of each decimeter graduation on the bar agreed with the independent measurement to better than .0000005 meter.

The laser was stable by virtue of its compact and sturdy design. However, it was unstabilized in the sense that no electronic feedback was used to lock its wavelength output automatically to the center of the neon line. Hence, stabilized lasers with single-mode operation will be used in future experiments to eliminate the need for manual adjustment. Thus, accurate length measurements through the use of a laser may ultimately be routinely performed. ▲

UNIQUE TEST SET

ONE of the methods used to determine the range and sensitivity of a radar set is to use an r.f. reflective target having exact known physical dimensions and radar reflectivity characteristics located at an exact known distance from the radar. This type of testing, known as radar cross-section measurement, is in common use at many of our test ranges today.

Most of these tests are made at special radar test ranges where the calibrated r.f. reflecting metal spheres are placed at various distances from the radar and their return signals measured. In this way, radar sensitivity and range characteristics are evaluated.

Recently, an Air Force Titan III rocket placed in orbit a 75-lb., precisely machined, carefully polished rigid aluminum sphere of unit square meter optical cross section (22.232 inches average radius).

The sphere was ejected from the Titan into a nearly circular orbit 1503 miles up. Making 10 passes each 24 hours, the high-flying test device is presently being used for accurate calibration at a number of radar stations scattered about the world. ▲

The meter bar is mounted within the interferometer unit. Its length is determined by counting the number of fringes.

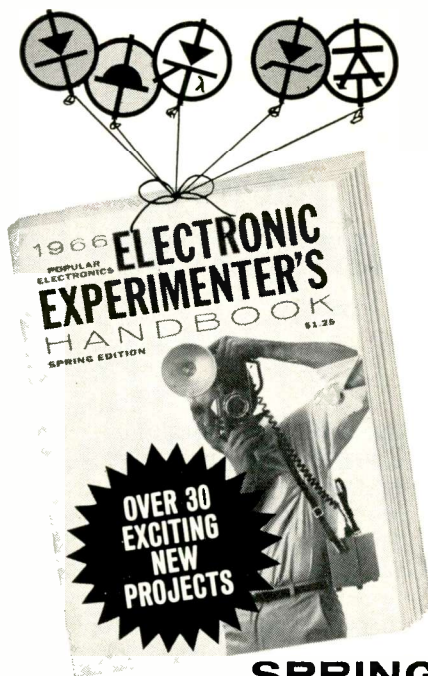
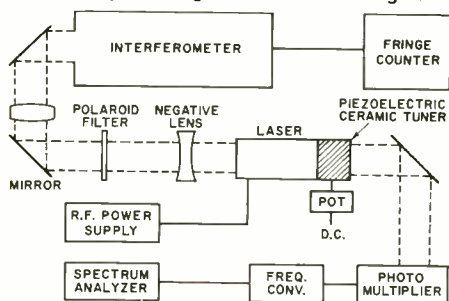

SPRING EDITION

Now Available—The all-new Spring 1966 Edition of ELECTRONIC EXPERIMENTER'S HANDBOOK! Another big package of over 30 fascinating do-it-yourself construction projects for:

**Amateur Radio
Photography
Test Equipment**

**Automotive Electronics
HiFi/Stereo & Audio
Short-Wave Listening**

You'll build such valuable units as... a super photo flash... a simple auto light minder... a transistor FM multiplexer... an electric fence charger... and a self-regulating lighting controller.

Each has complete, easy-to-follow schematics, parts lists and how-to instructions that guarantee you perfect finished products! Plus—dozens of professional pointers, tips and techniques to increase your overall electronics skills and proficiency.

In all, more than 148 pages of challenging projects that will deliver hour after hour of sheer fun... and provide you with economically-built, useful items (to keep, or sell for a profit) after you've finished.

Make sure you receive your copy of this \$1.25 valuable handbook. Fill in the coupon and mail it today!

**A DELUXE, GOLD-EMBOSSED
LEATHERFLEX-BOUND EDITION
...just \$3.00 postpaid**



This deluxe edition is a permanent, hand-somely-bound collector's item that belongs in your electronics library! Check appropriate box on coupon.

ZIFF-DAVIS SERVICE DIVISION, Dept. EEH
589 Broadway, New York, N.Y. 10012

COUNT ME IN...for a copy of the Spring 1966 ELECTRONIC EXPERIMENTER'S HANDBOOK as I've indicated:

- \$1.25 enclosed, plus 15¢ for shipping and handling. Send me the regular edition. (\$1.50 for orders outside U.S.A.)
- \$3.00 enclosed. Send me the Deluxe Leatherflex-Bound edition, postpaid. (\$3.75 for orders outside U.S.A.) Allow three additional weeks for delivery.

name _____ please print EW-36
address _____
city _____ state _____ zip code _____

PAYMENT MUST BE ENCLOSED WITH ORDER

BOOK REVIEWS

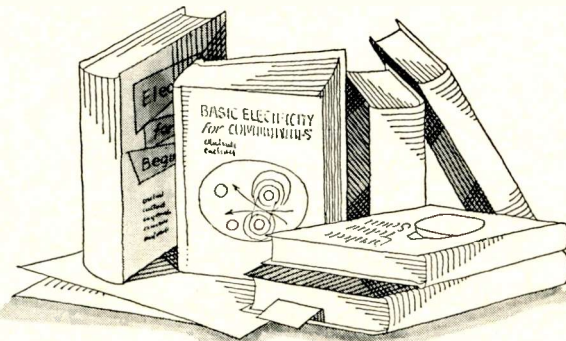

"SOUND AND HEARING" by S. S. Stevens, Fred Warshofsky & Editors of *Life*. Published by *Time-Life Books*, New York, N.Y. 196 pages. Price \$3.95.

This is Volume 14 in the *Life Science Library Series* and it is a good one. In informal, easy-to-understand style, the authors—a professor of psychophysics at Harvard and a science writer—cover their subject in eight fascinating chapters. Each of these text chapters is accompanied by a companion picture essay with some of the most beautiful full-color photographic and artist-drawn illustrations to appear in a book in this price range.

The chapters cover sound propagation, the machinery of hearing, the route to the brain, the mind's influence on what we hear, the two-eared man, sensing the world by echo, when hearing fails, and the unwanted sounds.

An appendix carries a vocabulary for sound and hearing and a frequency chart allocating various familiar sounds. A bibliography is included for those who wish to go deeper into the subject.

"HIGH FIDELITY LOUDSPEAKER ENCLOSURES" by B. B. Babani. Distributed in the U. S. by *Leader Enterprises*, Box 44718, Los Angeles, California 90044. 46 pages. Price \$1.25. Soft cover.

Those who enjoy building their own cabinets to house hi-fi speaker systems will find this little manual handy. In addition to providing design charts for determining cabinet volume and dimensions for various sized speakers, the book contains "blueprints" for building such enclosures. In addition to providing general construction hints, there is even a section on "dressing up" a speaker box to give it a more "professional" look. Four valuable sections deal with tuning, damping, crossover filters, and speaker phasing.

The information and design data cover corner reflex, bass reflex, exponential horn, folded horn, tuned port, labyrinth, stereophonic, tuned column, loaded port, and multi-speaker panoramic enclosures.

"HIGH FIDELITY SYSTEMS" by Roy F. Allison & **"REPRODUCTION OF SOUND"** by Edgar Villchur. Published by *Dover*

Publications, Inc., New York. 90 pages & 92 pages respectively. \$1.00 a copy. Soft cover.

Both of these books have been reviewed in these columns in the past at the time they were being distributed directly by *Acoustic Research, Inc.* Now released under the aegis of *Dover*, the books have new and more durable covers and will, undoubtedly, be more widely available.

Each in its own way is a handy, not-too-technical manual for the layman. Each is lavishly illustrated and written in informal style for maximum communication of the subject matter.

"RCA RECEIVING TUBE MANUAL" compiled and published by *RCA Electronic Components and Devices*, Harrison, New Jersey. 576 pages. Price \$1.25. Soft cover.

This new streamlined edition, RC-24, provides up-to-date information on the firm's complete line of receiving tubes for home-entertainment applications, picture tubes for black-and-white and color-TV receivers, and voltage regulator and voltage reference tubes.

As in previous editions, the technical data section is restricted to detailed coverage of active RCA receiving types. Definitive data on discontinued and replacement receiving tubes, on picture tubes, and on voltage-regulator and voltage-reference tubes is presented in tabular form for easy reference and comparison.

As usual there is a series of chapters on tube theory and applications, a handy application guide, and a circuit section.

"VIDEO TAPE RECORDING" by Cris H. Schaefer, Cedric L. Suzman & Associates. Published by *Hobbs, Dorman & Company, Inc.*, 441 Lexington Ave., New York, N.Y. 10017. 104 pages. Price \$12.00.

This book, subtitled "New Products and Markets," is addressed to two major groups—the layman and the manufacturer. A description of video tape recording and the equipment to handle the process is couched in layman's language, while the manufacturing aspect receives a thorough-going analysis as to com-

petitive advantages over other reproduction processes, potential markets for the equipment, applications of video tape recorders in industrial and miscellaneous fields, plus a summary of the work being done by various manufacturers in developing video tape recorders for both the home and industrial market.

The text is illustrated by more than 30 halftones and line diagrams and is amplified by 15 tables, several appendices of relevant and useful data, and a selected bibliography.

"COMPUTERS AND THE HUMAN MIND" by Donald G. Fink. Published by *Doubleday & Company, Inc.*, New York, N.Y. 301 pages. Price \$1.45. Soft cover.

This is another volume in the excellent *Anchor Science Study Series* from this publisher, addressed to students and the general public. As "An Introduction to Artificial Intelligence," this would be a good starter. It is written in informal, easy-to-understand style that almost anyone can grasp.

The text is divided into twelve chapters and an appendix and bibliography. Covered are minds and machines; arithmetic for computers; how computers compute; two kinds of language; two kinds of logic; diodes, transistors, and cores; hardware and information; programs and software; the brain at work; the many faces of intelligence; four intelligent machines; can machines create?; and a FORTRAN program for computing pi. Diagrams and tables are used as required to explain and amplify the text material.

"ELECTRON OPTICS" by P. Grivet. Published by *Pergamon Press, Inc.*, 44-01 21st Street, Long Island City, N.Y. 11101. 775 pages. Price \$30.00.

This is a revised and updated translation of a basic French text "Optique Electronique" published in Paris several years ago. The book covers the principles of electron optics and many of its applications.

The first part of the book discusses electron lenses and the second part deals with cathode-ray tubes, microscopes, image-converters, diffraction devices, and mass and beta-ray spectrographs.

The treatment and the writing are slanted for the post-graduate student or those specializing in electron optics. No concessions are made for persons without the requisite background in mathematics and physics. Those without such background will be in trouble by page 4. The text is well illustrated with diagrams, line drawings, photographs, graphs, charts, and tables. An extensive bibliography is included but since most of the references are to European publications it may not be too useful to the American student unless he has access to a well-stocked technical library. ▲

The OAO

(Continued from page 30)

is a nebular photometer capable of measuring the spectral intensity of star clouds as observed through five programmable filters, each covering 600-Å bandwidths between 1500Å and 3800 Å.

Another experiment is intended to measure the brightness of 50,000 main-sequence stars in the ultraviolet region between 1200 Å and 2900 Å. Called Project Telescope, the experiment contains four independent Schwarzschild telescopes, each employing an imaging "uvicon" (ultraviolet vidicon) system. The bandwidths to be surveyed are 1200 Å to 1600 Å, 1300 Å to 1600 Å, 1600 Å to 2900 Å, and 2300 Å to 2900 Å. Because of its high rate of data output, this experiment will be done only during real-time contacts. A typical experiment routine would call for the warm-up of calibrator lamps in the five minutes just preceding ground contact. Three minutes of calibration will follow after contact has been made. To use the Telescope, the uvicons are scanned in the digital-direct mode, and the first picture, including calibration information, is transmitted to the ground via the WBT. Then, one or more standard Telescope data sequences are commanded. Each sequence includes a 60-second exposure and digital-direct scan for each camera. A two-degree by two-degree region is mapped, with some overlap for ease in data interpretation.

Still another experiment will examine approximately 14,000 stars a year, at first producing a resolution of 2 Å, which later will be upgraded to resolutions between .04 Å and .05 Å. Operation of this unique telescope is shown in Fig. 5. Ultraviolet light from a stellar source enters the telescope and is reflected off the primary 38-inch-diameter beryllium mirror onto a smaller quartz secondary mirror which converges the light onto the entrance slot leading to the spectrometer mirror. The spectrometer mirror directs the light to the spectrometer grating. The grating is a ruled square which disperses the light and sends it back to the spectrometer mirror and thence to a series of exit slits in a grating. The light then passes through the 2-Å slits in front of six photon-scintillation detectors. At appropriate times, the grating is synchronously rotated to facilitate illumination of the detectors by different portions of the spectrum, thereby permitting scanning of all the spectrum between 1000 and 4000 Å.

Additional experiments will continue to survey the ultraviolet region while others will experiment in the x-ray and gamma-ray ranges.

The OAO program may prove to be one of the most interesting scientific projects yet conceived. ▲

FREE

NEW 1966 GIANT CATALOG

100's of pages packed with savings

BURSTEIN-APPLEBEE CO. Dept. EW,
1012-14 McGee St., Kansas City, Mo. 64106

Rush me the FREE 1966 B-A Catalog.

NAME _____

ADDRESS _____

CITY _____ STATE _____

Please be sure to show your Zip No. _____

FOR 38 YEARS THE
OUTSTANDING
**MONEY
SAVING**

BUYING GUIDE FOR:

• Stereo & Hi-Fi Systems and Components • Tape Recorders • Electronic Parts, Tubes, Books • Phonos & Records • Ham Gear • Test Instruments and Kits • Cameras and Film • Public Address • Citizens Band • Transistor & FM-AM Radios.

RUSH COUPON TODAY

CIRCLE NO. 121 ON READER SERVICE CARD

*Back Issues
Available*

Use this coupon to
order back issues
of **ELECTRONICS WORLD**

We have a limited supply of back issues that can be ordered on a first-come, first-served basis. Just fill in the coupon at right, enclose your remittance in the amount of 65¢ each and mail.

ZIFF-DAVIS SERVICE DIVISION
Dept. BCEW, 589 Broadway
New York 12, New York

Please send the following back issues of **ELECTRONICS WORLD**. I am enclosing _____ to cover the cost of the magazine, shipping and handling.

Month _____ Year _____

Month _____ Year _____

Month _____ Year _____

Name _____

Address _____

City _____ Zone _____ State _____

No charge or C.O.D. orders please. EW

POWER-LINE SPIKE ABSORBER

By RONALD L. IVES

Designed to be placed across the power line, this device will remove those annoying spikes that so often cause faulty readings on voltage-sensitive measuring equipment.

SENSITIVE electronic equipment, when operated from the power line, is subject to a variety of troubles resulting from electrical disturbances which come in over the line. These annoyances are most serious in industrialized areas, particularly when the power system is overloaded.

Oscilloscope studies of line waveforms show that the supposedly sinusoidal supply-voltage waveform can be disrupted by spikes of random frequency and amplitude, most of them being of quite short duration—usually only a few microseconds. Amplitudes of some of these spikes run to as much as five times peak line voltage.

Reduction of line spikes is easily accomplished by shunting a suitable capacitor across the line. Increasing the value of shunt capacitance will make the spike absorption more effective, but even a 10- μ f. capacitor will not eliminate all spikes. A 100- μ f. capacitor would be a happy solution, but such a capacitor, suitable for continuous operation across a 117-volt line, is not only a bit bulky and costly but also has a capacitive reactance of only about 26 ohms so that it will draw about 4.5 amperes from the line. This drain is likely to be much greater than that of the device to be protected. Although the shunt capacitor will usually improve the power factor so that all of the added drain will not show up on your electric bill, such a load increment is a bit excessive.

Line noise is also effectively reduced by use of four-terminal, ladder-type LC filters, many of which are available commercially at less than the cost of components (in small lots). Representative of these is the J. W. Miller Co. "Cash Register Filter," a two-section device occupying 91 cubic inches (cased) and listing at \$18.25. This unit, capable of handling any load up to 5 amperes at a line voltage up to 230 volts, is one of a family of effective line-noise filters.

At the current state of the art, another method of reducing line spikes and their undesired effects seems possible. This is a power analog of the well-known, but

little-used, full-wave, self-adjusting noise limiter. A circuit of this with component values is shown in Fig. 1.

Operation is as follows. When the power is turned on, capacitor C3 charges from the line through the bridge rectifier, attaining equilibrium voltage, which is very nearly 1.414 times r.m.s. line voltage, in a few cycles. R1 is a peak current limiter, and R2 is a bleeder to prevent C3 from charging to the peak value of the noise voltage. With no line noise, the limiter has an infinitesimal effect on line voltage and waveform characteristics.

Capacitor C1, shunted across the line, furnishes a high-impedance path for 60-cycle current, but a low-impedance short circuit for higher frequencies. It effectively shunts out high-frequency sinusoidal "riders" on the power line and depeaks short-duration spikes. C2, at the output of the bridge rectifier, performs a similar function and is most desirable here, as electrolytic capacitors are not low-impedance paths at high frequencies.

Line spikes, of any polarity and duration, pass from the line through the bridge rectifier to the storage capacitor C3. Here they are stored instantaneously and bled away slowly through R2.

Performance

Tests of this line-spike absorber, in an industrial location where line noise is heavy, indicate that it is an effective performer. By its use, all electrical disturbances on the line having frequen-

cies exceeding about 50 kc. and durations less than about 10 μ sec. were attenuated to values too small to measure (*i.e.*, below 50 millivolts). Disturbances of lower frequency and/or of longer duration were attenuated by 30 or more db.

Line-voltage surges, which initially appeared on the oscilloscope as "step functions," were depeaked so that the line-voltage change occupied several cycles, substantially eliminating the "blip" formerly produced by such surges in sensitive receiving equipment.

Electrical placement of this line-spike absorber is quite important. When the noises originate exterior to the building, it is best placed at the service entrance so that it will attenuate the line noise before it has a chance to radiate from the interior wiring. If the noise is produced by a single source within the building, the spike absorber is best placed close (electrically) to the noise source. When there are multiple noise sources, or if the equipment is portable, the spike absorber should be connected as close to the power input of the using device as possible.

Alternate Construction

Inspection of the spike-absorber circuit discloses that many pieces of electronic equipment contain salient parts of the absorber as power-supply components. If the equipment uses either full-wave bridge rectifiers or full-wave center-tap arrangements, the power supply already functions as a spike limiter. Improvement can usually be brought about by shunting the primary and secondary of the power transformer with small (.02 to .1 μ f.) paper, mica, or ceramic capacitors. A similar capacitor shunting the first filter capacitor, if it is electrolytic, will also help. Additional changes in the equipment are not likely to bring about further improvement.

In a number of instances, but not in all, marked reduction in line noise (as well as pickup) was brought about by shunting the line on the load side of the device with a small capacitor, such as a .5- μ f. (500-volt rating) unit. ▲

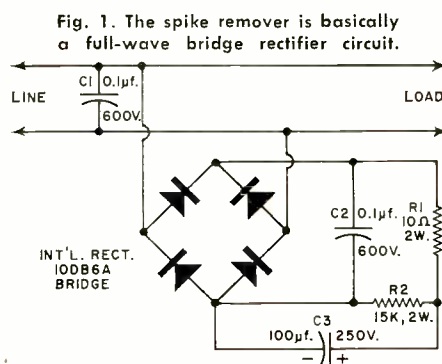

**THE MOST COMPLETE
AND UP-TO-DATE GUIDE
TO THE EXCITING WORLD
OF SPECIALIZED RADIO
COMMUNICATIONS!**

ONLY \$1.25



4
FACT-PACKED SECTIONS

**Short Wave Listening
Amateur Radio
Citizens Radio Service
Business Radio Service**

148 PAGES . . .

All-new and better than ever, the 1966 COMMUNICATIONS HANDBOOK brings you exclusive information on such vital subjects as getting started in SWL—buying equipment and station reporting; establishing your CB station, public service activities; ham license applications procedures, learning the code; typical business radio installations . . .

PLUS a special nation-wide listing of 250 amateur radio clubs offering code and theory courses and a roster of 400 CB clubs—both lists available nowhere else!

. . . and much, much more. Everything you need to know about your specialty is covered by a leading authority in the field—from basic instruction for the beginner through the most advanced data and techniques.

Complete with charts, tables and illustrations galore, it's a big, valuable "encyclopedia" of communications information you'll use all year long.

Just what you've been looking for? Then clip the handy coupon below and send for your copy today!



**AVAILABLE FOR
THE FIRST TIME!**

**GET THE EXQUISITE
LEATHERFLEX-
BOUND EDITION**
for just \$3 POSTPAID!

The 1966 COMMUNICATIONS HANDBOOK is now available in an attractive, gold-embossed, Leatherflex-bound edition—a superb addition to your library of permanent reference books. This deluxe volume will be mailed to your home, **postpaid**, for just \$3.00, when you check the appropriate box on the order form.

Ziff-Davis Service Division • Dept. CH
589 Broadway • N.Y., N.Y. 10012

YES! Send me a copy of the 1966 COMMUNICATIONS HANDBOOK, as checked below:

- \$1.25 enclosed**, plus 15¢ for shipping and handling. Send me the regular edition. (\$1.50 for orders outside the U.S.A.)
- \$3.00 enclosed**. Send me the Deluxe Leatherflex-bound edition, **postpaid**. (\$3.75 for orders outside the U.S.A.) Allow three additional weeks for delivery.

NAME

EW-36

ADDRESS

CITY

STATE

ZIP CODE

PAYMENT MUST BE ENCLOSED WITH ORDER.

**“Get more
education
or
*get out of
electronics***

...that's my advice.”

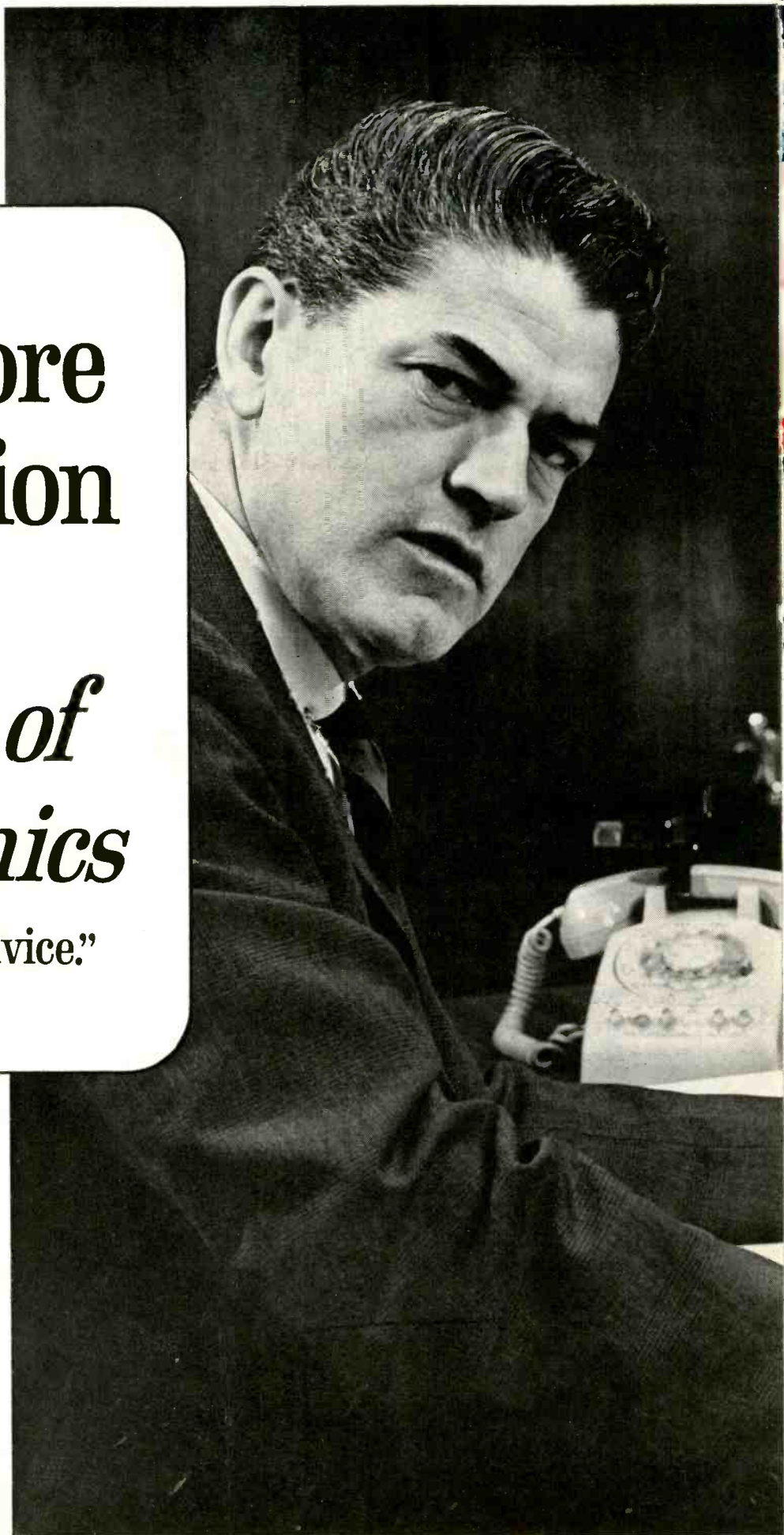



March, 1966

Ask any man who really knows the electronics industry.

Opportunities are few for men without advanced technical education. If you stay on that level, you'll never make much money. And you'll be among the first to go in a layoff.

But, if you supplement your experience with more education in electronics, you can become a specialist. You'll enjoy good income and excellent security. You won't have to worry about automation or advances in technology putting you out of a job.

How can you get the additional education you must have to protect your future—and the future of those who depend on you? Going back to school isn't easy for a man with a job and family obligations.

CREI Home Study Programs offer you a practical way to get more education without going back to school. You study at home, at your own pace, on your own schedule. And you study with the assurance that what you learn can be applied on the job immediately to make you worth more money to your employer.

You're eligible for a CREI Program if you work in electronics and have a high school education. Our FREE book gives complete information. For your copy, airmail postpaid card or write: CREI, Dept. 1103 D 3224 Sixteenth Street, N.W., Washington, D.C. 20010



**NOW!
TWO NEW PROGRAMS!**

- Industrial Electronics for Automation
- Computer Processing Systems

*Sign up
today!*

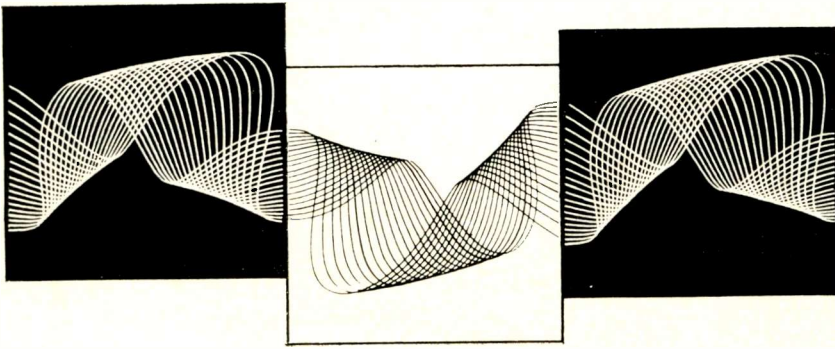

Square-wave Testing

By JAMES F. KENNEDY

Once you know how a square wave is made up, this useful waveform can be used to rapidly test an over-all system.

SQUARE waves are not only useful in testing audio amplifiers but they also occur in television, radar, digital computers, and many other types of modern electronic circuitry. For this reason, a knowledge of the makeup and use of square waves is vital to nearly everyone who deals with electronics.

With fifteen or twenty audio signal generators and lots of patience, a pretty good square wave could be developed. First, select a fundamental frequency of, say, 100 Hz of sine wave at a convenient amplitude. Then mix that with the third harmonic of the fundamental, or 300 Hz of sine wave at one-third the amplitude of the fundamental. From the next generator, feed in the fifth harmonic of the fundamental at one-fifth the amplitude; then the seventh harmonic at one-seventh the amplitude of the fundamental; and so on. Arrange it so all of these sine waves are exactly in phase (starting at the same time).

Fig. 1A shows how these waveforms will combine to form a square wave. As more and more odd harmonics having the proper phase and amplitude are added, the resultant waveform comes closer to a perfect square wave.

There are several important things to be learned from this analysis. First, a square wave is made up of a number of sine waves: it consists of the fundamental and a great number of odd harmonics. The higher the harmonics go, the closer the

final resultant waveform will resemble a square wave.

Second, notice from Fig. 1A that the fundamental and the lower harmonics fill in the flat top portion of the square wave.

Third, note that the higher harmonics contribute to the steepness of the leading and trailing edges of the waveform and to the squareness of the corners at the top.

If you feed a square wave into an audio amplifier and look at the result on a scope, you will actually be testing the amplifier from about one-tenth of the fundamental frequency up to about 40 times that frequency. The amplifier may handle a sine-wave input with no difficulty, but a square-wave test is much more realistic, as the amplifier is now being called on not only to handle the fundamental frequency, as it would do with a sine-wave input, but it is also being asked to amplify all the harmonic components in the wave equally, without changing the phase of any of them.

When a signal is passed through a capacitor, the voltage lags the current, and *vice versa* when the signal goes through an inductance. Most amplifiers use coupling capacitors. At medium and high frequencies, the reactance of the capacitors is negligible, but as the frequency goes down, the reactance increases until it may be considerable. When a capacitor is operated with a following grid resistor, for example, the combination will act like a frequency-sensitive voltage divider, reducing the level as the frequency goes down. Depending on the relative values of this pair of components, a certain amount of phase shift will also occur. This means that at the lower frequencies, the signal will be changed in phase and amplitude compared with a higher frequency signal. This is called phase distortion.

Fig. 1B shows the effect on the shape of the waveform if the fundamental is delayed in phase. Since time is read from left to right on the diagram, a lag in the fundamental frequency means that it will be displaced to the right, as shown. Note that the right-hand, or trailing, edge is higher in amplitude than the left-hand, or leading, edge. This is also called "tilt." If there is a phase lead, the lower frequency components will be moved over to the left and the tilt will be in the other direction.

Fig. 1. (A) Adding a large number of odd harmonics to a sine wave produces a square wave. (B) Phase lag of the fundamental.

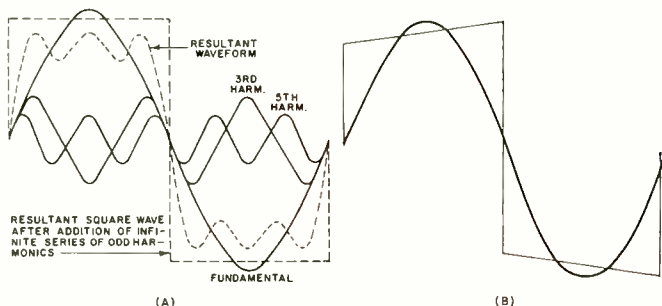

This particular amplifier would put out a good sine wave at 20 Hz, and there would be no clue as to the phase distortion present if it were tested with just a sine-wave signal.

As previously mentioned, capacitive reactance increases as the frequency goes down. This means that the output of the amplifier will fall off at the lower frequencies. Because the lower frequency components of the square wave contribute mostly to the flat top of the waveform, if these components are made weaker, or attenuated, the flat top portion will sag, as shown in Fig. 2A. This illustration shows the results on the shape of the square wave if the fundamental or the lower harmonics are attenuated while going through the amplifier. However, this attenuation is usually due to reactive components in the amplifier, that is, the effect of capacitance or inductance on the waveform. This means that usually there is going to be not only attenuation but also some phase shift along with it. The effect of phase shift at the lower frequencies is to cause a tilt in the flat top, and the attenuation at these lower frequencies causes a sag in the flat top, so that it is possible to see something like Fig. 2B.

Too much output at the lower frequencies, called low-frequency boost, will show up as a bulge in the flat top portion, as in Fig. 2C. Another point should be evident from the foregoing discussion: an audio amplifier cannot be tested by feeding in a square wave at just one frequency. A 20-Hz square wave will test up to about 40 times the fundamental, or 800 Hz. Obviously, this tells us nothing about the way the amplifier handles higher frequencies, say up to 20,000 Hz or so. If we divide 20,000 by 40 we get 500 Hz as a convenient value for our second test frequency.

Conversely, the 500-Hz test will tell us very little about the low-frequency operation of the amplifier. We have to be careful in choosing the frequencies for testing, too. If a 10,000-Hz square wave is used, the amplifier will be checked to 400,000 Hz.

The higher frequency components of the square wave contribute to the sharpness of the corners of the waveform and to the steepness of the rise of the wave. Fig. 2D shows a rounding of the upper corners caused by attenuation of the higher frequency harmonics in the square wave. This is called roll-off. Note particularly that the leading edge and trailing edge are both rounded, which shows that the phase of the high-frequency harmonics has not been changed with respect to the other frequencies in the wave. If we had both high-frequency loss and the phase shift (and this could happen), the waveform would look like Fig. 2E.

It is also possible to have one type of distortion at one end of the spectrum and a different type at the other end. Waveform shapes like Fig. 2F would indicate phase shift at the low-frequency end and high-frequency loss at the other end.

Too much amplification at the higher frequencies can result in a waveform with leading-edge overshoot like that shown in Fig. 2G.

Another type of distortion which may appear is evidenced by oscillation across the top of the waveform as in Fig. 2H. This is an indication that the amplifier is breaking into oscillation or ringing at some very high frequency.

There is nothing to prevent using the same technique for checking video amplifiers. The video amplifier in a television set should handle a range of frequencies from about 25 Hz to 4 MHz. If there is attenuation at the higher frequencies, fine details in the picture will not be clear.

Fig. 3 shows some of the nomenclature used in pulse measurements and discussions. Probably the most frequently used term is "rise time," which is just what the name implies: the time for the pulse to rise from 10% to 90% of its maximum value. In checking a computer, for example, part of the procedure would involve measurement of the clock pulse to make sure that the rise time was within certain limits. This time is usually measured in microseconds or nanoseconds. The vertical amplifier of the scope used would have to amplify the pulse

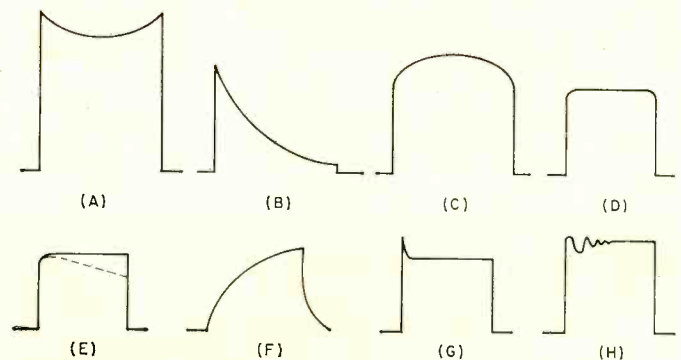

Fig. 2. Typical square-wave distortions. (A) Decrease in low-frequency gain. (B) Decrease in low-frequency gain plus phase shift. (C) Excessive low-frequency gain. (D) Poor high-frequency response. (E) Poor high-frequency response plus phase shift. (F) Low-frequency phase shift plus loss of high-frequency gain. (G) Excessive high-frequency response. (H) Oscillation occurring at a high frequency. In all these waveforms, it is assumed that the oscilloscope is not at fault.

without distortion so that an accurate measurement could be made. Such an amplifier would be flat within 3 dB from d.c. to 15 MHz, 30 MHz, or even higher.

So far only symmetrical square waves, that is, square waves in which the pulse-width time and the resting time are equal, have been discussed. A radar transmitter or a television set might involve square waves in which the pulse width is only a small part of the total time. For instance, the pulse width might be one microsecond, or $\frac{1}{1,000,000}$ of a second, and the pulse might be repeating 5000 times a second. These are non-symmetrical square waves. The 5000 figure would represent the "pulse-repetition rate," which is generally used in preference to the word frequency. This pulse occurs for one microsecond, 5000 times a second, or 5000 microseconds out of each second. Since there are 1,000,000 microseconds in each second, the pulse is actually present only .005% of each second and the rest of the time the circuit is resting. This is called the duty cycle and is one reason why such huge amounts of power may be developed with radar transmitters. The transmitter is operating for only a very small portion of the total time so that it can withstand tremendous overloads and then cool off until the next pulse comes along.

Short pulses of this type have a very fast rise time, which means higher frequency harmonics in the waveform and the fact that the amplifiers must handle an upper frequency limit equal to the reciprocal of the pulse width. For a pulse of one-microsecond width, the amplifier would have to go up to at least the reciprocal of this, which is $\frac{1}{.000001}$ or 1,000,000 Hz. Some radar receivers have a bandwidth of 5 MHz or more to properly handle short pulses without distorting them. In the case previously mentioned, the lowest frequency the receiver would have to handle would be 5000 Hz, which is the pulse-repetition rate. This is equivalent to the fundamental frequency. The upper frequency limit is fixed by the pulse width, and even though the pulse may occur just once a second, if it is one microsecond wide then the amplifier must handle frequencies up to at least 1 MHz. ▲

Fig. 3. Complete nomenclature for defining a square wave.

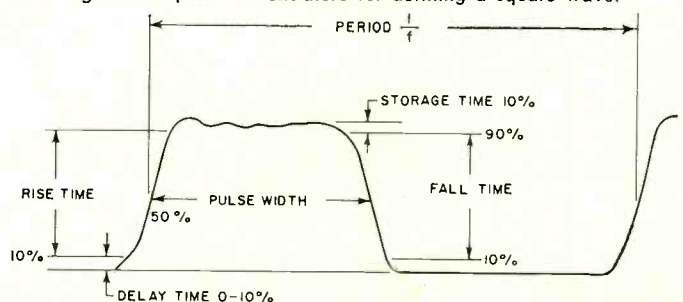

NEW PRODUCTS & LITERATURE

Additional information on the items covered in this section is available from the manufacturers. Each item is identified by a code number. To obtain further details, fill in coupon on the Reader Service Card.

COMPONENTS • TOOLS • TEST EQUIPMENT • HI-FI • AUDIO • CB • HAM • COMMUNICATIONS

RANDOM NOISE GENERATOR

A new solid-state 3-band random noise generator is being marketed as the Model 603A. Covering the spectrum from 5 cps to 5 mc. in three bands of 5 cps to 20 kc., 5 cps to 500 kc., and 5 cps to 5 mc., this instrument offers out-



put flatness of ± 1 db from 10 cps to 500 kc. and ± 3.5 db from 500 kc. to 5 mc. at maximum r.m.s. output level of 3 volts on all bands.

The five-position attenuator, continuous variable output level control, and fixed output impedance of 200 ohms adds to the versatility of the instrument. Various rack mounting options are available for either single or dual units. Eigenco

Circle No. 126 on Reader Service Card

INDUSTRIAL LINEAR CIRCUITS

A new family of linear integrated circuits designed specifically for applications in industrial environments has been put on the market as the Series 72.

The new family of monolithic silicon circuits initially includes the SN723 general-purpose differential amplifier and the SN724 general-purpose operational amplifier. These units are limited-temperature versions of circuits first announced for military applications more than a year ago. Operating temperature range is 0° to $+70^{\circ}$ C. Package for the SN723 is the standard hermetically sealed TO-84 flat pack with 14 lateral leads while the SN724 package is the 10-lead TO-89 flat pack. Texas Instruments

Circle No. 127 on Reader Service Card

U.H.F.-V.H.F. TV CABLE

The new "Durafoam" u.h.f.-v.h.f. television transmission cable features two carefully spaced tubes of yellow foam polyethylene, the outer jacket and barrier separating the conductors is 115 mils of patented "Permaline" insulation. The company is guaranteeing the new product for 15 years.

Impedance of the cable is 290 ohms, nominal capacitance is 4.9 and attenuation is 1.04 db at 100 mc., 3.5 db at 500 mc., and 4.5 db at 900 mc. The cable is 0.410 inch wide and 0.150" over foam polyethylene tubes. Columbia Wire

Circle No. 1 on Reader Service Card

HIGH-POWER SCR'S

A new high-power a.c. switch capable of handling 1200 amperes r.m.s. continuous current with blocking capability to 1800 volts now permits switching of 1.5-megawatt loads. Power handling capacity which greatly exceeds previous devices is achieved primarily with water cooling and a method of heat transfer which dissipates heat from both sides of the SCR junction structure.

The new switch is particularly suited for resistance welding because of its small size ($6'' \times 6'' \times 5''$), excellent thermal and overload ca-

capacity, high surge current rating, ability to be installed in any position, long life, and low power requirements. General Electric

Circle No. 128 on Reader Service Card

TETRODE FET

A new high-frequency, high-transconductance "n"-channel tetrode FET has been added to a line of junction field-effect transistors as the T1XS35.

This double-gate TO-12 device offers a two-to-one improvement in transconductance and frequency capability over currently available tetrode FET's, according to the manufacturer. The units are suitable for use in autodyne mixer circuits where they can function as both mixer and local oscillator, eliminating one transistor and associated oscillator circuitry. Other principal applications include high-frequency mixers, amplifiers, and choppers. They can also be used in multiplex and sample-hold circuits. Texas Instruments

Circle No. 129 on Reader Service Card

CRT CHECKER/REJUVENATOR

The Model CR128A CRT checker/rejuvenator is a revised and improved version of the firm's CR128 and provides for more accurate checks on the new black-and-white and color picture tubes. All the necessary sockets are mounted on two permanently attached cables and include the latest rectangular color-tube socket for such tubes as the 15", 19", 23" and 25" sizes.

Other features include the use of a taut-band meter and all-steel construction for maximum service and durability. Checks include emission,



shorts, and leakage between elements; gas; and expected tube life. The instrument measures $10'' \times 9'' \times 3\frac{1}{2}''$ and weighs ten pounds. Sencore

Circle No. 2 on Reader Service Card

SNAP-IN SUPPORT CLIPS

A complete new line of nylon snap-in support clips is now available. The clips are snapped by hand into a $\frac{1}{4}''$ hole in metal, plastic, or any surface with a thickness from $\frac{1}{32}''$ to $\frac{1}{8}''$ to quickly and securely hold wires, tubes, hoses, or rods from $\frac{1}{8}''$ to $\frac{3}{8}''$ diameter.

Made of strong nylon plastic, the clips are held firmly in place by flexible snubber tips which compensate for variations in wall thickness. Thogus Products

Circle No. 130 on Reader Service Card

PC BOARD PROTECTION

A specially formulated polyvinyl fluoride coating, PT 207, has been developed expressly for the purpose of protecting printed-circuit boards and increasing their reliability.

PT 207 adds extra resistance to high-"g"

shock impact to provide excellent environmental protection. It is non-volatile and self-extinguishing. Because of its formulation, the coating flows around discrete components and provides smooth fillets at all angular intersections. The coating is removable with a hot soldering iron.

The product air dries in 30 minutes and may be applied by spraying, dipping, or brush painting. It is also available in aerosol form. Product Techniques

Circle No. 131 on Reader Service Card

10-TURN PRECISION POT

A 10-turn, $\frac{1}{2}$ -inch diameter precision potentiometer for industrial use is now available as the Model 3707.

Despite its relatively low cost, the new pot is encased in a compact plastic case measuring $1\frac{1}{2}''$ long, features the company's exclusive "Silver-weld" termination, and has a special rotor de-

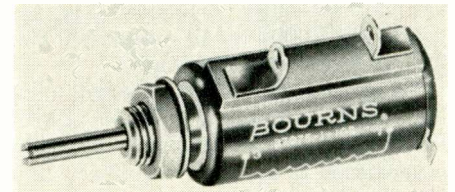

sign which assures excellent wiper stability under 50g shock and 10g vibration.

Standard resistance range is 100 to 100,000 ohms, resistance tolerance is $\pm 5\%$, linearity is $\pm 1\%$. The unit is rated at 1 watt at 40° C over an operating temperature range of -55° to $+105^{\circ}$ C. Trimpot Div., Bourns

Circle No. 132 on Reader Service Card

WIRE AND CABLE MARKING SYSTEM

A unique marking system designed to last the life of the wire and cable under all conditions has been developed and is being marketed as "Z" markers.

The new units can't peel off, rub off, fall off or unravel, according to the manufacturer. Extruded of durable polyvinyl chloride, they will resist abrasion, grease, oils, and chemicals. Packaged in continuous pre-cut strips of 50 or 500, the individual marker is a one-piece, flexible sleeve with an accordion-type pleated back.

Available in white with black markings, black with white markings, blue, green, yellow, or red with black or white markings, the complete alphabet, numerals from 0 to 9, symbols, and combinations are available to meet all requirements. Electrovert

Circle No. 133 on Reader Service Card

MINIATURE INDICATOR LIGHTS

A new series of 120-volt incandescent bi-pin cartridge and miniature bayonet indicator lights is available in a variety of lens colors—blue, colorless, red, green, and yellow.

These miniature indicator lights eliminate the use of transformers and resistors and are manufactured to strict quality-control standards. Complete specifications on this new line are contained in Folder No. 6507 which will be forwarded on request. Drake

Circle No. 134 on Reader Service Card

ELECTRONIC COMBINATION LOCK

A new electronic lock that operates by pressing the correct combination of four out of ten buttons at the selector box has been developed

to provide protection for both homes and factories. Unauthorized persons trying some combination other than the correct one will trigger an audible alarm. The same alarm can also be set to ring if the door is forced or remains open too long.

Known as "Passkey," the unit comes in two sections. The small (2" x 3½" x 6½") selector box mounts at the public side of the controlled door. The selector is electrically connected to a pad-locked control box inside the controlled area. This box measures 3½" x 8" x 9½". More than 500 different combinations are easily set or changed. Pulsecom

Circle No. 3 on Reader Service Card

110-AMP SCR'S

A new series of 110-ampere silicon controlled rectifiers for power control and switching applications is now available under the numbers 2N1792 through 2N1800.

These units are designed to be used for voltage regulators, power converters and inverters, dynamic braking, ignition firing, and frequency converters. They are also applicable for constant-current supplies, pulse-width modulators, for thyatrons, ignitrons, magnetic amplifiers, power transistors, relays, switches, contactors and circuits. Silicon Transistor

Circle No. 135 on Reader Service Card

ALUMINUM HEAT SINKS

A line of extruded aluminum heat sinks for TO-1 case transistors featuring a unique patented angled configuration, provides a number of important benefits for manufacturers.

Lower cost, simpler and faster assembly, and more effective clamping action are benefits claimed for the new units. Thermal resistance from case to ambient is reduced by a factor of

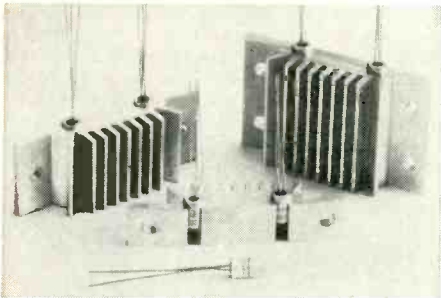

about 2:1, which permits the user to almost double the power output capabilities of present devices.

Three types are available, differing primarily in length and application. The HS-3 is ½" long and is used in amplifiers up to 10 watts. The HS-2 is 1" long and can be used as a completely independent heat dissipating system. The HS-1 is 1½" long and will provide adequate heat sinking for two output pairs for up to 10 watts per channel when mounted on a chassis. Ampere

Circle No. 136 on Reader Service Card

HI-FI—AUDIO PRODUCTS

MAGNETIC TAPE HEADS

A new line of magnetic tape heads, tailored to the needs of the high-fidelity, commercial, and auto-tape equipment OEM market, is now in reproduction. A full line of laminated heads in quarter-track, half-track, full-track, and eight-track versions is being offered. MacAllister/Hogan

Circle No. 4 on Reader Service Card

IMPROVED SPEAKER SYSTEM

The new speaker model, AR4S, is a modified version of the company's AR-4. The ¾-inch tweeter of the AR-4 has been replaced by a new 2½-inch unit with improved smoothness and high-frequency range as well as improved dispersion. The crossover frequency has been lowered from 2000 cps to 1200 cps.

The new unit is compatible in stereo with the older AR-4 and is identical in appearance. Con-

March, 1966

Extend CB "Talk Power"

Hy-Gain's

CLR 2

**the world's most powerful
all-directional base station
antenna for Citizens Band**

**With a Hy-Gain CLR2, any 5-watt
transceiver delivers all-directional power
equivalent to what you'd get with a
12.55 watt rig.**

That's "TALK POWER!"

For maximum range and greatest reliability in all-directional CB communications, Hy-Gain's CLR2 is the one antenna that's built to do the job. It is loaded with electrical and mechanical features that clearly put it in a class all its own. Take for example the 5/8 wavelength radiator...proven in test after test by every authoritative source in the electronics field to deliver a stronger signal over a greater area than either a ¼ wavelength or ½ wavelength radiator. Or, take the original static-removing "Top Hat" that cuts receiver noise...the moistureproof matcher that insures total electrical reliability...the unique electrical system that puts the entire antenna at DC ground for maximum static removal and lightning protection...or, the rugged, heavy duty all-weather construction that's rated to withstand winds up to 100 MPH. Any way you want to look at it, it's obvious the CLR2 is built to provide superior all-directional performance on CB. And, it sells for only \$29.95 Net.

Available from your Hy-Gain Representative or write...

HY-GAIN ELECTRONICS CORPORATION

8473 N.E. Highway 6
Lincoln, Nebraska 68501

CIRCLE NO. 105 ON READER SERVICE CARD

NIMS

**NATIONWIDE
IMPROVED
MAIL SERVICE—**

**A PROGRAM
FOR REDUCING
POSTAL COSTS
AND IMPROVING SERVICE
MAIL EARLY IN THE DAY
IT'S THE BETTER WAY!**

LETTERS READY?—MAIL THEM EARLY!

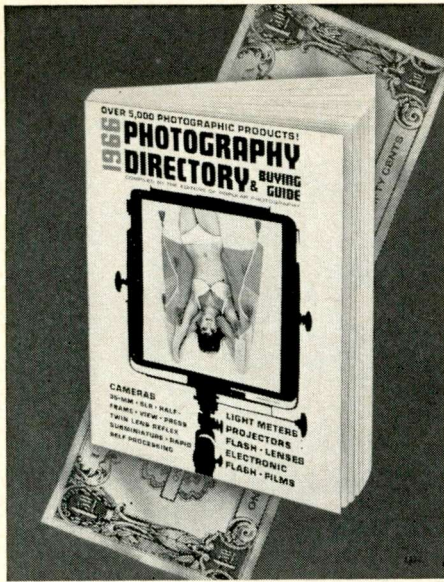

Dollar-st-r-e-t-c-h-e-r ...1966 edition!

If you're in the market for photography equipment and you want to get the most for your money, send for the 1966 PHOTOGRAPHY DIRECTORY & BUYING GUIDE right now!

Then just sit back and be as choosy as you like!

You'll have access to over a thousand different items—with complete, point-by-point information on manufacturer, model number, size, special characteristics and price.

And the 1966 edition of this big, valuable factbook is more comprehensive than ever before. A large, new 8½" x 11" format now brings you virtually every category of photo gear you want to know about...160 pages of all the latest equipment!

Expert tips on how to buy and what to look for in...still cameras, flash equipment, exposure meters, lenses, movie cameras, projectors, super-8, sound, titlers, editors, slide equipment, tape recorders, enlargers, films, filters...and more!

The 1966 PHOTOGRAPHY DIRECTORY & BUYING GUIDE has been compiled by the editors of POPULAR PHOTOGRAPHY. That means authoritative, precise information. Dollar-stretching data that will help you select the best equipment in your price range, consistently, all through the next twelve months!

This year, play it smart. Shop before you buy, confidently, with the up-to-the-minute 1966 PHOTOGRAPHY DIRECTORY & BUYING GUIDE.

First Time Ever Offered!
A DELUXE, GOLD-EMBOSSD
LEATHERFLEX-BOUND EDITION
... just \$3.00 postpaid.



Ziff-Davis Service Division
Dept. PD, 589 Broadway • N.Y., N.Y. 10012
YES! Send me a copy of the 1966 PHOTOGRAPHY DIRECTORY & BUYING GUIDE, as checked below:

- \$1.25 enclosed, plus 15¢ for shipping and handling. Send me the regular edition. (\$1.50 for orders outside the U.S.A.)
- \$3.00 enclosed. Send me the DeLux Leatherflex-bound edition, postpaid. (\$3.75 for orders outside the U.S.A.) Allow three additional weeks for delivery.

name _____ EW-36
address _____
city _____ state _____ zip code _____

—PAYMENT MUST BE ENCLOSED WITH ORDER.—

version kits are available to owners of AR-4's who wish to upgrade their present speakers. The skills required to make this conversion are comparable to those involved in wiring an amplifier kit. Acoustic Research

Circle No. 5 on Reader Service Card

REDESIGNED LINE RADIATOR

The LR45A line radiator is a redesigned version of the firm's popular LR45 all-weather speaker system. The new model is totally different in outward appearance with modern, clean-looking, extruded aluminum case and black metal front grille. The new speaker will handle 40 watts of program power, an increase of 15 watts over the former model. The unit generates sound pressure of 116 db at 4 feet on-axis with 40 watts input. Electro-Voice

Circle No. 6 on Reader Service Card

160-WATT SILICON AMPLIFIER

An all-silicon amplifier-preamp featuring 160 watts of music power at 8 ohms is now available as the S-9000-a. According to the company, the all-silicon reliability plus thermostatic protection of the silicon output transistors makes possible

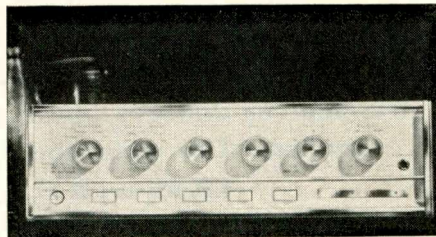

120 watts of continuous sine-wave power output (both channels driven) at less than 0.3% distortion. Corrective feedback of 46 db maintains distortion at 0.1% or less below 10 watts.

The new unit features special circuitry which extends the phono-input signal handling capabilities to 250 mv. and provides a phono sensitivity of 1.8 mv. to accommodate the lowest output magnetic phono cartridges. Power bandwidth at 0.5% harmonic distortion is 12 to 25,000 cps. Sherwood

Circle No. 7 on Reader Service Card

SOLID-STATE COMPRESSOR

A new solid-state compressor for professional recording and broadcasting use, the Model C-20, features a 10:1 compression ratio with all plug-in electronic circuitry. The unit provides automatic control of system gain to achieve maximum levels on tape and disc and more effective radiated power in broadcasting.

The compressor consists of two separate components: the CA-20, the electronic portion, is a plug-in circuit board containing a transformer-input bridging amplifier. The other component, CC-20, is the control portion for panel mounting and includes a compression meter and variable controls for adjustment of threshold level and release time. Melcor

Circle No. 137 on Reader Service Card

120-WATT SOLID-STATE STEREO AMP

A solid-state integrated stereo amplifier rated at 120 watts has been added to the "Superba" series of hi-fi equipment in kit form. The circuit employs 26 premium-quality transistors and 8 diodes; features direct-coupled output; freedom from microphonics and mechanical noises; virtual elimination of heat, hum, and thermal sound; and instant operation with no warm-up.

Rated output into an 8-ohm load is 120 watts IHF, 60 watts per channel, and 240 watts peak.



Frequency response is 18-30,000 cps \pm 1 db at full rated output. Channel separation is better than 55 db and damping factor is 6 for 8-ohm speakers.

The "Knight KG-895" measures 5" x 16¾" x 15" over-all, and comes complete with detailed assembly manual. Allied Radio

Circle No. 8 on Reader Service Card

COMPACT REVERB DEVICE

A new, compact reverb device that is said to be especially useful to manufacturers of small-sized musical instruments, radios, and sound-amplification equipment is being marketed as the Type VII.

The new half-size reverb unit measures only 4 inches yet provides comparable delay time, decay time, and superior shock resistance to spring units many times the size.

Complete details and specifications on this reverb unit are available on request. Gibbs

Circle No. 9 on Reader Service Card

TRIPLE PLAYING-TIME TAPE

A new Mylar-base recording tape on a 2¾-inch reel, which triples playing time without any sacrifice of quality, is now on the market.

The use of a recently developed oxide formulation provides the TP-3 tape with an output of 5 db more than any other extended-play tape, according to the manufacturer. The tape may be interspersed or programmed with standard tapes without causing differences in playback level.

The TP-3 provides 300 feet of 0.5-mil Mylar on each 2¾-inch reel. This gives 64 minutes of playing time at 1½ ips or 32 minutes at 3¼ ips. Reeves Soundcraft

Circle No. 10 on Reader Service Card

WIRELESS PAGING SYSTEM

A new high-output, two-way paging and talk-back system that simply plugs into a.c. outlets has been recently introduced as the "Plug-in Pager." The system consists of one Model WPT-2 paging/talkback amplifier, one or more Model CO-1 call originators, and two or three speakers as required. The system permits one (or more) person to originate the call, while the paged party can reply by speaking in the direction of the

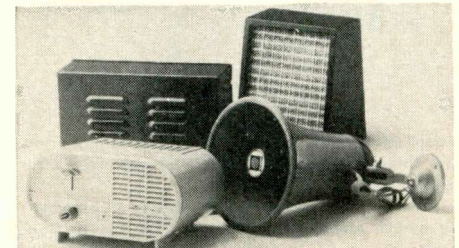

speaker. The reply is accomplished "hands-free" since it is unnecessary to press a switch to respond.

Complete specifications and application data are available from the manufacturer on request. Fanon

Circle No. 11 on Reader Service Card

CB-HAM-COMMUNICATIONS

25-WATT V.H.F. FM RADIOS

New two-way, 25-watt v.h.f. FM mobile units are now available in several versions to meet the requirements of business users.

These "Continental" models are available in both trunk-mount and dash-mount versions. Different variations provide up to six switch-selected channels on fixed frequencies between 25 and 174 mc., with channel spacings of 20 kc. low band or 30 kc. high band.

The trunk-mount consists of two units connected by a 20-foot multi-lead cable. The main unit, which houses the transmitter-receiver and power supply in a splash-proof aluminum case, is primarily designed for trunk mounting, but can be installed in a horizontal or vertical position in any vehicle where the necessary 12 volts d.c. is available.

Don't Buy a 1966 Car!

... unless you've read the 1966 Car and Driver Yearbook. It's got the

answer to every automotive question you can think of...

- All new road tests of 60 models — economy cars; compact, intermediate and full-size sedans; sports sedans; sports and GT cars; luxury cars.
- A buyer's guide to more than 100 other models, covering virtually every car available in the U.S.A.
- A comprehensive analysis of what's happening in the automobile industry — styling, engineering, safety, prices and predictions.
- Technical specifications of all domestic and imported cars.
- A spectator's guide to racing, with action-packed photos.
- 16 pages of accessories and performance equipment.

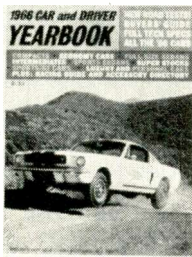

8-COLOR ANTIQUE CAR CHART

—ready for framing—printed in Sweden. Regularly \$2.95. Save \$1 by ordering now with 1966 Yearbook—both for just \$3.35!

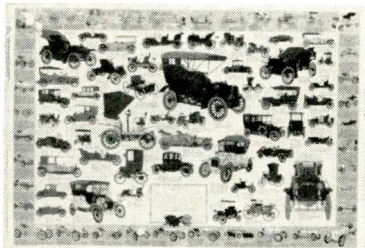

— Fill in Detach and Mail Coupon Today —

Ziff-Davis Service Division/Dept. CDY
589 Broadway/New York, N.Y. 10012

- Send me the Yearbook only, \$1.25 enclosed, plus 15¢ for shipping and handling. (\$1.50 for orders outside the U.S.A.)
- Please send me the 1966 Car and Driver Yearbook plus the Antique Car Chart, \$3.35 enclosed. (\$4.00 for orders outside the U.S.A.) Allow three additional weeks for delivery.

print name _____ EW-36

address _____

city _____ state _____ zip code _____

PAYMENT MUST BE ENCLOSED WITH ORDER

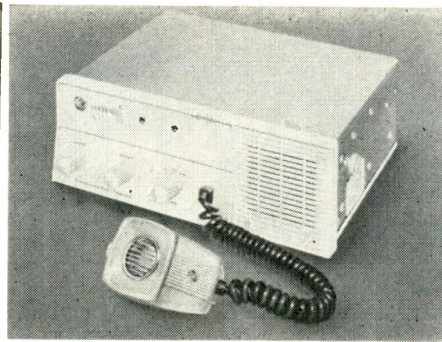

The dash-mount unit is extremely compact and fits under the dashboard of most vehicles. A single unit, it is completely enclosed and protected from dust and moisture.

In both models a three-position power switch provides "off/receiver/standby" control facilities. The receivers are fully transistorized double superhets. They incorporate a squelch circuit which eliminates background noise in the absence of a signal and utilize a sealed i.f. block filter for improved selectivity. ARC

Circle No. 12 on Reader Service Card

TWO-CHANNEL CB UNIT

A hand-held, 2-watt, two-channel CB radio is now being marketed as the Model T-2. The new unit is completely solid-state and contains 14 transistors. It is ruggedly housed and specially engineered for all types of industrial applications such as in the construction field, warehousing, material handling, and for field, portable, and mobile use.

The circuit features a built-in meter for modulation and battery test, adjustable squelch, automatic noise limiter, and jacks for external earphone and microphone where required. The unit measures 3½" w. x 10¼" h. x 2" d. and weighs 2 pounds. It comes complete with a pair of crystals, self-contained nickel cadmium batteries, 117-volt a.c. charger, leather case, and earphone. Sonar

Circle No. 13 on Reader Service Card

12-CHANNEL MOBILE CB

A 12-channel solid-state mobile CB unit, the "Pace-H-S," features a front-panel "S" meter which indicates relative incoming signal strength in "S" units and db over S-9. The information is displayed on a back-lighted 1½" edgewise scale, factory calibrated to read S-9 at 100 microvolts.

The transmitter is rated at full 5 watts output and delivers 3½ watts to the antenna at 100%



modulation. The double-conversion superhet receiver features a narrow-band shaped audio response and single crystal tolerance of 0.0033%.

Features include a two-position extended noise limiter, external speaker jack with p.a. facility, and a rear panel squelch sensitivity adjustment. Pace

Circle No. 14 on Reader Service Card

MOBILE CB UNIT

The KX-100 23-channel CB unit features a crystal filter to produce 95 db or better adjacent-channel selectivity. A built-in low-pass filter reduces TVI and frequency synthesis is used to cover all 23 CB channels.

The unit is equipped with a key-operated power switch to prevent unauthorized use. The

"Which microphone should I use for tape recording?"



Free!

Microphones '66 — a book every owner of a tape recorder should have. Send coupon today!



UNIVERSITY SOUND
A DIVISION OF LTV LING ALTEC INC.

Dept. C65, P.O. Box 1056, Oklahoma City, Okla.

Name _____

Address _____

City _____

State _____ Zip _____

CIRCLE NO. 83 ON READER SERVICE CARD

VALUABLE books from E. & E.

great "how-to-build" data in the famous

RADIO HANDBOOK (16th Ed.)

Tells how to design, build, and operate the latest types of amateur transmitters, receivers, transceivers, and amplifiers. Provides extensive, simplified theory on practically every phase of radio. Broadest coverage; all original data, up-to-date, complete. 816 pages. Order No. 166, only.....\$9.50

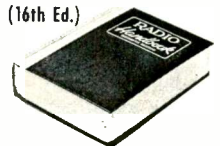

RADIOTELEPHONE LICENSE MANUAL

Helps you prepare for all commercial radiotelephone operator's license exams. Provides complete study-guide questions and answers in a single volume. Helps you understand fully every subject you need to know to obtain an operator's license. 200 pp. Order No. 030, only \$5.75



LEADING BOOK ON TRANSISTORIZED COMMUNICATIONS EQUIPMENT

TRANSISTOR RADIO HANDBOOK, by Donald L. Stoner, W6TNS, Lester A. Earnshaw, ZL1AAX. Covers a wide range of communication uses for both amateur and commercial applications. Includes audio and speech amplifiers, VHF transmitting and receiving equipment, SSB exciters, and complete SSB transceivers. 180 pages. Order No. 044, only.....\$5.00



EDITORS and ENGINEERS, Ltd.

P.O. Box 68003, New Augusta, Indiana, Dept. EWE-3

Ship me the following books:

No. 166 No. 030 No. 044 \$_____encl.

Name _____

Address _____

City _____ State _____ Zip _____

CIRCLE NO. 115 ON READER SERVICE CARD

Tarzian offers FAST, DEPENDABLE TUNER REPAIR SERVICE (ALL MAKES)

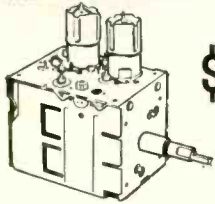

ONLY
\$950
INCLUDING

ALL PARTS (except tubes) and LABOR

24-HOUR SERVICE 1 YEAR WARRANTY

Sarkes Tarzian, Inc. maintains two complete, well-equipped Factory Service Centers—assisted by Engineering personnel—and staffed by specialized technicians who handle ONLY tuner repairs on ALL makes and models. Tarzian-made tuners received one day will be repaired and shipped out the next. Allow a little more time for other tuners.

One year guarantee against defective workmanship and parts failure due to normal usage. Cost — \$9.50 per unit. \$15 for UV combinations. Absolutely no additional, hidden charge for ANY parts, except tubes. You pay shipping costs. Replacements on tuners beyond practical repair are available at low cost.

When inquiring about repair service, always give TV make, chassis and Model number. Tuners repaired on approved, open accounts. Check with your local distributor for Sarkes Tarzian replacement tuners, replacement parts, or repair service. See your distributor, or use the address nearest you for fast factory repair service:



SARKES TARZIAN, INC.

537 South Walnut Street
Bloomington, Indiana
Tel: 332-6055

10654 Magnolia Blvd.,
North Hollywood, Calif.
Tel: 769-2720

CIRCLE NO. 91 ON READER SERVICE CARD

SAY YOU
SAW IT
IN
ELECTRONICS
WORLD



main unit weighs 5 pounds and is 8" x 8" x 4". Both power supply and loudspeaker are remote units to simplify dashboard mounting and to reduce heat within the basic unit. Tram

Circle No. 15 on Reader Service Card

FIVE-CHANNEL TRANSCIVER

The new "S5S" CB transceiver has five crystal-controlled transmit/receive channels and an exclusive "Noise Silencer" circuit that defeats noise caused by auto ignition, power lines, and fluorescent lights without loss in signal level and without the introduction of audio distortion. This device utilizes a pre-i.f. silencer that detects noise before the pulse is broadened by i.f. selectivity. The unit also uses a diode noise limiter which attenuates broadband noise.

The "S5S" features solid-state circuitry throughout, low battery drain, and small size (8" x 3 1/2" x 7"). A full complement of accessories is available for use with the basic unit. Squires-Sanders

Circle No. 16 on Reader Service Card

23-CHANNEL CB UNIT

An all-solid-state, 23-channel CB radio which features extremely low power drain is being marketed as the "Director." This compact (8 1/2" w. x 2 3/4" h. x 8 1/4" d.) unit can be mounted virtually anywhere that 13.8 volts d.c. are available. For mobile installations, the unit features a reversible mounting cradle with "instant release."

The transmitter features an exclusive frequency synthesis circuit which the company claims results in exceptional stability with maximum protection against spurious signals.

A data sheet giving full specifications will be forwarded on request. Pearce-Simpson

Circle No. 17 on Reader Service Card

MARINE EQUIPMENT

An extensive line of marine equipment, including two-way CB units, a radio-direction finder, a gas fume detector, and several radiotelephones of various powers, is now available.

Included in the new line are "Newport 100" 100-watt marine radiotelephone; the "Gulfstream 150" 150-watt unit; the "Carib 150-B" radiotelephone; the "Carib 154" 150-watt radiotele-



phone; and the "Commercial 300-A" radiotelephone; the marine "Sea-B" Citizens Band unit; the Model DF 765 radio direction finder (photo); and the Model FD-164 fume detector.

Complete specifications on any of these units are available in the form of data sheets which will be supplied on request. Pearce-Simpson

Circle No. 18 on Reader Service Card

CB UNITS

The "Mustang II" is an eight-channel, crystal-controlled transmitter and receiver with an

added transmitter crystal socket. It receives all 23 CB channels. The receiver has an illuminated "S" meter, a spotting switch, and a squelch. The transmitter features push-to-talk relay-less switching, and built-in speech clipping. Power source is 117 volt a.c., 60 cps. Dimensions are 5 1/8" high x 11 1/16" wide x 6 3/4" deep.

The "Pacer II" has 11-channel, crystal-control transmit and receive and is receiver tunable over all 23 CB channels. The receiver features an automatic noise limiter, a large-size "S" meter, and a squelch circuit. The transmitter features push-to-talk relay-less switching and built-in speech

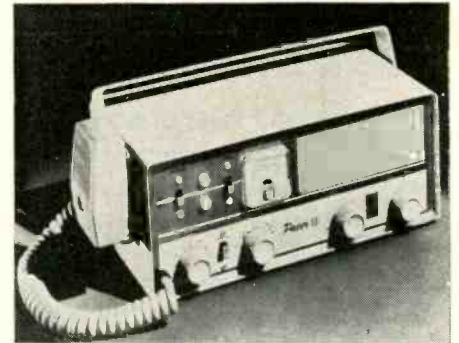

clipping. Power source is either 117 volts a.c. or 12 volts d.c. The unit is 4 3/4" high x 11 1/16" wide x 6 3/4" deep. Metrotek

Circle No. 19 on Reader Service Card

MANUFACTURERS' LITERATURE

TOGGLE SWITCHES

A specification sheet covering a line of three-pole toggle switches in solder lug, space terminal, screw terminal, and wire-lead terminal styles, with or without rocker actuator, is now available. Switches are UL listed and have ratings of 3 through 17 amperes, 125-250 volts a.c., and up to 2 hp, 600 volts a.c., three-phase. Carling

Circle No. 138 on Reader Service Card

RECTIFIER CATALOGUE

A new four-page catalogue covering high-power diode rectifiers and SCR's gives key ratings such as voltage ranges, r.m.s. current (SCR's only), average current, d.v./d.t. in volts per microsecond, pellet construction, and model numbers for 20 lines of high-power rectifiers and SCR's.

The publication is designated No. 170.01. General Electric

Circle No. 139 on Reader Service Card

METAL INFORMATION

A pocket-sized (4" x 9") table of weights for tungsten, columbium, tantalum, and molybdenum that breaks down the weights of the various metals in inches and feet and includes the weights of round bars, billets, and sheets according to their sizes in inches is now available. Universal-Cyclops

Circle No. 140 on Reader Service Card

PRECISION POT CATALOGUE

Specifications and prices for twenty-five types of precision potentiometers are covered in short-form catalogue No. 3. Trimpot Div., Bourns

Circle No. 141 on Reader Service Card

TRANSISTOR SYSTEMS

Besides including complete specifications and prices on its line of transistor hi-fi equipment, this 8-page, full-color brochure also covers such subjects as why germanium output transistors are used, why output coupling capacitors are not used, and a discussion of the power of sound. Harman-Kardon

Circle No. 20 on Reader Service Card

COAXIAL CONNECTORS

A new 24-page catalogue describing series TNC, TM (miniature), and GM (microminiature) r.f. coaxial connectors has been published. Com-

plete specifications for a wide range of plugs, jacks, receptacles, and adapters are provided as well as cable assembly instructions and mounting data. General RF Fittings

Circle No. 142 on Reader Service Card

TANTALUM CAPACITORS

Complete information on a new family of rectangular metal-case foil tantalum capacitors (Types 300D through 303D) is supplied in engineering bulletin No. 3650.

Performance characteristics, standard ratings, performance curves, a guide for application and operation, and an explanation of the catalogue numbering system are provided. Sprague

Circle No. 143 on Reader Service Card

COMPONENTS CATALOGUES

A completely revised 1966 "Component Selector" catalogue covering thousands of items has been released. The 128-page publication includes application charts, type selector charts, and standard rating selector tables.

As a further design and purchasing aid, the company has produced a convenient pocket-sized "Rating Selector" to complement the new catalogue. Cornell-Dubilier

Circle No. 144 on Reader Service Card

CONNECTOR ASSEMBLIES

Concise descriptions of 43 major series of electronic and electrical connectors are offered in a new illustrated short-form catalogue, No. 127G. The brochure covers ultraminiature, subminiature, miniature, and power types, with and without shields or shells. U.S. Components

Circle No. 145 on Reader Service Card

EMERGENCY GENERATORS

A timely publication, in light of the recent Northeast power failure, entitled "How to Select and Install Standby Electric Plants" is now available. The 8-page illustrated brochure discusses plant size, type of engine (gas, gasoline, or

diesel), cooling methods, typical installations, and installation considerations.

Also supplied is a list of technical manuals and product catalogues which provide information on all aspects of emergency generator selection, installation, and operation. Onan

Circle No. 21 on Reader Service Card

COMMUNICATIONS SYSTEM

A complete tactical communications facility currently being built for the Marine Corps and Air Force is discussed and illustrated in a new 12-page booklet.

The system, designated AN/TRC-97/97A, is suitable for multi-channel voice, teletypewriter, or data traffic with high reliability and features over-the-horizon capability by tropospheric scatter phenomenon. RCA Defense Electronic Products.

Circle No. 146 on Reader Service Card

P. A. AMPLIFIERS

The "Mercury" series of compact public address amplifiers is discussed and illustrated in a new 2-page combination data sheet and catalogue. All models feature universal microphone input circuits, push-pull output stages, and front-panel controls and are small enough to be placed on a shelf or beneath or on top of a counter. Harman-Kardon

Circle No. 22 on Reader Service Card

TEMPLATES

A wide variety of electrical, architectural, mechanical engineering, ellipse, general, lettering guide, pipe and valve, and spacing templates is offered in a new 32-page, fully illustrated catalogue. Alvin

Circle No. 147 on Reader Service Card

PRECISION SWITCHES

Over 1000 switches, including limit types, enclosed switches, explosion-proof devices, proximity switches, basic and small basic mechanisms,

manually operated devices, and miscellaneous switches, are covered in a new 61-page illustrated catalogue (No. 50). Micro Switch

Circle No. 148 on Reader Service Card

TEST EQUIPMENT

A new 12-page illustrated catalogue (AP 22) of professional test equipment is now available. Television analyzers for both black-and-white and color, color generators, CRT rejuvenators and checkers, transistor radio analyzers, professional tube testers, in-circuit and out-of-circuit capacitor analyzers, and automatic-scale multimeters are offered. B&K

Circle No. 23 on Reader Service Card

RESISTORS & CAPACITORS

Technical information on microcircuit resistors and capacitors is contained in a new 8-page illustrated brochure recently released. Performance curves are amply provided. Corning

Circle No. 149 on Reader Service Card

DESK-TOP CALCULATOR

A new 8-page full-color brochure describing the "Epic 2000" electronic calculator is now available. The device combines electronic speed with the ease of operation of a desk-top calculator and provides a line-by-line printed record of all calculations.

Capable of extracting roots or computing the value of a sine without interpolation, the unit is virtually maintenance-free and requires no special atmospheric conditioning. Monroe

Circle No. 24 on Reader Service Card

VOLTAGE REGULATORS

A new 20-page illustrated buyer's guide (GEC-1064) describing a complete line of voltage regulation and control devices has been published.

Manual, plug-in, motor-operated, and automatic "Volt-Pac" variable transformers; a.c. voltage stabilizers; and regulated d.c. power sup-

THE TURNER TRANSISTORIZED



WITH VARIABLE OUTPUT LEVEL

Now, from Turner comes the very finest base station microphone ever designed. The **+2** features a two transistor pre-amp with volume control to give you up to 50 times the output level you now have. Yes, just dial your desired signal for maximum modulation all the time — every time. You can work close or far away from this microphone, or change the output for a big or little voice.

Eventually, all sets lose some of their initial power. Turner's **+2** puts the zip back into your set and keeps it up to full strength at all times!

The **+2** has tailored frequency response of 300-3500 c.p.s. for best and clearest voice transmissions with knocked down local noise interference.

Exclusive touch-to-talk or lock on-off switching — the **+2** works with all tube or transistor sets regardless of switching requirements or type.

Ask your dealer about the new **+2**.



LIST PRICE
\$49.50



THE TURNER MICROPHONE COMPANY

900 17th Street N.E., Cedar Rapids, Iowa

Available in Canada

Export: Ad Auriema, Inc., 85 Broad Street, New York 4, N.Y.

all the vital facts about all the latest hi-fi/stereo equipment

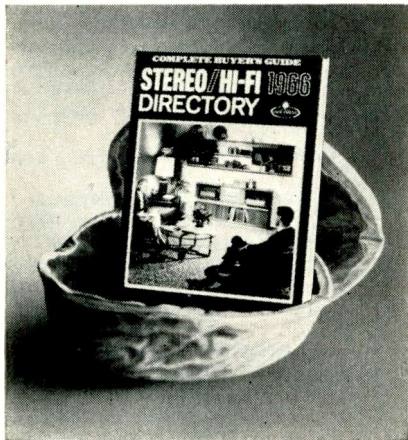

...in a nutshell!

The "meat" in this nutshell is guaranteed to whet the appetite of every audiophile and music lover who plans to buy hi-fi equipment during the next twelve months.

In over 172 fact-and-photo-filled pages, the new 1966 **STEREO/HI-FI DIRECTORY** gives you all the vital statistics on amplifiers, changers & turntables, cartridges, tonearms & accessories, receivers, tuners, tape machines, speakers & cabinets — on every hi-fi component manufactured today!

With this authoritative guidebook which costs only \$1.25, you can compare similar items, feature-for-feature, dollar-for-dollar, before you buy! You'll avoid making even one costly mistake by making sure, in advance, that you get the best value for your money on everything you buy!

The 1966 **STEREO/HI-FI DIRECTORY** will help you select the finest equipment in your price range, and derive greater pleasure than ever from your records and tapes. Now, (to ask a redundant question) where else can you get this kind of "satisfaction insurance" for a mere \$1.25?



First Time Ever Offered!
**A DELUXE,
GOLD-EMBOSSSED
LEATHERFLEX-BOUND
EDITION**
just \$3.00 postpaid!

This deluxe edition is a permanent, handsomely-bound collector's item that belongs in your hi-fi library! Check appropriate box on coupon!

FILL IN, DETACH & MAIL COUPON TODAY

ZIFF-DAVIS SERVICE DIV., Dept. SD
589 Broadway, New York, N.Y. 10012

Yes! Send me the new, 1966
STEREO/HI-FI DIRECTORY.

\$1.25 enclosed, plus 15¢ for shipping and handling. Send me the regular edition. (\$1.50 outside U.S.A.)

\$3.00 enclosed. Send me the Deluxe Leatherflex-Bound edition. (\$3.75 outside U.S.A.) Allow three additional weeks for delivery.

name _____ please print EW-36

address _____

city _____ state _____ zip code _____

PAYMENT MUST BE ENCLOSED WITH ORDER.

plies are offered. Dimensional drawings and operating characteristics are included. General Electric

Circle No. 150 on Reader Service Card

PUSH-BUTTON SWITCHES

Information on lighted push-button switches and matching indicators is contained in a new 12-page full-color booklet (No. 70). A wide variety of display button shapes, sizes, and colors is offered, and a modular mounting system using a box-girder framework assures compact matrix arrays in minimum space.

Charts and diagrams cover mounting and wiring hardware, spacers, and mechanical interlock "add-on" devices; mounting dimensions are also provided. Micro Switch

Circle No. 151 on Reader Service Card

VISUAL CONTROL SYSTEMS

A wide range of visual control systems, including magnetic schedule boards, data-processing and computer schedule boards, production control systems, and special boards, is presented in a new 28-page profusely illustrated catalogue.

Standard off-the-shelf items, such as magnetic card holders, flexcards, and magnetic write-on strips, are listed in a 4-page section. Methods Research

Circle No. 25 on Reader Service Card

WALL-SHELF CONSTRUCTION

A new 4-page leaflet that provides complete instructions for building a wall-mounted shelf specifically to house hi-fi components is now available. The shelf requires no brackets and hooks over a single strip that can be attached to any wall containing studs.

The booklet supplies detailed drawings as well as cutting and assembly directions. Acoustic Research

Circle No. 26 on Reader Service Card

ETV SYSTEM

Information on a new type of educational TV system is contained in a recently published brochure. Featured in the booklet is the "Versa-Lock," an automatic unit which allows a school system to originate programming from any room to all other rooms while also distributing off-the-air TV wherever desired, without any interruption or special patching needed. Blonder-Tongue

Circle No. 27 on Reader Service Card

COAXIAL SWITCHES

Twenty-three different series of coaxial switches are offered in a new 16-page short-form catalogue. Highlighted in the illustrated booklet (CS-5) is the "Dynaform" series featuring modular construction that provides infinite variety and off-the-shelf delivery as well as uniform size and appearance. Amphenol

Circle No. 152 on Reader Service Card

DIELECTRIC CAPACITORS

A new series of miniature Mylar dielectric capacitors in hermetically sealed (glass-to-metal) tubular metallic cases is fully described in engineering bulletin No. 383.

Designed primarily for application in military and commercial electronic equipment such as radar and remote communications installations, the capacitors are rated from 30 to 600 v.d.c. and operate within the temperature range of -55°C to +150°C. Gudeman

Circle No. 153 on Reader Service Card

INDICATOR LIGHTS

Information on new 120-volt incandescent indicator lights is supplied in a 4-page illustrated folder (No. 6507). Available with bi-pin cartridge or miniature bayonet bases, the lights come in a variety of colors and lug configurations. Drake

Circle No. 154 on Reader Service Card

WIRE CLOTH CATALOGUE

The latest developments in precision metal and synthetic cloth, screens, and woven prod-

ucts are offered in a revised 107-page wire cloth catalogue.

The comprehensive publication includes trade definitions, applications, specifications, metal and alloy characteristics, weaves, and a 7-page reference data section. Cambridge

Circle No. 155 on Reader Service Card

CONNECTOR INFORMATION

A comprehensive 28-page "Encyclopedia of Connectors" has been published. Designed to assist engineers, planners, and buyers in the selection of electrical connectors, the illustrated booklet indexes connector prefixes, explains nomenclature and how to select connectors, and contains a MIL Spec index and a cross-reference guide to the products of six manufacturers. Spacecraft Components

Circle No. 156 on Reader Service Card

VARACTOR DIODE THEORY

A new application report (No. S-124/S-125) offering a short course in theory, design, and construction of varactor triplers is now available.

The report discusses basic concepts of harmonic generation with non-linear reactances, series and shunt circuit configurations, filters, and the design and construction of an actual working tripler. Amperex

Circle No. 157 on Reader Service Card

GERMANIUM SEMICONDUCTORS

Two new catalogues covering germanium transistors and diodes are currently available. The 16-page transistor brochure describes 145 types of alloyed junction and diffused alloyed junction transistors, including computer types, bilateral units, high-voltage devices, and audio transistors.

The 8-page diode booklet lists more than 200 germanium gold-bonded diodes, including low-, medium-, and high-voltage units and fast-recovery devices. General Instrument

Circle No. 158 on Reader Service Card

INTEGRATED CIRCUITS

Complete technical information on a new line of integrated circuits is supplied in a new 12-page product guide. Both digital and linear devices are offered, and the booklet contains four pages of schematic diagrams and dimensional outlines. RCA Electronic Components

Circle No. 159 on Reader Service Card

PHOTO CREDITS

Page	Credit
28	Grumman Aircraft
34	Westinghouse
53, 55, 56	Magnaflux Corp.
68	Educating Systems Inc.

(Answer to Puzzle appearing on page 82)

M	O	D	U	L	A	T	E	B	I	A	S
O	R	U	A	N	T	E	N	N	A		
D	E	A	D	M	A	N	R	A	T	F	
E	I	C	I	T	R	I	T	E	E		
O	N	N	A	O	N	U	T				
P	A	F	A	I	L	E	D	S	H	Y	
A	R	G	O	N	U	T	E	I	F	F	
R	A	R	C	M	A	I	T	A			
A	C	M	E	T		A	N	Y	C		
B	T	E	E			C	F	T			
O	E	X	P	A	N	S	I	O	N	O	
L	O	W	U		E	L	M	I	R		
A	P	E	R	T	U	R	E	L	E	N	S

ELECTRONICS MARKET PLACE

COMMERCIAL RATE: For firms or individuals offering commercial products or services. 70¢ per word (including name and address). Minimum order \$7.00. Payment must accompany copy except when ads are placed by accredited advertising agencies. Frequency discount: 5% for 6 months; 10% for 12 months paid in advance.
READER RATE: For individuals with a personal item to buy or sell. 40¢ per word (including name and address). No Minimum! Payment must accompany copy.
GENERAL INFORMATION: First word in all ads set in bold caps at no extra charge. Additional words may be set in bold caps at 10¢ extra per word. All copy subject to publisher's approval. Closing Date: 1st of the 2nd preceding month (for example, March issue closes January 1st.) Send order and remittance to: Hal Cymes ELECTRONICS WORLD, One Park Avenue, New York, New York 10016

FOR SALE

JUST starting in TV service? Write for free 32 page catalog of service order books, invoices, job tickets, phone message books, statements and file systems. Oelrich Publications, 6556 W. Higgins Rd. Chicago, Ill. 60656.

GOVERNMENT Surplus Receivers, Transmitters, Snooperscopes, Radios, Parts, Picture Catalog 25¢. Meshna, Nahant, Mass. 09108.

INVESTIGATORS, FREE BROCHURE, LATEST SUBMINIATURE ELECTRONIC SURVEILLANCE EQUIPMENT. ACE ELECTRONICS, 11500-J NW 7TH AVE., MIAMI, FLA. 83168.

CANADIANS—Giant Surplus Bargain Packed Catalogs. Electronics. Hi-Fi, Shortwave, Amateur, Citizens Radio. Rush \$1.00 (Refunded). ETCO. Dept. Z, Box 741, Montreal, Canada.

RESISTORS precision carbon-deposit. Guaranteed 1% accuracy, 1/2 watt 8¢. 1 watt 12¢. 2 watt 15¢. Rock Distributing Co., 902 Corwin Road, Rochester 10, N.Y.

NEW supersensitive transistor locators detect buried gold, silver, coins. Kits, assembled models. \$19.95 up. Free catalog. Relco-A22, Box 10563, Houston 18, Texas.

JAPAN & Hong Kong Electronics Directory. Products, components, supplies. 50 firms—just \$1.00. Ippano Kaisha Ltd., Box 6266, Spokane, Washington 99207.

BIG CATALOG
 World's "BEST BUYS" in GOV'T. SURPLUS Electronic Equipment

100 NEW ITEMS

INCLUDED IN OUR NEWEST
SPRING-SUMMER '66 CATALOG
SEND FOR YOUR COPY NOW!

- SP-600 Super Pro Receiver \$349.95
- MICROSCOPE PROJECTOR 75X Comparator 99.50
- ELECTROFAX SIGNAL GUARD 34.95
- READOUT BOARD—30 Lights, 110 Volts 1.95
- COMPUTER MEMORY CORE MATRIX 24.95
- AN/PDR-8B RADIATION DETECTOR 29.95
- BOMB DIRECTOR COMPUTER 7.95
- SUPERSONIC SELECTOR, 10 Channel 8.95
- AUDIO BOOSTER AMPLIFIER 12.95
- TN-1/APR-1 TUNING UNIT 30-90 MC. W/Case (New) 24.95
- MILLIVAC D.C. MILLIVOLTMETER 1 MV. To 1000 V. 115.00
- BALLTINE VOLTMETER No. 300—1 MV. To 100 V. 85.00
- CEDCO CRYSTAL CALIBRATOR—Model C-S 39.95
- POWER SUPPLY For Transistors, Voltage Regulated 29.95
- FR-24 WAVEMETER—12,400 To 15,000 MC. 150.00
- BC-221 FREQUENCY METER Used: \$79.50—New: 125.00
- OS-26/OS-51 OSCILLOSCOPE (See Catalog) \$44.95 To \$9.50
- AN/UPM-8 RADAR TEST SET 39.95
- TS-414 DYNAMOTOR TEST SET 79.50
- AN/UPM-11 RANGE CALIBRATOR 100.00

FOR BIG CATALOG—SEND 25¢ (stamps or coin) and receive 50¢ CREDIT on your order!

Address Dept. EW • Prices F.O.B. Lima, O. • 25% Deposit on C.O.D.'s • Minimum Order \$5.00

FAIR RADIO SALES
 2133 ELIDA RD. • Box 1105 • LIMA, OHIO

ELECTRONIC Ignition Kits, Components. Free Diagrams. Anderson Engineering, Epsom, New Hampshire 03239.

WEBBER Labs. Transistorized converter kit \$5.00. Two models using car radio 30-50Mc or 100-200Mc, one Mc spread. Easily constructed. Webber, 72 Cottage, Lynn, Mass.

ACHTUNG! Das machine is nicht fur Gerfingerpoken und mittengraben. Is easy schnappen der Springenwerk, blowenfusen und poppencorken mit spitzen-sparken. Ist nicht fur gewerken by das Dummkopfen. Das rubbernecken sightseeren keeppen hands in das pockets. Relaxen und watch das Blinkenlights. This attractive, brass metal plaque only \$2.00 ea. ppd. Southwest Agents, Dept. E, P.O. Box 12283, Fort Worth, Texas 76116.

CANADIANS, transistors, all semiconductors and components. Free catalogue contains reference data on 300 transistor types. J.&J. Electronics (Dept. EW), P.O. Box 1437 Winnipeg, Manitoba, Canada.

TRANSISTORS—Miniature Electronic Parts. Send for Free Catalog. Electronic Control Design Company, P. O. Box 1432M, Plainfield, N.J.

ELECTRONIC Bargains—Free Catalog, Tubes, Diodes, CRT's Tuner Cleaner, etc. Cornell, 4213-W University, San Diego, Calif. 92105.

TRANSISTORIZED Products Importers catalog. \$1.00. Intercontinental. CPO 1717, Tokyo, Japan.

MESHNA'S TRANSISTORIZED CONVERTER KIT \$4.50 Two models—converts car radio to receive 30-50 mc or 100-200 mc (one mc tuning). Meshna, Lynn, Mass. 01901.

SECURITY ELECTRONICS introduces its NEW 1966 line of SURVEILLANCE EQUIPMENT. Improved NEW designs for maximum performance and greater value. FREE DETAILS. Security Electronics-EW, 11 East 43rd St., New York, N.Y. 10017.

R.F. CONVERTERS \$10 up. World's largest selection. Also CCTV cameras, transmitters, etc. Lowest factory prices. Catalog 10¢. Vanguard, 196-23 Jamaica Ave., Hollis, N.Y. 11423.

IT'S SUPERCALIFRAGILISTICEXPIALIDOCIOUS. Free information on Kit-of-the-Month Club and new catalog of etched circuit boards and radio books. Many exclusive items. Leader Enterprises, Box 44718KN, Los Angeles, 90044.

SAFEGUARD PRIVACY! New instrument detects electronic "bugs," wire-tapping and snooping devices. Free information. Dee Equipment, Box 7263-7, Houston 8, Texas.

METERS—Surplus, new, used, panel and portable. Send for list. Hanchett, Box 5577, Riverside, Calif. 92507.

REMOTE CONTROL DEVICE. Small hand-held ultrasonic Transmitter Controls TV, Lamps, Anything Electrical—Full Plans and Parts Information, \$2.00—Electronic Specialists, Box 9339, Rochester, N.Y. 14604.

FREE—FREE—FREE—FREE—FREE—FREE—FREE Send in for your FREE one year subscription to Olson Electronics' fantastic value packed catalog—unheard of low, low prices on brand name speakers, changers, tubes, tools, stereo amplifiers, tuners, CB and other values. Credit plan available. If you have a friend interested in electronics send his name and address for a FREE subscription also. Olson Electronics, Inc., 454 S. Forge St., Akron, Ohio 44308.

SPECIALS on citizens band equipment. Free price list. Randall Communications, 7035 N. 39th Street, Milwaukee, Wis. 53209.

DIAGRAMS, service information, Radio \$1.00, Television \$1.50. BEITMAN, 1760 Balsam, Highland Park. Ill. 60035.

GIANT TESLA COIL—FORTY-INCH SPARKS! Complete plans, photo \$5.00. Details 30¢. Huntington Electronics, Inc., Dept. B, Box 9, Huntington Station, Shelton, Conn. 06484.

CONVERT any television to sensitive big-screen oscilloscope. Only minor changes required. No electronic experience necessary. Illustrated plans, \$2.00. Relco-A22, Box 10563, Houston 18, Texas.

ANTIQUE Atwater-Kent radio. Tisa Geng, 28 Division St., New Brunswick, N.J. 08901.

AMPEX model 450R and Altofonic Model 450 for background music system complete with 10 tapes. \$900. Vincent French, Box 814, Charleston, South Carolina.

SCHEMATICS For Professional Sub miniature surveillance equipment. Send for Free Brochure. Tri Tron, Inc., 7800 Phoenix NE, Dept. A, Albuquerque, New Mexico 87110.

INVESTIGATORS—Subminiature Electronic Surveillance Devices. NEW 1966 Professional models ready NOW! Free details. Tri Electronics-EW, 31 West 8th St., New York, N.Y.

HARD-TO-GET TUBES IN STOCK

BRAND NEW—1 YR. GUARANTEE

Type	Price	Type	Price	Type	Price	Type	Price
00A	3.50	6AU8	1.38	6W6GT	.74	12SR7	1.79
01A	2.75	6AW8	1.25	6W4	.93	12W6	1.15
1A7	1.05	6AX4	.89	6W6GT	.98	12W6	1.15
1AX2	.75	6AX5	1.05	6X4	.56	13GF7	1.70
1B3	.95	6AX7	1.25	6X5GT	.72	14A4	1.45
1H5	2.59	6BA1	5.95	6X8A	1.05	14A5	1.45
1L6	2.60	6B7	2.75	6Y6GA	1.45	14AF7	1.85
1L4A	1.30	6BB7	2.45	6Z4/84	1.25	14AF7	1.85
1L6A	1.49	6BA6	.60	7A4	2.25	1486	1.85
1L6C	1.80	6BA8	1.27	7A5	1.95	1488	1.95
1L6S	1.95	6BE6	.74	7A6	2.25	14C5	1.75
1LE3	1.95	6BE6	.89	7A7	2.35	14C7	2.19
1LM4	2.69	6BH8	1.24	7A8	2.75	14E6	1.39
1LMS	2.25	6BK5	1.25	7AD7	1.25	14E7	1.39
1V6	1.95	6BK7	1.14	7AF7	2.10	14F7	2.95
1P5	2.00	6BQ6	1.45	7AG7	2.85	14F8	2.23
1R4	1.80	6BQ7	1.33	7AH7	1.95	14H7	1.95
1V6S	.99	6BX7	1.75	7AU7	2.83	14J7	1.95
1T5	.80	6C5M	1.63	7B5	2.75	14K7	1.95
1U5	.99	6C6	2.00	7B6	1.25	14W7	1.85
1U6	.95	6C6G	2.95	7B7	1.25	14W7	1.75
1V	1.85	6CA7	1.95	7B8	2.00	14Y4	1.75
1V2	.79	6CC7	.75	7C4	1.15	19	1.00
2A3	3.50	6C6	1.95	7C5	1.95	22	1.15
2A5	2.50	6CL6	1.15	7C6	2.69	25	1.45
2A6	8.50	6CL8	1.10	7C7	1.23	25C5	.65
2X2A	1.95	6CM7	.94	7E5	2.00	25C06	1.94
3A3	1.18	6C8	1.95	7E6	1.25	25D6G	1.95
3A5	1.10	6C9	1.95	7E7	1.95	25L6	.77
3B7	2.39	6CWA	1.59	7F7	2.59	25Z5	1.50
3B4A	1.05	6D4	2.42	7H7	1.95	25Z6	.94
3BZ6	.79	6D5	1.48	7G7	1.99	25Z7	1.40
3C8	1.25	6D6	1.75	7H7	1.65	27	1.60
3DG4	1.25	6D7	2.00	7J7	2.00	30	1.25
3DT6	.74	6DA4	.98	7K7	2.96	30	1.25
3V4	.85	6DN6	2.54	7L7	1.99	33	1.15
4B07	1.30	6DQ6	1.21	7M7	2.61	34	1.15
4B7	1.49	6DQ7	1.49	7N7	2.61	34A5	1.15
4CB6	.79	6DQ8	.91	7O7	2.25	35L6	.78
5AM8	1.30	6DQ5	2.75	7R7	2.75	35W4	.35
5A8	1.25	6DQ6	1.39	7S7	1.79	35Y4	1.62
5A9S	.76	6F5GT	1.72	7X6	1.35	35Z5	.72
5AS8	1.50	6F7	1.95	7X7	1.35	36	1.50
5A24	1.85	6F8	3.95	7Y4	2.35	37	1.10
5B07	1.35	6F8	3.08	7Y7	1.79	38	1.10
5C8	1.25	6G7	1.39	7Z4	2.35	39/44	.95
5J6	.96	6G8	1.95	8A8	1.39	40	1.40
5U4	.70	6G9	1.69	8BQ5	.99	42	1.98
5U8	1.14	6G9T	1.49	8C7	.86	43	2.85
5V4	1.29	6J8	2.50	8C8	.67	45/2A3	3.25
5W4	1.75	6KGT	.90	8G7	1.31	46	3.00
5Y3	.59	6K7	1.69	8H8	1.29	47	3.00
5Y4	1.45	6L6C	1.61	8J8	1.32	48	4.00
5Z3	1.30	6L7M	2.48	8K7	1.50	50A5	2.10
6A5	1.95	6L7M	1.75	8L7	1.50	50C5	.65
6A7	2.90	6P5	2.50	8M7	1.50	50D6	.81
6B8M	2.39	6Q7	1.95	8N7	.71	50X6	1.96
6B8	2.10	6R7	1.95	8P7	.71	50Y6	1.49
6B7	2.10	6S8GT	1.50	8Q6	.56	50Z6	1.42
6AC5	2.12	6S47M	1.49	12BE6	.59	57	1.50
6AC7	1.75	6S87M	2.19	12BH7	.96	58	1.50
6AF3	.99	6S87M	1.88	12B06	.94	59	3.00
6AG5	.89	6SF5	1.08	12BR7	1.08	59L7	1.25
6AG7	1.95	6SF7	2.19	12BY7	1.09	71A	1.25
6AH4	1.19	6S7M	1.95	12K7	1.27	75	2.62
6AK5	1.49	6S7M	1.05	12K8M	2.95	75	1.25
6AL7	1.95	6S7GT	1.49	12L6	1.18	77	1.50
6AW8	1.25	6S7M	1.72	12L8	1.50	78	1.65
6AN8	1.35	6SK7	1.30	12M7	1.50	80	1.25
6AQ7	1.37	6SK7M	1.38	12S47	1.49	83	1.75
6AR5	.92	6SL7GT	1.19	12SCT	1.99	89/199	3.00
6AS5	.92	6SN7GT	.89	12SF7	2.23	90	2.05
6A57	2.85	6SQ7GT	1.25	12S7	1.54	91	2.50
6AT8	.58	6SR7	1.42	12SH7	1.75	93	4.75
6AU4	1.19	6TB	1.15	12SK7	1.35	95	3.00
6AU5	1.55	6U5	2.35	12SL7	1.28	SAR4	1.50
6AUG	.62	6U8	1.12	12SQ7	1.29	KT-88	4.95

OUR MINIMUM ORDER \$5.00

ADD POSTAGE
SEND FOR COMPLETE TUBE CATALOG OF OVER 3500 ADDITIONAL TYPES

UNITED RADIO CO.
 EW-3, P.O. BOX—1000 A4, NEWARK, N.J.
 CIRCLE NO. 84 ON READER SERVICE CARD

UNUSUAL BARGAINS

... MANY U. S. GOV'T SURPLUS

Brand New, Quick-Charge, Industrial Surplus
NICKEL-CADMIUM BATTERY

Unparalleled Value



For the first time a 6-volt, light-weight nickel-cadmium battery in stainless steel strap type casing, 4-amp hour capacity. Almost unlimited life—thousands of discharge-charge cycles with minute deterioration—charges fully in approx. 1 hr. with Edmund charger kit. Just a few drops of water per year provide full maintenance. Hundreds of uses for hobbyists, amateur photographers, campers, model builders, etc. Unequaled for rechargeable lanterns; cycle scooters, and boat lights; portable fluorescent and ultraviolet lights; electronic flash units. Battery requires minimum of electrolyte: is sealed to prevent loss; delivers nearly 100% of output at below freezing temperatures compared to 50% for lead-acid batteries. No corrosive fumes under any stage of recharge. Can't be damaged by accidental charge in reverse (but not recommended). Stud type terminals on top 1 1/4" apart, marked for polarity; 6-32 thread, nuts and lock washers 6" x 2 1/2" x 4". Wt. 2 lbs. 12 ounces.
Stock No. 70,776-AK \$15.00 Ppd.
CHARGER FOR 6-VOLT BATTERY. Charges in approx. 1 hr. Shuts off automatically, attaches to Stock No. 70,776 battery case. Includes transformer, ballast resistors, charger circuit board, mounting hardware, 8-ft. cord, plug switch, assembly instr.
Stock No. 70,807-AK \$8.00 Ppd
ONE 1.2 VOLT NICKEL-CADMIUM CELL \$3.95 Ppd.
Stock No. 40,798-AK

SPELLBINDING EXPERIMENTS WITH SILICON SOLAR CELL AND SUN BATTERY!

Experience endless fascination in converting sunlight into electricity to power small motors, amplifiers, etc. Ideal for scientific student projects. Plastic case 1 1/4" x 1 1/4" x 9/16". Produces 3 to 4.5 volts, 10-16 milliamps. 24-page Handbook gives full details of 12 pat. experiments.
Stock No. 60-216-AK \$2.25 Postpaid
Selenium Photocell. Lower power, lower price than Silicon Cell.
Stock No. 20-411-AK \$1.50 Postpaid
Solar Cell and Photocell Handbook. Fascinating 112-page Handbook on Silicon Cell and Selenium projects, demonstrations, etc. Extensive photographic performance. Gives infrared and ultra-violet applications. Paper-bound, 6" x 9".
Stock No. 9230-AK \$2.00 Postpaid

Send Check or M.O.—Money-Back Guarantee
EDMUND SCIENTIFIC CO., Barrington, N. J.

SEND FOR NEW 148-PAGE FREE CATALOG—"AK"

Completely new 1966 edition. New items, categories, illustrations. 148 easy-to-read pages packed with nearly 4000 unusual items. Dozens of electrical and electronic parts, accessories. Enormous selection of Astronomical Telescopes, Microscopes, Binoculars, Magnifiers, Magnets, Lenses, Prisms. Many war surplus items for hobbyists, experimenters, workshop, factory. Write for catalog "AK".

ORDER BY TUBE NUMBER, CROWN AGE TO GRADE ITEM, BARRINGTON QUARTER
EDMUND SCIENTIFIC CO., BARRINGTON, NEW JERSEY 08007
CIRCLE NO. 114 ON READER SERVICE CARD

ELECTRONICS ENGINEERING AND INSTRUCTION

FCC LICENSE in six weeks. First class radio telephone. Results guaranteed. Elkins Radio School, 2603C, Inwood, Dallas, Texas.

ELECTRONICS! Associate degree—29 months. Technicians, field engineers, specialists in communications, missiles, computers, radar, automation. Start September, February. Valparaiso Technical Institute, Dept. N, Valparaiso, Indiana.

ELECTRONICS—F.C.C. License Training—correspondence, or resident classes. Free details, Write: Dept. 6, Grantham, 1505 N. Western, Hollywood, Calif. 90027.

REI First Class Radio Telephone License in (5) weeks Guaranteed. Tuition \$295.00. Job placement free. Radio Engineering Institute, 1336 Main Street, Sarasota, Fla.

HIGHLY—effective home study review for FCC commercial phone exams. Free literature! COOK'S SCHOOL OF ELECTRONICS, Craigmont, Idaho 83523.

LEARN ELECTRONIC ORGAN SERVICING at home. All Makes including transistors. Experimental kit—trouble-shooting. Accredited NHSC. Free Booklet. NILES BRYANT SCHOOL, 3631 Stockton, Dept. A, Sacramento 20, Calif.

B.Sc. DEGREE (Engineering) or College Entrance by home study. Send \$1 for 1966 prospects. CIST, Suite 674, 263 Adelaide St. W., Toronto, Canada.

DRAFTING (Electronic, Mechanical, Architectural, Art). Home Courses \$25.00. Send \$2.00 first lesson. PRIOR, INC., 23-09 169 Street, Whitestone 57, New York.

SPOT TV TROUBLES in minutes. Repair all makes and models without book theory. "Work bench" simplified system. Used by "pros" throughout repair industry. Write, specifying black/white, or color. National Technical Research Labs, 6420 S. Western Ave., Whittier, Calif.

PATENTS

INVENTIONS: Ideas developed for Cash Royalty sales. Raymond Lee, 130-G West 42nd, N.Y.C. 10036.

TUBES

BEFORE you buy receiving tubes, Transistors, Diodes, Electronic Components and Accessories... send for Giant Free Zalytron Current Catalog, featuring Standard Brand Tubes; RCA, GE, etc.—all Brand new premium quality individually boxed. One year guarantee—all at biggest discounts in America! We serve professional servicemen, hobbyists, experimenters, engineers, technicians. Why pay more? Zalytron Tube Corp., 469-W Jericho Turnpike, Mineola, N.Y. 11502.

TUBES—33¢ each. One year guaranteed. Complete stock. Free list. Cornell, 4215—W University, San Diego, Calif. 92105.

FREE Catalog. Electronic parts, tubes, Wholesale. Thousands of items. Unbeatable prices. Arcturus Electronics 2D, 502-22 St., Union City, N. J. 07087.

TUBES, SEMICONDUCTORS, ELECTRONIC EQUIPMENT & COMPONENTS. Quality merchandise only! Serving engineers, purchasing agents TV/Hifi servicemen and hams for 16 years. Write for catalog or call WA 5-7000, BARRY ELECTRONICS, 512 Broadway, New York, N.Y. 10012.

GOVERNMENT SURPLUS

JEEPS FROM—\$52.50 Typewriters From—\$4.15, Cars From—\$31.50, Walkie-Talkies, Guns, Airplanes, Boats. Typical "As Is" Bid Bargains From Uncle Sam. Tremendous Variety. Exciting Free List. Write: Enterprises, Box 402-B7, Jamaica, N.Y. 11430.

JEEPS Typically From \$53.90... Trucks From \$78.40... Boats, Typewriters, Airplanes, Electronics Equipment, Photographic Equipment, used. 100,000 Bargains Direct From Government. Complete Sales Directory and Surplus Catalog \$1.00 (Deductible First \$10.00 Order). Surplus Service, Box 820-K, Holland, Mich. 49424.

CLUBS

COUPON BOOK, special offers from various firms. Latest Membership Benefit of Electronic Experimenters' Club. Dues \$2.00. Further Information FREE. Box 5332S, Inglewood, Calif. 90310.

NEON AC DC ELECTRIC TESTER FOR HOME AUTO SHOP

SPECIAL! 59¢

Special! With every \$10 Order

25¢ per tube

(No Limit) from this list.

6AG5 6BM7
6AU6 6I6 6BS4
6AQ5 6K6 6W4

CORNELL TUBES

1 YR. GUARANTEED

Mutual Conductance Lab-tested, Individually Boxed, Branded and Code Dated Tubes are new, or used and so marked.

21 PICTURE TUBES \$13.95

all purpose ELECTRONIC CLEANER 89¢

33¢ PER TUBE

100 TUBES OR MORE: 30¢ PER TUBE

CHEATER CORDS 29¢

NOISE FILTER STOP TV & RADIO NOISE INSTANTLY 89¢

SILICON RECTIFIERS 69¢

DIODES / RECTIFIERS 39¢

Picture Expander 99¢

SOLDERING GUN 2.99

Radio-TV Tube Tester 2.89

High Gloss Clay Coated Tube Cartons

SIZE	FOR TUBE SIZE	PRICE PER 10 CARTONS	PRICE PER 100 CARTONS
MIR	6AU6	.79	7.99
GT	6BS7	.39	3.49
L.G.T	6BA6	.59	5.79
R	6W4	.89	7.99

ABC TV \$100

Electronic Solder 29¢

CORNELL ELECTRONICS CO.

Dept. EW3 4217 University Ave., San Diego, Calif. 92105

TERMS: Add 3¢ per tube shipping. Orders under \$5.00 add 3¢ per tube shipping plus 50¢ handling. Canadian orders add approximate

postage. Send 25¢ deposit on C.O.D. orders. No C.O.D. orders under \$5.00 or to Canada. No 24 hr. free offer on personal check orders 5-DAY MONEY BACK OFFER!

NO SUBSTITUTIONS WITHOUT YOUR PERMISSION

SENSATIONAL VALUE! 29¢

RECTIFIERS & TRANSISTORS

Silicon Diodes

Amps	50 PIV	100 PIV	150 PIV	200 PIV
.75*	.05	.07	.10	.10
1	.08	.14	.16	.22
3	.35	.50	.65	.75
18**	.26	.45	.60	.70
35	.60	.80	1.15	1.30

Amps	300 PIV	400 PIV	500 PIV	600 PIV
.75*	.12	.14	.18	.21
3	.25	.28	.35	.40
15	.90	1.30	1.40	1.65
18**	.85	1.25	1.85	2.50
35	1.90	2.25	2.50	2.90

Amps	700 PIV	800 PIV	900 PIV	1000 PIV
.75*	.25	.32	.40	.55
3	.49	.58	.67	.78
15	1.90	2.30	2.50	2.70
35	3.65	4.40	4.65	4.90

* Top Hat, Epoxy or Flangless **Press Fit pkg

1100 PIV, 70¢, 1200 PIV, 85¢, .75A (Top Hat, Epoxy or Flangless)

10 Watt Sil. Zener Stud 20%, 12-200V..95¢ ea.
 1 Watt Zener, axial 20%, 8-200V.....50¢ ea.
 Sil. diode Stud, 1500 piv, 300 ma.....50¢ ea.
 Sil. diode, 1500 piv, 50 ma, axial leads.....35¢ ea.
 Hoffman Sil. Epoxy diodes 2½x¾x½ 200 ma—
 3000 piv \$1.49 ea., 6000 piv.....\$2.49 ea.
 Thermistor bead, 900 or 1200 ohms, 600°F.2 \$100
 SILICON POWER TRANSISTORS, 85W, 2n1724, \$1.50

LIGHT SENSITIVE RESISTOR

75 ohms - 10 meg, 100 volts, 150 mw \$1.75 ea.

Matched diodes, 9V, 25ma, 100 mcs....30¢ pair

Ger. diodes, glass—1N34A, 15/\$1.00—

Sil. diodes, 1N200 series, ass't new..15 for \$1.00

Nickel Cadmium Battery 9½ oz. 8 amp hr....\$1.95

Mercury Batt. 5.4V, 5/8"x1".....25¢

Varicap—Voltage Variable Capacitor

27, 47, or 100 pf at 4v., 4:1, new \$1.25 ea.

2N1300 series, NPN or PNP..... 6 for \$1.00

150 watt Ger. Power

2N456A—70¢ 2N457A—80¢

2N458A—90¢ 2N511—1.50

Med. Power Ex. Heat Sink

2N1044—60¢ 2N1045—80¢

70 amp stud, 50PIV—\$2.50; 100PIV.....\$3.50

Sensitivity Amplifier, 7 tubes 5"x4"x3"....1.75

SILICON CONTROLLED RECTIFIERS

PRV .75A 1A 7A 16A PRV .75A 1A 7A 16A

25 — .20 .28 .48 200 .80 .90 1.15 1.70

50 — .40 .48 .78 300 1.20 1.30 1.80 2.20

100 — .55 .70 1.20 400 1.70 1.85 2.20 2.70

150 .60 .70 .80 1.50 500 1.95 2.05 3.00 3.30

.75A Top Hat, IATO-5, 600 2.30 2.50 3.20 3.90

7A & 16A Stud

Money back guarantee, \$2.00 min. order, include postage. Catalog 25¢.

Electronic Components Co.

Box 2902, Baton Rouge, La. 70821

CIRCLE NO. 112 ON READER SERVICE CARD

WANTED

QUICKSILVER. Platinum, Silver, Gold. Ores Analyzed. Free Circular. Mercury Terminal, Norwood, Mass.

CASH PAID! Sell your surplus electronic TUBES. (Want UNUSED, clean Radio/TV Receiving, Transmitting, Special Purpose, Magnetrons, Klystrons, Broadcast Types.) Want military and commercial Lab/Test Equipment. Want commercial Ham Receivers and Transmitters. For a Fair Deal Write: BARRY Electronics, 512 Broadway, New York, N.Y. 10012 (WA 5-7000.)

TV SETS Wanted! "As Is." T.V., 467 Columbus Ave., N.Y., N.Y. TR 3-9400.

GOLD, Silver, Platinum (Any Form) Diamonds Bought, Information Free. Wilmo's, 1067V Bridge, Grand Rapids, Mich. 49504.

LAMPKIN 205-A meter. Measurements 80 AMSG and/or 560 FMSG. Write G. G. Keys, Box 99, Abingdon, Va.

WESTERN Electric #111A Or #119B Repeat Coils. Box 133, Seattle, Wash. 98111.

SEMICONDUCTORS Inexpensive Quality Diodes SCRS From 480V. 50A. Upwards. Bowitz, 1609 E. Altolane, Fullerton, Calif.

DO-IT-YOURSELF

PROFESSIONAL ELECTRONIC PROJECTS—\$1.00 up. Catalog 25¢, refundable. PARKS, Box 25565, Seattle, Wash. 98125.

REPAIRS AND SERVICES

TV Tuners Rebuilt and Aligned per manufacturers specification. Only \$9.50. Any Make UHF or VHF. We ship COD Ninety day written guarantee. Ship complete with tubes or write for free mailing kit and dealer brochure. JW Electronics, Box 51B, Bloomington, Indiana.

METERS—TEST EQUIPMENT REPAIRED—CALIBRATED. Free catalog. Bigelow Electronics, Bluffton, Ohio 45817.

SPEAKERS Complete Speaker Reconciling Service Any Make, Any Size. MIDWEST SPEAKER SERVICE, 715 NORTH SHERMAN, INDIANAPOLIS, INDIANA.

March, 1966

TAPE AND RECORDERS

RENT Stereo Tapes—over 2,500 Different—all major labels—free brochure. Stereo-Parti, 1616—E. W. Terrace Way, Santa Rosa, California.

BEFORE renting Stereo Tapes, try us. Postpaid both ways—no deposit—immediate delivery. Quality—Dependability—Service—Satisfaction—prevail here. If you've been dissatisfied in the past, your initial order will prove this is no idle boast. Free Catalog. Gold Coast Tape Library, Box 2262, Palm Village Station, Hialeah, Fla. 33012.

TAPE RECORDER SALE. Brand new, latest models, \$10.00 above cost. Arkay Sales, 1028-B Commonwealth Ave., Boston, Mass. 02215.

STEREO TAPES. Save up to 60% (no membership fees, postpaid anywhere USA). Free 60-page catalog. We discount batteries, recorders, tape accessories. Beware of slogans "not undersold," as the discount information you supply our competitor is usually reported to the factory. SAXITONE, 1776 Columbia Rd., Washington, D. C. 20009.

HI-FI components, tape recorders, sleep learn equipment, tapes. Unusual Values. Free Catalog. Dressner, 1523 Jericho Turnpike, New Hyde Park 10, N.Y.

TAPE-MATES now offers ALL TAPES—ALL LABELS at TREMENDOUS SAVINGS plus FREE Tape-Mates membership. For FREE brochure write TAPE-MATES, 5280-EW W. Pico Blvd., Los Angeles 90019.

HIGH FIDELITY

LOW, LOW quotes: all components and recorders. Hi-Fi, Roslyn 9, Penna.

HI-FI Components, Tape Recorders, at guaranteed "We Will Not Be Undersold" prices. 15-day money-back guarantee. Two-year warranty. No Catalog. Quotations Free. Hi-Fidelity Center, 239 (L) East 149th Street, New York 10451.

FREE! Send for money saving stereo catalog #E3W and lowest quotations on your individual component, tape recorder or system requirements. Electronic Values Inc., 200 West 20th Street, N.Y., N.Y. 10011.

FREE—\$1.00 Value "Miracle" Record cleaning cloth with every quotation on HI-FI EQUIPMENT. Our "ROCK BOTTOM" prices on NAME BRAND amplifiers—tuners—taperecorders—speakers—FRANCHISED—59 YEARS IN BUSINESS. Write for this month's specials—NOW! Rabsons 57th St., Inc., Dept. 569, 119 W. 57th St., New York, New York 10019.

BRITISH High Fidelity 6" Woofer, 5" Tweeter. Exceptional Performance. 11,500 gauss, 30-20,000 cps., \$14.95. Enclosure Plans \$2.50. C-T Acoustic Laboratories, Box 543, Newark, Calif.

EQUIPMENT

McGEE RADIO COMPANY. Big 1966 Catalog Sent Free. America's Best Values. Hi-Fi-Amplifiers—Speakers—Electronic Parts. Send name, address and zip code number to McGee Radio Company, 1901 McGee Street, Dept. EG, Kansas City, Missouri 64108.

RECORDS

DISCOUNT Records, All Labels—Free Lists. Write Cliff House. Box 42-E. Utica, N.Y.

RUBBER STAMPS

RUBBER ADDRESS STAMP \$1.00. Signature \$2.88. Off-set printing. Free catalog. Jackson Products, 1433 Winnemac, Chicago Ill. 60640.

MAGNETS

MAGNETS — Alnico—Ceramic—Flexible—Assemblies. What you need, we have. Special-Five assorted magnets, \$1.00. Maryland Magnet, 5412-E Gist, Baltimore, Md. 21215.

PHOTOGRAPHS

PHOTOGRAPHS and transparencies wanted, to \$500.00 each. Valuable information free—Write Intrapphoto-EW, Box 74607, Hollywood 90004.

GREGORY ELECTRONICS

Reconditioned & Used FM 2-WAY RADIO SAVINGS

Partial list—Send for New '66 catalog

Voice Commander

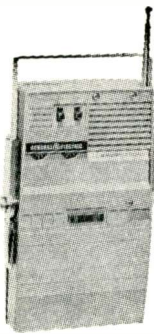

132 to 172 MC, 1W 9.5" x 5.3" x 1.7" Reduced price including brand New Rechargeable Nickel Cadmium Battery Pack

\$148

If crystal & tuning is desired add \$40.00
 Battery charger for these units \$16.00

WRITE FOR QUANTITY PRICES

MOTOROLA—30-50 MC



T-51 G Series
 Vibrator
 6/12V
 50-60 watts

Same unit tuned to desired Frequency, Including New Antenna Add \$45.00

Complete with all Accessories, Less crystals & antenna Wide Band \$208.
 Transmitter & Receiver Fully Narrow Banded \$238.
 (Less accessories, deduct \$30.00)

MOTOROLA "DISPATCHER"

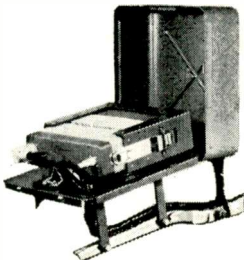

T33AAT Transistorized for Motor cycle and Industrial Use
 7 Watts Output
 Complete Accessories includes mtg Rack, Dust Cover.

6 Volt Price **\$88.**

We Buy Late Model Equipment for Cash

—Write; Wire or Phone!



GREGORY ELECTRONICS CORPORATION

249 Rt. 46 • Phone 489-9000
 Saddle Brook, N.J. • Area Code 201 07662

CIRCLE NO. 107 ON READER SERVICE CARD

TOOLS

TOOL CATALOG Send 25¢. Silvo Hardware, 107 Ziff, Walnut, Phila., Penna. 19106.

HYPNOTISM

FREE Hypnotism, Self-Hypnosis, Sleep Learning Catalog! Drawer H400. Ruidoso, New Mexico 88345.

PHOTOGRAPHY—FILM, EQUIPMENT, SERVICES

MEDICAL FILM—Adults only—"Childbirth" one reel, 8mm \$7.50; 16mm \$14.95. International W, Greenvale, Long Island, New York.

SCIENCE Bargains—Request Free Giant Catalog "CJ"—148 pages—Astronomical Telescopes, Microscopes, Lenses, Binoculars, Kits, Parts, War surplus bargains. Edmund Scientific Co., Barrington, New Jersey.

GET IT from GOODHEART!

EVERYTHING UNCONDITIONALLY GUARANTEED!

The Best Air-to-Ground Radio Receiver: URR-13 is continuous tuning AM superhet 225-400 mc plus 1 xtl-control channel, 2 stages RF, 5 stages IF, 5 stages AF, noise limiter, 3 stages AF, 120 v 50/60 cy pwr sply. With tech. data, aligned, OK **149.50**
Truck collect, remit for two

TWO LV XFRMRS each 115v 60 cy. connect for 115 or 230v. Gives 4 separate 6.3vct 35A secs. connect for 25.2vct rms 35A or 12.6vct 70A or 6.3vct 140A. 2 weigh 54 lb. RadEx or 54 lb. Truck collect, remit for two **14.50**

ALL-BAND SSB RCVR BARGAIN: Hallicrafters R-45/ARR-7, 550 kc to 43 mc continuous. Voice, CW, MCW, aligned, grid, w/book; 2-RF, 2-IF's, S-meter; noise limtr; 3 xtl, 3 non-xtl selectivity choices. **149.50**
Less pwr sply **149.50**
60 cy pwr sply: \$30. SSB product detector: \$20.

TIME PAY PLAN: Any purchase totalling \$160.00 or more, down payment only **10%**

RBS-2 Rcvr: 2-20 mc, ready to use on 115 v 60 cy, aligned, grid OK, w/tech. data **69.50**

R-23/ARC-5 Command rcvr 190-550 kc. . . . 14.95
A.R.C. 12 #22 Command rcvr 540-1600 kc. . . . 17.95
ARR-5 rcvr, 60 cy, am/fm, 27-140 mc. . . . 179.50
APR-4Y AM/FM Rcvr mod. to 115 v 50/60 cy, with pwr plug, book, tuners 38-1000 mc. . . . 250.00
P.U.R. for tuners 975-2200 and 2175-4000 mc. RA-62-B is AC pwr sply for SCR-522, only. . . . 17.95
LM-14 freq. meter, .01% 125 kc-20 mc. . . . 57.50
TS-323/UR freq. meter 20-480 mc., .001%. 199.50
Berkeley Counter-Timer counts to 1 mc. . . . 495.00
Tektronix 514AD scope dc to 10 mc. . . . 395.00
Bnanon 160A Q-meter similar to 260A. . . . PUR
Stoddard Noise & Field Strength Meters. . . . PUR
H.P. 608B Signal Generator modified, to same or less incidental FM as 608D. . . . 475.00
1KVA Line Volt. Regul. holds to 0.1%. . . . 149.50
3 KVA Line Volt. Regul. holds to 0.1%. . . . 279.50
Cubic Water Calorimeter RF Wattmeter. . . . PUR
TS-418A U sig. gen. to 0 dbm 0.4-1.0 gc. . . . 395.00
Hewlett-Pack. #615A Sig. Gen. 1.8-4.0 gc. 795.00
Borg-Warner High-Power sig. generators. . . . PUR
SLRD sig. gen. 275-2750 mc. 20 watts. . . . PUR

AND MUCH MORE! We have many other Signal Generators, many Meters, VTVM's, Line Voltage Regulators, Regulated Power Supplies, Precision Bridges, ac & dc Voltage Dividers, Galvos, Calorimetric & Indicating RF Wattmeters, other Spectrum Analyzers, Etc. . . . WRITE . . . WIRE . . . PHONE . . . YOUR SPECIFIC NEEDS!

WE RENT EQUIPMENT! WE BUY EQUIPMENT!

R. E. GOODHEART CO., INC.

Box 1220-A, Beverly Hills, Calif. 90213.

Phone: Area 213, office 272-5707, messages 275-5342

CIRCLE NO. 109 ON READER SERVICE CARD

AUTHORS' SERVICES

AUTHORS! Learn how to have your book published, promoted, distributed. FREE booklet "ZD," Vantage, 120 West 31 St., New York 1.

WANTED WRITERS! Short stories, articles, books, plays, poetry. Will help place, sell your work. Write today, free particulars! Literary Agent Mead, Dept. 37A, 915 Broadway, New York 10, N.Y.

POEMS or new songs wanted. Tin Pan Alley, Inc., 1650 Broadway, New York, N.Y. 10019.

INVENTIONS WANTED

PATENT Searches including maximum speed, full air-mail report and closest patent copies, \$6.00. Quality searches expertly administered. Complete secrecy guaranteed. Free Invention Protection forms and "Patent Information." Write Dept. 1, Washington Patent Office Search Bureau, 711 14th Street N.W., Washington 5, D.C.

INVENTORS. Outright cash sale or royalties for your inventions. Patented. Unpatented. Active demand from our client manufacturers. Financial assistance available. Write Dept. 48, United States Invention Brokerage, 78 Wall Street, New York 5, N.Y.

IMMEDIATE cash, for Patent Applications, free Patent Searches. Write for details. Universal Patents, 184-Y, Marion, Ohio.

BOOKS AND MAGAZINES

PAPERBACKS, Lafayette Hill, Pa. 19444. Catalog 10¢. Paperback books, records, tapes, stationery.

GET INSTANT MONEY!

We want your surplus, obsolete, or excess inventory equipment, components and parts! Need ground and air communication equip., teletype, all GRC, PRC, ARC, ARN—all test equip. What have you? WE PAY TOP DOLLAR! We make deals—now! And we pay freight. Tell us what you have—not tomorrow—today!

COLUMBIA ELECTRONICS—DEPT. EW
4365 W. Pico Blvd.
Los Angeles, Cal. 90019

AN/APR-4Y FM & AM RECEIVER "FB" FOR SATELLITE TRACKING!



High precision lab instrument suitable for monitoring and measuring frequency and relative signal strength of signals from 38 to 4000 Mc. In 5 tuning ranges. For 110 volt 60 cycle AC operation, built-in power supply. Original circuit diagram included. Checked out, perfect. LIKE **\$88.50**
NEW

TN-19 TUNING UNIT for above, continuous tuning 975 to 2200 Mc., just right for 1298 Mc. Satellite Frequency and other current team activity. Checked out, perfect **\$69.50**
Other tuning units for above, TN-16, TN-17, TN-18, TN-54 in stock **P.U.R.**

LORAN R-65/APN-9 RECEIVER & INDICATOR

Used in ships and aircraft. Determines position by radio signals from known xmitters. Accurate to within 1% of distance. Complete with tubes and crystal. IN LIKE NEW Condition **\$79.50**
Used, with all parts, less tubes, crystal and visor **Special \$29.50**

Shock Mount for above **\$2.95**
Circuit diagram and connecting plugs available.

LORAN APN-4 FINE QUALITY NAVIGATIONAL EQUIPMENT

Determine exact geographic position of your boat or plane. Indicator and receiver complete with all tubes and crystal.
INDICATOR ID-6B/APN-4, and RECEIVER R-9B/APN-4, complete with tubes. Exc. Used. **\$88.50**

NEW! APN-4A Receiver-Indicator as above, changed to operate same as APN-4B for improved performance. NEW **\$88.50**
Shock Mount for above **\$2.95**

We carry a complete line of replacement parts and accessories for above.

234-258 MC RECEIVER AN/ARR-2

BRAND NEW 11-tube UHF Tunable Receiver with schematic. Only a few at this low price! Complete with tubes. Exc. used **\$7.95** **\$10.95**

SCR-625 MINE DETECTOR
Complete portable outfit in original packing, with all accessories. Exc. Used **\$29.50**

BC-929 3-Inch Scope, with all tubes, LIKE NEW **\$16.50**
Conversion instructions, with diagram, for 110 V AC operation **\$.65**

LM FREQUENCY METER

Crystal calibrated, modulated. Heterodyne, 125 KC to 20,000 Kc with Calibration book. **\$79.50**
Complete, like new
LM Frequency Meter as above, completely checked out, with tubes and crystal, less calibration book. Exc. Used, clean **\$34.50**

BC-221 FREQUENCY METER
Equipped with original calibration charts. 125 Kc to 20,000 Kc with crystal check points in all ranges. Like new condition, checked out. Modulated only **\$129.50**

TS-175 FREQUENCY METER
80 to 1000 Mc. Heterodyne type with 5-Mc crystal oscillator and 900 cycle modulation. Like new condition, checked out. **\$125.00**

SCR-274 COMMAND EQUIPMENT				
All Type	Complete Description	Used	Like New	Brand New
BC-453	Receiver	\$14.95	\$18.95	P.U.R.
BC-454	Receiver 3-6 Mc.	\$15.95	\$24.50	
BC-455	Receiver 6-9 Mc.	\$13.95	\$19.50	\$24.50
BC-456	Receiver, 530-1300 Kc. Complete with all tubes. Brand New, in original packing	\$48.50	\$48.50	\$48.50
1.5 to 3 MC.	Receiver Brand New	\$22.50	\$22.50	\$22.50

110 Volt AC Power Supply for all 274 N and ARC-5 Receivers. Complete with metal case. Instructions. Factory wired, tested, ready to operate. **\$12.50**

SPINED TUNING KNOB for 274-N and ARC-5 RECEIVERS. Fits BC-453, BC-454 and 49¢ others. Only

2.1 to 3 Mc. Transmitter, Brand New **\$12.95**
BC-458 TRANSMITTER—5.3 to 7 Mc. Complete with all tubes and crystal **\$13.95**
BRAND NEW **\$13.95**
BC-459 TRANSMITTER—7 to 9 Mc. Complete with tubes & crystal **\$19.50**
Like New **\$16.95**
BC-695 TRANSMITTER 3.4 Mc Complete with All Tubes & Crystal, Brand New **\$12.95**
Like New **\$12.95**
BC-458 Modulator **USED 3.45 NEW \$5.95**
ALL ACCESSORIES AVAILABLE FOR ABOVE

SEND FOR BIG NEW G&G CATALOG

Military & Electronic Surplus—Sensational Bargains!
Include **25¢**
(Refunded with First Order)

Please include 25% Deposit with order—Balance C.O.D. or Remittance in Full. 50¢ Handling Charges on all orders under \$5.00. All shipments P.O. Our Warehouse, N.Y.C. All Merchandise subject to Prior Sale and Price Change.

G & G RADIO SUPPLY CO.
Telephone: (212) CO 7-4605
77 Leonard St. New York, N.Y. 10013

CIRCLE NO. 110 ON READER SERVICE CARD
ELECTRONICS WORLD

CLASSIFIED ADVERTISING ORDER FORM

Please refer to heading on first page of this section for complete data concerning terms, frequency discounts, closing dates, etc.

1	2	3	4	5
6	7	8	9	10
11	12	13	14	15
16	17	18	19	20
21	22	23	24	25
26	27	28	29	30
31	32	33	34	35

Words { @ .40 Reader Rate } = \$
{ @ .70 Commercial Rate }

Insert _____ time(s) Total Enclosed \$ _____

NAME _____

ADDRESS _____

CITY _____ ZONE _____ STATE _____

SIGNATURE

WORD COUNT: Include name and address. Name of city (Des Moines) or of state (New York) counts as one word each. Zone or Zip Code numbers not counted. (Publisher reserves right to omit Zip Code if space does not permit.) Count each abbreviation, initial, single figure or group of figures or letters as a word. Symbols such as 35mm, COD, PO, AC, etc., count as one word. Hyphenated words count as two words. EW-366

EMPLOYMENT INFORMATION

FOREIGN Employment. Construction, other work projects. Good paying overseas jobs with extras, travel expenses. Write only: Foreign Service Bureau, Dept. D, Bradenton Beach, Florida.

RESUMES printed. Details with model resume: \$1.00. Resumes, P.O. Box 1178, Washington, N.C. 27889.

EMPLOYMENT OPPORTUNITIES

ELECTRONICS TECHNOLOGY TEACHER: Formal training and current industrial experience in electronics. Send application to Dr. Charles W. Meister, President, Eastern New Mexico University, Portales, New Mexico.

PRINTING

BUSINESS Letterheads, Envelopes, Cards. Free brochure. Prestige Press, Box 146-E, Newton, Iowa 50208.

Your Postmaster Suggests:

Always Include

Your (ZIP CODE) Number

in your

Return Address

MOVING?

ATTACH LABEL HERE

If you've recently changed your address or plan to in the near future, be sure to notify us at once. Affix address label showing old address here, and print new address below.

My New Address is:

name please print

address

city state

zip-code date at new address

Notify us of your address change as far in advance as possible—it takes about 2 months for a change to become effective. (Eg. A notice received in May becomes effective with the July issue.)

Mail to: **ELECTRONICS WORLD**
1255 Portland Pl., Boulder, Colo. 80302

March, 1966

REAL ESTATE

FLORIDA WATER WONDERLAND—Home, cottage, Mobil-sites. Established area. \$590 full price, \$9.00 a month. Swimming, fishing, boating. Write: Lake Weir, Box KE38, Silver Springs, Fla. AD 646-127 (F-1).

FREE!—SPRING CATALOG Giant 180 pages! Thousands of properties described, pictured—Land, Farms, Homes, Businesses—Waterfront, Recreation, Retirement. Selected Best Buys from The World's Largest. 489 Offices, 36 states Coast to Coast. Mailed **FREE!** **STROUT REALTY**, 60-2D East 42nd St., New York, N.Y. 10017.

EDUCATIONAL OPPORTUNITIES

LEARN While Asleep, hypnotize with your recorder, phonograph. Astonishing details, sensational catalog free! Sleep-Learning Association, Box 24-ZD, Olympia, Washington.

LEARN while asleep. Remarkable, scientific. 92% effective. Details free. ASR Foundation, Box 721, Dept. e.g., Lexington, Kentucky.

USED Correspondence Courses and Books sold and rented. Money back guarantee. Catalog free. (Courses Bought). Lee Mountain, Pisgah, Alabama.

BUSINESS OPPORTUNITIES

INVESTIGATE Accidents—Earn \$750 to \$1,400 monthly. Men urgently needed. Car furnished. Business expenses paid. No selling. No college education necessary. Pick own job location. Investigate full time. Or earn \$6.44 hour spare time. Write for Free Literature. No obligation. Universal, CZ-3, 6801 Hillcrest, Dallas, Texas 75205.

SELL CB Equipment—Dealerships available to aggressive people who can sell Citizens Band Radio full or part time. Knox Electronic, Dept. 194, Galesburg, Ill. 61401.

FREE BOOK "990 Successful, Little-Known Businesses." Work Home! Plymouth-945W, Brooklyn, New York 11218.

I MADE \$40,000.00 YEAR by mailorder! Helped others make money! Start with \$10.00—Free proof. Torrey, Box 3566-N, Oklahoma City, Oklahoma 73106.

ARNOLD PALMER OFFERS YOU unequalled opportunity to profit from tremendous popularity of golf and power of Palmer. Highly profitable exclusive Palmer Golf Franchises available. Complete national program. Hefty profits—minimum investment. Write for details. Arnold Palmer Enterprises, Dept. CD, Pleasantville, New Jersey, Tel. 609-646-3500.

MAILORDER LAWS \$2.00. Kelvin Kahn, Attorney, 4504 Pine, Philadelphia, Pa.

EARN extra money selling advertising book matches. Sample kit furnished. Match Corp, Dept. MO-36C, Chicago, Ill. 60632.

OPERATE Restaurant or diner. Free booklet reveals profitable plan. Write Restaurant Business School, Dept. BAC-36, 1920 Sunnyside, Chicago, Ill. 60640.

FREE "Franchise Profit Letter" tells how unique NFR service is helping thousands seeking profitable businesses. Write today. National Franchise Reports, D-528, 333 North Michigan, Chicago 60601.

STAMPS

VALUABLE UNITED STATES STAMPS—Only 10¢! Scarce genuine centennial postage stamp, picturing first USA (issued in 1847!); Collection all-different United States—Ancient 19th Century, \$1.00 stamp, etc.; Collection beautiful commemoratives: American Revolution, Wild West, 1893 Columbian, many others. **PLUS** Collector's Guide; other fine stamps from our approval service returnable without obligation; Complete new profusely illustrated USA Catalog. Send only 10¢! H. E. HARRIS, Dept. C-38, Boston, Mass. 02117.

MISCELLANEOUS

WINEMAKERS: Free illustrated catalog of yeasts, equipment. Semplex, Box 7208, Minneapolis, Minn. 55412.

ROTARY QSL HOLDER STORES, PROTECTS 600 CARDS. Easy "Flip-Viewing." Nordlund, 7635 Irving Park, Chicago 60634.

EMPLOYMENT Resumes. Get a better job & earn more! Send only \$2.00 for expert, complete Resume Writing Instructions. J. Ross, 80-34 Kent St., Jamaica 32, N.Y. Dept. EW.

1.000.000 PARTS SALE PLUS

FREE CHOOSE ANY \$1.00 ITEM FREE

\$25 WORTH OF TRANSISTORS, RECTIFIERS, RESISTORS, CONDENSERS, DIODES & ETC.

Include 25¢ for handling

BOTH FREE WITH ANY \$10 ORDER

LOW NOISE FETS FROM CRYSTALONIC Vacuum Tube Equivalent

\$1.95 ELEC. WORLD November. for uses 'n' hookups.

C610 N-channel

Bidirectional Transistors C101 2 \$1

*PNP—NPN 2N1641 2N1640 FOR 1

- 60 CERAMIC CONDENSERS, discs, npo's, to .05 \$1
- 10 TRANSISTOR ELECTROLYTICS: 10mf to 500mf \$1
- 50 COILS & CHOKES, if, rf, ant, osc, & more . . \$1
- 10 ELECTROLYTICS, to 500mf, asst FP & tubulars \$1
- 10 VOLUME CONTROLS, to 1 meg, switch tool . \$1
- 60 HI-Q RESISTORS, 1/2, 1, 2W, 1% & 5% values \$1
- 60 TUBULAR CONDENSERS, to .5mf, to 1KV, asst \$1
- 40 DISC CONDENSERS, 27mmf to .05mf to 1KV \$1
- \$25 SURPRISE PAK: transistors, rect, diodes, etc. \$1
- 30 POWER RESISTORS, 5 to 50W, to 24 Kohms \$1

Tested "SCR" SILICON CONTROLLED RECTIFIERS

PRV	7 AMP	16 AMP	25 AMP	PRV	7 AMP	16 AMP	25 AMP
25	.30	.49¢	.85	250	1.29	1.99	2.50
50	.45	.69¢	1.00	300	1.50	2.15	2.75
100	.69	1.19	1.50	400	1.95	2.50	3.25
150	.99	1.37	2.00	500	2.59	3.10	3.80
200	1.05	1.60	2.25	600	2.95	3.75	4.50

750 MIL TOP HATS TRANSISTORS

PIV Sale PIV Sale

50	5¢	1000	45¢
100	5¢	1200	69¢
200	9¢	1400	95¢
400	13¢	1600	1.10
600	19¢	1800	1.35
800	29¢	2000	1.50

Supplied with SILICON PLANARS, POWER, RF, IF, AUDIO, SWITCHING no test

100 for \$2.98

750 MIL TOP HAT AND EPOXIES

1000 PRV **3** Full Leads for \$1.00

Factory Tested

"EPOXY"—3000 piv 200 ma RECTIFIERS, 1.00

"EPOXY"—6000 piv 200 ma RECTIFIERS, 2.50

- 15 PNP TRANSISTORS, CKT 22, 2N35, 107 no test \$1
- 15 NPN TRANSISTORS, 2N35, 170, 440, no test \$1
- 30 TRANSISTORS, rf, if, audio osc-ifs, F05 no test \$1
- 10 FAMOUS CK722 TRANSISTORS, pnp no test \$1
- 5 2N107 TRANS'RS, by GE, pnp, pop, audio pak \$1
- 3 40-WATT TRANSISTORS PNP, stud, 800V volts \$1
- 4 2N213 TRANSISTORS, mixer-conv, TO22 . . . \$1
- 85 WATT 2N1212 PLANAR, drift, 10me, npn . . . \$1
- 85 WATT 2N424 PLANAR, silicon, TO-53 npn \$1

ZENERS ONE WATT

3V check W-V block **3 For \$1**

6V	30V	90V
8V	45V	110V
12V	60V	100V
20V	70V	124V
24V	80V	150V

10-WATT 89¢ ea.

- 3 2N706 500MW, 300MC NPN PLANAR, TO16 . \$1
- 10 2N255 PWR TRANS'RS, TO3 case no test . . . \$1
- 2—500MC, 2N708 NPN Silicon planar TO16 . . \$1
- 25 GERMANIUM & SILICON DIODES, no test . . \$1
- 25 TOP HAT RECTIFIERS, silicon, 750ma, no test \$1
- 3 2-WATT PLANAR TRANS'RS, 2N697, 100me \$1
- 25 "EPOXY" SILICON RECTIFIERS no test . . . \$1
- 10 2-6amp RECT's, studs, silicon, 50 to 400V . \$1
- 10 PHILCO MAT HI-FREQ. TRANSTRS, untested \$1

HIGH POWER SALE

PNP 100Watt/15 Amp Hi Power \$1

T036 Case! 2N441, 442, 277, 278, DS501 up to 50 Volts

10¢ SPRING CATALOG ON: PAKS, PARTS, RECTIFIERS, TRANSISTORS, SCRS, ZENERS

POLY PAKS

TERMS: Send check, money order. Add postage—avg. wt. per pak 1 lb. Rated net 30 days. COD 25% deposit.

P.O. BOX 942W
50, LYNNFIELD, MASS.
"PAK-KING" of the world

CIRCLE NO. 94 ON READER SERVICE CARD

First Time Ever Published

**SKIING INTERNATIONAL
YEARBOOK 1966**

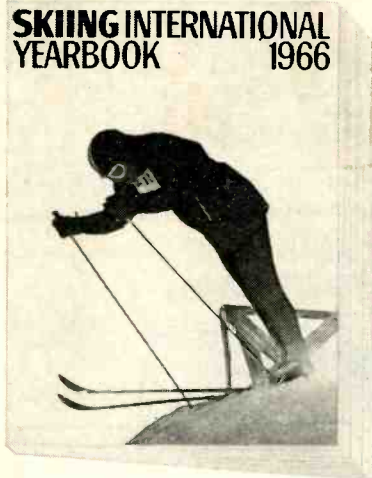

**The 1966 SKIING
International Yearbook**

... a luxuriously illustrated compendium of 1965's important events... a timely forecast of the excitement-packed 1966 season—by the editors of SKIING MAGAZINE. **only \$1.25**

The 166-page Charter Edition of the SKIING International Yearbook is a collector's item that will be relished by every serious skier.

Far more than just a major artistic endeavor (although there are numerous original drawings, dramatic photographs, striking full-color pages and specially designed type, which make for extremely pleasing composition)—the 1966 SKIING International Yearbook enables you to relive the best moments of the past season and to glimpse into the dynamic year of skiing just ahead. For example—

complete reviews of the major European and American Alpine events—pro racing—Nordic events—season's records, U.S. and abroad—plus—

EQUIPMENT: A complete guide, prices and brands!

TECHNIQUE: comparison of the major skiing systems.

TRAVEL: complete Guide To Skiing in North America... what the new European season holds in store!

PLUS: "Equipment & The History of Skiing"—illustrated with original art and way-back-when photos.



**DeLuxe, Gold-Embossed
Leatherflex-bound Charter Edition
... just \$3 postpaid!**

A handsome, permanent edition of this brand new yearbook, mailed postpaid!

To order the regular or DeLuxe edition, complete this coupon and mail it today!

ZIFF-DAVIS SERVICE DIVISION • Dept. SIY
589 Broadway • New York, N.Y. 10012

Send me a copy of the 1966 SKIING International Yearbook, as checked below:

\$1.25 enclosed, plus 15c for shipping and handling. Send me the regular edition. (\$1.50 for orders outside the U.S.A.)

\$3.00 enclosed. Send me the DeLuxe Leatherflex-bound edition, postpaid. (\$3.75 for orders outside the U.S.A.) Allow three additional weeks for delivery.

name _____ please print EW-36

address _____

city _____ state _____ zip code _____

PAYMENT MUST BE ENCLOSED WITH ORDER.

ELECTRONICS WORLD MARCH 1966

ADVERTISERS INDEX

READER SERVICE NO.	ADVERTISER	PAGE NO.	READER SERVICE NO.	ADVERTISER	PAGE NO.
125	Allied Radio	78		Kuhn Electronics	24
	American Institute of Engineering & Technology	84	102	Lampkin Laboratories, Inc.	60
124	Argo Electronics	17			
123	B & K Division of Dynascan	65	101	Mallory & Co. Inc., P. R.	2
122	Belden Manufacturing Company	13	100	Milwaukee School of Engineering	14
	Birnbach Radio Co., Inc.	82	99	Motorola Training Institute	83
121	Burstein-Applebee Co.	87	98	Multicore Sales Corp.	70
	Capitol Radio Engineering Institute, The	90, 91, 92, 93	96	Music Associated	81
	Castle TV Tuner Service	24		National Radio Institute	8, 9, 10, 11
	Channel Master Corp.	61, 62, 63, 64	95	Olson Electronics, Inc.	58
120	Cleveland Institute of Electronics	15			
	Cleveland Institute of Electronics	18, 19, 20, 21	94	Poly Paks	107
	Columbia Electronics	106		RCA Electronic Components and Devices	FOURTH COVER
119	Conar	65		RCA Sales Corp.	26
118	Cornell Electronics Co.	104		RCA Institutes, Inc.	72, 73, 74, 75
	EICO Electronic Instrument Co., Inc.	71	93	Radar Devices Manufacturing Corp.	1
115	Editors and Engineers, Ltd.	99			
114	Edmund Scientific Co.	104	92	Sams & Co., Inc., Howard W.	4
117	Electro-Voice, Inc.	SECOND COVER	91	Sarkes Tarzian, Inc.	100
113	Electronic Chemical Corp.	58	90	Schober Organ Corporation, The	6
112	Electronic Components Co.	105	89	Sprague	16
	Fair Radio Sales	103	88	Superscope Inc.	7
111	Finney Company, The	5			
110	G & G Radio Supply Co.	106	87	Telex	24
109	Goodheart Co. Inc., R. E.	106	86	Texas Crystals	78
108	Grantham School of Electronics	81	97	Triplet Electrical Instrument Company	THIRD COVER
107	Gregory Electronics Corporation	105	85	Turner Microphone Company, The	101
106	Heath Company	23, 66, 67	84	United Radio Co.	103
	Henshaw TV Supply	84	83	University Sound	99
105	Hy-Gain Electronics Corporation	97		Valparaiso Technical Institute	60
	Jan Crystals	84	81	Winegard Co. Antenna Systems	84
104	Jerrold Electronics Corporation	77			
103	Johnson Company, E. F.	25	82	Xcelite, Inc.	22

CLASSIFIED ADVERTISING 103, 104, 105, 106, 107

Printed in U.S.A.

**BEST FOR YOU—
IT'S MOST VERSATELE**



MODEL 850 ELECTRONIC VOLT-OHMMETER

USES UNLIMITED:

Field Engineers • Application Engineers • Electrical, Radio, TV, and Appliance Servicemen • Electrical Contractors • Factory Maintenance Men • Industrial Electronic Maintenance Technicians • Home Owners, Hobbyists

MODEL 850 \$85.00

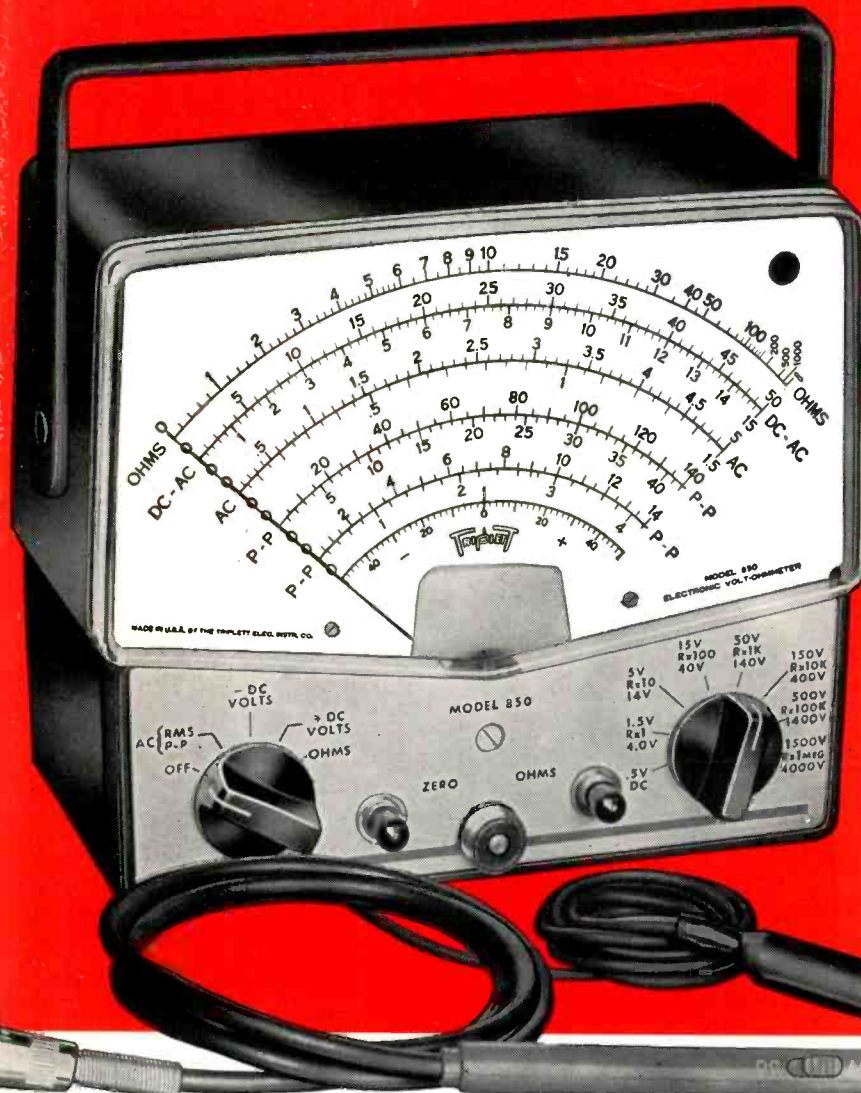

FACTS MAKE FEATURES:

1 Long 7" easy-to-read scale.

2 .5 D.C. volt range for transistor circuits.

3 HIGH STABILITY. Meter connected in cathode circuit of 12 AU7.

High Input Impedance (11 MEGOHMS) and wide Frequency Ranges give this extremely versatile Electronic Volt-Ohmmeter considerable advantage in the measurement of DC voltages, AC RMS and Peak-to-Peak voltages. It measures directly the Peak-to-Peak values of high-frequency complex wave forms and RMS values of sine waves on separate scales. Exclusive Triplet BAR-RING instrument is fully self-shielded; high flux magnet and spring-backed jewels for ruggedness. Wired circuit.

ADDED PROTECTION. Meter is shorted out in OFF position for greater damping, meter safety during transit, electrically protected against accidental overload. ZERO CENTER mark for FM discriminator alignment, plus other galvanometer measurements.

New pencil thin test probe used for all functions: DC, AC, and ohms. No need to change cables. Beautifully styled case for professional appearance and functional utility, 7 $\frac{7}{8}$ " x 6 $\frac{1}{16}$ " x 3 $\frac{3}{4}$ ".

Carrying handle can be used as a tester stand to place the tester at 25° angle for ease in reading.

Frequencies to 250 MC may be measured with auxiliary Diode. Probe, \$8.00 extra. DC voltages to 50 KV may be measured with auxiliary High Voltage Probe. \$23.00 extra.

CARRYING CASE

Case 859—OP—Black leather Padded Carrying Case. \$21.00 Net



RANGES

8 DC VOLTS RANGES	0-.5-1.5-5-15-50-150-500-1500
7 AC RMS VOLTS RANGES	0-1.5-5-15-50-150-500-1500
7 PEAK-TO-PEAK VOLTS RANGES	0-4-14-40-140-400-1400-4000
7 RESISTANCE RANGES	0-1000-10,000-100,000 OHMS; 1-10-100-1000 MEGOHMS.

FREQUENCY RANGE 15 CPS to 3MC; (Up to 250 MC with accessory diode probe available extra.)

INPUT IMPEDANCE DC Volts 11 Megohms; AC Volts minimum of .83 Megohms.

TRIPLET ELECTRICAL INSTRUMENT COMPANY, BLUFFTON, OHIO



THE WORLD'S MOST COMPLETE LINE OF V-O-M'S. AVAILABLE FROM YOUR TRIPLET DISTRIBUTOR'S STOCK.

RCA rare-earth

Hi-Lite

Color TV Picture Tubes

for every smart
customer who wants
a superior color picture

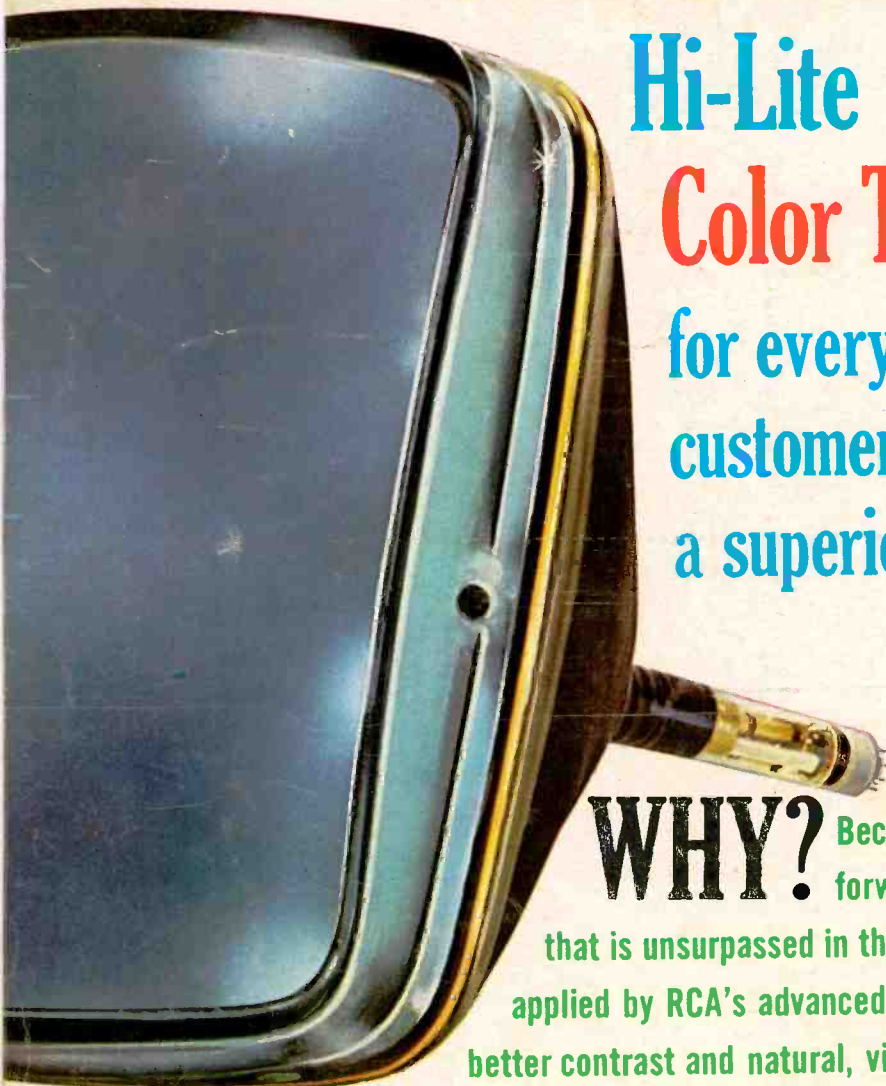

WHY?

Because RCA's Hi-Lite line represents a big step forward in color picture brightness—brightness that is unsurpassed in the color TV industry. Rare-earth phosphors applied by RCA's advanced screening methods create brighter reds, better contrast and natural, vivid colors . . . Everything the smart customer wants. Are you ready to service your smart customers? Keep posted. See your RCA Distributor today.

RCA ELECTRONIC COMPONENTS AND DEVICES, HARRISON, N.J.



The Most Trusted Name in Electronics

