

# Electronics World

SEPTEMBER, 1965  
50 CENTS

**MAGNETIC REED SWITCHES AND RELAYS**

**THE OPTICAL LINK: A New Circuit Tool**

**LASERS: Practice & Applications**

*Parallel Resistor Monogram 27*

*TRANSISTOR;  
data sheets 40*

*Curve tracer 49*

*Test equipment 42*

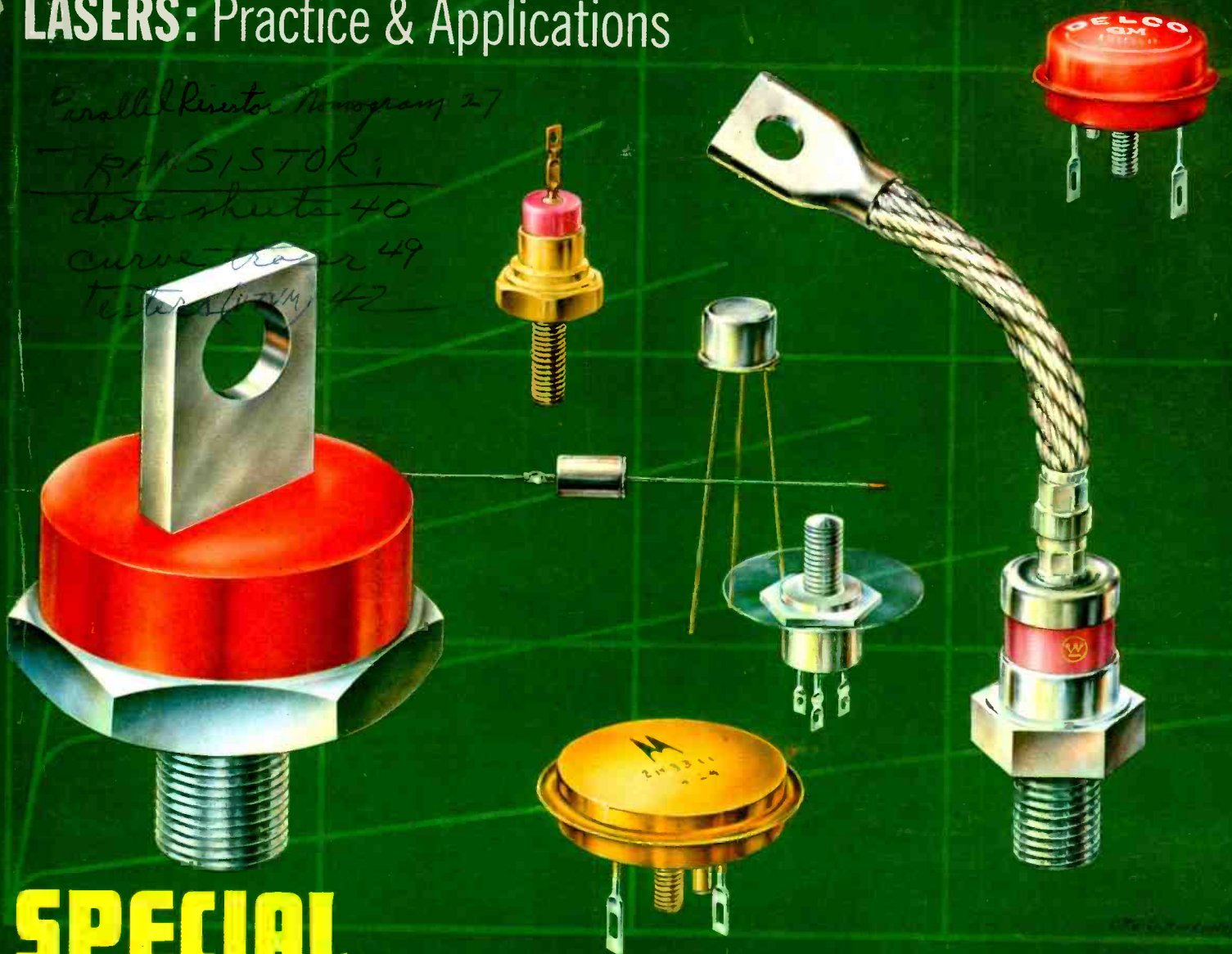

**SPECIAL  
FEATURE  
ISSUE:**

**TEST EQ  
FOR SEMIC**

0166 641492BBA10216CM069  
WM J BATTAGLIA  
216 CLARK AV  
CLARKS SUMMIT 11 PA

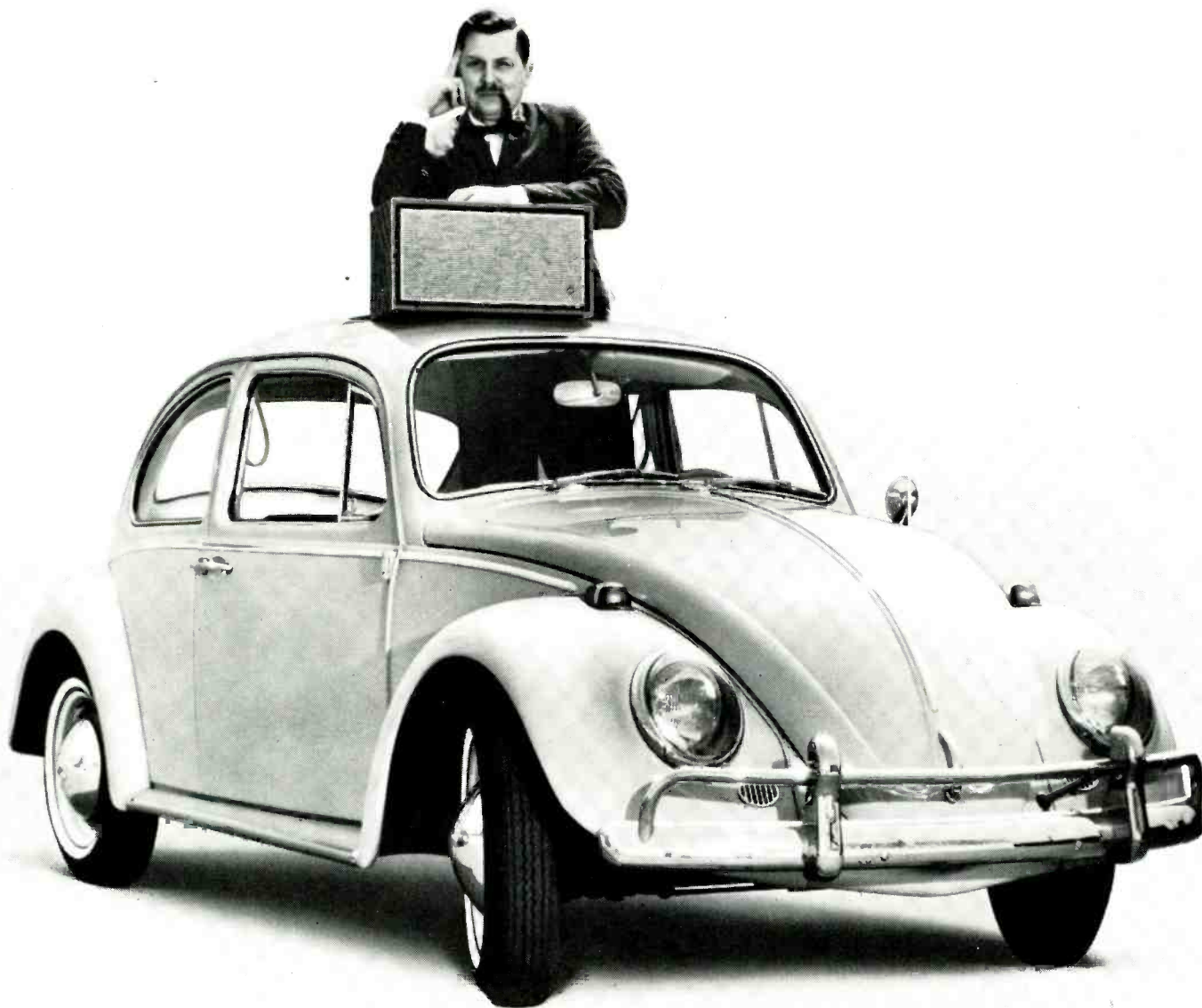

ELECTRO-VOICE, INC., Dept. 954N Buchanan, Mich. 49107

## Of Beetles, Beatles, and Beethoven!

The new E-V SEVEN speaker system—like the VW beetle—is not for everyone. You have to be someone special to appreciate its value.

That's because the E-V SEVEN doesn't go along with the crowd. There are no claims that it's the world's finest loudspeaker regardless of size—none of that malarkey. (You know better, and so do we.)

So let us show you how much rare value we've packed into this practical-sized cabinet. Value you'd not suspect

in a speaker this size.

First off: it really fits a bookshelf. Just 9" deep, 10" high, 19" wide. Easier to park anywhere you want to play it.

Then the sound: it starts with an honest 50 cps from the 8" acoustic-suspension woofer. On up—smoothly—to 15,000 cps from the 3½" cone tweeter.

And no mere switch or volume control adjusts the highs. An expensive RC network actually "tilts" the E-V SEVEN's response—up or down—from flat to whatever your room may need. Con-

**CIRCLE NO. 120 ON READER SERVICE CARD**

tinuously smooth. Absolutely unique.

You can put up to 50 watts peak power into the E-V SEVEN: no strain, just music. Beethoven. The Beatles. Anything! All this for just \$65.00 list, in an oiled walnut cabinet finished on four sides.

The E-V SEVEN is carefully engineered, carefully constructed, and far ahead of the other compacts in value—just like the VW.



There is one big difference. We think you'll like our styling better!



# Crime does pay!

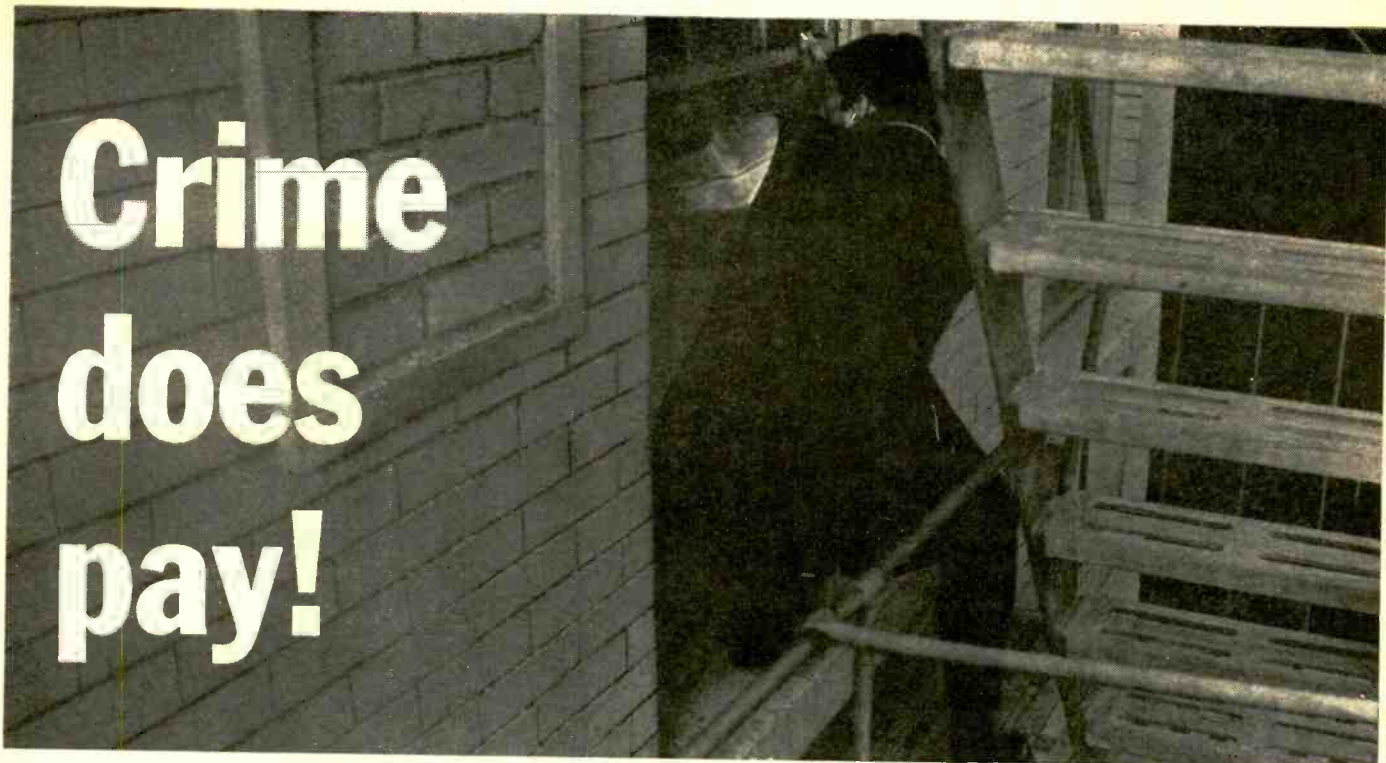

**Every 40 seconds a burglary takes place in the United States.**

## TECHNICAL INFORMATION

The RADAR SENTRY ALARM is a complete U.H.F. Doppler Radar System which saturates the entire protected area with invisible r.f. microwaves. It provides complete wall to wall—floor to ceiling protection for an area of up to 5,000 square feet. Without human movement in the protected area, the microwave signal remains stable. Any human movement (operation is unaffected by rodents and small animals) in the area causes the doppler signal to change frequency approximately 2 to 4 cps. An ultra-stable low frequency detector senses this small frequency change, amplifies it and triggers the police type siren—which is heard up to a half mile away.

In addition, the RADAR SENTRY ALARM's protection can be extended to other areas with the use of the following optional accessories:

- remote detectors for extending coverage to over 10,000 sq. ft.
- rate of rise fire detector U.L. approved for 2,500 sq. ft. of coverage each (no limit on the number of remote detectors that can be used)
- hold-up alarm
- central station or police station transmitter and receiver (used with a leased telephone line)
- relay unit for activating house lights
- battery operated horn or bell which sounds in the event of: powerline failure; equipment malfunction or tampering

At that rate, it's a multi-million dollar a year business... for burglars.

And an even better business opportunity for you.

Why? Because burglary can be stopped...with an effective alarm system.

In fact, police and insurance officials have proved that an alarm system reduces, and in many cases, eliminates losses—even helps police apprehend the criminal.

Here's where you come in.

Only a small percentage of the more than 100 million buildings—stores, offices, factories, schools, churches and homes are protected by an effective alarm system.

That means virtually every home, every business is a prospect.

You can sell them!

And you don't have to be a super-salesman to sell the best protection available—a Radar Sentry Alarm unit. All you have to do is demonstrate it...it sells itself.

A glance at the technical information shows why.

It's the most unique and effective alarm system ever invented.

And here's the proof.

In the past six years, thousands of RADAR SENTRY ALARM units have been sold in the Detroit, Michigan area alone—sold by men like yourself on a part-time and full-time basis.

Here are just a few customers who are protected by RADAR SENTRY ALARMS:

U.S. Government  
U.S. Air Force  
Detroit Board of Education  
Hundreds of Churches,  
Banks, Businesses and  
Homes.

Everyone is a prospect.

So take advantage of your profession. Put your technical knowledge and experience to work for you in a totally new area—an area that will make money for you!

Don't wait!

Let us prove that crime does pay.

Become a distributor.

Write now for free details.

## RADAR SENTRY ALARM

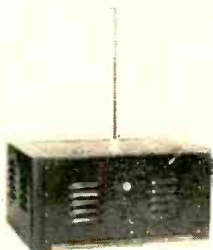

Mail to: RADAR DEVICES MANUFACTURING CORP.  
22003 Harper Ave., St. Clair Shores, Michigan 48080



Please tell me how I can have a business of my own distributing Radar Sentry Alarm Systems. I understand there is no obligation.

Name \_\_\_\_\_ Ew-9

Address \_\_\_\_\_

City \_\_\_\_\_ State & Code \_\_\_\_\_

# RCA Solid Copper Circuits



replace old-fashioned  
"hand wiring"...give TV  
space age  
dependability.

RCA Solid Copper Circuits are made by methods as modern as tomorrow. They give greater dependability . . . better TV performance. It's typical of the advanced design you'll find throughout every RCA Victor home instrument. It all adds up to sets that are easier to service so that owners are more satisfied with results.

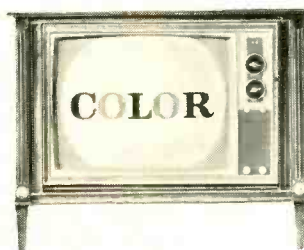

The Most Trusted Name  
in Electronics ™ ©

More TV servicemen own RCA Victor Color TV than all other leading makes combined



ELECTRONICS WORLD





THIS MONTH'S COVER symbolizes the theme of our special feature issue dealing with test equipment for semiconductor devices. In the foreground is a grouping of Delco, Motorola, and Westinghouse semiconductors—including high-power and zener diodes along with power and high-frequency transistors. In the background is a family of characteristic curves of a transistor as might be displayed on the cathode-ray tube screen of a curve tracer. Feature stories in this issue cover various types of testers for semiconductors, curve tracers, the use of simple test equipment for transistor measurements, a glossary of important transistor terms, and a directory of test equipment for semiconductors. (Illustration: Otto Markevics.)



*Publisher*  
**PHILLIP T. HEFFERNAN**

*Editor*  
**WM. A. STOCKLIN**

*Technical Editor*  
**MILTON S. SNITZER**

*Associate Editors*  
**LESLIE SOLOMON**  
**P. B. HOEFER**

*Assistant Editor*  
**MARSHA JACOBS**

*Contributing Editors*  
**WALTER H. BUCHSBAUM**  
**Prof. ARTHUR H. SEIDMAN**

*Art Editor*  
**RICHARD KELLY**

*Art and Drafting Dept.*  
**J. A. GOLANEK**

*Advertising Sales Manager*  
**LAWRENCE SPORN**

*Advertising Service Manager*  
**ARDYS C. MORAN**

- 23** **Magnetic Reed Switches and Relays** Gary A. Lehmann  
*These new components, though not as fast as transistor-operated switches, have lower contact resistance, higher open-circuit resistance, less capacitance, and will switch higher voltages.*
- 27** **Parallel-Resistor Nomogram** Max H. Applebaum
- 28** **Recent Developments in Electronics**
- 30** **Directory of Test Equipment for Solid-State Devices**  
*Fifty-one manufacturers are engaged in turning out test equipment for solid-state devices. These range from kits to complex testers.*
- 31** **Testing Semiconductors with V.O.M. or V.T.V.M.** Carl David Todd  
*Many tests can be performed on transistors, diodes, FET's, and SCR's using simple circuits and a v.o.m. or v.t.v.m. However, testing can also be catastrophic if characteristics of the test set are unknown.*
- 35** **Improved Switching of Inductive Loads** James P. Reed
- 36** **The Optical Link: A New Circuit Tool** Donald Lancaster  
*If you pair a light source with a photosensitive device inside an opaque enclosure, you have a 4-terminal network that can perform many electronic functions which are impossible or extremely difficult by any other means.*
- 40** **Understanding the Transistor Data Sheet**
- 42** **Testers for Semiconductor Devices** A. H. Seidman  
*Survey of circuits and operating principles employed in commercial test equipment. Emphasis is on direct-reading type of transistor testers.*
- 45** **Laser Practice & Applications** Warren Groner
- 49** **Using a Transistor Curve Tracer** Ralph E. Show
- 62** **Additional Channels for Business Radio** Leo G. Sands
- 65** **New Citizens Band Circuits** Len Buckwalter
- 82** **deForest's Early Audions** Paul G. Watson
- 84** **Laser Carries Seven TV Channels**
- 85** **Versatile Oscillator**

- 
- 6** **For the Record (Editorial)** W. A. Stocklin  
*The Battery Renaissance*
  - 16** **EW Lab Tested**  
*Acoustic Research AR-2ax Speaker System*  
*KLH Model 18 FM Tuner*
  - 56** **Chemicals for the Service Shop** John Frye

## MONTHLY FEATURES

- |                                    |           |                                     |           |
|------------------------------------|-----------|-------------------------------------|-----------|
| Coming Next Month . . . . .        | <b>4</b>  | Electronic Crosswords . . . . .     | <b>77</b> |
| Letters from Our Readers . . . . . | <b>12</b> | Book Reviews . . . . .              | <b>86</b> |
| Radio & TV News . . . . .          | <b>30</b> | New Products & Literature . . . . . | <b>94</b> |

Copyright © 1965 by Ziff-Davis Publishing Company. All rights reserved.

# ASSEMBLE YOUR OWN ALL-TRANSISTOR *Schober* ELECTRONIC ORGAN



3 NEW MODELS  
Recital \$1500  
Console II 850  
Spinet 550

This is the new, all-transistor Schober Console II... the most luxurious

"home-size" organ available today.

Full 61-note manuals, 17 pedals, 22 stops and coupler, 3 pitch registers, and authentic theatre voicing leave little to be desired. Comparable to ready-built organs selling from \$1800 to \$2500.

The pride and satisfaction of building one of these most pipe-like of electronic organs can now be yours... starting for as low as \$550. The Schober Spinet, only 38 inches wide, fits into the smallest living room. The all-new, all-transistor Schober Recital Model actually sounds like the finest pipe organ; its 32 voices, 6 couplers, 5 pitch registers delight professional musicians... making learning easy for beginners.

AND YOU SAVE 50% OR MORE BECAUSE YOU'RE BUYING DIRECTLY FROM THE MANUFACTURER AND PAYING ONLY FOR THE PARTS, NOT COSTLY LABOR.

It's easy to assemble a Schober Organ. No special skills or experience needed. No technical or musical knowledge either. Everything you need is furnished, including the know-how. You supply only simple hand tools and the time.

You can buy the organ section by section... so you needn't spend the whole amount at once.

You can begin playing in an hour, even if you've never played before—with the ingenious Pointer System, available from Schober.

Thousands of men and women—teen-agers, too—have already assembled Schober Organs. We're proud to say that many who could afford to buy any organ have chosen Schober because they preferred it musically.

Send for our free Schober Booklet, describing in detail the exciting Schober Organs and optional accessories; it includes a free 7-inch "sampler" record so you can hear before you buy.

IN OUR 10TH YEAR

THE *Schober Organ* CORPORATION

43 West 61st Street, New York, N. Y. 10023  
Also available in Canada, Australia, Hong Kong, Mexico, Puerto Rico, and the United Kingdom

THE SCHOBER ORGAN CORP., DEPT. RN-39  
43 West 61st Street, New York, N. Y. 10023  
 Please send me FREE Schober Booklet and FREE 7-inch "sampler" record.  
 Enclosed find \$2.00 for 10-inch quality LP record of Schober Organ music. (\$2.00 refunded with purchase of first kit.)

Name \_\_\_\_\_

Address \_\_\_\_\_

City \_\_\_\_\_ State \_\_\_\_\_ Zip. No. \_\_\_\_\_

CIRCLE NO. 92 ON READER SERVICE CARD

# COMING NEXT MONTH SPECIAL ISSUE



A special sixteen-page section devoted to the design, characteristics, and operation of all types of batteries used in electronic equipment. A directory of battery sources is also included for reference purposes.

**DR. H. J. STRAUSS**, R&D director for Burgess, covers alkaline-manganese, silver oxide-zinc, silver oxide-cadmium, and air-depolarized types.

**LEWIS HOFSTATTER**, applications engineer for Sonotone, reports on rechargeable nickel-cadmium batteries, the most promising of batteries from a marketing standpoint. Portable equipment for both home and industry will be a major influence on their future growth.

**GORDON E. KAYE**, Mallory Battery applications engineer, reviews mercury batteries, those cells which are widely used because of their voltage accuracy, extended shelf-life, high-energy density, and good temperature stability.

**R. B. PIPAL**, manager of the Battery Engineering Dept. of Union Carbide, covers carbon-zinc cells, the most widely used primary battery system because of its low cost, reliable performance, and ready availability.

**SPECIAL FEATURE:** A new and stable pattern of growth for Midwest electronics is emerging in the mid-1960's with a second postwar boom—this time in consumer products, industrial controls, and stepped up research and development output. "Midwest Electronics—A Changing Pattern of Growth" is a vital article for everyone in the electronics industry.

## SILICON TRANSISTOR I.F. AMPLIFIER FOR FM TUNER

*D. R. von Recklinghausen of Scott outlines the general requirements for hi-fi tuner i.f.'s and includes a practical circuit design demonstrating these requirements.*

## 3-D FROM LASER PHOTOGRAPHY

*Details on how 3-D pictures can be created without use of special optical devices—a process involving a lensless camera and projector—based on work at the University of Michigan.*

All these and many more interesting and informative articles will be yours in the OCTOBER issue of *ELECTRONICS WORLD*... on sale September 21st.

## ZIFF-DAVIS PUBLISHING COMPANY

William B. Ziff  
Chairman of the Board (1946-1953)

William Ziff  
President

W. Bradford Briggs  
Executive Vice President

Hershel B. Sarbin  
Vice President and General Manager

Philip Sine  
Financial Vice President

Walter S. Mills, Jr.  
Vice President, Circulation

Stanley R. Greenfield  
Vice President, Marketing

Phillip T. Heffernan  
Vice President

Frank Pomerantz  
Vice President, Creative Services

Arthur W. Butzow  
Vice President, Production

Editorial and Executive Offices  
(212 ORegon 9-7200)  
One Park Avenue, New York, N.Y. 10016

NEW YORK OFFICE (212 ORegon 9-7200)  
James J. Sullivan  
Joseph E. Halloran

MIDWESTERN OFFICE (312 726-0892)  
307 North Michigan Avenue, Chicago, Ill. 60601  
Midwestern Advertising Manager, Royce Richard

WESTERN OFFICE (213 Crestview 4-0265)  
9025 Wilshire Boulevard, Beverly Hills, Cal. 90211  
Western Advertising Manager, Bud Dean

CIRCULATION OFFICE  
Portland Place, Boulder, Colorado, 80311



Member  
Audit Bureau of  
Circulations

Radio & TV News • Radio News • Radio-Electronic Engineering Trademarks Reg. U.S. Pat. Off.  
**SUBSCRIPTION SERVICE:** All subscription correspondence should be addressed to Electronics World, Circulation Dept., Portland Place, Boulder, Colorado 80311. Please allow at least six weeks for change of address. Include your old address as well as new—enclosing if possible an address label from a recent issue.  
**EDITORIAL CONTRIBUTIONS** must be accompanied by return postage and will be handled with reasonable care; however publisher assumes no responsibility for return or safety of art work, photographs, or manuscripts.  
**ELECTRONICS WORLD** (September 1965, Vol. 74, No. 3) is published monthly by Ziff-Davis Publishing Company at 307 North Michigan Avenue, Chicago, Ill. 60601. (Ziff-Davis also publishes Skiing, Flying, Business/Commercial Aviation, Popular Boating, Car and Driver, Popular Photography, HiFi/Stereo Review, Popular Electronics, Modern Bride and Skiing Trade News.) One year subscription rate for U.S., U.S. Possessions and Canada, \$5.00; all other Foreign, \$6.00. (Schedule for payment in Foreign currencies may be found elsewhere in this issue.) Second class postage paid at Chicago, Illinois and at additional mailing offices. Authorized as second class mail by the Post Office Department, Ottawa, Canada and for payment of postage in Canada.

ELECTRONICS WORLD



Created by The Hand of Experience



**CONTROL? IDENTIFICATION? SURVEILLANCE?**

**There's an RCA Vidicon to meet every closed-circuit TV requirement**

- Industrial Plants—for remote meter reading, flame burner observation, production testing, quality control, warehouses, parking lots, shipping and receiving areas.
- Institutions—for security and emergency stations, power plant control, instruction classes, and amphitheatres.
- Municipal Governments—for highway traffic control, pools, playgrounds, and schools.
- Public Transportation—for railroad, aircraft, and truck traffic control.
- Business—for bank signature verification, department store surveillance.

Wherever or however you use closed-circuit TV, RCA provides the Vidicon most ideally suited for your specific equipment. RCA offers the most complete line of Vidicons available in the industry—a wide selection of sizes, electrical construction, and performance characteristics.

*Outstanding features:* exceptional sensitivity • high resolution • high uniformity of tube-to-tube characteristics • low lag • uniform photoconductive surface • new tight limits on spurious signals • low geometrical distortion. When you replace a Vidicon, check with your local RCA Industrial Tube Distributor. His tube inventory will meet your equipment requirements on short notice. Ask him for a copy of the RCA Camera Tube Catalog CAM-600, or write: RCA Electronic Components and Devices, Commercial Engineering, Section 141Z, Harrison, N. J.



**The Most Trusted Name in Electronics**



**LITTLE DOTS OF  
SOLDER  
PUT IN PLACE  
AS PLANNED...**

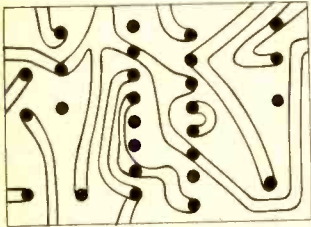

**...make for mighty savings,  
faster production, and  
greater reliability—when  
you're using Ungar  
precision soldering tools**

A solder dot on a drawing implies a perfect joint—but it may not always turn out that way. That's why Ungar designs improved soldering tools to put precision into hand soldering. Take Ungar's new #777 Clean-Room Handle for surgical-clean environments. It's light, cool and easy to handle—won't catch dust, can't contaminate work.

The #777 can use nearly four dozen interchangeable tips, heating units and tiptlets that are precision-matched for every conceivable hand-soldering task. Ungar irons can top all others for engineered tip heat, quick recovery, sustained connections per minute, and economy of operation.

Why settle for less? Ask your Authorized Ungar Distributor or send the coupon for complete information.



**Ungar®**

**UNGAR ELECTRIC TOOLS**  
2701 W. El Segundo Blvd.  
Hawthorne, Calif. 90252

Send information about:

- New #777 Clean-Room Handle  
 Ungar Precision-Matched Soldering Irons and accessories

Dept. EW-965

Name \_\_\_\_\_

Title \_\_\_\_\_

Company \_\_\_\_\_

Address \_\_\_\_\_

CIRCLE NO. 196 ON READER SERVICE CARD



# For the record

WM. A. STOCKLIN, EDITOR

## THE BATTERY RENAISSANCE

**E**LECTRONICS will always be a fascinating subject. Just think of such past developments as the laser, the superconducting cryogenic magnet, and satellite communications, for example—all, of course, involving highly sophisticated equipment of major interest to the professional electronics man. Yet, unsuspected by most, a great new era of electronic products is emerging which will influence every man, woman, and child. This era encompasses not sophisticated devices but rather simple, low-cost products in the area of portable tools and appliances for the home, and even industry.

A combination of events has been occurring slowly, not so much in the technology but in the reduction of manufacturing costs, so that a breakthrough is evident.

G-E has just announced that SCR's with a 150-watt rating will be made available in quantities at 35 to 50 cents each, and these are small enough to fit in the base of an electric light socket. Power transistors are steadily improving in reliability and prices are being reduced. Rechargeable batteries of the nickel-cadmium and alkaline types are reliable and reasonably priced, just awaiting more applications.

The conventional carbon-zinc battery had its renaissance some twelve years ago with the employment of the transistor in the portable and pocket radio. One and a half million transistor sets were produced in 1953 and this increased to a total of 17 million sets in 1963.

Mercury cells, sophisticated devices but not rechargeable, are finding wide application in both military and medical electronics. The cardiac Pacemaker (where the battery is imbedded in a person's body) is a good example of a case where reliability and battery life are major factors. Also, hearing aids and some wristwatches depend on mercury cells as their sources of operating power.

The rechargeable type, however, will be the key product in the upcoming, portable, cordless-power era. Today's market for rechargeable batteries alone is nearing \$50 million, compared to \$50 thousand in 1948.

Just imagine 4.5-million cells used to date in the \$35-million electric-toothbrush market.

Twelve-million cells have been sold to date for cordless electric shavers. Major

manufacturers intend eventually for all shavers to be both 117-volt a.c. and battery operated.

Multi-million cell use is anticipated for the rapidly developing electric slicing-knife industry.

When production costs come down, the nickel-cadmium auto starting battery is a possibility. Even the electric auto is not as remote as one might believe.

There is no end to the many types of portable, battery-operated items that will be produced in the near future. A present list we have seen already exceeds 1000, which includes all types of home tools and appliances.

The day isn't far off when most homeowners will have a simple, built-in battery recharging system. Batteries will simply be plugged in after use and stay on charge until needed.

In view of the cutback in military expenditures, many manufacturers are channeling their efforts toward diversification. This, combined with recent reductions in prices of batteries and electronic components, will result in a crash program in marketing cordless consumer products.

The rechargeable group of batteries is, of course, a major factor. Yet it is only a stepping stone between now and the time when economically priced fuel cells will become available.

"Is it portable?" will soon become as important a question as "Is it a.c./d.c. or gasoline-driven?" is today. With portability one must use batteries—and not just one type since there is a choice of various kinds. There will be applications where the low cost, throw-away non-rechargeable ones will be most suitable. There are other applications where more sophisticated and more reliable, but not rechargeable, batteries will be employed. Then, of course, there are the rechargeables. All of these will find their niche, whether it be in consumer products, in industry, or in military applications.

Batteries may seem like uncomplicated items yet the variations among them are extremely important, especially when designing new products.

In view of this, our next month's issue is a "Special Issue" devoted to the subject of batteries—all types. Four major articles, covering the four major types of batteries presently available, will be included. See page 4 for details. ▲

ELECTRONICS WORLD



# FINCO

## COLOR-VE-LOG ANTENNAS

### FOR UHF, VHF, FM RECEPTION

#### ALL-BAND UHF-VHF-FM ANTENNA

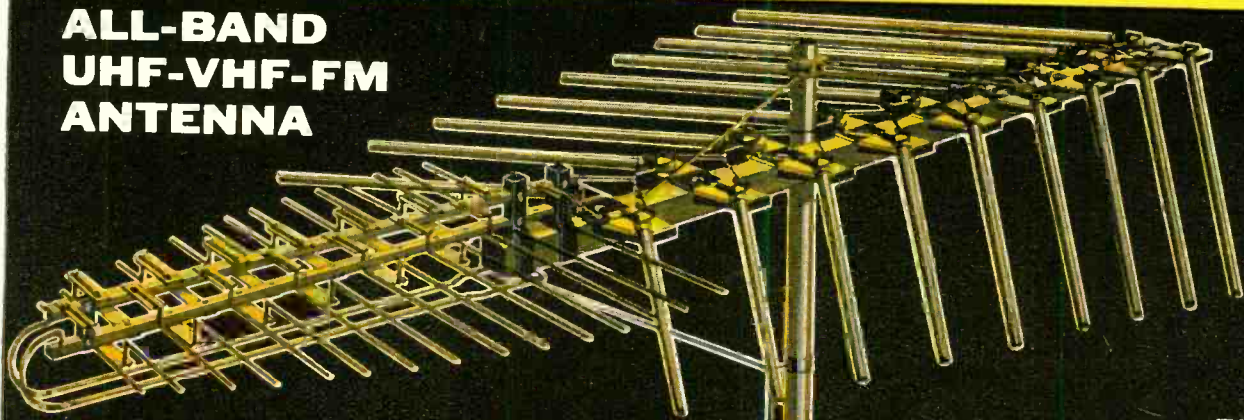

**FINCO**  
**Model UVF-24**  
**\$59.95 list**

The one antenna that does the work of 3! Gives startlingly clear black and white pictures and beautiful color on both UHF and VHF television channels — plus the finest in stereophonic and monophonic sound reproduction.

FINCO Model UVF-18 — \$42.50 list  
FINCO Model UVF-16 — \$30.50 list  
FINCO Model UVF-10 — \$18.50 list

#### SWEPT-ELEMENT VHF-FM ANTENNA

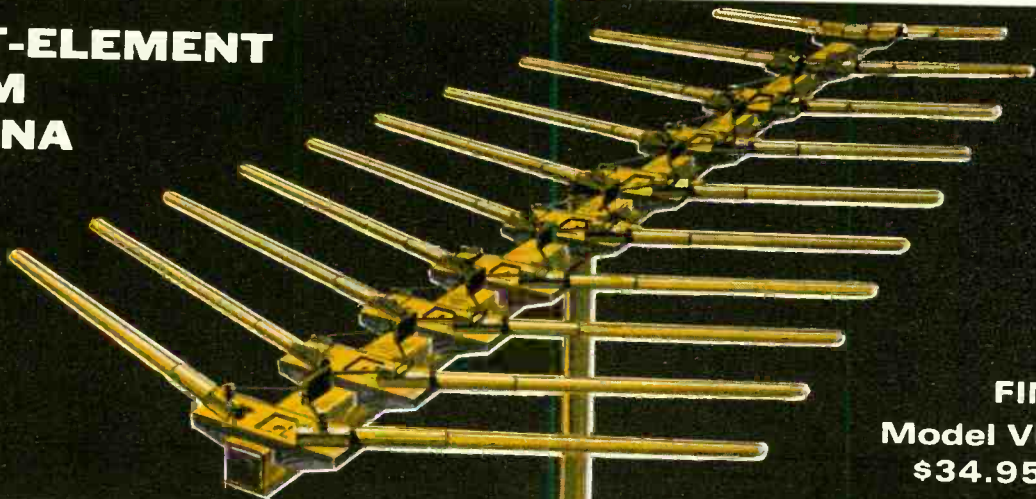

**FINCO**  
**Model VL-10**  
**\$34.95 list**

FINCO's Color-Ve-Log challenges all competition! Its swept-element design assures the finest in brilliant color and sharply defined black and white television reception — as well as superb FM monaural and stereo quality.

FINCO Model VL-18 — \$54.50 list  
FINCO Model VL-15 — \$46.95 list  
FINCO Model VL-7 — \$23.95 list  
FINCO Model VL-5 — \$16.95 list

Featuring FINCO's exclusive Gold Corodizing

## FINCO COLOR-VE-LOG

Prices and specifications subject to change without notice

**THE FINNEY COMPANY • 34 W. Interstate Street • Bedford, Ohio**

Write for beautiful color brochures Number 20-322, and 20-307, Dept. 410





***Learning electronics at home is faster, easier, more interesting with new achievement kit***

**GET A FASTER START IN THE COURSE YOU CHOOSE WITH NRI'S REMARKABLE ACHIEVEMENT KIT**

When you enroll with NRI we deliver to your door everything you need to make a significant start in the Electronics field of your choice. This remarkable, new starter kit is worth many times the small down payment required to start your training. And it is only the start . . . only the first example of NRI's unique ability to apply 50 years of home-study experience to the challenges of this Electronics Age. Start your training this exciting, rewarding way. No other school has anything like it. What do you get? The NRI Achievement Kit includes: your first set of easy-to-understand "bite-size" texts; a rich, vinyl desk folder to hold your training material in orderly fashion; the valuable NRI Radio-TV Electronics Dictionary; important reference texts; classroom tools like pencils, a ball-point pen, an engineer's ruler; special printed sheets for your lesson answers—even a supply of pre-addressed envelopes and your first postage stamp.

Only NRI offers you this pioneering method of "3 Dimensional" home-study training in Electronics, TV-Radio . . . a remarkable teaching idea unlike anything you have ever encountered. Founded more than half a century ago—in the days of wireless—NRI pioneered the "learn-by-doing" method of home-study. Today, NRI is the oldest, largest home-study Electronics school. The NRI staff of more than 150 dedicated people has made course material entertaining and easy to grasp. NRI has simplified, organized and dramatized subject matter so that any ambitious man—regardless of his education—can effectively learn the Electronics course of his choice.

**DISCOVER THE EXCITEMENT OF NRI TRAINING**

Whatever your reason for wanting knowledge of Electronics, you'll find the NRI "3 Dimensional" method makes learning exciting, fast. You build, test, experiment, explore. Investigate NRI training plans, find out about the NRI Achievement Kit. Fill in and mail the postage-free card. No salesman will call. NATIONAL RADIO INSTITUTE, Electronics Division, Washington, D. C. 20016





## **ELECTRONICS COMES ALIVE AS YOU LEARN BY DOING WITH CUSTOM TRAINING EQUIPMENT**

Nothing is as effective as learning by doing. That's why NRI puts so much emphasis on equipment, and why NRI invites comparison with equipment offered by any other school, at any price. NRI pioneered and perfected the use of special training kits to aid learning at home. You get your hands on actual parts like resistors, capacitors, tubes, condensers, wire, transistors and diodes. You build, experiment, explore, discover. You start right out building your own professional vacuum tube voltmeter with which you learn to measure voltage and current. You learn how to mount and solder parts, how to read schematic diagrams. Then, you progress to other experimental equipment until you ultimately build a TV set, an actual transmitter or a functioning computer unit (depending on the course you select). It's the practical, easy way to learn at home—the priceless "third dimension" in NRI's exclusive Electronic TV-Radio training method.

## **SIMPLIFIED, WELL-ILLUSTRATED "BITE-SIZE" LESSON TEXTS PROGRAM YOUR TRAINING**

Certainly, lesson texts are a necessary part of training . . . but only a part. NRI has reduced reading matter to "bite-size," programmed texts as simplified, direct and well-illustrated as half a century of teaching experience can make them. The best scientific techniques and extensive study have gone into each book. The amount of material in each text, the length and design, is precisely right for home-study. NRI texts are programmed with NRI training kits to make things you read about come alive. As you learn, you'll experience all the excitement of original discovery. Texts and equipment vary with the course you select. Choose from three major training programs in TV-Radio Servicing, Industrial Electronics and Complete Communications. Or select one of seven specialized courses for men with specific wants or needs. Check the courses of most interest to you on the postage-free card and mail it today for your free catalog.

# ***custom training kits "bite-size" texts***



# don't gamble

Get the Vidicon quality you pay for...



with Amperex Vidicons,  
pre-tested and pre-selected  
to match your  
specific application

With three Amperex low filament-current (0.6V) Vidicon types to choose from—pre-selected for you by Amperex—the 55850 AM—for low cost applications, the 8483 for all conventional applications, and the 55850 S for the most exacting commercial and broadcast applications...with each Amperex type offering unparalleled tube-to-tube uniformity (each tube comes with its own test data, covering all important parameters) and with each and every Amperex vidicon providing you with sensitivity and resolution second to none, outstanding lag characteristics and amazingly uniform operation throughout its life...with all this and more (our vidicons are packed and shipped in individual gimbal-stabilized containers) getting the exact number of tubes you need...of the quality you need...at the right price...is now a safe bet, no longer a gamble!

For complete data, write: Amperex Electronic Corporation, Tube Division, Hicksville, Long Island, N. Y. 11802.

## Amperex®

IN CANADA: PHILIPS ELECTRON DEVICES, LTD., TORONTO 17, ONTARIO.  
CIRCLE NO. 124 ON READER SERVICE CARD

## LETTERS FROM OUR READERS

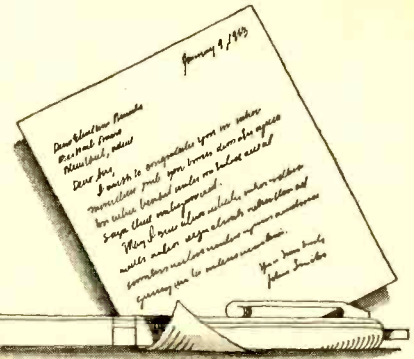

### COAX VS TWINLEAD

To the Editors:

With so many unsolved problems confronting our world, there is little point in inventing spurious ones, as did Lon Cantor in "Coax vs Twinlead" (*ELECTRONICS WORLD*, July, 1965). The two sentence editorial footnote appended to this article scarcely hints at the flaws in the author's indictment of twinlead for color-TV reception.

Twinlead of high quality, which is still inexpensive relative to coax, overcomes most of the problems cited. Signal fields surrounding the conductors of an encapsulated 300-ohm line, for example, remain confined within the line, as is the case with coax. This avoids the "drastic" changes that can degrade color signals wrought by water, ice, and even metals. Using the wrong type of standoff or staple, or using these improperly, can impair function of *any* transmission line. Mr. Cantor himself specifies certain precautions in the handling and stapling of coax. Why he considers vulnerability to abuse reasonable in one type of line but unforgivable in another is not explained. As to standoffs (which are a good idea to support any downlead), inexpensive ones with all-polyethylene heads are available that do *not* surround the line with metal rings.

Even so, one may question how harmful nearby metals, including standoff rings, actually are with good twinlead. A recent series of tests by *Belden Manufacturing Co.*, which makes both coax and twinlead, is interesting. Identical signals were fed to identical lengths of RG59/U coax, 8285 encapsulated twinlead in air, and 8285 run through a metal pipe. Signal in the pipe-enclosed line was attenuated somewhat as compared to the same twinlead in air, but output was nevertheless higher than at the end of the coax cable. Attenuation alone is not the only part of the problem, although it is important. Also significant from the viewpoint of standing-wave development and phase shifting, which can affect quality of the color picture, was the fact that transmission-line impedance was *not* drastically changed.

The matter of attenuation brings us to the serious but entirely unmentioned flaw in coax. Even in the low v.h.f. band, it will attenuate signal more than twin-

lead. At the high end of the v.h.f. band, *half* the signal sent down by the antenna can be consumed by coax before reaching the set, in a typical run. On u.h.f., of course, use of coax is impossible. In fact, few wire manufacturers even bother to specify losses above 400 mc. Toward the low end of the u.h.f. band, signal loss will run about 9 db or more per 100 feet. Toward the high end of the band, with considerably shorter runs, attenuation can be great enough to negate the gain of the most sensitive u.h.f. antennas now available. In other words, an elaborate outdoor array feeding through coax may deliver less signal to a TV set than a simple indoor bow-tie or u.h.f. loop at the receiver itself! What happens to the color quality we are trying to protect in u.h.f. transmission?

We have still to assess the matching transformers needed with coax, which simply involve more expense and more sources of trouble. These, too, can introduce attenuation and mismatch at certain frequencies. When two are used—and most antennas will require one at each end of the coaxial line—the problem is multiplied. We return to the very color-degrading deviations we are trying to avoid.

The only remaining justification for choosing coax is in the rare case of severe interference *when it is picked up primarily on the downlead*, to which coax is immune.

EDWARD FINKEL  
Vice-President, Sales  
JFD Electronics Corporation  
Brooklyn, N. Y.

*Quite a bit of work is now being done on the development of shielded 300-ohm twinlead which should possess the advantages of both coax and twinlead. We expect to see this type of line re-introduced to the color-TV market shortly. Meanwhile, we have been gathering technical information and test data on such line for a possible article on the subject in a forthcoming issue.—Editors.*

### CITIZENS RADIO BILL

To the Editors:

Because of several recent articles in past issues of *ELECTRONICS WORLD* on the subject of the Citizens Radio Service, I thought you might be interested in a



# What you should know about TV lead-in before you buy!



By Roland Miracle  
 Engineer, Electronics Division  
 Belden Manufacturing Company  
 Richmond, Indiana

There are four basic types of cable for TV lead-in on the market today—flat ribbon, tubular, encapsulated, and coaxial. The advantages and disadvantages of each type should be understood before making an installation.

Here, Roland Miracle, electronics engineer at Belden Manufacturing Company's Richmond plant, answers questions regarding the suitability of the 300-ohm twin-lead types and coaxial cable.

**Q.** What is the best TV lead-in for most applications?

**A.** The choice is not simply between coaxial cable and twin-lead. This is because there is a great deal of difference between old style 300-ohm line and encapsulated 300-ohm line. Ordinary ribbon lines will give troublesome and inconsistent performance in color or UHF installations.

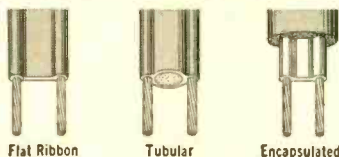

**Q.** What are the differences in 300-ohm line?

**A.** Flat ribbon and tubular 300-ohm line perform well at UHF frequencies *only* when they are free from all traces of surface deposits. When these lines encounter dirt, rain, snow, salt, smog, fog or industrial deposits, problems arise. Impedance drops abruptly, and attenuation soars. Ghost pictures result.

Encapsulated 300-ohm line features a low loss cellular polyethylene protective jacket which keeps all surface deposits out of the critical conductor area—regardless of

weather conditions. This type of lead-in is made by Belden under the name of "Belden All-Weather Permohm\* Lead-In" and is highly recommended for UHF and color installations.

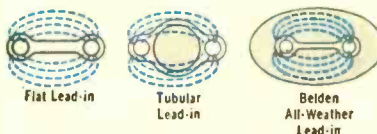

**Q.** When and where are coaxial cable installations best?

**A.** Coaxial cable systems are preferred where strong interference signals are present. This will usually be an urban location near a hospital, an industrial complex, or other such locations where extreme interference is radiated.

**Q.** Are the transmission characteristics of coaxial cable superior to 300-ohm twin-lead?

**A.** No! The attenuation of TV signals through coaxial cable is *much* greater than through 300-ohm twin-lead. This higher loss reduces the signal delivered to the TV receiver and makes booster amplifiers necessary at VHF frequencies in all but high strength areas. Coaxial cable systems also require two matching transformers—one at the set and one at the antenna—because all coaxial cables are unbalanced lines and normally have a 75-ohm impedance. TV antennas and receivers are normally designed to use balanced lines having 300-ohm impedance.

**Q.** How does the attenuation of Permohm compare with coaxial lead-in?

**A.** The chart in the next column compares the values of Belden Permohm (No. 8285) with a typical coaxial line (RG-59U) under similar conditions. Note, how even when enclosed in metal pipe, the encapsulated line delivers a stronger signal than an equal length of coaxial cable under the same circumstances. The difference is even more apparent at UHF frequencies.

## 300 MICROVOLT ANTENNA SIGNAL

Channel 6		
RG-59U	[Bar]	201
8285 in air	[Bar]	261
8285 in pipe	[Bar]	210

Channel 13		
RG-59U	[Bar]	153
8285 in air	[Bar]	231
8285 in pipe	[Bar]	172

Channel 20		
RG-59U	[Bar]	99
8285 in air	[Bar]	195
8285 in pipe	[Bar]	123

Channel 83		
RG-59U	[Bar]	69
8285 in air	[Bar]	162
8285 in pipe	[Bar]	100

**Q.** What about cost?

**A.** A coaxial cable installation is much more expensive. The cost of a typical 75-ft. coaxial lead-in installation is about \$20.00 compared to \$7.00 for the best *encapsulated* 300-ohm lead-in. This extra cost results from the higher cost of the coaxial cable plus the extra cost of the two matching transformers. Also, coaxial cable requires carefully made electrical connections which are time consuming and costly.

**Q.** Does Belden make all types?

**A.** Yes. Belden offers the most complete line of TV lead-in, including coaxial cable. However, because of the many superior transmission characteristics of Permohm 300-ohm line, it continues to be the best lead-in for 90% of all TV installations. Ask your distributor about Belden Permohm.

**BETTER BUILT  
 BETTER BUY...**



**BELDEN MANUFACTURING COMPANY**  
 P. O. Box 5070-A • Chicago, Illinois 60680  
 8-6-5 \*Belden Trademark Reg. U.S. Pat. Off.



If you think the RCA BK-6B  
is a great lavalier mike...

TRY THE NEW BK-12A FOR SIZE!



$\frac{1}{3}$  smaller  
Only  $\frac{1}{3}$  the weight  
Extra rugged  
Improved performance  
Only \$900\* more

- ✔ Extremely small and light weight. Only  $1\frac{1}{2}$ " long,  $\frac{3}{4}$  ounce.
- ✔ Rugged. Designed to withstand rough handling.
- ✔ Non-directional pickup.
- ✔ Wide frequency response. 60 to 18,000 cps. Excellent speech balance when talking "off mike."
- ✔ Readily serviceable. Easily installed replacement cartridge makes factory repair unnecessary.
- ✔ Comes complete with clip-type lanyard, tie-clip holder and cable clip.

FOR COMPLETE SPECIFICATIONS, see your authorized RCA Microphone Distributor. Or write to RCA Commercial Engineering, Department 1 41 MC, Harrison, N. J. \*\$95.00 optional distributor resale price.

RCA ELECTRONIC COMPONENTS AND DEVICES



The Most Trusted Name in Electronics

bill I introduced recently, House Resolution 377. I am enclosing a copy along with a press release explaining my position on the subject.

FRANK T. BOW, M.C.  
House of Representatives  
Washington, D.C.

*Rep. Bow (R-Ohio) has introduced legislation calling for an investigation of the recent FCC order which severely restricts Citizens Band operations. He asked the Interstate Commerce Committee to study possibilities of enlarging Citizens Radio frequencies, including the assignment of all or part of the 28-mc. band now assigned to the hams.*

*There are 800,155 licensed stations in the Citizens Radio Service. Bow said FCC failure to explain or enforce limitations on Citizens Radio Service hobby operation encouraged its development and "it seems to me that justice requires us to find a means of continuing to permit hobby-type operation in the Citizens Band."—Editors.*

#### JUNE CORRECTIONS

To the Editors:

This is in reference to your June, 1965 issue of **ELECTRONICS WORLD**.

On p. 66, the parts list for Fig. 2 specifies meter M1 as being a 0.50- $\mu$ a. type. Is this correct?

On p. 35, Fig. 4 specifies an a.g.c. resistor to the first mixer's base of 2.7k ohms. In Fig. 5, the corresponding resistors are specified as 27k each. Both call for the same transistor. Has the decimal point slipped a decade?

GERALD K. SHERMAN  
Winnipeg, Man., Canada

*In both the cases cited above by Reader Sherman, we must confess to an overuse of the decimal point. In the first instance, a hyphen should be substituted for the decimal point so that the meter is a 0- to 50- $\mu$ a. type. This is clearly shown in the photograph at the lower left-hand corner of p. 66.*

*On p. 35, the decimal point should be deleted altogether so that all a.g.c. resistors have 27k ohm values.*

*Incidentally, with regard to this latter article ("Receiver Requirements for Monitoring Gemini"), we must repeat the statement contained in the story to the effect that the receiver is too expensive and complex to be built in the home workshop. Even for those readers who want to attempt to construct the simpler version of it discussed briefly at the end of the article, a good knowledge of receiver techniques is a must before approaching such construction. The purpose of the article was mainly to show the design requirements of the receiver rather than to serve as a construction project. We strongly advise against construction unless the builder can supply further details himself.—Editors.* ▲



# 9

*money-saving*

# NEW REASONS FOR BUYING EICO

UNCOMPROMISING ENGINEERING AT LOWEST COST ■



**1** New Model 965 - FaradOhm Bridge/Analyzer. 9-range, low-voltage capacitance-resistance bridge safely measures even 1-volt electrolytics. Metered bridge balance, leakage test voltage (6 DC VTVM ranges 1.5-500 V), leakage current (11 DC VTAM ranges 0.15  $\mu$ a-15 ma). DC VTVM & VTAM externally usable. \$129.95 wired.



**2** New Model 342 - FM Multiplex Signal Generator. Design lab quality. Both composite audio and FM RF outputs. Inputs for stereo audio source for store demonstrations, critical A/B listening tests. \$149.95 wired.

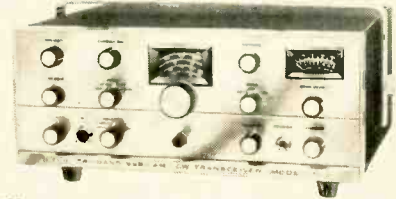

**3** New Model 753 - The one and only SSB/AM/CW Tri-Band Transceiver Kit. 200 watts PEP on 80, 40 and 20 meters. Receiver offset tuning, built in VOX, high level dynamic ALC. Unequaled performance, features and appearance. Sensationally priced at \$179.95 kit, \$299.95 wired.



**4** New model 3566 - All Solid-State Automatic FM MPX Stereo Tuner/Amplifier, kit or wired. No tubes, not even nuvistors. Delivers 112 watts IHF total to 4 ohms, 75 watts to 8 ohms. Completely pre-wired and pre-aligned RF, IF and MPX circuitry, plus plug-in transistor sockets. \$219.95 kit (optional walnut cabinet \$14.95), \$325.00 wired including walnut cabinet. UL approved.



**5** New Model 435 - D-C Wideband Scope. Top-quality DC-4. 5Mc scope with 3" flat-face CRT, Zener callibrator. Outperforms 5" scopes three times its size, facilitates on-location color TV and other servicing. \$99.95 kit, \$149.95 wired.



**6** New Model 779 - Sentinel 23 Dual Conversion 5-watt CB Transceiver. All crystals provided for 23 crystal-controlled transmit and receive channels. Delta tuning for receiving off-frequency transmissions. Panel switches for standby and use as 3.5 watt PA system. Transistorized 12VDC & 117VAC dual power supply. \$169.95 wired only.

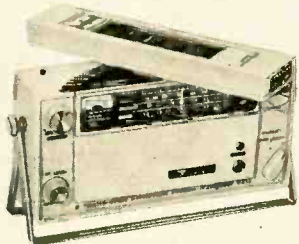

**7** New Bendix NAVIGATOR 420 - BFO for CONSOLAN navigation, antenna post for pulling-in weak signals, illuminated dial for night navigation. Battery saver cord permits use of external 6 VDC sources. \$99.95 complete.



**8** New Doormatic 4000 - Automatic Garage Door Opener. Quick, dependable, silent radio-controlled operation of garage doors with exclusive TONECEIVER (audio modulated transmitter and receiver). System includes garage door mechanism, electronic control box with radio receiver, transistorized portable transmitter, and all mounting hardware. Furnished completely wired, UL approved. \$59.95 mechanism only. Complete ready to install only \$159.95.



**9** New Model 380 - Solid State NTSC Color Generator generates exact NTSC color signals individually and all required dot-bar patterns. Super-compact, 4 pounds, light. Instant operation. \$109.95 kit, \$159.95 wired.

Over 3,000,000 EICO instruments now in use! Preferred by engineers, scientists, technicians and students. EICO equipment is available nation-wide through 2500 EICO dealers.

Send for FREE catalog describing the full EICO line of 200 best buys. EICO, 131-01 39th Ave., Flushing, N.Y. 11352.

1945-1965: TWENTY YEARS OF LEADERSHIP IN CREATIVE ELECTRONICS



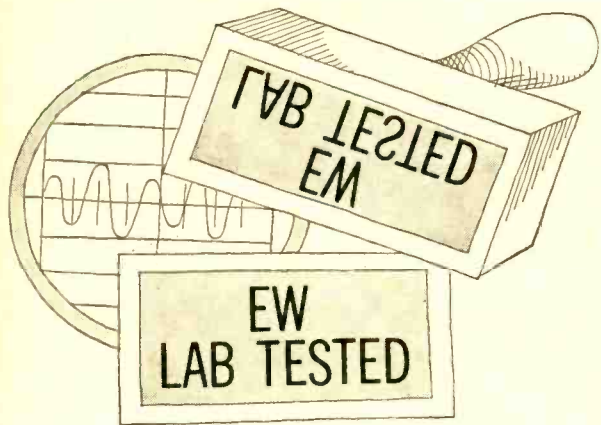

# HI-FI PRODUCT REPORT

TESTED BY HIRSCH-HOUCK LABS

**Acoustic Research AR-2ax Speaker System**  
**KLH Model 18 FM Tuner**

## Acoustic Research AR-2ax Speaker System

For copy of manufacturer's brochure, Circle No. 25 on Reader Service Card.

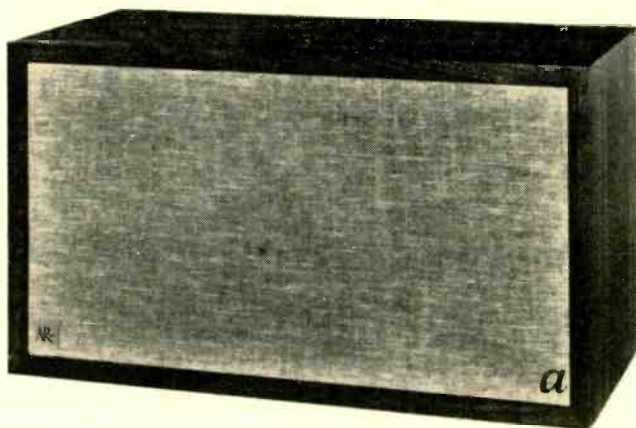

**T**HE Acoustic Research AR-2 speaker system, which has been manufactured with no significant change since 1957, uses a 10-inch acoustic-suspension woofer and a pair of 5-inch cone tweeters. The effective acoustic crossover frequency is 7500 cps. The tweeters are angled toward each other to improve their high-frequency dispersion.

To augment the extreme high-frequency response, an optional "super-tweeter" was made available in 1959. This is a hemispherical dome radiator (sometimes called the "fried egg" because of its distinctive appearance). With this high-frequency speaker, the system was known as the AR-2a.

The original pair of 5-inch cone speakers were not as smooth and well dispersed as either the woofer or the super-tweeter with which they were used. Recently, AR developed a new mid-range speaker, replacing the pair of 5-inch speakers in the AR-2 series. It is a 3½-inch, broad-dispersion cone radiator, heavily damped on both sides of the cone with fiberglass, and fully enclosed in the rear to simplify installation in a woofer cavity.

When the new speaker is supplied in AR-2 or AR-2a systems, they become the AR-2x and the AR-2ax. The 3½-inch speaker on its mounting plate is physically and electrically interchangeable

with the older tweeter structure. A conversion kit is available to owners of AR-2 or AR-2a systems who wish to update them to the "x" version.

We measured the frequency response of the AR-2ax by averaging eight sets of data taken at different microphone positions in a "live" room (see solid curve). Allowing for the known response characteristics of the room, the response of the AR-2ax was within  $\pm 1.5$  db from 100 to 2000 cps and within  $\pm 1$  db from 2500 to 15,000 cps. There is a 7.5 db "shelf" in the response between 2000 and 3000 cps, in the normal settings of

the mid-range and tweeter level controls located on the rear of the cabinet. With both controls at maximum, the over-all response is within  $\pm 3.5$  db from 100 to 15,000 cps or a most impressive  $\pm 5$  db from 20 to 15,000 cps (allowing for room response).

(EDITOR'S COMMENTS: We have long been concerned with the various bumps and dips that have appeared in the loud-speaker response curves we have been showing in some of our reports. We decided to try to track these down by measuring this particular speaker system under a variety of conditions to see the effect on the measured response curves.

It is well known that room characteristics and resonances, as well as speaker placement, have a profound effect on measured response, particularly at the lower frequencies. In the case of this curve, notice the peaks at 30, 60, and 120 cps. To make certain that these were due to the room rather than the speaker, we checked the speaker in a larger, live listening room. After we averaged our measurements, we now found peaks at 50, 75, and 100 cps. There probably would also have been a peak at 25 cps as well, except that the speaker output was not high enough to excite a room resonance. Because this listening room was larger than the one originally used (it measured at least 15 by 30 feet), the

(Continued on page 92)

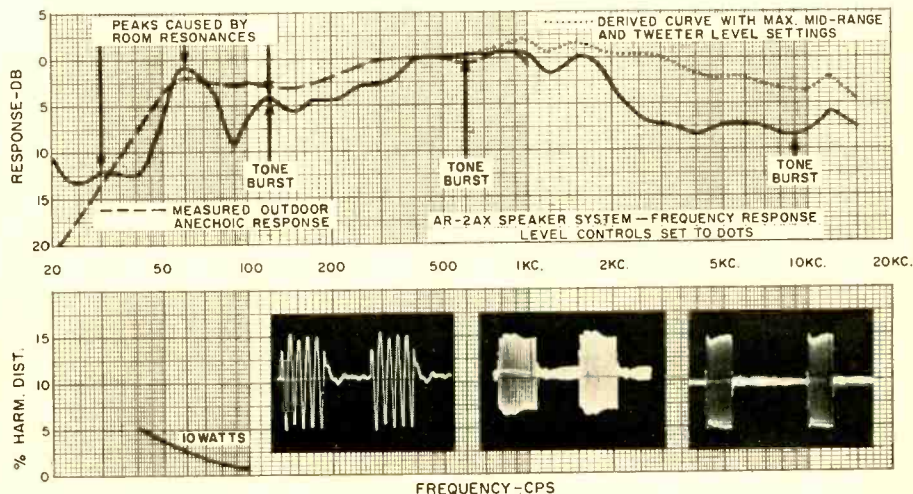



**Who makes  
the only great  
amplifier  
for \$99.50?**

**You do . . .  
with the new  
Fisher KX-90 StrataKit.**

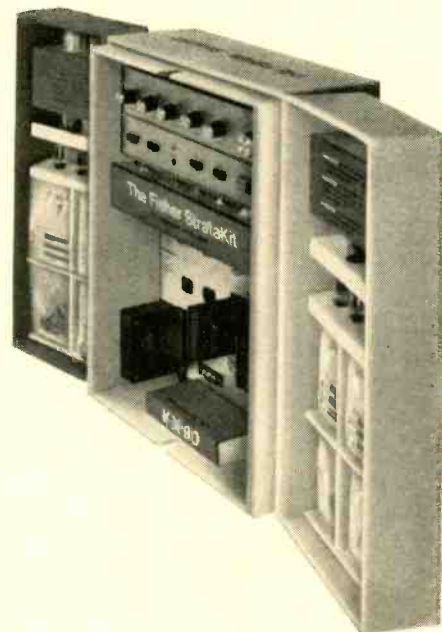

Now, for the first time in high fidelity history, you can own a truly distinguished stereo control-amplifier for less than \$100—if you are willing to build it yourself.

Fisher refuses to compromise quality. Therefore, even at \$99.50\*, the Fisher KX-90 StrataKit incorporates the same basic standard of fidelity as the most expensive Fisher components. Take away its price tag and it would still excite the admiration of the fastidious audiophile.

With 40 watts of clean power, the KX-90 can drive even inefficient speakers to their maximum performance level. Superior output transformers make certain this power will not fall off steeply at the frequency extremes. Advanced preamplifier control features, including rocker switches and complete phono and tape facilities, provide unlimited flexibility.

It's all yours if you follow directions. And that's no problem with the exclusive Fisher StrataKit method. No experience is necessary. Assembly takes place by simple, *errorproof* stages (Strata). Each stage corresponds to a *separate* fold-out page in the uniquely detailed instruction manual. Each stage is built from a *separate* packet of parts (StrataPack). Major parts come already mounted on the extra-heavy-gauge steel chassis. Wires are *precut* for every stage—which means every page. All work can be checked stage-by-stage and page-by-page, before proceeding to the next stage.

The end result is a Fisher amplifier that is fully equal in performance and reliability to its factory-wired prototype. Fisher guarantees this. And who should know better than Fisher?

**The  
Kit Builder's  
Manual**

**FREE! \$1.00 VALUE!**  
Send for The Kit Builder's Manual, an illustrated guide to high fidelity kit construction, complete with detailed specifications of all Fisher StrataKits.

Fisher Radio Corporation  
21-40 44th Drive  
Long Island City, N. Y. 11101

079

Name \_\_\_\_\_

Address \_\_\_\_\_

City \_\_\_\_\_ State \_\_\_\_\_

\*WALNUT CABINET, \$24.95.

OVERSEAS RESIDENTS PLEASE WRITE TO FISHER RADIO INTERNATIONAL, INC., LONG ISLAND CITY, N. Y. 11101. CANADIAN RESIDENTS WRITE TO TRI-TEL ASSOCIATES, LTD., 55 BRISBANE ROAD, DOWNSVIEW, ONTARIO.

**The Fisher**

CIRCLE NO. 114 ON READER SERVICE CARD

“He’s a good worker.  
I’d promote him  
right now  
if he had  
more  
education  
in electronics.”







## Could they be talking about you?

You'll miss a lot of opportunities if you try to get along in the electronics industry without an advanced education. Many doors will be closed to you, and no amount of hard work will open them.

But you can build a rewarding career if you supplement your experience with specialized knowledge of one of the key areas of electronics. As a specialist, you will enjoy security, excellent pay, and the kind of future you want for yourself and your family.

Going back to school isn't easy for a man with a full-time job and family obligations. But CREI Home Study Programs make it possible for you to get the additional education you need without attending classes. You study at home, at your own pace, on your own schedule. You study with the assurance that what you learn can be applied to the job immediately.

CREI Programs cover all important areas of electronics including communications, servomechanisms, even spacecraft tracking and control. You're sure to find a program that fits your career objectives.

You're eligible for a CREI Program if you work in electronics and have a high school education. Our FREE book gives complete information. For your copy, airmail postpaid card or write: CREI, Dept. 1109C, 3224 Sixteenth Street, N.W., Washington, D.C. 20010.

Founded 1927  
**CREI**  
Accredited Member  
of The National Home Study Council

# Delco Radio offers a new kind of volume control

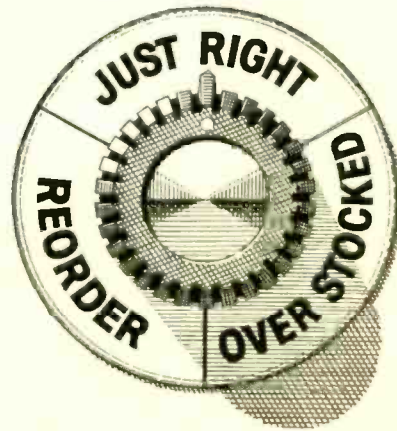

This year you can get a Delco Radio Parts Kit for each 1966 General Motors car. You buy only what you need—no more. That controls the volume of parts you need to carry.

There's a separate kit for Chevrolets, Pontiacs, Oldsmobiles, Buicks,

and Cadillacs. Plus a Universal Kit with parts that are interchangeable on *all* GM cars.

All kits contain the fastest moving parts and information pinpointing the models they're meant for. There are no carryovers from previous years.

Now's the time to order your Delco Radio Parts Kits for the

makes you service most. Just call your United Delco representative.



Delco Radio, Division of General Motors, Kokomo, Indiana



# MAGNETIC REED SWITCHES AND RELAYS

By GARY A. LEHMANN

Characteristics of these fairly new components make them suitable for a variety of electronic applications. Though not as fast as transistor switches, they have lower contact resistance, higher open-circuit resistance, will switch higher voltages, and have less capacitance. Practical uses include: tach pickups, proximity switches, d.c. choppers.

**N**OT too long ago, a new component made its first appearance in electrical and electronic equipment. As with most really basic inventions, the operation of the magnetic reed switch is strikingly simple. Rapid acceptance throughout the industry shows that it filled a definite need for bridging the gap between the ordinary electromechanical contactor or relay and the solid-state switch.

A survey of conventional relays shows that only specially designed types will operate faster than four milliseconds, will exhibit low contact bounce and contact capacitance, will work in a wide range of environment, and have long life expectancy. The reed relay makes all these features possible, and for a price that is well below that of the highly specialized electromechanical relay.

The reed switch has definite advantages over the transistor switch: high ratio of open-contact to closed-contact resistance, (typically  $10^{10}$  to 1), high breakdown voltage (300 volts at 60 cps and more), and contact capacitance of less than 1 pf. These properties make the reed switch well suited for use in high-impedance circuits, to handle higher voltages than a transistor switch, and to switch radio-frequency signals.

Transistor-switching circuits with equal load capacity, while capable of operating in the microsecond range, seldom exceed "off-on" resistance ratios of 100,000 to 1; collector-to-emitter breakdown voltages of 50 volts to 60 volts; and generally have base-to-collector and collector-to-emitter capacitances of 40 pf. and 80 pf. respectively. Unless protected by breakdown diodes, transistors can be damaged quite easily by voltage transients which will not affect reed switches. Furthermore, a simple transistor switching circuit provides little insulation between the controlling and the controlled sig-

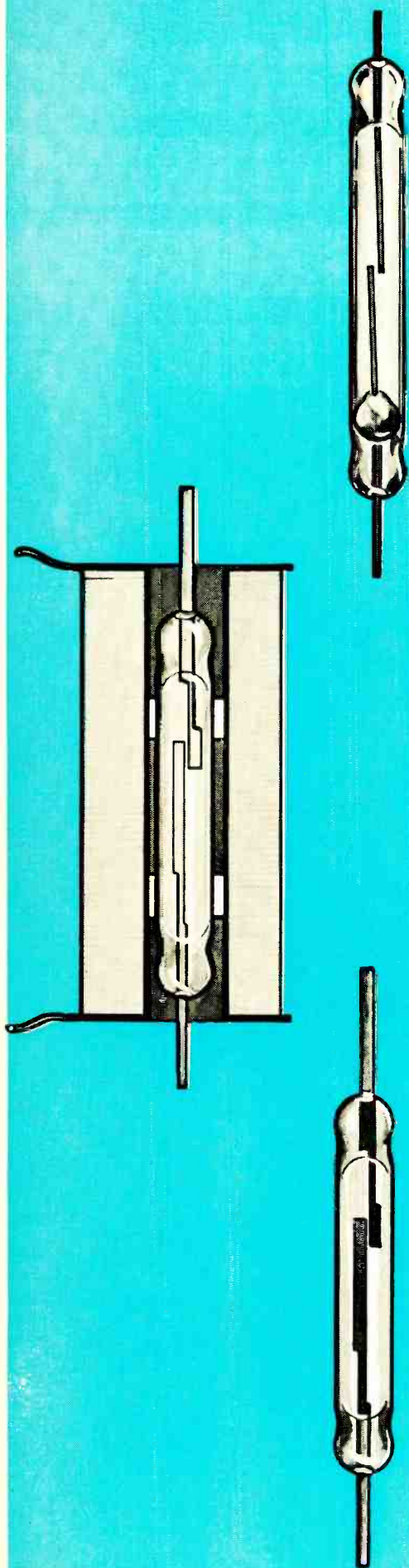

COMMON CHARACTERISTICS	TYPICAL CONVENTIONAL RELAYS	TYPICAL REED RELAYS	TYPICAL TRANSISTOR SWITCHES
Actuating Speed	3-5 msec.	1 msec.	0.1 $\mu$ sec.
Release Speed	3 msec.	200 $\mu$ sec.	0.2 $\mu$ sec.
Actuating Power	0.2-0.5 w.	0.15 w.	0.2-0.5 w.
Contact Resistance	0.2 ohm	0.05 ohm	1 ohm
Open-circuit to Closed-circuit Res.	better than 100 million/1	better than 100 million/1	100,000/1
Contact Capacity	1 a. @ 30 v. d.c.	0.5 a. @ 30 v. d.c.	1 a. @ 30 v. d.c.
Max. Switched Voltage	250 v. d.c.	250 v.d.c. or more	60 v. d.c.
Contact/Junction Capacitance	20 pf.	1 pf.	20 pf. or more

Table 1. Comparative data on typical conventional relays, reed relays, and transistor switching circuits with approximately the same amount of load-handling capabilities.

nal; both are applied to the same transistor which is not a unilateral device such as the vacuum tube. If the reed switch is actuated by a coil (reed relay), both signals are electrically insulated from each other and mutual capacitance between coil and reeds can be low.

Table 1 compares pertinent data on typical electromechanical, reed, and solid-state relays with similar load capacities. All values given in the table are approximate.

### The Contact Capsule

The reed switch consists of two or more metal reeds which are enclosed in a hermetically sealed glass capsule. The reeds are made from nickel-iron, a magnetically "soft" alloy that retains only a little magnetism. Fig. 1 shows a s.p.s.t., normally open reed switch. The overlapping ends of the nickel-iron reeds are the contact surfaces which are usually plated with gold or other suitable noble metal. This will promote lower contact resistance and help keep the surfaces electrically clean. A chemically inert gas which is enclosed in the capsule further contributes to the maintenance of good contact properties. As with any switch, contact arcing should be suppressed by suitable circuitry; whatever remains is confined to the glass capsule. This permits operation of the reed switch in chemically active or explosive atmospheres. It can be seen

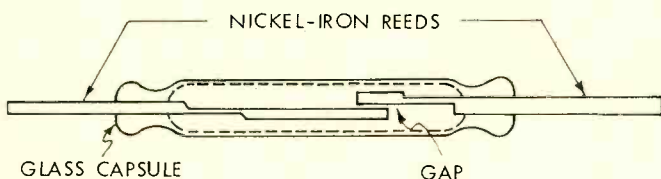

Fig. 1. An s.p.s.t. normally open magnetic reed switch.

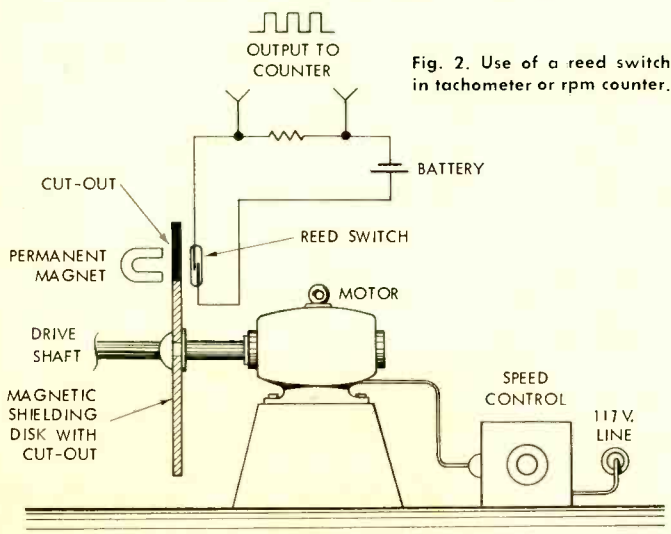

Fig. 2. Use of a reed switch in tachometer or rpm counter.

that the overlapping contact ends of the reed switch represent little mutually opposing area, hence the inherent contact capacitance is low.

Contact capsules are made in various sizes and for different current- and voltage-switching ranges, giving the circuit designer a wider range of specifications from which to choose. Reed switches can be actuated by permanent magnetic or electromagnetic fields, or by a combination of both.

When a magnet is moved close to a reed switch, more and more of its field lines tend to permeate the reeds because of their lower magnetic reluctance in comparison to air. As the magnet moves closer to the reeds, it reaches a point where the mutual attraction between the reeds begins to pull them toward each other. As the mutual distance is shrinking, the magnetic flux across the gap between the reeds increases as the square of the distance of separation. Even if the external magnet were not moved much beyond the point where mutual attraction begins to pull the reeds together, the increasing attraction between the reeds causes them to accelerate until they make contact.

The reverse action takes place when the external magnet is removed. As the distance between the magnet and the reeds is increased, the magnetic remanence tends to keep the ends of the reed together. But since the reeds consist of a magnetically "soft" alloy, the point is soon reached where the decreasing flux from the receding magnet is insufficient to hold the reeds together and they begin to separate. At this moment, the air gap reduces the remaining flux sharply, causing the reeds to recede with increasing speed.

It can be seen that this magnetic effect also helps to reduce contact bounce which tends to occur, especially at the moment of closure. As the reeds make contact, the magnetic flux and the mutual attraction increase greatly and help to counteract the tendency of the reeds to rebound. The magnetic effect, in conjunction with the relatively low mass of the reeds, permit the reed switch to follow rapid changes of the actuating magnetic field, allowing switching rates of several hundred cycles per second.

These properties can be put to use, for instance, in a pulse generator, tachometer, or revolution-counting circuit, as shown in Fig. 2. The drive shaft of the electric motor rotates a disk made from a magnetic shielding material such as Mu-metal with a cut-out along part of its periphery. The disk normally shields the contact capsule from the permanent magnet. As the disk is rotated, the magnetomotive force of the magnet actuates the contact capsule every time the cut-out permits the flux to reach the reeds. The reeds are connected in series with a battery and a suitable resistor. The pulsating current or voltage across the resistor is available for indicating or processing in external equipment, such as an integrating voltmeter for a tachometer or an electric counter.

Another application of the contact capsule would be to monitor the condition of a window or door. The capsule and actuating magnet can be easily concealed in adjacent parts of the wooden structures as shown in Fig. 3. With the window closed, the magnet energizes the reeds and thereby maintains a short-circuit across the pilot light at a guard's desk, preventing the bulb from glowing. As soon as the window or door is opened, the magnet no longer holds the reeds together, the short-circuit is removed, and the pilot light is energized. One advantage of the reed switch in this application is that the invisible magnetic flux actuates the contacts rather than a stud or contact button which might, by its presence, reveal the presence of an alarm system on the premises.

### Magnetic Biasing

The magnetic reed switch can be actuated by an external permanent magnet as well as by the magnetic field of current flowing through a solenoid, or by both. When a small permanent magnet is placed in the vicinity of the reed capsule, the resulting flux permeates the reeds and acts as a magnetic bias



which can be modulated by a changing magnetic field from the solenoid. With an actuating current of a given intensity, pull-in or drop-out points of the reed relay can be adjusted by varying the distance between the external magnet and the contact capsule and coil assembly. Magnetic biasing makes it possible to convert a normally open reed switch into a normally closed type. The constant magnetic field keeps the reeds closed. To open the contact, the electromagnetic flux of the solenoid must counteract the permanent flux of the magnet to neutralize the mutual attraction of the reeds.

Fig. 4 shows how magnetic biasing can be used to make a single-pole, double-throw switch. The small permanent magnet between the two reeds shown to the right in the diagram establishes a field with lines of force perpendicular to the main axis of the contact capsule. Depending on the strength and polarity of the actuating magnetic field, the large reed is attracted by either the upper or lower contact reed.

### Mercury-Wetted Reeds

For certain applications, even the low contact bounce of a reed switch cannot be tolerated. This residual bounce may be eliminated by the use of mercury-wetted contacts. Fig. 5 illustrates this special form of reed switch. A small amount of pure mercury is enclosed in the contact capsule. The form of the reeds promotes capillary action and keeps the contact ends of the reeds covered with a thin film of mercury.

Mercury has a very high surface tension (which accounts for its tendency to form small globules when spilled on a flat surface). When an object is pressed against a mercury surface, the mercury recedes until the pressure of the object exceeds the surface tension of the liquid metal. At this point the object penetrates suddenly and rapidly and the mercury flows up on the object, seeking to cover as much of it as possible. When the object is withdrawn, the opposite action takes place. A mercury filament is formed which is suddenly broken when the surface tension is exceeded. The same surface tension is responsible for the capillary action which maintains a constant film at the contact surface that is fed by means of the mercury pool at the bottom of the capsule.

One disadvantage of the mercury-wetted contact is the need to prevent the mercury from flowing across the contact

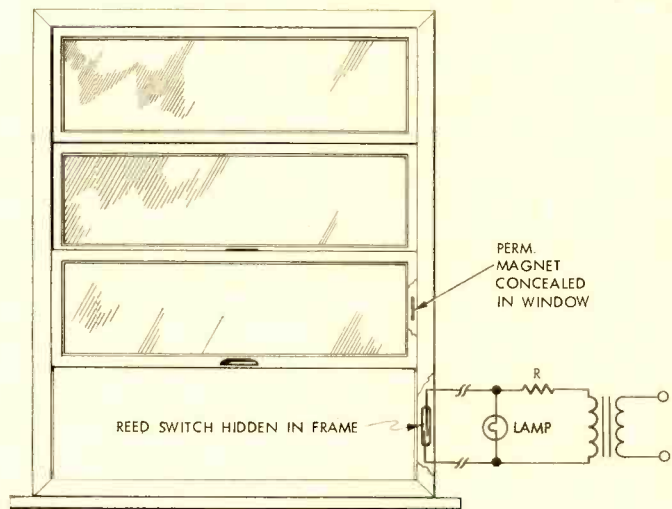

Fig. 3. When the window is opened, the lamp is turned on.

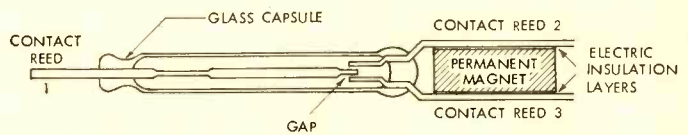

Fig. 4. Use of magnetic biasing to produce s.p.d.t. switch.

gap. To accomplish this, the capsule's longitudinal axis must be maintained in a perpendicular or near-perpendicular position, with the mercury pool at its lowest point. This might preclude the use of the switch in certain types of aircraft or for missiles whose attitude and acceleration in flight may frequently nullify the action of gravity.

### The Reed Relay

The contact capsule can be actuated by a permanent magnet (to form a proximity switch) or by current flowing through a solenoid to provide the magnetic flux. In the latter case the arrangement is called a reed relay. Conventional relays require magnetic forces on the order of ounces, whereas reed relays can be actuated by considerably less than one

Table 2. Characteristics and performance data on a number of typical magnetic reed switches and relays.

TYPE & MFR.	CAPSULE DIM. (in.)	CONTACT TYPE	MAX. VOLT.	MAX. LOAD (va.)	LIFE EXPECT. (No. cycles)	INIT. CONTACT RES. (milliohms)	AV. PULL-IN (amp-turns)	AV. DROP-OUT (amp-turns)	AV. OPER. TIME	AV. RELEASE TIME	AV. RESON. FREQ.	MIN. INSUL. RES. (ohms)	AV. CAP. (in pf.)
MR-100 Gordos Corp.	0.75 x 0.10	S.p.s.t. n.o.	300 v., 60 cps	4 resist.	10 x 10 <sup>6</sup> 50% load	60 to 200	35 ± 10	15 ± 5	0.5 msec.	50 μsec.	2150 cps	5 x 10 <sup>10</sup>	0.2
MR-800-1 Gordos Corp.	1.70 x 0.19	S.p.s.t. n.o.	500 v., 60 cps.	15	10 x 10 <sup>7</sup> 50% load	25 to 40	60 ± 10	22 ± 5	1.0 msec.	200 μsec.	540 cps	5 x 10 <sup>10</sup>	0.8
MR-200-1 Gordos Corp.	1.1 x 0.2	S.p.d.t.	300 v., 60 cps	15	20 x 10 <sup>6</sup> 50% load	20 to 50	40 ± 10	15 ± 10	2.5 msec.	150 μsec.	—	3 x 10 <sup>7</sup>	0.8
MRG-1 Hamlin, Inc.	0.8 x 0.14	S.p.s.t. n.o.	250 v., d.c.	10 resist.	10 x 10 <sup>7</sup> full load	100	100	40	0.2 to 1 msec.	*0.1 to 0.3 msec.	2500 to 3500 cps	1 x 10 <sup>8</sup>	0.2
DRG-2 Hamlin, Inc.	1.9 x 0.22	S.p.s.t. n.o.	250 v., d.c.	15 resist.	10 x 10 <sup>6</sup> full load	100	65	*20 to 30	*2 msec.	*0.1 to 0.3 msec.	*500 cps	5 x 10 <sup>8</sup>	*1.0
DRG-DTH Hamlin, Inc.	1.5 x 0.22	S.p.d.t. n.c.	250 v., r.m.s.	20 resist.	10 x 10 <sup>7</sup> full load	25 to 40	65	20 to 30	0.5 msec.	*0.1 to 0.3 msec.	*800 cps	5 x 10 <sup>8</sup>	*0.2
MRC-1 Hg-wet. Hamlin, Inc.	0.7 x 0.13	S.p.s.t. n.o.	100 v., d.c.	3 resist.	10 x 10 <sup>6</sup> full load	50	40 to 60	*20 to 30	1.0 msec.	*0.1 to 0.3 msec.	*2500 to 3500 cps	*1 x 10 <sup>8</sup>	*0.2
6ST1E** Douglas Randall	2.0 x 0.5	S.p.s.t. n.o.	500 v., d.c.	15 resist.	*10 x 10 <sup>7</sup> full load	35	6 v. d.c.	*4 v. d.c.	2.0 msec.	*0.1 to 0.3 msec.	*500 cps	1 x 10 <sup>10</sup>	*1.0
260-1A** Wheelock	1.4 x 0.5	S.p.s.t. n.o.	250 v., d.c.	4 resist.	10 x 10 <sup>6</sup> 50% load	60 to 200	6 v. d.c.	*4 v. d.c.	0.9 msec.	0.06 msec.	1080 cps	5 x 10 <sup>8</sup>	*1.0
MRR1A** Struthers-Dunn	1.1 x 0.43	S.p.s.t. n.o.	250 v., d.c.	4 resist.	10 x 10 <sup>6</sup> full load	200 max.	6 v. d.c.	*4 v. d.c.	1.0 msec.	*0.1 msec.	*1000 cps	10 x 10 <sup>8</sup>	*1.0

\*Estimated \*\*Reed Relay

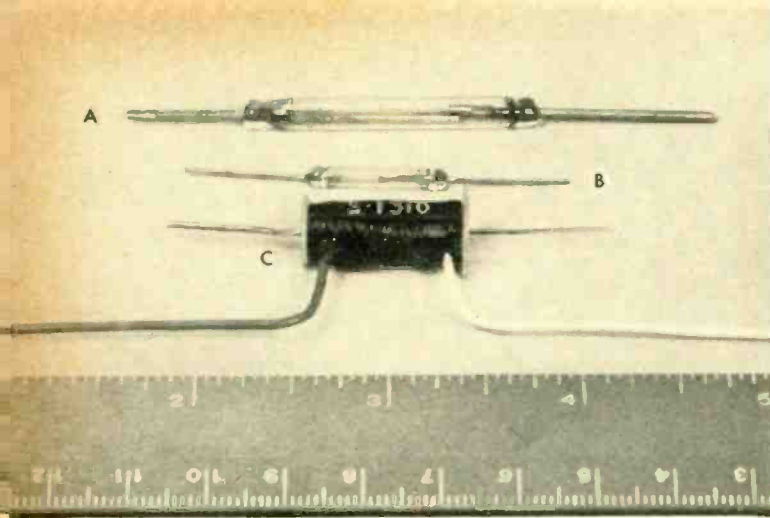

Typical magnetic reed switches. (A) S.p.s.t. standard, 15 va., 500 v., Gordos Corp. (B) S.p.s.t. miniature, 4 va., 300 v., Gordos Corp. (C) S.p.s.t. miniature mercury-wetted magnetic reed switch inserted into test coil, 3 va., 100 v. Hamlin, Inc.

ounce. Consequently, reed relays require driving power from as little as 20 mw. for miniature relays to approximately 500 mw. or more for multiple contact relays where several contact capsules are actuated by the same relay coil. In a conventional relay, the driving member is usually spring loaded and mechanically linked with the contact member. It

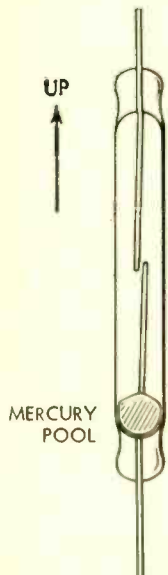

Fig. 5. By means of capillary action, the film of mercury from the pool at the bottom of the capsule covers the contact surfaces. This is done to prevent contact bounce. The switch must be kept in a vertical position, however, in order to keep the mercury from bridging the contact gap.

can be seen from Fig. 6 that the driving member and contact member in a reed relay are one and the same and that the natural elasticity of the cantilever construction makes additional spring loading unnecessary.

Physical dimensions, position, and magnetic properties of the reeds of a contact capsule are closely controlled during manufacture. The fabrication of capsules is largely automatic. This results in remarkable uniformity among one type, as far as pull-in, drop-out, and contact resistances are concerned. Pull-in and drop-out points are described in

terms of magnetomotive force  $F$  which is measured in ampere-turns ( $NI$ ).

A typical contact capsule requires  $60 \pm 10$  ampere-turns for closure and opens at a flux corresponding to  $22 \pm 10$  ampere-turns. The difference between pull-in and drop-out results from mechanical and magnetic properties of the reeds,

Typical reed relays. (A) MIL-type sealed s.p.d.t., C.P. Clare & Co. (B) Printed-circuit s.p.s.t., normally open, and s.p.s.t., normally closed, Wheelock Signals Inc. (C) Printed-circuit encapsulated MIL-type, s.p.s.t., manufactured by General Reed Co.

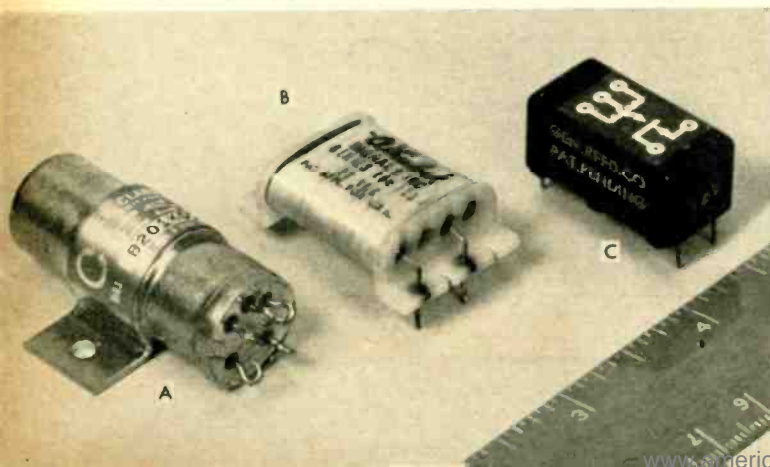

mainly from the hysteresis of the nickel-iron alloy. Once the working gap of the reed switch is closed, reluctance of the magnetic circuit is reduced and less magnetomotive force is required to maintain the flux needed to keep the reeds together. Contact resistance is on the order of 20-50 milliohms. Operating time is composed of field development time and reed motion time, and can be reduced by increasing the magnetomotive force, or electrical power, if a coil is used to activate the reeds. However, there is a minimum switching time for a given contact capsule, and any further increase in coil power generally results in an increase in contact bounce only.

To a great extent, the life expectancy of reed relays depends, among other factors, on the magnitude and type of the switching load. If used in so-called "dry circuits," i.e., with no or very low current loads (on the order of 10 ma. at less than 12 volts), billions of operations can be expected. Manufactur-

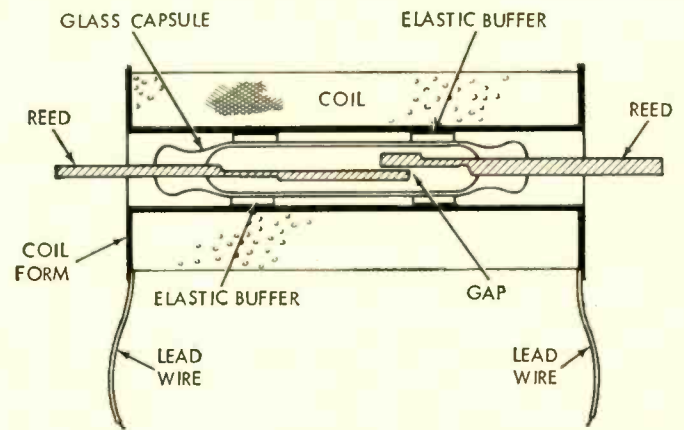

Fig. 6. Cross-sectional view of a typical magnetic reed relay.

ers' test reports show that a typical contact capsule can handle 20 million switching cycles of a 15-watt non-inductive load. Table 2 indicates the wide range of performance characteristics of contact capsules and reed relays. The photographs show typical reed relays and reed switch capsules.

If more than one contact is to be actuated by the same signal, the required number of contact capsules may be inserted in a common driving coil. In this manner, single-pole, single-throw and single-pole, double-throw capsules may be combined into one relay. Power requirements will increase accordingly because more area must be permeated by the magnetic flux. A minor problem is that, unless the capsules are specially matched, not all capsules will be actuated at exactly the same time. This particular characteristic is due to pull-in tolerances among individual reeds.

### Reed Relay as D. C. Chopper

Table 2 shows that most reed relays will operate within one millisecond and release even faster. Contact bounce is in the neighborhood of 10% of the actuating time. These properties indicate that reed relays may be used as inexpensive d.c. choppers.

Choppers have been around for a long time, the best known is the car radio vibrator, which was widely used before the advent of transistorized car radios. Precision choppers are used in commercial and military equipment, such as voltage comparators and test instruments, where the cost of the precision chopper is of secondary importance. The attractive feature of a chopper is that it converts a d.c. voltage which can be measured quite accurately by a good meter movement, into a rectangular waveform with corresponding peak voltage. The waveform can be handled by a a.c.-coupled amplifiers and also conveniently displayed on an oscilloscope.

The main advantage of an electromechanical chopper over a transistorized square-wave generator lies in the ease of calibration and the near constant voltage output which is almost independent of operating

(Continued on page 64)



# PARALLEL-RESISTOR NOMOGRAM

By MAX H. APPLEBAUM / Warwick Electronics Inc., Pacific Mercury Div.

Total resistance of two resistors in parallel is readily found with chart showing standard EIA resistor values.

**E**NGINEERS and technicians will find this a most valuable nomogram. It is unique insofar as standard EIA values of resistors are indicated on all scales.

Values of resistors larger or smaller than those shown on the scales can be mentally calculated by multiplying all scales by the same factor  $10^n$ , where  $n$  may be positive or negative.

*Example:* Find the correct value of the resistor necessary to

shunt a 560,000-ohm resistor to get a total of 390,000 ohms.

*Solution:* Place a straightedge across the three scales crossing 56 on the  $R_2$  scale and 39 on the  $R_T$  scale. The solution is the point where the straightedge crosses the  $R_1$  scale. In this case it crosses just below 130. The closest EIA value on the scale is 120. Multiplying all scales by 10 gives an answer of 1.2 megohms. ▲

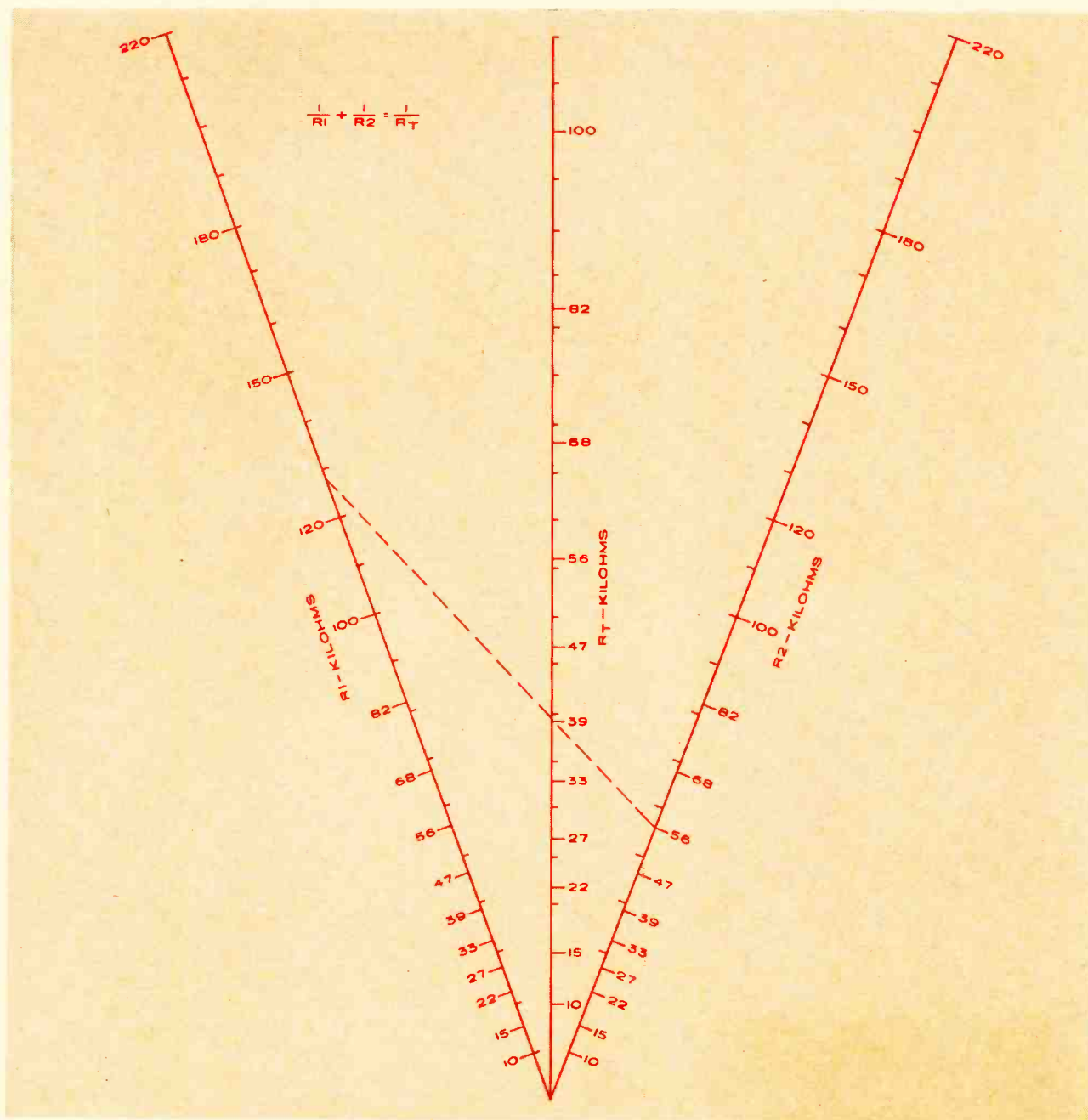

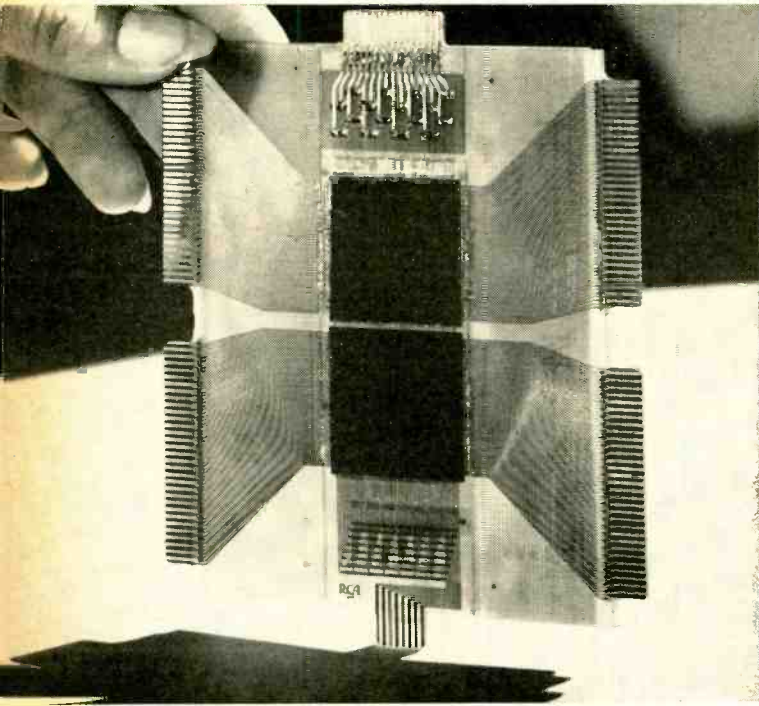

**Monolithic Ferrite Memory.** (Left) A high-speed memory unit, potentially one of the simplest and most economical approaches to producing complex memory systems, has been made available to computer manufacturers by RCA. The memory wafer is constructed by embedding groups of perpendicular word and bit conductors between very thin sheets of ferrite material to form closed-loop ferrite "cores" with integral windings. This laminated structure is sintered using suitable ferrite firing techniques to produce a solid monolithic ferrite wafer with 64 word and 64 bit windings. This new process eliminates the tedious task of individual ferrite core stringing and handwiring, prime cost factors in conventional memory systems. Each wafer contains, in effect, 4096 cores with 5-mil diameter, not much larger than a hair.

## RECENT DEVELOPMENTS in ELECTRONICS

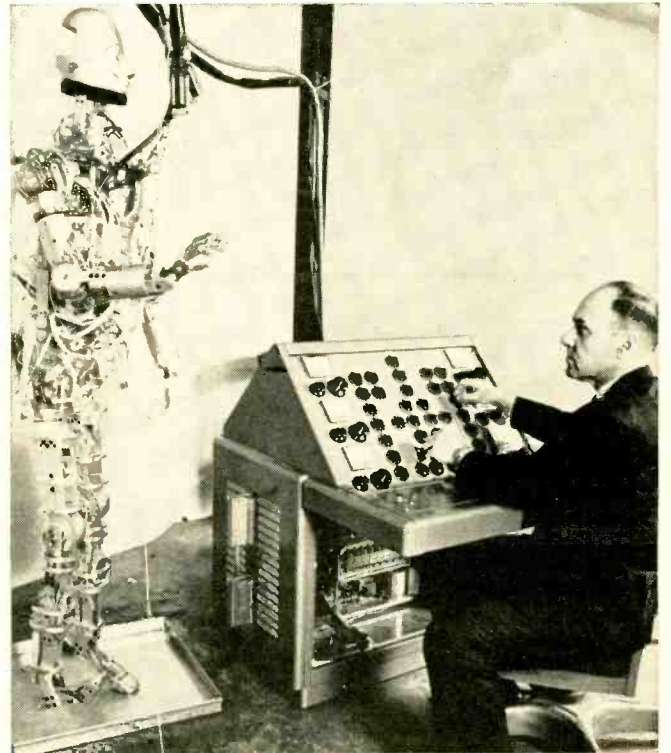

**Electronically Controlled Robot.** (Above) A six-foot-two 230-pound electronically controlled robot has been developed by IIT Research Institute for NASA as a mechanical model for space suits. Once fitted to a space suit, the dummy will give engineers exact measurements of the force it develops in order to overcome resistance to the occupant's movements offered by a pressurized space suit. The robot is shown without its aluminum-plate skin. The dummy is powered by hydraulic actuators at 35 joints, controlled by electrical servo valves directed from a remote panel. Sensors at each joint send back signals that indicate amount of force in each movement.



**Code Translator.** (Left) A new device that transforms the dots and dashes of Morse code into ordinary English is shown under field test by the Army. The translator allows those untrained in the code to read messages readily. The unit, built by Regency Electronics, is simply plugged into a radio set tuned to the station to be decoded. The letters are displayed by means of 17 tiny incandescent lamps in the panel of the cigarette-package-size device. Integrated circuits containing the equivalent of 350 diodes and 75 transistors are employed with 4 rechargeable nickel-cadmium batteries.



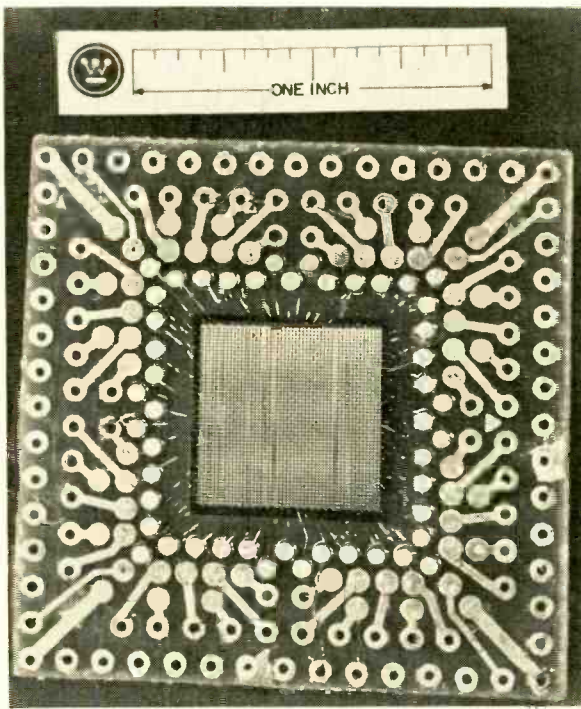

**Solid-State Camera "Tube".** (Above) A camera system that uses a solid-state imaging device instead of an electronic tube for light sensing and image conversion has been developed for NASA by Westinghouse. The imaging device is a mosaic made up of 2500 photo-transistors; it is ½-inch square with 50 light-sensitive semiconductor elements on a side. The image produced has a resolution of 100 lines per inch. The associated camera system uses integrated circuitry in order to perform the necessary functions to obtain video output.

**Shipboard Satellite Communications.** (Below) A small, 6-foot antenna now being sea tested aboard the USS Canberra and USS Midway gives the Navy the capability for instant ship-to-ship and ship-to-shore communications through high-altitude "stationary" satellites. The shipboard satellite communications sets, built by Hughes Aircraft Co., provide both voice and teletypewriter communications unaffected by atmospheric conditions. The engineer shown would be dwarfed by "normal" paraboloid.

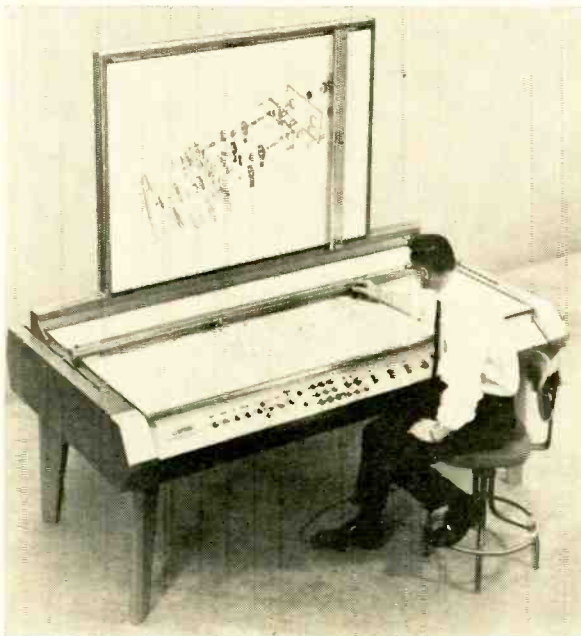
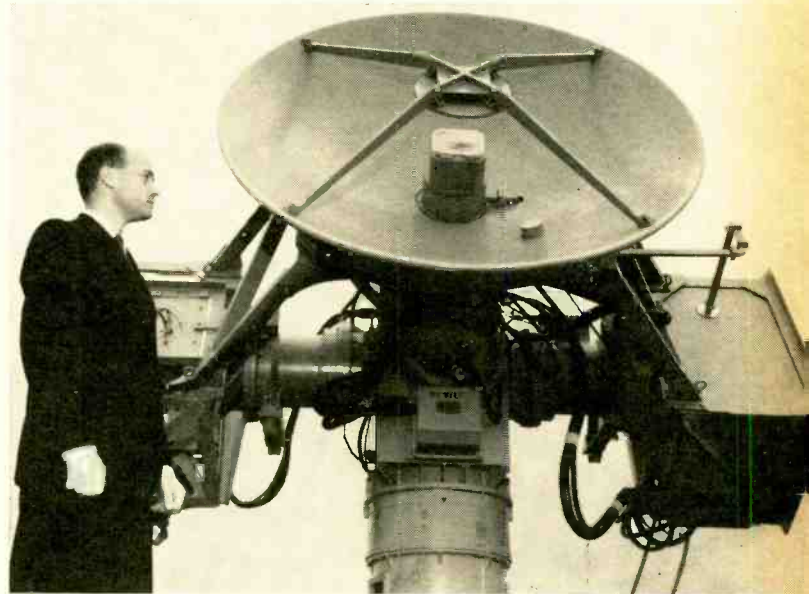

**Computer-Directed Drawing Machine.** (Above) The drawing machine shown here enables a draftsman to convert two-dimensional drawings into visually accurate perspective illustrations. Two styli on the horizontal plane trace blueprint views of the subject. Information is fed into the computer, which then guides an X-Y plotter pen on the vertical surface, creating a three-dimensional view. Tilt and rotation are determined by settings on a control panel on machine developed by Perspective, Inc.

**Integrated-Circuit Computer.** (Below) The new integrated-circuit card, right, is one-fourth the size and does the same work as the old discrete component circuit board that it replaces in the new line of Systems Engineering Labs computers. The integrated circuits used are all silicon monolithic types. The new line of computers are general-purpose types designed for real-time processing and control operations or for scientific and general off-line computation. The silicon monolithic circuit elements used are supplied by Fairchild Semiconductor.

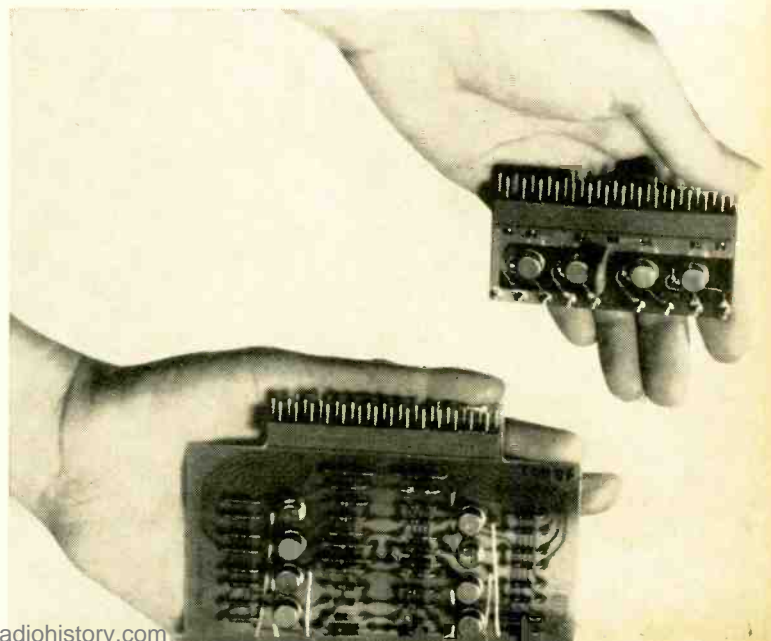







# TESTING SEMICONDUCTORS WITH V.O.M. or V.T.V.M.

By CARL DAVID TODD  
Electronics Consultant

*Some simple test circuits, coupled with the easy readout of a conventional v.o.m. or v.t.v.m., will enable testing of a wide variety of semiconductors.*

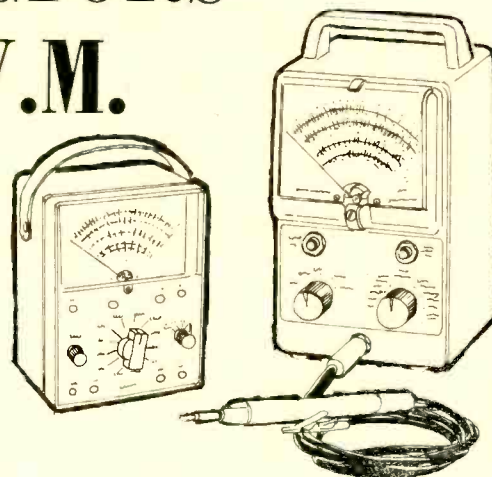

SEMICONDUCTOR devices are used in many different kinds of equipment today. Because the specialized test equipment needed for checking all critical parameters may not be available, this article will consider how either the common v.o.m. or v.t.v.m. may be used to measure many of the more important parameters of diodes, rectifiers, and SCR's, as well as junction and field-effect transistors.

Other simple test circuits requiring a minimum number of parts which may be quickly hooked up will be described, along with their features and limitations. These tests will not substitute for equipment needed for precise parameter measurements, but they can be useful even in the most elaborate laboratory because of their simplicity. In many instances, the results obtained by the simple approaches will be adequate even though only 10 or 20% accurate.

All two-terminal measurements will be illustrated by a diode, although they are generally applicable to equivalent diodes in transistors. Likewise, all transistor circuits will be illustrated by *p-n-p* transistors even though they are also ap-

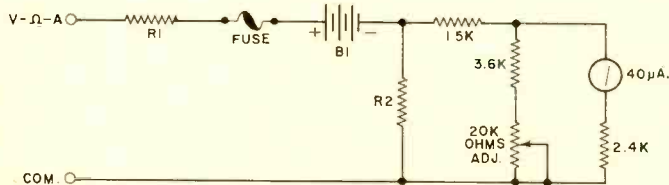

RANGE	R1 (Ω)	R2 (Ω)	B1 (V.)
R X 1	0	3.7	1.5
R X 10	3.16	40	1.5
R X 100	35	400	1.5
R X 1K	380	5K	1.5
R X 10K	40K	2.1K	31.5
R X 100K	415K	∞	31.5

Fig. 1. Ohmmeter portion of typical v.o.m. with range values.

Table 1. Characteristics of typical v.o.m., ohmmeter section.

Range	Battery (v.)	Effective Series R (Ω)	Maximum Current (ma.)	Maximum Power (mw.)
R X 1	1.5	≈ 4	350	130
R X 10	1.5	43	35	13
R X 100	1.5	427	3.5	1.3
R X 1K	1.5	4.29K	.35	.1
R X 10K	31.5	42K	.75	5.9
R X 100K	31.5	433K	73 µa.	.6

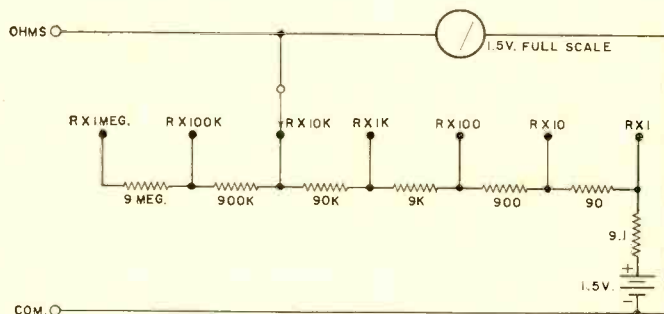

Fig. 2. Ohmmeter portion of typical v.t.v.m. showing range values.

Table 2. Characteristics of typical v.t.v.m. ohmmeter section.

Range*	Effective Series R (Ω)	Maximum Current	Maximum Power
R X 1	10	150 ma.	56 mw.
R X 10	100	15 ma.	6 mw.
R X 100	1K	1.5 ma.	.6 mw.
R X 1K	10K	150 µa.	56 µW.
R X 10K	100K	15 µa.	6 µW.
R X 100K	1 meg.	1.5 µa.	.6 µW.
R X 1 meg.	10 meg.	150 na.	60 nW.

\*1.5-volt battery used.

applicable to *n-p-n* types if the battery polarities are reversed.

## The Ohmmeter

The ohmmeter function of either the v.o.m. or the v.t.v.m. may be used to good advantage in the testing of semiconductor devices. However, before using it to perform special tests, we must know the actual circuit and component values.

Consider the simplified ohmmeter circuit for a typical v.o.m. as shown in Fig. 1 for the various ranges. The circuit seen from the external terminals is that of a resistance in series with either a 1.5-volt or 31.5-volt battery. The short-circuit (maximum) current is given in Table 1 for the various ranges.

The ohmmeter circuit function that is common to many of the v.t.v.m.'s used today is illustrated in Fig. 2. The basic circuit is of the shunt variety, as opposed to the series-type ohmmeter circuit generally found in v.o.m.'s. The characteristics of this arrangement are given in Table 2.

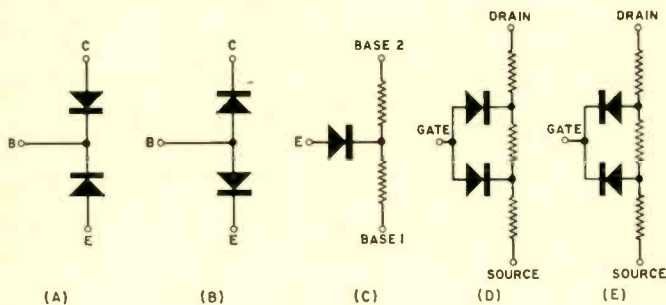

Fig. 3. Diode representation of various types of well-known semiconductors: (A) "p-n-p" transistor; (B) "n-p-n" transistor; (C) unijunction; (D) "n"-channel FET; (E) "p"-channel FET.

Note that the meter effectively indicates the voltage across the external terminals, with full-scale being approximately 1.5 volts, the value of the battery being used.

### Precautions

Before we look at some of the possible tests which may be made with the ohmmeter, it will be well to consider the potential dangers to the component being tested. Rather high currents are involved in conjunction with the lower resistance ranges which could exceed the maximum device current rating.

In all but the lowest range (for both the v.o.m. and v.t.v.m.), the maximum power delivered by the ohmmeter to any circuit connected across its terminals is very small, and in only rare circumstances could damage occur. The  $R \times 1$  range should be used only if it is known that the component will tolerate the current which may be delivered.

Keep in mind that the maximum currents listed in Tables 1 and 2 are for a complete short. The actual current flow will decrease linearly to zero for an open circuit. Although the v.o.m. circuit shown in Fig. 1 has an open-circuit terminal voltage of 31.5 volts for the two highest ranges, only the most fragile device can be damaged due to voltage overload. This is true because the maximum current is greatly limited by the internal series resistance of the ohmmeter.

### Polarity Checks

An ohmmeter can be used to identify the cathode and anode terminals of a diode or rectifier or to tell whether a transistor is *p-n-p* or *n-p-n*. To do this, it is necessary to know the polarity of the open-circuit voltage across the ohmmeter terminals. For the circuits of Figs. 1 and 2, the  $V-\Omega-A$  lead or "Ohms" lead will be positive with respect to the common lead. Other circuits might have the opposite polarity, and even two instruments with the same model number could have opposite polarities because of a slight circuit change. In addition, some ohmmeters actually change polarities when switching to the higher resistance ranges.

The ohmmeter can be tested to determine its polarity characteristics by using a diode which has the anode and cathode terminals positively identified (either by markings or by checking with a battery, load resistor, and current meter to determine which connections will permit the greatest current). The ohmmeter leads are placed across the known diode so as to get the lowest equivalent resistance reading. Under this condition, the lead going to the anode is positive with respect to the lead going to the cathode.

To check the polarity of an unknown diode, connect the ohmmeter leads across it in such a way as to obtain the lowest effective resistance reading. The positive lead of the ohmmeter will be connected to the anode. Actually, any ohmmeter range may be used, but usually the  $R \times 10$  range will provide the best reading without exceeding the current rating.

To determine whether a transistor is *p-n-p* or *n-p-n*, consider either the base and emitter or base and collector as a diode. If the emitter or collector checks out to be the "anode"

by the previously described test, then the transistor must be *p-n-p*. If the emitter or collector checks out as a "cathode," then the transistor must be an *n-p-n* type.

### Short-Open Tests

The ohmmeter may be used to determine whether a semiconductor device has been shorted or opened by performing the polarity test just described. A normal silicon diode or transistor will produce roughly a mid-scale deflection on the meter when the diode is forward-biased and a deflection corresponding to practically infinite resistance when reverse-biased. A germanium diode will have a lower resistance for both possible connections but will still provide a relatively high ratio of reverse to forward resistance readings.

Any reverse resistance reading which is much lower than that normally expected indicates a shorted diode or at least a very large leakage current. If neither connection produces a low resistance reading, then the diode or transistor is probably open.

We may test for shorts and opens for normal transistors, unijunction transistors, and field-effect transistors (FET's) by considering them as made up of diodes in the manner indicated in Fig. 3. The resistance obtained with the ohmmeter connected across the two bases of the unijunction transistor, or from source to drain of the FET, may vary considerably depending upon the parameters of the individual type under test. This test will not work for metal-oxide FET's.

### Leakage Current

Since the d.c. ohmmeter actually responds to the amount of current which flows through its terminals, it does not care whether this current is due to a resistor, a semiconductor device, or a combination of the two. The full-scale current is the maximum value indicated in the previous tables and is not an even figure. The equivalent current corresponding to a given indication of resistance may be found by dividing the battery voltage corresponding to the specific range as indicated in the tables by the sum of the indicated resistance and the effective series resistance as shown in the tables.

The voltage applied across the device under test may be quite low unless one of the higher ranges of the v.o.m. is used. For the lower resistance ranges of the v.o.m. and for all ranges of the v.t.v.m., the applied voltage will be less than 1.5 volts. But this will be high enough to get a general indication of leakage current for most devices, especially if the range is chosen to produce a reading on the higher portion of the resistance scale.

We may interpret the current value for the v.t.v.m. ohmmeter in another manner without using the resistance scale. The value of the unknown current is simply the difference between 1.5 volts and the meter reading, using the 1.5-volt scale divided by the resistance given in Table 2 for the particular range in use. The resistance is always an even multiple of 10 for the circuit shown in Fig. 2.

Note that the v.t.v.m. ohmmeter is capable of measuring very low leakage currents. A current of 15 nanoamperes

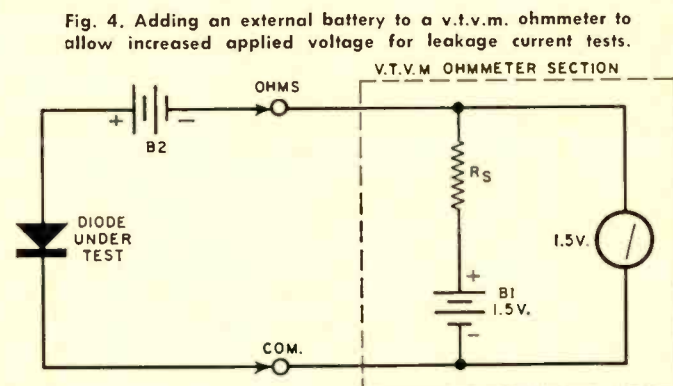

Fig. 4. Adding an external battery to a v.t.v.m. ohmmeter to allow increased applied voltage for leakage current tests.



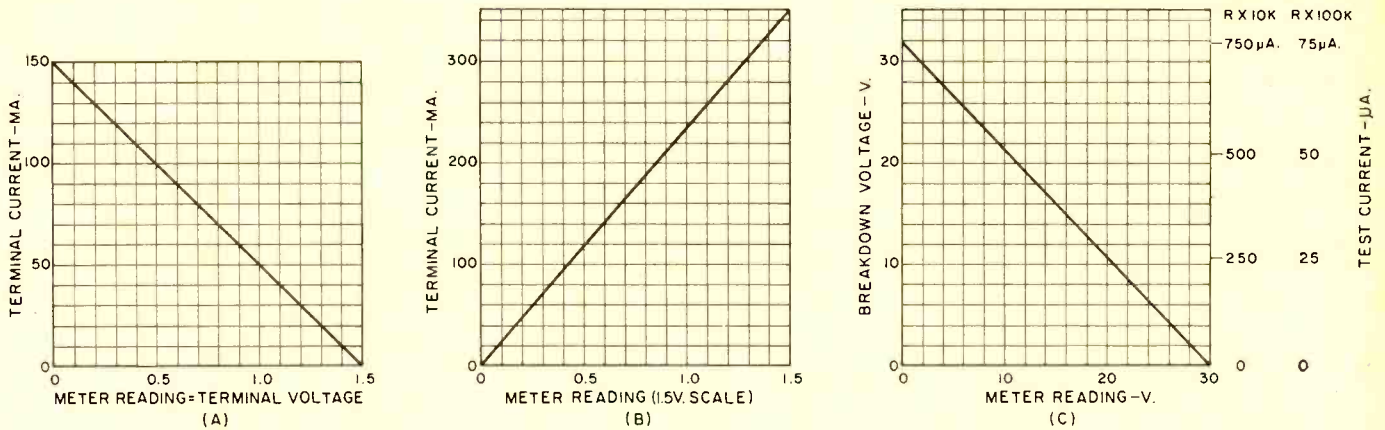

Fig. 5. (A) Terminal current as a function of meter scale for a v.t.v.m. ohmmeter,  $R \times 1$  (1.5-v. scale). (B) Terminal current as a function of meter scale for a v.o.m.  $R \times 1$  range. (C) Diode breakdown for v.o.m. ohmmeter  $R \times 1$  and  $R \times 100K$  scale.

(0.015  $\mu$ a.) will produce a reading corresponding to 1.35 volts on the 1.5-volt scale.

The voltage applied to the semiconductor under test may be increased by connecting a battery in series with the v.t.v.m. ohmmeter lead as shown in Fig. 4. This will not affect the calibration of the current range but will raise the test voltage by an amount equal to  $B2$ . This is not recommended for use with the  $R \times 1$  or  $R \times 10$  ranges because a momentary short could damage the internal resistors in the ohmmeter circuit. A short circuit or overload on one of the higher ranges will pin the meter but will cause no damage to the instrument unless the added voltage is excessive.

#### Forward Voltage Tests

The ohmmeter circuit provides a ready source of power and the capability for making measurements of the voltage drop across a forward-biased diode. Although we may not control the exact value of test current, we can set the order of magnitude by means of the ohmmeter range switch.

The actual test current as a function of meter reading is given in the graphs of Fig. 5A for the v.t.v.m. ohmmeter and Fig. 5B for the v.o.m. circuit. In each case, the 1.5-v.d.c. scale is used as a reference scale. This is especially convenient in the case of the v.t.v.m. The terminal voltage is then indicated directly on the meter with 1.5 volts representing the maximum value for an open circuit.

The graphs of Figs. 5A and 5B are for the  $R \times 1$  range but may also be used for  $R \times 10$ ,  $R \times 100$ , and  $R \times 1K$  ranges by dividing the current scale by 10, 100, and 1000 respectively. The v.t.v.m. ohmmeter may be carried further to the  $R \times 10K$ ,  $R \times 100K$ , and  $R \times 1$  meg. ranges having a full-scale current of 15  $\mu$ a., 1.5  $\mu$ a., and 150 na., respectively.

The terminal voltage for the v.o.m. ohmmeter is always equal to the difference between 1.5 volts and the relative meter reading (using only through the  $R \times 1K$  ranges with a 1.5-volt battery).

We may use this means of measuring the forward voltage drop to check for relative efficiency of a rectifier or detector and may match diodes by choosing two having the same (or very closely matched) ohmmeter scale readings.

#### Breakdown Voltage

The higher resistance ranges on the v.o.m. which use the

Fig. 6. A v.t.v.m. with a series of switchable external shunt resistors is used to measure a wide range of leakage currents.

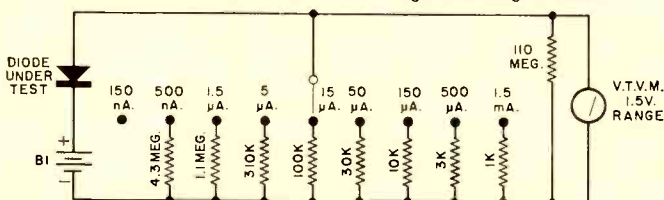

31.5-volt battery voltage may be employed to measure the breakdown voltages of diodes in the range of 0-30 volts. For a rough value of the breakdown voltage, we may use the 30-v.d.c. scale on the meter and say that the breakdown voltage is the difference between 30 volts and the meter reading. For a more exact reading as well as an indication of the actual test current for two ranges, use the graph of Fig. 5C.

This measurement is especially useful in checking the emitter-base breakdown voltage  $BV_{EBO}$  and in testing voltage regulator diodes.

#### Junction Transistor Measurements

Other simple tests which may be performed on transistors with the v.o.m. or v.t.v.m. in conjunction with very simple test circuits are discussed below.

**Leakage currents.** The ohmmeter section may be used for the measurement of leakage currents in diodes or transistors with very little external circuitry. In fact, if the internal voltage is sufficient, no external parts are needed at all. The current value is not direct-reading, however, and numerous measurements become tiresome.

The v.t.v.m. may be adapted to the measurements of rather small currents with the circuit of Fig. 6. A shunt is placed across the voltmeter terminals to provide the proper voltage corresponding to a given current range. A range-switch arrangement is shown with nine full-scale currents from 150 na. to 1.5 ma. but can be extended to higher currents.

External voltage supply  $B1$  provides the test voltage. If the value of  $B1$  used is less than about 50 volts, the meter cannot be damaged even if the diode under test is shorted. The v.t.v.m. is capable of rather substantial overload without being harmed.

If only one range is necessary, then simply wire in the 110-meg. resistor (to make the basic meter equivalent to 150 na. for 1.5-volts full-scale) in parallel with the appropriate shunt resistor.

If careful measurements are required, the shunt resistors should be precision carbon film. Normally, such accuracy is not needed, particularly since the value of the leakage current typically will vary about  $\pm 20\%$  for a room-temperature variation of only  $2^\circ\text{C}$ .

The v.o.m. may be used on its current ranges to measure leakage current, although the minimum readable current is not low enough to do any critical testing of silicon devices. In addition, severe overloads which could occur if the leakage current were higher than we thought or if the device suddenly failed under test should be avoided. A method of limiting current to a safe level is shown in Fig. 7A.

In this illustration, the transistor is operated in common-base and normally remains saturated with very little voltage dropped from collector to base. Should the leakage current for the device under test be greater than about 80  $\mu$ a., the transistor will come out of saturation, most of the test voltage

will now be dropped across the collector to base, and the current through the meter will be safely limited. The 2N1305 transistor may be used for test voltages up to about 20 volts. For larger test voltages, it will be necessary to use a higher voltage transistor.

While the current in Fig. 7A has been limited to 80  $\mu$ a., the limit value may be increased by changing the value of R1 to permit a loop current in the emitter-base circuit a little larger than the maximum test current. The maximum current should never be more than about five or ten times the meter range being used unless the v.o.m. is capable of withstanding greater overloads.

**D.c.-current gain and saturation voltage.** A very simple test circuit (Fig. 7B), consisting of a power supply and two resistors, may be used with the v.o.m. or v.t.v.m. to permit measurement of  $V_{CE(sat)}$  or  $h_{FE}$ .  $V_{CE(sat)}$  is normally measured under specified conditions of a fixed collector current,  $I_C$ , and a fixed base current,  $I_B$ . These are set by the values of resistors  $R_C$  and  $R_B$  in conjunction with the value of supply voltage  $B1$ . For a first approximation, the voltage drop across the transistor may be neglected if  $B1$  is made greater than about 25 volts. The relationships will then be those indicated on the drawing.

Once the current biases have been applied, the voltmeter is placed across the collector-emitter of the transistor to read  $V_{CE(sat)}$ . The value of the d.c. current gain,  $h_{FE}$ , is the ratio of  $I_C$  to  $I_B$ . Choose the value of  $R_C$  to provide the desired collector-current bias and then make the value of  $R_B$  equal to the  $h_{FE}$  limit times  $R_C$  (assuming that  $B1$  is much larger than  $V_{CE}$ ).

The collector voltage is measured with the meter, and if the reading is above that specified for the  $V_{CE}$  bias voltage, the value of  $h_{FE}$  is lower than the limit value. If, on the other hand,  $V_{CE}$  is less than the specified value, then  $h_{FE}$  is greater than the limit value. This makes a very good "go/no-go" type of test.

It might be wise to use a regulating (zener) diode with a breakdown voltage just above the test limit of  $V_{CE}$  across the transistor to prevent excessive power dissipation in transistors with an  $h_{FE}$  lower than the limit.

**Breakdown voltage.** Carefully performed, the breakdown-voltage measurement is a non-destructive test. Care must be taken, however, to limit the current or the component under test may be destroyed. More elaborate test equipment de-

signed to measure the breakdown voltage of diodes or transistors uses a current generator to set the bias condition in the breakdown region. For a very simple measurement, we may utilize the property of a semiconductor diode to have a relatively constant leakage current over the entire range of reverse voltage.

The test arrangement illustrated in Fig. 7C uses the reverse leakage current of a germanium rectifier as the current source to bias the diode under test within the breakdown region. The supply voltage  $B1$  should be considerably larger than the breakdown voltage being determined. Leakage current of  $D1$  should be about 100  $\mu$ a. and its own breakdown voltage much greater than  $B1$ . A v.t.v.m. with its high input resistance is then used to read the voltage drop across the diode or other device under test. The reading will be approximately equal to the breakdown voltage, although the bias current may not be just what is specified. Switch  $S1$  normally shorts the terminals of the device under test to protect the operator making the test, to prevent the v.t.v.m. from being driven off scale, and to minimize stray capacitances from being charged to an excessive level.

This method may be used only for components having a normal leakage current which is substantially less than that of  $D1$ . If a larger bias current must be provided, it becomes necessary to replace current-limiting diode  $D1$  with a relatively large resistor and current meter. Source  $B1$  may then be adjusted from zero (with  $S1$  open) until the proper current is read on the meter. The breakdown voltage is then read on the v.t.v.m. To prevent possible damage to the device under test, the limiting resistor should be made several times the anticipated breakdown voltage divided by the test current.

**Reach-through voltage.** Another parameter which limits the maximum applied voltage for alloy transistors is the reach-through (formerly called punch-through) voltage  $V_{RT}$ . This may be measured very easily by the circuit of Fig. 7D.

A variable voltage is applied between the collector and base and adjusted from zero until a 1-volt signal is read by the v.t.v.m. connected across the emitter and base. The value of  $V_{RT}$  is then one volt less than the value of  $V_{CC}$ . Resistor  $R1$  serves to limit the collector current should collector-base breakdown occur before breakthrough.

### FET Measurements

Gate leakage currents and (Continued on page 63)

Fig. 7. Typical test circuits. (A) Transistor limits current flow through device under test. (B) Test for  $V_{CE(sat)}$ ,  $V_{CE}$ , or  $h_{FE}$ . (C) Breakdown voltage measurements use reverse current of large-area germanium rectifier as current limiter. (D) Reach-through voltage measurement for alloy transistors. (E) Measuring pinch-off voltage of field-effect transistors. (F) Simple test configuration for measuring  $g_{fs}$  and  $I_{DSS}$  for field-effect transistors. (G) Measuring the gate current of an SCR.

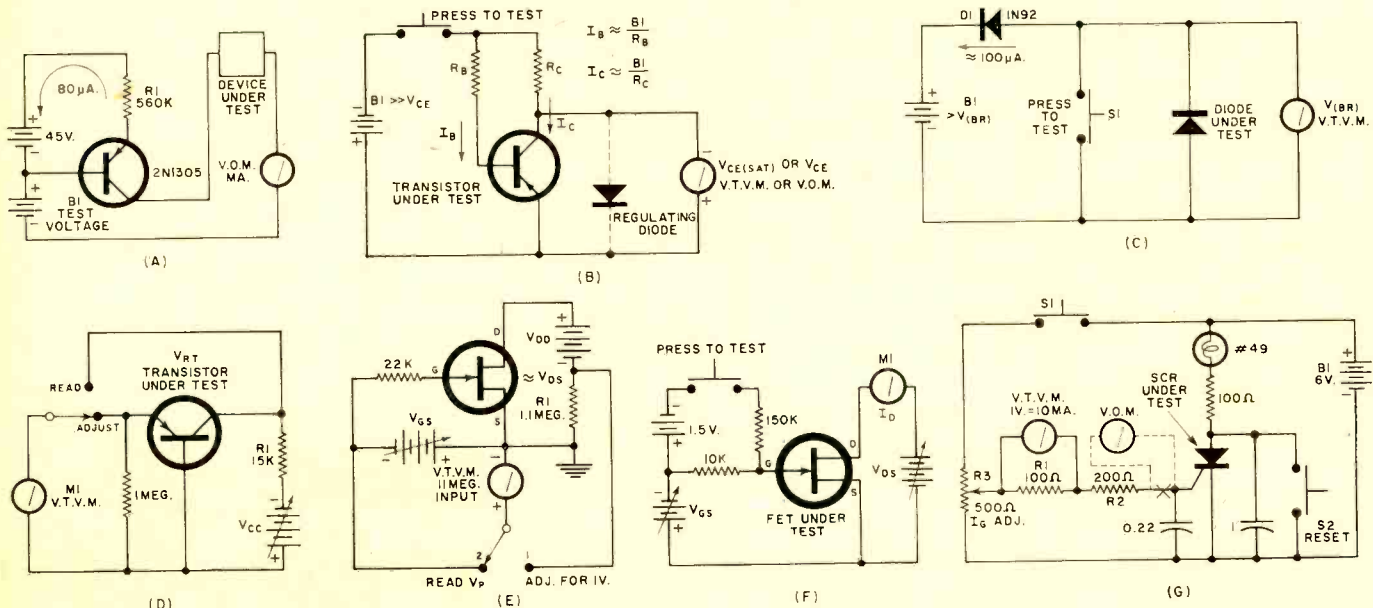



# IMPROVED SWITCHING OF INDUCTIVE LOADS

By JAMES P. REED

By protecting relay contacts and semiconductor drivers from h.f. transients produced by inductive loads, switching element life and reliability can be greatly increased.

**M**ANY modern electronic devices, especially computers and industrial control systems, contain complex relay circuits in which contacts and semiconductor drivers (transistors and SCR's) are used to switch such inductive loads as relay coils, solenoids, or motor windings. The life of the switching elements can be extended significantly by protecting them from the high-voltage inductive kickback produced when the loads are switched. Inductive kickback exhibits itself as a high-voltage spike created by the collapsing field in the inductor when the switching circuit is opened. This voltage is generally several times greater than the supply voltage.

Typical switching circuits (Fig. 1) need no protection for circuit closure since the inductive effect of the load causes the current to build up slowly when the switch is closed. As the current reaches its steady-state condition, energy is stored in the inductor in the form of a magnetic field. The amount of energy is equal to  $W = \frac{1}{2}LI^2$  where  $L$  is the inductance in henrys,  $I$  is the current in amperes, and  $W$  is the energy in joules. The greater the current flow or the larger the inductance, the greater the energy.

When the contact in the circuit shown in Fig. 1A is opened, the magnetic field in the relay coil collapses. The collapse of the field causes the lines of flux to move through the coil's winding. This, in turn, creates a high voltage across the terminals of the coil and a potential difference across the switching contacts. Arcing at the contacts will occur and will continue until the contact gap becomes too great to sustain the arc. Considerable heat is generated by the arc and contact burning results. The frequent burning at the switching contact will, in short order, destroy the contact. An additional detrimental effect of the arc is the severe r.f. noise generated.

Equally important is the suppression of high-voltage spikes when inductive loads are switched by semiconductors. Semiconductors are usually quite voltage-sensitive and will rapidly be destroyed by the high-voltage transient. While it may be possible to select a semiconductor switching device with adequate voltage ratings to withstand the kickback, it is generally more economical to choose a semiconductor within the power-supply ratings and provide suppression at the inductance to protect against the over-voltage condition.

## Resistor-Capacitor Suppression

A common technique for suppressing the high-voltage transient is the use of a capacitor and resistor in series across either the inductor or the switch (Fig. 2A). While the RC network (and other suppression devices) will be effective at either circuit location, placement at the inductor will be more economical since one suppressor could protect a number of controlling contacts. The RC method of suppression is adequate where switching currents are less than one ampere. In terms of clipping the high-voltage spike, the RC network is the least effective method that can be employed, and therefore it

should not be utilized to protect semiconductor drivers.

The values of  $R$  and  $C$  are best determined on an experimental basis, using an oscilloscope across the inductor while varying the component values. The value of  $R$  should be small;  $C$  should be large.  $R$  will probably fall within the range of 10 to 1000 ohms while  $C$  may have values from .01 to 1.0  $\mu$ f. The voltage rating of  $C$  must be greater than the expected high-voltage peak for maximum reliability.  $R$  serves to limit current through the switch to the capacitor if the network is placed at the inductor and to limit discharge current if the network is placed at the switch.

## Diode Suppression

When it is necessary to gain the maximum transient suppression, silicon or germanium diodes are used. The diode presents a very low impedance to the transient, thereby holding it to a very low value.

The diode is placed in the circuit (Fig. 2B) so that it is in a blocking condition for the supply voltage but will conduct during the period when the field is collapsing in the inductor. Care should be taken to select a diode with sufficient p.i.v. and  $I_f$  ratings to withstand the

(Continued on page 76)

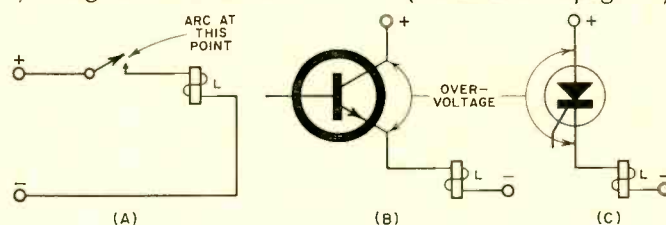
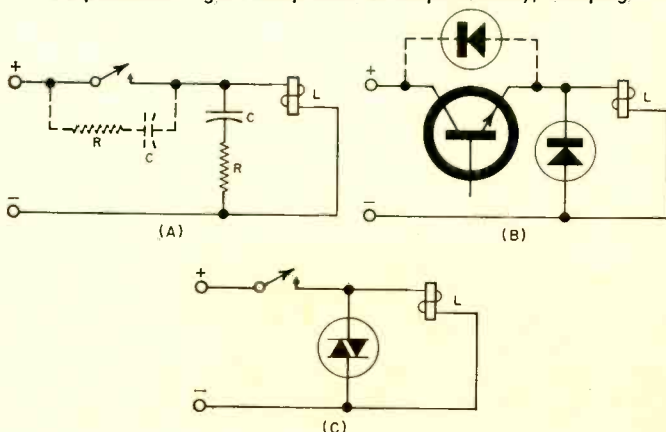

Fig. 1. Typical switching circuits involving inductive loads. Arcing occurs in (A) when contacts are opened. The semiconductor drivers in (B) and (C) are exposed to spikes when turned off.

Fig. 2. (A) RC networks may be used to protect mechanical switching devices with suppression at either load or contacts. (B) Semiconductors usually require diode protection to limit transients to safe levels. (C) Non-linear resistor protection is good compromise in drop-out delay, clamping.



A light source coupled to a photosensitive device in an opaque enclosure forms a 4-terminal network with a variety of useful electronic applications.

# THE OPTICAL LINK:

## A NEW CIRCUIT TOOL

By DONALD LANCASTER

**P**AIR a light source with a photosensitive device inside an opaque enclosure and you have an optical link, a new circuit tool that can perform many electronic functions impossible or extremely difficult by any other means. Optical links are now available commercially with frequency response from d.c. to 10 mc. and power control capabilities from a few milliwatts to 100 watts. Laboratory optical links are now working in the gigacycle region with extreme linearity and power densities.

What is so spectacular about a light bulb and a photocell? For one thing, a pair forms an ideal four-terminal network. The input and output are completely isolated. Any change of output termination is not reflected at the input. Output and input may be at quite different supply levels, to 20 kv. or more if necessary. There are two independent signal paths in cascade, an electrical one and an optical one. Any circuit function may be performed on either signal path with absolutely no interaction. The devices are entirely resistive and contain no transient-producing reactances. From d.c. to cut-off frequency the amplitude and phase response is perfectly flat. When used as a switch, there is no contact bounce, key clicks, or other transient—just a smooth transition from an “on” to an “off” state. The device can act as an amplifier, integrator, control, multiplier, or transformer. Optical links can be made self-indicating, acting as readouts or indicators.

Optical links have become practical due to the tremendous advances made recently in the available light sources and photoconductors. Several dozen firms now offer optical links commercially, ranging in price from a \$4.00 unit intended specifically for tone switching in electronic organs, through multi-pole relays and electronic choppers, to \$100.00, 10-mc. bandwidth units. A versatile link that exhibits a 2-watt control capability and a response time of a few milliseconds, can be built by any experimenter for around 85 cents.

### Available Light Sources

The characteristics of an optical link are determined by the light source, the geometry, and the photodetector. An obvious light source is the incandescent lamp. These are low in cost, readily available, and have a wide spectral output. The rise time is extremely poor, on the order of 100 msec., thus limiting incandescent links to d.c. and low-frequency audio applications. They are highly non-linear and subject to vibration and burnout. They are compatible with the voltages and currents common to transistorized circuitry.

A second low-cost source is the neon lamp. Above a threshold value, the light output vs power input is very linear. Response time is a few microseconds. A photodetector with a good orange response must be used since neon output is primarily limited to two orange spectral lines. The maximum available output is somewhat limited which, in turn, limits the control capability of the optical link. At least 60 volts of control voltage are required, but the input power is generally much less than required for incandescent sources.

Electroluminescent devices offer a uniform light output with millisecond response time, but they are highly fre-

quency-dependent and have a limited light output. They will not work at all with a d.c. input.

A new and quite promising light source is the injection diode, a class of semiconductor which produces light output in direct proportion to a forward bias current. A nanosecond rise time is combined with a wide dynamic range and good linearity. Light output is typically in the infrared region (9000 Å) requiring a detector with good infrared response. The light output is almost a point source (20 mils or so) and emission is in one direction only. A light pipe consisting of fiber optic bundles may be used to conduct virtually all the light produced to the photodetector end of the link. This can be quite important since some detectors have very small effective areas. These new devices are still rather expensive, costing from \$25 to \$100 in small quantities.

The gas or ruby laser offers an intriguing light source for laboratory optical links, providing coherent, monochromatic light at extreme power densities. Lasers can produce light power densities so powerful that dielectric breakdown of the air can occur if the normally collimated laser beam is focused to a point. Coherent light is much like a crystal-controlled r.f. source. A laser's output can be modulated with hundreds of gigacycles of signal bandwidth. The high cost of such devices generally precludes their use in all but lab devices at present, but this source holds great promise for the future.

### Types of Photodetectors

An optical link must have input and output matched. It would be rather foolish to drive a nanosecond photodetector with an incandescent lamp that has a frequency response of 20 cps at best. Similarly, a wide-area light source would lose most of its energy trying to drive a small photojunction device, unless all the output light is somehow gathered and focused into a useful position.

For low-frequency applications, the cadmium-sulfide and cadmium-selenide photoresistors are preferred. They are low in cost, have a large surface response area, and can control considerable power. They are bilateral, operating equally well from a.c. or d.c. input current. The resistance value is constant and independent of the applied voltage.

Fig. 1. Types of commercially available optical links.

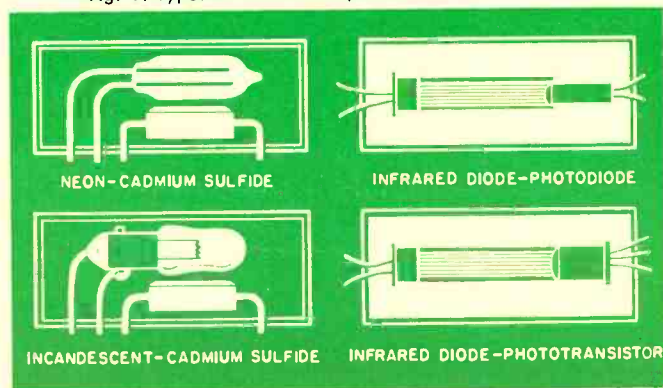





The Allen LR-1 is a fairly inexpensive incandescent optical link that is used for tone switching in electronic organs.

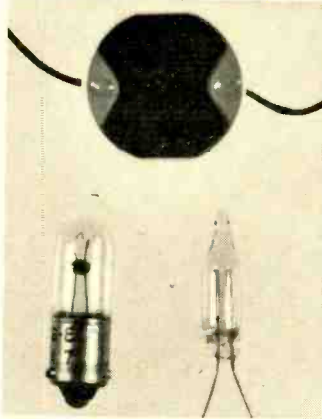

An experimenter's optical link costing under a dollar can be made from a Sigma 5HC1 photoresistor and either an NE-2H neon bulb or a type #47 pilot bulb. Link can control 2.4-watt load at up to 300 volts peak.



This compact Sigma unit serves as a d.p.s.t. relay that has millisecond response time.

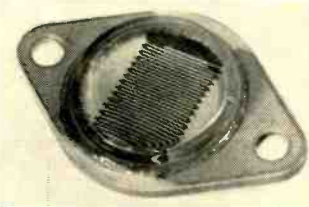

The Delco LDR-25 light-dependent resistor may be employed in an optical link to allow 100 watts of control power.

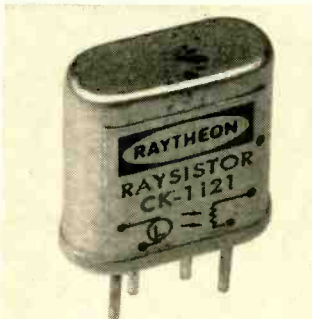

Raytheon has a line of general-purpose optical links that include both neon light and incandescent light sources.

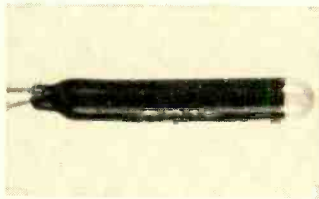

A silicon photodiode, such as this Texas Instruments Type H-60, may be utilized in an optical-link arrangement.

As specific examples, the *Sigma* 5HC1 is a 600-mw., 300-volt unit costing 75 cents singly. It has a rise time of 3 msec. and a fall time of 25 msec. A second unit is the *Delco* LDR-25, a 25-watt, 200-volt, \$1.50 device. The power-handling ability of any control resistor is equal to four times its dissipation when driven from a constant-voltage supply. These two photoresistors can control 2.4 and 100 watts respectively. The fastest available units of this type turn on in considerably less than a millisecond and turn off in 1 or 2 milliseconds.

Solar cells are detectors that offer a unique advantage. They produce an output voltage on their own, requiring no additional power supplies for the load. One-tenth microsecond rise time is combined with fairly low cost and good linearity. Their efficiency is very low and the output power available is, at best, a few milliwatts, limiting their present commercial use.

The photodiode is finding wide application in high-frequency linear optical links. These devices are reverse-biased *p-n* junctions that produce microampere-sized currents in linear proportion to the incident light. The frequency response of some units is good to the gigacycle region, with corresponding nanosecond rise times. Prices start at around \$4.00. A typical unit is the *Texas Instruments* Type H-60 which produces a maximum light current of 200  $\mu$ a. when biased between 10 and 50 volts. It responds to beyond a

megacycle and is quite small, measuring 70 mils in diameter by  $\frac{1}{2}$  inch long. For useful control output, the light current must be amplified by a transistor or two to a useful power level.

A phototransistor is a photodiode with a built-in gain of as much as several hundred. The best rise times are longer than a straight photodiode. They are somewhat more expensive.

The photo field-effect transistor is a brand new device with tremendous light sensitivity, good linearity, and fast response time. As yet, this device is too new and too expensive for widespread use, but it should become an important photodetector.

The method of specifying just how a photodetector will perform is a figure of merit called the *quantum efficiency*. This is simply a ratio of input photons to output electrons. If 1000 photons of incident light produce 1000 electrons, the quantum efficiency is 1.0. The cadmium-sulfide photoresistors have an efficiency of around 1,000,000. The photodiode and solar cell are very much poorer, having quantum efficiencies of 0.5. A phototransistor has an efficiency of 100 or so. The new photo field-effect transistor can exhibit quantum efficiencies of several *billion* under certain circumstances, making this device the most sensitive known.

Commercially available optical links take one of the two general forms shown in Fig. 1. The first form pairs an incandescent or neon bulb with a cadmium-sulfide photoresistor to provide a low-frequency, high-power control device. Prices start at \$4.00 each. Typical units are shown in the photos. Incandescent bulbs are used for "on-off" power control at very low frequencies, while the neon units serve well for more linear applications at higher frequencies. Although higher voltage (at least 60 volts) is normally required for the neon units, they draw considerably less power.

The second form pairs an injection diode with a *p-n* photodiode or phototransistor, giving a more expensive (\$100 to \$250) device that serves as isolator or linear amplifier up to 10 mc. The controlled power is considerably less than the low-frequency units.

Table 1 lists a few of the commercially available optical links and their manufacturers. The table is by no means complete, but at least one of each general type of optical link is listed as representative.

There are two present limitations to the widespread use

Table 1. Some commercially available optical links.

Manufacturer	Model	Type	Cost	Application
Allen Organ Co. Macungie, Penna.	LR-1	I/C	\$4	Tone switching in electronic organs; remote controls.
General Electric Co. 1 River Road Schenectady 5, N.Y.	PC-L	I/C N/C	\$8	General-purpose line of electrically variable resistors.
Hewlett-Packard Assoc. 620 Page Mill Road Palo Alto, Calif.	HPA-4301	D/P	\$145	10-mc. wide photon-coupled isolator.
Raytheon Industrial Comp. Div. 55 Chapel Street Newton 58, Mass.	CK1121 CK1124	I/C N/C	\$4 \$4	Full line of low-frequency optical links. Various packages.
Sigma Instruments Co. 70 Pearl Street South Braintree, Mass.	4L2N	N/C	\$5	D.p.s.t. relay. Four-pole models also available.
Texas Instruments Semiconductor Div. Box 5012 Dallas 22, Texas	PEX-3002	D/P	\$275	Electronic chopper. Cut-off frequency is 30 kc.

Light Sources: D—irradiated diode; I—incandescent; N—neon.  
Detectors: C—cadmium sulfide; P—"p-n" photodiode.

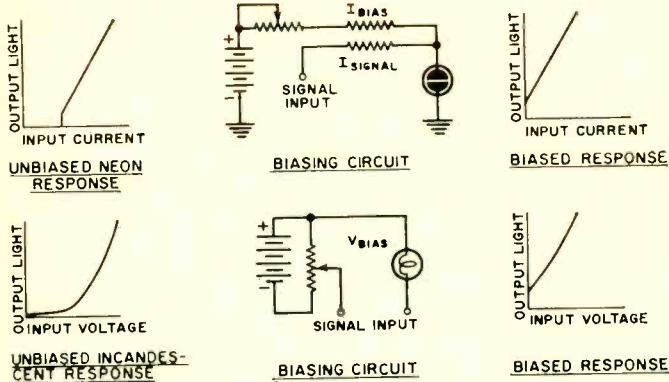

Fig. 2. Bias may be added to low-frequency optical-link light sources in order to improve their linearity and sensitivity.

of optical links. The first has been the unrealistic pricing of some of these devices to date, primarily due to low volume and lack of applications. Since it is now possible to build a low-frequency optical link for one-fifth the cost of equivalent commercial units, the commercial prices will certainly drop. The injection diode and the *p-n* photodiode are still new devices that have not as yet achieved the high-volume, low-cost status of many of today's semiconductors. The low-frequency optical links will be drastically reduced in price in the near future, while the higher performance devices will trend downward in price over the next five or six years. Both types should ultimately become low-cost volume devices.

A second problem is the poor linearity of the low-frequency optical links. A neon lamp is linear only after ionization; a threshold exists up to the ionization current. Incandescent lamps are highly non-linear, due to a change in efficiency of radiation as the filament temperature is changed. Bias may be used to advantage to linearize either light source, as shown in Fig. 2. In the neon units, a current bias is provided to keep the neon ionized at all times. The signal then adds to this ionization level, producing a linearized output. Voltage bias is used with the incandescent bulbs to keep the filament

moderately visible at all times. The input signal again adds to the brightness level, giving an output more in proportion to the drive signal. The price paid for biasing is a reduced change in resistance ratio at the output.

### Applications

There are many uses for optical links. Perhaps the simplest application is an isolated remote-control switch. The "off" resistance of a cadmium-sulfide cell is several megohms; the "on" resistance is between 10 and 100 ohms. In operation, the exciting lamp is turned "off" or "on" which then turns the output "off" or "on." This is most useful in electronic-organ tone switching where transients and key clicks must be eliminated. The isolation allows a low-voltage or low-current remote control totally independent of the controlled signal, useful for many other "off-on" applications. Fig. 3A.

There is no reason to limit one source to one detector, for either may be used in multiples. A multi-pole, single-throw noiseless relay results from a single neon or incandescent lamp driving two or more photoresistors in a single package (3B). Logic functions are a natural extension of this. For instance, any number of detectors may be placed in series. Unless all are illuminated, the output will remain in a high-resistance state, producing an *and* circuit (3C). An *or* circuit is obtained by exciting a single detector with multiple sources. Any source that is "on" will excite the output which, in turn, assumes an "on" or low-resistance state (3D).

Any logical decoding operation may be obtained by using a multiplicity of sources, masks, and detectors. A decimal-to-binary converter requires 9 lamps and 4 detectors. A "3" excites only lamp #3 which illuminates the  $2^0$  and  $2^1$  detectors, but not the  $2^2$  and  $2^3$  detectors, forming an 0011 binary output (3E).

If a square-wave input is fed into an optical link, the output will follow an "off-on-off-on" sequence, making an excellent chopper for low-drift d.c. amplifiers and other uses. A slowly varying d.c. input signal may be chopped up by the optical link, fed to a gain-stable a.c. amplifier, and then detected and filtered. The output is the input d.c. signal,

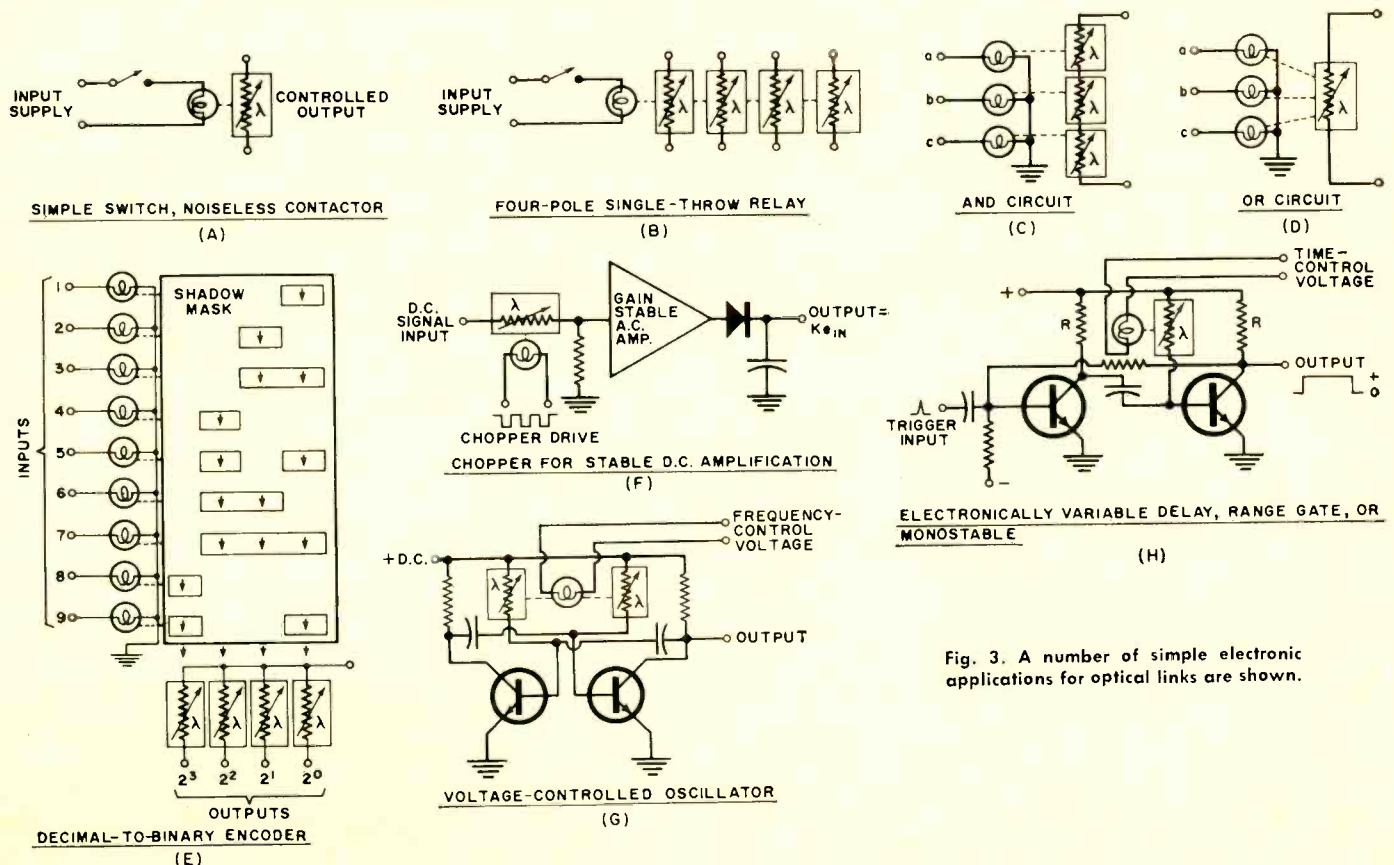

Fig. 3. A number of simple electronic applications for optical links are shown.



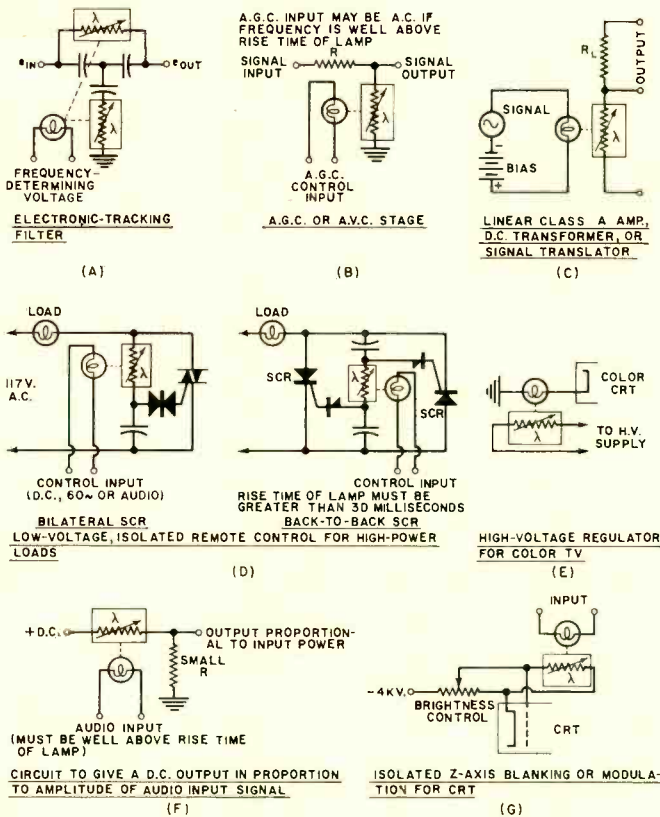

Fig. 4. Additional applications discussed in the text.

highly amplified and drift-free (3F). An optical-link chopper using cadmium-sulfide cells has no d.c. offset term, no switching noise, no transients, and is wear free. The chopping drive is isolated from the input signal.

The simplest linear mode of operation uses the optical link as an electrically variable resistor. One application is a voltage-controlled oscillator where the optical link forms an electrically variable multivibrator. Two optical links are used to replace the normal timing resistors in an astable multivibrator. Varying the control voltage varies the frequency of the multivibrator by changing the RC charging time (3G). If only one optical link were used, a symmetry-modulated rectangular-wave generator would result (3H). By replacing the resistors in a bridged-T filter, the rejection frequency may be varied, forming an electronic-tracking filter (Fig. 4A).

The purely resistive nature of the optical link makes it ideal for a.v.c. and a.g.c. systems. A control signal can alter the gain of an electronic system without affecting the bandwidth or bias of any signal stages. Total isolation of a.g.c. and system signals is maintained (4B).

The signal need not be d.c. With an incandescent link, the bulb cannot follow 60 cps and higher power variations and lights to an average value in proportion to the input power, thus setting an output resistance value that only follows the average value of the input and not the input itself (4F).

This same technique comes in handy in SCR dimmers and power controls. The normal timing resistor in the SCR control is replaced by an incandescent optical link, driven by a low-voltage, line-isolated 60-cycle or d.c. source (4D). An important application is in theater lighting where doorbell circuitry can provide long remote-control runs for high-power lights. Similarly, the bulb may be excited by an audio source to allow audio control of lights. This technique completely isolates the input audio from the a.c. line and the controlled output.

There are many circuits that take an audio signal, amplify it, emitter follow, filter, rectify, and then filter again to obtain a slowly varying d.c. output in proportion to the power pres-

ent in the input audio signal. Examples are in tone signalling, music analysis, voice controls, alarms, and commercial killers. A single optical link will replace all these parts. Input audio is used to excite the source. The output resistance variation will follow the input power level smoothly as long as the audio frequency is well beyond the response time of the source or detector.

Below its cut-off frequency, an optical link makes a linear amplifier that can exhibit substantial power gain. This permits signal translation between two systems with no interconnection except a beam of light. The optical link also serves as a wideband transformer having no reactance or resonances and a response from d.c. to its cut-off frequency (4C).

A number of specialized circuits are of interest. Two involve the use of an optical link to control a signal at a supply voltage several kilovolts different from the control signal. One of these is in a color-TV set. The CRT cathode current may be used to excite an optical link which serves as the high-voltage regulator, increasing the horizontal drive as the beam current goes up (4E). Oscilloscopes usually require expensive high-voltage capacitors to couple signals, blanking, and modulation to the grid and cathode. The time constants can prevent very low-frequency or d.c. Z-axis modulation. This is simple for an optical link. The link is put in parallel with the brightness control and is driven by the Z-axis input (4G).

The brightness variations of a light source occur at *twice* the frequency of the supply, since maximum power is delivered both on negative and positive signal peaks. This allows an optical link to be used as an untuned frequency doubler (Fig. 5A). Any number of stages may be cascaded

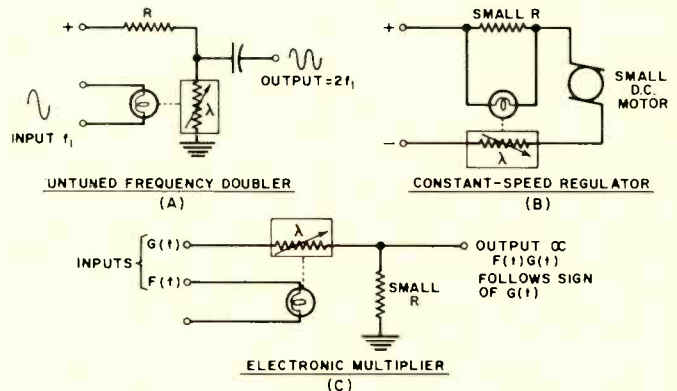

Fig. 5. Optical links as doublers, regulators, multipliers.

to provide frequency multiplication of 2, 4, 8, . . . The upper limit is determined by the cut-off frequency of the optical links used.

The power optical link can form an efficient regulator for small series d.c. motors, allowing constant-torque or constant-speed operation. Usually the back-e.m.f. of the motor is used to drive an optical link which, in turn, regulates the motor current (5B).

Cadmium-sulfide optical links have another interesting application which makes use of the fact that their output is a constant resistance independent of the polarity and magnitude of the signal across their terminals. If such a link is driven by a signal  $G(t)$ , the output will be the product  $F(t)G(t)$ . This is a two-quadrant multiplier that follows the sign of  $G(t)$  (Fig. 5C). Unlike most electronic multipliers, substantial output swings may be obtained at useful power levels. The maximum permissible frequency of  $F(t)$  is determined by the link response time, but  $G(t)$  may be any frequency. For instance, in an incandescent link  $F(t)$  would have to be less than 20 cps, but  $G(t)$  could be 10.7 mc.

As the prices drop and more use is made of this powerful new circuit tool, the optical link will emerge as an important, low-cost electronic control component. ▲

# UNDERSTANDING THE TRANSISTOR DATA SHEET

*More than a mere glossary of terms, this article discusses and explains the commonly used symbols and terms found on data sheets for specifying junction transistors, FET's, as well as for the junction, tunnel, and zener diodes.*

**M**ANUFACTURERS' data sheets are normally consulted when choosing a semiconductor device for a given application.

On top of the data sheet, alongside the identifying number, will be found a summary of the general characteristics of the device. The statement includes information as to device material, e.g., silicon or germanium; type: *n-p-n* or *p-n-p*; construction, e.g., planar; intended service: power, small signal, etc.; operating temperature range; and a few electrical characteristics such as current gain may be cited.

With information on the general capabilities of the device, the user can then examine the detailed specs. These will fall into two broad categories: absolute maximum ratings and electrical parameters. For each value specified it is essential that the corresponding test conditions be clearly stated on the data sheet in order to be of real value.

## Junction Transistor

The most commonly encountered specs for junction transistors will be considered first.

### Voltage:

$BV_{CBO}$  is the maximum d.c. reverse (breakdown) voltage that can be applied between collector and base with the emitter open-circuited.

$BV_{CEO}$  is the maximum d.c. reverse (breakdown) voltage that can be applied between collector and emitter with the base open-circuited.

$BV_{CES}$  is similar to  $BV_{CEO}$ , except that the emitter is connected to the base.

$BV_{CEX}$  is the collector-emitter breakdown voltage for a reverse-biased base-emitter junction under specified circuit conditions.

$V_{CE(sat)}$  is the collector saturation voltage when both the emitter-base and collector-base junctions are forward biased. This spec has significance for a transistor operated as a saturated switch.

$V_{RT}$  is the reach-through (or punch-through) voltage. At this voltage, depletion regions of the emitter-base and collector-base junctions touch each other

and breakdown occurs in the device.

### Current:

$I_{CBO}$ ,  $I_{CO}$  is the reverse d.c. saturation collector current with the emitter open-circuited.

$I_{CEO}$  is the reverse d.c. saturation collector current with the base open-circuited.

$I_{CES}$  is similar to  $I_{CEO}$  except the base is connected to the emitter.

$I_{CEX}$  is the d.c. collector current for a specified base emitter connection.

$I_{EBO}$ ,  $I_{EO}$  is the d.c. emitter current with the emitter-base junction reverse-biased and the collector open-circuited.

$I_{ECS}$  is similar to  $I_{EBO}$  except the collector is connected to the base.

### Power Dissipation:

Power dissipation is defined as the product of the average operating current and voltage. For class-A operation, the total power dissipation is equal to the product of the d.c. quiescent collector voltage and current (collector circuit dissipation) plus the product of the d.c. quiescent base voltage and current (base circuit dissipation). Generally, the base circuit dissipation can be neglected and the total taken as the collector dissipation,  $P_c$ . For class-A operation, maximum collector dissipation occurs when the amplifier is idling. Maximum dissipation for a class-B push-pull amplifier is slightly more than 20% of the power output.

Device dissipation ratings may be given for free air or case temperature. Case temperature usually infers that the device is mounted on an infinite heat sink. In addition, a derating curve (see Fig. 1A) may be included on the data sheet. This curve tells the user what the maximum allowable dissipation is for a given ambient temperature.

Power transistors normally have to be mounted on a heat sink to insure safe operation. To aid in calculating the required sink size for a given collector dissipation, a thermal equivalent circuit, as shown in Fig. 1B, may be used. The collector dissipation  $P_c$ , is represented by a current source while thermal loss is indicated by a thermal resistance,  $\theta$ . One

can write an equation for the thermal circuit which is analogous to Ohm's Law for an electric circuit:  $P_c = (T_j - T_a) / (\theta_{jc} + \theta_{cs} + \theta_{sa})$ .

For example, let the maximum junction temperature  $T_{j(max)} = 100^\circ\text{C}$ , the ambient temperature  $T_a = 25^\circ\text{C}$ , and  $P_c = 10$  watts. If  $\theta_{jc} = 0.2^\circ\text{C/w.}$ , and  $\theta_{cs} = 0.8^\circ\text{C/w.}$ , thermal resistance of the heat sink  $\theta_{sa}$ , cannot exceed:  $\theta_{sa} = (100 - 25) / 10 - 0.2 - 0.8 = 6.5^\circ\text{C/w.}$

A typical curve relating heat-sink size and  $\theta_{sa}$  is given in Fig. 2A. For the above example, a heat sink measuring 4" x 4" x 1/4" is required.

### Electrical Parameters:

For small-signal operation at low frequencies, the transistor may be repre-

CONFIGURATION	CB	CE	CC
Input resistance	$h_{ib}$	$h_{ie}$	$h_{ic}$
Forward current gain	$h_{fb}$	$h_{fe}$	$h_{fc}$
Reverse transfer voltage ratio	$h_{rb}$	$h_{re}$	$h_{rc}$
Output admittance	$h_{ob}$	$h_{oe}$	$h_{oc}$

Table 1. Summary of the *h*-parameters for three basic transistor circuits.

sented by the hybrid (*h*) model shown in Fig. 2B. When the output is short-circuited ( $v_2 = 0$ ), the short-circuit *h*-parameters are defined:

$h_i = v_1 / i_1$ : input resistance (ohms).

$h_r = i_2 / i_1$ : forward current gain (dimensionless). When the input is open-circuited ( $i_1 = 0$ ), the open-circuit parameters are defined.

$h_r = v_1 / v_2$ : reverse transfer voltage ratio (dimensionless).

$h_o = i_2 / v_2$ : output impedance (mhos).

A second subscript is added to the *h*-parameters to denote the transistor configuration being used. For example,  $h_{ie}$  is the input resistance for the transistor in the common-emitter (CE) configuration;  $h_{fe}$ , the forward-current gain in the CE connection and often referred to as *beta* ( $\beta$ );  $h_{fb}$ , forward current gain for the transistor in the common-base (CB) configuration, and is also called *alpha* ( $\alpha$ ); and  $h_{oc}$ , the output admittance of a transistor connected in the common-collector (CC) or emitter-follower mode. Table 1 summarizes the *h*-parameters.



$$\begin{aligned}
 h_{ib} &= r_e + r_b(1 - \alpha) & r_b &= h_{rb}/h_{ob} \\
 h_{fb} &= -\alpha & r_e &= h_{rb} - (1 - h_{rb})h_{rb}/h_{ob} \\
 h_{rb} &= r_b/r_e & r_e &= 1/h_{ob} \\
 h_{ob} &= 1/r_e
 \end{aligned}$$

**Table 2. Summary of h- and r-parameter relationships. (It is assumed that effective collector load is under 5000 ohms.)**

Another model for small-signal transistors operated at low frequencies is the r-T network of Figs. 3A and 3B. The parameters are defined as:

- $r_b$  = base resistance (ohms).
- $r_e$  = emitter resistance (ohms).
- $r_c$  = collector resistance (ohms).
- $\beta$  = forward current gain (dimensionless).

Some relations among the r-parameters are:

$$\begin{aligned}
 r_d &= r_c(1 - \alpha) \text{ (ohms).} \\
 r_m &= \alpha r_c \text{ (ohms).} \\
 \beta &= \alpha / (1 - \alpha).
 \end{aligned}$$

Table 2 provides equations relating the h- and r-parameters.

The small-signal parameters are determined with an a.c. signal (usually 1000 cps) applied to the transistor under test. If d.e. or static measurements are made, the subscripts used are capital letters. For example,  $h_{FE}$  = static (d.c.) forward current gain for the transistor in the common-emitter configuration.

With regard to high-frequency operation of junction transistors, there are a variety of models from which to choose.

One particular circuit, the hybrid-pi of Fig. 3C is perhaps the most often used model. The parameters are:

- $r_b$  = base-spreading resistance (ohms). This represents the bulk resistance in the base region of the transistor.
- $g_{b'e}$  = emitter conductance (mhos).
- $g_{b'c}$  = collector-base conductance (mhos). This quantity can usually be neglected when making calculations.
- $g_{ce}$  = collector-emitter conductance (mhos).
- $g_m$  = transconductance (mhos)
- $C_{b'e}$  = emitter-base diffusion capacitance (picofarads).
- $C_{cb'}$  = collector-base transition capacitance (picofarads).

**Frequency Response:**

The upper cut-off frequency denotes the frequency at which the transistor gain falls -3 db from its mid-frequency value (usually taken as 1000 cps). For the transistor in the CB mode, the symbol used for the cut-off frequency is  $f_{fb}$  or  $f_{\alpha}$ ; for the CE connection,  $f_{mc}$  or  $f_{\beta}$ .

Other parameters used are  $f_T$ , which is the frequency at which the CE current gain is unity (or 0 db). Parameter  $f_T$  is also referred to as the gain-bandwidth-product of the transistor. Generally,  $f_{\alpha} > f_T > f_{\beta}$ . Another frequently listed spec is the maximum frequency,  $f_{max}$  or  $f_{osc}$ , at which a transistor can oscillate.

**Switching Response:**

For a transistor operating as a switch, such as used in digital computers, the

turn-on and turn-off times of the transistor are significant quantities to consider. Fig. 4A shows a rectangular current input pulse to a CE-connected transistor. The output pulse, disregarding phase inversion of the transistor, would appear as shown in Fig. 4B. The delay-time parameters are defined as:

$t_d$  = delay time: The time required for the output current to reach 10% of its maximum value.

$t_r$  = rise time: The time required for the output current to rise from 10% to 90% of its maximum value.

$t_s$  = storage time: The time required for the output current to decrease from its maximum to 90% of maximum value when the transistor is turned off.

$t_f$  = fall time: The time required for the output current to fall from 90% to 10% of its maximum value.

Turn-on time =  $t_d + t_r$ ; turn-off time =  $t_s + t_f$ .

Occasionally, the manufacturer will include the charge-control parameters in specifying a switching transistor. These parameters are  $Q_T$ , the total control charge in the base, and constant  $S_T$ ,  $\tau_S$ , and  $\tau_F$ , which refer to rise, storage, and fall time constants, respectively. Using these parameters, the expected delay times just defined can be calculated.

**Field-Effect Transistor**

Some important d.c. ratings used to (Continued on page 74)

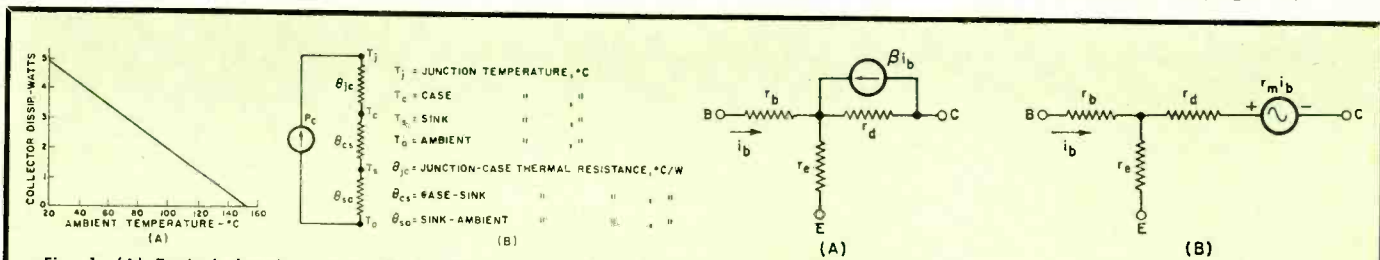

Fig. 1. (A) Typical derating curve. (B) Thermal equivalent circuit.

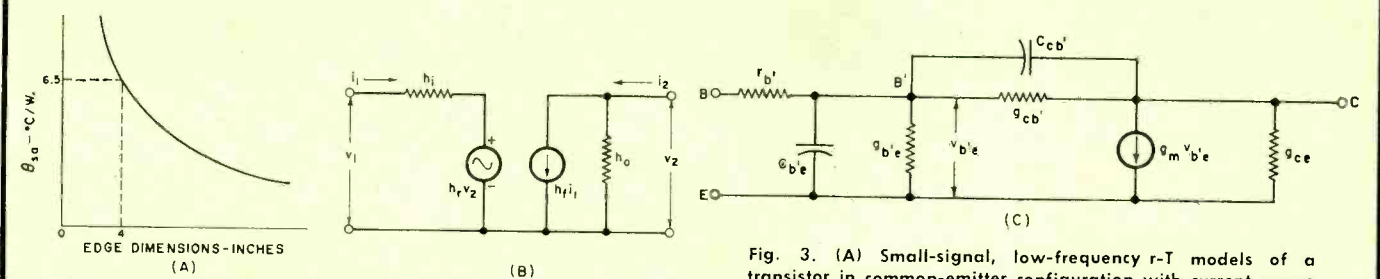

Fig. 2. (A) Thermal impedance curve of heat sink. (B) The small-signal, low-frequency hybrid model of a transistor. (C) Hybrid-pi model for a transistor that is operating in common-emitter circuit configuration.

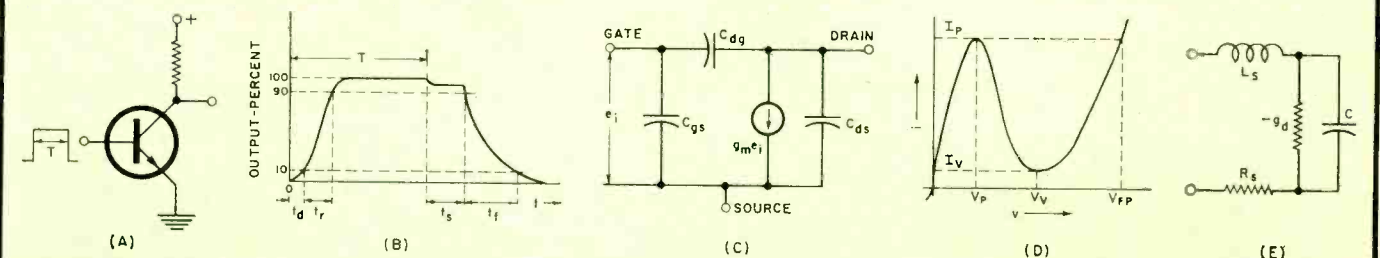

Fig. 3. (A) Rectangular switching waveform of length T applied to transistor. (B) Output waveform. (C) Simple model of a field-effect transistor. (D) Tunnel-diode voltage-current characteristics. (E) Tunnel-diode model.

A survey of circuits found in commercial test equipment for checking transistors and other semiconductor devices. Operation is analyzed and the order of accuracy of measurements to be expected indicated.

# TESTERS FOR SEMICONDUCTOR DEVICES

By A. H. SEIDMAN / Contributing Editor

**S**INCE transistors and other members of the growing semiconductor-device family are being specified for a wide variety of consumer as well as commercial and military products, sooner or later technicians and engineers are faced with the problem of selecting appropriate equipment for checking out these semiconductor devices.

The fact that there is a plethora of such test equipment doesn't help matters. How does one make a choice? What is available? What differences, if any, exist among the various testers? This article will attempt to answer these questions and, in addition, will analyze the basic and special circuitry found in a number of commercial testers. Measurement accuracy to be expected from different types of equipment will also be covered in the course of this article.

## What's Available

For purposes of identification, test equipment can be divided into the following categories:

1. *Direct reading*: This is the largest category and includes instruments which measure  $h$ -parameters, leakage current,

saturation voltage, and check the condition of semiconductor diodes. Many of the testers yield d.c. values of  $\alpha$  and  $\beta$ ; others provide an a.c. value of current gain. The d.c. and a.c. measurements of transistor gain are analogous to checking a vacuum tube with the emission and transconductance type tube testers, respectively.

2. *Bridges*: These are used to determine transistor parameters and capacitances at high frequencies with extremely good accuracy. Bridge measurements are usually confined to laboratory applications.

3. *In-circuit tester*: This equipment permits the determination of transistor gain and the condition of a diode while the semiconductor device is in the circuit.

4. *Switching-time test sets*: These instruments are designed for measuring various delay times, such as rise and storage times, of a transistor operated as a switch.

5. *Curve tracer*: This instrument enables the user to display the characteristics of a semiconductor device on its cathode-ray tube. Information such as breakdown voltage and  $h$ -parameters can be determined from the displayed curves with a fair degree of accuracy.

6. *Special testers*: This category includes equipment for checking SCR's, tunnel diodes, and for measuring thermal resistance.

7. *Automatic test equipment*: This equipment is used for determining pertinent semiconductor device parameters on a quantity basis. "Go/no-go" test procedures may be used. This equipment is normally found on the production line.

In this article, emphasis will be placed on direct-reading testers designed for laboratory and servicing applications. Curve tracers are covered in a separate article.

## Direct-Reading Test Sets

Direct-reading testers are widely used by technicians and engineers as general-purpose instruments. Equipment which bases its measurement of parameters on an a.c. signal will be considered first. For small-signal, low-frequency operation, the transistor is generally represented by the hybrid or  $h$ -model. The  $h$ -model for a transistor in the common-base configuration is shown in Fig. 1A. Parameters  $h_{ib}$  and  $h_{fb}$  are measured with the output shorted (i.e.,  $v_2 = 0$ ) to the a.c. signal. It must be remembered that the device is biased at a definite operating point which is specified on the data sheet. The shorted condition refers only to the a.c. signal and the d.c. bias circuit is unaffected. Short-circuit parameters ( $v_2 = 0$ ) are:

$h_{ib} = v_1/i_1$ : input resistance (ohms).

$h_{fb} = i_2/i_1$ : forward current gain (dimensionless). Parameter  $h_{fb}$  is also referred to as the  $\alpha$  ( $\alpha$ ) of the transistor.

The open-circuit parameters, determined with the input

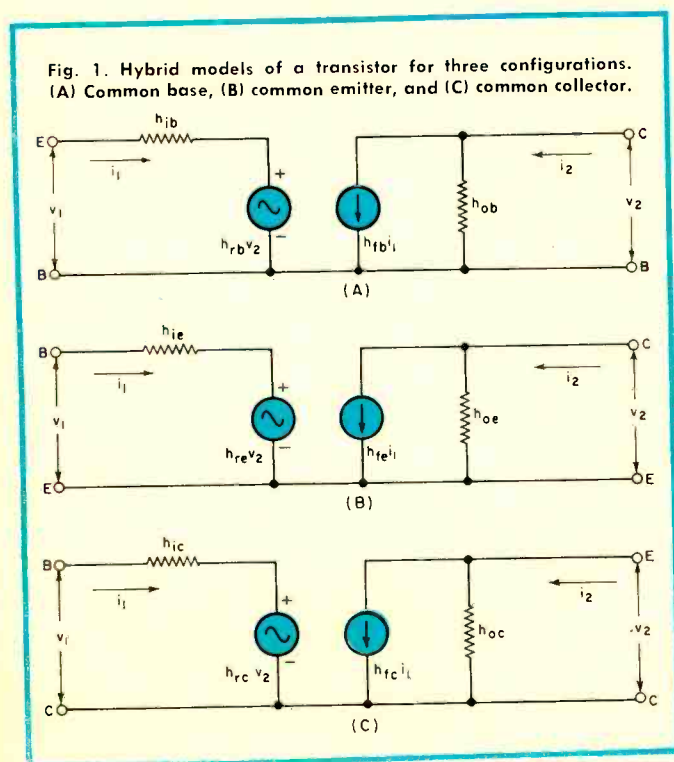



current of the circuit set to zero ( $i_1=0$ ) are as follows:  
 $h_{rb}=v_1/v_2$ : reverse transfer voltage ratio (dimensionless).  
 $h_{ob}=i_2/v_2$ : output admittance (mhos).

The  $h$ -model of Fig. 1A is also applicable to the transistor in the common-emitter (Fig. 1B) and common-collector (Fig. 1C) configurations. The second subscript indicates the mode of transistor operation. The definitions of the  $h$ -parameters just given also apply to the transistor in the common-emitter and common-collector configurations.

A transistor can be connected in one of three configurations for measuring its parameters. Because the common-base connection is the most stable, this configuration is usually used in making measurements. The  $h$ -parameters for the other two configurations can be readily derived from the common-base  $h$ -parameters.

An example of a circuit used for measuring  $h_{ib}$  is shown in Fig. 2A. Capacitor C2 is sufficiently large so that its reactance at the test frequency is very low and may therefore be considered as a short to a.c. This insures that  $v_2=0$ . Note that C2 does not affect the d.c. operating point of the device (X) under test. Inductance L provides a d.c. path for the emitter-base bias circuit and offers a high impedance to the signal source. C1 is a coupling capacitor.

Parameter  $h_{ib}$  is determined by measuring the voltage across the base-emitter circuit,  $v_1$ , and the current  $i_1 = v_b/R_B$ . The ratio  $v_1/i_1$  yields  $h_{ib}$ . In commercial equipment these and other calculations are usually handled by the instrument and the meter reads  $h$ -parameter values directly.

A circuit for measuring  $h_{ib}$  is shown in Fig. 2B. Capacitor C2 now serves to bypass the collector supply,  $E_{CC}$ . Current  $i_1$  is determined in the same manner as for measuring  $h_{ib}$ . Current  $i_2 = v_c/R_C$ , and the ratio  $i_2/i_1$  gives  $h_{ib}$ . Resistance  $R_C$  is made as small as possible to satisfy the condition that  $v_2=0$  and still permit  $v_c$  to be determined accurately.

Parameter  $h_{rb}$  is obtained with the basic circuit of Fig. 2C. Inductance L provides a high impedance to  $i_1$ , thus effectively opening the input and making  $i_1=0$ . To realize an even higher impedance at the input side, capacitor C may be shunted across L and the parallel combination resonated at the test frequency. A significant characteristic of a parallel-tuned circuit is to exhibit a very high impedance (infinite impedance for ideal L and C elements) at resonance. The

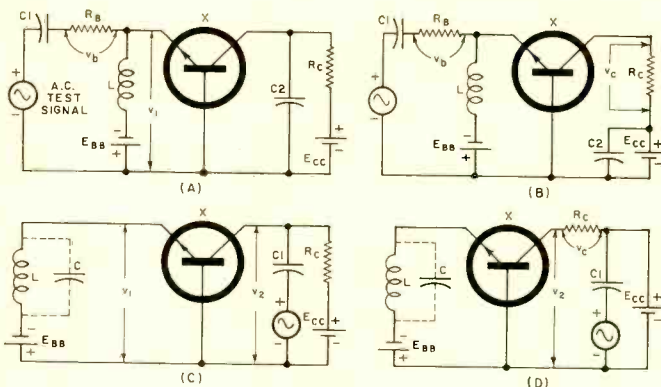
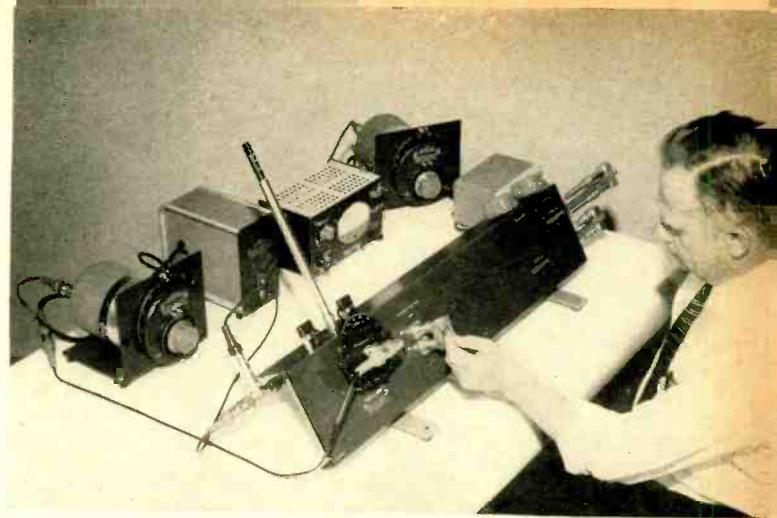
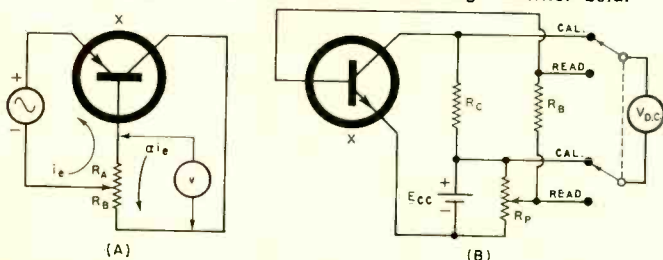

Fig. 2. Measuring the common-base  $h$ -parameters. The setup in (A) is for  $h_{ib}$ , in (B) for  $h_{ib}$ , in (C) for  $h_{rb}$ , in (D)  $h_{ob}$ .

Fig. 3. (A) Another a.c. method for measuring alpha or beta. (B) Example of a d.c. method for measuring transistor beta.



Engineer is shown measuring high-frequency parameters of transistor.

function of C1 is to isolate the signal from  $E_{CC}$ . The value of  $v_1/v_2$  gives parameter  $h_{rb}$ .

The circuit of Fig. 2D can be used to determine  $h_{ob}$ . Current  $i_2$  is measured across  $R_C$  and is equal to  $v_c/R_C$ . The ratio  $i_2/v_2$  yields the value of  $h_{ob}$ .

Measurements of the  $h$ -parameters are usually made at a frequency of 1000 cycles. However, the above procedures lend themselves to parameter measurements up to about 1 mc. and accuracy can be better than 3%. Some of the test sets manufactured by *Baird-Atomic*, for example, are based on the methods just outlined.

An interesting variation of the a.c. method for measuring  $h$ -parameters is found in a transistor test set made by *Boonton*

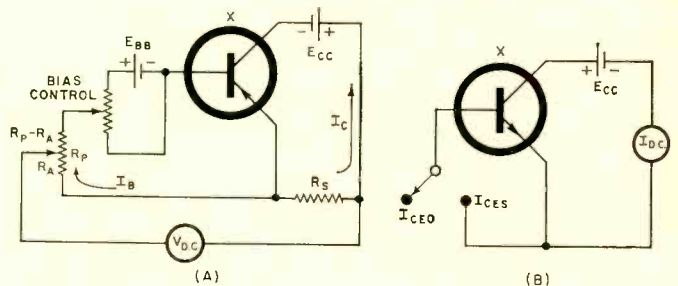

Fig. 4. (A) Using a linear pot for determining transistor current gain. (B) Method of finding the amount of  $I_{CBO}$  or  $I_{CES}$ .

*Radio*. Referring to Fig. 3A, resistance  $R_A + R_B = R_T$ , the resistance of a linear potentiometer. For simplicity, the d.c. bias sources are omitted from the diagram. When measuring  $\alpha$ , the pot is adjusted until the a.c. voltmeter reads zero (null is obtained). For this condition,  $i_b R_A = \alpha i_c (R_A + R_B)$  and  $\alpha = R_A/R_T$ .

The gain of a transistor in the common-emitter configuration,  $\beta$ , is  $\beta = \alpha / (1 - \alpha)$ . Consequently,

$$\beta = \frac{R_A/R_T}{1 - R_A/R_T} = R_A/R_B$$

Accuracies claimed are better than  $\pm 0.5\%$  for the determination of  $\alpha$ ,  $\pm 2\%$  for  $\beta$ .

Most direct-reading test sets provide only a d.c. value of  $\alpha$  or  $\beta$ . A circuit used in the test set offered by *Abbey Electronics Corp.* is presented in simplified form in Fig. 3B. With the switch in the "Calibrate" position, pot  $R_p$  is adjusted until the meter reads full-scale. When the "Read" position is selected, the meter indicates the d.c. voltage across base resistance,  $R_B$ , and the meter is calibrated to read  $\beta$  directly. A small base voltage indicates a high-gain device.

A d.c. method which uses a linear potentiometer (similar to the null method employed by *Boonton Radio*) is offered by *Heath*. A simplified diagram of the circuit is shown in Fig. 4A. Potentiometer  $R_p$  is a linear pot calibrated directly in  $\beta$  or  $\alpha$ . When the pot is adjusted for a null on the meter, the following condition is satisfied:  $R_A I_B = R_C I_C$  and  $\beta = I_C/I_B = R_A/R_C$ . Resistance  $R_A$  is that portion of the total pot's resistance  $R_p$ , across the meter.



The previously considered methods can also be used for finding the parameters for high-power transistors. One technique often employed, however, uses a pulse drive of variable duty cycle for determining d.c. parameters. This method allows measurements to be made at power levels greater than possible with normal d.c. methods without damage to the device.

Measurement of leakage current and saturation voltage are also possible with most direct-reading instruments. A simplified schematic of a circuit used in many test sets for measuring  $I_{CEO}$  and  $I_{CES}$  (the reverse collector-emitter saturation current with the base open or shorted to the emitter, respectively) is shown in Fig. 4B. The reverse current is read directly on the meter.

When both the emitter-base and collector-base junction become forward biased, the transistor is said to be in saturation. This mode of operation frequently occurs when the

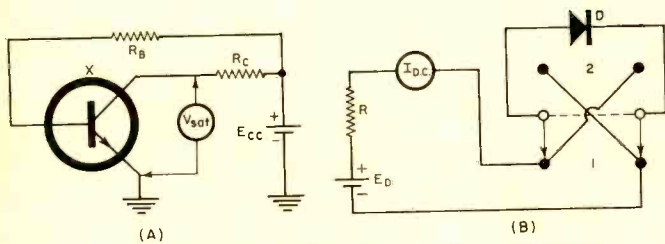

Fig. 5. (A) Measuring  $V_{sat}$  of a transistor. (B) Circuit used to measure forward and reverse currents of a diode.

transistor is used as a switch. An example of a circuit used for measuring the collector-emitter voltage of a saturated transistor,  $V_{sat}$ , is given in Fig. 5A. Values of  $R_B$  and  $R_C$  are such that the collector-base and emitter-base junctions are forward biased. The magnitude of  $V_{sat}$  is indicated directly on the meter.

Most simple diode testers (e.g., Heath, Knight, Eico, and Lafayette) determine the quality of a diode by comparing its ability to pass current in the forward and reverse directions. The basic concept is illustrated in Fig. 5B. Resistance  $R$  serves to limit the diode current to a safe value.

When the switch is in position 1, the diode under test,  $D$ , is forward biased and the meter reading is noted. Throwing the switch to position 2 reverse biases the diode and the meter reading is extremely low. The ratio of forward to reverse currents indicates the condition of the diode. Ratios of 10:1 or more (depending on the diode and the particular test set used) denote a good diode. Should the diode be shorted, high current will flow when the switch is in either position. An open diode prevents current flow and no meter deflection is obtained.

A direct-reading instrument made by Summers and Mills measures transistor and diode junction capacitances to a full-scale accuracy of 1% (when calibrated with an external standard). The unit employs a fixed- and variable-frequency oscillator. Before making a measurement, both oscillators are tuned to the same frequency. The unknown capacitance is introduced in the tank circuit of the variable oscillator causing its frequency of oscillation to decrease. The two oscillator frequencies are then mixed and the frequency difference (which is a function of the unknown capacitance) is recorded

by an analog frequency counter. The unknown capacitance is read directly on a meter in the instrument.

## Bridges

Admittance bridges can be used to measure transistor parameters, including junction capacitances, at frequencies from 1 mc. to 1500 mc. with an accuracy better than  $\pm 2\%$ . The Wayne Kerr Corp. and General Radio Co. are two manufacturers that offer bridges and special transistor adapters for high-frequency measurements.

A useful circuit for determining high-frequency transistor operation is the  $y$ -model of Fig. 6A. The parameters  $y_{11}$ ,  $y_{12}$ ,  $y_{21}$ , and  $y_{22}$  are short-circuit admittance parameters, that is, determined with  $v_2 = 0$ . From the  $y$ -parameters, one can obtain the  $h$ -parameters and values of device capacitances.

An example of a bridge circuit in simplified form, as used in the Wayne Kerr admittance bridge, is shown in Fig. 6B. When the bridge is balanced, the detector indicates a null and the standard admittance  $Y_S$  is equal to the unknown admittance  $Y_X$ . Suppose parameter  $y_{21}$  ( $y_{21} = i_2/v_1$  with  $v_2 = 0$ ) is to be determined. Referring to Fig. 6C, the condition that  $v_2 = 0$  is satisfied because at balance  $v_1 = v_S$ . Also,  $i_S = -i_2$  at balance and consequently  $y_{21} = i_2/v_1 = -i_S/v_S = -Y_S$ . The other parameters are found in a similar manner.

## In-Circuit Testers

An example of a circuit for measuring  $\beta$  which is used in an in-circuit tester made by American Electronics Labs is given in Fig. 7. The accuracy claimed for this instrument is

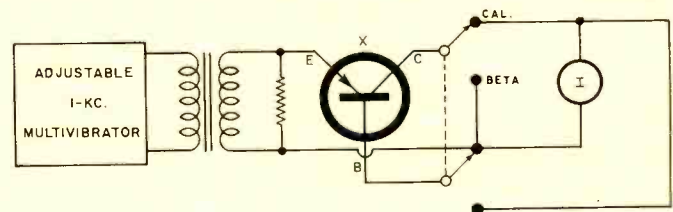

Fig. 7. An in-circuit tester for measuring  $\beta$  of transistor.

$\pm 5\%$ . With the switch in the "Calibrate" position, the 1-kc. multivibrator source is adjusted until the meter reads full-scale, which corresponds to 1 ma. The switch is then thrown to the "Beta" position (where the base current is measured) and the transistor a.c. gain is read directly on the meter.

During the negative half of the signal, the emitter-base junction becomes forward biased and collector current flows. The resulting current is directly proportional to the a.c.  $\beta$  of the device. The meter cannot be calibrated for a shorted collector-base, emitter-base, or collector-emitter junction and an open collector-base junction. An open emitter-base junction results in an infinite reading on the meter.

If a diode is inserted across terminals  $E$  and  $C$ , the diode under test behaves as a rectifier. For a good device, the 1-kc. signal is rectified and the meter reads a current. No meter deflection is obtained for an open diode.

Some testers perform an in-circuit check by using the transistor as part of a low-frequency oscillator. If the circuit oscillates, the transistor is considered to be good. This kind of testing method yields only

(Continued on page 72)

Fig. 6. (A) The  $y$ -model of a transistor. (B) Basic bridge circuit and (C) example of its use in determining  $y_{21}$ .

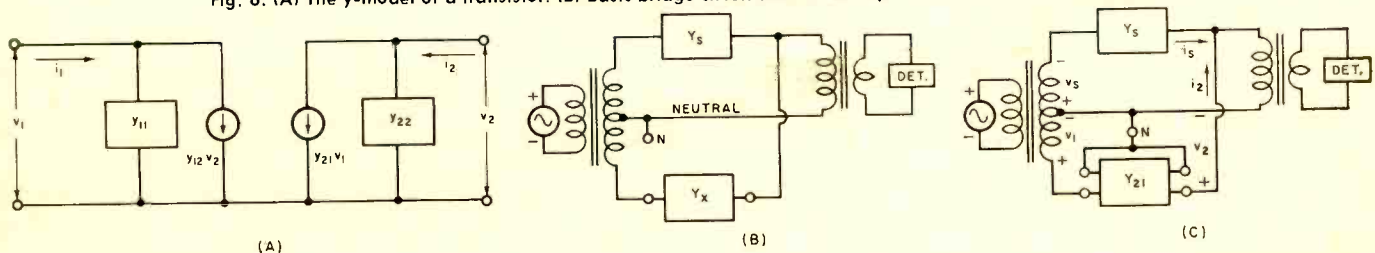



Injection laser operation explained; pumping power-supply circuits, and modulation and demodulation of laser beam are considered. Important applications are included.

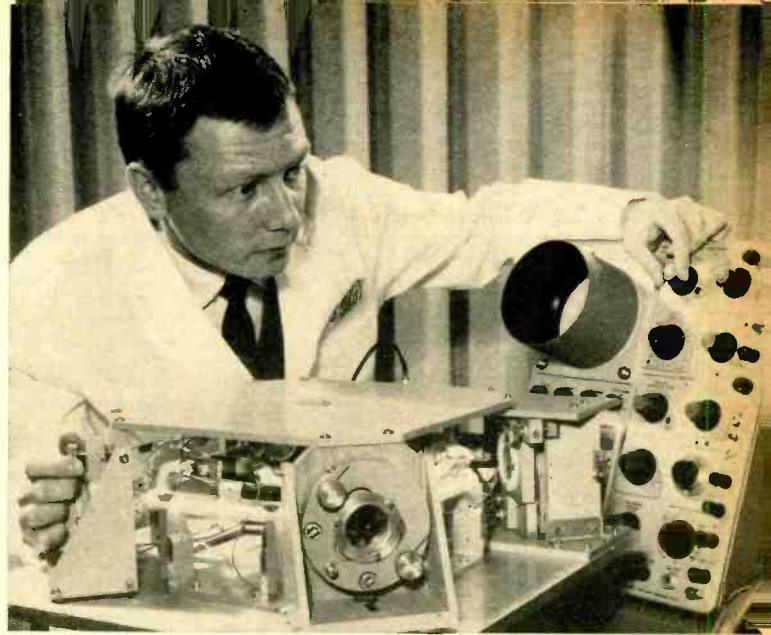

Miniaturized version of laser gyroscope. Two such gyros are being delivered to NASA for evaluation and precision tracking.

# LASER

By WARREN GRONER / Sr. Engineer, Electro-Optics Group, Sperry Gyroscope Co.

## practice and applications

**T**HIS article will consider some of the practical aspects and applications of the laser. Before we begin, however, a review of laser action is in order. For a complete discussion of the fundamentals of laser action, the reader is referred to the author's article "Lasers" in the August, 1965 issue.

The laser is an example of a quantum electronic device, that is, a description of its operation is based on modern quantum concepts of the atom. According to the quantum theory, the energies of a physical system, such as an atom, are described by a set of specified energy levels which are separated by forbidden regions—the energy gaps. The system can never have an energy corresponding to the energies in the gap.

Ordinarily, an atom or group of atoms will be found in the ground state or lowest energy level. For this situation, one can say that the population of the ground state is greater than the population of the other permitted levels. The system may be induced to make transitions or "jumps" between levels under the influence of external force. If, for example, the system is exposed to light or radio waves whose frequency is related to the energy gap by the expression  $hf = \Delta E_g$  (where  $h$  = Planck's constant,  $f$  = frequency, and  $\Delta E_g$  = gap energy), a high probability of jumping the energy gap exists.

It helps if light or radio waves are visualized as bundles of electromagnetic energy, called photons. The energy of each photon is given by  $hf$ . When the system is induced to make a jump from a lower to a higher energy level, one photon is lost from the radiation field and absorption occurs. When the transition is from a higher to a lower energy level, stimulated emission results and the field gains one photon.

If a jump occurs without the presence of a radiation field, it is called *spontaneous emission*. Of critical importance to laser operation is the fact that stimulated emissions are in phase with the field that causes them. This consistent phase relation is called *coherence*. The significant difference be-

tween laser light and that of other sources is that the laser output is coherent.

From this it is seen that for laser action to take place, one must make the stimulated emission process occur more often than the competing process of absorption. Quantum theory predicts that the relative likelihood of these two processes depends only on the relative population of the two levels involved. As mentioned earlier, the system is generally found in the lower energy level. To obtain laser emission, the upper level must be populated at the expense of the lower one. This situation is called *population inversion*. The method of obtaining it is called *pumping*.

Laser action is confined to materials, such as ruby and helium-neon gas mixtures, which exhibit an energy level scheme whose population can be readily inverted by pumping. In each case the upper energy level that takes part in the laser jump is *metastable*. This means that the system will decay slowly from this level. The metastable level is always necessary as a sort of energy storehouse for laser action. Once population inversion is achieved, the system is an amplifier for the frequency that satisfies the relation  $hf = \Delta E_g$ .

Enclosing the active medium in a special container with highly reflective walls, called a cavity, supplies sufficient feedback to the amplifier to cause oscillation. The shortness of the optical wavelength requires practical laser cavities to be many times larger than one wavelength. Generally they are longer in one dimension than the others. The modes along the long dimension (axial modes) are favored and the light which escapes through the cavity ends is highly directional. In contrast to ordinary light sources, laser output is typified by its extremely high radiative density (watts/cm.<sup>2</sup>), its monochromaticity (time coherence), its space coherence, and its directionality.

Population inversion has been obtained in media such as ruby and other doped solids by optical pumping (from a high-intensity light source). In addition, gaseous mixtures, par-

Laser Material	Type	Means of Excitation	Emission Wavelengths	Operation Mode	Efficiency or Gain	Typical Output Power
Ruby	Solid	Optical Pumping	6943 Å	Pulsed	.2%	1→10 megawatt
Helium-Neon	Gas	Electrical Discharge	6328 Å 1.15 μ 3.39 μ	C.W.	.05 .1 5 } %/m.	10→100 mw.
Helium-Xenon	Gas	Electrical Discharge	3.5 μ 2.026 μ	C.W.	1%/m. 15%/m.	100 mw.
Xenon	Gas	Electrical Discharge	3.5 μ	C.W.	5%/m.	10 mw.
Cesium-Helium	Gas	Optical Pumping	7.18 μ	C.W.	1%/m.	1→10 mw.
Argon	Gas	Electrical Discharge	4880 Å	C.W.	15%/m.	1→10 watt
Neodymium in Glass	Solid	Optical Pumping	1.06 μ	Pulsed	.2%	100 kw.
Neodymium in Calcium Tungstate	Solid	Optical Pumping	1.06 μ	C.W.	.05%	1 watt
Gallium Arsenide	Diode	Injection Current	8450 Å	C.W., Pulsed	10→30%	.1→1 watt

Table 1. Summary of important properties of common lasers.

ticularly a mixture of helium and neon, have been made light amplifiers in a glow discharge (produced by an r.f. source) by electron collision pumping. Table 1 is a summary of current laser types.

To complete the picture, account must be taken of the emission of coherent light from the neighborhood of the junction in certain semiconductor diodes. Consequently, a brief description of the diode or injection laser will precede the discussion of some important laser applications.

### The Injection Laser

Laser action is observed when large forward currents are applied to special gallium arsenide diodes maintained at very low (cryogenic) temperatures. Onset of lasing occurs at a definite current threshold, indicating that a population inversion is involved. These observations confirm the existence of a new type of laser, the *injection laser*.

Fig. 1 shows the experimental setup accompanying these observations. Pulses of high current density are put through the diode while it is immersed in liquid nitrogen. The light which emerges from the plane of the junction is usually in the near infrared and may only be viewed indirectly through an infrared image converter ("snooperscope"). Alternately,

Fig. 1. Experimental setup for observing injection laser.

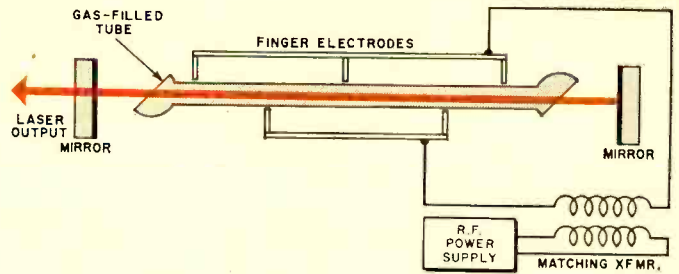
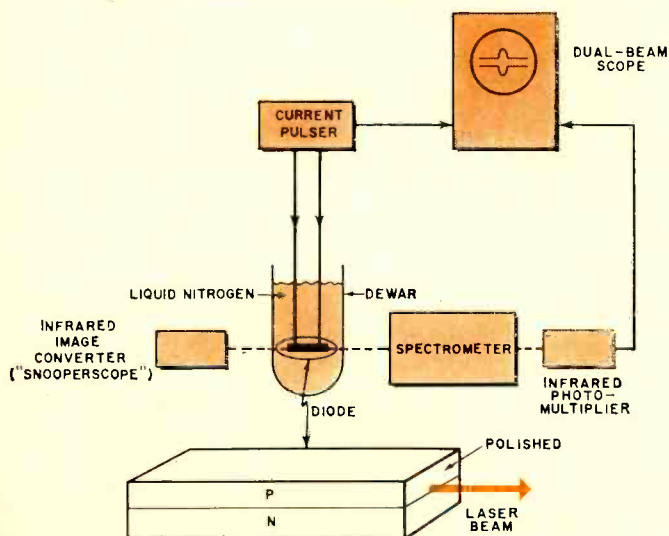

Fig. 2. Method of r.f. pumping a gaseous laser is shown.

by passing the light through a spectrometer (an optical frequency analyzer), the spectrum of the emitter radiation may be determined. This spectrum shows a marked peaking coincident with the onset of laser action. To understand the operation of the injection laser, it is necessary to take note of the close analogy between the band structure diagram, familiar to those who work with semiconductors, and the energy level diagram which describes the behavior of atoms.

Of particular interest is that recombination of an electron-hole pair at a semiconductor junction is frequently accompanied by the emission of a photon. The photon's energy may be expressed as  $E = hf = \Delta E_G$ , where  $\Delta E_G$  is the energy band gap. The energy gap is the difference in energy between the lowest level of the conduction band and the highest level in the valence band.

At normal temperatures, recombination of carriers (conduction electrons and holes) may occur without any radiation. These radiationless recombinations occur at sites where the periodic crystal structure is disturbed by the presence of impurities and defects in the crystal. Such sites are called traps. The lifetime of an electron in the conduction band is strongly limited by the traps. For this reason, the conduction band is generally unsuitable as the metastable state, which is so crucial in obtaining population inversion.

When the temperature of the diode is lowered, the effectiveness of the traps is reduced and lifetimes are considerably extended. In certain semiconductors at extremely low temperatures, the radiative process dominates recombination. Under this condition the situation is analogous to the laser transition levels in the ruby crystal. In order to pump the system it is necessary to create a region in which conduction electrons and holes abound. The most elementary considerations show that this state of affairs exists in the immediate neighborhood of the junction when a forward bias is applied. Consequently, at extremely low temperatures and sufficiently strong forward bias, the region of the junction should be an amplifier for radiation satisfying  $hf = \Delta E_G$ . By cleaving and polishing the diode into a rectangle with faces perpendicular to the plane of the junction, a resonant cavity is formed and oscillation may be observed.

In comparison with other lasers, over-all efficiency of the diode laser is 10%-30%, much higher than for any other type of laser. However, the junction region is necessarily quite small, and the total power which may be radiated is limited. Because the conduction and valence bands are considerably broader than the discrete atomic energy levels, the emission contains a comparatively broad band of frequencies. These two facts tend to offset the obvious advantages gained in the ability to pump the diode laser directly with electrical energy, and being able to modulate the output at high frequencies (about 1000 mc.) by modulating the pumping current.

### Pumping the Laser

Operation of a gas laser (pumped by electron collision) requires a means of creating an electrical discharge in a tube containing low pressure gas. This is done by either one of two methods, r.f. or d.c. pumping. In the r.f. case, an r.f. generator, capable of supplying 50 to 100 watts of power is used. This supply is coupled to an electrode or electrodes spaced



around the outside of the gas-filled tube. Coupling is provided by a matching coil specially designed for maximum power transfer to the electrodes (see Fig. 2). For an approximately 1-mw. output laser (typical helium-neon operation), pumping power levels run from 20 to 50 watts at about 30 megacycles.

Alternatively, the discharge may be maintained by supplying a sufficiently high d.c. field between electrodes contained in the laser tube. Heating the cathode with a filament supplies electrons for the collision process (operation is similar to a gassy vacuum tube). The necessary potential depends on the separation between the electrodes and the tube diameter. A potential drop of 4 kilovolts is typical in a laser tube 4 mm. in diameter and 1 meter long.

Pumping a solid laser rod, such as ruby, is accomplished optically. In order to obtain sufficient light power for inversion, it is usually necessary to fire a high-power xenon-filled flash tube. The flash tube is optically coupled by mirror geometry to the laser rod. Operation of the flash tube is similar to that of a thyratron. A high-voltage trigger breaks down the gas (xenon) between two electrodes which have been maintained at different potentials. Upon breakdown, the lamp resistance drops to a low value (1 ohm) and high peak currents flow.

The magnitude and duration of these currents depend upon the capacity and voltage of the supply, that is, the peak current is  $I_p = V/R$  and the duration is equal to  $RC$  where  $V$  is the supply voltage,  $C$  the capacitance, and  $R$  the resistance of the flash tube. Flash tubes are generally rated in maximum watt-seconds (or joules) per current pulse. Typically, these values are quite high (250 watt-seconds are necessary for a small ruby laser and up to 12,000 may be needed for a large ruby laser). Considerable energy must therefore be stored in large capacitor banks before discharge. The large values of stored energy at high voltages make safety an important consideration in handling the power supplies for even small ruby lasers. Fig. 3 shows a typical power-supply schematic for a small ruby laser.

Operation of the injection laser on a pulsed basis (typical usage) is similar in many respects to firing a flash lamp. High peak currents ( $\approx 70$  amps) are necessary to create inversion, and the forward resistance of the diode is considerably less than 1 ohm. However, there is no provision for triggering the current, hence a transistor or SCR must be placed in series with the diode. Direct modulation of forward current and hence laser output may be applied by coupling, *via* a tee, an r.f. generator to the pumping supply. Modulation rates of up to 1000 mc. are possible in this manner.

### Modulation and Demodulation

The laser, by virtue of its coherence properties, has offered the communications industry the possibility of using carrier frequencies of  $10^{14}$  to  $10^{15}$  cps for communication. The significance of this contribution is established by communication theory where it has been shown that the information capacity of a communications channel is proportional to its bandwidth. The modulation capabilities of a carrier wave is proportional to its center frequency.

For example, it is theoretically possible to modulate a 100-mc. carrier with approximately 3000 20-kc. audio channels without overlapping. A laser channel at a center frequency of  $10^{15}$  cps will permit 10 million times that number. A single laser is therefore capable of simultaneously emitting 30 billion 20-kc. audio channels. To develop the laser to its full potential as a communications carrier, it is necessary to provide means of coherent modulation and demodulation, which are compatible with the tremendous allowable bandwidth.

Although the energy levels appearing on the energy level diagram for an atom are quite well defined and narrow, the stimulated emission is *not* strictly monochromatic. The spreading of the spectrum of radiation is due to several causes,

the most significant of which is simple doppler shifting. This phenomenon is essentially the same as that encountered in sound waves. The motion of the source relative to the receiver causes a shift in the received frequency proportional to the relative velocity. The atoms in a gaseous discharge have random velocities due to their thermal motions which may be as high as  $10^6$  cm./sec. These random velocities shift the atom's emission and absorption frequencies over a 1000-mc. frequency band.

However, the cavity modes for the laser oscillator are quite closely spaced because the cavity is many times larger than the wavelength. Frequency separation for two adjacent axial modes in a long narrow cavity of length  $L$  is given by  $\Delta f = C/2L$  where  $C$  is the velocity of light. For  $L=1$  meter, the frequency spacing between adjacent modes is 150 mc. The spacing between resonant frequencies is then much narrower than the spread of frequencies caused by the doppler shift. The result is that the laser oscillator output consists of several frequencies spaced in accordance with the cavity geometry.

The width of cavity resonances, as in microwaves, is determined by the cavity "Q." Cavity "Q" refers to the fraction of energy lost per cycle. The frequency spread due to these losses is  $f_0/Q$  where  $f_0$  is the center frequency. Because the gain of a laser amplifier (expressed in %/meter) is quite low (generally  $<1\%$ ), cavity losses must be proportionally small to achieve oscillation (gain  $>1$ ). Therefore, the "Q" is made high and the frequency spread of the cavity resonances is consequently small compared to the space between them. There also exists off-axis resonant modes of the cavity with sufficient gain to cause oscillation.

Fig. 4 shows the typical spectrum of a helium-neon laser. It may be seen that although the individual oscillator reso-

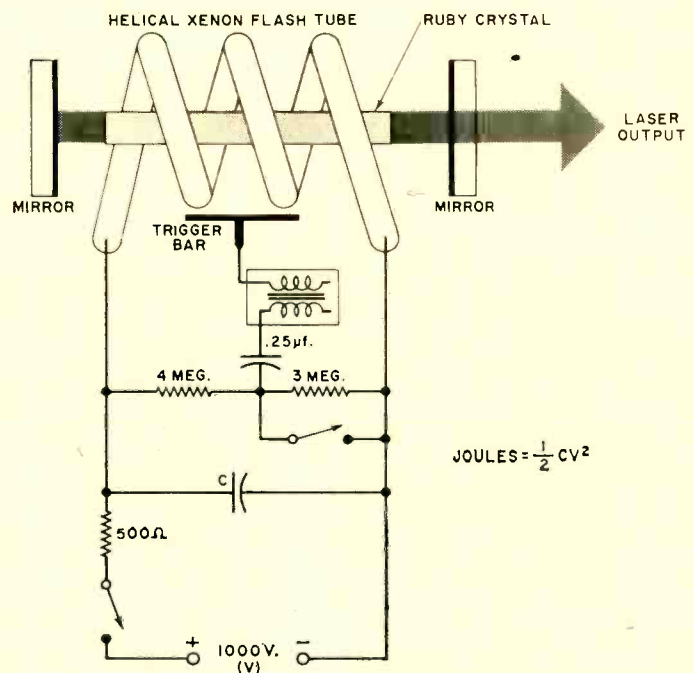
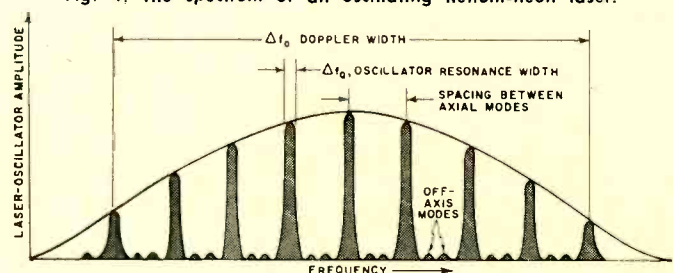

Fig. 3. A ruby laser being pumped with xenon flash tube.

Fig. 4. The spectrum of an oscillating helium-neon laser.



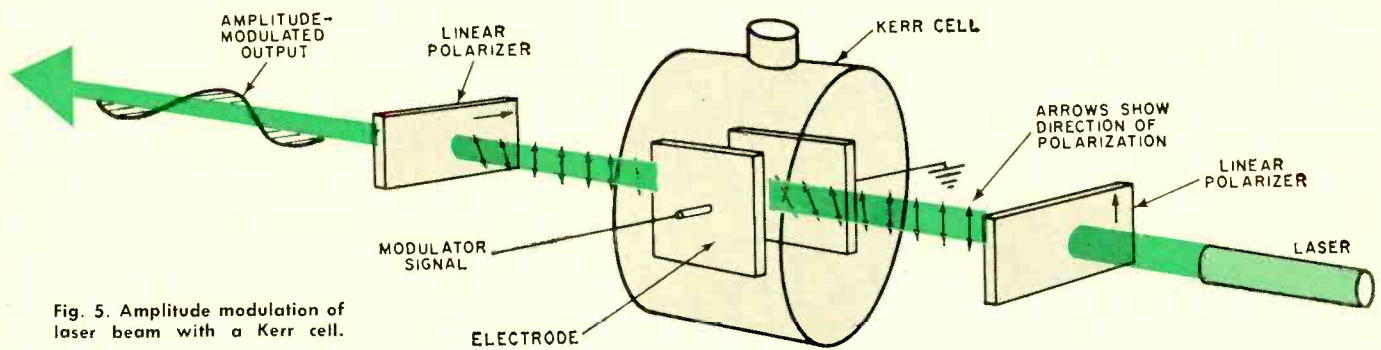

Fig. 5. Amplitude modulation of laser beam with a Kerr cell.

nances are narrow, the laser oscillator is operating at several frequencies simultaneously. In order to achieve a single oscillator frequency, it is necessary to pass the output through a narrow bandpass optical filter. This may be done by coupling to another high-*Q* cavity of a different length which is resonant for one of the oscillator outputs. Since the lengths are different, the spacing between resonant modes will be different and the second cavity will eliminate the other modes. The laser output, after passing through the narrow-band filter, will contain only a single frequency.

Applying this laser output to communications requires means of wideband modulation and demodulation. Direct modulation of the pumping source (flash lamp or gas discharge) in gaseous or solid lasers, which is limited by thermal inertia to a couple of kilocycles, is obviously insufficient. Other techniques must be considered. These may be divided into two groups: internal modulation in which the modulation is impressed upon an element of the feedback loop, and external modulation in which the modulation is impressed directly upon the oscillator (light-beam) output.

Various potential wide-band modulation schemes have been proposed, several of which have been successful over several gigacycles. We will only consider amplitude modulation by means of an external shutter, and frequency modulation

by means of varying the oscillator cavity length.

To obtain a fast shutter which may be directly operated by a voltage, a Kerr cell may be used. A Kerr cell consists of a special clear liquid (e.g., nitrobenzene) between two electrodes. When voltage is applied to the electrodes, the liquid acts to rotate the plane of polarization of light passing through it. The amount of rotation is proportional to the length of the cell and the square of the applied voltage. By modulating the voltage across the two electrodes, a linear polarized beam will become polarization-modulated. To convert polarization modulation to amplitude modulation, it is only necessary to pass the light through a polarizer. The transmission,  $T$ , of a linear polarizer for linearly polarized light is simply  $T = T_0 \cos^2 \theta$ , where  $\theta$  = the angle between directions of polarization and  $T_0$  is the transmission when they are perfectly aligned.

Fig. 5 shows the operation of a Kerr cell with a laser transmitter. Modulation by this means is limited by the time constant of the Kerr cell itself to a few megacycles. In order to achieve higher modulation frequencies, it is necessary to increase the interaction distance by forming a transmission line imbedded in a time-varying dielectric where the Kerr cell liquid acts as the dielectric.

Frequency modulation of the laser output may be accomplished by changing the cavity length and thereby varying the frequency of the resonant modes. For a helium-neon laser of 1 meter length a change of cavity length of  $\frac{1}{2}$  wavelength (to the next resonant mode) corresponds to a frequency shift of 150 mc. A  $\frac{1}{2}$  wavelength (for a helium-neon laser) is only  $3 \times 10^{-5}$  cm. The change of length necessary for wide-band modulation is, therefore, quite small. Such small displacements may be conveniently provided by a piezoelectric material.

A piezoelectric material (e.g., quartz) is one which contracts and expands along a dimension perpendicular to the direction of an applied voltage. By applying a varying voltage, with one face of a thin slab of piezoelectric material secured firmly to a stationary object, the exposed surface will undergo a vibration. This vibration may be transferred to a variation in cavity length by mounting one of the cavity mirrors on this surface. The motion of the mirror will modulate the cavity resonance and thus frequency-modulate the laser output. This method of modulation is suitable up to modulation rates of 1 mc., where the inertia of the mirror becomes the limiting factor. However, it does not pay to consider the extension of such a method to very high frequency, since the range of modulation is limited by the doppler width of the emission line.

To coherently detect a modulated carrier, it is necessary to compare the received signal to a local oscillator in a nonlinear element (mixer). In the case of a laser communications link, the local oscillator is provided by a second laser at the receiver operating at the same wavelength as the transmitter. The nonlinear element may be any material with nonlinear response at the carrier wavelength. For example, it may be the surface of an ordinary photodetector. All photodetectors are essentially square-law

(Continued on page 73)

Prototype of optical ranger/tracker using a laser source.

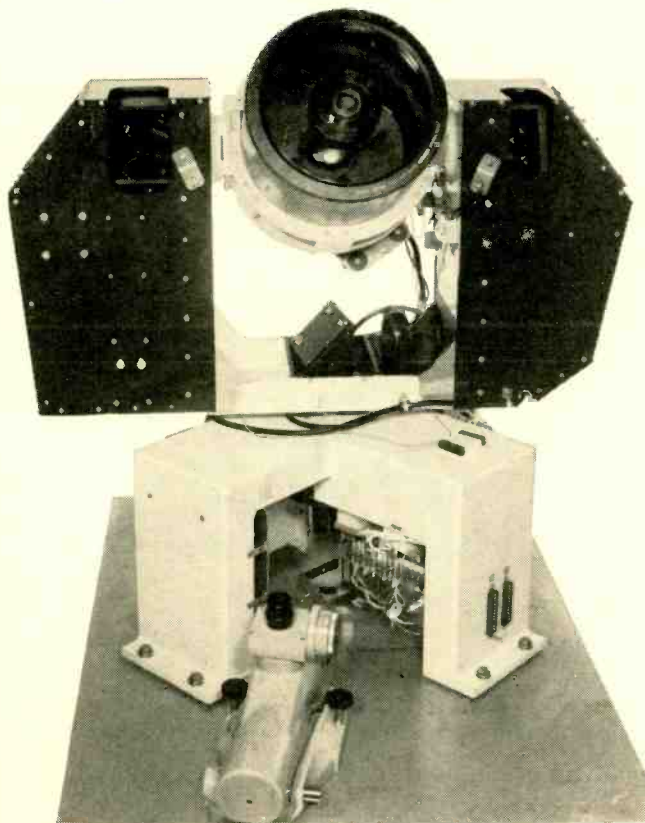



# USING A TRANSISTOR CURVE TRACER

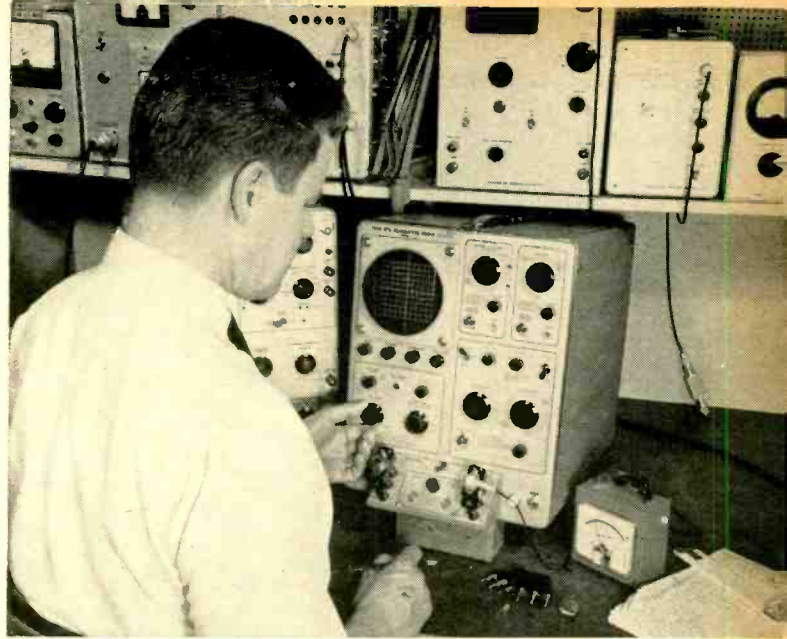

Fig. 1. The author is shown using a transistor curve tracer along with a thermocouple to check temperature effects on a transistor.

By RALPH E. SHOW/Instrument Engineering, Tektronix, Inc.

Operating principles of an important piece of test equipment which displays a complete family of diode or transistor characteristic curves. The method of interpreting curves to obtain parameters is covered.

A TRANSISTOR curve tracer displays the dynamic characteristic curves of transistors and semiconductor diodes on the screen of a cathode-ray tube. This article will show some of the displays it is possible to obtain with a curve tracer and how the displays may be used to determine transistor and diode parameters. These displays are intended for measurements of transistor characteristics which exist well below *alpha* cut-off, commonly measured between d.c. and 1000 cps; hence, we will not consider any high-frequency measurements.

Fig. 1 shows a curve tracer being used with a thermocouple to check temperature effects on a medium-power *p-n-p* transistor.

We have chosen to give examples of measuring the four *hybrid* or *h* parameters from the characteristic curves, although other parameters could be measured as well. Further, we have given examples predominantly in the common-emitter configuration. Measurements can also be made using common-base or common-collector circuits as well, with either *p-n-p* or *n-p-n* transistors being employed.

## Advantages of Curve Tracer

The visual display of a family of transistor characteristic curves using oscilloscopic techniques, employing synchronously stepped and swept voltage-current sources, offers certain advantages over the d.c. point-to-point measurement techniques:

1. Small irregularities in the characteristics, which may escape observation by the point-by-point method, are readily visible.

2. The extremes in the variation of a parameter value may be observed without altering the operating conditions of the transistor.

3. The changing magnitudes of two parameters may be observed simultaneously, as well as the dependence of one upon the other.

4. The short duration and lower duty cycle of the peak sweeping voltages or currents applied to the transistor produce less thermal rise than does the steady-state d.c. condition which occurs in point-by-point measurements. Inaccuracies due to thermal gradients are thereby minimized.

5. For the same reason noted in (4), the maximum ratings of the transistor may be observed without exceeding the safe limit of its power dissipation; thus incipient junction-breakdowns are minimized.

6. Observation, comparison, or a permanent record by photographic techniques of the transistor characteristics may be made more rapidly than by the point-by-point plot, thus affording a savings in manpower.

7. A resistive load line may be constructed in the family of characteristic curves so that dynamic performance data for the transistor may be forecast.

Transistor characteristic curves may be found to deviate more widely from the published "nominal" characteristic curves than those for vacuum tubes. For this reason, the curves obtained on a curve tracer may not always agree with curves published in data sheets or transistor manuals.

## Curve-Tracer Operation

A functional block diagram of the Tektronix Type 575 transistor curve tracer is shown in Fig. 2. In this curve tracer, two signals are developed to be applied to the transistor. One signal consists of either constant-current or constant-voltage steps, which are normally applied to the base (common-emitter configuration), or to the emitter (common-base configuration). The other signal is a variable amplitude half-

Fig. 2. Functional block diagram of the Tektronix Type 575 transistor curve tracer is shown here.

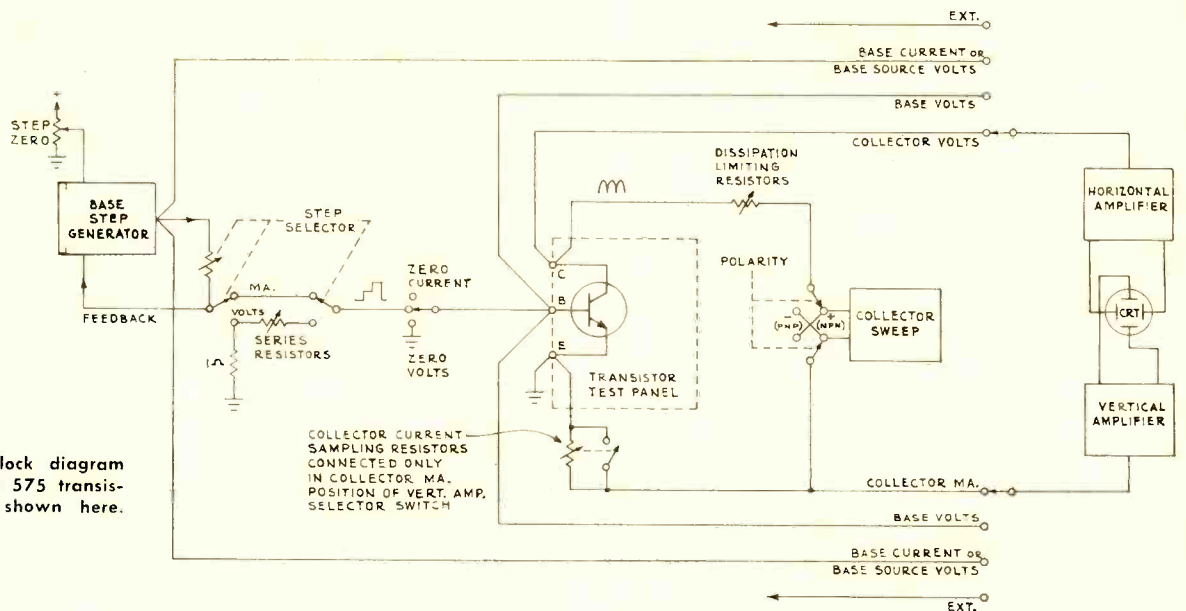

sine wave, normally applied to the collector. The two signals are synchronized so that for the duration of one step, or one-half step, there is one excursion of the half-sine voltage from zero (ground) to maximum and back to zero.

The base step generator produces from 4 to 12 steps in selected amplitude increments of constant current or constant voltage. The duration of each step is either 1/120th or 1/240th of a second. The steps may be made repetitive, to occur once, or made inoperative and held at zero step level. The steps may be positive (for *n-p-n*) or negative (for *p-n-p*) in polarity with the zero step value adjustable by a small amount, positive or negative, from ground to start the stair-steps on the zero-volts or zero-current input curve.

The output of the base step generator is fed through a switch to the base (B) terminal of the test panel. The switch provides a means of disconnecting the base terminal from the base step generator to either open or short the terminal to ground.

The collector sweep is the source of the half-sine collector sweep voltage. The peak collector sweep voltage is variable in amplitude from zero to 20 volts at 10 amps, or zero to 200 volts at 1 amp. The polarity of the half-sine shaped voltage

Fig. 3. Forward current transfer ratio  $h_{fe}$  (beta) is determined by measuring the change in collector current produced by a change in base current at a specified collector voltage. In this case at  $V_c = 10\text{v.}$ ,  $\beta = \Delta I_c / \Delta I_b = 1.6 \text{ div.} \times (2 \times 10^{-4}) / (2 \times 10^{-6}) = 1.6 \times 10^2 = 160$ .  $\text{Alpha} = \beta / (\beta + 1) = 160 / 161 \approx 0.994$ . Curves shown are for "n-p-n" transistor in common-emitter configuration.

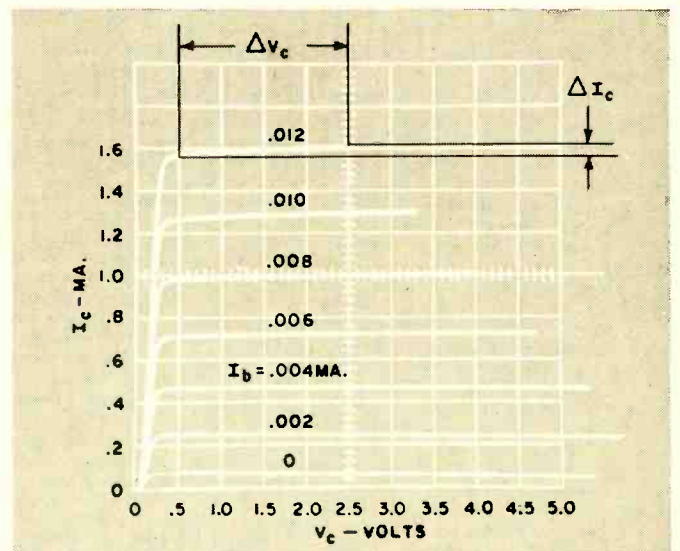
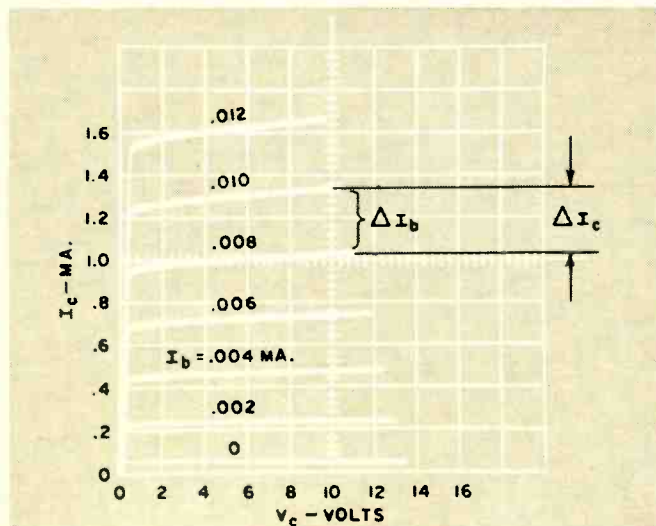

Fig. 4. Output conductance,  $h_{oe}$ , is determined by measuring the change in collector current produced by a change in collector voltage at a specified base current. At  $I_b = 0.012 \text{ ma.}$ ,  $h_{oe} = \Delta I_c / \Delta V_c = 0.2 (2 \times 10^{-4}) / (4 \times 0.5) = 0.4 \times 10^{-4} / 2 = 0.2 \times 10^{-4} = 20 \mu\text{mhos}$ . Curves are for "n-p-n" transistor, common-emitter circuit.

excursions may be made positive (for *n-p-n*) or negative (for *p-n-p*) from ground. The duration of sweep from zero to maximum and back to zero is always 1/120th of a second.

The collector supply may be fed directly to the collector terminal (C) of the test panel, or variable dissipation-limiting resistance values may be inserted.

The third terminal (E) of the test panel is ground. The test panel (not entirely shown in Fig. 2) has a switch for transferring all connections from the left-hand terminals and socket to the right-hand terminals and socket with a neutral "off" position. Another switch is provided to switch the sockets only from grounded base to grounded emitter.

The horizontal amplifier may be connected to display one of four signals on the horizontal axis of the cathode-ray tube: (1) collector volts; (2) base volts; (3) base current; (4) an external signal. In the same manner, the vertical amplifier may be connected to display one of four signals on the vertical axis of the CRT: (1) collector current; (2) base volts; (3) base current; (4) an external signal.

#### Display Considerations

The most common transistor display is a "collector family,"



such as shown in Fig. 3. In this display, collector voltage  $V_c$  is plotted horizontally, collector current  $I_c$  is plotted vertically, and each curve or step represents a different value of base current  $I_b$ . Such a display is obtained by connecting the transistor under test for the normal operating polarities, that is, for a forward-biased emitter and for a reverse-biased collector.

However, with the curve tracer, the polarity of the base step and collector sweep signals may be selected independently and used to advantage. For instance, the emitter may be reversed-biased in order to measure the amount of current or voltage required to decrease the collector current,  $I_{cbo}$  or  $I_{ceo}$ , to minimum value.

A given parameter may be measured from any one of the displays containing the current and voltage relationships involved in the parameter. The display chosen depends upon the particular parameter and the characteristics of the transistor under test. The display that should be used is, of course, the one which yields the most accurate measurement or vivid display of that parameter.

The user may sometimes prefer to measure other parameters that may be combined in a formula to produce a more

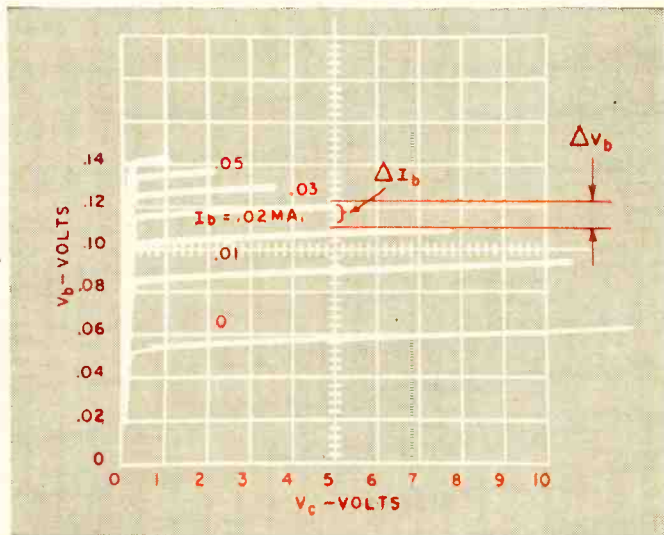

Fig. 5. Input impedance,  $h_{ie}$ , is determined by measuring the change in base voltage resulting from a change in base current at a specified collector voltage. At  $V_c = 5$  v.,  $h_{ie} = \Delta V_b / \Delta I_b = 0.6(2 \times 10^{-2}) / 10^{-5} = 1.2 \times 10^3 = 1200$  ohms. The above curves are for "n-p-n" transistor in common-emitter configuration.

accurate end result. A typical case is the relationship between  $\alpha$  (alpha), the common-base forward current transfer ratio and  $\beta$  (beta), the common-emitter forward current transfer ratio. In the common-base configuration of Fig. 7, for example, it can be seen that the change in collector current for a given change in emitter current is very close to one. In a common-emitter configuration, however (Fig. 3), the change in collector current is considerably more than the change in base current. Since  $\alpha$  and  $\beta$  are related by  $\alpha = \beta / (\beta + 1)$ , we may find  $\beta$  to a greater degree of accuracy as far as scaling is concerned, and solve for  $\alpha$ .

A word may be in order regarding small-signal *hybrid*, or *h*, parameters. In small-signal operation, linearity should exist over the operating range of the parameter and the value of the parameter should be independent of the signal amplitude. Ordinarily, the active region of a transistor without defects is quite uniform, and a cursory examination of the family of characteristics will verify that linearity exists over the operating range of the parameter.

The versatility of the curve tracer provides for making "small-signal" as well as "large-signal" measurements. In order to verify that the parameter value, or operating region, of the transistor is independent of the signal amplitude, additional

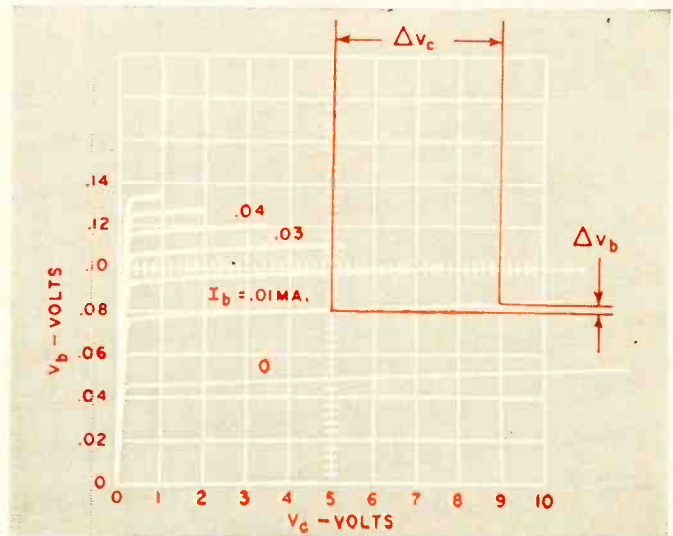

Fig. 6. Reverse voltage transfer ratio  $h_{re}$ , is determined by measuring the change in base voltage resulting from a change in collector voltage at a specified base current. In this case at  $I_b = 0.01$  ma.,  $h_{re} = \Delta V_b / \Delta V_c = 0.2(2 \times 10^{-2}) / 4 = 1 \times 10^{-3}$  or  $1000 \times 10^{-6}$ . "N-p-n" transistor in common-emitter circuit.

measurements of the parameter may be made adjacent to, or within, the intended operating region and the resulting values compared. For instance, the base step values may be reduced and the number of steps increased to examine a smaller segment within the same operating region, etc.

The waveforms, Figs. 3 through 6, illustrate some of the displays it is possible to obtain with a curve tracer and measurements that can be obtained from the displays. These show characteristics of a small-signal *n-p-n* transistor in the common-emitter mode, and how parameters may be obtained.

### Common-Base Configuration

The parameters for the common-base or common-collector configurations may be handled in the same manner as just illustrated for common-emitter configuration. From observation of the collector family of output characteristics in common-base configuration, shown in Fig. 7, it is clear that  $h_{fb}$  or  $\alpha$ , which equals  $\Delta I_c / \Delta I_e$ , and  $h_{ob}$ , which equals  $\Delta I_c / \Delta V_c$ , are difficult to scale from the graphic. This is quite normal and it may be anticipated that variations between transistors will not appear as vividly as they would in common-emitter operation.

The curves of Fig. 7, by themselves, are principally in-

Fig. 7. Collector family, "n-p-n" transistor, common-base circuit.

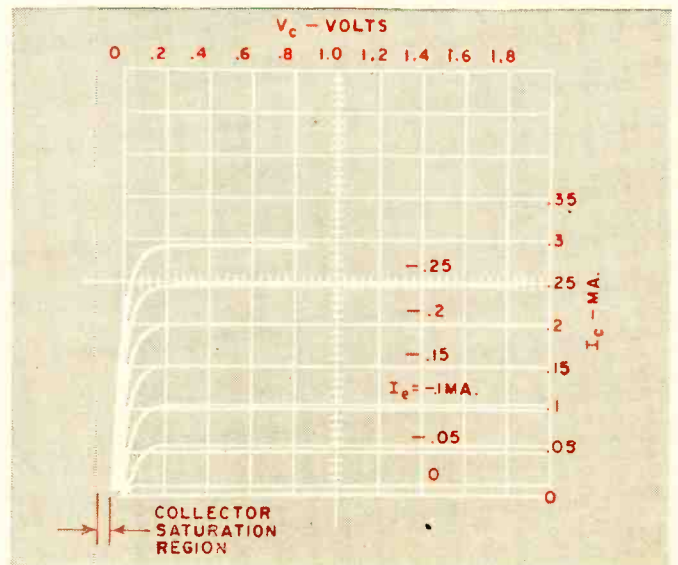

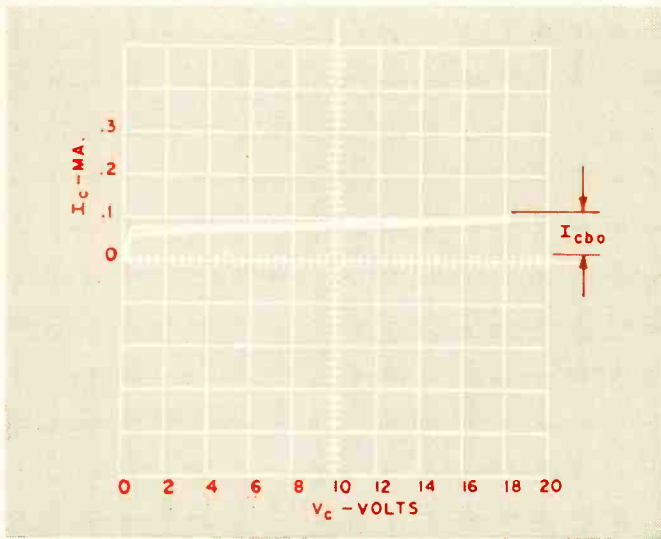

Fig. 8. Measurement of  $I_{cbo}$ , the collector current that flows with emitter circuit open is shown on  $I_c$  vs  $V_c$  display for "n-p-n" transistor in common-base circuit. At  $V_c = 18$  v.,  $I_{cbo} = 0.1$  ma.

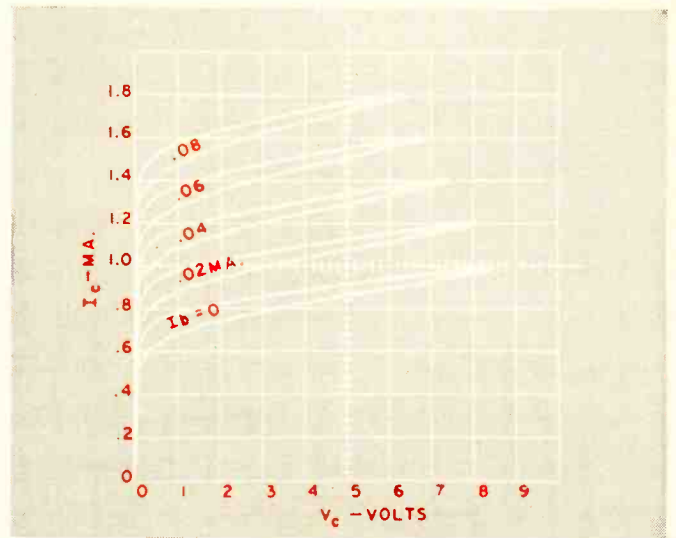

Fig. 10. The loops in the characteristic curves shown here are the result of the presence of collector-to-base capacitance. With reduced capacitance the loops shown will close up.

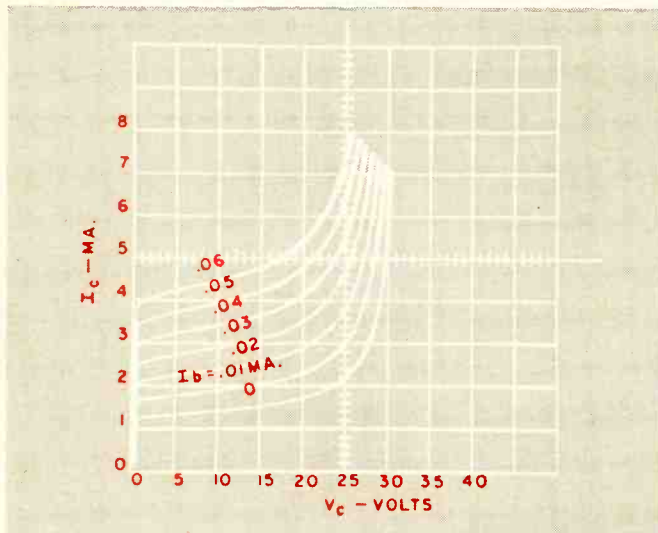

Fig. 9. Collector breakdown characteristic curves of  $I_c$  vs  $V_c$  for various values of  $I_b$  for "n-p-n" transistor in common-emitter configuration. Note sharp rise of current around 25-30 volts  $V_c$ .

formative in the "saturation region," which appears to the left of zero collector volts. It will be recalled that in common-base configuration, unlike common-emitter, the polarity of the emitter is opposite to that of the collector. The apparent forward biasing of the collector in the "saturation region" results from emitter current and hence appears opposite in polarity to the applied collector voltage. Its magnitude may approach the magnitude of the emitter voltage; however, it can never exceed this value of voltage.

### Collector Cut-off & Breakdown

The collector current which flows with zero emitter current (common base)  $I_{cbo}$  or with zero base current (common emitter)  $I_{ceo}$  may be measured directly from the collector family of curves. A typical measurement for  $I_{cbo}$  is illustrated above in Fig. 8.

As the voltage is increased on a reverse-biased collector of a transistor, a point will be reached where the collector current increases rapidly and may become essentially independent of the collector voltage. Several measurements of the breakdown characteristics may be obtained with a curve tracer, but in this article we will not attempt to differentiate among the phenomena referred to as avalanche, punch-through, zener breakdown, or carrier multiplication, since they are

largely dependent upon the configuration, type, and geometry of the transistor.

Collector breakdown is shown in Fig. 9, where  $I_c$  increases almost without limit in the vicinity of 25 to 30 volts on the collector ( $V_c$ ).

Under certain conditions, some transistors will exhibit a negative-resistance characteristic in the breakdown region. Oscillation may also occur in some other region of the characteristic curve and may be recognized by the faint and ragged, or erratic, behavior of the trace on the oscilloscope display on the curve tracer.

### Collector-Capacitance

The effect of the collector capacitance may become quite pronounced in some transistors. The loop resulting from the collector-to-base capacitance causes a displacement current to add and subtract from the current of the transistor. The effect is most pronounced in common-emitter configuration with low base drive, high collector voltage, and the greatest expansion of the vertical collector-current display. The capacitance effect is more pronounced at the knee of the curve in the collector family because of the sudden change in collector current in the transistor. At the same time, the rate of change of the collector half-sine shape sweep voltage is maximum, that is, near the

(Continued on page 61)

Fig. 11. Same display as shown in Fig. 10 except in this case a 1000-pf. capacitor was added externally between base and collector.

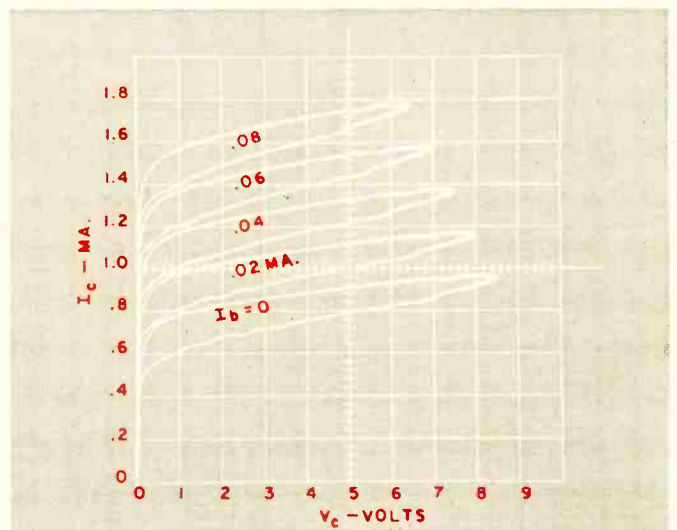





## Why does Arco wind all its tv-replacement capacitors with computer-grade 99.99% pure aluminum foil?

### To help cure that pain in your neck.

Impurities in aluminum foil can lead to deterioration, premature failures, lost customer confidence—and call-back time you can't charge for. Big pains in the neck.

So we wind every Arcolytic® electrolytic capacitor with the purest aluminum foil available: 99.99% pure. It meets computer manufacturer standards. And exceeds those of radio-tv manufacturers.

Result: Arcolytic capacitors last longer in your customer's set. In fact, they won't deteriorate even at high operating temperatures of 85° C.

And while we wind them with computer-grade foil, we price them for home-entertainment service. You pay no premium.

You'll find whatever discrete capacitance value you need at your Arco Distributor's. And in your choice of single- and multiple-section tubular, or twist-mount designs. (You'll also find a complete line of equivalent-quality miniature ceramic disc capacitors up to 6000 VDCW.)

Start using Arcolytic capacitors. And the next call from your customer will be because he likes your kind of reliability, and wants more of your service.

**Arco Electronics**  
A DIVISION OF LORAL CORPORATION

COMMUNITY DRIVE, GREAT NECK, N.Y. DALLAS, TEX. PASADENA, CALIF. WRITE FOR FREE CATALOG.

# Look What's

## NEW LOW PRICES

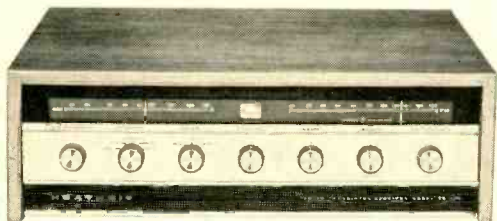

Kit AR-13A  
Now Only  
**\$184<sup>00</sup>**

### ALL-TRANSISTOR STEREO RECEIVER

Just add 2 speakers for a complete stereo system. AM/FM/FM stereo tuning; 46-transistor, 17-diode circuit for cool, instant operation & natural transistor sound; 66 watts music power @ ±1 db from 15 to 30,000 cps; walnut cabinet. 35 lbs.

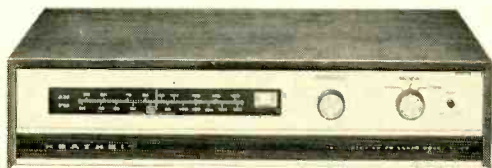

Kit AJ-33A  
Now Only  
**\$94<sup>50</sup>**

### TRANSISTOR AM/FM/FM STEREO TUNER

Features 23-transistor, 8-diode circuit; built-in stereo demodulator; automatic switching to stereo; stereo indicator light; stereo phase control; filtered outputs for beat-free recording; walnut cabinet. 17 lbs.

#### OTHER NEW LOW-PRICE COMPONENTS

- ★ Kit AJ-41 (tube), AM/FM/FM Stereo Tuner... Now Only \$112.50
- ★ Kit AJ-12 (tube), FM/FM Stereo Tuner... Now Only \$65.95
- ★ Kit AJ-13 (tube), FM/FM Stereo Tuner... Now Only \$47.00
- ★ Kit AJ-63 (tube), Mono FM Tuner... Now Only \$37.50

Now Install Any Of 3 Ways . . .  
Wall, Custom Or Heath Cabinets!

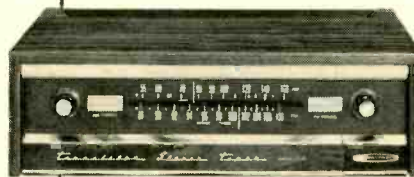

Kit AJ-43D  
Now Only  
**\$109<sup>00</sup>**  
(less cabinet)

### Deluxe Transistor AM/FM/FM Stereo Tuner

25-transistor, 9-diode circuit; automatic switching to stereo; stereo indicator light, stereo phase control; filtered outputs. 15 lbs. Optional cabinets, (walnut \$12.95), (metal \$6.95).



Kit AA-21D  
Now Only  
**\$137<sup>00</sup>**  
(less cabinet)

### Matching 100-Watt Transistor Stereo Amplifier

70 watts RMS power at ±1 db from 13 to 25,000 cps; 26-transistor, 10-diode circuit; inputs & outputs for any source; 4, 8 & 16 ohm speaker impedances. Opt. cabinets, (walnut \$12.95), (metal \$6.95). 23 lbs.

### New Low Price On Deluxe 21" Color TV

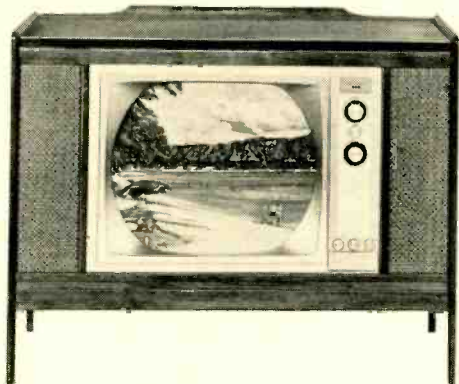

Kit GR-53A  
Now Only  
**\$375<sup>00</sup>**  
(less cabinet)

Ends costly color TV servicing . . . only set you adjust and maintain yourself. Only Color TV you can install 3 ways . . . wall, custom or Heathkit cabinets. Tunes all channels for 21" of the best color pictures in TV plus true hi-fi sound. Assembles in just 25 hours . . . no special skills needed . . . all critical circuits preassembled and aligned. 1-year warranty on picture tube, 90 days on all other parts. 127 lbs. Also new low prices on preassembled Heathkit cabinets: GRA-53-7, walnut cab. (illust.) 85 lbs. . . \$108; GRA-53-6, walnut-finish hardboard cab., 52 lbs. . . \$46.50

### New Low Prices On Heathkit®/Thomas Organs

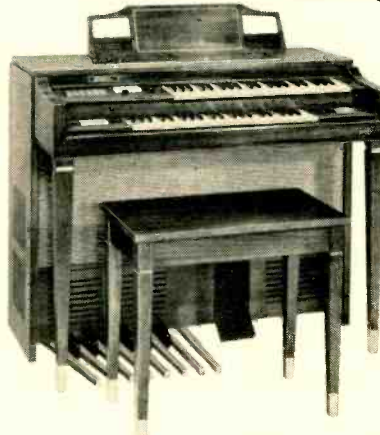

Kit GD-983  
Now Only  
**\$799<sup>00</sup>**

The Heathkit/Thomas "Coronado" Transistor Organ, (illust.) boasts 17 organ voices, two 44-note keyboards, Leslie plus 2-unit main speaker system, 28 notes of chimes, 13-note heel & toe pedalboard, color-tone attack & repeat percussion, matching bench, plus many more professional features. 242 lbs. Also the Heathkit/Thomas "Artiste" Transistor Organ with 10 voices, two 37-note keyboards, repeat percussion, etc. now at only \$332. 154 lbs. Both organs have all genuine Thomas factory fabricated components.



# NEW At Heath!

## NEW KITS

New Transistor FM Stereo Tuner . . .  
Build In 6 Hours!



World's easiest to build stereo/hi-fi kit . . . takes 6 hours or less! 14-transistor, 4-diode circuit for cool instant operation, natural transistor sound. Phase control assures best stereo performance. 4-stage IF for high sensitivity. Filtered outputs for direct stereo recording. Automatic stereo indicator light, preassembled & aligned "front-end." Install in a wall or either Heath cabinet; walnut (\$7.95), metal (\$3.50). 6 lbs.

Kit AJ-14  
**\$49<sup>95</sup>**  
(less cabinet)

New Deluxe Shortwave Radio

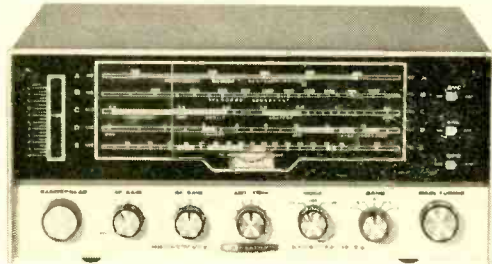

Compare it to sets costing \$150 and more! 5 bands cover 200-400 kc, AM, and 2-30 mc. Tuned RF stage, crystal filter for greater selectivity, 2 detectors for AM and SSB, tuning meter, bandspread tuning, code practice monitor, automatic noise limiter, automatic volume control, antenna trimmer, built-in 4" x 6" speaker, headphone jack, gray metal cabinet, and free SWL antenna. Assemble in 15 hours. 25 lbs.

Kit GR-54  
**\$84<sup>95</sup>**

New 23-Channel, 5-Watt Transistor  
CB Transceiver



23-channel transmit & receive capability. All-transistor circuit for instant operation, low battery drain . . . only .75 A transmit, .12 A receive. Only 2 7/8" H x 7" W x 10 1/2" D . . . ideal for car, boat, etc. 1/2 uv sensitivity for 10 db signal plus noise to noise ratio. Front-panel "S" meter, adjustable squelch, automatic noise limiter, built-in speaker, ceramic PTT mike, charcoal gray aluminum cabinet. 8 lbs.

Kit GW-14  
**\$89<sup>95</sup>**  
(Assembled  
GWW-14,  
\$124.95)

New 6-Meter SSB Ham Transceiver



Full SSB-CW transceive operation on 6 meters. 180 watts PEP SSB—150 watts CW. Operates fixed or mobile; PTT and VOX. Switch-selection of upper sideband, lower sideband, and CW. Covers 50-52 mc with crystals supplied, total coverage 49.5-54 mc. Famous Heath SB series Linear Master Oscillator for true linear tuning. Built-in 100 kc calibrator and antenna switching. Accessory mobile mount SBA-100-1 . . . \$14.95. 23 lbs.

Kit SB-110  
**\$320<sup>00</sup>**

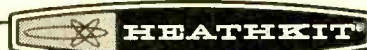

## NEW! 1966 CATALOG



Free! 108 pages . . . many in full color . . . describe these and over 250 easy-to-build Heathkits. Save up to 50%. Mail coupon for your free copy.

... Buy Now—Use This Order Blank ...

HEATH COMPANY, Dept. 15-9, Benton Harbor, Michigan 49023  
In Canada: Daystrom, Ltd., Cooksville, Ontario

Please send FREE 1966 Heathkit Catalog.

Model	Description	Weight	Price
Name _____ (Please Print)			
Address _____			
City _____	State _____	Zip _____	

SHIP VIA:  Parcel Post  Express Collect  Freight  20% Included, C.O.D.  
 Best Way

All prices & specifications subject to change without notice.

CL-216



# JOHN FRYE

*The wide variety of liquid service aids available today are as valuable to the technician as conventional tools.*

## CHEMICALS FOR THE SERVICE SHOP

BARNEY marched into the service department and ostentatiously placed a small spouted metal can on the shelf holding the various chemical service aids used in radio and TV servicing. "Please note," he said to Mac, his employer, "my free-will offering of one can of *Liquid Wrench*."

"What's *Liquid Wrench* and why the sudden burst of generosity?"

"You might say *Liquid Wrench* is a second-generation penetrating oil. I discovered what it could do Sunday when I took down my ham transmitting antenna to replace the feedline. Bolts holding the wire in the terminals were so badly rusted and corroded I couldn't budge them. The friend helping me suggested penetrating oil, but I didn't think much of the idea. My limited experience with penetrating oil led me to believe you had to let it soak in for two or three hours before it did much good; and I needed that antenna back up right away to keep a schedule. But my friend got his can of *Liquid Wrench* and squirted it on the bolts and nuts. In two or three minutes we were able to unscrew the nuts. I don't mean we could turn them with our fingers, but they all came off with a little persuading.

"Right then I decided I wanted a can of this quick-acting penetrating oil in my hip pocket the next time I climb a tower to replace an old TV feedline or to loosen the rust-encrusted nuts of an antenna rotor. By golly, there's progress in everything these days—even in penetrating oil!"

"It's odd you should discover this right now," Mac said. "I decided the same thing a couple of weeks ago and filled out an order to up-date our 'liquid tools,' as you might call them. I was arranging these on the shelf just before you came in, but a modern penetrating oil is one thing I overlooked.

"A technician is prone to think only of hand tools and service instruments as service aids and forget all about the wide variety of chemicals that can make his work so much easier. The day when all the chemicals a service shop used were a tube of speaker cement and a bottle of carbon tetrachloride is long gone. What say I sort of go through the items on this shelf with a little refresher discussion of the uses—and abuses—of each?"

"To coin a phrase, 'You're the boss,'" Barney quipped as he perched himself comfortably on a stool and prepared to listen.

"Let's start in the 'Protective Coatings' section with this bottle of *liquid tape*. In modern compact radios, tuners, tape recorders, and TV sets, wrapping an exposed wire with tape to provide insulation is often as difficult as trying to splint the leg of a mosquito inside a safety match box. Instead, you simply brush on a coating of the contents of this bottle. It quickly dries into a crack-proof, high-voltage layer of insulation. You can also brush it on the handles of tools to insulate them. This bottle of *red insulating varnish* will do the same job for solder connections, and it also serves nicely for sealing adjusting screws. Of course, we can call on our old reliable *corona dope* for really tough arcing cases in the high-voltage circuit. Finally, here is a bottle of silicone resin coating with the trade name of *Print Kote* to restore the protective coating

to printed circuits after a circuit repair has been made."

"That darned coating is a big fat nuisance when you're trying to solder a break in a printed circuit," Barney offered.

"Not if you use this *Print Kote Solvent* especially designed to remove the silicone resin," Mac said, moving over to the next section he had designated "Solvents" with the shop label-maker. "And incidentally, here is some special low-melting-point solder especially designed to resolder a break in a printed circuit without the necessity for too much damaging heat. Your *Liquid Wrench* goes in this section as does this bottle of *acetone* for dissolving speaker cement. Always remember, a little of this goes a long way."

"Yeah, I know," Barney answered. "The idea with acetone is to apply a little sparingly to a speaker-cone dust cover and then wait a few seconds for it to soak in. After that the cover can be lifted off intact with tweezers and can be used again. Trying to hurry things up by dousing the center of the cone with acetone is a good way to separate the voice coil from the cone."

"Right," Mac approved, "and the same thing goes when realigning a warped voice coil. After the speaker shims are in place, the idea is to apply just enough acetone with a long curved eyedropper to the pleated voice-coil spider to soften it and allow it to take a new set with the voice coil properly aligned. Too much acetone may loosen the spider from its plate or, still worse, may carry softened cement down into the space between the voice coil and the pole piece. If this occurs, you've had it."

"Hey, I'm surprised, knowing how you feel about the stuff, to see a bottle of carbon tet on the shelf under 'Cleaners.'"

"Well, I still consider it deadly dangerous and know that breathing the fumes can produce serious liver damage; but I'm also a great one for 'going by the book,' and the fact remains that several tape-recorder manufacturers still specify carbon tet for cleaning tape heads, capstans, and even pressure rollers. Others warn against using the stuff on tape heads or any rubber parts. I suppose it depends on the material in which tape-head laminations are embedded and the chemical nature of the rubber used. At any rate, here is a bottle of *tape-head cleaner* for general cleaning of that area, a bottle of *alcohol* for use where it is specified, and this *carbon tet* to be used when called for. But when you use this last be sure you have plenty of ventilation so you don't breathe the fumes, and be careful not to splash any into your eyes or into any breaks in the skin."

"Don't worry. I'm just as scared of that stuff as you are. I see you have a new pressure can of *contact cleaner* and another of *glass-and-plastic cleaner*. You know, it amuses me to see an inexperienced technician hopefully squirting contact cleaner on the outside of a volume-control shaft. In a very few cases this may clear up the trouble for a few days, but for lasting improvement the cleaner must reach the sliding contacts inside the control. I use the auxiliary flexible extension tube to squirt the cleaner through an opening where a terminal enters the control case. It will fog through here and saturate the whole inside of the control—including the two



critical sliding contacts I mentioned. Unlike old carbon tet, modern contact cleaners contain a lubricant and an anti-corrosion coating in addition to the corrosion solvent; so their effect lasts much longer.

"I'm glad to see that cleaner for glass and plastic. Lots of radios have plastic dial covers, and of course, most TV tubes now have bonded faceplate shields. Many cleaners for glass will attack and fog plastic—as you well know. It's a comfort to have one cleaner that can be safely used on both."

"Okay, let's go on to 'Cements and Glues,'" Mac said. "Here, of course, is a tube of our old reliable *speaker cement* that does many more things than repair cracks in speaker cones. Fixing dial cord knots, securing the pointer on the cord, and fastening loose loop and coil windings are a bare beginning or the uses for this versatile clear cement. But it's not so hot for repairing broken cabinets, although many try to use it for that. This *plastic cement* or this *Bakelite cement* should be used to repair cabinets or knobs in accordance with the material of the broken item. Properly used, either will create a strong, durable, inconspicuous repair. Since not all cabinets are Bakelite or plastic—yet—this *wood glue* still comes in handy quite often. And this *rubber-to-metal cement* is excellent for fastening loosened rubber drives back on their shafts or wheels. Finally, these two tubes contain an *epoxy cement* and *catalyst* that combine into a glue coming as near to bonding 'anything to anything' as you will find. We don't need it often in service work, but it's sort of a reserve heavy artillery that can be called in when nothing else will do a heavy-duty cementing job.

"Under 'Lubricants' we have a *light machine oil* for general lubrication, *tuner lube* for TV tuners, *Lubriplate* for sliding dial pointers and for tape-recorder and record-changer mechanisms, a *fiber grease* that will cling to a rotating gear or wheel in spite of high temperatures, and this *silicone grease* for providing a good heat-transferring bond for mounting power transistors."

"That leaves only the 'Miscellaneous' section," Barney noted.

"Yes, and there aren't too many items here. Of course, this *cabinet repair kit* embraces several individual stains, varnishes, shellac sticks, etc., with which we can work a scratch out of just about any kind of wood or plastic cabinet. Another item we both like is this pressurized can of *refrigerant gas* that is marketed under various trade names such as *Circuit Cooler*, *Zero Mist*, and so on. A shot of this gas will abruptly drop the temperature of a suspected item in an intermittent set and often make that component reveal itself as the cause of the trouble. We don't hold our fingers in

# Have you tried new **QUIG**<sup>®</sup> connectors?

**Not just another wire spring connector!**  
The 3-in-1 QUIG is brand new and different . . .  
Copperweld wire inner core, a layer of flux, and  
an outer jacket of solder . . . all you need is heat!  
**Makes one-handed soldering possible!**

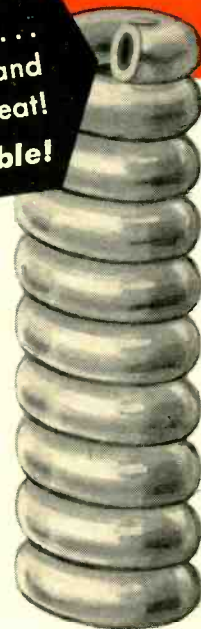

Ten times  
actual size

Once again, Sprague helps the TV-radio service industry by solving two increasingly serious problems . . . parts replacement in those "inaccessible" chassis nooks, such as crowded tube sockets, as well as soldering onto the delicate circuitry of printed wiring boards.

Mechanically sturdy and electrically reliable, the revolutionary QUIG provides fast, expertly-soldered connections as easy as A-B-C!

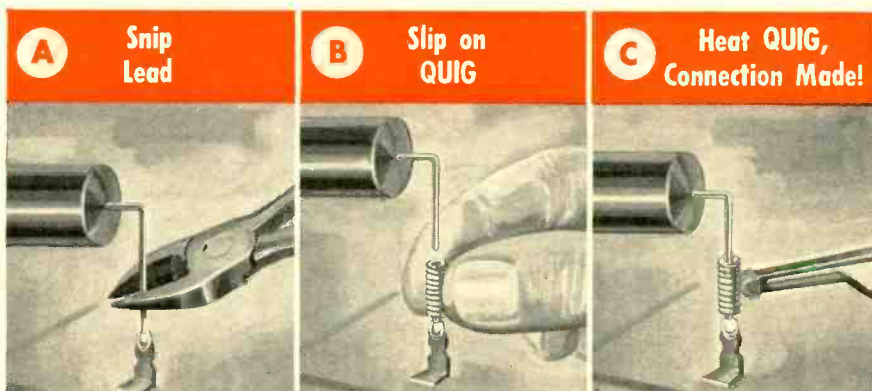

**NOBODY ELSE HAS QUIG CONNECTORS...  
YOU GET 'EM ONLY FROM SPRAGUE PRODUCTS!**

QUIGS are now being packed with Sprague Atom<sup>®</sup> Capacitors at no extra cost to you! Whenever you need tubular electrolytics, insist on pre-packaged Sprague Atoms from your parts distributor and you'll automatically get your QUIG component connectors . . . the biggest boon to the service technician since the soldering gun!



WORLD'S LARGEST MANUFACTURER OF CAPACITORS  
65-4105



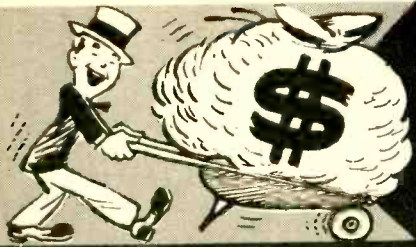

## THERE'S BIG MONEY IN MOBILE-RADIO MAINTENANCE with a 2nd Class Ticket and LAMPKIN METERS

Business and Industrial Radio . . . CB . . . Public Safety . . . Marine . . . and Aircraft Radio all are booming; all need maintenance and frequency checks. Much of this can be on a long-term contract basis, so you can fill in those non-productive hours with a steady extra income. Begin with the ideal instrument to build your business around — the LAMPKIN 105-B FREQUENCY METER. Low-cost, it will measure unlimited numbers of channels and is all you need for CB and all other mobile services except the high-band split channels; later you can add the LAMPKIN FM MODULATION METER and the split-channel PPM METER as your business grows. To learn more, use coupon for your free copy of "How to Make Money in Mobile Radio Maintenance"!



**LAMPKIN 105-B FREQUENCY METER** 100 KC to 175 MC and up, continuous coverage. Heterodyne type. Only 8 lbs. (\$295.00. (0.0001% accuracy with inexpensive accessory PPM Meter.)

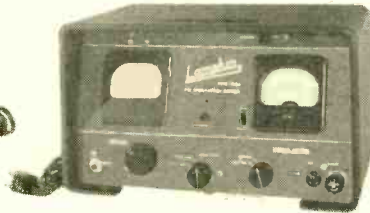

**LAMPKIN 205-A FM MODULATION METER** 25 to 500 MC continuous. Dual scales, 0-12.5 and 25 Peak KC, \$290.00. With Quad scales, 0-1.25 and 2.5 KC added, \$340.00.

**LAMPKIN LABORATORIES, INC.**  
MFM Division, Bradenton, Florida

At no obligation to me, please send free booklet and information on Lampkin meters.

Name \_\_\_\_\_  
Address \_\_\_\_\_  
City \_\_\_\_\_ State \_\_\_\_\_

**MAIL COUPON TODAY!**

**LAMPKIN LABORATORIES, INC.** MFM DIVISION  
BRADENTON, FLA.

CIRCLE NO. 104 ON READER SERVICE CARD



## Your new copy is waiting

**FREE!** For fun and pride in assembly, for long years of pleasure and performance, for new adventures in creative electronics mail the coupon below and get Conar's brand new catalog of quality do-it-yourself and assembled kits and equipment. Read about items from TV set kits to transistor radios . . . from VTVM's to scopes . . . from tube testers to tools. And every item in the Conar catalog is backed by a no-nonsense, no-loopholes, money-back guarantee! See for yourself why Conar, a division of National Radio Institute, is just about the fastest growing entry in the quality kit and equipment business.

# CONAR

**MAIL THIS COUPON NOW**

CONAR 3939 Wisconsin Ave., Washington 16, D.C.

JB5C

Please send me your new catalog.

Name \_\_\_\_\_  
Address \_\_\_\_\_  
City \_\_\_\_\_ State \_\_\_\_\_ Z-Code \_\_\_\_\_

the spray and freeze them, though, as the salesman told us one of his customers did!"

"Practically all chemicals can do physical damage if used carelessly, I reckon," Barney observed. "But all you have to do is read the instructions and warnings on the can and then follow them. If they say: 'Don't use near an open flame'; or 'Don't inhale fumes'; or 'Keep away from eyes'; or 'Avoid prolonged contact with skin'; or 'Highly flammable,' assume there's a good sound reason for the warning and heed it."

"See that you do," Mac said. "At any rate, that winds up our little seminar on chemicals. Keep your eyes open for additions to this shelf, though; I'm sure there are others that belong there."

"Will do," Barney answered, getting off his stool and stretching; "but if you will allow me to coin another phrase—I'm full of 'em today—I think you should entitle your lecture 'Better Things for Better Servicing Through Chemistry!'"

## EPOXY TRANSISTOR RADIO

**T**HIS G-E circuit is based on high performance obtained with the least number of transistors used at optimum conditions rather than a large transistor count. The transistors used are all epoxy-housed silicon planar passivated types except in the class-AB output where planar passivated epitaxial types are used with a small heat sink.

Half-voltage performance is equal or better than that obtained with germanium transistors due to the special biasing technique used on the low-level stages and to the silicon diode added to the biasing circuit of the output amplifiers. The diode tends to maintain the cross-over current and power output more nearly constant as the battery voltage decreases in addition to providing a temperature compensation superior to that obtained with a thermistor.

The circuit also includes a tuned r.f. stage for extra sensitivity, selectivity, and improved noise figure. Both i.f. and r.f. stages are a.v.c. controlled resulting in an improved S/N ratio at points higher than sensitivity level because of the lowered current in the r.f. stage.

An autodyne converter is used where the mixer is a common-emitter and the oscillator is a common-base configuration.

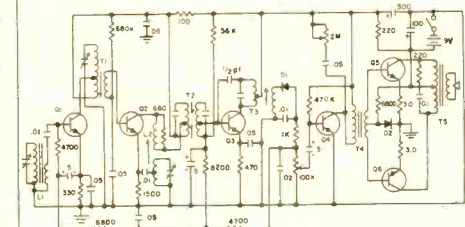

GENERAL ELECTRIC CO.		RADIO INDUSTRIES, INC.		PERFORMANCE	
Q1	2N2715	T1	1542	NOMINAL SENSITIVITY	200 μV
Q2	2N2715	T2	1544	RATED OUTPUT POWER	500 mW
Q4	2N2924 OR 2N3512	T3	1364	BATTERY DRAIN	12.5 mA
Q5	2N2714 (WITH HEAT SINK)	L1	1543	OTHER COMPONENTS	
D1	02 1N4009	L2	1541	T4	5V/2K CT
				RADIO CONDENSER CORP.	
				TUNING CONDENSER	
				MODEL 42-34 (CN 90991)	



**free** with your purchase of a **PHOTOFACT®** Library—  
*the supreme gift for your family...*  
**the famous 14-volume NEW STANDARD ENCYCLOPEDIA!**

**AN INVALUABLE  
 TREASURY OF  
 KNOWLEDGE FOR  
 ALL THE FAMILY**

*sells at retail for*  
**\$149.50**

*now yours*

**FREE** with the purchase  
 of a Photofact  
 Library consisting of  
**225 Sets or more—**

*Offer for limited time only—ACT NOW!*



A HANDSOME, PRACTICAL  
 HOME REFERENCE  
 LIBRARY

**Get this wonderful bonus for your family—give  
 your earning power a big boost with PHOTOFACT  
 —the world's finest TV-radio service data**

Now, more than ever, it pays to own a PHOTOFACT Library—the time-saving, troubleshooting partner guaranteed to help you earn more daily. Now, you can start or complete your PHOTOFACT Library the special Easy-Buy way, and get absolutely FREE with your purchase, the famous 14-volume NEW STANDARD ENCYCLOPEDIA. It's a great reference library for all the family—complete, authoritative, indispensable. Retail for \$149.50—yours absolutely FREE with the purchase of a PHOTOFACT Library consisting of 225 Sets or more!

**THERE ARE 4 CONVENIENT WAYS  
 TO SELECT YOUR PHOTOFACT LIBRARY**

1. Complete your present PHOTOFACT Library.
2. Order a PHOTOFACT "Starter" Library—225 Sets (Sets 451-675—coverage from 1959 to 1964—only \$14.29 per month).
3. Order by brand name and year—see the handy selection chart at your distributor.
4. Order a complete PHOTOFACT Library—and the famous 14-Volume New Standard Encyclopedia is yours FREE!

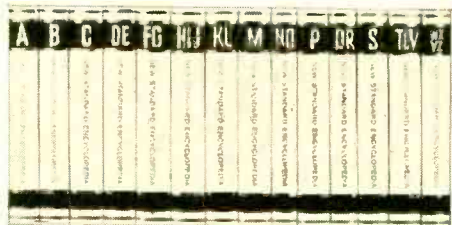

**ORDER YOUR PHOTOFACT LIBRARY NOW—  
 AND GET YOUR FREE STANDARD ENCYCLOPEDIA**

See your Distributor for the full details of the PHOTOFACT-Encyclopedia Deal, or send coupon at right! Also ask about a Standing Order Subscription to current PHOTOFACT and Specialized Service Series (FREE File Cabinets available with Subscriptions). ACT NOW!

**SEE YOUR DISTRIBUTOR OR SEND COUPON TODAY**

**OWN A PHOTOFACT LIBRARY THE EASY-BUY WAY:**

- Only \$10 down • 30 months to pay
- No interest or carrying charges • Prepaid transportation
- Add-on privilege of a year's advance subscription to current Photofact data, on the same Easy-Buy contract
- Save 30¢ per Set—special \$1.95 price applies on Easy-Buy (instead of regular \$2.25 price)

**THERE'S NEVER BEEN A DEAL TO EQUAL THIS!**

**GET THE  
 DETAILS  
 NOW**

**HOWARD W. SAMS & CO., INC.**

Howard W. Sams & Co., Inc., Dept. EWF-9  
 4300 W. 62nd St., Indianapolis, Ind. 46206

Send full information on the PHOTOFACT Library-Encyclopedia Deal, and details of the Easy-Buy Plan

My Distributor is: \_\_\_\_\_

Shop Name \_\_\_\_\_

Attn. \_\_\_\_\_

Address \_\_\_\_\_

City \_\_\_\_\_ State \_\_\_\_\_ Zip \_\_\_\_\_

# NEW MOOG KIT



## THE PMS-15 SELF-POWERED AMPLIFIER-SPEAKER

Rugged lightweight cabinet, advanced design amplifier, JBL speaker and rechargeable battery in one integrated unit for work or play... that's the new PMS-15 by Moog.

Get these advanced features in this unique portable, hi-fi unit:

- Solid state amplifier with two independent low-noise inputs, bass and treble controls, and high-efficiency power stage; regulated power supply; battery charger.
- Genuine JBL speaker Model D-216 for large power-handling capability, wide range, low distortion.
- Lightweight, rugged cabinet with special sandwich type construction.
- Heavy duty rechargeable battery (optional) gives you 5 to 30 hours playing time.
- Easy-to-follow, step-by-step instruction booklet for assembly and application.

PMS-15 Kit	<b>\$129.95</b>
PMS-15 Kit with battery	<b>174.95</b>
PMS-15 Assembled (without battery)	<b>199.95</b>
PMS-15 Assembled (with battery)	<b>244.95</b>



SEND FOR NEW CATALOG  
**R. A. Moog Company**

Dept. 1E, Trumansburg, New York

CIRCLE NO. 102 ON READER SERVICE CARD

## TAPE RECORDER

(liquidation stock)

**\$8.99**



production left over from giant national department store promotion where recorders were taped with a message to give to passing customers. Comes complete with standard 1/4" magnetic tape. Use for messages, rig with remote control invisible thread for detective work. Has unique endless loop feature. Hide anywhere, conceal in toy animal and let it make outrageous remarks to guests. Hundreds of uses. While they last. Send \$1 deposit for C.O.D. 14-Day Money Back Guarantee.

**MISSION LIQUIDATORS.**

P.O. Box 4187 San Fernando 27, California

# RADIO & TV NEWS

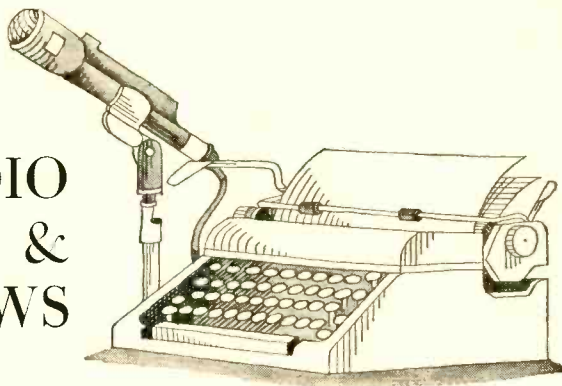

EVERY year since 1948, when the transistor was invented, there have been a considerable number of people who believe that the vacuum tube would perish momentarily. According to Merle W. Kremer, Senior Vice President of *Sylvania*, there is still considerable life left in tubes, as he announced that his company had a 25% increase in receiving-tube sales in the first five months of 1965.

Although the transistor was developed in 1948 and was in quantity production and use by 1958, the sales of domestic receiving tubes reached a peak of about 393 million units in 1960.

The current higher sales of color-TV sets, coupled with the fact that most color sets use nearly twice as many tubes as black-and-white sets, is a major reason for the significant increase in receiving-tube sales.

Mr. Kremer stated, "in the home today, there are approximately 67 million TV sets plus millions of radios and audio systems, all of which use vacuum tubes. The replacement market normally follows the original equipment by five years.

"One of the reasons for the continued use of vacuum tubes lies in their improved reliability. Tests have shown a decrease in tube failure from 5% per thousand hours to less than one-half percent failure per thousand hours." Mr. Kremer continued, "These figures are particularly important since the entertainment industry accounts for nearly 83% of all receiving-tube sales. An additional 8% of sales is to the government and military, with the remaining 9% for industrial and specialty markets.

"As a result of the increase in vacuum-tube sales, many manufacturers have taken a second look at the projected transistorization of TV sets.

"Less than two years ago, indications were that black-and-white sets would be completely transistorized by 1968. Now it looks like this will not occur until the early 1970's, with the transistorization of color sets a little slower.

"In the meantime," he added, "manufacturers will slowly increase the use of solid-state devices in TV sets."

Mr. Kremer concluded, "Considering this, receiving-tube manufacturers are

constantly exploring new areas of use, particularly in control and industrial applications."

### Ocean Antenna Tower

People have built antenna towers in strange places, but the *Boeing Co.*, in conjunction with the University of Washington Department of Oceanography, was the first one to build a 150-foot tower on a rock formation 120-feet under water. The system was designed to perform a series of underwater experiments and transmit the results back to the mainland *via* a 350-mile-long v.h.f. meteor-burst communications system. It was felt that this system would be more flexible than a floating buoy.

The bulk of the electronic equipment, including the power supply and the transmitter, is mounted at the base of the tower to minimize the impact of wave forces. Various sensors will record surface and sub-surface measurements, store them in a memory device, and automatically transmit the data back to the base station upon command from master control.

### Radio Population

Last month we covered the numerical arrangement of TV sets scattered about the world. Now we will have a look at the radio population.

According to a census made by the United States Information Agency, at the end of 1964 there were some 286,000,000 radios in use in the world outside of the U.S. and Canada, an increase of some 18,000,000 over 1963 figures.

Of the sets overseas, 36% were in Western Europe, 21% in the Far East, 20% in Eastern Europe, 12% in Latin America and the Caribbean, 7% in the Near East and South Asia area, and 4% in Africa.

The ratio of radio sets to population (exclusive of the U.S. and Canada) ranged from one set for every three persons in Western Europe to one set for every 40 persons in the Near East and South Asia.

With an estimated 228,000,000 radio sets in use in the U.S. and an estimated 10,500,000 in Canada, the world total substantially passed the half-billion mark in 1964. ▲



## Transistor Curve Tracer

(Continued from page 52)

beginning and near the ending of the particular operating cycle. The equivalent steady-state d.c. value of collector current may be established by decreasing the collector voltage until only the peak of the collector sweep occurs at the point in question. The approximate magnitude of the capacitance may be measured by adding a capacitor of 10 to 1000 pf. between the base and collector terminals. The transistor capacitance is approximately equal to the capacitance of the external capacitor when the vertical size of the loop is doubled. A comparison of Figs. 10 and 11 illustrates the effects of the collector-to-base capacitance.

### Diode Characteristics

Forward-conduction or reverse-voltage breakdown of a diode may be displayed on a curve tracer by the simple expedient of using the collector sweep supply as a voltage source. The display will represent the  $E-I$  plot with anode current plotted vertically as  $I_c$  and the anode voltage plotted horizontally as  $V_c$ . Forward and reverse zener diode characteristic curves are shown directly below in Figs. 12 and 13 respectively.

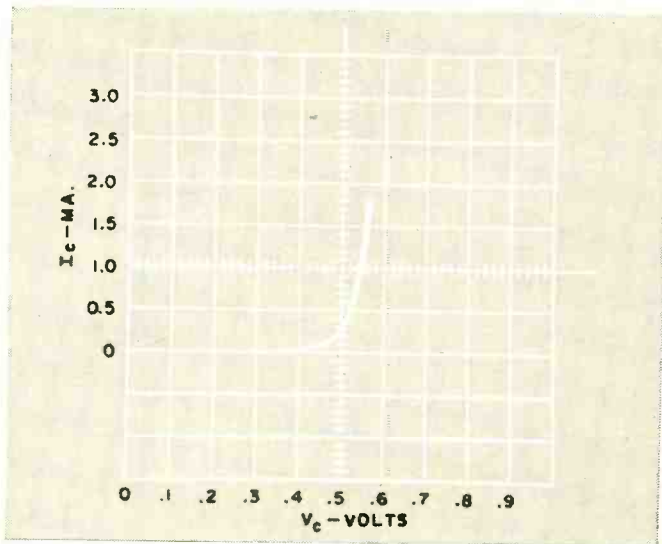
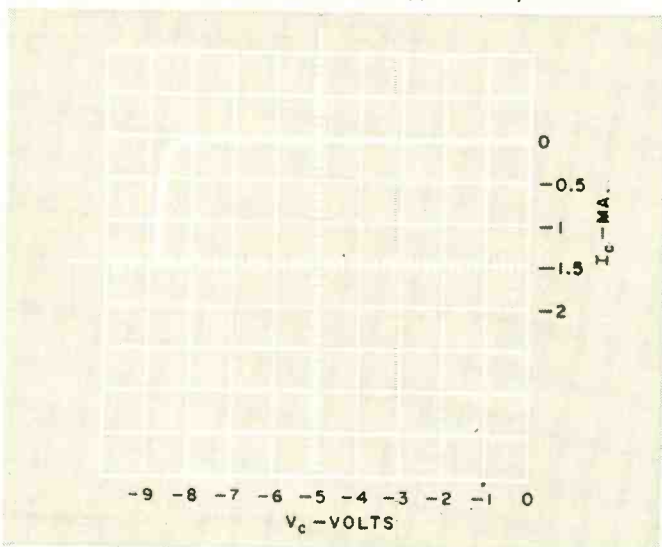

Fig. 12. The zener diode forward conduction characteristics.

Fig. 13. Zener diode reverse breakdown characteristics. The zener control voltage is shown to be approximately 8.7 volts.



September, 1965

\$175<sup>00</sup> new reduced price!



AEL

Model 245

SEMICONDUCTOR TESTER

- ✓ Tests low and high power semiconductors either in or out of circuit.
- ✓ Measures Beta with as low as 50 ohms emitter-base shunt.

### OTHER IMPORTANT FEATURES

- Measures beta in two ranges covering 1 to 1000.
- No critical nulling adjustments required.
- Measures diodes and rectifiers for opens or shorts, in-circuit with 20 ohms across device terminals.
- Completely safe for semiconductors — resistance measurements are independent of semiconductor loading. Power output limited to 0.25 microwatts.
- Simple to operate — only three controls . . . can be used by semi-skilled personnel.
- Operates on type "C" flashlight batteries.
- Easy to read — measurements are indicated on a 6½" taut-band meter.
- Portable — easy to carry — weighs less than 10 pounds.
- Ruggedly built — has high impact plastic case.

WRITE NOW for detailed technical bulletin on the amazing AEL Model 245 Semiconductor Tester.



American Electronic Laboratories, Inc.  
P. O. BOX 552R, LANSDALE, PENNA. 19446 • (215) 822-2923  
suburban Philadelphia

CIRCLE NO. 195 ON READER SERVICE CARD

61

# CHEK-IT CIRCUIT TESTER

FOR ONLY **\$1.49** DEALER NET  
LESS BATTERIES

**BATTERY OPERATED  
TESTS WITH POWER OFF**

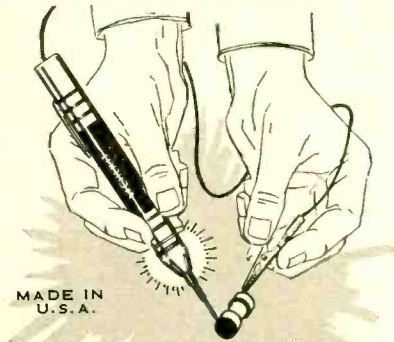

MADE IN  
U.S.A.

- CONTINUITY • FUSES • SWITCHES
- CHIMES • APPLIANCES • MOTORS
- BUZZERS • PUSH BUTTONS
- AUTO IGNITION and VOLTAGE REGULATORS, ETC.

ASK YOUR ELECTRONIC  
PARTS DISTRIBUTOR FOR

MODEL NO. **BZ5**

MANUFACTURED BY  
**WORKMAN** Electronic  
SARASOTA FLORIDA PRODUCTS INC

CIRCLE NO. 86 ON READER SERVICE CARD

### SUB CARRIER DETECTOR



Adds programs of commercial-free music thru your FM tuner when plugged into multiplex output of tuner or wired into discriminator. Detector, self-powered, permits reception of famous background music programs now transmitted as hidden programs on the FM broadcast band from coast to coast.

WIRED UNIT \$75.00. KIT, with pretuned coils, no alignment necessary \$49.50. Crystal-controlled receivers available.

#### MUSIC ASSOCIATED

65 Glenwood Road  
Upper Montclair, New Jersey  
phone 744-3387 area code 201

### 361C AUDIO EQUALIZER

Variable Equalizer necessary for professional quality recording or playback. Ideal for use between mixer and tape recorder or tape to tape, etc. Write for details or send \$2.00 for LP demonstration record. Covers tape and disc recording techniques. Refunded with purchase.

361C

**\$44<sup>95</sup>**



Order Direct or Write for information.

**KUHN ELECTRONICS**  
CINCINNATI 17, OHIO

### EARN Electronics Engineering DEGREE

You can earn an A.S.E.E. degree at home. College level HOME STUDY courses taught so you can understand them. Continue your education. Earn more in the highly paid electronics industry. Missiles, computers, transistors, automation, complete electronics. Over 27,000 graduates now employed. Resident school available at our Chicago campus—Founded 1934. Send for free catalog.

American Institute of Engineering & Technology  
1141 West Fullerton Parkway, Chicago 14, Ill.

# ADDITIONAL CHANNELS FOR BUSINESS RADIO

By LEO G. SANDS

NEW communications channels have been allocated to the Business Radio Service. A total of 12 specific frequencies in the 952-960-mc. band and more than 7000 mc. of space in the microwave bands have been made available. For the first time, the 2000-mc. band has been opened up for use in the Business Radio Service.

The 12 frequencies in the 952-960-mc. band are, however, available only for fixed stations to those who render a commercial central-station protective service. Eight of the frequencies are available only in pairs for duplex (two-way) operation, and the other four frequencies are available by themselves for simplex or one-way operation. In addition, the 10-mc. wide band between 2150 and 2160 mc. is available for duplex operation. The frequencies in this band are not specified and may be selected by the license applicant.

This recent action by the FCC is a breakthrough for central-station fire and burglar alarm system companies whose growth has been impeded by the relatively high cost or non-availability of leased wire circuits in some areas. Such companies normally lease wire lines and employ closed-loop d.c. circuits for monitoring the premises of subscribers.

Many central-station alarm companies have shown great interest in utilizing radio links for expanding their operations and for reducing wire line leasing costs. Now that 12 frequencies in the 952-960-mc. band and an entire 10-mc. slot in the 2000-mc. band are available to them, they will be able to employ new techniques using these frequencies.

In both of these bands, omnidirectional antennas may be used with up to

100 watts of transmitter input power on the four nonpaired frequencies and 30 watts on the paired frequencies in the 952-960-mc. band, and 15 watts of input power in the 2150-2160-mc. band.

Still available to Business Radio Service license applicants of all types are 64 frequencies (32 pairs) in the 952-960-mc. band which can be used only for control-repeater applications, such as remote control of base stations. Those eligible in the Public Safety and Land Transportation Radio Services, and some categories of the Industrial Radio Service, however, may use these frequencies for fixed point-to-point communications.

In the 952-960-mc. band, the radio bandwidth is limited to 100 kc. which allows use of a modulation baseband of 25 kc., adequate for four or six voice channels or up to about 200 tone-signaling channels. Bandwidth up to 800 kc. is permitted in the 2150-2160-mc. band.

The most recently published modifications of Part 91, FCC Rules and Regulations, governing the Industrial Radio Services, lists new microwave bands above 10,000 mc. as available to the Business Radio Service. See table below.

In addition to the previously listed 12,200-12,700 mc. and 13,200-13,250 mc. bands, there are four new bands specified extending up to 40,000 mc. The permitted radio bandwidths are wide enough to allow TV transmission.

It is interesting to note that the 10,550-10,680-mc. band is reserved for base and mobile stations. The 12,200-12,700 mc. band is reserved for operational fixed stations. But, in the five higher frequency bands, mobile, base, and operational fixed stations may be operated. ▲

BAND (mc.)	FREQUENCIES (mc.)	XMTR. INPUT (watts)	RADIO BANDWIDTH (kc.)	ANT. BEAMWIDTH (degrees)	FIXED	MOBILE	BASE
952-960	952.1	100	100	360	X		
	952.2	100	100	360	X		
	952.3	100	100	360	X		
	952.4	100	100	360	X		
	952.8;956.4	30	100	360	X		
	952.9;956.5	30	100	360	X		
	956.2;959.8	30	100	360	X		
	956.3;959.9	30	100	360	X		
2159-2160	not specified	15	800	360			X
10550-10680	not specified	5	25,000	4		X	X
12200-12700	not specified	5	20,000	4	X		
13200-13250	not specified	5	*	*	X	X	X
17700-19300	not specified	5	50,000	*	X	X	X
19400-19700	not specified	5	50,000	*	X	X	X
27525-31300	not specified	5	50,000	*	X	X	X
38600-40000	not specified	5	50,000	*	X	X	X

\*To be specified in the station license.



## Testing Semiconductors

(Continued from page 34)

gate-to-channel breakdown voltages may be measured in the simple test circuits given earlier for diodes. We will now look at three parameters of prime importance in working with field-effect transistors (FET's). The circuits given are shown for *n*-channel FET's but may be adapted for use with *p*-channel units if all polarities are reversed.

**Pinch-off voltage.** The value of critical gate voltage necessary to reduce the drain current to a stated minimum level is referred to as the pinch-off voltage,  $V_p$ . This may be measured in the simplified manner shown in Fig. 7E.

To take the measurement, the v.t.v.m. is connected across  $R_1$  to read drain current, and the gate voltage is adjusted from zero to the value necessary to give a v.t.v.m. reading of one volt. This means that the drain current is  $1 \mu a$ . ( $R_1$  is in shunt with the v.t.v.m. input resistance to produce a parallel value of one megohm.)

The selector switch (or v.t.v.m. probe) is moved to position 2 to read the value of  $V_{GS}$ , which equals pinch-off voltage  $V_p$ .

The  $V_p$  for some FET's is specified at a drain-current level much lower than  $1 \mu a$ . Although the value of  $V_p$  will be fairly close to the same value as measured at  $1 \mu a$ , a more accurate value may be obtained by omitting  $R_1$  and then adjusting the gate voltage until the meter reads about 0.5 volt on the 1.5-volt scale. This gives an equivalent drain current of about 50 nanoamperes. Lower values can be obtained, but stray leakages tend to give problems. Source  $V_{GS}$  should be a small battery so it can be well isolated.

**Transconductance and drain current.** A convenient circuit arrangement for measuring the transconductance ratio  $g_{fs}$  and the drain current for any level of gate-voltage bias is shown in Fig. 7F.

The parameter  $g_{fs}$  is actually a small-signal a.c. measurement but it may be approximated, with accuracy adequate for most purposes, by an incremental d.c. approach. When the test switch is depressed, the gate voltage will change by 0.1 volt. This causes the drain current to change by an amount which is proportional to the value of  $g_{fs}$ .

Since transconductance is merely amperes-per-volt of input signal,  $g_{fs}$  in micromhos will be equal to ten times the change in drain current expressed in microamperes.

The most common measurement of  $g_{fs}$  is for a nominal gate voltage of zero and is referred to as  $g_{fs0}$ . To obtain this, set  $V_{GS}$  to zero, read the drain current carefully, close the switch, and read the drain current again. The value of  $g_{fs0}$  may

## CRYSTALS are not all the same!



TEXAS CRYSTALS quality is outstanding as evidenced by use in numerous government space projects where there's no compromise with quality, reliability or accuracy. For commercial two-way, ham operation or special frequency control crystals, Texas Crystals are your best buy.

If your dealer is temporarily out of stock or does not carry Texas Crystals, send us his name along with your order. Minimum order, check or C.O.D. is \$5.00. Add 5¢ per crystal for postage, 10¢ for air mail.

Send for Free Catalog with Circuits

## TEXAS CRYSTALS

1000 Crystal Drive  
Fort Myers, Florida 33901  
Phone 813 — WE 6-2109



4117 W. Jefferson Blvd.  
Los Angeles, California 90016  
Phone 213 — 731-2258

A Division of Whitehall Electronics Corp.

CIRCLE NO. 90 ON READER SERVICE CARD

## Otto Werk sent in this Coupon

LTV UNIVERSITY

Desk J-55, P.O. Box 1056  
Oklahoma City, Oklahoma

- Send me the UNIVERSITY Hi-Fi Guide  
 Send me the MUSTANG STORY

NAME .....

ADDRESS .....

CITY ..... STATE ..... Zip Code .....

## Look what he got!

Lots of help . . . right from the horse's mouth, 'cause now University's got a Mustang! Plus a corral full of other speakers. University speaker guides showed him how to choose a speaker system, how to build a custom system with separate speakers—and much more! Send for these guides right away. You'll be an expert too. Just like a smart Dane named Otto.



LTV UNIVERSITY  
A DIVISION OF LING-TEMCO-VOUGHT, INC. SPEAKERS / MICROPHONES

9500 W. Reno, P. O. Box 1056, Oklahoma City, Oklahoma

CIRCLE NO. 106 ON READER SERVICE CARD



## The most up-to-date guide available today to the world of Radio Communications!

**4 BIG SECTIONS** Here is an information-packed "encyclopedia" covering the four major branches of specialized radio communications—

**CITIZENS RADIO SERVICE**    **SHORT WAVE LISTENING**  
**AMATEUR RADIO**            **BUSINESS RADIO SERVICE**

Complete with charts, tables and illustrations this all-new work brings you exclusive information on such vital subjects as obtaining your license, establishing your CB station, CB ethics—practice and procedure, SWL and station reporting, CB clubs, Ham license application procedures, learning the code, typical business radio installations, and much more—every major area of the field is covered by a leading authority and presents a wide range of material—from basic fundamentals for the beginner through exclusive up-to-the-minute data and techniques essential for those in advanced communications.

### EXTRA!

FOR THE FIRST TIME  
TWO EXCLUSIVE DIRECTORIES

- ★ Complete directory of all new citizens band equipment
- ★ Complete specifications on every new 1965 SWL Receiver and every new 1965 CB Transceiver

**Only \$100**

**FILL IN, DETACH AND MAIL THIS COUPON TODAY!**

ZIFF-DAVIS SERVICE DIVISION, Dept. CH  
589 Broadway, New York, N.Y. 10012

Please send my copy of the 1965 COMMUNICATIONS HANDBOOK. My dollar (plus 15¢ for shipping and handling; 25¢ outside U.S.A.) is enclosed.

name  please print

address

EW-95

city  state  zip code

then be calculated as just described.

Parameter  $g_{fs}$  may also be measured for any other value of test or drain current. Voltage  $V_{GS}$  is adjusted until the desired bias conditions are reached, then the switch is closed.

Another important FET parameter is  $I_{DSS}$ , the drain current which flows for zero gate voltage. This is read on the v.o.m. used to register the drain current when  $V_{GS}$  is set to zero and the switch left open. Fig. 7F is also helpful in experimenting with various bias levels.

### SCR Measurements

One of the most important SCR parameters, outside of perhaps the breakdown voltage, is the gate current required to cause it to fire. This may be determined using the circuit of Fig. 7G.

### Switches and Relays

(Continued from page 26)

temperatures. The base-to-emitter and collector-to-base voltage drop of transistors vary considerably with temperature, and inexpensive transistors of the grown-junction type have objectionable base charge characteristics which preclude saturated operation if a perfect square wave is to be obtained.

The low cost of a reed relay makes it very attractive for use as a d.c. chopper. Switching rates of several hundred cycles per second are possible, and the high re-

sistance differential between closed and open condition, together with a lack of temperature problems, offer considerable advantage over a transistorized switching circuit.

The development of the magnetic reed switch filled a definite need for a component that can supplement the solid-state switch in certain specific areas. Its tolerance to voltage transients, simple and reliable construction, together with its low cost, are added advantages which leads to various applications. The imaginative reader will think of many other uses for this extremely versatile new component.

The SCR to be tested is placed in the socket with the gate-current adjust potentiometer  $R3$  set to zero. Current  $I_G$  is slowly increased with  $S1$  closed, until the lamp lights. The gate current just at the instant the SCR fires is the critical value. The lamp will remain lit (even if  $S1$  is released to remove the gate current) until the SCR is removed, or until  $S2$  is depressed momentarily (closed) to reset the SCR. The capacitors prevent unwanted firing of the SCR.

Two means of measuring the critical current are shown. If a v.o.m. is handy, then it may be used to measure the current directly. On the other hand, a v.t.v.m. may be placed across  $R1$  to measure the current indirectly. For very low-level SCR's, it will be necessary to increase the value of  $R1$  substantially. ▲

Two means of measuring the critical current are shown. If a v.o.m. is handy, then it may be used to measure the current directly. On the other hand, a v.t.v.m. may be placed across  $R1$  to measure the current indirectly. For very low-level SCR's, it will be necessary to increase the value of  $R1$  substantially. ▲

### REED-RELAY MANUFACTURERS

Allen-Bradley Co.  
136 W. Greenfield Ave., Milwaukee 4, Wis.

Automatic Electric Co.  
Sub., General Telephone & Electronics  
Northlake, Illinois

Computer Components Inc.  
8806 Van Wyck Expwy., Jamaica 18, N.Y.

Coto-Coil Comp., Inc.  
Providence, R.I.

Clare, C.P. Co.  
3103 Pratt Blvd., Chicago 45, Ill.

Davis Electric Co.  
230 N. Spring Ave., Cape Girardeau, Mo.

Douglas-Randall, Inc.  
Sub., Walter Kidde & Co., Inc.  
6 Pawcatuck Ave., Westerley, R.I.

Filters, Inc.  
65 Daly Rd., East Northport, L.I., N.Y.

General Electric Co.  
General Purpose Control Dept.  
Bloomington, Ill.

General Reed Co.  
174 Main St., Metuchen, N.J.

Gordos Corp.  
250 Glenwood Ave., Bloomfield, N.J.

Grigsby Co., Inc., The  
407 N. Salem Ave., Arlington Heights, Ill.

Hamlin, Inc.  
Lake & Grove Sts., Lake Mills, Wis.

Hathaway Instruments, Inc.  
5800 East Jewell Ave., Denver 22, Colo.

Jaidinger Mfg. Co., Inc.  
1921 W. Hubbard St., Chicago 22, Ill.

Line Electric Co.  
249 River St., Orange, N.J.

Magnecraft Electric Co.  
5575 N. Lynch Ave., Chicago 30, Ill.

Milwaukee Relays, Inc.  
Box 123, Cedarburg, Wis.

Minneapolis-Honeywell Regulator Co.  
Microswitch Div.,  
Freeport, Ill.

MKC Electronics Corp.  
454 E. Donovan Rd., Kansas City 15, Kans.

Radio Corporation of America  
Electron Tube Division  
Harrison, N.J.

R.B.M. Controls Div.  
131 Godfrey St., Logansport, Ind.  
2908 Nebraska Ave., Santa Monica, Calif.

Revere Corp. of America  
845 N. Colony Rd., Wallingford, Conn.

S.R. Engineering  
123 W. 155th St., Gardena, Calif.

Struthers-Dunn, Inc.  
Lamb's Rd., Pitman, N.J.

Wabash Magnetics, Inc.,  
Box 454, Wabash, Ind.

Western Electric Co.  
Allentown, Pa.

Wheelock Signals, Inc.  
273 Branchport Ave., Long Branch, N.J.

Wintronics, Inc.  
1132 S. Prairie Ave., Hawthorne, Calif.





# NEW CITIZENS BAND CIRCUITS

By LEN BUCKWALTER

Simplified frequency-synthesis transceiver / Dual-power transmitter / Zener-regulated circuit

**F**REQUENCY synthesis—the technique for achieving all-channel operation with few crystals—appears in a new transceiver by *Pearce-Simpson*. Like other circuits of this type, it uses only 14 crystals to obtain, through suitable mixing, the equivalent of 46 crystal-controlled channels (23 receive, 23 transmit). In the "Hetrosync" system, however, the circuit goes a step farther. It not only eliminates some crystals, but a mixer stage as well. Second, we look at a novel feature in a *Kaar* 5-watt transceiver that could signal a new trend in CB; a simple modification which reduces power. This conventional CB unit can be easily converted to operation as a license-free 100-milliwatt set. Our third circuit is the *Lafayette* HB-500, a completely solid-state transceiver that relies on a network of zener diodes to keep the receiver stable during mobile operations.

## Pearce-Simpson "Hetrosync"

Before introducing its 23-channel transceiver, *Pearce-Simpson* reports that it evaluated several design possibilities using frequency synthesis. In one approach, three oscillators operate simultaneously to generate various signals. They combine to produce the final operating channels. While this approach is functional, it is subject to spurious products in the transmitted signal or "birdies" in the receiver. The solution is generally one of suppression, rigorous shielding, and additional tuned circuits in sensitive stages. For its "Guardian 23" (photo A), however, the company has elected to use a system which requires only two oscillators in operation at a given time. Undesired harmonics and beat frequencies are thereby reduced.

The system, called "Hetrosync," is shown in the circuit of Fig. 1. Two stages not common to the conventional transceiver are the master oscillator (V1A) and transmit mixer (V2A). These stages will process signals in the 33-mc. and 6-mc. range to produce a difference frequency—27 mc.—which falls into the correct transmission band.

Consider circuit conditions for transmitting on channel 1, or 26.965 mc. As the operator turns the channel-selector switch, the master oscillator is activated by a crystal on 33 mc. At the same time, the transmit oscillator, V2B, develops a crystal-controlled 6.035-mc. signal. Heterodyning of the two signals occurs in the transmit mixer (V2A) and the difference is channel 1 on 26.965. By consulting the crystal

chart shown next to the master and transmit oscillator stages, it can be seen that a total of 10 crystals yields the necessary difference combinations to establish a full complement of 23 transmit channels. The channel-selector switch connects the correct crystal pairs for each channel.

In the receive mode, a similar system is used but it is not, strictly speaking, frequency synthesis. There are no additional mixer the same crystal frequency used earlier for channel 1 sion receiver. The significant feature is that i.f. frequencies were chosen to make use of crystals which also function on transmit.

Consider how channel 1 is received. An incoming signal on 26.965 mc. enters receiver r.f. amplifier V3, then is coupled to 1st mixer V1B. The master oscillator now injects to the 1st mixer the same crystal frequency used earlier for channel 1 transmit (33 mc.). It beats with the received signal to produce an i.f. on 6.035 mc.

The next step-down in frequency occurs in the 2nd mixer (V4A). Here, a new set of four crystals is introduced at receiver oscillator (V4B). In the second conversion process, a 6.490-mc. crystal beats with the 1st i.f. (6.035 mc.) to obtain 455 kc., the second i.f. Again, the chart reveals how four crystals in the V4B stage can produce various channel combinations with the master oscillator. In this fashion, only two oscillators are activated at a given time.

To keep within a transmit frequency tolerance of .005%, crystals in the 33-mc. range are rated at .002%, and 6-mc. units held to .0025%. These result in an over-all frequency tolerance of .003%.

*For a copy of the manufacturer's brochure, circle No. 27 on Reader Service Card.*

## Kaar D333 Dual-Power Transmitter

At least two CB manufacturers now offer the dual-power transceiver; a unit that operates in conventional 5-watt fashion or reduces r.f. input to 100 milliwatts. The transceiver is converted to a low-power communications device and comes under Part 15 of FCC regulations. Although range is limited, the rules are considerably less strict. The unit may be freely used without call signs, station identification, or the operating limits of class D.

To achieve power reduction from 5 watts down to 100

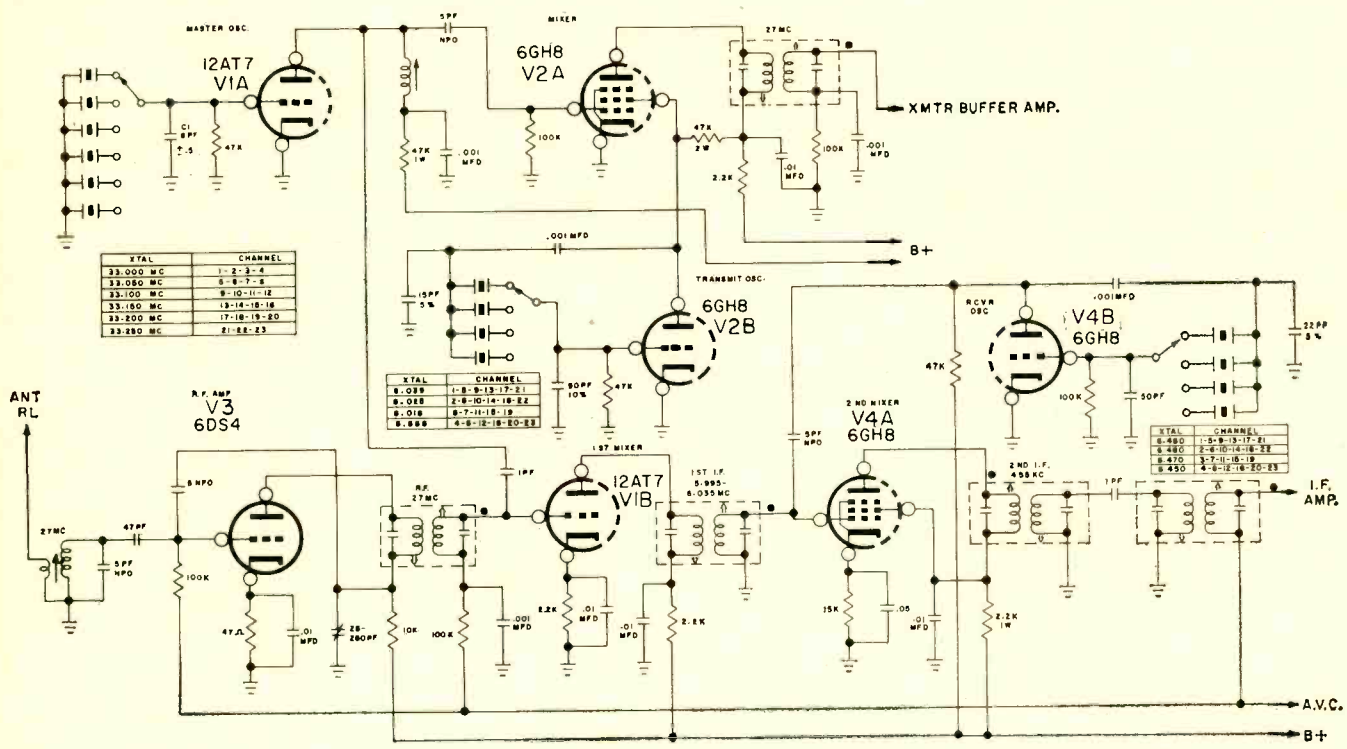

Fig. 1. The Pearce-Simpson "Hetrosync" circuit frequency synthesizer employs only two oscillators at a given time.

mw. it is not acceptable to add some form of resistive dummy load to the transmitter and dissipate excess output power as heat. Part 15 of the rules is explicit in specifying a maximum input of 100 mw. to the final r.f. stage. One approach to reduced-power operation occurs in the Kaar D333 5-watt CB transceiver (see photo B). In the schematic may be seen three modifications which alter the transceiver for Part 15 operation when desired.

The transmitter section is shown in Fig. 2. During conventional CB transmit operation, the final r.f. amplifier, V2, receives approximately 240 v.d.c. from the power supply to develop 5-watt input power. Audio at about 2.5 watts is applied to the plate of the tube for modulation. The major circuit change for reducing final power to the 100-mw. level is the insertion of the "B+" voltage divider. As shown in dotted lines, R1, a 10,000-ohm resistor, is added from "B+" to ground. The other portion of the divider consists of parallel resistors R2-R3 in series with the "B+" supply to the tube plate. In this manner, the original 240-volt plate potential is

reduced to approximately 80 volts. The final stage now develops the desired 100-mw. input.

Next, the audio from the modulator tube is reduced. Since it is applied along the leg which also powers the r.f. amplifier (Mod. "B+"), audio encounters the same voltage divider. Audio is dissipated in the divider which loads the modulator tube. Another factor to reduce audio reaching the final r.f. stage is an impedance mismatch. With the r.f. stage now operating at less than 5-watt input, it presents an excessively high modulating impedance to the audio modulation transformer. Loss of efficiency reduces audio power to proper levels for modulating a 100-mw. carrier.

A third circuit modification occurs for low-power operation. The signal power meter at the lower right requires additional r.f. voltage to read adequately during 100-mw. operation. This is solved with the addition of a 2.5-mhy. choke (L1) across the r.f. sampling source in the antenna circuit. Additional impedance presented by the choke raises r.f. voltage applied to meter-rectifier diode D1.

Fig. 2. The Kaar transmitter can be operated at either 5 watts input or at 100 milliwatts input power.

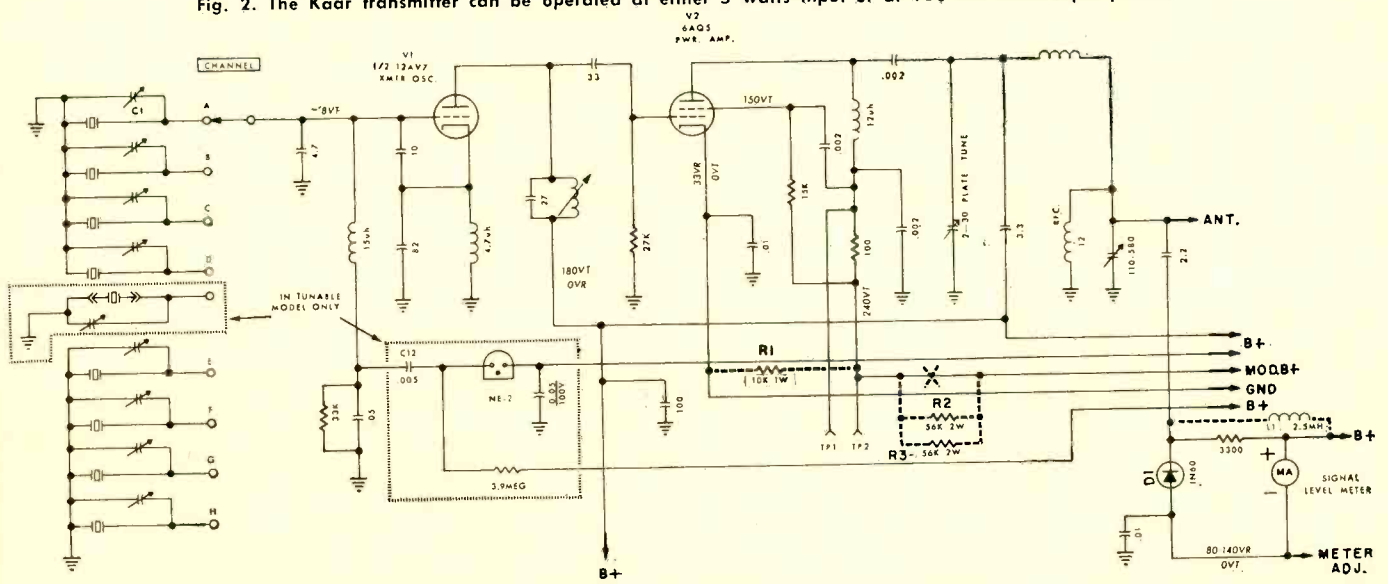



Another notable feature of the *Kaar* circuit is the use of trimmers across all transmitter crystals, as typified by capacitor C1 at the top left. Rated at about 1-8 pf., the trimmers permit small variations in crystal frequency during initial transmitter alignment. According to the manufacturer, they narrow frequency tolerance down to .003 percent, as opposed to the broader .005 percent limit that is stated in the applicable FCC regulations.

For a copy of the manufacturer's brochure, circle No. 28 on Reader Service Card.

### Lafayette HB-500 Zener Regulator

To solve several problems which accrue from shifting supply voltage in mobile operation, the *Lafayette* HB-500 transceiver (see photo C) utilizes regulator circuitry built around two zener diodes. The set is all-transistor which makes it somewhat more susceptible to supply fluctuations than the equivalent tube transceiver. One major problem originated in the receiver's tunable oscillator but, as we will see, the particular solution that is employed also benefited other voltage-sensitive stages.

Fig. 3 is a simplified schematic of the regulator and the receiver stages it controls. Source voltage from the automobile is introduced near the left side of the schematic and is nominally 11.7 volts at this point. It may be expected to run anywhere from about 11 to 14 volts as engine speed or the car's generator adjusts output according to the condition of the battery. This primary voltage is seen leading through a 330-ohm resistor to the first zener diode (D1), rated at 7.8 volts. Working in combination with the large 50- $\mu$ f. capacitor, the zener stiffens the voltage, then branches it off to the squelch pot. Without this circuit-design feature, the squelch setting of the receiver would tend to vary with changes in the primary supply voltage.

Another branch from the 7.8-volt zener is applied through an 18,000-ohm resistor. Voltage here is dropped to 1.38 v. to provide steady bias to the base circuits of several receiver transistors, the r.f. amplifier and two i.f. stages. This introduces a slight degree of delayed a.v.c. The 1.38-volt potential establishes forward bias on the transistors so these stages are held at maximum sensitivity in the absence of a received signal. As negative a.v.c. develops during signal reception, the fixed 1.38-volt bias is overcome and receiver sensitivity reduces in step with carrier strength.

The second zener diode (D2) seen at the bottom of the schematic is a 7-volt type which picks up regulated voltage from the other zener through a 270-ohm resistor. Function of the 7-volt unit is to closely control the supply to the 1st conversion oscillator. During manual receiver tuning, the stage operates as a self-excited oscillator and is especially responsive to supply-voltage change. Without the 7-volt zener, frequency drift would make tuning difficult. It is seen that the zener, in this case, regulates both base bias and collector voltage of the transistor. Another benefit of this particular circuit arrangement is that oscillator pulling on strong-signal reception is reduced. ▲

For a copy of the manufacturer's brochure, circle No. 29 on Reader Service Card.

Fig. 3. Lafayette circuit employs a pair of zener diodes.

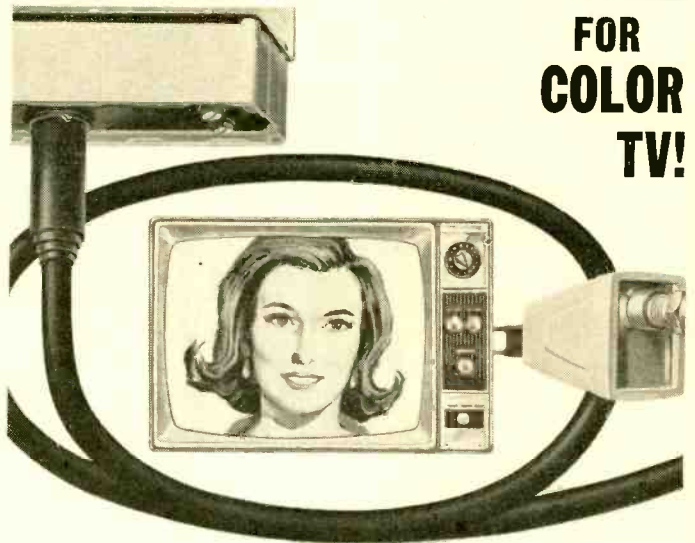
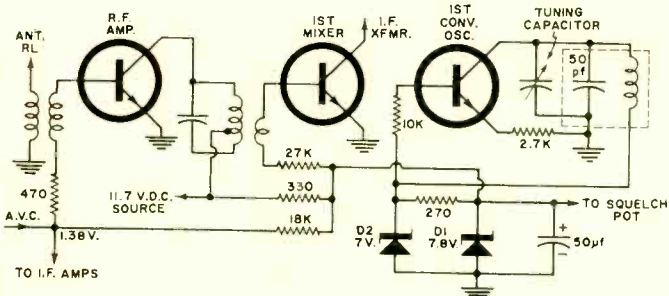

## NEW JERROLD COLORAXIAL™ Reception System

The old familiar twinlead antenna line, that worked pretty well for black-and-white TV, is hopelessly inadequate for color. When your pictures change color, smear, and ghost, it's usually the fault of the twinlead connecting your set to the antenna.

NOW, Jerrold, pioneer and leader in TV reception systems, announces Coloraxial™—a system for converting any outdoor antenna to shielded coaxial-cable operation. Installs in minutes... keeps color, b&w, and FM stereo signals clean... keeps interference out. Outlasts twinlead up to ten times.

Jerrold Coloraxial Kits give you everything you need for fast, low-cost installation: 50 or 75 feet of shielded Coloraxial cable complete with fittings; matching transformers; even a Coloraxial antenna if

your present antenna needs replacing.

Send coupon today for full information.



JERROLD ELECTRONICS, Dept. EW-9  
15th & Lehigh Ave., Philadelphia 32, Pa.  
Send me complete information on the new Jerrold Coloraxial™ TV/FM Antenna System.

Name .....

Address .....

City ..... State .....

# You can earn more money if you have an FCC License

FCC FORM 758 A

*The United States of America*

NUMBER  
PI-20-6490

**FEDERAL COMMUNICATIONS COMMISSION**

**RADIO TELEPHONE OPERATOR LICENSE**

**FIRST CLASS**  
(General Radiotelephone Certificate)

*This certifies that* TOMMY WILLIS DUFFY

IS A LICENSED RADIO OPERATOR, AUTHORIZED, SUBJECT TO ANY SPECIAL ENDORSEMENT PLACED HEREON, TO OPERATE THE CLASSES OF LICENSED RADIO STATIONS FOR WHICH THIS CLASS OF LICENSE IS VALID UNDER THE ORDERS, RULES, AND REGULATIONS OF THE FEDERAL COMMUNICATIONS COMMISSION, ANY STATUTE OF THE UNITED STATES AND ANY TREATY TO WHICH THE UNITED STATES IS A PARTY.

THIS LICENSE IS GRANTED UNDER THE AUTHORITY OF THE COMMUNICATIONS ACT OF 1934 AS AMENDED, AND THE TERMS AND CONDITIONS THEREOF AND OF ALL LEGISLATIVE ACTS, EXECUTIVE ORDERS, AND TREATIES TO WHICH THE UNITED STATES IS SIGNATORY, AND ALL ORDERS, RULES AND REGULATIONS OF THE FEDERAL COMMUNICATIONS COMMISSION, WHICH ARE BINDING UPON RADIO OPERATORS, ARE MADE A PART HEREOF AS THOUGH SPECIFICALLY SET OUT IN FULL HEREIN.

NEITHER THIS LICENSE NOR THE RIGHTS DERIVED THEREIN SHALL BE ASSIGNED OR OTHERWISE TRANSFERRED TO ANY OTHER PERSON.

PLACE AND DATE OF ISSUANCE: BUFFALO, NEW YORK SEPTEMBER 11, 1963

DATE AND TIME OF EXPIRATION: SEPTEMBER 11, 1968 AT THREE O'CLOCK A. M., EASTERN STANDARD TIME.

SPECIAL ENDORSEMENT: SHIP RADAR ENDORSEMENT - SEPTEMBER 11, 1963 - BUFFALO, NEW YORK

 *[Signature]*  
ISSUING OFFICER

*Federal Communications Commission*

*[Signature]* (Licensee)      *[Signature]* (Issuing Officer)      *[Signature]* (Secretary)

NOT VALID UNTIL SIGNED

## Employers are paying good money for men holding FCC tickets. Read how to get yours:

When you hold a Commercial License issued by the FCC (Federal Communications Commission) you have written proof that you know and understand basic electronic theory and fundamentals. It's worth plenty . . . particularly to companies on the lookout for qualified electronics technicians. Here's how one of the country's leading office machine manufacturers rates men with FCC Licenses:

"An FCC License is an asset to any man looking to enhance his career in the field of electronics. At our Company, a licensed man is well-rewarded because an FCC License attests to his knowledge of electronics theory . . ."

Thousands of employers will tell you the same thing. Licensed men get the good jobs. They make more money

. . . move ahead faster . . . enjoy exciting, challenging work. What's more, they're needed badly in every field of electronics. Industrial electronics. Radio-TV Broadcasting. Aerospace. Electronics Servicing . . . including mobile and marine radio *plus* CB.

Yes . . . your opportunities are unlimited once you're carrying that FCC Commercial Ticket. AND CLEVELAND INSTITUTE OF ELECTRONICS CAN GET ONE FOR YOU! On the facing page, read how four ambitious men just like you have cashed in on CIE's sure-fire FCC Licensing Program. Read about CIE's exclusive money-back offer. And then send in the postage paid reply card. CIE will quickly send you complete FREE information. You will soon be on *your* way to a Commercial FCC License and the many rewards that go with it!



# These CIE men have good jobs

(they have Commercial FCC Licenses)



**Matt Stuczynski, Senior Transmitter Operator, Radio Station WBOE.** "I give Cleveland Institute credit for my First Class Commercial FCC License. Even though I had only 6 weeks of high school algebra, CIE's AUTO-PROGRAMMING teaching method makes electronics theory and fundamentals easy. After completing the CIE course, I took and passed the 1st Class Exam. I now have a good job in studio operation, transmitting, proof of performance, equipment servicing. Believe me, CIE lives up to its promises!"



**Ted Barger, Electronic Technician, Smith Electronics Co.** "I've been interested in electronics ever since I started operating my own Ham rig (K8ANF). But now I've turned a hobby into a real interesting career. Cleveland Institute of Electronics prepared me for my Commercial FCC License exam . . . and I passed it on the first try. I'm now designing, building and testing all kinds of electronic equipment . . . do a lot of traveling, too. It's a great job . . . and thanks to CIE and my FCC License, I'm on my way up."



**Chuck Hawkins, Chief Radio Technician, Division 12, Ohio Dept. of Highways.** "Cleveland Institute Training enabled me to pass *both* the 2nd and 1st Class License Exams on my *first* attempt . . . even though I'd had no other electronics training. (Many of the others who took the exam with me were trying to pass for the eighth or ninth time!) I'm now in charge of Division Communications and we service 119 mobile units and six base stations. It's an interesting, challenging and extremely rewarding job. And incidentally, I got it through CIE's Job Placement Service . . . a free lifetime service for CIE graduates."



**Glenn Horning, Local Equipment Supervisor, Western Reserve Telephone Company (subsidiary of Mid-Continent Telephone Company).** "There's no doubt about it. I owe my 2nd Class FCC License to Cleveland Institute. Their FCC License Program really teaches you theory and fundamentals and is particularly strong on transistors, mobile radio, troubleshooting and math. Do I use this knowledge? You bet. We're installing more sophisticated electronic gear all the time and what I learned from CIE sure helps. Our Company has 10 other men enrolled with CIE and take my word for it, it's going to help every one of them just like it helped me."

## FCC LICENSE WARRANTY

A CIE FCC License Course will quickly prepare you for a Commercial FCC License. If you don't pass the FCC exam . . . on the first try . . . after completing your course, CIE will refund all your tuition. You get an FCC License . . . or your money back!

Two out of three men who took the 1st Class Commercial FCC License exam in 1964, failed.

Nine out of ten CIE-TRAINED men who take this exam, pass . . . the very first try!

And that's why CIE can back their courses with the warranty you see at the left. CIE-trained men know their stuff . . . because CIE AUTO-PROGRAMMED Home Study *works!*

Get started now. Send postage-paid reply card for free information about a plan that gets you an FCC License *or costs you nothing!*

**CIE** **Cleveland Institute of Electronics**  
1776 East 17th Street, Dept. EW-6 Cleveland, Ohio 44114



**WORLD'S FINEST**  
**5-CORE SOLDER**

**ERSIN MULTICORE**  
**NEW EASY DISPENSER PAK ONLY 69¢**

BUY IT AT RADIO-TV PARTS STORES  
 MULTICORE SALES CORP. PORT WASHINGTON, N. Y.  
 CIRCLE NO. 198 ON READER SERVICE CARD

when it's time to think of college  
 you should read this  
**FREE CAREER BOOKLET**

about electronics at  
**MSOE**

**MILWAUKEE SCHOOL OF ENGINEERING** MS-235  
 Dept. EW-965, 1025 N. Milwaukee Street  
 Milwaukee, Wisconsin 53201

Tell me about an engineering career through residence study in:

Electrical fields     Mechanical fields

Name..... Age.....

Address.....

City, State.....

CIRCLE NO. 103 ON READER SERVICE CARD  
 72

## Testers for Semiconductors

(Continued from page 44)

qualitative information on the over-all condition of the device.

### Switching Test Sets

A number of manufacturers (e.g., Fairchild, Texas Instruments, and Wiltron) market testers for measuring delay times of switching transistors with an accuracy as high as 2%. Many of the units are quite sophisticated and permit direct reading of the delay times. Automatic operation and "go, no-go" testing are also possible with these test sets.

In simple terms, a rectangular pulse (Fig. 8A) is applied to the base of a transistor. The output, neglecting the phase inversion introduced by the transistor, generally appears as shown in Fig. 8B. The times  $t_d$  (delay time),  $t_r$  (rise time),  $t_s$  (storage time), and  $t_f$  (fall time) can be observed on a cathode-ray tube or read directly on a meter. In the direct-reading instrument, a digital counter, for example, indicates the time it takes for the output waveform to reach a certain percentage of its maximum value. If the rise time  $t_r$  were measured, the counter would keep track of the time it takes the output waveform to rise from 10% to 90% of its maximum value. The binary count is converted to a decimal number and the rise time read on a meter or from a decimal counter.

### SCR Tester

An example of a special tester will be considered next. Teltronics offers an SCR gate sensitivity meter which enables its user to read directly gate current-to-fire ( $I_{gf}$ ) and gate voltage-to-fire ( $V_{gf}$ ) values for triggering a silicon controlled rectifier. A block diagram of the unit is shown in Fig. 9A. The adjustable source (either current or voltage) is varied until the SCR fires. The corresponding gate current (or voltage) is indicated directly on the meter. Claimed accuracies for the unit are: gate current,  $\pm 3\%$ ; gate voltage  $\pm 5\%$ .

### Automatic Test Equipment

With the large number of semiconductor devices manufactured, the need arises for automatic test equipment. Quite a few companies are engaged in

supplying this type of tester. For purposes of illustration, a unit produced by Fairchild will be analyzed. The equipment is switch-programmed and the various device measurements to be performed are automatically sequenced. Digital readout of the test results is another feature of the equipment.

The heart of the system is a current summing detector loop, shown in Fig. 9B. Assume a breakdown voltage ( $BV$ ) test of a transistor with the base open ( $BV_{CEO}$ ) is to be made. The programming unit in the system connects the  $BV$  supply,  $V_{ref}$  and  $R_{ref}$  to the bridge. The detector-amplifier circuit senses the current at the summing point junction (point A) and drives a digital loop which adjusts the  $BV$  supply until a null is obtained.

When the applied voltage across the transistor is less than the breakdown voltage, the current through the transistor is less than  $I_c$  and point A is negative with respect to ground. The summing junction becomes positive when the applied voltage exceeds the breakdown value of the device. The digital loop will continue to adjust the  $BV$  supply until current  $I_d = I_c$  and a null is consequently achieved. At this point, the detector-amplifier triggers the digital loop and the value of breakdown is indicated directly.

The prospective user and purchaser of test equipment should refer to the various catalogues published by manufacturers for complete data. A Directory listing such firms will be found elsewhere in this issue. ▲

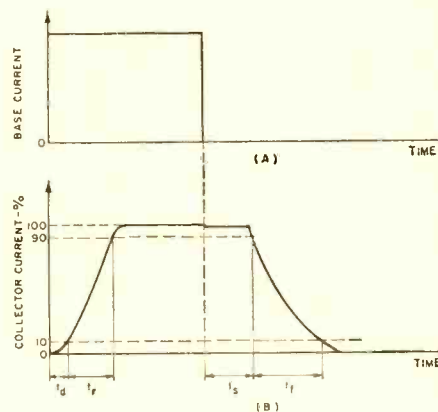

Fig. 8. Measuring delay times of a switching transistor. (A) Base-current waveform. (B) Collector current, neglecting inversion.

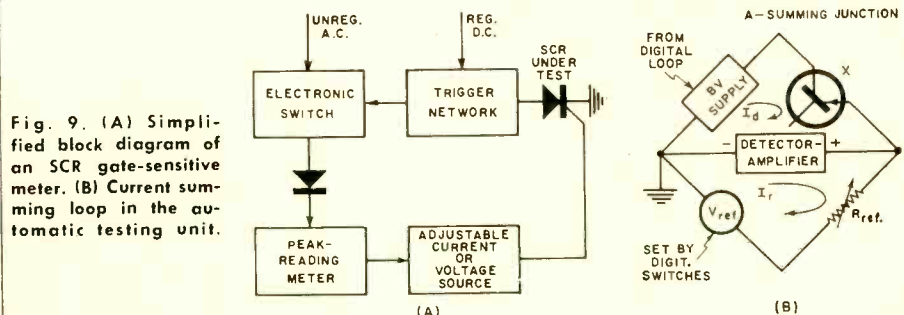

Fig. 9. (A) Simplified block diagram of an SCR gate-sensitive meter. (B) Current summing loop in the automatic testing unit.



## Laser Applications

(Continued from page 48)

devices, that is, the voltage developed is proportional to the intensity of light at the sensitive surface which, in turn, is proportional to the square of the electric field.

If the two inputs are mixed at the sensitive surface, the resultant response contains a term whose amplitude is proportional to the product of the local oscillator strength and signal strength. The frequency is equal to the difference in frequency between the local oscillator and signal. By frequency-locking the local oscillator to the transmitter, the carrier is suppressed and the information (AM or FM) appears directly as voltage at the terminals of the detector that is used.

It must be pointed out that the signal bandwidths concerned must exceed 1000 mc. if we are to effectively use the laser carrier frequency. This places a requirement on the frequency response of the photodetector which can only be met by means of a rather specialized construction of the detector element that is employed.

### Applications of the Laser

Although many components of a laser communications link are still in the development stage and many technical problems have yet to be solved, there is no doubt that optical communications systems will emerge and find extensive use in the future. Long distance line-of-sight communications outside the hindrance of the earth's atmosphere will certainly become necessary as man's domain extends into space. For this application, the small beam angles characteristic of the laser will have no competition from more conventional radio and radar systems. Also, as the ever greater number of telegraphy links demanded by the complexity of modern society grows, the tremendous capacity of the laser system may make the construction of optical tunnels between cities a more practical approach than the continued expansion of present-day methods.

Other systems for which the laser will certainly find application lie in the realm of military defense systems where tasks such as ranging and tracking are well suited to the high-frequency, narrow-beamwidth laser beam. An optical range tracker using a laser as its source is capable of range resolution greater than 3 feet in 10 miles. However, the laser will not entirely replace radar in these functions because the same narrow beamwidth desirable for accuracy makes it unsuitable for search and target acquisition. What is more, the laser beam is seriously affected as a result of atmospheric conditions.

A single pulse of ruby laser light less than a microsecond long, when well focused, may raise the temperature of a

Fig. 6. Laser interferometer for precision length measurements.

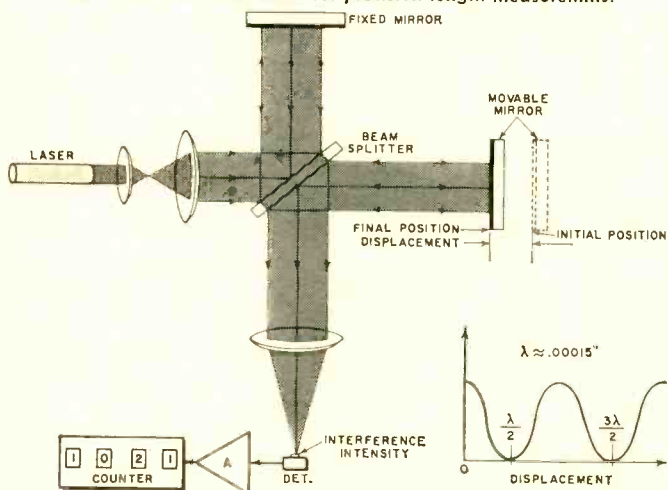

Use it... mobile...  
base...  
or portable!

## MESSENGER III



### Cape Horn to Fairbanks, Alaska

"Messenger III" goes all the way on Mercury Comet 16,200 mile durability run! Comet drivers report: Over 40 continuous days and nights, through rain, fog, sleet and snow... on washboard roads, some scarcely more than a trail... in tropic heat and frigid Arctic weather—the "Messenger III" never let them down!

## For unmatched quality and dependability—GO JOHNSON!

The most popular CB transceiver in the world—the "Messenger III" offers everything you ever wanted in a CB transceiver... compact size, a husky signal, extreme sensitivity, razor-sharp selectivity—and complete flexibility for base station, mobile, public address, or battery powered portable use! Double conversion receiver—set-and-forget "Volume" and "Squelch" controls—11 channel coverage—"Tone Alert" Selective Calling System available as accessory.



**E. F. JOHNSON CO.**

1127 10th Ave. S.W. • Waseca, Minnesota 56093

WRITE TODAY for full color brochure, or see your Dealer/Distributor and ask for a demonstration!



### PERSONAL MESSENGERS

100 Milliwatt and 1½ Watt hand-held units. Twice the sensitivity and 40% more range than similar units with conventional circuitry!



### MESSENGER

To date—one of the biggest sellers in the Citizens Band field! 5 channels—long on performance, short on cost.



**MESSENGER TWO**  
Ten channels and tuneable receiver. Excellent receiver sensitivity and selectivity. Plenty of features. Delivers a penetrating signal with solid punch!

# 696,000 TECHNICIANS NEEDED BY 1970!

## Government Report\* Points Out Rapidly Growing Job Opportunities: Need for Trained Electronics Technicians An Important Factor

By Bill Gordon, RCA Institutes, Inc.

**President Johnson Emphasizes Need.** In his 1964 annual manpower report, President Johnson indicated that the demands for manpower are expanding most in, among other fields, service and technical (including technician) occupations. This expansion is the result of a handful of causes underlying today's big changes in the occupational picture: (1) increasing complexity of modern technology, (2) trend toward automation of industrial processes, (3) growth of new areas of work, such as in the field of atomic energy, earth satellites and other space programs, and (4) data systems analysis and data processing. Indicative also of the growing importance of the use of technicians is a recent revision of the "List of Critical Occupations" published by the U.S. Department of Labor in which technicians are listed for the first time by the U.S. Government.

**Salary Levels for Trained Technicians Rising Fast.** Beginning salaries for graduates of top level technician education programs have continued to go up during the past five years, at a faster rate than salaries of similar types of jobs. In fact, a U.S. Labor Department projection based on the figures shows that by 1970, technician salaries will average an all-time high.

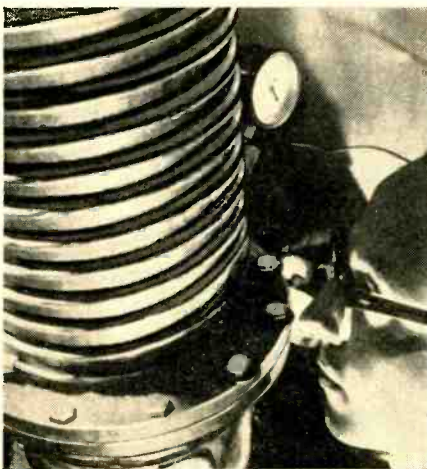

Nuclear Instrumentation

**Technical Education is One of Today's Best Investments.** Today, a person interested in becoming a technician can choose Home Training or Classroom Training to begin building his career. One of the nation's largest schools devoted to training electronics technicians, RCA Institutes, offers a wide variety of courses in both categories. In addition, the RCA "AUTOTEXT" Programmed Instruction Method is helping people learn faster and easier so they can get started on their careers in the shortest possible time. Dramatic proof comes from the success stories of countless graduates who find profitable positions in government, industry, or in their own businesses. Of the total 696,000 technicians needed by 1970, it can be estimated that electronics technicians at all levels will form a vital core in today's major job picture.

\*"Scientists, Engineers, and Technicians in the 1960's" U.S. Department of Labor, Bureau of Labor Statistics.



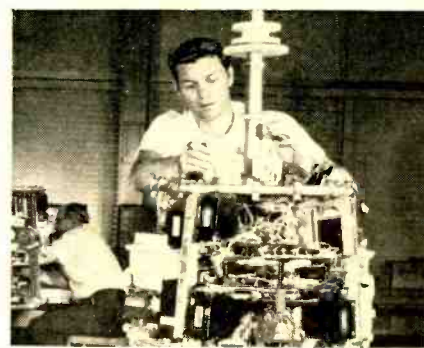

Space Electronics

# RCA DEVELOPS AN EASY WAY TO LEARN ELECTRONICS AT HOME

New "Career Programs" Help Train You For Expanding Job Opportunities.  
RCA "AUTOTEXT" Instruction Method Speeds Learning

Choose an RCA "Career Program" that will train you for the job you want in Electronics! No time wasted learning things you'll never get to use. "Career Programs" answer the need for today's growing job opportunities for trained Electronics Technicians. They can help you get the job you want faster and easier than you ever dreamed possible! And each "Career Program" starts with the amazing "AUTOTEXT" Programmed Instruction Method—the scientific way to learn that's almost automatic! "AUTOTEXT" helps even those who have had trouble with ordinary methods of home training in the past. This is the "Space Age" way to learn everything you need to know with the least amount of time and effort! Choose a "Career Program" now. Each one is designed to train you for a specific, rewarding career in one of the following exciting fields:

- TELEVISION SERVICING
- FCC LICENSE PREPARATION
- AUTOMATION ELECTRONICS
- AUTOMATIC CONTROLS
- DIGITAL TECHNIQUES
- TELECOMMUNICATIONS
- INDUSTRIAL ELECTRONICS
- NUCLEAR INSTRUMENTATION
- SOLID STATE ELECTRONICS
- ELECTRONICS DRAFTING

In addition to these "Career Programs" RCA Institutes offers a wide variety of separate



Radar Microwave

courses on many subjects—from Electronics Fundamentals to Computer Programming.

#### VALUABLE EQUIPMENT INCLUDED

And, with your RCA Training, you receive top-quality equipment to keep and use on the job. When you train with RCA Institutes, you never have to take apart one piece to build another. You'll get the new Programmed Electronics Breadboard which provides limitless experimentation...and, with which you construct a working signal generator and a superheterodyne AM Receiver.

#### SPECIAL BONUS—

#### OSCILLOSCOPE and METER KITS

Valuable Oscilloscope and Multimeter Kits are yours at no additional cost when you enroll in any one of the RCA Career Programs... "must" equipment for electronics technicians in almost all jobs.

#### LIBERAL TUITION PLAN

Only RCA offers you this most economical way to learn. You pay for lessons only as you order them. No long term contracts. You may stop your training at any time without owing a cent.

#### CLASSROOM TRAINING ALSO AVAILABLE

If you prefer to learn in a classroom, RCA Institutes maintains one of the largest schools of its kind where the latest classroom and laboratory training is available in day or evening sessions. You may be admitted without any previous technical training.

Preparatory courses are available if you haven't completed high school. Coeducational classes start four times a year.

#### FREE PLACEMENT SERVICE

RCA Institutes records prove that in a recent class 9 out of 10 Resident School students who used the Free Placement Service had their jobs waiting for them when they graduated. And, many of these jobs were with top companies in the field—IBM, Bell Telephone Labs, General Electric, RCA, and radio and TV stations, and other communications systems throughout the world.

SEND THE ATTACHED POSTAGE PAID CARD FOR COMPLETE INFORMATION WITHOUT OBLIGATION. NO SALESMAN WILL CALL. VALUABLE FREE BOOK INCLUDED. CHECK HOME STUDY OR CLASSROOM TRAINING.



Computer Programming

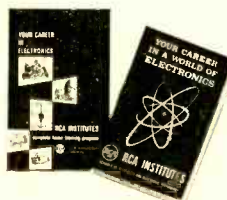

THE MOST TRUSTED NAME IN ELECTRONICS

**RCA INSTITUTES, Inc.,** Dept. EW-95  
A Service of Radio Corporation of America  
350 West 4th St., New York, N. Y. 10014

"AUTOTEXT"—An RCA Trademark

# FREE



**508 VALUE-PACKED PAGES**  
including exclusive products and  
special values available only  
from **ALLIED**

send today for your  
**ALLIED**  
**1966 CATALOG**  
world's largest selection

**SAVE MOST ON:**

*Stereo Hi-Fi*  
*Tape Recording*  
*CB 2-Way Radio*  
*FM-AM & AM Radios*  
*Short Wave Radios*  
*Portable TV • Phonographs*  
*Amateur Gear*  
*Intercoms & P.A.*  
*Automotive Electronics*  
*Test Instruments*  
*TV Tubes & Antennas*  
*Power Tools, Hardware*  
*Parts, Tubes, Transistors*

**MORE OF THE BEST IN ELECTRONICS FOR EVERYONE**

**EASY TERMS**

Use the convenient  
Allied Credit Fund Plan  
—over 24 months to pay

**ALLIED RADIO**

*The World's Largest Electronic Supply House*

*satisfaction  
guaranteed or  
your money back*

ELECTRONICS WORLD



# SPECIAL in your FREE 1966 ALLIED CATALOG

see what's new in the wonderful world of **knight-kits**®

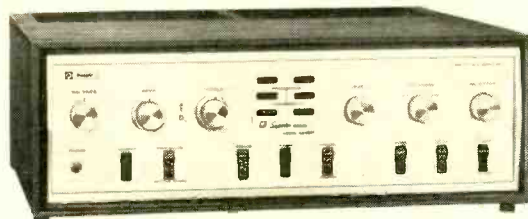

KG-895 Superba Series  
120-Watt Solid-State  
Stereo Amplifier Kit. \$149.95

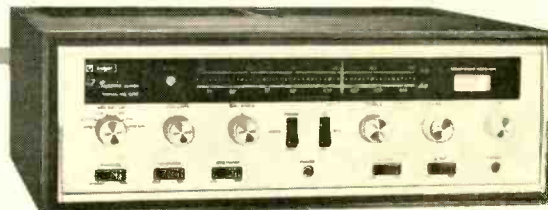

KG-964 Superba  
Series 64-Watt Solid-  
State FM-AM Stereo  
Receiver Kit.  
\$189.95



KG-635 5-Inch DC  
to 5.2 Mc Wide-  
band Oscilloscope  
Kit. \$99.95

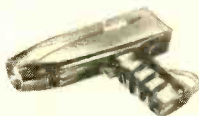

KG-371 Solid-State  
Auto DC Power  
Timing Light Kit.  
\$19.95

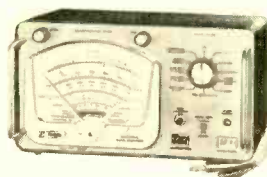

KG-375 Solid-State  
Universal Auto Ana-  
lyzer Kit. \$49.95



Safari-I Deluxe  
23-Channel Citizens  
Band Transceiver Kit. \$129.95



C-540 Low-Cost  
5-Watt Citizens  
Band Transceiver  
Kit. \$49.95



KG-221 FM Moni-  
tor Receiver Kit  
(police, fire, ma-  
rine, weather  
bands, etc.) \$39.95



KG-201 Solid-State  
Motor-Speed/Light  
Control Kit. \$9.95

KG-415 Superba  
Series Professional  
Solid-State Stereo  
Tape Deck Kit.  
\$249.95



**Knight-Kit GUARANTEE:** Buy any Knight-Kit. Build it. Operate it. You must be satisfied or we refund your money.

**THERE IS A knight-kit FOR EVERY NEED!**  
easiest to build—enjoy big savings

- Stereo Hi-Fi
- CB 2-Way Radio
- Short-Wave
- Hobby Kits
- Test Equipment
- Automotive
- Intercom
- Amateur Gear

send for your 508-page 1966 Allied Catalog

## FREE

Send today for your 508-page Allied 1966 value-packed catalog

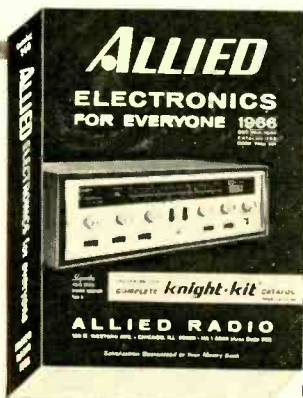

## FREE!

ALLIED RADIO, Dept. 1-J  
100 N. Western Ave., Chicago, Ill. 60680

Send FREE 1966 Allied Catalog

Name \_\_\_\_\_  
PLEASE PRINT

Address \_\_\_\_\_

City \_\_\_\_\_ State \_\_\_\_\_ Zip \_\_\_\_\_

# ALLIED RADIO



Tarzian offers  
**FAST, DEPENDABLE  
 TUNER REPAIR  
 SERVICE** (ALL  
 MAKES)

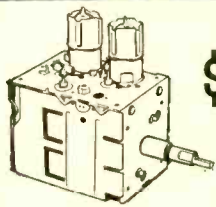

ONLY  
**\$950**  
 INCLUDING

**ALL PARTS**  
 (except tubes)  
**and LABOR**

**24-HOUR SERVICE  
 1 YEAR WARRANTY**

Sarkes Tarzian, Inc. maintains two complete, well-equipped Factory Service Centers—assisted by Engineering personnel—and staffed by specialized technicians who handle ONLY tuner repairs on ALL makes and models. Tarzian-made tuners received one day will be repaired and shipped out the next. Allow a little more time for other tuners.

One year guarantee against defective workmanship and parts failure due to normal usage. Cost — \$9.50 per unit. \$15 for UV combinations. Absolutely no additional, hidden charge for ANY parts, except tubes. You pay shipping costs. Replacements on tuners beyond practical repair are available at low cost.

When inquiring about repair service, always give TV make, chassis and Model number. Tuners repaired on approved, open accounts. Check with your local distributor for Sarkes Tarzian replacement tuners, replacement parts, or repair service. See your distributor, or use the address nearest you for fast factory repair service:



**SARKES TARZIAN, INC.**

537 South Walnut Street  
 Bloomington, Indiana  
 Tel: 332-6055

10654 Magnolia Blvd.,  
 North Hollywood, Calif.  
 Tel: 769-2720

CIRCLE NO. 93 ON READER SERVICE CARD

GET INTO **ELECTRONICS**



V.T.I. training leads to success as technicians, field engineers, specialists in communications, guided missiles, computers, radar and automation. Basic & advanced courses in theory & laboratory. Electronic Engineering Technology and Electronic Technology curricula both available. Assoc. degree in 29 mos. B. S. also obtainable. G.I. approved. Graduates in all branches of electronics with major companies. Start September, February. Dorms, campus. High school graduate or equivalent. Write for catalog.

**VALPARAISO TECHNICAL INSTITUTE**  
 Dept. RD, Valparaiso, Indiana

**EW Lab Tested**  
 (Continued from page 16)

room resonances moved downward in frequency. Had we done our measurements in a smaller listening room, these room resonances would have moved upward in frequency.

It is interesting to note that where there is little or no speaker output at one of the room resonant frequencies, the acoustic response measurement will not show a peak at this frequency. Hence, the curve may look good but, in fact, it indicates little or no acoustic output from the speaker at that particular frequency. Severe dips in "live"-room curves are also indicative of room resonances. In this case the pickup microphone is located at a region of minimum rather than maximum sound pressure.

Finally, in order to free the speaker entirely from the effects of our room, we measured its outdoor anechoic response (see dashed curve) below 1000 cps. This response was found to be extremely smooth and within  $\pm 2$  db of flat from 1000 cps down to 50 cps, below which output fell off rapidly. By comparing the solid and dashed curves, we can see exactly the contribution made by our particular listening room, especially at very low frequencies.)

The low-frequency distortion of the AR-2ax at 10 watts electrical input was 2.5% at 60 cps and about 5% at 40 cps. These figures are slightly above the distortion figures given by the manufacturer. This was probably due to room resonances at harmonic frequencies that show up as distortion products. In any case, the distortion figures were reasonably close to the manufacturer's figures of 1.7% at 60 cps and 3% at 40 cps. The excellent transient response of the system is illustrated by the tone-burst photos, which show little or no ringing at

any of the several frequencies checked.

We were able to compare the sound of the AR-2ax critically against the AR-2, AR-2x, and AR-3a. The new mid-range speaker makes a distinct improvement in the immediacy and dispersion of the sound and eliminates most of the "distant" character which some people have attributed to the AR-2 speaker. In the AR-2x, it adds life and sparkle to a remarkable degree as compared to the AR-2. All in all, the new speaker is a most worthwhile improvement. Best of all, it costs nothing, since the "x" models are priced the same as the older types.

The AR-2x is \$89 to \$102 and the AR-2ax is \$109 to \$128, depending on finish. The cabinets are finished on four sides.

The conversion kit, replacing the pair of 5-inch speakers with the new 3½-inch speaker, costs only \$15 and is well worth the modest investment for any owner of an AR-2 system. The old speakers are still available at the same price for those who wish to match earlier models, but our experience is that the "x" versions are fully compatible with the older ones in stereo systems.

(MANUFACTURER'S COMMENTS: The "shelf" in the curve that occurs above crossover does not represent an energy relationship, only a pressure relationship. The small mid-range and super-tweeter diaphragms have better dispersion than the woofer at its high end, and the same pressure exists over a larger solid angle. Therefore, a lower pressure response represents a much higher energy output. One can verify this very simply by putting the mid-range and tweeter level controls all the way up (providing a much flatter response curve). It will be found that under any but the most unusual acoustical conditions the balance of bass and treble is completely upset, to the extent that the speaker sounds painfully overbright. This is also true of the AR-3 loudspeaker system.) ▲

**KLH Model 18 FM Tuner**

For copy of manufacturer's brochure, circle No. 26 on Reader Service Card.



**T**HE KLH Model 18 is a fully transistorized FM-stereo tuner of unusually compact dimensions and excellent performance. Complete in its attractive walnut cabinet, it measures only 9 inches wide, 5½ inches deep, and 4½ inches high and weighs only four pounds.

The tuning drive uses a planetary reduction which gives very smooth and backlash-free tuning. The volume control and "on-off" switch are combined. Two other knobs, rarely used, are the "Mono-Stereo" switch and the "SCA Filter" switch. The tuner changes automatically from mono to stereo when the switch is in the "Stereo" position, so there is no need to use it unless a signal is too noisy for satisfactory stereo reception. The SCA filter reduces high-frequency separation, but may be required in some cases to remove interfering beats between an SCA broadcast and a stereo broadcast on the same channel.

A miniature zero-center tuning meter on the panel indicates correct tuning. A small neon light on the panel glows to







# NEW PRODUCTS & LITERATURE

Additional information on the items covered in this section is available from the manufacturers. Each item is identified by a code number. To obtain further details, fill in coupon on the Reader Service Card.

COMPONENTS • TOOLS • TEST EQUIPMENT • HI-FI • AUDIO • CB • HAM • COMMUNICATIONS

## PORTABLE DUAL-TRACE SCOPE

The Type 453 portable, 50-mc. dual-trace scope was developed primarily for field service of high-speed, solid-state computers. It measures 6 $\frac{3}{4}$ " x 10 $\frac{3}{4}$ " x 19" and weighs only 28 pounds. It uses

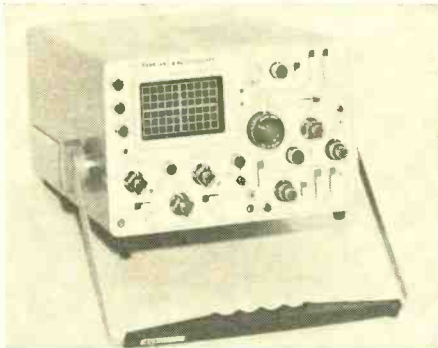

a new 4" CRT designed to provide the high writing rate and brightness required for use under high ambient light conditions.

Dual-trace sensitivity is to 20 mv./div. at 50 mc. and to 5 mv./div. at 40 mc. Channels can be cascaded to obtain 1 mv./cm. sensitivity at 25 mc. single trace. Tektronix

Circle No. 126 on Reader Service Card

## MAGNETIC REED RELAYS

The 210 series magnetic reed relays are designed for operation at low signal levels and exhibit low-noise, high-speed operation, and a life of 200 million operations. Loads are dry circuit to 10 ma. maximum, 10 volts maximum, bounce time 200  $\mu$ sec. nominal, contact resistance 0.1 ohm. Temperatures  $-55^{\circ}\text{C}$  to  $+85^{\circ}\text{C}$ . Relays are available in single-throw, 1, 2, 4, and 6 poles. Elec-Trol

Circle No. 127 on Reader Service Card

## SENSITIVE SCR'S

Six new TO-5 and TO-18 SCR families for 2 ma. to 1.6 amp applications feature gate trigger levels to 2  $\mu$ a. and voltage ratings to 400. They are designed for high-gain, high-voltage circuits to permit major simplification and increased reliability.

The new AA100-118 and AD100-118 families can be used as threshold detectors, timing circuits, level sensing, relay and solenoid driving, ring counters, protective and warning circuits, encoding and decoding, motor driving, pulse generation, lamp driving, gating, plus relay, mag amp, and thyatron replacement. Solid-State Products

Circle No. 128 on Reader Service Card

## POLYSTYRENE CAPACITOR FOR PC'S

The Style 603 capacitor is an encapsulated, high-reliability precision type designed for printed-circuit use. It features very high leakage resistance of more than 500,000 megohms and

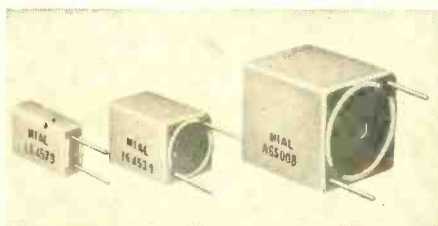

temperature coefficient ranging from  $\text{N150} \pm 70$  PPM/ $^{\circ}\text{C}$  for class 2, to  $\text{N150} \pm 50$  PPM/ $^{\circ}\text{C}$  for class 3. Capacitance tolerance spans  $\pm 1$  pf. to  $\pm 10\%$ . Voltage ratings are 63 through 1000 v.d.c.w. M.I.A.L.

Circle No. 129 on Reader Service Card

## MINIATURE MILITARY SWITCHES

A variety of lever lock configurations are provided in a new line of miniature military switches. Designed to meet all general requirements of MIL-S-8834 (Type I), the line is available in all (2- and 3-position) circuit arrangements, for maintained or momentary operation, in single- and double-throw. Resistive ratings include 4 amps @ 28 v.d.c., 3 amps @ 115 v.a.c.; inductive ratings are 1 amp @ 28 v.d.c. and 115 v.a.c. Minimum rating for dry circuit applications is 25  $\mu$ amp @ 5 mv. Cutler-Hammer

Circle No. 130 on Reader Service Card

## HALL-EFFECT DEVICE

The Model BH701 "Hall-Pak" combines high linearity, low temperature dependence, and low reversibility error in a small, rugged, ceramic-epoxy package. Individually plotted half voltage

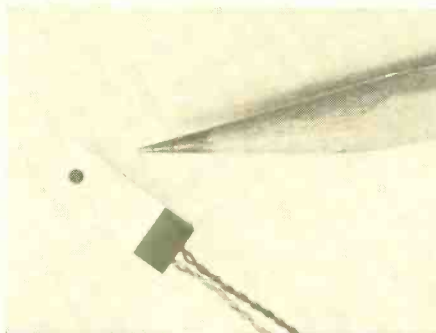

vs magnetic field strength linearity deviation curves are furnished with each unit.

Active sensing area is approximately 0.003 square inch. The unit measures 0.235" w. x 0.625" l. x 0.040" thick. F. W. Bell

Circle No. 131 on Reader Service Card

## "GHOST-KILLING" ANTENNA

Annoying reflected images in both black-and-white and color reception are canceled out by electronic circuitry built into the "Coloray" antenna. A transposing phasing harness with an impedance-balancing power equalizer circuit provides higher front-to-back ratios than 10-element yagis cut to each specific channel. FM gain is higher than turnstile-type units.

No external power is required for its operation and the antenna is matched for direct connection to standard 300-ohm receiver input. Channel Master

Circle No. 1 on Reader Service Card

## LIGHT-ACTIVATED SWITCHING RELAY

The LA-7 is a compact, solid-state device less than  $\frac{1}{2}$ " in diameter which serves as a fast-acting, highly sensitive unit that can control a particular function whenever the function exceeds or falls below preset limits.

It is optically coupled to an intense-point light source, enabling it to respond to reflected light from a mirrored surface or from an light-colored surface such as tape, paper, paint, or brushed metal. It will directly activate 6- to 12-volt relays, solenoid valves, signal lamps, or control motors

without additional power amplification. It operates from a 12-volt a.c. source. Datatron Laboratories

Circle No. 132 on Reader Service Card

## HIGH-VOLTAGE DIODES

This new line of silicon glass diodes combines a junction capacitance of 0.2 pf. and low inverse leakage characteristics of 5 namps at 6000 volts. Reverse recovery time is 0.2  $\mu$ sec. as measured in

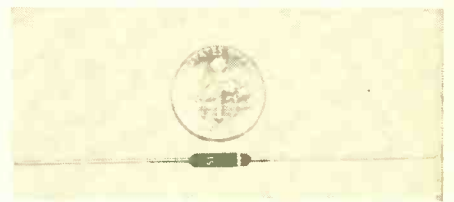

#256 JAN circuit. Maximum forward current rating is 25 ma. for 6000 volt series to 50 ma. for 1000 volt series.

The units can be used in laser power supplies, pulse detectors, and infrared power supplies. Semicon

Circle No. 133 on Reader Service Card

## MINIATURE TORCH

A tiny torch which welds metal smaller than .002" wire and up to 16 gauge steel uses oxygen and a fuel gas to produce flame temperatures to 6300 $^{\circ}\text{F}$ . It operates at pressures of 2 to 4 psi, and uses gas at the rate of .023 to 2.54 cfh. The unit is equipped with five different sized tips which swivel 360 $^{\circ}$  for complete handling ease. Tescom Corp.

Circle No. 134 on Reader Service Card

## TRANSISTOR NOISE TESTER

This compact and simplified transistor noise test set features automatic self-calibration. Model 512 is designed to measure accurately the broad-band noise figure of transistors from 10 to 10,000 cps.

Noise figures are read directly in db for the most popular values of base resistance but other



values may be used by applying a simple correction factor. In addition to the standard junction types, the unit will also measure FET's, including insulated gate types. Quan-Tech

Circle No. 135 on Reader Service Card

## REAR-PROJECTION READOUT

The Series 340 microminiature rear-projection readout is  $\frac{3}{4}$ " h. x  $\frac{1}{2}$ " w. x 2" deep and is capable of projecting a display character  $\frac{3}{8}$ " with a viewing distance of 20 feet. The unit consists of 11 incandescent lamps, two 11-lens honeycombs, an 11-message film, another honeycomb lens, and a viewing screen.

Since the messages are on film, the unit can



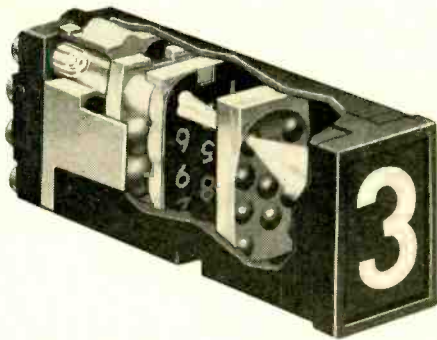

be set up to display anything that is photographically reproducible. Industrial Electronic Engineers

Circle No. 136 on Reader Service Card

#### FM-STEREO SIGNAL GENERATOR

The Type SMAF can be AM and FM modulated, simultaneously AM-FM modulated, or externally modulated by a stereo-FM signal in conformance with FCC standards. It supplies continuously adjustable output voltage from 0.05  $\mu$ v. to 50 mv. The 0 to 6.5 mv. video modulation bandwidth makes it suitable for measuring TV receivers as well as for developing and producing AM and FM receivers. Rohde & Schwarz

Circle No. 2 on Reader Service Card

#### PORTABLE TUBE CHECKER

A new model portable tube checker, the "Mighty Mite IV," features a specially designed hinge on the cover of the tester and a plastic holder that has been installed in the cover to



hold pages of the set-up booklet open for faster testing. New tubes can be tested, including Amperex and Mullard 10-pin types. Over 3000 tubes are listed on the accompanying chart. Sencore

Circle No. 3 on Reader Service Card

#### HIGH-POWER TRANSISTOR

A pair of the new DTG-110B transistors will handle up to 100 watts r.m.s. power in class AB audio power output applications. They offer low

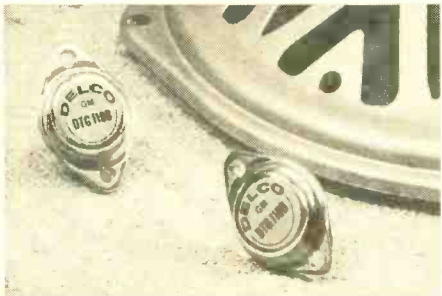

distortion at high power levels, while linear gain and transconductance characteristics provide very low amplifier distortion. They are housed in standard, copper-based TO-3 packages. Delco

Circle No. 4 on Reader Service Card

#### SMALL-SIZE COAX CABLES

Foam and air-dielectric "Helix" flexible cables are available in new 1/4", 3/8", and 1/2" sizes. They

September, 1965

meet the new  
**WINEGARD  
HOT-SHOT**

**Super Compact All-Band  
(UHF, VHF, FM)  
Color Antenna...**

*Eliminates Ghosts  
Better than any  
other Metropolitan  
Type Antenna*

Here's the antenna that replaces Conicals, Twin Vees, In-Lines and all Indoor antennas. It's Hot-Shot, the new antenna from Winegard that outperforms the others... yet lists for only \$8.80!

Designed specifically for all-band (UHF, VHF, FM) reception in metropolitan areas, Hot-Shot has a very high front to back and front to side ratio to eliminate ghosts more effectively than other antennas. Works on all bands to deliver life-like color, sharper black and white and distortion-free FM stereo. Easily installed, too, on roofs or in attics—you work with just one download. It even has Winegard's new Gold Vinylized finish to triple antenna life.

So don't give your customers the limited performance of an indoor or old fashioned outdoor antenna when for no more money than indoor types (\$8.80), you can give them the outstanding results of the all new Winegard Hot-Shot.

Ask your distributor or write today for Hot-Shot Fact-Finder #241. It's the hottest new all-band antenna for metropolitan and suburban reception areas.

**Winegard Co.**  
ANTENNA SYSTEMS

3000 Kirkwood • Burlington, Iowa

CIRCLE NO. 87 ON READER SERVICE CARD



feature a copper inner and low-loss corrugated outer conductor for long-life reliability. The cable is available in continuous splice-free lengths without or with polyethylene jacket. Cable assembled with Type N, Type UHF, or special connectors can be had. Andrew

Circle No. 5 on Reader Service Card

## HI-FI AUDIO PRODUCTS

### MIXER-PREAMP FOR P.A.

A mixer-preamp which permits seven input signals to be mixed simultaneously, up to five of the signals for high- or low-impedance microphones, is the MXM-2. Separate speech filters controlled by push-pull-turn knobs improve the speech clarity on all five microphone



inputs. A unique calibrated low-frequency notch filter aids in overcoming adverse acoustic conditions.

The solid-state power supply and d.c. voltage on filaments are designed to increase reliability. A 50- $\mu$ a. meter with sensitivity control is used to monitor the output of the unit or booster amplifiers. Bogen Communications

Circle No. 6 on Reader Service Card

### SOLID-STATE STEREO PHONO

The "Pro 50" is a compact stereo music system consisting of a 20-watt solid-state amplifier, a deluxe Garrard 4-speed automatic record changer, and a pair of matched speakers, all housed in walnut wood cabinets. There are FM tuner jacks and selector switch for the addition of an FM tuner. The record changer will handle the automatic intermix of 7", 10", and 12" records.

The control center measures 21" w. x 3 $\frac{7}{8}$ " h. x 13" d. The speaker enclosures measure 15 $\frac{1}{2}$ " h. x 13" w. x 4 $\frac{1}{2}$ " d. Operation is 110-120 volts, 60 cycles. Lafayette

Circle No. 7 on Reader Service Card

### HI-FI SPEAKER SYSTEM

A contemporary cabinet with Mediterranean overtones houses the 816A "Valencia" speaker system. The enclosure, of hand-rubbed walnut, includes a 811B aluminum sectoral horn powered by an 806A high-frequency driver, a 416 low-frequency speaker, and a two-section 800-cycle dividing network. Frequency response is 30-22,000 cps and power rating is 30 watts. Impedance is 8 or 16 ohms.

The cabinet measures 29 $\frac{3}{4}$ " h. x 27 $\frac{1}{2}$ " w. x 19". Altec Lansing

Circle No. 8 on Reader Service Card

### REPLACEMENT TAPE HEADS

A new line of tape heads and QK-75 "Quik-Kit" adapter are now available for replacement on

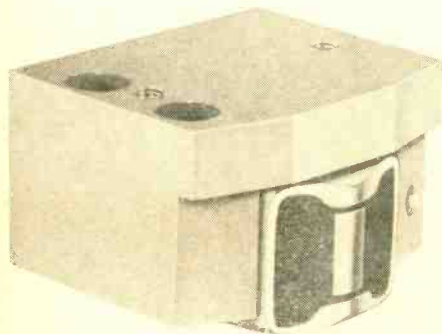

Ampex professional recorders. The "Quik-Kit" allows for rapid changeover of track styles and permits quick and easy installation of record, playback, and erase heads on Ampex 300, 350, 351, 400, 3000, and 3200 series recorders. Nontronics

Circle No. 9 on Reader Service Card

### COMPACT SPEAKER SYSTEM

The "Sonomaster" Model RM-2 measures 19" x 11 $\frac{1}{2}$ " x 8 $\frac{1}{2}$ " d. and is designed to be used either horizontally or vertically. It can handle 50 watts average program material, 100 watts peak. Input power is 10 watts minimum. Response is 40-20,000 cps. Crossover is at 4500 cycles. Output impedance is 8 ohms.

The system includes one 8" linear high-compliance acoustic-suspension woofer and one 3 $\frac{1}{2}$ " high-frequency, wide-dispersion cone tweeter. It has an LC crossover network and high-frequency listening control. Sonotone

Circle No. 10 on Reader Service Card

### SOLID-STATE MILLIVOLTMETER

The EMT-125 is an all-solid-state millivoltmeter which permits readings to 1.5% accuracy, switchable to either r.m.s. or peak. Bandpass is switchable to either 200 kc. or 20 kc. (17 db/octave filter slope) eliminating r.f. and leakage effects outside the a.f. range. Internal precision reference voltage for self calibration. The unit can be used as a measuring amplifier. It operates on a.c. voltages from 95 to 266 at 50/60 cps and measures 17" x 5 $\frac{1}{4}$ " x 9" d. and weighs 13 pounds. Gotham Audio

Circle No. 11 on Reader Service Card

### UNDER-DASH REVERB UNIT

"Stereo-Magic," an under-dash reverberation unit, when coupled to a car radio and rear-seat speaker produces two-source musical reproduction for cars. Available in three models (with



6" x 9" speaker, with special 6" round speaker for convertibles, and without speaker), the unit measures 15 $\frac{1}{2}$ " h. x 9" w. x 4" d. Tenna Corp.

Circle No. 12 on Reader Service Card

### HI-FI PHONO SYSTEM

A solid-state stereo component phono system, the Model 30, features 75 watts total IHF music

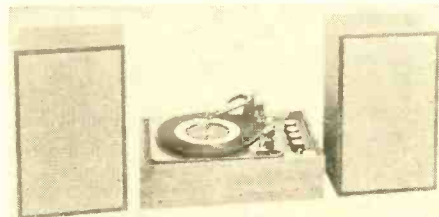

output. The amplifier has 12 transistors, 2 silicon full-wave rectifiers, a heavy-duty power transformer, and 2 driver transformers. Frequency response is 30-15,000 cps. The two air suspension speakers and two equal and separate stereo amplifiers have four stages of amplification. The system uses a Garrard 3000 four-speed automatic changer, a dynamically balanced tonearm, and Pickering magnetic cartridge with diamond stylus. Tele-Tone

Circle No. 13 on Reader Service Card

### CORDLESS TAPE RECORDER

The "Charger," a new cordless tape recorder with built-in power cell and recharger, will record or play back at 3 $\frac{3}{4}$  or 1 $\frac{7}{8}$  ips. The unit is 10 $\frac{3}{8}$ " x 6" x 2 $\frac{3}{4}$ " and weighs 5 pounds, includ-

ing the completely self-contained nickel-cadmium power cell and recharger. The unit will record or play back up to four hours on a single charge. The six-transistor recorder can be recharged hundreds of times simply by plugging into an ordinary a.c. outlet. It will also operate on a.c., recharging itself at the same time. It can also be operated and recharged from a car cigarette lighter. V-M Corp.

Circle No. 14 on Reader Service Card

### CAR STEREO TAPE PLAYER

Solid-state tape player with two-channel stereo amplifiers, dual-stereo playback heads, electronic track selector, push-pull output, and a new self-

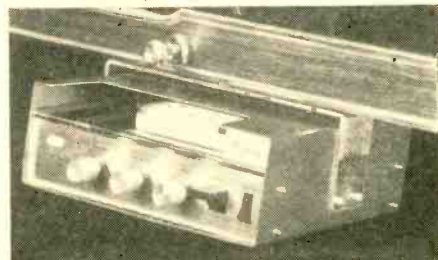

activating cartridge system operating on an auto battery are features of the C-502 car stereo.

The machine is housed in a steel case with brushed aluminum face plate. Craig Panorama

Circle No. 15 on Reader Service Card

### TWO-STATION INTERCOM

A low-cost, two-station intercom ("Echo-2") features a three-transistor push-pull circuit and a patented "beep-tone" signalling circuit. The unit will operate for a month from a single 9-volt battery. Master and remote stations are connected by 50 feet of two-conductor cable, equipped with plugs. Faunon

Circle No. 16 on Reader Service Card

## CB-HAM-COMMUNICATIONS

### MOBILE CB ANTENNAS

A new line of mobile CB antennas features resonators which may be tuned by means of a stainless steel tip rod. Masts are of chrome-plated brass, either one piece or telescoping, or fiberglass. Various models are designed for cowl, fender, or roof-top mounting. New-Tronics Corp.

Circle No. 17 on Reader Service Card

### CRYSTAL-CONTROLLED CB UNIT

The Model HB-600 provides deluxe features for CB communications plus provision for Business Band operation. Of 100% solid-state design, the transceiver has 23 crystal-controlled CB channels. All CB crystals—27 in all—are supplied. Two additional crystal positions are supplied for AM Business Band operation and H.E.L.P. channels.

The transceiver measures 4 $\frac{7}{16}$ " h. x 11 $\frac{3}{16}$ " w. x 8" d. It is supplied with push-to-talk dynamic microphone, a.c.-d.c. power cables, mobile mounting bracket, and microphone bracket. Lafayette

Circle No. 18 on Reader Service Card

### SOLID-STATE CB TRANSCEIVER

The "Skyhawk 335" is an all-solid-state, compact, 23-channel CB transceiver designed to work in any kind of vehicle. By using a frequency translator circuit, crystal requirements have been reduced to only one crystal per channel for both transmit and receive. The receiver, which draws only .025 amp from a 12-volt source, is a dual-





conversion superhet with sensitivity of 0.4  $\mu$ V. for 10 db S/N. The transmitter features a full five watts input, with high-level class AB2 modulation. Transmitter drain is 1 amp under 100% modulation.

The complete unit is 2 $\frac{3}{8}$ " h. x 6 $\frac{1}{2}$ " w. x 9 $\frac{1}{4}$ " d. Kaar Engineering

Circle No. 19 on Reader Service Card

#### CB DIRECTION-FINDING ANTENNA

A new loop antenna, the "Signal-Hunter," features sharply directional pickup of CB stations for emergency or operational applications. The antenna clips on the car window and is then retained by a heavy-duty suction cup. The only electrical connection is a coax connector plugged into the antenna socket of the CB set. An 8-ft. cable permits mounting on either side of the car. Tuning is by means of a knob on the top of the loop. Operation is by means of a directional pointer. Gold Line Co.

Circle No. 20 on Reader Service Card

#### 12-CHANNEL CB MOBILE

A fully transistorized 12-channel CB mobile transceiver whose transmitter is rated at the full authorized 5 watts, delivering 3.5 watts to the antenna at 100% modulation is available. The receiver is a double-conversion superhet with narrow-band, shaped audio response, and single-crystal tolerance of 0.0033%.

The set incorporates front panel controlled



extended noise limiter and a rear panel mounted squelch sensitivity adjustment.

The vinyl-coated aluminum case measures 7" x 2 $\frac{3}{8}$ " x 8 $\frac{3}{8}$ ". It is powered by standard 12-volt d.c. (positive or negative ground) electrical systems. Pace Communications

Circle No. 21 on Reader Service Card

## MANUFACTURERS' LITERATURE

#### SOUND-SYSTEMS CATALOGUE

The "Ampli-Vox" line of five complete sound systems for portable, mobile, and stationary p.a. applications is fully described in a new brochure (Catalog B278). All five are complete packages, including all-transistor amplifiers, loudspeakers, and microphones.

The illustrated booklet also covers a full line of accessories. Perma-Power

Circle No. 22 on Reader Service Card

#### INSTRUMENTS CATALOGUE

Oscilloscopes, plug-ins, pulse generators, cameras for scopes, and accessories are fully illustrated and described in a new 16-page short-form catalogue (No. 131). Fairchild

Circle No. 137 on Reader Service Card

#### IMPULSE COUNTERS

A new 6-page technical bulletin (No. 401) on specifying predetermining electromagnetic counters for all types of applications is now available. The brochure contains complete specifications, circuit diagrams, dimensions, and installation data. Landis & Gyr

Circle No. 138 on Reader Service Card

#### STRETCHABLE CABLE

"Retraflex" wire and cable, capable of elongating from 10% to over 200%, is described in a new 2-page bulletin. Suggested applications include shielded phono wire, headset cords, and test equipment where extreme limpness and flexibility are important factors.

The cable is available with silicone rubber or

# Let Detroit **DUAL** TRANSISTORIZE Your Car—At Less Than Half-Price!

AMAZING DUAL-TRANSISTOR **POWERTRON** FEATURES COMPONENTS BY TOP NAMES IN AUTOMOTIVES — OUTPERFORMS ANY OTHER TRANSISTOR IGNITION SYSTEM — AT ANY PRICE!

### ✓ CHECK YOUR VALUES!

FACTORY-INSTALLED ON THUNDERBIRDS, CONTINENTALS, ETC.; BUT ALSO IN AUTO STORES AT THE RETAIL PRICES SHOWN:

PRESTOLITE Trigniter	\$ 74.50
MOTOROLA Transignition	69.95
GM Delco CT System	125.00
FORD TI System	64.95
MALLORY TI System	79.50
TUNGSOIL CD System	99.50

**POWERTRON kit, complete, only \$19.95**

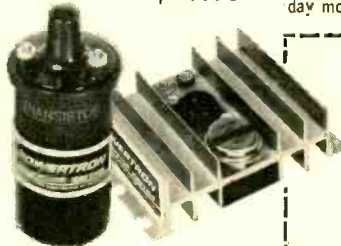

Forget about paying \$90.00 — \$60.00 — \$40.00 to add the pep, power and fuel economy to your engine only a modern transistorized ignition system can deliver! Now... ten major automotive companies contribute the POWERTRON dual-transistor ignition you install yourself in 20 minutes — and save more than half!

**DETROIT-ENGINEERED.** Look at these features of POWERTRON... guaranteed to deliver 18,000 volts to the spark plugs when you start your engine — then deliver full voltage at cruising speed, guaranteed to release FULL ENGINE POWER at all rpms... increase gas mileage by 15%, keep plugs and points bright and clean for the life of the car — keep fouled plugs firing — deliver instant starting in coldest weather.

**HOW POWERTRON WORKS.** The power and performance of any gasoline engine depends on the fire-power at the spark plugs. Low voltage at the plugs means incomplete combustion — great loss of power — a fantastic waste of fuel running out the exhaust pipe — accumulations of power-killing carbon — and a worsening condition every mile you drive. As engineers know, high voltage at the plugs solves the problem... and POWERTRON is the answer!

**NOW... POWERTRON AT A PRICE YOU CAN AFFORD.** Powertronics Corporation of America was formed to distribute the POWERTRON do-it-yourself transistor ignition kit. POWERTRON is completely waterproof, shockproof. Each factory assembled system is tested under actual operational load and is guaranteed for three full years. Your POWERTRON will pay for itself in less than 10,000 miles of driving. Order only with the coupon below on 10-day money-back guarantee!

### POWERTRON IS GUARANTEED TO

- Outperform any other transistor ignition system
- Release full engine power at all speeds — increase power and economy performance 10%
- Add 15% extra mpg—actually 2 to 6 extra mpg
- Give you instant starts — always!
- Eliminate engine "tune-ups"
- Keep breaker points perfect over 75,000 miles — spark plugs clean up to 50,000 miles



POWERTRONICS CORP., 387 Park Ave. So., New York 10016

I enclose \$19.95; plus \$1.00 shipping costs; rush my POWERTRON Transistor Ignition System on 10-day money-back guarantee for

Car Make \_\_\_\_\_ Year \_\_\_\_\_ Model \_\_\_\_\_

NAME \_\_\_\_\_

ADDRESS \_\_\_\_\_

CITY, STATE, ZIP CODE \_\_\_\_\_ EW9

CIRCLE NO. 98 ON READER SERVICE CARD

## HOLIDAY SALES DAYS ARE HERE

PLAN TO INCREASE YOUR HOLIDAY MAIL ORDER BUSINESS BY FEATURING YOUR CLASSIFIED ADVERTISING IN THE ELECTRONICS WORLD ELECTRONICS MARKET PLACE

The November issue closes September 1st and will be on sale Oct. 21st. The December issue closes October 1st and will be on sale Nov. 18th.

If you are offering any product or service of interest to Electronics Professionals—whether it is from a business or hobby viewpoint—your Classified Advertising belongs in ELECTRONICS WORLD—the world's leading magazine editorially geared to the needs of electronics professionals. More than 192,000 interested individuals buy ELECTRONICS WORLD each month—and read it from cover to cover. They read and respond to the ads... the Classified Ads in particular. If you want response to your ads such as you have never before experienced, they belong in the ELECTRONICS MARKET PLACE.

And now, take advantage of a money-saving opportunity, too. Although the rate per word increases to 70¢ effective with the October issue, we will accept orders at the old rate of 60¢ per word through September 15, 1965 and allow price protection through the December, 1965 issue.

ASSURE GREATER HOLIDAY MAIL ORDER SALES FIGURES FOR YOURSELF BY WRITING TODAY TO:

Hal Cymes, Classified Advertising Manager

**ELECTRONICS WORLD**

One Park Avenue • New York, New York 10016



plastic jackets characterized by excellent moisture resistance and low-temperature properties. Birnbach Radio

Circle No. 139 on Reader Service Card

**IRON-CORE INDUCTANCE**

An 8-page technical brochure entitled "A Production Technique for Determination of Inductance for Toroidal Powdered Iron Cores" is now available.

Completely illustrated, the booklet describes how to construct a special-purpose permeameter designed for production-line use and also discusses a method of maintaining high quality not only within a batch of inductors but also from batch to batch. Arnold Engineering

Circle No. 140 on Reader Service Card

**COMPUTER TAPE MAINTENANCE**

A discussion of the various problems that arise through poor magnetic-tape maintenance is contained in a 12-page booklet entitled "Why Is Tape Preventive Maintenance Needed?"

Among the sources of tape problems considered are dirt, edge damage, and tape skew as a result of improper winding, creases due to machine misalignment, and tape wear. General Kinetics

Circle No. 141 on Reader Service Card

**INDICATOR LIGHTS**

Incandescent and omnidirectional indicator lights, dimming and non-dimming types, and light-shield units are among the subminiature, one-terminal, fully insulated indicator lights described in a new 4-page catalogue (L-157D). Complete lamp data and mounting information are provided. Dialight

Circle No. 142 on Reader Service Card

**GALVANOMETERS**

Complete details on selecting the proper recording galvanometer, calculating damping networks, and operating tips and performance specifications

are presented in a new 24-page "Galvanometer Users' Handbook."

Bulletin 7300 is fully illustrated and includes an important section on galvanometer terminology. Consolidated Electrodynamics

Circle No. 143 on Reader Service Card

**PRODUCT SUPPLEMENT**

A new 24-page catalogue contains complete technical data on ultra-miniature and miniature rotary and push-button switches. Also included in this catalogue is a handy rotary-switch reference chart.

The fully illustrated booklet also lists transistor and pencil-tube sockets and plastic module cases and headers. Grayhill

Circle No. 144 on Reader Service Card

**RESISTOR HANDBOOK**

The manufacture and quality control of "Ultra Precise JXP" metal-film resistors, restricted to characteristic E of MIL-R-10509, are described in a 10-page handbook of particular interest to electronics engineers. Performance data and specifications are also given. Jeffers Electronics

Circle No. 145 on Reader Service Card

**SOLDER BULLETIN**

Ultra-high-purity metals, solder preforms, core solders, and printed-circuit materials are described and illustrated in a new multi-lingual (English, French, German, and Italian) product brochure.

Bulletin A-108 also contains a convenient flux-finder guide and solder-selector chart. Alpha Metals

Circle No. 146 on Reader Service Card

**INDUSTRIAL WIRING**

Technical information on Teflon-insulated power, control, and heating cables is presented in an 8-page catalogue entitled "High Temperature Industrial Wiring."

Typical applications, including burner control

and fire alarms, as well as advantages, are covered in the illustrated booklet (Bulletin HT-1000). Hiteip Wires

Circle No. 147 on Reader Service Card

**MULTI-CIRCUIT CONTROLS**

A new, 8-page, color-illustrated circular describes typical industrial applications of "Coordinated Manual Controls" (CMC). The product is a modular assembly combining up to four lighted legends and four-position control in one compact unit occupying a small area of panel space.

Form 8A-733 points out that virtually unlimited control capabilities are possible from four basic, oil-tight units: push-button, selector, combined selector-push, and an indicator without control. Applications covered include machine tools and air conditioning. Micro Switch

Circle No. 148 on Reader Service Card

**ELECTRONIC TIMERS**

A 4-page pamphlet describing two new lines of transistorized industrial timers has been published. Both the high-accuracy (ET 560 series) and the low-cost (ET 550 series) lines feature interchangeable time-range dials, pre-assembled mountings, and a variety of enclosures.

Brochure GEA-7668 is fully illustrated and contains pertinent information on the time-delay, timed-interval, and recycle functions of electronic timers. Complete ordering and pricing data is included. General Electric

Circle No. 149 on Reader Service Card

**QUARTZ CRYSTALS**

A product catalogue in an unusual arrangement which covers a complete line of high- and low-frequency quartz crystals and filters has been made available.

The bound section of the catalogue features a 4-page explanation of crystal properties and manufacturing procedures. The inside back cover contains a pocket for inserts which discuss a broad



**ARE YOU CASHING-IN ON THE PROFITABLE 2-WAY RADIO SERVICE BUSINESS?**

- ★ Motorola will train you for this rewarding, elite profession
- ★ Send for our FREE EVALUATION EXAM. Prove to yourself that you are ready to learn FM 2-way radio servicing.

Opportunities in 2-way radio servicing are virtually unlimited. ■ Just one of the hundreds of successful Motorola Service Stations writes, "we would be pleased to interview any graduate of your school that has received some training in 2-way radio maintenance. We are an established firm, 10 years old, with a promise of expansion governed by our ability to obtain competent technicians." ■ Get all the facts today. There is no obligation and no salesman will call.

**MOTOROLA TRAINING INSTITUTE**  
4545 West Augusta Blvd. • Chicago 51, Illinois • Dept. AEF538

- Send me FREE entrance exam.
- Send full details on Home Study Course on FM 2-way Radio Servicing
- Send me details on how you can help me prepare for an FCC License.

Name \_\_\_\_\_ Occupation \_\_\_\_\_  
Address \_\_\_\_\_  
City \_\_\_\_\_ Zone \_\_\_\_\_ State \_\_\_\_\_

CIRCLE NO. 100 ON READER SERVICE CARD

*Back Issues Available*

Use this coupon to order back issues of **ELECTRONICS WORLD**

We have a limited supply of back issues that can be ordered on a first-come, first-served basis. Just fill in the coupon below, enclose your remittance in the amount of 65¢ each and mail.

ZIFF-DAVIS SERVICE DIVISION  
Dept. BCEW, 589 Broadway  
New York 12, New York

Please send the following back issues of ELECTRONICS WORLD. I am enclosing \_\_\_\_\_ to cover the cost of the magazine, shipping and handling.

Month \_\_\_\_\_ Year \_\_\_\_\_  
Month \_\_\_\_\_ Year \_\_\_\_\_  
Month \_\_\_\_\_ Year \_\_\_\_\_

Name \_\_\_\_\_

Address \_\_\_\_\_

City \_\_\_\_\_ Zone \_\_\_\_\_ State \_\_\_\_\_ EW

No charge or C.O.D. orders please.

ELECTRONICS WORLD



# FREE!

Mail This Card Today For Your

# FREE!

1966 Lafayette Catalog 660

# LAFAYETTE

## 1966 Catalog 660



## Now BETTER THAN EVER

## Over 500 Pages

Featuring Everything in Electronics for

- HOME
- INDUSTRY
- LABORATORY

from the

### "World's Hi-Fi & Electronics Center"



Use Lafayette's Easy-Pay Budget Plan  
No Money Down... Up to 24 Months to Pay  
**Satisfaction Guaranteed or Money Refunded**

LAFAYETTE Radio ELECTRONICS  
Dept. RI-5 P.O. Box 10  
Syosset, L.I., N.Y. 11791  
Send me the Free 1966 Lafayette Catalog 660

Name .....

Address .....

City ..... State .....

Zip .....

(Please Give Your Zip Code No.)

[www.americanradiohistory.com](http://www.americanradiohistory.com)



Name

Address

City

State

Zip

Dept. RI-5

(Please Give Your Zip Code No.)

Mail This Card Today for Your Friend's

# FREE!

1966 Lafayette Catalog 660



Friend's Name

Address

City

State

Zip

Dept. RI-5

(Please Give His Zip Code No.)

### STORE LOCATIONS

NEW YORK  
Brooklyn  
Syosset  
Manhattan  
Jamaica  
Scarsdale  
Bronx

NEW JERSEY  
Newark  
Paramus  
Plainfield

MASSACHUSETTS  
Boston  
Natick

MARYLAND  
Mt. Rainier  
(Wash. D.C. Area)

Mail the Coupon  
Today for Your  
**FREE 1966**  
**Lafayette**  
**Catalog 660**

LAFAYETTE RADIO ELECTRONICS  
P.O. BOX 10  
SYOSSET, L.I., N.Y. 11791

PLACE  
STAMP  
HERE

LAFAYETTE RADIO ELECTRONICS  
P.O. BOX 10  
SYOSSET, L.I., N.Y. 11791

PLACE  
STAMP  
HERE

Live Better Electronically With

# LAFAYETTE RADIO ELECTRONICS

Mail The Card Today for Your

# FREE!

## 1966 Catalog 660



Shop At The  
"World's Hi-Fi &  
Electronics Center"  
For Widest Selection,  
Low Prices

- Stereo Hi-Fi • Citizens Band • Ham Gear • Tape Recorders
- Test Equipment • TV and Radio Tubes and Parts • Cameras • Auto Accessories • Musical Instruments • Tools • Books

Everything In Electronics for Home • Industry • Laboratory  
Exclusively Yours at Lafayette

A Complete Assortment of Musical Instruments

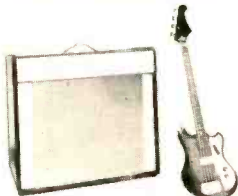

New! 25-Channel, Solid-State C.B. Transceiver Model HB-600



New! Criterion Hi-Fi Bookshelf Speakers

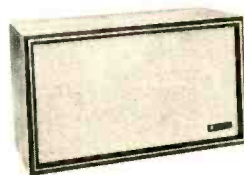

No Money Down • Up to 24 Months to Pay

70-Watt AM-FM Stereo Receiver, Model LR-800



New! Lafayette U. S. Army-Look-a-Like 2-Way Radio, Model GT-3

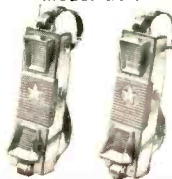

New! Criterion 1000B — Pushbutton 4-Track Stereo Tape Recorder in Teak Case



Satisfaction Guaranteed or Money Refunded

New! Lafayette Mobil-Ade™ 12-Channel Solid-State CB Transceiver, Model HB-555



50-Watt Solid-State Stereo Amplifier, Model LA-248



New! Complete Line of Lafayette TV Antennas

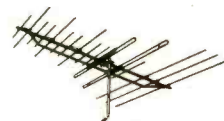

Do A Friend A Favor...

Have a friend interested in hi-fi or electronics? Send us his name and address and we will send him his own personal copy of the 1966 Lafayette Catalog 660.

# FREE

 Mail The Card Today



line of quartz crystals, filters, tuning-fork and crystal oscillators, and crystal and component ovens. This unique format will permit issuance of new pages without revision of the entire catalogue.

Each of the inserts is fully illustrated and includes complete mechanical and technical data on all devices listed in these catalogue sheets. McCoy Electronics

Circle No. 150 on Reader Service Card

#### VARIABLE CAPACITORS

A new 2-page bulletin (MT-65-1) covering a complete line of "Modutrim" micromodule ceramic variable capacitors has recently been issued. Designed to meet or exceed MIL Spec MIL-C-81A, the units are available in two series. Model MT 200 capacitors are constructed especially for mounting in TO-5 outline enclosures or in other micromodule applications where size is critical. The MT 100 series is slightly larger but has the same electrical properties as the MT 200.

The illustrated leaflet lists seven key advantages of these new capacitors and contains a table of electrical characteristics and outline drawings showing physical dimensions. JFD

Circle No. 151 on Reader Service Card

#### PRODUCT CATALOGUE

Complete information on industrial and military switches, pots, and resistors is offered in a new, 32-page 1965 catalogue. The booklet is fully illustrated.

Covered are composition element potentiometers, power rheostats, sound system controls, and a variety of dials, switches, and similar components. Clarostat

Circle No. 152 on Reader Service Card

#### ALUMINUM PACKAGING

Packaging standards for aluminum electric conductor are supplied in two 8-page booklets. The first is a new publication on covered electric conductor and service drop cable, which lists five standardized non-returnable reels.

The second is a revised edition on bare stranded aluminum conductor and ACSR, originally issued in 1961. Both publications include information on standard-sized packages and standard length and weight tolerances. Aluminum Assn.

Circle No. 153 on Reader Service Card

#### COAXIAL CABLE

An 8-page brochure entitled "Electronic Cables" which provides a complete list of coaxial and special-purpose cables is now available on request.

All products are classified by both type number and characteristic impedance for ease of selection. Also included in bulletin C-265 is a handy table of special r.f. cables for commercial applications. ITT Wire and Cable

Circle No. 154 on Reader Service Card

#### CONVERSION CHART

Conversion of micro-inches to angles and angles to micro-inches; inches to millimeters, microns, and angstroms; and millimeters, microns, and angstroms to inches is concisely shown on a new wallet-sized, plastic-coated conversion chart. Also included on this convenient chart are wavelengths of monochromatic radiation and selected physical constants. Engis Equipment

Circle No. 155 on Reader Service Card

#### SEALED RELAYS

A line of nine types of sealed relays, including five grid-space micro-miniature units, Unimite relays, and miniature devices, is presented in a new 22-page booklet (GEA-6628C).

Complete technical data, dimensional drawings, and mounting forms are included. General Electric

Circle No. 156 on Reader Service Card

#### SEMICONDUCTOR GUIDE

A line of thirteen germanium transistors and two silicon rectifiers, capable of replacing more than 2700 types of semiconductor devices used in radios, phonographs, tape recorders, and other entertainment equipment using solid-state devices, is offered in a 16-page semiconductor replacement guide.

Also included in the booklet are operating considerations, dimensional outlines, and terminal diagrams. RCA

Circle No. 23 on Reader Service Card

#### ELECTRONICS CATALOGUE

A complete selection of electronic equipment, including stereo/hi-fi, Citizens Band, tape recorders, ham gear, test equipment, cameras, tools, and books, is offered in a new, 512-page, illustrated, 1966 product catalogue. Lafayette

Circle No. 24 on Reader Service Card

#### HIGH-POWER TUBES

A line of high-power tubes for radar and microwave modulation applications is described in a new 6-page technical brochure. Included are both ceramic and glass hydrogen-filled diodes and thyatrons, along with several high-voltage, vacuum-switch tubes.

September, 1965

# Get the Best Matching Transformer Kit for Coax

## "COLOR-MATCH" by Winegard

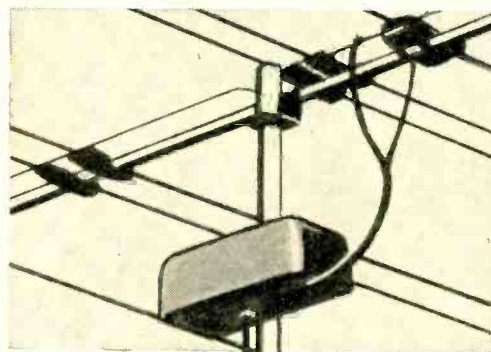

*The Convenient, Easy-to-Use Matching Transformer Kit for Quick, Permanent Coax Installations.*

75 ohm coaxial cable is the most permanent transmission line that can be used in a TV antenna installation. And, because it is shielded, it can be installed next to metal objects, run through conduit, and taped to the antenna mast without interfering with the TV signal. However, to install coax, you need the two matching transformers in "Color-Match".

Model T5911M Transformer mounts on or near the mast. It matches any 300 ohm antenna to 75 ohm coax cable. The T73 transformer mounts conveniently behind any TV set. It trans-

forms the signal back to 300 ohm impedance for a perfect match with the set. All mounting hardware and connectors are included.

When you use coax, be sure to use Winegard "Color-Match". Ask your distributor or write for spec. sheets. "Color-Match" is another convenience product for better TV reception from Winegard.

NOTE: When running 75-ohm coaxial cable in fringe areas, we recommend installation of Winegard 75-ohm Colortron Antenna amplifier Model AP275N—twin nuvistor, or model AP-275T—twin transistor to compensate for the

line loss inherent in all coax installations.

Model T-200 ONLY

\$8.25 LIST

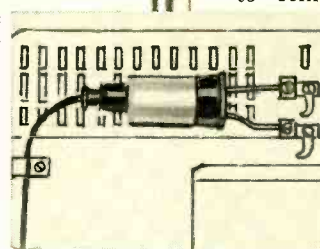

Model T73



Model T5911M



# Winegard Co.

ANTENNA SYSTEMS

3000 KIRKWOOD • BURLINGTON, IOWA

CIRCLE NO. 87 ON READER SERVICE CARD

101



Tri-State College's electronics lab

# electronics degree now in 36 months!

Small professionally-oriented college. Four-quarter year permits degree completion in three years. Summer attendance optional. *Engineering:* Electrical (electronics or power option), Mechanical, Civil, Chemical, Aeronautical. *Business Administration:* Accounting, General Business, Motor Transport Administration. One-year Drafting and Design Certificate program. Graduate placement outstanding. Founded 1884. Rich heritage. Excellent faculty. Small classes. Well-equipped labs. New library. New residence halls. Attractive 300-acre campus. Modest costs. Enter Jan., March, June, Sept. For Catalog and View Book, write Director of Admissions.



1695 College Ave., Angola, Indiana

## MINIATURE CAPACITOR PACKAGE 4000 mfd for \$1.00

High quality, metal cased completely sealed electrolytic capacitors made in USA for use in transistor auto radios, power supplies, communications equipment, "ham" gear and many other applications.

SEND TODAY for this package of 3 units; totaling 4000 mfd rated 16 volts DC; each unit 1 1/2" max dia by 2 1/4" max hgt.

SEND \$1.00 CHECK OR MONEY ORDER for each package, postage prepaid to:

LINDA SALES CORPORATION  
PO Box 68, Harrison, N.J.

Your Postmaster Suggests:

Always Include

Your (ZIP CODE) Number

in your

Return Address

Any Car Radio Repaired \$9.95

Includes all Labor and Parts. Radio must contain all parts & be defective due to normal usage.

Send Radio with check or money order to:

Universal Electronic Supply  
667 W. Avenue I  
Lancaster, California 93453

The brochure is fully illustrated and contains complete electrical and physical specifications for 49 different devices discussed. Tung-Sol

Circle No. 157 on Reader Service Card

### COMPONENTS CATALOGUE

Tube sockets, plugs, and connectors for industrial and commercial use are fully described and illustrated in a new 68-page catalogue (CC-1). Also discussed are the advantages and disadvantages of various types of contact and dielectric materials, as well as a chart giving the electrical and mechanical characteristics of dielectric materials. Amphenol

Circle No. 158 on Reader Service Card

### TECHNICAL PAPERS INDEX

A comprehensive subject-author index of nearly 1300 technical papers published during 1964 is now available. Among the topics covered in the 26-page booklet are amplification, communications, instrumentation, lasers, solid-state devices, and superconductivity. RCA

Circle No. 159 on Reader Service Card

### ROTARY SWITCHES

Descriptions, specifications, applications, and other pertinent product data are detailed in a new 20-page catalogue entitled "High Accuracy Rotary Commutating Switches and Analog-Digital Converters." Airlyte Electronics

Circle No. 160 on Reader Service Card

### WAVESOLDERING

A 6-page illustrated brochure describes the many automatic wavesoldering systems available to meet the various requirements of the printed-circuit industry, from compact low-volume processing to high-volume processing, and systems for special applications. Photographs and such descriptive details as wave characteristics, operating temperatures, applications, physical specifications and features are included for each type of wavesoldering machine. Electrovert

Circle No. 161 on Reader Service Card

### Answer to Crossword Puzzle (appearing on page 77)

P	E	N	T	O	D	E	D	Y	N	O	D	E
H	F	E	C	G	U	Y	E	I	D			
A	F	E	C	O	N	U	C	L	E	I		
N	I	R	U	M	B	L	E	K	C	S		
O	C	T	A	L	E	P	R	S	O			
T	I	E	T	E	A	A	U	D	I	O	N	
R	E	N	T	M	M	U	N	I	N			
O	N	R	F	R	S	H						
N	C	I	P	G	R	A	P	H	I	T	E	
Y	A	G	I	M	I	L	E	T	A	P		
P	U	A	G	R	T	B	T					
H	A	R	N	E	S	S	B	I	A	S	O	
O	R	A	U	N	O	M	E	A	D			
N	E	U	T	R	O	N	A	M	P	E	R	E

### PHOTO CREDITS

Page	Credit
16	Acoustic Research
28 (top)	Radio Corporation of America
28 (center)	IIT Research Institute
28 (bottom)	Regency Electronics
29 (left)	Westinghouse Electric Co.
29 (top right)	Hughes Aircraft Co.
29 (bottom left)	Perspective, Inc.
29 (bottom right)	Systems Engineering Labs.
44	General Radio Company
45, 48	Sperry Gyroscope Co.
49	Tektronix, Inc.
65 (top left)	Pearce-Simpson
65 (top right)	Kaar
65 (center)	Lafayette Radio Electronics
84	KLH

# 200-MW. TRANSISTOR INTERCOM

By EDWARD DAVIS

A "P-N-P" power transistor (Q1) is used in the common-emitter configuration to amplify the signal obtained from a small, standard carbon microphone cartridge and to provide direct-drive for a 3-4 ohm PM speaker.

Base bias is supplied through a voltage divider made up of the microphone and fixed resistor (R1) while operating power is obtained from a 3-volt flashlight battery (B1). Push-to-talk operation is provided by a s.p.s.t. push-button

switch (S1). Operation of intercom "B" is the same.

Neither layout nor lead dress is critical, but the author suggests only one push-button can be push-to-talk. If both intercom buttons are pushed, it will create feedback.

The 2N301 power transistor is mounted on a small metal chassis (6"x 5"x 4") which serves as a heat sink. A Lafayette SP-147 transistor may also be used in place of the unit shown. ▲

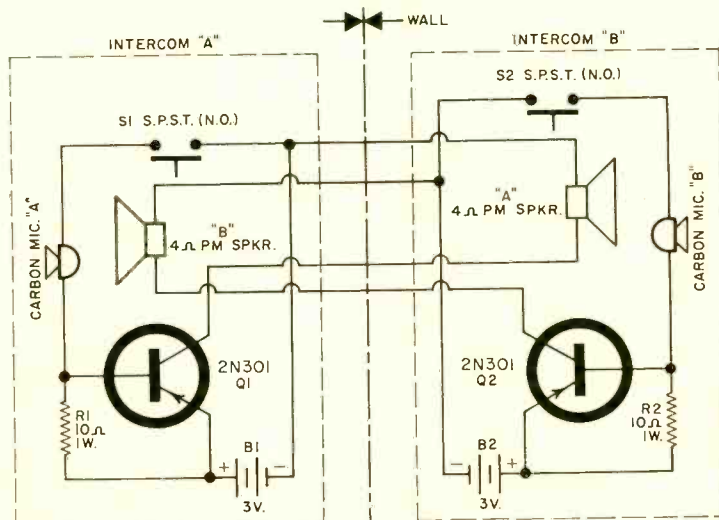



# ELECTRONICS MARKET PLACE

**COMMERCIAL RATE:** For firms or individuals offering commercial products or services. 60¢ per word (including name and address). Minimum order \$6.00. Payment must accompany copy except when ads are placed by accredited advertising agencies. Frequency discount: 5% for 6 months; 10% for 12 months paid in advance. **READER RATE:** For individuals with a personal item to buy or sell. 35¢ per word (including name and address). No Minimum! Payment must accompany copy. **GENERAL INFORMATION:** First word in all ads set in bold caps at no extra charge. Additional words may be set in bold caps at 10¢ extra per word. All copy subject to publisher's approval. Closing Date: 1st of the 2nd preceding month (for example, March issue closes January 1st.) Send order and remittance to: Hal Cymes ELECTRONICS WORLD, One Park Avenue, New York, New York 10016

## FOR SALE

**JUST starting in TV service?** Write for free 32 page catalog of service order books, invoices, job tickets, phone message books, statements and file systems. Delrich Publications, 6556 W. Higgins Rd. Chicago, Ill. 60656.

**GOVERNMENT Surplus Receivers, Transmitters, Snoposcopes, Radios, Parts, Picture Catalog 20¢.** Meshna, Nahant, Mass.

**INVESTIGATORS,** free brochure, latest subminiature electronic surveillance equipment. Ace Electronics, 11500-J NW 7th Ave., Miami 50, Fla.

**CANADIANS—Giant Surplus Bargain Packed Catalogs.** Electronics. Hi-Fi, Shortwave, Amateur, Citizens Radio. Rush \$1.00 (Refunded). ETCO. Dept. Z, 464 McGill, Montreal, Canada.

**INVESTIGATORS—Electronic surveillance devices.** Price breakthrough on ultra miniature professional devices. Free details. Trol Electronics-EW, 342 Madison Avenue, New York, N.Y.

**RESISTORS** precision carbon-deposit. Guaranteed 1% accuracy, 1/2 watt 8¢. 1 watt 12¢. 2 watt 15¢. Rock Distributing Co., 902 Corwin Road, Rochester 10, N.Y.

**NEW supersensitive transistor locators** detect buried gold, silver, coins. Kits, assembled models. \$19.95 up. Free catalog. Relco-A22, Box 10563, Houston 18, Texas.

**JAPAN & Hong Kong Electronics Directory.** Products, components, supplies. 50 firms—just \$1.00. Ippano Kaisha Ltd., Box 6266, Spokane, Washington 99207.

**TV CAMERAS, transmitters, converters, etc.** Lowest factory prices. Catalog 10¢. Vanguard, 190-48 99th Ave., Hollis, N.Y. 11423.

**WEBBER Labs.** Transistorized converter kit \$5.00. Two models using car radio 30-50Mc or 100-200Mc, one Mc spread. Easily constructed. Webber, 40 Morris, Lynn, Mass.

**ELECTRONIC Ignition Kits, Components.** Free Diagrams. Anderson Engineering, Epsom, New Hampshire 03239.

**BUILD TV Camera Cheaper Than Ever!** Send 10¢ for details. ATV Research, Box 396, South Sioux City, Nebr. 68776.

**ACHTUNG!** Das machine is nicht fur Gerfingerpoken und mittengraben. Is easy schnappen der Springenwerk, blowenfasen und poppencorken mit spitzen-sparken. Ist nicht fur gewerken by das Dummkopfen. Das rubbernecken sightseeren keepen hands in das pockets. Relaxen und watch das Blinkenlights. This attractive, brass metal plaque only \$2.00 ea. ppd. Southwest Agents, Dept. E, 8331 Hwy. 80 West, Fort Worth, Texas 76116.

**NEED RESISTORS?** Factory fresh, NAME BRAND, 1/2 watt, 10% standard carbon resistors. Any regular value from 10 ohms to 2.2 megohms, \$.05 each! Postpaid. Any quantity assorted. Minimum order \$1.00. TEPCO, Box 508, Tullahoma, Tenn.

**CANADIANS,** transistors, all semiconductors and components. Free catalogue contains reference data on 300 transistor types. J.&J. Electronics (Dept. EW), P.O. Box 1437 Winnipeg, Manitoba, Canada.

**CONVERT** any television to sensitive, big-screen oscilloscope. Only minor changes required. No electronic experience necessary. Illustrated plans, \$2.00. Relco, Box 10563, Houston 18, Texas.

**TRANSISTORS—Miniature Electronic Parts.** Send for Free Catalog. Electronic Control Design Company, P. O. Box 1432M, Plainfield, N.J.

**ELECTRONIC Bargains—Free Catalog, Tubes, Diodes, CRT's Tuner Cleaner, etc.** Cornell, 4213-W University, San Diego, Calif. 92105.

**DETECTIVES!** Free Brochures; Electronic intelligence devices for your needs and budget. SILMAR ELECTRONICS, 3476 N. W. 7th Street, Miami, Fla. 33125.

**TRANSISTOR Ignition Coils 400:1 Special \$3.95.** Two Delco Transistor Cascade Amplifier (15 Amp) in Anodized aluminum Heatsink. Below Parts Cost at \$5.95. 4/10-6/10 80 Watt Ballast Resistors, 69 Cents, 6-10 Volt 20 Amp load Relay with fuse, 99 cents. Complete Kit for 6-12 Volt Negative Ground, \$9.95 postpaid. Orders under \$5.00 Add 50 cents postage. Closeout, all new merchandise supply limited. Electronic Liquidators, Box 1946, Grand Junction, Colorado.

**SAFEGUARD Privacy!** New instrument detects electronic "bugs", wire tapping and snooping devices. Free information. Dee Equipment, Box 7263-E11, Houston 8, Texas.

**NEON AC/DC ELECTRIC TESTER**  
FOR HOME AUTO SHOP  
**SPECIAL! 59¢**

**Special!**  
With every \$10 Order  
**25¢** per tube  
(No Limit) from this list:  
6AG5 6AU6 6BS4 6SN7  
6BAQ5 6BK6 6W4

**CORNELL**  
**33¢** PER TUBE  
100 TUBES OR MORE:  
**30¢ PER TUBE**

**TUBES**  
1 YR. GUARANTEED  
Mutual Conductance Lab-tested, Individually Boxed, Branded and Code Dated

**Prestige & Success are yours as an ELECTRONIC EXPERT**  
FOR CORNELL CUSTOMERS ONLY by special arrangement with the publisher, these amazing bargains are available

COMPLETE RADIO SERVICING AND BASIC ELECTRONICS COURSE ONLY \$3.00 (15-30 - 50 working charges)

NEW PRACTICAL TV TRAINING COURSE ONLY \$3.50 (18-30 - 50 working charges)

**Both above courses \$6.00**

**21 PICTURE TUBES**  
1 Yr. Guar. Aluminized Pay Duct Deposit COO or Send Duct with Order

12AP5	12AP6	12AP7	12AP8
12AP9	12AP10	12AP11	12AP12
12AP13	12AP14	12AP15	12AP16
12AP17	12AP18	12AP19	12AP20
12AP21	12AP22	12AP23	12AP24

**all purpose ELECTRONIC CLEANER**  
79¢ plus 20¢ shipping

**CHEATER CORDS**  
29¢

**SILICON RECTIFIERS**  
750 MA 400 P.I.V. **69¢** PAID

**DIODES/RECTIFIERS**  
39¢ per pack plus 5¢ shipping

**sensational KIT VALUE!**

This kit is one of those rare electronic bargains. It contains a complete assortment of 20 types of diodes. These diodes have all been checked for G.C. Meq and the total cost ranged from \$1.00 to \$1.00 each. These are brand new diodes and were manufactured by the leading diode manufacturer. A few of the diodes included are: 1N4001, 1N4002, 1N4003, 1N4004, 1N4005, 1N4006, 1N4007, 1N4008, 1N4009, 1N4010, 1N4011, 1N4012, 1N4013, 1N4014, 1N4015, 1N4016, 1N4017, 1N4018, 1N4019, 1N4020.

Each pack is air conditioned and each pack is sealed in your pack.

**RADIO-TV TUBE TESTER**  
TEST AND REPAIR TV & RADIO SETS APPLIANCES  
**\$2.89** plus 30¢ shipping

**TUBE CARTONS**  
HIGH GLOSS CLAY COATED RED & BLACK WITH BUILT IN DIAGONAL PARTITIONS

SIZE	FOR TUBE SIZE	PRICE PER 10 CARTONS (25 cartons)	PRICE PER 100 CARTONS (250 cartons)
MIN	6AU6	29	2.59
GT	6SN7	39	3.48
L.G.T	6BAQ5	59	5.29
L	6W4	99	7.99

**PICTURE EXPANDER**  
REMOVES LOW REFLECTIVITY FROM HORIZONTAL CATHODE COMPARTMENT FOR LOW VOLTAGE SUPPLY  
**99¢**

**SOLDERING GUN**  
SPECIAL LOW PRICE **\$2.99** plus 30¢ shipping

**EASY TO HANDLE HOT SHOT**  
THE ONLY PORTABLE ELECTRIC SOLDERING GUN

IDEAL FOR:  
- LEAD SOLDER  
- FAST HEAT  
- PORTABLE  
- CONSTRUCTION USE  
- COOL TIP FOR

**TUBE SUBSTITUTES**  
11,000 TUBES  
**\$1.25**

**ABC TV \$100**  
BIG PROFITS ARE HERE IN COLOR TV REPAIR  
GET AHEAD OF THE FIELD

**Electronic SOLDER**  
SOLDER  
**SENSATIONAL VALUE! 29¢**

**CORNELL ELECTRONICS CO.**  
Dept. EW 9 4217 University Ave., San Diego, Calif. 9 2 1 0 5

**TERMS:** Add 3¢ per tube shipping. Orders under \$5.00 add 3¢ per tube shipping plus 50¢ handling. Canadian orders add approximate

postage. Send 25% deposit on C.O.D. orders. No C.O.D. orders under \$5.00 or to Canada. No 24 hr. free offer on personal check orders **5-DAY MONEY BACK OFFER!**



# GET IT from GOODHEART!

**LV PWR SPLY XFRMRS:** 115/230V 60cy 1 ph pri. Four 6.3vct secs 35A, so get up to 25.2v rms in steps of 3.15v or 25.2vct up to 35A or 12.6vct 70A or 6.3vct 140A. Evct pri. taps for closer togrid; make LINC solid-state converter to 115v 60 cy. Sealed, potted. Net 54#. **24.50**  
RailEX or Truck collect. remit

**ALL-BAND SSB RCVR BARGAIN:** Hallicrafters R-43/ARR-7. 550 kc to 43 mc continuous; Voice CV. MCIV aligned and modified; now also modified to include PROBE DETECTOR. 2 RF, 2 IF stages. S-Meter, XT, w/120/230 v 50/60 cy pwr sply. Hot and SHARP & works like a charm! FOH Los Ang. **199.50**

**TIME PAY PLAN:** Any purchase totalling \$100.00 or more, down payment only. **10%**

R-23/ARC-5 Command rcvr 190-550 kc. 14.95  
A.R.C. 12 #22 Command rcvr 540-1600 kc. 17.95  
ARR-5 rcvr, 60 cy, am/fm, 38-140 mc. 179.50  
Panadapter 5.25 mc for above, 60 cy. 69.50  
APR-4 rcvr, plug, book, 38-1000 mc. 179.50  
Add \$65.00 for 975-2200 mc. Add \$125.00 for 2175-4000 mc. Add \$30.00 for AM/TM w 60 cy pwr.  
RA-62-B is AC pwr sply for SCR-522, only. 17.95  
AN/URR-13(\*) Rcvr. 225-400 mc. 295.00  
TDZ 60 cy xmtr 225-400 mc 30 w Po, new. PUR  
LM-14 freq. meter, .01% 125 kc-20 mc. 57.50  
TS-323/UR freq. meter 20-480 mc., .001%. 395.00  
Tektronix 541A scope w/preamplifier. 795.00  
Tektronix 514AD scope dc to 10 mc. 195.00  
LP Signal Generator 9/2 kc-50 mc. 475.00  
H.P. 608B signal generator 10-400 mc. 525.00  
H.P. 608B modified to 10-500 mc. 395.00  
SLRD sig-gen. 275-2750 mc, 20 watts. PUR  
SG-66A/ARM-5 (A.R.C. H-14A) OHC. 795.00  
TS-418A U sig. gen. to 0 dbm 0.4-1.0 gc. 395.00

**LINE VOLTAGE REGULATION BARGAINS**  
Largest selection in the WORLD! Ask for list. from Solo 250 VA to Sorensen 10,000 VA!

**REGULATED DC POWER SUPPLY BARGAINS**  
Very large selection! Ask for list of these!

**HEWLETT-PACKARD & OTHER METERS, VTVMs**  
Very large selection! Ask for list of these!

**WHEATSTONE BRIDGES, VOLTAGE DIVIDERS, ETC.**

Very large selection! Ask for list of these!  
**AND MUCH MORE!** We have 33 other types of Signal Generators, Digital Counters & regu. pwr. splies, DVM's, other scopes, Pulse Generators, Precision Bridges & Voltage Dividers, AC & DC Galvos, Line Voltage Regulators, Phase-Angle Meters, VIM's, Spectrum Analyzers, Etc. WRITE WIRE PHONE YOUR SPECIFIC NEEDS!

**R. E. GOODHEART CO. INC.**

Box 1220-A, Beverly Hills, Calif. 90213

Phones: Area 213, office 272-5707, messages 275-5342

CIRCLE NO. 112 ON READER SERVICE CARD

# BIG CATALOG

World's "BEST BUYS" in GOV'T. SURPLUS Electronic Equipment

## OSCILLOSCOPE

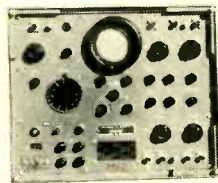

**USM-24:** 3 inch CR Tube 3JP1; recurrent sweep. 8 cyc. per sec. to 600 KC. Triggered sweep 1.25-125 M Microsec. vert. deflec. sensitivity .035 horz. deflec. 4.0 V. horz. response 5 cyc. per sec to 700 KC., Vert. response 4 cyc. per sec. to 10 MC. Beam mod. response 500 c/c. per sec to 10 MC. Horz. input impedance 300,000 ohms. Vert. input resistance 300,000 ohms. Beam mod. input resist. 56,000 ohms. Operates from 115 Volt 50 to 1000 cycle radio freq. & mod. Circuits use BCN series coaxial connectors. Size: 17x15x15"; Wt.: 60 lbs. USED, serviceable. Prices given below are less blowers, probes, cables, coaxial fittings and as offered:

OS-51/USM-24—Less Front and Back Covers **\$59.50**  
OS-26/USM-24—Less Front & Back Covers & Delay Line **\$39.95**  
OS-26/USM-24—Less Front Cover & Delay Line **\$49.50**

**BC-221 FREQ. METER**—per Aug. Ad.  
New: \$125.00—Used: \$79.50

## TRANSFORMERS:

SECONDARY:	PRIMARY:	No.:	PRICE:
4800 VCT 1.7 A	220 V 50-60 c/c	5214	\$34.95
2000 VCT 500 MA	115 V 60 c/c	5204	16.95
1000 VCT 400 MA	115 V 60 c/c	8894	8.95
500 VCT 60 MA	115 V 60 c/c		
840 VCT 255 MA			
12.6 VCT 13A			
5 V 4A	115 V 60 c/c	223959	7.95
2.5 V 10A	120 V 60 c/c	9611.144	2.95
6.7 V 21.8 A	115 V 60 c/c	7489149	6.95
5.6 V 10 A	115 V 60 c/c	9735158	2.95
5.6 V 10 A	120 V 60 c/c	1043	8.95
12.8 VCT 20 A	115 V 60 c/c	9992	8.95
24 VCT 6 A	115 V 60 c/c	C0N442	8.95
36 V 11.2 A	115 V 60 c/c		
SOLA CONSTANT VOLTAGE	Pri.: 190-250 V 60 c/c;		
Sec.: 115 V 2000 VA	30M811		75.00

## CHOKES:

10 Hy—75 MA. \$ .89 10 Hy—110 MA. \$1.75  
8 Hy—250 MA. \$ 4.95 8 Hy—300 MA. (oil) 5.95  
8 Hy—450 MA. \$ 6.95 10 Hy—500 MA. 6.95

FOR BIG CATALOG—SEND 25¢ (stamps or coin) and receive 50¢ CREDIT on your order!

Address Dept. EW • Prices F.O.B. Lima, O. • 25% Deposit on C.O.D.'s • Minimum Order \$5.00

**FAIR RADIO SALES**  
2133 ELIDA RD. • Box 1105 • LIMA, OHIO

TRANSISTORIZED Products importers catalog. \$1.00. Intercontinental. CPO 1717, Tokyo, Japan.

**DIAGRAMS,** servicing information; Radio, \$1.00: Television, \$2.00. **SUPREME,** 1760 Balsam, Highland Park, Ill. 60035

**HEWLETT PACKARD OSCILLOSCOPE Model 120A.** Excellent condition, \$200. Syncon Corporation, 10 George St, Wallingford, Conn.

**AMAZING CONSTRUCTION PROJECTS.** Color TV Converter, TV Camera, Electron Microscope, Telephone Answering Machine, Private Eye Tail Transmitter, Police Radar Detector plus legal jammer. Plans \$4.95 each. **SUPER HOBBY CATALOG 10¢.** Don Britton Enterprises, PO Box G, Waikiki, Hawaii 96815.

**TRANSFORMER BARGAINS!** Free catalog. Write CALENCO, Box 585; San Fernando, Calif.

**METERS.** DC and AC voltmeters and ammeters for school, lab, or home use. Frank J. Casasanto, 33 Worthington Ave, Shrewsbury, Mass.

**TELEVISION Cameras** Transistorized also monitors. Spera Electronics, 37-10 33 Street, L.I.C., N.Y.

## WANTED

**QUICKSILVER.** Platinum, Silver, Gold. Ores Analyzed. Free Circular. Mercury Terminal, Norwood, Mass.

**CASH Paid!** Sell your surplus electronic tubes. Want unused. Clean radio and TV receiving, transmitting special purpose. Magnetrons. Klystrons, broadcast types. Want military and commercial lab/test equipment. Want commercial Ham Receivers and Transmitters. For a Fair Deal write: Barry Electronics, 512 Broadway, New York, New York 10012 (Walker 5-7000).

**CASH, SONY TRANSISTOR TV's** etc. swapped for G-R H-P. L&N etc. equipment, special tubes, manuals, military electronics. **ENGINEERING ASSOCIATES,** 430 Patterson Road, Dayton, Ohio 45419.

ARC-27, ARC-34, ARC-38, ARC-44; ARC-52, ARC-55, ARC-73, ARC-84, RT-220C/ARN-21, APN-22, R-540/ARN-14c, ARN-18, ARN-59, 51X-2/17L-7, 17L-4, RT-68/GRC, Test Sets With ARM, UPM, URM, SG, Prefixes. Top Dollar Paid. Slep Electronics, Drawer 178-ZDEW, Ellenton, Fla. 33532.

## TUBES

**TUBES—TV, Radio Transmitting And Industrial Types** At Sensibly Low Prices. New, Guaranteed, 1st Quality. Top Name Brands Only. Write For Free Catalog or Call Walker 5-7000, Barry Electronics, 512 Broadway, New York N.Y. 10012.

**BEFORE** you buy receiving tubes, Transistors, Diodes, Electronic Components and Accessories... send for Giant Free Zalytron Current Catalog, featuring Standard Brand Tubes; RCA, EG, etc.—all Brand new premium quality individually boxed. One year guarantee—all at biggest discounts in America! We serve professional servicemen, hobbyists, experimenters, engineers, technicians. Why pay more? Zalytron Tube Corp., 469-W Jericho Turnpike, Mineola, N.Y. 11502.

**TUBES—33¢ each.** One year guaranteed. Complete stock. Free list. Cornell, 4215—W University, San Diego, Calif. 92105.

**FREE Catalog.** Electronic parts, tubes, Wholesale. Thousands of items. Unbeatable prices. Arcturus Electronics ZD, 502-22 St., Union City, N. J. 07087.

## TAPE AND RECORDERS

**RENT Stereo Tapes—over 2,500 Different—**all major labels—free brochure. Stereo-Parti, 1616—E. W. Terrace Way, Santa Rosa, California.

**TAPE-MATES MAKES AVAILABLE TO YOU—ALL 4 TRACK STEREO TAPES—ALL LABELS—POSTPAID TO YOUR DOOR—AT TREMENDOUS SAVINGS. FOR FREE BROCHURE WRITE TAPE-MATES CLUB, 5280-E W. PICO BLVD., LOS ANGELES, CALIF. 90019.**

**BEFORE** renting Stereo Tapes, try us. Postpaid both ways—no deposit—immediate delivery. Quality—Dependability—Service—Satisfaction—prevail here. If you've been dissatisfied in the past, your initial order will prove this is no idle boast. Free Catalog. Gold Coast Tape Library, Box 2262, Palm Village Station, Hialeah, Fla. 33012.

**TAPE RECORDER SALE.** Brand new, latest models, \$10.00 above cost. Arkay Sales, 1028-B Commonwealth Ave., Boston, Mass. 02215.

**STEREO TAPE.** Save up to 60% (no membership fees). We discount recorders, batteries, accessories. We mail prerecorded tape, prepaid, anywhere that United States rates prevail. Free 60 page catalog. Saxitone, 1776 Columbia Road, Washington, D.C. 20009.

## Rectifiers & Transistors

750 MA—Silicon Diodes "Epoxy" or "Top Hat"

PIV	5¢	12¢	21¢	40¢
50	300	400	700	1,000
100	400	14¢	25¢	1,000
200	500	18¢	32¢	1,100

Full Leads, all tests, Guaranteed, American made

**SILICON POWER DIODE STUDS**

AMPS	50 PIV	100 PIV	150 PIV	200 PIV
3	8¢	14¢	16¢	22¢
15	25¢	50¢	65¢	75¢
18	18¢	40¢	60¢	70¢
35	60¢	80¢	1.15	1.30

AMPS	300 PIV	400 PIV	500 PIV	600 PIV
3	25¢	28¢	35¢	40¢
15	90	1.30	1.40	1.65
18	85	1.25	1.35	1.60
35	1.90	2.25	2.50	2.90

\*Press Fit Package for Alternators  
10 Watt Sil. Zener Stud 6v-150v. 95¢ ea.  
1 Watt Zener Diode, axial leads 6v-200v. 50¢ ea.  
Sil. diode Stud, 1500 piv, 300 ma. 50¢ ea.  
Sil. diode, 1500 piv, 50 ma, axial leads. 35¢ ea.  
Hi-Voltage—Silicon Epoxy diode, 2 1/2"x3/8"x1/2".  
Hoffman—3000 piv 200 ma. \$1.49 ea.  
Hoffman—6000 piv 200 ma. \$3.49 ea.  
Thermistor bead, 900 or 1200 ohms, 600°F. \$100

**20 WATT GERMANIUM** (internal & external heat sink)  
2n1038 28¢ 2n1042 35¢  
2n1039 35¢ 2n1043 45¢  
2n1040 45¢ 2n1044 60¢  
2n1041 60¢ 2n1045 80¢  
**SILICON POWER TRANSISTORS, 85W, 2n1724 \$1.50**  
Silicon Sil., NPN, 2n2479, New. 3 for \$1.00  
HF Silicon 2n702, 100 MC 40¢; 2n703-150 MC 60¢

**LIGHT SENSITIVE RESISTOR**  
75 ohms - 10 meg, 100 volts, 150 mw \$1.75 ea.  
Sil. diodes, 1N200 series, ass't new. 15 for \$1.00  
Ger. diodes, glass, new, exceeds 1N34. 15 for \$1.00  
Nickel Cadmium Battery 9/2 oz. 8 amp hr. \$1.95  
Varicap—Voltage Variable Capacitor  
47 pf at 4v., 4-1, new. \$1.25 ea.

2N1300 series, NPN or PNP 6 for \$1.00  
2N1009, untested, miniature case. 30 for 1.00  
50 Watt Zener, 12 Volts 2.00  
2N2151, Silicon Power 1.25  
Precision Pots. 4 for 1.00  
Mica Capacitors assorted 60 for 1.00  
Computer boards, diodes & parts .05 each  
free, Transistors  
Sensitivity Amplifier, 7 tubes, 1.75  
5"x4"x3" case  
Variable Capacitors, small, 1.00  
4 different ones  
Magnet, 3/4 oz. half moon. 8 for 1.00

**SILICON CONTROLLED RECTIFIERS**

PRV	7 amp	16 amp	PRV	7 amp	16 amp
25	28	48	200	1.05	1.70
50	48	70	300	1.60	2.20
100	70	1.20	400	2.10	2.70
150	80	1.50	500	2.80	3.30
All Tests Stud Type	600	3.00	3.90		

Money back guarantee. \$2.00 min. order. include postage. Catalog 25¢.

**Electronic Components Co.**  
Box 2902, Baton Rouge, La. 70821

CIRCLE NO. 116 ON READER SERVICE CARD

## ELECTRONICS ENGINEERING AND INSTRUCTION

**FCC LICENSE** in six weeks. First class radio telephone. Results guaranteed. Elkins Radio School, 2603C, Inwood, Dallas, Texas.

**ELECTRONICS!** Associate degree—29 months. Technicians, field engineers, specialists in communications, missiles, computers, radar, automation. Start February, September. Valparaiso Technical Institute, Dept. N, Valparaiso, Indiana.

**ELECTRONICS—F.C.C. License Training—**correspondence, or resident classes. Free details, Write: Dept. 6, Grantham, 1505 N. Western, Hollywood, Calif. 90027.

**REI First Class Radio Telephone License** in (5) weeks Guaranteed. Tuition \$295.00. Job placement free. Radio Engineering Institute, 1336 Main Street, Sarasota, Fla.

**HIGHLY—**effective home study review for FCC commercial phone exams. Free literature! **COOK'S SCHOOL OF ELECTRONICS,** Craigmont, Idaho 83523.

**LEARN ELECTRONIC ORGAN SERVICING** at home. All Makes including transistors. Experimental kit—trouble-shooting. Accredited NHSC. Free Booklet. **NILES BRYANT SCHOOL,** 3631 Stockton, Dept. A, Sacramento 20, Calif.

**ELECTRONIC courses.** Industrial training programs now released to the public. Low tuition. Fundamental and advanced correspondence courses. Free information. Huntington Institute, division of Lantec, Box 2244B, Huntington Park, Calif.

## RECORDS

**DISCOUNT Records.** All Labels—Free Lists. Write Cliff House, Box 42-E, Utica, N.Y.



## FAMOUS BC-645 TRANSCEIVER

15 Tubes 435 to 500 MC

Can be modified for 2-way communication, voice or code, on ham band 420-150 mc. citizens radio 460-470 mc. fixed and mobile 450-460 mc. television experimental 470-500 mc. Now covers 460 to 480 mc. Brand new with tubes, less power supply in factory carton. Shipping weight 25 lbs.

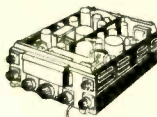

**\$19.50**

### SPECIAL!

PE-101C Dynamotor 12/24v Input ..... \$7.95  
UHF Antenna Assembly ..... 2.45  
Complete Set of 10 Plugs ..... 5.50  
Control Box ..... 2.25

### SPECIAL "PACKAGE" OFFER:

BC-645 Transceiver, Dynamotor and all accessories above. COMPLETE. BRAND NEW. **\$29.50**  
While Stocks Last

### AN/APR-4Y FM & AM RADIO RECEIVER

High precision lab instrument, suitable for monitoring and measuring frequency and relative signal strength of signals from 38 to 4000 Mc. in 5 tuning unit ranges. For 110 V 60 cycle AC operation. built-in power supply. **\$79.50**  
LIKE NEW. SPECIAL

TN-16, TN-17, TN-18, TN-19 and TN-34  
Tuning Units for above in stock. P.U.R.



### LORAN APN-4 FINE QUALITY

### NAVIGATIONAL EQUIPMENT

Determine exact geographic position of your boat or plane. Indicator and receiver complete with all tubes and crystal.

INDICATOR ID-6B/APN-4, and RECEIVER R-9B/APN-4, complete with tubes. Exc. Used. **\$88.50**

NEW! APN-4A Receiver-Indicator as above, changed to operate same as APN-4B for improved performance. **\$88.50**  
Shock Mount for above ..... **\$2.95**

INVERTER POWER SUPPLY for above APN-4. INPUT: 24 V DC. OUTPUT: 115 V AC, 800 cycles. Like New ..... **\$22.50**

We carry a complete line of replacement parts and accessories for above.

### SCR-625 MINE DETECTOR

Complete portable outfit in original packing, with all accessories. **\$275.00**  
Excellent, Used



BC-929 3-inch Scope, with all tubes, LIKE NEW ..... **\$16.50**

Conversion instructions, with diagram, for 110 V AC operation ..... **\$.65**

### BC-906 FREQ. METER—SPECIAL

Cavity type 145 to 235 Mc. Complete with antenna. Manual and original calibration charts included. BRAND NEW. OUR LOW PRICE ..... **\$14.50**

### 234-258 MC RECEIVER AN/ARR-2

BRAND NEW 11-tube UHF Tunable Receiver with schematic. Only a few at this low price! Complete with tubes. Exc. used **\$9.99**

BC-659 TRANSMITTER & RECEIVER 27 to 38.9 Mc FM. Two preselected channels crystal-controlled, 5 to 10 watts. Complete with speaker, tubes. NEW ..... **\$27.50**

Vibrator Power Supply for BC-659, 6/12/24V. Exc. Used ..... **\$11.50**

### SCR-274 COMMAND EQUIPMENT

ALL COMPLETE WITH TUBES			
Type	Description	Used	Like New BRAND NEW
BC-453	Receiver		
	190-550 Kc.	\$14.95	\$18.95 P.U.R.
BC-454	Receiver 3-6 Mc.	\$15.95	P.U.R.
BC-455	Receiver 6-9 Mc.	\$13.95	\$19.50 P.U.R.
BC-946	Receiver, 550-1500 Kc.		Complete with all tubes. Brand New, in original packing. P.U.R. \$21.50
	1.5 to 3 MC. Receiver Brand New		\$21.50

110 Volt AC Power Supply for all 274 N and ARC-5 Receivers. Complete with metal case, instructions. Factory wired, tested, ready to operate. **\$12.50**

SPLINED TUNING KNOB for 274-N and ARC-5 RECEIVERS. Fits BC-453, BC-454 and others. Only **49¢**

2-1 to 3 Mc. Transmitter, Brand New	<b>\$12.95</b>
BC-457 TRANSMITTER—4-5.3 Mc. complete with all tubes and crystal. BRAND NEW	<b>\$11.95</b>
Like New	<b>\$7.95</b>
BC-458 TRANSMITTER—5.3 to 7 Mc. Complete with all tubes and crystal. BRAND NEW	<b>\$13.95</b>
Like New	<b>\$8.95</b>
BC-459 TRANSMITTER—7 to 9 Mc. Complete with tubes & crystal. BRAND NEW	<b>\$19.50</b>
Like New	<b>\$14.95</b>
BC-696 TRANSMITTER 3-4 Mc Complete with All Tubes & Crystal. Brand New	<b>\$8.95</b>
Exc. Used	<b>\$5.95</b>
BC-456 Modulator	<b>USED 3.45 NEW \$5.95</b>

ALL ACCESSORIES AVAILABLE FOR ABOVE

Please include 25% Deposit with order—Balance C.O.D., or Remittance in Full. 50¢ Handling Charges on all orders under \$5.00. All shipments F.O.B. Our Warehouse, N.Y.C. All Merchandise subject to Prior Sale and Price Change.

### G & G RADIO SUPPLY CO.

Telephone: CO 7-4605

77 Leonard St. New York 13, N. Y.

CIRCLE NO. 113 ON READER SERVICE CARD  
September, 1965

## DO-IT-YOURSELF

PROFESSIONAL ELECTRONIC PROJECTS—\$1.00 up. Catalog 25¢, refundable. PARKS, Box 25565, Seattle, Wash. 98125.

## ANTENNAS

INSTALL YOUR OWN TV OR FM ANTENNA—SAVE UP TO \$50! Exclusive FREE booklet reveals secrets of antenna orientation, installation; tells how to get official TV/FM transmission data for your area. Plus prices, specs, of famous Channel Master Antenna Kits. Write: Dept. "W," Jefferson-King, South Fallsburg, N.Y. 12779.

## HIGH FIDELITY

LOW, LOW quotes: all components and recorders. Hi-Fi, Roslyn 9, Penna.

HI-FI Components, Tape Recorders, at guaranteed "We Will Not Be Undersold" prices. 15-day money-back guarantee. Two-year warranty. No Catalog. Quotations Free. Hi-Fidelity Center, 1797 (L) 1st Avenue, N.Y., N.Y. 10028.

HI-FI components, tape recorders, sleep learn equipment, tapes. Unusual Values. Free Catalog. Dressner, 1523 Jericho Turnpike, New Hyde Park 10, N.Y.

FREE! Send for money saving stereo catalog #E9W and lowest quotations on your individual component, tape recorder or system requirements. Electronic Values Inc., 200 West 20th Street, N.Y., N.Y. 10011.

FREE—\$1.00 Value "Miracle" Record cleaning cloth with every quotation on HIFI EQUIPMENT. Our "ROCK BOTTOM" prices on NAME BRAND amplifiers—tuners—taperecorders—speakers—FRANCHISED—59 YEARS IN BUSINESS. Write for this month's specials—NOW! Rabsons 57th St., Inc., Dept. 569, 119 W. 57th St., New York, New York 10019.

## MAGNETS

PERMANENT-Alnico-Ceramic-Flexible-Assemblies. What you need, we have. Maryland Magnet, 5412-E Gist, Baltimore, Maryland 21215.

## REPAIRS AND SERVICES

TV Tuners Rebuilt and Aligned per manufacturers specification. Only \$9.50. Any Make UHF or VHF. We ship COD Ninety day written guarantee. Ship complete with tubes or write for free mailing kit and dealer brochure. JW Electronics, Box 51B, Bloomington, Indiana.

METERS—Multimeters Repaired and Calibrated. Free estimates—Catalog. Bigelow Electronics, Box 71-F, Bluffton, Ohio.

METERS REPAIRED, VTUM, VOM. 90 Day Warranty. TV Tuner Service, Box 793 W, Twin Falls, Idaho.

## GOVERNMENT SURPLUS

JEeps from \$53.90... Trucks from \$78.40... Boats, Typewriters, Airplanes, Electronic Equipment, 100,000 Bargains "as is" Direct from Government in Your Area. Complete Sales Directory and Surplus Catalog \$1.00 (Deductible First \$10.00 Order). Surplus Service, Box 820-K, Holland, Michigan.

## EQUIPMENT

MC GEE Radio Company. Big 1965 176 page catalog sent free. America's Best Values. Hi-Fi—Amplifiers—Speakers—Electronic Parts. 1901 McGee Street (Dept. EW), Kansas City, Mo.

CUSTOM Electronics Equipment for your needs. Brown-Davis Enterprises, RFD 4, Abilene, Kansas 67410.

## HELP WANTED

YOUR own Business. Sell matchbook advertising—part or full-time. We tell you how. No experience needed. Earn cash commissions. Sales kit furnished. Matchcorp, Dept. MO-95, Chicago 60632.

## GREGORY ELECTRONICS

## USED FM 2-WAY RADIO SAVINGS

Partial list—Send for New '65 catalog

### SPECIAL PURCHASE



### RCA 25-54 MC

CMV2F5 6/12 volt 30 watt vibrator power supply FULLY NARROW BANDED (TX & RX) complete with all accessories.

Same unit tuned to desired frequency including new antenna \$128.00

**\$88**



### MOTOROLA 30-50mc

wide band Complete with all accessories, less crystals & antenna.

FMTR80D, 30 watts, 6 volt. .... **\$78**

(Less accessories, \$48.)

FMTR80D, 30 watts, 12 volt. .... **\$118**

(Less accessories, \$88.)

FMTR140D, 60 watts, 6 volt. .... **\$98**

(Less accessories, \$68.)

FMTR140D, 60 watts, 12 volt. .... **\$128**

(Less accessories, \$98.)

Add \$55.00 to narrow band transmitter, tuning of transmitter and receiver to desired frequency and new antenna.

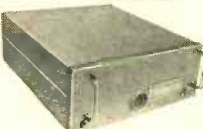

### 148-172mc RCA CMC 60B

6/12v dual dynamotor 60 watt. Fully narrow banded complete

with all accessories, less crystals & antenna. **\$178**

Less Accessories \$148.00. Same unit tuned to desired frequency including new antenna **\$213**

### RCA 148-172mc CMC25

12v 25 watt transistor power supply (a) Fully narrow banded complete with all accessories, less crystals & antenna **\$198**

Less accessories \$158.00

(b) Same unit tuned to desired frequency including new antenna **\$233**

G-E 4ET5 6v 30 watt 40-50mc Transmitter **\$10**

G-E 4ET5 12v 30 watt 40-50mc Transmitter **\$15**

### Extra Special Purchase Reconditioned General Electric

## Voice Commander

Personal FM Transmitter-Receiver  
132 to 172 MC, 1 W 9.5"x5.3"x1.7"



PRICE, including Brand New rechargeable Nickel-Cadmium Battery Pack

**\$178**

If crystals and tuning is desired, add \$40.00.

We also have the proper charges for these units, GE Model #4EP27A10, Price: \$18.

If add'l. nickel cadmium batteries are required, \$25. each. Lapel microphones at \$5. . . or battery pack, power supply bottom housing at \$40.

We Buy Late Model Equipment for Cash  
—Write: Wire or Phone!



## GREGORY ELECTRONICS CORPORATION

249 Rt. 46 • Phone 773-7550  
Saddle Brook, N.J. • Area Code 201

CIRCLE NO. 111 ON READER SERVICE CARD



## SILICON RECTIFIER SALE

IMMEDIATE

DELIVERY

FULLY GTD  
AMERICAN MADE



NEWEST TYPE  
FULLY TESTED

750 MA-SILICON "TOPHAT" DIODES  
LOW LEAKAGE FULL LEAD LENGTH

PIV/RMS 50/35 .05 ea.	PIV/RMS 100/70 .07 ea.	PIV/RMS 200/140 .10 ea.	PIV/RMS 300/210 .12 ea.
PIV/RMS 400/280 .14 ea.	PIV/RMS 500/350 .19 ea.	PIV/RMS 600/420 .23 ea.	PIV/RMS 700/490 .27 ea.
PIV/RMS 800/560 .35 ea.	PIV/RMS 900/630 .45 ea.	PIV/RMS 1000/700 .60 ea.	PIV/RMS 1100/770 .75 ea.

ALL TESTS AC & DC & FWD & LOAD  
SILICON POWER DIODE STUDS

D.C. AMPS	50 PIV 35 RMS	100 PIV 70 RMS	150 PIV 105 RMS	200 PIV 140 RMS
12	.05 ea.	.12 ea.	.16 ea.	.22 ea.
15	.25	.50	.65	.75
35	.65	.90	1.25	1.40
50	1.50	1.75	2.20	2.60
100	1.60	2.00	2.40	3.00

D.C. AMPS	300 PIV 210 RMS	400 PIV 280 RMS	500 PIV 350 RMS	600 PIV 450 RMS
3	.27 ea.	.29 ea.	.37 ea.	.45 ea.
12	.90	1.30	1.40	1.65
35	2.00	2.35	2.60	3.00
50	3.25	4.00	4.75	6.00
100	3.60	4.50	5.25	7.00

"SCR" PIV	7 AMP	16 AMP	25 AMP	PRV	7 AMP	16 AMP	25 AMP
25	.30	.50	.85	250	1.75	2.15	2.50
30	.45	.75	1.00	300	2.00	2.40	2.75
100	.80	1.25	1.50	400	2.40	2.75	3.25
150	.90	1.60	2.00	500	3.20	3.40	3.80
200	1.25	1.80	2.25	600	3.40	4.00	4.50

### SPECIALS! SPECIALS!

100 Different Precision Resistors  
1/2—1—2 watt 1/2%—1% TOL \$1.50  
2 amp 1000 Piv Silicon Power Rect. .70 ea.  
10 for \$6.50

RCA PNP TRANSISTORS  
Type 2N406—4 for \$1.00 ..... 100 for \$18.00  
Factory New

Computer Grade Condenser 15,500 MFD  
15 VDC American Mfg. .75 ea.  
Type IN34 DIODE GLASS .07 ea. 100 for \$5

Money Back guarantee. \$2.00 min. order. Orders  
F.O.B. NYC. Include check or money order. Shpg.  
charges plus. C.O.D. orders 25% down.

**Warren Electronic Components**  
230 Mercer St., N.Y., N.Y. 10012 • OR 3-2620

CIRCLE NO. 89 ON READER SERVICE CARD

SAY YOU SAW IT IN

# Electronics World

## CLASSIFIED ADVERTISING ORDER FORM

Please refer to heading on first page of this section for complete data concerning terms, frequency discounts, closing dates, etc.

1	2	3	4	5
6	7	8	9	10
11	12	13	14	15
16	17	18	19	20
21	22	23	24	25
26	27	28	29	30
31	32	33	34	35

Words @ .35 Reader Rate } = \$  
@ .60 Commercial Rate }

Insert \_\_\_\_\_ time(s) Total Enclosed \$ \_\_\_\_\_

NAME \_\_\_\_\_

ADDRESS \_\_\_\_\_

CITY \_\_\_\_\_

ZONE \_\_\_\_\_

STATE \_\_\_\_\_

SIGNATURE \_\_\_\_\_

WORD COUNT: Include name and address. Name of city (Des Moines) or of state (New York) counts as one word each. Zone or Zip Code numbers not counted. (Publisher reserves right to omit Zip Code if space does not permit.) Count each abbreviation, initial, single figure or group of figures or letters as a word. Symbols such as 35mm, COD, PO, AC, etc., count as one word. Hyphenated words count as two words. EW-965

## PATENTS

INVENTIONS: Ideas developed for Cash Royalty sales.  
Raymond Lee, 1606G Bush Building, New York City 36.

## MUSIC

POEMS Wanted for songs and records. Send poems.  
Crown Music, 49-RB West 32, New York 1.

## AUTHORS' SERVICES

AUTHORS! Learn how to have your book published,  
promoted, distributed. FREE booklet "ZD," Vantage,  
120 West 31 St., New York 1.

WANTED WRITERS! Short stories, articles, books, plays,  
poetry. Will help place, sell your work. Write today,  
free particulars! Literary Agent Mead, Dept. 37A, 915  
Broadway, New York 10, N.Y.

## PHOTOGRAPHS

PHOTOGRAPHS and transparencies wanted, to \$500.00  
each. Valuable information free—Write Intraphoto-EW,  
Box 74607, Hollywood 90004.

## HYPNOTISM

FREE Hypnotism, Self-Hypnosis, Sleep Learning Cat-  
alog! Drawer H400. Ruidoso, New Mexico 88345.

## COINS

"S" MINT Lincolns! 25 different, \$2.00. 30 different,  
\$3.50. 35 different, \$8.00 postpaid! John Finneran,  
22166 North 6th St., Castro Valley, Calif.

## REAL ESTATE

FLORIDA WATER WONDERLAND—Home, cottage, Mobil-  
sites. Established area. \$590 full price, \$9.00 a month.  
Swimming, fishing, boating. Write: Lake Weir, Box  
KE38, Silver Springs, Fla. AD 6-1070 (F-1)

NEW! FREE!—FALL CATALOG Bigger, 176 pages! Se-  
lected Best thruout the U.S. Thousands of properties  
described, pictured—Land, farms, homes, businesses—  
Recreation, Retirement. 476 offices, 35 states coast to  
coast, "World's Largest." Mailed FREE! STROUT  
REALTY, 50 ZD East 42nd St., New York, N.Y. 10017.

# NEW PORTABLE VACU VISE® WITH FREE GIFT



TO HOLD:  
Lightly hold Vacu-Vise  
in place. Turn down  
Vacu-Lever with finger-tip.

TO RELEASE:  
Release Vacu-  
Lever with  
finger-tip. Vacu-  
Vise lifts off.

ONLY  
\$6.95

## NO CLAMPS! NO SCREWS!

ATTACHES INSTANTLY—HOLDS SECURELY

Will not mar furniture  
or table tops!

For The "DO IT YOURSELF"  
For The REPAIRMAN  
For The MAN WHO NEEDS  
A THIRD HAND

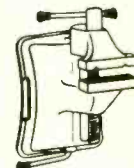

Holds firmly in  
any position.

You'll wonder how you ever got  
along before you had the new  
VACU-VISE with "Super Vacu-  
um" Power that HOLDS . . .  
It's like having a third hand  
. . . anywhere . . . on the  
job . . . right where you need  
it. No Clamps—No Screws—the  
Super Vacuum base does it  
all for you! Just one turn of a  
Vacu-Lever (use your finger-  
tip . . . no strength need-  
ed) and VACU-VISE holds  
firm and fast to any smooth  
non-porous surface such as  
Formica, Linoleum, metal, glass,  
etc. Large 2 1/2" jaws—with  
"V" grooves hold your work  
firmly to table top—bench. Com-  
pletely portable—weighs only  
3 lbs.



## FREE GIFT

Order imme-  
diately and  
receive FREE  
a set of  
Vacu Vise  
slide on Rubber  
Jaws for use  
when working  
on fragile or  
delicate  
materials.

WARRANTED FOR ONE YEAR!  
Will be replaced without  
charge in the event of any de-  
fect arising from normal use.

CONSUMER SERVICE COMPANY EW-95  
160 Mercer St., New York, N. Y. 10012

Enclosed is \$\_\_\_\_\_ for \_\_\_\_\_ Vacu Vise  
at \$6.95 ea. plus 55¢ ea. for postage and handling.  
(N.Y.C. residents please add 4% sales tax.)  
Foreign orders \$1.15 additional.

Name \_\_\_\_\_  
(please print)

Address \_\_\_\_\_

City \_\_\_\_\_ State \_\_\_\_\_ Zip Code \_\_\_\_\_

Sorry—No Charges or C.O.D. orders.

ELECTRONICS WORLD



# STOP FLATS

Protect Your Family  
PREVENT "FLAT TIRE"  
ACCIDENTS PERMANENTLY  
Before They Happen

CONVERT YOUR PRESENT TIRES  
INTO SELF-SEALING  
PUNCTURE-PROOF TIRES

PERMANENT—For the Life  
of the Tire.  
SAFE—Harmless to Rubber.  
Will Not Cause Imbalance.  
Will Not Gum or Ball.  
CONTINUOUS—Works Puncture  
after Puncture.



Stop Flats is a protective Sealing Force. Acts moment puncture occurs. Forms an immediate, air-tight and permanent repair. Applies in a minute through valve.

Acts continuously . . . puncture after puncture. Protection against all ordinary flats (up to 16 penny nails) regardless of road speed. One application will outlast any tire.

**NOT A REPAIR KIT!**  
Good for ALL passenger car tires . . . New and Used . . . Tubed, Tubeless, Retreads!

Now Available at Special Prices.

**SAVE \$4** Kit for tire sizes up to 7.90 x 14  
**\$7.95**  
reg. retail price \$11.92

**SAVE \$6** Kit for tire sizes 8.00x14 & larger  
**\$11.95**  
reg. retail price \$17.88

**Independent Laboratory Report States:**

"Stop Flats" successfully filled the punctures without loss of air. The balance of the tires was not disturbed by the introduction of "Stop Flats." Upon inspection of tires after the test, the "Stop Flats" was evenly distributed along the inside of the tire and did not gum or ball."

**MONEY BACK GUARANTEE**

**CONSUMER SERVICE COMPANY**  
160 Mercer St., New York, N. Y. 10012  
Enclosed is \$\_\_\_\_\_ Please ship me the following Stop-Flats Kits:

- \_\_\_\_\_ kits for tire sizes up to 7.90 x 14 at \$7.95 ea. plus 55c ea. for postage and handling.
- \_\_\_\_\_ kits for tire sizes 8.00 x 14 and over at \$11.95 ea. plus 80c ea. for postage and handling. Foreign orders \$1.25 additional. (N.Y.C. residents please add 4% sales tax.)

Name \_\_\_\_\_ (PLEASE PRINT) EW-95  
Address \_\_\_\_\_  
City \_\_\_\_\_ State \_\_\_\_\_ Zip Code \_\_\_\_\_  
Sorry—No charge or C.O.D. orders.

**PHOTOGRAPHY—FILM, EQUIPMENT, SERVICES**

**MEDICAL FILM**—Adults only—"Childbirth" one reel, 8mm \$7.50; 16mm \$14.95. International W, Greenvale, Long Island, New York.

**SCIENCE Bargains**—Request Free Giant Catalog "CJ"—148 pages—Astronomical Telescopes, Microscopes, Lenses, Binoculars, Kits, Parts, War surplus bargains. Edmund Scientific Co., Barrington, New Jersey.

**EDUCATIONAL OPPORTUNITIES**

**LEARN** While Asleep, hypnotize with your recorder, phonograph. Astonishing details, sensational catalog free! Sleep-Learning Association, Box 24-2D, Olympia, Washington.

**LEARN** while asleep. Remarkable, scientific. 92% effective. Details free. ASR Foundation, Box 721, Dept. e.g., Lexington, Kentucky.

**USED** Correspondence Courses and Books sold and rented. Money back guarantee. Catalog free. (Courses Bought). Lee Mountain, Pisgah, Alabama.

**FREE Education!** Greater Success! Information Free! Cameo Enterprises, Carrolltown, Pa. 15722.

**INVENTIONS WANTED**

**INVENTORS.** We will develop, help sell your idea or invention, patented or unpatented. Our national manufacturer clients are urgently seeking new items for outright cash sale or royalties. Financial assistance available. 10 years proven performance. For free information, write Dept. 42, Wall Street Invention Brokerage, 79 Wall Street, New York 5, N.Y.

**INVENTORS.** Outright cash sale or royalties for your inventions. Patented. Unpatented. Active demand from our client manufacturers. Financial assistance available. Write Dept. 48, United States Invention Brokerage, 78 Wall Street, New York 5, N. Y.

**IMMEDIATE** cash, for Patent Applications, free Patent Searches. Write for details, Universal Patents, 184-Y, Marion, Ohio.

**WISCONSIN** State Inventors Association Welcomes You. Investments earn 5%. Development Loans Available. Box 162, Sheboygan, Wis. 53082.

**EMPLOYMENT INFORMATION**

**FOREIGN** Employment. Construction, other work projects. Good paying overseas jobs with extras, travel expenses. Write only: Foreign Service Bureau, Dept. D, Bradenton Beach, Florida.

**EMPLOYMENT** Resumes. Get a better job & earn more! Send only \$2.00 for expert, complete Resume Writing Instructions. J. Ross, 80-34 Kent St., Jamaica 32, N.Y., Dept. EW.

**BUSINESS OPPORTUNITIES**

**INVESTIGATE** Accidents—Earn \$750 to \$1,400 monthly. Men urgently needed. Car furnished. Business expenses paid. No selling. No college education necessary. Pick own job location. Investigate full time. Or earn \$6.44 hour spare time. Write for Free Literature. No obligation. Universal, CZ-9, 6801 Hillcrest, Dallas 5, Texas.

**I Made \$40,000.00** Year by Mail Order! Helped others make money! Start with \$10.00—Free Proof. Torrey, Box 3566-N, Oklahoma City 6, Oklahoma.

**SELL CB** Equipment—Dealerships available to aggressive people who can sell Citizens Band Radio full or part time. Knox Electronic, Dept. 194, Galesburg, Ill. 61401.

**FREE** Book "990 Successful, Little-Known Businesses." Work home! Plymouth-845J, Brooklyn 18, New York.

**PHOTOGRAPH** accidents for Insurance Companies. \$10.00 hour, spare time. Not a school. Free Information. Underwriters ZDG, 7400 Pershing, St. Louis, Mo. 63130.

**MAILORDER.** No Investment In products. Free Brochure. Methods, 1402-FD, Lafayette Hill, Pa.

**MISCELLANEOUS**

**WORLDWIDE** Export and Buyers Guide \$1.50. Burke Associates, Manchester, Mass.

**DOUBLE BONUS SALE**

**\$25** FREE WORTH OF TRANSISTORS, DIODES, RECTIFIERS, KNOBS, CONDENSERS, COILS, etc.

**\$1** FREE POLY PAK OF YOUR CHOICE

**BOTH FREE WITH ANY \$10 ORDER**

**SILICON CONTROLLED RECTIFIERS**

PRV	7 AMP	20 AMP
100	.75	.90
150	1.00	1.25
200	1.25	1.50
250	1.50	1.75
300	1.75	2.00
350	2.00	2.25
400	2.25	2.50
450	2.50	2.75
500	2.75	3.00
550	3.00	3.25
600	3.25	3.50

**500 MC Silicon Planar POWER TRANSISTOR \$1.49** (ACTUAL SIZE) Fairchild

PNP NPN 3 12 30-120 1000

**FACTORY TESTED DOLLAR POLY PAKS**

- 30 SWITCHING TRANSISTORS, TO3 case, 10¢ each
- 10-WATT ZENER STUD ANY VOLTAGE to 100V \$1
- 1 CONTROLLED SCR SWITCH, Transiltron, TO18 \$1
- 3 40-WATT TRANSISTORS, 80V Voles pnp, stud \$1
- "MICRO-T" TRANSISTOR, like TMT-1818 npn, \$1
- 4 —1N155 TRANSISTORS, or equiv., TO3 cases \$1
- 2—800 MC, 2N709 NPN Silicon planar TO18 \$1
- 3 2N711 300MW, 300 MC, PNP MESA, TO18 \$1
- 1 40W, 2N1648 TRANS, NPN MESA, \$1
- 2 25-AMP SILICON RECTIFIERS, \$1
- 4 ZENER REFERENCES, 1N429, 6-volt, silicon \$1
- 2 "TINY" 2N1613 2W, 100MC, TO46 case, npn \$1
- 2 500MC TRANS, 2N964, mesa, pnp, TO18 \$1
- 10 "PIN HEAD" TRANSISTORS, rf, if, pnp \$1
- 4 2N43 OUTPUT TRANSISTORS, by GE, pnp, TO5 \$1
- 4 2N333 NPN SILICON transistors, by GE, TO5 \$1
- 8 2-6Amps RECTS, studs, silicon, 50 to 400V \$1
- 10 MICRO DIODE ZENER, 100V, 500V, by Transiltron \$1
- 4 4-WATT PLANAR TRANS, 2N497, 2N498 \$1
- 4 2N35 TRANSISTORS, npn, by Sylvania, TO22 \$1
- 6 "MICRO" TRANSISTORS, 2N141's, 1/16", rf \$1
- 4 CK721 TRANSISTORS, pnp, aluminum case \$1
- 10 1000 MC-1N251 GERMANIUM DIODES \$1
- 5 30MC TRANSISTORS, like 2N247, Sylvania \$1
- 85 W. TRANSISTOR, silicon npn mesa, 2N424 \$1
- 5 SUN BATTERIES TO 1 1/2" sizes, lite sensitive \$1
- 15 PNP SWITCHING TRANSISTORS, asstd, TO5 \$1
- 10 NPN SWITCHING TRANSISTORS, 2N338, 440 \$1
- 15 PNP TRANSISTORS, CK722, 2N35, 107 \$1
- 15 NPN TRANSISTORS, 2N35, 170, 440, \$1
- 30 TRANSISTORS, rf, if, audio, no test, TO5 \$1
- 4 35-W. TRANS, 2N141, CBS, TO10, stud \$1
- 2 2N708 SILICON 400MC NPN PLANAR, TO46 \$1
- 10 POPULAR CK772 TRANSISTORS, npn, no test \$1
- 5 2N107 TRANS, by GE, pnp, pnp, audio pak \$1

**PARTS BY THE POUND** 500-1000 pcs **ONE POUND 48¢** DISCS

**TRANSISTORS 100 for \$2.98** Power, Audio, RF, untested

- 4 2N170 TRANSISTORS, by GE, npn for gen'l rf \$1
- 25 TOP HAT RECTIFIERS 750 ma silicon, 50-400V \$1
- 25 GERMANIUM & SILICON DIODES, no test \$1
- 1 85W SILICON PWR TRANS, npn, like 2N1212 \$1
- 6 "TEXAS" 750 MA 400V RECTIFIERS, leads \$1
- 4 200 MC, PNP MESA, TO18 TRANSISTORS, \$1
- \$25 RELAY SURPRISE, sealed, tiny types \$1
- 3 INFRA-RED DETECTORS, with leads \$1
- \$25 SURPRISE PAK: transistors, rect, diodes, etc \$1
- 40 PRECISION RESISTORS, 1/2, 1, 2W; 1% values \$1
- 30 CORNING "LOW NOISE" resistors, asst. \$1
- 60 TUBULAR CONDENSERS, to .5mf, to 1KV, asst \$1
- 40 DISC CONDENSERS, 27mf to .05mf to 1KV \$1
- 60 TUBE SOCKETS, receptacles, plugs, audio, etc \$1
- 30 POWER RESISTORS, 5 to 50W, to 24 Kohms \$1
- 50 MICCA CONDENSERS, to 1mf, silvers tool \$1
- 10 VOLUME CONTROLS, to 1 meg, switch tool \$1
- 10 ELECTROLYTICS, to 500mf, asst. P&A tubulars \$1
- 50 RADIO & TV KNOBS, asst. colors & styles \$1
- 10 TRANSISTOR ELECTROLYTICS: 10mf to 500mf \$1
- 50 COILS & CHOKES, if, rf, ant. use, & more \$1
- 35 TWO WATERS, asst incl: A.B., 5% tool \$1
- 75 HALF WATERS, asst incl: A.B., 5% tool \$1
- 60 HI-O RESISTORS, 1/2, 1, 2W, 1% & 5% values \$1
- 10 PHONO PLUG & JACK SETS, tuners, amps \$1
- 50 TERMINAL STRIPS, 1 to 8 solder lug types \$1
- 30 "YELLOW" MYLAR CONDENSERS, asst val \$1
- 60 CERAMIC CONDENSERS, discs, nps, to .05 \$1
- 3-TRANSISTOR SUBMINIATURE AMPLIFIER \$1
- 4 TRANSISTOR TRANSFORMERS, asst, worth \$25 \$1
- 1 FILAMENT TRANSFORMER, 117 to 6.3vct, 3A \$1
- 3 GEIGER COUNTER DETECTOR, tubes, assorted \$1

**10C XMAS BARGAIN CATALOG ON: PARTS □ REC TIFIERS □ TRANSISTORS □ SCRS □ ZENERS**

**POLY PAKS**

TERMS: send check, money order. Add postage—avc. wt. per pak 1 lb. Rated net 30 days. COD 25%.

P.O. BOX 942W  
SO. LYNNFIELD, MASS.  
"PAK-KING" of the world



NO C.O.D. ORDERS

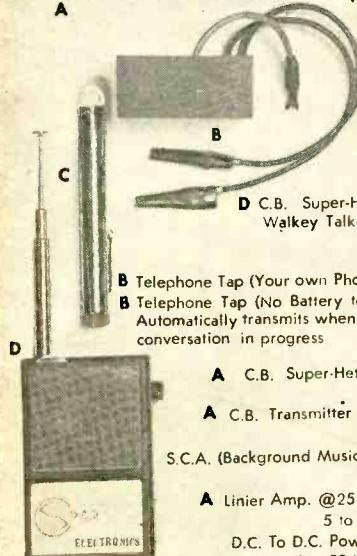

**D C.B. Walkey Talkey Regen** \$ 9.99  
 Kit \$ 6.00

**D C.B. Walkey Talkey Super-Het** \$35.99  
 Kit \$25.00

**D C.B. Super-Het Ni-Cad Bat Walkey Talkey** \$52.22  
 Kit \$39.95

**B Telephone Tap (Your own Phone)** \$11.88  
**B Telephone Tap (No Battery to Replace)**  
 Automatically transmits when phone conversation in progress \$49.77

**A C.B. Super-Het Receiver** \$19.95  
 Kit \$12.95

**A C.B. Transmitter 100 M.W.** \$11.95  
 Kit \$ 6.95

**S.C.A. (Background Music) Adaptor** \$39.95  
 Kit \$29.95

**A Linier Amp. @25 to 50 Mc.**  
 5 to 100 Watts \$59.95

**D.C. To D.C. Power Supply**  
 12 Volts In 450 Volts Out \$35.00

**C Wireless Microphone Broadcast Band** \$35.95

**C Wireless Microphone F.M. Band** \$39.95

**A \*Tone Radio Control Switch (Transmitter & Receiver)** \$25.88

**SPAR ELECTRONICS** P.O. BOX 87  
 LAS VEGAS, NEVADA SE

CIRCLE NO. 83 ON READER SERVICE CARD

**NIMS**  
**NATIONWIDE**  
**IMPROVED**  
**MAIL SERVICE—**

●

**A PROGRAM**  
**FOR REDUCING**  
**POSTAL COSTS**  
**AND IMPROVING SERVICE**  
**MAIL EARLY IN THE DAY**  
**IT'S THE BETTER WAY!**

●

LETTERS READY? — MAIL THEM EARLY!

**ELECTRONICS WORLD SEPTEMBER 1965**  
**ADVERTISERS INDEX**

READER SERVICE NO.	ADVERTISER	PAGE NO.	READER SERVICE NO.	ADVERTISER	PAGE NO.
125	Allied Radio	88, 89, 90, 91	103	Milwaukee School of Engineering	72
195	American Electronics Labs, Inc.	61		Mission Liquidators	60
	American Institute of Engineering & Technology	62	102	Moog Company, R. A.	60
124	Amperex Electronic Corporation	12	100	Motorola Training Institute	98
84	Arco Electronics	53	198	Multicore Sales Corp.	72
				Music Associated	62
199	Belden Manufacturing Company	13		National Radio Institute	8, 9, 10, 11
	Capitol Radio Engineering Institute	18, 19, 20, 21	99	Poly Paks	107
	Channel Master Corp.	84	98	Powertronics Corp.	97
	Cleveland Institute of Electronics	68, 69, 70, 71	108	RCA Electronic Components and Devices	FOURTH COVER
122	Cleveland Institute of Electronics	84	97	RCA Electronic Components and Devices	14
121	Conar	58	96	RCA Electronic Components and Devices	76
119	Cornell Electronics Co.	103		RCA Electronic Components and Devices	5
				RCA Institutes, Inc.	78, 79, 80, 81
118	Delco Radio	22		RCA Sales Corp.	2
			95	Radar Devices Manufacturing Corp.	1
117	EICO	15		Sams & Co., Inc., Howard W.	59
120	Electro-Voice, Inc.	SECOND COVER	93	Sarkes Tarzian, Inc.	92
116	Electronic Components Co.	104	92	Schober Organ Corporation, The	4
	Fair Radio Sales	104	91	Sencore	77
115	Finney Company, The	7	83	Spar Electronics	108
114	Fisher Radio Corporation	17	197	Sprague	57
113	G & G Radio Supply Co.	105	90	Texas Crystals	63
112	Goodheart Co. Inc., R. E.	104		Tri-State College	102
	Grantham School of Electronics	74	101	Triplett Electrical Instrument Company, The	THIRD COVER
111	Gregory Electronics Corporation	105	196	Ungar Electric Tools	6
				Universal Electronic Supply	102
110	Heath Company	54, 55			
				Valparaiso Technical Institute	92
109	Jerrold Electronics	67			
107	Johnson Co., E. F.	73			
	Kuhn Electronics	62	89	Warren Electronic Components	106
			88	Weller Electric Corp.	85
			87	Winegard Co. Antenna Systems	95, 101
106	LTV University	63	86	Workman Electronic Products Inc.	62
105	Lafayette Radio Electronics	99, 100			
104	Lampkin Laboratories, Inc.	58			
	Linda Sales Corporation	102	85	Xcelite, Inc.	93

CLASSIFIED ADVERTISING... 103, 104, 105, 106, 107

Printed in U.S.A.



# STEP UP

TO WIDER RANGES  
GREATER ACCURACY



**Model 630-NA**  
VOLT-OHM-MILLIAMMETER  
PRICE \$79<sup>50</sup>

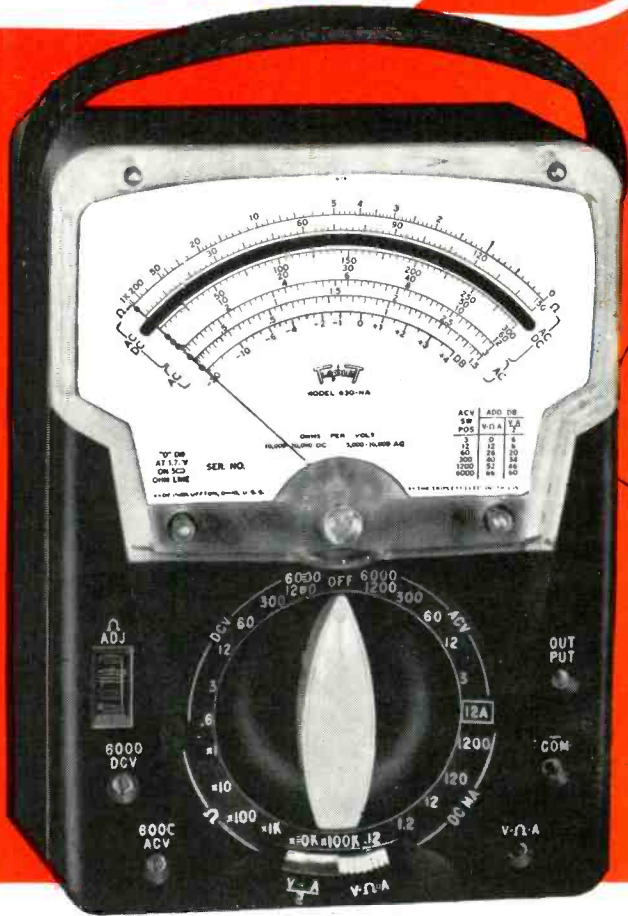

**EXCLUSIVE PATENTED**  
.....  
**Bar-Ring Shielded Movements**

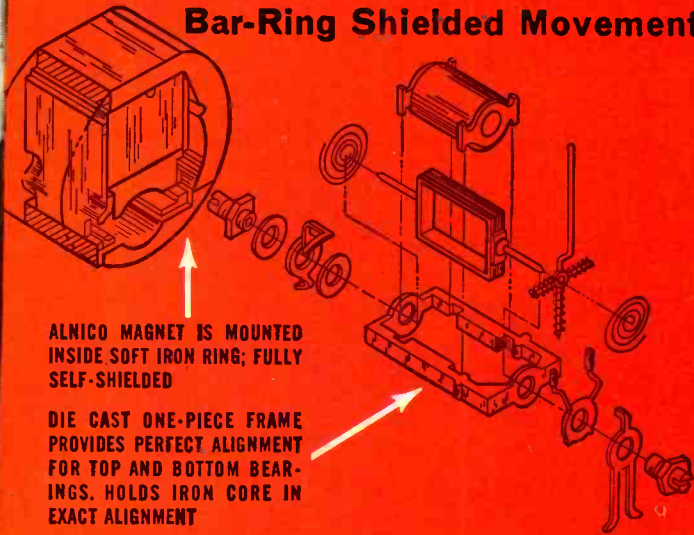

ALNICO MAGNET IS MOUNTED  
INSIDE SOFT IRON RING; FULLY  
SELF-SHIELDED

DIE CAST ONE-PIECE FRAME  
PROVIDES PERFECT ALIGNMENT  
FOR TOP AND BOTTOM BEAR-  
INGS. HOLDS IRON CORE IN  
EXACT ALIGNMENT

## FACTS MAKE FEATURES:

- 1** 70 RANGES—nearly double those of conventional testers. Un-breakable window. Mirror Scale.
- 2** HIGHEST ACCURACY—1½% DC to 1200 volts, 3% AC to 1200 volts; mirror scale and knife-edge pointer to eliminate parallax.
- 3** FREQUENCY COMPENSATED—Flat from 20 CPS to 100,000 CPS; varies from ¾ to 1½ DB at 500,000 CPS. Temperature compensated. Meter protection against overloads.

THE TRIPLETT ELECTRICAL INSTRUMENT COMPANY, BLUFFTON, OHIO

### Uses Unlimited:

FIELD ENGINEERS ■ APPLICATION ENGINEERS ■ ELECTRICAL, RADIO, TV, AND APPLIANCE SERVICEMEN ■ ELECTRICAL CONTRACTORS ■ FACTORY MAINTENANCE MEN ■ INDUSTRIAL ELECTRONIC MAINTENANCE TECHNICIANS ■ HOME OWNERS, HOBBYISTS



**MODEL 630-NA-RM**  
RACK MOUNTED VOM

Same ranges as Model 630-NA, except for 3000 and 6000 AC and DC volts. Heavy etched aluminum panel 19" x 5¼". Standard test leads come out the front. \$109.50.

CIRCLE NO. 101 ON READER SERVICE CARD



THE WORLD'S MOST COMPLETE LINE OF V-O-M'S. AVAILABLE FROM YOUR TRIPLETT DISTRIBUTOR'S STOCK

# You probably thought top quality electronic test instruments were too expensive...*didn't you?*

*Well, they're not when you build them with money-saving RCA kits*

You've known right along that you can save money on electronic test instruments by building from kits.

But you may have shied away from kits because you thought they involved complicated calibration or adjustment problems. Forget it!

RCA kits are inexpensive, of course, but they're also easy to build. Build them right and they'll give you the best performance you can buy in their price range.

What's better about RCA test instrument kits?

**Ease of assembly is one thing.** Parts are clearly identified. Each assembly diagram appears on the same page as the step-by-step instructions for that section of assembly. There's no need to refer back constantly to other pages, which consumes time and increases the chance of error.

**Ease of alignment is another thing.** Each kit contains complete instructions for accurate calibration or alignment of the instrument. Where necessary, precision calibrating resistors are provided for this purpose.

**What does it mean?** It means that with RCA kits you can get a professional V-O-M or VTVM for as little as \$29.95\*. Or you can get a good oscilloscope (one of the most useful—but normally one of the most expensive—test instruments) for only \$79.50\*

Specialized instruments such as an AC VTVM or an RF Signal Generator are also available as kits for far less than they would cost otherwise. In every case, RCA kits, when completed, are identical with RCA factory assembled instruments.

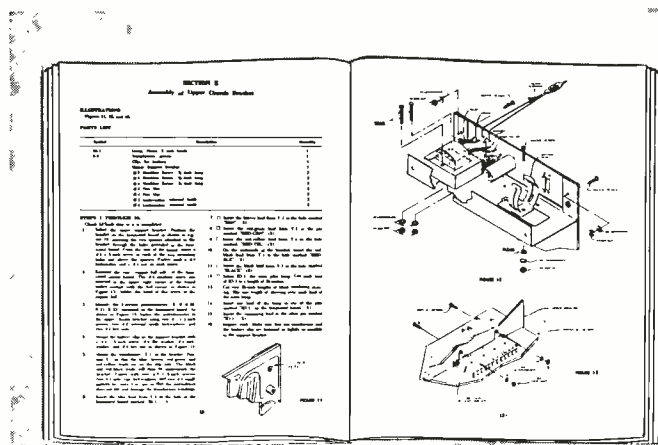

Each sub-assembly is described in a separate section with illustrations applying to that sub-assembly available at a glance. No cross referencing necessary.

## LOOK WHAT'S AVAILABLE TO YOU IN KIT FORM:

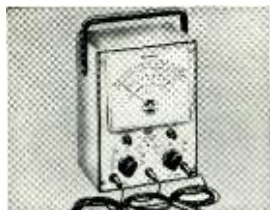

RCA VOLT-OHM-MILLIAMMETER. The most popular VTM on the market. WV-77E(K). Kit price: \$29.95\*

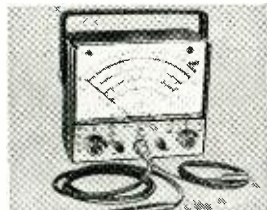

RCA SENIOR VOLT-OHM-MILLIAMMETER. A professional VTM. WV-98C(K). Kit price: \$57.95\*

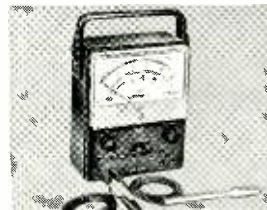

RCA VOLT-OHM-MILLIAMMETER. One of most useful instruments. WV-38A(K). Kit price: \$29.95\*

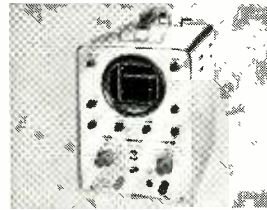

RCA 3-INCH OSCILLOSCOPE. Compact, lightweight, portable. WO-33A(K). Kit price: \$79.95\*

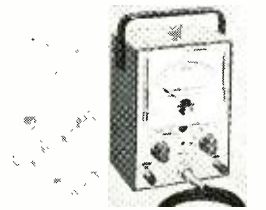

RCA HIGH-SENSITIVITY AC VTVM.



RCA RF SIGNAL GENERATOR. For audio and TV servicing. WR-50A(K). Kit price: \$39.95\*

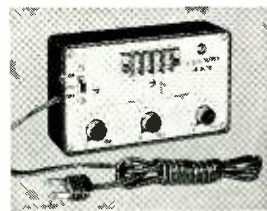

RCA TV BIAS SUPPLY. For RF, IF alignment in TV sets. WG-307B(K). Kit price: \$11.95\*

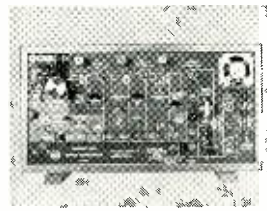

RCA TRANSISTOR-RADIO DYNAMIC DEMONSTRATOR. For schools. WE-93A(K). Kit price: \$39.95\*

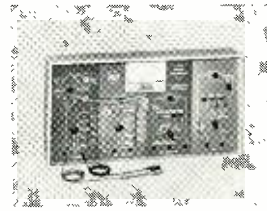

RCA V-O-M DYNAMIC DEMONSTRATOR. A working V-O-M. WE-95A(K). Kit price: \$37.95\*

See them all—and get full technical specifications for each—at your local Authorized RCA Test Equipment Distributor. Or write for information to: Commercial Engineering, Section 141W RCA ELECTRONIC COMPONENTS AND DEVICES, HARRISON, N.J.

RCA ELECTRONIC COMPONENTS AND DEVICES, HARRISON, N.J.

\*Optional Distributor Resale Price. All prices are subject to change without notice. Prices may be higher in Alaska, Hawaii and the West.



The Most Trusted Name in Electronics

CIRCLE NO. 108 ON READER SERVICE CARD

www.americanradiohistory.com