

# Electronics World

JUNE, 1964  
50 CENTS

**OSCILLATORS FOR MUSICAL INSTRUMENTS**  
**U.H.F. TUNERS FOR 1964 TV SETS**  
**PLUMBING THE MICROWAVE CIRCUIT**

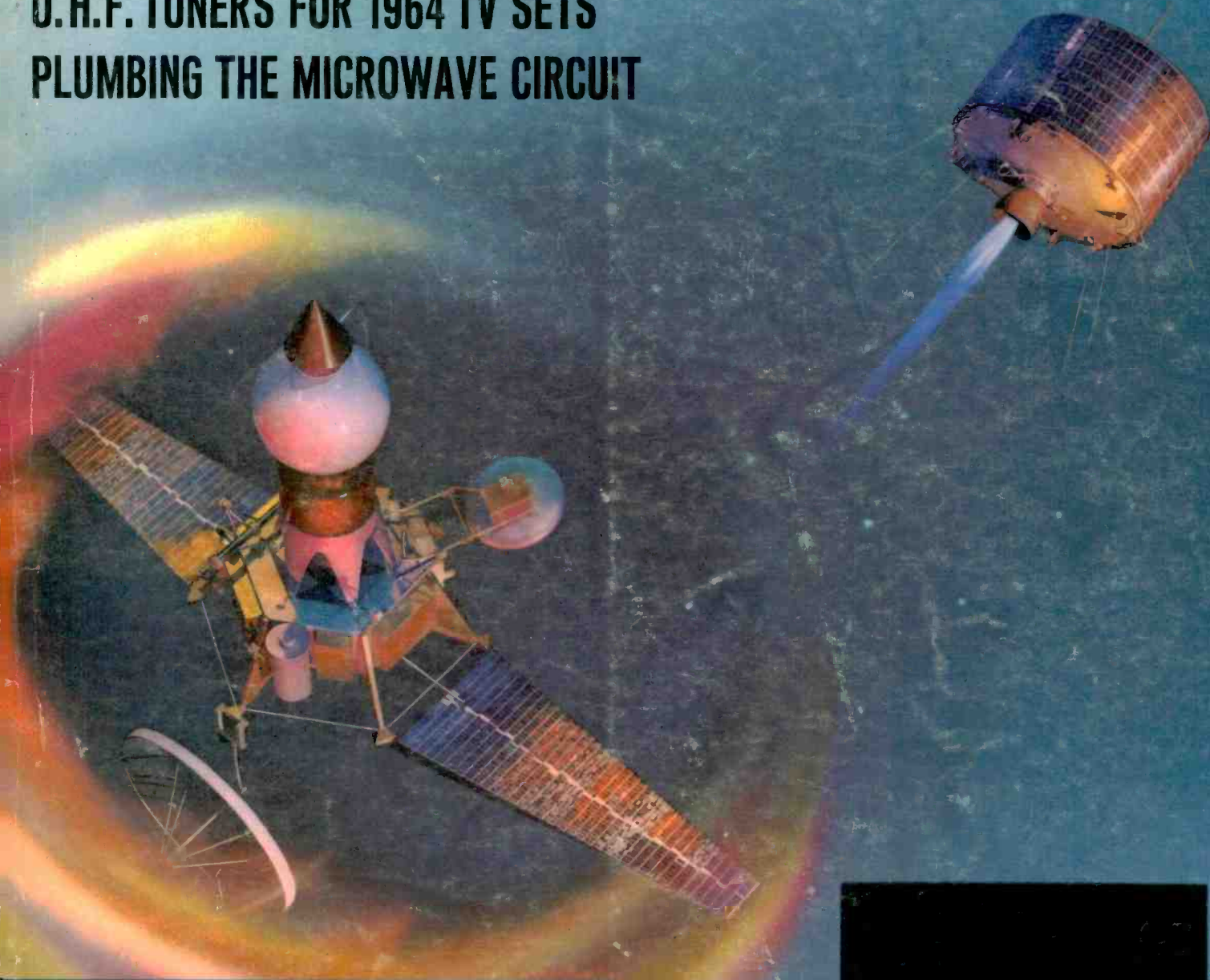

## **SPECIAL SECTION:**

**ELECTRONICS IN SPACE**  
**NASA'S GODDARD**  
**SPACE FLIGHT CENTER**



W13D180 56  
M J HINDMAN  
2724 E LINWOOD  
SPRINGFIELD MO



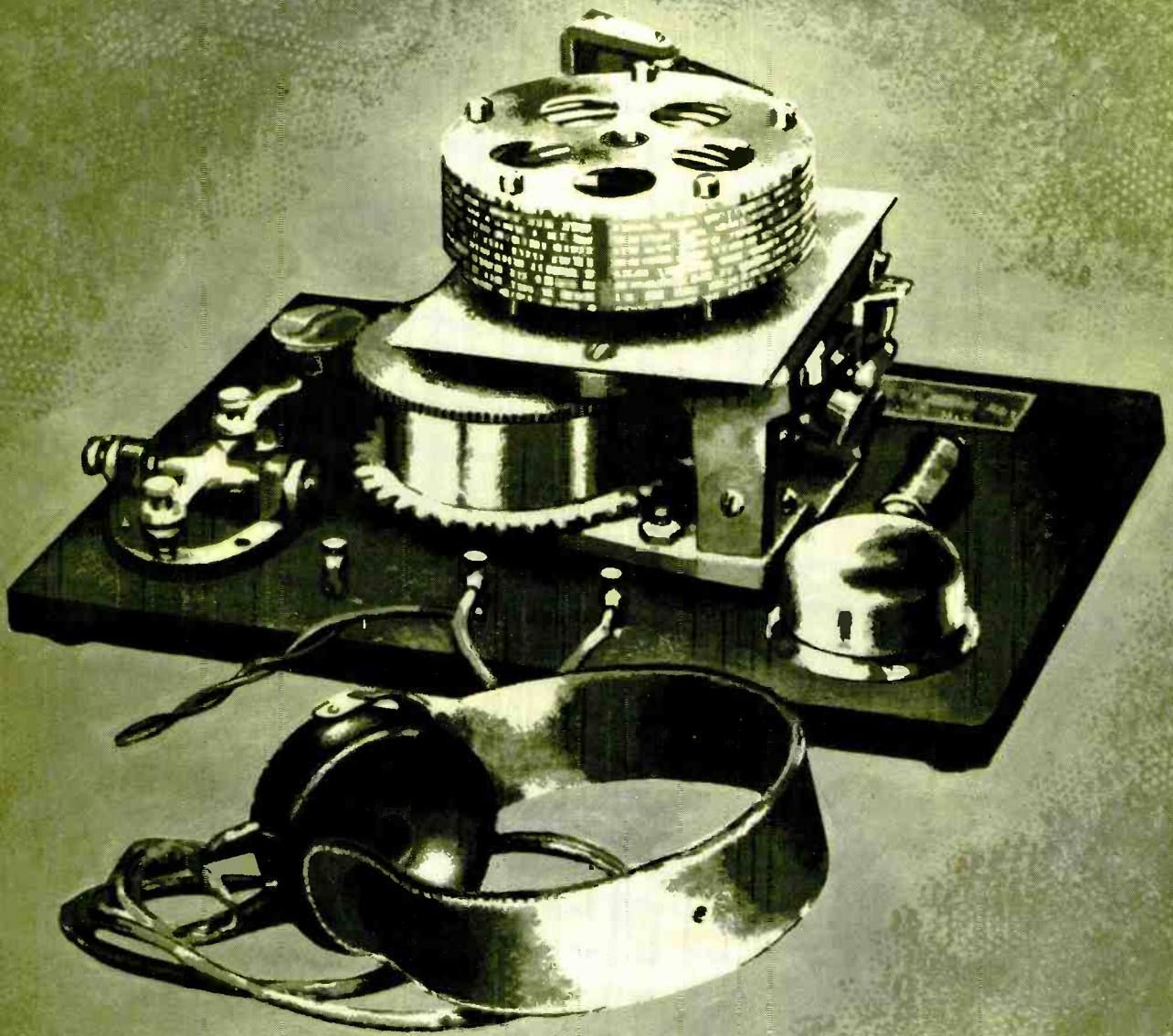

## DISCOVER THE EXCITEMENT OF LEARNING ELECTRONICS WITH NRI CUSTOM-DESIGNED TRAINING EQUIPMENT

The Natrometer was invented and patented by J. E. Smith, the man who founded National Radio Institute half a century ago. He knew men had to get their hands on actual parts if they were to effectively learn radio at home. Like so many other electronic innovations, the Natrometer is now just a relic of the past. In its place is an impressive array of NRI training equipment with which you build, experiment, explore, discover . . . with which you bring to life the theory and practice of Electronics, TV-Radio. NRI training equipment is the finest money can buy, the finest highly skilled instructors and engineers can design and perfect for you.

NRI training equipment is programmed into "bite-size" texts (as direct and well-illustrated as 50 years of home-study teaching experience can make them). That's why the best way to train at home is the practical, thorough, absorbing NRI way. Whatever your interest in Electronics . . . whatever your education . . . whatever your need . . . before you decide on any home-study school you'll want to investigate NRI's extensive list of training plans and interesting training methods. Mail postage-free card for your copy of the NRI catalog. No salesman will call. NATIONAL RADIO INSTITUTE, Washington, D.C. 20016.

**BUILD YOUR OWN TRANSMITTER** as part of the NRI complete Communications course. This phone-CW transmitter complies with FCC regulations and can be put on the air quickly and easily.

**BUILD ACTUAL COMPUTER CIRCUITS** in NRI's Industrial Electronics course. Solve simple mathematical problems on this analog computer you build yourself. One of 10 training kits included in this course.

**BUILD CUSTOM ENGINEERED TV SET** when you enroll for NRI Radio-TV Servicing course. It's the attractive, table model "Custom 70" from Conar, NRI's Instrument Division. The best way to learn is to do it!

**BUILD THIS VACUUM TUBE VOLT-METER** with any major NRI course. Every Technician's indispensable test instrument. You'll use it often as you conduct home lab experiments during training.

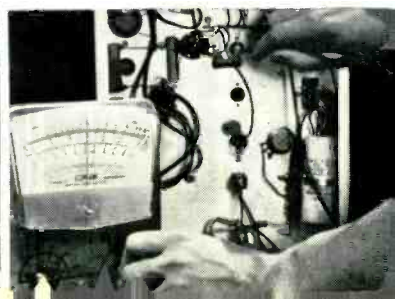
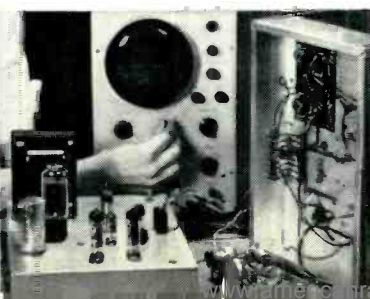

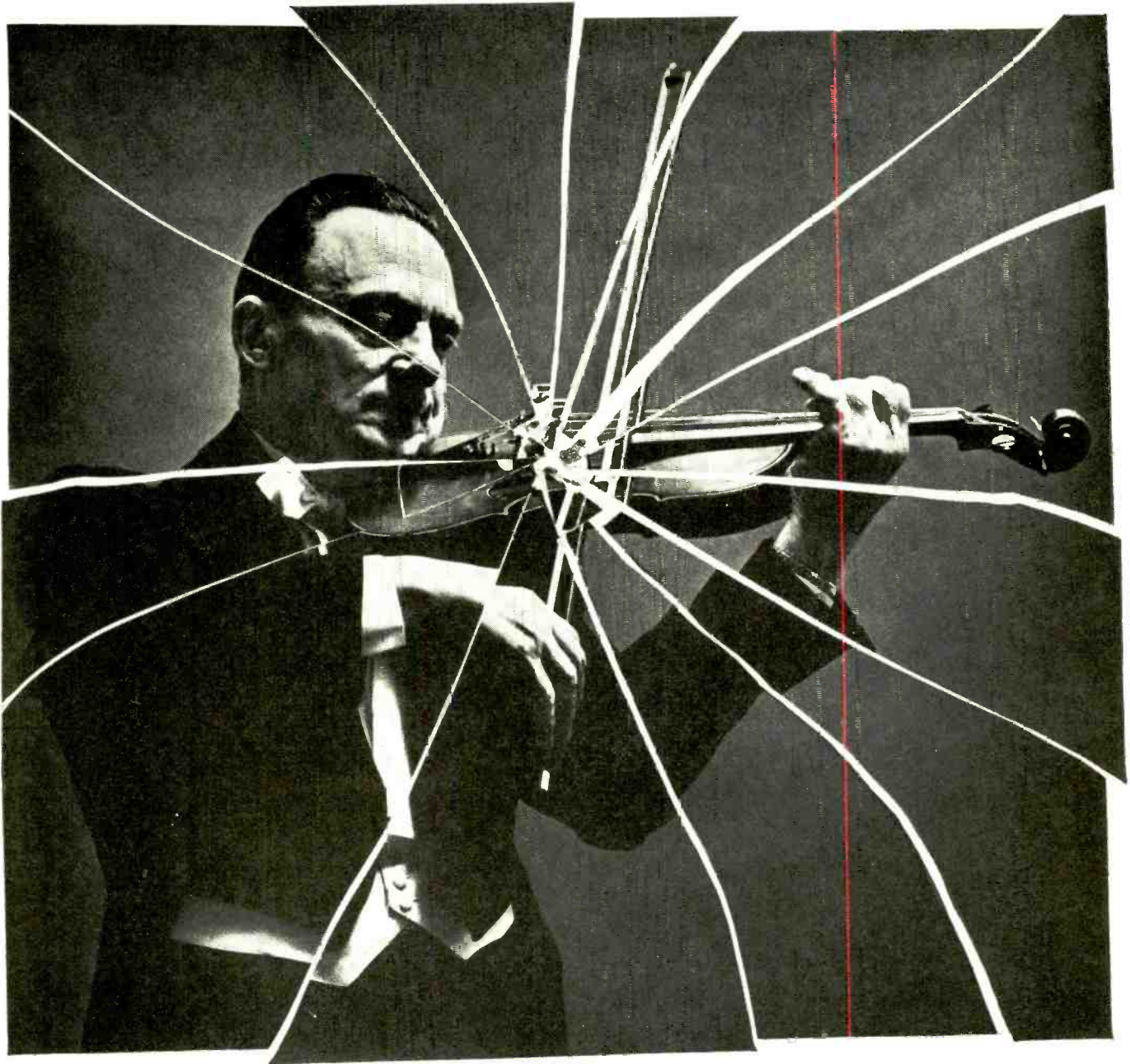

## *Flawed fiddles in your fugue?*

*...then "bargain" recording tape's no bargain!*

What's the "joker" in cheap recording tape with an unknown name? This danger for audiophiles: You're likely to miss out on the sharpest sensitivity, the fullest frequency response your recording equipment has to offer. And you risk excessive background hiss, distortion, besides. Your recorder just can't deliver its best on tape that lacks uniformity, owes its cheap price to manufacturing flaws.

SCOTCH® BRAND Recording Tapes, on the other hand, bring out the best in a recorder. No wonder these tapes are the pick of the professionals! They must pass over 100 quality tests (something "bargain" tapes just couldn't do) to earn their "brand." And they make crystal-clear recording, long tape life a certainty.

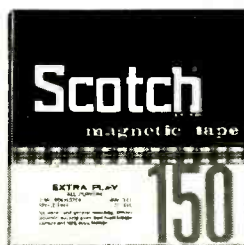

On "SCOTCH" Recording Tapes, full-frequency magnetic recording properties are identical inch after inch, tape after tape. Thinner, more flexible coatings of high-potency oxides assure intimate tape-to-head contact, sharp resolution, wide dynamic range. Exclusive lifetime Silicone lubrication protects against head and tape wear, assures smooth tape travel. Complete selection—from standard to triple length tapes (up to 6 hours recording at 3¼ ips).

See your dealer. Ask to see the new "SCOTCH" Self-Threading Reel. And remember... on "SCOTCH" Recording Tape, you hear it crystal clear.

Magnetic Products Division **3M** COMPANY

\*\*SCOTCH\*\* AND THE PLAID DESIGN ARE REG. TMS OF 3M CO., ST. PAUL, MINN. 55101 © 1964 3M CO.



# MALLORY

## Tips for Technicians

Mallory Distributor Products Company  
A division of P. R. Mallory & Co. Inc.  
Indianapolis, Indiana 46206

# How to select high-reliability capacitors



Computer Grade Capacitor

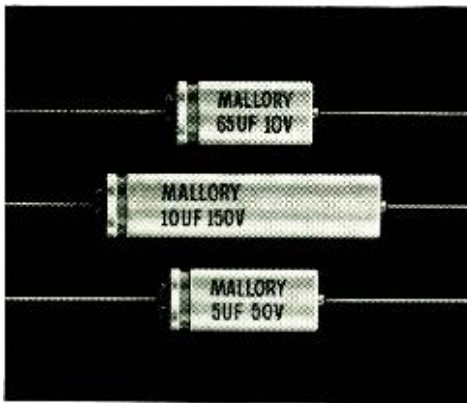

▲ Type TPG Capacitors



Metallized Mylar\* Capacitors

Much of today's electronic gear is used in places where a shutdown because of failure can be astronomically expensive—or it could be downright dangerous to life and limb. In these places it is essential that high reliability components be used. But how does one select truly highly reliable components? The surest method is to bank on the reputation of the manufacturer and to have an intimate knowledge of types of products available.

Take the case of tubular electrolytic capacitors. The standard Mallory TC type has been used for years in literally millions of radios and TV sets with unparalleled success. But the new TPG (Tubular Premium Grade) type is engineered and manufactured to vastly more critical standards. These standards apply to the aluminum foil, to the electrolyte, the all-welded construction, safety vent, and to the extra testing required.

Then there are computer grade filter capacitors. Mallory computer grade types have proven their ability to be better than new after twenty years of continuous service. Standard ratings are available "off-the-shelf" up to 115,000 mfd.

When it comes to Mylar\* capacitors one may select from dipped, molded, wrapped, and umpteen other styles. There are dual-dielectrics, plain Mylar, Metallized Mylar, etc. Mallory PVC and the all-new GEM series utilize 100% Mylar dielectric, but these are commercial types. For high reliability applications, one needs the new ELECTRON metallized Mylar type available in up to 10 mfd @ 100 WVDC. And in the smallest package by volume available anywhere. ELECTRON capacitors are metallized with *aluminum* . . . not zinc as are virtually all other types. Capacitor cartridges are sealed in pre-molded cases with high-density epoxy and the cases are rectangular to better withstand vibration and occupy minimum space.

Tantalum capacitors to meet the most extreme standards of reliability are stock items with Mallory: solid electrolyte, plain and etched foil, wet slug types and 200°C high capacity types (even radiation resistant types).

Whenever you need a truly high reliability capacitor, call your Mallory Distributor. Just ask him for a copy of the 1964 Mallory General Catalog and you'll be able to make a selection from the hundreds of types listed.

\*Registered Trademark E. I. du Pont de Nemours

- 23** Plumbing the Microwave Circuit *R. C. Apperson, Jr.*
- 26** First-Hand Report on TV Tape Recorder for Home Use *M. S. Snitzer*
- 28** U.H.F. Tuners for 1964 TV Sets *Walter H. Buchsbaum*
- 31** Mid-Frequency Amplifier-Gain Nomogram *K. W. James*
- 32** Self-Protecting Transistor Hi-Fi Amplifier *N. Kramer & R. Japenga*
- 34** Recent Developments in Electronics
- 36** Twin-T Oscillators for Electronic Musical Instruments *Fred Maynard*
- 40** Radio & TV Interference (Part 2) *T. R. Haskett & J. D. Blount*
- 42** How Big is Your Volt? *Robert Jones*
- 43** Simple Dwell Meter *T. C. Penn*
- 44** Diode Curve-Tracer & Analyzer *Jim Kyle*
- 46** Computer Logic Fundamentals *Samuel Lukens*
- 49** Special Section: Electronics at NASA's Goddard Space Flight Center
- 50** Guest Editorial *Dr. Harry J. Goett*
- 51** Satellites in Space *Michael J. Vaccaro*
- 52** What Is Goddard?
- 54** Spacecraft Technology and Electronics Packaging
- 56** Manned Space Flight
- 58** Satellite Tracking, Telemetry, and Communications *John T. Mengel*
- 61** Advanced Research for Meteorological Satellites *E. A. Neil*
- 62** Goddard's Technical Manpower *Robert W. Hutchison*
- 64** Advanced Research for Communications Satellites *R. J. Mackey, Jr.*
- 65** Magnetic Modulators *Sidney L. Silver*
- 73** Kelvin Color Temperature
- 76** Wide-Range Wow & Flutter Meter *Frank J. DiElsi*
- 85** Repairing Miniature I.F. Transformers *Glen McKinney*

- 
- 8** For the Record (Editorial) *W. A. Stocklin*  
*Electronics in Space*
  - 18** EW Lab Tested  
*Scott 340B FM-Stereo Receiver*  
*Shure Model 570 Microphone*
  - 70** For Men Only *John Frye*
  - 82** Test Equipment Product Report  
*Hewlett-Packard 208A Test Oscillator*  
*Houston Instrument VM-77B A.C. V.T.V.M.*  
*Mar-Con DRT-100 Tachometer*

## MONTHLY FEATURES

Coming Next Month . . . . .	<b>4</b>	Radio & TV News . . . . .	<b>80</b>
Letters from Our Readers . . . . .	<b>10</b>	Book Reviews . . . . .	<b>86</b>
Reader Service Page . . . . .	<b>15</b>	New Products . . . . .	<b>91</b>
Manufacturers' Literature . . . . .	<b>.95</b>		

Copyright © 1964 by Ziff-Davis Publishing Company. All rights reserved.

## Electronics World



SPECIAL SECTION:  
ELECTRONICS IN SPACE  
NASA'S GODDARD  
SPACE FLIGHT CENTER

OUR COVER shows a group of satellites that typify the U.S. space program. At the upper right is Syncom, an active-repeater communications satellite that has been placed in a synchronous orbit 22,300 miles above earth. At the left is Ranger, designed to transmit TV pictures of the moon's surface back to earth. At lower right is Apollo, a 3-man spacecraft slated to orbit the moon at an altitude of about 100 miles. From this vehicle, 2 astronauts will travel by way of a small lunar excursion module to the surface of the moon. (Photos: NASA. Cover design: George Samerjan.)



*Publisher*  
**PHILLIP T. HEFFERNAN**

*Editor*  
**WM. A. STOCKLIN**

*Technical Editor*  
**MILTON S. SNITZER**

*Associate Editor*  
**LESLIE SOLOMON**

*Associate Editor*  
**P. B. HOEFER**

*Industrial Consultant*  
**WALTER H. BUCHSBAUM**

*Art Editor*  
**DONALD R. THAYER**

*Art and Drafting Dept.*  
**J. A. GOLANEK**

*Advertising Sales Manager*  
**LAWRENCE SPORN**

*Advertising Service Manager*  
**ARDYS C. MORAN**

...for

NATURE LOVERS ...



Record nature sounds. Set on auto operation. Sound starts and stops it automatically.

SLIDES & SOUND

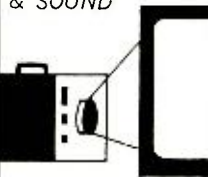

Built-in automatic synchronizer advances slides; coordinates them with commentary or music.

SECRET RECORDINGS ...



For investigations, interrogations, gathering of evidence. Works unattended. Voice starts and stops it.

DICTION ...



Use voice operation or remote-control microphone. Dictate anywhere — office, home or on the road.

MUSIC WHEREVER YOU GO ...



Enjoy music at the beach, on your boat, anywhere. Play commercial tapes or your own selections from radio or records.

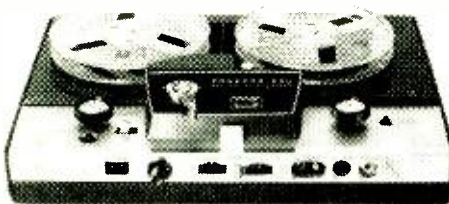

World's First Fully-Automatic Voice-Operated Portable Tape Recorder!

**CONCORD 330**

You'll find all sorts of "hands-free" uses for Concord's amazing portable 330 — applications not possible with an ordinary recorder. You don't even have to be there. Sound starts it; sound stops it. Just set it and forget it! □ The 330 is packed with features: automatic slide projector advance; automatic Synctrol for home movies; automatic self-threading too! Up to 6 hours playing time on 5" reels; 2 speeds; VU meter/battery life indicator and an optional AC adaptor. □ See your Concord dealer right away for a demonstration. Under \$200.00.\* Other Models to \$450.00.

For Connoisseurs Of Sound

**CONCORD 330**

CONCORD ELECTRONICS CORPORATION

809 N. Cahuenga Blvd., Dept. 24, Los Angeles 38, Calif.

\*price slightly higher in Canada.

CIRCLE NO. 104 ON READER SERVICE PAGE

# COMING NEXT MONTH



## RADIO TELESCOPES

These complex and often unique devices have opened a new "window" on the universe to scientists. Albert Giddis and Louis Maggi of Philco provide an international round-up of radio telescopes, tell how they work, discuss some of the new designs, and predict their future.

## LIGHT DIMMER & POWER-TOOL CONTROL

The advent of moderately priced bilateral switching diodes makes practical a compact, inconspicuous control unit that will handle low-power loads or lighting circuits up to 250 watts. The entire control circuit can be housed in a fixture the size of a standard wall-switch plate.

## RATING UNKNOWN POWER TRANSFORMERS

If you have on hand a supply of "unknown" transformers, these simple techniques will help you determine the characteristics of standard radio- and TV-type transformers having end shells.

## TRANSDUCERS FOR INDUSTRIAL INSTRUMENTATION

Electronic devices are used to measure mechanical parameters in various in-

dustrial processes. Without these transducers, high-speed production lines might come to a standstill. Ray A. Shiver explains their operation and role in industrial applications.

## BINARY COMPUTER CODES

A new binary language has been standardized to permit different makes of computers and data processors to "talk" to each other. This is the American Standard Code for Information Interchange (ASCII) and Author Ed Bukstein explains what it is and provides a tabulated listing of this new code.

## EW TESTS

### U.H.F. TV CONVERTERS

From our results, many of the u.h.f. converters now on the market are literally transmitters. There will be interference problems ahead unless many of the current designs are re-engineered and greatly improved.

### SIMPLIFIED MEXICAN COLOR TV

Mexican engineers have come up with a unique switching method which is being used by Mexican TV channel 5 to provide color signals from a standard monochrome transmitter, a special camera, and associated switching circuits.

All these and many more interesting and informative articles will be yours in the JULY issue of ELECTRONICS WORLD... on sale June 18th.

## ZIFF-DAVIS PUBLISHING COMPANY

William B. Ziff  
Chairman of the Board (1916-1953)

William Ziff  
President

W. Bradford Briggs  
Executive Vice President

Hershel B. Sarbin  
Vice President and General Manager

M. T. Birmingham, Jr.  
Vice President and Treasurer

Walter S. Mills, Jr.  
Circulation Director

Stanley R. Greenfield  
Vice President

Phillip T. Heffernan  
Vice President

ZIFF-DAVIS PUBLISHING COMPANY  
Editorial and Executive Offices  
One Park Avenue, New York, N.Y. 10016  
212 ORegon 9-7200

MIDWESTERN and CIRCULATION OFFICE  
434 South Wabash Avenue, Chicago, Ill. 60605  
312 WAbash 2-4911  
Midwestern Advertising Manager, Royce Richard

WESTERN OFFICE  
9025 Wilshire Boulevard, Beverly Hills, Cal. 90211  
213 CRestview 4-0265

Western Advertising Manager, Bud Dean  
FOREIGN ADVERTISING REPRESENTATIVE  
D. A. Goodall Ltd., London, England



Member  
Audit Bureau of  
Circulations

Radio & TV News • Radio News • Radio-Electronic Engineering Trademarks Reg. U.S. Pat. Off.

**SUBSCRIPTION SERVICE:** All subscription correspondence should be addressed to Electronics World, Circulation Dept., 434 South Wabash Ave., Chicago, Ill. 60605. Please allow at least six weeks for change of address. Include your old address as well as new—enclosing if possible an address label from a recent issue.

**EDITORIAL CONTRIBUTIONS** must be accompanied by return postage and will be handled with reasonable care; however publisher assumes no responsibility for return or safety of art work, photographs, or manuscripts.

**ELECTRONICS WORLD** is published monthly by Ziff-Davis Publishing Company at 434 South Wabash Avenue, Chicago, Ill. 60605. Ziff-Davis also publishes Popular Photography, Popular Electronics, HiFi/Stereo Review, Popular Boating, Car and Driver, Flying, Modern Bride, Amazing, and Fantastic. Subscription rates: one year United States and possessions \$5.00; Canada and Pan American Union countries \$5.50; all other foreign countries \$6.00. Second class postage paid at Chicago, Illinois and at additional mailing offices. Authorized as second class mail by the Post Office Department, Ottawa, Canada and for payment of postage in cash, June, 1964, Vol. 71, No. 6.

**PAYMENT MAY ALSO BE REMITTED** in the following foreign currencies for a one year subscription: Australian pounds (2/16); Belgian francs (310); Danish kroner (43); English pounds (2/4/6); French francs (31); Dutch guilders (22); Indian rupees (31); Italian lire (3900); Japanese yen (2100); Norwegian kroner (15); Philippine pesos (25); South African rands (4.50); Swedish kronor (33); Swiss francs (27); West German marks (25).

ELECTRONICS WORLD

# YOUR FIRST CLASS COMMERCIAL F.C.C. LICENSE

## Your Ticket To A Better Paying Job And Greater Job Security

We train you — prepare you to pass the FCC exam for your first class FCC license. The leading course of its kind, Grantham FCC License Preparation is available in resident classes in Los Angeles, Calif.; South Gate, Calif.; Seattle, Wash.; Kansas City, Mo.; and Washington, D.C. Or, if you prefer, our specialized training is available *in your own home* from our Home Study Department, Kansas City, Mo. Regardless of where or how you study with Grantham, you are taught *right* and prepared *quickly* for your first class FCC license.

### Grantham Students Get Their Licenses

Following is a list of a few of the many students who have completed our FCC license preparation recently and obtained their *first class* FCC licenses:

Edwin Keister, 1201 Dennis Ave., Silver Spring, Md.  
 Herbert Braswell, 416 E. Bellefonte Ave., Alexandria, Va.  
 Floyd R. Henderson, 3219 Andritta St., Los Angeles, Calif.  
 Gerald D. Herbert, Route 6, Bloomfield, Iowa  
 William Seymour, 6924 - 32nd St., N.W., Washington, D.C.  
 Nelson H. Crumling, 92 N. Second St., Mt. Wolf, Pa.  
 Irvin Griffin, 2421 W. Lexington St., Baltimore, Md.  
 Denis Christopherson, 4402 Waite Lane, Madison, Wisc.  
 David H. Klempel, Lambert, Montana  
 Armand E. Pinard, P.O. Box 3193, Washington, D.C.  
 Wayne A. Taylor, 4111 Nicholson St., Hyattsville, Md.  
 William I. Brink, 12 Meade Ave., Babylon, L.I., N.Y.  
 John Ponchock, Box 88, Coupon, Pa.  
 John A. Cork, 3535 N. Utah, Arlington, Va.  
 Charles Bartchy, 1222 S. Park Ave., Canton, Ohio  
 Gene M. Walker, 1400 S. Wilcox Ave., Monterey Park, Calif.  
 David Kaus, 5218 Canterbury Way S.E., Washington, D.C.  
 Wm. S. Bullock, P.O. Box 1133, Atlantic City, N.J.  
 James W. Logan, 464 DeLeon Dr., Miami Springs, Fla.  
 Emory R. Valla, Box 616, Imperial, Pa.

Hall Blankenship, Route 2, Rockwood, Tenn.  
 Charles D. Summers, 451 Hillcrest Dr., Statesville, N.C.  
 William H. Ames, CMR 2, Box 2112, Travis AFB, Calif.  
 Alexander Mikalaski, 4510 Rittenhouse St., Riverdale, Md.  
 Wayne F. Murphy, 317 Jefferson St., Roanoke Rapids, N.C.  
 Ralph Munday, 417 W. Pecan, Rogers, Ark.  
 John L. Marlow, Box 384, Umatilla, Ore.  
 Allen Lee Park, 3024 S. Buchanan St., Arlington, Va.  
 Clarence E. Daly, 517 N. Allendale St., Baltimore, Md.  
 John M. Quickel, Jr., 1418 Saratoga Ave., N.E., Washington, D.C.  
 Garland Hadley, 205 E. Washington St., Shepherdstown, W. Va.  
 George L. Heable, 214 N. Main St., Attica, Ohio  
 Robert J. Maickel, 520 Market St., Havre De Grace, Md.  
 Harold F. DeBruin, 1621 N. Morrison St., Appleton, Wisc.  
 James Lee Winde, 805 Princeton Rd., Wilmington, Del.  
 Thomas J. Bailey, 1005 Penn St., Hollidaysburg, Pa.  
 Charles G. Suit, 8016 - 14th Ave., Hyattsville, Md.  
 James R. Reese, Jr., Station WCFV, Clifton Forge, Va.  
 Charles Deitzel, 342 Walnut St., Columbia, Pa.  
 Norman Tilley, Jr., 8613 Piney Branch, Silver Spring, Md.  
 Guy C. Dempsey, 1326 - 19th St., Washington, D.C.  
 Earl J. Mahoney, Box 296, Newport, Vt.  
 Joseph J. Hytovick, 260 Poplar St., Dickson City, Pa.  
 Charles H. Hayden, 2607 Kirkwood Pl., Hyattsville, Md.  
 James D. Neidermyer, R. D. 1, Leola, Pa.  
 John D. Borin, 5356 Franklin Ave., Hollywood, Calif.  
 Arthur C. McGuire, 1510 Mahiole Pl., Honolulu, Hawaii  
 Roy Coleman, 769 Yale Ave., Baltimore, Md.  
 Daniel F. Fountain, 710 Chrysler St., Kalamazoo, Mich.

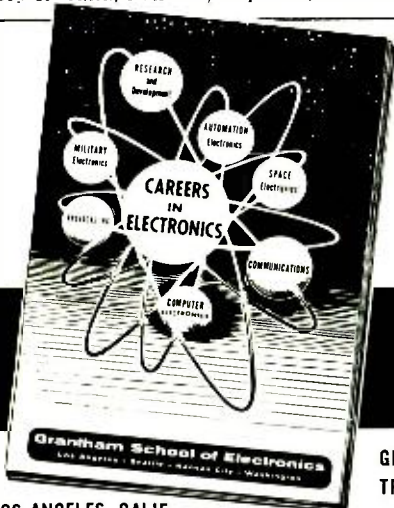

THIS 44 PAGE  
 BOOKLET  
**FREE!**

Our free, 44-page booklet, "Careers in Electronics," contains full details on how Grantham training can prepare you for your first class FCC license and for a successful electronics career. For your free copy, complete the coupon below and mail it to our National Headquarters Office (address in coupon), or write or telephone one of our teaching divisions which appear to the left. You'll be glad you did!



**GRANTHAM**  
 SCHOOL OF ELECTRONICS



GRANTHAM F.C.C. LICENSE  
 TRAINING OFFERED AT:

<b>LOS ANGELES, CALIF.</b> 1505 N. Western Ave., Los Angeles, Calif., 90027	HO 7-7727
<b>SOUTH GATE, CALIF.</b> 9320 Long Beach Blvd., South Gate, Calif., 90280	564-3421
<b>GARDEN GROVE, CALIF.</b> 12732 Garden Grove Blvd., Garden Grove, Calif., 92640	530-0795
<b>SEATTLE, WASH.</b> 408 Marion Street, Seattle, Wash., 98104	MA 2-7227
<b>KANSAS CITY, MO.</b> 3123 Gilham Rd., Kansas City, Mo., 64109	JE 1-6320
<b>WASHINGTON, D. C.</b> 821 - 19th Street, NW, Washington, D.C., 20006	ST 3-3614

mail in envelope or paste on postal card

**TO: GRANTHAM SCHOOL OF ELECTRONICS**

NATIONAL HEADQUARTERS OFFICE

1505 N. WESTERN AVE., LOS ANGELES, CALIF., 90027

Please send me your FREE 44 page booklet telling how I can get my commercial F.C.C. license quickly and can continue into advanced electronics if I wish. I understand there is no obligation and no salesman will call.

Name \_\_\_\_\_ Age \_\_\_\_\_  
 (PLEASE PRINT)

Address \_\_\_\_\_

City \_\_\_\_\_

State \_\_\_\_\_

I AM INTERESTED IN:  HOME STUDY  RESIDENT CLASSES

46-G

# Has the Space Age outdated your knowledge of Electronics?

What happens to transistors in the Van Allen Belt? How are vacuum tubes used in space? Why can't regular lubricants be used on moving parts in a spacecraft? To what extent has the space effort changed reliability standards?

These and other questions reflect the changes taking place with space applications of electronics. Project Apollo and other missions in the space effort are rapidly outdated conventional concepts.



## Protect your future through the New CREI Program in Space Electronics

For a career in space electronics you must acquire considerable new knowledge—knowledge that just didn't exist when you studied electronics. And, because developments in space electronics are quickly applied to other areas of electronics, knowledge of space electronics is an asset to a man in any field of electronics.

You can protect your future through the new CREI Program in Space Electronics which offers you up-to-date knowledge of these specialties:

**SPACE DATA SYSTEMS**—Includes analog and digital computers, information theory, data acquisition and processing.

**SPACE TRACKING SYSTEMS**—Includes microelectronics, space propagation, masers, lasers, infrared techniques.

**SPACE GUIDANCE & CONTROL**—Includes inertial navigation, space radar, star tracker systems, tracking networks.

• The first extension programs developed specifically to help men in electronics apply their experience to the space effort.

ELECTRONICS WORLD



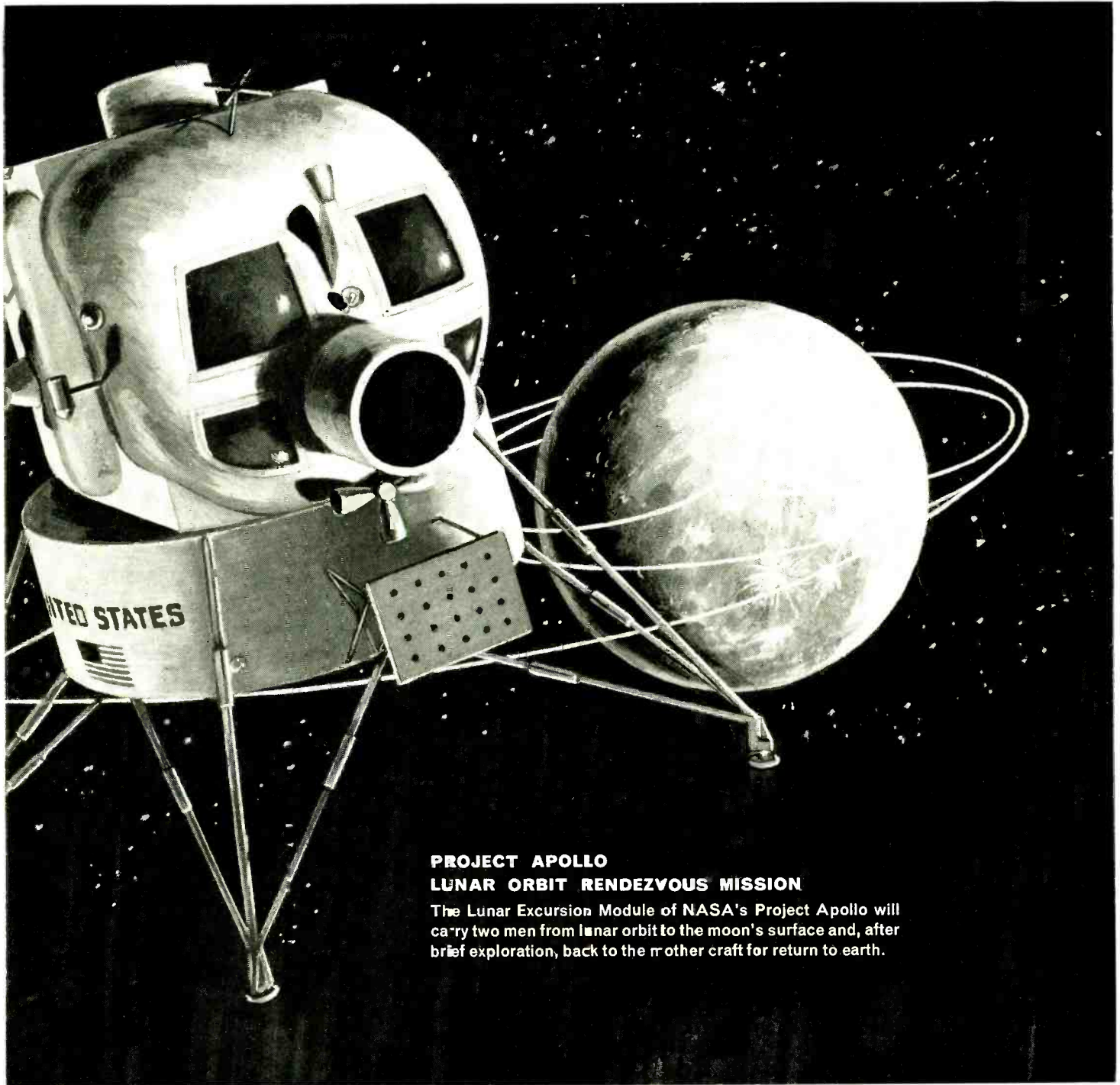

**PROJECT APOLLO  
LUNAR ORBIT RENDEZVOUS MISSION**

The Lunar Excursion Module of NASA's Project Apollo will carry two men from lunar orbit to the moon's surface and, after brief exploration, back to the mother craft for return to earth.

• Content developed to meet employment requirements as determined by consulting government and private organizations in the space field. • Text material prepared in leading space-oriented organizations.

CREI also offers specialized education in these important areas of electronics: Communications, Aeronautical and Navigational, Television, Automation and Industrial Nuclear, Servomechanisms and Computers. You are eligible for these programs if you work in electronics and have a high school education.

**FREE BOOK GIVES FULL INFORMATION ON CREI PROGRAMS.** For your copy, mail coupon or write: CREI, Dept. 1106-B, 3224 Sixteenth Street, N. W., Washington, D. C. 20010

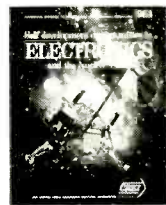

**The Capitol Radio Engineering Institute**

Founded 1927, Accredited Member of the National Home Study Council  
Dept. 1106-B, 3224 Sixteenth St., N. W.,  
Washington 10, D. C. 20010

Please send me FREE book describing CREI Home Study Programs including new Program in Space Electronics. I am employed in electronics and have a high school education.

Name \_\_\_\_\_ Age \_\_\_\_\_

Address \_\_\_\_\_

City \_\_\_\_\_ Zone \_\_\_\_\_ State \_\_\_\_\_

Employed by \_\_\_\_\_

Type of Present Work \_\_\_\_\_

Check:  Home Study  Residence School  G. I. Bill



**Crown**

— first choice  
of those who  
demand the best!

**NEW**

**Solid  
State**

**RECORDERS**

**INCOMPARABLE  
PERFORMANCE**

Quarter-Track Record/Play Data

ips	db	cps	s/n
7-1/2	±2	50 — 30,000	56db
3-3/4	±2	30 — 20,000	52db
1-7/8	±3	30 — 12,000	46db

The most complete recording instruments ever designed for stereo use. Audio circuitry, ±1/4 db from 10-100,000 cps; extended range, 5-500,000 cps. Plug-in circuit modules are printed on epoxy and gold plated. Engineered to space craft reliability.



THE HALLMARK  
OF CROWN —  
SUPERLATIVE  
CRAFTSMANSHIP  
THROUGHOUT!

**INDIVIDUAL PERFORMANCE  
RECORD SUPPLIED  
WITH EACH CROWN**

WRITE DEPT. EW-06



**Crown  
INTERNATIONAL**  
1718 Mishawaka Rd. • Elkhart, Ind.

CIRCLE NO. 105 ON READER SERVICE PAGE

8



# For the record

WM. A. STOCKLIN, EDITOR

## ELECTRONICS IN SPACE

THE development of the cotton gin, steam engine, radiotelephone, the airplane, and many other inventions represent significant industrial contributions that have made the United States the world leader it is today. The development of nuclear energy, for both destructive and peaceful purposes, was another major contribution in maintaining this leadership.

No nation, or for that matter no company, can maintain this preeminence without making progress. There are many who will argue for the *status quo*, yet man is an inquisitive creature. He looks for new ideas, new developments and, particularly, new opportunities to investigate any areas that are unknown.

Danger is never an inhibiting factor and, in many cases, it is actually an incentive. To conquer space, to learn what is beyond, and to solve its mysteries are challenges that cannot be denied.

To obtain complete competence in manned space flight to the moon is a goal which the United States, through NASA, must attain. It would give us freedom of choice to carry out whatever missions our national interests may require—be they for prestige, military supremacy, scientific knowledge, or other purposes. The final objective, of course, is for the United States to maintain its world leadership.

The goal of our Mercury program, which was concluded a year ago, was to obtain complete competence in near-earth orbital flights and to return our astronauts safely. This was the beginning, but we (and the Russians as well) proved that man could perform useful functions in space under weightless conditions for fairly long periods of time. We also proved that we had the scientific know-how and ability to launch satellites into orbit and return the men and instruments to earth safely.

In the four years and eight months from the beginning to the successful culmination of Project Mercury, the world has witnessed two manned sub-orbital and four manned orbital flights that were outstanding contributions to American technology. In addition, more than two million people from many major government agencies and much of the aerospace industry demonstrated their ability to combine skills and experience in a national effort. Although the Mercury program is now completed, work has not stopped. NASA has outlined an extensive new program involving the Gemini and Apollo projects. Gemini will be concerned with orbiting two men in a single spacecraft

around the earth; Apollo will carry three men and put one of them on the moon. It is their hope that, as a result of these projects, by 1970 the United States will have accomplished the feat of putting an American astronaut on the moon and returning him safely to earth.

(Just as we were going to press, we learned that the first test flight in our Gemini program has been a success. An unmanned capsule carrying a minimum amount of equipment plus ballast has been placed into orbit around the earth by a two-stage Titan II rocket.)

There are many divisions of NASA, each one of them playing a vital role in the success of our space program. However, since our interests are mainly in the area of electronics, we naturally turned to NASA's Goddard Space Flight Center near Washington D.C. This is where almost all tracking, communications, and data compilation is handled. Their world-wide complex of computers, radar, and communications equipment automatically determines the precise orbits of our various satellites and spacecraft on a split-second basis. Mission controllers continuously receive information from more than thirty instantaneous displays depicting the flight of a spacecraft and predictions of its future course.

From the instant of launch to the moment of recovery a steady stream of raw data on a space vehicle's position, velocity, and performance flows into the computing system at Goddard from the many remote tracking sites and from the vehicles themselves. Seconds after each bit of flight data is picked up by distant radar and telemetry receivers, interconnecting computers automatically combine it with masses of stored and other incoming information and, making thousands of calculations a minute, display to the flight controller the mission's up-to-the-second status on electronic wall maps, clocks, and console display devices.

We feel that the Goddard Space Flight Center, where electronics plays such a vital role, is so important that all our readers should know more about it. Therefore, in this issue, starting on page 49, we are presenting a special 16-page section describing the various activities of the Center.

We hope that every one of our readers will find this section of interest. We would appreciate receiving your comments—either pro or con—on this type of coverage. If there is enough reader interest in this subject, we will plan similar stories on the electronic aspects of other divisions of our space program. ▲



## Sit right down in this high-paying job . . . after you get your FCC License

It's true. There are hundreds of high-paying, challenging jobs for men with official proof of their electronics skill and knowledge . . . the Commercial FCC License. And the quickest, easiest, most economical way to get your license is Cleveland Institute of Electronics Home Study. Will it work for you? Cleveland Institute is so sure of it they make this exclusive promise: "Should you fail to pass your Commercial FCC License examination after completing one of our licensing programs, we will refund all your tuition payments." The offer is as straightforward as it sounds . . . you get your FCC license or your money back!

You'll be amazed how fast, how easily you can learn electronics with a Cleveland Institute Check-Point Plan of Home Study. Facts and concepts are presented in small, easy-to-understand segments, then reinforced with clear explanations and examples. Through this modern, proven method, you will learn at your own pace . . . and remember what you learn!

So pick the program that fits your career objective, mark your choice on the coupon, and mail it today. We'll

send you, without obligation, complete details on Cleveland Institute home study. Act right now . . . there will never be a better time to start towards a high-paying, interesting job in electronics.

### Mail Coupon TODAY For FREE Catalog

#### Cleveland Institute of Electronics

1776 E. 17th St., Dept. EW-90  
 Cleveland, Ohio 44114

Please send FREE Career Information prepared to help me get ahead in Electronics, without further obligation.

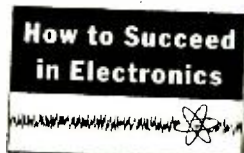

#### CHECK AREA OF MOST INTEREST—

- |   |  |
|---|--|
| <input type="checkbox"/> Electronics Technology | <input type="checkbox"/> First Class FCC License   |
| <input type="checkbox"/> Industrial Electronics | <input type="checkbox"/> Electronic Communications |
| <input type="checkbox"/> Broadcast Engineering  | <input type="checkbox"/> Advanced Engineering      |

Your present occupation \_\_\_\_\_

Name \_\_\_\_\_ Age \_\_\_\_\_  
 (please print)

Address \_\_\_\_\_

City \_\_\_\_\_ State \_\_\_\_\_ Zip \_\_\_\_\_

Approved for Veteran's Training under Korean GI Bill. EW-90

## Cleveland Institute of Electronics



1776 E. 17th St., Dept. EW-90, Cleveland, Ohio 44114

Accredited Member



## DYMO LABELMAKER

Make permanent, raised letter plastic labels in seconds. Professional quality labels for pennies. Dial letters, numbers, symbols, squeeze handle. ■ 1001 uses for the Hi-fi enthusiast. ■ At fine stores everywhere. Suggested price \$9.95



**FREE:** Label samples and literature. Write: Dymo Industries, Inc., Dept. EW-6-4, Box 1030, Berkeley, Calif. Priced same in Canada.

CIRCLE NO. 107 ON READER SERVICE PAGE

# LETTERS FROM OUR READERS

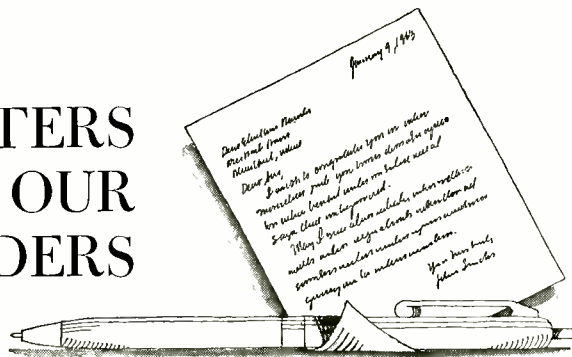

### CB REPAIR & ADJUSTMENT

*A copy of the following letter was sent to this office by the FCC. It answers the questions often asked by our readers on the legality of making adjustments and repairs on their Citizens Radio equipment.—Editor*

Dear Sir:

This is in reply to your letter in which you refer to several magazine articles concerning repair and adjustment of Citizens Radio Service equipment and ask for clarification of the meaning of Section 19.71 (now 95.95) of the Rules.

A basic purpose of Section 19.71 is to prevent the operation of Citizens Radio station equipment: (1) beyond the required frequency tolerance; (2) with excessive input power; (3) with over-modulation, or; (4) with excessive harmonic or other spurious emissions. Any adjustment or alteration of the equipment which is likely to cause any one of the above violations must be made by, or under immediate supervision and responsibility of a person holding a first- or second-class commercial radio operator license. This applies to normal operation, installation, servicing, and maintenance.

A commercial operator license is not required for adjustments or tests of class C or class D equipment normally made during normal operation, installation, servicing, and maintenance provided the manufacturer has verified that the transmitter meets the specifications of Section 19.71 (d) (1) (2) (3) and (4). In effect, these normal adjustments and tests must not be capable of causing any of the four technical violations listed in the preceding paragraph.

When a station's equipment is found operating contrary to any of the technical regulations, restoring it to compliance must be done by or under the supervision of a person holding the required commercial operator license. Where off-frequency operation has not occurred or is not suspected, crystals may be added or substituted provided that the manufacturer of the equipment or of the crystal has stated that the particular make and type of crystal is suitable for proper operation in that specific make and model number of equipment.

Otherwise substitution or addition of crystals requires a frequency check by or under the supervision of the required class of commercial operator licensee.

BEN F. WAPLE, Secretary  
Federal Communications Commission  
Washington, D.C.

### TRANSISTORS VS TUBES

To the Editors:

We have been following with a great deal of interest the numerous articles concerning transistors *versus* tubes in the audio field. In recent issues, Mr. Furst and Mr. Chou outlined a number of advantages of transistor amplifiers, among them the most important being: (1) high damping factor, (2) no output transformer, and (3) wide, phase-linear response.

We would like to point out that there is a vacuum-tube amplifier on the market delivering 50 watts per channel which displays the same characteristics as the finest transistor amplifiers. Its damping factor is an unusual 200. The 20-kc. square waves show no evidence of ringing or overshoot. The frequency response is advertised as being flat from 5-90,000 cycles per second. We would like to see this amplifier, the Futterman amplifier, distributed by *Harvard Electronics*, receive at least a mention.

We do not wish to seem that we are anti-transistors for this is certainly not the case. We do wish to register a vote for the vacuum tube in this field for it certainly has a record for dependability under many conditions which many transistor devices, unfortunately, do not.

LUCIUS MORRIS,  
Director of Engineering  
Acoustic Engineers  
Washington, D. C.

*An early version of the Futterman amplifier appeared as a construction project in our May, 1959 issue. For further details on the latest commercial version, readers can contact Harvard Electronics, 693 Broadway, New York, N. Y.—Editors.*

### LOUDSPEAKER IMPROVEMENTS

To the Editors:

Reader Burris (March 1964 *ELECTRONICS WORLD*) is right in saying that



## How to make some sound money

Talk up rear-seat speakers! Here's a good profit item you can sell to your car-owning customers. And spring is the time when everyone wants one. If he doesn't have a rear-seat speaker now he's probably already half sold, just waiting for someone to ask him to buy.

The Delco Radio Universal 8-10-OHM 6"x9" Rear Speaker Package #6122 contains all material necessary for a quick, easy one-man installation. Will take "tip jack", "blade", or

solder connection. And you're sure of selling the "right kind" because these speakers are acoustically designed for use in cars.

This spring make some sound money on rear-seat speakers. For full information on the complete Delco Radio line of speaker packages and accessories, call your United Delco supplier.

DELCO RADIO, Division of General Motors, Kokomo, Indiana

# simply say **Delco**

**Delco Radio** Automotive Radio Service Parts and Electro-Mechanical Devices are distributed nationally through **United Delco**



CLASSROOM TRAINING COURSES  
IN NEW YORK CITY

# START YOUR CAREER IN ELECTRONICS NOW AT RCA INSTITUTES...

Choose from this list

	INDUSTRY DESIGNATED JOB TITLES	RCA PROGRAM	ENTRANCE REQUIREMENTS
A	Engineering Aide Junior Engineer Field Engineer Sales Engineer Electronics Instructor	Electronics Technology (T-3)	High School grad, with Algebra, Geometry, Physics. (Review courses available)
B	Computer Technician Broadcast Engineer Field Technician Medical Electronic Technician	Industrial and Communications (V-7) Electronics	*2-yrs. High School with Algebra, Physics or Science
C	Electronic Tester Junior Technician Service Man	Electronics and Television Receivers (V-3)	*2-yrs. High School with Algebra, Physics or Science
D	Industrial Electronic Technician	Automation Electronics (V-14)	Radio Receiver and Transistor Background
E	Computer Service Technician	Digital Computer Electronics (V-15)	Radio Receiver and Transistor Background
F	Coder, Junior Pro- grammer, Console Operator	Computer Programming (C-1)	College Grad. or Industry Sponsored
G	Programmer-Analyst	Computer Programming (C-2)	Programming Experienced
H	TV Serviceman	Color Television	Television Background
I	Transistor Circuits Specialist	Transistors	Radio Background

DAY & EVENING CLASSES: Coeducational Classes Start 4 Times Each Year.

\*Experience may be substituted.  
Preparatory Courses available.

RCA Institutes is one of the largest technical institutes in the United States devoted exclusively to electronics. Free Placement Service. Applications now being accepted for next term classes in New York City.



The Most Trusted Name  
in Electronics  
RADIO CORPORATION OF AMERICA

RCA Institutes, Inc. Dept. EWR-62  
350 West Fourth Street  
New York 14, New York

Please send me your FREE catalog. I am interested in the courses circled below.

A B C D E F G H I

Name \_\_\_\_\_ (please print)

Address \_\_\_\_\_

City \_\_\_\_\_ Zone \_\_\_\_\_ State \_\_\_\_\_

For Home Study Courses See Ad On Opposite Page



development in the field of woofers has lagged behind that in other components. One reason for this backwardness has been a misplaced emphasis on redesign of the speaker driving motor, rather than of the driven mechanical and acoustical system, an emphasis reflected in Mr. Burris' own letter.

In a good modern woofer, perhaps 10% of its performance deficiencies relates to its electrical and magnetic system, and 90% to its passive mechanical system. Non-linear suspensions, cone break-up, non-uniform radiation patterns, etc. are the real speaker problems. If, by the wave of a magic wand, we could instantly create a perfect electro-magnetic drive system for a woofer, the speaker would prove much less expensive to make and possibly have higher electro-mechanical efficiency, but one would hardly notice any improvement in quality.

It is the mechanical system that has required, and still does require, further development. This is why *Acoustic Research* introduced the acoustic suspension system in 1954. In this system, control of the speaker cone by mechanical suspensions is given over to the body of air in the enclosure, with an attendant increase in linearity of four or five times. The mechanical system of cone restoring force is replaced by a system where more than three-quarters of the restoring force is supplied by the linear air cushion in the cabinet.

Reader Burris states that minute leaks in the cabinet are of no importance. This is an understatement, in the sense that if the cabinet were truly airtight the entire system would act as an aneroid barometer, and the neutral position of the cone would change with the weather. A leak *must* be provided. However, in an AR acoustic suspension system we provide very slow leaks, so that it takes a few seconds for the air to escape. Larger leaks create a slight loss of bass, and annoying noises from the back of the cabinet when deep organ pedal tones are played.

EDGAR VILLCHUR  
Acoustic Research, Inc.  
Cambridge, Mass.

### CB CHECKER

To the Editors:

Your test equipment product report on the "Knight-Kit" Ten-2 CB Checker (Feb. issue) is objective and complete. Your typesetter, however, raised the price. The Ten-2 is available for \$25.95 in kit form and \$39.95 for the factory-assembled unit.

J. W. RUBIN  
Dir. of Public Relations  
Allied Radio Corp.  
Chicago, Ill.

### SOLID-STATE COLOR ORGAN

To the Editors:

Some readers have advised me that the audio transformers (T1, T2, T3) used in my article "A Simplified Solid-State Color Organ" (Jan. 1964 issue) are temporarily out of stock. Suitable substitutes are the "Knight" 61-G-449 or 61-G-492, or the more expensive *Triad* A6X or A7J.

Also, the *Motorola* people have announced a new SCR that will work well in this circuit. It is an MCR-1304-4 and sells for less than \$2.50 each. This device is rated at 8 amperes maximum, which would allow a control capability of almost 1 kw. *per channel*, or almost 3 kw. total. Suitable heat sinks must be used, naturally.

DONALD E. LANCASTER  
Phoenix, Ariz.

*Incidentally, for those interested in constructing the author's earlier version which appeared in our April, 1963 issue, the symbols for Q4, Q5, and Q6 unijunction transistors should have been drawn with the arrows pointing upward rather than downward. The upper electrodes are Base 1 and the lower electrodes are Base 2.—Editors.* ▲

# SEND NOW!

**RCA INSTITUTES, INC.** DEPT. EW-64

350 West 4th St., New York, N. Y. 10014

Rush me by return mail your FREE illustrated 64-page book on electronics careers through Home Training! No obligation to me! No salesman will call!

NAME \_\_\_\_\_ AGE \_\_\_\_\_

ADDRESS \_\_\_\_\_

CITY \_\_\_\_\_ STATE \_\_\_\_\_ ZIP \_\_\_\_\_

Classroom Training available in New York City. Coeducational classes start four times a year. Check here for FREE Resident School Catalog

**CANADIANS** — Take advantage of these same RCA Institutes courses at no additional cost. No postage, no customs, no delay. Send coupon to: RCA Victor Company, Ltd., 5581 Royalmount Ave., Montreal 9, Quebec.

## RCA will show you how to start a profitable career in Electronics at home!

### Faster, Easier Way to Begin

If you are considering a future in electronics, now is the time to start! A great new teaching aid—“AUTOTEXT”, developed by RCA and introduced by RCA Institutes, will help you master the fundamentals of electronics almost automatically. “AUTOTEXT” is a system of programmed instruction, a method of learning, proved with thousands of students. Even people who have had trouble with conventional home training methods in the past are finding it easier and more fun to begin their training this new way.

### Complete Selection of Courses

RCA Institutes offers you a really wide selection of Home Training Courses for every phase of electronics. You can actually pick the field of your choice from a great

variety of courses such as:

- Electronics Fundamentals • TV Servicing • Color TV • Communications • Computer Programming • Drafting • Automation • Transistors • Industrial Electronics.

### Liberal Tuition Plan

RCA Institutes Tuition Plan affords you the most economical possible method of home study training. You pay for lessons only as you order them. No monthly payments! No installments necessary! No long term contracts! If you should wish to interrupt your training for any reason, you can do so and not owe one cent!

### Top Quality Equipment

All equipment furnished to you in RCA Institutes Home Training Courses is top quality. All kits and the equipment you build are yours to keep and use on the job! You never have to take apart one piece to build another!

For Resident School courses, see ad on opposite page.

### Graduates Prove Results

RCA Institutes Graduates not only enjoy the prestige associated with the internationally famous name of RCA, but some have gone on to open their own businesses; have important positions in business, industry and government.

**START BUILDING A  
BETTER FUTURE TODAY!  
SEND COUPON RIGHT AWAY!**

**RCA INSTITUTES, INC.**

DEPT. EW-64

A Service of Radio Corporation of America  
350 West 4th Street, New York, N. Y. 10014



**The Most Trusted  
Name in Electronics**

# INTERNATIONAL'S NEW EXECUTIVE 750-H CITIZENS BAND TRANSCEIVER . . . FOR PEOPLE WHO EXPECT THE VERY BEST\*



The International **Executive 750-H** introduces a transceiver that is quickly adaptable to all types of mobile or base installations.

The remote console, which is normally installed under the auto dash, has a new companion speaker console. It may be combined with the remote unit or mounted separately. The speaker makes a perfect base when the remote console is used on a desk. Provision has also been made for adding an S/meter.\*\*

What's more, the Executive 750-H is loaded with extra performance features; such as, 23-crystal controlled channels, illuminated channel selector dial, a new speech clipper, increased selectivity, new connections for easy cabling.

The Executive 750-H is complete with crystals, mounting rack for the remote console, trunk mounting rack for the set, push-to-talk microphone, power cable kit, plus all necessary connecting cables. Operates on 6 vdc, 12 vdc, or 115 vac.

Your International dealer has a liberal trade-in plan. **Step up to an Executive 750-H today!**

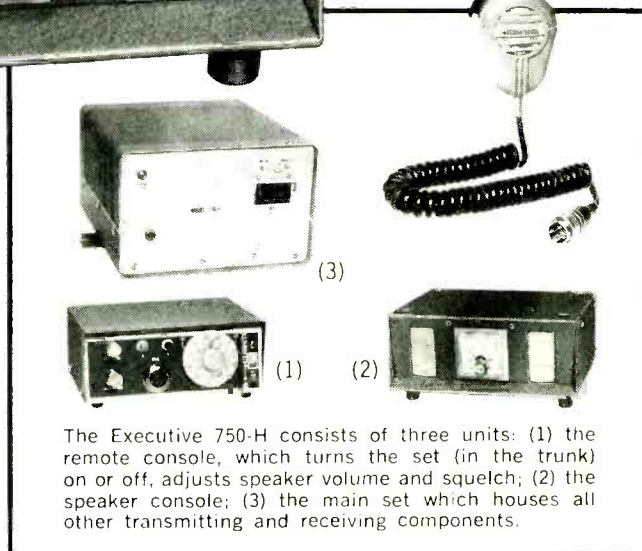

The Executive 750-H consists of three units: (1) the remote console, which turns the set (in the trunk) on or off, adjusts speaker volume and squelch; (2) the speaker console; (3) the main set which houses all other transmitting and receiving components.

\*Performance—Construction—Design—Components  
\*\*S/meter available as an accessory item.

WRITE TODAY FOR OUR 1964 CATALOG.



18 NORTH LEE • OKLAHOMA CITY, OKLA.



# READER SERVICE PAGE

Please use the coupon at the bottom of this page to obtain more information about products advertised in this issue.

Simply circle the number on the coupon that corresponds to the number at the bottom of the advertisement in which you are interested.

Additional information on items mentioned in "New Products," "Hi-Fi Product Report," and "Test Equipment Product Report" can also be obtained by following this same procedure.

PRINT your name and address on the coupon and mail it to:

**ELECTRONICS WORLD**  
 P.O. BOX 7842  
 PHILADELPHIA 1, PA.

Your requests for literature will be forwarded to the manufacturers who will be glad to fill them promptly.

**ELECTRONICS WORLD**  
 P.O. BOX 7842  
 PHILADELPHIA 1, PA.

TOTAL NUMBER OF REQUESTS

Please send me additional information concerning the products of the advertisers whose code numbers I have circled.

100	101	102	103	104	105	106	107	108	109	110	111	112	113	114	115	116	117	118	119
120	121	122	123	124	125	126	127	128	129	130	131	132	133	134	135	136	137	138	139
140	141	142	143	144	145	146	147	148	149	150	151	152	153	154	155	156	157	158	159
160	161	162	163	164	165	166	167	168	169	170	171	172	173	174	175	176	177	178	179

NEW PRODUCTS	1	2	3	4	5	6	7	8	9	10	11	12	13	14	15	16	17	18	19
20	21	22	23	24	25	26	27	28	29	30	31	32	33	34	35	36			

(Key numbers for advertised products also appear in Advertisers Index)

NAME (PRINT CLEARLY) \_\_\_\_\_

ADDRESS \_\_\_\_\_

CITY \_\_\_\_\_ ZONE \_\_\_\_\_ STATE \_\_\_\_\_

**VOID AFTER JUNE 30, 1964**

**6**

# Winegard COLORTRON Antenna

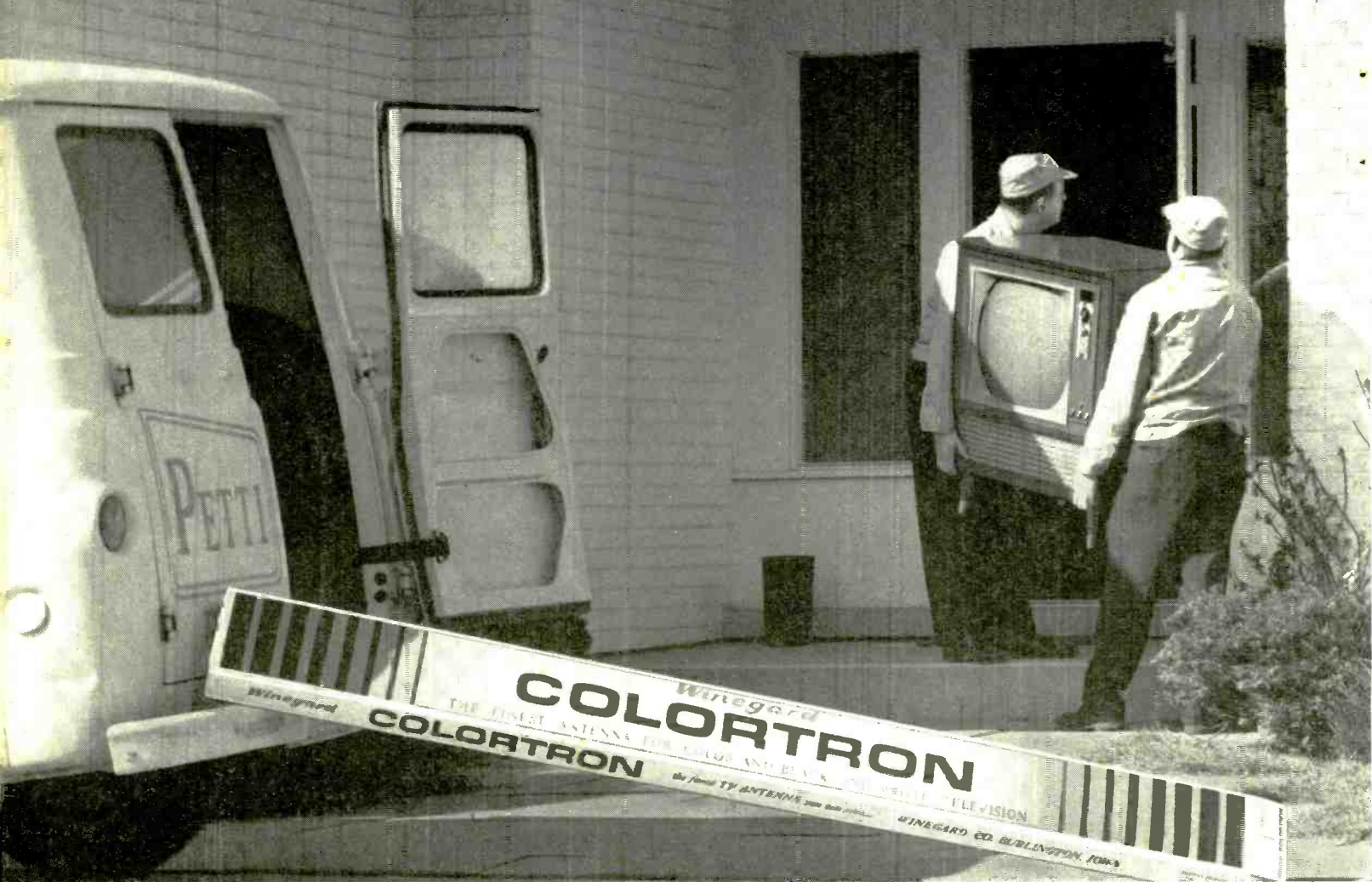

## The Colortron Antenna's "BALANCED DESIGN" is the Winegard secret of superior color reception!

It takes a combination of high gain, accurate impedance match, complete band width and pinpoint directivity to make the perfect color antenna. Only the Winegard Colortron gives you all 4 with **BALANCED DESIGN**.

*What is Balanced Design?* It's not enough to design an antenna for high gain alone and expect good color reception. A high gain antenna without *accurate impedance match* is ineffective. Or an antenna with *good band width* but *poor directivity characteristics* is unsuitable for color. The Winegard Colortron is the one antenna with *balanced design*, excellence in *all* the important characteristics that a good color antenna requires.

### For example:

**Gain and Bandwidth**—A superior color antenna must have high gain and complete bandwidth as well. But the response must be *flat* if it is to be effective. Peaks and valleys in the curve of a high gain antenna can result in acceptable color on one channel and poor color on another.

No all-channel VHF-TV antenna has more gain with complete bandwidth across each and every channel than the Colortron. Look at the Colortron frequency response in this oscilloscope photo.

Note the consistent high gain in *all* channels. Note the absence of suck-outs and roll-off on end channels. The flat portion of the curve extends on the low band from the channel 2 picture carrier past the channel 6 sound carrier. On the high band, it is flat from the channel 7 picture carrier to the channel 13 sound carrier. There is less than 1/2 DB variance over any channel.

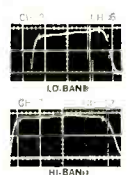

**Impedance Match**—the two 300 ohm "T" matched Colortron driven elements have far better impedance match than *any* antenna using multiple 75 ohm driven elements. The Colortron transfers *maximum* signal to the line without loss or phase distortion through mismatch. Winegard's "T" matched driven elements cost more to make, but we know the precision results are well worth the added manufacturing expense . . . because a mismatched antenna causes loss of picture quality which *might* get by in black & white, but becomes highly disturbing in color.

The oscilloscope photo here shows the Colortron VSWR curve (impedance match). No current VHF-TV antenna compares with it across all 12 channels.

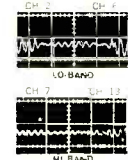

...made for color!



**Directivity**—Equally important for superior color pictures is freedom from interference and ghosts. Therefore, an antenna with sharp directivity and good signal-to-noise characteristics is necessary. Extraneous signals picked up at the back and sides produce objectionable noise and ghosts in black and white reception . . . frequently ruin color reception.

Winegard's Colortron has the most ideal directivity pattern of any all channel VHF antenna made. It has no spurious side or large back lobes . . . is absolutely dead on both sides. Colortron does not pick up extraneous signals, and even has a higher front-to-back ratio than a single channel yagi.

Look at this Colortron polar pattern. No other VHF-TV antenna has sharper directivity on a channel-for-channel comparison.

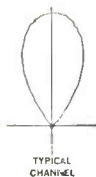

**BALANCED DESIGN COLORTRONS HAVE SUPERIOR MECHANICAL FEATURES, TOO!**

Every square inch of the Colortron has been engineered for maximum strength, minimum weight and minimum wind loading. Even the insulators are designed for low wind resistance. The result

is a streamlined, lightweight antenna that stays stronger longer. Colortrons have been wind tested to 100 mph.

Colortrons are simpler to put up, too. Easier to carry up a ladder and mount on a high mast. No extra weight and bulk to frustrate the antenna installer.

And, you can see the difference in quality when you examine a Winegard Colortron. The GOLD ANODIZED finish is bright weather-proof gold that *won't fade*, rust or corrode. It's the same finish specified by the Navy for military antennas. Full attention is paid to every detail.

**Winegard Helps You Sell**—does more national advertising than all other brands combined. When you sell Winegard, you sell a brand your customer knows . . . backed by a *written factory guarantee of satisfaction*.

It's not surprising that Winegard leads the field in the number of antennas installed with color sets. And Colortrons have been installed by the hundreds of thousands for black and white sets too—for the antenna that's best for color is best for black and white as well. Why don't you try a *balanced design* Colortron and see for yourself?

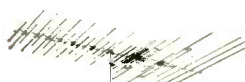

COLORTRON ANTENNA  
Model C-44 • Gold Anodized • \$64.95



COLORTRON ANTENNA  
Model C-43 • Gold Anodized • \$51.90



COLORTRON ANTENNA  
Model C-42 • Gold Anodized • \$34.95



COLORTRON ANTENNA  
Model C-41 • Gold Anodized • \$24.95



**Winegard Co.**

3003-F KIRKWOOD • BURLINGTON, IOWA

CIRCLE NO. 136 ON READER SERVICE PAGE

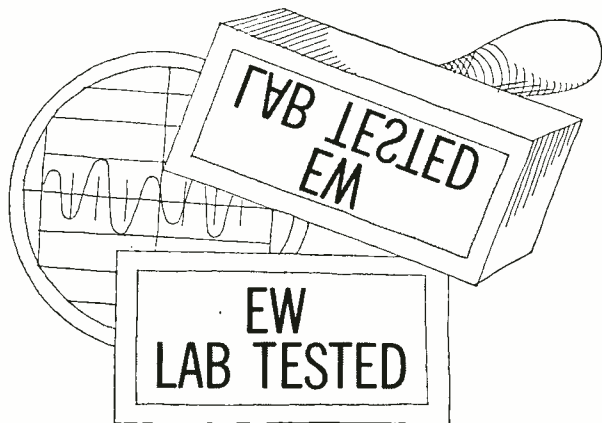

# HI-FI PRODUCT REPORT

TESTED BY HIRSCH-HOUCK LABS

**Scott 340B FM-Stereo Receiver**  
**Shure Model 570 Microphone**

## Scott 340B FM-Stereo Receiver

For copy of manufacturer's brochure, circle No. 32 on coupon (page 15).



THE new H. H. Scott Model 340B stereo receiver is a striking departure, at least as far as styling is concerned, from previous Scott high-fidelity components. Instead of the familiar circular dial with its planetary drive, the 340B has a more conventional cord-driven "slide-rule" dial. Although most receivers currently on the market have similar dials, the 340B is distinctive in appearance and not likely to be mistaken for any other receiver. All in all, this has been a most successful re-styling, resulting in an instrument which has less "laboratory" appearance.

The 340B is very complete with all the operating flexibility one could desire. The concentric tone controls can be operated as single-knob controls in the usual case where matched speakers are used or adjusted individually when this is required. The loudness control has switchable compensation to boost both high and low frequencies at low levels. The balance control can cut off either channel without affecting the other.

The input selector offers a choice of

phono, FM mono, automatic FM-stereo, stereo with sub-channel filtering, and an external high-level input. The mode selector has left and right balance positions in which the same signal is fed to either side alone for matching the levels from the two speakers; mono, stereo, reversed-channel stereo, and either left or right input to both outputs. There are slide switches for rumble and scratch filters, tape monitoring, loudness compensation, speakers on or off, and power.

A headphone jack is located on the front panel, with built-in attenuators to reduce the output levels sufficiently so that normal control settings may be used. The speaker switch cuts off the speakers if this is desired while headphones are being used. There are terminals in the rear for 4-, 8-, and 16-ohm speakers, a center-channel speaker, and a phase-reversing switch for one speaker output. There is also a derived center-channel output jack for driving an external amplifier.

These features suggest that the unit is a rather complete instrument. Its per-

formance confirms this impression. The FM tuner is in the first rank in all respects. IHF usable sensitivity (rated at 2.2  $\mu\text{v}$ .) measured 1.7  $\mu\text{v}$ .. The measured FM hum was -61 db, which we know to be the residual hum in our signal generator. The manufacturer's specifications rate the FM hum at -60 db. Limiting was complete at 3  $\mu\text{v}$ ., and as far as monophonic reception is concerned, there is absolutely no change in the audible output of the receiver for signal variations between 3 and 100,000  $\mu\text{v}$ ..

The frequency response of the tuner section was within  $\pm 1$  db from 30 to 15,000 cps. Its stereo channel separation is about 30 db at mid-frequencies, reducing to 24 db at 90 cps and 10 db at

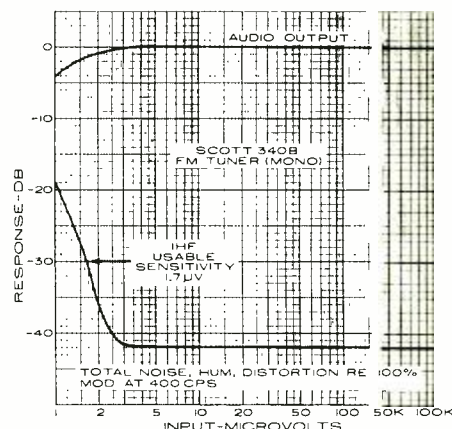

9500 cps. The sub-channel filter is very effective in reducing noise on weak stereo signals, but causes a reduction of channel separation to 10 db at 1000 cps and 0 db at 10,000 cps. There is remarkably little audible loss of separation when using the filter, however.

The husky audio section of the 340B, which is rated at 30 watts (r.m.s.) per channel, delivers about 36 watts per channel with both channels operating. This power is available over the full range from 30 to 20,000 cps, at 2% distortion. The distortion at ordinary listening levels is very low—on a par, in fact, with many of the better basic power

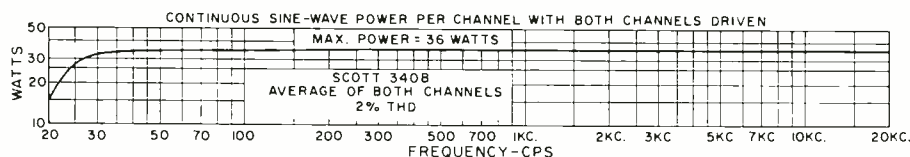

# You probably thought top quality electronic test instruments were too expensive...*didn't you?*

*Well, they're not when you build them with money-saving RCA kits*

You've known right along that you can save money on electronic test instruments by building from kits.

But you may have shied away from kits because you thought they involved complicated calibration or adjustment problems. Forget it!

RCA kits are inexpensive, of course, but they're also easy to build. Build them right and they'll give you the best performance you can buy in their price range.

What's better about RCA test instrument kits?

**Ease of assembly is one thing.** Parts are clearly identified. Each assembly diagram appears on the same page as the step-by-step instructions for that section of assembly. There's no need to refer back constantly to other pages, which consumes time and increases the chance of error.

**Ease of alignment is another thing.** Each kit contains complete instructions for accurate calibration or alignment of the instrument. Where necessary, precision calibrating resistors are provided for this purpose.

**What does it mean?** It means that with RCA kits you can get a professional V-O-M or VTVM for as little as \$29.95\*. Or you can get a good oscilloscope (one of the most useful—but normally one of the most expensive—test instruments) for only \$79.50\*

Specialized instruments such as an AC VTVM or an RF Signal Generator are also available as kits for far less than they would cost otherwise. In every case, RCA kits, when completed, are identical with RCA factory assembled instruments.

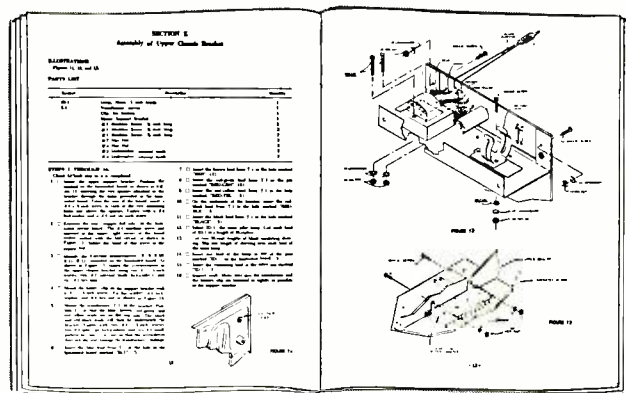

Each sub-assembly is described in a separate section with illustrations applying to that sub-assembly available at a glance. No cross referencing necessary.

## LOOK WHAT'S AVAILABLE TO YOU IN KIT FORM:

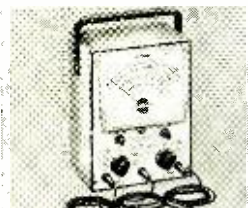

RCA VOLT-OHM-MILLIAMMETER. The most popular VTVM on the market. WV-77E(K). Kit price: \$29.95\*

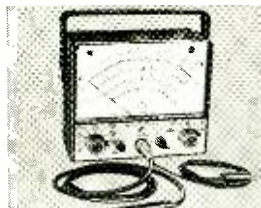

RCA SENIOR VOLT-OHM-MILLIAMMETER. A professional VTVM. WV-98C(K). Kit price: \$57.95\*



RCA VOLT-OHM-MILLIAMMETER. One of most useful instruments. WV-38A(K). Kit price: \$29.95\*

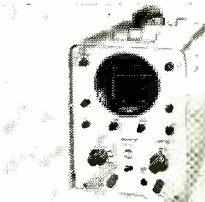

RCA 3-INCH OSCILLOSCOPE. Compact, lightweight, portable. WO-33A(K). Kit price: \$79.95\*



RCA HIGH-SENSITIVITY AC VTVM. Doubles as audio pre-amplifier. WV-76A(K). Kit price: \$57.95\*

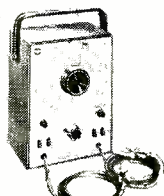

RCA RF SIGNAL GENERATOR. For audio and TV servicing. WR-50A(K). Kit price: \$39.95\*

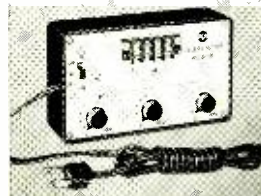

RCA TV BIAS SUPPLY. For RF, IF alignment in TV sets. WG-307B(K). Kit price: \$11.95\*

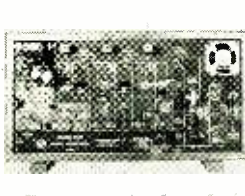

RCA TRANSISTOR-RADIO DYNAMIC DEMONSTRATOR. For schools. WE-93A(K). Kit price: \$39.95\*

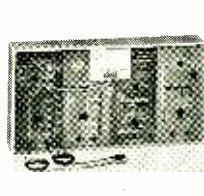

RCA V-O-M DYNAMIC DEMONSTRATOR. A working V-O-M. WE-95A(K). Kit price: \$37.95\*

See them all—and get full technical specifications for each—at your local Authorized RCA Test Equipment Distributor. Or write for information to: Commercial Engineering, Section F-41-W RCA ELECTRONIC COMPONENTS AND DEVICES, HARRISON, N. J.

\*User price (optional)

RCA ELECTRONIC COMPONENTS AND DEVICES, HARRISON, N. J.



The Most Trusted Name in Electronics

# 3 WAYS TO BIGGER

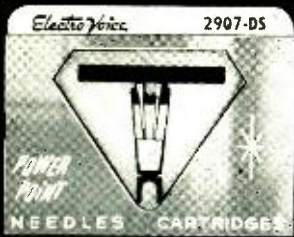

# NEEDLE



# CARTRIDGE PROFITS!

1. More "look-alike" exact replacement models than any other brand. Over 350 needles, 225 cartridges.
2. Easy-to-use reference material. E-V computer-printed catalogs make proper needle/cartridge selection easy, fast and accurate.
3. Highest standards. Rigid quality control and inspection cuts call-backs, gives full value to every customer.

Stock and sell E-V needles and cartridges for more profits, today! Write for FREE replacement guides!

**ELECTRO-VOICE, INC.**  
Dept. 647N, Buchanan, Michigan 49107



CIRCLE NO. 109 ON READER SERVICE PAGE 20

amplifiers on the market. The 1000-cps harmonic distortion is under 0.25% up to 30 watts output. Intermodulation distortion on one channel was also under 0.25% up to 30 watts; the other channel had 1.25% IM at 30 watts and 0.25% at 4 watts.

The frequency response of the amplifiers was +0.5 db from 25 to 20,000 cps. RIAA phono equalization was within  $\pm 0.5$  db from 50 to 15,000 cps. Like all Scott amplifiers, the 340B has a built-in roll-off below 20 cps to reduce the effects of rumble and possible subsonic overload. In addition, the rumble filter introduces a 6 db/octave roll-off below

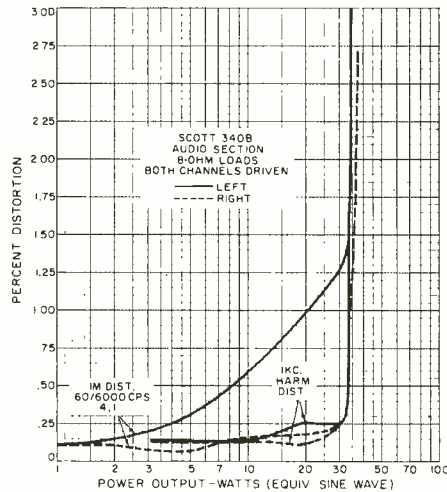

100 cps, while the scratch filter has a 6 db/octave slope above 3000 cps. Both filters are quite mild in their effects. The loudness compensation is very effective with adequate, but not excessive, bass boost and enough high-end boost to retain "sparkle" at low listening levels.

The service bulletin which accompanies the receiver has a very complete list of performance specifications. We checked most of them, but they are too numerous to list here. Suffice it to say that the unit met, and in many cases substantially exceeded, every one of the ratings for which we were able to test. It is not often that we can confirm every published specification of a high-fidelity component, particularly one as complex

as a receiver, and it was a gratifying and pleasant experience.

There are several small operating conveniences which add to one's enjoyment of this receiver. Below the dial scale is a row of tiny neon lamps which are illuminated to show whether the tuner, phono, or extra input is selected. A fourth lamp lights when the tape monitor switch is operated. This can be appreciated by anyone who has accidentally moved the monitor switch on an amplifier and wondered why it went "dead." The automatic FM-stereo selection is entirely electronic, very smooth and silent in its operation. A neon indicator on the dial face glows when a stereo signal is received. If the signal fades below the level where satisfactory stereo reception is possible, the receiver changes almost imperceptibly to mono (only a slight decrease of background noise accompanies this change). Tuning is smooth and non-critical, and the tuning meter peaks quite broadly. This is a good indication of the flat-topped i.f. response characteristic which contributes so much to the overall performance of this receiver.

Before making any measurements on the receiver, we listened to it for some time. From the first, it was evident that this was a superior receiver. It has the utterly smooth, clean sound which we normally associate with the finest component systems. It was no surprise, therefore, to find that our measurements confirmed our subjective impressions. There was only one minor irritation which we encountered in its use, and this could be easily corrected by the manufacturer. The soft green dial illumination, well suited for that purpose, is much too faint for the tuning meter scale. The latter, in fact, is almost impossible to see at a distance of more than one foot. A little more light on it would be most helpful.

The Scott 340B receiver sells for \$399.95. The same unit, with the addition of an AM tuner section, is designated the Model 380 and is priced at \$459.95. Cabinets are available in metal or wood for \$17.95 and \$29.95 respectively. ▲

## Shure Model 570 Microphone

For copy of manufacturer's brochure, circle No. 33 on coupon (page 15).

**I**N many situations it is desirable to use a microphone which is inconspicuous. The "lavalier" microphone,

usually worn around the user's neck on a cord, is a popular solution to public-  
(Continued on page 90)

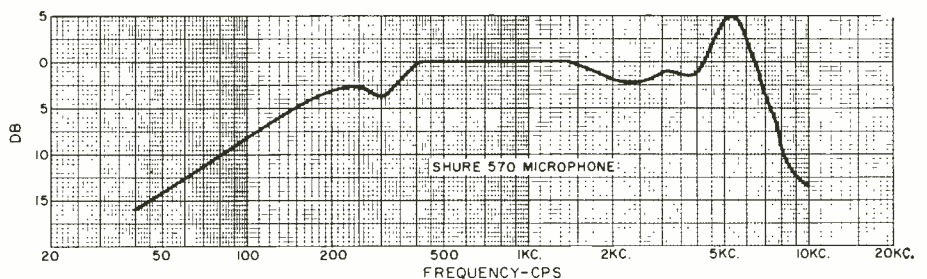



# Build your own top quality Eico Kits and save up to 50%

## New Tape Deck



Eico Classic 2400 stereo/mono 4-track tape deck, 3 motors. Kit \$199.95; wired \$269.95 (Incl. oil finish walnut base)

## New 3" Portable Scope

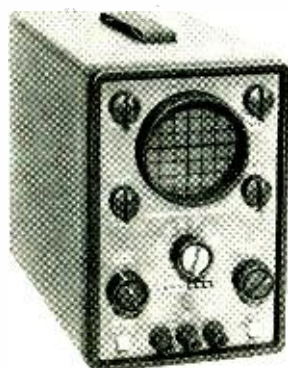

Eico 430 General Purpose 3" Scope. Flat-face CRT with mu-metal shield. Kit \$69.95; wired \$99.95

Color  
and  
B&W

## FM Sweep Generator

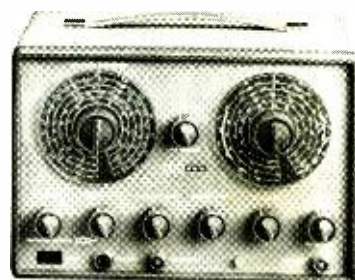

Eico 369 TV/FM Sweep generator, with built-in post injection marker adder. Kit \$89.95; wired \$139.95.

## New CB Transceiver



Eico 777 dual conversion 6 crystal-controlled channels, 5 watts. 3-way power supply. Kit \$119.95; wired \$189.95

## New Stereo Rcvrs.

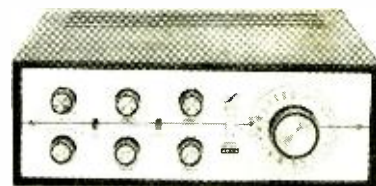

Eico Classic 2536 36-watt FM-MX Stereo Receiver. Kit \$154.95; wired \$209.95 (Incl. F.E.T.)  
New Stereo Tuner Eico Classic 2200 FM-MX Stereo Tuner. Kit \$92.50; wired \$119.95 (Incl. F.E.T.)

New Stereo Amplifiers Eico Classic 2036 36-watt. Kit \$79.95; wired \$109.95. Eico Classic 2050—50-watt stereo. Kit \$92.50; wired \$129.95. Eico Classic 2080 80-watt stereo. Kit \$112.50; wired \$159.95.

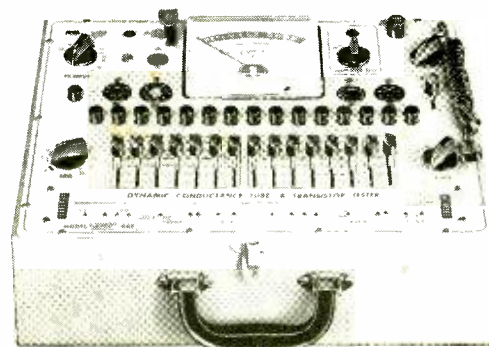

## New Tube Testers

Eico 667 Dynamic Conductance Tube & Transistor Tester. Kit \$79.95; wired \$129.95.  
Eico 628 Tube Tester. Kit \$44.95; wired \$59.95



Add 5% in West

EICO Electronic Instrument Co., Inc.  
131 01 39th Avenue, Flushing, N.Y. 11352  
Please send free  New 1964 catalog EW-6  
 Name of nearest Eico dealer

Name \_\_\_\_\_  
Address \_\_\_\_\_  
City \_\_\_\_\_  
Zone \_\_\_\_\_ State \_\_\_\_\_





Fig. 1. Combination of bends and twists shows how polarization can be changed as the wave travels through composite system.

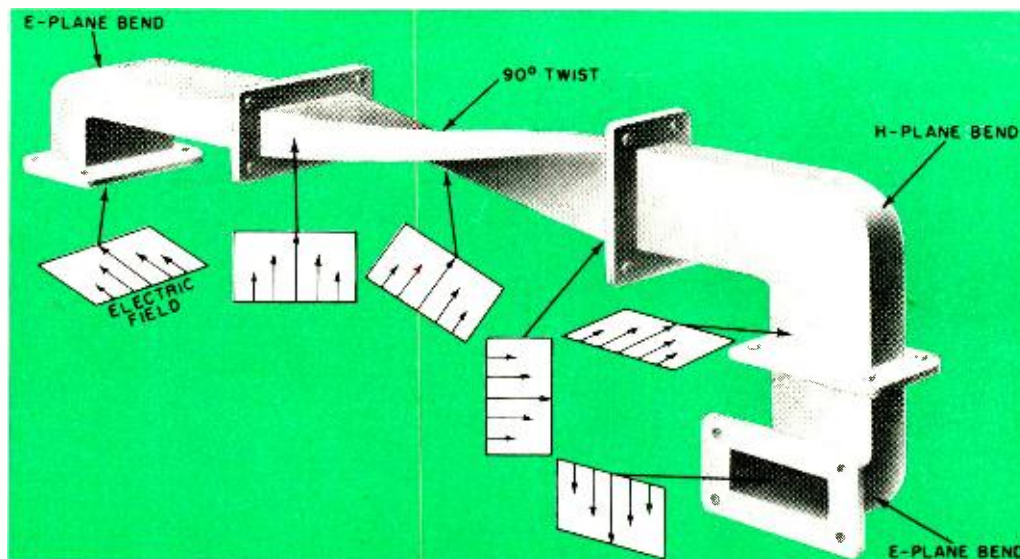

# PLUMBING THE MICROWAVE CIRCUIT

By R. C. APPERSON, JR.

Instead of wires, a microwave circuit is interconnected with electronic plumbing. Here is a description of some of these semi-mechanical devices and their operation.

THE language of the microwave technician is completely foreign to his kinsmen in other areas of electronics. The devices and methods employed by this technician are not physically related to those used in other areas of electronics, although many are analogous. As an example of the language used, a conventional electronic circuit is said to be "wired"; however, because microwave circuits use sections of solid waveguides to interconnect various units of the circuit, and such an arrangement bears a resemblance to a maze of water pipes, microwave circuits are said to be "plumbed."

This article will not go into the many complex areas of microwaves, but will discuss the many methods and components used to "plumb," or interconnect, a microwave circuit.

## Waveguides

Unlike lower frequency electronics, microwaves are actually radiated from one point in a circuit to another. To control the direction of travel, the radiated energy is confined within circular or rectangular metal pipes called waveguides. The energy is radiated from a probe inserted into the guide and the wave moves down the guide, restricted to the interior.

Waveguides are made in two forms, rigid and flexible, terms that are self-explanatory. With rigid guides, a need may arise for various twists and bends for use in a particular configuration. To determine the type of bend or twist needed, operation of a waveguide must be understood.

Fig. 2 illustrates a rectangular waveguide and shows the magnetic and electric fields existing within it. Since we are concerned with propagation rather than current flow, the walls of the guide are defined by the electromagnetic field which is parallel to it as it passes down the guide. The narrow side of the guide is called the *H* plane, since the magnetic field is parallel to it. The wide side is called the *E* plane, or wall that is perpendicular to the electric field. Thus, an *H*-plane bend guide section is bent along the narrow *H* walls, while an *E*-plane is bent along the wider dimension.

These bends are designed for minimum disturbance to the travel of energy. Waveguide twists are also made to shift the polarization of the wave from one direction to the other. By using these wave rotation sections, corners may be turned in any manner desired and the wave will not otherwise be disturbed. Such an arrangement is shown in Fig. 1.

## Attenuators

Like any other r.f. carrier, the level of a microwave carrier can be controlled by an attenuator. A typical attenuator, such as shown in Fig. 3, consists of a short section of waveguide with a slot in it so arranged that a sheet of lossy (r.f. absorbent) material can be inserted into the guide to block the flow of r.f. A precise gear arrangement is used to insert the lossy material and the operating dial of the attenuator is calibrated in decibels of signal-level attenuation.

## Couplers

When a small amount of energy must be extracted from the main guide, a coupler must be used. These couplers are directional and the direction of coupling can be determined by examination of the device.

The crossguide coupler shown in Fig. 4 consists of two

Fig. 2. Rectangular waveguide showing one electric and one magnetic component of electromagnetic energy. Each component travels parallel to opposite walls on its way down the guide.

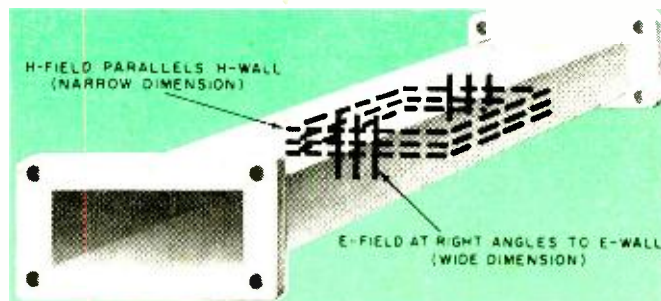

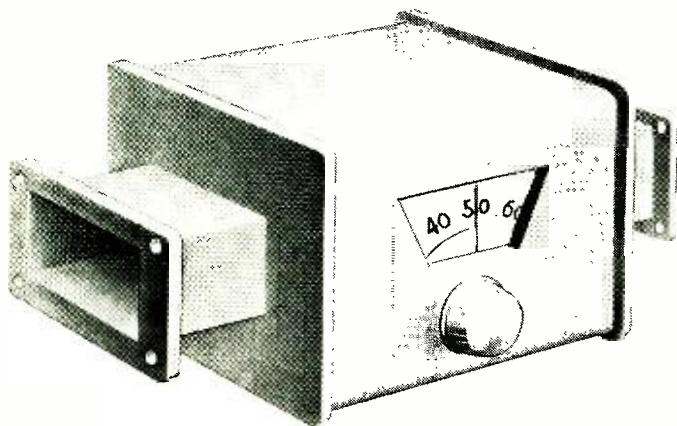

Fig. 3. Typical calibrated attenuator fits into the waveguide.

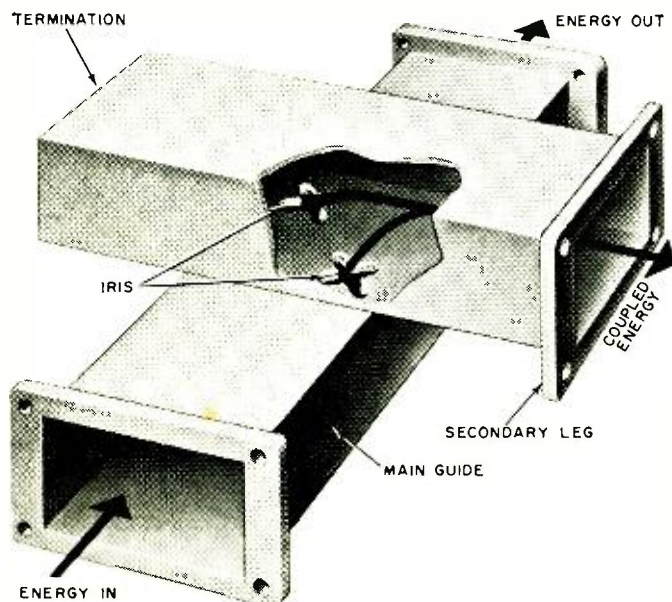

Fig. 4. Crossguide coupler showing the physical arrangement.

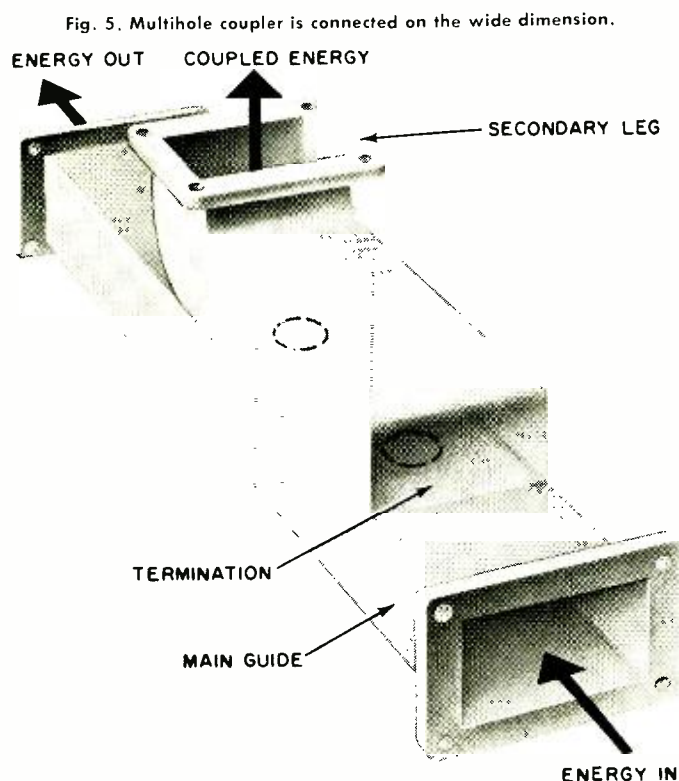

Fig. 5. Multihole coupler is connected on the wide dimension.

small sections of waveguide, mounted to each other with a right-angle displacement, and with a pair of holes (called irises) connecting the two sections. Placement of the iris on the common wall determines the direction of coupling. As the r.f. passes down the main guide, some of it leaks through the iris into the secondary leg. One side of the secondary leg is coupled to other devices while the other end is terminated.

The sidewall coupler shown in Fig. 5 consists of two sections of waveguide joined along the wide (*E*-field) dimension. As in the crossguide coupler, the two sections are interconnected by holes. Couplers are calibrated in db.

### Isolators

An isolator is used to make the microwave energy travel in a desired direction. Basically, it acts like a diode in that energy can travel easily in one direction but is severely attenuated if it attempts to travel in the other direction. Isolators are used where two signals must share a common waveguide (for example, both transmitted and received energy in a radar system) yet each must be channeled into the correct plumbing at the appropriate point.

Another form of isolator is the circulator. As an example of this one-way device, visualize a circular waveguide-like circulator with 4 waveguide flanges spaced each 90° around the circle. The flanges are connected to a transmitter, antenna, receiver, and a termination in that order.

As the circulator will pass energy only in one direction, when the transmitter operates, its energy goes only to the antenna (because of its lower impedance to the r.f. flow than either the receiver or the termination). The signal arriving at the antenna can only be passed to the receiver, while any radiation from the receiver will be dissipated in the dummy load resistive termination.

### Power Measurement

Microwave energy can be either c.w., pulsed, or modulated like any other r.f. carrier. Because of the high carrier frequencies involved, a detection device that views the modulation envelope (in the case of a modulated carrier), or a power measuring device that produces a d.c. readout when the carrier is unmodulated, is used. The former is achieved by extracting a small portion of energy and applying it to a microwave crystal diode, mounted in a special holder that causes little energy reflection (low v.s.w.r.). The demodulated signal from the diode can be observed on an oscilloscope. The same type of diode can be used to mix two microwave signals to produce an i.f. in the same fashion as is done at the lower r.f. frequencies.

Low-level microwave power can be measured by a bolometer, a heat-sensitive device which is excited by the r.f. energy. As the bolometer dissipates the microwave energy, it heats up and changes its resistance. A measurement of the resistance is a measurement of power. For pulse work, the bolometer is biased, and after signal shaping and peak detection, readout can be made directly in power. Low-level c.w. signal power is usually measured with another form of bolometer called a thermistor. This device also changes its resistance with heat and when mounted in a bridge circuit and subjected to microwave r.f. energy, bridge unbalance is a measure of the c.w. power of the microwave energy.

### Tuned Cavity

Operating wavelength determines the internal physical dimensions of microwave plumbing; the higher the frequency, the smaller the physical dimensions, and conversely, the lower the frequency, the larger the physical dimensions. If the internal dimensions are adjustable, the frequency of operation is adjustable. This is the principle of the microwave tuned cavity. When a cavity is tuned to a particular internal volume, it acts like a conventional *LC*-resonant circuit at that frequency with a "Q" determined by the ratio of volume to in-

ternal surface area. Here, volume is analogous to the reactance and the internal surface area acts as the resistive, or lossy, part of the circuit. By accurately calibrating the internal volume, a direct-reading frequency meter, such as shown in Fig. 6, is obtained. The frequency is determined by an amplitude change in the detected signal.

Frequency meters are either absorption or transmission types. The absorption meter extracts signal energy when tuned in resonance and the indication is a dip in amplitude. With the transmission type of frequency meter, there is no signal passing through the device until resonance is reached, at which point it produces a peaked output. These two types of frequency meters can be compared with series or parallel resonant LC circuits. In both cases, the sharpness of the frequency indication is a function of the cavity "Q".

Cavities are used in many microwave applications. There are dual-mode cavities that produce an output similar to a conventional FM discriminator when a signal is frequency modulated about its center frequency. This type of cavity is commonly used for automatic frequency control (a.f.c.).

### Dummy Loads

When it becomes necessary to terminate a waveguide so that no signal can get out and be radiated, a dummy load is

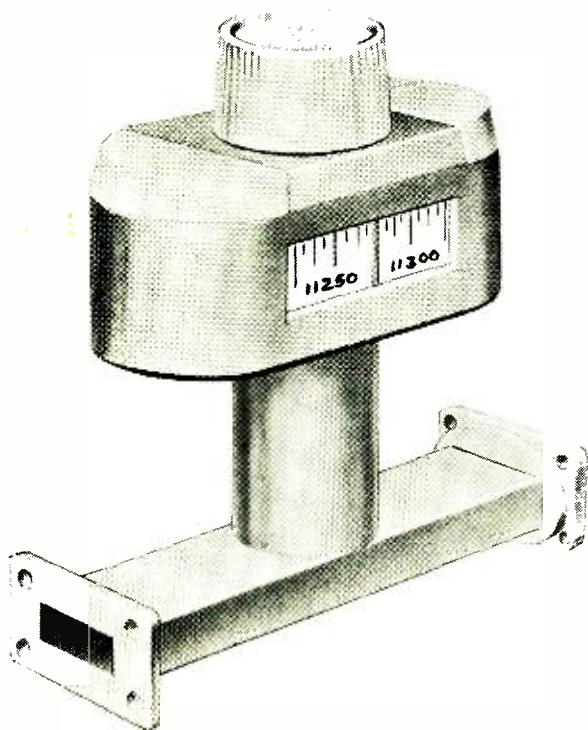

Fig. 6. Frequency meter with direct readout; one use of tuned cavity.

used. These loads must absorb all the microwave energy arriving without introducing mismatching that would produce a large standing wave. These standing waves cause a loss in available power and introduce complicating factors into the waveguide system. A dummy load would be used to terminate the unused arm of a coupler, or another type of dummy load could be used in place of the actual antenna when testing transmitter operation without radiation.

These loads come in many versions, with two shown in Fig. 7. The low-power version looks like a section of conventional waveguide, is closed at one end, and is partially filled with a material that absorbs the r.f.

The high-power version is basically the same as the low-power version with the addition of heat-dissipating fins. Other high-power versions include water cooling to prevent damage to the load and to dissipate a larger power.

There are many ways to generate microwave power. These

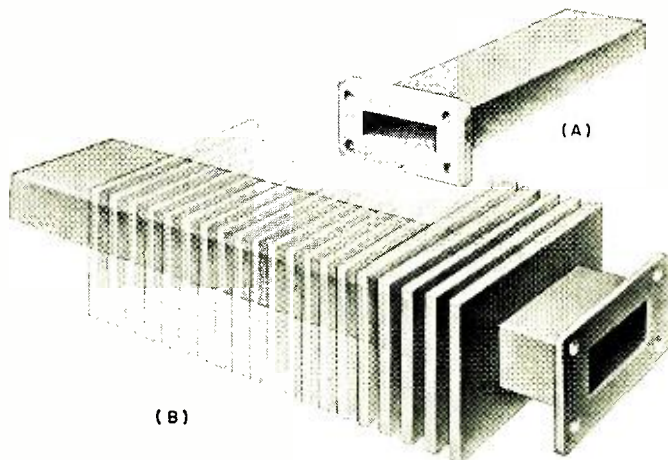

Fig. 7. (A) Low-power termination (dummy load), (B) The high-power termination has cooling fins for better heat dissipation.

range from magnetrons, klystrons, and backward-wave oscillators through new devices including solid-state oscillators.

The bulk of the vacuum-tube devices are unlike their lower frequency counterparts in that no external circuits are required to make them oscillate. As they have their tuned circuit already built in, they merely have to have power applied to them and be tuned to the desired operating frequency.

The output connectors of these devices are usually waveguide flanges so that the only external circuitry required is the waveguide plumbing necessary to direct the generated energy to the desired point.

Amplifiers are also varied and range from vacuum-tube devices such as the traveling-wave tube to solid-state devices such as the tunnel diode and semiconductor harmonic diodes.

### Lab Set-Up

A typical laboratory set-up for testing a variable attenuator is shown in Fig. 8. The waveguide is drawn as a single line, with the small lines drawn at right angles to it representing waveguide flanges. The isolator, slide-screw tuner, and tuning stub are used to reduce unwanted reflections in the line. To measure the v.s.w.r., a slotted line and an indicating meter are used. The slotted line consists of a length of waveguide with a long slot cut into it. A probe, connected to a crystal diode, is arranged so that it protrudes into the waveguide and can be moved along the slot to search for standing waves. The v.s.w.r. meter measures the signal level when the probe is at a node (valley) and at an antinode (peak) of the wave existing within the guide. The difference between these two readings is the standing wave ratio and, as the variable attenuator is undergoing test, the amount of v.s.w.r. that it introduces into the line can be measured. ▲

Fig. 8. Laboratory set-up for testing a variable attenuator.

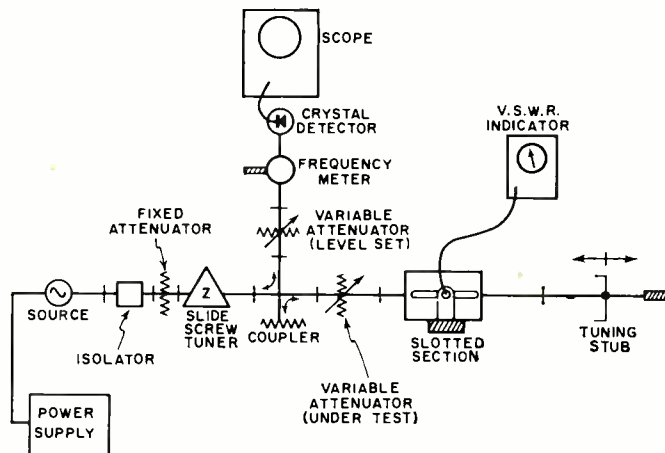

# First-Hand Report on TV TAPE RECORDER FOR HOME USE

By MILTON S. SNITZER / Technical Editor

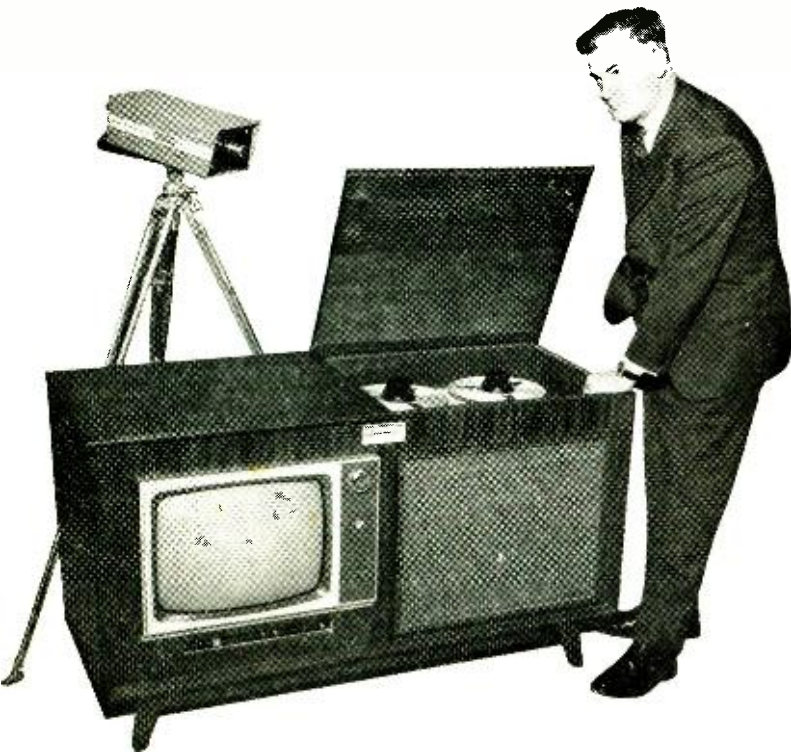

A prototype of the new tape recorder is shown here with its developer, Wayne R. Johnson, Technical Director of Winston Research Corp., subsidiary of Fairchild Camera and Instrument Corp. The tape transport and the solid-state electronics circuitry occupy less than half the volume of the right-hand portion of the console cabinet. A conventional TV receiver occupies most of the volume of the left-hand portion. A regular high-quality closed-circuit TV camera, which can be used with the recorder, is shown just behind the console.

A HOME TV recorder has been demonstrated recently of such mechanical simplicity that a real price breakthrough is possible. When connected to an ordinary TV set, the recorder made a tape of the program being viewed. This was then played back immediately through the TV set. The played-back picture and sound were of excellent quality and stability for home viewing. The recorder was then connected to a small TV camera that was focused on several of the interested viewers. Again, the played-back picture and sound were fine.

The real significance of the demonstrations was in the simplicity of the recorder itself. Video recorders have been with us since about 1956. These, however, used as many as four rapidly revolving tape heads, commutators, and an elaborate servo system and vacuum arrangement to keep the wide magnetic tape close to the heads and maintain alignment. As a result, these recorders, designed to meet broadcast standards, sell for over \$50,000. Today there are a number of smaller and simpler video recorders for closed-circuit TV work

but even these cost no less than about \$11,000 to \$12,000.

When we examined the new recorder, designed by *Winston Research* division of *Fairchild*, we saw only a single, stationary recording tape head and a single, stationary playback head beside it. The entire tape transport was no more elaborate than that used in a good audio recorder. In order to get good video on the tape, however, a few special things had to be done. First, the heads are special types that are used for instrumentation. Their very narrow gaps, only 1 micron or about 40 microinches across (almost a hundredth the thickness of a human hair) permit good high-frequency response. Second, a high tape speed is used. This speed, 120 inches per second, is 16 times faster than that used for quality sound tape recording in the home. Third, a special electronic technique is used which the developer would say nothing about other than it involves "information theory enhancement." Until present patent proceedings are concluded, no further technical details will be available on this circuitry.

About a year ago, the *Telcan* tape recorder was demonstrated in Britain. This, too, used a stationary head and a high recording speed. Although the first price figure mentioned was around \$170, many who saw the early demonstrations were disappointed by the poor picture quality and lack of stability. More recently, however, the British recorder has been taken over for U.S. distribution by *Cinerama, Inc.* Reports of more recent demonstrations have indicated much improvement in picture quality. Talk of prices in this country give somewhat higher figures than those quoted originally.

*Fairchild* officials emphasized that their recorder does not now represent a commercially available product. Instead, it represents a progress report to the industry showing what they have been able to do so far. Scheduled to see the recorder is just about every manufacturer of TV sets. If any of them is sufficiently interested, we may see a TV console like that shown in the photo as part of their new line. Such a console, equipped with a timer switch, could record your favorite TV program in your absence for later playback. When used with an inexpensive TV camera, the recorder should be real competition for home movies using photo film.

A price of \$500 has been mentioned for the tape recorder. The exact price will, of course, depend on the quantity of production. However, company officials stated that this price is a "very conservative estimate." They also felt that a simple TV camera selling for about \$150 would be possible. It is our own feeling, after examining the recorder, that there should be little difficulty in bettering the \$500 figure. The special quarter-inch instrumentation tape used should cost around \$30 for an hour's playing time, but this price may come down to \$15 to \$20 in quantity production.

The high tape speed and high recorded frequencies result in two problems: head wear and inability to use an erase head. Using low-friction tape, however, the heads should last for 1500 hours before requiring replacement. A replacement head should cost about \$15 if made in production quantities. Because a large amount of very high frequency power would be needed to erase the high video frequencies

## *Are we close to an under-\$500 video tape recorder that will record your favorite programs and compete with home movies?*

from the fast-moving tape, no erase head is used in the recorder. Instead the tape must be bulk-erased prior to re-use. The tape can be so erased and re-used for at least 500 passes before wear and dropouts become a problem.

The transport uses a 1/30 h.p. induction motor to drive the two capstans plus two smaller motors to drive the supply and take-up reels. This transport is of the type used for instrumentation tape recorders. Even simpler versions could be built in the future using only a single drive motor.

Since tape-gap alignment is critical, an azimuth adjustment (called "Focus") is provided. This is simply adjusted for best picture while the tape is running.

### Receiver Connections

Three connections are made to the TV set. One of these picks up the video signal at the set's detector. A second picks up the sound signal at the volume control. A third supplies sync signals from the set's sync separators. All three signals are combined (using a multiplexing technique for the audio) into a single signal that forms one track on the tape. When the recorder is playing back, these three connections supply video, audio, and sync signals to the TV set.

Because of the high tape speed, only about 15 minutes of recording can be made on one pass of the tape. Even this amount of time requires 9000 feet of special quarter-inch half-mil tape on an 11-inch reel. However, the recorder borrows a technique used in regular 4-track audio stereo tape machines. It actually puts 4 parallel tracks of signal on the tape. At the end of the first pass, the machine automatically reverses (a simple photocell circuit operating on a "window" scratched into the oxide coating at the ends of the tape accomplishes this). The tape head then moves down a bit and the second track is recorded or played back. At the end of the second and third passes of the tape, automatic reversals also occur and the tape head moves down. Hence, a total playing time of a full hour is achieved on a single reel of tape.

### Additional Technical Details

We could not learn whether the video was recorded as an FM or AM signal, the special equalization used, means used to obtain the good signal-to-noise ratio shown by the noise-free picture, or method used to compensate for transport speed fluctuations. Some sort of signal enhancement based on information theory is used. We did learn that the bias oscillator operates at 10 mc. and that bandwidth is flat up to 2 mc., with a fairly gradual roll-off by 6-7 db at 2½ mc.

Because the bandwidth is somewhat narrower than most home TV sets (which average about 3 mc.), it was possible to see a slight loss in the high video frequencies in the picture.



Top panel of the tape transport mechanism. Standard 10½" reels of instrumentation tape were used for the demonstration. The tape has a low-friction high-resolution coating. The "Focus" control emerging from the head cover adjusts the head azimuth. The five push-button controls at right are for record, fast rewind, fast forward (at about 200 ips), playback, and stop. Indicator at left shows which of the four tracks on tape is being recorded or played.

A careful observer could note a slight lack of sharpness on picture outlines and small objects. However, most viewers would not notice this slight loss of highs and would consider the picture to be excellent. Because of the gradual roll-off, there was absolutely no ringing in the picture.

The electronics in the recorder uses some 50 entertainment-type silicon transistors. Later models in which some of the record and playback circuits could be shared might reduce this number to 35. The total power required by the recorder is only several hundred watts, most of which is drawn by the transport motors.

Fairchild is not interested in manufacturing the recorder themselves. Instead they are trying to interest some mass manufacturer, preferably of TV receivers. The company, which also manufactures home sound-movie equipment, gave some interesting figures comparing this new TV tape system with its sound-movie system. Cost for equipment in both cases would be about the same, including a camera—\$600 to \$650. In the case of movie film, however, the cost per 1 hour showing would be about \$108, including processing. With tape, cost for an hour showing would be under \$30. What's more, no processing is needed and the tape can be reused many times. ▲

Left-hand photo shows TV screen during the closed-circuit TV portion of the demonstration. The output of the TV camera was connected directly to the TV receiver to produce this picture. The scene was then recorded by means of the tape recorder and then played back on the same TV receiver (right-hand photo). Although a very slight loss of highs could be noted, (see lettering in the background), in general the picture quality and sync stability were excellent for home viewing.



# U.H.F. TUNERS

# for 1964 TV SETS

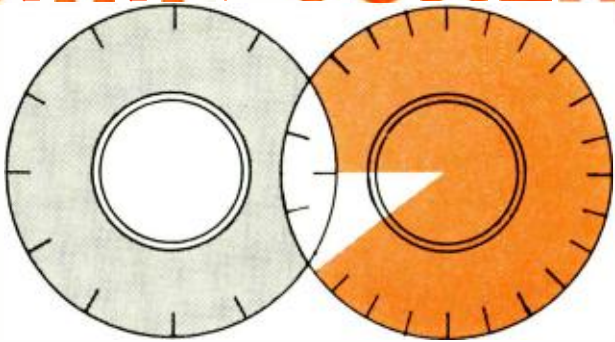

By WALTER H. BUCHSBAUM

*Most u.h.f. tuners in 1964 television sets are similar in design. Here is an explanation of circuit operation coupled with troubleshooting and alignment hints.*

**A**LL television receivers manufactured after April, 1964, must feature all-channel reception and that means that regardless of channel allocations for a particular area, all sets will be equipped to receive u.h.f., as well as v.h.f. stations. Since this ruling has been known for several years, manufacturers have been prepared, and even in 1963, many sets were made with provisions for u.h.f. reception.

The u.h.f. band extends from channel 14 at 470 mc. to channel 83 at 890 mc. and a tuner with 70 separate detents would hardly be economical, nor would it be practical for the set owner to tune over so many individual stations. The problem of tuning over such a wide band, in steps of 6 mc., has occupied the best technical minds of the industry for quite a while, but no simple, inexpensive all-channel detent tuner has been produced. One possible solution to this problem would be to use the frequency synthesizer technique employed in step tuning of military and aircraft communications receivers. Unfortunately, the cost of such a scheme would run to more than the total cost of the rest of the receiver and the viewer would still have trouble tuning to the

Fig. 1. The Standard Kollsman Model U u.h.f. tuner is typical of the small size associated with present-day u.h.f. tuners.

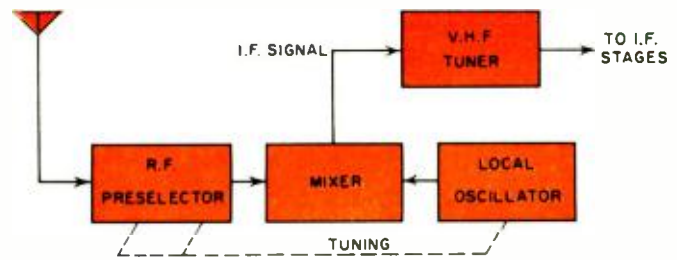
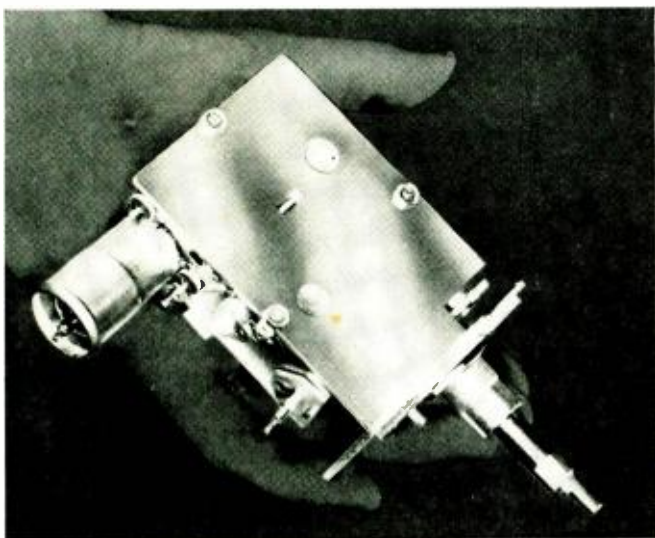

Fig. 2. The u.h.f. tuner uses v.h.f. TV set as i.f. amplifier.

desired channel despite the additional electronic assistance.

The tuners used in the new 1964 television receivers are practical, inexpensive, and relatively easy to operate. Most major manufacturers will use a continuously tuned u.h.f. tuner in addition to a conventional 13-step v.h.f. tuner, with the 13th channel providing the input for the u.h.f.-i.f. signal. These new u.h.f. tuners are quite small, as indicated by the example of the *Standard Kollsman* tuner shown in Fig. 1.

A preliminary survey of the major tuner and TV set manufacturers indicates that practically all tuners use the same basic circuit and differ mostly in mechanical drive.

## Circuit

All u.h.f. tuners depend on the v.h.f. set for i.f. amplification and provide only preselection in their r.f. section. The reason for the lack of r.f. amplifiers is the high cost of tubes and their tuning circuits that could cover the u.h.f. band with sufficient gain and low noise figure. Most u.h.f. tuners consist of a preselector, an oscillator, and a mixer as indicated in the block diagram of Fig. 2. The oscillator may be a vacuum tube or a transistor, but the mixer is invariably a silicon or germanium diode. The i.f. output goes to the v.h.f. set which acts as the i.f. amplifier.

At u.h.f., inductors and capacitors are so small, both in physical size and electrical values, that they can be replaced by distributed constants, such as quarter-wavelength tuned lines. To vary the resonant frequency of a tuned line, either its physical or its electrical length can be changed by a moving shorting contact that grounds one end of the line. To avoid the need for moving contacts that may wear and cause intermittent contact, most new u.h.f. tuners change the resonant

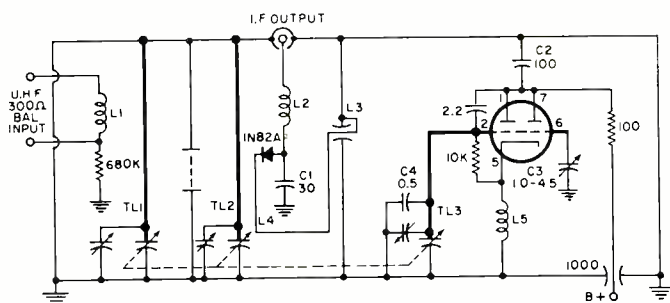

Fig. 3. Schematic of a typical tuner shows use of tuned lines.

frequency of the tuned lines by varying a capacitor at its ungrounded end. An exception to this is the *Mallory* HT-318 which uses a shorting contact riding over a portion of a tuned line. A screw-type trimmer capacitor is in parallel with the tuning element for alignment purposes.

The circuit of a typical tube-type u.h.f. tuner is shown in Fig. 3. In this (*Standard Kollsman*) tuner, the balanced 300-ohm input from the transmission line is inductively coupled to the first tuned line *TL1*. A trimmer and variable capacitor tune the ungrounded end of the line. At the u.h.f. frequencies, the grounded walls surrounding the tuned line form part of the resonant circuit and the hole in the wall between the first (*TL1*) and the second (*TL2*) tuned lines couples the signal between the stages. To understand the r.f. section in terms of conventional lumped circuits, Fig. 4 shows the equivalent of *L1*, *L2*, *L3*, *L4*, *TL1* and *TL2*. Now it will become apparent how the signal from the local oscillator is coupled, together with the received signal, into the mixer diode. The output of the mixer diode is bypassed to ground for the u.h.f. signals by *C1*, the 30-pf. capacitor. *L2* resonates

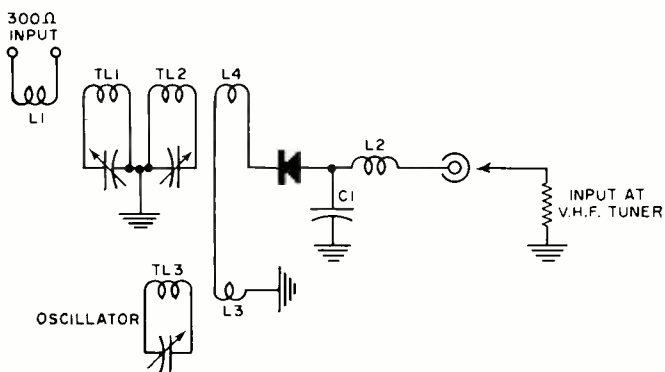

Fig. 4. Lumped constant equivalent of circuit shown in Fig. 3.

with *C1* and the input capacity of the v.h.f. tuner to the 41- to 46-mc. TV set i.f.

The oscillator tube circuit also deserves some discussion. Because of the high frequency of operation, two pins each are used for the grid and plate leads to minimize internal tube inductance. The plate is effectively bypassed to ground through *C2* and the required feedback occurs between the grid tank circuit and the cathode which contains r.f. choke *L5*. Notice that three adjustable capacitors act as trimmer, padder, and tuning capacitor in the grid circuit. *C3*, the padder located directly at the grid, tunes the oscillator at the low-frequency end, while another trimming adjustment is located near the ganged capacitor to tune the oscillator at the high-frequency end. Each of the other two resonant circuits also has this high-frequency trimming adjustment. The filaments of the oscillator tube contain bi-filar chokes to reduce the cathode-to-filament-to-ground capacitance.

The use of transistors in u.h.f. tuners is limited to the oscillator function. This has one great advantage in that it does not require filament power. This is particularly convenient in receivers using series filaments. The circuit of such a tuner,

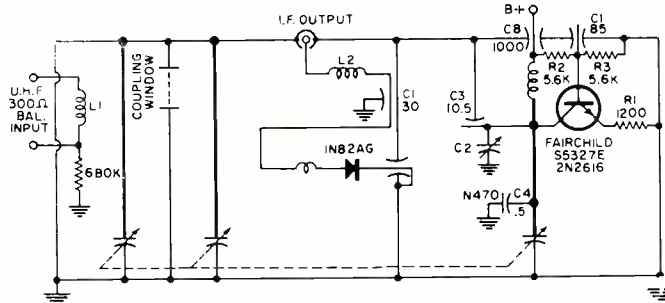

Fig. 5. Some u.h.f. tuners use a transistor local oscillator.

the *Standard Kollsman* Model UT, is shown in Fig. 5 and is typical of most transistor u.h.f. circuits. The preselector or r.f. section and the mixer diode are essentially the same as for the tube version, but the oscillator is quite different. The tuned circuit is in the collector and is therefore at "B+" voltage. A small resistor, *R1*, is sufficient to provide feedback in the emitter lead, while the base is grounded for r.f. through *C1*. A forward bias is fixed on the base through *R2* and *R3* to assure conductance of the transistor. As in the tube oscillator, a padder capacitor *C2* is located at the "hot" side of the tuned line but the trimmer capacitor which tunes the end of the line is not shown. *C3* is a fixed capacitor and consists of a metal tab located close to the line and *C4* is a small negative-temperature-coefficient capacitor to stabilize the oscillator frequency against temperature drift. Tube oscillators also frequently use temperature stabilizing capacitors, such as *C4* in Fig. 3.

One of the most important features of all u.h.f. tuners is reduction of oscillator radiation and this is accomplished by rigorous shielding of all components, bypassing of all "B+" and filaments leads and, in the case of many transistor tuners, mounting the transistor inside the metal tuner as in Fig. 6. Another important characteristic is the noise figure due to the tuner itself. This depends to a great extent on the mixer crystal and in some tuners ranges as low as 9 db. Comparable noise figures for v.h.f. television tuners may be as low as 4 to 6 db. Noise figure determines where the fringe area starts.

### Mechanical Description

Probably the outstanding fact about the new u.h.f. tuners is their small physical size. The transistor tuner shown in Fig. 6, for example, is only about 2.5 x 2.5 x 1.25 inches without the gearing mechanism. This latter feature is a very important part of every u.h.f. tuner since the 180° rotation of the ganged capacitor must be multiplied to permit the selection

Fig. 6. General Instrument tuner encloses transistor in the oscillator compartment (rear) to reduce oscillator radiation.

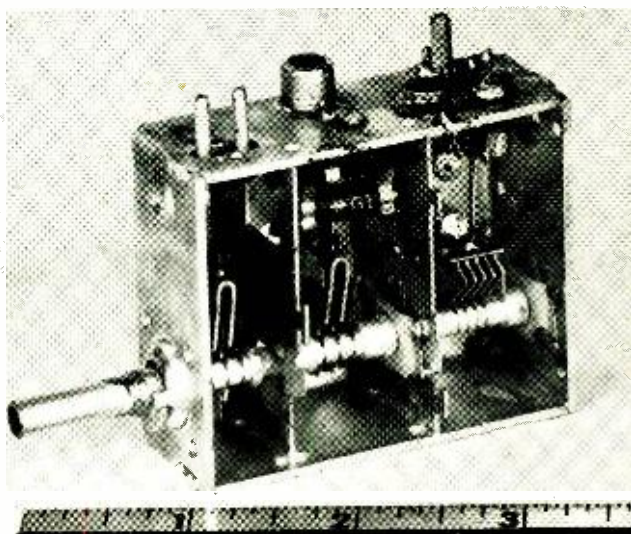

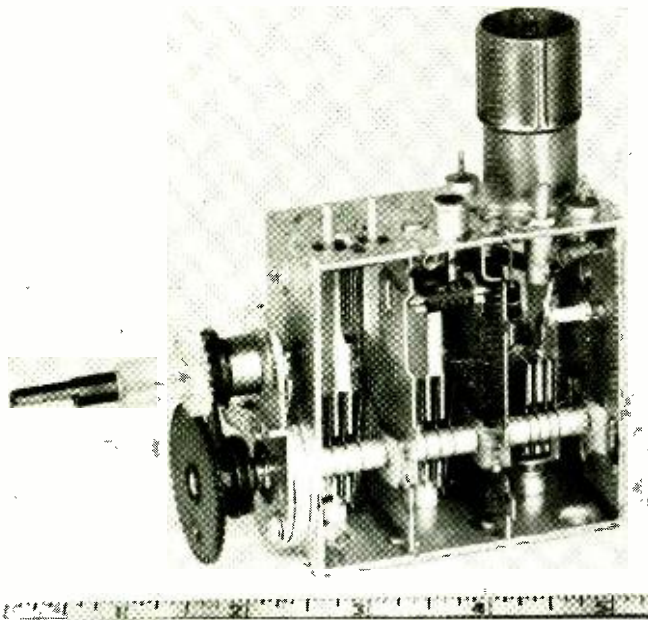

Fig. 7. Tuning gearing as used in the General Instrument tuner.

of all u.h.f. channels. Most u.h.f. tuners are produced in standard models by the major tuner manufacturers such as *Standard Kollsman*, *General Instrument*, *Sarkes Tarzian*, *Oak*, and *Mallory*. The TV set manufacturers specify the method of gearing and the mechanical linkages between the u.h.f. tuner, the v.h.f. tuner, and the channel indication for particular TV models. These mechanical arrangements use either straight gearing, like the *General Instrument* tuner of Fig. 7, or planetary friction drives like the *Standard Kollsman* models. In either mechanism, stops are required and some linkage to an indicator dial is also necessary. In a few TV receivers, a radio-type dial cord arrangement is used, but more ingenious arrangements are now coming to the fore. One such system permits single-knob tuning with the v.h.f. channel selector. When that control is set to the u.h.f. position, a mechanical linkage disconnects the drive to the detent v.h.f. tuner and connects the control knob direct to the geared drive of the u.h.f. tuner, while at the same time, the u.h.f. dial is displayed. *Olympic* is one of the first to use this system, but a number of other manufacturers will have similar arrangements in their latest sets.

The ratio between the tuning knob and the actual ganged capacitor shaft varies with different manufacturers but typical values are 15:1, 25:1 and even 50:1. Where circular channel marker dials are used, they are usually mounted on another shaft which has an approximate 2:1 gear ratio with the ganged capacitor to cause a 360° dial rotation for a 180° capacitor rotation. To minimize possible backlash between gears, one of them is usually of the spring-loaded, anti-backlash type. Many of the gears are either of nylon or plastic fiber and need no, or very infrequent, lubrication.

A novel and quite different tuning mechanism is used in the *Mallory HT-318* shown in Fig. 8.

To provide detent tuning for those u.h.f. channels received, a number of sliding tabs are located around the rim of the main drive shaft. A flat spring de-

tent is shown in the cut-out of the mounting bracket and the sliding tabs snap into that spring detent. To set up the detent arrangement for a particular location, the u.h.f. stations are tuned in one at a time, and the respective detent tab is locked in place with a screw, accessible from the front of the cabinet through a suitable hole. Once a tab is locked in place for each received channel, the viewer turns the shaft until the detent snaps in and the u.h.f. channel is tuned in. The next channel is located at the next detent.

The *Oak Manufacturing Co.* has also developed a detent tuner for u.h.f. This transistorized unit, shown in Fig. 9, uses 270° of dial rotation to cover the 70 u.h.f. channels, giving about 4 degrees rotation per channel.

### Alignment

In most locations, only a few u.h.f. stations can be received and tuners are generally aligned for optimum performance on those channels. It is usually possible to perform this alignment in the field, without using a u.h.f. sweep generator. In areas with many u.h.f. stations, it may be worthwhile to invest in a sweep generator since it makes the technician independent of the station transmission and permits a much more exact alignment. A very handy tool for aligning u.h.f. tuners is obtained by cutting a slot, about the width of a hacksaw blade, to a depth of about 1/4-inch into the flat tip of a 1/4-inch diameter plastic rod. This can then be used to adjust trimming tab capacitors and tuning capacitor rotor blades without the detuning effect of a metal tool. In general, u.h.f. tuner alignment is very similar to the alignment of a broadcast radio. First, the oscillator is set at the lowest frequency station to correspond with the dial reading. This is done by adjusting the padder capacitor, C3 in Fig. 3, with the tuning shaft set so that the dial reads correctly. Next, the highest frequency station is tuned in according to the dial setting and the trimmer is set to bring that station in. This trimmer is usually a tab near the ganged capacitor, and is bent closer or farther away with the insulated tool. In a few u.h.f. tuners, this trimmer is a screw which can be set for greater or lesser proximity to the ganged capacitor. As in broadcast radio receivers, the low-frequency oscillator adjustment and the high-end tuning may interact and require some touch-up.

The r.f. "trimmer" tab or screws for each tuned line are set for the strongest signal at the highest-frequency u.h.f. station. To overcome the effect of a.g.c. in the i.f. section, it is best to replace this voltage with a bias battery just as in conventional alignment of the v.h.f. and i.f. section. Signal strength is then measured as d.c. voltage at the video detector. Care must be taken to adjust the bias so that the detector does not overload. A generally accepted arrangement will produce about 3 volts maximum at the video detector for a properly aligned station and less than 0.7 volt when the tuner is set between stations.

After the r.f. section has been set for the highest-frequency u.h.f. channel received, tune to the lowest-frequency station and observe results on the screen with normal a.g.c. action. If the picture appears weak, the r.f. section must be adjusted by bending the outer rotor plates of the ganged capacitor. These plates are serrated, just as in most broadcast radios, and great care must

(Continued on page 81)

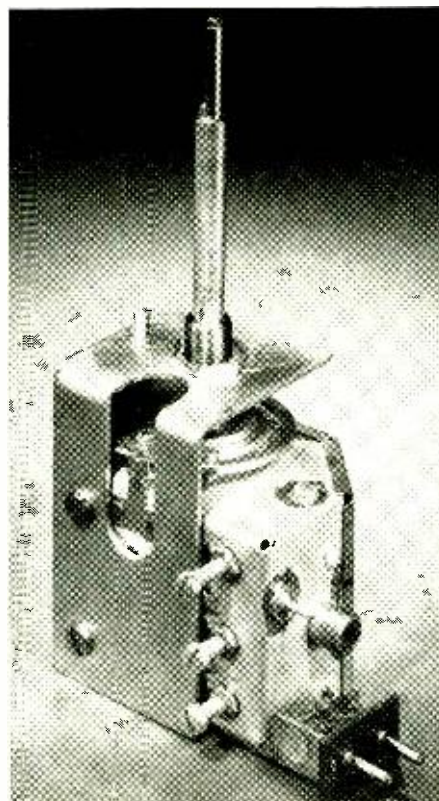

Fig. 8. P. R. Mallory employs a series of detents in its tuner.



# MID-FREQUENCY AMPLIFIER-GAIN NOMOGRAM

By K. W. JAMES

*Relationship between triode plate-load resistor value and the following grid resistor for various amounts of gain.*

WHILE the triode amplifier mid-range gain equation,  $gain = \mu R_L / (R_p + R_L)$ , is familiar to most technicians and engineers, it is easy to forget that the " $R_L$ " involved in the equation is a *dynamic* resistance composed of the parallel combination of the actual plate-load resistor ( $R_L$ ) and the following grid or shunt resistor ( $R_G$ ). What's more, the ways in which stage gain can be manipulated by proper choice of the plate resistor and following shunt resistor are not made obvious by the conventional approach.

Both in the design of new equipment and in analyzing circuits for the first time, a chart which shows at a glance the relationships between the values of these two resistors and the stage gain is an exceptionally helpful item to have around. The accompanying nomogram is such a chart.

The nomogram deals with the ratios  $R_L/R_p$  and  $R_G/R_L$ , rather than with actual resistance values so that it may be applied in any case. The result read from the center scale is the ratio of actual gain to " $\mu$ " or amplification factor; this ratio can never reach one and, in practice, will seldom exceed 0.8.

When used in conjunction with detailed tube-data sheets and tube characteristics curves, the chart's results will be accurate within 10%, which is about as accurate as the curves themselves are likely to be, due to manufacturing tolerances.

However, the detailed curves are not necessary for approximate analysis of a circuit. Data published in handbooks such as RCA's "Receiving Tube Manual" series is sufficient. Here is how to use it with this data, before we get into an accurate but detailed approach.

First, estimate the actual voltage between plate and cathode of the tube, and pick the set of published "typical operating conditions" which most closely corresponds to this plate-voltage condition. Then extract from this set of conditions the plate resistance,  $R_p$ , and the amplification factor,  $\mu$ . Divide  $R_p$  into the plate-load resistance value,  $R_L$ , to obtain the ratio  $R_L/R_p$ . Divide the plate-load resistance value into the shunt resistance value,  $R_G$ , to obtain the ratio  $R_G/R_L$ . Locate the two ratios on their appropriate scales and connect them with a straight line. At the intersection of this line and the center scale, read the value of the ratio  $gain/\mu$ . Multiply the value of  $\mu$  obtained from published data by the ratio and the result is the approximate actual gain of the stage that is being designed here.

For high accuracy, the detailed curves are necessary. Let us work out an example for a type 12AX7 tube operating from a 180-volt supply, using G-E data sheet ET-T509B. The tube is operating with a load resistor ( $R_L$ ) of 510k ohms, following grid resistor ( $R_G$ ) of 1 megohm, and has a 4400-ohm cathode-bias resistor.

From the curves, we determine that the plate current of the tube is 0.21 ma. and that the plate resistance ( $R_p$ ) at this point, with approximately 100 (Continued on page 87)

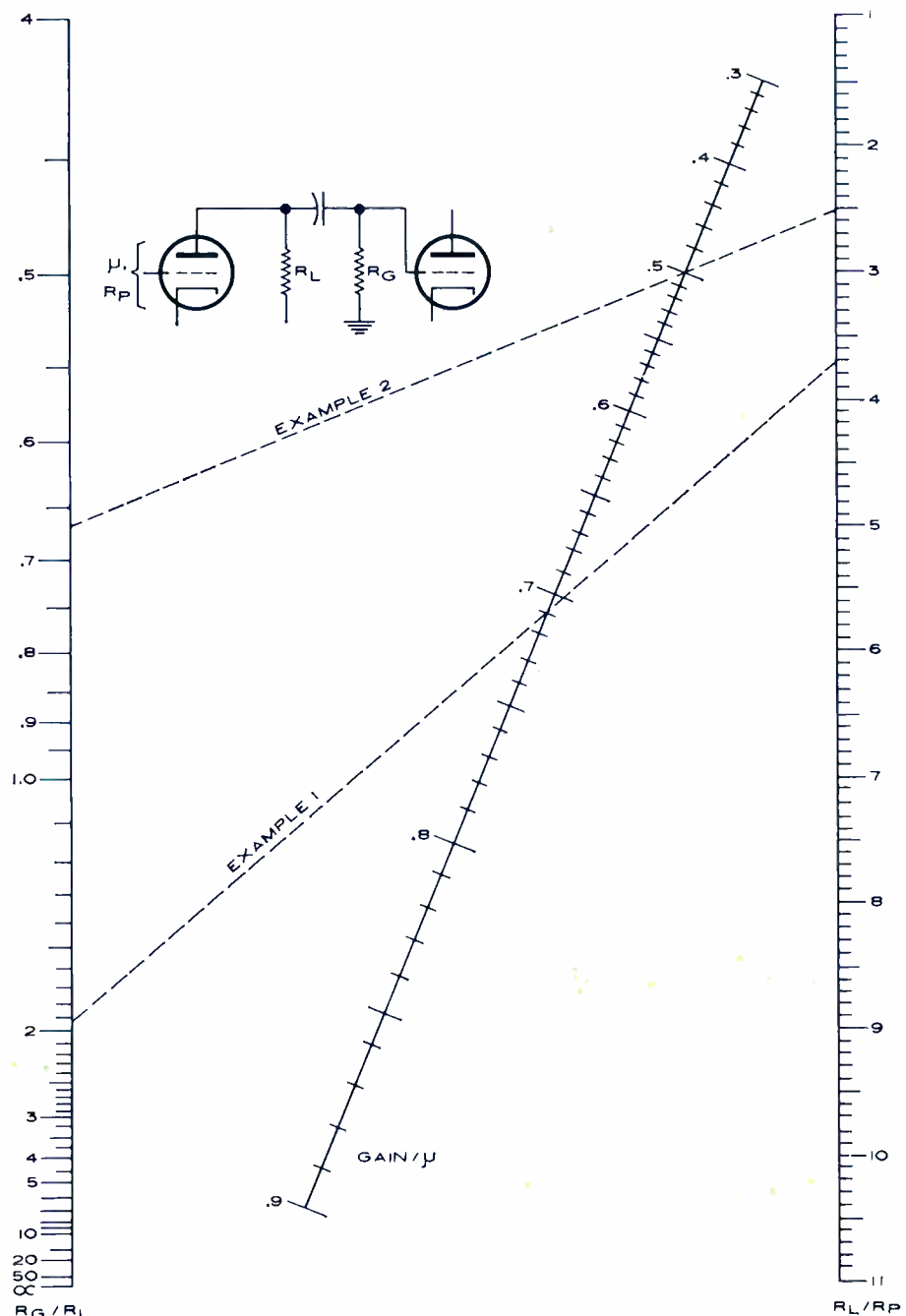

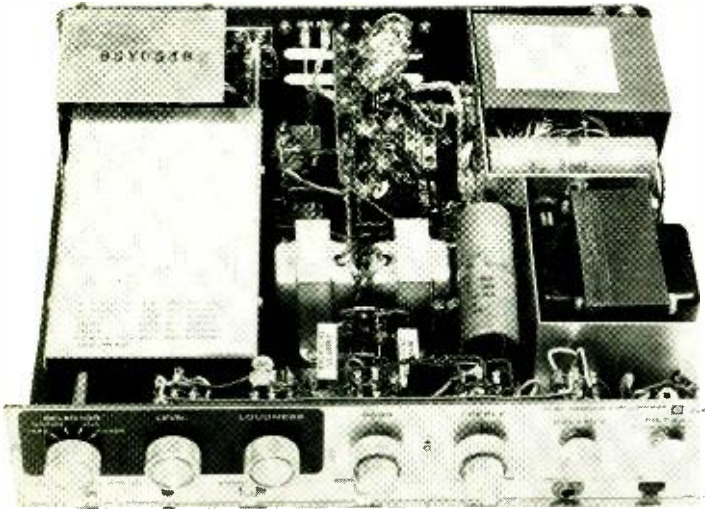

Chassis view of KG-870 showing hinged circuit board containing predriver, driver, and output stage protective lamp bulbs.

# Self-Protecting TRANSISTOR HI-FI AMPLIFIER

By NORMAN KRAMER and RONALD JAPENGA  
Knight Electronics Corp.

*Circuit description and design of the new "Knight-Kit" high-quality dual 35-watt integrated stereo amplifier.*

THE past several years have shown that high-performance home entertainment equipment is evolving rapidly toward complete transistorization. In addition to the obvious advantages such as small size, low heat dissipation, and low power consumption, the design engineer is becoming further influenced by the elimination of the output transformer and the reduction of phase shift throughout the audible spectrum.

We at *Knight Electronics* have long felt that the "transistor sound" was not just an advertising catch phrase but a recognizable tonal quality. We feel that this results from the direct coupling of stages in the basic power amplifier and the direct coupling of the speaker to the amplifier without the use of either a coupling capacitor or an output transformer to match the loudspeaker.

The purpose, then, in the design of the "Knight-Kit" KG-870 amplifier, was to show that these inherent transistor advantages were possible in a medium-to-high power complete stereo home instrument which provided all the performance versatility required by the audiophile at moderate cost.

## Output Circuitry

The output circuit was the obvious starting point in this design. Choice of circuits centers around complementary pairs, half-bridge, or full-bridge configurations. The comple-

Fig. 1. (A) Basic half-bridge single-ended push-pull arrangement. (B) Output circuit modified for stabilization, balance.

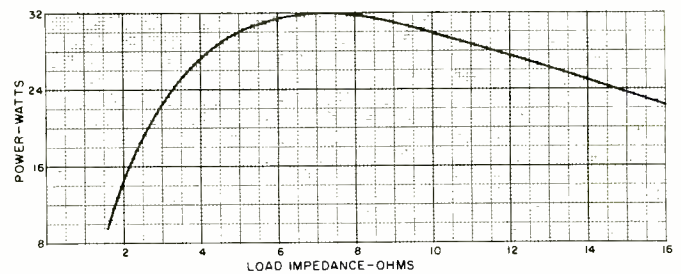
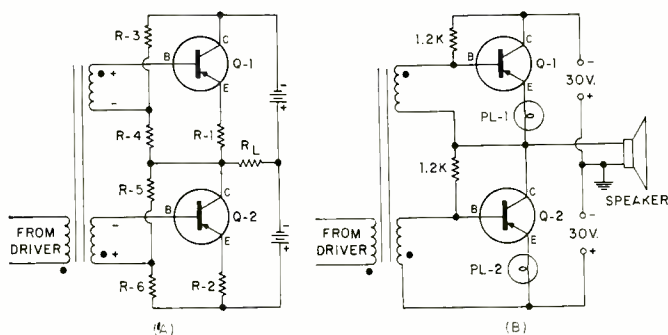

Fig. 2. Variation of steady-state output power with load impedance. Music-power output is approximately 35 watts/channel.

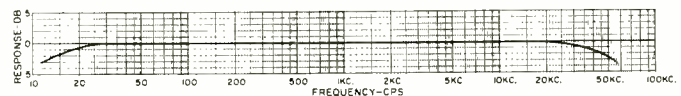

Fig. 3. Frequency response taken at an output power of 1 watt.

mentary circuit requires matched  $p-n-p/n-p-n$  pairs and the cost of such transistors at relatively high power levels would be prohibitive. The full-bridge circuit places less of a voltage demand on the transistor but requires four output transistors per channel. The half-bridge circuit is the one most commonly accepted and the variations in design are in the method of drive and the use of either a split power supply or a coupling capacitor and a single power supply. Using an output capacitor would merely be exchanging some of the limitations of a transformer for the limitations of the output capacitor.

The output transistors are driven by a transformer as this is a convenient way of obtaining the floating input required by the lower output transistor. The driver transformer has the further advantage of providing the required current gain while permitting the resistance in the base circuit to be kept low—which helps the d.c. stability.

Fig. 1A shows the conventional half-bridge circuit. Class B transistor output circuits require that some quiescent collector current flow with no signal applied to avoid crossover distortion.  $R_3$  and  $R_4$  establish bias voltage for  $Q_1$  while  $R_5$  and  $R_6$  bias  $Q_2$ . The value of this idling current is quite crit-

ical since too low a current could cause severe distortion in the crossover region while too high a current could cause excessive transistor dissipation with the likelihood of permanent damage.  $R1$  and  $R2$  provide d.c. stabilization and set the transistors' operating points to levels where they are fairly independent of their individual characteristics and ambient as well as junction temperatures.

The KG-870 amplifier has this conventional circuit modified to look like Fig. 1B. Here the emitter resistors  $R1$  and  $R2$  have been replaced by 6-volt automotive-type incandescent lamps  $PL1$  and  $PL2$ . These are tungsten-filament lamps with just the proper positive temperature coefficient to provide not only the d.c. stabilization but also circuit balance and two-way overload protection. Since the lamps are in series with each output emitter, they provide thermal runaway protection by offsetting increases in transistor current by increases in lamp resistance. Further, since emitter resistance is a function of emitter current and the stability factor is a function of current, the limitation on power output is maximum junction temperature and not thermal runaway. The transistors are also protected from excessive dissipation resulting from a shorted speaker load since the lamp will glow and change the bias on the transistors. The cold resistance of the lamp affects the stage gain by only 5 percent in the worst case and the thermal time constant of the lamp is approximately 500 milliseconds causing virtually no effect on program material being amplified.

The lamps act as fast fuses in the event of wiring error or component failure because they are extremely sensitive to applied voltage. Their life varies inversely as the 12th power of applied voltage. In this way, their normal life of 200 hours at 6 volts would be reduced to less than 10 milliseconds if they were exposed to the full 30-volt supply. This provides adequate protection for both speaker and transistors. In normal use as emitter resistors, they are exposed to less than 1 volt, assuring a life in excess of the sum of the life of all the other components.

A further fringe benefit from the lamps is the measure of self-balancing provided for the output circuit since they are sensitive to current through them and seek an equilibrium with their series transistors. This provides a balancing of the bridge and keeps d.c. from flowing through the loudspeaker.

The use of the lamps in the emitter circuits further provides a non-linear current feedback which considerably reduces the effect of varying load impedance on maximum

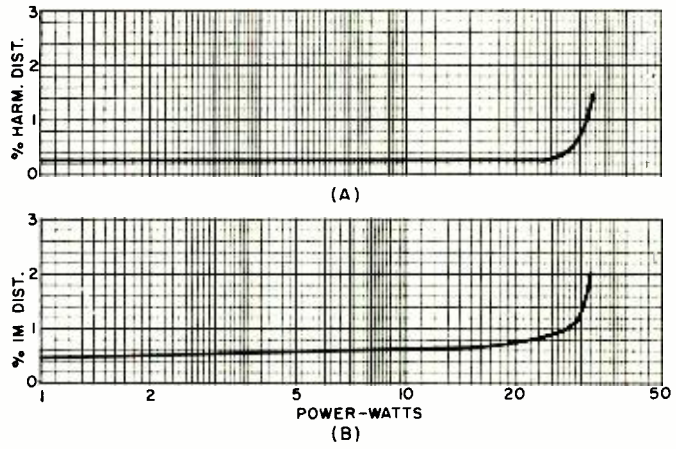

Fig. 4. (A) Total harmonic distortion taken at 1 kc. (B) The intermodulation distortion (60,700 cps; 4:1) of amplifier.

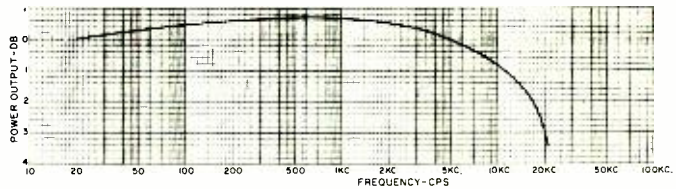

Fig. 5. Power response curve at 2% total harmonic distortion.

power output. Fig. 2 illustrates maximum output power vs load impedance and clearly shows the tendency of the amplifier toward a constant power device instead of constant voltage. A constant-voltage device would produce output power that varied inversely with the value of the load impedance used.

### Transistor Choice

The choice of an output transistor which would provide the best over-all performance in terms of high power output at low distortion and flat frequency response without excessive amplifier cost was the next major design consideration. Quality silicon power transistors were not economically feasible. Germanium diffused-junction power transistors, which have good high-frequency performance, are still plagued, to a certain extent, by the phenomenon of secondary breakdown voltage. Therefore, in terms of ultimate reliability, we concentrated on the better-grade (Continued on page 74)

Fig. 6. Circuit diagram of one of the channels of the amplifier from the 1-volt level point to the speaker output.

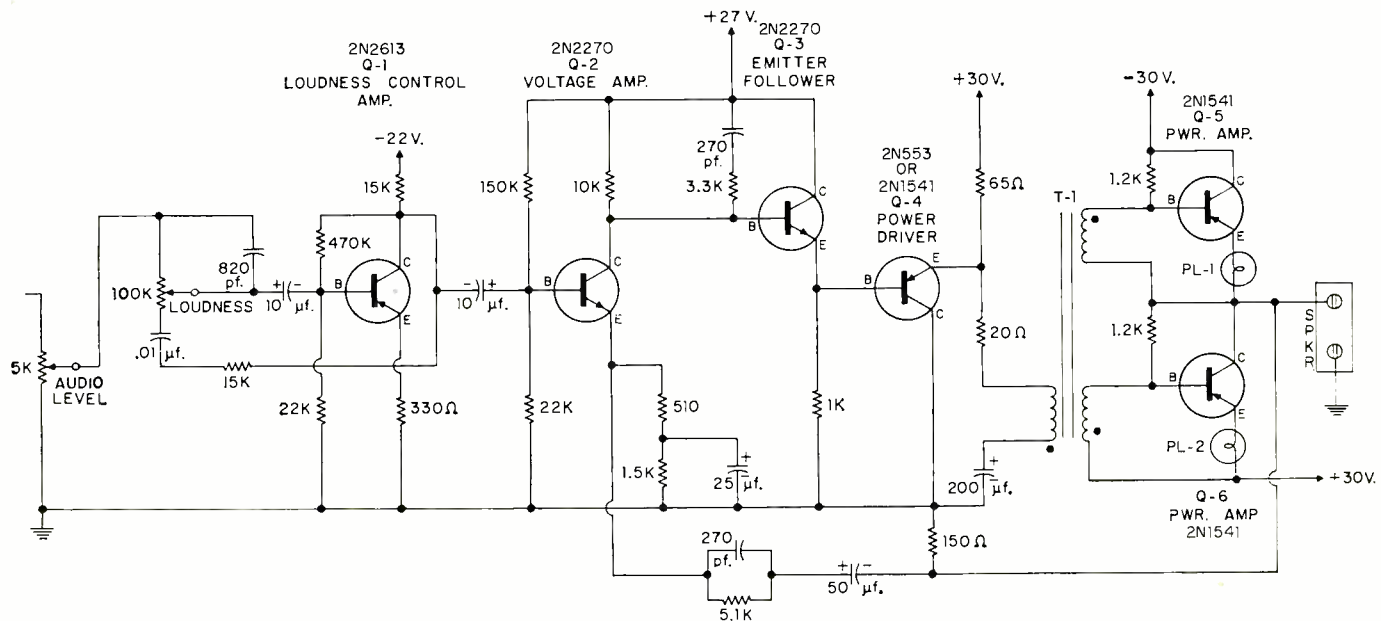

# RECENT DEVELOPMENTS in ELECTRONICS

**Three-Laser Radar.** (Below) Experimental, all solid state model of what Sperry Rand says will be the first practical optical radar to use the full potential of the laser. The optical heterodyne radar operates at a wavelength of 1.06 microns (near infrared). At right, between a pair of metal plates, is a doped calcium tungstate c.w. laser oscillator. The preamplifier, a doped calcium tungstate pulsed laser, is between the irises. The pulsed power amplifier, a doped glass laser, is inside the squat cylinder being aligned at the left. The system's tiny receiver is located at the extreme left, just behind the scientist's right shoulder.

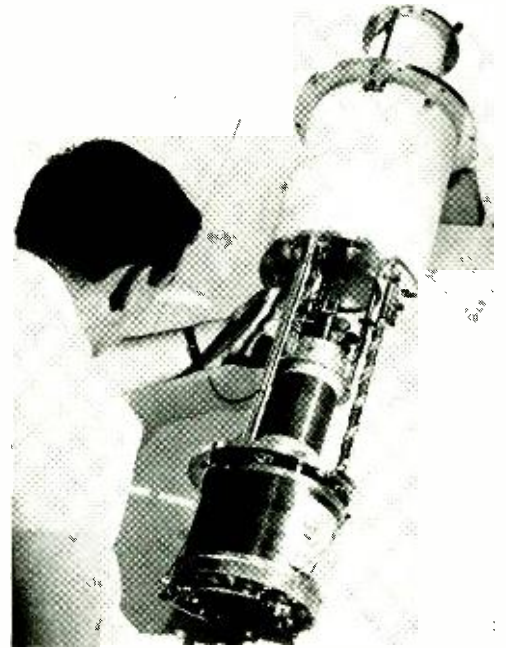
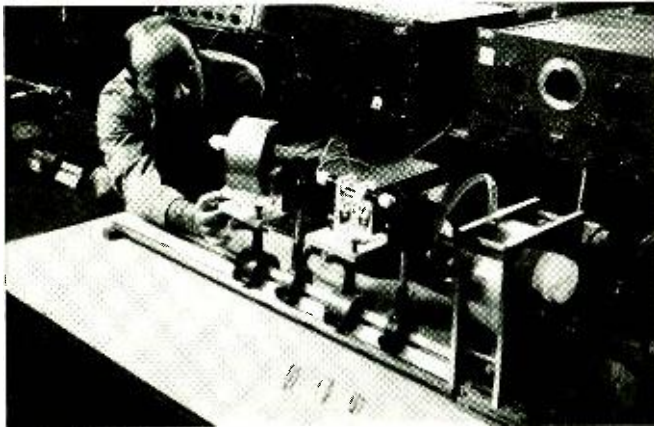

**Superconducting Magnet.** (Above) The first superconducting magnetic solenoid to repeatedly achieve a magnetic field of 100,000 gauss has been reported by Westinghouse engineers. This is about 200,000 times the average magnetic field strength of the earth and about 5 times the field at which the iron core of a conventional electromagnet saturates. The super-strength solenoid uses over 20 miles of a niobium-titanium alloy wire, about the thickness of a sewing thread, to produce the intense field. The coil is operated in liquid helium at  $-452^{\circ}\text{F}$  to maintain it in the superconducting state.

**Ceramic Microtransistors.** (Below) New ceramic microtransistors are being mounted on a printed board by means of tweezers. The substrate for each tiny package consists of a ceramic block with a center channel on which the transistor is mounted by alloying. The devices can be welded, soldered, and resoldered by standard methods. The micro packages, developed by National Semiconductor, can be used in subminiature assemblies and as discrete active elements in various integrated circuits.

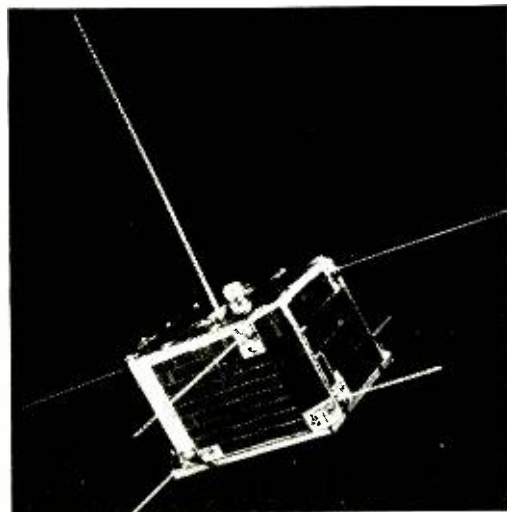

**Map-Maker Satellite.** (Above) Helping U.S. scientists draw a truer picture of the face and shape of our world is the mission of this new Army satellite built by International Telephone and Telegraph Corp. Launched early this year, the space traveler is designed to work with ground stations to provide more accurate data on the locations of continents, islands, and other landmarks. The satellite may also yield important measurements on the shape of the earth, which some scientists believe is more egg-shaped rather than spherical.

**Radar Dead Room.** (Right) Designs of re-entry vehicles that cannot be detected by the searching rays of radar are evaluated in this microwave anechoic chamber at Douglas Missile & Space Systems. The chamber is 50-foot long, 17-foot square and is lined with thousands of carbon-impregnated sponge-rubber baffles. This material almost totally absorbs stray radar signals permitting highly accurate measurements of the energy reflected by the test specimens. In the photo, an engineer is positioning one of the precisely machined scale models used in the experiments. Research indicates that large geometric shapes do not necessarily produce obvious "signatures" which betray their presence to a radar beam.

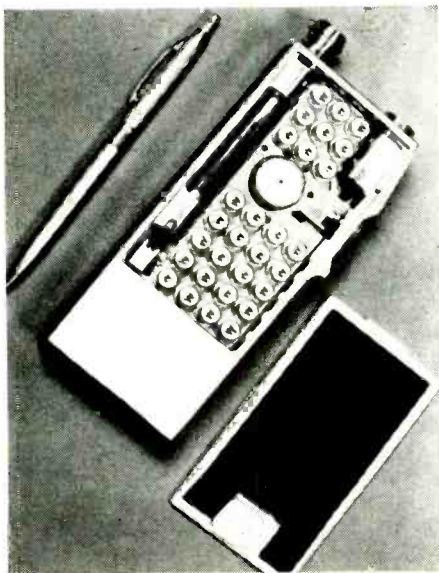
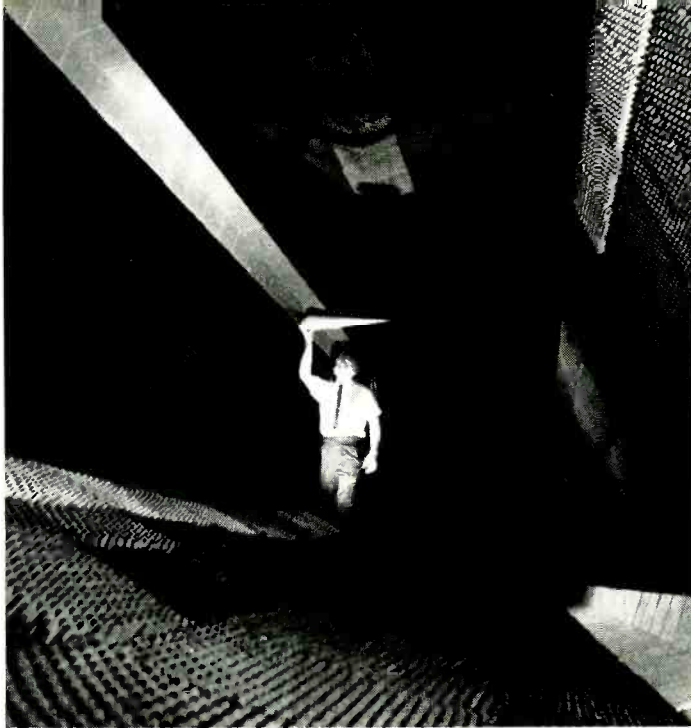



**Integrated - Circuit Transmitter - Receiver.** (Above) This model of a 120-mc. AM transmitter-receiver demonstrates the application of compatible integrated circuits to v.h.f. communications equipment. The model was developed as a research project for the Air Force by Motorola. It does not illustrate the maximum potential size and weight reduction possible. The circuits consist of silicon dice with diffused active elements (transistors, diodes) on which the passive elements (resistors, capacitors) are deposited by thin-film techniques. The use of thin films rather than diffusing techniques for these elements substantially increases the range of part values, tolerances, and temperature coefficients.

**Handwriting on Telephone Circuits.** (Right) A system that transmits handwriting over conventional telephone circuits was installed recently at Stephens College (Missouri) by General Telephone Co. The experimental system is expected to develop a suitable "blackboard" for long-distance telephone lectures to students at schools across the country. Handwriting on an Electrowriter is transmitted over the phone circuits in the form of voice-frequency tones to another Electrowriter.

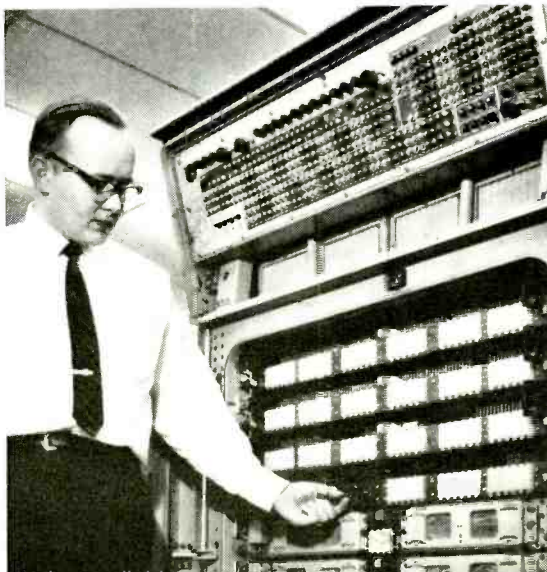

**Military Computer.** (Below) A military computer comparable in speed and memory capacity to the largest commercial machines now available, yet in a cabinet only 3 feet square by 6 feet high, has been delivered to the Navy by Univac. A high-speed thin-film memory unit is used in the computer along with a main memory consisting of almost 5-million magnetic cores. Semiconductor integrated circuits, in transistor-like containers, are used throughout.





A small chord organ can be built in a toy piano case yet produce a big organ sound. This particular version can be powered by "C" cells.

# TWIN-T OSCILLATORS FOR ELECTRONIC MUSICAL INSTRUMENTS

By FRED MAYNARD / Motorola Semiconductor Products, Inc.

**Simple circuit designs using transistors in high stability, wide-range oscillators for instruments that vary from toys to elaborate electronic organs.**

**T**HE twin-T oscillator can be readily designed from conventional components to cover a very wide range of audio frequencies in simple transistorized circuits. This wide range, which extends from less than 1 cps to well over 10,000 cps is provided only by changes in component values, and when coupled with the inherent circuit stability and extremely simple resistive "actuate" and "tune" function, facilitates the simple and straightforward design of a wide range of musical instruments extending from toys to sophisticated and complete electronic organs.

Since publication of the author's May, 1963 article on the design of this type oscillator, the author has received many requests for specific information in its application to musical instruments. It is hoped this article will provide some design guides in this interesting area.

In so-called electronic musical instruments, the same functions as provided by the strings, reeds, pipes, bells, etc., of conventional instruments are generated by electrical means. These electrical means of tone generation are quite varied, ranging from almost purely electromechanical systems to several different electronic oscillator approaches. All of the systems which have been used are good—all are capable of producing a wide range of beautiful tonal effects.

The basic criteria of the worth of any system for producing music are economy, stability, power conservation, and simplicity and reproducibility of construction.

Almost all of the functional tone generating systems require either highly refined mechanical structures or special-

purpose electronic structures. Examples of these are the tone-wheel approach used by *Hammond* and others, and the various oscillator and divider systems in other commercial organs, some of these requiring specially wound inductor components.

The only basic oscillator systems which can be designed from easily obtainable conventional components are the so-called *RC* oscillators. There are several versions of these, including the phase-shift and twin-T configurations. After many exhaustive tests, the author has concluded that in design simplicity, stability, component requirement, and general adaptability to a musical instrument system, the twin-T oscillator configuration stands out as the best basic approach for the builder who wishes to start from "scratch."

The scope of a musical instrument derived from twin-T oscillators depends entirely on the builder's ingenuity.

## Twin-T Generators

A special nomogram has been prepared (Fig. 1) for the rapid design of twin-T tone generators. This has some of the same information as given in the general-purpose nomogram in the author's previous article, with added musical intervals and frequencies over a six-octave range.

The interval frequencies, based on the international pitch scale in which middle A ( $A_3$ ) = 440.00 cps, are indicated on the A frequency scale. More accurate musical scales, to .01 cycle, are given in other references, or may be obtained by using the frequencies and multiplying factors indicated in Table 1.

The nomogram solution for any given twin-T bridge configuration is based on the balanced-bridge conditions, in which  $R1 = R2$ ,  $R3 = 10\%$  of  $R1$ ,  $C1 = C2$ , and  $C3 = 2C1$ , in the circuit shown in Fig. 2 and the insert of Fig. 1.

This solution provides approximately a musical augmented second or full third of some chromatic octave scale. The intervals are tuned downward by making  $R3$  larger, and upward by going smaller from this 10% value.

An approximate tuning curve in terms of  $R3$  values versus musical scale pitches is given in Fig. 3 for a typical middle-C octave generator.

Because of capacitor and resistor tolerances, and other factors, these  $R3$  values will not provide perfect tuning. This is generally done by any of several methods.

### Design Example

A complete C-scale tone generator schematic is shown in Fig. 4A. This consists of a high-gain, general-purpose audio transistor  $Q1$ , for which a *Motorola 2N1193* is recommended.

$R4$  is the collector load resistor and  $R1, R2$  the T-bridge resistors. These also provide a negative feedback stabilizing bias to transistor  $Q1$ . The range of values for these resistors is restricted, for bias considerations, to a minimum of 50,000 and a maximum of 200,000 ohms each. These limits are included in Fig. 1. Preferably, the  $R1, R2$  resistors should be as close to 100,000 ohms as is feasible with the desired solution.

The solution for this oscillator is found from Fig. 1 with the best frequency centering by assuming the musical augmented second as the design center. In the C scale this interval is  $D\#$  (311.13 cps).

Using a straightedge across the nomogram we see that from the frequency we can obtain a convenient solution when  $C1 = .01 \mu\text{F}$ . and  $R1 = 100,000$  ohms. A second solution is provided with  $R1 = 50,000$  ohms and  $C1 = .02 \mu\text{F}$ ., and a

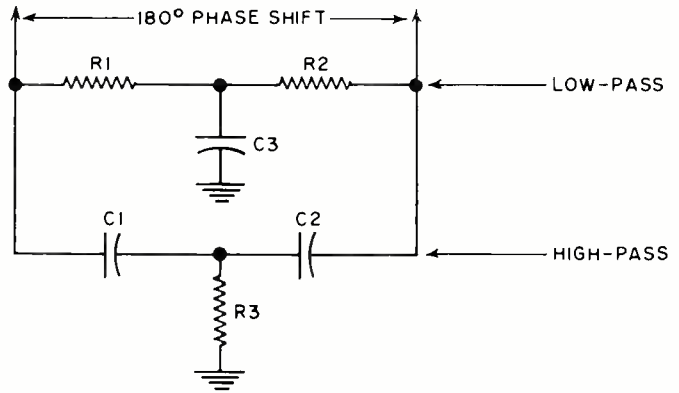

Fig. 2. Basic twin-T bridge consists of two phase shifters.

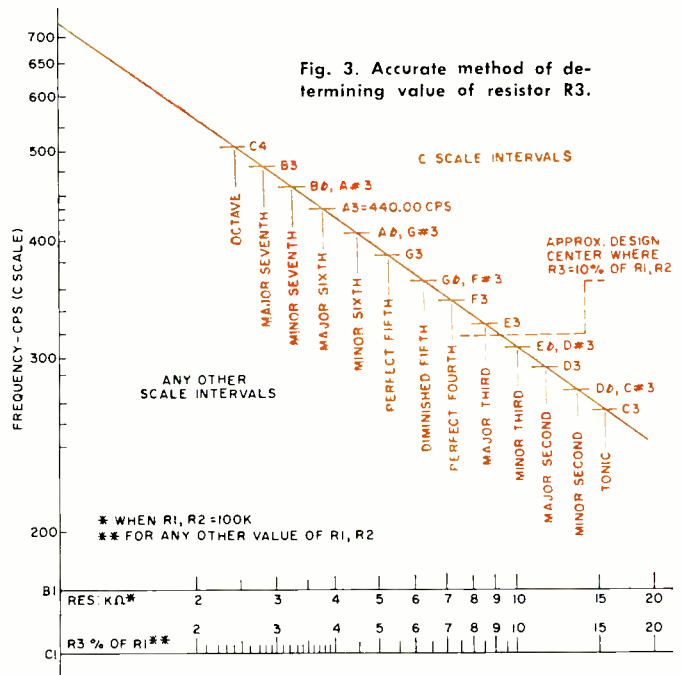
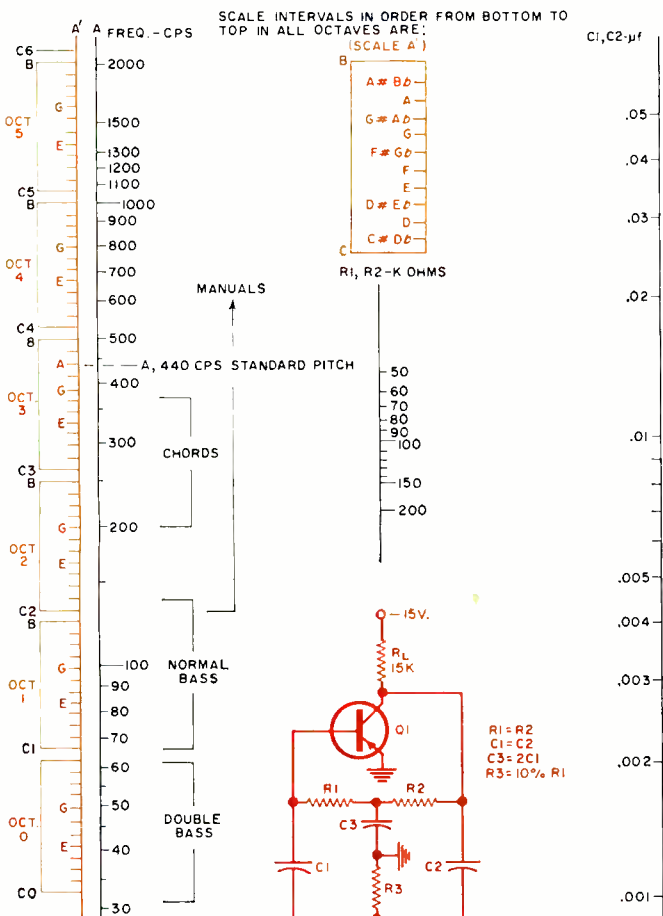

Fig. 3. Accurate method of determining value of resistor  $R3$ .

Fig. 1. Nomogram for use in the design of a twin-T oscillator.



third with  $C1 = .005 \mu\text{F}$ . and  $R1 = 200,000$  ohms. There are also an infinite number of other solutions to the same problem between these limits. The values  $.01 \mu\text{F}$ . and 100,000 ohms are selected as the best for this case.

Resistors can be readily obtained in incremental values of 5% or 10%. However, capacitors do not ordinarily have this fineness of ratings. Therefore, the design values must be selected on the available capacitor listings, remembering that whatever  $C1$  value is selected, a  $C3$  value of twice this amount must be also available.

Using these same considerations, a suitable solution can be found for any other tone generator. For example, a bass generator ranging from  $C = 65.4$  cps to  $C = 130.8$ , or any or all of the higher octaves above or below the middle-C, octave-3 register.

Fig. 4A shows one of the methods of pitch control in a simple keyboard instrument. This is shown as a scale in the diatonic form (do, re, mi, etc.). Five more half-tone intervals can be added in the resistor string to provide a full chromatic scale.

Exact or optimum values of these tuning resistors cannot be accurately predicted. They should come out approximately as given in Fig. 3 for the generator configuration shown. For accurate tuning, the  $R3$  values are adjusted or selected in comparison to some other frequency source, such as an accurate frequency generator or aural comparison to a piano or other instrument.

In the series tuning arrangement shown in Fig. 4A, the intervals are tuned in steps from the highest pitch downward.

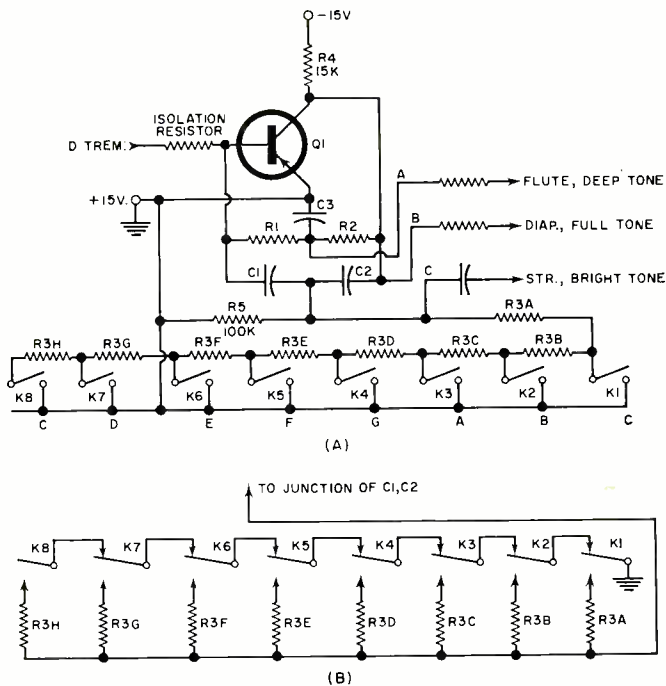

Fig. 4. (A) Basic circuit of a one-octave (C-scale) generator. (B) An alternate method of keying R3 into the scale generator.

Whereas this provides the simplest non-ambiguous kind of switching arrangement, requiring only one "make" contact to a common grounded bus on each key, it has some drawbacks in that an adjustment of any higher interval also affects those below.

A somewhat more sophisticated and satisfactory arrangement is parallel tuning, shown in Fig. 4B.

In this arrangement, a normally closed contact is applied to each key switch and carried over in series to the next contact spring. This series line is the ground bus. If any key is pressed, the ground bus is broken for all keys below this position, hence there is no tonal ambiguity if two or more keys are pressed at the same time. In this arrangement, tuning resistors R3A through R3H may be selected or adjusted independently of each other.

In connection with these keying systems, R5, about 100,000 ohms, is used to suppress key clicks and chirps which may be objectionable when the instrument is played. This resistor has a "keep-alive" effect. It is too large to sustain oscillation, but just large enough to keep the circuit in an oscillation ready state.

Input D, in Fig. 4A is used to inject a tremolo signal. This signal is developed on a separate twin-T oscillator as shown in Fig. 5. In this circuit, the values of components shown will generate frequencies in the 5-10 cycle range. The best tremolo effect is at 6-8 cycles. "Tremolo Rate" and "Tremolo Depth" controls are provided. Both of these may be used as variable controls or adjusted for fixed effects and keyed in by stop switches. When several tone generators are used in an instrument, the tremolo is injected into each through separate isolating resistors R1 through Rn whose values range from 300,000 to 600,000 ohms and are selected to provide the best balanced over-all tremolo effect. It has been determined that this generator will effectively drive at least 30 tone generators and probably more if needed.

### Organ Voicing

The circuit of Fig. 4A shows three output lines A, B, and C. These lines represent three tone colors which may be used as organ voices. A, from the low-pass network, is a very pure tone, which may be called a flute or deep tone; B is somewhat brighter, called diapason or full tone; and C, from the high-pass leg of the bridge, is very rich in higher har-

monics and can be called the string or bright tone output.

These three outputs provide a simple organ voicing system. These waveforms, C particularly, may be further modified by LC and RC filters.

The LC formant, or resonant-overtone peaking, can provide a really large variety of tone colors. Simple resonant circuits composed of inductors and capacitors, as shown in Fig. 6A, can be set up to establish a range of formants all through the horn and reed families.

Suitable laminated core inductors may sometimes be obtained from audio transformers or small filament transformers in which the 110-volt winding is used as the inductor. Effective inductance values range from 100 to 500 millihenrys and capacitor values from .005 to .05  $\mu$ f.

After the voicing system is complete, it is necessary to balance the voice outputs for tonal loudness, which should be essentially equalized and pleasing. This is done by adding series resistors in the A and B output legs.

### Multi-Tone Generators

Sophisticated musical instruments will always have a multiplicity of tone generators. These can be designed in several ways, such as a two- or three-octave solo keyboard, a shared oscillator keyboard, chord organ, or a bass pedal organ.

The shared oscillator organ provides the most in musical performance for the least in circuit complexity. A shared manual or keyboard is equipped with one oscillator or tone generator for each 3-half tone interval, each octave requiring four oscillators. Such a manual may be played very flexibly, with only an occasional lost interval due to the sharing which sometimes happens in complex chord structures.

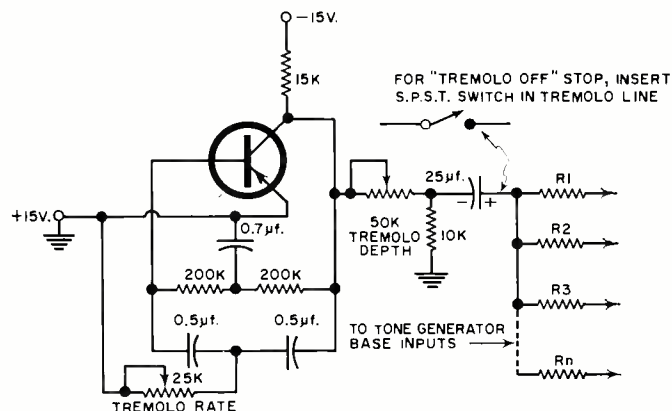

Fig. 5. This tremolo generator will drive 30 tone generators.

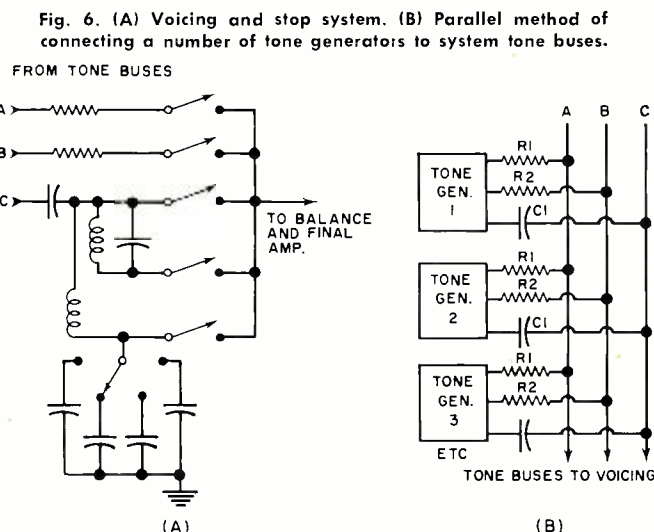

Fig. 6. (A) Voicing and stop system. (B) Parallel method of connecting a number of tone generators to system tone buses.



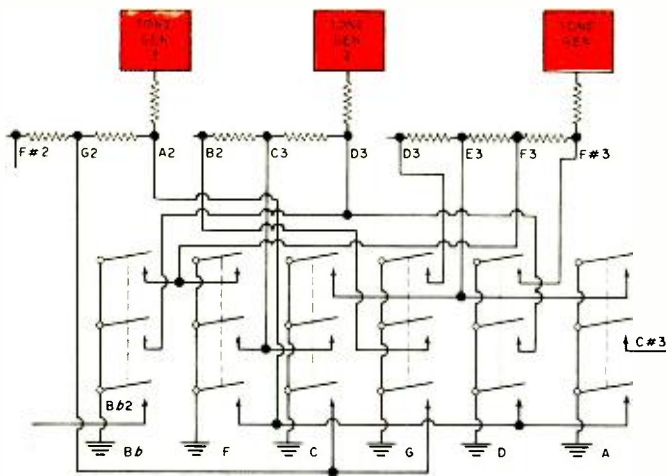

Fig. 7. Partial development of a chord register for an organ.

The tone outputs of any given register, such as the complete treble or keyboard complement, are combined onto tone buses by coupling the various generator outputs to common lines through large-value resistors (Fig. 6B). Typical values of R1 and R2 are 100,000 and 500,000 ohms. Output B requires a larger value since the signal at this point is 5 to 10 times the level at other points. The large resistor values not only balance the outputs, but reduce oscillator loading and crosstalk.

In the case of the high-harmonic output tone source, output C, it is advantageous to couple through a small capacitor which may range from .001 to .005  $\mu\text{f}$ . depending on the frequency and balance. This capacitor provides isolation as well as an added high-pass effect, further accentuating the high-harmonic output of this source.

### Chord Register

The organ with an auxiliary chord register has become very popular, due to its simplicity in playing for the novice. Such a chord register can be developed as shown in Fig. 7. This three oscillator system is keyed by a 3-contact "make" switch to ground. With a separate, button-operated, 3-contact switch for each separate chord, the three oscillators can produce all major and minor triads, as well as simulate the more complex dominant 7ths, 9ths, etc., by omitting the less-important chord intervals.

A very convenient switch for this purpose is the stacked leaf spring arrangement often used in relays.

### Output

After the coupling, balancing, voicing, and stop systems, the entire organ complement is assembled on a single amplifier line. The organ signal levels will range between 10 and 100 millivolts. The high treble will generally approach the smaller figure and the bass the larger.

In some respects, the final organ balancing depends on the output amplifier used. For example, a high-quality audio system with large speakers does not require as much bass as a smaller system, for a given aural effect.

Hence, one should decide on the amplifier to be used prior to the final balancing. This final balancing stage, Fig. 8, is accomplished by combining the various register systems on an amplifier line through resistors, adjusted for best sound. It is generally advisable to include on the organ output line both a manual maximum volume control as well as the dynamic swell control. A simple way of achieving these is shown in Fig. 8. With some external amplifiers which may be used with an instrument, more organ gain may be needed. In this case, a built-in preamplifier as shown in Fig. 9A, may be included as part of the organ complement.

In the event a built-in final amplifier is also desired, the

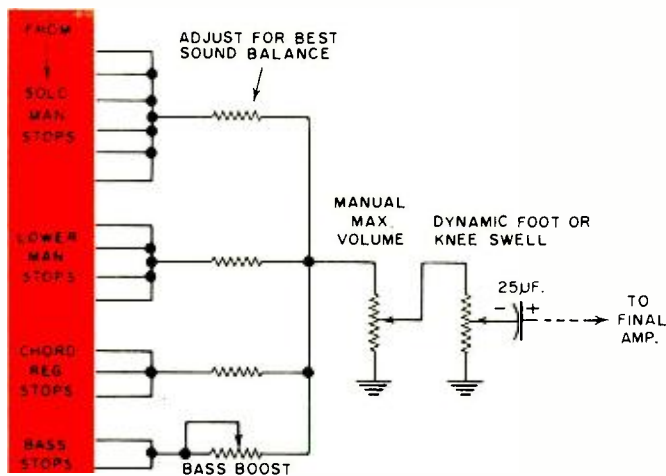

Fig. 8. Final balance and swell control governs dynamic range.

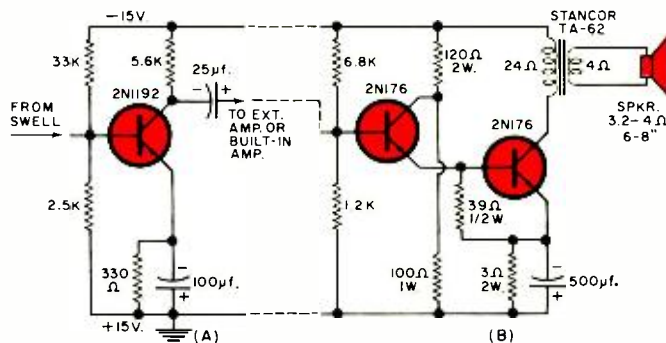

Fig. 9. (A) Preamplifier for external use. (B) Optional built-in amplifier can deliver approximately 2 w. to 8-in. speaker.

extension constituted in Fig. 9B may be added. This amplifier will drive up to an 8-inch speaker, providing about two watts average output power and with good quality.

### Power Supply

All of the tone generator and tremolo generator circuits require a supply voltage of 12 to 15 volts, with a preference for the higher value. Each generator draws about 2 ma. of current continuously, whether being used or not. Thus, even in an instrument with a substantial number of oscillators where used with an external separately powered amplifier, the current drain is not large; for example, 30 ma. in a 15-oscillator organ.

For this magnitude of current drain, batteries provide a convenient supply. The author has used 10 "C"-type flashlight cells in a 17-oscillator organ for one to three months before battery replacement was necessary.

If the builder prefers a line-operated supply and a built-in low-power amplifier, the circuit shown in Fig. 10 may be used. This power supply can handle up to twenty or more tone generators, as well as the internal amplifier.

Possible musical instrument approaches utilizing some of the principles and applications considered in this article can be quite varied. As examples of this, the toy organ shown in the lead photograph represents a (Continued on page 79)

Fig. 10. Power supply for organ and built-in 2-watt amplifier.

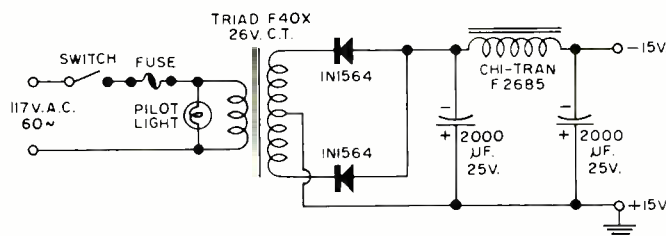

# RADIO & TV INTERFERENCE:

## *Receiver Problems*

By THOMAS R. HASKETT & JACK D. BLOUNT

*Part 2. Once electrical noise has been removed from the power line, the receiver may need minor conversion or some slight additions to reduce other received interference to a minimum.*

**I**N Part 1 last month we covered the shielding of suspect electrically noisy devices and power-line filtering to further reduce possible interference. This article will deal with the various types of received interference and what can be done to reduce it.

Treating r.f. interference at the source is best but not always possible and sometimes the interference cannot be completely removed. In receivers, the answer is to keep such interference from getting in. There are three modes of entry: (1) direct pickup by the parts and wiring—for which shielding and grounding are the only answers; (2) sneaking in the “back door” along the power line; and (3) entry through the receiver’s internal or external antenna circuits.

### Static

Natural noise is the simplest troublemaker, most complaints coming from listeners who want to receive distant, weak stations. Poor signal-to-noise ratio makes these static bursts annoying and one way to alleviate this problem is to use an amplitude noise limiter. Fig. 1 shows a simple, effective series circuit in which noise cannot exceed signal strength. It won’t remove noise pulses weaker than the signal—but ear-shattering lightning blasts will be removed.

Grounding is the first remedy, not only because it is often the only treatment needed, but it is necessary to make the other methods completely effective. The same system applies as with noise sources: large diameter wire, short runs, and a good contact with the earth—using a ground spike where needed. Sometimes, however, a particular radio will pick up less noise ungrounded. With a.c.-d.c. sets and some older TV receivers that use an autotransformer, chassis grounding must be through a capacitor (.01- $\mu$ f., 600 v.). If the set has the usual type of power transformer, you can connect the chassis directly to ground. Do *not* depend on grounding through the a.c. line as it is a rich source of hum and noise. A cold-water pipe is not as desirable as a wire and ground spike, but it will do if it is not used for grounding any other possible source of interference.

Whether the noise sources have filters or not, a power-line

filter at the receiver will further reduce r.f. interference. The filter should be in a grounded metal case, which may be mounted on the chassis or alongside the wall power outlet. If at the wall outlet, the a.c. line to the set must be shielded to prevent pickup. This filter can be a commercial one (or made per Fig. 1, Part 1). The choke wire need not be heavier than #18 or #20 gauge—even for TV sets.

### Antenna Noise Pickup

After filtering the power line, you may get impulse noise picked up on the antenna. Figs. 2A and 2B show the usual AM receiver with the first-stage grid about one megohm above ground. This high-impedance circuit permits easy pickup of noise voltage which is then amplified by the input tube simultaneously with the desired signal.

### Shielded Loop

The r.f. contains two energy components (electrostatic and electromagnetic) but only the electromagnetic field is needed for reception. The electrostatic field can be canceled—eliminating much noise with it—by using a loop with an electrostatic shield, as shown in Fig. 2C.

Break the shield opposite the feedpoint to avoid a shorted turn so that the magnetic component can induce signal currents in the inner loop. The outer shield stops—and grounds—the electrostatic component. Do *not* omit the ground.

Most sets are not designed to work directly with low-impedance loops therefore an r.f. transformer is needed to adapt them. To avoid noise pickup, this transformer must be in a grounded shield can. You may buy one, make one, or easily modify one already in the set by winding a few turns of the same kind of coil wire over the *grounded* end of the existing coil. This will transform the low-Z of the loop to the high-Z of the grid circuit. This change is not critical; when you determine the best location and number of turns, cement the new coil in place. One end goes to earth ground and to chassis (if an a.c.-d.c. receiver, through a capacitor); the other end to the hot side of the loop.

The low-Z shielded loop is made of about 16 feet of two-conductor-plus-shield cable. An excellent type is broadcast-quality mike cable as it is rugged and has low impedance. The length isn’t critical but the larger the loop, the better the signal pickup. Break the shield opposite the feedpoint and *tape it apart*. The lead-in is the same cable, over 100 feet if you need it.

Being directional, you can orient the loop either for maximum pickup in a desired direction or, since the nulls are sharp, to minimize any undesired signal or noise. To obtain nearly non-directional coverage, the loop can be bent at a right angle. Additional information on construction of shielded loops can be found in the article “V.L.F. Loop Antenna” in the January 1963 issue of this magazine.

### Cross-modulation

Receiver r.f. inputs are usually broadly tuned and it isn’t difficult for a strong interfering signal to enter, whatever

Fig. 1. A series limiter can be used to clip the noise peaks.

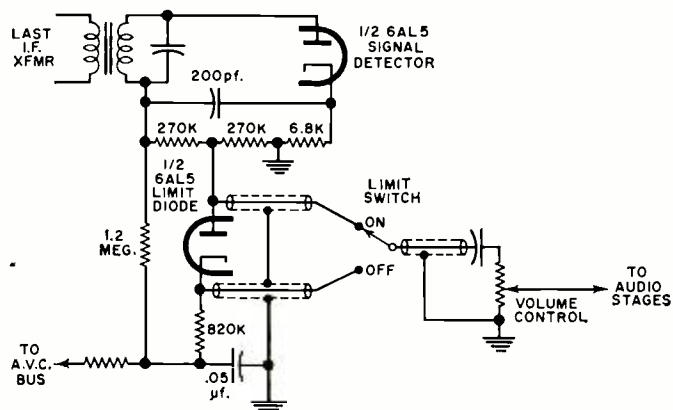

its fundamental frequency or waveshape. Another means of entry is direct pickup by a component or chassis wiring.

Once the undesired signal reaches a tube, it clamps itself to the desired signal in either the r.f., converter, or i.f. stage. The high-level r.f. may shift the bias, thus the tube operates in a non-linear portion of its plate curve. Through this non-linearity, heterodyning with the desired signal occurs.

There are several ways to minimize cross-modulation. One method is to use a trap at the antenna terminals, as in Fig. 3, tuning for maximum rejection. Traps can be purchased for any frequency. For direct pickup, the interior of the receiver cabinet will have to be shielded and grounded. Although a.v.c. will handle fairly strong signals, it *can* be overloaded. If the receiver uses an r.f. stage, re-set the r.f. gain (or install one). This is generally a variable cathode resistor, eliminating non-linearity by biasing the tube sufficiently. It is very useful when DX-ing since it permits maximum gain for weak signals and the best signal-to-noise ratio.

If interference still occurs after taking these steps, it is possible that the r.f. is being grid-rectified in the audio section. As Fig. 4 shows, the a.f. grids may be bypassed to chassis for r.f. only. Keep all leads short.

In institutions where receivers are often only four or five feet apart, the interference produced in one receiver by the local oscillator of another is a major problem. The greatest amount of such interference comes from the sets which do not isolate their oscillators from the antenna and are often connected to long-wire antennas, strung close to another, or sharing a common antenna. Both methods, plus receiver

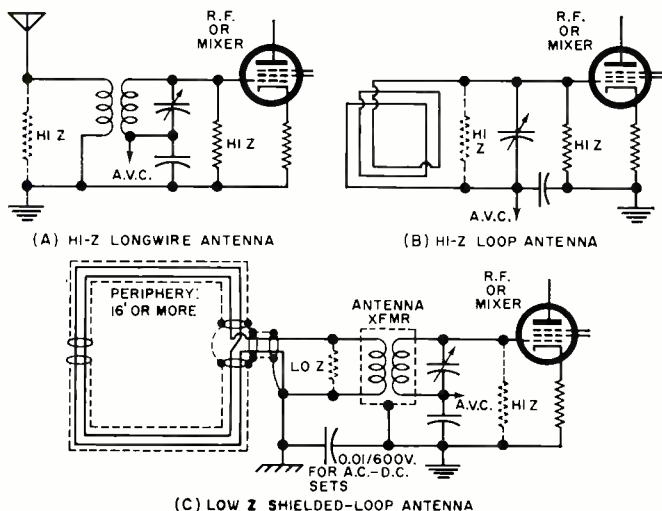

Fig. 2. Input of conventional AM radios for (A) high-impedance long-wire antenna, (B) high-impedance loop antenna, and (C) for low-impedance shielded loop antenna to reduce noise pickup.

proximity and common power-lines, create oscillator cross-coupling.

When a superhet with a 455-kc. i.f. is tuned to 700 kc., its oscillator will be near 1155 kc. Should a nearby set be tuned to 1150 or 1160 kc., it can pick up and rectify both the desired signal and the oscillator of the other set to produce an audio beat note. Since very few sets would be precisely aligned—and precisely tuned—the beat note may be any frequency up to 5000 cycles.

This beat can be extremely annoying—particularly if several nearby radios are tuned to the same station. Then, the multiple oscillators will sound like a conglomeration of “birdies” jamming the desired frequency. Because the broadcast band extends only to 540 kc., there are few problems below 990 kc. In most cities, the frequency assignments of local broadcasters avoid this difficulty with each other. The problem is trying to tune in weak, distant stations near frequencies jammed by oscillators tuned for local stations. Since you can't prohibit

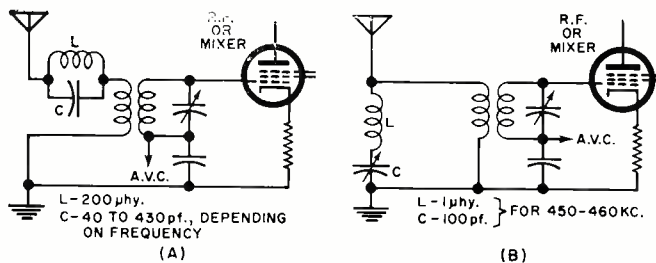

Fig. 3. (A) Series trap and (B) shunt trap. Either can be used to tune out interference coming in on a particular frequency.

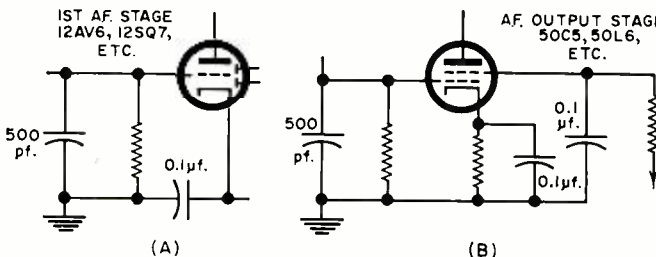

Fig. 4. When r.f. is rectified in the audio stages, it produces unwanted signals. Bypass capacitors are used to prevent this.

the use of such radios, you must use line filters and antenna isolation, putting them on *all* sets (if you can).

Avoid sharing, or parallel, antennas if possible. Where you *must* share, use antenna isolation, as in Fig. 5. Whatever value of *R* you use, put the same value in each feedleg. If each receiver then loses 10% of the signal, it also loses 20% of the oscillator signal. Keep the number of receivers coupled to each antenna to a minimum.

### TV Oscillator Problems

A similar “birdie” problem, mentioned in Part 1, is caused by harmonics of the TV horizontal sweep frequency (15,750 cps) beating with other r.f. signals in an AM radio. Treating the TV set (covered in Part 1) is preferable, but where that isn't possible, or when some trouble still exists, you must turn your attention to the radio receiver. If an r.f. signal (including the local oscillator) in the AM first-detector circuit beats with any TV sweep harmonic having a frequency-difference that is within the i.f. bandpass, the beat will come through—creating a raspy, fixed-frequency squeal. For instance, a receiver tuned to 660 kc. will pick up not only the broadcast station but the sweep harmonic at 661.5 kc. The audio beat is then 1500 cycles. Since this type of interference is a harmonic problem, it can occur *only* at multiples of the TV horizontal frequency. Many heterodynes will fall near the limit, or outside the passband of the i.f., which is why some AM channels are clearer than others. Broadly tuned receivers can be peaked to narrow the response, thereby rejecting many of the TV sweep harmonics.

To reclaim more signals, selective rejection is required. This means using a crystal filter, “Q”-multiplier, “Selectoject,” or a null filter. These

(Continued on page 84)

Fig. 5. Resistive isolation for AM sets using a common antenna.

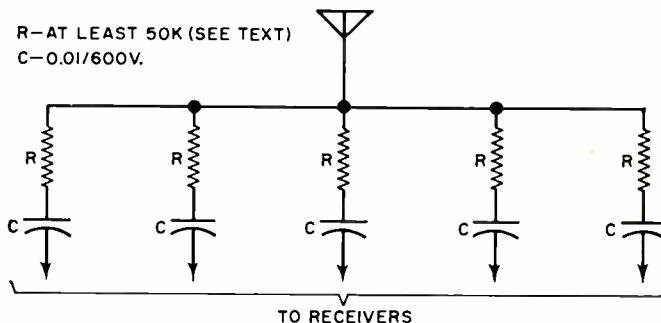

# HOW BIG IS YOUR VOLT?

By ROBERT JONES

*Characteristics of available voltage sources and methods of spot checking an overloaded meter to determine to what degree accuracy is impaired.*

**A**LMOST every technician has at some time overloaded a meter and wondered if its calibration had been affected. At this point, the first thing he usually does is locate some previously measured voltage or current to enable him to evaluate the damage. This is a crude method, since it usually depends on memory, as well as the stability and regulation of the source of voltage or current.

Giving up in disgust, he usually consoles himself with the thought that since the meter reads somewhere near correct, the instrument is working properly. Then he views with suspicion any reading that must be quite accurate.

The following survey of voltage sources provides a ready reference as to the accuracy that can be expected from each of the common sources available to the experimenter.

## Dry Cell

The common flashlight battery is usually the first thought as a source of voltage. In a new cell, nominal voltage is 1.581 with a variation of 60 millivolts above or below this value, while internal resistance averages 0.34 ohm with a variation of 0.09 ohm above and below this value. Variation in voltage due to temperature is 69  $\mu\text{v}$ . per degree F for each degree change above or below 70°F. As the cell ages on the shelf, the voltage drops 6 mv. per month. In addition to all this, the age of the cell since manufacture may be on the order of 1 to 6 months, depending on demand. This demand figure includes the demand on the manufacturer, wholesaler, and retailer. Under these conditions, the cell could not be depended on for a no-load voltage of better than 1.581 volts plus or minus 0.078 volt or 4.9% tolerance, at 70°F.

## Storage Cell

The lead-acid storage cell is usually the second choice, since it can be found in any car. The characteristics of this cell at 70°F are: voltage at full charge is 2.09 to 2.12 volts depending on cell condition and representing a tolerance of 0.71% from the nominal of 2.105 volts. Temperature affects the voltage by virtue of changing the density of the electrolyte and accounts for about minus 0.3% change in voltage for each 10°F increase in temperature.

For a conventional car battery, a trickle charge of 50 ma. will maintain the cells at 2.20 to 2.23 volts. While the voltage of each cell varies with the density of its electrolyte, the problem in relating the specific gravity to voltage is in the accuracy of battery hydrometers. Some commercial hydrometers can be in error by as much as 10%. The voltage tolerance represented by this is on the order of 5%. Before any reading can be taken on a wet cell, it must be agitated to make sure that electrolyte concentration is constant throughout the cell. Agitation of the battery is necessary where the cell has been charged or discharged less than 12 hours before a voltage reading is to be taken, or if the cell has been idle for more than two weeks prior to the voltage reading. The internal resistance of the car battery runs on the order of 0.002 ohm, and therefore has an extremely small voltage variation with small current loads. If the voltage is known accurately, this is a fine source for calibration of milliammeters and ammeters. If the voltage is known, the current flowing through the circuit can be calculated by Ohm's Law

if the internal resistance of the measuring meter is known.

To use the battery as a voltage source requires an hydrometer and a thermometer, to allow a voltage tolerance of 0.71% from a nominal of 2.105 volts. The hydrometer gives a constant reading. This constant reading tells us that the cell is fully charged. By correcting for electrolyte temperature and shaking the cell gently, voltage tolerance will remain at 0.71% at 70°F for a fully charged cell.

## VR Tubes

Tubes such as VR75, VR90, VR105, and VR150, each regulate a source of supply and this can be used as a reference voltage. Unfortunately, the past history of these tubes must be known. Some tubes drift badly even when a constant current is supplied to them. The drift can easily be as high as 10%. If the drift is found to be negligible, the nominal voltage drop across a typical VR75 equals 68 to 85 volts plus or minus 6.5 volts for a current range of 5 to 40 ma., representing a tolerance of about 19% from 76.5 volts nominal. Similar

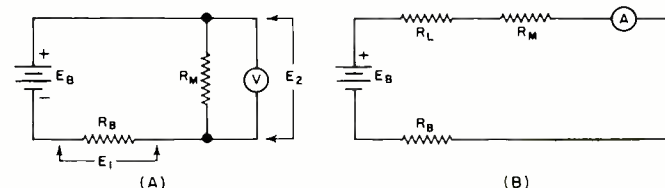

Fig. 1. (A) Voltage and (B) current calibration circuits.

results could be shown for other voltage-valued VR tubes.

Voltage regulators such as the 991, have a voltage variation between tubes of 48 to 67 volts. The nominal is 57.5 volts plus or minus 9.5 volts or a tolerance of 16%.

## Mercury Cell

Mercury cells are usually the least common type of cell available. While all of these cell types have good voltage stability, the R.M.-42R has the greatest advantage, having a very-low internal resistance. The characteristics of this cell are: average voltage 1.3569 with a cell-to-cell variation of plus or minus 150  $\mu\text{v}$ . Temperature variation is 43  $\mu\text{v}$ . per degree F for temperatures above or below 70°F, increasing voltage with increasing temperature. Internal resistance is 0.75 ohm per cell with a variation of plus or minus 0.30 ohm. Shelf storage causes the cell to lose voltage at the rate of 360  $\mu\text{v}$ . per month. (These conditions are for new cells only.) Since this cell is not in great demand, the age of the cell is always in doubt. The average age can be considered as 7 months, assuming a production run every year and possibly 1 month minimum delay from the date of manufacture to the time it arrives in the consumer's hands. This means the cell could be 1 month to 13 months old. The average of 7 months would appear reasonable. This uncertainty of age represents a possible open-circuit cell voltage variation of 4320  $\mu\text{v}$ . To reduce this error as much as possible, the nominal voltage of a cell in the consumer's hands is considered to be 1.3544 volts plus or minus (2160  $\mu\text{v}$ . for age uncertainty plus 150  $\mu\text{v}$ . for original cell-to-cell

(Continued on page 75)



Switches were mounted to allow one-hand operation.

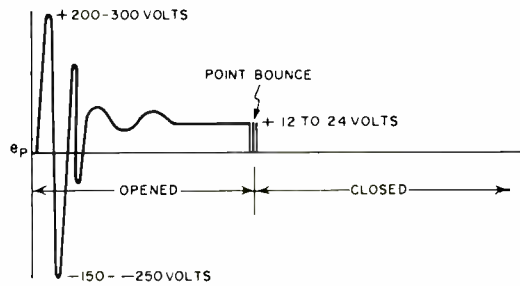

(A)

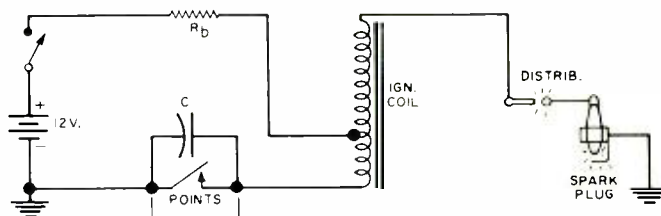

(B)

Fig. 1. Typical ignition system showing breaker-point voltage.

# SIMPLE DWELL METER

By T. C. PENN

*If your car's points stay closed (dwell) too long or too little, the engine performance will suffer. Here is how to measure this factor.*

THE use of a dwell meter to adjust the spacing of the breaker points of an automobile is well known to mechanics and becoming familiar to the "do-it-yourselfer." Several transistor circuits of varying complexity have been published for dwell meters. In view of these previously published circuits, a circuit as simple as the one to be described might well be viewed with skepticism. Aside from justifying the simpler circuit on the basis that it has been used successfully for the past two years, it will be shown that this dwell meter is even more accurate than some of the circuits that have been published in the past.

Before touching on the details, some discussion of what a dwell meter can and cannot do might be worthwhile. For example, a dwell meter will not insure "up to 20% more horsepower" nor "up to 5 more miles per gallon of gas." A dwell meter by itself is useful only in adjusting the breaker-point gap in the distributor. It is very useful with modern engines which provide for such adjustment while the distributor cap remains in place. A dwell meter is also useful in checking the breaker point condition of older engines since it replaces the function of a gap gauge.

Each time the cam lobe of the distributor pushes open the breaker points, a spark plug ignites. Changing the dwell angle (during which the points remain closed) changes the point spacing and obviously changes the angle the cam makes when the points first open. In other words, it should be appreciated that any adjustment of the breaker-point gap requires that the engine be re-timed.

The mechanical-electrical characteristics of most single breaker point ignition systems are chosen to hold the points closed (dwell) twice as long as they are open. The dwell duty cycle is therefore two-thirds and that is really all that needs to be remembered regardless of the number of cylinders. Not every model of every car has been checked, so you are encouraged to check the specs of your own car.

An eight-cylinder engine has a timing cam which turns 45°

between the successive firings of spark plugs. The nominal dwell angle is two-thirds of this angle, or 30°. In a six-cylinder engine the timing cam rotates 60° between ignition times and thus the nominal dwell angle is 40°. A tolerance of ±5% is quite acceptable.

Faulty dwell settings produce undesired results, as might be expected. If the dwell angle is too small, the current in the primary of the ignition coil does not reach its proper amplitude at high speeds. This causes the ignition coil voltage to decrease. In addition, the breaker points are thrown open so wide that severe contact bounce results when they close. If the dwell angle is too large, the points are not opened wide enough and arcing will take place across the points, resulting in decreased point life and low voltage.

The dwell meter to be described is based on the same principle as that illustrated by the old electronics riddle. "An electrical black box has three terminals accessible for an ohm-meter check. Terminals 1 and 2 (Continued on page 88)

Fig. 2. Circuit diagram of dwell meter designed by author.

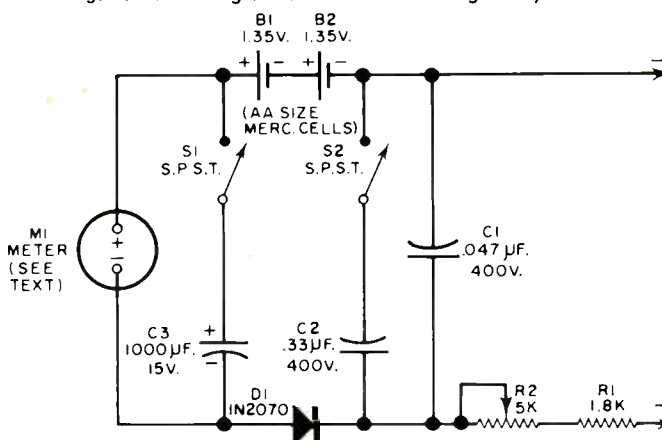

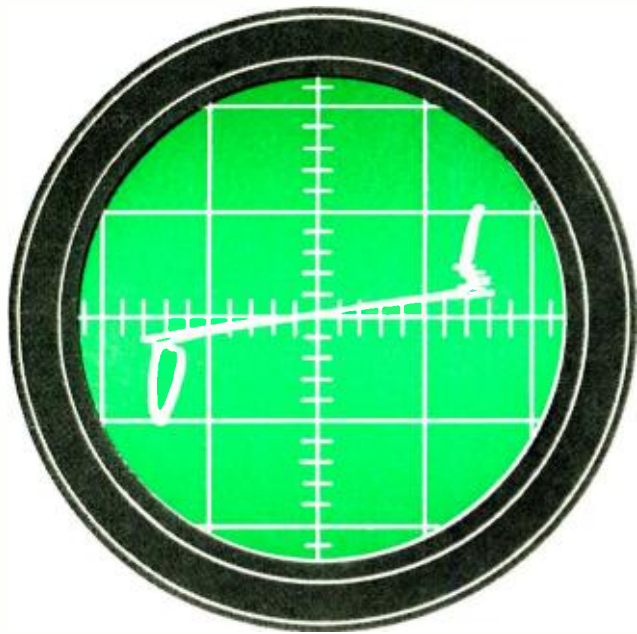

By JIM KYLE

# DIODE CURVE-TRACER & ANALYZER

**A simple instrument that checks forward resistance, reverse resistance, and p.i.v. of semiconductor or vacuum-tube diodes, using oscilloscope as readout.**

**T**ECHNICIANS, radio amateurs, and experimenters often need to know the dynamic operating characteristics of a diode (either vacuum-tube or semiconductor). For example, semiconductor diodes may be purchased in bulk at reduced prices, but their characteristics may not be fully known. If the technician has a quick and simple means of determining the essential characteristics—forward resistance, reverse resistance, and peak inverse voltage—of such diodes, he will be able to use the diodes properly.

In addition, the same three tests offer a complete check of a diode in any circuit. Thus a diode analyzer capable of giving immediate readings of all three characteristics is useful both as a laboratory sorting device and as a troubleshooting instrument. The instrument described here performs all three tests simultaneously and provides immediate readout in the form of an oscilloscope trace which is the complete characteristic curve of the particular diode that is under test.

While many diode curve tracers have been described in the past, none has included full capability for making all three measurements over a full range of voltages at which diodes may be used. The instrument described here is useful with both low-voltage units, such as the 1N34, and with power diodes up to 600 p.i.v. The only adjustment required in going from one extreme to the other is a resetting of the horizontal gain control of the associated oscilloscope.

## Circuit Operation

Operation of the unit is similar to that of several previous curve tracers with two modifications which provide the extended range. The basic theoretical circuit is shown in Fig. 1A, while the practical circuit (including the modifications) appears in Fig. 1B.

Fig. 1A shows an a.c. generator feeding a load composed of the diode under test and a load resistor in series. A d.c. scope is connected with its ground terminal to the junction of the diode and the load resistor, while the other end of the load resistor connects to the vertical deflection input. The horizontal input of the scope is connected to the "hot" end of the diode.

Thus the vertical deflection of the scope shows the voltage across the resistor while the horizontal trace shows the voltage across the diode junction. However the resistor is in series with the diode as far as the generator is concerned so that the only voltage that can develop across the resistor is that resulting from current flow through the diode.

This makes the vertical trace height proportional to the current through the diode, while the horizontal trace depends

on the voltage across the junction. Since these are the same parameters plotted on the conventional characteristic curve, the scope display will correspond exactly to the conventional curve.

Previous curve tracers based on this principle have employed low-voltage generators, usually in the neighborhood of 2 to 8 volts, to prevent damage to the diode. This presents an excellent display of the low-voltage characteristic of the diode, but can tell nothing about the peak-inverse-voltage characteristic, usually called the "zener point" in referring to power diodes.

The simple circuit of Fig. 1A might be used with some scopes to measure p.i.v. simply by raising the a.c. supply voltage to around 1250 volts peak, and increasing the value of the load resistor sufficiently to limit current flow to a safe value.

However, with the author's scope such an attempt led to failure. This scope, and possibly other scopes as well, employs a cathode-follower input stage on both vertical and horizontal amplifier chains, with no attenuator between the input terminal and the cathode follower. As a result, even with no diode in the circuit, an excellent display was achieved showing good forward conduction and a "zener point" at 185 volts. This display resulted from clipping in the cathode follower when it was hit by a 1250-volt peak signal.

Raising the supply voltage to encompass the zener point of conventional power diodes was one of the modifications; we will now examine the other.

**Completed analyzer constructed by author shown connected to scope. With power on, there are 625 v. peak across terminals.**



Several attempts to introduce attenuation ahead of the scope failed because they loaded the diode and/or generator to such an extent that available voltage across the diode dropped to unusably low values.

Finally, the arrangement shown in Fig. 1B was tried. The accompanying scope-trace photos show the result.

In this circuit, the diode is subjected to full supply as in the basic circuit of Fig. 1A. However, both the current-derived voltage across the resistor of Fig. 1A and the diode-junction voltage, are sampled by the divider made up of the 4700-ohm and 1-megohm resistors in series. Tolerances, by the way, are not at all critical since the completed analyzer is calibrated in use and depends not at all upon close-value components.

Thus, if 600 volts (peak) are developed across the diode, less than 3 volts will appear across the associated 4700-ohm resistor. Even the full 1250-volt (peak) supply allows only some 6 volts to appear at the scope input terminals. These voltages are well within the acceptable input values for any scope.

The entire tracer, except for the scope, is built into a small metal box; the transformer is one salvaged from a junked TV set (a smaller unit would result if a *Triad* R-43C scope power transformer were used). The front panel contains a

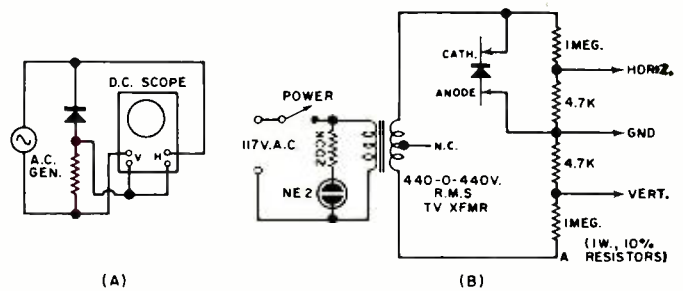

Fig. 1. (A) Basic circuit of curve tracer. (B) Practical circuit applies up to 625 volts peak to diode that is under test.

Set the scope for external horizontal input, plug in the analyzer, and turn the power switch on.

The resulting trace should show a near-vertical line at its right-hand end; the base-line may be slanting, or it may be almost horizontal. The "zener point" may or may not be visible, depending on the p.i.v. characteristic of the diode picked.

Adjust the vertical gain control of the oscilloscope for a convenient trace height; we are more interested in the base-line slope than in the height of vertical portion.

To calibrate the horizontal trace in terms of voltage, either

Fig. 2. Calibration trace using VR-150 tube connected across test clip. Horizontal distance between pips is 300 v. The loop effect is due to phase shift in scope amplifiers. Wiggly portion of trace (right) is damped tube oscillation.

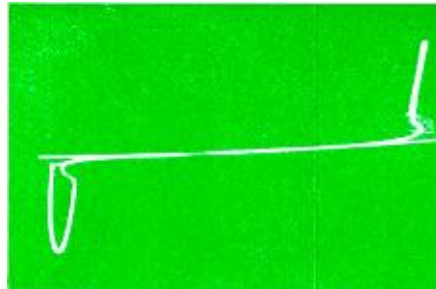

Fig. 2

Fig. 3. Good germanium crystal diode shows sharp forward-conduction trace (vertical line with some scope phase-shift evident) and bend in reverse characteristic. P.i.v. is about 10% to the right of bend in reverse characteristics trace.



Fig. 3

Fig. 4. Curve of faulty diode, superimposed on 300-volt calibration trace. The dark markings are at 50-volt intervals. Diode was rated at 400 p.i.v. When photo was made, p.i.v. (shown by double-looped trace at extreme right) was only 25 v.

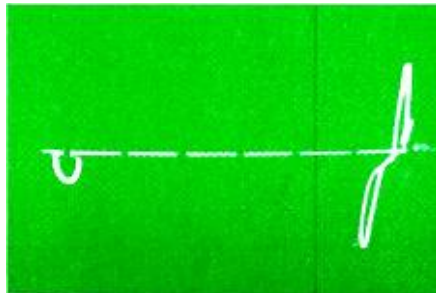

Fig. 4

Fig. 5. Double-exposure trace photo shows 200-volt rated diode curve at top and 300-volt calibration trace below. This diode appears to be good for at least 425 volts p.i.v. although only rated at 200. No zener point could be detected.

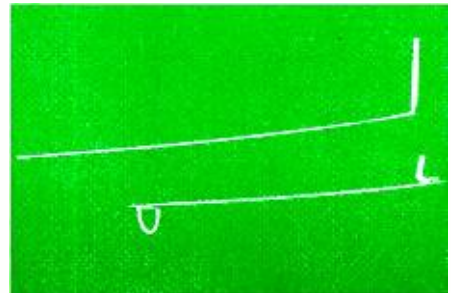

Fig. 5

power switch, pilot bulb, two connectors for scope leads, and the diode-under-test holders. These spring clips for holding the diode were made from Vectorboard components; a 1" x 3" piece of Vectorboard (the kind with .093-inch diameter holes) was obtained and two Vector Type T-30 springclips. While the springclips are intended to hold component leads in a vertical slot for lab breadboard work, the author finds that merely pressing the diode lead against the side of the clip makes a firm contact for testing purposes. Holes 1/4-inch in diameter were drilled in the panel to clear the clips, since one is some 625 volts above case potential. *The high potential present on the clips makes caution necessary when using the analyzer.* However, it is perfectly safe just as long as the power is always off when changing from one diode to another.

#### Calibration

To use the analyzer, connect its output leads to the scope. Any kind of scope may be used; the only reason a d.c. instrument is specified in Fig. 1A is to avoid the need for recentering the trace from diode to diode. Place a diode known to be good in the test clips, observing cathode-anode polarity.

a VR tube or a zener diode may be used. Both work nicely.

To use a VR tube, connect its anode and cathode to the appropriate terminals of the diode test clips, using a pair of test leads. Turn on analyzer power. The photo (Fig. 2) shows what you should expect to see; it was made using a 150-volt tube and the distance between pips equals 300 volts (since the tube limits at 150 volts on both positive and negative peaks). Adjust the horizontal gain and centering controls as necessary to place the center of each pip on a graticule line, using lines which are even multiples of 3 apart. If the pips are spaced 3 inches apart, then a distance of 1 inch on the horizontal axis will equal 100 volts.

The vertical gain can also be calibrated by using a 105-volt VR tube from the "hot" end of the 1-megohm resistor (point A in Fig. 1B) to scope ground. Adjust vertical gain so that the distance between pips equals 21 graticule divisions (peak-to-peak voltage across tube is 210 v.), and each division will then be equal to 10 microamperes of current through the diode.

Once the gain controls have been calibrated, they should not be disturbed. (Continued on page 90)

# COMPUTER LOGIC FUNDAMENTALS

By SAMUEL LUKENS / Applications Engineer, Sylvania Semiconductor Div.

*"Shall I play golf tomorrow?" If you program a digital computer properly, it will make the decision for you.*

A DIGITAL computer is a high-speed electronic device capable of many thousands of arithmetical operations in a span of time measured in seconds. Thus, many time-consuming arithmetical operations that formerly took hours or even days to perform, can now be done in moments.

If we look at the "innards" of a digital computer, we find that most calculation is based on various forms of electronic circuits that have two stable states, often called "1" or "0," "true" or "false," or any other pair of opposite-sense descriptions. Each of these electronic circuits is called a logic element, and many thousands of them are interconnected to form the logic flow of a digital computer.

A symbolic logic system called Boolean algebra is widely used in designing digital computers and while it is not the purpose of this article to discuss this algebra in detail, we will cover such fundamental functions as "AND," "OR," and "NOT." While many other functions are possible, they are primarily variations of the basic functions which will be described in the following paragraphs of this article.

## Logic Example

Assume that the problem is: "Shall I play golf tomorrow?" Further assume that the decision will be based on three variables: whether or not Tom will play, whether or not Dick will play; and whether or not Harry will play.

For convenience, symbols are assigned to these three variables with *A* meaning Tom will play, *B* meaning Dick will play, *C* meaning Harry will play, and *D* meaning I will play.

To consider all possibilities, some way to indicate when one of the above statements is not true is needed. This is done by drawing a line (called a vinculum) over the statement that is *not* true. Thus *A* means that Tom *will* play while  $\bar{A}$  means that Tom *will not* play. The symbol  $\bar{A}$  is read as "not A."

Let us assume that I will play golf if I can get one other person to go with me. If Tom *or* Dick *or* Harry will play, then I *will* play. In Boolean algebra, "OR" is designated "+", so the expression can be written as  $A+B+C=D$ . This is called a "logical OR" function.

Now, let's change the problem a little. I won't play golf unless we can get a foursome together. If Tom *and* Dick *and* Harry will play, then I will play. Because "AND" can be written as  $ABC$  or  $A \cdot B \cdot C$  (the vertically-centered decimal point also means "AND"), the above statement can be written as  $ABC=D$ . This is called a "logical AND" function.

A third possibility might be that I can't stand Tom, Dick, or Harry. Therefore, if Tom *or* Dick *or* Harry wants to play, I will *not*. In Boolean algebra, this would be written as  $A+B+C=\bar{D}$ . Note that the above sentence could have read

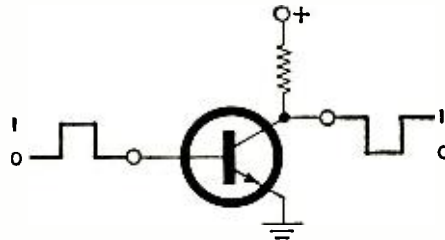

Fig. 1. Common-emitter stage used as an inverter to produce the "NOT" function.

—if neither Tom *nor* Dick *nor* Harry wants to play, I *will* play. This then would be written as  $\bar{A}+\bar{B}+\bar{C}=D$ . It is in this second form that the "NOR" function is most often written, but the two are completely interchangeable.

Another way of expressing it would be to say—if Tom *doesn't* want to play, *and* if Dick *doesn't* want to play, *and* Harry *doesn't* want to play, I *will* play. This can be written as  $\bar{A} \cdot \bar{B} \cdot \bar{C}=D$ . Thus,  $\bar{A}+\bar{B}+\bar{C}=D$  is the same as  $\bar{A} \cdot \bar{B} \cdot \bar{C}=D$ . This is an example of an important

manipulation in Boolean algebra known as DeMorgan's Theorem, which states that the complement of a function is obtained by complementing the individual terms and interchanging the "AND" and "OR" functions.

Suppose that for some reason if Tom *and* Dick *and* Harry (all together) want to play, I *won't* play. This is the "NAND" function, and is written  $\overline{ABC}=\bar{D}$  or  $\bar{A}\bar{B}\bar{C}=\bar{D}$ . This is the

AND $AB=C$			OR $A+B=C$		
A	B	C	A	B	C
1	0	0	0	0	0
0	1	0	0	1	1
0	0	0	1	0	1
1	1	1	1	1	1

NAND $\overline{AB}=C$			NOR $\overline{A+B}=C$		
A	B	C	A	B	C
0	0	1	0	0	1
0	1	1	0	1	0
1	0	1	1	0	0
1	1	0	1	1	0

Fig. 2. Truth table shows relation between input/output of logic element.

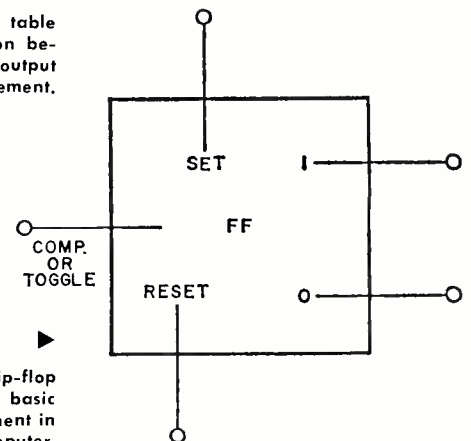

Fig. 3. A flip-flop is used as a basic counting element in a digital computer.



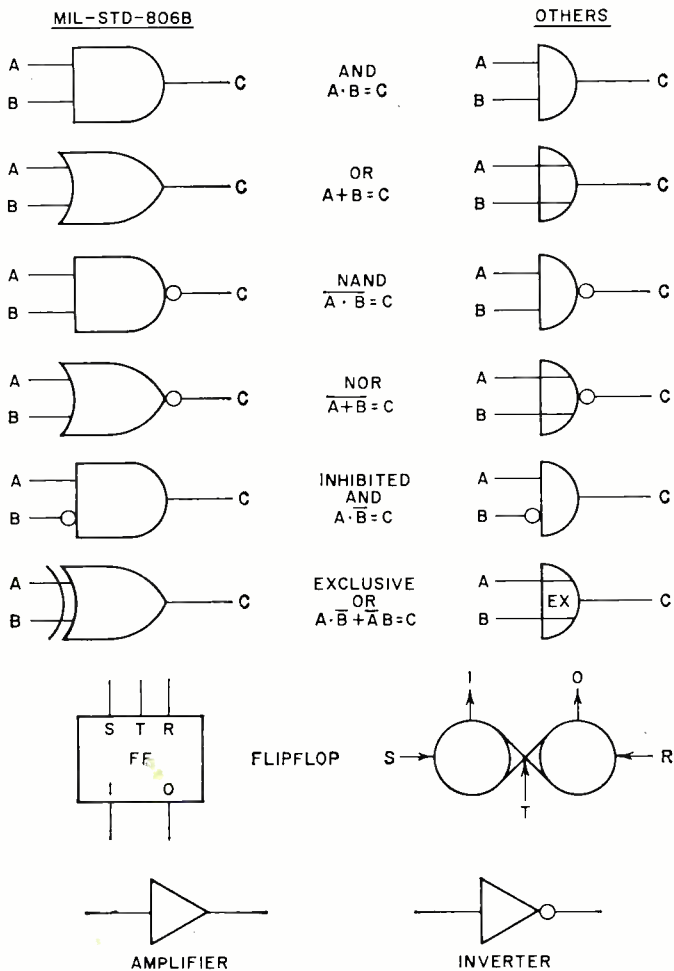

Fig. 4. Some typical symbols as used in logic flow diagrams.

equivalent of saying that if Tom or Dick or Harry won't play, I will play. Thus it can be seen that  $ABC = A + \overline{B} + C$ .

Suppose that I will play if Tom and Dick want to play and Harry does not want to play. This is called the "inhibited AND" function meaning that whenever C is true, D cannot be true. This then would be written  $A \cdot B \cdot \overline{C} = D$ .

One other function to consider is the "exclusive OR." Suppose I will play golf if Tom wants to play and Dick doesn't, or if Tom doesn't want to play and Dick does. If both want to play, or if neither wants to play, then I will not. This would be written as  $\overline{AB} + \overline{AB} = D$  or  $AB + \overline{AB} = D$ .

Having gone through some functions involved in computer logic, we will now define some other terms.

**Gate.** A gate or gate circuit is a circuit that will have an output only when specified conditions are met at the input.

**AND Gate.** This gate will have a "1" output only when there is a simultaneous occurrence of all input variables in the "1" state.

**OR Gate.** This gate will have a "1" output only when one, or more than one, of the input variables is in the "1" state.

**Inverter.** An inverter performs the "NOT" function and will have a "1" output when the input is "0," and a "0" output when the input is "1." A common-emitter transistor circuit, such as shown in Fig. 1, is often used.

**NAND Gate.** A "NAND" gate is an "AND" gate followed by an inverter. It will have a "0" output only when all the input variables are "1."

**NOR Gate.** A "NOR" gate is an "OR" gate followed by an inverter. It will have a "0" output only when one, or more than one, of the input variables is "1."

**Positive Logic.** In positive logic, the most positive relative d.c. voltage level represents the true state or binary "1" and

the most negative relative d.c. voltage level represents the false binary "0" state. Thus, in a positive logic system where voltage levels shift between +6 v. and +1 v., the +6 v. would be a "1" while the +1 v. represents the "0."

**Negative Logic.** In negative logic, the most negative relative d.c. voltage level represents the true state or binary "0."

**Truth Table.** The binary relationship between the input and output of a logic element is frequently shown by a truth table. The table is constructed by writing the letters representing each input and output symbol on a horizontal line. All possible combinations of inputs are then entered under the input letters and the simultaneous resultant binary output for each case is entered under the output symbols. A typical truth table is shown in Fig. 2.

**Flip-Flop.** In addition to logic functions, a logic system must also provide for information storage. In addition to bulk storage memories used for more or less permanent information storage, circuits known as flip-flops are used. The flip-flop is a bistable circuit used to store a single "bit" or binary digit. It normally has two outputs—"1" or "0" as shown in Fig. 3. As these two outputs have opposite sense, they complement each other. A "1" is considered to be stored in the flip-flop when a "1" appears at the "1" output terminal. This will occur after a trigger signal is applied to the "Set" input. The opposite binary state ("0" at the "1" output) will occur after a trigger is applied to the "Reset" input. The flip-flop will reverse state regardless of its initial condition whenever a trigger is applied to the "Toggle" input.

### Graphical Symbols

Some of the symbols used in logic diagrams are shown in Fig. 4. One group is taken from MIL-STD-806B. These symbols are not as yet universally used so some other symbols widely encountered are also shown.

The presence of a small circle at the input(s) indicates that a "0" at this input will cause a "1" output while the

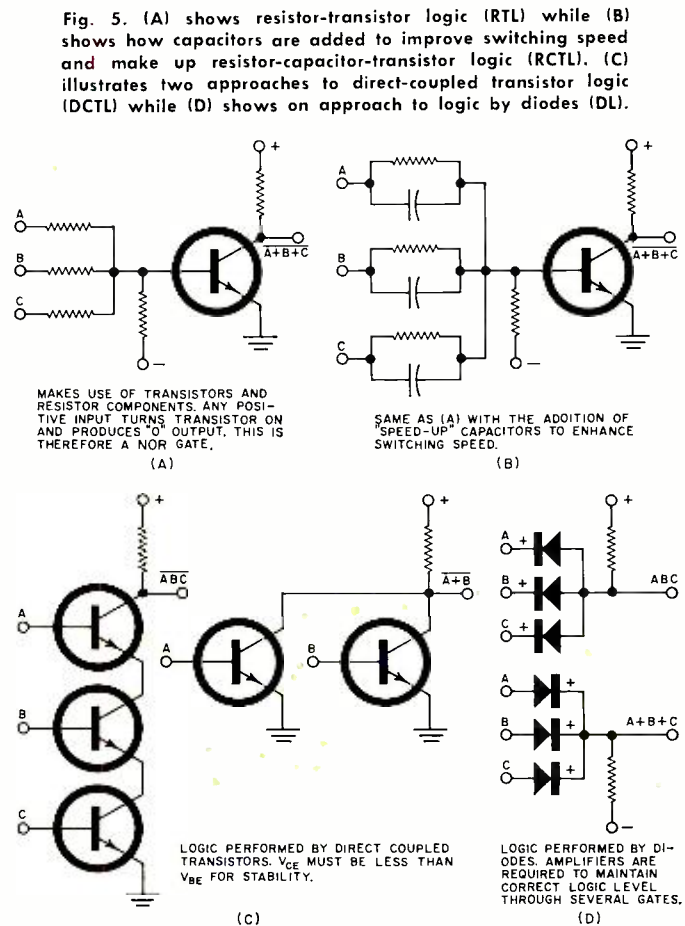

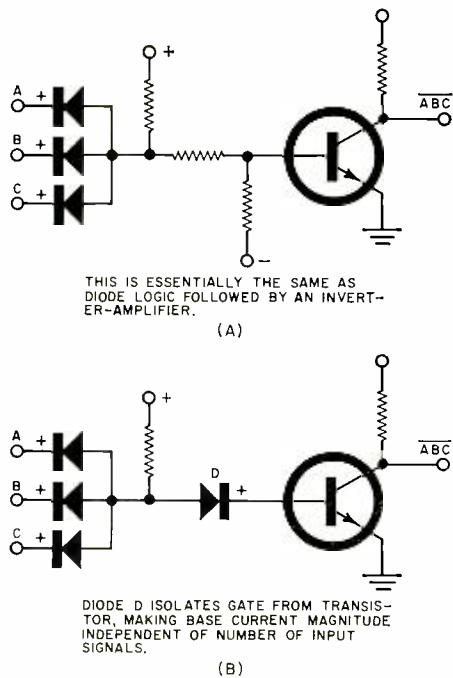

Fig. 6. (A) Shows diode-transistor logic (DTL) while (B) shows low-level logic (LLL) called current-steering diode logic.

small circle at the output(s) indicates that the output will be "0" when the required inputs are "1." The small circle then indicates a "NOT" function. However, the circle is never used on a circuit diagram.

### Logic Blocks

Up to this point, only logic functions have been discussed. To mechanize these logic functions, various combinations of diodes, resistors, and transistors are used. Fig. 5A shows how resistor-transistor logic (RTL) is made up while Fig. 5B shows how speed-up capacitors are added to RTL logic to make up RCTL or resistor-capacitor-transistor logic. Fig. 5C shows two versions of direct-coupled transistor logic (DCTL) and Fig. 5D shows a diode logic (DL) approach.

Fig. 6A illustrates an example of diode-transistor logic (DTL) while Fig. 6B shows a low-level logic (LLL) system that is also known as current-steering-diode logic.

Fig. 7 shows a pair of transistor-transistor logic arrangements (TTL). This is very similar to the low-level logic shown in Fig. 6B.

Fig. 8 diagrams an approach to current-mode logic (CML) in which the transistors are operated out of saturation, allowing very fast switching speeds.

There are a group of miscellaneous terms often found in computer logic diagrams, and their definitions will be given.

**Clock.** This is a pulse generator used in a computer to set the operating frequency and synchronize the passage of

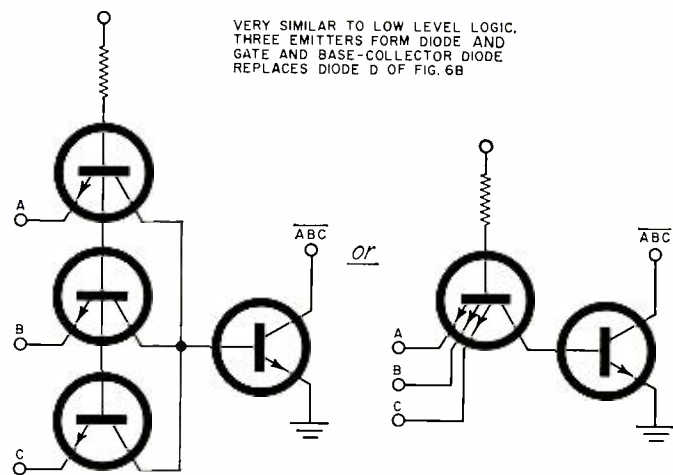

Fig. 7. A pair of transistor-transistor logic (TTL) schemes.

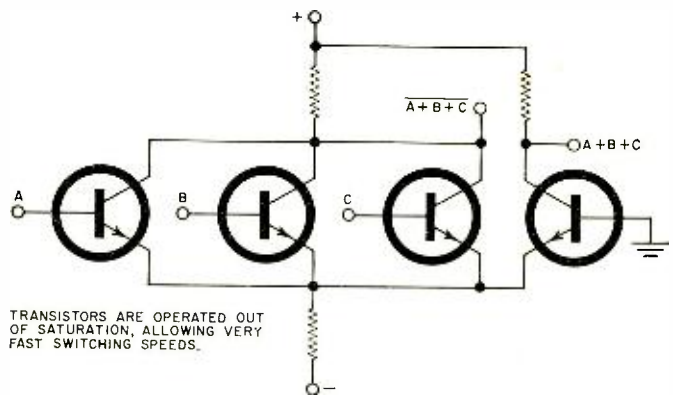

Fig. 8. One approach to transistor current-mode logic (CML).

pulses through the various operating stages of the computer. **Clock Width.** The width of the clock output pulse.

**Fan-In.** The number of inputs to a stage.

**Fan-Out.** The number of parallel stages that can be driven from one of the outputs.

**Propagation Time or Propagation Delay.** The elapsed time between the 50% point on an input pulse and the corresponding 50% point on the output pulses. A measure of the time required for a pulse to pass through a stage. This is frequently measured over several stages in series and then averaged. A typical propagation delay test circuit to make these measurements is shown in Fig. 9.

### Practical Circuits

The first large-scale arithmetic machines used mechanical relays to perform logic functions. There was also a brief period during the rapid growth of computer technology when vacuum tubes were used as the logic elements. However, solid-state devices, represented by the diodes and transistors, are now found exclusively in logic modules. This has led to an enormous reduction in size and weight and has made high-speed, small-size computers practical. ▲

Fig. 9. A propagation delay test circuit is used to measure the time it takes for a signal to pass through several stages. The time is measured and averaged.

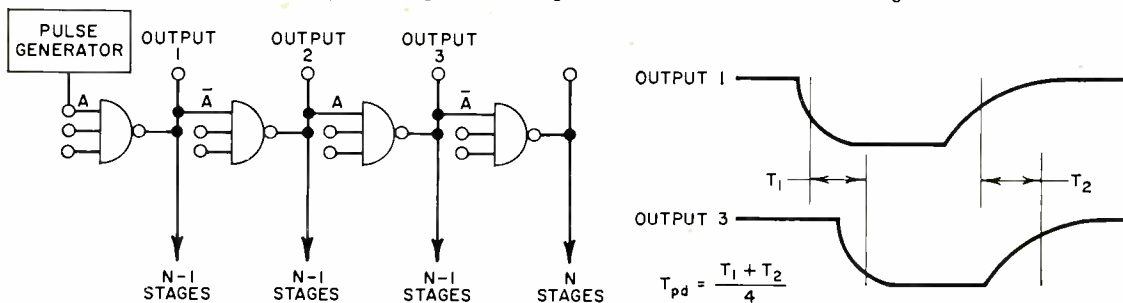

# ***ELECTRONICS* at NASA'S GODDARD SPACE FLIGHT CENTER**

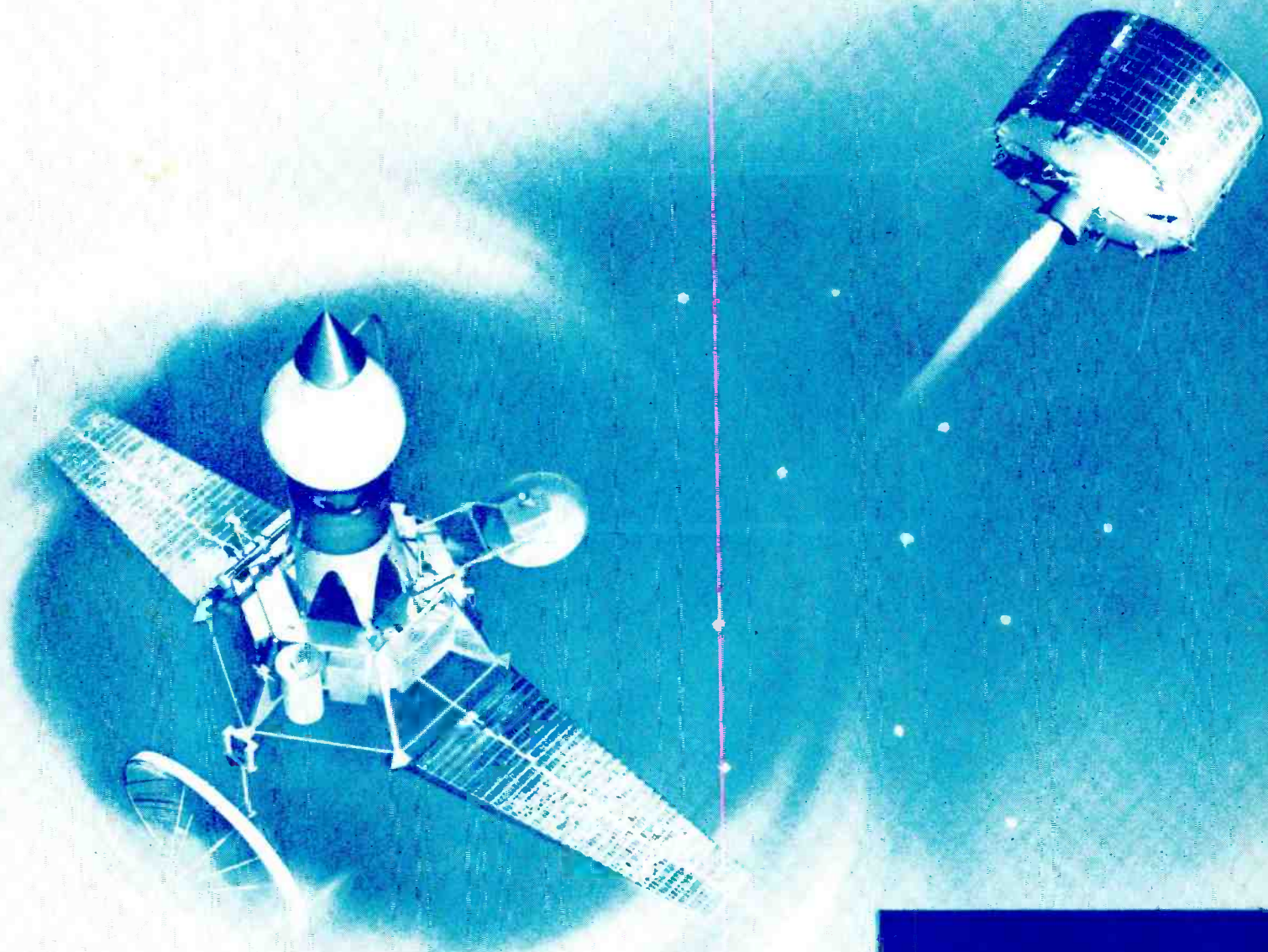



**By DR. HARRY J. GOETT**

Director, NASA Goddard Space Flight Center

Director of NASA's Goddard Space Flight Center in Greenbelt, Maryland, since September, 1959, he joined Goddard from Ames Research Center (NASA), Moffett Field, Calif. where he was Chief of the Full-Scale and Flight Research Division from 1948 to 1959. He has been involved in solving aero-dynamic and engineering problems ever since 1936 when he joined NACA's (National Advisory Council on Aeronautics) Langley Aeronautical Laboratory. Dr. Goett obtained his B.S. in Physics at Holy Cross College (1931) and a degree in Aeronautical Engineering at New York University in 1933. An honorary Doctorate of Engineering was conferred on him by the New Mexico State University of Agriculture, College of Engineering and Science. He has been responsible for some thirty successful satellite projects which carried over 100 scientific experiments. He is now busy supervising NASA's "second generation" of cis-lunar satellites.

## *GUEST EDITORIAL*

**T**HE Electronics Engineer and Technician give "life" to our orbiting scientific laboratories. Without electronics systems, a spacecraft launched into a perfect orbit is worthless. Electronics gives us the capability to communicate, to receive telemetered data, to track, and to command our satellites. Electronics literally extends the hands and senses of our scientists to the far reaches of space.

The space scientist is thus largely dependent on the tools which the electronics engineer can make available to him. This point is emphasized by the fact that about 40 percent of all booster costs, 70 percent of all major spacecraft dollars, and 90 percent of the money spent on tracking and data acquisition equipment goes into electronics. Unfortunately, in this same context, approximately 90 percent of flight failures, not to mention flight delays, result from electronics problems.

Along with the astronomers, astrophysicists, geologists, and meteorologists, the electronics engineer has joined in this search for new knowledge. His role will be a dual one. On the one hand he will be involved in implementing the unique needs of the scientists in their exploration of space. But of potentially greater importance, will be his role of moderator or intermediary between the two worlds of science and human needs. To the professional engineer will fall the task of applying the benefits of the new knowledge, the new techniques, and the new instrumentation derived from our space efforts to an acceleration of our industrial progress throughout the land. ▲

# SATELLITES IN SPACE

By MICHAEL J. VACCARO  
Assistant Director for Administration

*A description of our present and future satellite programs in the fields of space research, communications, and meteorology.*

FROM the vantage point provided by an orbiting satellite or a space probe, Goddard scientists are now attacking some of the most challenging scientific problems of today. Their goal is to "map" outer space and better understand the phenomena and properties of this new frontier and further, to relate these things to life on earth.

## Space Research

The science-in-space program produces much information about our universe and provides important knowledge needed for our manned space flights. The work can be divided into three general areas.

The first concerns the sun itself. Before the advent of the satellite, man could study the sun only through a translucent blindfold, because of the earth's atmosphere. Our present objectives with satellites are to observe sunspots and solar flares which seem to be the cause of many phenomena experienced on earth; weather generation for example.

The second study area is interplanetary space. In this region it is possible to observe the sun's electromagnetic radiation and solar activities unaffected by the earth's magnetic field.

The third region being investigated is the near-earth region called the "magnetosphere." Here the magnetic field of the earth exerts a major influence. At the equator, the magnetosphere extends some six earth radii, or 24,000 miles; at the magnetic poles this shield is much thinner.

Modern space technology has made it possible to build orbiting scientific "laboratories" with which to conduct *extended* observations at and beyond the earth's atmosphere. See Table I. Out of this scientific research we are gaining new knowledge about the universe and its laws; about the earth and its atmosphere; the sun and its influence on the

earth and finally, knowledge about physical life, its origins and fundamental nature.

To date, our scientists and engineers have been responsible for some 30 successfully launched scientific satellites which carried more than 120 scientific experiments. In addition, this team has a launch schedule of approximately 100 sounding rockets per year.

Our scientific satellites have already paid off in expanding man's knowledge. For example, the first U.S. satellite confirmed the existence of the great radiation belt which surrounds the earth; Vanguard I discovered that the earth is slightly flattened at the poles and that an equatorial bulge gives the earth a pear shape.

Observations of the ionosphere have explained some of the mysteries of these layers of ionized gases which have profound effects on radio transmission. Satellites have also detected a layer of helium beginning at an altitude of about 600 miles, possibly extending out some 6000 miles. In this region a concentration of cosmic dust has been discovered which may be related to periods of heavy rainfall.

Other satellites have already provided valuable information on solar flares, solar wind, micrometeoritic activities and temperature, composition and electrification of the earth's outer atmosphere. These and other phenomena continue to be revealed in some 50 miles of magnetic tape recorded at the Space Flight Center from telemetered satellite transmissions each and every day of the year.

## Communications Satellites

The communications satellite program is a success story in itself. A little more than a year after the first active experimental repeater satellite (AT&T's Telstar, launched by NASA) went into orbit, Syncom II was successfully launched into its high-altitude synchronous orbit.

Table I. Scientific satellite projects managed by NASA's Goddard Space Flight Center include those listed below.

PROJECT	OBJECTIVE
● Orbiting Solar Observatories	Studies of electromagnetic radiation from the sun.
● Orbiting Astronomical Observatories	Telescopic stellar observations in the ultraviolet spectrum.
● Atmospheric Structure Satellites	Study of composition, density, pressure, temperature of upper atmosphere.
● Swept & Fixed Frequency Topside Souders	Studies of upper ionosphere.
● Ionosphere Beacon Satellite	Studies of entire ionosphere.
● Interplanetary Monitoring Platforms	Studies of cosmic rays, magnetic fields, and energetic particles in space.
● Orbiting Geophysical Observatories	Broad-scale geophysical studies; radiation belts, ionospheric, and magnetic phenomena.
● Energetic Particles Satellites	Radiation and magnetic fields.
● International Satellites	To provide cooperative experimental capabilities in space.
● Electron Density Profile Probes	Ionospheric electron concentration and radio wave propagation studies.

## WHAT IS GODDARD?

**T**HE Goddard Space Flight Center, a key element of NASA (the National Aeronautics and Space Administration), is the first major United States laboratory devoted entirely to the investigation and peaceful exploration of space with unmanned space vehicles. Established in 1959, the Center was named after America's rocket pioneer, Dr. Robert H. Goddard.

The staff has grown dramatically since the day its first employees, 157 individuals from the Navy Vanguard Project, reported on board. Today, most of the 3600 employees occupy spanking new buildings on a 600-acre site in Greenbelt, Maryland, a Washington suburb. The laboratory currently represents an investment of over \$60 million in structures and equipment. Its employees are responsible for investing about \$1 million per day on some 30 major projects running the gamut of space exploration and technology.

The Center is responsible for complete development of unmanned sounding and earth-orbiting spacecraft experiments in basic and applied science covering three specific areas: communications, weather observations, and advanced scientific technology. Goddard also manages the development and launch of NASA's Delta rocket, and launches Centaur and Atlas-Agena rockets on behalf of other members of the NASA family. Finally, the Center directs two world-wide satellite tracking, data acquisition, and data-reduction networks. These are the Space Tracking and Data Acquisition Network (STADAN) and the Manned Space Flight Network (MSFN).

Due to the extremely varied and complex projects under its direction, Goddard has developed an unusually wide range of talents and capabilities. It is in fact one of the few installations in the world capable of conducting a full-range space science experimentation program as shown below. This involves carrying a concept through theoretical work to experimental design and engineering . . . to payload fabrication and assembly . . . to a complete test and evaluation program . . . to rocket launch and satellite tracking, data acquisition, and data reduction.

Theoretical studies are of course vital to any scientific laboratory. To serve as a center for its basic theoretical research, Goddard operates the Institute for Space Studies in New York City. The Institute staff works with the staffs and graduate student bodies of nearby space-oriented colleges and universities.

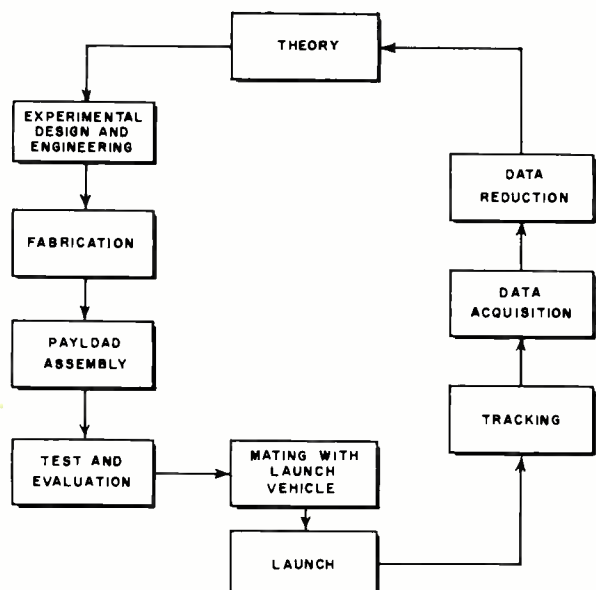

Three lower orbiting active repeater spacecraft had been launched by this time, AT&T's two Telstars and NASA's Relay I. Syncom A had also been launched, had gone into a high synchronous orbit, but had its power supply fail minutes later.

Telstar I was the first active communications satellite which proved that high-quality transmission of telephony and television signals across oceans was possible. Relay I added to this proof. Syncom II, during the first few weeks after launch, was maneuvered into a desired position over Brazil by its gas jet control system. Repeated demonstrations with this satellite exploded the belief that the delay time due to its great altitude would make voice transmissions impossible.

Three Goddard-managed active repeater communications satellites are now in orbit and operating (Relay I, Relay II, and Syncom II), as well as the two Echo balloon passive satellites.

Relay I, an RCA-built satellite launched December 13, 1962, has been aloft the longest making it the veteran among all the active repeater satellites. It weighs 172 pounds and has an 18-inch long wide-band communications antenna extending from its narrow end and four telemetry antennas from the other.

It was designed to transmit one TV signal (both video and audio) or 600 one-way voice channels; or high-speed data, facsimile, or teletype traffic with bandwidths of up to 4 mc. Two completely independent transponders were installed to increase reliability, a design feature that paid off. When a switch in one of them failed, causing a severe voltage drop, it was possible to continue operations by switching to the other transponder.

The satellite transmitter output power of 10 watts (four times that of any prior satellite) permits TV transmission over a maximum slant range of approximately 5000 nautical miles.

Relay I had an electrolytic timer which was scheduled to shut the satellite off one year after launch. It failed to do so and the satellite is still operating, having completed 3420 revolutions as of February 26, 1964, and 299 hours of experiments. The satellite is in a 185-minute round-the-earth orbit of 4620 miles apogee, 820 miles perigee, 47.5 degrees inclination.

Relay II was launched on January 21, 1964 into an orbit with 4600 miles apogee and 1300 miles perigee. Its period is 195 minutes. Like Relay I, it is continuing to function well.

Both satellites have been used in spectacular communication demonstrations, between ground stations in the United States, Great Britain, France, Italy, Brazil, Japan, and Germany.

Syncom II, built by Hughes Aircraft and launched on July 26, 1963, was modified to prevent the high power drain suspected of causing the first Syncom's power supply to fail. Its apogee motor rocket nozzle, which provides the kick into synchronous orbit, protrudes from one end, antenna from the other. Unfueled, the spacecraft weighs about 86 pounds. Power is supplied by 3840 silicon solar cells. Antennas include a slotted array for communications, a dipole for the receiver, and four whip antennas in a turnstile arrangement that is employed for telemetry and command.

Syncom has redundant transponders. One receiver has two narrow-band channels, each with a noise bandwidth of 500 kc. The other's noise bandwidth is 5 mc. The antenna receives at about 7360 mc., transmits at about 1815 mc. at two watts.

Syncom was kicked into synchronous orbit by its apogee rocket when it reached 22,300 miles above the earth. It was used extensively for tests and narrow-band demonstrations between the United States and Africa, between U. S.

Army ground stations at Fort Dix, Lakehurst, New Jersey, and Camp Roberts, California, and the USNS Kingsport, anchored in the harbor of Lagos, Nigeria.

The next Syncom, last scheduled satellite in the series, will be boosted into a true equatorial orbit. This satellite will be used for trans-Pacific experiments, U.S. to the Philippines.

The latest communications satellite to go into orbit was Echo II, boosted by a Thor Agena from the Pacific Missile Range on January 25, 1964. The 135-foot balloon is at an inclination of 81.5 degrees and circles the globe every 108.8 minutes. Its apogee is 820 miles, perigee 635. Echo II is made of heavier material than the still-orbiting 100-foot Echo I. It uses Mylar film that has been sandwiched between aluminum foil.

Russian and English observatories are among the experimenters working with Echo, and using it as a passive reflector for radio signals.

### Meteorological Satellites

The star performer in NASA's meteorological program has been Tiros (Television Infrared Observation Satellite), a hat-box-shaped satellite which has scored eight successes in as many attempts since its maiden flight in 1960. Tiros satellites have supplied the Weather Bureau with more than 300,000 cloud-cover photographs the past four years and have spotted many hurricanes in advance of other conventional means. All weather data received from the satellite is given to the Weather Bureau for analysis.

In addition to supplying stations on earth with weather data, the 300-pound electronic meteorologist has also tested numerous systems to be flown in the second generation Nimbus satellite.

The backbone of Tiros is a maze of electrical wiring and electronic components which power the satellite's television cameras. These cameras operate in two different modes. By commanding the system on when it comes into communication range (1500-mile radius of a tracking station), direct pictures can be taken and read out on the ground. In the other mode the satellite can be commanded to take a series of 32 pictures remotely, store them on magnetic tape, and transmit the video signal to a ground station at a pre-determined time.

When a series of pictures is received on the ground, it is recorded on magnetic tape for permanent storage, and the signals are simultaneously sent through demodulators to a kinescope camera which immediately converts the electrical signals to film.

The Tiros VII satellite carried an experimental camera subsystem, designed for Nimbus, which proved the theory that real-time photographs (taken as the events occur) could be sent to earth from a satellite. The camera system is called Automatic Picture Transmission (APT). APT ground stations are relatively simple and inexpensive (approximately \$50,000 per station). Each station can receive up to three cloud pictures on a normal Tiros pass.

Nimbus, an 800-pound weather satellite, is to be placed into a polar orbit this year. It is a three-axis, earth-stabilized spacecraft that will provide full earth coverage on a daily basis. The earth's rotational movement provides the mechanism for longitudinal coverage while latitudinal coverage is obtained by means of the spacecraft's orbit motion.

Nimbus carries two camera systems—the Advanced Vidicon Camera System (AVCS) and the Automatic Picture Transmission (APT) system. The AVCS system, an array of three TV cameras, can send pictures direct or store the pictures, like the Tiros system, on a tape recorder for later read-out. Pictures from the AVCS camera are transmitted over a 1700-mc. S-band transmitter while the APT pictures are sent using the slow-scan principle used to send radio photographs—over the 136-mc. space telemetry band.

In addition to the camera system, Nimbus uses a high-resolution infrared radiometer to provide cloud-cover data during the dark portion of an orbit. Terrestrial thermal radiation provides the mechanism for nighttime cloud-cover generation.

Further meteorological investigations in the upper atmosphere are carried out with sounding rockets. These relatively small vehicles can carry heavy payloads of instruments above balloon altitudes to study physical properties of the atmosphere, air mass characteristics and patterns, wind speeds and directions, and temperatures.

Various techniques are used to gather the aeronomy and meteorological data, from the commonly known pitot tube to ejecting a trail of sodium vapor and optically measuring its diffusivity.

Beyond the current meteorological space projects Goddard scientists are conducting feasibility studies for placing a weather package into synchronous orbit, approximately 23,000 miles above the earth. At this altitude, the satellite travels at the same speed as the earth and appears not to move. By placing three synchronous satellites into a 24-hour orbit, the entire world's weather conditions can be observed at once from space.

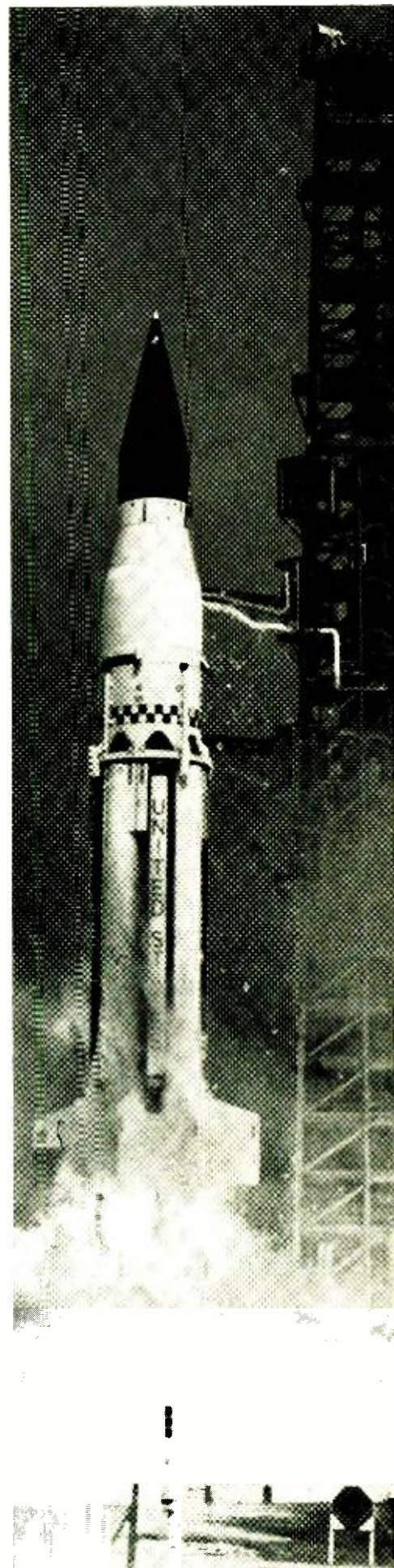

Lift off of Saturn SA-5 from its launching pad early this year. ►

# SPACECRAFT TECHNOLOGY and ELECTRONICS PACKAGING

*Reducing size and weight of electronic and power components while increasing their reliability in outer space is the goal.*

**A**PPLIED research and development in spacecraft power systems technology at Goddard is the job of the Spacecraft Technology Division. This work supports the Center's smaller scientific satellites such as those of the Explorer and Interplanetary Monitoring Platform (IMP) series developed in house.

## Solar-Cell Development

Solar cells convert the sun's energy into the electrical power needed by the various components of the spacecraft. Such power is also used to charge the spacecraft's battery packs to supply energy when the spacecraft is not in good view of the sun. Continued development is underway to devise better ways of employing present solar cell systems as well as developing new and better devices and systems.

Today's solar cell is made up of an outer layer radiation shield bonded to a silicon energy collector. Each solar cell is connected by an electrical interconnector and bonded to a substrate material. The various glasses and sapphire are under study for radiation shielding applications. Epoxies and silicon rubbers are being studied as bonding materials. Several types of solar cell materials (various silicons, cadmium sulfide, and gallium arsenide) are being investigated for possible future use.

One development is a flexible substrate which can be rolled up. A solar-cell paddle using this substrate would employ telescoping rods mounted between two rollers on which the single flexible substrate would be rolled. Once the spacecraft is in orbit, the telescoping rods would be energized to roll out the substrate. Such a solar-cell paddle could be rolled up inside the spacecraft during launch and unrolled once the spacecraft is in orbit.

In an effort to come up with more radiation-resistant solar cells, we are considering new solar-cell structures. One of these, which looks promising, is an  $n$  on  $p$  cell with a built-in drift field. This is produced by controlling the distribution of impurities in the crystal. In such a cell, defects caused by radiation will not impede the flow of current carriers that produce the power.

Although the best efficiency of laboratory-produced solar cells of this type has been about 13 percent, we are looking forward to achieving the theoretical maximum efficiency of 16 to 18 percent.

## Battery Supplies

As one of the sources of steady current required for operation of the spacecraft and its experiments, the electrochemical battery demands particular attention. A major problem is pressure build-up in the cells due to evolved gases. Several approaches to solving this problem are under consideration. These include the recombination of electrodes, the use of control electrodes, and the use of pressure-switching devices. Another problem under attack is

the dendritic growth in zinc electrodes. We are developing new materials which will better survive in the battery environment. Sealing presents another battery problem in the vacuum environment of space.

We are now looking at the type of batteries which will probably be used for emergency and peak power energy sources in planetary base experiments and manned flight. This effort includes investigation of the techniques required to develop and control large capacity cells in the order of 1000 ampere-hours.

## Power Conversion and Control

Present spin-stabilized satellites carry up to six times more solar cells than they would require if the cells were constantly exposed to the sun. By orienting the solar-cell paddles used on many of the satellites, it will be possible to eliminate a number of the paddles and thereby reduce the spacecraft weight.

Under investigation right now is a solar paddle re-orientation system which is designed to function in the vacuum of space and continually point the paddle towards the sun. This system utilizes a brushless torque motor which is expected to mechanize the entire system without the use of any gears, brushes, commutators, or slipping assemblies.

As a possible means of controlling the re-orientation system, we are developing a pulse-controlled technique using a specially designed magnetic-core stepper controller. This controller is designed to draw zero standby power.

The transfer of the d.c. power from the solar-array paddles requires an improved technique because sliding electrical contacts have limited life in space. To get around this problem, we are developing a rotary transformer in which the air gap energy is used in the power conversion system.

All of the new energy sources for spacecraft application have low-voltage and high-current characteristics. This includes nuclear power sources, fuel cells, large-area solar cells, and single electro-chemical power packs.

The fuel cell, for example, can deliver up to 1000 amperes at less than 1 v.d.c. This is insufficient to energize a satellite payload which requires from 12 to 28 v.d.c. To overcome this problem, we have under development a low input voltage converter that will effectively convert 0.8 to 1.6 v.d.c. to 28 v.d.c. output, regulated to  $\pm 1\%$ . This converter employs germanium transistors because their very low saturation resistance allows them to handle very high currents.

Another development in this area is a tunnel-diode low-voltage converter which will operate from a source voltage of approximately 0.25 v.d.c. and deliver about 28 v.d.c.

Space probes designed to operate in the vicinity of the sun or those which will operate with nuclear power



sources require high-temperature and radiation-resistant converters. A study is being made on the practicality of modifying ceramic electronic components to permit their use in conversion equipment capable of operating within a temperature range of 25 to 580° C.

### Development & Spacecraft Integration

The spacecraft technology developed at Goddard is put to practical use by the Center's Spacecraft Integration and Sounding Rocket Division. This division is responsible for project management, engineering development, and integration of the scientific satellites developed in the house.

Getting the most electronics in the least amount of space while minimizing weight and maintaining high reliability is the goal of this division in electronics packaging. For every time the weight of a satellite can be reduced by one ounce, the rocket fuel required to put the satellite into orbit can be reduced by 1000 ounces.

An electronic packaging is made up of an assembly of electronic modules which contain such components as decoders, amplifiers, timers, power converters, and scientific experiments.

In its approach to packaging, Goddard investigates ways of better fitting the modules together as well as the arrangement of components inside the module to save space and weight.

The most advanced module shape under investigation is the delta or keystone. Like the separate slices of a pie still in the pie plate, a series of keystone modules can be placed side by side in a near-circular satellite space. Special interconnectors permit the keystone modules to be stacked one atop the other, thus eliminating the need for weight-consuming racks. These interconnectors also protect the modules from vibration.

We are also looking for better ways of arranging the electronic components inside the modules. The best concept used today is separate plug-in circuits on the circuit boards within the module. By separating each circuit so that individual electronic units can be plugged in, last-minute repairs can be done quickly. In this way, time-consuming solder jobs are eliminated. Due to the method of mounting the units and components on the main printed-circuit board, it can be flexed during handling without damage.

We are also turning to microminiaturized circuits. The principal problem is reducing the power requirements of currently available integrated circuits, particularly for scientific research satellites. One device being developed in this area is a symmetrical complementary flip-flop with a power drain of about 0.3 milliwatt. Currently available flip-flops of this type require at least 3 mw. Advanced circuits that will permit more complex spacecraft computers to be designed within the limited power requirements are also needed.

### Spacecraft Test & Evaluation

Qualifying Goddard's in-house scientific satellites for flight is a function of the Test and Evaluation Division. This division also is capable of handling large scientific satellites such as the Orbiting Geophysical Observatory (OGO) being developed under contract.

This division is equipped with complete facilities and technical manpower to "launch and orbit" a spacecraft inside the laboratory under controlled conditions.

Since a satellite is primarily electronic in nature, the T&E Division maintains an Instrumentation Laboratory which develops special sources to energize and calibrate experiment sensors during tests.

In the eyes of Goddard, the T&E Division serves as a "reliability conscience" for the Center. ▲

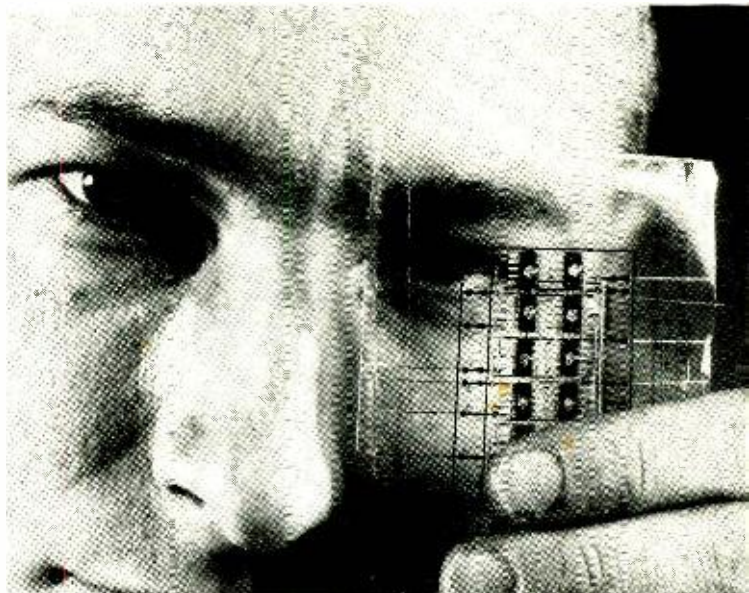

This is an experimental microelectronic circuit that is employed as a 14-bit binary counter. Each circuit is a monolithic block of silicon using all-diffused components.

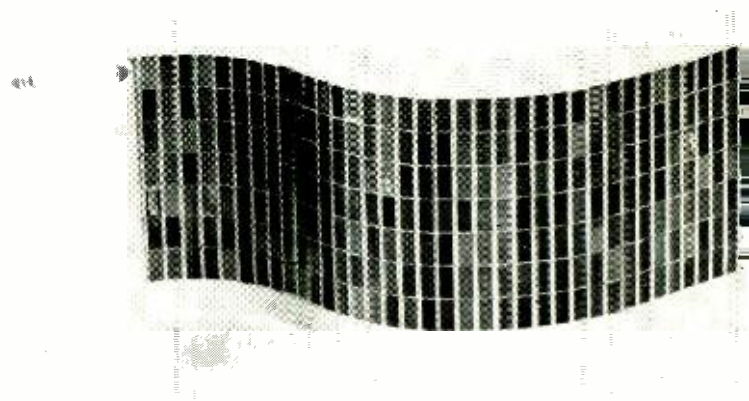

A test model of a flexible substrate on which solar cells have been mounted. The interconnections are designed to facilitate rolling the substrate compactly. A solar paddle constructed of this type of assembly can be rolled up tightly before the launch, and then unrolled in orbit.

Breadboard model of 50-watt inverter that changes a low d.c. voltage to a square-wave output. The inverter is being used as part of a power-conversion system that will change low d.c. voltage (as from fuel cells) to higher d.c.



# MANNED SPACE FLIGHT

Man now stands on the threshold of space. Our first step was Project Mercury, the second will be Project Gemini, and the third, to land men on the moon, will occur with Project Apollo.

**M**ANNED space flight has come into its own as a major part of this nation's total space program. The first step in this area was the completed Project Mercury, which provided the foundation upon which all future space flight programs will be built. It was the project that orbited the first American astronaut.

Project Gemini, the next in the series of space flights, will use a two-man spacecraft for long duration missions and for rendezvous and docking experiments. This project will also provide flight experience and technical knowledge that will be applied to Project Apollo which, according to the best present estimates, will reach the test flight stage about 1965. It will be in Project Apollo that the first astronaut will land on the moon.

## Communication and Tracking

The Manned Space Flight Network (MSFN) is being augmented and modified to support the Gemini and Apollo programs. For Gemini, the network will consist of 9 primary stations including two ships, and 6 secondary stations. The network will be further modified for Apollo to include 9 ground stations using 30-foot antennas, three stations having 85-foot antennas, a checkout station at Cape Kennedy, five instrumentation ships, and several aircraft. The aircraft are needed to maintain voice communications with the astronauts and telemetry coverage of the space vehicle during the critical orbit injection phase. The geographic position of injection will vary widely for a particular day and, in addition, it also shifts each day during the month since the moon is continuously changing

its position with respect to the earth and launching site.

The only reasonable way to provide voice and telemetry coverage is through instrumented aircraft that can be deployed along the path of possible injection points. At the present time, it appears that a total of six aircraft will be used, with two additional as standby.

## Project Gemini

The objectives of this program are to give NASA the necessary experience to go to the moon.

Under present plans, manned Gemini flights should begin late in 1964. The flight phase started with a recent unmanned orbital flight to check over-all launch-vehicle-spacecraft compatibility under aerodynamic loads during the launch phase. There were no plans for the recovery of this assembly. The second flight will be an unmanned ballistic, parachute-recovery flight in mid-1964.

Rendezvous and docking missions will start with the third manned flight and after docking and pre-planned maneuvering experiments, the crew will prepare for re-entry.

The Gemini spacecraft is similar in shape to the Mercury craft, weighs about twice as much and has about 50% more internal volume. The space between the outside of the pressurized crew compartment and the external surface of the craft will house instrument packages, electronics, and landing equipment. This type of construction also serves as a micrometeorite shield. Only systems directly connected with the two-man crew are housed within the pressurized area.

Gemini does not use the rocket escape tower like those

Probable arrangement of flight paths for Apollo to and from the moon including landing and take off of the lunar excursion module.

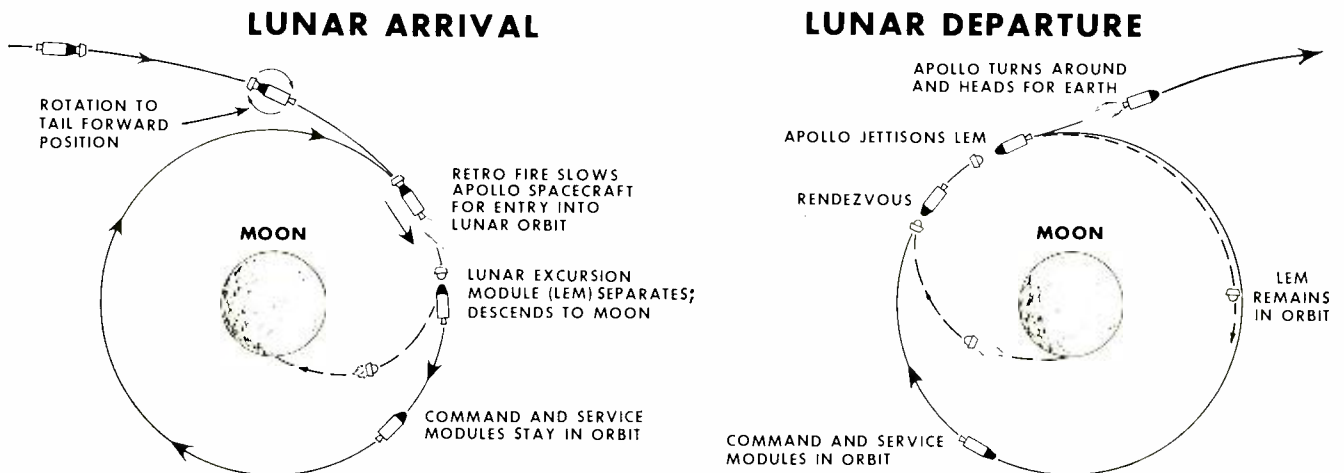

used on Project Mercury vehicles. Instead it uses ejection seats for the two-man crew similar to those used in modern high-performance aircraft. These seats are suitable for Gemini because of the much lower explosive yield of the storable hypergolic (self-igniting upon mixing) fuels used in the Titan II vehicles.

The Gemini launch vehicle is a modified Titan II, a second generation launch vehicle. As this vehicle uses hypergolic fuel, it will have a much shorter countdown than the Mercury-Atlas combination. These short countdowns are necessary because of the tight schedule between launch of the Gemini and rendezvous vehicles.

An Agena-D vehicle will be used as the rendezvous target. This vehicle is 32 feet long and 60 inches in diameter. It will be launched with an Atlas booster with the Agena providing the necessary thrust to propel itself into orbit. Once this happens, the Agena engine shuts down.

Once ground tracking has acquired the Agena, and it is in proper orbit, the Gemini will be launched to arrive in close proximity to the Agena. If necessary, the Agena can wait in its orbit for five days.

As Gemini gets within 250 miles of the Agena, the astronauts use radar and gas jets to control the vehicle's attitude. When the range closes to about 20 miles, the astronauts will be able to see a high-intensity flashing light aboard the Agena. Final docking to the Agena will be made by gas jet thrusters. An index bar on the Gemini capsule will engage a slot in the docking collar of the Agena. When the two vehicles are clamped together, various electrical connections will be made automatically. This will enable the Gemini pilots to start the Agena engine for experimental maneuvers.

Since Project Gemini has mission potential of up to 14 days, special spacesuits that enable the astronauts to remove some sections have been designed. Also, at some times during the mission, the pilots—one at a time—will unlatch their hatches and climb out of the spaceship for up to 15 minutes, protected by their spacesuits and an auxiliary oxygen pack strapped to their legs.

### Project Apollo

This is the biggest and most complex project of the U.S. manned space flight program. Its goal is to land Americans on the moon and return them safely to earth.

The Apollo spacecraft will consist of three sections, the command module, the service module, and the lunar excursion module. The 5-ton, 11-foot tall, 13-foot base diameter command module houses the three-man crew and their support equipment, and will be the only section that returns to earth. The service module contains the fuel and engines to propel the entire craft into and out of lunar orbit; this section will weigh about 24 tons and measure 23 feet high, and about 13 feet in diameter and will be jettisoned prior to earth re-entry. The lunar excursion module (LEM) will carry two men from lunar orbit to the moon's surface. Braking rockets will allow the LEM to hover and land gently on the lunar surface. Four 8-ft long legs, straddling a 27-ft circle, will telescope about 2 feet to absorb landing forces. The astronauts, weighing about 37 lunar (225 earth) pounds, will exit the LEM and explore the area. The legs and landing rocket framework will support the LEM in a take-off attitude and will be left on the moon's surface when the astronauts, together with an 80 pound load of lunar material, ascend to the command module in the remainder of the LEM vehicle.

Fully fueled and assembled, the LEM will weigh about 14 tons, be about 20 feet high, and have a nominal diameter of about 10 feet. The LEM section that leaves the lunar surface will weigh about 4 earth tons (approximately ½ lunar ton). After the crew and lunar samples transfer to the command module, the LEM section will be jettisoned. ▲

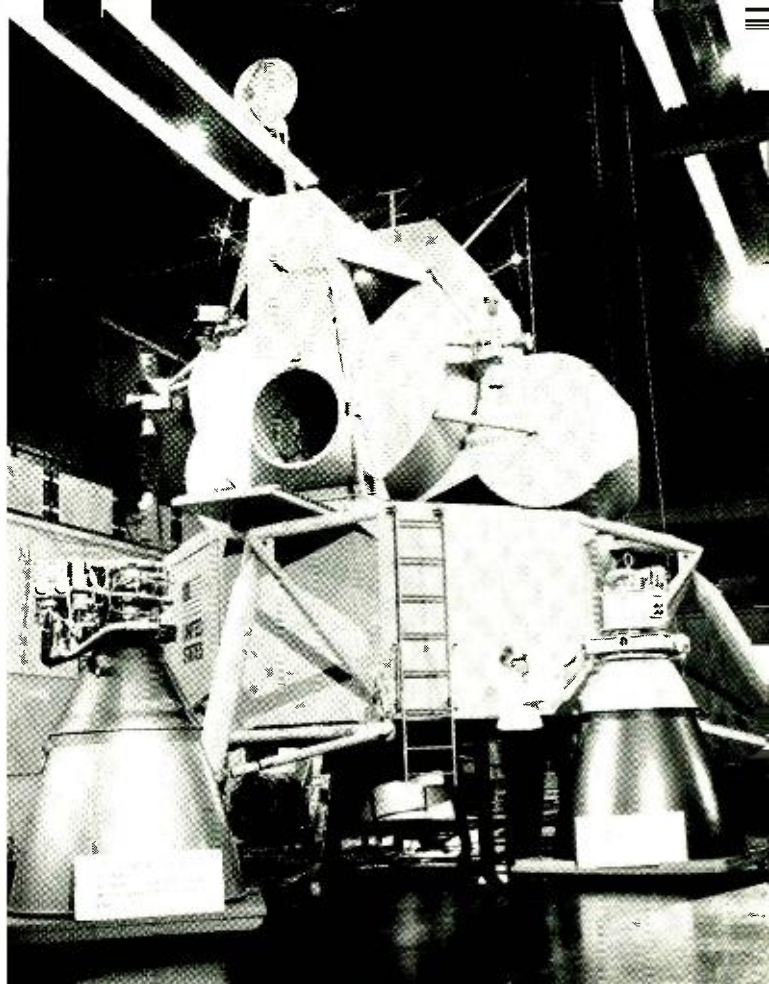

This is a model of NASA's Lunar Excursion Module (LEM). This two-man spacecraft will be separated from the lunar orbiting command module and bring the astronauts to the moon's surface.

(Below, left) Full-scale model of the Apollo vehicle. The Lunar Excursion Module fits into the lower section while the upper section houses the three astronauts. The service module is the center section. (Below, right) The Gemini I spacecraft being raised for mating with a Titan II booster. Similar to a Mercury capsule, the Gemini will carry two men into space.

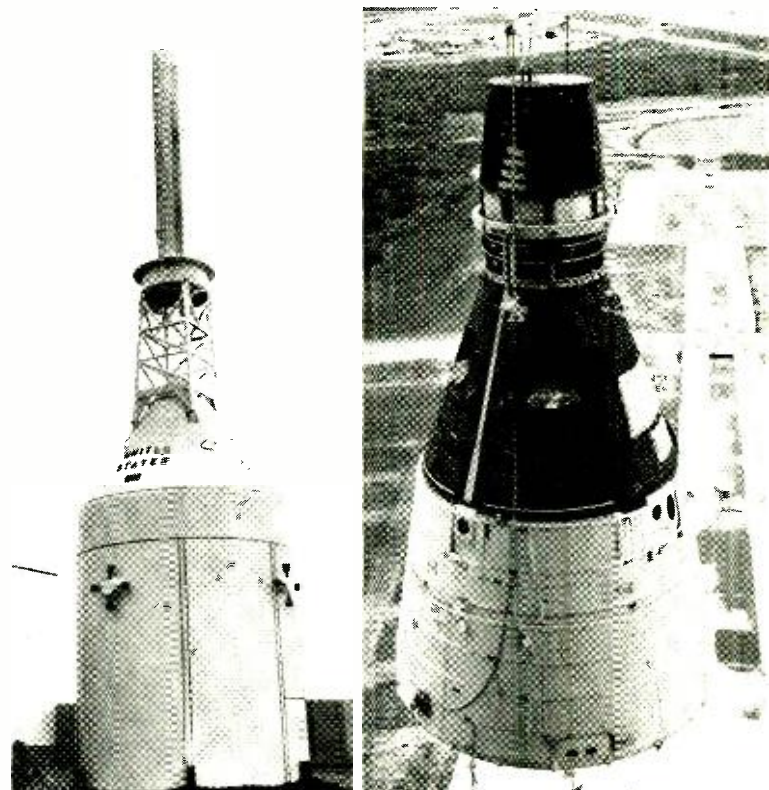

# SATELLITE TRACKING, TELEMETRY, and COMMUNICATIONS

By JOHN T. MENGEL / Assistant Director, Tracking and Data Systems

*Two major satellite tracking networks, one for manned and the other for unmanned flights, interconnected with a communications and computing network, make Goddard the nerve center for all the U.S. space operations.*

A SPACECRAFT with the finest scientific instruments, launched perfectly into orbit, is worthless unless it can be tracked and its scientific information recorded at ground stations.

To accomplish this task, Goddard serves as the tracking, communications, and computing hub of NASA's global network of stations for both manned and unmanned earth satellites. The Jet Propulsion Laboratory, working in conjunction with Goddard, operates three deep-space instrumentation facilities for tracking and data acquisition of lunar and planetary satellite projects, while the Smithsonian Astrophysical Observatory directs a twelve-optical-tracking-station network for NASA. The over-all ground support network consists of 41 ground stations and two ships, located in 13 foreign countries and the United States. Of this global network, some stations just track satellites, others receive telemetry, while still others have capabilities for tracking, telemetry, and in case of manned flights, some stations have provisions for controlling certain functions within the spacecraft and maintaining voice communications with an orbiting astronaut.

## Networks

To meet the demands for various space shots, Goddard has established two basic ground-station networks; one for unmanned satellites called STADAN (Space Tracking and Data Acquisition Network); and the other called MSFN (Manned Space Flight Network), used for manned space operations.

The STADAN network consists of 18 stations which includes eleven stations of the original 13-station Minitrack

Network, whose basic equipment consists of a 136-mc. radio interferometer, ground-command transmitters, telemetry data recording systems, and various ground communications terminal equipment; three stations used only for data acquisition having 85-foot antennas; and four data-acquisition-only stations having 40-foot antennas.

Both the 40- and 85-foot data acquisition antennas are of the X-Y mount type eliminating gimbal lock problems at the zenith for low-altitude, high-angular rate satellite passes. These antennas are self-tracking at 136 mc. and by throwing a switch can transfer auto-track to either 400 or 1700 mc. without any delay. They will be a major element in allowing the Nimbus, OAO, EGO, and the advanced OSO satellite programs to meet project requirements for data bandwidth and range.

The heaviest load on the STADAN network is the reception and recording of telemetry data from the various scientific and applications satellites. All of this data is transmitted to Goddard for reduction into the form required by the experimenters. The volume of this traffic is increasing rapidly. At one time it averaged between 500 and 700 rolls of half-mile-long magnetic tape per week; it is now approaching 1500 rolls per week.

Each of these tapes contains the combined telemetry and time-of-receipt signals as received at the STADAN station. The tape is evaluated at the data processing center.

The MSFN network uses 14 land-based tracking and data acquisition stations and 2 ocean stations. These were previously established for Project Mercury. The system spans three continents and three oceans and is interconnected by a communications network using land-lines,

Besides the 29 stations shown here, Goddard also uses 12 optical tracking stations and two tracking ships in its world-wide system.

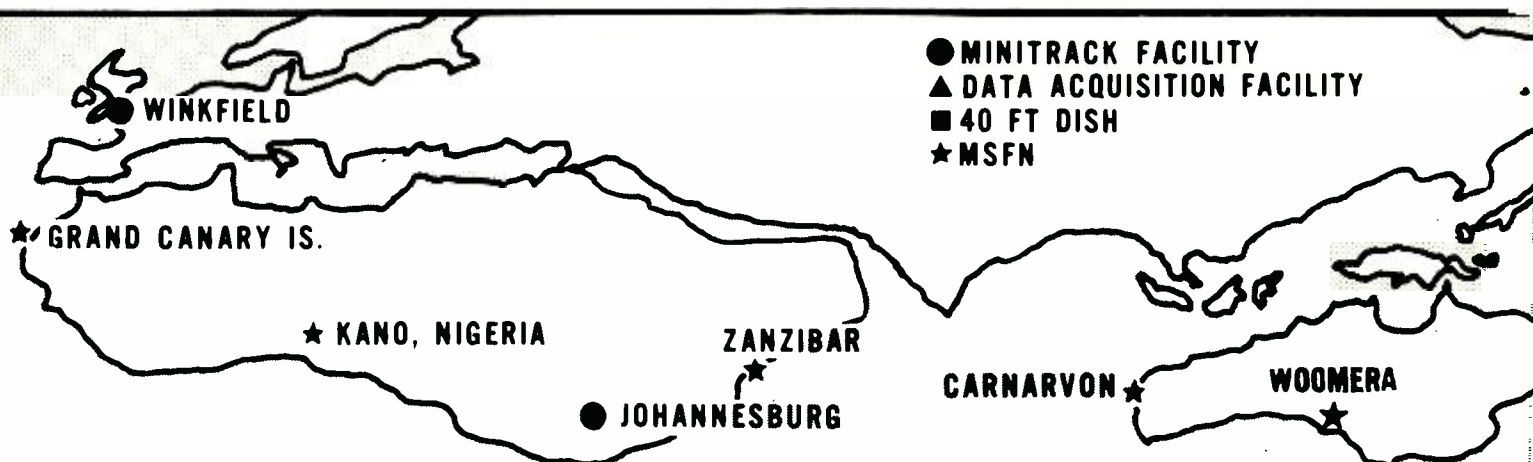

undersea cables, radio circuits, and special communications equipment installed at commercial switching stations in both hemispheres.

The 14 land-based stations provide capsule-to-ground telemetry, communications, and direct voice and teletypewriter communications to Goddard headquarters. Eight of these stations also include C-band radar while seven have S-band radar tracking systems. Six of the stations have additional ground command capability for operation of on-board systems of the manned spacecraft. The ships are positioned at sea according to the mission profile.

The radar tracking system for this network provides "real time" information; that is, as soon as the radar has acquired the capsule during its orbital pass, the operator throws a switch which immediately transmits the range, angle, and time data directly into the computing equipment at Goddard.

In essence, Goddard is responsible for the establishment and operation of a world-wide ground communications network providing teletypewriter, voice, and data links between the control centers for both networks. They are also a supporting arm of the Deep Space Instrumentation Facility of the Jet Propulsion Laboratory. This communications network uses both leased commercial and government circuits. The circuits are tailored to project needs, including the capability for immediate automatic handling for the Manned Space Flight Network circuits, and for the extremely high message density in the STADAN circuits. Voice circuits are provided for all users and data circuits are provided for MSFN use of 1000 to 2000 bits between Bermuda and Goddard and three 48-ke. lines for STADAN use to Alaska and one 1-mc. line to Rosman.

Automatic switching centers are provided at Goddard and the Manned Spacecraft Center in Houston, Texas, and subswitching centers are located in London for the England/Europe/Africa circuits, at California for Western USA/JPL/Pacific circuits, and at Adelaide for the various Australian communications circuits.

### Communications Center

The Communications Center at Goddard is a switching and relay center capable of accepting messages from all sites and automatically relaying them to the Manned Space Flight Control Center. In addition, any site can work through the Communications Center to all other sites, and data from radar stations can be relayed direct to the Goddard computers. Messages may also be relayed from the Control and Space Flight Communications Centers to any site or to all sites simultaneously, and the Goddard Space Flight Center computers can be connected directly with any site.

The Center also provides memory for message storage, analyzes line readiness, and provides routine system status information.

Switching and directing is automatic with teletypewriter equipment responding to specific directing codes in the address format of all incoming teletypewriter messages.

In the case of the Manned Space Flight Network, all tracking sites are provided with voice communications connections to the switching center at the Space Flight Center. This system comprises 173,000 actual circuit miles, consisting of 102,000 miles of teletypewriter facilities, 51,000 miles of telephone, 8000 miles of high-speed data circuits, and 12,000 miles of tone remoting circuits.

Typical of the communications circuit for message traffic between the tracking stations and the Control Center, is the network between the Canary Islands and Goddard. A teletypewriter message originating at Canary is carried by land-line to the terminal of *Compania Telefono Nacional De Espana*, thence by *Transradio Espanola* to the *London External Telecommunications Executive* terminal, thence via transatlantic cable (a joint American and British commercial facility) to the *RCA Communications* terminal in New York, and then through AT&T long-lines terminal in New York to Goddard. This makes a total route distance of 5218 miles. A second network, using separate circuits, on the same general route is used to handle additional traffic as required by a particular program.

### Computing Center

In order to tie the entire space operation together, modern digital computers are used to assemble, store, and operate on the received information. The Goddard computation center includes four IBM 7094's, a Univac 1107, two IBM 1410's, and two CDC 160-A's. These high-speed computers, in the simplest mathematical explanation, are capable of adding a column of 10-digit numbers,  $\frac{1}{2}$  of a mile in length, every second.

In the Computing Center at Goddard, triplexed IBM 7094 computers and mission status display panels are arranged for direct manned space flight mission support. These computers are supplied from separate power systems to avoid loss of computing capability in the event of a power failure.

These three computers each have 64,000 word memory units and are provided with a direct communication channel for direct input for Manned Space Flight Network station radar data. During manned flight missions, these computers initially determine launch trajectory, insertion parameters, retro-fire time, and abort impact point. After capsule insertion (orbit attained), they determine orbital parameters, capsule positions, emergency abort information, and retro-fire times for the re-entry maneuver and the actual impact point.

For non-manned missions, these computers determine the refined orbits for NASA scientific and applications satellites, produce station acquisition data and look-angles for these satellites, analyze and develop improved prediction methods, and process and print out the satellite telemetry data.

When the magnetic tape containing telemetry and associated time signals is received at the computing center, the tape is processed so that the received signals are "conditioned," by being enhanced in the case of PFM (pulse

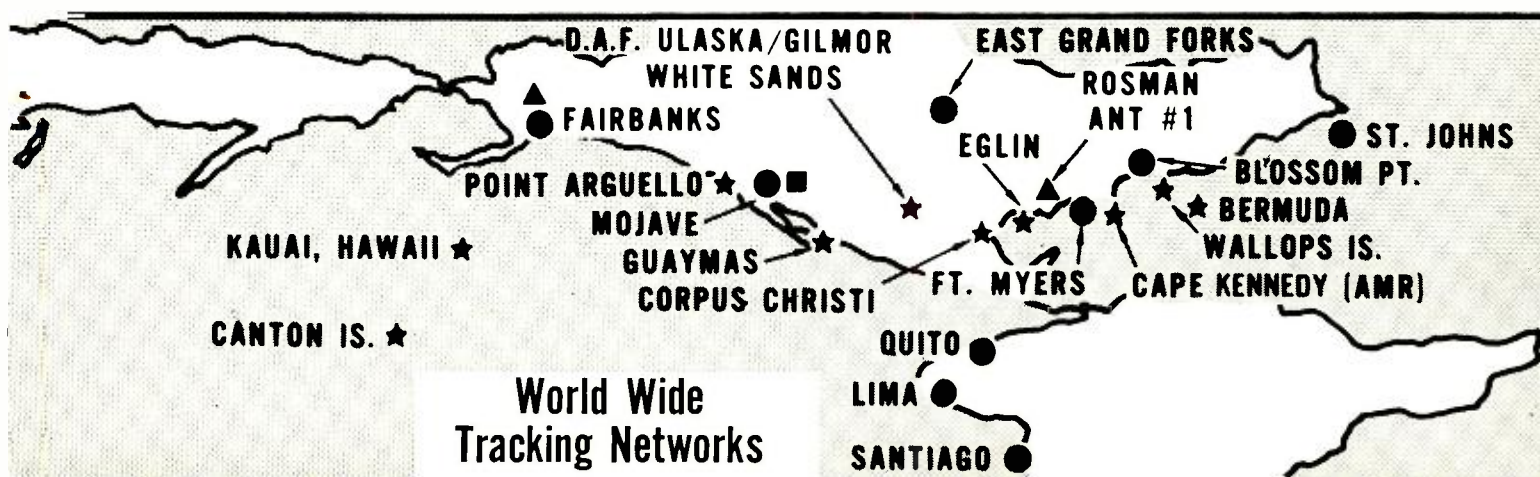



This 85-ft. antenna, located at the Rosman, N.C. tracking and data acquisition site, will be used with NASA's "second generation" vehicles such as the Nimbus weather satellite. A permanent staff of 75 people is needed to run this tracker site.

frequency modulation) to improve signal-to-noise ratio, and reconstructed in the case of PCM (pulse code modulation) to generate reliable sync and time references.

The data is then converted to a special computer-compatible digital format. In this form, the signals are processed to identify channels and to provide any necessary editing and reformatting. They are then re-recorded on magnetic tape in a form capable of being handled in conventional general-purpose digital computers.

The computers also sort, merge, calibrate, and decommutate the data into the individual experimenter's tapes, or provide a special output such as tabular print out, an X-Y plot, or an analog strip chart as required by the experimenter.

Six lines of equipment are presently being operated at Goddard for the telemetry data. Four of these are for reducing PFM telemetry, one is for FM/FM data, and the other is for PCM data. In addition, six more lines, three for PCM, one for PFM, and two for special data, will be in service this year.

Because of the many varied projects being undertaken as part of our space program, and because a limited number of tracking and other ground support stations is available, a series of common requirements must be met.

### Ground Tracking

For near-earth satellites, the Minitrack system (providing accurate angle data at precise time) in conjunction with an IBM 7094 computer will provide for 90% of the requirements.

For highly eccentric orbits where more and different information is required, Goddard has developed techniques of range and range-rate measurements using coherent radio carrier plus coherent discrete side-tone modulation capable of being built into small lightweight packages for satellite use. This system is capable of providing accurate orbital determination out to approximately 300,000 miles

with accuracies better than ½ mile in range, and a few feet per second in velocity.

### Data Acquisition

This is now the largest requirement being placed on the ground support network and it encompasses the simple conventional PFM (pulse frequency modulation) having a 10-kc. bandwidth and used for most of the smaller satellites, to full multiple-carrier PCM (pulse code modulation) telemetry requiring major fractions of a megacycle per carrier. In addition, several projects require unchanneled readout with multiple-megacycle bandwidths needed for an experiment.

### Ground Command

A major requirement for most advanced satellite systems is a method of ground command control of satellite functions to read out stored magnetic tape, to turn on data measurement systems, to cycle experiments during the time of ground station readouts, to change the range or direction of view of a measurement, or to activate a spacecraft relay beacon in the case of a communications satellite.

The complexity and number of these commands have grown significantly during the past few years. Originally consisting of a simple, discrete audio tone on a single r.f. carrier, each command now consists of a digital code for an address (different for each satellite), and other digital codes to execute various commands.

### Inter-Station Communications

Two types of communications exist between ground stations and the control/computing center. One is physical shipment (usually air mail) of magnetic tapes and associated documents that represent the data received by the ground station from a satellite. This is fine when the time element is not of great importance. For a world-wide network, with a large data processing facility working in high gear during the lifetime of each satellite, just getting the tapes from all sites to the processing system in orderly time sequence is a major problem.

The other type of inter-station communications is the use of hard-wire and radio links from each station to the central computing and data processing center. These links consist of at least one full-time 60 word-per-minute teletypewriter circuit to each station, plus (in most cases) a full-time voice link. In addition, the larger acquisition sites have wide-band data links (from a few kc. to one megacycle bandwidth) between the particular stations that are involved and the Goddard Space Flight Center.

### Project Control

A characteristic of the larger, more advanced satellite projects such as Nimbus, OAO, OGO, and OSO, is that results of ground commands and data transmissions must be evaluated by someone who is intimately knowledgeable with the on-board experiments so that changes in the experiment's performance and any needed corrective action can be made on an orbit-by-orbit basis.

A second requirement may involve the detailed control of satellite basic in-flight functions in accordance with extremely exact criteria.

Both of these functions could be accomplished with a team of project-knowledgeable controllers at each site. However, with the wide-band communications links now available, each project can be provided a special project control center where all communications links from the respective field sites terminate. Here, real-time telemetry data can be displayed, computations provided, and corrective commands can be scheduled by a small group of specialists who are aware of the satellite's total operational picture as seen at all stations. ▲

# ADVANCED RESEARCH for METEOROLOGICAL SATELLITES

By E. A. NEIL / Aeronomy and Meteorology Division

ONE of the biggest challenges facing scientists at Goddard is the development of meteorological systems which will work longer in space.

## TV Cameras

Instant pictures of the earth's cloud cover was successfully demonstrated for the first time with the Automatic Picture Transmission (APT) camera carried in the Tiros VIII satellite. Although the TV camera performed to design specifications, it has a limited lifetime. This is due to deterioration of the vidicon's polystyrene storage layer caused by electron bombardment.

It has been determined that the vidicon problem is one of manufacturing techniques, not materials or application. Studies are well along to improve camera lifetime to at least one year.

A major problem still to be solved involves image orthicon camera tubes. Present tubes cannot be mounted vertically due to loss of electrode spacing under vibration and shock. Studies will continue through 1965 to develop a tube rigged enough for space flights.

Another possibility is the image dissector tube. This is a phototube requiring no filament and no shutter. It can operate as a line-scan device in simple camera systems.

## Advanced Sensors

Radiation sensors are now being developed based on the experience of the Tiros and Nimbus programs. Better sensors are needed to improve the quality of nighttime cloud-cover data.

Work is being done on a digital IR (infrared) system where the data is transmitted in digital form. This will provide information that can be used faster by both the researcher and meteorologist.

More advanced IR sensors are being investigated—including methods of scanning and the basic techniques. Microwave radiometry and spectrometers as well as different wavelengths, optics, and resolutions are all under investigation. We are studying methods of analysis and

presentation of IR data on the ground to improve distribution time and format.

The major problem with advanced IR sensors appears to be in the scanner-drive mechanisms, optics, and filter materials. While no easy solution can be forecast, we are producing radiometers with increasing lifetimes in orbit.

## Tape Recorders

Tape-recorder development for storing cloud pictures has been highly successful. In eight consecutive Tiros flights, there has been only one tape-recorder failure.

Studies are now underway to develop tape recorders with greater storage capability. A compact recorder under design is a 1200-foot, ¼-inch tape recorder which measures approximately 10 inches across compared to an earlier model which measured almost 18 inches across. Both have the same amount of tape and, therefore, the same storage capability, but the smaller model takes up considerably less room in the spacecraft.

Goddard's Spacecraft Technology Division is developing a new capacitor-sensing brushless d.c. motor for spacecraft tape recorders which has possible application in meteorological satellites. The switching of power to the d.c. windings to drive the rotor of this motor is accomplished by capacitance air gap plates which mesh. One set of these plates is attached to the rotor and the other set is stationary. As the signal from an oscillator is fed to the rotor, it is capacity coupled to the various stator plates. Then it is converted to d.c. by means of solid-state devices and applied to the stator windings.

There are no wearing parts in the sensing network and no elements to burn out. In addition, such a motor operates efficiently under the extreme environmental conditions of outer space. Other important features of this motor are its simplicity and low production cost.

Our goal is to design a weather satellite that can carry more weather-measuring equipment and experiments and to achieve a substantially longer life expectancy in its space orbit. ▲

A new modularized tape recorder that will be used in orbiting solar observatory satellite.

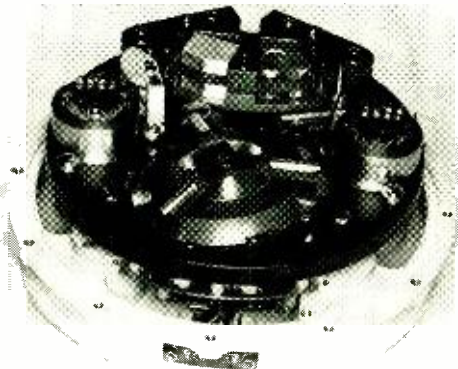

TV camera, with vidicon and electronics, used with Tiros VIII satellite.



Recently developed sensor unit that will supply digital solar-aspect information.

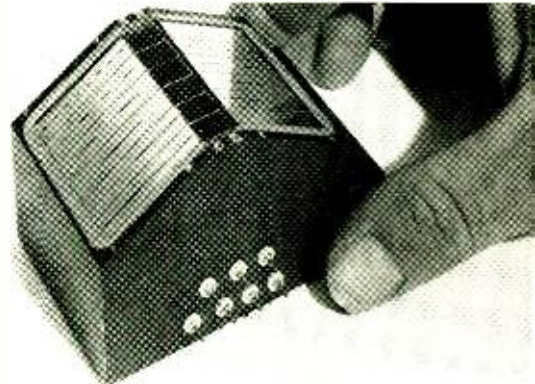

# GODDARD'S TECHNICAL MANPOWER

By ROBERT W. HUTCHISON / Chief, Organization & Personnel Division

***Over one-third of all scientists, engineers, and technicians at Goddard's Space Flight Center are electronically oriented.***

**G**ODDARD'S most precious asset is not in modern equipment and impressive facilities. Our strength, like that of any research and development organization, is in the scientific, technical, and administrative know-how of 3500 men and women. Of this number, almost 60 percent (2042) are scientists, engineers, and technicians of various specialized talents. This group of highly skilled technical manpower is made up of 1457 scientists and engineers and 585 technicians of various types.

Working as teams, these talented people conceive and direct complex programs; they convert ideas and theories into space and electronic hardware and data systems. Whether the teams be small or large, whether they stay on a given project for many weeks, months, or even years, all operate with one goal in mind: to obtain ever-increasing knowledge about the universe in which we live.

Since electronics plays such a vital role in our work, it is natural that a large portion of our technical personnel are electronically oriented. We actually have a total of 723, or 35% of our entire technical staff, engaged in electronic

development and application work. Of this group, we have 469 scientists and engineers and 254 technicians or equipment specialists. It is interesting to note that there is a higher ratio of technicians in the field of electronics (1 technician to every 1.85 engineers and scientists) than there is in the over-all technical group (1 technician to every 2.5 engineers and scientists).

Technicians at Goddard support well-integrated teams of scientists, engineers, and related personnel in the important fields of instrument development and testing, new circuit design, equipment adaptation and modification, calibration, and systems integration.

## Background and Training

Statistics, ratios, and other figures can be misleading. Our objective is not numbers, but quality. Our qualification standards for all our technical personnel are high, and the quality of candidates for employment is even higher now than it has been in the past.

In the case of scientists and engineers, applicants must have completed a standard curriculum in an accredited college or university leading to a bachelor's degree in engineering, physical science, or mathematics (or equivalent qualifications, on an exception basis). Applicants for key positions must demonstrate technical know-how and the ability to supervise comprehensive programs. In our recruitment we try to emphasize job content and requirements to such an extent that most non-qualified prospective applicants screen themselves out.

Technician staff members must have both a theoretical and practical knowledge of electronics and must be able to apply this knowledge to the design, operation, and capabilities of electronic equipment. The scope and depth of training and experience required depends upon the level of the position. Suitable training would be of the type offered at technical institutes and community colleges. Actual troubleshooting and repair experience is frequently required and in some cases, amateur radio operation (if it includes design, construction, and maintenance of the equipment used) is acceptable. Military electronics experience, and technical experience in radio, radar, and communications, as well as experience as an instructor in electronics are suitable backgrounds for some technician positions with higher responsibilities.

At present, the annual salaries for scientists and engineers at Goddard range from \$6770 to \$15,665. Salaries for technicians range from \$4690 to \$11,725 per year. This salary spread for technicians is fairly wide as compared to technician salaries in industry. As a result there is very low technician turnover. The salary range for engineers is also fairly good for young engineers who have recently

**A technician checks the dimensions of a printed-circuit pattern on negative to make sure they are as specified.**

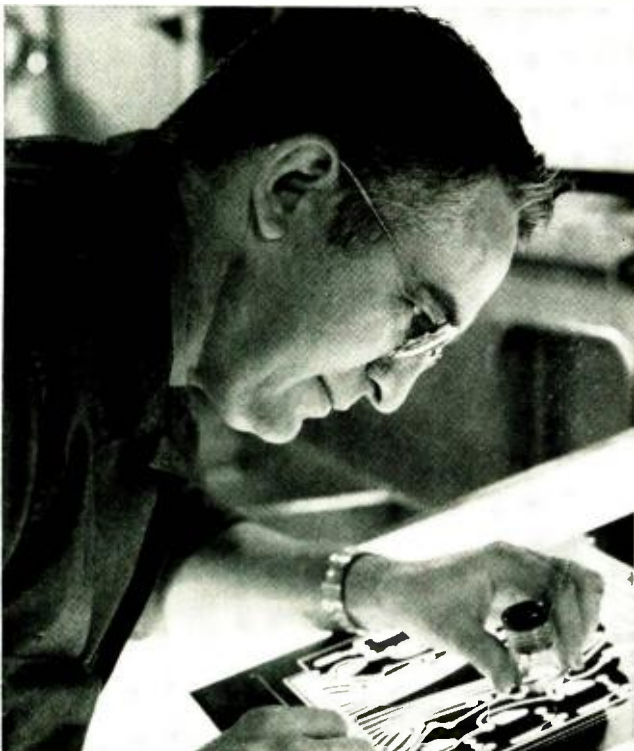



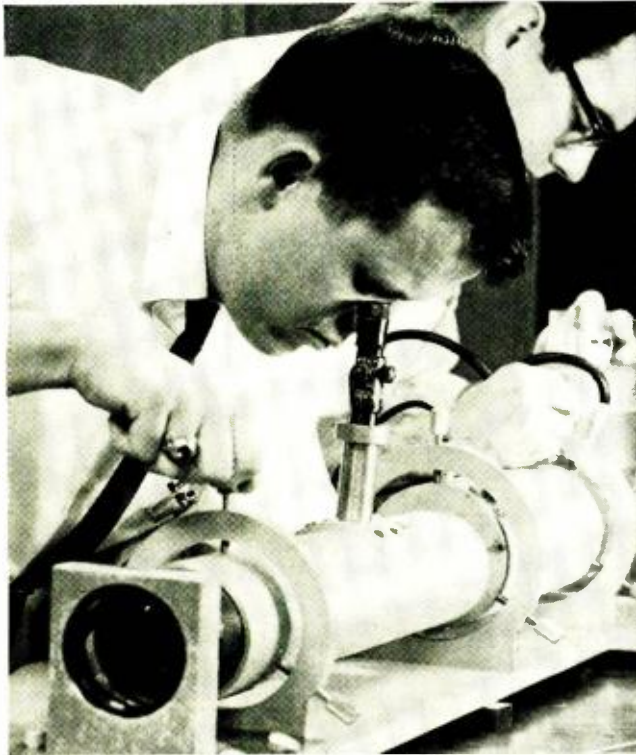

A technician in the Optical Systems Branch boresights laser optical system to assure accurate visual aiming.

completed their formal training and have had some experience. (The average age of our technical staff is in the mid-30's.) Also, the fact that there are many opportunities for further education and training both at Goddard and at nearby universities and technical schools is an added incentive. However, salaries offered for top positions are somewhat lower than offered by private industry and universities. Currently, however, there is a salary bill in Congress that is a step toward comparability with industry and college.

All personnel are under the Civil Service merit system and other Federal regulations and must be U.S. citizens. While Goddard's efforts are directed to the peaceful exploration of space and are of a non-classified nature, government security checks are made of all applicants and employees to insure the selection of high-caliber personnel.

Although NASA's over-all employment situation is far below expected needs for the coming years, Goddard may have already gone through its heaviest recruitment period during these early years of rapid growth. However, opportunities will always exist for highly specialized technical personnel either as replacements or additions to the staff. It is anticipated that this will continue as extensive program efforts are maintained. While it is difficult to accurately predict impacts of future plans, our rough estimate for staff needs in electronics for 1964 would be 300-400 people, and for 1965, 100-125 personnel.

While NASA as a whole is looking for inertial and space systems engineers, flight controllers for manned space flights, flight systems engineering, and orbital and trajectory studies specialists, our own major shortage areas in electronics are the following: telecommunications engineers for global data-switching networks, communications engineers, tracking and data operations engineers, computer programmers, solid-state miniaturization engineers, telemetry and guidance systems specialists.

#### Professional Growth

Much has been written and spoken recently about technical obsolescence and the need for continuing study and

training. In a recent article, Dr. J. R. Killian, Chairman of MIT, stated, "It is likely that thousands of engineers in industry are working with reduced effectiveness, or are in danger of being shunted aside by progress because their knowledge and skills are obsolescent or because they have not had an opportunity to enhance or update their abilities by acquiring new skills and knowledge."

NASA has recognized the problem of technical obsolescence of personnel and has acted to keep such obsolescence from occurring. It believes that personnel associated with the newly emerging aerospace sciences must have continuous, lifetime retraining in order to maintain their effectiveness.

Training of engineers and technicians at Goddard represents a large investment. Technical personnel seeking careers in space science technology find ample opportunities for professional growth. New engineers and scientists are placed on a 12-month program of intensive training. During that period, supervised on-the-job training is provided along with lectures on NASA functions and missions. Courses are held at Goddard and at local universities. Each participant makes a formal presentation before a panel of professional experts at the conclusion of this full year program of learning and doing.

Since aerospace technology is moving faster than some college curricula, this program is especially meaningful since the courses presented by Goddard personnel contain what is considered current knowledge of the state-of-the-art. Typical of such courses are "The Physical Principles of Astronautics," "Digital Computer Logic Design," "Antennas," "Transistor Circuit Applications," "Physics of Planetary Atmospheres," "Spherical Astronomy," and "Satellite Communications." These courses are offered during working hours at the Space Flight Center two or three times a week.

The Graduate Study Program for advanced professionals permits the staff to further their education at local universities and colleges. Currently, 300 Goddard employees are attending Johns Hopkins University, Georgetown University, Howard University, University of Maryland, Catholic University, and American University. Attendance is also encouraged at seminars and short courses held throughout the United States. Goddard and Catholic University have entered into a unique agreement on a program of graduate study in aerospace engineering, mechanical engineering, and physics. In this arrangement students work at Goddard on Monday, Wednesday, and Friday, and attend Catholic University on Tuesday and Thursday. This enables the students to carry approximately 10 semester hours per semester. The Government pays the student's salary, tuition, and certain related fees.

Beyond this level, Research and Study Fellowships are available for a select number of scientists and engineers. This provides an opportunity for exceptional candidates to spend up to 1 year in full-time study. Also, bi-weekly colloquia are conducted at Goddard which are open to interested electronics personnel.

For technicians and equipment specialists, programs in mathematics through calculus are conducted. Transistor courses from fundamentals through sophisticated design problems are offered. Technicians are encouraged to take advantage of local university and technical school courses that have a direct application to their own particular assignments.

While no campus in itself can produce a "space" engineer any more than it can evolve a "space scientist," the Goddard Space Flight Center through its various training programs has fired the imagination of men and women whose ideas and initiative produce the facts and technologies needed in man's newest quest for knowledge—the exploration of outer space. ▲

# *ADVANCED RESEARCH for* **COMMUNICATIONS SATELLITES**

By ROBERT J. MACKEY, Jr. / Head, Communications Satellite Research Branch

**T**O advance communications-satellite technology, the Goddard research program investigates technology in three areas: the ground systems, propagation path, and the satellites themselves.

## Ground Systems

In the ground systems we are investigating distortion and linearity in high-powered transmitters and the development of broad-band phase-lock receivers. We are evaluating the relative performance of high-powered klystrons and traveling-wave tubes for operating with either a frequency-modulated or a single-sideband carrier. The information obtained will provide data on high-power microwave tubes of various designs for multichannel wide-band communications systems.

The wide-band phase-lock receiver work has advanced the state-of-the-art substantially. This receiver reduces threshold and distortion, thereby adding a considerable margin of performance to a multichannel telephony communications system.

In the future we will investigate elements of ground terminals to improve over-all operating efficiency. These include low-loss transmission components and improved transmitting-antenna illumination, and lower antenna-systems noise. These studies will be done throughout the microwave- and millimeter-wave regions.

## Propagation Paths

All of the communications satellite radio frequencies, to date, have been below 10,000 mc. This is because most common carrier and military equipment and techniques employ these frequencies. Because of overcrowding in the present frequency bands, it may be necessary to move to higher frequencies. Atmospheric water-vapor absorption at 20,000 mc. and oxygen absorption at 70,000 mc. have been investigated. However, most of this work has been done within the atmosphere at spot frequencies of interest.

We would like to gain information on the use of millimeter waves between 15,000 mc. and 35,000 mc. for communications with satellites.

## Active Satellites

For the active type of communication satellite, work is going on in several areas. Work was begun last year to develop a low-noise microwave front-end for general application to satellite repeaters. Receiver noise figures of 5-6 db have been achieved with tunnel-diode amplifiers and mixers at 6000 mc. At present the effects of space environment on these components are being investigated thoroughly and initial results obtained so far are encouraging although the investigation is far from complete.

Additional effort is getting underway to explore the use of "cold" cathodes. These do not require heat for the release of electrons but rely on "tunneling" effects in solid-state materials. Such cathodes have already been employed in traveling-wave tubes but under pulsed condi-

tions only. The object here is to first investigate cathode materials suitable for continuous-wave use; then to develop higher efficiency traveling-wave tubes (TWT) at communications frequencies.

## Microwave Conversion

For about the past six months, methods of directly converting one microwave frequency to another without resorting to an intermediate frequency have been under investigation. Two methods are being explored; one using a "serrodyne" technique and the other a re-entrant TWT (traveling-wave tube) technique.

In the serrodyne method, the TWT slow-wave structure is modulated by a linear saw-tooth at the difference frequency. Hence, the incoming signal is linearly phase-shifted along the slow-wave structure at the rate of the saw-tooth modulating frequency. The TWT output frequency is the output frequency shifted by the saw-tooth frequency with the amplification available in the TWT. If the saw-tooth is not linear with negligible flyback, undesired harmonics are generated.

The second approach involves passing the input frequency through a TWT which amplifies it. Down conversion of this frequency then takes place by conventional local-oscillator/mixer techniques to the desired frequency to be transmitted. This frequency is then amplified by passing it back through the TWT. This involves some tricky microwave hybrid networks, filter design, and broad-band TWT's. A system of this nature has been developed and is about to be tested.

Other phases of development include microwave frequency generation using varactors and tunnel diodes, as well as microwave filter design for harmonic isolation and frequency selection. Other solid-state devices are being explored for possible use as power generators at microwave frequencies. New types of electronic components are tested when they become available.

## Spacecraft Antennas

In the area of spacecraft antennas, a study of all electronic beam shaping and steering techniques was initiated last fall. This applies to the microwave- and millimeter-wave region. The study will include prototype spacecraft antennas, having high gain with self-steering and remote-steering features. The most promising techniques will be selected and developed to demonstrate their feasibility. The purpose here is to form an antenna beam in a satellite, point it at a desired ground station or stations, and tracking the station(s) whether the satellite or station is moving, regardless of spacecraft attitude. In addition, such antennas provide spacecraft-to-spacecraft communication links.

Finally, work is also being done in the advanced passive satellite area. Improved lightweight structural materials, components, plastic removal, and erection techniques are under study. ▲



# MAGNETIC MODULATORS

By  
SIDNEY L. SILVER

*Operation of devices used in measurement and control instrumentation that permit drift-free amplification of low-voltage d.c. signals with complete isolation.*

IN the amplification of low-level d.c. signals where a high degree of stability and accuracy is required, it is common practice to convert the d.c. data into a.c. information by means of a suitable modulator. An effective modulation technique is the employment of magnetic devices which produce a phase-sensitive sinusoidal output proportional to an applied signal input voltage. These magnetic devices are closely related to magnetic amplifiers but correspond functionally to modulators, or converters. Magnetic modulators permit drift-free amplification of d.c. signals in the microvolt or millivolt range with complete isolation between input and output.

These units are extremely rugged and are capable of high performance in applications where operating conditions do not permit the use of delicate instruments or electronic devices. Furthermore, they can operate satisfactorily under highly unfavorable ambient conditions and are virtually unaffected by shock, vibration, or radiation. Since there are no moving parts, these devices require no adjustment or maintenance during their relatively unlimited life.

Magnetic modulators are now widely used in all phases of measurement and control instrumentation including data processing systems, radar, automatic flight control, servomechanisms, missile guidance, telemetry, geophysical survey and exploration, nuclear test equipment, and similar high-reliability applications. They are remarkably well suited for the linear amplification of small signals from transducing devices such as resistive strain gages, chemical pickups, thermocouples, radiation pyrometers, and photocells. In addition, they serve as high-sensitivity preamplifiers in multi-channel transducer measuring systems, whereby a number of variables may be added magnetically while remaining electrically isolated.

The types of magnetic converters most frequently encountered in industrial and military applications are the fundamental-frequency modulator, the second-harmonic modulator, and the flux-gate modulator. Although the basic operating principles are essentially the same, each type has ideal characteristics for specific requirements.

## Fundamental-Frequency Modulators

In one of its simple forms, the fundamental-frequency modulator consists of a pair of carefully balanced ferromagnetic cores and an arrangement of coils which operate as a gate winding, a control winding, a bias winding, and a pick-off winding. Fig. 1 shows a typical winding configuration employing matched toroids in which each coil is split into two symmetrical halves and wrapped around each core in a series-connected mode. The gate winding is excited by a sinusoidal a.c. source which serves as a carrier for the d.c. input signal applied to the control winding. A bias winding, supplied by an auxiliary d.c. source, feeds a constant input current to the modulator in order to operate the device over the desired part of the characteristic curve of the magnetic core material. The a.c. output voltage is developed across the pick-off winding through normal transformer action. It is desirable that all the windings be placed on the cores in such a way that

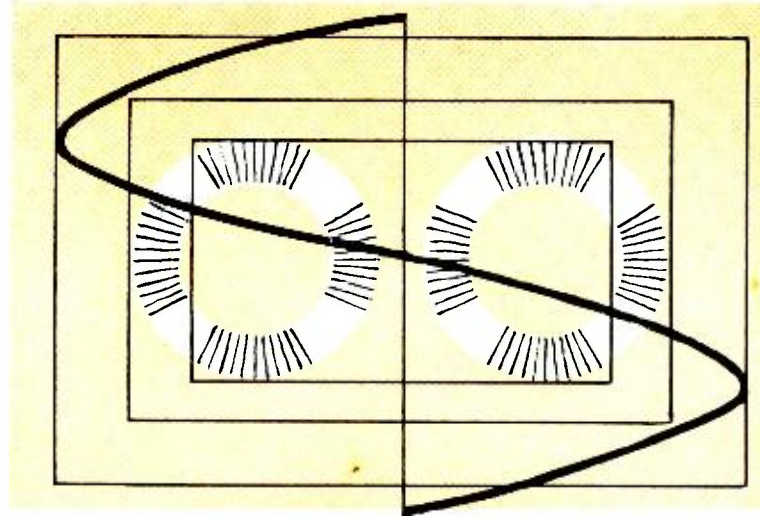

leakage effects are reduced to an entirely negligible value.

In the quiescent state, that is, with excitation and bias but no d.c. input signal applied to the modulator, the net output voltage is theoretically zero. In practice, owing to the difficulty of obtaining saturable cores perfectly matched in permeability and maximum flux density, the differential output contains residual harmonic components of the fundamental frequency. To avoid undesirable coupling effects between the gate winding and the other windings, it is necessary to prevent the circulation of a.c. currents of the excitation frequency in the control, bias, and output circuits.

This requirement is met by connecting the gate winding of each core in series-opposition so that the alternating fluxes in each core are cancelled. Since the control winding of each core is connected in series-aiding, the voltages induced from the gate winding into the control circuit are equal in magnitude and opposite of phase so that interaction due to mutual coupling is eliminated. Similarly, by connecting the pick-off winding of each core in series-aiding to obtain the required voltage cancellation, the resultant output voltage becomes a minimum (null). To prevent disturbing coupling effects between the gate winding and the bias circuit, a sufficiently high impedance ( $R_B$ ) is connected in series with the bias winding so that negligible circulating currents of the fundamental frequency are produced by the excitation voltage.

When analyzing the magnetic properties of saturable cores, it is convenient to assume a magnetizing field ( $H$ ), as producing a magnetic induction ( $B$ ) in the material. For the sake of simplicity, the hysteresis loop is omitted and the  $B$ - $H$  characteristic represented by a single curve, the slope of which is a measure of the permeability of the core material. As shown in Fig. 2, the bias sets the zero-signal operating point on the magnetization curve of each core. The excitation voltage produces equal and opposite variations in flux density which result in the cancellation of the differential output voltage.

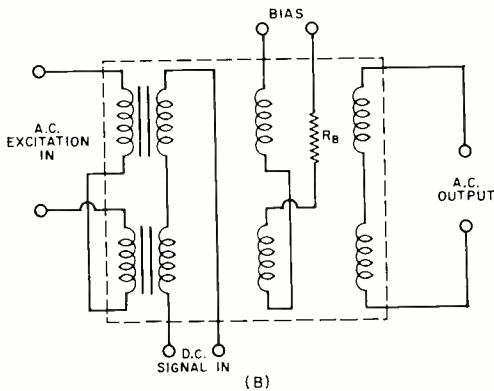
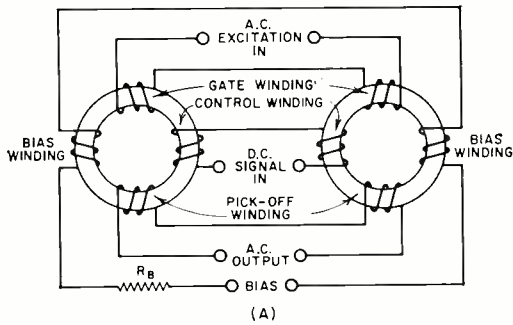

Fig. 1. A two-core fundamental-frequency magnetic modulator is shown at (A) in pictorial form and at (B) in schematic.

In the active state, that is, with excitation, bias, and a d.c. input signal applied to the modulator, the total magnetizing force is displaced by a constant amount depending upon the magnitude and direction of the d.c. signal. Since the bias winding of each core is connected in series-opposing, and the control winding is series-aiding, the input signal shifts the operating point of each core in different directions. The flux produced by the input signal adds to the bias flux in core #1 (Fig. 3A) and subtracts from the bias flux in core #2 (Fig. 3B). By this means, a net flux is produced which induces an a.c. output voltage in the pick-off winding. The output voltage varies linearly with the d.c. input signal within the operating range of the modulator and reverses in phase 180° when the d.c. input polarity changes. If desired, the a.c. output may then be fed to a phase-sensitive demodulator and subsequently amplified by a conventional magnetic amplifier.

An important consideration is the precise bias current necessary to move the operating point to the region of optimum slope. The bias must be properly adjusted along a symmetrical portion of the *B-H* curve in order to produce a corresponding symmetry of the output voltage wave. This symmetrical condition must be maintained as closely as pos-

Fig. 4. Arrangements for increasing available winding area of cores by using common winding for bias and for excitation, with the d.c. signal path traversing the two output windings.

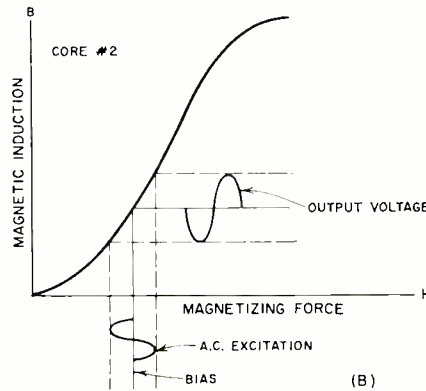
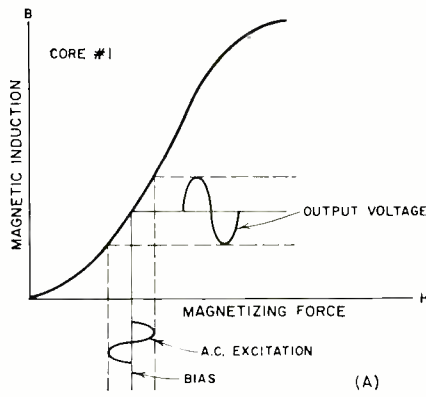
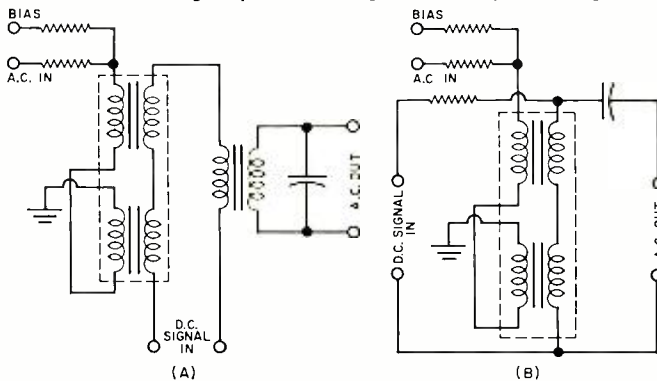

Fig. 2. In quiescent state, *B-H* curves of biased modulator indicate flux cancellation between the two cores. Net output is zero.

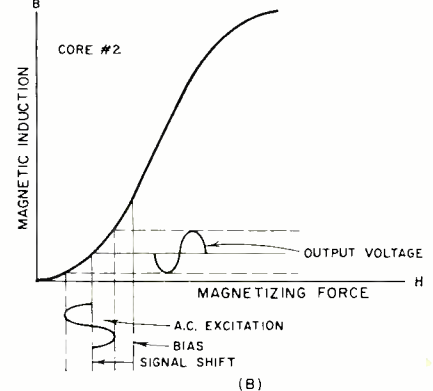
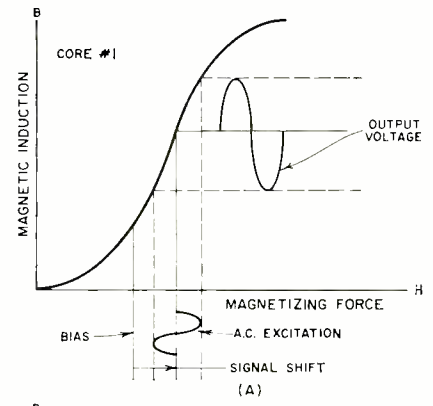

Fig. 3. In active state, bias flux aids signal in core #1 and opposes signal in core #2. Differential output is produced.

sible within the operating range of d.c. input control current. In Fig. 3A, waveform symmetry is maintained along a relatively linear portion of the magnetic curve and in Fig. 3B, along a non-linear, yet symmetrical, portion of the region of negative saturation. Both waveforms are characterized by half-wave symmetry which implies that the algebraic sum of each core output consists of the fundamental frequency and odd harmonics.

If a pure sinusoidal waveform is required at the output of the modulator, a harmonic suppressor in the form of a suitable capacitor across the pick-off winding provides adequate filtering action. In the ideal case, assuming perfect symmetry cores and assuming a pure sine wave of excitation frequency, no even-harmonic components of the fundamental frequency are produced across the output. However, in practice, due to the difficulty of balancing the cores exactly at all points on the magnetization curve and due to the presence of even harmonics in the excitation, residual voltages developed across the output may obscure the null point. The magnitude of the zero error must be minimized since it determines the minimum control signal which can be satisfactorily handled by the modulator. To help maintain zero stability, a regulated bias supply is necessary in order to avoid null drift caused by variations of bias voltage.

A problem which arises in the use of toroidal cores is the crowding together of the windings as they pass through the center of the toroids. This condition leads to a non-uniform shape of the coils which adversely affects the performance of the device. To obtain the largest possible number of ampere-turns, it is desirable to utilize a large portion of the winding space for the control winding. Furthermore, to achieve a high gain the pick-off winding should be designed to have a minimum impedance for a given number of turns. This implies that both windings should occupy a large proportion of the total available winding space.

In practice, it is possible to obtain a better winding distribution and hence a more uniform flux density, by reducing the total number of windings so that one winding serves two functions. For example, in the circuit configurations shown

in Fig. 4, the bias and excitation are superimposed on the same winding. Similarly, a common winding is employed for the output signal and the d.c. input signal.

### Second-Harmonic Modulators

In addition to the fundamental-frequency circuits, there are other modes of operation which utilize the second-harmonic component of the output so that the frequency of the load voltage is twice that of the excitation voltage. The second-harmonic modulator is a device which depends on the asymmetrical distribution of a flux wave caused by the application of a d.c. input signal, so that no biasing arrangement is employed. A primary requirement is that the excitation source deliver sufficient power to the gate winding in order to drive the core material close to saturation during a portion of each cycle.

Fig. 5 shows a typical winding arrangement of a second-harmonic modulator employing two matched toroidal cores. The gate winding of each core is connected in series-aiding and the control winding and the pick-off winding are in series-opposing. With this configuration, the fundamental frequency and odd-harmonic components balance each other while the second-harmonic components are summed at the output. The d.c. input signal is fed into the control winding through a parallel-resonant trap tuned to the second-harmonic frequency, which prevents a large a.c. from flowing into the d.c. source.

Under steady-state conditions, with no d.c. input applied to the control winding, the waveform across each pick-off winding consists of equal and opposite voltages which are symmetrical with respect to time. If the cores are properly balanced the resultant core flux, and hence the net output voltage, contain only the fundamental frequency and odd-harmonic components. Consequently, as shown in Fig. 6, the differential output voltage of the circuitry is zero.

In the active state of operation, assuming a positive con-

control signal is applied to the modulator, the zero-axis symmetry of each core is upset so that a portion of the positive half-cycle of the a.c. excitation traverses an unsymmetrical section of the  $B-H$  curve. The differential output waveform, as illustrated in Fig. 7, now contains a second-harmonic term and higher even-harmonic components, which are linearly related to the d.c. input signal.

In most applications, only the second harmonic is used as an output since the impedance level of the source for second harmonics is lower than for higher harmonics. Furthermore, a simple narrow-band amplifier can be employed to selectively amplify the second-harmonic component. The phase of the second-harmonic output voltage follows the polarity of the d.c. input signal, so that if the input signal changes polarity, the second-harmonic output undergoes a phase change of  $180^\circ$ . By using a phase-sensitive detector for re-conversion of the second-harmonic to direct current, the polarity of the input signal is recovered.

### Flux-Gate Modulators

Basically, the flux-gate modulator is similar to the second-harmonic modulator but differs only in form and construction. In the arrangement shown in Fig. 8, the flux gates consist of a pair of matched coils ( $L1$  &  $L2$ ), each wound on a core consisting of a fine Mumetal or permalloy wire. Both coils are arranged astatically, that is, the polarity of one winding is reversed in relation to the other so that the device is relatively insensitive to external magnetic fields. To further reduce the effects of magnetic disturbances, the coil assembly is encased in a high-permeability magnetic shield.

The flux gates are connected to balancing capacitors ( $C1$  &  $C2$ ) to form a bridge network which is supplied by a constant excitation voltage of fixed frequency. Under quiescent conditions, with no d.c. control signal applied to the input, the bridge is initially balanced by adjusting  $C1$  and  $C2$ , and since perfect balance cannot be achieved in practice, residual

Fig. 5. Circuit diagram of a two-core second-harmonic magnetic modulator. The output feeds second-harmonic amplifier.

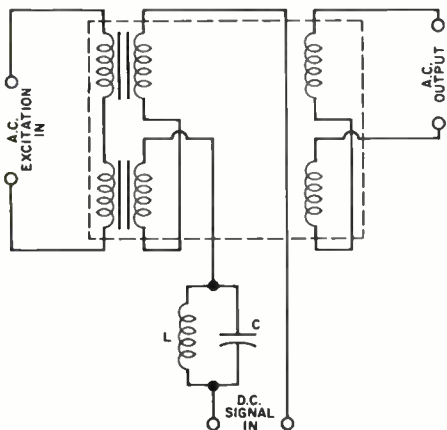

Fig. 6. Under quiescent conditions,  $B-H$  curves of unbiased modulator indicate combined output of cores  $\#1, \#2$  is zero.

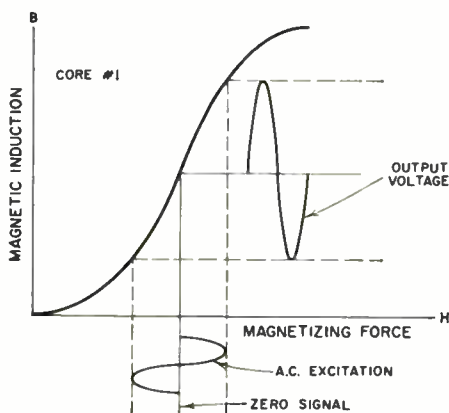

Fig. 7. Under active conditions, curves of unbiased modulator show differential output that consists of even harmonics.

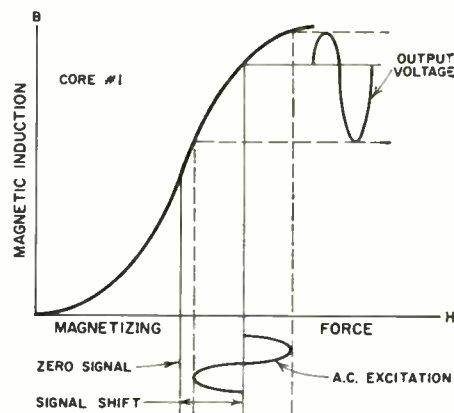
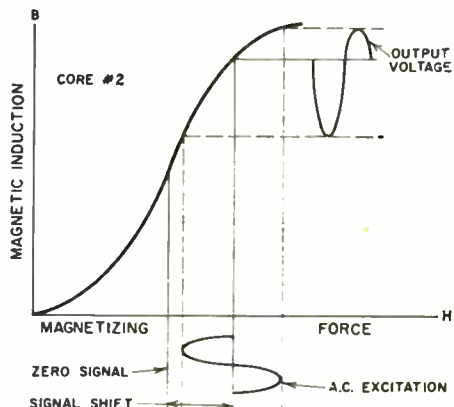
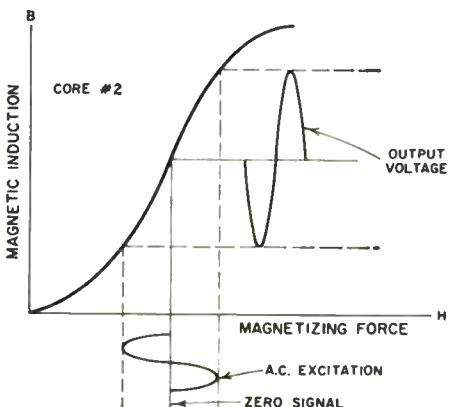
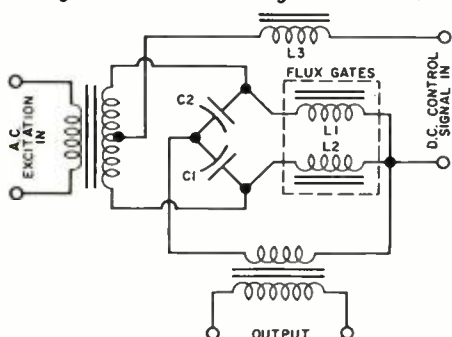

Fig. 8. Schematic of flux-gate modulator.



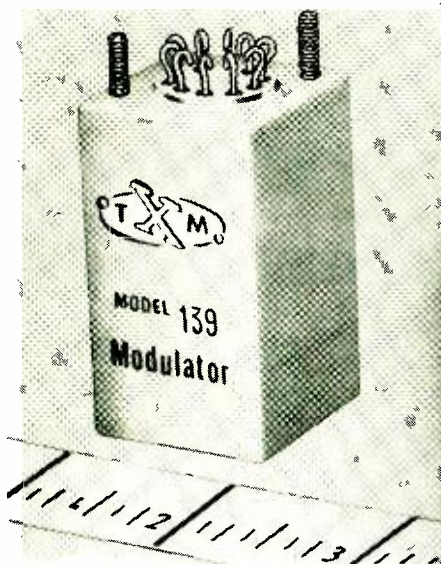

Fig. 9. A typical commercially available magnetic modulator.

odd-harmonic components appear in the output. When a d.c. control signal is applied to the input, the Mumetal wires are polarized, causing the bridge to become unbalanced so that an even-harmonic component is superimposed on the odd-harmonic output. One or more of the even harmonics may be selected by suitable filtering, amplified, and fed to a phase-sensitive detector to provide an indication of the magnitude and polarity of the d.c. input signal. The series inductance  $L_3$  prevents even-harmonic currents from being dissipated in the control circuit. As a result of this, the over-all amplification would be reduced.

#### Electrical Characteristics

In evaluating the performance characteristics of magnetic modulators, it is useful to define some of the terms used in specifying them, and to determine what ranges of the important parameters have been realized in practical units. A characteristic of prime interest is the transimpedance, which is a term used to describe the incremental gain of a magnetic modulator. This term expresses the ratio of changes in the output voltage to changes of control current and is analogous to the transconductance term ( $G_m$ ) used with vacuum tubes. Transimpedance ( $Z_m$ ) is given by the formula:

$$Z_m = \frac{\Delta E_{out}}{\Delta I_{cont}} \text{ ohms}$$

With proper design,  $Z_m$  is relatively constant over large temperature and excitation voltage changes.

Since a magnetic modulator responds to the net ampere-turns applied to the cores, it is useful to know the voltage gain ( $A$ ) of a circuit. This is expressed by the equation:  $A = Z_m / R_{tp}$  where  $R_{tp}$  is the control loop resistance. This refers to the total resistance in the control circuit including the source and control winding resistance.

Another important parameter is zero stability, which refers

to the change in output voltage with a constant input signal, and is usually measured in terms of a d.c. signal required to restore normal output. The value of the restoring signal is specified as zero drift and may be expressed in volts or watts. Null stability of about  $10^{-10}$  watt can be expected from fundamental-frequency modulators, while a better figure of  $10^{-12}$  watt is common for second-harmonic modulators, under normal operating conditions. These figures for zero drift apply only when the modulator is enclosed in a suitable magnetic shield, such as Mumetal. Unless the unit is adequately shielded, the earth's magnetic field or any other external magnetic field, will polarize the cores to some extent and give rise to zero error.

While matching the input impedance to the transducer or previous stage, it is desirable that the impedance level be as high as possible in order to avoid adverse loading effects. The limiting factor is the difficulty of using a large number of turns for the control winding since distributed capacity may cause undesirable tuning effects (resonance) and associated phase shift. For this reason, the practical range of input impedances generally lies between zero and 5000 ohms. Nominal d.c. input signals for average units may vary from zero to 200 microamperes. A typical commercial magnetic modulator designed for precision computing applications is shown in Fig. 9. It features extremely low drift, negligible distortion, and high linearity.

#### Magnetic-Modulator Applications

In the field of industrial measurement and control, magnetic modulators are frequently employed as low-level preamplifiers in connection with such self-generating devices as thermocouples and photocells. Fig. 10 shows a high-gain preamplifier stage which provides good zero stability and linear output-input characteristics for the amplification of very small direct voltages created by thermocouples. The output of the preamp may subsequently be fed to a magnetic power amplifier to actuate a relay, provide information to a measuring instrument, or control a processing system.

Since it is desirable to operate the preamp as a voltage-sensitive device, a large number of turns is wound on the control coil ( $L_c$ ) to keep the current requirements from the thermocouple to low values and to increase amplifier sensitivity. The input impedance must be increased to a value which makes the amplifier gain substantially independent of changes in thermocouple resistance.

To stabilize the amplifier against variations of control-circuit impedance, both positive- and negative-feedback loops are employed in the system. The net compensation provided by the feedback circuits maintains a constant input impedance over the operating temperature range. Positive feedback is applied through an auxiliary coil ( $L_f$ ) consisting of a small number of turns inductively coupled to the control winding of each core. To obtain a regenerative effect, the excitation current flowing through the load winding ( $L_l$ ) is rectified (by the full-wave gate rectifier) to produce a d.c. component which is applied to the feedback winding. The feedback coil is so phased as to introduce ampere-turns which aid the control winding magnetomotive force so that effective input impedance is increased. For proper operation, regeneration is set to a critical point which yields the largest amount of system gain, consistent with good stability. With this arrangement, however, a shift in the operating point may give rise to drift, in which an output voltage may appear across the load in the absence of an input signal.

To offset this limitation, an over-all negative feedback loop is utilized in which a portion of the load current is fed back to the input as a voltage across  $R_i$ , opposing the input signal. By this means, the ratio of load current to control signal voltage is independent of variations in amplifier gain or control-circuit resistance and depends only upon the characteristics of the feedback network. To obtain a d.c. output, the

Fig. 10. Magnetic modulator as high-gain instrument preamp.

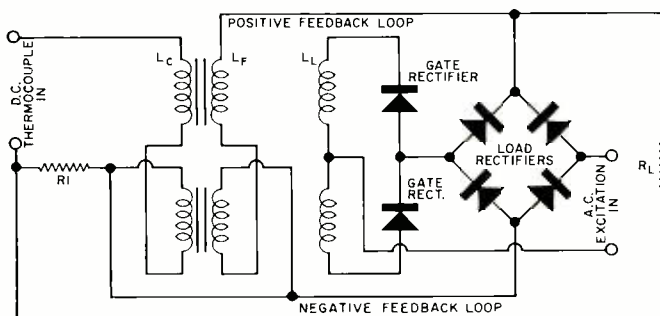

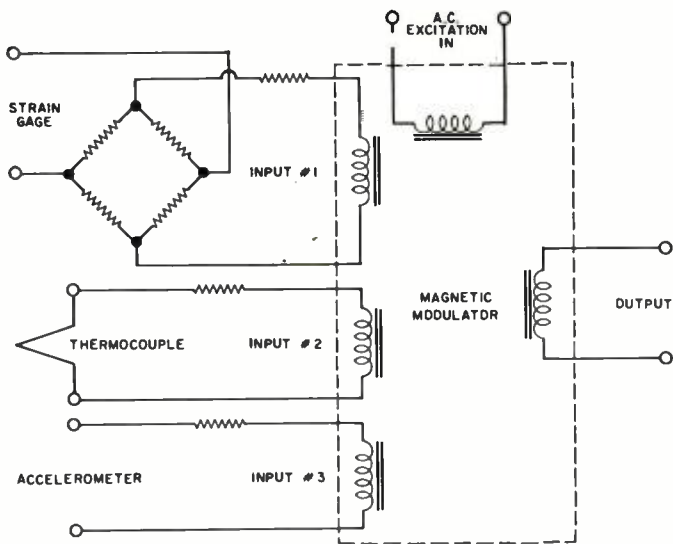

Fig. 11. Magnetic mixing of number of d.c. inputs which are floating above ground is performed with complete isolation.

load is supplied through a full-wave rectifier bridge, and since the load rectifiers are included in the feedback loop, such an arrangement tends to stabilize the circuit against changes in rectifier characteristics with age and temperature. The actual feedback factor is a function of the current ratio (ratio between forward current and reverse current) of the rectifier elements, so that for maximum sensitivity this ratio must be as high as possible.

The preamp circuit just described is characterized by single-ended operation so that only unipolarity signals are produced at the output. It is sometimes required that the direction of the load current reverse by 180° when the d.c. control signal changes sign. To obtain a bidirectional output, a push-pull operation may be achieved by connecting two identical single-ended amplifiers back-to-back.

It is possible to design a magnetic modulator with several input windings so that a number of variables can be summed algebraically with complete isolation. Fig. 11 shows an arrangement where the output signals from a strain gage,

accelerometer, and thermocouple are magnetically mixed so that a common ground connection is not required. The input coils may operate at different impedance levels and each winding may have its own scale factor which can be varied by changing the input turns ratio or by inserting a series resistor.

By modifying the second-harmonic flux-gate modulator, it is possible to obtain a device for measuring external magnetic fields, referred to as a magnetometer. The essential difference between a flux-gate modulator and a magnetometer is that in the first case the device is controlled by an electrical signal applied to the input, whereas in the second case the device is controlled by the external field to be measured. Magnetometers are commonly used for recording changes in intensity of the earth's magnetic field. These devices are also suitable for geophysical measurements in the prospecting of magnetic mineral deposits. Airborne magnetometers are extensively used for making accurate magnetic surveys in areas inaccessible by surface transport.

In the configuration shown in Fig. 12, the magnetometer sensing element consists of a pair of thin Mumetal or permalloy rods surrounded by series-aiding primary coils (L1 and L2) which are excited by an a.c. source. The secondary coils (L3 and L4) are connected in series-opposing and feed a conventional a.c. amplifier. Under no-signal conditions, that is, with no external magnetic field, the secondary voltages are equal and opposite so that the net output voltage is zero. The presence of an external magnetic field along the axes of the cores polarizes the rods with a d.c. flux, so that the voltages across the secondary coils become asymmetrical and a second-harmonic voltage appears across the input of the amplifier.

The output of the amplifier, which is a function of the d.c. flux, feeds a phase-sensitive rectifier and is measured by a suitable moving-coil instrument. Since the phase of the differential secondary voltage reverses when the direction of the d.c. flux is reversed, the device is able to measure not only the intensity of an external field but also its polarity.

Magnetic modulator techniques may be applied to microwave radar receivers in conjunction with automatic-frequency-control systems, to provide a means of correcting for drift in the i.f. stages caused by deviation of the local oscillator frequency. In the a.f.c. system shown in Fig. 13, a small quantity of pulsed energy derived from the r.f. signal is combined in a separate mixer with energy from a reflex klystron oscillator. The difference frequency produced by the mixer is fed to a phase-shift discriminator which is set so that its center frequency corresponds to the correct i.f. A d.c. output is developed by the discriminator which has a magnitude and polarity determined by the amount and direction of the local oscillator deviation from the value required to produce the desired i.f.

To produce a stable control signal, a fundamental-frequency magnetic modulator is employed to convert the d.c. signal into an a.c. output, which is then fed into a drift-free a.c. amplifier. The control signal is reconverted to d.c. by a phase-sensitive demodulator and applied to the repeller electrode of the klystron oscillator, thereby correcting its frequency.

The several examples cited above indicate the versatility of the magnetic modulator as well as some of its other features that make it an important component in industrial instrumentation. ▲

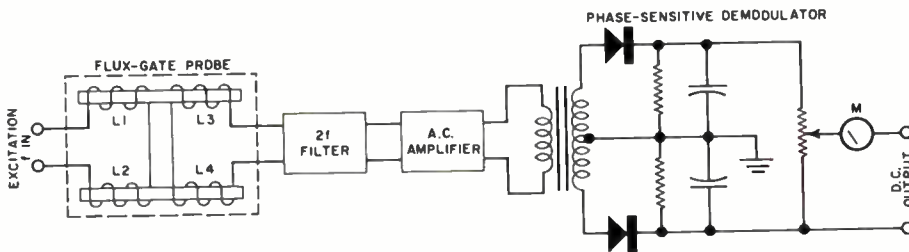

Fig. 12. Schematic diagram of a second-harmonic flux-gate magnetometer.

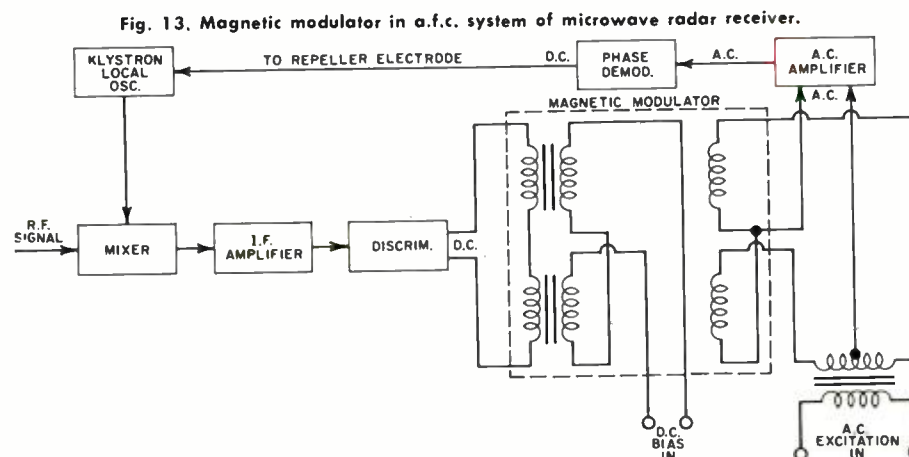

Fig. 13. Magnetic modulator in a.f.c. system of microwave radar receiver.



# J OHN FRYE

*In defense of the specialist as opposed to the "jack-of-all-trades" role many husbands are required to assume at home.*

## FOR MEN ONLY

MAC, returning to the service shop after lunch with the Rotary Club, found Barney, his Number One Boy, busy at the bench. The older man walked over to the youth and deliberately scanned him from head to toe with a quizzical glance. Then he walked to the other side and repeated the scrutiny.

"Okay, okay! What have I done now?" Barney asked, laying down his solder gun. "Why the evil-eye bit?"

"I'm not trying to put a whammy on you," Mac answered. "I'm simply trying to see you in the light of what I heard at Rotary today. No less than four guys there were singing your praises, telling me how smart and courteous you were, and declaiming how lucky I was to have such a personality-kid in my employ. I felt sure they were talking about someone else, but they insisted they were speaking of my own red-headed fiddle-footed Barney. What kind of brainwashing you been practicing?"

"A prophet is not without honor save in his own country," Barney quoted, grinning smugly. "There's been no brainwashing. I simply let the married fellows know I'm on their side."

"What do you mean, 'on their side'?"

"You know. I just subtly let the fellows sense I'm in their corner in the undeclared beef that seems almost always to be going on between men and their wives."

"No I *don't* know," Mac said, "but I'm certainly getting interested. Suppose you tell me."

"Well, I'm fed up to here with the way women are taking over in this country and the way we men are supposed to kowtow to their wishes and whims. They already hold most of the stocks and bonds; and they control the spending, directly or indirectly, of most of the money. Manufacturers and advertisers never forget this, and they won't let us forget it. Take a look through the advertising pages of any magazine and see for whom the pitch is being made. Houses, cars, TV shows, furniture, airlines, cigarettes, and even ham transmitters and men's clothing—in fact, just about anything you can name except possibly plug chewing tobacco and the double-bitted ax—are designed to please women.

"Our field hasn't escaped. I've read umpteen articles explaining just how the radio and TV service technician can favorably impress his women customers. You know how these articles go: the technician should groom himself as though he were going on a date; he must not burn holes in the rug with his soldering iron; he must keep his temper when the kids play catch with tubes from his caddy; he mustn't kick the woman's dog or shush her canary, even though the former bites him and the latter's 'peeping' masks the intermittent birdie he's trying to locate in the TV sound; he must never give impatient or sarcastic answers to inane questions she asks; etc., etc. But do you remember *ever* reading an article about how we can please our men customers? I thought not! Well, in my own small way, I'm trying to correct this shameful neglect. I cater to the down-trodden man of the house, but I do it so smoothly the little woman doesn't catch on."

"Sounds like a neat trick," Mac said, lighting his pipe and leaning back against the wall. "How do you pull it off?"

"First you gotta understand women cling stubbornly to two fallacies. They believe: (1) most men are natural-born mechanics and technicians and know how to fix things; but (2) their own husbands are stupid exceptions.

"In pioneer days, most men *were* fair mechanics. They had to be, for they lived in a do-it-yourself-or-else age. Even during the first part of this century, when most people lived on farms, the men had to be able to drive a nail, saw a straight line, keep the simple farm machinery going, or put new bands in the transmission of the family Model-T under a shade tree. Boys helped their fathers with these chores and so learned the rudiments of repairing. But what chance does a city boy, growing up in a second-floor apartment with an office-worker father, have to learn about repairing things—especially when our gadgets are a hundred-fold more sophisticated and complicated than they were fifty years ago? The truth is that most men today have absolutely no business tinkering with the automatic washer, the power lawn-mower, the family car, or—above all!—the TV set.

"And there's no reason why women should belittle him for this lack of ability. How many of them can bake a loaf of good home-made bread? churn butter? make soap out of bacon fryings and lye? quilt a comfort? or act as midwife and deliver a baby without the aid of a doctor? When a man was expected to be some sort of mechanic, any woman worth her salt could do all these things. A modern husband, of course, no longer expects such pioneer abilities in his wife; but by the same token she should not expect him to be a jack-of-all-trades.

"But she does. No sooner does the TV quit than she starts talking about how other men fix their sets and escape service bills. After all, it's probably just a tube. Fixing a TV set can't be so difficult when that sixteen-year-old kid down the street built his own receiver. She keeps harping on this string until the husband, against his own good judgment, starts removing the back of the receiver. Then, just to take out a little I-told-you-not-to-insurance, she says maybe he'd better call a service shop. After all, he's not much good at fixing things.

"By this time, naturally, he's been goaded to the point where nothing can stop him. Blindly he wrenches and twists from their sockets all the tubes he can see, puts them into a paper bag, and trots off to the drugstore tube tester with them. The answers the poor fellow gets from the gadget are as enigmatic and confusing as those delivered by the Delphic Oracle. In desperation he buys several tubes he does not need and goes home. When he tries to replace the tubes, he usually manages to break off a prong or so and to put two or three of them where they do not belong. When the set is hopefully turned on, at best it probably refuses to work; at worst smoke comes from it or the fuses blow. Then the wife contemptuously calls us.

"Now you'd naturally think that since she egged him into trying to fix the set she'd stand by him and keep still about it, wouldn't you? But does she? Oh no! No sooner do I enter the door than she starts rattling on him, explaining how she 'begged' him not to tamper with the receiver but that he



# NOW THERE ARE TWO...



SB-400 TRANSMITTER



SB-300 RECEIVER

## IN THE NEW HEATHKIT® SB SERIES

### Introducing the New SB-400 SSB Transmitter!

The new Heathkit SB-400 is the second in the sensational new series of Deluxe SSB Amateur equipment designed to bring you professional performance and features at tremendous savings! Following the same high standards set by the Heathkit SB-300 Amateur Receiver, the new SB-400 Transmitter offers a matching counterpart for complete transeive capability with a host of advanced-design features. Check the many features below and see why this new series has taken the Amateur Radio Field by storm!

- Built-in power supply • Complete transeive capability with SB-300 Receiver • Linear Master Oscillator frequency control • Built-in antenna change-over relay • All crystals supplied for complete 80-10 meter coverage • Automatic level control for higher talk power, minimum distortion • 180 watts PEP SSB, 170 watts CW • Crystal filter type SSB generation • Operates SSB (upper or lower sideband) & CW • VOX & PTT control in SSB operation, VOX operated CW break-in • Crystal controlled heterodyne oscillators • 1 kc dial calibration—100 kc per dial revolution • Dial bandspread equal to 10 feet per megacycle • 500 kc coverage per bandswitch position • Switched 120 V AC for external antenna relay • Sturdy, lightweight, heavy-gauge aluminum construction throughout • Neat, modern "Low-Boy" styling! • Variable loading!

### Easy to Assemble

The SB-400 features a prebuilt Linear Master Oscillator (LMO), prebuilt crystal SSB filter, two circuit boards, and three wiring harnesses for easy assembly. Construction proceeds smoothly from start to finish with the complete, illustrated instructions furnished.

### Sturdy Construction Throughout

Heavy-gauge aluminum construction throughout provides extra-strength and light weight. Complete shielding by partitioned chassis construction minimizes TVI and eliminates

instability. Order your SB-400 today! Enjoy a new high in operating versatility and convenience with all the deluxe design features that guarantee finest amateur radio communications.

Kit SB-400...30 lbs.....\$325.00

**SPECIFICATIONS—Emission:** SSB (upper or lower sideband) and CW. **Power input:** 170 watts CW, 180 watts PEP SSB. **Power output:** 100 watt (80-15 m-tx), 80 watts (10 m-tx). **Output impedance:** 50 to 75 ohm—less than 2:1 SWR. **Frequency range:** mc 3.5, 7.0, 7.5, 14.0, 14.5, 21.0, 21.5, 28.0, 28.5, 28.75, 29.0, 29.5, 33.0, 33.5, 37.5-38.0. **Frequency stability:** less than 100 cps per hr. after 70 mins. warmup. **Carrier suppression:** 50 db at 100 cps. **Unwanted sideband suppression:** 55 db @ 1 kc. **Intermodulation distortion:** 30 db below 100 V output (100 tone pair). **Keying characteristics:** Break-in CW provided by operating VOX from a key or low (Grid block keying). **ALC characteristics:** 10 db nominal @ 0.2 ma final grid current. **Noise level:** 40 to 45 db nominal (at 100 cps output). **Visual dial accuracy:** Within 100 cps (all bands). **Audio input:** High impedance, microphone or remote meter. **Audio frequency response:** 350 to 2450 CW, at 100 cps. **Power requirements:** 120 v. 60 cycle AC, key down @ 120 V AC min. **Dimensions:** 14" W x 6" H x 13" D.

### This is #1... The SB-300 SSB Receiver...\$265

The first in the new Heathkit SSB series! A new dimension in quality features, smooth operation and performance, you never before thought possible in kit form!

- Professional styling and features at 60% savings! • Complete coverage of 80 through 10 meter amateur bands • All crystals included, plus provision for VHF converters • Hermetically sealed 2.1 kc crystal bandpass filter • Built-in 100 kc crystal calibrator • Smooth, non-backlash vernier dial mechanism • 100 cps stability after initial warmup • 1 kc dial calibrations—100 kc per dial revolution (provides bandspread equal to 10 feet per megacycle) • Provision for transeive operation with SB-400 Transmitter • Prebuilt linear master oscillator (LMO), wiring harness and two heavy-duty circuit boards for fast, easy assembly.

Kit SB-300...less speaker...17 lbs.....\$265.00  
 SBA-300-1 Optional AM Crystal Filter (3.75 kc)...1 lb.....\$ 19.95  
 SBA-300-2 Optional CW Crystal Filter (400 cps)...1 lb.....\$ 19.95

**SPECIFICATIONS—Frequency range (megacycles):** 3.5 to 10, 7.0 to 7.5, 14.0 to 14.5, 21.0 to 21.5, 28.0 to 28.5, 28.5 to 29.0, 29.0 to 29.5, 33.5 to 38.0. **Intermediate frequency:** 3,000 mc, mc, cps. **Frequency stability:** 100 cps after warmup. **Visual dial accuracy:** Within 200 cps (all bands). **Electrical dial accuracy:** Within 400 cps (all bands). **Backlash:** No more than 50 cps. **Sensitivity:** Less than 1 microvolt for 15 db signal plus noise to noise ratio for SSB operation. **Modes of operation:** Switch select CW, USB, USB, CW, AM. **Selectivity:** SSB: 2.1 kc at 10 db down, 5.0 kc at 60 db down (crystal filter sustains 10 db). AM: 3.75 kc at 0 db down, 10 kc at 60 db down (crystal filter available as accessory). CW: 400 cps at 0 db down, 2.5 kc at 60 db down (crystal filter available as accessory). **Spurious response:** Image and HF rejection better than 50 db. Internal spurious signals below equivalent input of 1 microvolt. **Audio response:** SSB: 350 to 2450 cps nominal at 6 db; AM: 200 to 3500 cps nominal at 10 db; CW: 300 to 1200 cps nominal at 0 db. **Antenna input impedance:** 50 ohms nominal. **Muting:** Operates manual and Multi-Jack. **Crystal calibrator:** 100 kc crystal. **Front panel controls:** Main tuning dial, function switch, mod. switch, AGC switch, band switch, AF gain control, RF gain control, push-control, phone jack. **Rear apron connections:** Accessory power plug, HF antenna, VHF #1 antenna, VHF #2 antenna, multi-pin anti-trip 500 ohm 50mm speaker, 100 cps clock, 100 cps audio oscillator output, LMO output, BFO output, VHF converter, antenna. **Tube complement:** (1) 6BE6 RF amplifier, (1) 6AU6 H-tube linear mixer, (1) 6AB4 H-tube detector/crystal filter, (1) 6AU6 LMO, (1) 6AU6 LMO mixer, (2) 6X4 AF amplifier, (1) 6AU6 Cr. tal. calibrator, (1) 6HF8 100 cps audio oscillator, (1) AS11 Product Detector, BFO, BFO Amplifier. **Power supply:** Transformer operated with silicon diode rectifier. **Power requirements:** 120 volt AC, 50-60 cps, 50 watt. **Dimensions:** 14" W x 6" H x 13" D.

**MORE TO COME!**  
**WATCH FOR THE NEW HEATHKIT SB-100 TRANSEIVER AND SB-200 LINEAR AMPLIFIER COMING IN THIS SERIES!**



### FREE CATALOG

See the wide array of Heathkit Amateur Radio Equipment available at tremendous do-it-yourself savings! Everything you need in "mobile" or "fixed" station gear with full descriptions and specifications... Send for Free copy!

**HEATHKIT**  
 A Division of Heath Company

**HEATH COMPANY, Dept. 15-6-1**  
 Benton Harbor, Michigan 49023  
 In Canada: Daystrom, Ltd., Cooksville, Ontario

Please send Free 1964 Heathkit Catalog.

Name \_\_\_\_\_  
 Address \_\_\_\_\_  
 City \_\_\_\_\_ State \_\_\_\_\_ Zip \_\_\_\_\_ AM-141

Please Print Name and Address on envelope without notice.

## WONDERSHAFT . . .

### a standout in Mobile Antennas

Here's a whip antenna that provides full quarter wave efficiency in antenna lengths approximately 10% shorter than its metal counterpart. The exclusive Columbia Products fiberglass construction loads the conductor dielectrically and reduces the velocity of electromagnetic propagation. This gives a physical shortening effect in the same way that a coaxial transmission line does.

Fiberglass gives **WONDERSHAFTS** other advantages, too: insulation to reduce operating hazards under live wires . . . a surface that won't rust or corrode . . . high impact and flexural strength . . . lightweight . . . reduces road noises and sway.

**WONDERSHAFT** mobile whips are, of course, fiberglass (—all Columbia Products antennas are). Style 10 series include lengths for frequencies of 25-54 mc.

STYLE 10-1	54"-60"
STYLE 10-2	61"-102"
Citizens Band	
STYLE 10-3	96"



COLUMBIA PRODUCTS COMPANY  
COLUMBIA, S. C. Subsidiary Shakespeare Co.

CIRCLE NO. 103 ON READER SERVICE PAGE

GET  
INTO

## ELECTRONICS



V.T.I. training leads to success as technicians, field engineers, specialists in communications, guided missiles, computers, radar and automation. Basic & advanced courses in theory & laboratory. Electronic Engineering Technology and Electronic Technology curricula both available. Assoc. degree in 29 mos. B. S. also obtainable. G.I. approved. Graduates in all branches of electronics with major companies. Start September. February. Dorms. campus. High school graduate or equivalent. Write for catalog.

VALPARAISO TECHNICAL INSTITUTE  
Dept. RD, Valparaiso, Indiana

simply wouldn't listen and now he's probably ruined it.

"Right here is where I start helping the poor guy, who's usually sitting there looking like a whipped dog. I blandly remark that with the cost of living being what it is, you can't blame anyone for trying to save money; and I ruefully recall the time I attempted to repair my own watch. I express cheerful doubts the set has been ruined, and I make quite a show out of getting out my service data and consulting the tube layout. I point out to him how my diagrams show the pin positions of hard-to-see sockets and mention that without the help of such data it is very easy to mix up the tubes or bend the pins.

"As soon as I have quietly and unobtrusively undone the damage he has caused, I settle down to fixing the set; but I keep talking to him in a friendly man-to-man sort of way while I'm working. I stress how complicated and delicate the TV receiver is and admit that without my instruments I'd be almost as helpless as he in trying to repair it.

"Then I try to switch the conversation to his line of work. I ask him questions about it, and invariably I find some knowledge or skill or experience that he possesses which I can honestly envy. It may be his ability to set up a turret lathe, or add accurately and quickly long columns of figures, or sell insurance, or teach a history class; but there's always something he knows or does about which I can really marvel.

"Finally, when I've located the trouble, I explain to him in simple terms what went wrong and the steps I'm taking to correct it. I try to inject a cosy I - can - explain - this - to - you - because - you're - intelligent flavor into the explanation. All the time I'm addressing my remarks to the husband, but I'm really talking to his wife.

"Your husband is no dope,' I'm saying to her. 'He couldn't fix the TV set because he lacked the service data, the expensive instruments, and the specialized experience to do the job. I can make the repairs because I have these things; but I still admire, respect, and envy your husband because of his abilities in his own field.'

"When I leave, the husband and I are friends because I've restored his stature in the eyes of his wife, and consequently in his own eyes. What's more, I've given him a perfect excuse to avoid being trapped in a similar situation again: he can't fix a broken appliance because he doesn't have the service data, the instruments and tools, or the very specialized training necessary. The smart thing to do is to call us, who have this equipment, and pay us with money the husband makes working at *his* specialty. Yep," Barney finished smugly, "I really know how to handle women—"

He was interrupted by the ringing of the telephone in the front office. "It's for you, Barney," Matilda called back from her desk. Barney took the call on the wall phone at the end of the bench.

"Hi, Margie," he said. "Sure we've got a date . . . Well, I thought we'd drive down to Circle City and visit a ham friend of mine . . . No, we don't *have* to go. Did you have something else in mind . . . Oh no! It's too hot to get all gussied up and sit through a graduation exercise . . . Your favorite cousin can get her diploma without our watching . . . Of course I like your cousin, but . . ." He paused and glanced uncomfortably over his shoulder at his grinning boss, who was obviously enjoying the one-sided conversation. Then he continued in low tones barely above a whisper, "You know I do, Margie . . . Now don't do that, please! . . . Okay, I'll pick you up around seven . . . Uh huh, you know I feel the same way . . . Goodbye."

He replaced the receiver, and there was a long, uncomfortable silence. "Well," he said defensively, "she's always been doggone nice about doing things I want to do."

"You don't need to explain—not to a married man, Barney," Mac assured him, knocking the ashes from his pipe. "Most men can prescribe exactly how to handle other men's women. It's your own that gives you trouble.

"But this idea of yours about trying to please both sides of the family is a good one, and the impression you're making on my Rotary friends proves it works. It tickles me to see you realize that while we work *on* electronic equipment, we work *for* people." ▲

### HAMFEST-PICNIC

**S**AN Fernando Valley Radio Club will hold its 8th annual Hamfest-Picnic on June 21st at the Sunset Farm in Sylmar, California.

This will be a family affair with adult admission \$1.00 and children under 12, 75 cents. Bring your own picnic basket. ▲



"Malcolm is trying to decide whether to become a SWLer, a CBer, a DXer, or a ham—in case we get electricity some day."

# KELVIN COLOR TEMPERATURE

*A brief explanation of what color temperature means when applied to color-TV screens.*

THE color temperature of the raster on a color picture tube refers to the tint of white or gray produced by the raster, and not to its brightness level. To reproduce transmitted pictures properly on a color set during black-and-white and color programming, it is necessary that the raster be set up to a specific color temperature. This is to provide the background upon which the picture can be produced. Color temperature is given in degrees Kelvin.

This is a temperature scale that is often used in reference to light as a means of establishing certain characteristics of a light source, namely its hue. Most light is produced by thermal radiation (matter raised in temperature until it emits light) and is a quality of light that can be measured.

The Kelvin scale simulates the centigrade scale, but provides for a greater range in the degree of represented temperature without going below zero. The Kelvin scale uses absolute zero as its starting point, while the centigrade scale uses the freezing point of water as its zero (0° C equals 273° K).

In using temperature as a means of

LIGHT SOURCE	KELVIN TEMPERATURE
ORDINARY CANDLE	1900 - 1950
ORDINARY HOUSEHOLD LAMP	2750 - 2850
MOONLIGHT	4100
SUNLIGHT	5300 - 5800
DAYLIGHT (SUN AND CLEAR SKY)	5800 - 6500
DAYLIGHT (OVERCAST SKY)	6300 - 7200
CLEAR BLUE SKY	14,000 - 50,000

measuring the color of light, black is the color that an absolute black body would emit at 0° K. As the temperature of the black body is increased, the color emitted changes. When the temperature of the body reaches the range of 8000 to 9000 degrees Kelvin, it approaches the white seen on the TV screen.

The color temperatures of several common sources are shown in the table. In color TV, the 21CYP22 color picture tube should be at 8200° K, while the 21FJP22 and 21FBP22 should be at approximately 9300° K, producing a slightly bluish color.

When color temperature is set too high, a loss in red will result and the over-all picture will take on a metallic appearance. Too low a color temperature produces a loss in blue, green, or cyan, giving objects a reddish-brown cast.

This information is from a recent issue of RCA Victor "Technical Tips." ▲

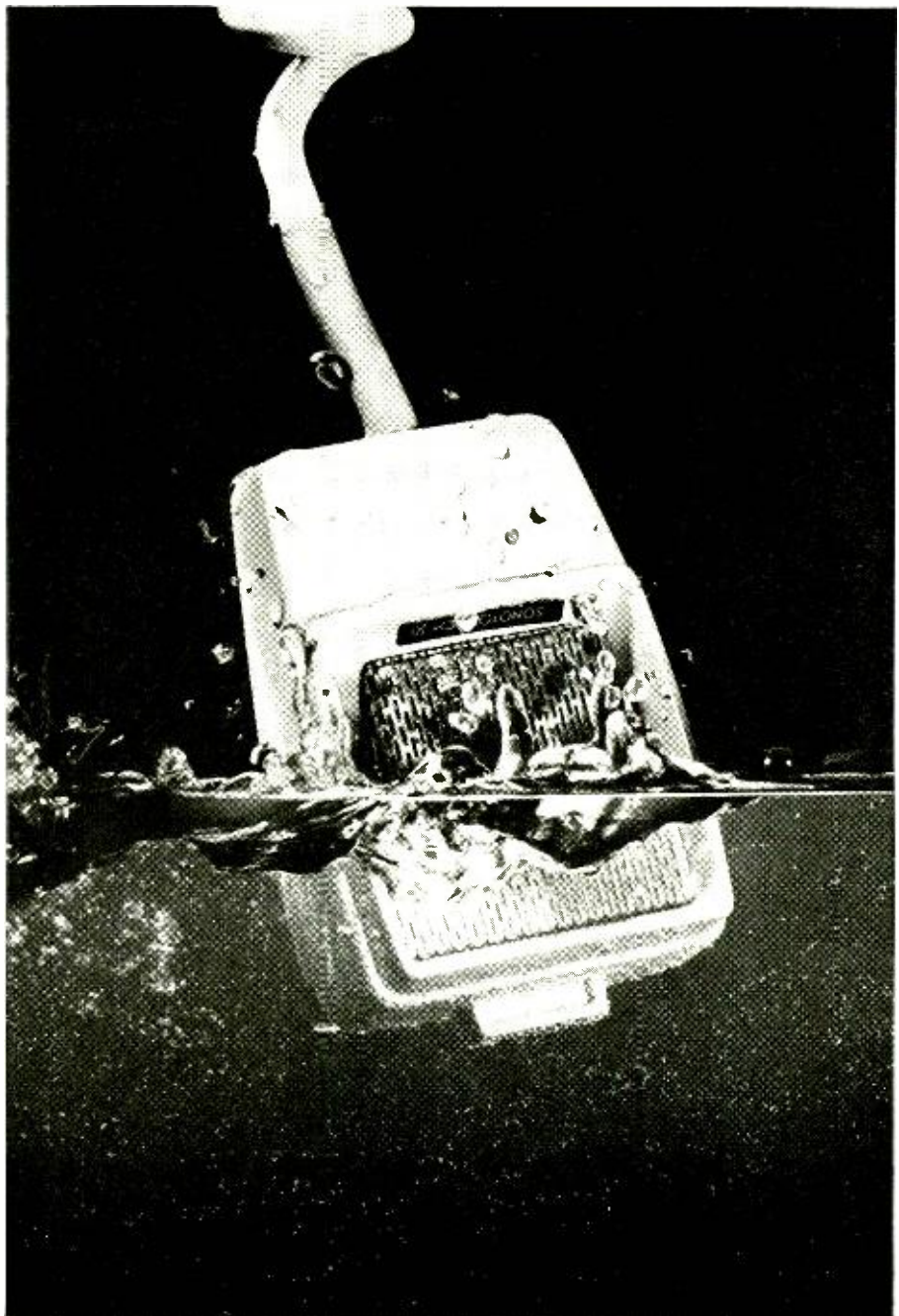

## DUNK IT!

### CERAMIKES STILL GIVE TOP FLIGHT PERFORMANCE

Anything can happen to a CB mike—and generally does. That's why the Sonotone Ceramike CM-30 is built to take such terrific punishment. Its heart—a rugged ceramic element—is mounted in a sturdy but pliant neoprene suspension, and is immune to shock, vibration, and moisture. Its operation is unaffected by even extreme humidity. Its light, short-travel switch will make over 100,000 clean, sharp contacts.

The CM-30M comes in a "shatter-proof" plastic case with a "push-to-talk" switch at the top and a 6-foot retractable cord.

For long life, ruggedness and outstanding performance, make your next CB mike a Sonotone Ceramike. Model CM-30, \$14.00. CM-30M (with convenient dashboard 'Magnet Mount'), \$16.50. CM-31 (same as CM-30 less switch), \$13.50.

**Sonotone** Sonotone Corp., Electronic Applications Div., Elmsford, New York  
Cartridges • Speakers • Microphones • Headphones • Hearing Aids • Batteries

CIRCLE NO. 129 ON READER SERVICE PAGE

# HERE'S WHY



**ELECTRONIC  
TRANSISTOR  
IGNITION**

**OUTPERFORMS  
all other  
IGNITION  
systems**



Every AEC-77 system is tested under actual operational load with 4 fouled and 4 operating spark plugs at  $-20^{\circ}\text{C}$  and at  $105^{\circ}\text{C}$  to insure reliability in usage under the most adverse operating conditions.

Every AEC-77 delivers 18,000 volts to the plugs at engine cranking as against 8,000 volts of other ignitions... guarantees instant starting in any type weather.

AEC-77 delivers 30,000 volts at 2,000 rpm, as against 18,000 volts of other ignitions.

AEC-77 delivers 30,000 volts beyond 6,000 rpm, as against 2,000 volts of other ignitions.

AEC-77's constant high voltage output guarantees more complete combustion to release full engine power... increases gas mileage by 15%... keeps plugs and points clean beyond 50,000 miles... engines run smoother... fires fouled plugs... increases top speeds... eliminates 4 out of 5 tune-ups... and it's guaranteed for 3 full years.

Completely waterproof and shockproof... AEC-77 will pay for itself in 12,000 miles usage through gas and maintenance savings!

World Champion Racing Driver Phil Hill states, "AEC-77 will improve a cars performance and economy."



Detailed easy to follow instructions make installation quick and simple by anyone in 20 minutes—no special tools or knowledge required.

2,000,000 miles of testing, 5 years of sales, with quality components such as General Motors Delco 15 ampere transistor (type 2N1358A), Motorola 50 watt zener diodes (type 1N2836B), prove without a doubt the reliability of every AEC-77.

Regardless of price, AEC-77, feature for feature at \$49.95 postpaid, cannot be duplicated or matched by any other system. Order now and Save \$10.00 by using the attached coupon, or see your local dealer.

## COMPLETE FACTORY WIRED SYSTEMS!

(Regularly \$49.95)

AEC 77 with (400:1) Ignition Coil... \$39.95

6/12 volt systems

AEC 77 for Positive Ground British Cars... \$39.95

6/12 volt

**NEED COILS & BALLAST RESISTORS ONLY?**

Transistor 77 (400:1) Ignition Coil 6/12 Volt \$11.95

Ballast Resistor variable .3 to .9-250 watt \$ 1.95

## COMPLETE DO IT YOURSELF KIT!

AEC M4 Negative Ground only \$32.95

## AUTOMOTIVE ELECTRONICS CO.

387 PARK AVE., SO. NEW YORK, N.Y. 10016

NAME .....

ADDRESS .....

CITY..... ZONE..... STATE.....

AEC-77 For Negative ground 6/12 v ..... \$39.95

AEC-77P For Positive ground 6/12 v ..... \$39.95

Kit \$32.95  400:1 Coil \$11.95  Ballast \$1.95

FREE BROCHURE ON AEC 77 SYSTEMS. EW-6

CIRCLE NO. 102 ON READER SERVICE PAGE

74

## Transistor Hi-Fi Amplifier

(Continued from page 33)

of germanium power output transistor.

Working closely with the supplier, we were able to get a high-gain transistor with consistently low base-emitter voltage which helps minimize distortion. The device also features very low collector-to-emitter saturation voltage which improves efficiency and increases the allowable collector voltage swing before clipping. Distortion is further reduced by virtue of the fact that the transistor also has a very linear  $V_{be}$  versus  $I_c$  characteristic. The high gain and high common-emitter cut-off frequency permit the use of feedback to improve the frequency response while maintaining acceptable gain at high frequencies. The low thermal resistance of the transistor plus the heat-sinking of the outputs and drivers to a black anodized aluminum chassis .093" thick provide remarkably high power capabilities well within safety margins imposed by temperature.

### Performance & Operation

Fig. 3 shows the frequency response of the amplifier at the 1-watt power level. Figs. 4A and 4B show the harmonic and intermodulation distortion characteristics of the amplifier while Fig. 5 shows the power response at 2% total harmonic distortion at 8 ohms.

Fig. 6 shows one channel of the amplifier from the approximate 1-volt point to the speaker output terminal. The basic function of the output circuit Q5 and Q6 has already been explained. The power driver transistor Q4 is of the same type already described and is connected as an emitter-follower to the primary of the tri-filar-wound driver transformer T1. Q2 and Q3 are direct-coupled pre-driver stages and provide voltage gain and impedance matching to the driver circuit. The direct coupling reduces phase shift through the amplifier and makes the amplifier more stable with the 30 db of feedback applied from the output to the emitter of Q2. Q2 and Q3 are required to handle some power and since they are directly coupled to Q4, we chose silicon planar  $n-p-n$  transistors which exhibit extreme stability to temperature variations and signal conditions.

Q1 is a small-signal  $p-n-p$  germanium transistor and is used as the loudness

control amplifier. It is a noise-selected device with signal-to-noise ratio of better than 60 db. It is connected in an unusual feedback circuit with a loudness control which, together with the 5000-ohm level control, can provide continuous loudness compensation to any desired level.

The power supply employs four silicon rectifiers in two full-wave circuits to provide the +30 and -30 volts. The filtering is pi-type LC with two separate chokes and 10,000  $\mu\text{f.}$  of capacity. The positive and negative supply buses are separately fused. The driver and pre-driver circuits are so designed that each works from a different power supply. In this way the loads on both the positive and negative supplies are balanced to provide best power output capabilities. This also helps provide extremely good channel separation at all frequencies.

Due to the direct coupling of the load to the output circuit and because considerable negative voltage feedback is provided, a high positive damping factor is achieved for any load impedance. Fig. 7 shows the damping factor for various loads versus the frequency. Unlike many vacuum-tube amplifiers the damping factor remains high even at the extremes of the audio spectrum. This, in part, accounts for the "transistor sound" characteristic of this amplifier.

Another unique feature is the hinged printed-circuit board containing the pre-driver, driver, and output biasing components. This board pivots up out of the way during construction and wiring of the kit version of the amplifier.

We have listened to this amplifier with virtually every commercially available speaker system and listener opinion as to the best matching speaker varies as much as does speaker design. Nevertheless since, in the last analysis, the overall sound is a function of the listening room and room acoustics, final choice of a speaker system should be based on the particular user's requirements.

The outstanding design features of the basic amplifier section are complemented by the ten-transistor preamplifier, which forms part of the integrated unit. The low-noise transistors in the preamp section achieve outstanding over-all hum and noise performance. This, plus its input and frequency-control features, allows the KG-870 to serve as the heart of a high-performance home music system. ▲

Fig. 7. Damping factor remains high over entire audio spectrum.

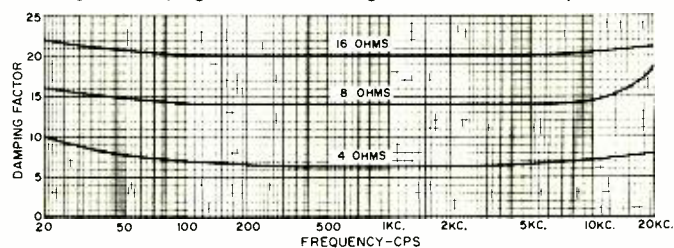

## How Big is Your Volt?

(Continued from page 42)

variation) equals 2310  $\mu$ V, or 0.17% tolerance. By marking the date of purchase on the cell case and applying corrections for age, temperature, and the internal voltage drop due to internal resistance at the time of measurement, this accuracy can be maintained. Life of this cell for very light loads and shelf storage conditions is in excess of 3 years.

Mallory also produces a voltage reference battery with a range of 10.828 volts in steps of 1.3535 volts. The accuracy is claimed at  $\frac{1}{2}\%$  for 70°F. A 100  $\mu$ A load and a temperature range of -20°F to +160°F gives a tolerance of 1%.

The 1.34 volts usually listed for the mercury cell is not the open-circuit value, but represents the voltage of the cell under a predetermined load. Usually this load represents about 5% of the maximum current capacity of the cell.

### Voltage Calibration Check

Use the circuit of Fig. 1A where  $E_n$  is the nominal battery voltage,  $R_n$  is the internal resistance of the battery,  $R_v$  is the internal resistance of the measuring instrument,  $E_1$  is the voltage drop across the cell's internal resistance, and  $E_2$  is the actual voltage across the instrument. By using the meter at  $V$  we can tell the current flowing in the circuit since the sensitivity of the instrument is generally known. Also, the position of the meter gives us some idea of the current flowing in the circuit. If, for example, we had a 1-mA meter movement or an instrument of 1000 ohms-per-volt switched on an appropriate range to read the battery voltage, and the meter reads .30% of full scale—then the current  $I$  flowing must be 300  $\mu$ A. The meter may not be reading accurately, but should give an indication sufficiently accurate for our purpose, since this will be applied only to correct for the voltage drop across the cell. Knowing the current flow and using Ohm's Law,  $E_1$  equals  $IR_n$  and  $E_n$  minus  $IR_n$  equals  $E_2$ . The tolerance of the voltage will remain as shown under each cell or voltage source for small values of current. In most cases the current flowing will not have to be taken into account since this represents a correction voltage of 1 mv. for each milliamperere if the cell had a resistance of 1 ohm. Most cells have a voltage of over one volt so this represents a change in voltage tolerance of less than 0.1%.

### Current Calibration Check

Checking the current calibration of a meter requires the use of a cell or source of extremely low resistance. Fig. 1B shows the circuit used.  $R_v$ ,  $R_n$ ,  $E_n$  are as in Fig. 1A and  $R_l$  is the value of resistance necessary to limit current value. ▲



# Pictures in Sound... on Tarzian Tape

■ Sounds are a part of your life. Many will never recur. Like treasured photographs, they deserve to be saved. Treat your favorite sounds carefully. Record them on long-lasting Tarzian Tape.

**FREE**... Ask for your copy of Tarzian's illustrated 32-page book, "Lower the Cost of Fun with Tape Recording."

Tarzian Tape is sold by better high fidelity, photographic, and electronic parts stores throughout the U. S. and Canada. Choose standard, long play, and extra long play lengths, Mylar or acetate, all popular reel sizes.



## SARKES TARZIAN Inc.

World's Leading Manufacturers of TV and FM Tuners • Closed Circuit TV Systems • Broadcast Equipment • Air Trimmers • FM Radios • Magnetic Recording Tape • Semiconductor Devices

**MAGNETIC TAPE DIVISION • BLOOMINGTON, INDIANA**

Export: Ad Auriema, Inc., N.Y. • Canada: E. J. Piggott Enterprises Ltd., Toronto, Ont.

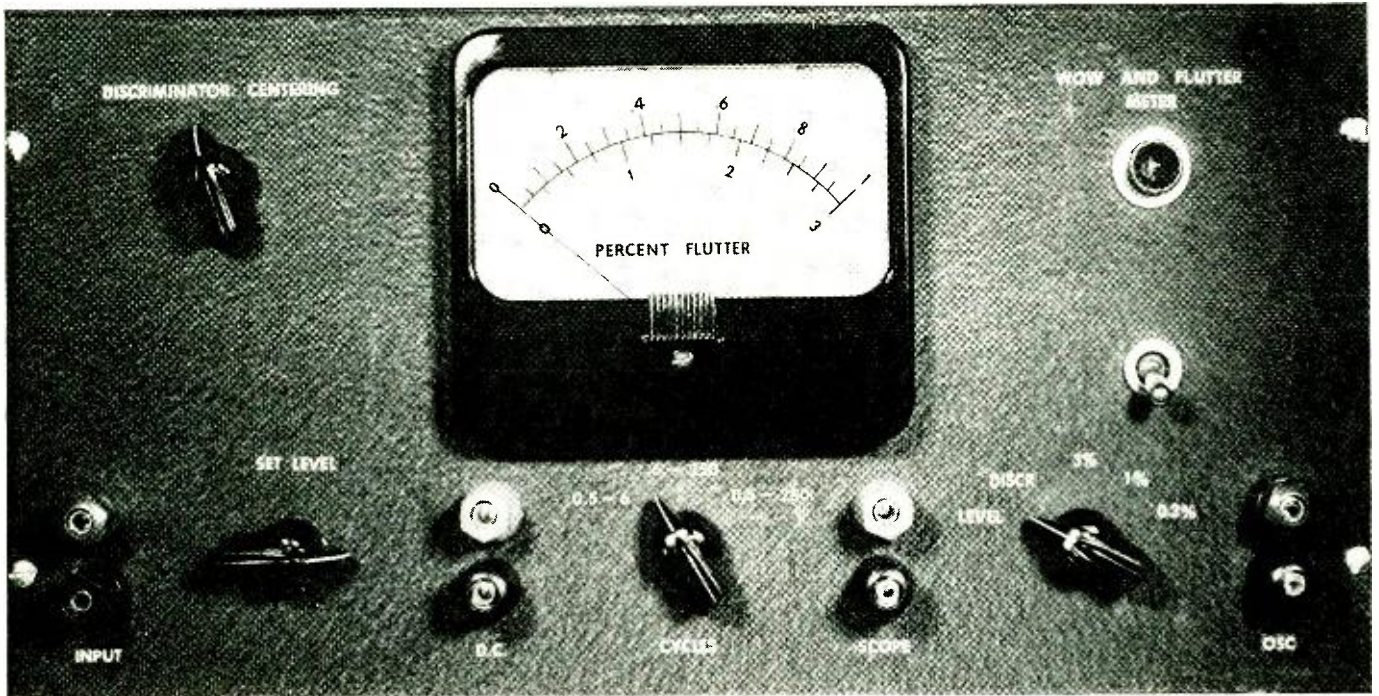

Front-panel layout of the instrument showing major controls.

# WIDE-RANGE WOW & FLUTTER METER

By FRANK J. DIELSI

*Unless wow and flutter are kept at a minimum in any recording or playback system, even the best of sounds may be distorted. This professional-type device can measure these quantities.*

**M**AINTEINING low flutter and wow in a mechanical system used for recording and reproducing sound is just as important as maintaining low distortion and noise levels. Here is a valuable addition to any audio shop, lab, or production test line, that will give direct readings of flutter and wow in the full-scale ranges of 3, 1, and 0.3 percent. It includes a very stable 3000-cycle carrier oscillator and a bandwidth switch with filters for measuring the flutter and wow spectrums separately. It also has separate output terminals for a direct-writing recorder and terminals for observing flutter and wow components with a scope.

## Circuit

Fig. 1 shows the complete schematic of the flutter and wow meter. It is essentially an FM receiver that measures the frequency modulation of the 3000-cycle carrier signal that is recorded or reproduced by the device being tested.

The tuned input amplifier V1A has a selective parallel-*T* network in an inverse feedback loop to produce maximum gain at the 3000-cycle null frequency of the network. To avoid sideband attenuation, the constants of the parallel-*T* network were selected to produce a broad-topped response curve rather than the sharp selective curve usually associated with such a filter.

Instead of the abrupt phase reversal at the null frequency, a gradual change from 90 to 270 degrees occurs, producing the broad-topped curve shown in Fig. 2. This is due to the opposing effects of the attenuation and phase characteristics at the null frequency. The gain of the input tuned amplifier is kept low to prevent instability caused by the regeneration

at the center frequency. This selective amplifier removes any distortion, hum, extraneous noise, and high-frequency tape bias components that may be present on the 3000-cycle flutter-modulated input signal.

Following the isolation stage V1B, the signal feeds a biased double-diode limiter that removes any amplitude modulation. The limiter is designed for symmetrical clipping to avoid introducing any phase modulation of the signal. The limited signal is amplified by V2A and fed to the cathode-follower discriminator driver V2B.

The discriminator is a balanced dual-tank circuit with each tank tuned approximately 450 cycles each side of the 3000-cycle center frequency. It uses toroid coils with temperature-stable capacitors for maximum stability. The discriminator response curve is shown in Fig. 3. A direct coupled cathode-follower output stage, V3A, prevents any effect on the discriminator linearity by output loading. The cathode of this stage is connected to the "D.C." terminals and feeds a direct-writing recorder that can be used to measure long-term drift of the system being tested. The positive 7.5-volt quiescent potential at these terminals can be balanced out with a series battery. This potential is also fed to the discriminator position of the meter switch S2 to indicate center tuning of the discriminator by a mid-scale deflection on the meter. In this position, the meter itself can be used to indicate a positive or negative drift of the carrier signal by any positive or negative deflection of the meter from mid scale.

A 500-cycle LC low-pass filter follows the discriminator output stage and removes any residual 3000-cycle carrier

from the demodulated signal. The attenuation curve of this filter is also shown in Fig. 2. A bandwidth switch with appropriate high-pass and low-pass RC filters is used to divide the flutter and wow spectrums for separate measurements.

The meter amplifier consists of the low-noise, cascade-connected V4A and V4B followed by the meter driver V3B. The cathode of V3B is used to pick off the demodulated signal for the "Scope" terminals. Meter sensitivity is adjusted with the inverse feedback potentiometer R49 ("Sensitivity"). This feedback also helps to achieve meter-scale linearity.

The Colpitts oscillator V6A is operated class A and uses a toroid coil and very high C in the tank circuit. This, combined with the cathode-follower isolating amplifier V6B, and the voltage-regulated power supply, provides excellent stability. C33, the 340-1070 pf. padder, is used to tune the oscillator to exactly 3000 cycles.

The instrument is built on a 2 x 13 x 7 inch aluminum chassis. The cabinet is 7 x 14 x 8 inches. The usual wiring precautions for any high-gain audio amplifier should be

followed. The discriminator is built in a separate 5 x 4 x 3 inch metal box. A partition shield is used around the oscillator components to prevent leakage of the 3000-cycle signal into the high-gain meter amplifier. A shield should also be mounted between switch sections S2A and S2B-S2C. This is done by using a basic index assembly long enough for three sections and mounting the shield in place of the middle section. One pole of the S2A wafer is not used. To prevent drift, all heat-generating parts should be mounted as far as possible from the oscillator and discriminator components.

### Calibration

Turn on the instrument and let it warm up for at least 5 minutes. Disconnect C25 from the arm of S2A, feed a .015-volt r.m.s. 60-cycle signal into C25, and set R49 ("Sensitivity") for full-scale meter deflection with the meter selector set in any position except "Discr." Reconnect C25. Next, put the meter selector switch in the "Discr" position and without any external signals, adjust R50 ("Discriminator") for mid-

**Fig. 1. Schematic and parts list for the wow and flutter meter. It is basically an FM receiver that measures the frequency modulation of a built-in 3-kc. oscillator. Modulation is produced by speed variations present in record/playback systems.**

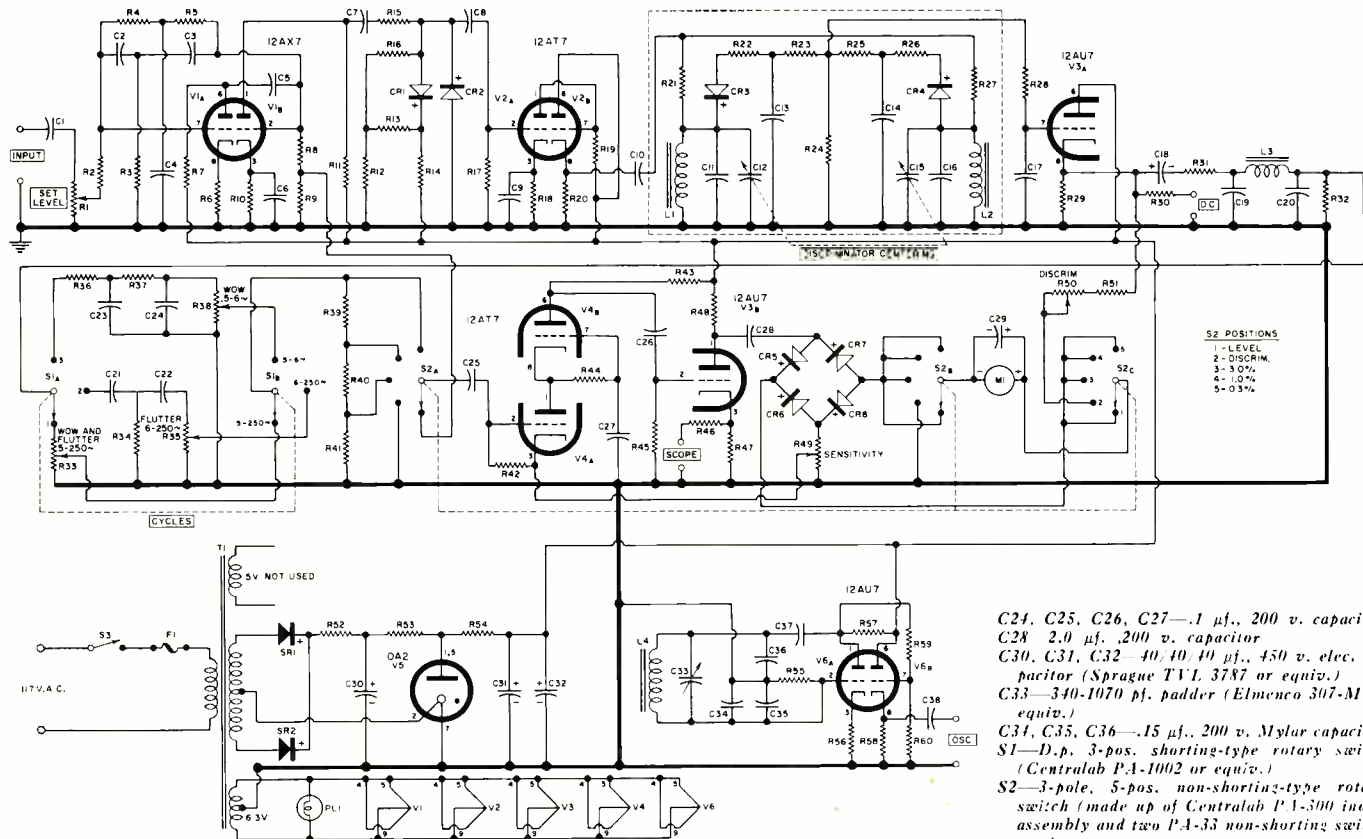

- R1—100,000 ohm audio-taper pot.
- R2, R8, R24, R59—470,000 ohm, 1/2 w. res.
- R3—2200 ohm, 1/2 w. res. ±5%
- R4, R5, R22, R26—27,000 ohm, 1/2 w. res. ±5%
- R6, R47—1500 ohm, 1/2 w. res.
- R7, R11, R19, R28, R30, R37, R43—100,000 ohm, 1/2 w. res.
- R9, R31, R32, R46, R48, R57—22,000 ohm, 1/2 w. res.
- R10, R18, R56—2200 ohm, 1/2 w. res.
- R12, R13—470 ohm, 1/2 w. res.
- R14—82,000 ohm, 1/2 w. res.
- R15, R60—220,000 ohm, 1/2 w. res.
- R16, R44, R45—2.2 megohm, 1/2 w. res.
- R17, R55—1 megohm, 1/2 w. res.
- R20—39,000 ohm, 1/2 w. res.
- R21—22,000 ohm, 1/2 w. res. ±5%
- R23, R25—68,000 ohm, 1/2 w. res. ±5%
- R27—25,000 ohm, 1/2 w. res. ±5%
- R29—3900 ohm, 1/2 w. res.
- R33, R35, R38—2 megohm audio-taper pot.
- R34—330,000 ohm, 1/2 w. res.
- R36—68,000 ohm, 1/2 w. res.
- R39—1 megohm, 1/2 w. res. ±5%
- R40—360,000 ohm, 1/2 w. res. ±5%

- R41—150,000 ohm, 1/2 w. res. ±5%
- R42—10 megohm, 1/2 w. res.
- R49—100 ohm, 1/2 w. pot.
- R50—25,000 ohm, 1/2 w. pot.
- R51—56,000 ohm, 1/2 w. res.
- R52, R53—2500 ohm, 10 w. res.
- R54—470 ohm, 1 w. res.
- R58—4700 ohm, 1/2 w. res.
- C1—.001 μf., 200 v. capacitor
- C2, C3—.002 μf., temp.-stab. capacitor (Sprague 10TS-D20 or equiv.)
- C4—.0068 μf., temp.-stab. capacitor (Sprague 10TS-D68 or equiv.)
- C5, C10, C37—.05 μf., 200 v. capacitor
- C6, C9, C23, C38—.25 μf., 200 v. capacitor
- C7, C8, C17—.002 μf., 200 v. capacitor
- C11, C13, C14—.02 μf., temp.-stab. capacitor (Sprague type 10TS-S20 or equiv.)
- C12, C15—2 gang var. capacitor, 15.5-467.8 pf. per section, (Allied 611,059 or equiv.)
- C16—.01 μf., temp.-stab. capacitor, (Sprague 10TS-S10 or equiv.)
- C18, C29—200 μf., 12 v. elec. capacitor
- C19, C20—.02 μf., 200 v. capacitor
- C21—.5 μf., 200 v. capacitor
- C22—.033 μf., 200 v. capacitor

- C24, C25, C26, C27—.1 μf., 200 v. capacitor
- C28—2.0 μf., 200 v. capacitor
- C30, C31, C32—40/40/40 μf., 450 v. elec. capacitor (Sprague TVL 3787 or equiv.)
- C33—340-1070 pf. padder (Elenco 307-M or equiv.)
- C34, C35, C36—.15 μf., 200 v. Mylar capacitor
- S1—D.p. 3-pos. shorting-type rotary switch (Centralab P.A-1002 or equiv.)
- S2—3-pole, 5-pos. non-shorting-type rotary switch (made up of Centralab P.1-300 index assembly and two P.A-33 non-shorting switch sections, see text)
- S3—S.p.s.t. toggle switch
- CR1-CR2—Matched pair 1N34A germanium diodes
- CR3-CR4—Matched pair 1N34A germanium diodes
- CR5-CR6-CR7-CR8—Matched 1N34A germanium diodes
- SR1, SR2—800 p.i.v. silicon rectifier (RCA 1N3196)
- T1—Power trans. 235-0-235 v. @ 40 ma.; 6.3 v. @ 2 amps; 5 v. @ 2 amps (not used); (Stancor PM-8401 or Triad R-4B)
- L1, L2—200 mhy., 25-ohm toroid coil (Triad EC-200 or equiv.)
- L3—12 hy., 30-ma. choke (Stancor C-2318 or equiv.)
- L4—300 mhy., 7.9-ohm toroid coil (Triad EC-030 or equiv.)
- F1—5 amp, 3AG fuse
- PL1—#47 pilot light
- M1—0-200 μa. meter (Beede Model 16 or equiv.)
- V1—12AX7 tube
- V2, V4—12AT7 tube
- V3, V6—12AU7
- V5—0A2 tube

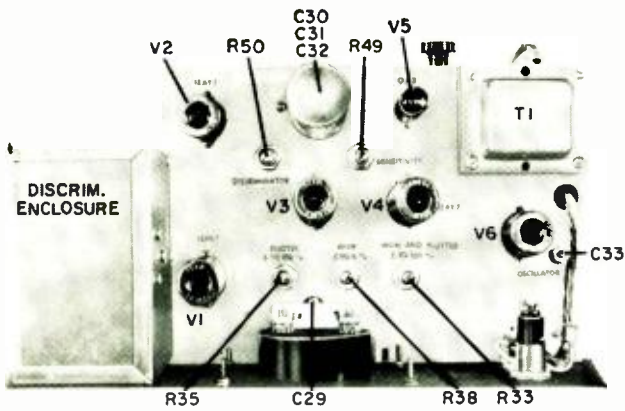

Top of chassis view shows both the tube and control layout.

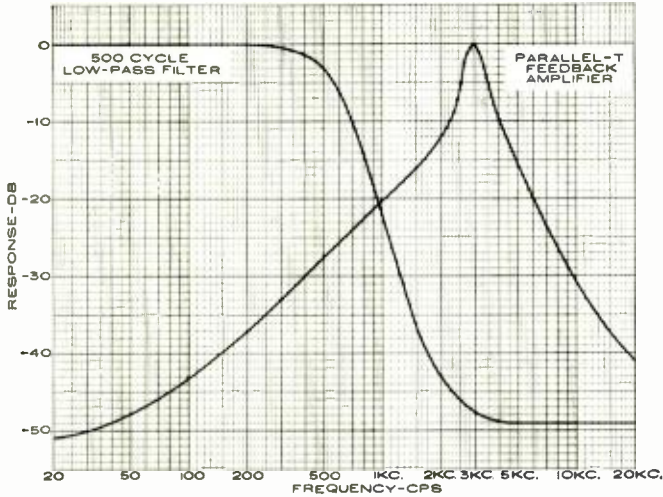
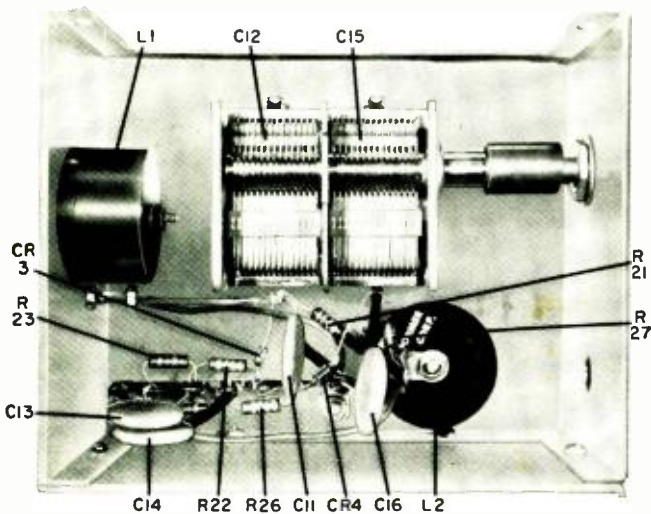

Fig. 2. Frequency response on the 500-cps low-pass filter and parallel-T feedback amplifier used in the measurement circuit.



Internal view of separate, shielded discriminator enclosure.

scale meter deflection. "Wow and flutter 0.5 to 250" control R33 calibrates the instrument for flutter and wow from 0.5 to 250 cycles; "Flutter 6 to 250" control R35 calibrates it for flutter alone from 6 to 250 cycles, and "Wow 0.5 to 6" control R38 calibrates the wow spectrum from 0.5 to 6 cycles. These controls can be set with a standard source of flutter and wow or by calibrating them against another instrument.

If another calibrated instrument or calibrated source of flutter is not available, R33, R35, and R38 can be set at approximately 700,000 ohms, 800,000 ohms, and 400,000 ohms respectively from the high side. This may not give extreme accuracy but will enable the instrument to be used

for relative measurements for locating the sources of wow and flutter in a tape machine or in a phonograph turntable.

### Operation

To test a tape machine, the output of the oscillator is fed to the input of the recorder and the 3000-cycle signal is recorded for about one minute each on the beginning, middle, and end of the reel. This is necessary because wow and flutter can vary considerably from the beginning to the end of a reel. Play back the tape and feed it to the "Input" of the flutter meter. With the meter switch S2 in the "Level" position, adjust the "Set Level" control R1 for mid-scale meter deflection. Rotate S2 to the "Discer" position and adjust the "Discriminator Centering" control C12-C15 for mid-scale meter deflection. Rotate meter switch S2 to the range necessary to read flutter or wow or both together as selected with the "Cycles" switch S1. If the tape recorder has a separate playback head and amplifier, the measurements can be taken from the playback amplifier while the signal is being recorded.

A standard calibration disc is required for testing turntables. A calibration disc, part No. 37-1002 or tape part No. 62-1002A, is available from *D and R Ltd.*, 402 East Gutierrez St., Santa Barbara, California. These standards can also be used to calibrate the instrument if they are played on a machine with reasonably low inherent flutter and wow. This method of calibration will introduce an error of less than 2 percent because the total meter reading will be the r.m.s. value of the inherent flutter of the playback machine and the calibration signal.

Considering the total potential sources of wow and flutter in any system for recording and reproducing high fidelity, this instrument will prove to be a tremendous time saver for maintenance and repair. ▲

Fig. 3. Discriminator S-shaped output curve is centered at the 3-kc. operating frequency output of the internal oscillator.

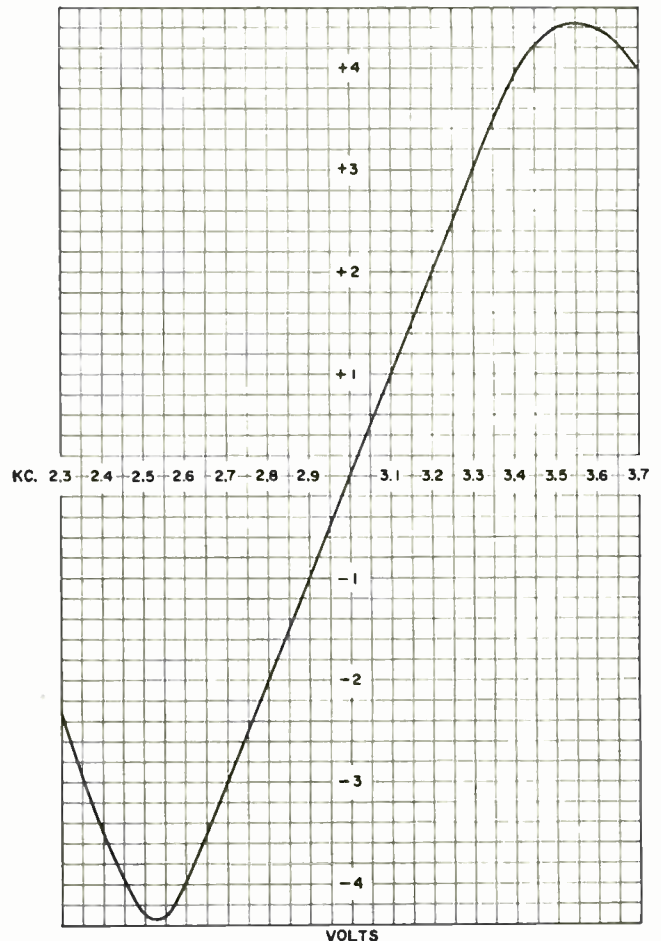



## Twin-T Oscillators

(Continued from page 39)

quite sophisticated approach. This little instrument, built as a demonstrator, has a duo-tone keyboard of  $1\frac{1}{2}$  octaves, a 5-chord accompaniment register, and eight manual and chord stops. It has a built-in amplifier and speaker and variable rate and intensity tremolo. It was built into a small upright model toy piano and sounds like a big organ.

A highly sophisticated model was also built using the twin-T system. This is a full organ, capable of powering a full three-manual console. The demonstrator version shown has not only a large stop selection, a 20-watt, dual-channel amplifier with 16-foot bass, chord register, and pedal bass, but also incorporates sustain and chime effects.

The electronic part of the instrument can be fabricated in any convenient way, without regard to the possibility of inductive intercoupling which presents some problems with LC oscillators.

The low-voltage transistor circuits do not require high insulation as do vacuum-tube circuits. It is perfectly feasible to assemble the generators directly on dry plywood (shellacked), Masonite, or any other suitable insulated support material.

The best contact material for key and stop switches with these high-impedance switching circuits is gold. An inexpensive way of providing gold contacts is to have a suitable length of .010"- to .015"- diameter steel piano wire gold plated then cut to desired lengths.

### Keyboards

The best source of keyboards is a low-cost keyboard instrument such as a toy piano or electric reed organ. Some of the latter can be obtained second-hand economically and provide not only a good keyboard but in many cases a presentable console as well. By removing most of the wind blown accessories, room can generally be found for the electronic circuit structures. ▲

Table 1. Accurate intervals for one octave.

Tone	Frequency (in cps)	Tone	Frequency (in cps)
C3	261.63	F#3	369.99
C#3	277.18	G3	392.00
D3	293.66	G#3	415.30
D#3	311.13	A3	440.00
E3	329.63	A#3	466.16
F3	349.23	B3	493.88

For higher octaves, multiply frequency by 2, 4, 8, etc.  
For lower octaves, multiply frequency by  $\frac{1}{2}$ ,  $\frac{1}{4}$ ,  $\frac{1}{8}$ , etc.

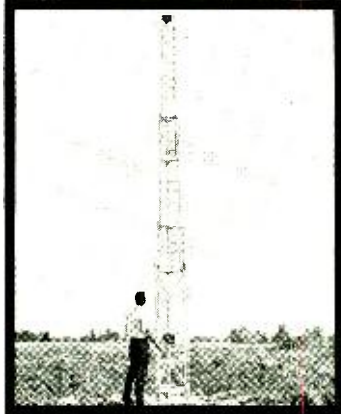
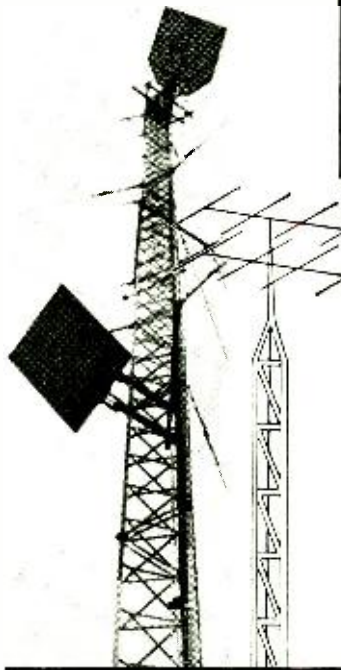

The most Famous Name in  
**TOWERS of ALL KINDS!**

Here are the advantages you get  
when you insist on **ROHN TOWERS**

**LARGEST FULL RANGE OF TOWERS**—you can get anything from home TV and amateur radio towers to heavy-duty communication and micro-wave towers. Included are 500 foot self-supporting towers, 1,000 foot guyed towers, "fold-over" and crank-up towers. Regardless of your needs, ROHN can supply it.

**UNQUESTIONED LEADERSHIP IN DESIGN AND MANUFACTURE**—you get the latest in advanced tower engineering. All communication towers are engineered to EIA specifications, and are proved by thousands of installations. No other manufacturer can surpass the quality and fine reputation of ROHN.

**QUALITY MATERIALS AND WORKMANSHIP**—Only highest quality steel is used which fully meets the specifications for the job. ROHN towers are hot-dipped galvanized **after fabrication**—a feature ROHN pioneered!

**SERVICE WHEREVER YOU WANT IT**—ROHN representatives are world-wide. Complete erection service for communication systems, broadcasting, micro-wave, and other needs is available; also competent engineering service to help you.

**Settle for the BEST in TOWERS**—ROHN—today the world's largest, exclusive manufacturer of towers of all kinds!

**Also available:** Rohn Lighting Kits, Microwave Passive Reflectors, Tower Installation Service and Engineering Assistance. Representatives World-Wide to Serve You.

For your needs, contact your local ROHN salesman, distributor or dealer; or write direct for information.

SEND THE HANDY COUPON INDICATING YOUR NEEDS

**ROHN**  
Manufacturing  
Co.  
BOX 2000  
PEORIA, ILLINOIS

Send me complete literature on the following ROHN Products:

- Home TV Towers       Amateur Towers  
 Communication Towers       AM-FM Broadcasting Towers  
 Micro-Wave Towers       Government

Name \_\_\_\_\_

Firm \_\_\_\_\_

Address \_\_\_\_\_

City \_\_\_\_\_ State \_\_\_\_\_

"World's Largest EXCLUSIVE Manufacturer of Towers; designers, engineers, and installers of complete communication tower systems."

CIRCLE NO. 126 ON READER SERVICE PAGE

MODEL 99 POWER-5

Free Pocket Flashlight  
WITH  
**5 POWER TRANSISTORS 99¢**  
GENERAL REPLACEMENT EACH

WORKMAN Electronic PRODUCTS, INC.  
SA A. O. TA. FLORIDA

**POWER TRANSISTORS**

GENERAL REPLACEMENTS FOR 71 ENTERTAINMENT TYPE TRANSISTORS.  
**FREE FLASHLIGHT**

WITH PACK OF 5 **\$4.95** D.U.R. NET

Ask your Electronic Parts Distributor for Model No. 99 POWER-5

WORKMAN Electronic PRODUCTS, INC.  
SA A. O. TA. FLORIDA

**HOME** 

**OFFICE** 

**FACTORY** 

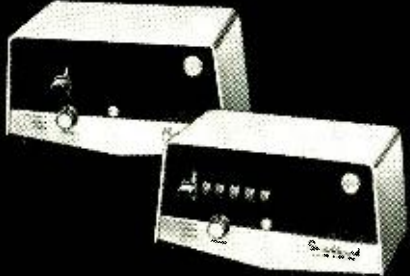

**AN RCA INTERCOM SYSTEM**  
Is a Long-Term Investment in  
Convenience and Efficiency

Why wait longer to enjoy the convenience of your own intercom network? Simple or complex, wired or wireless, for home or business use, there's an RCA intercom system to meet your needs. You'll find it quickly justifies its cost in savings of time and energy, and in the increased efficiency it provides.

**"Switchboard" Intercom System.** Master with up to 4 remote units. Master can be set up for remote-to-remote conversation, or speak with any one or all remote units.

**"Mastercom" Intercom System.** Up to 6 units. With an all-master system, any unit can call any other unit direct; system permits 3 separate private conversations simultaneously or conference among all 6.

**Wireless Intercom System.** No connecting wires, no installation. Just plug unit into any 110-120 volt wall socket and talk with all other units on the same wiring system.

**Transistorized Intercom System.** Battery-operated (uses penlite cells), can be set up anywhere: parking lots, storerooms, etc.

**"Partyliner" Intercom System.** Basic 2-station system. As many as 4 additional remotes can be added. Very low cost. Ideal for paging; master calls all remote units at once. Any remote unit can call master.

For more information see your Authorized RCA Intercom Distributor—or, attach coupon below to a postcard and mail.



**The Most Trusted Name**  
in Electronics

RCA ELECTRONIC COMPONENTS AND DEVICES  
Commercial Engineering Dept. F-41-TT  
415 South Fifth Street, Harrison, N.J.

Please send detailed information on the RCA INTERCOM SYSTEMS checked below:

All systems                       "Switchboard" System  
 "Mastercom" System             Wireless System  
 Transistorized System         "Partyliner" System

Name \_\_\_\_\_ Title \_\_\_\_\_  
Company \_\_\_\_\_  
Address \_\_\_\_\_  
City \_\_\_\_\_ Zone \_\_\_\_\_ State \_\_\_\_\_

## RADIO & TV NEWS

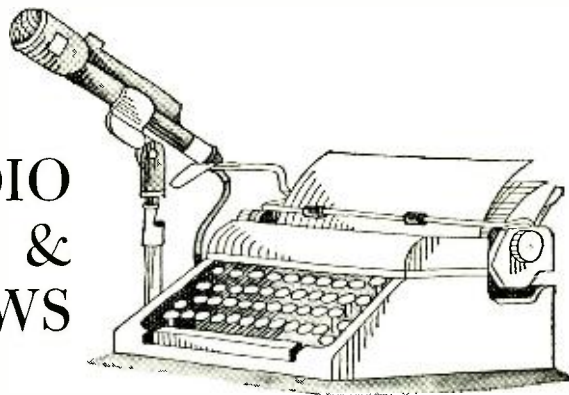

**R**ISING electronic imports already have had a heavy impact on employment in a number of states and threaten further reductions in jobs if U.S. tariff rates on these products are reduced in the forthcoming GATT negotiations, according to the EIA.

EIA spokesmen have already presented data to show that 47,000 jobs had been lost due to imports in the electronics manufacturing industry while Japan has increased its penetration of the American market tenfold within six years. The domestic economy suffered an annual loss of \$197.6 million in payrolls, \$21.8 million in capital expenditures, and \$206.4 million in consumption of domestic materials.

EIA also asked that foreign duties higher than those of the U.S. be reduced to the American level and the American GATT negotiators insist that Europe provide full access for the exports of Japanese and Hong Kong electronic manufacturers so as to relieve the unnatural pressure which Japan's nearly exclusive attention to the U.S. market places on U.S. industry.

The EIA submitted figures to show the increasing penetration of the American market by imports and their impact on the economy. The greatest foreign competition has been in consumer goods and various components serving this market. Similarly, the consumer products sector is experiencing an unfavorable balance of trade, while U.S. exports in government and industrial electronic products have increased and are chiefly responsible for the fact that total exports exceed imports.

EIA presented comparative data on foreign and domestic radio and TV sets to illustrate the advantage of imports. The average factory sales price of monochrome television receivers, the figures showed, in 1963 was \$129.73 in the U.S. compared with \$57.84 for the imported article f.o.b. origin. Comparable portable radio prices were \$18.82 in this country and \$6.24 imported. Receiving tube prices were 81 cents for U.S. as against 36 cents for imported tubes. Components for a 6-tube radio were estimated at \$9.53 if of U.S. origin and \$5.90 if imported. In a 16-tube tele-

vision receiver, the comparative costs of domestic and foreign components are \$57.45 and \$36.68, respectively.

### U.H.F. To Dominate TV?

By 1970, the number of U.S. homes being served by u.h.f. TV will be greater than those served by v.h.f., according to Jerry Balash, manager of home products for *Blonder-Tongue Labs, Inc.*

"The 55 million TV sets now in consumer hands will be replaced in a period of 8 to 9 years," Mr. Balash stated. "This means that 5 to 6 million u.h.f. sets will enter the economy each year, starting from the effective date of the all-channel law (April 30, 1964)."

Mr. Balash went on to say that as of February, 1964, there were 124 u.h.f. stations on the air and there were 60 construction permits granted by the FCC. During this time period, only 23 v.h.f. permits were granted. "The special significance of these figures lies in the fact that this marks the first time in broadcasting history that u.h.f. applications have exceeded those for v.h.f."

Mr. Balash went on to urge members of the TV and broadcasting industry to campaign for the elimination of excise taxes on u.h.f. sets. He claimed "The Treasury Department must make this temporary adjustment to equalize the cost of all-channel and v.h.f.-only sets during the period of the changeover."

### Light-Sensitive Glass

One of the interesting, yet relatively lost items at the last IEEE show, was a demonstration by *Corning Glass* of an optical quality glass that darkens rapidly when exposed to light and just as rapidly clears when the light fades.

According to Dr. Stookey, co-inventor of the material, the photochromic glass indefinitely retains the ability to darken quickly and then clear.

According to *Corning* engineers, one of the possible uses for this light-sensitive material is faceplates for cathode-ray tubes. With a TV picture presented on the tube, variations in the ambient light of the viewing area will cause the faceplate to darken, thus improving the picture contrast. When the ambient light is reduced, the faceplate clears. ▲

## U.H.F. Tuners

(Continued from page 30)

be taken to avoid their touching the stator plates. Use the bias battery and v.t.v.m. again for exact alignment. Where a number of lower frequency u.h.f. channels are received, the highest of these is adjusted first, bending only those plate sections which mesh with the stator at that channel. Going to the next lowest frequency u.h.f. station, the following plate sections are then bent. In general, only a small amount of plate bending is required.

The last adjustment which may be required is to vary the coupling loop that couples the local oscillator to the mixer. The d.c. voltage due to oscillator injection can be checked by connecting a v.t.v.m. across the u.h.f. tuner output. This can be done either by unplugging the u.h.f. tuner output cable and connecting a low-value resistor (100 to 500 ohms) from this terminal to ground and then measuring the voltage across the resistor, or else using a u.h.f. test point on the tuner (if provided). Depending on the model and the mixer crystal used, the v.t.v.m. should read from about 0.23 to 1 volt. If the oscillator injection voltage is too low, bend the loop in the oscillator compartment (L3 in Fig. 3) closer to the oscillator tuned line. Occasionally this does not help and then the mixer crystal itself may have to be replaced. Whenever that is done, the entire u.h.f. tuner may have to be re-aligned. A weak oscillator tube may also be at fault and replacement of that tube will require at least re-alignment of the oscillator section at the highest and lowest u.h.f. station to insure correct tracking.

In u.h.f. tuners, the oscillator is the most likely section to become defective. Since transistors are much more reliable than tubes, many technicians make it a practice to suspect the tube first and then the mixer diode, but reverse the order of suspects in transistor tuners. If neither of these parts is the culprit, all solder joints should be inspected since poor contact, even when it checks with an ohmmeter, may have a high enough r.f. impedance to cause trouble at u.h.f. Rotor and stator plates of tuning capacitors that are in contact and broken leads should be easily spotted. ▲

Fig. 9. Detented u.h.f. tuner made by Oak.

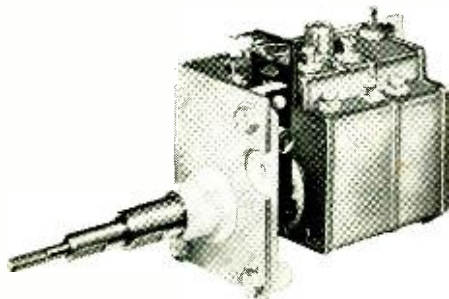

June, 1964

## FREE BOOKLET

with

## FACTS & FIGURES

You can be on the threshold of an entirely new income! One of the biggest booms nowadays is in 2-way mobile-radio communication. Every installation is practically a guaranteed income for some qualified serviceman. These stations must be kept on the air . . . must have FCC-required checks . . . and because they make money for their owners, they can afford to pay well for service.

Lampkin Laboratories, Inc., has made a study of how other servicemen are making money in this business. Now they offer the results of this study to you — in this FREE booklet — so that you can increase your income thousands of dollars. Use the coupon today!

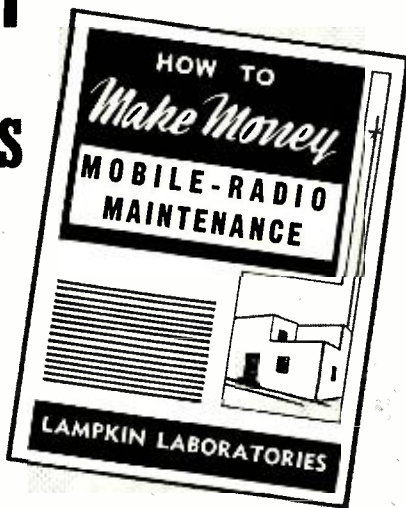

Lampkin instruments are used by thousands of mobile-radio engineers!

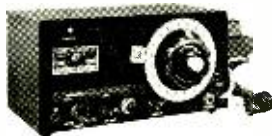

LAMPKIN 105-B FREQUENCY METER, RANGE 0.1 TO 175 MC AND UP. PRICE \$260.00 NET.



LAMPKIN 205-A FM MODULATION METER, RANGE 25 TO 500 MC. PRICE \$270.00 NET.

MAIL COUPON TODAY ➔

**LAMPKIN LABORATORIES, INC.**  
MFM Division BRADENTON, FLORIDA

LAMPKIN LABORATORIES, INC. 1  
MFM Division, Bradenton, Florida  
At no obligation to me, please send  
 Free booklet  Data on Lampkin meters  
Name \_\_\_\_\_  
Address \_\_\_\_\_  
City \_\_\_\_\_ State \_\_\_\_\_

CIRCLE NO. 120 ON READER SERVICE PAGE

### HI-FI SPEAKERS

FOR ONLY PENNIES MORE  
AT McGEE  
NORELCO 12"

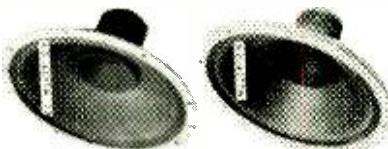

Model AD-4277M, Norelco 12" full range high-fidelity speakers. Rated 20 to 30 watts peak, 98,000 Maxwells. Match 4 to 6 ohm output. Ticonal 7 Magnet. The Twin cones both operate from same voice coil. Response 35 thru 18,000 CPS. An extra fine speaker at a reasonable price.

McGEE SALE PRICE \$14.95 MATCHED PAIR \$28.50

Model AD-4201M/77, Norelco 12" full range high-fidelity speaker. Response from 40 thru 15,000 cps. Features the famous Norelco Twin cone design, 8 ohm voice coil. Norelco Ferrrodure ceramic magnet gives a total flux of 42,000 Maxwells. A Tremendous speaker for Hi-Fi at a Terrific low price.

McGEE SALE PRICE \$8.88 MATCHED PAIR \$17.50

WRITE FOR McGEE'S MID-YEAR BARGAIN CATALOG  
Thousands of items at bargain prices

**McGEE RADIO CO.**

1901 McGEE St., Kansas City 8, Missouri

CIRCLE NO. 138 ON READER SERVICE PAGE

### COLOR CODED PHONO PLUGS

PREVENT...



### STEREO-CONNECTION MIX-UPS

To avoid wiring errors when interconnecting two pieces of stereo equipment . . . use new Switchcraft phono plugs with "SNAP-ON" Color Coded Handles, in RED, BLACK and WHITE.



Just solder wire and "SNAP-ON" plastic handle. Handle "locks-on" plug to give you a permanent finger grip when disconnecting equipment.

For positive Stereo channel identification order Switchcraft Series 3508 Color Coded Phono Plugs in Red, Black or White,—only \$0.25 LIST PRICE.

Contact your dealer or write us for name of dealer nearest you. ●

**SWITCHCRAFT**

5577 N. Elston Ave. / Chicago 30, Ill.

CIRCLE NO. 131 ON READER SERVICE PAGE

# TEST EQUIPMENT

## PRODUCT REPORT

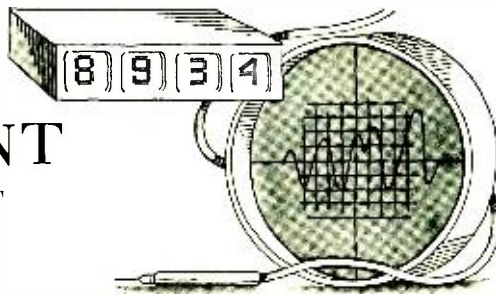

### Hewlett-Packard 208A Test Oscillator

For copy of manufacturer's brochure, circle No. 34 on coupon (page 15).

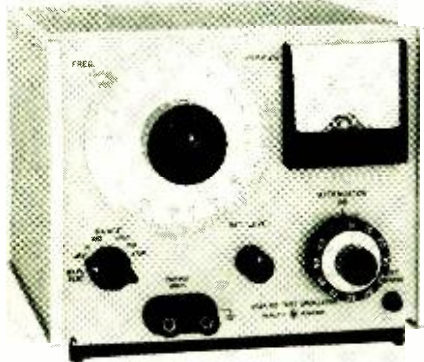

A WIDE-RANGE audio oscillator for general-purpose laboratory and production use is Hewlett-Packard's Model 208A. Since the instrument is transistorized and battery-operated, it can be used for portable or field work. The batteries, four 6.5-v. nickel-cadmium types, will operate the unit for 30 hours before recharging is required. To recharge, the oscillator is simply plugged into the a.c. line (during which time the instrument can still be used) and the batteries are trickle charged.

The frequency range of the 208A is from 5 cps to 560 kc. It has a stable output signal that is adjustable from 5  $\mu$ v. to 2.5 v. Its frequency response is essentially flat into a rated 600-ohm load throughout the complete frequency range. This is accomplished by automatically regulating the amount of negative feedback applied to the Wien-bridge oscillator to keep the output constant. In earlier vacuum-tube circuits of this type,

the changing resistance of lamp filaments was used for this purpose. In this case, a transistor peak detector and diode circuit sample the output and apply a correcting amount of negative feedback as required. This circuit maintains the output within 3 percent over the entire frequency range.

Excellent frequency stability is maintained in spite of varying loads; stability is typically better than 5 parts in 10,000. Short-term stability is better than .001 percent at 400 cps. Part of the reason for this kind of performance is the use of 1 percent polystyrene capacitors and special resistors in the bridge arms.

Referring to the block diagram, note that the basic oscillator consists of an RC Wien bridge, a two-stage amplifier (Q1, Q2) and two emitter followers (Q3, Q4). The bridge consists of an RC frequency-selective network and a resistive voltage divider. The frequency-selective network supplies positive feedback to the amplifier and determines the frequency of oscillation. The resistive network supplies negative feedback, which determines the amount of output in conjunction with the positive feedback. The division ratio of the resistive network is affected by the operation of the peak detector circuit (Q5, D3). By increasing the negative feedback when the output tends to rise and by reducing it when the output tends to fall, a constant output amplitude is maintained.

An intermediate 20-db attenuator follows. Then the signal is applied through a pair of precision output attenuators to the output connector of the instrument.

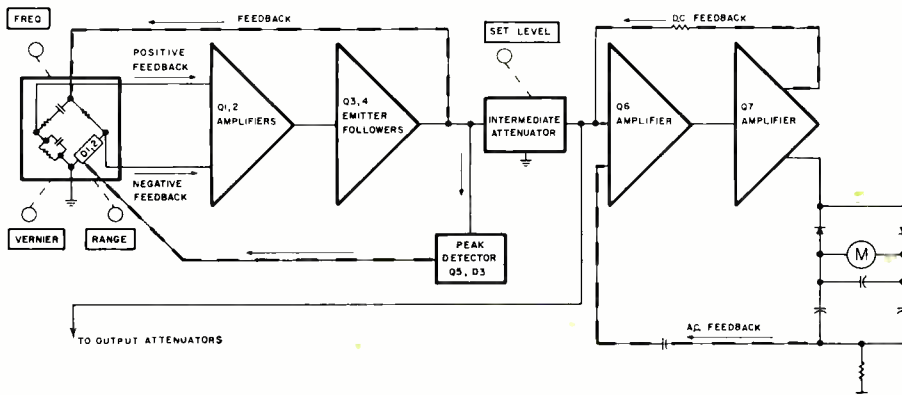

In addition, the audio signal is applied to a transistorized (Q6, Q7) voltmeter circuit that monitors and measures the output voltage.

In the Model 208A, the meter indicates the r.m.s. voltage at the input of the output attenuators. These provide 100-db attenuation in 20-db steps. In the Model 208A-DB (see photo), the output meter is calibrated in db with respect to 1 mw. In this case the output attenuators provide 110-db attenuation in 1- or 10-db steps.

The total hum and noise are less than .05 percent (-66 db), and distortion is under 1 percent. The Model 208A is priced at \$525 and the 208A-DB is \$535. ▲

### Houston Instrument VM-77B A.C. V.T.V.M.

For copy of manufacturer's brochure, circle No. 35 on coupon (page 15).



UNTIL fairly recently, voltage measurements made at very low level audio and radio frequencies had to be made with an expensive scope or a laboratory-priced meter. The demand for a high-quality, reasonably priced, reliable a.c. voltmeter for use in the radio, TV, and hi-fi market was responsible for introduction of the VM-77B.

The Houston Instrument Model VM-77B a.c. v.t.v.m. is a versatile general-purpose instrument designed for use in service shops, laboratories, and production work. The design was originally conceived by engineers of *Advance Components Ltd.* in England, and is now manufactured and sold under license by *Houston*.

The two outstanding features of the VM-77B are its extremely wide frequency range and its very high sensitivity. The full-scale input of one millivolt makes the instrument very useful as a null indicator for tuning many r.f. and i.f. circuits.

The voltmeter consists of two amplifier sections, each having two stages and two attenuator sections (see diagram). The power supply is electronically regulated providing stability for the instrument during line-voltage variations and transients. The use of negative feedback

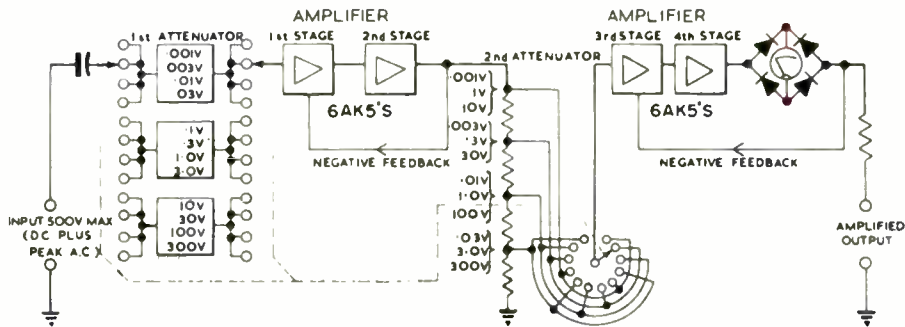

around the two amplifier sections results in a very wide range and frequency response. Signals are measured as low as 0.1 millivolt and are resolved to as low as ten microvolts. The meter, which is calibrated in r.m.s. volts and db, is in the feedback path of the second amplifier section.

The instrument has twelve overlapping ranges covering full-scale inputs from one millivolt to 300 volts. The input impedance is 10 megohms shunted by 20 pf. If it is desired to extend the range of input, this may be done by putting a small trimmer capacitor in series with the shielded test lead supplied with the instrument. This trimmer, when set for 10 to 1 voltage division, will extend

the range by a factor of 10 and reduce the input capacity to approximately 6 pf.

The accuracy of the instrument is  $\pm 3\%$  from 50 cps to 100 kc. The accuracy from 15 cps to 2 mc. is  $\pm 5\%$  and from 2 mc. to 4.5 mc. is  $\pm 2$  db. The usable range of the instrument extends to 10 mc.

Use of the unit as an amplifier is especially valuable in view of the extended frequency response of the instrument. The gain of the amplifier may be switched in 10-db steps up to 60 db or 1 volt r.m.s. output. The output impedance is 1500 ohms.

The unit measures 9"x 6½"x 7" and weighs eight and one-half pounds. The manufacturer's list price is \$195. ▲

### Mar-Con DRT-100 Tachometer

For copy of manufacturer's brochure, circle No. 36 on coupon (page 15).

**T**HE Mar-Con Model DRT-100 electronic tachometer is an ignition pulse powered instrument that is used to measure car or boat engine speed. The tach has a rear-mounted switch that allows a choice of one of two full-scale readings, 4000 rpm or 8000 rpm.

The tach is stabilized with a zener diode so that variations in battery voltage or generator output will not affect the accuracy or linearity of reading. Accuracy is within 2 percent over the entire range. Tachs are available for 2, 4, 6, or 8 cylinder engines.

The instrument is extremely simple, using only 10 components plus the meter itself. The manufacturer feels that simplicity is the best form of reliability.

The input to the tach consists of ignition pulses obtained across the breaker points of the engine's distributor (see diagram). The rate of these pulses is a function of the engine speed. As the engine speeds up, the pulse frequency increases in direct proportion. The pulses are applied to a zener regulator which



limits the amplitude to a fixed value. The pulses are then applied to an amplifier and voltage-doubler circuit, where they are amplified, rectified, filtered by an averaging circuit, and applied to the indicating meter.

The tachometer is housed in a steel case with a bracket for steering-column mounting. The meter dial face is illuminated for night-time viewing.

Price is \$33.50. The tach is obtainable in kit form at \$27.50. ▲

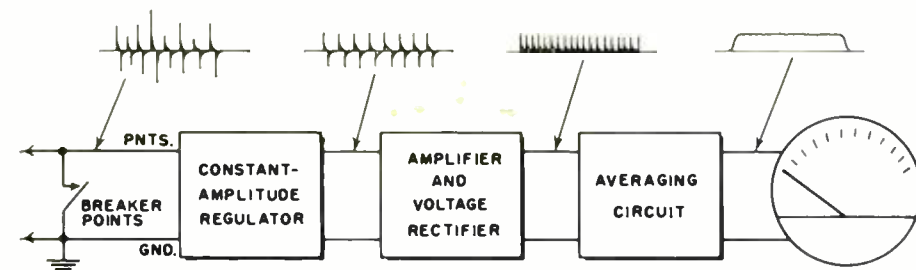

Outperforms Finest Vacuum Tube Units

# NEW SCOTT 312 SOLID STATE FM TUNER

... yet it's only \$259.95!



Scott announces a top-performing solid-state FM stereo tuner at a modest price... a no-compromise tuner that exceeds the performance of conventional tube units... it's factory-guaranteed for 2 full years. Not just a redesigned unit, the Scott 312 incorporates an entirely new approach to tuner circuit design:



Exclusive "Comparatron" provides foolproof silent automatic stereo switching. Momentary changes in signal strength will not cause stereo to switch in and out as do ordinary automatic devices.



"Flat-Line Limiting" circuits assure quiet, noise-free FM reception, impervious to outside electrical interference. There's actually less than 1 db difference in tuner output whether you listen to a strong local station or a weak distant one.



H. H. SCOTT, INC. Dept. 160-6  
111 Powdermill Road, Maynard, Mass.

Please rush me complete information and specifications on the new Scott 312 FM solid-state tuner, plus Scott's full-color 24-page Guide to Custom Stereo for 1964.

Name \_\_\_\_\_

Address \_\_\_\_\_

City \_\_\_\_\_

State \_\_\_\_\_ Zip \_\_\_\_\_

Export: H. H. Scott International, 111 Powdermill Road, Maynard, Mass. Cable HiFi Canada: Atlas Radio Corp., 50 Wingold Avenue, Toronto

CIRCLE NO. 100 ON READER SERVICE PAGE



**NEED A  
110 VOLT  
A.C. OUTLET?  
In CAR, BOAT or TRUCK,  
YOU HAVE IT WITH A**

## terado POWER INVERTER

Actually gives you 110 volt, 60 cycle A.C. from your 6 to 12 volt D.C. battery! Plug inverter into cigarette lighter, and operate lights, electric shavers, record players, electric tools, portable TV, radios, testing equipment, etc. Frequency stable within one cycle.

Models from 15 to 600 watts, priced as low as **\$12.95** LIST

See Your Electronic Parts Dealer or Jobber, or Write:

**terado CORPORATION**  
1058 Raymond Ave.  
St. Paul 8, Minn.  
In Canada: Atlas Radio Corp. Ltd. — Toronto, Ont.  
**CIRCLE NO. 133 ON READER SERVICE PAGE**

Wherever you use a screwdriver  
**QUICK-WEDGE**  
SCREW-HOLDING SCREWDRIVER  
does the job faster and easier!



**BECAUSE** a Quick-Wedge\* Screw-Holding Screwdriver holds, starts and drives the screw . . . straight, every screwdriving job is easier . . . goes faster. No longer will you waste time fumbling with the screw. Thus if your screwdriving job is overhead, below ground level, or even in hard-to-get-at places you simply affix the screw . . . place it in the desired spot . . . drive it in . . . release the screwdriver and the job is done! Prove it yourself! Use a Quick-Wedge\* once and you'll never be without one. They're unconditionally guaranteed! Ask your dealer or write for our catalog today!



**KEDMAN COMPANY**

233 So. 5th West, P. O. Box 267, SALT LAKE CITY, UTAH 84110

**CIRCLE NO. 118 ON READER SERVICE PAGE**

84

## Radio & TV Interference

(Continued from page 41)

function to narrow the receiver band-pass, or insert a tunable notch which rejects the sweep harmonic without affecting the rest of the signal. Commercial units are available to add these features to conventional AM receivers. These will help alleviate the problem of both radiating local AM oscillation and TV sweep oscillators. But, unlike the TV sweep, the AM local oscillator isn't synced so you will have to tune for it by ear.

### Sweep Harmonics

It is possible to get a sweep harmonic at either 267.75 or 456.75 kc., producing fixed audio beats of 5750, 1750, or 750 cycles, depending on the i.f. In this case, re-align the i.f. stages to a slightly lower frequency. If this is undesirable, try a trap in the antenna circuit, such as shown in Fig. 3, tuned for maximum undesired signal rejection. A high-pass filter with a cut-off frequency of about 500 kc. can be used in the r.f. input. Commercial filters are available from parts distributors. If this is no help, shield the receiver, particularly the converter and i.f. stages. Another possibility could be r.f. pickup in the audio section, where grid rectification can take place.

This is covered by Fig. 4 and the text associated with it.

One peculiar form of interference is caused by the wandering harmonic of a TV sweep circuit. If the TV receiver is left operating after station sign-off, the horizontal oscillator is then free-running and wandering around its natural frequency thus producing a wandering harmonic. This is difficult to remove unless you can turn off the offending TV set.

### TV and FM Receivers

In a typical intercarrier sound TV set, the video response is approximately d.c. to 4 mc., sound from 4.4 to 4.6 mc. and the picture i.f. about 4-mc. wide either in the 20 or 40 mc. region. Here is plenty of spectrum space for harmonics to cause trouble. If you follow the practices outlined in Part I to keep sweep radiation from leaving the set, you will have little trouble with harmonics entering the set. These measures (ground, filter, and shield) also apply to FM. Be certain an

effective high-pass filter is used in the antenna circuit. You may find that a twin-lead stub, such as shown in Fig. 6, will trap out interference. Also, don't overlook the possibility that the set may generate its own interference — Barkhausen radiation, for example.

An excellent all-around facility for institutions is a master radio and/or TV distribution system.

### Master Systems

It is not easy to make specific recommendations about master systems, for each is a custom job, and ordinarily you must assemble and modify the equipment to fit your particular location. However, for maximum utility, use separate AM and FM tuners. For the ultimate in AM receivers, either as a personal set or as the front-end for a master system, the double superhet is preferred. It is the surest way to cut through sweep hash and other interference. Using double-conversion and selectable-sideband, it sidesteps most fixed-frequency interference.

The FM installation should be carefully made, using enough tower to put the FM (and possible TV) antenna at least 20 feet higher than any building within two city blocks. Then, with a broadband antenna, mast-mounted pre-amplifier, and coaxial cable feeders, you will be relatively immune to noise and have the maximum deliverable signal at the receiver.

Sensitivity and low input noise aren't the only things to look for in FM—you want adjacent-channel selectivity to slice through the heterodynes and beats. The best tuners have from three to six i.f. stages and at least two limiters to give maximum selectivity and protection from noise.

All this won't be cheap. Good tuners are expensive. Don't skimp—but you can be economical. Get one each of the best AM and FM tuners; then, for any additional programs buy inexpensive receivers, using them for local reception. The high-priced ones can be used to pull in special programs.

Master TV systems are adequately covered in existing literature. With a good cable system, even the least expensive TV sets can be used because of the high-level and well-isolated signals delivered to them. ▲

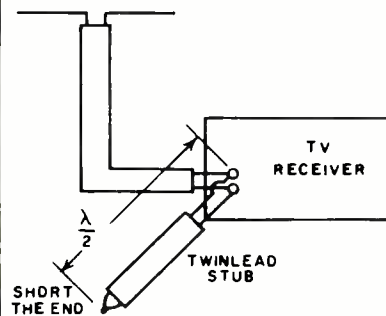

TV Channel (pix)	Stub Length (inches)
2	88 1/2
3	80
4	72 7/8
5	63 1/2
6	58 7/8
7	27 3/4
8	27
9	26 1/4
10	25 3/8
11	24 5/8
12	23 7/8
13	23 1/4

Fig. 6. A tuned stub can be used to reduce TV interference.

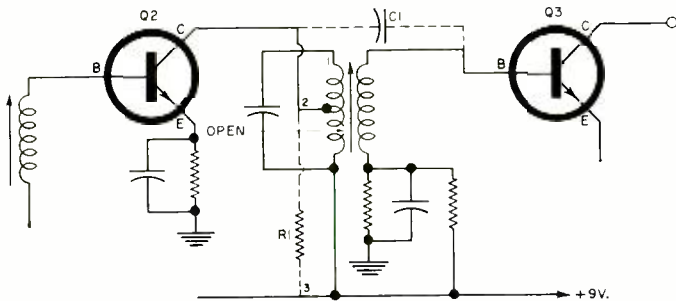

Fig. 1. Slight circuit changes makes i.f. amplifier operable.

## REPAIRING MINIATURE I.F. TRANSFORMERS

By GLEN MCKINNEY

**Q**UITE often, a transistor radio having a defective i.f. transformer can be put back in service using the circuit changes shown in Fig. 1. These changes are not a substitute for replacement of the faulty i.f. transformers involved, but are meant to be used in an emergency when an exact replacement is not available and the set has to be used.

In the example shown, the primary of the i.f. transformer has an open circuit. This would be evidenced by lack of collector voltage on Q2. This stage would be inoperative and no signal transfer is possible. A capacitor (C1) connected from the collector of Q2 to the base of Q3, and a resistor (R1) from the collector of Q2 to point 3, will put the stage back into operation.

C1 should be fairly large for the i.f. signal path, and usually about .001  $\mu$ f. should be adequate for a starter. This value depends on the particular circuit involved.

To get maximum signal voltage developed across R1 requires as high a resistance as possible, consistent with circuit impedance. Raising this resistance means that Q2 collector voltage will suffer, thus reducing stage gain. A compromise value of this resistor must be made for best performance. Generally, about 5000 ohms will make a good starting point and may have to be adjusted up or down depending on the circuit involved.

The i.f. transformer secondary remains unaltered so that Q3 bias is not affected and this stage works normally.

In some sets, a fast repair may be made (where the primary of the i.f. transformer is opened as indicated in Fig. 1), by jumping a lead from point 1 to point 3. This will restore collector voltage to Q2, but chances are the stage will oscillate violently because the collector current is now flowing through a greater number of turns in the primary coil than it was originally. This is due to the fact that the collector tap on the transformer primary is closer to the +9-v. end of the coil, and when the +9-v. is applied to point 1, the turns ratio between the primary and secondary is altered. This produces overcoupling to the secondary with oscillation as a consequent result.

To overcome this effect, a resistor will have to be inserted between points 1 and 2 to load the winding and damp out the oscillation. The correct value of this resistor should be that which just eliminates the oscillation. A lower value will reduce stage gain.

To avoid further trouble when installing a new transformer, make a small pencil sketch of the changes made and affix this to the interior of the set's plastic case. This insures the removal of all added components. ▲

Everything you ever wanted in a CB transceiver!

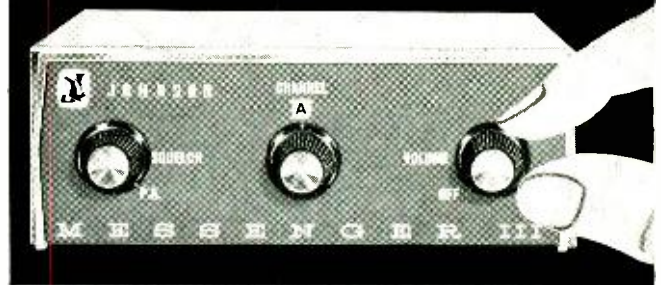

Newest! Most Versatile! Most Power Out!

The 11 channel "Messenger III" will change every idea you ever had about what a Citizens Band unit should offer! Tiny, all transistor, it's really quiet, really hot! Interchangeable for base or mobile—use it as a full 5-watt battery powered portable pack set or a 3-watt PA system. The "Messenger III", with an aerospace transistor developed for the "Relay" communications satellite, delivers *more* power output with maximum legal input! Double conversion receiver with high 1st I.F. provides excellent spurious and image rejection. Set-and-forget "Volume" and "Squelch" controls make it possible for the first time to work "close-in" or at extended range with initial settings. Furnished with dynamic microphone—full line of accessories available for selective calling, portable field pack, or public address use!

Cat. No. 242-150 ..... \$189.95 Net



**E. F. JOHNSON COMPANY**

1110 Tenth Ave. S.W. • Waseca, Minnesota

Please send full details on the "Messenger" CB line.

NAME \_\_\_\_\_

ADDRESS \_\_\_\_\_

CITY \_\_\_\_\_ STATE \_\_\_\_\_

WRITE TODAY for details on the "Messenger" CB line—Or see your distributor!

CIRCLE NO. 117 ON READER SERVICE PAGE



### ARE YOU CASHING-IN ON THE PROFITABLE 2-WAY RADIO SERVICE BUSINESS?

- ★ Motorola will train you for this rewarding, elite profession
- ★ Send for our FREE EVALUATION EXAM. Prove to yourself that you are ready to learn FM 2-way radio servicing.

Opportunities in 2-way radio servicing are virtually unlimited. ■ Just one of the hundreds of successful Motorola Service Stations writes, "we would be pleased to interview any graduate of your school that has received some training in 2-way radio maintenance. We are an established firm, 10 years old, with a promise of expansion governed by our ability to obtain competent technicians." ■ Get all the facts today. There is no obligation and no salesman will call.



**MOTOROLA TRAINING INSTITUTE**

4545 West Augusta Blvd. • Chicago 51, Illinois • Dept. AEF422

- Send me FREE entrance exam.
- Send full details on Home Study Course on FM 2-way Radio Servicing
- Send me details on how you can help me prepare for an FCC License.

Name \_\_\_\_\_ Occupation \_\_\_\_\_

Address \_\_\_\_\_

City \_\_\_\_\_ Zone \_\_\_\_\_ State \_\_\_\_\_

CIRCLE NO. 124 ON READER SERVICE PAGE

85

# BOOK REVIEWS

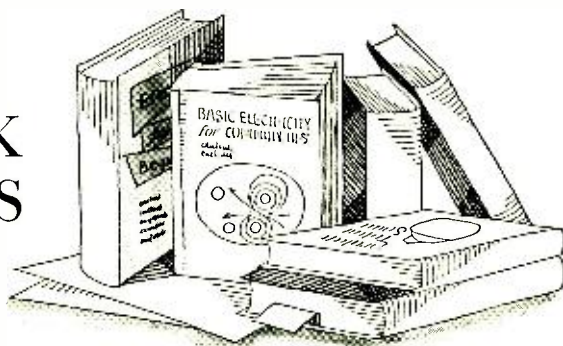

**"PRINCIPLES OF ELECTRICITY AND BASIC ELECTRONICS"** by Cornetet & Cornetet. Published by *McKnight & McKnight Publishing Company*, Bloomington, Illinois. 359 pages.

This volume can serve as a high-school or trade-school textbook or for self-instruction in basic electricity. Starting with magnetism and static electricity, the authors progress through Ohm's Law, electric current and chemical action, electric meters, direct-current dynamos, and alternating current to electronic rectifiers and filters, electronic amplifiers and oscillators.

The level is basic and the use of mathematics is minimal. There is a series of experiments which can be performed with limited equipment and test questions are appended to each chapter for classroom quizzes or self-testing.

An appendix includes nine tables ranging from conversion equivalents to natural trigonometric functions.

**"BILLIONS FOR CONFUSION"** by Malden G. Bishop. Published by *McNally and Loftin*. 123 pages. Price \$3.50.

The major point made by this hard-hitting, controversial book is that we are paying billions of dollars through our defense contractors to the technical writing industry to produce inept, unclear technical manuals which frequently are of limited value to their users. Author Bishop indicates that six cents out of every defense dollar goes for the publication of these manuals but because of wasteful practices, incompetence, and in some cases, downright dishonesty, most of this is wasted.

One point made is that engineers rarely make good technical writers and that good technical writers need not be engineers to practice the science-art of technical communications. In all too many cases, the reader is completely forgotten or overlooked. Instead, the manual is made to fit a sometimes meaningless format and its acceptance depends on arbitrary judgments.

Although Mr. Bishop casts a favorable nod to the Society of Technical Writers and Publishers for trying to upgrade the profession, he takes a justified jab at some of the writing in their own publication. It might be well for all who

practice technical writing, either for the military or not, to take heed of some examples of what not to do, as given in this slim volume.

**"TRANSISTORIZED MINIATURE AMPLIFIER AND TUNER APPLICATIONS"** by Rufus P. Turner. Published by *Lafayette Radio Electronics*. 95 pages. Price \$1.50. Soft cover.

This is a "how-to-do-it" handbook for the hobbyist, experimenter, and technician who is interested in building a wide range of miniaturized transistor equipment.

The pre-tested projects cover audio applications, ham radio and CB, control applications, test instruments, miscellaneous amplifier applications, and tuners and their applications. All of the circuits feature the firm's miniature printed-circuit transistor amplifiers and tuners. With photographs, line drawings, schematics, and block diagrams the author demonstrates how various equipment items can be constructed with minimum effort and maximum performance. The parts lists carry the company's stock numbers but values are given for each component to permit substitution or the use of junk-box parts if desired.

**"PRESSURE-FIT RECTIFIERS"** by David L. Mohn. Published by *Tung-Sol Electric Inc.* 90 pages. Price 75 cents. Soft cover.

This manual covers applications of two families of high-performance silicon diodes: an 18-amp family in five voltage categories from 50 to 400 volts and a 25-amp family in seven voltage categories from 50 to 600 volts.

Basic rectifying theory and standard rectifier circuits are covered in some detail. In addition, the book describes 27 special circuit applications. A section is devoted to the numerous ways that the pressure-fit rectifier may be mounted. Another section presents tables and curves for the ratings and characteristics of pressure-fit rectifiers.

**"TRANSISTOR SPECIFICATIONS AND SUBSTITUTION HANDBOOK"** compiled and published by *TechPress Publications*. Chicago. 96 pages. Price \$1.95. Soft cover.

This handy, pocket-sized handbook is

designed especially for the service technician and covers approximately 4700 transistors and their specifications as compiled from material furnished by 59 domestic and foreign transistor manufacturers.

Although the bulk of the book is devoted to tabulated specifications, the text also contains chapters on how the book is to be used most profitably, ten pitfalls to avoid in using power transistors, manufacturers' codes, an explanation of transistor symbols, plus transistor case diagrams.

**"COLOR TV SERVICING MADE EASY"** by Wayne Lemons & Carl Babcoke. Published by *Howard W. Sams & Co., Inc.* 186 pages. Price \$2.95. Soft bound.

As more color receivers come into the hands of the public, service technicians will have to become more adept at servicing them and those who hesitate to get on the color bandwagon will lose out. This hesitancy on the part of technicians is, according to the authors, uncalled for since most color receivers involve little more than five or six additional tubes and their associated circuitry than the familiar black-and-white set.

All popular makes of color receivers, including *Admiral, DuMont, Emerson, G-E, Hoffman, Magnavox, Olympic, Philco, RCA, Silvertone, Westinghouse,* and *Zenith*, have been included. Specific setup and troubleshooting procedures for the different models are given in a handy chapter-by-chapter arrangement.

Antennas and antenna distribution systems as well as receiver installation and customer relations are also discussed in some detail.

**"THE RADIO AMATEUR'S HANDBOOK"** compiled and published by the *ARRL, Inc.*, Newington, Conn. 592 pages plus tube and semiconductor tables and catalogue section. Price \$3.50. Soft cover.

This 41st edition of the "Ham's Bible" makes its appearance on the occasion of the ARRL's Golden Anniversary. In honor of this event, the book has been redesigned typographically and printed on non-gloss paper stock which eliminates glare and provides sharper and clearer reproduction of the diagrams and illustrations.

Much of the material from the 40th edition has been revised and up-dated to reflect current theory and the construction projects incorporate the latest components and techniques. Once again the chapter and accompanying characteristics charts on tubes and semiconductors is an outstanding feature which will be warmly welcomed by the many radio amateurs, engineers, and students of radio and electronics who have come to rely on the Handbook as a one-stop source for much pertinent and valuable information. ▲



## Gain Nomogram

(Continued from page 31)

volts from plate to cathode, is about 138k ohms while  $\mu$  equals 97.

Dividing  $R_p$  into  $R_i$  gives us 510k/138k or 3.7 while dividing  $R_i$  into  $R_c$  gives us 1000k/510k or 1.96. Connecting these two points with a straight line (dashed on the nomogram) gives us a gain/ $\mu$  ratio of 0.71 and multiplying this by the  $\mu$  of 97 gives an actual gain of 69.

The data sheet also gives measured gain figures for the identical set of conditions; the measured gain is 64, which is within our 10% tolerance.

Had we been designing an amplifier stage and needed a gain of 50, we could have used the chart in reverse. Average  $\mu$  of a 12AX7 under almost all conditions is 100 (from the tube curves) so one of our two points would be a gain/ $\mu$  ratio of 0.5. We would then have the option of picking any ratio of  $R_c/R_i$  we wanted, and reading the corresponding  $R_i/R_p$  from the chart, or of picking a convenient value for  $R_i$ , then determining the  $R_c/R_p$  ratio and finding the proper  $R_c/R_i$  ratio from the chart. Let us do one problem the second way, as follows:

Assume we have a 200-volt supply and we want our tube to operate with 100 volts (approximately) from plate to cathode at a plate current of 0.5 ma. Under these conditions,  $R_p$  equals 80k ohms. The plate current and plate-cathode voltage fix our value of  $R_i$  as that which gives a 100-volt drop at 0.5 ma. or 200k. Then  $R_i/R_p$  equals 200k/80k or 2.5. Drawing a line (dashed example 2) through gain/ $\mu$ =0.5 and  $R_i/R_p$ =2.5 gives us an  $R_c/R_i$  ratio of 0.67, so the following grid resistor would be 134k ohms (140k would be suitable).

Whether the nomogram is used to analyze existing circuits, or to help design new ones, it will provide full data within the limits of its calibration. ▲

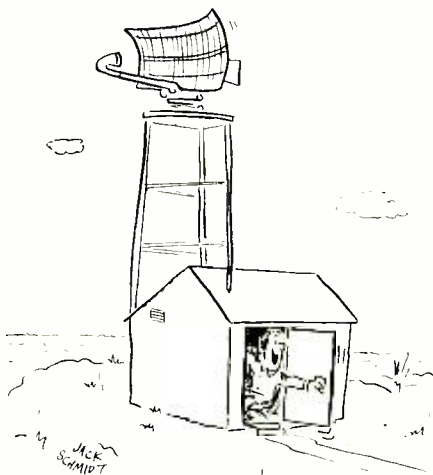

"Come on, Gang—we've got the ball game on!"

June, 1964

**R** FOR "DOCTORS OF SERVICING"



## Where there's a contact... or a relay...

**Service with Contact Shield! Protective! Corrective!** It not only cleans and safeguards contacts better on TV, radio, and hi-fi sets; on all relay-operated electrical equipment, regular protective maintenance with this versatile cleaner prevents sticky relays—while corrective servicing unsticks them... in seconds. Promotes greater conductivity, keeps relays working smoother, longer. Contact Shield—the professional service man's cleaner.

### APPLICATIONS INCLUDE:

- Bowling Alley Automatic Pin Spotters
- Vending Machines
- Slot Machines
- IBM Computers and other data processing equipment
- Industrial Equipment using relays, such as welding machines, etc.
- Pinball Machines
- Telephone Switchboards

For handy guidebook to better servicing, write Channel Master Corp., Ellenville, N.Y.

## Back Issues Available

Use this coupon to order back issues of **ELECTRONICS WORLD**

We have a limited supply of back issues that can be ordered on a first-come, first-served basis. Just fill in the coupon below, enclose your remittance in the amount of 65¢ each and mail.

(Issues prior to 1963 not available.)

**ZIFF-DAVIS SERVICE DIVISION**  
Dept. BCEW, 589 Broadway  
New York 12, New York

Please send the following back issues of **ELECTRONICS WORLD**. I am enclosing \_\_\_\_\_ to cover the cost of the magazine, shipping and handling.

Month \_\_\_\_\_ Year \_\_\_\_\_

Month \_\_\_\_\_ Year \_\_\_\_\_

Month \_\_\_\_\_ Year \_\_\_\_\_

Name \_\_\_\_\_

Address \_\_\_\_\_

City \_\_\_\_\_ Zone \_\_\_\_\_ State \_\_\_\_\_

No charge or C.O.D. orders please. EW

send for NEW FREE CRYSTAL CATALOG with NEW TRANSISTOR OSCILLATOR CIRCUITS

Citizen Band Class "D" Crystals **\$2.95** EACH

3rd overtone — .005% tolerance — to meet all FCC requirements. Hermetically sealed HC6/U holders, 1/2" pin spacing. .093 pins. (Add 15¢ per crystal for .093 pins).

TEXAS HCB/U

All 23 megacycle frequencies in stock: 26.965, 26.975, 26.985, 27.005, 27.015, 27.025, 27.035, 27.055, 27.065, 27.075, 27.085, 27.105, 27.115, 27.125, 27.135, 27.155, 27.165, 27.175, 27.185, 27.205, 27.215, 27.225, 27.235.

Matched crystal sets for ALL CB units (Specify equipment make and model numbers) \$5.90 per set

### RADIO CONTROL CRYSTALS

in HC6/U HOLDERS—SIX FREQUENCIES

In stock for immediate delivery (frequencies listed in megacycles; tolerance .005%; 1/2" pin spacing; .093 pin diameter. .093 pins available; add 15¢ per crystal.) Specify frequency.

26.995, 27.045, 27.095, 27.145, **\$2.95**

27.195, 27.235 ..... EACH

(add 5¢ per crystal for postage and handling)

### HERMETICALLY SEALED PRECISION GROUND CUSTOM MADE NON-OVEN CRYSTALS

1000KC to 1600KC (Fund. Freq.) .....

Prices on Request

1601KC to 2000KC (Fund. Freq.) .....\$5.00 ea.

2001KC to 2500KC (Fund. Freq.) ..... 4.00 ea.

2501KC to 5000KC (Fund. Freq.) ..... 3.50 ea.

5001KC to 7000KC (Fund. Freq.) ..... 3.90 ea.

7001KC to 10,000KC (Fund. Freq.) ..... 3.25 ea.

10,001KC to 15,000KC (Fund. Freq.) ..... 3.75 ea.

15MC to 20MC (Fund. Freq.) ..... 5.00 ea.

## ORDER FROM CLOSER PLANT TEXAS CRYSTALS

DEPT. R-64  
1000 Crystal Drive  
FORT MYERS, FLORIDA  
Phone 813 WE 6-2109  
TWX 813-334-2830

AND  
4117 W. Jefferson Blvd.  
LOS ANGELES, CALIF.  
Phone 213-731-2258  
TWX 213-737-1315



CIRCLE NO. 134 ON READER SERVICE PAGE 87

## NEW! LAFAYETTE 1-WATT 2-CHANNEL SUPER CB "WALKIE TALKIE"

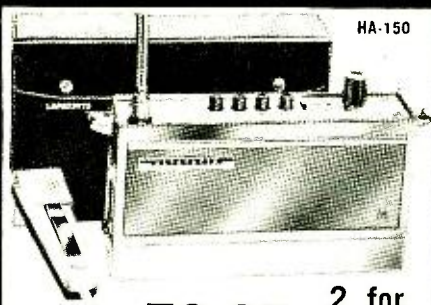

**79.95** 2 for **154.95**

- Lightweight, compact . . . Self-contained with Leather Case and Shoulder Strap
- External Push-to-Talk Dynamic Microphone
- Powerful 13-Transistor 5-Diode Circuit
- Modulation/Battery Strength Meter
- Push-Button Operation
- Powered by Flashlight Batteries or External 12 VDC Supply
- Complete with 2-Pair Transmit/Receiver Crystals Imported

Free! Lafayette's 1964 Catalog No. 640

422 Giant-Size Pages Everything in Electronics, Hi-Fi, C.B., Test Equipment, Amateur Gear, TV and Radio Parts, and much more.

**LAFAYETTE Radio ELECTRONICS**  
Dept. RF-4 P.O. Box 10,  
Syosset, L.I., N.Y. 11791  
 Rush me FREE Giant 422 Page 1964 Cat. 640  
 HA-150L Walkie-Talkie \$ . . . Enclosed Shipping Charges Collect

NAME.....  
ADDRESS.....  
CITY..... STATE..... ZIP.....  
CIRCLE NO. 119 ON READER SERVICE PAGE

Tuner covers 26-54 and 88-174 MC in eight overlapping bands with good sensitivity. Ideal for use with amplifier or Hi-Fi to listen to Aircraft, CB, Fire, Police and other signals in the VHF bands.

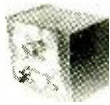

**355A AM/FM TUNER \$49.95**

Order today or send for free catalog on full line of converters and receivers for every application.

**KUHN ELECTRONICS**  
CINCINNATI 17, OHIO

when it's time to think of college you should read this  
**FREE CAREER BOOKLET**  
about electronics at

**MSOE**



**MILWAUKEE MS-220**  
**SCHOOL OF ENGINEERING**  
Dept. EW-664, 1025 N. Milwaukee Street  
Milwaukee, Wisconsin 53201

Tell me about an engineering career through residence study in:

Electrical fields  Mechanical fields

Name..... Age.....

Address.....

City, State.....

## Simple Dwell Meter

(Continued from page 43)

read open circuit, both terminals 2 and 3 as well as 1 and 3 give a half-scale reading on all ranges. What is in the box? The usual answer is a vibrator or chopper. The duty cycle of the chopper is 50%, so the meter reads halfway between open and short circuit.

Unfortunately, the voltage waveform appearing across the breaker points of an automobile is not quite as ideal as a chopper. Fig. 1 illustrates a typical waveform of the point voltage in a negative-ground system. (For positive-ground systems the waveform is inverted.) Note the large magnitude transients caused by resonance of the coil with capacitor *C* across the points. If one is tempted to use a clipper or a Schmitt trigger to produce a rectangular pulse of the same length as the open time, the negative transient will momentarily turn off the clipper or reverse the Schmitt trigger. The shaped waveform will therefore not be representative of the open time of the points.

Fig. 2 is a schematic of the dwell meter. When the meter is connected across the points of an automobile, the internal batteries drive the meter to full-scale as long as the points remain closed. As the points open, the 200- to 300-volt positive spike is unable to produce current flow through the meter due to the diode. At the same time the *RC* product is chosen such that the subsequent negative voltage spikes are also unable to cause current to flow through the meter. When the points again close, *C1* is discharged through *R1* and *R2* via the points. The internal batteries again drive the meter toward full-scale. The meter reads linearly in duty cycle, 0 being points fully open and 100% deflection, fully closed. A linear angular scale may be added for dwell if preferred, although two-thirds full-scale is the nominal dwell reading, as mentioned previously. Inasmuch as almost any meter movement up to 10 ma. is suitable for this application (a 2" Weston 500- $\mu$ a. meter with internal resistance of 235 ohms was used by the author) the following rules of thumb are included for the constructor:

1. Choose a battery voltage which requires a limiting resistance (*R1* plus *R2*) that is at least ten times larger than the internal resistance of the meter.

2. Choose *C1* such that the product of the limiting resistance (in ohms)  $\times$  *C1* (in  $\mu$ f.) is approximately 250.

3. Choose *C2* approximately eight times larger than *C1*.

If these rules are followed the dwell meter may be used with reliability over a wide speed range and not just at idle speed where dwell adjustments are being made. This permits checking for

"point bounce" and "floating." *C2* and *C3* have been included to facilitate adjusting the points of automobiles not having external access to a point-adjusting screw.

### Operation

To use the dwell meter on an automobile engine with negative ground, having external access to the points, the following instructions apply:

1. Switch out *C2* and *C3*.
2. Connect the "plus" lead of the dwell meter to the junction of the ignition-coil primary and the points. This terminal is readily available on the ignition coil.
3. Connect the "minus" lead to a ground.
4. Turn on ignition switch without starting. If the points are closed, the dwell meter will read up-scale. If points are open, momentarily crank engine until points stay closed.
5. With ignition switch still on and the points closed, adjust *R2* for exactly full-scale deflection.
6. Start engine and read dwell meter directly for duty cycle (or add degree scale if preferred).

7. Set the point-adjusting screw for two-thirds full-scale (6.7 if your meter reads 10 full-scale).

8. Reset engine timing.

These instructions are also applicable for positive-ground ignition systems by merely reversing the meter leads.

For engines not having external access to the points, the following instructions apply:

1. Switch in *C2* and *C3*.
2. Perform steps 2, 3, 4, and 5 as before with due regard to polarity of ground.
6. Remove center wire (high tension) from distributor and place on or near a ground away from the carburetor. This minimizes chance of coil damage due to internal arcing.
7. Remove distributor cap and rotor.
8. Crank engine with starter and read dwell while cranking. Stop, adjust points, crank again until satisfied.
9. Re-assemble distributor, insert high-tension wire, and time engine.

The meter is very handy for checking point condition of any car by simply clipping the meter in, calibrating, then starting the engine.

This meter has been used with satisfaction by several persons in the past two years on engines with 4-, 6-, and 8-cylinders. One of these autos had a transistor ignition system.

A chassis box was chosen for the housing with the switches mounted for one-hand operation as shown in the photo. The meter shown is a readily available surplus unit. Leads should be unplugged when not in use to conserve batteries or a power switch could be added if desired. ▲



# NOW...GET THE FINEST STEREO TEST RECORD

ever produced

for just...**\$4.98**

Featuring Tests Never Before Available  
Outside Of The Laboratory

## Why We Make the Model 211 Available Now

Although there are many stereo test records on the market today, most critical checks on existing test records have to be made with expensive test equipment.

Realizing this, HiFi STEREO REVIEW decided to produce a record that allows you to check your stereo rig, accurately and completely, just by listening! A record that would be precise enough for technicians to use in the laboratory—and versatile enough for you to use in your home.

The result: the HiFi STEREO REVIEW Model 211 Stereo Test Record!

## Stereo Checks That Can Be Made With the Model 211

- ✓ Frequency response—a direct check of eighteen sections of the frequency spectrum, from 20 to 20,000 cps.
- ✓ Pickup tracking—the most sensitive tests ever available on disc for checking cartridge, stylus, and tone arm.
- ✓ Hum and rumble—foolproof tests that help you evaluate the actual audible levels of rumble and hum in your system.
- ✓ Flutter—a test to check whether your turntable's flutter is low, moderate, or high.
- ✓ Channel balance—two white-noise signals that allow you to match your system's stereo channels for level and tonal characteristics.
- ✓ Separation—an ingenious means of checking the stereo separation at seven different parts of the musical spectrum—from mid-bass to high treble.

ALSO: ✓ Stereo Spread  
Speaker Phasing  
Channel Identification

## PLUS SUPER FIDELITY MUSIC!

The non-test side of this record consists of music recorded directly on the master disc, without going through the usual tape process. It's a superb demonstration of flawless recording technique. A demonstration that will amaze and entertain you and your friends.

### UNIQUE FEATURES OF HiFi/STEREO REVIEW'S MODEL 211 STEREO TEST RECORD

- Warble tones to minimize the distorting effects of room acoustics when making frequency-response checks.

*Warble tones used are recorded to the same level within  $\pm 1$  db from 40 to 20,000 cps, and within  $\pm 3$  db to 20 cps. For the first time you can measure the frequency response of a system without an anechoic chamber. The frequency limits of each warble are within 5% accuracy.*

- White-noise signals to allow the stereo channels to be matched in level and in tonal characteristics.
- Four specially designed tests to check distortion in stereo cartridges.
- Open-air recording of moving snare drums to minimize reverberation when checking stereo spread.

## All Tests Can Be Made By Ear

HiFi STEREO REVIEW's Model 211 Stereo Test Record will give you immediate answers to all of the questions you have about your stereo system. It's the most complete test record of its kind—contains the widest range of check-points ever included on one test disc! And you need no expensive test equipment. All checks can be made by ear!

*Note to professionals: The Model 211 can be used as a highly efficient design and measurement tool. Recorded levels, frequencies, etc. have been controlled to very close tolerances—affording accurate numerical evaluation when used with test instruments.*

### DON'T MISS OUT—SUPPLY LIMITED

The Model 211 Stereo Test Record is a disc that has set the new standard for stereo test recording. Due to the overwhelming demand for this record, only a limited number are still available thru this magazine. They will be sold by ELECTRONICS WORLD on a first come, first serve basis. At the low price of \$4.98, this is a value you won't want to miss. Make sure you fill in and mail the coupon together with your check (\$4.98 per record) today.

### FILL IN AND MAIL TODAY!

Stereo Test Record  
Electronics World—Dept. SD  
One Park Ave., New York 16, N.Y.

Please send me \_\_\_\_\_ test records at \$4.98 each. My check (or money order) for \$\_\_\_\_\_ is enclosed. I understand that you will pay the postage and that each record is fully guaranteed. (Orders from outside the U.S.A. add 50c to partially defray postage and handling costs.)

Name \_\_\_\_\_ (Please Print)

Address \_\_\_\_\_

City \_\_\_\_\_ Zone \_\_\_\_\_ State \_\_\_\_\_

SORRY—No charges or C.O.D. orders!

EW-64

**NOW—YOU CAN PLAY A VITAL ROLE IN SPACE AGE COMMUNICATIONS**

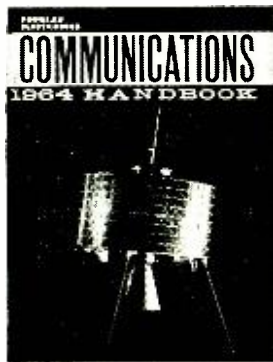

**THE 1964 COMMUNICATIONS HANDBOOK**

is the only publication that covers the entire specialized field of today's rapidly expanding radio communications. It gives you 148 fact-filled pages—complete with charts, graphs and tables—covering:

- *Citizens Band*
- *Short-Wave Listening*
- *Ham Radio*
- *Business Radio Services*

**PLUS THESE SPECIAL FEATURES:**

Up-to-the-minute Space Data  
 Latest US and Canada License Requirements  
 A Build-it-yourself World Time Calculator

Look for the 1964 COMMUNICATIONS HANDBOOK—it's *now on sale* at your newsstands or electronics parts store. Or, if you prefer, use this handy coupon for ordering your copy of the 1964 COMMUNICATIONS HANDBOOK.

EW64

Ziff-Davis Service Division, Dept. CH  
 589 Broadway, New York 12, New York

Please send me \_\_\_\_\_ copies of COMMUNICATIONS HANDBOOK, at \$1.00 each—plus 15¢ mailing and handling charge on each. (Canada and Overseas: \$1.25 plus 25¢ postage.)

I enclose \_\_\_\_\_

NAME \_\_\_\_\_

ADDRESS \_\_\_\_\_

CITY \_\_\_\_\_ ZONE \_\_\_\_\_ STATE \_\_\_\_\_

**Diode Curve-Tracer**  
*(Continued from page 45)*

If they are moved, recalibration will be necessary.

With the analyzer calibrated, all you need to do to determine the key parameters of an unknown diode is to place it in test clips and turn the power on. If the trace appears to be upside down you have reversed cathode and anode leads; this effect can be used to determine polarity of unmarked units. The p.i.v. is given by the distance along the horizontal axis from the vertical forward-conduction line at the right to zener point at the left; moving the trace with the scope horizontal-centering control until the forward break coincides with a graticule marking makes the measurement easy.

Reverse resistance is given by two factors. Most accurate is the slope of the base-line, with both gain controls calibrated. Count the number of volts (horizontal) required for the line to drop 10 graticule divisions vertically; divide the volts by 100 and the result is reverse resistance in megohms. Don't expect reverse resistance greater than 1 megohm, because of the shunting effect of the analyzer.

The other factor is simply the length of the trace. A low-resistance diode will have a shorter trace than will a high-resistance unit since the horizontal deflection voltage is developed from a voltage-divider string which includes as one resistor the diode's reverse resistance. The higher the diode reverse resistance, the higher the horizontal deflection voltage available.

Forward resistance of the diode is estimated by the closeness with which the forward-conduction trace approaches a true vertical line. If diode forward resistance is high, the forward-conduction trace will slope to the right rather than rising vertically. If forward resistance is low, the trace will be nearly vertical.

An open diode shows up as a complete absence of any vertical breaks, either at the right or the left, while a shorted one eliminates the horizontal traces and leaves only the vertical. Zener diodes show pronounced zener breaks at their regulating voltage; so do many power diodes, which can be pressed into service as low-power zeners. Neon tubes show the same characteristics as the VR tubes used for calibrating and the analyzer can be used to match neons for any application requiring matching firing and holding voltages.

To show more detail on low-voltage diodes, simply increase the oscilloscope horizontal gain until 100 volts occupies 4 inches of scope trace; this can be done with a 33-volt zener diode if gain is set so that the distance between pips is 1½

inches. No other changes are necessary; the high-valued current-limiting resistors prevent diode damage.

As you test more and more diodes, you will find some strange effects. No selenium rectifier tested here showed a zener point, but all showed greatly increased reverse leakage as voltage increased. Germanium diodes of the 1N34 type show a reverse resistance characteristic which falls from a "medium-low" value of about 20,000 ohms to a much lower value just *past* their p.i.v. No trace of a zener break, as such, is visible. (See Fig. 3.) One brand-new silicon power diode rated at 400 p.i.v. showed an actual p.i.v. of less than 25 volts (Fig. 4), while two others rated at only 200 p.i.v. showed no trace of a zener break within the range of the analyzer (Fig. 5). ▲

**EW Lab Tested**  
*(Continued from page 20)*

address, TV, and similar requirements.

The Shure Model 570 dynamic lavalier microphone is only 2¾ inches long and 25/32 inch in diameter. It is supplied with a "Flex-Grip" lavalier assembly which engages the user's shirt or blouse, and has a neck cord which may be used with the clip or instead of it.

The 570 is designed to have a rising response to 6000 cps, and an over-all useful frequency range of 50 to 12,000 cps. It is omni-directional and its output matches any low-impedance input between 50 and 250 ohms. It is finished in a non-reflecting gray, with a stainless-steel grille. A non-detachable 30-foot two-conductor shielded cable is included. The weight of the microphone itself is 2 ounces.

In our laboratory tests, we measured the frequency response of the microphone relative to that of our calibrated



laboratory microphone, with both units in the same position relative to the loudspeaker which drove them. The frequency response of the 570, corrected for the known response of the reference microphone, was within ±2 db from 180 cps to 7000 cps, except for a 5 db peak at 5500 cps. It falls off at 6 db/octave below about 400 cps.

In use tests the microphone had a very natural, balanced, and pleasing sound in conventional lavalier applications. Indeed, it was much closer to "broadcast" quality than to "public-address" quality and only the loss of the extreme highs distinguished its sound from that of stand microphones costing several times as much.

The Shure Model 570 microphone sells for \$57.00. ▲

# NEW PRODUCTS

Additional information on the items covered in this section is available from the manufacturers. Each item is identified by a code number. To obtain further details, simply fill in the coupon appearing on page 15.

COMPONENTS • TOOLS • TEST EQUIPMENT • HI-FI • AUDIO • CB • HAM • COMMUNICATIONS

## MICROCIRCUIT SOLDERING TOOLS

**1** Oryx Company has announced the availability of two new microcircuit soldering instruments designed for soldering the very smallest electrical connections.

The Model 5A weighs only 8 grams, including



tip, and has an over-all length of less than 5½ inches. The low-voltage heating element is located entirely within the tip, insuring high efficiency and extremely fast heat recovery. This model operates on 6 volts and consumes 5 watts.

The Model 5-S (photo) is a special design featuring a short shaft to increase finger control. It is particularly useful in soldering operations carried out under a microscope or when using an eyepiece. This model weighs approximately 7 grams and has an over-all length of 4¾ inches. Operating voltage is 4.5 v. and power consumption is 4.5 watts.

## 8-AMPERE SCR'S

**2** Motorola Semiconductor Products Inc. has announced a new series of 8-ampere silicon controlled rectifiers which are nearly 50 percent smaller than other devices now available for this current level.

Designated types MCR1304-1 through 6, the series is suited to power and motor-speed control devices in all types of commercial and industrial equipment, including portable electric tools, washers, and other appliances as well as in light dimming and temperature control units. Available voltages extend from 25 to 400 volts.

The new units are housed in steel cases which are only .345" in diameter and .278" high.

## HEAVY-DUTY VIDEO TAPE

**3** Reeves Soundcraft Division has developed a new heavy-duty video tape which is claimed to provide longer tape life, longer head life, and better pictures. Produced by the company's "Micro-plate" process, the tape is extremely smooth and results in a rugged, long-life, scratch-resistant, non-shedding tape which has intimate tape-to-head contact thus reducing head wear and tape or head fouling.

In field tests, the tape exhibited a tape life of over 700 passes without sign of deterioration.

## ULTRASONIC CLEANING UNIT

**4** Crest Ultrasonics Corporation is now offering a new line of cleaning systems which will handle everything from precision parts such as ball bearings, hypodermic syringes, and semi-conductors to large castings.

Placed within the standard tank, the cleaner provides a wide band of frequencies ranging from 20 to 100 kc., eliminating the conventional standing waves caused by single frequencies, resulting

in uniform cleaning, permitting the use of baskets.

Further cleanliness results from the higher frequencies creating the tiny cavitation "scrubbing bubbles" to work into small cracks and crevices and penetrate heavy contaminants to loosen them and enable the lower frequency, larger bubbles to complete the job.

Currently available in the standard line are tanks and generators from ½ to 30 gallon capacities.

## ULTRASONIC INTRUSION ALARM

**5** Walter Kidde & Company, Inc. is now offering an attache-case-size model ultrasonic intrusion alarm designed for temporary or permanent protection of such areas as doorways, display cases, small offices or other rooms, hotel accommodations, closets, files, and safes.

The 8-pound unit plugs into a wall outlet and emits inaudible ultrasonic waves. This high-frequency "silent sound" saturates a zone extending to 12 feet in front of the unit. If desired, this sensitivity can be adjusted so that the alarm will be tripped only by activity within a closer range.

The "Mini-Guard" is housed in a grey ripple finish steel cabinet measuring 2¾" high x 9¾"

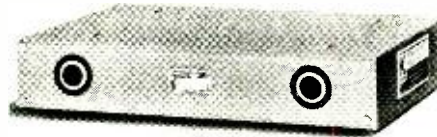

wide x 12" long. If the user wishes to conceal the control unit, optional extension sensors are available. These can be flush-mounted in ceiling or wall.

## BULB-SAVING CARTRIDGES

**6** Lamp-Life Inc. has developed a new series of cartridge units which are designed to double the average life of any standard light bulb. These units are placed either side up in the lamp socket and the standard incandescent bulb of corresponding wattage is screwed in.

Currently the cartridges are available for 15, 25, 40, 60, 75, and 100 watt bulbs. The units will not work with 3-way bulbs.

## VOLTAGE-VARIABLE POT

**7** Computer Instruments Corporation is in production on a new lightweight voltage-variable pot that permits precise, automatic coefficient setting in analog computer applications.

Basically an analog storage device, the unit also finds application in offset milling in process control simulation, automatic arbitrary function

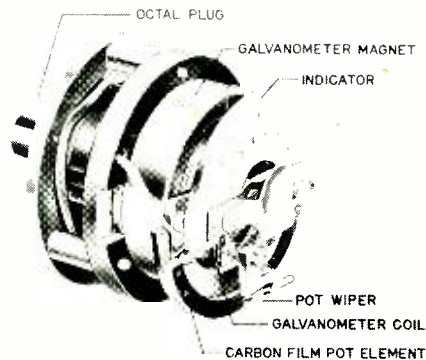

generation, and as a transport log device.

The pot measures 1¾" in diameter by 1½" long, not including the octal socket, and has a response speed of as little as 50 msec. Program signals can be nulled to within 0.005% and end errors of the precision-film element are as low as 0.01%.

## TEMPERATURE METER

**8** Amark Corporation is handling the U.S. distribution of the "Mavotherm," a portable electrical temperature measuring instrument made by P. Gossen & Co.

The instrument provides for the direct reading of temperatures from -20 to +200 degrees C in solids, liquids, or gases. It utilizes solid-state probes which cause little heat dissipation and provide excellent heat-transfer characteristics. The principle of operation is the measurement of a temperature-dependent resistance with an internal Wheatstone bridge. The indicator is a portable meter with spring-loaded jewel bearings. It is calibrated in degrees centigrade in two ranges: -20 to +90 and +90 to +200. The instrument is 1.5-volt battery operated and has an accuracy of ±2 degrees C.

## CIRCUIT-BOARD INSPECTION

**9** A.R.F. Products, Inc. has developed a new X-Y coordinate table gauge which the company claims provides savings of up to 80% of inspection time on circuit boards and panels.

Known as "Metab," in use the two-dimensional object is placed under a precision grid with .100" calibration marks. Grid displacement by X and Y micrometers quickly locates points of interest

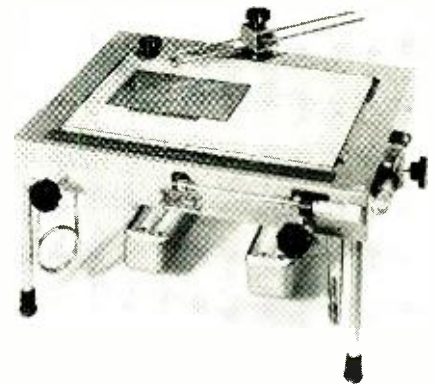

to an accuracy of .001" or better in rectangular coordinates. Top or bottom illumination is as needed. Although designed especially for circuit boards, the new unit can be used for drilling and milling templates, panels, and similar flat objects and may be adapted to photographic, drafting, and graphic arts applications.

With profile instead of the grid, the instrument becomes a comparator.

## FLUID-FLOW METER

**10** Medicon has developed a new electronic instrument for measuring flow rates of ionizable fluids in laboratory applications, and in chemical process, petrochemical, and general industrial pilot plants. The flow measurement may be displayed on the panel meter of the instrument or on a standard chart recorder.

The Model E-3000 "Macroflow" is portable, simple to use, versatile, and mechanically rugged. It consists of an electromagnetic sensor located

# DO YOU SAVE YOUR COPIES OF Electronics World



Make sure they're kept neat and always handy for instant reference—with a handsome file that's designed to hold a full year's copies!

- washable Kivar cover has a leather-like appearance
- available in maroon backing with black sides or black with maroon
- 24-karat solid gold leaf embossed lettering for magazine's name
- attractively priced at only \$2.95 each, 3 for \$8.00, 6 for \$15.00
- files are shipped to you prepaid and are fully guaranteed

NOTE: these special-quantity prices apply for any combination of titles, so you can have them for all your favorite magazines.

Order several today—for all the Ziff-Davis magazines: Popular Photography, Modern Bride, HiFi/Stereo Review, Electronics World, Popular Electronics, Flying, Car and Driver, Popular Boating, Amazing, and Fantastic, and for your other favorite publications, as well. (Ziff-Davis magazine files available in colors of your choice as noted in coupon. Those for other publications will be shipped in standard colors available.)

Jesse Jones Box Corp., Dept. EW Box 5120  
Philadelphia 41, Pa.

Please send me: (Fill in title, quantity and check appropriate column for color desired)

MAGAZINE TITLE	QUANTITY	BLACK BACKING/ MAROON SIDES	MAROON BACKING/ BLACK SIDES
Electronics World	_____	_____	_____
_____	_____	_____	_____

\$2.95 each, 3 for \$8.00 or 6 for \$15.00 — shipped prepaid — fully guaranteed

Total amount enclosed \_\_\_\_\_

Name \_\_\_\_\_

Address \_\_\_\_\_

City \_\_\_\_\_ Zone \_\_\_\_\_ State \_\_\_\_\_

at the point of measurement and an electronic amplifier-indicator unit which may be removed to any convenient location. The indicator is available with three ranges: 0-0.5, 0.5-1.0, and 1.0-1.5 gal. min. Each range scale is subdivided into 0.01 gal. min. graduations and the two highest ranges have suppressed zero scales.

## TRANSFERS FOR PANELS & DIALS

**11** The Datak Corporation has added a meter and dial set to its line of "Instant Lettering" dry transfer markings. Included are arcs, lines, arrows, and assorted rotary tap switch patterns covering all common angular detents.

Featured are sheets of arcs and fine (12-mil) graduation lines for marking special and proto-

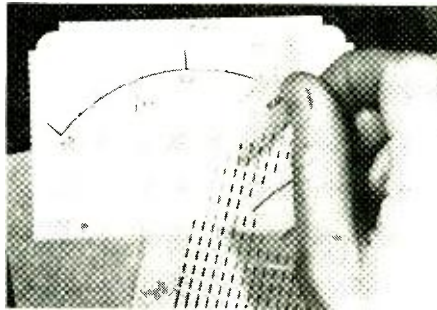

type meter dials. Meter scales calibrated with these transfer sheets are said to be indistinguishable from photographed production dials.

Each set of twelve 5" x 7" sheets contains a complete assortment of patterns in black, white, and red arranged according to frequency of use.

## R.F. TEST LEAD CABLE

**12** Fairhill Products Corporation is in production on a new r.f. test lead cable which has broad applications in testing and connecting. The new lead has a 750-volt r.m.s. maximum working capability and features RG/62A-U cable which has a capacity of 13.5 pf. per foot and a nominal impedance of 93 ohms.

One end of the test lead is equipped with a cable connector and the other has a fully insulated alligator clip. The test lead can be supplied with any type of standard or environmental termination and can be made to industrial as well as MIL specs.

## HI-FI — AUDIO PRODUCTS

### FM-STEREO TUNER/AMP

**13** TRW Columbus Division has announced a new addition to its "Bell Imperial" series of stereo components.

The new item is the "Imperial 900" which features an 80-watt transistorized stereo amplifier

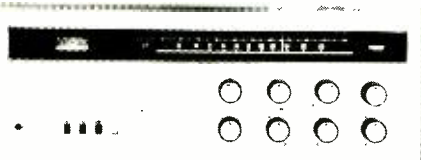

plus a self-contained FM-stereo tuner. Frequency response of the amplifier is 9-75,000 cps, IM distortion is less than 0.8%, and harmonic distortion is 0.3%.

The plug-in tuner chassis can be removed for servicing and its design permits the potential customer to purchase the amplifier section only and add the plug-in tuner chassis at a later date.

### TRANSISTORIZED PORTABLE RECORDER

**14** Kouyoh International Corporation is now marketing an all-transistor portable tape recorder as the "Saxon 555."

The unit operates on portable 9-volt batteries, 12-volt auto battery by plugging into the car cigarette lighter, or on ordinary house power by means of its own built-in a.c. system.

Featuring three speed record and playback, 17.8, 3 3/4, and 7 1/2 ips, the 8-transistor instrument includes capstan constant speed drive and fingertip

push-button control. Additional features include recording level meter, tape counter, tone control, a.c. pilot light, and external speaker jack.

Standard accessories include dynamic remote-control microphone, radio patch cord, magnetic earphone, batteries, cigarette-lighter connector cord, tape reels, and carrying case.

## NEW PHONO CARTRIDGE

**15** Shure Brothers, Inc. is now marketing the V-15 "Stereo Dynamic" cartridge which features a unique bi-radial elliptical stylus. In both shape and performance, the new stylus duplicates as far as possible the wedge-shaped styli used to cut records and thereby reduces distortion produced when a playback stylus does not track a record groove with the same motions made by a cutting stylus.

Frequency response of the V-15 is 20 to 20,000 cps; output is 6 mv.; separation is over 25 db; compliance is 25 x 10<sup>-6</sup> cm./dyne; impedance is 17,000 ohms, and recommended tracking force is 3/4 gram.

## TRANSISTOR ORGAN KIT

**16** Schober Organ Corp. has announced a new all-transistor electronic organ which is being offered in kit form. Known as the "Recital Organ," the basic instrument has two 61-key manuals, 5 pitch registers on each manual, 4 pitch registers on pedals, 6 couplers, 2 swell shoes, vibratos separate for the two manuals, and pedal sound without vibrato.

Printed circuits are used for every component section except the power supply. Switch contacts are gold against gold for corrosion-free life.

The console in which the instrument is housed



measures 55 inches wide, 29 inches deep without pedals, and 43 1/2 inches high plus a 10" music rack. Assembled, the organ weighs about 250 pounds.

## LIGHTWEIGHT TAPE RECORDER

**17** Roberts Electronics is now offering a lightweight two-track mono tape recorder as the Model 1600. Weighing just 22 pounds, the instrument features a vu meter, index counter, and microphone and will record at 7 1/2, 3 3/4, and 1 3/8 ips.

## INTERCOM PHONES

**18** Fanon-Masco has developed a two-station intercom which features one-piece telephone-type handsets which stand upright and occupy a minimum of desk or table space.

Tradenamed "Verti-Phones," the new units stand 8 1/2 inches high and are powered by two standard "C" cells which are contained within



ELECTRONICS WORLD

the handset. In normal usage, battery life is one year since the circuit is automatically disconnected when the handsets are placed on the desk. Either unit may originate the call by means of a ringer circuit which is activated by a button on each phone. When the handset is picked up, the intercom circuit is energized.

**PORTABLE TAPE RECORDER**

**19** Freeman Electronics Corporation has announced the availability of the "550 Senior," a portable record/playback unit that operates off self-contained batteries or through an optional

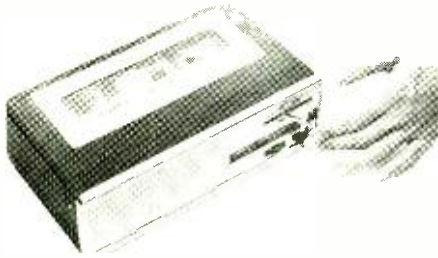

a.c. power supply. The front panel includes a battery condition indicator as well as a professional vu meter and single-lever control of rewind, stop, play, and record.

Other features include a professional capstan drive, fast forward and rewind, built-in monitor speaker, microphone and radio-phono input jacks, high-frequency a.c. bias oscillator and erase, among others.

**FIVE-WAY AM-FM TUNER**

**20** Calbest Electronics now has available the Model 9150 five-way AM-FM tuner which includes built-in circuitry for receiving the SCA sub-carrier channels.

In the FM-stereo mode, channel separation is 30 db at 1000 cps with -44 db suppression at 38 kc. and -45 db SCA suppression. Tuning range for FM multiplex operation is 32 to 75 kc. with hum and noise -60 db. Over-all FM frequency response is  $\pm 1$  db from 50 to 15,000 cps and 5000 cps -6 db on AM.

The circuit uses 13 tubes plus 6 germanium crystal diodes and one dual silicon power rectifier. The instrument measures 15" x 9 1/2" x 4 1/2" and draws 47 watts at 117-volt, 60-cycle input.

**INDOOR/OUTDOOR SPEAKER**

**21** Electro-Voice, Inc. is now offering a new indoor/outdoor portable speaker as the "Sonocaster." Weighing only eight pounds, the unit is designed to be placed temporarily whenever sound is required or installed outdoors on a permanent basis. The housing is molded of durable, crack-proof, plastic material which shields the driver unit from weather yet is itself immune to the effects of the elements.

The new speaker is a high-efficiency unit permitting use with even low-powered amplifiers and transistor radios or phonographs. The 8" speaker includes a rigid die-cast frame, ceramic magnet assembly, and double-wound voice coil.

**CB-HAM-COMMUNICATIONS**

**23-CHANNEL CB TRANSCEIVER**

**22** Lafayette Radio Electronics Corporation has recently introduced a 23-channel, crystal-controlled CB transceiver, the Model 11B-222.

The new unit provides a tunable receiver with crystal accuracy on every channel. It features 23-channel crystal-control receive and transmit with all necessary crystals supplied. Fine tuning compensates for crystal tolerance. The receiver is a dual-conversion superhet which uses a 1650 kc. and 262 kc. i.f. system with better than 1- $\mu$ v. sensitivity. Audio output is 3 watts to the PM speaker. Signal-to-noise ratio is better than 1  $\mu$ v. for a 10:1 S/N.

The transceiver measures 12" x 5" x 8 1/2" and has a bracket handle for underdash mounting.

**You get two very important benefits from this great new CB transceiver:**

1. Hallicrafters performance standards.
2. Change from a \$100 bill.



**NEW CB-7**  
six channel citizens band  
TRANSCEIVER

**\$99<sup>95</sup>** complete

You also get a flock of other, very useful benefits that help to make the CB-7 the greatest transceiver value in citizens band history.

- New design concepts give you great economy with no sacrifice in performance.
- Six channel, crystal-controlled convenience.
- New all-electronic push-to-talk circuitry.
- Highly compact new size (only 12" x 5" x 7")... same great "drop-down" chassis feature as CB-3 series.
- Nothing else to buy! Ready to operate either base AC or mobile DC, including all necessary power cords and mounting bracket.
- Standardized channel crystals — interchangeable in all Hallicrafters transceivers.
- Accommodates all CB-3 Series accessories: HA-9 S-Meter; HA-11 Noise Eliminator; HA-12 Encoder/Decoder; HA-13 VFO.
- Full 100% modulation capability; sensitivity 1  $\mu$ v for 10 db. S + N/N ratio; power input 5 watts, receive output 2 watts.



The new ideas in communications are born at...

**hallicrafters**

Export: Hallicrafters International Div.

5th & Kostner Aves., Chicago, Illinois 60624

**CIRCLE NO. 114 ON READER SERVICE PAGE**

**SEND ELECTRONICS WORLD**

**EVERY MONTH**

SPECIAL SECTION  
ELECTRONICS IN SPACE  
NASA'S GODDARD  
SPACE FLIGHT CENTER

name \_\_\_\_\_

address \_\_\_\_\_

city \_\_\_\_\_ zone \_\_\_\_\_

state \_\_\_\_\_

Check one:  3 years for \$12  
 2 years for \$9  1 year for \$5  
 In the U.S., and possessions.  
 Payment enclosed  Bill me

Foreign rates: Canada and Pan American Union countries, add 50¢ per year; all other foreign countries, add \$1.00 per year.

New  Renewal

Mail to: **ELECTRONICS WORLD**  
 Dept. 1-2516, 434 S. Wabash Ave.  
 Chicago 5, Ill.

# MOVING?



If you've recently changed your address or plan to in the near future, be sure to notify us at once. Place magazine address label here and print your new address below.

## NEW ADDRESS:

NAME \_\_\_\_\_ PLEASE PRINT

ADDRESS \_\_\_\_\_

CITY \_\_\_\_\_ ZONE \_\_\_\_\_ STATE \_\_\_\_\_

MAIL COPIES TO NEW ADDRESS STARTING WITH \_\_\_\_\_ ISSUE.

If you have any questions about your subscription be sure to include your magazine address label when writing us.

Mail to: ELECTRONICS WORLD, 434 So. Wabash Avenue, Chicago 5, Illinois

## B.S. Degree in 36 months

Small professionally-oriented college. Four-quarter year permits completion of B.S. Degree in three years. Summer attendance optional. *Engineering:* Electrical (electronics or power option), Mechanical, Civil, Chemical, Aeronautical. *Business Administration:* General Business, Accounting, Motor Transport Administration. One-year Drafting-Designer Certificate program. Graduate placement outstanding. Founded 1884. Rich heritage. Excellent faculty. Small classes. 200-acre campus. Well equipped labs. New library. Residence halls. Modest costs. Enter Sept., Jan., March, June. For Catalog and View Book, write J. H. McCarthy, Director of Admissions.



### LOW-COST BUSINESS AIDS FOR RADIO-TV SERVICE

Order books, invoice forms, job ticket books, service call books, cash books and statement books for use with your rubber stamp. Customer file systems, book-keeping systems, many others. Write for FREE 32 PAGE CATALOG now. OELRICH PUBLICATIONS 6556 Higgins Rd., Chicago, Ill. 60656

### EARN Electronics Engineering DEGREE

You can earn an A.S.E.E. degree at home. College-level HOME STUDY courses taught so you can understand them, continue your education, earn more in the highly paid electronics industry. Missiles, computers, transistors, automation, computer electronics. Over 27,000 graduates now employed. Resident school available at our Chicago campus—Founded 1931. Send for free catalog.

American Institute of Engineering & Technology 1141 West Fullerton Parkway, Chicago 14, Ill.

There is a built-in 117-volt a.c. power supply and a 12-volt transistorized d.c. mobile power supply.

#### SSB TRANSCEIVER

**23** Linear Systems Inc. has developed an all-semiconductor single-sideband transceiver which provides 75 watts output with low battery consumption of 1 watt on receive and an average of only 60 watts under SSB modulation.

The LSF-1 is designed for fixed, portable, or mobile operation by non-technical personnel. Op-

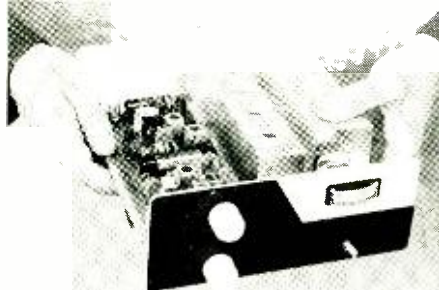

erating from 2 to 15 mc. single-channel simplex, selectable sideband, or compatible AM with inserted carrier, the unit is suited as a replacement in marine operations below 10 mc. where SSB is expected to be mandatory in the 1970's.

Separate power supplies accommodate the unit to 6, 12, 24, or 32 volt d.c. or 110/220 volt a.c., 50/60 cps sources.

#### V.H.F. COAXIAL ANTENNA

**24** Regency Electronics, Inc. has added a new whip-type antenna to its line for use in the 108-136 mc. v.h.f. aircraft band.

With a nominal impedance of 72 ohms, the Type AA-1 antenna comes in two easily assembled sections, each 23½ inches long (47" fully extended). Of lightweight sturdy metal construction, the entire antenna weighs 4 ounces. The antenna can be mounted vertically or aimed in the direction of stations or transmitting sources. It is designed to use RG-59U cable for interconnection with the receiver.

#### RADIO PAGING EQUIPMENT

**25** Multitone Electronics, Ltd. has developed a new line of transistorized encoders for use with its "Personal Call Pocket Paging" equipment. These new encoders are preset for automatic coding and call duration and have provision for connecting a speech unit, remote



control units, or remoted triggering. These are easily serviced by utilizing interchangeable circuit boards.

Two codes permit identification of urgent messages or speech calls. A two-wire connection is all that is needed to control from one to six remotely located transmitters at any distance. Speech is transmitted simply by plugging in the firm's dynamic microphone, which has a built-in preamplifier and noise-cancelling features.

#### 23-CHANNEL BASE STATION

**26** Browning Laboratories, Inc. has recently introduced a 23-channel base station consisting of the "Eagle" R-27 receiver and the "Eagle" S-23 transmitter.

The R-27 features an r.f. gain control, a selec-

tivity switch giving a choice of either broad or narrow selectivity, a cascode muvistor front end, 12 tuned i.f. coils, as well as other of the firm's special circuit features.

The S-23 employs a compression amplifier and clipper-filter stage for highest percent of modulation as well as all 23 channels and a built-in s.w.r. meter.

#### ALUMINUM SCAFFOLDING TOWER

**27** Alpar Manufacturing Corp. has just added a fully collapsible aluminum scaffolding tower to its line of antenna towers.

Measuring 4 x 4 x 6 feet, and collapsible to 9½" x 10½" x 7'4", the tower is light weight (9 pounds per foot), easy to erect, and capable of attaining heights up to 400 feet. It is designed for collimation work as well as serving as a base for antenna systems and as a vertical radiator.

#### WIDEBAND FM RECEIVERS

**28** RHG Electronics Laboratory, Inc. has announced the availability of wideband FM receivers incorporating baseband capabilities to 15 mc. with low distortion.

Designed for applications such as missile TV telemetry, the basic units are available with i.f.'s

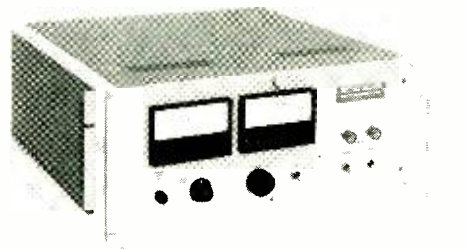

of 60 and 160 mc. Complete microwave receivers in L, S, C, and X bands are also available.

The unit shown in the photo has an r.f. frequency of 860 mc., an i.f. of 60 mc., FM bandwidth of 20 mc., and a base bandwidth of 30 cps to 8 mc. Non-linearity is 3% maximum and the noise figure is 10 db.

#### REMOTE-CONTROL HEAD

**29** Gonset, Incorporated has developed a new, compact control unit for remote operation of a two-way mobile communications system which is especially designed to be used with the firm's G-151A "Communicator."

Measuring only 2½" high x 7" wide x 5½" deep, the new unit can be located under a dashboard without interfering with leg room and still provide speaker emission in a forward direction. All necessary controls as well as the speaker are incorporated in the remote-control head, including "on-standby-off" switch, volume control, squelch control, plus the pilot lights and mike jack.

#### FREQUENCY-SYNTHESIZED CB

**30** Sonar Radio Corp. has added the FS-23 to its line of Citizens Band equipment. The new unit incorporates 23 frequency-synthesized crystal-controlled channels, continuous one-control channel switching, low-noise dual-purpose transistor power supply, low-noise muvistor receiver r.f. stage, provisions for accessory VOX control and two-tone squelch, class-B push-pull modulation, and crystal-controlled receiver fine tuning.

The unit comes complete with microphone, power supply cables, and mobile brackets.

#### SELECTIVE-CALL PAGING

**31** Motorola Inc. has added selective signaling facilities to its "HT" series of "Handie-Talkies" to speed up response to emergency calls and increase the efficiency of routine plant activities. The new unit enables each man to hear only calls sent to him and eliminates constant monitoring of all messages on the plant network.

The basic system for these new paging radios has a capacity of 360 units. Larger networks may include as many as 7500 units. ▲



**TERMINALS & CONNECTORS**

**37** The Thomas & Betts Co. has published a 56-page illustrated catalogue of terminals, splices, and installation tools.

The new catalogue contains illustrations of all of the firm's solderless connectors together with complete dimensional information. Installing tools, both hand and production types, are keyed to the types of fittings for which they are applicable. Military standards and specifications are referenced where pertinent.

**DATA PRINTERS & CONVERTERS**

**38** General Radio Company has issued a four-page brochure which provides technical details on its Type 1151-A digital time and frequency meter, the Type 1150-A digital frequency meter, the Type 1137-A data printer, Type 1136-A digital-to-analog converter, and Type 1536-A photoelectric pickoff.

Each unit is illustrated and pertinent characteristics listed.

**SCR TECHNICAL PAPER**

**39** Sprague Electric Co. is offering copies of a technical paper "Unique SCR Firing Circuit Increases Current Handling Capacity" which describes the details of firing an SCR through a rather unique method whereby two output pulses per cycle from one set of terminals fire one SCR twice in each cycle and provide full-wave controlled a.c. or d.c. The 360-degree firing increases the d.c. current handling capability of the SCR by 40%, due to improved form factor.

**PROTOTYPE BREADBOARD DATA**

**40** Vicon Instrument Company is offering a four-page, two-color brochure which explains in detail and illustrates the firm's new method of preparing prototype breadboard circuitry and limited-production circuitry by means of its "Proto-Board."

The publication lists the components of an experimental and a laboratory kit as well as the separate units which can be supplied for specific breadboard applications.

**MINIATURE SIDEVIEW HEADS**

**41** General Electric Company has published a two-page data sheet, Bulletin GEA-7620, which describes its right-angle photoelectric light source and receiving heads for limited space applications in sensing, sorting, detecting, diverting, identifying, indicating, controlling, counting, switching, and actuating.

The bulletin explains the units and contains pictures, ordering information, outline dimensions, and a drawing of their use on parallel conveyors which now need to be separated by no more than one inch.

**D.C. POWER SUPPLY DESIGNS**

**42** Magnetic Circuit Elements Inc. is now offering a series of design sheets which provide complete electrical data for building 36 different miniature power supplies including transformers, rectifiers, and filters. The d.c. supplies covered by these designs range from 10 to 80 volts with power ratings from 280 mw. to 24 watts.

**TRANSISTOR/DIODE CHART**

**43** Semitronics Corporation has just published a new and expanded transistor and diode replacement and interchangeability guide, CH-10-50M.

Presented in the form of a two-color 19" x 25" chart, the publication now includes diodes as well as transistors and lists 40 basic semiconductors that can be used as substitutes for 3000 types.

Separate color-keyed sections list the company's replacements for EIA types, private-manufacturer type numbers, and foreign semiconductors.

**INSULATED STRIP TERMINALS**

**44** Kent Corporation has just published a 6-page, four-color bulletin which describes a complete line of PVS (insulation support) insulated strip terminals applied by machine.

Bulletin K-4 also covers nylon (insulation grip)

# MANUFACTURERS' LITERATURE

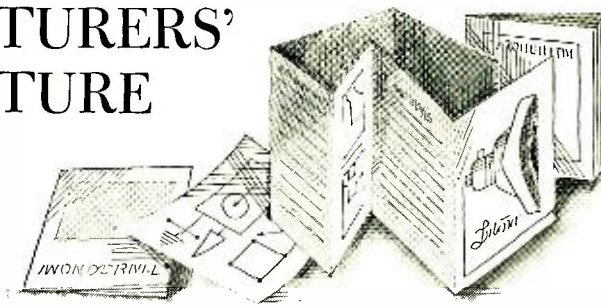

terminals for military spec requirements in strip form. Dimensional drawings and catalogue numbers are listed as well as electrical and mechanical properties.

**TEST & MEASUREMENT INSTRUMENTS**

**45** John Fluke Mfg. Co., Inc. has issued a 14-page catalogue digest which lists 41 test and measurement instruments including four new products. Catalogue 64A describes and pictures seven models of precision differential voltmeters and 13 models of voltage dividers and power supplies among other instruments covered. The new units include a microvolt potentiometer, a solid-state voltage calibrator, a combination voltage/current calibrator, and an electronic galvanometer with 2-nanoampere scale divisions.

**SERVICE COMPONENTS CATALOGUE**

**46** Clarostat Manufacturing Company, Inc. has just published a 20-page catalogue which covers replacement resistors, potentiometers, and switches for service applications.

Included is the firm's complete line of wirewound and carbon pots, fixed value or adjustable wirewound resistors, switches and other resistance devices for servicing radios, TV receivers, hi-fi equipment, p.a. amplifiers, and other electronic equipment.

**STEREO COMPONENTS**

**47** TRW Columbus Division has issued a new catalogue covering a full line of stereo components marketed under the "Bell Sound" label. The 16-page catalogue describes and pictures stereo tuners, amplifiers, receivers, tape decks, and tape recorders. Complete specifications are included for all of these components in catalogue CL-643.

**LASER CATALOGUE**

**48** Maser Optics, Inc. has just issued a 20-page illustrated catalogue which gives complete operating data on the firm's line of solid-state and gas lasers, laser systems, and accessories.

Pertinent specifications are given in concise, easy-to-use form.

**TRANSPARENT TUBING DATA**

**49** Pennsylvania Fluorocarbon Co., Inc. has issued a single-page data sheet which describes

a line of low-cost, transparent, heat-sealable plastic tubing which is designed for elevated and cryogenic temperatures and features chemical inertness, toughness, zero moisture absorption, and non-inflammability.

Bulletin 33 lists available sizes and covers applications for this new product.

**FILTER APPLICATIONS**

**50** Cornell-Dubilier Electronics Division has issued another of its "how to" reference guides in its "Filter Guideline Application Chart." The two-color 22" x 17" wall chart displays in one viewing the inter-relationships between applications and filter types and characteristics. Terminations and mountings are also classified.

**SOLDERING IRON SELECTION**

**51** Alpha Metals, Inc. is now offering copies of a technical article on considerations involved in the selection of the right soldering iron and tip. Co-authored by the company's Director of Solder Research, H. M. Manko, and R. R. Ross of IBM Corporation, the article discusses heat content, shape, conductivity, and tip materials.

The article contains cut-away views of soldering irons showing construction features, a table on iron classification, and a table on heat characteristics of tip metals.

**LITERATURE ON B.F.O.'S**

**52** B&K Instruments, Inc. has published a new 16-page technical brochure covering its Models 1013, 1017, and 1022 beat-frequency oscillators. These instruments are used for an almost infinite number of frequency-response and linear measurements in acoustical, electro-acoustical, electronic, and vibration investigation.

The technical bulletin contains detailed descriptions of the instruments and their specifications. Typical application of the instruments in use on measuring, calibrating, and automatic recording setups is also illustrated.

**FIXED-STATION ANTENNAS**

**53** Andrew Corporation has recently released a new 1964 Fixed Station catalogue which features several new antennas in the frequencies used for mobile communications.

Two new gain antennas for 136-174 mc. band are introduced as well as improved characteristics

**ELECTRONICS WORLD** TOTAL NO. OF REQUESTS

P.O. BOX 7842, Philadelphia 1, Pa.

Please send me copies of the literature whose code numbers I have circled.  
(Your requests will be forwarded to the manufacturers who will be glad to fill them promptly.)

37	38	39	40	41	42	43	44	45	46	47	48	49	50	51	52
53	54	55	56	57	58	59	60	61	62	63	64	65	66	67	

NAME (PRINT CLEARLY) \_\_\_\_\_

ADDRESS \_\_\_\_\_

CITY \_\_\_\_\_ ZONE \_\_\_\_\_ STATE \_\_\_\_\_

COMPANY \_\_\_\_\_ TITLE \_\_\_\_\_

VOID AFTER JUNE 30, 1964 6

# SELLING THAT RECORDER? BUYING A RECEIVER?



ELECTRONICS WORLD runs a Hot Line into the 201,000 electronics professionals who buy the magazine each month. And, for only 35¢ a word, a personal classified ad will help you make your connection.

ELECTRONICS WORLD has the largest audience of its kind in the world, and this creates an ideal market place for you. Actually, when you get together with your co-professionals, you may find that many are near neighbors. Yet your mutual needs may be met only through the medium of our classified columns.

Take advantage of our special personal rate of 35¢ a word (including name and address)

## NO MINIMUM REQUIRED

a saving of 25¢ a word from our commercial rate of 60¢.

A small investment can bring quick results, and a handy order form is printed in the Classified Advertising Section. Write your ad in the spaces provided and mail it today, with your payment, to:

MARTIN LINCOLN

Classified Advertising Manager  
ELECTRONICS WORLD

One Park Ave., N. Y., N. Y. 10016

AUGUST ISSUE CLOSES JUNE 5th

on antennas serving the 25-148 and 150-470 mc. bands. Specifications on foam "Heliax" low-loss, flexible coax are also given in Catalogue F.

### KIT & WIRED INSTRUMENTS

**54** Eico Electronic Instrument Co. Inc. has just issued a 2-color, 32-page catalogue covering its complete line of stereo and mono hi-fi equipment, test instruments, ham gear, Citizens Band radios, and transistor receivers available in both kit and wired form.

In all, over 200 items, kit and wired, are fully described in the new catalogue.

### STANDARD INDUSTRIAL RELAYS

**55** Potter & Brunfield has issued a new 20-page catalogue describing its complete line of electromagnetic relays. Separated into illustrated sections (high performance, special purpose, power, general purpose, and telephone types), the catalogue features several new relays never before catalogued.

Coil voltages, resistances, time values, contact ratings, terminations, dimensions, and other pertinent engineering data are listed for each type of relay. Also shown are standard enclosures, mountings, and UL and CSA labeled relays.

### ELECTRONIC COMPONENTS

**56** National Tel-Tronics Corp. is offering a 48-page illustrated catalogue covering a wide range of electronic components in the firm's line.

Included are terminal boards, printed circuits, binding posts, contact strips, contact connectors, receptacles, mounting bases, lugs, plugs and jacks, light shields, alligator clips, test prods, hardware, and laminated sheets.

### MEASURING INSTRUMENTS

**57** Hewlett-Packard Company has issued a compact, concise data sheet covering a representative line of laboratory-type instruments for all types of measurement applications.

Pictured and described are multimeters, r.m.s. voltage instruments, differential voltmeters, integrating digital voltmeters, comparators, calibrators for frequency standards, oscillators, frequency dividers, microwave frequency converters, among others. Each instrument is pictured and a brief description of the item given.

### IMPROVED TV & FM RECEPTION

**58** Cornell-Dubilier Electronics Division is offering copies of a 20-page booklet which provides a factual, unbiased analysis of the causes of TV and FM reception difficulties and their remedies.

The booklet describes, in detail, the reasons for poor TV and FM reception, the basic forms of antennas available and their purpose, and the advantages of coupling the proper directional antenna with a rotor system for optimum reception.

Details on the firm's rotors and their installation and application are also included.

### PULSE & DELAY GENERATORS

**59** Orbitran Company, Inc. has published two technical data sheets covering a completely new line of marker pulse and pulse delay generators. In addition to describing each unit in some detail, the data sheets provide complete information on application, full specifications, and other performance features to be found in each unit.

### COAXIAL CABLE DATA

**60** Alpha Wire Corporation has announced publication of a 16-page catalogue which describes the construction and characteristics of 58 widely used coaxial cables made with polyethylene and Teflon insulation. The cables listed meet applicable military specifications.

### FLASHTUBE MANUAL

**61** Amglo Corporation has just published a new flashtube engineering manual which describes the characteristics of xenon, neon, and argon helical and straight flash lamps.

Special sections of the new publication are devoted to circuit design, parameters of a.c. and battery high-voltage power supplies, and stroboscopic equipment design.

Complete information on availability and where the components may be purchased is also included in this reference manual.

### TELEMETRY FILTERS

**62** Kenyon Transformer Company has issued a 4-page, 2-color brochure on a new line of telemetry filters of advanced design.

These subminiature subcarrier filters for FM-FM telemetry are completely immune to environmental stresses specified in MIL-F-18327-B and are available in seven mechanical configurations and three standard electrical configurations in each of the 23 IRIG standard frequencies—a total of 183 in all.

Block diagrams and performance curves in the brochure illustrate typical applications and performance. Drawings are used to illustrate standard cases, terminations, and terminal/mounting placement.

### VARIABLE-TRANSFORMER DATA

**63** The Superior Electric Company is now offering copies of Bulletin P963 which carries complete information on the firm's new 22 Series of "Powerstat" variable transformers.

The bulletin describes both manually operated and motor-drive units which are available for 210 or 480 volt, 50/60 cycle, single- or three-phase service along with performance curves and tabulated connections and rating data.

### CHARGE POWER AMP DATA

**64** Columbia Research Laboratories, Inc. has issued a four-page data sheet which describes in some detail its Models 7000 and 7003 charge power amplifiers which are designed to detect, amplify, and monitor signals between 0.1 g and 10,000 g's from piezoelectric accelerometers.

The data sheet lists nine features of the Model 7000 charge amplifier, including a novel input circuit which detects accelerometer charge as if there were no input cable present.

Complete specifications are given, with a photo of three modules in a bench-type cabinet.

### POWER-SUPPLY CATALOGUE

**65** Acopian Technical Company is offering copies of a new 12-page catalogue which includes specifications and prices on both single- and dual-output transistorized regulated plug-in power supplies.

Also included in the new publication are details for mounting modules on standard 19" panels.

### RUBY LASER DATA

**66** Maser Optics, Inc. has available a new technical bulletin which gives complete design and operating data on what is believed to be the world's most powerful laser.

Bulletin 1500 illustrates and describes the Model 4500 ruby laser whose outstanding characteristic is its rated 1500-joule output.

### EDUCATIONAL-TV EQUIPMENT

**67** Visual Communication Products, General Electric Company has available a new descriptive bulletin (GEA-7850) which covers the use, function, and operation of all elements of its FE-18-A educational-TV operating center.

The six-page brochure describes the Center's packaged system of audio and video components for origination and control of professional-quality broadcast or in-school ETV programs. ▲

### PHOTO CREDITS

Page	Credit
18	H. H. Scott, Inc.
23, 24, 25	Otto E. Markevics
26, 27	Fairchild/Winston
32	Allied Radio Corp.
49 through 64	Goddard Space Flight Center
68 (Fig. 9)	Transmagnetic, Inc.
82 (left)	Hewlett-Packard Co.
82 (right)	Houston Instrument Corp.
83	Mar-Con Instrument Corp.
90	Shure Brothers, Inc.

# ELECTRONICS MARKET PLACE

COMMERCIAL RATE: For firms or individuals offering commercial products or services. 60¢ per word (including name and address). Minimum order \$6.00. Payment must accompany copy except when ads are placed by accredited advertising agencies. Frequency discount: 5% for 6 months; 10% for 12 months paid in advance.

READER RATE: For individuals with a personal item to buy or sell. 35¢ per word (including name and address). **No Minimum!** Payment must accompany copy.

GENERAL INFORMATION: First word in all ads set in bold caps at no extra charge. Additional words may be set in bold caps at 10¢ extra per word. All copy subject to publisher's approval. **Closing Date:** 5th of the 2nd preceding month (for example, March issue closes January 5th). Send order and remittance to: Martin Lincoln, ELECTRONICS WORLD, One Park Avenue, New York, New York 10016

## FOR SALE

TRANSISTOR Ignition coils, components, kits. Advice Free. Anderson Engineering, Wrentham 5, Mass.

CANADIANS—Giant Surplus Bargain Packed Catalogs. Electronics. Hi-Fi, Shortwave, Amateur, Citizens Radio. Rush \$1.00 (Refunded). ETCO. Dept. Z, 464 McGill, Montreal, Canada.

JUST starting in TV service? Write for free 32 page catalog of service order books, invoices, job tickets, phone message books, statements and file systems. Oelrich Publications, 6556 W. Higgins Rd. Chicago, Ill. 60656.

GOVERNMENT Surplus Receivers, Transmitters. Snooperscopes, Parabolic Reflectors, Picture Catalog 10¢. Meshna, Nahant, Mass.

TRANSISTORIZED Products importers catalog. \$1.00. Intercontinental. CPO 1717, Tokyo, Japan.

DIAGRAMS for repairing Radios \$1.00. Television \$2.50. Give make model. Diagram Service, Box 1151 E, Manchester, Connecticut 06042.

INVESTIGATORS, free brochure, latest subminiature electronic surveillance equipment. Ace Electronics, 11500-A NW 7th Ave., Miami 50, Fla.

## Now you can get the 1964 PHOTOGRAPHY DIRECTORY & BUYING GUIDE

For up-to-the-minute news on virtually all the products on the photo market, get the 1964 *Photography Directory & Buying Guide*.

It covers: still cameras  
flash equipment  
movie cameras  
still and movie projectors  
still and movie films  
lighting equipment  
exposure meters  
darkroom equipment  
tape recorders

The 1964 *Photography Directory & Buying Guide* is only 75¢. Available at your favorite newsstand and camera store or enclose your payment (plus 15¢ postage and handling) and mail to: Ziff-Davis Service Division, Dept. PD, 589 Broadway, New York 12, N.Y.

RESISTORS precision carbon-deposit. Guaranteed 1% accuracy. 1/2 watt 8¢. 1 watt 12¢ 2 watt 15¢. Rock Distributing Co., 902 Corwin Road, Rochester 10, New York.

IGNITION! Transistor. Coil, ballast \$7.95. Free Parts Lists. Transfire, Carlisle 2, Mass.

DIAGRAMS for repairing radios \$1.00. Television \$2.50 and \$1.00. Give make, model. Diagrams, Box 55, Williamsport, Pa.

METER Protector, will give positive and permanent protection to the meter of your volt ohm meter. No more bent pointers, or burnt out movements from accidental overloads. Will protect meter from severe overloads, will not affect the accuracy of your volt ohm meter, will protect any meter up to 20,000 ohms per volt. 100,000 ohms per volt model available if you specify. You can install yourself in 5 minutes, \$2.98 post paid. James Electronics, 8 W. Main Street, DuQuoin, Ill.

SURPLUS Equipment, Tubes, Parts—Send 10¢ for bargain sheets—D & L Electronics, Box 2715, Harrisburg, Pa.

COMPLETE KNIFE catalog 25¢. Hunting, Pocket, Utility, Heartstone, Dept ZD, Seneca Falls, New York 13148.

WHOLESALE prices on TV cameras, transmitters, converters, etc. direct from factory. Catalog 10¢. Vanguard, 190-48 99th Ave., Hollis, N.Y. 11423.

AMPEX 601-2 with accessories. Charles Goodman, 10 Woolson St., Mattapan, Mass.

PORTABLE REFRIGERATOR—16 pounds, battery operated in car or boat or 110V-AC house current. Office, spare for home. Free details—Sheirr Electronics Lab, 1490 Jesup Avenue, 3Q, Bronx, N.Y. 10452.

DIAGRAMS, service material, Radio, Television, \$1.00. Supreme Publications, 1760 Balsam, Highland Park, Ill. 60035.

C-B'ERS—Ground Plane Antennas. List \$9.95 and up. Dealers wanted. Write circular. Komet Electronics, P.O. 222EW, Tilton, N.H. 03276.

\$100.00 WEEKLY Spare Time selling Banshee TS-30 Transistor Ignition Systems and Coils. Big Demand. Free money making Brochure Slep Electronics, Drawer, 178ZD, Ellenton, Fla. 33532.

STEREO TAPES, Record Albums At Cost! All Labels Factory Sealed, Guaranteed. Monthly new release bulletin. Holiday Enterprises, Box 1601, Des Moines, Iowa 50306.

JAPAN & Hong Kong Electronics Directory. Products, components, supplies. 50 firms—just \$1.00. Ippano Kaisha Ltd., Box 6266. Spokane, Washington 99207.

UNUSUAL. Electronic Organ. Full constructional details in seven consecutive issues of Australia's national electronics magazine "Radio/TV/Hobbies." Set of seven copies (we have hundreds of sets) mailed for check or money order for \$3. Electronics Publications, 11 Cadow St., Pymble, NSW, Australia.

NEW transistor buried treasure, coin detectors. Kits, assembled models. \$19.95 up. Free catalog. Relco, A-22, Box 10563, Houston 18, Texas.

MULTIPLE STEREO—14 Channel Computer Tape Recorder, Amplifier, etc. Offers considered. Photo \$1.00. F. Jansen, 440 Ladera, Monterey Park, Calif.

SELLING YOUR ELECTRONICS EQUIPMENT? Get the message across to more than 200,000 avid electronics professionals each month through these classified columns. Take advantage of our new personal rate and place your ad at the special low price of only 35¢ a word (including name and address)—NO MINIMUM REQUIRED. Fill in the order form found in this section and mail today to: Martin Lincoln, Classified Ad Manager, Electronics World, One Park Avenue, New York, New York 10016.

## ELECTRONICS ENGINEERING AND INSTRUCTION

FCC LICENSE in six weeks. First class radio telephone. Results guaranteed. Elkins Radio School, 2603C, Inwood, Dallas, Texas.

HIGHLY-effective home study review for FCC commercial phone exams. Free literature! Wallace Cook, P.O. Box 10682, Pittsburgh, Pa. 15235

ELECTRONICS! Associate degree—29 months. Technicians, field engineers, specialists in communications, missiles, computers, radar, automation. Start February, September. Valparaiso Technical Institute, Dept. N, Valparaiso, Indiana.

USED Correspondence Courses and Books sold and rented. Money back guarantee. Catalog free. (Courses Bought). Lee Mountain, Pisgah, Alabama.

DRAFTING, Blueprint reading, schematics. Send \$2.00 first lesson. Complete home course \$25.00. Prior Inc., 23-09 169 St., Whitestone 57, N. Y.

INSTRUCT our readers of your educational services. A low cost classified ad (only 60¢ per word) will bring immediate responses. Use the order form in this section to mail your ad today!



RECEIVERS:	
RAX-1 200 to 1500 KC.....	Re-New: \$29.95
BC-348 200 to 500 KC—1.5 to 18 MC.....	Used: 89.50
R-48/TRC-8 230 to 250 MC FM (No meter).....	Used: 19.95
R-23/ARC-5 190 to 550 KC.....	Used: 12.95
R-25/ARC-5 1.5 to 3 MC.....	New: 19.95
BC-454 3 to 6 MC.....	New: 19.95
BC-455 6 to 9 MC.....	Used: 11.95
R-77/ARC-3 100 to 156 MC.....	Used: 22.50
BC-1206 200 to 400 KC.....	Used: 9.95
BC-733 108 to 110 MC.....	Used: 5.95
BC-229 200 to 400 KC—2500-7700 KC.....	Used: 8.95
R-5/ARN-7 100 to 1750 KC.....	Used: 18.95
BC-433G 100 to 1750 KC.....	Used: 12.95
MN-26C 150 to 1500 KC.....	Used: 9.95
MN-26 LB 200-410, 500-1200 KC—2.9-6 MC.....	U: 9.95
R-156/ARR-16 62.8 to 72.1 MC FM.....	Used: 16.95
R-89/ARN-5.....	Used: \$5.95 R-443/ARN-5: 7.95

TRANSMITTERS:	
ART-13 2 to 18 MC.....	Used: \$59.50
BC-604 21 to 27 MC FM.....	New: 7.95
BC-684 27 to 38 MC FM.....	Used: 6.95
BC-924 27 to 38 MC FM.....	New: 12.95
T-14/TRC-1 70 to 100 MC FM.....	Used: 24.95
BC-1158 53.3 to 95 MC AM.....	New: 29.95
BC-191 1.5 to 12.5 MC.....	New: 34.95
BC-230 3000 to 7000 KC.....	Used: 8.95
T-17/ARC-5 1.3 to 2.1 MC.....	New: 14.95
T-18/ARC-5 2.1 to 3.0 MC.....	Unused: 8.95
T-21/ARC-5 5.3 to 7 MC.....	New: 8.95
T-20/ARC-5 4.0 to 5.3 MC.....	New: 9.95
BC-459 7.0 to 9 MC.....	New: 14.95
T-23/ARC-5 100 to 156 MC.....	Used: 18.95
T-67/ARC-3 100 to 156 MC.....	Used: 22.95
GP-7 350 to 9050 KC.....	New: 34.95

RECEIVER—TRANSMITTERS:	
LINK 1905-1906 152 to 172 MC FM.....	Used: \$59.50
AN/VRC-4 1.7 to 8.7 MC.....	Unused: 59.95
RT-19/ARC-4 140 to 144 MC AM.....	Used: 22.95
BC-1335 27 to 38.9 MC FM.....	As is Used: 6.95
SCR-522 100 to 156 MC AM.....	Used: 29.95
BC-645 (Converts to: 435 to 500 MC).....	New: 14.95
RU-18 Complete Set, 12 Volts.....	New: 19.95
RU-19 Complete Set, 24 Volts.....	New: 19.95

Address Dept. EW • Prices F.O.B. Lima, O. • 25% Deposit on C.O.D.'s • Minimum Order \$5.00  
SEND FOR BIG FREE CATALOG!

**FAIR RADIO SALES**  
2133 ELIDA RD. • Box 1105 • LIMA, OHIO

CIRCLE NO. 110 ON READER SERVICE PAGE

## ADVANCE ELECTRONICS

		SILICON CONT. RECT.		COMPANION RECTIFIERS	
		TESTED			
PRV		7 Amp	25 Amp	2 Amp	6 Amp
70	1.35	2.60	—	—	—
140	1.85	3.10	—	—	—
200	2.10	3.25	.40	—	.45
250	2.60	3.60	—	—	—
300	2.85	3.85	.50	—	.60
350	3.35	4.25	.60	—	.75
400	3.85	—	—	—	—
450	4.25	—	—	—	—
500	4.60	—	.70	—	.90
600	5.35	—	.80	—	1.00

**SCRs**

### VARIACS

6 AMP	12.95	10 AMP	18.95
2 AMP	7.50	20 AMP	24.95
3 AMP	8.95	20 AMP (Cased)	29.95

Clock Motors 4: 6; 12 RPM, 60 cyc. \$1.95 ea.  
Clock Motors 1/2 RPM, 400 cyc. \$2.75 ea.

### VARIAN FOCUS MAGNETS

1504-A New \$975.00 Pair

### METERS

SQUARE		200 MA DC	
0-1MA 1/2"	\$3.25 ea.	0-200 MA DC	\$4.25 ea.
0-2MA	\$3.25 ea.	0-200 MMA	\$4.95 ea.
0-100 MV	\$3.25 ea.	0-1 MA (Arbitrary Scale)	\$3.95 ea.
0-500 MMA	\$3.50 ea.		

AC Volts 0-2; 3; 5; 10; 15; 25; or 50	\$3.95 ea.	0-150 VDC Weston (dual scale)	\$5.25 ea.
AC Amps 0-1; 2; or 3	\$5.95 ea.	0-150 VDC	\$4.75 ea.
DC-MA 0-50 or 100	\$5.95 ea.	0-10 MA DC	\$3.95 ea.
DC Volts 300	\$5.95 ea.	0-5A AC (marked 0-150)	\$3.75 ea.
		0-75 VDC	\$3.95 ea.
0-30 VDC	\$5.25 ea.		
0-5 MA DC	\$3.95 ea.	AC Volts 0-50	\$3.50 ea.
		AC MA 0-150	\$3.50 ea.
		DC Volts 0-25; 300; or 500	\$3.50 ea.

ROUND  
0-200 VAC \$4.49 ea.  
"S" meter 0-9 \$3.95 ea.

### MONTHLY SPECIALS

Solenoid Guardian No. 16AC 115 VAC—2 lb. pull \$1.79 ea. 12 for 20.00  
Relays. Sigma 500 S11 6—24 VDC 10 MA @ 6V 89c each. 10 for 7.50  
Alnico V Magnets Horseshoe type facing 2 1/8" x 5/8" x 1 1/2" High. \$1.95 Pr.  
NPN-Germanium MESA Transistors F max—250 MC-BV-10W \$1.00  
Germanium Diodes. 10 4.00 100/35.00  
Computer type—\$8/100  
Micro Switches V3-ISPTD .4/1.75  
Micro Switches ISMI PDT .4/1.75

### ASSORTED RELAYS—QUANTITIES WRITE FOR PRICES.

All Shipments FOB NYC

## ADVANCE ELECTRONICS

79 Cortlandt St., New York 7, N.Y. RE 2-0270

CIRCLE NO. 101 ON READER SERVICE PAGE

# FREE CATALOG

## OFFERING MANY SURPLUS BARGAINS

These items are just a sample of the equipment bargains available.

SPECIAL PRD 1100A 3db. Attenuator	\$ 22.50
PRD 390 Adaptor NEW	\$ 22.50
PRD 130B 6db. Attenuator	\$ 25.00
Sierra 160-5 1-Watt load	\$ 9.50
Sierra 160-5 5-Watt load	\$ 14.50
H.P. 455A Probe T. Connector	\$ 20.00
AN/URM 14 Mike Simulator	\$Q
AN/URM-1 100kc Dig. Counter	\$ 290.00
RDO Receiver 38-1000Mc	\$Q
AN/URM 25 Sig. Gen 10K-50Mc	\$ 275.00
HP 540B Transfer Oscillator	\$ 605.00
HP 212A Pulse Generator	\$ 350.00
683C 2 to 4 KMC Sweep Oscillator	\$1800.00
650AR Test Oscillator	\$ 300.00
410B VTVM	\$150.00
202A Function Generator	\$ 250.00
Ad-Vu Precision Phase Angle Voltmeter	\$ 450.00
TS-47A/APR Sig Generator	\$ 75.00
TS-147/D X Band Test Set	\$ 675.00
BC-1032B Pandaptor 5.25mc/F	\$ 125.00
Ballentine 300 VTVM	\$ 99.00
Hewlett Packard 430B Power Mtr	\$ 120.00
TS-268D/U Extal Rectifier Test Set	\$ 17.50
TS-375A/U VTVM	\$ 65.00
TS-917 Analyzer for TYP	\$ 175.00
TMC Type FFR Receiver	\$Q
Measurements 80 Sig Gen	\$Q
Dumont 304AR Scopes	\$ 195.00
Dumont 256D Scopes	\$ 90.00
Dumont 32A Scopes	\$ 245.00
Boonton 212A Glide Scope Tester L N	\$ 375.00
PL-259, 50239, M-359-UG-100A/U	\$ 1.00
New Any 3	\$ 450.00
SP-600 JX-540K-54mc/s	\$Q
R-390 Digital Job 500-32mc/s	\$Q
URR-13 225 to 400mc/s	\$ 320.00
Wilcox F-3 Fixed Freq	\$ 125.00
TS-174/U Freq. Mtr 20mc to 250mc/s	\$ 150.00
TS-175A/U Freq. Mtr 85mc to 100mc/s	\$ 135.00
Collins 513J Receiver	\$ 550.00
AN/URM-26 SIG. Gen. 4mc to 408mc	\$Q
Hewlett Packard 400DR VTVM	\$ 140.00

We buy military and test equipment. What do you have for sale or for trade? Call collect.

## SPACE ELECTRONICS

4178 PARK AVE.  
BRONX, N.Y.  
(212) CY 9 0300

CIRCLE NO. 130 ON READER SERVICE PAGE

## TUBES

TUBES—TV, Radio, Transmitting And Industrial Types At Sensibly Low Prices. New, Guaranteed, 1st Quality. Top Name Brands Only. Write For Free Catalog or Call WALKER 5-7000, Barry Electronics, 512 Broadway, New York N.Y. 10012.

BEFORE you buy receiving tubes, test equipment, Hi-fi components, kits, parts, etc. . . . send for your giant free Zalytron current catalog, featuring Standard brand tubes; RCA, GE, etc.—all brand new premium quality individually boxed. One year guarantee—all at biggest discounts in America! We serve professional servicemen, hobbyists, experimenters, engineers, technicians. Why pay more? Zalytron Tube Corp., 469-W Jericho Turnpike, Mineola, N. Y.

BRAND New Tubes, World's lowest prices on Radio, TV-industrial-special purpose tubes. Write for free parts catalog. United Radio, Newark, N.J.

7" TV test tube—\$6.99. Tubes—6146—\$2.95; 6211 (12AU7 equiv.) 39c, 3 for \$1.00. Germanium diodes, tested, equiv. 1N34, 1N60 etc., 30 for \$1.00. Tophat silicon rectifiers, 750 MA—1000 piv 75c. Transistors, tubes, resistors, condensers etc., bargain priced. Free catalog. Arcturus Electronics, Dept. ZD, 502-22nd St., Union City, N.J. 07087.

RADIO & TV Tubes—33c each. Send for free list. Cornell, 4215-W University, San Diego, Calif. 92105.

TUBES WANTED, all types, highest \$\$\$ paid, Lou-Tronics, 74 Willoughby Street, Brooklyn, N.Y. 11201, UL 5-2615.

ELECTRONIC TUBES—Top Brands SOLD at substantial savings! (Minimum Order \$15.00) Authorized GE Distributor. Send for FREE Buyers' Guide for all your Tube Requirements. TOP CASH PAID for your excess inventory (New ONLY—Commercial Quantities). Metropolitan Supply Corp., 443 Park Avenue South, New York, N.Y. 10016. 212-MU 6-2834.

## TAPE AND RECORDERS

RENT Stereo Tapes—over 2,500 Different—all major labels—free brochure. Stereo-Parti, 1616—E. W. Terrace Way, Santa Rosa, California.

SELF-Hypnosis. New concept teaches you quickly by tape or LP-record. Free literature. McKinley Publishers, Dept. T6 Box 3038. San Bernardino, California.

SAVE 30-60% Stereo music on tape. Free bargain catalog/blank tape/recorders/Norelco speakers. Saxitone, 1776 Columbia Road, Washington, D.C.

TAPE Recorder Sale. Latest models \$10.00 above cost. Arkay Sales, 22-21 Riverside Avenue, Medford 55, Massachusetts.

TAPEMATES MAKES AVAILABLE TO YOU—ALL 4-TRACK STEREO TAPES—ALL LABELS—POSTPAID TO YOUR DOOR—AT 40% COMBINED SAVINGS. FOR FREE BROCHURE WRITE TAPEMATES CLUB, 5280-E W. PICO BLVD., LOS ANGELES, CALIF. 90019.

PHONOGRAPH RECORDS MADE FROM YOUR TAPES. Send \$1.00 for format containing price breakdowns, tape preparation, profitable commercial applications. "Custom Recording," Box 206. North Wales, Pa.

## WANTED

QUICKSILVER. Platinum, Silver, Gold. Ores Analyzed. Free Circular. Mercury Terminal, Norwood, Mass.

CASH Paid! Sell your surplus electronic tubes. Want unused. Clean radio and TV receiving, transmitting special purpose. Magnetrons, Klystrons, broadcast types. Want military and commercial lab/test equipment. Want commercial Ham Receivers and Transmitters. For a Fair Deal write: Barry Electronics, 512 Broadway, New York, New York 10012 (Walker 5-7000).

ENGINEER or company with marketable products or ideas wanted. We can offer interest or merger in old established business. Box 392, 1501 Broadway, New York.

## RECORDS

RARE 78's. State Category. Write Record-Lists, P.O. Box 2122, Riverside, Calif.

## ROTH CAPACITORS

Computer Grade Electrolytics

MFD	VOLTS	PRICE*
8000	55	\$1.25
5500	45	.75
2500	45	.75
2500	80	.75
2000	70	.75
2000	100	.75
1500	100	.75
1250	180	.75
500	200	.75
400	300	.75
4	600	.75
14000	13	.75
11000	19	.75

\*SPECIAL! 8000 3 for \$3.00.  
All others 3 for \$2.00.

### PYRANOL

MFD	VOLTS	VOLTS DC	PRICE*
10	60	1500	\$1.25
10	235	400	1.00
8	850	1500	1.25
5	850	1500	1.25
4.5	1000	3000	1.25
4.5	850	2000	1.25
3	1000	3000	1.25

\*10 MFD @ 400V 3 for \$2.50.  
All others 3 for \$3.00.

ALL ITEMS REMOVED FROM COMPUTER EQUIPMENT ORDERS 20 LBS. OR MORE SHIPPED FREIGHT COLLECT. LESS THAN 20 LBS. INCLUDE SUFFICIENT POSTAGE. EXCESS PAYMENTS WILL BE REFUNDED.

## ROTH STEEL CORP.

127 Oakwood Ave. Syracuse, N.Y. GR5-8431

## SAY YOU SAW IT IN

# Electronics World

## SILICON RECTIFIER SALE

IMMEDIATE DELIVERY  
FULLY GUAR'N'T'D AMERICAN MADE

NEWEST TYPE FULLY TESTED

### 750 MA-SILICON "TOP-HAT" DIODES

LOW LEAKAGE FULL LEAD LENGTH

PIV/RMS	PIV/RMS	PIV/RMS	PIV/RMS
50/35	100/70	200/140	300/210
.05 ea	.09 ea	.12 ea	.16 ea
PIV/RMS	PIV/RMS	PIV/RMS	PIV/RMS
400/280	500/350	600/420	700/490
.20 ea	.24 ea	.32 ea	.40 ea
PIV/RMS	PIV/RMS	PIV/RMS	PIV/RMS
800/560	900/630	1000/700	1100/775
.48 ea	.55 ea	.70 ea	.75 ea

### ALL TESTS AC & DC & FWD & LOAD

#### SILICON POWER DIODE STUDS

D.C. AMPS	50 PIV	100 PIV	150 PIV	200 PIV
	35 RMS	70 RMS	105 RMS	140 RMS
.1	.15	.20	.25	.30 ea.
.12	.45	.65	.75	.95 ea.
.15	1.05	1.30	1.50	1.70 ea.
.20	1.60	2.10	2.40	3.00 ea.
.100	1.80	2.30	2.75	3.25

D.C. AMPS	300 PIV	400 PIV	500 PIV	600 PIV
	210 RMS	280 RMS	350 RMS	450 RMS
.1	.43	.52	.62	.68
.12	1.10	1.35	1.50	1.70
.15	2.40	2.55	3.00	3.00
.20	3.50	4.20	5.25	7.00
.100	3.80	4.65	5.65	8.00

### "SCR" SILICON CONTROLLED RECTIFIERS "SCR"

PRV AMP	16 AMP	25 AMP	PRV AMP	16 AMP	25 AMP
.35	.55	.90	1.25	2.50	2.55
.50	.90	1.25	1.45	3.00	2.80
1.00	1.40	1.95	2.25	3.00	3.75
1.50	1.75	2.25	2.75	5.00	4.30
2.00	2.00	2.65	3.05	5.00	5.35

Money Back guarantee. \$2.00 min. order. Orders F.O.B. NYC. Include check or money order. Shpg. charges plus. C.O.D. orders 25% down.

**Warren Electronic Components**  
89 Chambers St. NYC 7, NY Wo 2-5727

**SCR-625 MINE DETECTOR**  
Complete portable outfit in original packing, with all accessories. **\$29.50**  
Brand New

**NEW SHIPMENT! VICTOREEN RADIATION DETECTOR (DOSIMETER)**   
**\$2.25** Model 506 BRAND NEW, actual value \$45.00 SPECIAL. WHILE THEY LAST

**LM FREQUENCY METER**  
  
Crystal calibrated modulated. Heterodyne, 125 Kc to 20,000 Kc. With Calibration Book. Complete. Like new ..... **\$69.50**  
LM Frequency Meter as above, completely checked out, with tubes and crystal. Less calibration book. Exc. Used, clean ..... **\$34.50**

**BC-221 FREQUENCY METER**  
SPECIAL BUY! This excellent frequency standard is equipped with original calibration charts, and has pointers from 125 Kc to 20,000 Kc with crystal check points in all ranges. Excels. Used with original Calibration Book, Crystal, and all tubes. CHECKED OUT! Unmodulated ..... **\$89.50** Modulated ..... **\$129.50**  
BC-221 1000 Kc Crystal Brand New ..... **\$8.95**

**BC-906 FREQ. METER—SPECIAL**  
Aurality type 145 to 235 Mc. Complete with manual. Manual and original calibration charts included. BRAND NEW, OUR LOW PRICE... **\$12.88**

**LORAN APN-4 FINE QUALITY NAVIGATIONAL EQUIPMENT**  
  
Determine exact geographic position of your boat or plane. Indicator and receiver complete with all tubes and crystal.  
INDICATOR ID-6B/APN-4, and RECEIVER R-9B/APN-4, complete with tubes, Exc. Used. **\$69.50**  
NEW! APN-4A Receiver-Indicator as above, changed to operate same as APN-4 for improved performance ..... NEW **\$88.50**  
Shock Mount for above ..... **\$2.95**  
INVERTER POWER SUPPLY for above APN-4. INPUT: 24 V DC. OUTPUT: 115 V AC, 800 cycles. Like New ..... **\$22.50**  
12-Volt Inverter Power Supply for above APN-4. Like New. **\$12.50**  
We carry a complete line of replacement parts and accessories for above.

**LORAN R-65/APN-9 RECEIVER & INDICATOR**  
  
Used in ships and aircraft. Determines position by radio signals from known xmitters. Accurate to within 1% of distance. Complete with tubes and crystal. IN LIKE NEW Condition ..... **\$79.50**  
Used, with all parts, less tubes, crystal and visor ..... Special **\$29.50**  
INVERTER POWER SUPPLY for above APN-9. INPUT: 24 V DC. OUTPUT: 115 V AC. 800 cy. Like New **\$22.50**  
12-V. Power Supply for APN-9, like New P.U.R. Shock Mount for above ..... **\$2.95**  
Circuit diagram and connecting plugs available. We carry a complete line of replacement parts and accessories for above.

**APN-12 3-INCH SCOPE**  
  
Has vertical and horizontal sweep with focus and intensity controls, coaxial antenna changeover motor. Complete with 11 tubes and 3J1 CR Tube. For C15 V, 400 cycle AC and 24 V DC. Circuit diagram included. LIKE NEW **\$14.95**

**TS-100AP 'SCOPE**  
EXC. USED (worth \$750) OUR LOW PRICE **\$39.50**  
Brand New **\$69.50**  
In use as a linear sweep or general purpose test scope. Cables included. Also used with circular sweep as precision range calibrator. Self-contained in metal case 8" x 12 1/2" x 10" deep. For 110 V 50 to 1200 cycles AC. Excellent used. Like new, with all tubes including crystals and CR Tube.

**BC-929 3-Inch Scope, with all tubes, BRAND NEW** ..... **\$14.95**  
E88 FIELD PHONES. Checked out, perfect working order. Complete with all parts. Excellent Cond. Each ..... **\$12.95**

**IMPORTERS—EXPORTERS of ELECTRONIC EQUIPMENT**

We specialize in the export of military surplus electronic equipment:

- All at LOWEST PREVAILING PRICES.
- In addition to items shown on this page, we have in stock or can obtain for export and domestic customers, military electronic equipment made for World War II, Korean War, and later. We maintain one of the largest stocks of Government Electronic Surplus Equipment in America!
- IF YOU DON'T SEE WHAT YOU WANT HERE, WRITE US YOUR NEEDS. WE'LL QUOTE ON ANY GOV'T SURPLUS EQUIPMENT YOU SEE ADVERTISED ANYWHERE. Write or call today for our low LOW PRICE, and SPEEDY DELIVERY FROM STOCK!
- All packing and shipping is made directly from our own warehouse in NYC to give you substantial savings in handling costs!

**AN/APR-4 RADIO RECEIVER**  
High precision lab instrument, suitable for monitoring and measuring frequency and relative signal strength of signals from 38 to 4000 Mc., in 5 tuning unit ranges. LIKE NEW, SPECIAL ..... **\$79.50**  
TX-10, TX-14, TX-18, TX-19 and TX-51 Tuning Units for above in stock, F.U.R.

**SCR-522 2-METER TRANSMITTER-RECEIVER**  
Tone Mod. VHF Transmitter-Receiver. 144.1-146 Mc. 1-Planned. Modulated. Amplified. Modulated voice. Complete with all 18 tubes, top rack and metal case. LIKE NEW, SPECIAL ..... **\$129.50**  
SCR522 as above, exc. used ..... **\$32.50**

BC-624 Receiver only, with all tubes (of SCR-522) Clean. ..... **\$24.50**  
LIKE NEW Condition ..... **\$24.50**  
BC-625 Transmitter only, with all tubes (of SCR-522) Clean. ..... **\$24.50**  
LIKE NEW Condition ..... **\$24.50**  
RA62 AC POWER SUPPLY FOR SCR522 Transceiver, Like New **\$42.50**

**AN/ART-13 100-WATT XMTR**  
11 CHANNELS  
200-1500 Kc  
2 to 18.1 Mc  
**\$79.50**  
EXC. USED  
complete with Tubes  
  
Famous Collins Autotune Aircraft Transmitter. AM CW, MCW. Quick change to any of ten preset channels or manual tuning. Speech amplifier/clipper uses carbon or magnetic noise. Highly stable, highly accurate VFO. Built in Xtal controlled oscillator. PP8T1s modulate 813 in final up to 90% class. "B" Section "B" Ham bug at our low price!  
AN ART-13 XMTR, as above. IN LIKE NEW Condition, with all tubes and crystal. .... **\$89.50**  
O-16 Low Freq. Osc. Coil for ART-13 ..... **7.95**  
24V Dynamotor for ART-13 ..... **11.95**  
We carry a complete line of spare parts for above.

**SCR-274 COMMAND EQUIPMENT**  
ALL COMPLETE WITH TUBES

Type	Description	Used	Like NEW
BC-453	Receiver 190-550 KC.	\$12.95	\$14.95
BC-454	Receiver 3-6 MC.	12.45	17.95
BC-455	Receiver 6-9 MC.	11.50	13.95
1-5	to 3 MC. Receiver Brand New		17.95

110 Volt AC Power Supply Kit for all 274-N and AR-65 Receivers. Can be used with metal case. Instructions. Factory wired, tested, ready to operate. **\$8.95**  
SPECIAL TUNING KNOB for 274-N and AR-65 Receivers. Fits BC-453, BC-454 and BC-455. Only **49c**  
BC-453 Transmitter, Brand New, ..... **\$12.95**  
BC-457 TRANSMITTER—4.5-3 Mc. complete with all tubes and crystal, BRAND NEW ..... **\$9.75**  
Like New ..... **\$7.95**  
BC-458 TRANSMITTER—5.3 to 7 Mc. Complete with all tubes and crystal, BRAND NEW ..... **\$10.95**  
Like New ..... **\$7.95**  
BC-696 TRANSMITTER 3.4 Mc Complete with A1 Tubes & Crystal Like New ..... **\$11.95**  
BC-453 Mc. M. M. USED **\$3.45** NEW **5.95**  
ALL ACCESSORIES AVAILABLE FOR ABOVE

**SCHEMATIC DIAGRAMS** For most equipment on this page, each **65c**  
Please include 25% deposit with order—Balance C.O.D., or Remittance in Full. 50c Handling Charges on all orders under \$5.00. All shipments F.O.B. Our Warehouse in N.Y.C. All Merchandise subject to Prior Sale and Price Change.

**G & G RADIO SUPPLY CO.**  
Telephone: CO 7-4605  
77 Leonard St. New York 13, N. Y.

**APX-6 TRANSCEIVER.** Excellent for conversion to 1220 MC. Brand New. Complete with tubes. SPECIAL BUY! **\$39.50**  
BC-344 RECEIVER. 150-1500 Kc., continuous tuning, 4-band, for 115 V 60 Cycle AC. Excellent used, perfect working order. complete with tubes. **\$79.50**  
BC-342 RECEIVER. 1.5 to 18 Mc. AC Only. Like New, complete with all tubes ..... **\$79.50**  
BC-348 SUPERHET RECEIVER 200 to 500 Kc and 1.5 to 1800 Mc. Voice Tone. CW. Self-contained dynamotor for 24 V DC. Exec. Used. (Checked out) ..... **\$89.50**  
AC Power Supply ..... **\$14.50**

**FAMOUS BC-645 TRANSCEIVER**  
  
BRAND NEW! 15 Tubes 435 to 500 MC Can be modified for 2-way communication, voice or code, on ham band 420-450 mc, citizens radio 460-470 mc, fixed and mobile 450-460 mc, television experimental 470-500 mc. 15 tubes (tubes alone worth more than sale price!): 4—7F7, 4—7H7, 2—7E6, 2—6F6, 2—955 and 1—WV-316A. Now covers 460 to 490 mc. Brand new BC-645 with tubes, less power supply in factory carton. Shipping weight 25 lbs. SPECIAL! ..... **\$19.50**  
PE-101C Dynamotor, 12/24V input ..... **\$7.95**  
UHF Antenna Assembly ..... **2.45**  
Complete Set of 10 Plugs ..... **5.50**  
Control Box ..... **2.25**  
SPECIAL "PACKAGE" OFFER  
BC-645 Transceiver, Dynamotor and all accessories above, COMPLETE, BRAND NEW While Stocks Last. .... **\$29.50**

**ARB/CRV 46151 NAVY AIRCRAFT RADIO RECEIVER**  
190 to 9050 Kc in four bands. 6-tube super communications receiver with local and remote tuning, band change. Complete with tubes and dynamotor. LIKE NEW ..... **\$39.50**  
Pwr Supply, 110 V AC wired ..... **\$8.95**

**ARC-3 RECEIVER!**  
  
Complete with All Tubes Exc. Used **\$21.50**  
Like NEW ..... **\$33.50**  
Crystal-controlled 17-tube superhet, tunes from 100 to 156 MC., AM., on any 8 preselected channels. 28V DC power input. Tubes: 1-9002, 6-6AK5, 1-125H7, 3-12SG7, 1-9001, 1-12H6, 2-12SN7, 1-12SL7, 1-12A6.  
110 V A.C. Power Supply Kit for above 15.00  
Factory Wired and Tested ..... **19.95**  
ARC-3 TRANSMITTER  
Companion unit for above, tunes 100 to 156 MC on any 8 pre-selected channels. 9 tube crystal controlled, provides tone and voice modulation. 28V DC Power input. Complete with all tubes: 3-6V6, 2-832A, 1-125H7, 1-6J5, 2-6L6. Exc. Used ..... **\$18.95**  
Like new condition ..... **\$28.50**  
ARC-3 PUSHBUTTON CONTROL BOX ..... **\$5.95**

**AN/ARN-7 RECEIVER**  
Frequency range 100 Kc to 1750 Kc in 4 bands. Aircraft navigational instrument comprising superhet receiver and additional circuits. Complete with tubes, exc. cond. .... **\$29.50**  
Accessories for above, available.

**MOBILE-MARINE DYNAMOTOR**  
Model DM35  
Input 12V DC. Output: 625 V DC @ 225 Ma. for press-to-talk intermittent operation.  
Shpg. wt. 14 lbs. **\$19.50**  
BRAND NEW .....  
DYNAMOTOR VALUES: Excellent BRAND

Type	Input	Output	Used	NEW
DM-32A	28V 1.1A	250V .05A	2.45	4.45
DM-33A	28V 5A	575V .16A		
	28V 7A	540V .25A	2.95	4.45
DM-34D	12V 2A	220V .080A	4.15	5.50
DM-36	28V 1.4A	220V .080A	1.95	2.95
DM-43	28V 23A	925V .220A		7.95
		460V .185A		
DM-53A	28V 1.4A	220V .080A	3.75	5.45
PE-73C	28V 20A	1000V .350A	8.95	14.95
PE-86	28V 1.25A	250V .050A	2.75	3.65
DM-37 DYNAMOTOR.	Input 23.5 V DC @ 9.2 A. Out put 625 V DC @ 225 Ma. BRAND NEW Each			<b>\$3.25</b>

**MICROPHONES Checked Out, Perfect**

Model	Description	EXC. USED	BRAND NEW
T-17D	Carbon Hand Mike	\$4.45	\$7.95
RS-38	Navy Type Carbon Hand Mike	3.95	5.75

**HEADPHONES Checked Out, Perfect**

Model	Description	EXC. USED	BRAND NEW
HS-23	High Impedance	\$2.79	\$4.95
HS-33	Low Impedance	3.15	5.45
HS-30	Low Imp. (featherwt.)	.90	1.65
H-16 U	High Imp. (2 units)	3.75	7.95
TELEPHONES—600 ohm Low Impedance HEAD.			
SETS, BRAND NEW, PER PAIR			<b>\$3.95</b>
CO-307A Cords, with PL55 plug and JK26 Jack			<b>.99</b>
Earphone Cushions for above—pair			<b>.50</b>

**"TAB" ★ SCR'S ★ TRANSISTORS ★ DIODES!!!**

Full Leads Factory Tested & Gld! U.S.A. Mfg.  
PNP 50Watt 15Amp HiPower TO36 Pckgs:  
2N441, 442, 277, 278, D5501 up to  
50 volts VCB0 \$1.25 @ .5 for \$5.  
2N278, 443, 174 up to 80V \$3 @ 2 for \$5.  
PNP 10Watt 3A-2N155, 156, 235, 242, 254,  
255, 256, 257, 301, 351; c35 @ .4 for \$1  
PNP Signal up to 350MW T05, c25 @ .6 for \$1  
PNP Signal IF, RF, OSC, T05, OVS, c25 @ .6 for \$1  
PNP 2N670 300MW c35 @ .4 for \$1  
PNP 2N671 1Watt c50 @ .3 for \$1  
Silicon PNP T05 & T018, Pckg c25 @ .5 for \$1  
TO36, T03 Pckg Mica Mtg Kit 5 for \$1  
Power Heat Sink Finned 80 50 1.25 @ 5 for \$5  
3Amp T03 Pwr Transistors Untested! .10 for \$1  
Pwr Transistors T03 3A Untested .10 for \$1  
Stabistor Diodes up to one watt .5 for \$1  
Silicon Diodes 35-amp Studs Untested .3 for \$1  
Silicon Dio .5 epoxv 750Ma Untested .25 for \$1

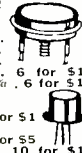

**"TAB", SILICON 750MA\* DIODES**

**NEWEST TYPE! LOW LEAKAGE!**

Piv Rms	Piv Rms	Piv Rms	Piv Rms
50 35	100 70	200 140	300 210
.05	.09	.12	.16
Piv Rms	Piv Rms	Piv Rms	Piv Rms
400 280	500 350	600 420	700 490
.22	.28	.34	.43
Piv Rms	Piv Rms	Piv Rms	Piv Rms
800 560	900 630	1000 700	1100 770
.50	.60	.72	.80

**ALL TESTS AC & DC & FWD & LOAD!**  
D.C. Power Supply: Output 300mA 165VDC @ 15V  
Max. Input 115V 60Hz 800W. Cased! Special \$5

**Silicon Power Diodes Studs & P.F.\***

D.C. Amps	50Piv 35Rms	100Piv 70Rms	150Piv 105Rms	200Piv 140Rms
3	.15	.20	.25	.35
12	.50	.70	.80	.95
*18	.30	.45	.60	.90
35	1.50	1.40	1.60	1.80
100	1.90	2.50	3.00	3.50
240	6.50	7.70	8.90	10.40

D.C. Amps	300Piv 210Rms	400Piv 280Rms	500Piv 350Rms	600Piv 420Rms
3	1.15	1.40	1.60	1.80
*18	1.10	1.35	1.60	1.80
35	2.70	3.20	3.90	4.50
100	4.00	4.75	5.75	8.50
240	19.50	27.50		

Sil. Pressfit 18A upto 100 Piv .4 for \$1  
Micro or MuSwitch CSD 35Amp AC-DC 3 for \$1

**SCR'S SILICON CONTROLLED RECTIFIERS:**

PRV	7A	16A	15A	PRV	7A	16A	25A
25	.60	1.00	1.35	250	2.70	3.00	3.55
50	1.00	1.35	1.65	300	3.00	3.45	3.85
100	1.60	2.15	2.45	400	3.75	3.90	4.50
150	1.95	2.45	3.00	500	4.75	4.80	5.30
200	2.20	2.80	3.25	600	5.45	5.65	6.00

SCR KIT UNITS UP TO 25-AMPS UNTESTED 4 for \$2  
Silicon Diodes 3&6 Amp Studs Untested 12 for \$1  
Glass Diodes 1N34 48 50 64 Untested 20 for \$1

**"TAB"** TERMS: Money Back Guarantee! Our 18th year. \$2 Min. order F.O.B. N.Y.C. Add ship. charges or for C.O.D. 25% Dep. Prices shown subject to change.  
111-WJ, Liberty St., N.Y. 6, N.Y.  
Send 25c Phone: Rector 2-6245 for Catalog

**CIRCLE NO. 132 ON READER SERVICE PAGE**

SAY YOU SAW IT IN  
**Electronics World**

**CLASSIFIED ADVERTISING ORDER FORM**

Please refer to heading on first page of this section for complete data concerning terms, frequency discounts, closing dates, etc.

1	2	3	4	5
6	7	8	9	10
11	12	13	14	15
16	17	18	19	20
21	22	23	24	25
26	27	28	29	30
31	32	33	34	35

Words @ .35 Reader Rate } = \$  
@ .60 Commercial Rate }  
Insert time(s) Total Enclosed \$

NAME \_\_\_\_\_  
ADDRESS \_\_\_\_\_  
CITY \_\_\_\_\_ ZONE \_\_\_\_\_ STATE \_\_\_\_\_  
SIGNATURE \_\_\_\_\_

WORD COUNT: Include name and address. Name of city (Des Moines) or of state (New York) counts as one word each. Zone or Zip Code numbers not counted. (Publisher reserves right to omit Zip Code if space does not permit.) Count each abbreviation, initial, single figure or group of figures or letters as a word. Symbols such as 35mm, COD, PO, AC, etc., count as one word. Hyphenated words count as two words. EW-664

**HIGH FIDELITY**

LOW. LOW quotes: all components and recorders. Hi-Fi, Roslyn 9. Penna.

Hi-Fi components, tape recorders, sleep learn equipment, tapes. Unusual Values. Free Catalog. Dressner, 1523 Jericho Turnpike, New Hyde Park 10. N.Y.

Hi-Fi Components. Tape Recorders, at guaranteed "We Will Not Be Undersold" prices. 15-day money-back guarantee. Two-year warranty. No Catalog. Quotations Free. Hi-Fidelity Center, 1797 (L) 1st Avenue, N.Y., N.Y. 10028

FM BROADCAST music without commercials. Schematics, pictorials, instructions. \$3.00. Complete receivers and adapters also available. Music Associated, 65 Glenwood Road, Upper Montclair, New Jersey.

STEREOSPHERE Decoder. New Concept in Sound. Using present two track signals with conventional stereo equipment Decoder attaches to power output connections, drives speaker cabinets with individual signals (determined by original two stereo signal source), reestablishing original recorded locations. This information is present in conventional two signal playback equipment But Not Available Without Decoder. Decoder approximately 2" x 2" x 3" encapsulated in epoxy. \$39.95 post paid. Stereosphere, Dept. R, Post Office Box 3009, Huntsville, Alabama 35811.

**EXPORT DIRECTORIES**

GERMAN Manufacturers 485 page Directory \$4.95, Burke Associates, Manchester, Mass.

**STAMPS**

KENNEDY STAMP FREE! U.S. Dollar Stamps. Columbus Issue, Pony Express. All Genuine and FREE! Send 10¢ for mailing. EMPIRE STAMP CORP., Dept. Z2, Toronto, Canada.

**EQUIPMENT**

WALKIE-TALKIES—Communicate with friends, business associates, up to 5 miles. Service, construction, business, boating, hunting, Fire Dept., Police. Free Details Sheirr Electronics Lab, 1490 Jesup Ave., 3M, Bronx, N.Y. 10452.

FREE electronics catalog. Tremendous bargains. Electrolabs, Dept. C101E, Hewlett, N.Y. 11557.

**GREGORY ELECTRONICS  
Reconditioned FM  
2-Way Radio Savings**

THIS IS A PARTIAL LIST  
WRITE FOR NEW '64 CATALOG



**30-50mc MOBILES**

GE 2-Piece Unit—6 volt or 12 volt  
4ER6—4ET5 30w 30-40mc 40-50mc . . . \$ 88  
4ER6—4ET6 60w 30-40mc 40-50mc . . . \$108  
Complete with all accessories except antenna and crystals.  
Equipment can be crystallized and tuned to any frequency in the 30-50mc band.  
GE 2-Piece Unit—6 volt or 12 volt  
4ER6—4ET5 30w 30-50mc . . . \$168  
4ER6—4ET6 60w 30-50mc . . . \$188  
Complete with all accessories including antenna and crystals. Fully narrow banded (Tx & Rx) and tuned to your frequency with in the 30-50mc range.



**MOTOROLA 450-470mc**

T44A1. 12 volts, complete with all accessories less crystals and antenna . . . \$98  
Same unit less accessories . . . \$68  
T44A6. 6/12 volts, complete with all accessories, less crystals and antenna . . . \$108  
Same unit less accessories . . . \$78  
T44A6A. 6/12 volts, complete with all accessories, less crystals and antenna . . . \$128  
Same unit less accessories . . . \$98



**148-172mc  
RCA  
CMC 60B**

6/12v dual Dynamotor 60 watt  
(a) Fully narrow banded complete with all accessories, less crystals & antenna . . . \$218  
(same unit without accessories \$198.00)  
(b) Same unit tuned to your frequency including brand new antenna . . . \$253

We Buy Late Model Equipment for Cash  
—Write: Wire or Phone!

**GREGORY ELECTRONICS CORPORATION**  
249 Rt. 46 • Phone 773-7550  
Saddle Brook, N.J. • Area Code 201

**CIRCLE NO. 113 ON READER SERVICE PAGE**

**ARR-2 RECEIVER** W 11 tubes, schematic & conversion data for CB and 2 meters. Re-new . . . \$6.95  
**WOBBULATOR CAPACITOR**—for FM sweep generator. 6.3 v. AC W generator schematic. New . . . 1.95  
**R-237 B VR MOBILE FM RECEIVER** 30-40 MC. Double conversion superhet. 6V v.b. Power Supply—easily converted to 12V input. Kit for Fire & Police Calls on 4M Ham band. Complete with Xtals, 15 tubes & schematic. Used. Good . . . 26.95  
**VHF SIGNAL GENERATOR** 100-150 MC. With Xtal osc. For spot checking. With schematic. Good . . . 10.95  
**LAZY MAN'S "Q-Ser"**—Navy audio filter, single signal selectivity—the easy way. 100 CY bandpass. New . . . 2.49

Send M.O. or check with Order  
Min. C.O.D. \$10.00 with 25% Deposit  
Write for Bulletin #39—Loads of Bargains  
**R.W. ELECTRONICS INC.**  
2430 So. Michigan Ave. Dept. 675  
Chicago, Ill. 60616 Phone CALumet 5-1281

**NOW IT'S A BREEZE**

to paint everything  
you see here  
including the room—

with the  
**WORLD'S FIRST ROTARY  
ACTION PAINT GUN!**

All yours with practically  
**NO MISTING — NO OVERSPRAY —  
CAN'T EVER CLOG IN OPERATION!**

**ONLY THE SLOAN-ASHLAND  
ROTARY ACTION PAINT GUN...**

let's you paint a line  
so fine you can  
write your name...



cover a full foot-and-a-  
half swath with one pass...



paint within inches...



Delivers as much paint per minute as a \$200 industrial compressor model. HANDLES WATER SOLUBLE, RUBBER BASE, OIL BASE, FLAT, SEMI-GLOSS AND ENAMEL PAINTS. LIGHT OILS... INSECTICIDES... FLOOR WAXES, POLISHES AND OTHER LIQUIDS.

- No costly compressors
- No nozzles, needles, strainers to clog
- No air hoses to drag
- No flimsy vibrators
- 2-SPEED OPERATION for perfect control of light and heavy liquids.
- FINGER-TIP CONTROL OF PAINT FLOW—trigger lets you start and stop spraying instantly
- ADJUSTABLE GATE FOR EXACT WIDTH OF SPRAY YOU WANT—from 1/4" to 18"—can't ever clog in operation.

- CLAMP-ON CAN holds full quart
- PAINT VOLUME CONTROL lets you deliver just the amount of paint desired to the working surface
- For 115V AC operation
- Fully guaranteed
- ALUMINUM DIE CAST HOUSING for light weight and rugged durability
- CAN'T EVER CLOG IN OPERATION  
Powerful GE motor and rotary action spin the paint at a steady 17,000 RPM... actually makes the Sloan-Ashland Paint Gun impossible to clog in operation!
- Reduces misting and overspray to a minimum. Eliminates 90% of usual masking! No more need to cover everything in sight.



Powered by  
**GENERAL ELECTRIC**

**AMAZINGLY EASY TO CLEAN OR CHANGE COLORS...**  
Fill container with water or proper solvent, run gun for a minute or two. That's all there is to it! No mess, no bother!

**\$59<sup>95</sup>**



**FREE**

**TWO QUARTS OF  
SPRED-SATIN PAINT**

**Covers 300% more width  
in each stroke than a 6" brush or roller...**

Now you can do 100 Sq. ft. of surface in minutes—because you cover three times as much area on each stroke, with the Sloan-Ashland Rotary Paint Gun. You cover a full foot-and-a-half swath with perfect control. Big job or small... inside or outside... whether you're spraying paint or other fluids—nothing does the work as quickly, as easily as this amazing paint gun!

**Typical Oval Pattern of  
Ordinary Spray Gun.**



Oval spray and wide feathering around edges make precise work difficult, requires extensive masking.

**"Straight Line" Pattern of  
Sloan-Ashland Paint Gun.**



Straight line spray and minimum of feathering gives you perfect control for the most precise painting.

American Products Division, 589 Broadway, New York 12, N.Y.

Send me your new Sloan-Ashland Rotary Paint Gun. I may use it for seven days free, and return it at your expense if I am not fully satisfied.

Also—send me two free quarts of Spred Satin Paint (worth \$4.30) which I may keep and use whether or not I agree to buy the Sloan-Ashland Rotary Paint Gun.

If I do agree to keep it, I will pay only \$8.50 a month until I've paid the low price of just \$59.95 (plus shipping and handling).

Name \_\_\_\_\_ (Please print)

Street \_\_\_\_\_

City \_\_\_\_\_ Zone \_\_\_\_\_ State \_\_\_\_\_

Where employed \_\_\_\_\_

Home phone number \_\_\_\_\_

EW6





# 18 TOOLS IN ONE!

FOR HOME-CAR SHOP  
HOBBIES-SPORTS



## RATCHET ACTION SOCKETOOL BY SHELTON

*Offers Unlimited versatility—handles popular sizes of nuts, bolts and screws with slotted, recessed, square or hex heads!*

Features fast action speedy 3-way ratchet handle that operates in either direction or locks; regular and recessed-head screwdrivers; straight and offset adapters; eight hex and square sockets from 1/4" to 7/16". Does the work of 18 tools—8 straight and 8 offset wrenches, plus 2 screwdrivers, yet fits in a 5 1/4" x 4 1/4" case.

**ONLY \$295**

complete with case—attractively packed in gift sleeve upon request.

### ORDER TODAY!

Consumer Service Company EW-64  
589 Broadway  
New York 12, New York

Please send me \_\_\_\_\_ SOCKETOOL sets at \$2.95 each. (N.Y.C. residents please add 4% Sales Tax). My check (or money order) for \_\_\_\_\_ is enclosed.

I understand that you will pay the postage and that each SOCKETOOL is fully guaranteed.

Check here for gift sleeve packing.

Name \_\_\_\_\_

Address \_\_\_\_\_

City \_\_\_\_\_ Zone \_\_\_\_\_ State \_\_\_\_\_  
(SORRY—No Charges or C.O.D. Orders)

### BUSINESS OPPORTUNITIES

**INVESTIGATE** Accidents—Earn \$750 to \$1,000 monthly. Men urgently needed. Car furnished. Business expenses paid. No selling. No college education necessary. Pick own job location. Investigate full time. Or earn \$6.44 hour spare time. Write for Free Literature. No obligation. Universal, CZ-6, 6801 Hillcrest, Dallas 5, Texas.

I Made \$40,000.00 Year by Mail Order! Helped others make money! Start with \$10.00—Free Proof. Torrey, Box 3566-N, Oklahoma City 6, Oklahoma.

**METHODS** and Procedures of Manufacturing TV Picture tubes. \$29.95. 100 Page Book. Tells how to start a highly profitable TV tube manufacturing business for less than \$1,000.00 Gives source of supplies, how to assemble equipment, etc., using new glass or salvage glass. Electronics World, Box 581, 1 Park Ave., New York, N.Y. 10016.

EARN \$2.50 hour assembling our small Lures and Flies for stores. Write: Lures, Lake Village 14, Arkansas.

FREE "Franchise Profit Letter" sent to ambitious men who want to operate their own business. Describes wide range of opportunities in expanding franchise field. Write today. National Franchise Reports, EW-528, 333 North Michigan, Chicago 60601.

MAIL Order Merchandise that sells—repeats. Generous profits. Orders drop shipped. New offer sent each month for one year. Literature imprinted in your name. Details free. General Enterprises, Box 303, Island Park, N.Y.

SELL HiFi Components—As distributors handling all major brands of HiFi components, we can now offer dealerships to aggressive people who can sell full or part time. Knox Electronic, Dept. 764, Galesburg, Ill. 61401.

NEW! FREE BOOKLET. \$8.70 profit per hour. Work from car. All year. Part time. Full time. Free protected territory. Own business. Non-competitive. No experience needed. Easy to learn. Everyone a customer. Vital service. 21 days from today you can be on road to \$15,000. yearly income. Get in on ground floor. No selling. Loads of repeat business. Flex-Cote Corporation, 30 W. Sunrise Highway, Valley Stream 13, N.Y.

TREMENDOUS Opportunities — U.S.A. — Overseas — Choose Jobs — Locations — Transportation — Free Details. Occupations, International Airport, Box 100-V3, Jamaica 30, N.Y.

\$75.00 Weekly Possible Clipping Newspaper Items for Publishers. Some worth \$10.00 each. Details free. Graham's, 1255-N, Englewood, Col. 80110.

FREE Book "990 Successful Little-Known Businesses." Work Home! Plymouth-717L, Brooklyn 4, New York.

IMPROVE YOUR BUSINESS OPPORTUNITIES by advertising in the Electronics Market Place. Our readership of more than 200,000 electronics professionals monthly assures you of success. Use the handy order form found in this section and mail it today! If you are interested in additional information, write: Martin Lincoln, Electronics World, One Park Ave., New York, N.Y. 10016.

### MISCELLANEOUS

SPANKEE! New Fashioned Shingle! With Old Fashion Results! \$1.00 Postpaid. Spankee! Box 466, Salem, Mass.

SAVE \$200 to \$2,000 on European automobiles delivered at low, low factory tax-free prices by using our direct shipment plan. Delivery guaranteed, references available. Tourist and Military deliveries available in Europe. Information on all models and makes Eurauto, Postbus 333, Rotterdam, Holland.

LET our more than 200,000 monthly readers learn of the advantages of doing their substantial mail order business with YOU! Your classified advertisement in the ELECTRONICS MARKET PLACE will cost little—only 60¢ per word—but you will be more than satisfied with the results achieved. New type style makes YOUR advertisement easier to read (thereby allowing you more exposure)—and you may run extra words in all capital letters for just 10¢ a word additional. The next available issue is August, and your payment and copy should be received by June 5th to insure insertion. Use the handy order coupon found in this section and send today to: Martin Lincoln, Classified Advertising Manager, ELECTRONICS WORLD, 1 Park Ave., New York, N.Y. 10016.

## ANNIVERSARY DOUBLE BONUS

**FREE**  
\$25 WORTH OF  
• Transistors  
• Diodes  
• Rectifiers  
• Knobs  
• Condensers  
• Coils, etc.  
Include 25¢ for handling

**PLUS**  
\$1 FREE  
POLY PAK  
OF YOUR  
CHOICE

BOTH FREE WITH EVERY \$10 ORDER

TRANSITRON SCRs			
TESTED SILICON CONTROLLED RECTIFIERS			
BRAND	PRV	7 Amp	15 Amp
NEW	50	1.00	1.25
NEW	100	1.50	1.95
NEW	150	—	2.25
NEW	200	—	2.75
NEW	250	2.25	2.95
NEW	300	2.69	3.19
NEW	350	2.95	3.50
NEW	400	—	3.95

### SEMI-KON-DUCTORS

- 10 RAYTHEON CK722 TRANSISTORS, pnp.....\$1
- 6 SYLVANIA 750 MIL 400V TOP HAT rectifiers.....\$1
- 10 NPN SWITCHING TRANSISTORS, 2N440 equals.....\$1
- 4 SYLVANIA 2N323 200 MW PNP transistors.....\$1
- 4 CK 721 TRANSISTORS, new aluminum case, pnp.....\$1
- 6 2N408 TRANSISTORS TO1, pnp, output.....\$1
- 2 TRANSITRON 2N341, 1 watt, npn, silicon, TO8.....\$1
- 6 UPRITE ZENER DIODES, silicon, asst voltages.....\$1
- 10 PNP SWITCHING TRANSISTORS, 2N1303, equals.....\$1
- 4 TEXAS 2N117 TRANSISTORS, npn, silicon, TO22.....\$1
- 3 2-WATT 512Z zener references, axial leads, 1 volt.....\$1
- 2 TRANSITRON 1N429 ZENER REFERENCES, 6V.....\$1
- 1 85W "DRIFT" 2N122 npn transistors, TO10.....\$1
- 1 20W SILICON MESA, 2N1648, TO10 transistor.....\$1
- 6 TEXAS 750 MIL 400V RECTIFIERS, epoxy, axial.....\$1
- 3 2N255 POWER TRANSISTORS or equal, TO3 case.....\$1
- 1 TEXAS 3N35 TETRODE 150 MC SILICON transfr, TO5 \$1
- 1 2N718 NPN SILICON PLANAR, 1W, TO18 case.....\$1
- 1 SYLVANIA 2N705 300MC, 300MW, pnp, mesa, TO18.....\$1
- 3 ONE WATT ZENER DIODES, 6V, axial leads.....\$1

**\$1**  
WORTH \$42  
SILICON NPN  
MESA—85 WATTS

TEXAS INSTRUMENT  
**150 WATT  
TRANSISTORS**  
• IGNITION • SWITCHING  
• 2N1907  
• 2N1046  
**\$1.47**  
15 amp. 15 mc  
50 to 100 base  
volts  
**1 EA.**

- 2 25-AMP SILICON STUD RECTIFIERS.....\$1
- 4 2N35 SYLVANIA NPN TRANSISTORS, TO22.....\$1
- 2 'MESA' 4-WATT TRANSISTORS, npn, silicon, TO5.....\$1
- 15 UPRIGHT SILICON DIODES, worth \$40.....\$1
- 4 GENERAL ELECTRIC 2N170 NPN RF TRANSISTORS.....\$1
- 5 GENERAL ELECTRIC 2N107 PNP TRANSISTORS.....\$1
- 15 AMP SWITCHING TRANSISTOR, TO3 case.....\$1
- 3 CBS 20-WATT TRANSISTORS, npn, stud, 2N1320.....\$1
- 15 CBS GERMANIUM DIODES, 1N34, 1N48 equals.....\$1
- 2 500-MC MESA TO18 CASE TRANSISTORS, pnp.....\$1
- 20 TOP HAT RECTIFIERS, 750 MIL, untested.....\$1
- 15 NPN TRANSISTORS, asst. types and cases.....\$1
- 15 PNP TRANSISTORS, asst. types and cases.....\$1

**3-TRANSISTOR AUDIO AMPLIFIER** \$195  
• Printed Circuit • Subminiature  
• With Transistors • Wired

**10 WATT ZENERS**  
5V \$149  
12V  
14V  
20V  
24V  
42V  
45V  
60V  
70V  
80V  
90V  
100V  
110V  
124V

TEXAS  
20 WATTS  
In TO8 Case,  
Like 2N1039,  
2N1040, etc.  
with built-in  
heat sink  
**4 for \$1\***  
\*Sale till July 15th

### WORLD'S MOST POPULAR \$1 PARTS PAKS

- 35 2-WATT RESISTORS, popular asst. values, 5% too \$1
- 10 TANTALUM ELECTROLYTICS, \$15.00 value.....\$1
- 50 MICA CAPACITORS to .01mf, silvers too.....\$1
- 30 POWER RESISTORS to 50W, to 24K ohms.....\$1
- 60 TUBE SOCKETS, receptacles, audio, plugs.....\$1
- 40 DISC CONDENSERS, 27mmf to .05mf to 1KV.....\$1
- 60 TUBULAR CONDENSERS, to .5mf to 1KV.....\$1
- 30 TEXAS PRECISION RESISTORS, 1/2, 1, 2W, 1%.....\$1
- 10 TRANSISTOR ELECTROLYTICS, 5mf to 100mf.....\$1
- 50 COILS & CHOKES, rf-if, osc-peaking, etc.....\$1
- 50 TERMINAL STRIPS, asst 1-to-10 lug types.....\$1
- 10 RCA PHONO PLUG-n-JACK SETS, tuners-amps.....\$1
- 60 HI-Q RESISTORS, 1/2, 1, 2W to 1 meg, 5% too.....\$1
- 100 ASST HALF WATT RESISTORS, 5% too.....\$1
- \$25 PARTS SURPRISE, wide asst of parts.....\$1
- 40 WORLD'S SMALLEST RESISTORS, 5% too, 1/10W.....\$1
- 4 TRANSFORMER TRANSFORMERS, worth \$25.....\$1
- 60 CERAMIC CONDENSERS, discs, nps's, to .05mf.....\$1
- 50 1-WATT RESISTORS, popular values, asst, 5% too \$1

**POLY PAKS**  
TERMS: send check, money order, include postage—avg. wt. per pak by airmail not 30 days CODs 25%  
FREE CATALOG!  
P.O. BOX 942W  
SO. LYNNFIELD, MASS.  
"PAK-KING" of the World

CIRCLE NO. 125 ON READER SERVICE PAGE

Change blades with a flick of your finger!



Three blades—two regular, one recessed-head—work in straight or offset positions for extra leverage or hard-to-get-at screws, swivel out of sight when not used. Universal ratchet head works left, right or locked. Heat-treated steel blades, Butyrate handle.

**ORDER TODAY!**

Consumer Service Company EW-64  
589 Broadway  
New York 12, N.Y.

Please send me \_\_\_\_\_ VERSATOOL sets @ \$1.95 each. (N.Y.C Residents please add 4% Sales Tax). My check (or money order) for \$\_\_\_\_\_ is enclosed. I understand that you will pay the postage and that each VERSATOOL is fully guaranteed.

Name \_\_\_\_\_  
Address \_\_\_\_\_  
City \_\_\_\_\_ Zone \_\_\_\_\_ State \_\_\_\_\_  
(SORRY—No charges or C.O.D. Orders)

**ELECTRONICS WORLD JUNE 1964**

**ADVERTISERS INDEX**

READER SERVICE NO.	ADVERTISER	PAGE NO.	READER SERVICE NO.	ADVERTISER	PAGE NO.
101	Advance Electronics .....	98	138	McGee Radio Co. ....	81
	American Institute of Engineering & Technology .....	94	121	Mallory & Co. Inc., P. R. ....	2
102	Automotive Electronics Co. ....	74	122	Micro Electron Tube Co. ....	102
	Capitol Radio Engineering Institute, The .....	6, 7		Milwaukee School of Engineering ..	88
	Channel Master Corp. ....	87		Minnesota Mining & Mfg. Company .....	1
	Cleveland Institute of Electronics ..	9	124	Motorola Training Institute .....	85
103	Columbia Products Company .....	72		National Radio Institute .....	SECOND COVER
104	Concord Electronics Corporation ...	4		Oelrich Publications .....	94
105	Crown International .....	8	125	Poly Paks .....	103
	Delco Radio .....	11		RCA Electronic Components and Devices ....	FOURTH COVER, 19, 80
107	Dymo Industries, Inc. ....	10		RCA Institutes, Inc. ....	12, 13
	EICO Electronics Instrument Co., Inc. ....	22		R. W. Electronics Inc. ....	100
109	Electro-Voice, Inc. ....	20	126	Rohn Manufacturing Co. ....	79
	Fair Radio Sales .....	97		Roth Steel Corp. ....	98
	G & G Radio Supply Co. ....	99	128	Sarkes Tarzian Inc. ....	75
112	Goodheart Co., Inc., R. E. ....	102	100	Scatt, Inc., H. H. ....	83
	Grantham School of Electronics ...	5	129	Sonotone Corp. ....	73
113	Gregory Electronics Corporation ..	100	130	Space Electronics .....	98
	Hallicrafters .....	93	131	Switchcraft, Inc. ....	81
115	Heath Company .....	71		Sylvania .....	21
	International Crystal Manufacturing Co., Inc. ....	14	132	"TAB" .....	100
	Johnson Company, E. F. ....	85	133	Terado Corporation .....	84
	Kedman Company .....	84	134	Texas Crystals .....	87
	Kuhn Electronics .....	88		Transistors Unlimited Company ...	102
	Lafayette Radio Electronics .....	88		Tri-State College .....	94
120	Lampkin Laboratories, Inc. ....	81	135	University Loudspeakers, Inc. ....	THIRD COVER
				Valparaiso Technical Institute ....	72
				Warren Electronic Components ....	98
			136	Winegard Co. ....	16, 17
			137	Workman Electronic Products Inc. ..	79

Classified Advertising ..... 97, 98, 100, 102, 103

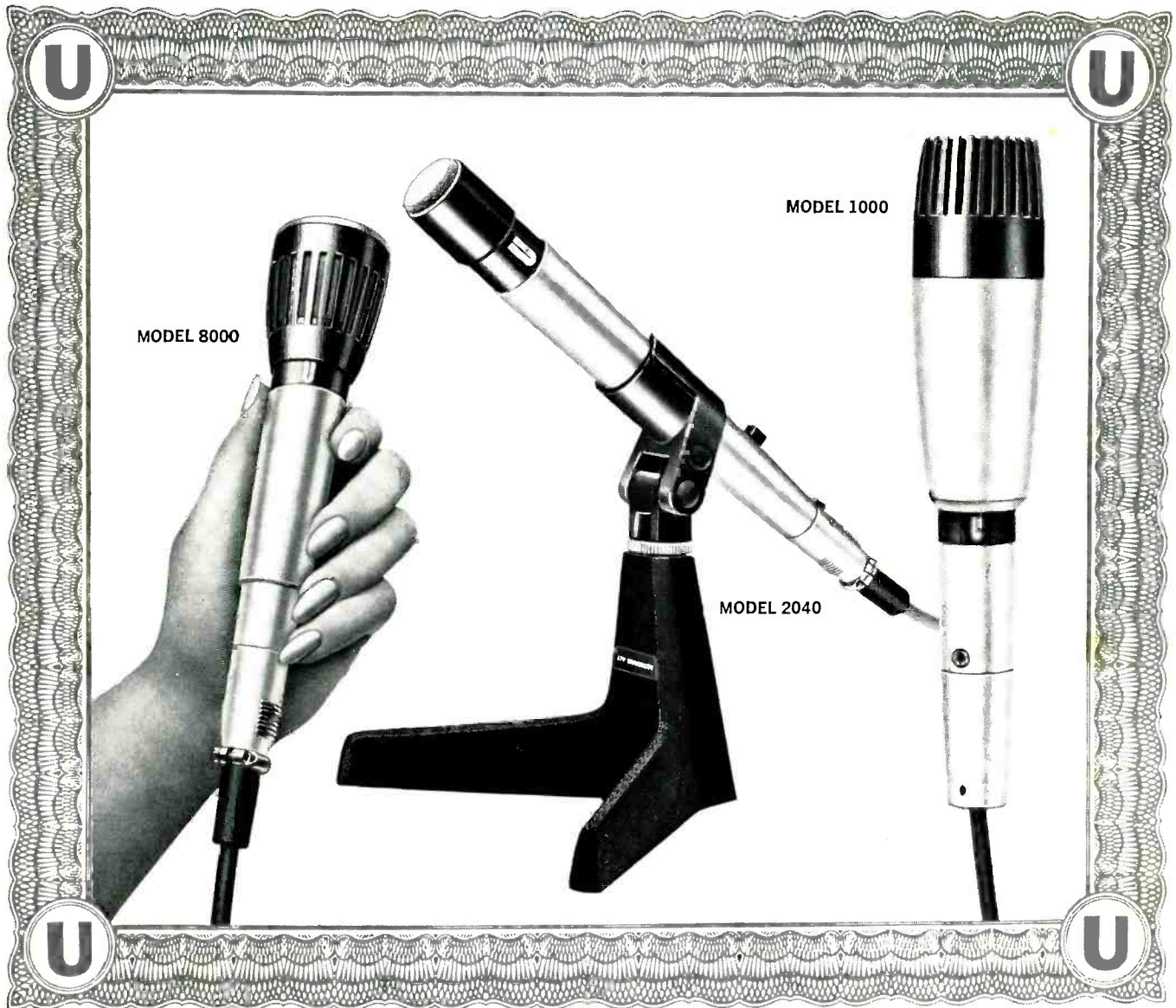

## INTRODUCING THE WORLD'S NEWEST MICROPHONES... GUARANTEED FOR FIVE YEARS!

ALL NEW DESIGN...ALL NEW PERFORMANCE—Today... from the laboratories of University...an advanced technology has produced a great new breed of microphones for broadcasting, TV, professional and home recording, P.A., ham and CB applications. Each one represents a clean and dramatic break with tradition...with outmoded notions. Each one is far superior to any other microphone in its class. Let other microphone manufacturers offer the usual two to three-year warranty. Every University microphone—whether designed for the professional studio or the home recordist—is sold with a five-year warranty. For complete specifications, write: Desk S-6, LTV/University, 9500 West Reno, Oklahoma City, Oklahoma.

### EXAMPLES OF THIS GREAT NEW LINE!

**MODEL 8000**—A high performance dynamic cardioid for only \$29.95 net! Response: 70-13,000 cps. Sensitivity: -156 db (EIA). Output Level: -59 db/1mw/10 dynes/cm<sup>2</sup>. Includes 15 ft. cable with Cannon plug and receptacle, and desk stand adaptor.

**MODEL 2040**—VOICE REALISM AT ITS BEST! New omnidirectional dynamic microphone that has astounded hams in initial trials! Modulation free of the harshness and muddy effect common to most microphones in this class. Ideal for upgrading P.A. and home tape recording performance as well.

**MODEL 1000**—CARDIOID DYNAMIC. Unique directional characteristics provide unexcelled discrimination against unwanted sounds—assure superior results even in noisy or reverberant locations. Internally shock-mounted—sensitive elements float, vibration-free, on polystyrene ribs! For any application requiring a truly discrete sound source.

**LTV  
UNIVERSITY**

A DIVISION OF LING-TEMCO-VOUGHT, INC.

CIRCLE NO. 135 ON READER SERVICE PAGE

U-47

# SEE HOW RCA RECEIVING TUBES KEEP GETTING BETTER

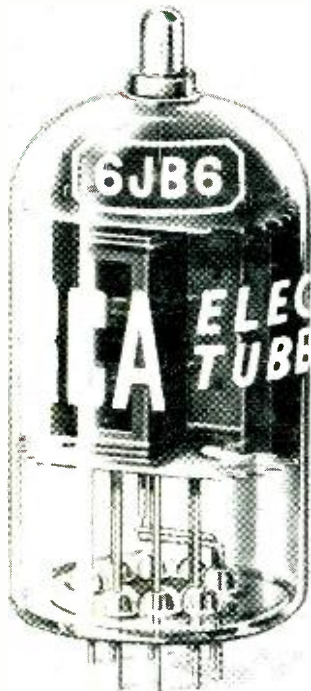

**1959-N-132 Cathode Base Material**

**1960-S-311 Plate Material**

**1961-RCA Dark Heater**

**...AND 1963**

## THE BONDED CATHODE



Ends cathode peeling, even after long periods of high-temperature, high-voltage tube operation.

Picture on right is an example of peeling which may occur in non-bonded cathode of a horizontal-deflection-amplifier tube after several hundred hours of operation in a TV receiver.

From RCA research comes another major contribution to electronic performance and reliability: the bonded cathode. Its emissive coating will not peel even after extended service under high-voltage, high-temperature conditions encountered in TV horizontal-deflection-amplifier tubes and damper diodes. Permanent adhesion of the emissive-oxide coating of the RCA bonded cathode improves over-all tube performance and reliability. Here's why:

### THE NEW RCA BONDED CATHODE:

- virtually eliminates peeling of emissive oxide coating
- reduces cathode interface-type impedance effects during life
- reduces grid-to-cathode shorts during life
- improves stability of cathode-to-grid spacing

- improves anode-voltage-per-mil-spacing safety factor in damper diodes
- transmits heat more efficiently and uniformly—thereby providing more uniform cathode-current density

The RCA bonded cathode was first applied with outstanding success in beam power tube types 6DQ6-B and 6JB6 and half-wave vacuum rectifier types 6AU4-GTA and 6AY3. This new development is now being incorporated in a growing number of types where service conditions show a need.

Such RCA developments as the bonded cathode result in reliable components for you to sell and install. Use RCA receiving tubes for all replacements. You have the benefit of continuing tube improvement from the research, design and development facilities of the world's broadest-based electronics company—RCA!

RCA ELECTRONIC COMPONENTS AND DEVICES, HARRISON, N. J.



**The Most Trusted Name in Electronics**