

Electronics World

AUGUST, 1963
50 CENTS

SPECIAL
TEST EQUIPMENT
ISSUE

DIRECT-READING INSTRUMENTS
SIGNAL-GENERATING EQUIPMENT
CATHODE-RAY OSCILLOSCOPES

THE INSTRUMENT CALIBRATION & REPAIR TECHNICIAN • DETECTION OF NUCLEAR RADIATION BY SEMICONDUCTORS • CALIBRATING TEST EQUIPMENT • ACCURATE AUDIO FREQUENCY MEASUREMENT • 1963 DIRECTORY OF TEST EQUIPMENT KITS

bonus insert: Color Codes Chart

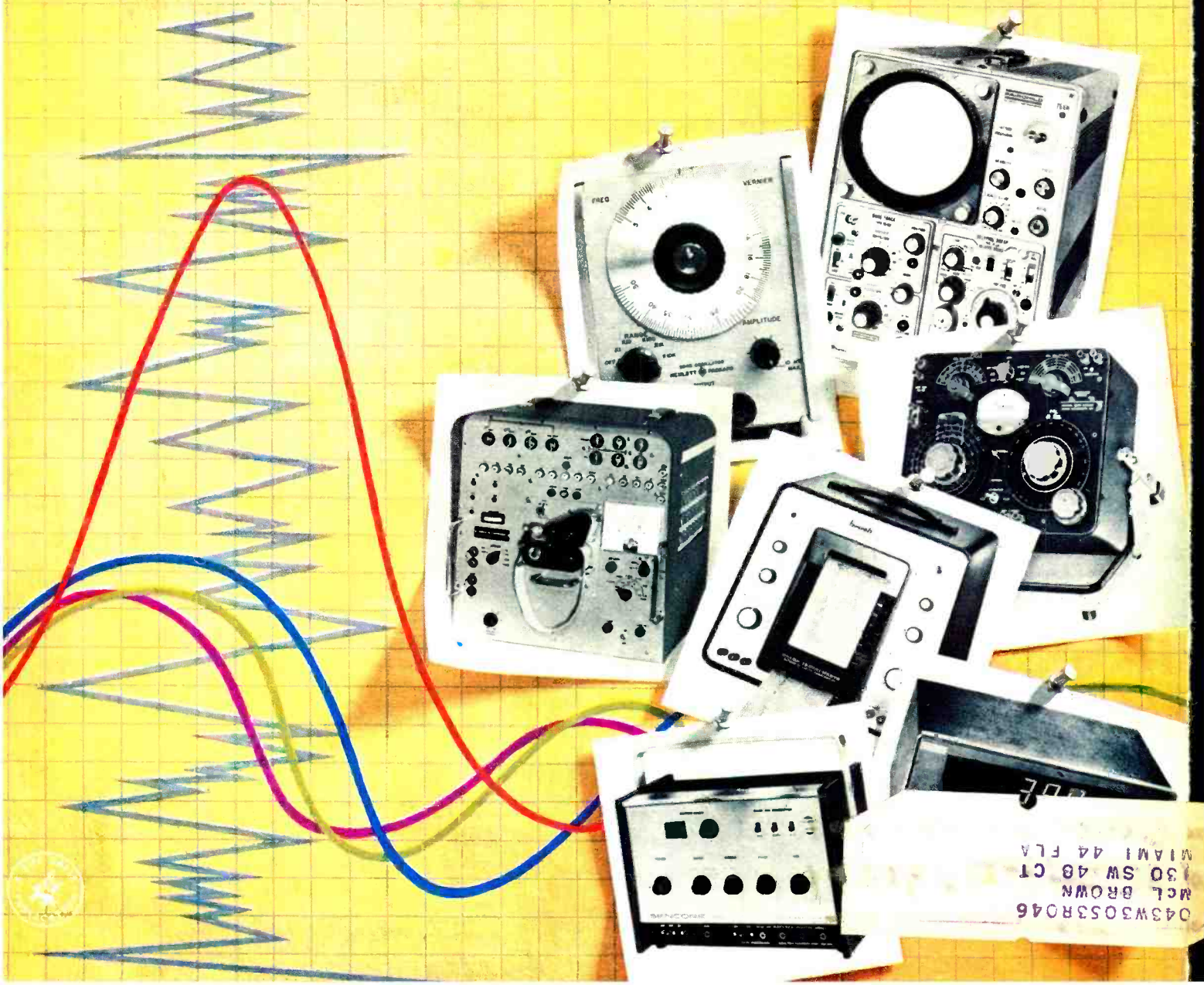

043W3053R046
MCL BROWN
130 SW 48 CT
MIAMI 44 FLA

Where You Train Is As Important As Your Decision To Train



Electronics is a growing and expanding industry. That's why so many ambitious men are deciding to train for careers in this exciting field. They recognize the opportunities to advance and prosper. But, where a man trains and how the school of his choice teaches Electronics

how it encourages him to reach his goals and realize his ambitions . . . is most important to his success.

This is a fast changing world. A school offering Electronics courses must keep pace. That's why NRI—with nearly 50 years specialized experience—now offers nine choices of training within the one field of Electronics. Select the course of most interest to you and receive the kind of home-study training that prepares you for a specialized career. NRI's large staff of specialists is always on the job keeping course material up-to-date . . . helping you earn your way while training . . . assisting you with job placement when ready. In short, whatever branch of Electronics you select, NRI is qualified through knowledge and experience to help you grow.



SPECIAL TRAINING EQUIPMENT INCLUDED

NRI "learn by practice" method is the time-proved way to learn easier, faster, better. Most NRI courses include—at no extra cost—special training equipment to give you top and laboratory experience in your own home. All equipment is yours to keep.

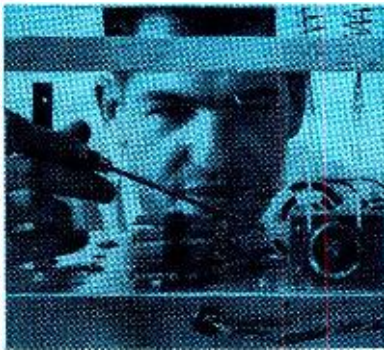

Projects you build, experiments you perform, make NRI lessons come to life. Complex subjects become interesting, easy to grasp. Your first projects are measuring voltage and current in circuits you build yourself. You use a Vacuum Tube Voltmeter which you construct. Later on, you progress to more involved experiments. If you like working with your hands, you'll enjoy learning Electronics with NRI.

THE PROVEN WAY TO BETTER PAY

Best of all, NRI provides training right in your own home and on your spare time. No time wasted getting to school. You fit study hours to your own schedule. You go as fast or as slow as you like. Check the training of most interest to you; cut out and mail the postage-free card now. Read about Electronics opportunities, NRI courses, the NRI trial plan, convenient terms.



America's Oldest and Largest Radio-TV Electronics Home-Study School

Pick the ELECTRONICS CAREER You Want

1 RADIO AND TELEVISION SERVICING

Learn to service AM-FM Radios, black and white and color TV sets, Stereo Hi-Fi, PA systems, etc. A profitable, interesting field for part-time or full-time business of your own.

2 INDUSTRIAL-MILITARY ELECTRONICS

Learn Principles, Practices, Maintenance of Electronic equipment used today in business, industry, defense. Covers Electronic controls and measurement, computers, servos, telemetry, multiplexing, many other subjects.

3 COMPLETE COMMUNICATIONS

A comprehensive training course for men seeking careers operating and maintaining transmitting equipment in Radio-TV Broadcasting or mobile, marine, aviation communications. Prepares you for FCC License.

4 FCC LICENSE

Prepares you quickly for First Class License exams. Every communications station must have one or more FCC-licensed operators. Also valuable for Service Technicians. You train at home.

5 BASIC ELECTRONICS

An abbreviated, 26-lesson course covering Automation-Electronics, Radio-Television language, components and principles. Ideal for salesmen, hobbyists and others who find it valuable to be familiar with the fundamentals of this fast-growing industry.

6 MATH FOR ELECTRONICS

A short course package of five carefully prepared texts that take you from basic arithmetic review through graphs and electronic formulas. Quick, complete and low in cost.

7 AVIATION COMMUNICATIONS

For men who want careers working with and around planes. Covers direction finders, ranges, markers, loran, shoran, radar, landing systems, transmitters. Prepares you for FCC License exams.

8 MARINE COMMUNICATIONS

Shipboard transmitting equipment, direction finders, depth indicators, radar are all covered in this course. You prepare for your First Class Radiotelephone License with Radar Endorsement.

9 MOBILE COMMUNICATIONS

Training in installation and maintenance of mobile equipment and associated base stations like those used by fire and police, taxi companies, etc. Prepares you for First Class FCC License exams.

MAIL POSTAGE-FREE CARD NOW

Add 15 miles to UHF reception range

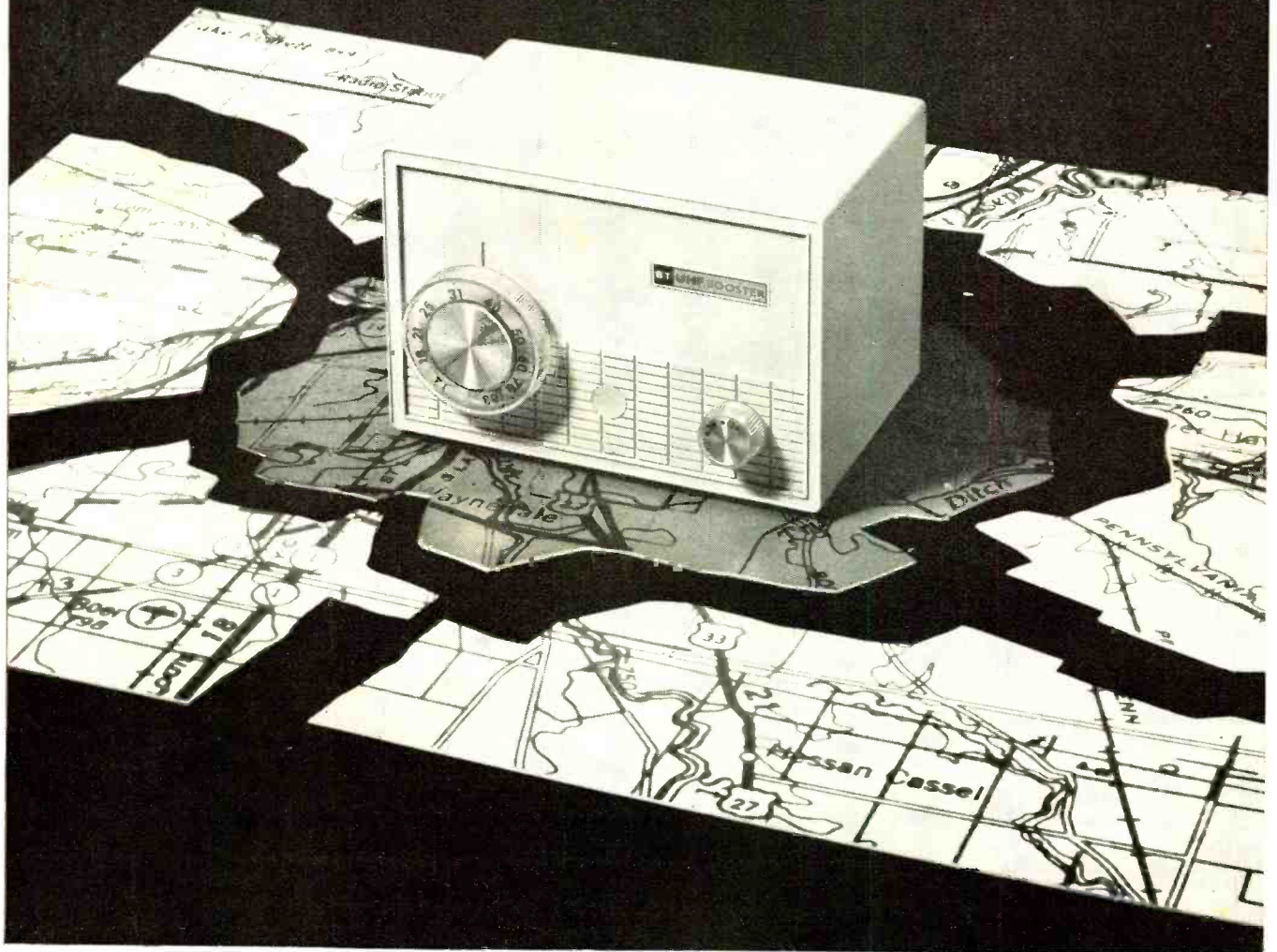

First All Channel UHF Booster—Blonder-Tongue U-BOOST

The fabulous new Blonder-Tongue U-Boost adds up to 15 miles to the UHF reception range. Homes formerly out of the range of UHF can now receive sharp, clear reception. The U-Boost will also clean up and improve fuzzy TV pictures in weak UHF signal areas, making them sharp and clear.

The U-Boost (gain 10 db) triples the antenna signal voltage. Teamed up with any UHF converter, or added to an all-channel receiver, the U-Boost improves reception on any UHF channel 14 to 83. Just a turn of the dial pinpoints the desired channel and brings it in sharp and clear. The TV picture quality is always excellent with the U-Boost, since it amplifies the signals before conversion, delivering the best signal-to-noise ratio.

Installation of the U-Boost is easy. It has an AC convenience

receptacle; patented 300 ohm stripless terminals make it a cinch to connect twin lead without stripping or splicing.

The modern U-Boost styling matches the new Blonder-Tongue UHF converters. **U-Boost**, List \$39.95

BLONDER-TONGUE UHF CONVERTERS, PERFORMANCE-PROVED 2,000,000 TIMES
Blonder-Tongue 99-S — all-channel UHF converter for prime signal areas List \$27.95

Blonder-Tongue BTU-2T—all-channel converter with 5 to 8 db increase in signal power. For weak signal areas List \$44.95

Look to the leader in UHF.

See your *Blonder-Tongue distributor.*

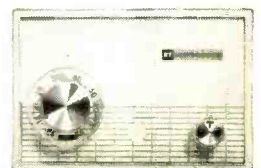

engineered and manufactured by

BLONDER-TONGUE
 9 Alling St., Newark 2 N. J.

Canadian Div.: Benco Television Assoc., Ltd., Toronto, Ont./home TV accessories • closed circuit TV • community TV • UHF converters • master TV



Original Equipment Designers

Choose Tubes from Complete Stocks at Local RCA Distributor

Just call. And watch your RCA Industrial Tube Distributor perform on any of your OEM or replacement needs for RCA tubes. He carries large inventories. Latest tube types available immediately can help you meet emergency lab requirements, help keep your production schedules rolling.

He can also provide practical application data. When you need it, just ask him.



So. Get to know your local RCA Industrial Tube Distributor... for priority service on quality RCA tubes for color TV, black-and-white TV, AM-FM radio, Hi-Fi, Phonographs, and industrial and communications equipment of every description.

RCA ELECTRONIC COMPONENTS AND DEVICES, HARRISON, N. J.



The Most Trusted Name in Electronics

For name and address of your local distributor write or call your nearest RCA Distributor Products Sales Office—New York, N. Y.: 36 W. 49th St., MUrray Hill 9-7200; Needham Heights 94, Mass.: 80 "A" St., Hillcrest 4-8480; Washington 7, D. C.: 1725 "K" St., S.W., FEderal 7-8500; Atlanta, Ga.: 134 Peachtree St., N.W., JACkson 4-7703; Cleveland, Ohio: 1621 Euclid Ave., CHerry 1-3450; Chicago, Ill.: Merchandise Mart, 467-5900; Dallas 7, Texas: 7901 Carpenter Freeway, MELrose 1-3050; Kansas City 14, Mo.: 7711 State Line, EMerson 1-6462; Los Angeles 22, Cal.: 6801 E. Washington Blvd., RAYmond 3-8361.

- 23 Direct-Reading Instruments**
Frederick Van Veen of General Radio Company, a leading manufacturer in the field of direct-reading instruments, gives an industry-wide report on the very latest equipment and measuring techniques.
- 27 On Our Cover**
- 28 The Calibration & Repair Technician** G. Gedney & F. Winterburg
- 30 Naval Observatory Time Signals** H. Charles Wood
- 31 Signal-Generating Equipment**
Howard L. Roberts of the Hewlett-Packard Co., prominent in the field of signal-generating equipment, discusses all types of devices employed to generate test signals from below the audio range up through microwaves.
- 35 Color Codes Chart**
- 37 Meter Range-Extension Nomogram** A. L. Teubner
- 38 Decibel Table**
- 39 Detection of Nuclear Radiation by Semiconductors** H. Renne
- 43 Calibrating Test Equipment** Walter H. Buchsbaum
- 46 Accurate Audio Frequency Measurement** Aaron W. Edwards
- 48 The Operational Amplifier (Part 2)** Jack E. Frecker
- 50 Cathode-Ray Oscilloscopes**
Edward K. Marrie of the Fairchild-DuMont Laboratories, producers of the first commercial oscilloscope in 1932, describes the latest advances in the design and performance of present-day instruments.
- 54 1963 Directory of Kit Test Equipment**
A complete listing of all test equipment available in kit form. Over 200 designs, divided into 29 categories according to function, are covered.
- 69 FCC Establishes Fees for Radio Licenses**
- 77 Simple Hum-Bucking Circuit** G. R. Gilbert

-
- 6 For the Record (Editorial)** W. A. Stocklin
Special Issue
 - 12 EW Lab Tested**
*Shure Model 560 Lavalier Microphone
Scott 350-B Stereo Tuner*
 - 66 Semiconductor Seminar** John Frye
 - 78 Test Equipment Product Report**
*RCI Model W R-51 FM Stereo Signal Generator
Associated Research 2850 Megohmmeter
Sencore CR125 Cathode-Ray Tube Tester*

MONTHLY FEATURES

Coming Next Month	4	Electronic Crosswords	71
Letters from Our Readers	8	Radio & TV News	81
Reader Service Page	19	New Products & Literature	85

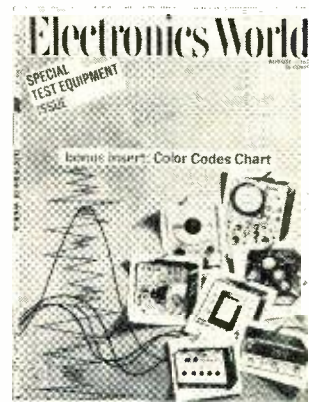

THIS MONTH'S COVER symbolizes the important role played by test equipment on the service bench, on the production line, and in our laboratories. Special articles in this Test Equipment Issue survey the entire field with coverage of direct-reading instruments, signal-generating devices, cathode-ray oscilloscopes, and test-equipment kits. Other articles on the calibration of test equipment and role of technicians responsible for checking and repair are also included. For a description of the specific pieces of equipment shown on our cover, see the Cover Story on page 27.



Publisher
PHILLIP T. HEFFERNAN

Editor
WM. A. STOCKLIN

Technical Editor
MILTON S. SNITZER

Service Editor
SIDNEY C. SILVER

Associate Editor
P. B. HOEFER

Editorial Consultant
OLIVER READ

Industrial Consultant
WALTER H. BUCHSBAUM

Art Editor
MILTON BERWIN

Art and Drafting Dept.
J. A. GOLANEK

Advertising Sales Manager
LAWRENCE SPORN

Advertising Service Manager
ARDYS C. MORAN

All Tape Heads Wear Out

THAT MUSIC SOUNDS TERRIBLE. THE TAPE MUST BE WORN OUT.

NORTRONICS SAYS "TAPE DOESN'T WEAR OUT."

SPOT CHECK HEADS IN 2 MINUTES
...Look for
A. Grooves or spots on surface.
B. Thin vertical black line dividing either pole piece.

BUT, TAPE HEADS DO! SURE ENOUGH, OUR HEADS HAVE A BLACK VERTICAL LINE THROUGH THE POLE PIECES. I BETTER SEE OUR DEALER TOMORROW

BOY, THESE HEADS ARE WORN. WE CAN REPLACE THEM OR YOU CAN DO-IT-YOURSELF. NORTRONICS HEADS AND "QUIK-KITS" HAVE COMPLETE EASY-TO-FOLLOW INSTRUCTIONS.

JUST A MINUTE, I'LL AZIMUTH THIS NEW HEAD AND WE'RE IN BUSINESS.

WHAT A BIG DIFFERENCE. THE MUSIC SOUNDS EVEN BETTER THAN WHEN THE RECORDER WAS NEW.

HAVE YOU CHECKED YOUR HEADS LATELY?

Get the most from your investment in tape equipment. Be certain that head wear is not causing you to lose the clean, crisp sound which only tape can give you. Give your heads the quick two minute spot check as shown above — or, have your Hi-Fi dealer, Radio-TV serviceman or camera store check your heads for wear.

Insist on NORTRONICS replacement heads and "Quik-Kit" mounting hardware; both correctly matched to your recorder.

"Music sounds best on tape—
Tape sounds best with Nortronics heads"

Nortronics 
8127 10th Ave. North • Minneapolis 27, Minn.

Write today for your FREE copy of NORTRONICS
Tape Head Replacement Guide.

Name _____
Address _____
City _____ State _____
I own a _____ Model _____ tape recorder

CIRCLE NO. 129 ON READER SERVICE PAGE

COMING NEXT MONTH

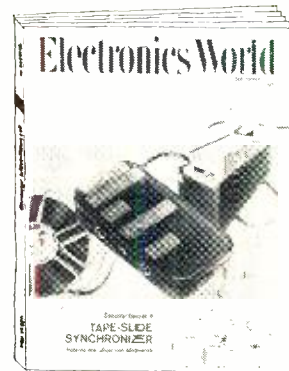

ELECTRONIC ANESTHESIA

Although the technique is far from perfected, interesting research and development work is underway as this survey indicates.

THIN LOUDSPEAKER SYSTEMS

The various methods being used to make hi-fi speakers and their enclosures as shallow as possible are evaluated and described in George Augspurger's article. Available commercial thin loudspeaker units are illustrated.

LOW-PASS AUDIO FILTERS FOR INCREASED "TALK-POWER"

The addition of this simple, low-cost device to the amateur phone transmitter will improve performance to a great extent. The unit is easy to build from standard, readily available electronic parts.

ELECTRONICS FIELD ENGINEERS AROUND THE WORLD

These specialists—in great demand—are trained to do the "impossible" in keeping military, government, and industrial equipment in top working condition at locations ranging from the arctic regions

to dense jungle areas—wherever electronics equipment must be installed and kept in reliable operation.

TAPE-SLIDE SYNCHRONIZER

A silicon-controlled switch is the "heart" of this compact device designed for the photography fan who wants to record a commentary on his slide on tape and then synchronize the picture with his talk.

FREQUENCY MULTIPLICATION AND DIVISION

A survey of the techniques and circuits commonly found in such diverse units as frequency standards, counters, digital clocks, multiplex adapters, transmitters, and electronic organs. Practical applications are also covered.

TRANSISTORS IN HI-FI: PANACEA OR PANDEMONIUM?

Three top engineers from H. H. Scott discuss the conceptions and misconceptions prevalent in the industry regarding the role of transistors in high-fidelity audio equipment. This is the first article of a two-part series discussing this subject in depth.

All these and many more interesting and informative articles will be yours in the SEPTEMBER issue of ELECTRONICS WORLD... on sale Aug. 15th.

ZIFF-DAVIS PUBLISHING COMPANY

William B. Ziff
Chairman of the Board (1946-1953)
William Ziff
President

W. Bradford Briggs
Executive Vice President
Hershel B. Sarbin
Vice President and General Manager
M. T. Birmingham, Jr.
Vice President and Treasurer

Robert P. Breeding
Circulation Director
Charles Housman
Financial Vice President
Stanley R. Greenfield
Vice President
Phillip T. Heffernan
Vice President

ZIFF-DAVIS PUBLISHING COMPANY
Editorial and Executive Offices
One Park Avenue, New York 16, New York
ORegon 9-7200

MIDWESTERN and CIRCULATION OFFICE
434 South Wabash Avenue, Chicago 5, Illinois
WAbash 2-4911
Midwestern Advertising Manager, Gilbert J. Jorgenson

WESTERN OFFICE
9025 Wilshire Boulevard, Beverly Hills, California
CRestview 4-0265

Western Advertising Manager, Bud Dean

FOREIGN ADVERTISING REPRESENTATIVE
D. A. Goodall Ltd., London, England



Member
Audit Bureau of
Circulations

Radio & TV News • Radio News • Radio-Electronic Engineering Trademarks Reg. U.S. Pat. Off.

SUBSCRIPTION SERVICE: All subscription correspondence should be addressed to Electronics World, Circulation Dept., 434 South Wabash Ave., Chicago 5, Ill. Please allow at least six weeks for change of address. Include your old address as well as new—enclosing if possible an address label from a recent issue.

EDITORIAL CONTRIBUTIONS must be accompanied by return postage and will be handled with reasonable care; however publisher assumes no responsibility for return or safety of art work, photographs, or manuscripts.

ELECTRONICS WORLD is published monthly by Ziff-Davis Publishing Company at 434 South Wabash Avenue, Chicago 5, Illinois. (Ziff-Davis also publishes Popular Photography, Popular Electronics, HiFi/Stereo Review, Popular Boating, Car and Driver, Flying, Modern Bride, Amazing, and Fantastic.) Subscription rates: one year United States and possessions \$5.00; Canada and Pan American Union countries \$5.50; all other foreign countries \$6.00. Second class postage paid at Chicago, Illinois and at additional mailing offices. Authorized as second class mail by the Post Office Department, Ottawa, Canada and for payment of postage in cash, August 1963, Vol. 70, No. 2.

PAYMENT MAY ALSO BE REMITTED in the following foreign currencies for a one year subscription: Australian pounds (2/15/12); Belgian francs (31.0); Danish kroner (43); English pounds (2/4/6); French francs (31); Dutch guilders (22); Indian rupees (31); Italian lire (3900); Japanese yen (2100); Norwegian kroner (45); Philippine pesos (25); South African rands (4.50); Swedish kroner (33); Swiss francs (27); West German marks (25).

Get Your First Class Commercial F.C.C. License In a Hurry — Or at Your Own Pace!

Is the Course Proven?

A high percentage of Grantham *resident* students get their 1st class FCC licenses in the short period of 12 or even 8 weeks from the time they start the course. Many others choose *home study*, completing the course and getting their licenses at their own convenience.

Is the Course Complete?

Not only does the Grantham course cover all required subject matter completely; it grows and changes and expands in phase with change and expansion in the electronics field generally. With the Grantham course, you are assured of modern, up-to-the-minute instruction.

Is the Course "Padded"?

The streamlined Grantham course is designed specifically to prepare you to pass FCC examinations and examinations given by electronics firms. What you need to know to achieve these goals, you are taught completely and in detail. The course is not "padded" with information you will not need.

Is It a "Coaching Service"?

The weakness of the "coaching service" or "Q & A" method employed by some schools and individuals is that it presumes the student already has a knowledge of basic electronics.

The Grantham course is presented from the viewpoint that you have no prior knowledge of the subject; nothing is taken for granted where your training is concerned. We "begin at the beginning" and progress in a logical, step-by-step manner from one point to another, with the necessary math taught as an integral part of the course. Every subject is covered simply and in detail; the emphasis is on making the subject easy to understand.

With each lesson you receive an FCC-type test so that you can discover after each lesson just which points you do not understand and clear them up as you go along. In addition to the lesson tests, ten comprehensive Review Exams are given throughout the course.

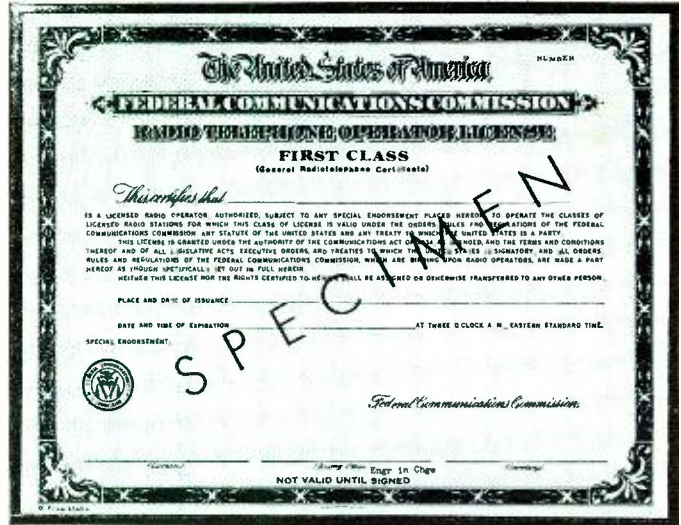

Is the School Accredited?

Grantham School of Electronics is accredited by the Accrediting Commission of the National Home Study Council.

Is It a "Memory Course"?

Grantham School has never endorsed the "memory" or "learn by rote" approach to preparing for FCC license exams. This approach may have worked in the early days of broadcasting, to the extent that a man could get his license that way; but, Heaven help the employer who expected this man to be able to demonstrate abilities implied by possession of the license!

Fortunately for all concerned, it is no longer possible for a man to pass FCC exams by spilling out memorized information which is essentially meaningless to him. Advances in the field of electronics—and the desire of the FCC to have the license really mean something — have caused upgrading of the exams to the point where only the man who is able to *understand* and *reason* electronics can acquire the 1st class FCC license.

Learn to thoroughly understand basic electronics from the school whose graduates are successfully employed by virtually every major electronics firm in the United States. Why not join them through Grantham training?

For further details concerning F C.C. licenses and our training, send for our FREE booklet



GRANTHAM SCHOOL OF ELECTRONICS



Train through home study or at one of our four convenient resident locations shown below:

1505 N. Western Ave.
Los Angeles 27, Calif.
(Phone: HO 7-7727)

408 Marion Street
Seattle 4, Wash.
(Phone: MA 2-7227)

3123 Gillham Road
Kansas City 9, Mo.
(Phone: JE 1-6320)

821-19th Street, N.W.
Washington 6, D. C.
(Phone: ST 3-3614)

(Mail in envelope or paste on postal card)

To: GRANTHAM SCHOOL OF ELECTRONICS
NATIONAL HEADQUARTERS OFFICE
1505 N. Western Ave., Hollywood 27, Calif.

Gentlemen:

Please send me your free booklet telling how I can get my commercial F.C.C. license quickly. I understand there is no obligation

Name _____ Age _____

Address _____

City _____ State _____

I am interested in:

Home Study, Resident Classes 36-M



plays your precious records
with a light, gentle touch

Light, feather-touch push buttons provide gentle, automatic handling of single records, or stacks of up to 10. Or you can play your records manually. Brings out their best performance, and preserves their quality for lasting enjoyment. Miracord model 10 with 4-pole motor, \$89.50; model 10H with hysteresis motor, \$99.50; base and cartridge, extra. Details at your hi-fi dealer, or write.

**BENJAMIN
MIRACORD**

Benjamin Electronic Sound Corp., 80 Swalm St., Westbury, N.Y.

CIRCLE NO. 104 ON READER SERVICE PAGE

6



For the record

WM. A. STOCKLIN, EDITOR

SPECIAL ISSUE

EVERY issue of ELECTRONICS WORLD, in its own way, presents interesting challenges to our staff, but since the electronics industry is so vast, it is not too difficult to find some theme that is outstanding and of special interest to most readers.

"Special Issues," however, present unusual challenges. Although we do not run too many, those we do must not only be better than any we have published previously, but they must be superior to any "Special Issue" published by others in our field.

We have seen many such issues that were simply directories or catalogues of equipment, while others have been so narrow in scope that only a limited number of professional readers would find them of value.

After months devoted to surveys and evaluation of the test-equipment industry, our present theme evolved—a "Special Test Equipment Issue" that would be broad in scope, covering every type of equipment, and written by experts employed by leading companies in a particular test-equipment field.

Many of our readers will ask, "Why such broad coverage?" Because there are many electronics technicians as well as engineers who daily use test techniques and equipment that are outdated and who have little or no desire to embrace modern practices. These individuals, unless they change, will find themselves on a road that will dead-end their careers.

Times have changed—even within the past few years. It seems like only yesterday when technicians in the consumer-product area considered a fraction of a volt, ohm, or milliamperere the limit of their measurements. With the introduction of transistors and other semiconductors, they can no longer be vague. Many circuits call for a more exact evaluation of operating characteristics to insure top performance. The old philosophy "if it works the consumer will be happy" is obsolete. Today the consumer expects his radio and TV sets to perform as they were intended. Hi-fi equipment, particularly since the advent of FM multiplex, demands not only new test equipment unfamiliar to many technicians, but a degree of servicing competence far beyond that previously required. The alignment and adjustment of Citizens Band equipment is certainly critical and, again,

must be done more accurately than is the case with conventional consumer products. Obviously, new equipment and new techniques are needed.

The old-time radar technician, who once measured time in microseconds, felt that it was impossible to go beyond this point. Today some of these same men are working with semiconductor computer circuits that can go through a complete cycle of operation in a few thousandths of a microsecond (a few nanoseconds).

Even within the past few years, measurements have been refined and some new and strange words have been creeping into our vocabulary. For example: The old expression "micromicro" has been replaced by "pico," "femto," "atto," "giga," and "tera" are fairly new prefixes for units of measurement, so new that not many technicians and engineers have become familiar with them. "Femto," abbreviated *f*, is 10^{-15} . For example, one femtoampere (an amount of current that is actually measurable today) would appear in decimal form as .000000000000001 amp. "Atto," abbreviated *a*, is 10^{-18} . This prefix is for a quantity that is a thousand times smaller than a "femto" unit.

As numbers keep getting larger and larger, we need new prefixes to simplify our language. For example, as we go higher and higher in frequency, the next logical step above *megacycle* would be use of the term *kilomegacycle*. Today the unhandy prefix *kilomega* has been replaced by "giga" (10^9 , abbreviated *G*).

As we go still higher up into the frequency spectrum, instead of using the term *megamegacycle*, the prefix "tera" (10^{12} , abbreviated *T*) will be used.

Language usually advances along with advances in techniques. Some of the terms mentioned above, now finding their way into current technical literature, are one indication of the sophistication of today's test equipment. There should be no doubt that electronic circuits today require highly diversified test equipment that is faster, better, and more accurate than the equipment being tested. To continue progress in the electronics industry, not only must test equipment keep pace, but the engineers who design the equipment and the technicians who use it must keep pace as well. ▲

Planning his future is one thing...providing for it is another

Can you do it without more education in electronics?

You don't want to accept second-best for yourself and those who depend on you. But you may have to unless you get more education. In electronics, you must learn more to earn more. And, because electronics keeps changing, you must keep learning. Stop—and you soon won't be worth what you're earning now.

Your job and family obligations may keep you from going to school. But you can continue your education in electronics beyond high school through a CREI Home Study Program in Electronic Engineering Technology.

CREI Programs cover all important areas of electronics including communications, servomechanisms, even nuclear engineering technology. They have just one purpose—to get you from where you are now to where you want to be in electronics. They do it by giving you the specialized knowledge of electronics that will make you worth more money to your employer.

You're eligible if you have a high school education and work in electronics. Our free book gives all the facts. Mail coupon or write: CREI, Dept. 1108-A, 3224 Sixteenth Street, N. W., Washington 10, D. C.

SEND FOR FREE BOOK



The Capitol Radio Engineering Institute.
Dept. 1108-A, 3224 Sixteenth St., N. W.
Washington 10, D. C.

Please send me FREE book describing CREI Programs in Electronics and Nuclear Engineering Technology. I am employed in electronics and have a high school education.

Name _____ Age _____

Address _____

City _____ Zone _____ State _____

Employed by _____

Type of Present Work _____

Check: Home Study Residence School G. I. Bill

Accredited Member of the National Home Study Council

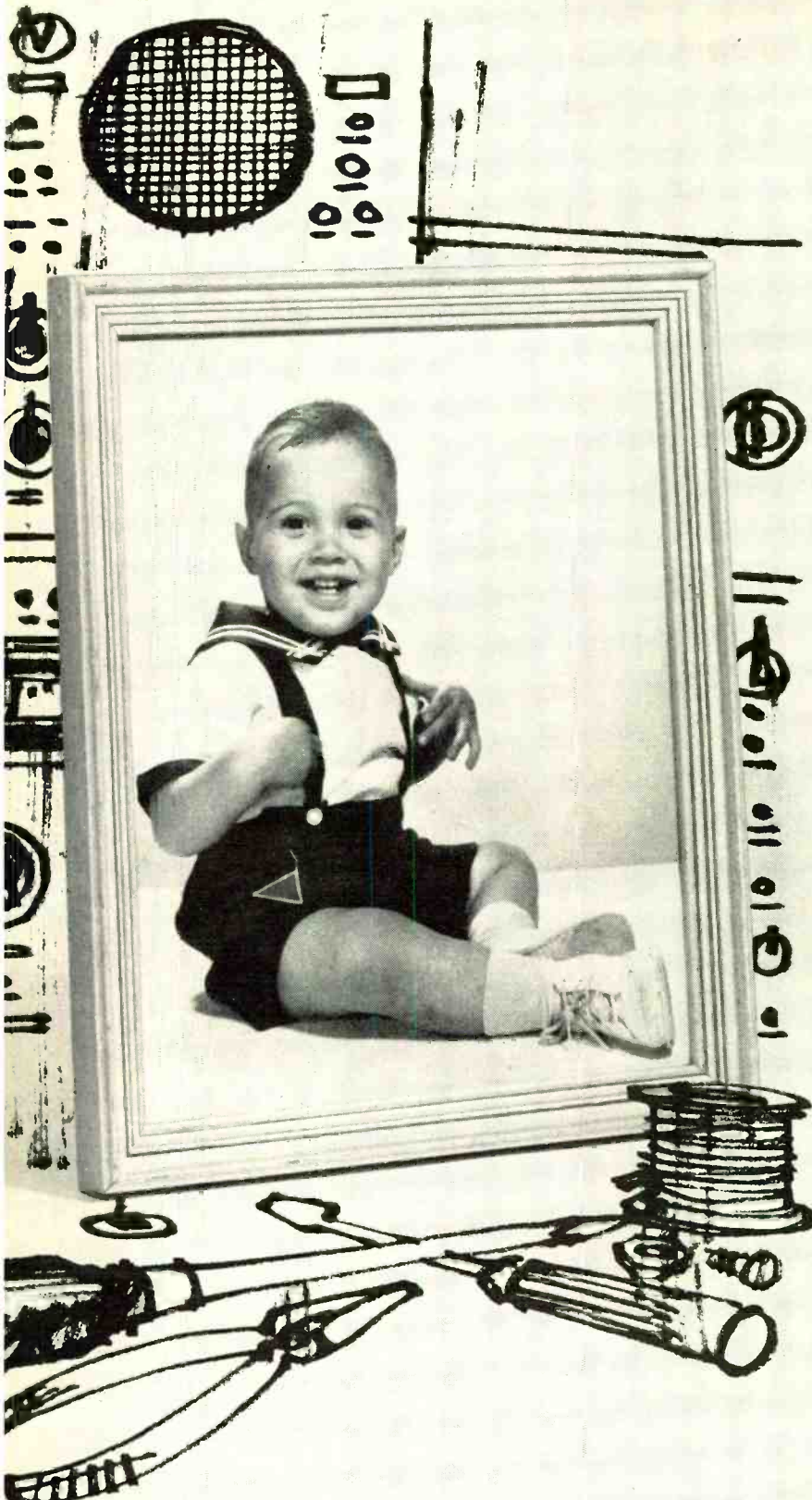

Wondrous stereo sound by Grommes . . . to thrill the budget-minded as well as the affluent. Enjoy the luxury of Grommes E-Line—a happy marriage of thrift and excellence.

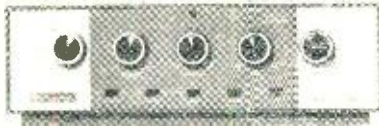

- Model E-24 24 watt Stereo Amplifier 79.95
 - Model E-36 36 watt Stereo Amplifier 119.95
(Illustrated above)
 - Model E-104M FM-AM Stereo Tuner 129.95
 - Model E-105M FM-AM Stereo Tuner 139.95
(Illustrated below)
- Prices include desert-gray metal cover

Write GROMMES
Division of Precision Electronics,
Inc., 9101 King Street, Franklin Park,
Illinois

Grommes
sets the
scene...



LETTERS FROM OUR READERS

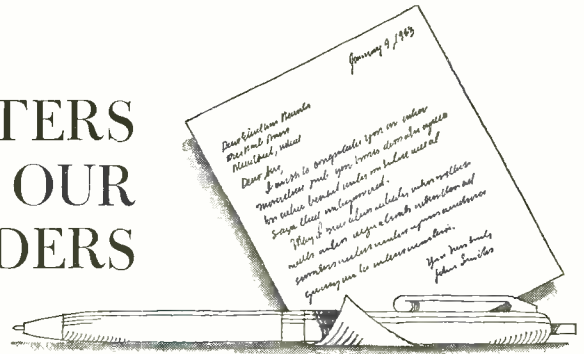

TRANSISTOR IGNITION SYSTEMS

To the Editors:

Mr. Lynn's question (in the November, 1962 "Letters From Our Readers" section) concerning how the transistorized ignition system could improve overall engine performance when energy and secondary voltage considerations seem to favor the standard ignition system is well taken. Since Mr. Saatjian's reply did not do more than prove empirically the superiority of his system ("Transistorized Ignition System," August, 1962), I feel it may be of interest to Mr. Lynn and other readers to discuss why the system performs as it does.

The equation for energy storage in a coil (ignition coil, in this case), shows that as engine speed increases and point closure time decreases, the primary current and energy stored at break decrease. The larger the primary inductance, the more this current decreases with increasing engine speed. Furthermore, since the current in this relationship is a function of the second power as opposed to inductance which is a function of the first power, it is clear that it is more important to have a lower inductance and a high current at break than *vice versa*.

The foregoing being true, you may wonder why not merely increase the primary current by reducing the value of the ballast resistor in the standard ignition system? This is impractical because of the capabilities of the ignition points. For reasonable point life, the largest current that can be interrupted is about 5 or 6 amps and most modern systems push this limit closely. Currents higher than this will cause excessive arcing with resultant reduced contact life.

It may appear that simply substituting the transistor to carry the primary current with the points carrying only .6 or .7 amp would be sufficient improvement in the system. This is not true for we would still have the problem of voltage developed across the primary, which is a source of energy loss, not to mention the problem it presents to protect the transistor from destruction.

The problem of high primary induced voltage is licked by the special coil used in the transistorized system. The special coil has greater flux response and closer

coupling between primary and secondary than the usual induction coil, thus allowing more energy transfer from the primary ampere turns to build flux and consequently greater voltage output. Since more energy is transferred to the secondary due to the close coupling, less energy is allowed to return to the primary by the collapsing flux, consequently the primary-induced voltage is less and the problem of protecting the transistor is reduced considerably.

Incidentally, I have built Mr. Saatjian's circuit and have found that it does everything he says it will do. My only problem is to find a place to put it in my "Corvaire!"

BRIAN HOGAN
Parts & Materials Engineering
AC Spark Plug Division
General Motors Corporation
Milwaukee, Wisconsin

REGULATED POWER SUPPLIES

To the Editors:

We would like to applaud the excellent article "Regulated Transistorized Power Supplies" by John R. Collins in your March issue. The article is a pioneering step in acquainting your readership with a class of instruments formerly restricted to applications in the heavy military and industrial phases of electronics.

However, we would like to point out that an acknowledgment should have been made to our firm for the use of Fig. 5 on page 41.

SIDNEY NORINSKY, Ad. Mgr.
Electronic Measurements Co., Inc.
Eatontown, New Jersey

WRONG-WAY CHECK

To the Editors:

The use of magnetic numbers on checks may speed up banking considerably, but I am afraid that the check shown on your April cover won't get routed to the right bank.

If you look carefully, you will see that part of the bank's transit number shown in magnetic ink does not jibe with the transit number printed beside the date on the check.

ROGER McELROY
Los Angeles, Calif.

Reader McElroy has sharp eyes. Our

NOW EVERYONE CAN QUICKLY Set up and Service Color TV



New! **B&K** Model 850 **COLOR GENERATOR**

*Most Complete, Most Versatile, Portable Instrument for Use in the Home and in the Shop
Makes Color TV Set-up and Service Easier, Faster than ever!*

Now every service technician can be ready to set-up and service color TV with amazing new ease and speed! New advanced design simplifies the entire operation, saves time and work in every installation. Eliminates difficult steps in digging into the color TV set. Gives you new confidence in handling color.

Produces Patterns, Burst, and Colors Individually—Provides dot pattern, crosshatch, vertical lines, horizontal lines, burst signal, and individual colors—one at a time—on the TV color set—for fastest, easiest check. Unique window-viewer on front of the instrument panel shows you each pattern and color as it should be—gives you an exclusive display standard to use as a sure guide for quick, visual comparison.

Provides Accurate, Individual Color Display—Produces Green, Cyan, Blue, B-Y, Q, Magenta, R-Y, Red, I, Yellow, and Burst—one at a time. All colors are crystal-controlled and are produced by a precision delay-line for maximum accuracy. Each color is individually switch-selected—no chance of error.

Provides Accurate NTSC-Type Signal—Color phase angles are maintained in accordance with NTSC specifications.

Makes Convergence and Linearity Adjustments Easy—Highly stable crystal-controlled system with

vertical and horizontal sync pulses, assures the ultimate in line and dot stability.

Simplifies Demodulator Alignment—The type of color display produced by this instrument provides the ultimate in simplicity for precise demodulator alignment.

Provides Automatic Deconvergence—Eliminates the necessity for continual static convergence adjustments. The instrument automatically deconverges a white into a color dot trio without digging into the color set to mis-adjust the convergence magnets. It also deconverges a white horizontal or vertical line into red, green and blue parallel lines. This greatly simplifies dynamic convergence adjustments.

Provides Exclusive Color Gun Killer—Front-panel switch control makes it easy to disable any combination of the three color guns. Eliminates continuous adjustment of the background or screen controls, or connection of a shorting clip inside the receiver. The switch also selects the individual grids of the color tube and connects to a front-panel jack to simplify demodulator alignment.

Provides Switch-Selected R.F. Signals—Factory-tuned, for channels 3, 4, and 5—for open channel use in your area.

Model 850 also includes other features that make it invaluable for home and shop use. Net, \$199⁹⁵

See Your B&K Distributor
or Write for Catalog AP21-N



B & K MANUFACTURING CO.

Division of DYNASCAN CORPORATION

1801 W. BELLE PLAINE AVE. • CHICAGO 13, ILL.

Canada: Atlas Radio Corp., 50 Wingold, Toronto 19, Ont.

Export: Empire Exporters, 253 Broadway, New York 7, U.S.A.

WHAT'S REALLY NEW IN FREQUENCY STANDARDS?

① ELTEC'S NEW MODEL 600!

The First Truly Low Cost Precision Citizens Band
Frequency Standard On The Market!

ONLY
\$349⁹⁵

F.O.B. Middletown



Eltec Model 600

**5 times more
accurate than
FCC requirements**

Eltec's Model 600, with amazing accuracy of .0002% and frequency range 25 MC to 54 MC, exceeds FCC requirements by five times. Now you can quickly adjust frequencies of both transmitter and receiver with real precision. Stability excellent over entire range; easily checked against W.W.V. in the field. Calibration charts furnished — no mathematics or interpolations. Ready to go — nothing else to buy!

② ELTEC'S NEW ZERO-BEAT!™

Now A "Combination" "Secondary Frequency Standard"
5 kc F. M. Deviation Standard
And Signal Generator Output
The First Practical Approach To Meeting
and Exceeding Service Needs at 1/3 The Cost!

ONLY
\$695⁰⁰

F.O.B. Middletown



ELTEC ZERO-BEAT

ZERO-BEAT exceeds FCC requirements. Features: Range 25 MC to 470 MC; Accuracy — .00003% as secondary standard — .0002% as primary standard; no interpolations; will calibrate new crystals or re-calibrate crystals in portable frequency meters; will calibrate deviation meters; dial settings for non-allocated frequencies easily determined in field; simple W.W.V. check in the field; light and portable; operates on 115 V. A.C., 6/12 volt inverter; no temperature correction charts.

ELTEC

ORDER DIRECT OR SEND FOR **FREE**

Rush Model 600 Brochure

Rush Zero-Beat Brochure

BROCHURE

Phone -Area Code
203-DI-6-8611



Name _____

Company _____

Street _____

City & State _____

LABORATORIES, INC. 18 Alsop Avenue, Middletown, Conn.

©Eltec Laboratories Inc., 1963

artist used a blank check from one source and put his own number in magnetic ink at the bottom of the illustration. The first group of numbers in magnetic ink should actually have been: 0210-0012.—Editors.

HIGH-PERFORMANCE IGNITION

To the Editors:

In my "High-Performance Transistor Ignition System" described in your June issue, I have made one minor change to compensate for a possible difference in the amplification of transistors Q1 and Q2. If such a difference exists, I would suggest that a 5-ohm, 25-watt resistor be shunted across the present R7. Also, RL2 is P-B type KA5DY.

M. R. MAYFIELD
Lancaster, Calif.

MUSIC-SPEECH DISCRIMINATOR

To the Editors:

Some confusion has arisen regarding the relay used on my music-speech discriminator (April issue).

The relay is actually marked: *Allied Control Co., Inc.*, T-154-CC-CC. 1250 ohms, contacts 1 amp. 28 volts d.c. The coil is marked CL686-1250. This relay is definitely a 1250-ohm one, and I assume that it was designed for 24 volts d.c., but I do not know this for certain.

I was also under the impression that the relay was a low-cost stock item, but conceivably it was a special unit. The relay may be purchased from *Femco, Inc.*, Irwin, Pennsylvania, under the stock number RL2594.

The relay is used as the collector load of the Schmitt trigger. Any change of this value will shift the operating point of the circuit. Any reasonable 24-volt d.c. relay may be used, but the values of R25, R26, R27, and R28 will have to be changed somewhat.

FRANK D. GROSS
Phoenix, Arizona

Also, in answer to many queries, the discriminator is not available in kit form nor is the author's unit available for sale or loan.—Editors.

MICROPHONE VOLUME CONTROL

To the Editors:

We read with great interest your article in the April issue of *ELECTRONICS WORLD* entitled "Microphone Volume Control" by Art Trauffer. One reason for our interest is that Mr. Trauffer's mike volume control is very useful and can be used in many instances. A second reason is that *Switchcraft* has been manufacturing a similar volume control for many years. Part No. 329. However, since many of your readers might want to assemble such a control themselves, we would like to make a few suggestions.

One, for best results, use this type of volume control in a high-impedance circuit only; two, the female mike connector should be located off-center to facilitate mounting on microphones used with stands.

C. J. SCHULTZ
Switchcraft, Inc.
Chicago, Ill.

TECHNICAL WRITERS

To the Editors:

There was a typographical error in my article "Are You a Potential Electronics Technical Writer?" (May, 1963). The salary range given for trainees and junior writers on page 59 should have been from \$65 to approximately \$100 per week.

CYRUS GLICKSTEIN
Flushing, N. Y.

The article gives exactly the same salary range for trainees and junior writers as for intermediate writers. This, of course, is not correct.—Editors.

RCA introduces a new easy way to learn electronics at home

Learn faster, remember more with this revolutionary new "learning method". And RCA Institutes, Inc. is first to bring it to you!

Forget all your old ideas about learning! The newest method, RCA "Autotext", uses the latest scientific development in the field of home training! RCA "Autotext" is a system of programmed instruction, accurately planned so that as you read a series of statements, questions, and answers, you learn almost without realizing it! It's fun to learn this new RCA way!

We'll prove it to you! . . . RCA Institutes now offers you a complete Home Training Course using RCA "Autotext" called "Introduction to Electronics." In addition, you get a complete set of experiment lessons, service practice lessons, and all the kits you need. You learn electronics theory faster with less effort.

FREE OFFER!

We'll send you complete information on the amazing new RCA "Autotext", along with a FREE SAMPLE of a Home Training lesson to prove to you how easy it is to learn this new way. Check "Autotext", and information will be rushed to you.

WIDE CHOICE OF HOME TRAINING COURSES: In addition to Introduction to Electronics, RCA Institutes offers this complete selection of Home Training Courses:

- Electronics Fundamentals*
- TV Servicing
- Color TV
- Transistors
- Electronic Drafting
- Communications Electronics
- FCC License Preparation
- Mobile Communications
- Automation Electronics
- Computer Programming

**Also available in Spanish*

All RCA Institutes Home Training Courses are complete step by step easy-to-understand units. You get prime quality equipment in the kits furnished to you to keep and use on the job. In addition, RCA's liberal tuition plan affords you the most economical possible method of home study training. You pay for lessons only as you order them. If you should wish to interrupt your training for any reason, you do not owe one cent. Licensed by the N. Y. State Department of Education. Approved for Veterans.

CLASSROOM TRAINING AVAILABLE IN NEW YORK CITY, LOS ANGELES, AND CHERRY HILL (NEAR CAMDEN) NEW JERSEY. For information on Classroom Training see our ad on page 57.

RCA INSTITUTES, INC., Dept. EW-83

A Service of Radio Corporation of America

350 West 4th St., New York 14, N. Y.

Pacific Electric Bldg., 610 S. Main St., Los Angeles 14, Calif.



**The Most Trusted Name
in Electronics**

RCA Institutes, Inc. Dept. EW-83
350 West 4th St., New York 14, N. Y.
Pacific Electric Bldg., 610 S. Main St., Los Angeles, Calif.
Please rush me FREE illustrated book with information checked below. No obligation. No salesman will call.
"Autotext" _____ Home Training _____
Classroom Training (choice of city) _____
Name _____ Age _____
Address _____
City _____ Zone _____ State _____

CANADIANS: Take advantage of these same RCA Institutes Courses at no additional cost. No postage, no customs, no delay. Fill out this coupon and send in envelope to: RCA Victor Ltd., 5581 Royal Mount Ave., Montreal 9, Quebec.

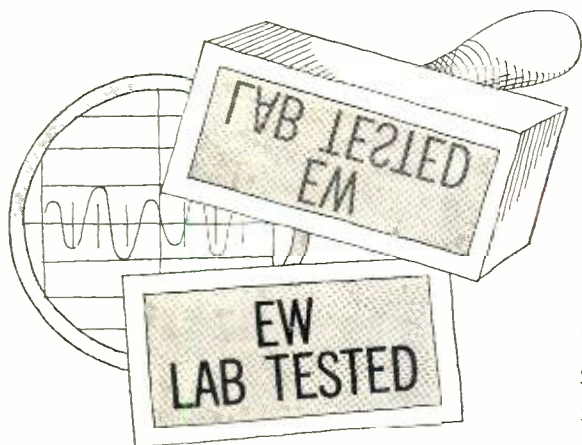

HI-FI PRODUCT REPORT

TESTED BY HIRSCH-HOUCK LABS

Shure Model 560 Lavalier Microphone
Scott 350-B Stereo Tuner

Shure Model 560 Lavalier Microphone

For copy of manufacturer's brochure, circle No. 56 on coupon (page 19).



THE Shure Model 560 lavalier microphone is a dual-impedance dynamic unit designed for applications requiring a wearable microphone. Typical usage includes teaching, lecturing, or other activities where the speaker wishes to leave his hands free. The 560 is a compact, cylindrical microphone, finished in flat black and measuring less than 4" long and 1 1/8" diameter. Weighing only 5 ounces, it comes with a lavalier cord and clip so the unit can be worn around the neck. It may also be hand-held or mounted on a stand with an accessory swivel adapter.

The microphone, as shipped, is connected for high-impedance operation. The load impedance should be at least 100,000 ohms. By changing its internal connections, it may be converted into a

low-impedance microphone operating into a 150- to 250-ohm load. The unit is supplied with an integral 18-foot, two-conductor shielded cable.

The manufacturer's specifications rate the Model 560 as having a smooth, uniform response from 40 to 10,000 cps, with rising characteristics to 4500 cps. It is omnidirectional and has a rated voltage sensitivity of -57 db referred to 1 volt per microbar at 1000 cps, with a ± 3 db tolerance. We measured its response by comparison with our calibrated laboratory microphone and found it to be in general agreement with the response curve in the microphone in-

struction sheet. At the lower frequencies, the measured response was better than the manufacturer's curve, while above 4500 cps it was lower. The response was ± 4 db from 20 to 2500 cps, rising to about +10 db at 3500 cps and falling to -10 db at about 6000 cps. The voltage sensitivity was -55 db referred to 1 volt per microbar at middle frequencies.

We used the microphone in a public-address application, and it performed very well. The sound quality was crisp, clean, and highly intelligible. Feedback problems which had existed with some other microphones were greatly reduced or eliminated with this unit. The Model 560 lavalier microphone is priced at \$25.00. ▲

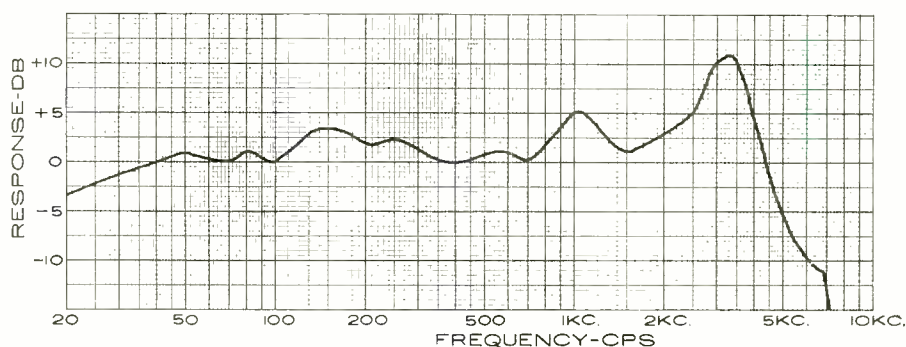

Scott 350-B Stereo Tuner

For copy of manufacturer's brochure, circle No. 57 on coupon (page 19).



THE Scott 350-B FM stereo tuner is similar to the FM portions of the Model 333 FM-AM tuner and Model 340 tuner-amplifier, which were de-

scribed in previous EW Lab Tested Reports. For those who already have good stereo amplifiers, or do not need an AM tuner, the Model 350-B offers the same

high quality FM performance as the other units.

The silver-plated, shielded front end uses a low-noise cascode r.f. amplifier and a triode-pentode oscillator/mixer. The wide-band ratio detector is preceded by two i.f. amplifiers and a limiter stage. The multiplex demodulator uses the switching-type circuits found in other Scott tuners and receivers. Noisy reception of stereo broadcasts can be improved, at the expense of separation, by the switchable sub-channel filter. Another filter circuit rolls off high-frequency response without affecting channel separation. The "Sonic Monitor" circuit provides a positive indication of a stereo broadcast. When a switch is moved from "Listen" to "Monitor," the
(Continued on page 73)

“ Well worthy of the Fisher name, both in performance and in ease of construction... Beautifully packaged and ‘instructed’... Excellent specifications, and the performance equals or exceeds the specs.”

—AUDIO MAGAZINE

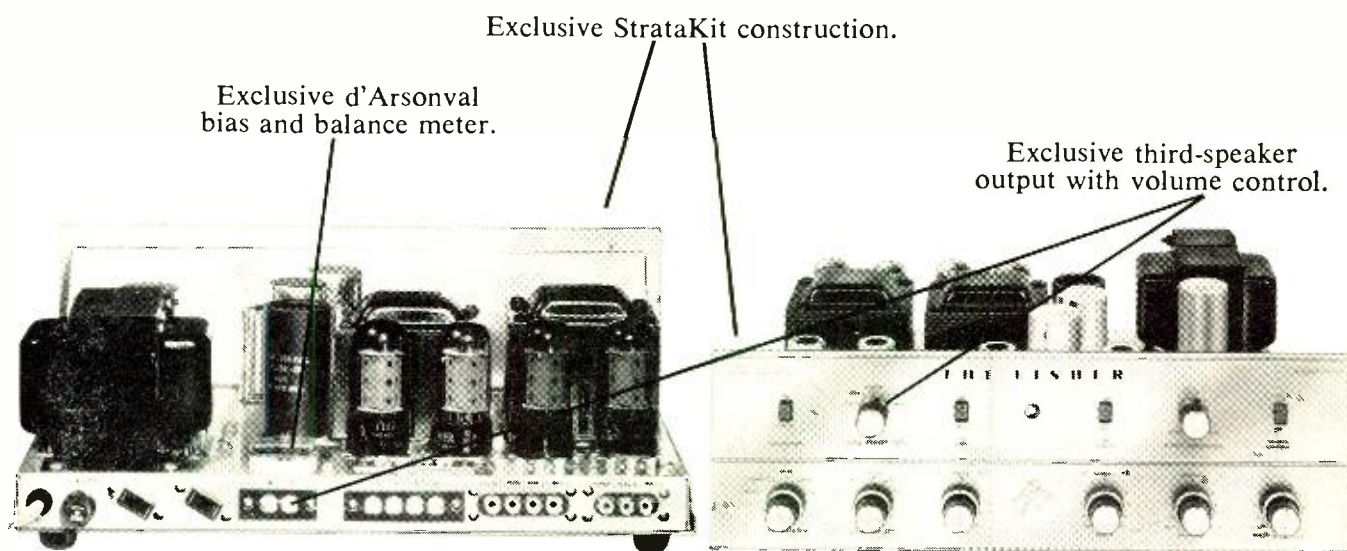

The Fisher KX-200 StrataKit, the 80-watt stereo control-amplifier kit, \$169.50*

This is the most powerful and in every way the most advanced single-chassis stereo control-amplifier kit you can buy — and by far the easiest you can build.

The 80-watt music power output (IHFM Standard, both channels) assures peak performance with even the most inefficient speakers. Engineering features never before offered in an integrated control-amplifier kit result in unequaled versatility. And the exclusive Fisher StrataKit method of kit construction makes the technical skill or previous experience of the builder completely unimportant and immaterial.

But the most exclusive thing about the KX-200 is the Fisher name -- your guarantee of a head start in kit building before you even pick up your screwdriver!

FREE! \$1.00 VALUE! The Kit Builder's Manual: a new, illustrated guide to high-fidelity kit construction.

The Kit Builder's Manual

FISHER RADIO CORPORATION
21-38 44th Drive
Long Island City 1, N. Y.

Please send me without charge The Kit Builder's Manual, complete with detailed information on all Fisher StrataKits.

Name _____

Address _____

City _____ Zone _____ State _____

07811

* WALNUT OR MAHOGANY CABINET, \$24.95. METAL CABINET, \$15.95. PRICES SLIGHTLY HIGHER IN THE FAR WEST. EXPORT: FISHER RADIO INTERNATIONAL, INC., LONG ISLAND CITY 1, N. Y. CANADA: TRI-TEL ASSOCIATES, LTD., WILLOWDALE, ONT.

SERVICE TECHNICIANS, ENGINEERS, TEST LABS SAY . . . THE POPULAR MIGHTY MITE IS

"The Best Tube Checker they ever used."

Here it is . . .

THE **MIGHTY MITE**

Designed for the present and far into the future. Tests all of your present tubes plus the new FCA Nuvisitors and Novars, GE Compactrons and Sylvania 10 pin tubes.



*Finds 'em Fast!
Checks 'em All!*

A complete tube tester that is smaller than a portable typewriter yet outperforms testers costing hundreds of dollars. A real money maker for the serviceman and a trusty companion for engineers, maintenance men and experimenters. Even though the Mighty Mite weighs less than 8 pounds, new circuitry by Sencore enables you to use a meter to check grid leakage as high as 100 megohms and gas conditions that cause as little as one half microamp of grid current to flow. Then too, it checks for emission at operating levels and shorts or leakage up to 120,000 ohms between all elements. This analytical "stethoscope" approach finds troublesome tubes even when large mutual conductance testers fail. And it does all this by merely setting four controls labeled A, B, C, & D.

Check these plus Sencore features: New, stick-proof D'Arsonval Meter will not burn out even with a shorted tube • Meter glows in dark for easy reading behind TV set.

- New large Speedy Set-Up Tube Chart in cover, cuts set-up time
- Rugged, all-steel carrying case and easy grip handle
- Smallest complete tester made, less than one foot square.
- The Mighty Mite will test every standard radio and TV tube that you encounter, nearly 2000 in all, including foreign, five star, auto radio tubes (without damage) plus the new GE Compactrons, RCA Nuvisitors and Novars and Sylvania 10 pin tubes.

Mighty Mite also has larger, easy-to-read type in the set-up booklet to insure faster testing. Why don't you join the thousands of servicemen, engineers, and technicians who now own a Mighty Mite tube tester? Tube substitution is becoming impossible and costly with nearly 2000 tubes in use today. Ask your authorized Sencore Distributor for the New Improved Mighty Mite. Size: 10¼" x 9¼" x 3½". Wt. 8 lbs.

MODEL TC114

Dealer Net **\$74.50**

Sencore Sam says . . .
"They all agree . . . the Mighty Mite is the real answer for the man on the go."

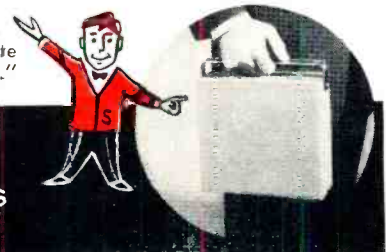

SENCORE ADDISON, ILLINOIS

Pick the course for your career...

Electronics Technology

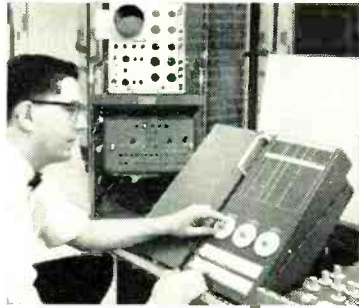

A comprehensive program covering Automation, Communications, Computers, Industrial Controls, Television, Transistors, and preparation for a 1st Class FCC License.

Electronic Communications

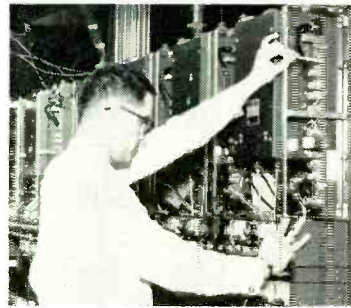

Mobile Radio, Microwave and 2nd Class FCC Preparation are just a few of the topics covered in this "compact" program . . . Carrier Telephony too, if you so desire.

First Class FCC License

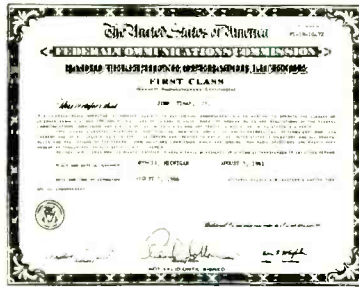

If you want a 1st Class FCC ticket quickly, this streamlined program will do the trick and enable you to maintain and service all types of transmitting equipment.

Broadcast Engineering



Here's an excellent studio engineering program which will get you a 1st Class FCC License and teach you all about Program Transmission and Broadcast Transmitters.

Get A Commercial FCC License ... Or Your Money Back!

A Commercial FCC License is proof of electronics skill and knowledge. Many top jobs require it . . . every employer understands its significance. In your possession, an FCC Commercial Ticket stamps you as a man who knows and understands electronics theory . . . a man who's ready for the high-paid, more challenging positions.

Cleveland Institute home study is far and away the quickest, most economical way to prepare for the FCC License examination. And that's why we can make this exclusive statement:

The training programs described above will prepare you for the FCC License specified. Should you fail to pass the FCC examination after completing the course, we will refund *all* tuition payments. You get an FCC License . . . or your money back!

Before you turn this page, select the program that fits your career objective. Then, mark your selection on the

Cleveland Institute of Electronics

1776 E. 17th Street, Dept. EW-80
Cleveland 14, Ohio



Accredited Member

coupon below and mail it to us today. We'll send you . . . without obligation . . . complete details on our effective Cleveland Institute home study. Act NOW . . . and insure *your* future in electronics.

Mail Coupon TODAY For FREE Catalog

Cleveland Institute of Electronics

1776 E. 17th St., Dept. EW-80
Cleveland 14, Ohio

Please send FREE Career Information prepared to help me get ahead in Electronics, without further obligation.

How to Succeed
in Electronics

CHECK AREA OF MOST INTEREST—

- | | |
|---|--|
| <input type="checkbox"/> Electronics Technology | <input type="checkbox"/> First Class FCC License |
| <input type="checkbox"/> Industrial Electronics | <input type="checkbox"/> Electronic Communications |
| <input type="checkbox"/> Broadcast Engineering | <input type="checkbox"/> _____
other |

Your present occupation _____

Name _____ Age _____
(please print)

Address _____

City _____ Zone _____ State _____

Approved for Veteran's Training under Korean GI Bill. EW-80

the challenging field of communications

CB GETTING A LICENSE
LATEST USA & CANADIAN LICENSE REQUIREMENTS
CB IN CIVIL DEFENSE

IDENTIFYING RADIO SIGNALS
SWL EQUIPMENT
FREQUENCIES & TIME ZONE TABLES **SWL**

**HAM
RADIO**

THE SWITCH FROM
CB TO HAM RADIO
FCC TESTS

PRACTICES
OPERATING
LICENSE QUALIFICATIONS
REQUIRED EQUIPMENT

**BUSINESS RADIO
SERVICE**

completely covered in this unique, new publication

1963 COMMUNICATIONS HANDBOOK

- 148 pages of comprehensive information
- 4 big sections covering each of the main branches of communications
- illustrative graphs, charts and tables



The 1963 COMMUNICATIONS HANDBOOK is now on sale at your favorite newsstand or electronics parts stores. Or get your copy by using this handy coupon. Just PRINT your name and address clearly and enclose \$1.00, the cost of the HANDBOOK, plus 15¢ to cover mailing and handling charges (Canada and foreign countries, \$1.25 plus 25¢ postage).

Ziff-Davis Publishing Company
Dept. CH3
One Park Avenue
New York 16, New York

EW83

NAME _____
(please print)

ADDRESS _____

CITY _____ ZONE _____ STATE _____

READER SERVICE PAGE

Please use the coupon at the bottom of this page to obtain more information about products advertised in this issue.

Simply circle the number on the coupon that corresponds to the number at the bottom of the advertisement in which you are interested.

Additional information on items mentioned in "New Products & Literature" can also be obtained by following this same procedure.

PRINT your name and address on the coupon and mail it to:

ELECTRONICS WORLD

P.O. BOX 7842

PHILADELPHIA 1, PA.

Your requests for literature will be forwarded to the manufacturers who will be glad to fill them promptly.

ELECTRONICS WORLD

P.O. BOX 7842
PHILADELPHIA 1, PA.

TOTAL NUMBER OF REQUESTS

Please send me additional information concerning the products of the advertisers whose code numbers I have circled.

100	101	102	103	104	105	106	107	108	109	110	111	112	113	114	115	116	117	118	119		
120	121	122	123	124	125	126	127	128	129	130	131	132	133	134	135	136	137	138	139		
140	141	142	143	144	145	146	147	148	149	150	151	152	153	154	155	156	157	158	159		
160	161	162	163	164	165	166	167	168	169	170	171	172	173	174	175	176	177	178	179		
NEW PRODUCTS & LITERATURE					1	2	3	4	5	6	7	8	9	10	11	12	13	14	15	16	
17	18	19	20	21	22	23	24	25	26	27	28	29	30	31	32	33	34	35	36	37	38
39	40	41	42	43	44	45	46	47	48	49	50	51	52	53	54	55	56	57	58	59	60

(Key numbers for advertised products also appear in Advertisers Index)

NAME (PRINT CLEARLY) _____

ADDRESS _____

CITY _____ ZONE _____ STATE _____

VOID AFTER AUGUST 31, 1963

8

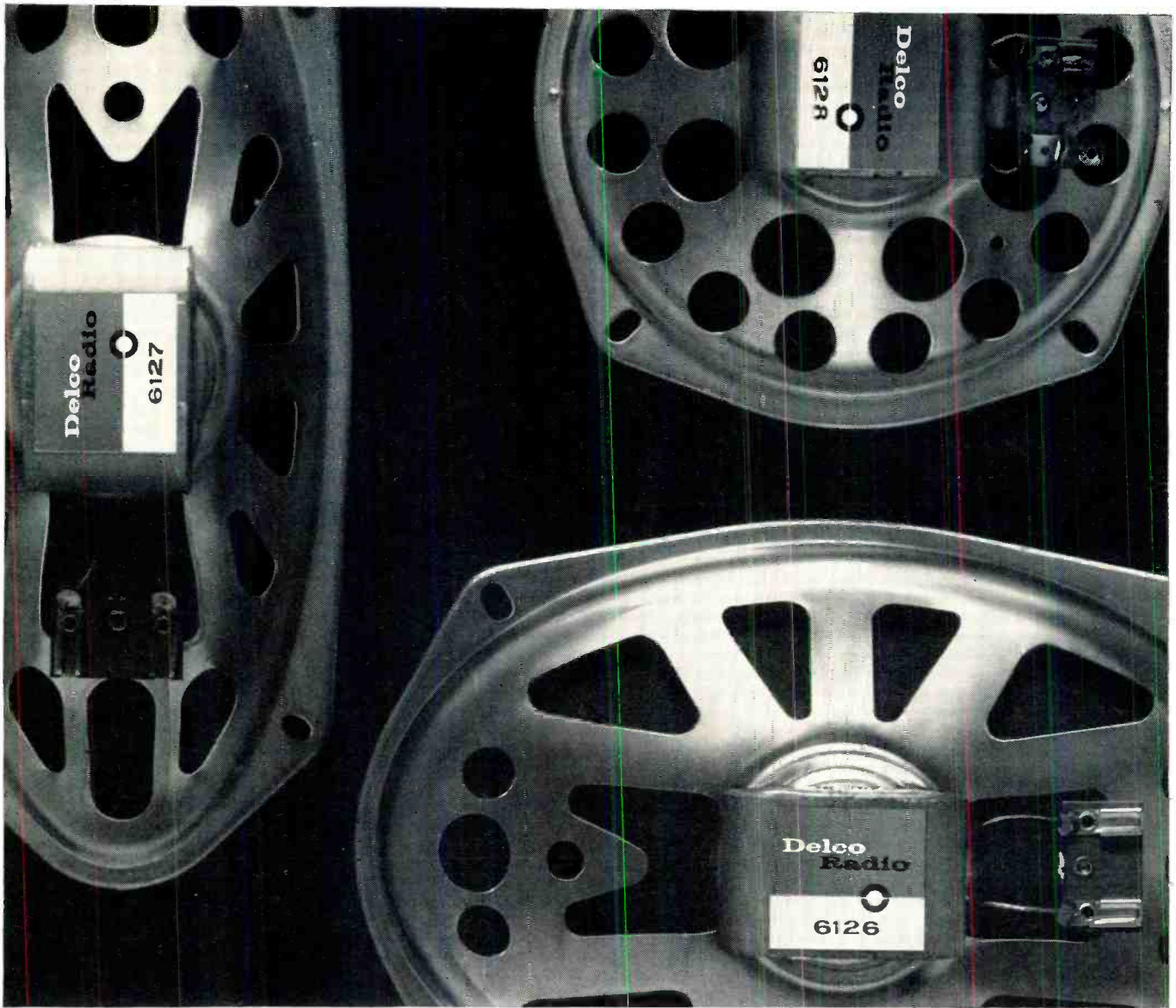

3 SPEAKERS CAN NOW REPLACE 16

simply say **Delco**

These three new Delco Radio 8-10-ohm replacement speakers permit you to cut 16 numbers from your inventory. They can replace all units in current General Motors cars and many competitive makes. They

install easily and quickly, take a "tip jack," "blade," or solder connection. Excellent for home hi-fi and TV sets, too! Speak up for the latest in replacement speakers. Call your United Delco supplier today.

THREE NEW SPEAKERS, ALL WITH SLOTTED MOUNTING HOLES

Number	Size	Magnet Wt.	Mounting
6126	6 x 9"	1.6 oz.	front/rear
6127	4 x 10"	1.6 oz.	front/rear
6128	6" round	2.5 oz.	rear-seat

SPECIAL

**UNIVERSAL 8-10-OHM
6 x 9" REAR SPEAKER PACKAGE**
Contains all materials necessary for rear-seat speaker installation: Speaker, Grill, Wiring, Switch. Part No. 6122.

Delco Radio Automotive Radio Service Parts and Electro-Mechanical Devices are distributed nationally through **United Delco**

DELCO RADIO, Division of General Motors, Kokomo, Indiana



PHOTOFACT[®]

GIVES YOU MAXIMUM TV COVERAGE

to keep you up-to-the-minute!

NOW—PHOTOFACT gives you quicker-than-ever service data coverage for TV and for more of the kind of equipment you most frequently repair!

It's the same famous PHOTOFACT time-saving, troubleshooting help—*everything* you need to earn more daily. You get: Exclusive Standard Notation Schematics, packed with all the service details you need; full photo coverage of all chassis views; *complete* replacement parts lists; tube placement diagrams; actual waveform photos; CircuTrace[®] for printed boards; alternate tuner data; terminal identification and connections; disassembly instructions; field servicing notes—plus dozens of other great time-saving features.

Take the *right* step to fast, profit-building servicing—see your Sams Distributor for details on a money-saving PHOTOFACT Standing Order Subscription and Easy-Buy Library—or send coupon today!



Sylvania 19T09

Olympic 9T22

Truetone 2DC3360



Coronado TV2-9650A



Westinghouse H-K3911U



Panasonic AN-14



Coronado TV2-9442A



Olympic 9TV19-B



RCA Victor 213G235RV



Emerson C-2001A



AMC D1863A



Electrohome Cameo



Capehart 19PT25



J. C. Penney 19P362A

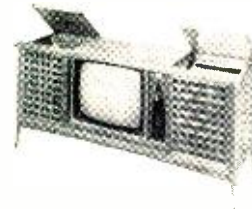

Clairtone ST-801

SAVE 30¢ PER SET!

SIGN UP TODAY FOR A MONEY-SAVING PHOTOFACT STANDING ORDER SUBSCRIPTION!

With a Standing Order Subscription to receive PHOTOFACT regularly each month as issued, you pay only \$1.95 per Set instead of the regular \$2.25 price. You save 30¢ per Set—and you keep right up with the rapidly-increasing current model output! You enjoy the same 30¢ per Set savings when you purchase an Easy-Buy PHOTOFACT Library. Take advantage of substantial savings—sign up for a Standing Order Subscription or Easy-Buy Library with your Sams Distributor, or send coupon now for full details.

SAVE WITH A STANDING ORDER SUBSCRIPTION!

HOWARD W. SAMS & CO., INC.

Howard W. Sams & Co., Inc., Dept. 5-H3
4300 W. 62nd St., Indianapolis 6, Indiana

- Enter my Photofact Standing Order Subscription
- Send full information on money-saving Easy-Buy Plan

My Distributor is: _____

Shop Name _____

Attn. _____

Address _____

City _____ Zone _____ State _____

UNCOMPROMISING ENGINEERING CREATES THE BEST BUY... EICO

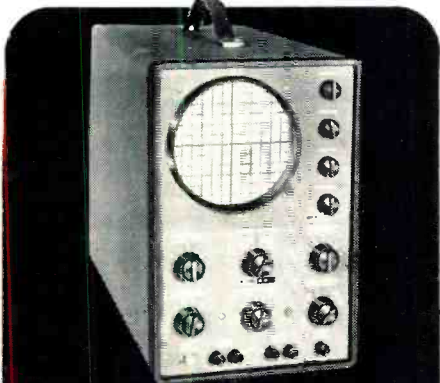

**NEW ADVANCED GENERAL PURPOSE
5" CATHODE OSCILLOSCOPE #327**
Kit \$69.95 Wired \$109.95

Vertical amplifier with 3 push-pull stages, direct coupled throughout; 4-position, frequency-compensated V input attenuator; internal calibrating voltage. Recurrent sweeps from 10cps-100kc in 4 overlapping ranges; choice of int. +, -, 60cps, or ext. sync; fully automatic sync. operation; full retrace blanking. Intensity, focus and astigmatism controls on panel. Sharp, clean, non-blooming trace. Instantaneous drift-free positioning. Convenient direct probe connections. V amp: 10mv p-p/cm sens.; flat cc-500kc, -6db at 1mc; 1 meg input Z. F amp 0.5V p-p/cm sens.; 2cps-450kc flat response 10 meg input Z.



AC VTVM & AMPLIFIER #250
Kit \$49.95 Wired \$79.95

Highly sensitive, reliable AC VTVM & wideband amplifier. Measures 100 microvolts to 300V in 12 ranges; 10c-600kc ± 0 db response, 10 megohms input impedance, $\pm 3\%$ accuracy. Wide-band amplifier switch-controlled for external use; 8c-800kc response, 5VRMS output, 5K ohms output impedance, gain control, noise -40db. Frame-grid triode cathode follower input circuit, freq.-compensated input attenuator, cathode circuit attenuator. Regulated power supply.

AC VTVM #255 Kit \$44.95 Wired \$72.95
All the precise VTVM facilities of the #250 less external use of the wide-band amplifier.



AC VOLT-WATT METER #261*
Kit \$49.95 Wired \$79.95

AC voltmeter & load-compensated audio wattmeter of unique quality. Measures AC voltages from 1mv to 1000V in 11 ranges, power from 0.15mw to 150W in 7 ranges, across standard loads from 4 to 600 ohms. Tapped power resistor load (4, 8, 16 and 600 ohms) handles up to 80W on 8 ohms and 40W on other taps. Switch to external load up to 150W. Meter automatically compensated for any load selected, internal or external, to provide single watt scale.

*Formerly designated as #260.

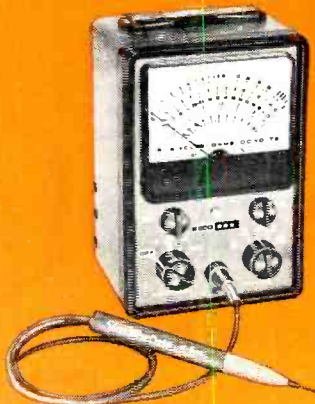

VACUUM TUBE VOLTMETER #222

Complete with exclusive dual-purpose Uni-Probe® (U. S. Pat.)

Kit \$27.95 Wired \$42.95

Entirely electronic, direct reading measurement of resistance, and AC & DC to 1500V in 5 ranges. May be calibrated without removal from cabinet. Complete electronic overload protection, plus fuse. 1% precision ceramic resistors. Exclusive AC/DC Uni-Probe® selects DC or AC-Ohms. DC voltmeter input impedance 11 megohms, accuracy $\pm 3\%$. AC voltmeter input impedance 1 megohm, accuracy $\pm 5\%$. Ohmmeter 0.2 ohms to 1000 megohms in 5 ranges.

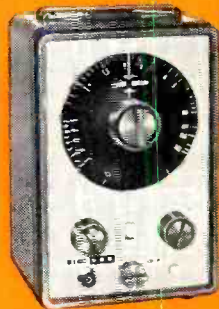

IN-CIRCUIT CAPACITOR TESTER #955

Kit \$19.95 Wired \$39.95

Tests capacitors in the circuit without unsoldering. Checks for shorts, (even in the presence of as little as 1 ohm shunt resistance). Checks open units (as little as 5MMF in the circuit). Measures capacitance with $\pm 10\%$ accuracy between 0.1mf and 50mf. Measures RC product, convertible into dissipation or power factor. Utilizes electron-ray tube EM84/6FG6 with sharp bar pattern. Line adjust control permits maximum sensitivity regardless of line voltage variations.

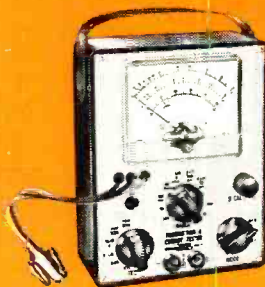

TRANSISTOR & CIRCUIT TESTER #680

Kit \$25.95 Wired \$39.95

Measures ICBO, ICBC & DCB directly, ACB indirectly, without charts or special settings—plus all dc volts, currents & resistances needed to service transistor equipment. Battery powered. 50 μ A, 3 $\frac{1}{2}$ " face meter movement provides sensitivity & scale length necessary for accuracy. Built-in 20,000 Ω VOM facilities free your other test equipment.



Extra-Low
Ripple

**6 & 12 VOLT
BATTERY ELIMINATOR & CHARGER #1064**
Kit \$43.95 Wired \$52.95

Heavy-duty 2-ranges for operating any mobile radio & transceiver including transistor or "hybrid" types. Also usable as charger for either 6 or 12 volt batteries. Variable transformer provides continuous output adjustment. 2 meters simultaneously observe output voltage and current. Ratings: 0-8V: 10A continuous, 20A intermittent; 0-16V: 6A cont., 10A interm. AC ripple: 0-16V range: 0.3% @ 2A, 1% @ 5A. Heavy-duty selenium rectifiers, & automatic reset overload relay.

**METERED VARIABLE
AUTO-TRANSFORMER AC BENCH SUPPLIES**



#107A: 3A rating Kit \$35.95 Wired \$47.95
#107B: 7 $\frac{1}{2}$ A rating Kit \$42.95 Wired \$54.95

For study of components under varying line conditions. Delivers any voltage up to 140VAC with linear variation of output throughout entire range. Smooth rotary brush-tap controlled by panel dial. Highly efficient variable toroidal core design. Auto-transformer. No waveform distortion or voltage drop from no-load to full load. Separate output ammeter & output voltmeter.



TUBE TESTER ADAPTOR #610

Kit \$5.95 Wired \$11.95

Adapts EICO models 625 or 666 tube testers for testing the following new tube types: nuvistor 5 pin; avustor 7 pin; novar, 10 pin miniature; compactron; 12 pin. Included are roll-chart supplements for both 625 and 666 models.

EICO®

EICO ELECTRONIC INSTRUMENT CO., INC.
3300 NO. BLVD., L.I.C. 1, N. Y.

EICO, 3300 N. Blvd., L.I.C. 1, N.Y.

Send free 32-page catalog & Distributor's name.

EW-8

Send Free Schematic of Model No. _____
 Send new 36-page GUIDEBOOK TO HI-FI for which I enclose 25c for postage & handling.

Name _____
Address _____
City _____ Zone _____ State _____

Add 5% in West.

Over 2 MILLION EICO Instruments in use.
Most EICO Dealers offer budget terms.

Listen to the EICO Hour, WABC-FM, N. Y. 95.5 MC, Mon.-Fri., 7:15-8 P.M.
Export Dept., Roburn Agencies Inc., 431 Greenwich St., New York 18

DIRECT-READING INSTRUMENTS

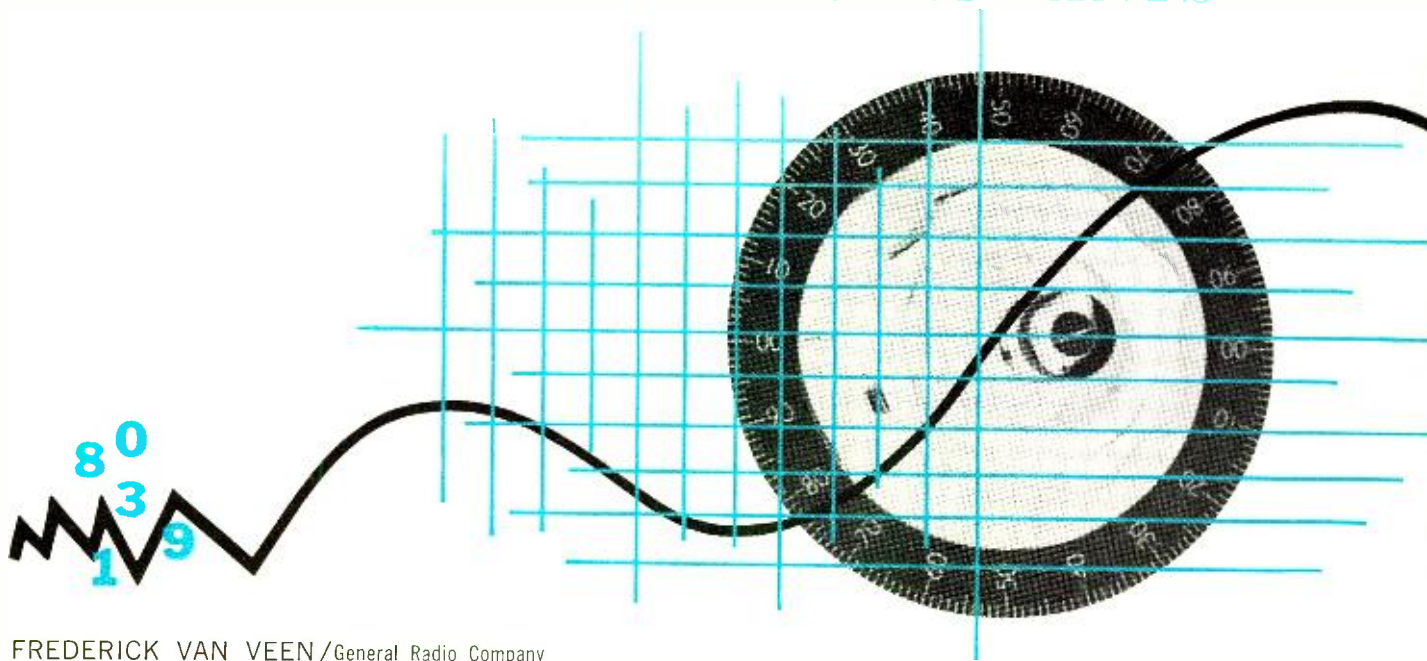

By FREDERICK VAN VEEN/General Radio Company

Significant developments in the past ten years, especially those that have advanced the art of measuring. New types of test instruments that measure frequency by counting, record quantities graphically, measure L, C, R, Z, voltage, and special microwave measuring devices.

Which you can measure, has been increasing, also, and it is less a matter of how much you can measure than of how you can measure it. Vol. 4, Kelvin.

THERE has been, over the past decade, a tremendous improvement in electronic measuring instruments. The rapid advances in precision, accuracy, and convenience of measurement have played a vital part in the electronics "boom" that has meant a 600% rise in sales dollars. Everything, in a sense, begins with measurements, and the limits of measurement are the limits of science.

The boom in electronic measuring instruments is a mixed blessing to the average technician. Ten years ago it was pretty easy to select a bridge or voltmeter for a specific job. Shopping was a matter of looking at a few catalogues and inter-comparing some specifications. Then the measurement industry really expanded, manufacturers outdid one another in offering varieties of multipurpose instruments, and the catalogues bulged. The 1953 *IRE Directory* listed 69 manufacturers of bridges; the 1963 edition lists 140. Under "Graphic Recorders" the 1953 directory lists 47 companies, the current volume, 145. The 1963 edition lists no fewer than 224 companies making digital counters, a category not even included in the directory of a decade ago!

The hundreds of different instruments manufactured to measure frequency, impedance, resistance, inductance, ca-

pacitance, voltage, and current represent a wide choice of accuracies, features, and price. There is also, of course, the duplication inherent in our competitive system. No one article or series of articles can do justice to the overwhelming number of direct-reading instruments available today. The emphasis here will be on the more significant developments of the past ten years, and especially those that have advanced the state of the measurement art.

Mechanical and Convenience Improvements

The measuring instruments of 20 or 30 years ago were typically big, black, square, and heavy. This was simply the way people thought instruments *should* look; indestructible, reliable, conservative. But styles change and most of the black, square instruments went the way of black, square automobiles. Today's instruments enjoy the benefits of new materials, miniaturization, and much of what is sometimes called "human engineering" but which has always been a part of just good mechanical design.

Instrument cabinets now try to be all things to all people; some can be quickly adapted to relay-rack, bench, or portable use. Then there is the tiltable cabinet, with a captive cover that serves as an easel-type stand when the instrument is in use. Extensible front legs on many cabinets let the user look

Probably the most important new type of instrument of the past decade is the frequency meter using digital counting techniques. This example, the General Radio 1151-A, is a general-purpose counter for laboratory or production-line use that can measure frequency accurately from a fraction of a cps up to 300 kc. The unit also measures the period of a cycle and frequency ratios. Price: \$1195.





A



B



C

(A) Many direct-reading instruments are highly versatile since they may combine several functions within a single unit. Our example is in the audio field. The device shown, the Eico 902, combines an a.c. v.t.v.m. for accurate audio measurements, and generators and filter circuits for making both harmonic-distortion and inter-modulation-distortion tests. Such measurements are read directly on the meter face. Distortion figures are within 5% of full scale and the voltage figures are $\pm 4\%$ of the full-scale reading. The price is \$250, factory-wired.

(B) With the increasing use of semiconductor diodes in equipment have come specialized testers for checking these components. Many of these testers have been designed for practical laboratory use as well as for incoming diode stock inspection. One typical unit, the Seco 210, includes tests for zener diodes, silicon and germanium power and signal diodes, as well as selenium rectifiers. Various variable sources of power are incorporated in the circuit. Results are displayed on two meters. Price of unit: \$154.95.

(C) Not all frequency meters are digital devices. Typical of the more common and, incidentally, less expensive type is the Lampkin 105-B shown. This instrument is a heterodyne-type frequency meter with a built-in crystal calibrator. It is used to measure transmitter frequencies anywhere in the range of 100 kc. to 175 mc. In addition, it will function as an accurate weak-signal generator for receiver alignment. Instrument meets FCC requirements for a frequency monitor in the mobile-radio service below 50 mc. With some additional equipment, the meter will also meet the FCC accuracy requirements for the newer split-channel frequencies. The price is \$260.

at the front panel head-on whether he is sitting or standing at the bench. And cabinets of the larger manufacturers come in standard sizes, so that they can be stacked into a neat arrangement.

Readouts have improved tremendously. The meters are larger with scales designed for easy reading. And, too, there are now digits—neon digits, incandescent digits, projected digits, digits in windows, and more digits on printed tape.

Instruments are lower—the form factor apparently follows that of automobiles. The day of the three-inch-high instrument has arrived, apparently to save relay-rack space. Instruments used in the field have become more portable than ever, as they are transistorized. Also, some instruments with heavy power demands are starting to “go portable,” thanks to the rechargeable nickel-cadmium battery.

There are so many convenience improvements in instruments that it is difficult to list them all. But one that deserves special note is the quality of instruction manuals. Another is the greater availability of manufacturers' sales and service engineers. Manuals and consulting services can be just as important as some of the instrument's technical specs.

Instrument Specifications

The buyer of an electronic instrument must be guided by the specifications published by the manufacturer, but the catalogue shopper who tries to select an instrument purely by published data had better be on his toes.

Not that the manufacturers aren't truthful. Dishonest specifications are fortunately a rarity in this business, because they punish their perpetrators too quickly. But every manufacturer wants to put his best foot forward and stress the specifications where he is strongest. Also, there are many honest differences of opinion among manufacturers on just how best to state something. Take, for instance, the problem of specifying the low limit of measurement on a v.t.v.m. Suppose the voltmeter has a low range with a full scale of 10 microvolts, and an accuracy of $\pm 10\%$ of full scale. The voltmeter will certainly measure voltages below 10 microvolts, but a 1-microvolt reading might be wrong by 100%, and most people would not consider that a measurement. Another aspect of the same problem: a 3% voltmeter is generally more accurate than a 2% voltmeter if the 3% is 3% of indicated value and the 2% is 2% of full scale. The moral of all this is that you should not play the numbers game with instrument specifications, but should read words as well.

One of the best ways to approach laboratory instrument selection is to consult the manufacturer. Sales engineers who sell such electronic instruments are, by and large, extremely competent, helpful, and low-pressure. They will try to steer you to the right choice of instrument, even if it means steering you to another company. They offer a valuable consulting service for anyone with a measurement problem, and the wise shopper takes advantage of it.

But even knowing where to start is a problem. There is a bewilderingly large number of electronic measuring instruments made by several hundred different manufacturers to measure more than 200 different electrical and electronic parameters, separately and in combination, in many different frequency ranges, and to varying degrees of accuracy and precision. You may know exactly what you want to measure and the conditions of measurement, yet there is no quick way to narrow your selection to those instruments that qualify. Certain so-called “buyers' guides” try to classify instruments, but the task is too much for them. Several manufacturers publish excellent catalogues that bring order to their own houses. But the job of classifying all instruments in terms of well-defined standards remains.

A hopeful beginning is the recently published¹ program of IEEE Subcommittee 25.1 on Basic Standards and Calibration Methods. As a first step, this committee has designated three echelons of accuracy level. Echelon I is the highest calibration accuracy available within a country, Echelon II an intermediate level, typically that of the calibration laboratory of an instrument manufacturer, and Echelon III a level at which measuring instruments are calibrated before use by the ultimate consumer. For each echelon, various IEEE Technical Committees will report on the measurement accuracies available and needed. In its statement of objectives, the IEEE Committee says, “An appraisal of the present status of electrical measurements points up mainly the limited availability of complete, reliable technical information.” All who make, buy, or use electronic instruments will wish this particular committee Godspeed in its work.

Measurement of Frequency

Today's most popular frequency-measuring instrument—the counter—scarcely existed ten years ago. Now that digital counting techniques are being widely applied to so many measurements, the frequency counter must be considered the most important new instrument of the past decade. The

modern frequency counter represents a unique melding of borrowed technologies: the flip-flop circuit from atomic research, pulse techniques from radar, binary switching logic from computers. The counter became a practical instrument with the development of a method of converting binary information to decimal, new digital indicators, and improved switching devices.

The principles of counters are well known, and are here worth only passing mention: Successive cycles of the frequency to be measured are passed through a "gate" and counted, the total being indicated by a digital display. The counting time, or the time that the gate is open, is determined by a reference crystal oscillator, usually built into the counter. If the gate is set to remain open for one second, the digit display is direct-reading in cycles per second. The unit of time is established by a crystal oscillator—usually called the "time base"—and the accuracy of this time base determines, more than any other single factor, the accuracy of frequency measurement.

If one is interested chiefly in accuracy, then the significant specification is the accuracy and stability of the time-base oscillator. The possible error corresponding to time-base inaccuracy must be added to the plus-or-minus one-count error inherent in all counters. Other errors can be caused by noise², but these are harder to evaluate.

Frequency ranges of counters vary widely, but the upper limit for direct-reading counters is presently about 50 mc. Heterodyne converters extend this range up to 1000 mc. with no sacrifice in accuracy, and transfer techniques are used from 1000 mc. to above 10,000 mc.

One of the most valuable features a counter can offer is versatility—the ability to rearrange its components for different types of measurements. Thus many firms advertise "universal" counters. This usually means that the instrument can measure not only frequency, but also period, time interval, and frequency ratio as well.

To measure period, the functions of the "unknown" and time-base signals are interchanged, so that successive cycles of the unknown frequency open and close the gate, while "clock" pulses from the time base are counted. As a result, the digits displayed indicate the number of time units (e.g., 10- μ sec. units if the time base is a 100-kc. oscillator) passed during one cycle of the unknown frequency. At frequencies much lower than that of the time base, a period measurement

will yield greater precision, due to the higher count used.

A time-interval measurement also counts "clock" pulses from the time base, but here the gate is opened by one signal and closed by another. In frequency-ratio measurement, one signal is used to open and close the gate, while the other is counted.

A consideration of increasing importance is the adaptability of the counter to accessory instruments. If you require permanent records of measurements, you will need either a data printer or the combination of digital-to-analog converter and analog recorder. Whether a particular counter will operate with a certain printer or D/A converter depends on the type of coding used, input and output voltage levels, and other considerations. Failure to check these in advance can easily lead to a pair of incompatible instruments.

Digital counters are by no means the only way to measure frequency, and it is unlikely that they will ever take over completely. For some applications, in fact, digits are a real nuisance. Suppose, for example, that you are trying to adjust a variable-frequency oscillator to exactly 12,230 kc., while monitoring the output frequency on a counter. You trim one way and then the other, as the digits dance tantalizingly around (but not on) the desired frequency. How you would long, at this point, for a heterodyne instrument with which your ears could guide you quickly to zero beat! It is a good idea to remember that any good variable-frequency reference, such as a signal generator, can be used with mixer and detector to measure frequency.

At frequencies up to about 1.5 mc., there are lab analog instruments available. One, using an interpolation technique with most of the frequency suppressed onto a switch setting, offers an over-all accuracy of $\pm 0.2\%$ from 3 cps to 1.5 mc. And instruments for coarse frequency measurements—wave-meters and grid-dip meters—still enjoy a brisk market.

There is every reason to expect further substantial improvements in frequency measurements. Accuracy is, as mentioned, largely a function of the accuracy or stability of the frequency reference. Thus, it is possible to increase the accuracy of any counter by the use of a highly accurate frequency standard as the time base.

Measurement of Capacitance & Inductance

Capacitance and inductance measurements involve similar techniques and limitations. The basic instrument for precision

(A) Graphic recorders are widely used in industry where a written chart showing one or more variable functions is required. The recorder shown, a Moseley 2D-4, draws rectangular coordinate curves from two related sources of d.c. electrical information on standard graph paper. Writing area is 10 x 15 inches. High-gain solid-state servo amplifiers drive the two motors that are coupled to balance pots and recording pen. Ten calibrated input ranges from 0.5 mv./div. to 10 v./div. may be selected from the front panel of the recorder. The liquid-ink pen has a maximum writing speed of 15 inches per second. Price is \$1490.

(B) Even vacuum-tube voltmeters have become transistorized. DeVry transistorized meter combines advantages of a v.t.v.m. with those of a sensitive microammeter for service-bench use. Instrument is completely

portable, operating on four flashlight batteries. It has usual a.c., d.c., and resistance ranges, along with four d.c. current ranges from 50 μ a. to 50 ma. full-scale. D.c. input impedance is 10 meg on most ranges. The price of the voltmeter is \$89.50 ready-wired or \$64.50 in kit form.

(C) Graphic recorders need not be large and bulky as shown by the Amprobe ATM-2. This is actually two most-frequently used recorders in a single compact carrying case. One of the units is an expanded-range a.c. voltmeter and the other is a high-current a.c. ammeter. Roll of 2 1/2" wide pressure-sensitive paper, traveling at 12" per hour carries the record of voltage and current. With the paper removed, pointer position is visible on a calibrated scale so that unit can be used as an indicating meter. Price of the 2-recorder unit and case is \$181.20.



A



B



C

measurements is the *bridge*—an instrument that permits the adjustment of a calibrated known until a state of electrical balance exists between it and the unknown. Here, as in frequency measurements, the major burden is on the accuracy of the “calibrated known,” or standard. But even the best standard is of little practical use in measurements unless its accuracy can be somehow extended over a wide range of values. One significant advance in bridges over the past few years is the transformer ratio-arm bridge, a device for extending the usefulness of a single standard over a range from 1/1000 to 1000 times its value or better, with no sacrifice in accuracy. Although the transformer bridge was originally conceived over 30 years ago, its principles have only recently been exploited in commercial instruments. The most accurate capacitance bridges available use ratio arms to achieve direct-reading accuracy of 0.01% over a wide range of capacitance.

Capacitance standards can be made more accurate than inductance standards. The capacitance bridges just mentioned use $\pm 0.005\%$ standard capacitors, for example, whereas the best standard inductors are $\pm 0.1\%$ units. Inductance bridges therefore use capacitors, rather than inductors, as standard reactances. The most accurate inductance bridges available offer $\pm 0.1\%$ direct-reading accuracy.

The ultimate accuracy of most precision bridges is, incidentally, well beyond the direct-reading accuracy. A high degree of resolution, that is, a readout of five, six, or more significant figures, can be used for ultraprecise intercomparisons. One of the 0.1% capacitance bridges, for example, permits intercomparison of capacitors to within one part per million.

Capacitors and inductors can be measured in terms of either series or parallel equivalent circuits, and many bridges therefore offer switch selection of C_s , C_p , L_s , and L_p . The difference between L_s and L_p and between C_s and C_p is less than 1% for inductors with “Q’s” over 10 and for capacitors whose dissipation factor is less than 0.1.

Resistance Measurements

The instruments most often used to measure resistance are the ohmmeters included with many voltmeters. The accuracy of such an ohmmeter is limited to 5 or 10%, partly because of trying to squeeze an infinite range into a finite scale.

The resistance bridge is easily able to achieve 0.1% ac-

curacy up to 10 megohms or so. Measurements of very high resistance are made by megohm bridges, which supply the required high voltages. One megohm bridge will measure resistances up to 10^{15} ohms, with 1% accuracy up to 10^{12} .

Resistance limit bridges are direct-reading in percent deviation rather than in ohms. Such bridges are used by production-line personnel to determine quickly whether a component is within specified tolerance.

The exceptional accuracy of frequency standards has been applied to the measurement and standardization of other quantities. The ohm has thus been defined in terms of frequency and length, and standard resistors can now be specified in terms of a few parts per million. Standard resistors are used in series and parallel combinations, linear voltage dividers, and conventional bridges to extend their usefulness over a wide-range of measurement. Present state-of-the-art for general-purpose, wide-range resistance bridges seems to be the same as for capacitance: $\pm 0.01\%$.

The most popular bridges are those that measure resistance, capacitance, and inductance—the so-called “universal” bridges. This popularity is easy to understand when, in this day of four- and five-figure prices, less than \$500 can buy a self-contained, battery-operated, portable, five-bridges-in-one instrument that measures C , R , and L to $\pm 1\%$, and also measures dissipation factor and “Q.”

Voltage Measurement

The digital revolution came to voltmeters less than ten years ago, and digital voltmeters are now produced by many manufacturers. The extra precision afforded by digital readout is of especial advantage in d.c. measurements, where the attainable accuracy warrants such fine resolution. Digital voltmeters are considerably more expensive than the usual analog meters of comparable ranges and quality, and this relation is likely to continue. Another relation that seems basic is that between the accuracies attainable in a.c. and d.c. measurements. While d.c. voltage can be measured to about $\pm 0.002\%$, the best a.c. measurements are at least an order of magnitude less accurate. The a.c. voltage is usually measured in terms of a d.c. equivalent, and the translation from one to the other has to cost accuracy.

The scales on almost all a.c. voltmeters are calibrated in terms of r.m.s. voltage. However, until a year or two ago,

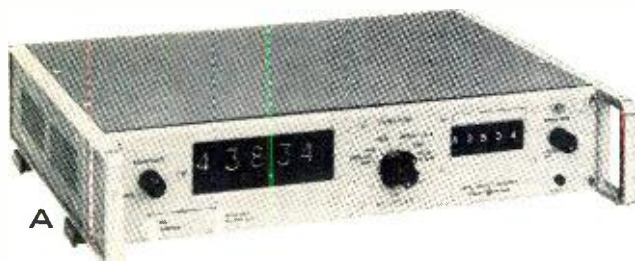

(A) Another example of an electronic counter is the Hewlett-Packard 5214L. This instrument totalizes and measures frequency and period. In addition, it can directly display readings in practical units, such as gallons/sec. or ft./min. from appropriate transducers. Two sets of decades are used: one to register the signal being counted; the other may be preset to any number from 1 to 100,000 to control a gate circuit that may be used to operate other equipment. Unit can be used to monitor automated processes, and for production testing and for laboratory applications. The price of the electronic counter is \$1475.

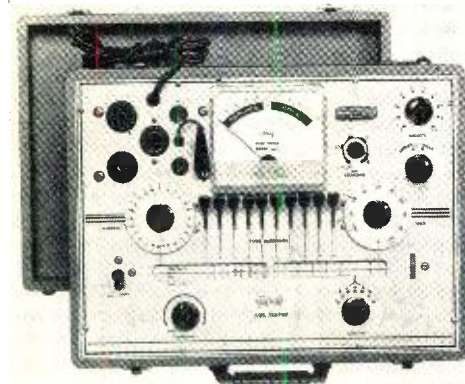

(B) There is still much equipment in use that employs vacuum tubes. To check the performance of these tubes on the service bench requires an easy-to-use, flexible tube tester, such as the Triplett 3414 shown. This unit checks for shorts, leakage, and plate conductance. A self-contained roll chart supplies test setup data. Sockets are provided for octal, loctal, and miniature tube types. The price of the tester is \$109.50.



(C) An example of direct-reading, accurate capacitance bridge that can measure very small capacitance values is the Boonton Electronics 75B shown. The instrument was originally designed for use in measuring the temperature coefficient of small “zero temperature coefficient” ceramic capacitors. It is also used for capacitance measurements of semiconductors at millivolt levels. Lowest range of the bridge is the extremely small value of only 0.1 pf. full-scale. Values as high as 1000 pf. can be measured with this particular capacitance bridge. Price: \$1375.

most voltmeters actually responded to either peak or average value, with the scale conversion in terms of r.m.s. voltage assuming sine-wave input. Now "true-r.m.s." voltmeters have begun to appear in quantity. The most common type of true-r.m.s. voltmeter measures a.c. voltage in terms of its heating effect on a thermocouple. This effect is compared with the heating effect produced by a reference voltage. Other true-r.m.s. meters use dynamometers and rectifiers whose non-linearities synthesize r.m.s. response. True-r.m.s. response cannot be maintained by these means for all input waveforms, and the specification "maximum crest factor," that is, the maximum ratio of peak to r.m.s. voltage for which the voltmeter is reliable, is especially significant in pulse work.

The peak- and average-responding voltmeters are highly refined from years of development, and will probably continue to enjoy considerable popularity based on their price advantage.

Most peak instruments rectify the input voltage and then amplify the d.c. Their chief advantage is good high-frequency response. Also, since they include a d.c. amplifier, they can be made to measure both a.c. and d.c. voltage quite easily. A disadvantage at low voltages is that the a.c. output no longer bears a linear relation to the a.c. input.

The typical average-responding voltmeter first amplifies the input signal, then rectifies it. A wide-band amplifier, stabilized by negative feedback, is generally used. Although its high-frequency limit is well below that of the peak-responding voltmeter, it can measure much smaller voltages.

At very high frequencies, broadband amplifiers are difficult to design. At low voltage levels, rectifiers assume complicated characteristics. Therefore, the measurement of high-frequency, low-level voltages poses a special problem. One method of solving it is to accept the complex rectifier behavior and compensate for it on the meter scale. Another is to use a matched pair of semiconductor rectifiers, one to rectify the input voltage, the other to rectify a low-frequency reference voltage, and to compare the d.c. outputs. Commercial instruments of both types are available.

The measurement of very small d.c. voltages is best accomplished by an electrometer. Some electrometers convert the small d.c. voltage to an a.c. voltage that is amplified and metered, while others use direct-coupled amplifiers. A good electrometer can measure d.c. voltages down to a few microvolts or less and currents to below 100 femtoamperes (a femtoampere is equivalent to 10^{-15} ampere).

Wave Analyzers & Graphic Recorders

Many voltmeters travel under other names, because they are only indirectly concerned with mere measurement of voltage. An example is the frequency-selective voltmeter known as a wave analyzer. Operating ahead of the voltmeter in a wave analyzer is a filter that passes only a certain frequency band. The bandwidth is a constant number of cycles in some analyzers, a constant percentage of center frequency in others. The constant-cps bandwidth is generally more useful except at very low frequencies or where a logarithmic plot is required. Optimum bandwidth depends on how much detail you need. Very narrow bandwidths give more data but require more time for analysis. Wider bandwidths offer greater convenience at the cost of some detail. A wave analyzer with switch selection of two or three bandwidths lets you have your cake and eat it, too.

Of course, the chief application for wave analyzers is waveform measurement, and thus the oscilloscope and graphic recorder are important accessories.

The combination of a wave analyzer and an oscilloscope or recorder is known as a spectrum analyzer. Spectrum analyzers are available from very low frequencies to at least 100,000 mc. Most use automatic frequency sweeping to give continuous oscilloscope display. The modern spectrum analyzer combines the features (Continued on page 72)

ON OUR COVER

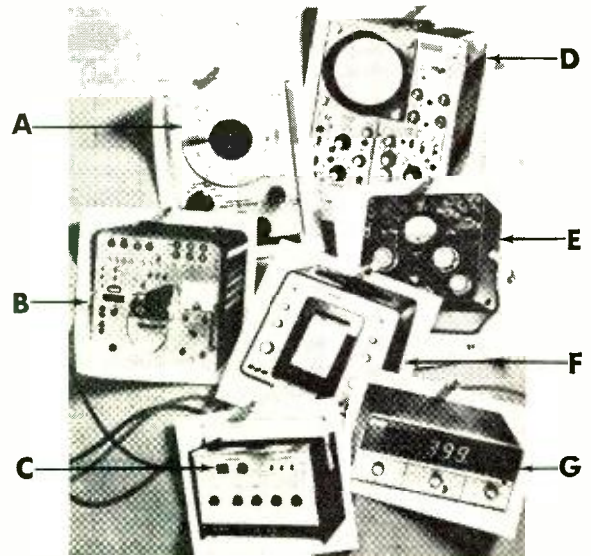

THE group of electronic test instruments on our cover this month indicates, in a small way, the tremendous variety of equipment being used in laboratories and on service benches.

For example, the portable audio oscillator at (A), the Hewlett-Packard 204B, is designed for reliable audio work in the laboratory or field. It is fully transistorized and battery-operated with a balanced, isolated 600-ohm output. The frequency range of 5 cps to 560 kc. means that the oscillator can be used for generating signals outside of the audio range as well. Price: \$315.

The field of automatic testing is represented by the Lavoie "Robotester" LA-303, shown at (B). This is an automatic, tape-programmed measuring instrument that can select any 2 of 250 circuit points and then automatically measure resistance, d.c. or a.c. voltage, insulation resistance, and impedance. Between 60 and 100 tests per minute indicate wiring or assembly failures by flashing-light indicators. Price of the basic unit is \$5600.

Representing the TV-servicing field is the Sencore CA122 color-circuit analyzer (C). This instrument generates all the test patterns (color bars, dots, cross-hatch) and signals for checking and adjusting the circuits in a color-TV receiver from antenna to tri-color picture tube. There are 10 crystal-controlled gated color bars of the RCA type. Signals are available in both r.f. and i.f. ranges; there are also video, sync, and audio signals for checking these portions of the TV set. Price: \$187.50.

One of the most useful and versatile pieces of test equipment is the cathode-ray oscilloscope, represented on our cover by the Fairchild-DuMont 766H (D). This is a bench and portable lab scope with a bandwidth from d.c. to 25 mc. The unit uses silicon transistors and features a new high-brightness CRT. The high sensitivity of 5 mv./cm. is provided with a rise time of 15 nsec. Price is \$545 without the plug-in preamps and time-base generator.

A universal, general-purpose impedance bridge, the General Radio 1650-A, is shown at (E). This is a self-contained, battery-operated, portable instrument for the measurement of: inductance and "Q" of inductors; capacitance and dissipation factor of capacitors; and a.c. and d.c. resistance of resistors. The unit is actually five bridges in one, together with a transistorized 1-kc. oscillator and sensitive detector. This bridge has an accuracy of $\pm 1\%$ and is priced at \$475.

Graphic recorders are widely used in industry when a written record is required of one or more variables. The instrument (F) is the Brush Mark II recorder. Two channels of analog plus two of coded event or time data may be directly written on the moving roll of chart paper. Four chart speeds are available and, at the slowest speed, over 25 hours of data can be recorded on a 300-foot chart roll. Available for either ink or electric writing, the recorder is priced at \$1495.

Where high-speed, accurate voltage measurements are required, especially by non-skilled personnel, and where this measurement is to be available in digital form, the digital voltmeter is used. The Dynascan 111 shown at (G) is an example of a simple, fairly inexpensive instrument of this type. This unit uses all solid-state circuitry except for a single nuvistor. There are four ranges: 1, 10, 100, and 1000 volts d.c. with either polarity at an input impedance of 11 meg on all ranges except for 1 meg on the lowest range. Accuracy is $\pm 0.1\%$. Price: \$399.50. ▲

the INSTRUMENT CALIBRATION and REPAIR



(Left) Teletypewriter is tested with specially built test console.
(Right) Checking voltage and current calibration of standard meter.

A growing field for qualified electronics technicians and engineers in government, military, and industrial laboratories in this country and all around the world.

By GROVER C. GEDNEY & FRANCIS M. WINTERBURG / Federal Electric Corp., Service Associate of ITT

ASTRONAUT Walter Schirra's flight was held up for five days because one pressure transducer was out of tolerance by 1½ pounds. This error in a simple instrument made necessary a new countdown and the expenditure of many, many thousands of extra dollars.

Accuracy in this case was critical. It is just as critical—if not as dramatic—in countless instances every day. Military operations, industry, and laboratories around the world all require greater and greater degrees of accuracy. The instruments which provide this accuracy could not serve their purpose properly without accurate calibration.

Calibration is the comparison of one instrument with another which has a higher order of accuracy. The ultimate in standards in this country are at the National Bureau of Standards in Washington, D.C. and at Boulder, Colo.

The importance of calibration cannot be overstressed. Research and development, manufacturing, and the installation of complex systems in the field can only be successful if measurements are taken by instruments calibrated to give nearly identical readings during each of these stages. For example, one microvolt prescribed by the design engineer in the laboratory must be read and set to one microvolt by the test technician during field installation.

There are, broadly speaking, three categories of instruments: (1) *Test instruments* are used to test and set up systems or equipment in the lab, factory, or in the field, and are of medium to high accuracy. (2) *On-line instruments* are associated with processing plants and other facilities utilizing automated production techniques, and are usually of lower accuracy. (3) *Precision-measurement instruments* are more unique, due to their specialized applications. These are used in space capsules, missile ranges, built-in test consoles and the like, and require a high degree of accuracy.

All of these must be calibrated but not at the same intervals. Here are some typical calibration intervals.

Daily	Six-month Interval
WWV receiver	Potentiometers High-resistance ohmmeters Decade capacitors Decade resistors
30-day Interval	Shunts Slotted lines Standard cells Ratio transformers Voltage regulators
Digital voltmeter Digital radiometer Digital divider	
90-day Interval	One- to two-year Interval (All NBS certified standards)
Frequency meters Oscillators Oscilloscopes V.T.V.M.'s Generators Galvanometers Resistance bridges	Standard cells Standard resistors Standard capacitors Standard inductors Standard potentiometers

While test instrument calibration and repair are closely allied, they require different levels of technical competence.

Standards-lab technicians perform lengthy and very precise calibration of the highest level, usually with secondary standards certified by the National Bureau of Standards. They must be proficient in the theory of instruments and the mathematical calculations necessary to determine probability of error and long-term reliability. They usually work in a controlled environment where temperature fluctuates not more than a degree, where humidity is held at plus or minus 10%, and where dust particles are no larger than 10 microns. The work is exacting, requires considerable training and experience. Base salaries range from \$6000 to \$9500. Highly qualified standards-lab technicians are hard to find.

Test-equipment technicians are called upon to diagnose and repair the many types of faulty and inoperative instruments which are brought to them. Their work is rarely routine, and they must be capable of operating independently, with a minimum of supervision. If gifted with the ability to

train others quickly. a test-equipment technician may soon be given the opportunity of assuming supervisory responsibilities. He must respect the mission of the standards lab and establish a confidence in the accuracies to which standard instruments are calibrated for his use.

This category of technician, too, is in relatively short supply and the pay scales are only slightly lower than for the standards-lab group—approximately \$5000 to \$8000 a year.

As in other branches of electronics, the opportunities for graduate engineers in this particular field of electronics are growing steadily. The demand for specialized training in this area has been great enough for George Washington University to establish a "Center for Measurement Science" which offers an engineering curriculum oriented to the measurement field. Called "metrologists," these engineers develop new measurement criteria and prepare measurement and calibration procedures which the technician may perform. They may be called upon to assist technicians in solving difficult instrument troubleshooting problems, or to determine the probable error of calibration in several instrument systems tied together. Salaries range from \$6000 to \$15,000 and more.

Background Requirements

Most of the instrumentation we are concerned with at *Federal Electric Corporation* is in the electrical-electronic field. To qualify for employment in one of our calibration and repair facilities, a man must be a high-school graduate; he must have had one or two years of electronic schooling in a trade service school or engineering college; and three years of experience, at least one of which was in the test instrument field.

Math is extremely important; the more the better. We look for people who have had college physics, college algebra, trigonometry, analytical geometry, statistics, and even calculus. Any math above the high-school level conditions a man's mind to think along technical lines.

With this background, we can train technicians for calibration work on the job. Let's take, for example, a position in our DEW Line Communications and Electronic Equipment Depot.

The man usually begins by working with a more experienced man on the repair and overhaul of meters, or in troubleshooting a piece of test equipment. He then begins to assist in the calibration of test equipment. We have a set of written procedures to follow that becomes routine with experience. After a month or two of this, he may be ready to become a member of the mobile calibration team. This is a group of five technicians who carry certified instruments from our headquarters in Paramus, N.J. to different areas of the DEW Line Early Warning System in the Arctic, where they calibrate the test equipment that keeps the giant communications and radar system operating at peak efficiency.

After months of mobile team experience, a technician may be qualified to begin work in the Standards Laboratory. He

will assist the more experienced men, learn the procedures, and become proficient in the techniques of transfer calibration from NBS standards to our secondary standards.

In choosing a calibration technician for the Early Warning System, a man who is single and willing to travel is preferred to a married man. We do have married men working on the mobile teams and will hire them if well qualified, but the single man is given preference because of having fewer home responsibilities.

These mobile teams travel to Alaska, across Canada at the Arctic Circle, and into Greenland and may be gone for four months at a time. They return to the Communications and Electronic Equipment Depot for three or four weeks to recalibrate their standard instruments and then again return to the DEW Line.

There is adequate opportunity for the married man with a family in the fixed laboratories or facilities. Only on mobile teams staying away from a home base for a considerable period of time is the unmarried man preferred.

Opportunities for Technicians

The instrument calibration and repair field is growing and the supply of qualified men is completely inadequate. For example, there are only about 14,000 engineers and technicians who are members of the Instrument Society of America. The U.S. Air Force, to cite another example, has within the past five years: (1) installed a standards laboratory at Newark, Ohio; (2) built 19 area laboratories; and (3) added 149 precision measurement laboratories.

Within industry, the example of the *International Telephone and Telegraph Corporation* might be of interest. To assure the accuracy and reliability of its products, *ITT Federal Laboratories* established in 1956 one of the first large-scale standards laboratories to serve an industrial facility. For several years, the calibration and repair of test instruments have been important services of *Federal Electric Corporation*.

The instrument technician of today is not confined to the laboratory or factory. If he is well qualified, he enjoys an unprecedented demand for his services. ▲

ABOUT THE COMPANY

The Federal Electric Corp. operates instrumentation calibration centers in this country and overseas. At Paramus, N.J. there is the Communications and Electronic Equipment Depot established by the Air Force to repair and calibrate our Early Warning System instrumentation. There are 40 people employed there, including three traveling calibration teams made up of five technicians each. Some 20 are employed at an instrumentation center in Albuquerque, N.M. to serve Sandia Corporation, prime contractor for the Atomic Energy Commission, and other users in the Southwest.

The company also operates a standards laboratory at Chateauroux, France, serving the Air Force in Europe, Near and Middle East, and Africa. This group, consisting of 125 people, has technical teams and mobile calibration trailers for on-site checking and repair of electronic equipment. Over 400 are employed by the company in our Pacific Missile Range. These are responsible for the operation and maintenance of the Navy's range instrumentation facilities at Point Arguello and the missile launch facilities in California. Over 1500 pieces of precision measuring equipment are calibrated and repaired by this facility, which has its own 15-man standards laboratory.

(Left) Technician is shown calibrating a u.h.f. signal generator. (Center) Calibration of a vacuum-tube voltmeter against a standard. (Right) Checking an oscilloscope time base against a master frequency standard.



NAVAL OBSERVATORY TIME SIGNALS

By H. CHARLES WOOD

Description, use, and schedules for the "time ticks" that are broadcast on low, medium, and high frequencies.

Editor's Note: Although not as widely known and used as the National Bureau of Standards WWV and WWVH time signals, useful time signals are also broadcast by a number of Navy radio stations to ships around the world. This article discusses these time signals, tells how to interpret them, and gives the broadcast schedules of the stations involved.

JOHN HARRISON of Yorkshire, England is credited with developing the first practical shipboard clock (or chronometer) in 1735, and thus earned a handsome reward of £40,000 from the British Parliament. Prior to that date, accurate navigation on the high seas could not be achieved, because one of the major factors of celestial navigation is an accurate knowledge of time; an impossible feat in the days of the Ancient Mariner. This accounted for a seaman's reluctance to venture beyond the sight of land.

It wasn't long after Harrison's invention was made available to sea captains that new problems arose, the most important of which was the inability to predict the daily rate of error of the chronometers when the vessels were away from their home ports for a long period of time. This error is normally applied to the watch-time to determine the correct local time.

A small step forward was made in the 19th century when most of the major ports of the world were equipped with a "time ball" which was dropped from a conspicuous location in the harbor at noon. The sea captains in port would then set their chronometers accordingly. Unfortunately, however, not all port officials had the correct time. The problem of incorrect time, and the consequent error in a ship's position, continued throughout the 19th century, resulting in much loss of life and property, and was not solved until the invention of radio at the beginning of the 20th century.

Stations & Schedules

In 1904, U.S. Navy Radio Station NSS, newly established at Washington, D.C., began broadcasting time signals synchronized with the precision clocks at the Naval Observatory. This was the first significant advancement since Harrison perfected his invention nearly two centuries before, for now at last mariners all over the world could correct their chronometers with a signal of known accuracy.

Throughout the years, the U.S. system of radio time signals has been improved in accuracy and presentation, the power of the transmitters has been increased, new frequencies have been added, and new Naval radio stations have been built. Today, there is scarcely a spot on the planet that is not within range of at least one of the daily time signals.

Naval Observatory time signals are now being broadcast at

numerous times throughout the day by five widely separated Navy radio stations: NSS Washington, D.C.; NBA Canal Zone; NPG San Francisco, California; NPM Honolulu; and NPN Guam. The hours of the transmissions and the frequencies of emission are listed in Table 1. At the top of each tabulation are the call letters, location of the station, and the frequency of transmission in kilocycles. The Greenwich Mean Time (GMT) of transmission is located in the left-hand column, followed by a conversion to the zone times maintained throughout the United States. Local time for any other location can be computed by applying the time zone number to the GMT. For example, Los Angeles, California is located in time zone +8. This means that 8 hours must be subtracted from GMT to obtain the local time of Los Angeles. Thus the 2400 hours midnight time signal will be heard in California at 1600 hours local time (4:00 p.m. for you landlubbers). It will be one hour later if your community is on daylight saving time. World time zone charts are available at U.S. Hydrographic Offices, nautical equipment stores, and most bookshops.

Now let's examine the time signal itself, as it is graphically displayed in Fig. 1. Essentially, (Continued on page 82)

STATION: NSS Washington, D. C.

Frequency in kc.: 121.95; 5870; 9425; 13,575; 17,050.4; 23,650

GMT =	Eastern Std. Time Zone +5	Central Std. Time Zone +6	Mount. Std. Time Zone +7	Pacific Std. Time Zone +8	Alaska-Honolulu Time Zone +10
0155-0200	2055-2100	1955-2000	1855-1900	1755-1800	1555-1600
0555-0600	0055-0100	2355-2400	2255-2300	2155-2200	1955-2000
0755-0800	0255-0300	0155-0200	0055-0100	2355-2400	2155-2200
1155-1200	0655-0700	0555-0600	0455-0500	0355-0400	0155-0200
1355-1400	0855-0900	0755-0800	0655-0700	0555-0600	0355-0400
1755-1800	1255-1300	1155-1200	1055-1100	0955-1000	0755-0800
1955-2000	1455-1500	1355-1400	1255-1300	1155-1200	0955-1000
2355-2400	1855-1900	1755-1800	1655-1700	1555-1600	1355-1400

STATION: NBA Balboa, Canal Zone

Frequency in kc.: 147.85; 5448.5; 11,080; 17,697.5

GMT =	Eastern Std. Time Zone +5	Central Std. Time Zone +6	Mount. Std. Time Zone +7	Pacific Std. Time Zone +8	Alaska-Honolulu Time Zone +10
0455-0500	2355-2400	2255-2300	2155-2200	2055-2100	1855-1900
0955-1000	0455-0500	0355-0400	0255-0300	0155-0200	2355-2400
1655-1700	1155-1200	1055-1100	0955-1000	0855-0900	0655-0700
2355-2400	1855-1900	1755-1800	1655-1700	1555-1600	1355-1400

STATION: NPG San Francisco, California

Frequency in kc.: 114.95; 4010; 6428.5; 9277.5; 12,966; 17,055.2; 22,635

STATION: NPM Honolulu

Frequency in kc.: 131.05; 4525; 9050; 13,655; 17,122.4; 22,593

STATION: NPN Guam

Frequency in kc.: 484; 4955; 8150; 13,530; 17,530; 21,760

GMT =	Eastern Std. Time Zone +5	Central Std. Time Zone +6	Mount. Std. Time Zone +7	Pacific Std. Time Zone +8	Alaska-Honolulu Time Zone +10
0555-0600	0055-0100	2355-2400	2255-2300	2155-2200	1955-2000
1155-1200	0655-0700	0555-0600	0455-0500	0355-0400	0155-0200
1755-1800	1255-1300	1155-1200	1055-1100	0955-1000	0755-0800
2355-2400	1855-1900	1755-1800	1655-1700	1555-1600	1355-1400

Table 1. Schedule of the U.S. Naval Observatory time signals.

Fig. 1. Arrangement of "time ticks" as transmitted by stations.

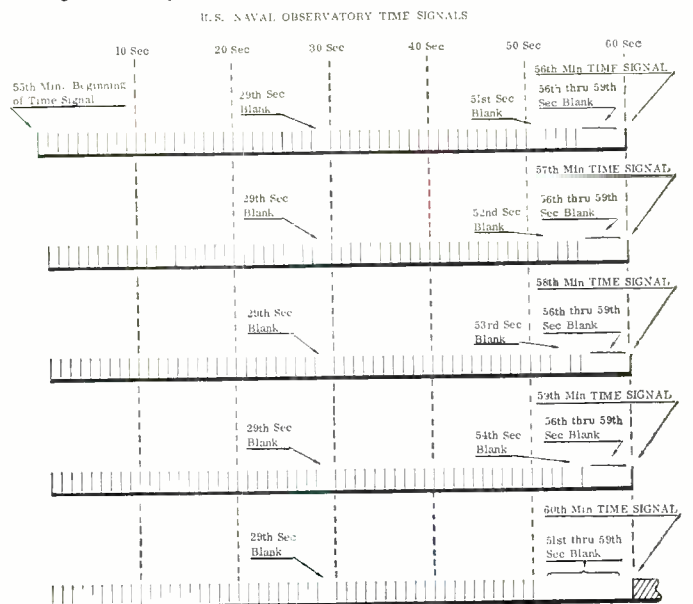

SIGNAL-GENERATING EQUIPMENT

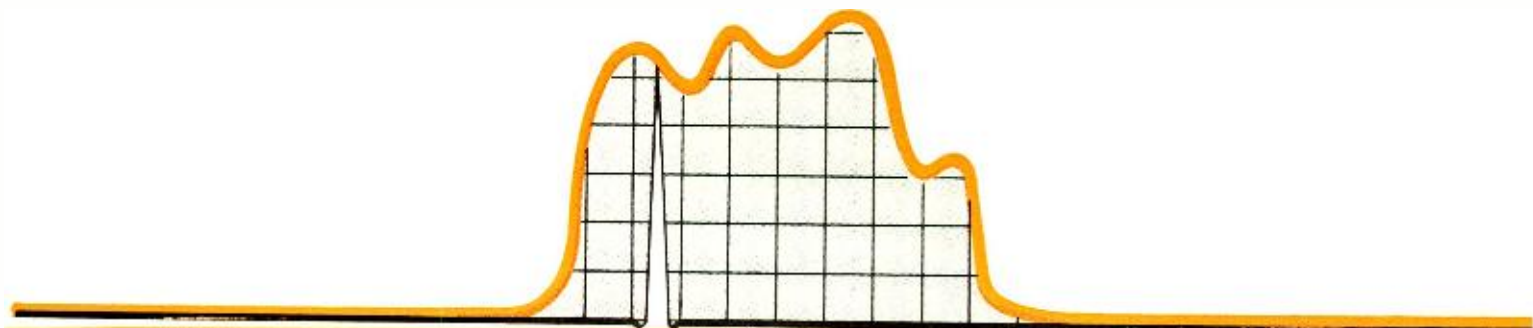

Devices used to generate test signals from below the audio range up through microwaves. Performance, specifications, and effect of semiconductors on equipment design are covered.

By HOWARD L. ROBERTS / Hewlett-Packard Co.

SIGNAL-generating equipment comprises a wide variety of electronic instruments for generating test signals. This class of instruments includes everything from the human finger, placed on a grid connection, to complicated check-out equipment which automatically generates a number of frequencies, voltages, and other signals for quickly testing intricate missile systems.

The finger test may be all that you need if you merely want an indication of whether the equipment is working or not. But when you need to know *how well* the equipment works, then the appropriate piece of signal-generating equipment must be called upon to provide the answer.

If, for instance, you want to measure distortion in an audio amplifier, you need an oscillator that generates sine waves with far less distortion than you expect the amplifier to have. If you want to measure the rise time of a switching circuit, you ought to have a pulse generator that produces pulses with rise times faster than the switching circuit.

Types of Equipment

Signal-generating devices may be loosely grouped into two categories: special-purpose and general-purpose generators. Special-purpose generators are designed for specific kinds of tests and usually generate only those combinations of frequencies needed to test certain kinds of equipment. An example of this type is an FM stereo test generator. Special-purpose generators are best suited for making repetitive measurements since their built-in features make specific tests faster.

General-purpose equipment may not have many combinations of signals but usually can generate signals over broader ranges of frequency and amplitude. These generators find most use in the experimental and development laboratory, both professional and hobbyist, but are often used for specific tests as well. Presumably, any test performed by a special-purpose generator can be performed by an assortment of

general-purpose equipment, but several instruments may be required to do the same job.

Since the basic design principles involved in general-purpose laboratory instruments are also used in special-purpose generators, we'll confine this discussion to general-purpose instruments.

Signal-generating equipment is often grouped according to the shape of the output signal waveform. Sine-wave generators form one important category since the sine wave is the most fundamental waveform. These instruments are widely used to test equipment performance at discrete frequencies.

Oscillators and Signal Generators

Among sine-wave generating equipment, a distinction is made between oscillators and signal generators. A signal generator is an oscillator that has accurately known amounts of output power as well as known frequencies. In many cases, this means simply that a signal generator has a meter to show the power generated by the output stage, and a precision attenuator for cutting down the indicated power by known amounts.

At audio frequencies it is a simple enough matter to read oscillator output with a lab voltmeter. For this reason, output meters are not included in the majority of audio oscillators. At r.f. frequencies, though, voltage measurements are more com-

When an accurate, stable v.h.f. signal source is required for receiver or v.h.f. amplifier measurements, then a standard signal generator is required. Our example is the Hewlett-Packard 608D. The instrument is especially suited for precise tests of narrow-band v.h.f. aircraft communications equipment. It has a calibrated output of 0.1 μ v. to 0.5 v. throughout the 10 to 420-mc. band. Output frequency can be set to within a few kc. with built-in crystal calibrator. Price: \$1300.



plex so that r.f. generators include a built-in output meter designed especially for each generator. (An r.f. generator without a meter is known as a "signal source.")

RC oscillators have dominated the audio and neighboring ranges for more than twenty years. This range extends from subsonic through ultrasonic and into the low-frequency r.f. ranges.

RC oscillators are so named because their frequency-determining networks consist only of resistance and capacitance—no inductance whatever. The reason for using an RC circuit is that if an LC circuit were used, the large inductors required for low-frequency oscillations would be much too cumbersome. The RC oscillator is much lighter, easier to build, and, as it turns out, a good source of distortion-free sine waves.

These oscillators generally use some form of amplitude limiting other than driving a tube to cut-off and/or saturation. The most common form of amplitude control is the use of a small incandescent lamp as a non-linear resistance in one of the feedback loops. The lamp's resistance changes, if the oscillation amplitude changes, readjusting the amount of feedback to counteract the change in amplitude. This type of limiting prevents the tubes (or transistors) from being driven beyond their linear operating regions and accounts for the low distortion output of these oscillators.

The oscillator circuit may also be followed by a tuned amplifier-filter ganged to the tuning dial so as to track the oscillator tuning. Filtering attenuates what little harmonic content there may be in the oscillator signal, resulting in hyper-pure sine-wave output. This type of instrument is most useful for making distortion measurements on other types of equipment.

Multivibrators with very long time constants are used in instruments for the very low frequencies, some of these operating as low as 0.001 cps (about 1 cycle per 15 minutes!). Multivibrators generate square waves, of course, but the square waves are changed to sine waves by wave-shaping networks. This is just opposite to the audio-range sine/square wave generators which start with sine waves and form these into square waves with clipping or triggering circuits.

Above 1 mc., the usual RC oscillator runs into certain problems. The tuning capacitors are in a range of values comparable to distributed circuit capacitance which makes tuning less precise. Phase-shift oscillators, a different form of the RC oscillator, swamp out the stray capacitances and can be used up to 10 mc. and beyond.

Beat-frequency oscillators are also used throughout the low-frequency region. These instruments use two r.f. oscillators, one generating a fixed frequency and the other being tunable.

The outputs of these oscillators are mixed and the difference frequency is separated from the mixture by filter circuits.

The advantage of the beat-frequency oscillator is that very wide frequency ranges can be covered by a single sweep of the tuning dial, at the expense of tuning resolution however. The disadvantage is that the oscillators must be made many times more stable than the desired stability of the output signal because of the large step-down in frequency. High-quality beat-frequency oscillators made for laboratory applications do achieve the desired stability, however.

R.F. Signal Generators

The designation "r.f." is another all-embracing term, originally referring to signals that were destined to be radiated or detected as radio waves. As it turns out, radio signals are now propagated at frequencies even lower than 20 kc. (standard frequency broadcasts such as WWVL) and at super-high frequencies measured in thousands of megacycles (gigacycles). Our discussion here will be confined mainly to those radio-frequency generators which have lumped LC circuits, using coils and capacitors in the resonant circuit.

During the forty-odd years that these generators have been used, they have undergone considerable refinement. Factors which upset frequency stability have been designed out of the circuits. Manufacturers have learned how to wind coils tightly of low expansion wire on matched ceramic forms so that there is little change of inductance with a change in temperature. In high-quality generators, capacitors are made from rigid precision-machined plates, which are silver- or gold-plated for minimum resistance to r.f. surface currents (skin effect). In recent years negative feedback has been used in various ways to improve amplitude stability and modulation characteristics.

Even with all these refinements, a good r.f. signal generator still includes an accurate crystal-controlled frequency calibrator to enable precise setting of frequency. The calibrator frequency is usually a whole number, such as 1 mc., so that it is easy to spot the harmonics.

Such r.f. generators also include amplitude or frequency modulation capabilities. This enables the generator to supply signals which resemble the actual signals to be used by the equipment being tested.

When the response of a sharp cut-off filter or i.f. circuit is being measured, modulation may wobble the r.f. frequency across the circuit's cut-off point, broadening the apparent response curve. For this reason, most r.f. generators use the master oscillator-power amplifier (MOPA) configuration which isolates the oscillator from the output amplifier, per-

Designed mainly for servicing AM, FM, and TV receivers is the Hickok 288AX sweep and marker generator. The instrument has 8 bands of unmodulated or AM signal output from 35 kc. to 110 mc. as well as frequency-modulated output up to 160 mc. A built-in audio oscillator, tunable from 20 to 15,000 cps, is used for modulation or for audio tests. A crystal calibrator, with a choice of 100- or 1000-kc. signals, is also provided along with a 3-range decibel meter. Price of this unit: \$315.



An example of a versatile pulse generator is the Fairchild-DuMont 404-B. This device can generate pulses suitable for use in signal-sampling techniques in conjunction with oscilloscopes. Another application is to trigger scope sweeps at the proper time to view the leading edges of very short transients. Pulses can be generated with widths continuously variable from 0.05 to 105 μ sec., with various delays, and with repetition rates up to 250,000 p.p.s. Generator price: \$760.

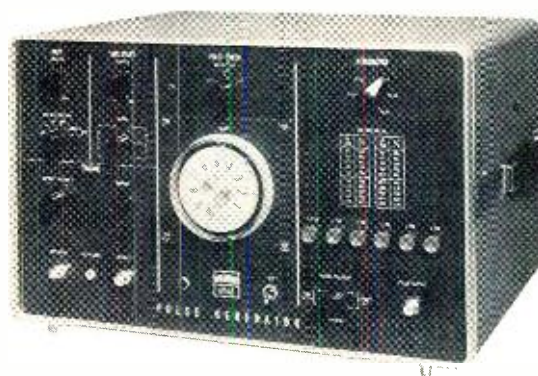

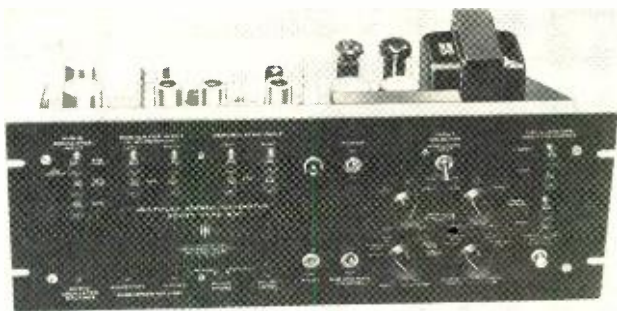

A multiplex stereo generator developed for design and production testing of FM multiplex adapters, tuners, and receivers is the Scott 830. The unit has also been used by FM broadcast stations to produce a composite stereo signal. When feeding a composite stereo signal into the front end of a tuner, the generator's output is used to modulate a laboratory-quality standard FM signal generator. The price of the unit: \$600.



Intended mainly for the service technician working on FM multiplex equipment is the Fisher Model 300 multiplex signal generator. The instrument is also suitable for use in production testing. Incorporated are an audio oscillator and an r.f. generator, which is factory tuned to the approximate center of the standard FM broadcast band. An output-level indicator is also provided. Price of generator: \$495.

mitting amplitude modulation of the amplifier without affecting the frequency of the oscillator.

The output impedance of r.f. generators deserves special comment. If the output cable and load impedances aren't the same, r.f. energy reflects from the load, giving rise to standing waves. If the generator itself is not matched to the output cable, then reflections are re-reflected, which alters the character of the standing wave and interferes with measurement accuracy. Most r.f. generators are matched to one of the 50, 75, or 300-ohm impedance levels commonly used but pads or baluns are required to match other impedances.

Because of standing waves, the r.f. voltage at the generator may be different from the load voltage. For this reason, an output voltmeter is a reliable indicator of signal strength only when the load is matched to the generator.

The attenuators of r.f. generators require careful design to account for distributed capacitance and inductance. These devices are frequency-sensitive unless components are positioned carefully. Furthermore, the impedance of the attenuator must be matched to the output cable at all settings.

U.H.F. and Higher Frequencies

Above 300 mc. the inductance and capacitance of tuned circuits become so small that it is difficult to treat them as discrete circuit elements. At these higher frequencies, resonant cavities of one sort or another are generally used as the resonating elements.

Gridded tubes for u.h.f. frequencies have rather odd shapes so that all elements make contact at the right place when installed in a cavity. Above 1000 mc., klystrons are most often used as oscillators.

Microwave signal generators use a single power oscillator for the r.f. channel, avoiding the cost and complexity of a power output stage. Because of this, modulation is usually restricted to pulses and square waves. Modulating waveforms turn the power oscillator completely off and on, making the transition between off and on states as fast as possible to minimize frequency pulling or FM as the klystron voltage changes. On the other hand, it is relatively easy to frequency-modulate a klystron over a range of a few megacycles by applying a saw-tooth voltage to the klystron repeller.

The attenuators of these generators also avoid the use of lumped circuit elements, the waveguide-beyond-cut-off type being favored. This attenuator uses a pickup loop which slides in and out of a length of waveguide that opens into the resonant cavity. The waveguide dimensions are smaller than those required to carry an electromagnetic wave at the frequency of the oscillator but the cavity's magnetic field

leaks into the waveguide. The further the loop is from the cavity end, the weaker the field is and, what is more, the field strength drops off in a predictable manner so that these attenuators are inherently accurate.

Sweep Generators

Sweep generators are indispensable for anyone concerned with circuit response throughout a band of frequencies. A straightforward way of obtaining a sweep frequency is to add a motor drive to the oscillator tuning dial. This approach is widely used at audio and low frequencies, where electronic techniques for changing frequency fail to achieve the necessary wide (in terms of number of octaves) bandwidth. The beat-frequency oscillator shines here as a means of getting wide sweeps.

Motor drives are also used at radio frequencies but vibrating capacitors often serve to vary the oscillator frequency. At microwave frequencies, the voltage-tuned backward-wave oscillator (b.w.o.) can easily sweep through an octave band of frequencies simply by modulating the helix voltage.

Motor-driven sweeps, unless carefully designed, cause mechanical vibrations which induce microphonics that generate spurious oscillations. Motor-driven sweeps are also limited in speed. Electronic sweeps, which vary the oscillator tank circuit's resonant frequency either with a reactance tube, a voltage-variable capacitor, or a saturable reactor, are used wherever possible.

Many service-shop sweep generators have a fixed sweep rate of 60 cps, taken right from the power line. This simplifies circuitry and also makes synchronization of related oscilloscopes easier.

Circuit response is usually displayed on an oscilloscope. The sweep rate should be fast enough to obtain a flickerless display. Slow sweep rates are required for pen recorders which may trace with more detail than a scope does.

Pulse and Square-Wave Generators

Pulse and square-wave generators produce signals of an "off-on" nature by switching between two d.c. levels. These generators are used to check systems which operate in a pulsed mode, such as radar modulators, oscilloscope triggering circuits, computer circuits, and teletypewriter systems. These generators are also used for transient response testing of linear systems.

The shape of the input pulse or square wave has to be neatly rectangular if anything is to be learned from the shape of the output pulse. Rounding of the pulse corners, or overshoot, wiggles, and sag of the pulse top, are the symptoms of system performance so should not be present on the

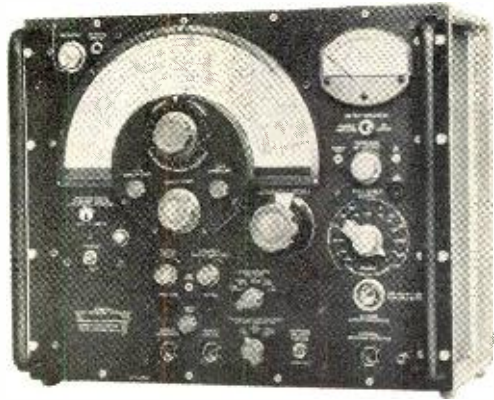

In order to take quantitative r.f. frequency response measurements, a sweep-frequency generator is used. The response curve, traced on a scope, is usually marked with a marker generator. Incorporating both functions in a laboratory instrument is the General Radio 1025-A. The unit covers 0.7 to 230 mc. plus two bandspread ranges (400-500 kc., 10.4-11 mc.) for i.f. curves. The accurate marker pip is continuously adjustable in frequency and amplitude. Price: \$3250.

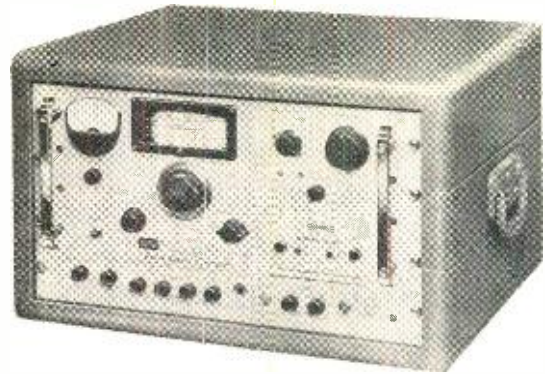

Another example of sweep-frequency generator is the Jerrold Model 900-B. This instrument, which has been designed for laboratory or production use, generates sweep signals with center frequencies from 500 kc. up to 1200 mc. in the u.h.f. range. Sweep widths vary from a narrow 10 kc. to a wide 400 mc. for the higher frequencies. The unit also has built-in crystal-controlled harmonic markers and provision for external variable marker signal generator. Price of unit: \$1980.

input pulse that is produced by the pulse generator employed.

A square-wave generator is really a pulse generator having equal "on" and "off" times. "On" time duration therefore varies with frequency. Pulse generators have one control for frequency, or pulse repetition rate, and a separate control for "on" time duration, or pulse width. "On" time is usually much shorter than "off" time so that pulse generators are often used to drive r.f. oscillators or other circuits where high power is needed during the pulse but where average power should be kept low.

These generators usually use some form of multivibrator circuitry for wave generation with clipping circuits and other devices for "squaring up" the waveform. An exception is the mercury-wetted relay which, unlike ordinary relays that have a certain amount of contact bounce, latch on for good when contact is made. Generators using these relays are able to generate high power pulses with turn-on times (rise times) measured in fractions of a nanosecond (10^{-9} second) but their use is limited because of relatively slow repetition rates.

Noise Generators

Measuring signal-to-noise ratios in receivers with sine waves or other coherent signals is complicated because of theoretical considerations involving bandwidth and noise power per cycle bandwidth. This difficulty is circumvented by using broadband noise from a suitable generator as the test signal. A comparison of receiver noise output without signal input to noise output with a known amount of noise power at the input, provides a measure of receiver performance.

Noise generators are also used as a source of broadband signals. Since "white" noise is an equal mixture of all frequencies, a test using a noise voltage as the input is a test which covers the complete range of a system all at once. This is a good one to use for spotting any resonances in audio systems or in acoustic measurements.

Broadband noise sources require careful design; otherwise, resonances may prevent an equal-energy distribution for all frequencies. Noise sources include hot resistors, gas tubes, and temperature-limited diodes (these are diodes operated with low filament voltages and with plate voltages high enough to maximize shot noise in the diode current).

Impact of Semiconductors

Transistors are used in signal generating equipment where their low power drain and low heat can contribute to a lightweight, battery-powered design. As the cost of transistor circuitry becomes more competitive with vacuum tubes, we can

expect to see more use made of transistors in test equipment.

Low-capacitance semiconductor diodes can be used at much higher frequencies than thermionic diodes and are used as harmonic generators to double the frequency of microwave generators. They do this by partial rectification which distorts the r.f. wave, creating harmonic frequencies.

Tunnel diodes find application as low-level, low-impedance r.f. generators and as fast-rise pulse generators. One available pulse generator uses a simple tunnel diode circuit to generate pulses with rise times of less than 0.1 nanosecond. Pulse amplitude, though, is less than half a volt.

The step-recovery or snap-off diode represents a recent discovery which is being designed into fast-pulse generators. Any semiconductor diode stores a charge, when forward-biased, which flows as reverse current for a brief interval when a reverse bias is suddenly applied. The step-recovery diode is designed so that this stored charge is used up abruptly, making the transition from short-circuit (charge carriers flowing) to high impedance (no charge carriers) in less than a nanosecond. This device is used in a new pulse generator as a pulse sharpener to square up the output pulses.

Still another kind of diode is revolutionizing the modulator in microwave generators. This device, known as a *p-i-n* diode because of the intrinsic (no impurities or doping) silicon layer sandwiched between the *p* and *n* layers, also exploits charge carrier flow. At microwave frequencies, a half-cycle does not last long enough for the charge carriers to be swept out, so that current flows through the diode in alternate directions in response to the r.f. voltage waveforms. The diode appears resistive, however, and the apparent resistance is changed by varying the diode bias.

A voltage-controlled attenuator is made by placing *p-i-n* diodes across a transmission line so that they bypass or absorb some of the r.f. energy, the amount that is bypassed being controlled by the diode bias. The oscillator can then operate continuously and modulation is achieved by absorbing various amounts of r.f. energy without causing reflections on the transmission line.

With these diodes, it is now possible to amplitude-modulate a klystron output with sine waves, or any kind of complex wave for that matter. What is more, the microwave power can be turned on and off more quickly with these attenuators than power can be built up or damped out in high-"Q" cavities.

Equipment Accuracy

A quality r.f. signal generator built during the past ten or fifteen years can be expected to have about a 1% or 2% accuracy in frequency setting. (Continued on page 80)

DECIBEL TABLE

Voltage Ratio (Equal Impedance)	Power Ratio	$\leftarrow -$ db $+ \rightarrow$	Voltage Ratio (Equal Impedance)	Power Ratio
1.000	1.000	0	1.000	1.000
0.989	0.977	0.1	1.012	1.023
0.977	0.955	0.2	1.023	1.047
0.966	0.933	0.3	1.035	1.072
0.955	0.912	0.4	1.047	1.096
0.944	0.891	0.5	1.059	1.122
0.933	0.871	0.6	1.072	1.148
0.923	0.851	0.7	1.084	1.175
0.912	0.832	0.8	1.096	1.202
0.902	0.813	0.9	1.109	1.230
0.891	0.794	1.0	1.122	1.259
0.841	0.708	1.5	1.189	1.413
0.794	0.631	2.0	1.259	1.585
0.750	0.562	2.5	1.334	1.778
0.708	0.501	3.0	1.413	1.995
0.668	0.447	3.5	1.496	2.239
0.631	0.398	4.0	1.585	2.512
0.596	0.355	4.5	1.679	2.818
0.562	0.316	5.0	1.778	3.162
0.531	0.282	5.5	1.884	3.548
0.501	0.251	6.0	1.995	3.981
0.473	0.224	6.5	2.113	4.467
0.447	0.200	7.0	2.239	5.012
0.422	0.178	7.5	2.371	5.623
0.398	0.159	8.0	2.512	6.310
0.376	0.141	8.5	2.661	7.079
0.355	0.126	9.0	2.818	7.943
0.335	0.112	9.5	2.985	8.913
0.316	0.100	10	3.162	10.00
0.282	0.0794	11	3.55	12.6
0.251	0.0631	12	3.98	15.9
0.224	0.0501	13	4.47	20.0
0.200	0.0398	14	5.01	25.1
0.178	0.0316	15	5.62	31.6
0.159	0.0251	16	6.31	39.8
0.141	0.0200	17	7.08	50.1
0.126	0.0159	18	7.94	63.1
0.112	0.0126	19	8.91	79.4
0.100	0.0100	20	10.00	100.0
3.16×10^{-2}	10^{-3}	30	3.16×10^2	10^3
10^{-2}	10^{-4}	40	10^2	10^4
3.16×10^{-3}	10^{-5}	50	3.16×10^2	10^5
10^{-3}	10^{-6}	60	10^3	10^6
3.16×10^{-4}	10^{-7}	70	3.16×10^3	10^7
10^{-4}	10^{-8}	80	10^4	10^8
3.16×10^{-5}	10^{-9}	90	3.16×10^4	10^9
10^{-5}	10^{-10}	100	10^5	10^{10}
3.16×10^{-6}	10^{-11}	110	3.16×10^5	10^{11}
10^{-6}	10^{-12}	120	10^6	10^{12}

COLOR CODES CHA

CERAMIC CAPACITORS

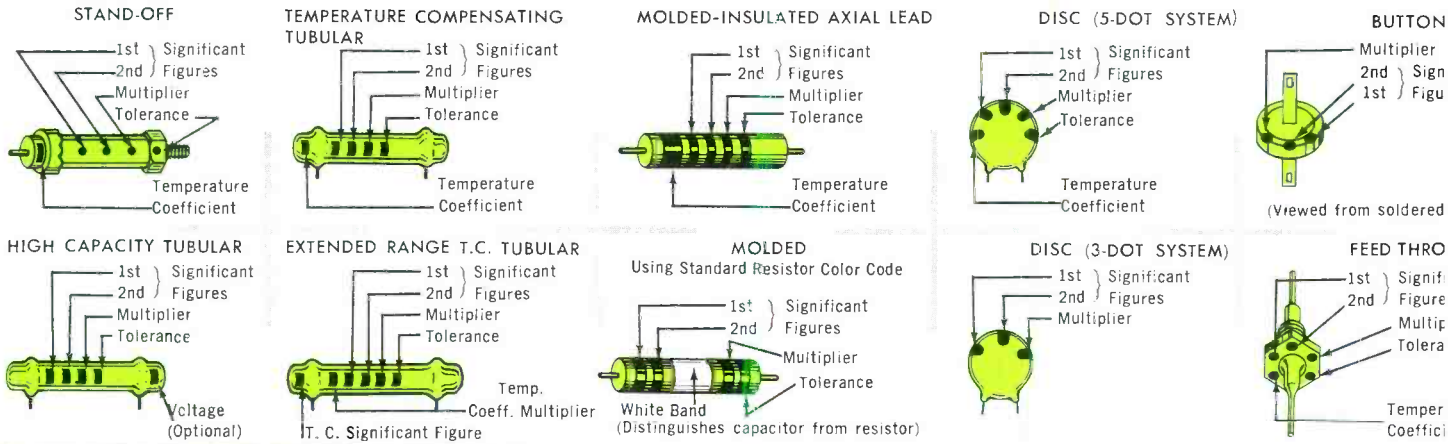

TRANSISTOR BASES

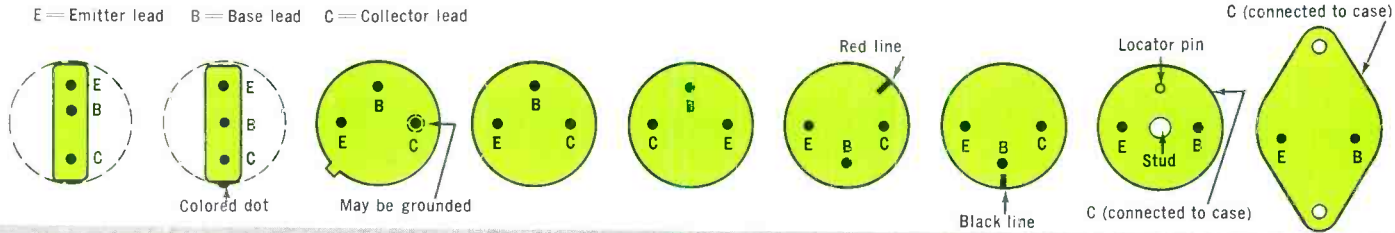

SEMICONDUCTOR DIODES

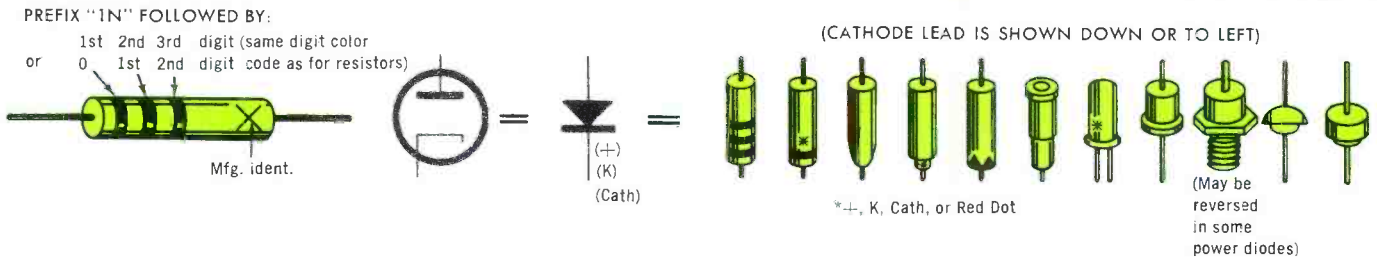

RESISTORS

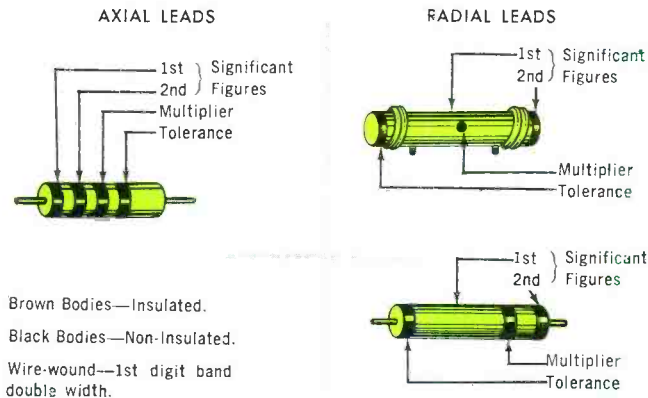

RESISTANCE IN OHMS			
COLOR	DIGIT	MULTIPLIER	TOLERANCE
BLACK	0	1	±20%
BROWN	1	10	±1%
RED	2	100	±2%
ORANGE	3	1000	±3%*
YELLOW	4	10,000	GMV*
GREEN	5	100,000	±5% (EIA Alternate)
BLUE	6	1,000,000	±6%*
VIOLET	7	10,000,000	±12 1/2%*
GRAY	8	.01 (EIA Alternate)	±30%*
WHITE	9	.1 (EIA Alternate)	±10% (EIA Alternate)
GOLD		.1 (JAN and EIA Preferred)	±5% (JAN and EIA Pref.)
SILVER		.01 (JAN and EIA Preferred)	±10% (JAN and EIA Pref.)
NO COLOR			±20%

*GMV = guaranteed minimum value, or -0 + 100% tolerance.
±3%, 6%, 12 1/2%, and 30% are ASA 40, 20, 10, and 5 step tolerances.

CAPACITY IN $\mu\mu\text{F.}$							
COLOR	DIGIT	MULTIPLIER	TOLERANCE		TEMPERATURE COEFFICIENT PPM/ $^{\circ}\text{C}$	EXTENDED RANGE TEMP. COEFF.	
			10 $\mu\mu\text{F.}$ or less	Over 10 $\mu\mu\text{F.}$		Sig. Fig.	Multiplier
BLACK	0	1	$\pm 2.0 \mu\mu\text{F.}$	$\pm 20\%$	0 (NPO)	0.0	-1
BROWN	1	10	$\pm 0.1 \mu\mu\text{F.}$	$\pm 1\%$	-33 (N033)		-10
RED	2	100		$\pm 2\%$	-75 (N075)	1.0	-100
ORANGE	3	1000		$\pm 2.5\%$	-150 (N150)	1.5	-1000
YELLOW	4	10,000			-220 (N220)	2.2	-10,000
GREEN	5		$\pm 0.5 \mu\mu\text{F.}$	$\pm 5\%$	-330 (N330)	3.3	+1
BLUE	6				-470 (N470)	4.7	+10
VIOLET	7				-750 (N750)	7.5	+100
GRAY	8	.01	$\pm 0.25 \mu\mu\text{F.}$		+30 (P030)		+1000
WHITE	9	.1	$\pm 1.0 \mu\mu\text{F.}$	$\pm 10\%$	General Purpose		+10,000
SILVER					Bypass & Coupling		
GOLD					+100 (P100, JAN)		

Voltage ratings are standard 500 volts for some manufacturers, 1000 volts for other manufacturers.

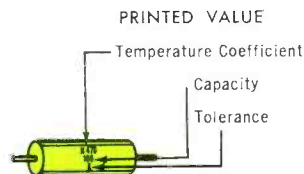

JAN LETTER	TOLERANCE	
	10 $\mu\mu\text{F.}$ or less	Over 10 $\mu\mu\text{F.}$
C	$\pm 0.25 \mu\mu\text{F.}$	$\pm 1\%$
D	$\pm 0.5 \mu\mu\text{F.}$	$\pm 2\%$
F	$\pm 1.0 \mu\mu\text{F.}$	$\pm 5\%$
G	$\pm 2.0 \mu\mu\text{F.}$	$\pm 10\%$
J		$\pm 20\%$
K		
M		

PAPER CAPACITORS

CAPACITY IN $\mu\mu\text{F.}$			
COLOR	DIGIT	MULTIPLIER	TOLERANCE
BLACK	0	1	20%
BROWN	1	10	
RED	2	100	
ORANGE	3	1000	
YELLOW	4	10,000	
GREEN	5	100,000	5%
BLUE	6	1,000,000	
VIOLET	7		
GRAY	8		
WHITE	9		10%
GOLD			5%
SILVER			10%
NO COLOR			20%

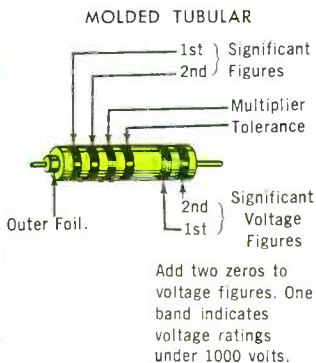

MOLDED FLAT (COMMERCIAL CODE)

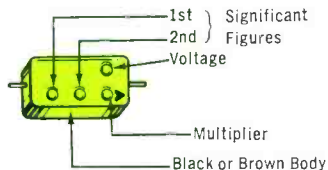

MOLDED FLAT (JAN CODE)

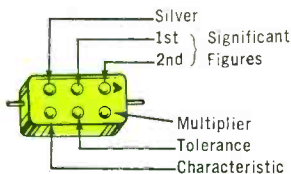

MICA CAPACITORS

CAPACITY IN $\mu\mu\text{F.}$				
COLOR	DIGIT	MULTIPLIER	TOLERANCE*	CLASS OR CHARACTERISTIC**
BLACK	0	1	20%	A
BROWN	1	10	1%	B
RED	2	100	2%	C
ORANGE	3	1000	3%	D
YELLOW	4	10,000		E
GREEN	5		5% (EIA)	F (JAN)
BLUE	6			G (JAN)
VIOLET	7			
GRAY	8			I (EIA)
WHITE	9			J (EIA)
GOLD		.1	5% (JAN)	
SILVER		.01	10%	

*or $\pm 1.0 \mu\mu\text{F.}$, whichever is greater.
**Specifications of design involving Q factors, temperature coefficients, and production test requirements. All axial lead mica capacitors have a voltage rating of 300, 500, or 1000 volts.

MOLDED FLAT

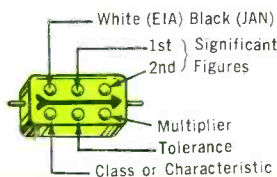

BUTTON SILVER

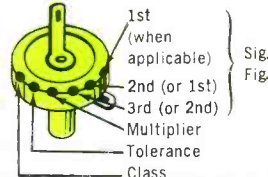

TRANSFORMERS

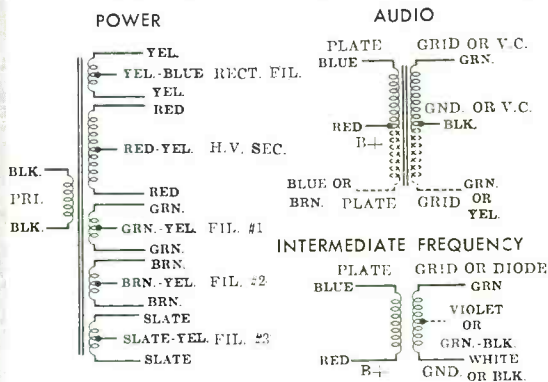

WIRING

COLOR	CIRCUITS
BLACK	GROUNDS
BROWN	FILAMENTS, HEATERS
RED	B-PLUS
ORANGE	SCREEN GRIDS
YELLOW	CATHODES
GREEN	CONTROL GRIDS
BLUE	PLATES
VIOLET	
GRAY	A.C. LINES
WHITE	OFF-GROUND RETURNS

METER RANGE-EXTENSION NOMOGRAM

The limited ranges of voltage- or current-reading panel meters can be extended quickly and without complicated calculations.

By A. L. TEUBNER

WHEN measurements are being made with limited-range panel meters, the situation often arises in which a voltage or current to be read exceeds the full-scale capability of the instrument. It is a relatively simple matter to extend the voltage range by adding an appropriate dropping resistor in series or to extend the current range by adding a shunt resistor, and then to multiply the reading by the appropriate factor. The calculation of the value of resistor to be added to provide the desired range extension and convenient multiplication factor is not so simple.

With the handy chart shown here, a meter can be extended to read up to 50 times its full-scale deflection. Depending on the instrument itself and what is known about it, it is possible to use the resistance of the movement alone or the over-all resistance presented by the meter to the external circuit. The chief precaution is that the user must keep track of the decimal point (or powers of ten).

The center line is for meter resistance, whether an ammeter or voltmeter is involved. The diagonal scale on each side of the chart represents the factor by which the original range is to be multiplied. Each diagonal is doubly graduated, with the "A" scale running from 1.5 to 5 (or 10) and the "B" scale from 5 to 50. Scales for the voltage dropping

resistor (left) and current shunt (right) are also doubly graduated. Always use an "A" scale with an "A" or a "B" with a "B." Value of the external shunt or dropping resistor will then be in the same units as meter resistance.

Use of the chart is best explained with an example, indicated with a broken line on the nomogram. Suppose you have a panel meter that reads 500 volts full scale and you want to read a potential known to be something over 2000 volts. The instrument is rated by the manufacturer at 1000 ohms per volt. Internal resistance is then 500,000 ohms, or .5 (in megohms) on the center scale. Increasing range by a factor of 6 will enable full-scale reading to 3000 volts.

Lay a straightedge from .5 on the center scale to 6 on the "A" side of the voltmeter diagonal. The line intersects the "A" side of the "dropping R" scale at 2.5 (still in megohms). A dropping resistor of this value in series with the meter will enable an on-scale reading, which is multiplied by 6 to determine the actual voltage. The procedure is similar, on the other side of the chart, for ammeter shunts.

The chart provides accuracy in the order of 5 per-cent, sufficient for most panel-meter applications. For greater precision you must pay the price in detailed calculation, precision components, and careful calculation. ▲

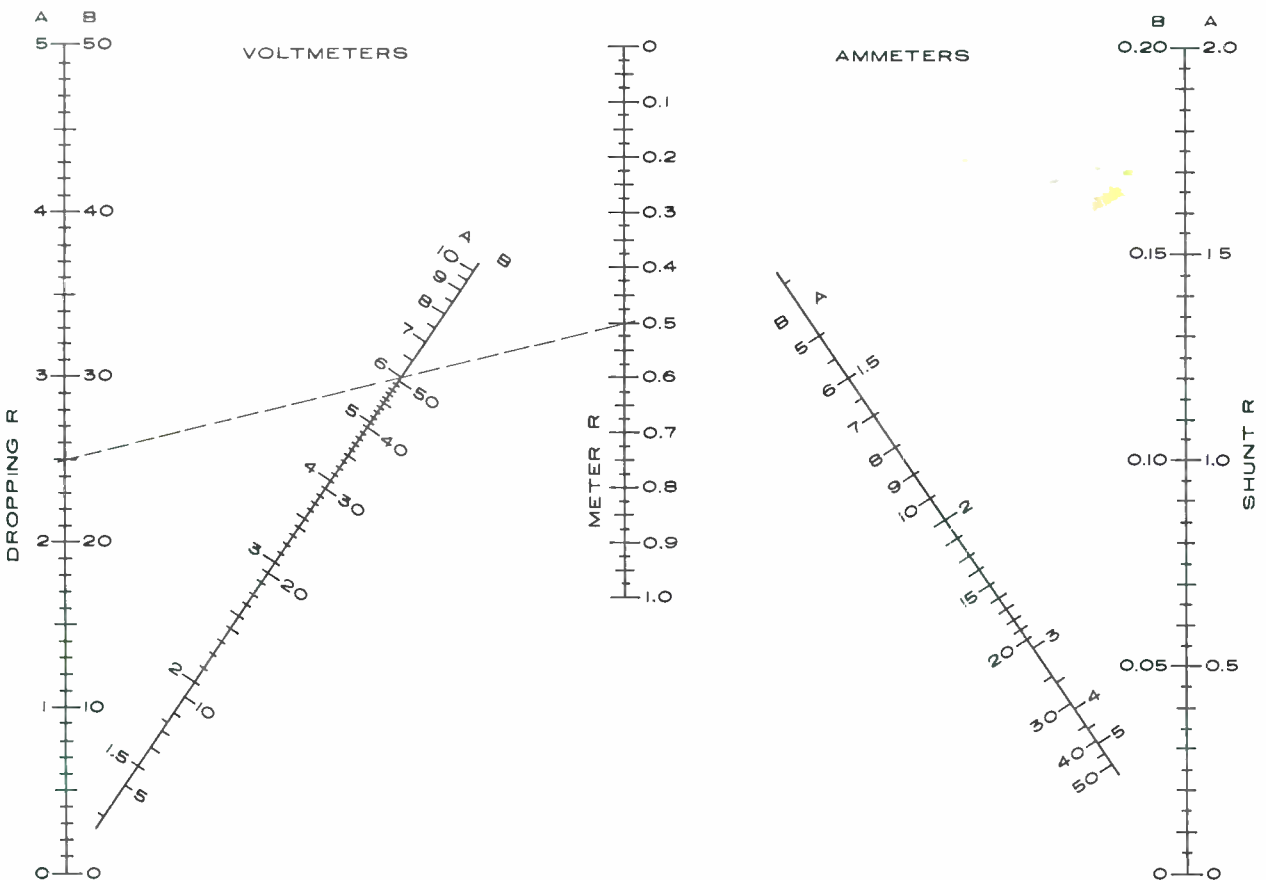

Semiconductor detectors were installed in both "Telstar" satellites, in "Relay," and in "Explorer" to measure radiation in space, including radiation in the Van Allen belts.

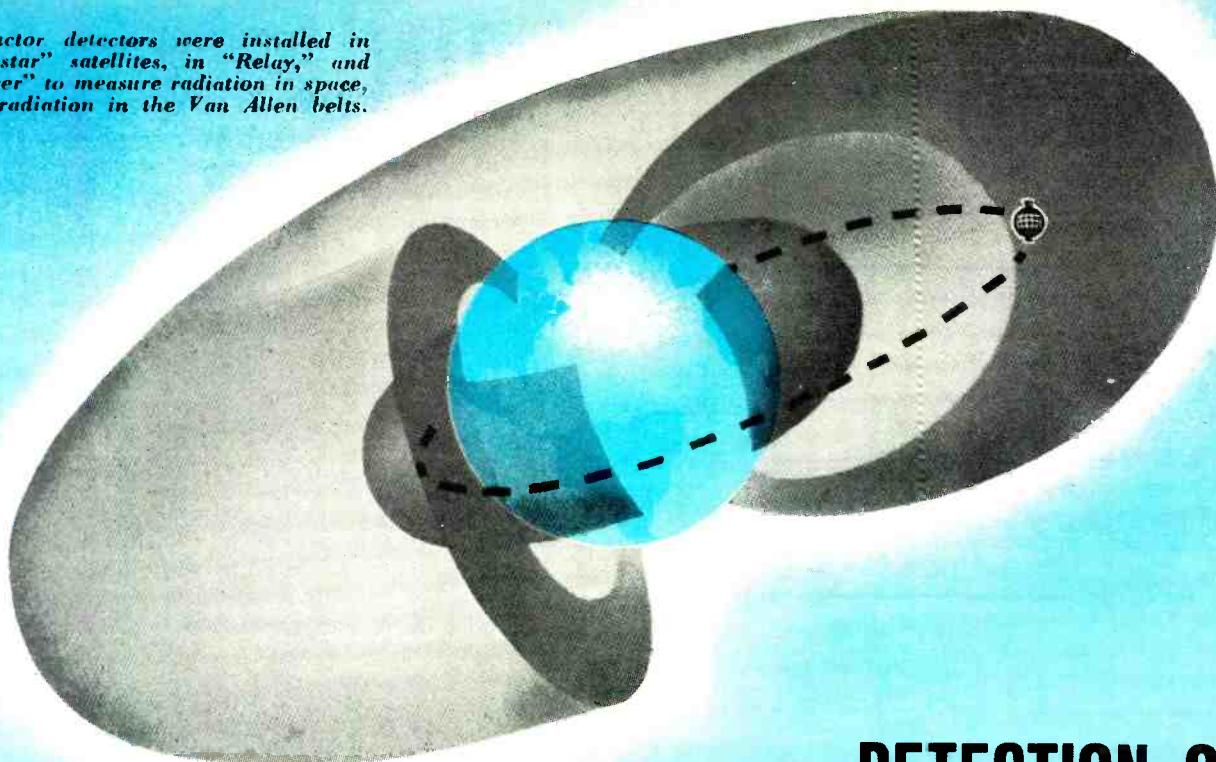

DETECTION OF NUCLEAR RADIATION BY SEMICONDUCTORS

By HAROLD S. RENNE

In order for radiation to be useful, we must be able to measure it easily, precisely, and inexpensively. Semiconductors, especially silicon, are now finding wide application in this important field.

GREAT strides have been made in the field of nuclear science in recent years. Evidence of these advances is all around us—new nuclear power plants, ships, submarines—and a continuing growth in the uses of radioactive isotopes. And nuclear radiation itself—*alpha*, *beta*, and *gamma* rays—is being employed in industry, medicine, and agriculture on an ever greater scale.

Food preservation by means of nuclear radiation is rapidly becoming a reality. The Army is embarking on an extensive program of testing irradiated bacon for palatability and preservation. The radiation protects the bacon from spoilage for long periods without refrigeration. And in Canada, much of the potato crop is irradiated to inhibit premature sprouting, thus prolonging the storage period of this important crop.

In the field of insect control, the screwworm fly has been almost completely eradicated in parts of the country. This was done by sterilizing male screwworms with nuclear radiation and then releasing them in infested areas. Similar techniques are being tested on many other insects with encouraging results—this may be a partial answer to the furor raised by Rachel Carson's book "The Silent Spring."

Horticulturists are using nuclear radiation to speed up mutations in plants in the interest of developing new strains that are more disease-resistant, produce larger crops, or have other desirable properties. This work has already paid off handsomely—in Michigan, a new strain of pea bean, called "Sanilac," developed by irradiation techniques, has almost completely displaced previous varieties because of its resistance to disease and larger yields. Florists now have greater variety of colored carnations, thanks to irradiation.

Industrial applications of both nuclear radiation and radioactive isotopes are legion. Radiation improves the properties of many materials, including some plastics, and *gamma* rays are used extensively for the nondestructive inspection of welds, castings, and the like. Radioactive tracers are widely employed, for example, in checking the wear on piston rings, locating leaks in pipes buried in concrete, checking the efficiency of washing machines, and in many other applications too numerous to mention. And nuclear power sources for satellites, remote weather stations, unmanned navigation buoys, and the like have been developed in which the heat resulting from the disintegration of a radioactive isotope, such as strontium-90, produces electricity directly through the use of thermoelectric elements.

In the medical field, significant advances have been made in the use of radiation to treat cancer and other diseases. Radioactive isotopes are now fed to or injected in human beings, and the paths followed by these isotopes are checked in various diagnostic and therapy applications, such as a diseased thyroid. Selective radiation in various parts of the body can be carried out by administering radioactive isotopes which concentrate in the portion of the body under treatment. Very precise, localized treatments can be administered in this manner.

We could fill an entire book by merely listing the many applications of nuclear radiation. However, the foregoing examples will serve to drive home the point that this field is expanding rapidly and that it touches most of our lives in one way or another.

These examples also serve to emphasize another point. To

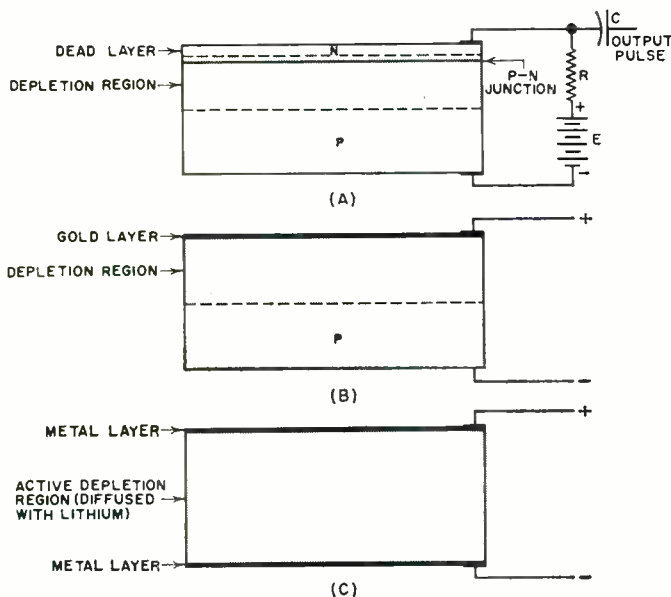
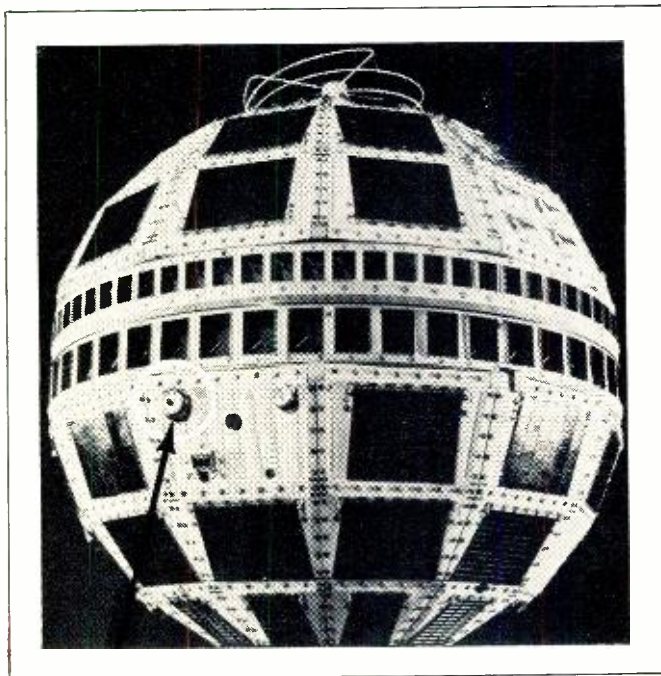

Fig. 1. Three basic types of silicon radiation detectors. (A) Junction, (B) surface-barrier, (C) lithium-drift* types.



The "Telstar II" communications satellite. There are 3600 solar cells on its surface. The two rows of microwave antennas around the center receive signals sent up to satellite and relay them back to earth. On the panel at left center, just below the antennas, is a silicon radiation-measuring device. An electron detector, it measures electrons in the range of 750,000 to two million electron volts.

be useful, we must be able to measure radiation easily, precisely, and inexpensively. It might be said that the usefulness of nuclear radiation bears a direct relationship to the ease with which it may be measured. For we must be able to administer precise doses in many applications, and must be able to measure these doses so we will know what has been administered. For these reasons, measurements in the field of nuclear science play an extremely important role in its application.

However, before we can discuss measuring equipment, we must know what we are trying to measure. The main products of a nuclear reaction, and the products which we want to measure, are *alpha* rays (helium nuclei), the *beta* rays (electrons), *gamma* rays, and neutrons. In some cases we want to measure the intensity of the radiation, that is, the rate at

which it strikes an object or area. Devices for making such measurements are called "ratemeters." In other cases, we are interested in the total amount of radiation, or dosage, calling for an instrument which is known as a "dosimeter."

In addition to knowing what we are measuring, we must have a standard to go by. The most commonly used unit is the *roentgen* (abbreviated *r*) which is defined on the basis of ionizing ability of the radiation in air. Multiples and submultiples of this unit are also employed. The *megaroentgen* (*Mr*) is a million roentgens, and the *milliroentgen* (*mr*) is one-thousandth of a roentgen. A total dose, or quantity of radiation, is then measured in roentgens.

If it is radiation intensity that we are concerned with, the customary unit is *roentgens per hour* (*r/hr.*) or, for low levels, *milliroentgens per hour* (*mr/hr.*).

Conventional Measuring Instruments

A number of different physical phenomena have been exploited in the measurement of nuclear radiation. These deal with the effects produced by such radiation on different materials. For example, there is the phenomenon of ionization—*alpha*, *beta*, and *gamma* rays will all produce varying amounts of ionization in a gas. The rays will expose photographic films—and will cause chemical reactions in various chemicals. In certain materials, flashes of visible light will be emitted when struck by radiation. The materials are then said to "scintillate." All of these phenomena have been utilized in commercial units now on the market.

Ionization. Geiger counters make use of a Geiger tube, which is nothing more nor less than a gas-filled tube with suitable electrodes for sweeping out the ions. Some measuring instruments use ionization chambers—again, a gas-filled chamber with an arrangement for removing the ions produced by the radiation.

Photographic Film. The fact that nuclear radiation will expose photographic film is the basis for an instrument known as the "film dosimeter." This instrument indicates the total dose of radiation received during the time the film is exposed. The density of the developed film is a measure of the total exposure and, with proper calibration, the dose of radiation can be measured with a very high degree of accuracy.

Chemical Dosimeter. Chemicals of various kinds can be employed to measure the total dosage of nuclear radiation. Certain chemical reactions take place under exposure, and the extent of these reactions is a measure of the total dose. Changes in color, acidity, transparency, as well as other characteristics may be employed in order to determine total exposure.

Scintillators. In scintillation counters, the flashes of light which are produced by nuclear radiation are counted by a

Fig. 2. Nomogram for determining depth of penetration in silicon for particles having various amounts of energy.

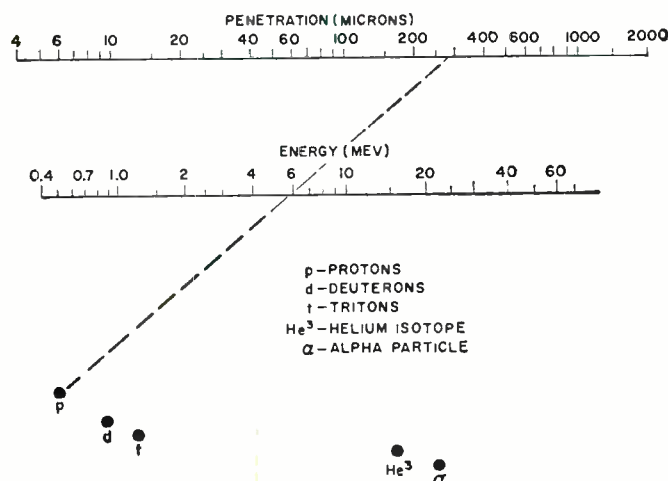

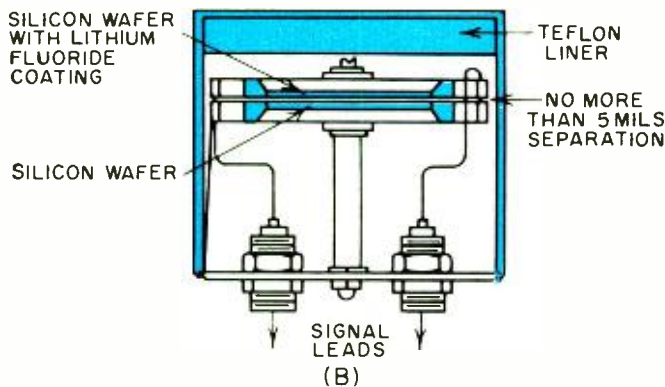
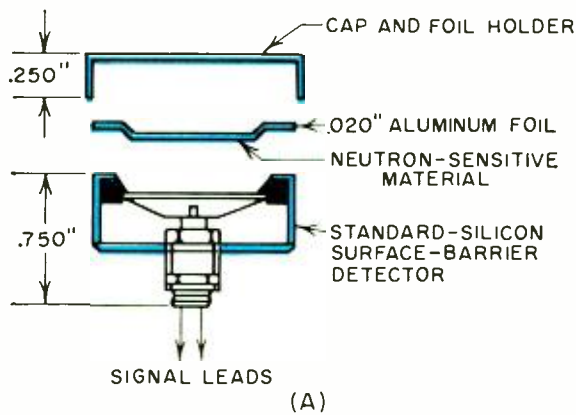

Fig. 3. (A) Cross-section of surface-barrier detector for neutron detection. Neutron-sensitive material is deposited on aluminum foil. (B) Fast neutron sandwich detector.

photomultiplier tube, together with suitable circuitry. The rate at which the flashes are produced gives an indication of the intensity of the radiations, and the total number of flashes indicates the total dose.

Semiconductor Detectors

There are three main effects to be considered when studying the use of semiconductors in measuring radiation. First there is an effect which is very similar to ionization in a gas, namely, the formation of electron-hole pairs in the material. Then there is the fact that semiconductors can become damaged when subjected to radiation. This damage is not the same as that suffered by the decoding transistors of "Telstar I," where trouble was apparently caused by gas ionization within the transistor encapsulation. Finally, there is the phenomenon in which electricity is produced when radiation strikes a semiconductor diode—as in a silicon solar battery.

As mentioned before, nuclear radiation will produce electron-hole pairs when it passes through a semiconductor material such as silicon. Harnessing this phenomenon then involves removing these electrons and holes from the material before they can recombine, and then counting or measuring the number of "pairs" that have been formed. The use of silicon instead of a gas has a very great advantage in that for a given amount of energy lost by the incident radiation, approximately ten times as many charge carriers are formed. About 3.5 electron volts of energy are required to form one electron-hole pair in silicon. The problem of sweeping out the electron-hole pairs has been solved in a number of ways.

Junction Detectors

Application of an electric field to a material such as silicon can result in large leakage currents, since silicon is not a perfect insulator. However, by first forming a $p-n$ junction in the silicon and applying a reverse bias, that is, applying a negative potential to the p region and a positive potential to the n region, the leakage current can be kept extremely small. Ap-

plication of this reverse bias produces a "depletion layer" in the silicon. This is a region in which all electrical charges are swept out as fast as they are formed, and thus the region is, in effect, an insulator. See Fig. 1A.

When a nuclear particle such as an electron or proton strikes this region, electron-hole pairs or ions are formed. The impressed voltage then sweeps these ions to the appropriate electrodes, where they are collected and measured by suitable electronic circuitry. A single ionizing event would then cause a single pulse in the output, the size of this pulse depending on the number of hole-electron pairs that were formed.

Conventional techniques, such as diffusion, are employed in forming the $p-n$ junction. Slabs of ultrapure high-resistivity p -type silicon from .5 to 1 centimeter square are cut from a single crystal and are carefully cleaned and processed in the same manner as in the production of semiconductor transistors and diodes. The proper impurity, which may be phosphorus, is then diffused a very short distance into the surface, forming a thin layer of n -type silicon. Electrical contacts are then made to this surface layer and to the bulk material, and the detector is ready for operation.

It will be noted that electron-hole pairs formed in the surface n layer are not collected, and are lost. Therefore, every effort is made to keep this layer as thin as possible so that it will introduce a minimum loss. This so-called "dead" layer

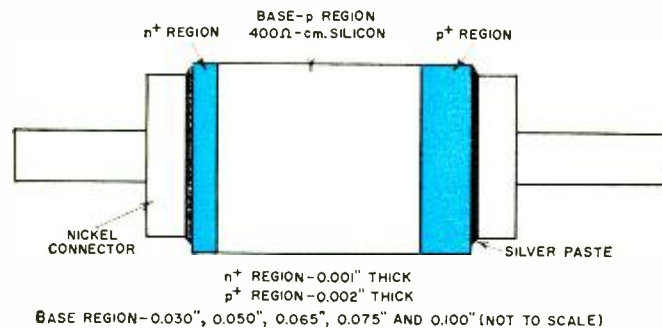

Fig. 4. An experimental silicon diode neutron dosimeter.

may be made as thin as 0.1 micron, so thin, in fact, that practically no hole-electron pairs are formed here, giving an essentially windowless detector.

The thickness of the depletion layer depends on a number of factors, the two most important being the resistivity of the p -type silicon, and the voltage applied across the junction. It is desirable to get as thick a region as possible in most cases, so that the incoming radiation will produce a maximum number of hole-electron pairs. Thus, high-resistivity silicon is employed, and a high bias voltage is used.

Reports from *Bell Laboratories* indicate that diffused junction detectors have been fabricated with a depletion layer thickness of as much as 0.7 millimeter at 400-volt bias. This is sufficient to stop a proton which has an energy of 10-million electron volts.

Another factor to consider in the use of junction radiation

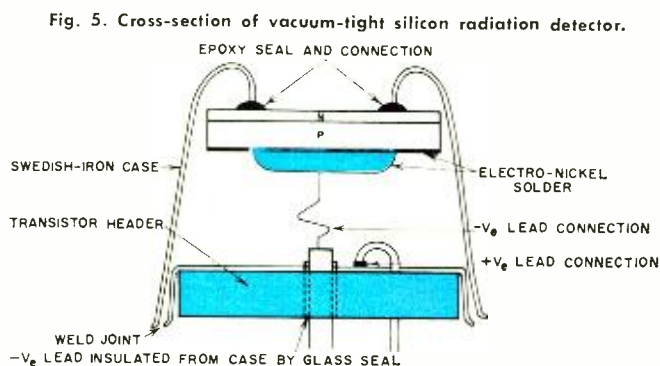
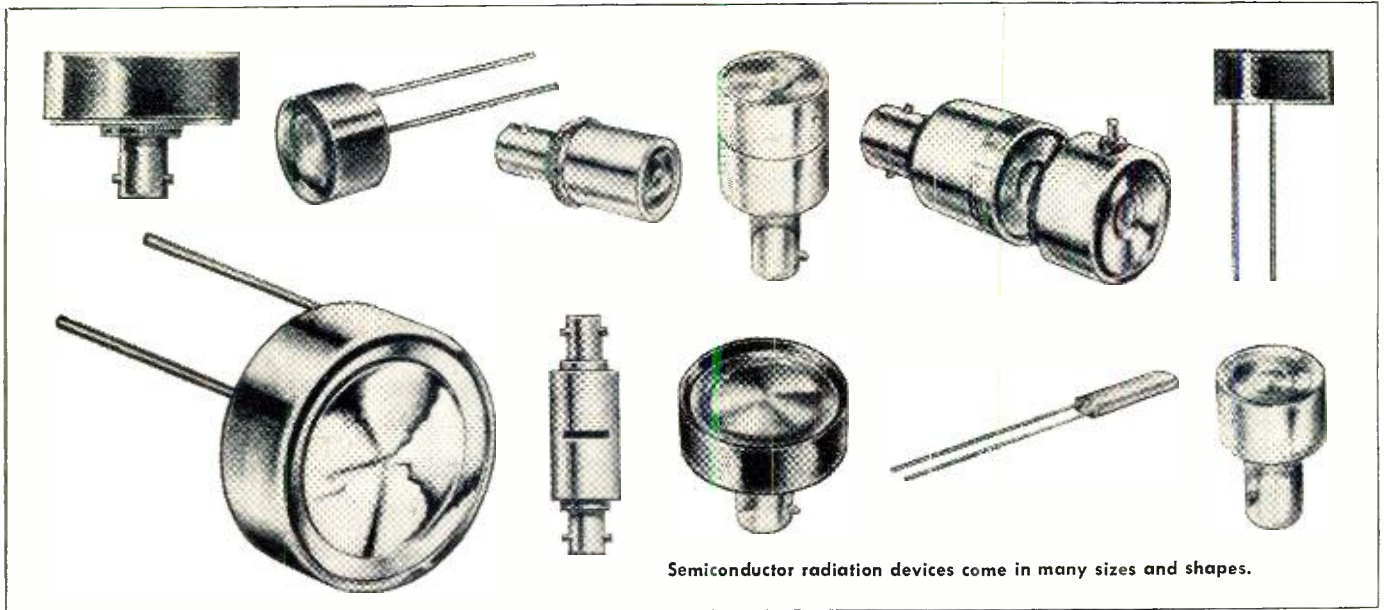

Fig. 5. Cross-section of vacuum-tight silicon radiation detector.



Semiconductor radiation devices come in many sizes and shapes.

detectors is their capacitance. The output signal energy of the detector is inversely proportional to the capacitance of the device. Thus it is important to minimize this capacitance to as great an extent as possible.

Surface-Barrier Detection

A highly satisfactory junction detector can be made by using the surface-barrier technique, as shown in Fig. 1B. Such detectors are formed by evaporating gold onto *p*-type silicon, forming a junction. When a suitable bias is applied, a depletion layer is formed as before, and the device functions in much the same manner as the diffused-junction device. Both techniques have been employed extensively in commercially available devices.

In surface-barrier devices, the radiation must penetrate the gold layer before it can be detected. Therefore, the layer is kept very thin—on the order of 150 angstroms—so there is essentially no “dead layer” or absorption. The Oak Ridge National Laboratory has produced depletion layers as thick as 1.7 millimeters in its surface-barrier detectors.

Lithium-Drift Detector

For some applications, it is desirable to have a much thicker active layer than it is possible to achieve using either of the above techniques. Such devices might be necessary in measuring very penetrating radiation, such as protons in excess of 10-million electron volts. The lithium drift technique has been developed for producing thick layers (see Fig. 1C). Sensitive thicknesses of up to 5 millimeters have been reported.

In low-resistivity *p*-type silicon there is an excess of positive charges, or acceptors. By introducing carefully controlled amounts of lithium, these excess acceptors are compensated for and very-high-resistivity silicon and a large depletion layer result. The depletion layer can extend clear through the material. A big advantage of this device is that it can be operated at relatively low reverse bias voltages. However, it appears to be much more sensitive to radiation damage than the diffused silicon detector.

The detectors just discussed are not particularly suited to measuring *gamma* rays. Because of their penetrating power, such rays will readily pass through depletion layers of the thicknesses we have been discussing, forming few or no ions. However, most fission products, including *alpha* rays, *beta* rays, protons, deuterons, tritons, and fission fragments can be easily measured. If the particle is completely stopped in the depletion layer, the size of the output pulse is a direct measure of its energy. Thus, with suitable instrumentation, the

silicon detector can be employed to measure the energy of incoming particles.

The penetrating power of various particles in silicon is given in the nomogram of Fig. 2. If the energy and type of particle are known, the range in microns can be determined directly. For example, the dotted line in Fig. 2 shows that a proton with an energy of 6 million electron volts will penetrate almost 300 microns of silicon.

Neutrons in general will pass through silicon without producing an appreciable number of electron-hole pairs. To use silicon diodes to measure neutrons, a “converter” layer is placed over the diode. This layer may contain lithium atoms, which react with neutrons to give a triton (isotope of hydrogen with an atomic number of 3) and a helium atom. These particles are then measured by the silicon diode. Typical construction for a device of this kind is shown in Fig. 3A. Sometimes, two silicon detectors are sandwiched together with a coating of lithium fluoride on one of the wafers. The basic detection principle is the same as before. See Fig. 3B.

Silicon radiation detectors have a tremendous dynamic range, that is, they can be employed for measuring radiation intensities varying from a small fraction of a milliroentgen per hour, or a few counts per minute, up to the limit of available electronic equipment which can be on the order of hundreds of thousands of counts per second. Also, since the size of the output pulse can be measured, the energy spectrum of the incoming radiation can be determined. This can be extremely useful in identifying the specific radiation or identifying the radioactive isotope which is producing the radiation.

An interesting application of silicon detectors is their extensive use in measuring radiation intensity in space, including the Van Allen belts. Systems were installed in both “Telstar” satellites, in the “Relay” satellite, “Explorer XV,” and others. With appropriate shielding and the use of magnetic and electric fields, these detectors have been used to count electrons, protons, and other charged particles of widely varying energies in areas of outer space.

Radiation Damage

Radiation can damage semiconductor devices—both diodes and transistors. Some work has been done in an attempt to utilize this phenomenon in developing a radiation measuring device, but as far as the author knows, no such device is commercially available.

Radiation damage acts to slow down the rate of diffusion of minority carriers in silicon. The current-gain characteristic of a transistor made of silicon de- (Continued on page 70)

Accuracy goals depend on applications and the quality of instruments being checked. For any situation, however, satisfactory standards or facilities can be worked out.

By WALTER H. BUCHSBAUM, Industrial Consultant

HOW MUCH precision should one expect and how much can actually be realized when one is calibrating test instruments? What standards can be or should be used? How does one go about doing the job or getting it done? The answers to these questions will depend on who wants the calibration performed, the type and quality of the equipment whose accuracy is to be checked, and finally the use to which this equipment will be put. These requirements allow for a wide variation in the results that will be obtained.

Consider one of the less demanding situations. When a technician wishes to check the "B+" in a radio or TV receiver, it is not too important if the nominal 250 volts is actually measured at 262.5 or 237.5 volts. If voltmeter accuracy is 5 per-cent, this alone could account for the 12.5-volt difference. Variation in line voltage could just as well be responsible. If both line voltage and the meter reading are down, only 225 volts might be read. Deviation would have to be at least this great and probably larger before the technician would begin to consider the possibility of a defect. Although the accuracy requirements here are not demanding, they do exist. If voltmeter error were, say, 10 per-cent or greater and the user did not know this, he could be misled.

In industrial and military electronics, on the other hand, standards are much more critical. Laboratories, factories, and installation facilities often allocate considerable time and money to the maintenance of test equipment accuracy. In fact, government contracts conventionally carry clauses requiring that all test equipment be calibrated carefully against approved standards at least once every six months.

Reference Standards

In the United States, the exact electrical values for voltage, current, frequency, resistance, capacitance, and inductance are determined by the National Bureau of Standards of the Department of Commerce. Laboratory or secondary standards for these electrical parameters are measured against the Bureau's primary standards at certain regular intervals and are then certified as to their accuracy.

Calibration against certified standards is generally a specialized job. Large organizations maintain special departments for this purpose. Smaller companies send or bring their equipment to nearby laboratories that offer a calibration service.

When such service is required on an outside basis, there should be little difficulty in locating a suitable agency. A request is addressed to the Bureau of Standards, either at Washington, D.C., or to the office in Boulder, Colo. The Bureau will advise where standards of the required type are available in the writer's locality. Each of the three armed services also maintains standards laboratories, which are available to qualified commercial firms. A qualified firm is one that holds a contract with the particular service. It can obtain permission to use standards facilities through the project director.

All major military bases involving electronics maintain standards facilities. Well known bases include the Signal Corps at Fort Monmouth, the Naval Research Laboratories, and the Air Force's Wright Field. For security reasons, the services avoid publicizing all such locations.

In addition, the Air Force maintains a fleet of trailer trucks, each of which carries a complete set of calibrating

standards. These mobile laboratories insure precise measurements by making the rounds of various Air Force installations and enabling frequent checks on test equipment calibration.

Although elaborate facilities of this nature are a far cry from what the aforementioned technician would need, many of the problems and principles are common. The technician in a non-critical role is mostly concerned with calibrating a.c. voltage, d.c. voltage, direct current, and resistance on his v.o.m. and v.t.v.m. These will be the most important ones, although there will also be some interest in capacitance, inductance, and frequency. While the required accuracy is much greater in industrial and military applications, essentially the same quantities are involved.

There are a number of references and methods that can be used to insure accuracy in non-critical situations short of comparison against certified NBS standards. Since these involve measures that may be applicable at any level of calibration they will be discussed first.

Basic Meter Checks

Conventional voltmeters, used everywhere for measurement of basic electrical quantities, include the v.o.m. and v.t.v.m. Such instruments are most often specified to have an accuracy of ± 3 per-cent for the d.c. scales, ± 5 per-cent for the a.c. scales, and still less for resistance measurements. Many users still overlook the implication of the clearly stated qualification that the specified accuracy is with respect to full-scale reading.

Consider a typical instrument with a 250-volt d.c. range and a full-scale accuracy of ± 3 per-cent. This means it could be off 7.5 volts not only at 250 volts, but at any other reading on that scale. This same voltage discrepancy would then amount to 7.5 per-cent error if 100 volts is being read. If 15 volts is being measured on the same range, allowable error could be as much as 50 per-cent.





Fig. 1. The Eppley Standard-Cell Voltage Reference, accurate to .005% or better, is tapped in ten steps up to 10.193 volts.

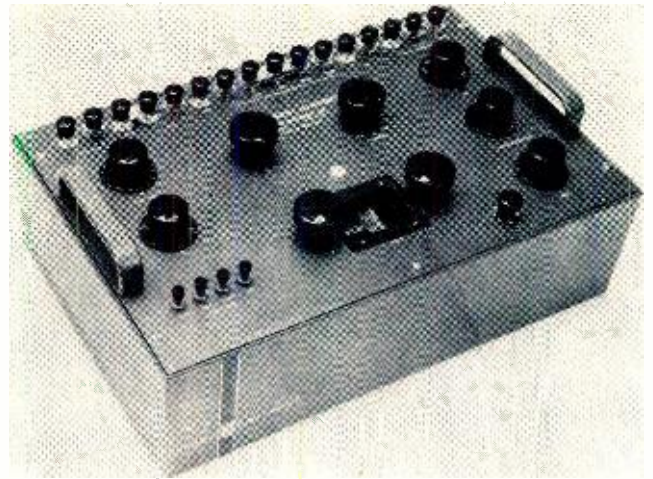

Fig. 3. A universal potentiometer by Leeds & Northrup. It combines a standard voltage reference with precision resistors and a closely calibrated potentiometer for fine resolution.



Fig. 2. An a.c.-powered, well-regulated standard, the VS-10 by North Hills Electronics, provides d.c. reference output.



Fig. 4. A resistive voltage divider made by North Hills Electronics. It is made for use with an external voltage source.

In practice, down-scale accuracy is considerably better than what these figures suggest. If the meter movement were a perfectly linear device, percentage accuracy would be the same at any point on the scale. However, there is some non-linearity in the magnetic meter circuit and some introduced mechanically by the use of springs and weights that balance the movement. Since calibration by the manufacturer is made at the full-scale end, the cumulative effect of errors will be experienced at the low end of the scale. It is therefore preferable, when possible, to use a range that permits readings to fall in the higher end of the scale.

The first step in checking a meter is to make sure that zero indication is accurate. The pointer is set, if necessary, *via* the external adjusting screw with the instrument in its normal operating position. The instrument should be on its lowest d.c. range, with all test leads disconnected.

Meter bearing balance is checked next. While all calibration will be performed in the instrument's normal operating position, the pointer should show no tendency to stick when the meter is tilted through any of the three major axes. If the pointer does not return to zero after tilting, rebalancing is needed. This is a job for an expert. The instrument manufacturer or an authorized agency should be used.

If balance is good, d.c. voltage ranges are checked by measuring a known voltage source. The most elementary source is the widely available 1.5-volt, carbon-zinc cell which, under certain conditions, will give good accuracy. To begin with, a large cell with screw terminals is preferred to a flashlight size. The battery should also be unused, and reasonably fresh. The nominal voltage usually given for calibration is 1.55 volts. Actually an unused cell about two years

old will probably still measure about that much, whereas a fresher one may read about 1.58 volts. However, this range of variation is no more than $\pm 1\%$, which is well within the specified accuracy for conventional meters. As a rule, the owner will consider his instrument does not need recalibration if it reads anywhere between 1.5 and 1.6 volts. At worst, error in this case is not likely to exceed $\pm 3\%$.

Higher d.c. voltages and scales can be checked by combining single cells in series. This is not recommended, however, as it builds up margin for uncertainty. Anyone who is really interested in maintaining a v.o.m. or v.t.v.m., or several such instruments, at good accuracy should consider investing in something better. Mercury cells, for example, are available that will maintain accuracy well within 1 percent over a period of several years. They can be obtained in calibration sets that include several in a single housing, in a series, with taps between cells. Still better, so-called "working standard" meters are available for less than \$100. Typical of these is the *Weston* 931 series, accurate to $\pm 0.5\%$. With one such, a single, accurate voltage source is not necessary. The instrument to be checked and the working standard monitor any voltage source or sources simultaneously, and readings at various voltage levels are compared.

On d.c. voltage checks, the lowest range is always calibrated first. In some meters, it is possible to adjust the series resistance here if calibration is seriously off. In most cases, a fixed resistor must be replaced. The next higher range is checked, and so on up to the highest. Resistors added in the voltage divider in each successive range are adjusted, if necessary.

The d.c. current ranges are checked out next, starting with the lowest first. If a standard calibration source is

not available, a known voltage and precision resistors are required. Current is calculated with Ohm's Law. In addition to the value of the calibrating resistors, input resistance of the meter on each current scale must be considered in calculating current. Possible error introduced by deviation in the latter resistance value can be made insignificant by choosing calibrating resistors whose values are many times higher than that of the meter. Percentage accuracy of the calibrating resistors is determined by the degree of accuracy required. Proceeding from current scale to scale, the values of successive meter shunts are corrected as needed.

Accuracy of the a.c. ranges is affected by frequency and waveshape of the voltage being measured and by components in the rectifier system, as well as by divider resistors. A reasonably good oscilloscope will make a reliable monitor for checking sinusoidal waveshape and will also indicate voltages in terms of peak-to-peak values, if it incorporates a voltage calibrator or is used in conjunction with one.

Good waveform is needed because the average meter does not respond to r.m.s. value directly. It is calibrated to read r.m.s. equivalent value on true sinusoidal a.c. only. If the scope shows that waveshape of the available 60-cps or 400-cps source is distorted, a good audio oscillator can be used. To convert scope peak-to-peak readings to r.m.s. equivalents, divide the former by 2.83 (or multiply by .353).

Inaccurate readings on a.c. may be due to faults in the a.c. rectifier system in addition to deviations in the divider resistors. Rectifier faults are most likely to show up as inaccuracy in the lower end of all scales. (Even with a good system, meters tend to be less accurate in down-scale readings than they are on d.c.) Although a calibration resistor is usually included in the rectifier assembly, the best cure for a fault here is replacement of the entire system with a new assembly obtained from the meter manufacturer.

Resistance scales are checked last. At best, the ohmmeter function of a multi-purpose meter is not designed for high precision and should not be used when such accuracy is required. The ohmmeter tends to be more accurate near the center of its scale than at either end, so calibration should be performed with precision resistors whose values fall in the center portion of each scale. The best one can hope for is good accuracy and scale-to-scale uniformity in this portion. The degree of error in extreme up-scale and down-scale readings can then be recorded and used to compensate readings taken subsequently in actual measurement.

More Accurate Standards

Certification of a standard by the NBS does not necessarily mean it is the most precise type that can be obtained; it simply provides assurance that the standard does indeed meet whatever accuracy it specifies. How much certified accuracy should be obtained depends on the instrument being calibrated. For example, the *Eppley* Standard-Cell Voltage Reference, shown in Fig. 1, provides ten taps from 1 to 10 volts d.c. with accuracy within $\pm 0.005\%$. It is available from the *Eppley Laboratory* in Newport, R.I., for about \$240. Such cells must be used in bridge circuits where little or no current is drawn.

An establishment that maintains a considerable number of service-type voltmeters for ordinary work might consider such an investment. If these meters are rated at $\pm 3\%$ accuracy, the standard would be more than adequate, as standards should ordinarily be at least twice as accurate as the instruments they will be used to check. If the establishment also uses a digital voltmeter or several for more critical work, and the latter is rated at $\pm 0.01\%$, purchase of the *Eppley* reference would be all the more worthwhile—but the standard would now be just about sufficient. These cells can be held to $\pm 0.001\%$ if ambient temperature is controlled.

While the mentioned sources depend on chemical action, there are also voltage and current references that are

purely electronic. One such is the so-called "Solidcell" in Fig. 2, available from *North Hills Electronics* of Glen Cove, N.Y., for \$750. Although a.c.-powered, it depends on a zener diode in a temperature-controlled box for an output of 10 volts d.c. Its guaranteed accuracy is also $\pm 0.005\%$, but it does not suffer from changes due to aging, overload, and ambient temperature in the way that chemical sources do.

Some instrument companies offer specialized calibration sets that combine such facilities as voltage and current sources for d.c. and a.c. with precision resistors, capacitors, and inductors. *Weston Instruments* of Newark, N.J. offers such sets. A simple voltage source, after all, is not self-sufficient for calibrating a variety of ranges.

In voltage calibration, it is often advisable to use a standard high enough for the high scales and employ a precise resistance divider for lower voltage scales. A "universal potentiometer" of this type, made by *Leeds & Northrup* of Philadelphia, Penna., is shown in Fig. 3. It combines a standard voltage source with resistors and a potentiometer of exceptional precision. Voltage accuracy is rated to $\pm 0.01\%$ and readable output down (Continued on page 76)

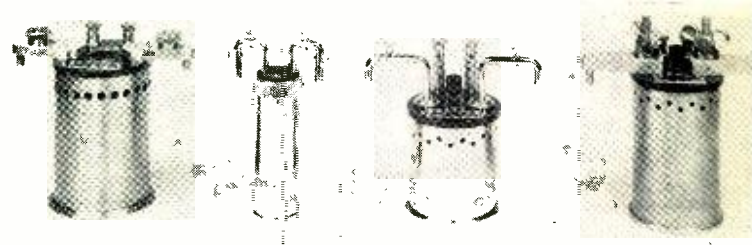

Fig. 5. Thomas standard resistor (left) is rated at 1 ohm to .0001%. Units to right are other low-resistance standards.

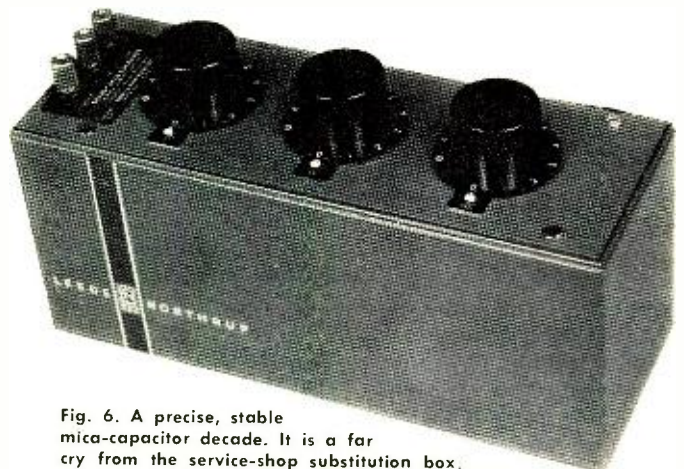
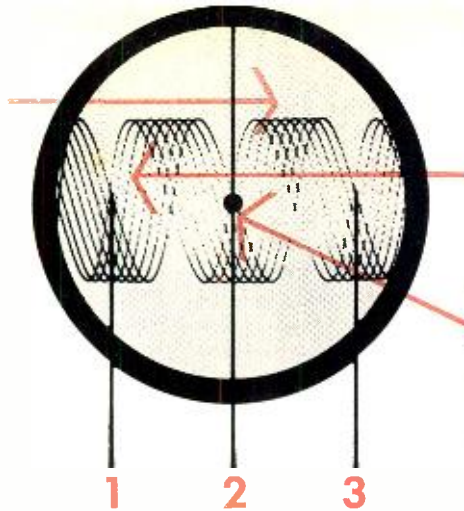

Fig. 6. A precise, stable mica-capacitor decade. It is a far cry from the service-shop substitution box.

Fig. 7. Three sets of carefully wound coils interact in the Brooks "Inductometer" for inductance readings on a linear scale.





ACCURATE AUDIO FREQUENCY MEASUREMENT

By AARON W. EDWARDS/Technical Research Laboratories

A novel method, accurate to within a few hundredths of a cycle, that requires only a scope, stop watch, and a source of accurate tones, such as from WWV.

TECHNIQUES for making absolute determinations of many physical quantities have been greatly refined in the past several years. Accuracies far beyond the requirements of ordinary practical application have been attained in a number of laboratories, including the National Bureau of Standards at Boulder, Colorado. Their announcements of the correctness of such quantities as time, for example, leave one shaking his head in profound admiration.

Less exacting accuracies, but still constituting a high order of precision, are achieved regularly in development laboratories, on missile ranges, and in various industries where research and data reduction are performed. It goes without saying that the apparatus required for the orders of precision produced at the National Bureau of Standards is very elaborate. Even the comparatively modest equipment of the other cited activities is far more costly than most individuals could afford.

Thus the author feels justified in describing a technique by which satisfactory determinations of audio frequency—out to within a few hundredths of a cycle—may be made with “garden-variety” tools. The items involved in this cycle-slicing are: a reasonably good oscilloscope; a stop watch; and a source of accurate tones—such as those transmitted by the NBS’s stations WWV and WWVH.

For several years the author has been concerned with making accurate quantitative measurements of certain data. Usually this data has been stored on magnetic tape and played back for analysis, but continuous “live” inputs are equally

susceptible to analysis. The author developed many methods and techniques for extracting and analyzing the acquired data. He had at hand the finest oscilloscopes, electronic counters, and other auxiliary equipment that could be purchased. Yet, the accuracy usually required for the satisfactory solution of the analyses performed was less than that possible with the simple technique to be described here.

This possibly surprising statement may require clarification. The use of an electronic decade counter made possible rapid and accurate frequency determination to within the inherent counter readout error, which was \pm one count. Since the quantities involved were mostly on the order of several hundred to several thousand cycles per second, an error of one count is negligible. Even at 100 cps, one count is only 1%; and at 1000 cps, the same error is only .1%.

Thus it is that, under certain conditions, the accuracy of an electronic counter may not only be duplicated, but may be exceeded, with the procedure to be described. This method is essentially an accurate, interpolative process of determining difference frequencies, or beats. One might say this method takes up where the counter leaves off.

Equipment Required

The mention of oscilloscope quality should be amplified, too. In this application, the scope is merely the display and indicating device; a comparator, if you please. The burden of accuracy is shared by the standard chosen and the finesse with which the timing operation is performed. The oscilloscope sweep speed must be capable of being controlled by an external source. This control signal is fed into the external sync binding post. The scope’s sync circuit is required only to behave well enough not to lose sync during measurement. Most oscilloscopes will perform satisfactorily.

Fig. 1 illustrates the basic equipment connections and a suggested switching arrangement. For purposes of this illustration, let us assume we have as a standard a 1000-cps electronic tuning fork. (Some of these units are of exceptionally high accuracy and stability.) The actual choice of frequency for f_{std} will depend on the approximate value of the unknown frequency, f_x . Generally, it is desirable that the value of f_{std} be much greater than that of f_x .

Notice that the drawing of the oscilloscope includes the two symbols “+” and “-”. These may be painted on the scope case if one wishes, or they may be marked on a piece of masking tape or gummed label and merely stuck in the indicated places; the “+” to the left side of the CRT, the “-” to the right side. Their use is in making the determination of whether the derived difference in frequency is addi-

Fig. 1. Suggested switching arrangement and equipment hookup.

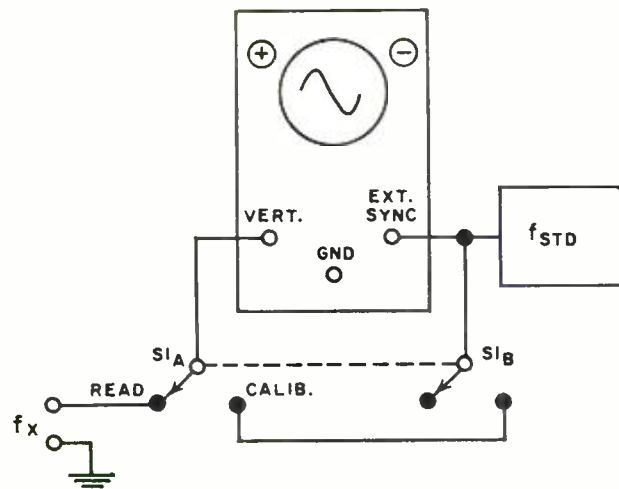

tive or subtractive. The function of S1 is to switch the Y-axis or vertical input between the known (standard) and unknown sources.

The stop watch should, preferably, be one that is calibrated in hundredths of a second. This is not mandatory, but the use of such a watch reduces the likelihood of introducing counting or calculating errors.

Measurement Procedure

With the oscilloscope connected as shown and warmed up, check that the following conditions also obtain: The external sync pot is at a neutral (zero) position; that is, no sync is applied. The sweep frequency controls are set to the appropriate range for displaying the unknown frequency. The brightness, focus, and gain controls are set to give a good image. The image should be positioned so that it is totally visible and centered approximately on the center line of the CRT face. This being done, the actual measurement procedure is as follows:

Step 1. Place S1 in the "Read" position. The unknown frequency is now deflecting the scope trace. No sync voltage is applied. By adjusting the coarse and fine sweep-speed controls, obtain a single cycle of the unknown frequency on the CRT (see Fig. 2A). Carefully adjust the fine frequency-control pot to make the single cycle hold stationary, or as nearly so as is possible. *Do not use sync.* (This step is only to determine which fraction of f_{std} is involved.)

Step 2. Place S1 in the "Calibrate" position. It is unlikely that a stationary pattern will be obtained. (If this pattern is stationary, check to see that the sync control has not been turned off the neutral spot.) *Cautiously* re-adjust the fine sweep-control pot up or down in frequency, depending on which direction gives the shortest route to obtaining a stationary pattern. (Hint: If the pattern drift is left, or toward the "+" side, slowly turn the pot clockwise to arrest the pattern. If drift is to the right, turn slowly counterclockwise.) When the pattern consists of some whole number of sine waves (say 3, 5, or 8), first attempt to stabilize the pattern by carefully adjusting the fine sweep speed. Then carefully inject the sync signal, *via* the "Ext. Sync" control, so that the pattern is firmly locked. At this point the sweep rate is being accurately controlled by the standard frequency.

Step 3. Suppose that the pattern obtained in this manner consists of 8 sine waves. Note: It will be necessary to allow for a missing portion of the last cycle, due to flyback time. See Fig. 2B. The exact sweep speed is now the frequency of the standard being used (1000 cps in this case) divided by the number of cycles seen, or $1000/8 = 125.00$ cps.

Step 4. Return S1 to "Read" position. Observe the direction of trace movement, but *do not touch any controls*. On a sheet of paper, record the sign "+" if the pattern drift is left (Fig. 2C), or "-" if it is right. This is the sign of the correction to be applied to the last calculation.

Step 5. Immediately begin the timing operation. If the CRT has a transparent scale, or graticule, refer to it. If not, mark with grease pencil some portion of the CRT face through which a part of the trace is drifting. (See Fig. 2D.) This is the reference mark, or index. As each succeeding wave passes through this index, it will be counted.

The technique of timing and counting is very important and, if not properly done, can be a source of error. Be sure that the first counting utterance is "zero" and not "one." After observing the pattern drift long enough to pick up the rhythm of the trace movement, begin the timing. At the same instant the selected portion of the wave passes through the index, start the stop watch and simultaneously count "zero (the watch is started), one, two, three . . . etc." The greater the number of cycles counted, the more accurate is the result. For very slow drifts, or beats, a count of from 10 to 20 may be sufficient. For faster ones, it is advisable to count a minimum of 50 to 100. When a sufficient number has been

counted, stop the watch. Example: ". . . 48, 49, mark!" The watch is stopped at "mark," or 50.

All is now done except the calculation. Recall that the sign of the correction was established from the prior observation of drift movement in Step 4. The amount of the correction is calculated as follows: Assume that 50 cycles were counted, and the stop watch recorded 21.42 seconds. This is equivalent to $50/21.42 = 2.334$ cps. Assuming that in Step 4 an additive correction was indicated, then 125.00 (exact sweep speed) + 2.334 (difference frequency) = 127.334 cps, which is the actual value of the previously unknown frequency f .

Depending on the skill with which the timing is performed, the figure in the hundredths place is of questionable accuracy. (The figure in the thousandths position is only a division result, and has little significance.) An average of three to five runs should enable the actual value of that decimal to be determined with reasonable accuracy. Recall, too, that any timing error becomes smaller the more beats that are counted. Whatever the error may be, it is divided by the total count taken, just prior to the final calculation.

Discussion of the Technique

All of the foregoing instructions are theoretically sound and practical. If, however, one is restricted to a single, or

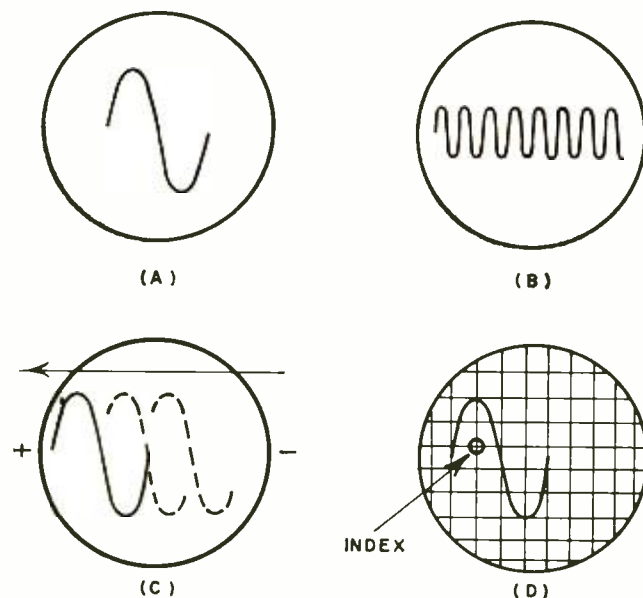

Fig. 2. Waveforms obtained during the measurement procedure.

even two sources for f_{std} , it will not be long before some inherent limitations will make themselves known. The technique has been presented in its simplest form. To make clear what kind of pattern is a desired indication, only a sinusoidal presentation has been described, as it is the most easily recognized. The patterns obtained in Step 2 are the simplest derivatives of f_{std} , that is, they are $f/2, f/3, \dots, f/8$, etc. Drift rates faster than about 6 cps are quite difficult to time, by eye. Thus, strict adherence to the patterns described would permit readouts of \pm about 6 cycles, of the frequency f/n .

Happily, these limitations have several solutions. Some of these do not involve a departure from the principles of economy that make this measurement technique available to the average reader. And, in any case, the limitations should not detract from the fundamental excellence of the general method. These solutions take the following form: (1) providing additional satisfactory sources of f_{std} ; and (2) providing ways to count the more rapidly drifting beat pattern.

A very simple way to get more mileage from a given standard frequency is illustrated. Suppose that, for example, the unknown frequency

(Continued on page 75)

THE OPERATIONAL AMPLIFIER

By JACK E. FRECKER / Applied Research Lab., University of Arizona

PART 2 / Applications of the unit, previously discussed, as a voltmeter calibrator, a frequency-sensitive circuit, an oscillator, a capacitance bridge, and as a multivibrator.

LAST month the theory and design of operational amplifiers were discussed and the circuit and construction of a two-amplifier unit were shown. The reader will recall that in the most general usage, shown in Fig. 1A, $Gain = E_{out}/E_{in} = -Z_f/Z_{in}$. Output impedance was assumed to be negligibly small, input impedance at point A was simply the value of Z_{in} , and the effective impedance from point B to ground was quite low. The output current capability of either amplifier was 3 to 5 ma. max. depending on output voltage.

When using the operational amplifier, the open-loop frequency-response curve in Part 1 should be kept in mind. As a rule of thumb, if the open-loop gain at any particular frequency is reduced by a factor of 100 or more by feedback, less than 1% error in calculated gain will result. In the following discussion it will be assumed that the amplifiers are always carefully zero-adjusted and that no attempt is made to use them beyond their frequency capabilities.

Amplifiers and Calibrator

The simplest application is that of Fig. 1A. This is a good general-purpose d.c. and low-frequency (audio) amplifier. Fig. 1B illustrates a second class of circuit and makes use of the differential input feature of the amplifier. In this circuit $Gain = (Z_{in} + Z_f) / Z_{in}$ and is non-inverting. The input impedance is between 100 megohms and 10,000 megohms, depending on the condition of the 6AU6 tubes.

By making Z_{in} an open circuit and Z_f a short circuit in Fig. 1B, the unit becomes a unity-gain amplifier similar to a cathode-follower. It is useful as an isolation device to over 100 kilocycles. Another use of this device is shown in Fig. 1C. The unity-gain amplifier is used as a coaxial-cable shield driver. As the shield is at the same a.c. voltage as the inner conductor, the effective capacity to ground of the inner conductor is reduced nearly to zero. The 1000-ohm resistor

is employed in order to prevent parasitic oscillations.

Fig. 1D is the circuit of a voltmeter calibrator. With the switch in the ground position the amplifier is carefully adjusted for zero volts out. Then the switch is turned to the mercury cell and the output voltage, $E_{out} = 1.35 \times (Z_{in} + Z_f) / Z_{in}$ with a very high degree of accuracy.

Integrators

Fig. 1E is an integrator. This circuit provides a frequency-response roll-off of 6 db per octave. To use this circuit, select the frequency at which gain is to be unity and let $X_c = R_{in}$ at this frequency. Then at one-half this frequency the gain will be 100, and so on. R_f is necessary to provide some d.c. feedback to prevent the amplifier from drifting into its limits. It should

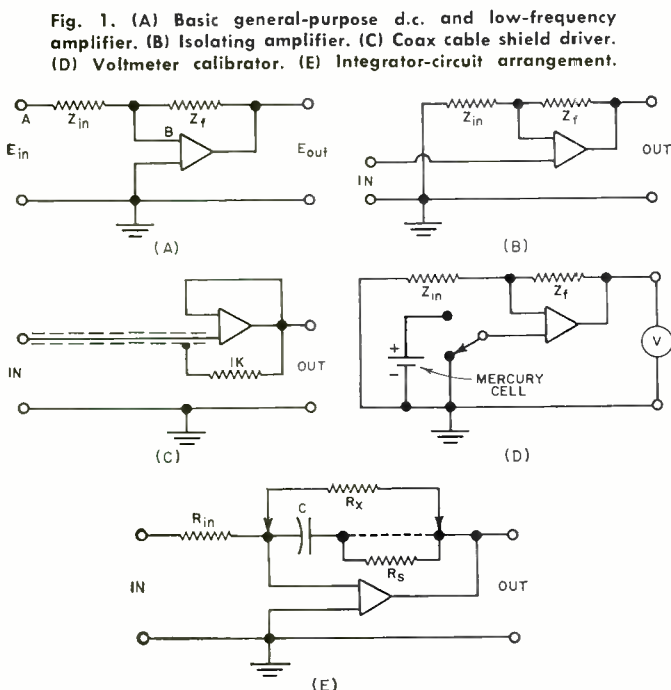

Fig. 1. (A) Basic general-purpose d.c. and low-frequency amplifier. (B) Isolating amplifier. (C) Coax cable shield driver. (D) Voltmeter calibrator. (E) Integrator-circuit arrangement.

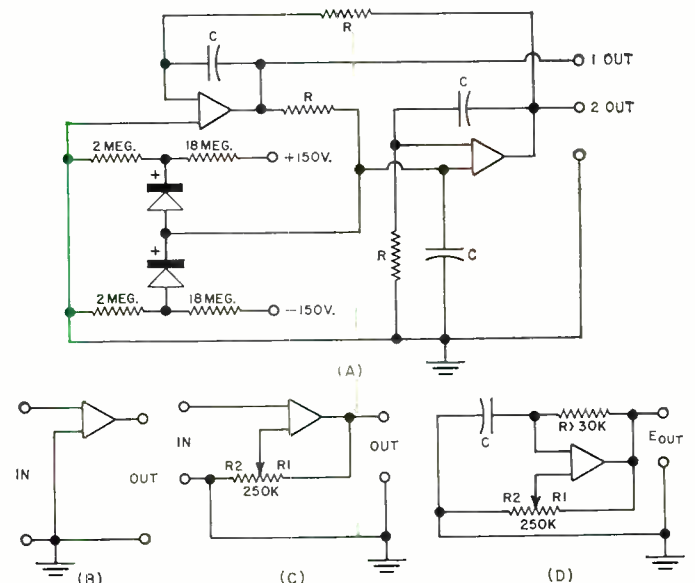

Fig. 2. (A) Modified sine-cosine oscillator. (B) Voltage comparator. (C) Circuit which adds hysteresis to transfer function. (D) One type of free-running multivibrator.

be no larger than $1000R_{in}$. It may be less and, if so, will determine the maximum gain of the amplifier at low frequencies. Also, a resistor can be inserted in series with C . This resistor will determine the minimum gain of the circuit. With both present the circuit will have a frequency response as shown in Fig. 3A.

Fig. 3B is a double integrator. This circuit has a roll off of 12 db per octave. Select the frequency at which the gain is to be one-fourth and let $X_c = R$ at this frequency. Then at one-half this frequency the gain will be unity, at one-twentieth this frequency the gain will be 100 and so on.

"Q"-Multiplier and Bridge

Fig. 3C is a "Q"-multiplier. The unity-gain amplifier output is fed back into the tuned circuit in a regenerative fashion. The effective "Q" of the circuit can be raised by a factor of 50 or more with good stability, and R can be decreased to a point where "Q" becomes infinite and oscillations take place. This circuit is useful to 100 kilocycles but is at its

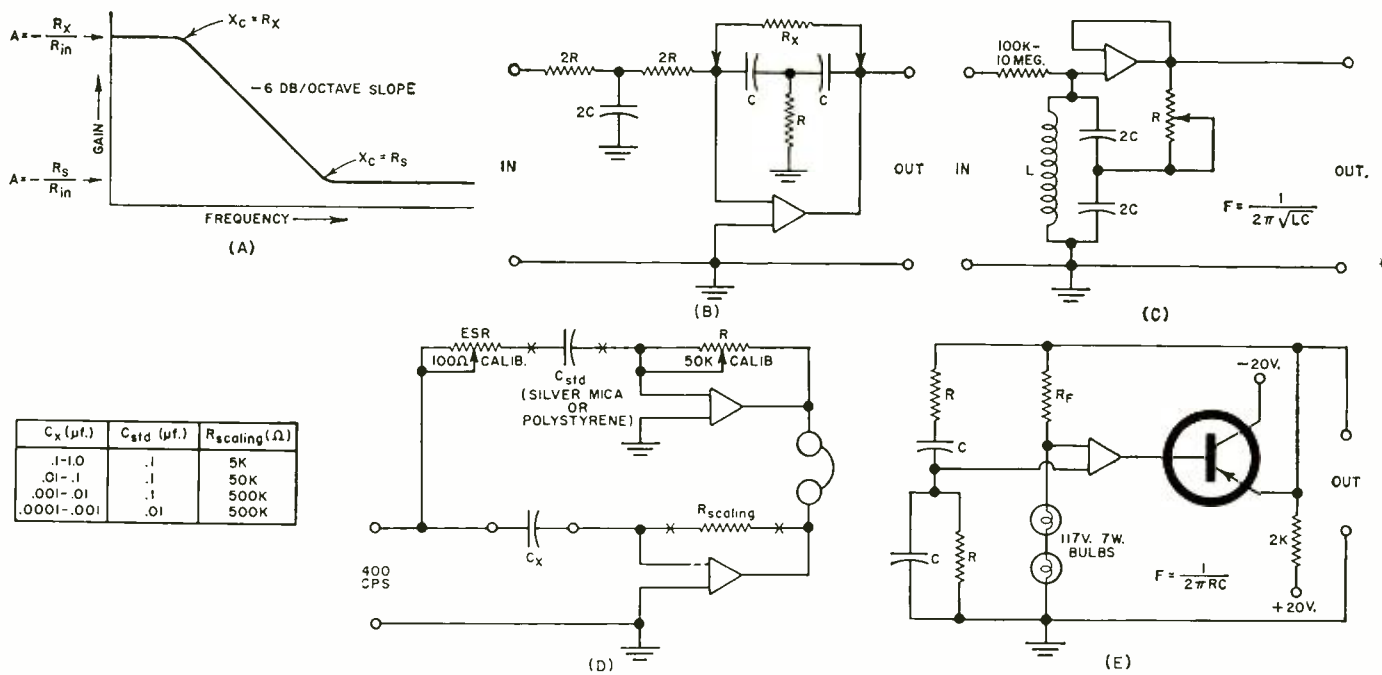

Fig. 3. (A) Frequency response of the circuit shown in Fig. 1E. (B) Double integrator circuit. (C) "Q"-multiplier circuit. (D) Use of operational amplifier as a capacitance bridge. (E) Wien-bridge oscillator connected to emitter-follower stage.

best when it is used within the audio-frequency range.

One of the most potentially useful circuits is the application as a capacitance or resistance bridge. The capacitance bridge is shown in Fig. 3D. In this circuit a low-level audio signal is connected to the input, the capacitor to be measured is connected at C_x , the appropriate values of C_{std} and $R_{scaling}$ are selected and the controls R and ESR are adjusted for a null in the earphones. Frequency is kept low in order that the amplifier open-loop gain will be high and the reactance of C_x and C_{std} will be high.

The most important advantage, to the experimenter, of this bridge over the completely passive bridge is that the bridge equations are an extremely simple matter of ratio and proportion rather than the gross and involved equations of the conventional types. If perfect components are used, the bridge can measure to an accuracy of .5 per-cent or better. When the bridge is adjusted for a null, $C_x = (R \times C_{std}) / R_{scaling}$. Since there are four different combinations of $R_{scaling}$ and C_{std} , they represent four different multipliers in decade steps. Equivalent series resistance of $C_x = (ESR \times C_{std}) / C_x$. Dissipation factor then equals $100R/X$, or $200\pi fRC$ in percent with f in cps, R in ohms, and C in farads. An entire plug-in subassembly unit containing components, switching functions, and a transistor audio oscillator could be constructed along these particular lines.

Sine-Wave Oscillators

Several types of sine-wave oscillators are possible with this unit. The Wien bridge, shown in Fig. 3E is one of the best. The emitter-follower is necessary in this circuit to supply the large amount of driving power required for the bridge. Frequency can be made continuously variable by varying either R or C . R should be always greater than 5000 ohms. R_f is selected to give an output of 7 volts r.m.s.

Another oscillator is a modified form of the sine-cosine oscillator used frequently in analog computer laboratories, and shown in Fig. 2A. The name comes from the fact that there is a 90-degree phase difference between the two outputs. Oscillations build up very slowly in this device and, when they are greater than sixty volts peak-to-peak, a weak diode limiting action takes place tending to hold the amplitude constant.

In the left-hand portion of the circuit, the output leads the input by 90 degrees at all frequencies. The right-hand

portion is a non-inverting integrator and its output leads its input by 270 degrees. The total of 360 degrees phase-shifted signal is fed back to the left-hand unit, and oscillations take place just lower in frequency than where loop gain exceeds unity. This circuit is particularly useful at frequencies from .1 cps to 1000 cps. To cause the unit to start faster, momentarily connect +150 volts to any input through a 10-megohm resistor. All values of R and C should be equal. Typically, R has a value of 200,000 ohms to 10 megohms.

Non-Linear Operation

These amplifiers perform well in non-linear and limit-to-limit operation if not too much is expected in the way of high-frequency performance. A few basic functions will be shown here. The first is a voltage comparator, shown in Fig. 2B. When the input goes ever so slightly positive, the output goes into its negative limit, and *vice versa*. By connecting the secondary input to some reference voltage, when the input exceeds the reference voltage, the output will go into its negative limit, and *vice versa*. (Continued on page 84)

Fig. 4. (A) Wave-shaping circuit. (B) Timing computer circuit.

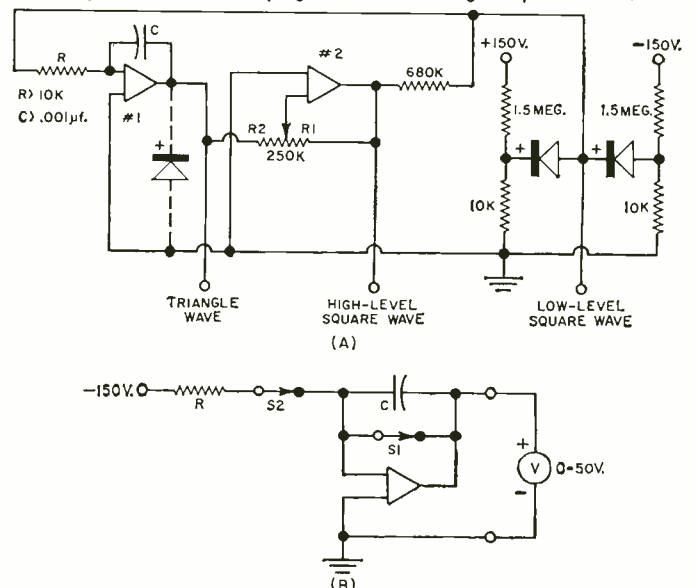

CATHODE-RAY OSCILLOSCOPES

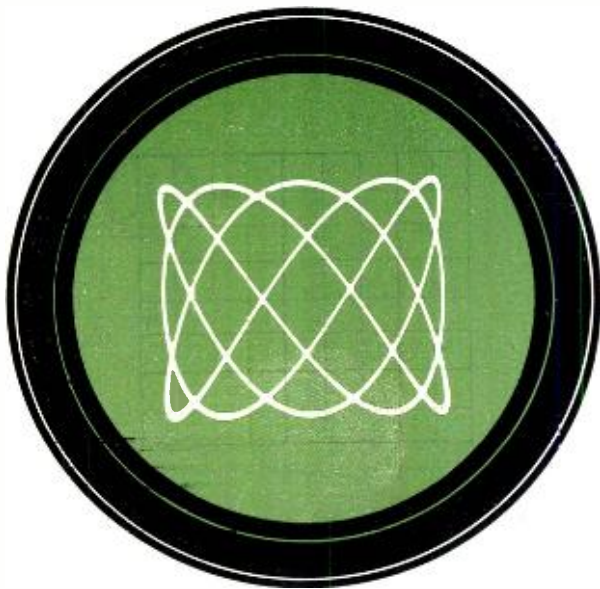

By EDWARD K. MARRIE
Scientific Instrument Dept., DuMont Laboratories
Divisions of Fairchild Camera and Instrument Corp.

One of the most useful and most versatile test instruments has made many advances in design and performance over the past decade.

SINCE its commercial origin in 1932 the cathode-ray oscilloscope has become a primary instrument for measuring electrical waveforms. It is used in a wide variety of fields and applications. Although oscilloscope manufacturers employ techniques that have brought the instrument from a simple indicator to a device that can measure electrical quantities accurately, the basic system concept has not changed. Exceptions are the new traveling-wave and sampling oscilloscopes which are special-purpose instruments.

Unlike many measuring devices, the cathode-ray oscillo-

scope enables rapidly varying analog information to be obtained. If the applied signals have random amplitude and time fluctuations, the oscilloscope must be employed. Scopes are multipurpose instruments combining features of both a.c. and d.c. voltmeters, ammeters, frequency and phase meters, waveform analyzers, and a good many more.

Types and Applications

Because it finds use in so many diverse measurement applications, no one oscilloscope can contain all desired characteristics. If scopes were to be classified into three general groups, these would probably be: (1) general purpose, low-frequency, (2) general-purpose, high-frequency, and (3) special purpose.

Just what constitutes low and high frequency depends on the range of frequencies required by industry at the time. In the early years of the oscilloscope, much of the electrical industry was concentrated in the area of a.c. power where scopes having bandwidths of only 10 kc. were sufficient. As the radio industry began to grow, a need developed for oscilloscopes which could be used to check out carrier and audio channels, modulators, and discriminators. To make such measurements the bandwidth of the oscilloscope was pushed to 200 kc., a wide-band instrument around 1942.

Techniques developed for military systems during World War II were quickly adapted for scope circuitry to keep up with the expanding electronics industry. Distributed amplifiers began to replace the cascaded pentode amplifiers to fulfill the 10- to 20-mc. requirements of post-war industry. Distributed amplifiers using tubes are now being phased out of newer equipment in favor of solid-state devices. High frequency in an oscilloscope today usually means 25 mc. or above. In two or three years this will probably be changed to 50 mc. or above.

The pressure for higher frequency instruments comes mainly from users and designers of advanced military systems and computer manufacturers. Already computers have reached a point where scopes with bandwidths of over 50 mc. are preferred in design work, or with 25-mc. passband for servicing.

Oscilloscopes having low-frequency characteristics are still required in industry. Many applications where mechanical or hydraulic systems are involved need electrical test equipment having a bandpass of only 500 kc. This class of instrument has had a fairly constant market for the past few years but does not have the growth potential of the high-frequency instruments used in the electronics field.

New and more sophisticated sweep circuits had to be developed for the higher frequency instruments. Originally

One of the very earliest oscilloscopes was the Type 126, manufactured in 1932 by the Allen B. DuMont Laboratories. Having developed a practical, long-lived cathode-ray tube, Dr. DuMont's first use for these tubes was in instruments of this type. The power-supply circuitry was in the cabinet shown while another cabinet, not shown, housed the sweep circuits that were employed with the separately mounted CR tube.

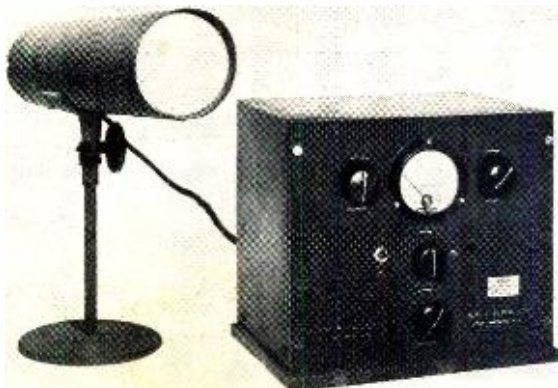

An example of a high-sensitivity, general-purpose lab scope is the Fairchild-DuMont 704. Identical vertical and horizontal amplifiers are used with sensitivities of 0.2 mv./cm. and bandwidths from d.c. to 500 kc. The triggered sweep is wide range from 0.1 μ sec./cm. to 1 min./full scale. Critical circuits use silicon transistors. The amplifiers are within $\pm 1^\circ$ relative phase shift to 100 kc. Price of the oscilloscope is \$645.

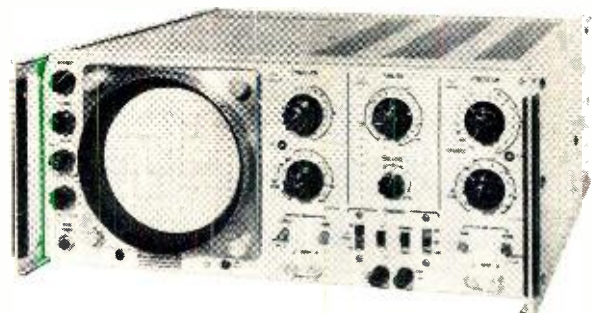

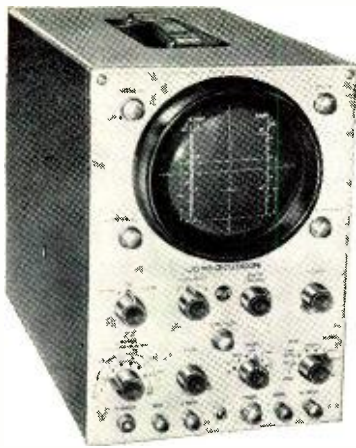

Designed for production and servicing of black-and-white and color-TV receivers is the RCA WO-91A. The scope can measure color-burst signals and can be used to troubleshoot wide-band color circuits. Either wide-band (10 cps to 4.5 mc.) or high-sensitivity (50 mv. p-p/in.) operation is provided. Price of unit: \$249.50.

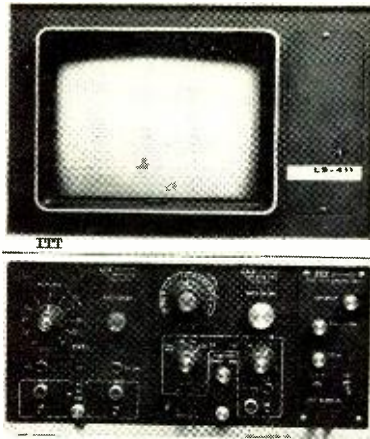

Although most scopes use electrostatically deflected 5" tubes, the ITT LS-411 uses a magnetically deflected 14" CRT for display. With its plug-in amplifier and sweep modules, it can display low-frequency waveforms from d.c. to 25 kc. For use with analog computers and telemetry systems. Basic price, less plug-ins, \$1965.



Another example of a general-purpose wide-band instrument designed mainly for black-and-white and color-TV servicing is the Jackson CRO-3. When switched to wide-band operation, the response is from 20 cps to 4.5 mc. When set for high sensitivity, 18 mv. r.m.s. signal produces a deflection of 1 inch. Price of unit is \$234.95.

saw-tooth sweep generators used thyatrons. These were free-running sweeps which could be locked to the synchronizing signal. Gas-tube sweep generators of this type had a maximum repetition rate of about 40 kc., or a minimum sweep time of about 25 microseconds. To examine a 20-mc. sine wave, a minimum of 0.1 μ sec. or 100 nanoseconds was required. More complicated and versatile saw-tooth generators such as the bootstrap and Miller integrator were devised.

In most present-day equipment, the Miller integrator is used because of its linearity and fast starting. The sync signal in this "triggered-sweep" system changes the state of a multivibrator which starts the sweep. Another feature is that the method or mode of triggering may be altered. By changing the mode of operation, a triggered repetitive, free-running, single or automatic sweep may be obtained.

Single sweeps have become more important since the development of oscilloscope recording cameras where a transient will start the sweep and activate the camera shutter at the same time. Triggered sweeps of this type produce linear sweeps of 5 nanoseconds.

To make scopes easier to operate, and due to the increased accuracy of the Miller sweep system (3%), newer instruments are calibrated directly in time. At present, the Miller sweep generator is restricted to either electron-tube or hybrid circuits. However, field-effect transistors, which are now becoming commercially available, will enable completely solid-state sweep generators to be built.

With the advent of pulse and digital circuitry, a new type of display was developed to single out and expand certain portions of a pulse train. At first it was sufficient to automatically change sweep rates during the sweep to produce a "notch." This notching technique, a forerunner of the delaying sweep, worked well for instruments which had a pass-band of 5 to 10 mc. As radar, pulse modulation, and computers became more refined and transportation of electrical information became faster, a new system was needed. It was important not only to know what pulse in a given train was being measured and its waveshape, but also its time relation to other waveforms in a system. To do all three jobs well, the modern delayed sweep was devised. Practically all missile projects require a number of scopes having delayed sweeps for systems check out.

Very accurate phase measurements at high frequency is another area which employs delayed-sweep scopes. In this method, a calibrated delay dial is used to measure phase.

Two types of instruments used for special high-frequency

measurements are the traveling-wave and sampling oscilloscopes. The traveling-wave scope has been designed for measuring very fast, single-shot or low-repetition-rate signals. Unlike the general-purpose scope, it does not have a vertical amplifier, but connects the signal directly to the CRT deflection plates. Second, the vertical deflection plates are divided into sections to reduce the transit time of the electron beam through the plates. These various sections are connected together with a delay line so that the signal progresses from one plate to the next in much the same manner as in a distributed amplifier. This instrument, which is usually used with a camera, provides a means of recording very fast transients. Reduction in sensitivity and scan must be tolerated in this system to achieve necessary bandwidth.

For higher bandwidths, a more versatile instrument, the sampling oscilloscope, may now be obtained. Using new solid-state components, sampling oscilloscopes will yield bandwidths over 1000 mc.

The sampling oscilloscope is closely analogous to a stroboscopic light for visual observation of rapid motion. Both techniques appear to slow down motion and depend on repetition of the phenomenon to build up the apparent image. Sampling differs from conventional display in that for each occurrence of the input signal only a single point or sample of the input is displayed. The amplitude of this point is proportional to the signal amplitude at the instant of time the sample is made. By sampling at slightly different times for each input cycle, a display showing the entire waveform is produced. With this method, the effective bandwidth of a fairly low-frequency amplifier may be extended upward and the loss of sensitivity and scan in the traveling-wave system may be overcome.

Plug-in Units

Not all improvements made to the oscilloscope have been in the electrical circuitry. More versatility has been built into the scope by the use of various plug-in units. At first only vertical preamplifiers were available. These enabled the user to select vertical characteristics for a given application. A few years ago this was extended to both vertical and horizontal channels. Sampling generators were packaged as plug-ins to permit operation of specific instruments as both standard and sampling scopes. At present scopes may be obtained which have all of the signal circuitry contained in the plug-ins. Such instruments may now keep pace with the rigid specifications of present-day industrial and military applica-



Another example of a wide-band laboratory oscilloscope is the Simpson 2610. This instrument was designed to fill the gap between service-type scopes, which have fairly limited performance but at reduced cost, and the very high-performance, high-cost laboratory instruments. Response is d.c. to 8 mc. (± 1.5 db); sensitivity is 6 mv. r.m.s./in. The price of the unit: \$575.

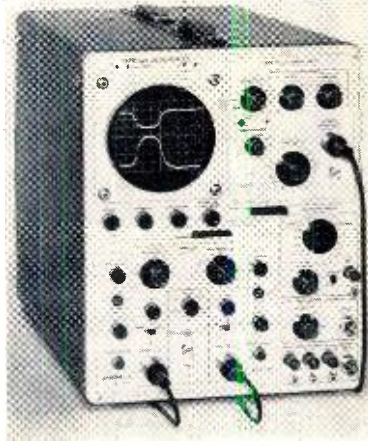

In order to view waveforms with very short rise times, a high-speed sampling technique is used in this Tektronix 661 with dual-trace sampling preamp unit. Small bits of the signal, sampled at slightly different portions of the waveform, recreate the display. The vertical passband is equivalent to d.c. to 3500 mc.; rise time is 0.1 nsec. Price of scope and plug-ins: \$3500.

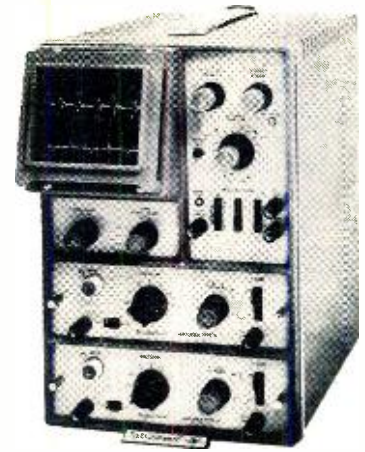

An oscilloscope that uses an unusual CRT to get a dual trace on the screen is the Telequipment (Avnet) D44. Although the tube uses a single cathode, control and focusing electrodes, two completely separate deflection systems operate on the electron beam which is split in two parts. Plug-ins are available for various bandwidths, gains. Price (basic unit): \$350.

tions and yet provide maximum versatility for foreseeable future requirements.

As an example of improvements that have been made in general-purpose low-frequency scopes in the past 10 years, let us compare some of the major characteristics of the DuMont Type 304 and the newer Fairchild-DuMont 704. The following table shows the improvement in the electrical

Characteristic	10-Year-Old Oscilloscope	New Oscilloscope
Bandwidth	100 kc.	500 kc.
Sensitivity	100 mv./div.	0.2 mv./div.
Sweep Rate	30 kc.	0.1 μ sec./div.
Phase Shift Between X-Y	Not Specified	$\pm 1^\circ$ to 100 kc.
Identical Amplifiers	No	Yes
Accuracy	$\pm 5\%$	$\pm 2\%$

characteristics of the units. It should be noted that in the older instrument the sweep is calibrated in the number of sweeps per second whereas in the newer type instrument

the horizontal axis is calibrated directly in time per division.

The latest development in oscilloscope circuitry has been the use of the transistor and other semiconductors. Although we know of no commercial oscilloscope that has been completely transistorized, semiconductors are now used in from 30 to 90 percent of the active stages in some present-day instruments currently on the market.

Advantages of Solid-State Oscilloscope

Obvious advantages of solid-state design are that the instrument will weigh less, require less space, and consume a smaller amount of power. Instruments which have the same electrical characteristics as the solid-state oscilloscope weigh from 2.5 to 3 times more, and consume over twice as much power. Tube instruments exhibit two problems which are directly related to tube aging. There is a slow degradation in the tube parameters with time. This causes trouble in the calibration and balance of the instrument. Certain types of silicon transistors, on the other hand, retain their original properties for practically their entire life.

A special cathode-ray storage tube is the heart of the Analab Model 1220, shown here with a dual-trace plug-in preamp. Information can be stored for many months or it may be erased in 30 seconds. Repetitive signals up to 100 kc. and single transients to several kc. can also be stored. Price of basic unit (no preamp) is \$1600.

An example of an inexpensive general-purpose and service-type oscilloscope is the Precision ES150. The unit can also be used for low-frequency work as its response goes down to d.c. On the high side response is -3 db at 4.5 mc. Sensitivity is 70 mv./in. on d.c. and 25 mv. r.m.s./in. on a.c. Price of the scope: \$149.95.

Designed mainly for industrial applications, such as general production testing, computer testing, and lab use, is the Hewlett-Packard 175A. The scope has a passband of from d.c. to 50 mc. with 7-nsec. rise time using a suitable plug-in preamp. A variety of vertical and time-base units are available. Price (basic unit): \$1325.

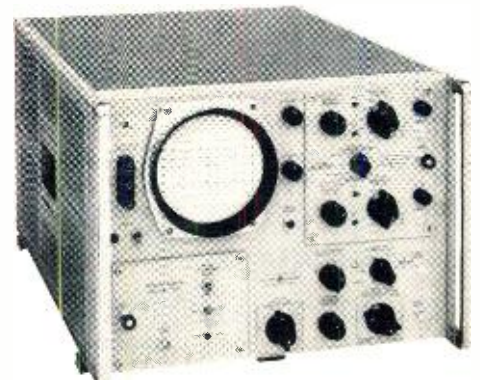

The second effect which is found in tube instruments is a tube disease known as "cathode interface." This trouble is inherent in the vacuum tube itself and has been a constant, but unavoidable, source of trouble in high-frequency scopes until the introduction of the solid-state scope. When the tube begins to age, a resistance is developed between the heater and cathode of the tube. It acts as if an RC network had been connected inside the tube. This reduces the gain at low frequencies while not affecting the higher ones. A gradual overpeaking is therefore developed in the square-wave response. Some large companies connect clocks to their oscilloscopes and replace all the tubes in the high-frequency amplifiers every 30 to 60 days. Since transistors have neither heaters nor cathodes, this problem is non-existent.

There is also more versatility when designing with transistors, since both *n-p-n* and *p-n-p* transistors are available. The *p-n-p* transistor has no tube counterpart, since the tube would have to operate with the cathode positive with respect to the plate. In direct-coupled systems, this is an easy method of keeping the power supplies at low values.

Not all types of transistors are suitable for use in oscilloscopes. To produce a stable, solid-state scope silicon transistors are usually used. The reverse current from collector to base in transistors doubles every time the temperature increases 10°C. Since the acceptable range of operation is be-

or not become obsolescent soon. These questions are general and could be used as a yardstick for either a scope to do a specific job, or one for general use.

1. *What sweep rates are necessary?* Some measurements require that the instruments have fast sweep rates, while others need slow sweeps. An oscilloscope having the greatest spread between fastest and slowest sweep would seem to be the more versatile. However, two important points should be considered in determining what sweep rates are necessary.

Are the frequency response of the vertical amplifier and the maximum sweep rate compatible and what is the sequence of the sweep-rate switching? As a rule of thumb, if one cycle of the upper passband frequency can be displayed across the face of the CRT, then the sweep rate is adequate. For example, if the passband were 500 kc., then the period for 1 cycle would be 1/500 kc. or 2 microseconds. If this time is divided by the number of divisions in the horizontal direction, usually 10, then the fastest sweep rate required will be 0.2 microsecond per division. Applying this rule to a 25-mc. bandwidth scope would yield the 4 nanosecond per division (4 nsec./div.) sweep rate required. This sweep rate is not obtainable in high-frequency scopes at present and some other criteria are needed. The state of the art requires that a ratio of 5 to 1 will have to be used between the calculated sweep rate and what is available at the present time.



A 3-inch d.c. oscilloscope that is available in kit form is the Heath IO-10. Identical vertical and horizontal channels are used with bandwidths from d.c. to 200 kc. Sensitivities of amplifiers are 0.4 v. (p-p) per inch. This compact scope weighs about 16 lbs. There is less than 5° relative phase shift between channels. Price: \$79.95.

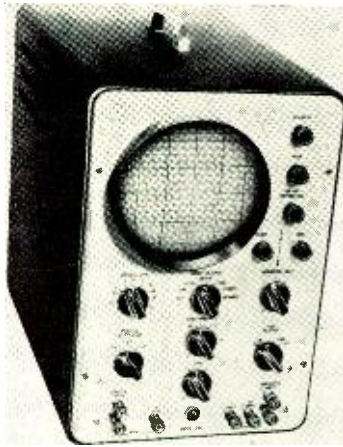

Another example of a scope in kit form is the Conar Model 250. This is a 5-inch wide-band scope for general and TV service use. The vertical sensitivity of the unit is 23 mv. r.m.s./in., and the vertical frequency response is flat from 13 cps to 2.5 mc. and down 1.5 db at 3.58 mc. Price: \$89.50, or \$139.50 assembled.



The most elaborate scope in kit form is the Knight 10-mc. d.c. laboratory scope shown here. This is a research-quality unit with interchangeable vertical preamps. Built-in sweep timing markers are provided along with built-in voltage calibrator. Dual-trace preamp is available. Price without plug-in preamps is \$395.

tween 0 and 50°C, an extremely low initial reverse current is a prime characteristic for transistors used in oscilloscopes. When germanium transistors are used, instability with temperature usually results due to their larger reverse currents.

Transistorized construction also makes it possible to package all the signal-carrying circuitry into plug-ins rather than having it distributed between a preamplifier plug-in and the main frame. The delayed sweep generator, which contains two complete sweeps, may be operated more easily than tube types due to its compactness. Automatic features within this unit, made possible by silicon planar transistors, decrease the number of controls on the front panel. Cabling, which had to be external in the past, is now done internally and may be changed by means of front-panel switches.

Choosing an Oscilloscope

When choosing an oscilloscope, there are certain questions which must be answered to obtain an instrument that will avoid erroneous readings, make the required measurement,

2. *What is the accuracy of the sweep?* If quantitative rather than qualitative information is required, the sweep accuracy timing should be no more than $\pm 5\%$ from nominal. Most commercial manufacturers hold the tolerance to within 3% on all ranges.

3. *Is vertical delay required?* Above 5 mc. the oscilloscope should have a delay built into the vertical amplifier. An exception to this is when using the instrument as an X-Y plotter where the sweep is inactive. Another application where a delay line is not necessary is when the scope is always triggered from an external source, which activates the sweep at a specified time before the signal applied to the vertical channel. Such an application is the servicing of computers where the sweep is referenced to a given point in the computer and other signals measured from this point.

4. *What rise time and bandwidth are required?* Normally the rise time of the scope should be 1/5 the rise time of the signal being observed. This will cause an error of about 2% when making a rise-time measure- (Continued on page 74)

1963 Directory of Kit Test Equipment

Complete listing of all presently available test equipment kits. Over 200 designs divided into 29 categories, according to function, are covered.

THE philosophy of producing kits is as old as the electronics industry itself, but it wasn't until after World War II that test equipment in kit form was produced in quantity. The advent of television generated an immediate need for test equipment for the installation, service, and maintenance of this new entertainment phenomenon. Not only were new forms of test equipment needed, but if relatively accurate and stable equipment could be produced at reasonable prices, there was a ready-made market for such output. Industry more than fulfilled its promise in the way of kits whose quality and low price far overshadowed the inconvenience of assembling such equipment. The fact that equipment had to be put together ultimately proved a real selling point since technically oriented persons derived tremendous satisfaction from building their own units.

Almost simultaneously with the service industry, a new market opened up in test equipment for the home workshop. Hobbyists, experimenters, and even electronics engineers, found test equipment kits the answer to their needs.

Today one can find test equipment kits in every area, from industrial and military plants to electronics laboratories. Service departments; production-line testing departments for radio, TV, hi-fi, and industrial electronic equipment; medical and educational institutions are among the diversified places where such test equipment can be used. Test equipment kits have become so sophisticated that in many cases they are the equal of all but highly elaborate and specialized factory-assembled units. In laboratories, once they have been checked against calibrated equipment, they are ideal for making comparative measurements on all types of products.

Kits have achieved these advances for several good reasons: (1) Design standards, component quality, and accuracy are relatively high. (2) Technicians can assemble them during free time while drawing regular salary. In this way key employees can be kept busy without additional cost. (3) One of the most important reasons why kit test equipment has made inroads in the industrial area is that their circuits can be modified during construction to adapt the instrument to special applications. In many cases there is a need for specific individual tests, especially for production applications. Why tie up multiple-operation units in such cases?

Today, kits bear little resemblance to the first 5" scope kit that sold for \$39.95 in 1947. Circuit design, performance, and versatility of present-day test equipment have kept pace with the industry. Transistors are now beginning to replace vacuum tubes in some kits.

Over 200 different test equipment kits are available ranging in price from \$5.50 for a capacitor substitution box to \$395.00 for a laboratory oscilloscope. There is actually no limit to the degree of complexity of the test equipment that can be designed and marketed in kit form. Why this is so is largely a matter of the painstaking detail and clarity of the construction manuals accompanying such equipment.

If you have never assembled a kit, be assured that these manuals are well written with step-by-step instructions so clearly presented that an operating instrument is guaranteed. Calibration procedures are simple and provide a relatively high degree of accuracy. Should problems arise, manufacturers will, for a nominal fee, check out any kit that does not operate, calibrate it, and put it in top working order. ▲

R.F. SIGNAL GENERATORS

Mfr.	Model	Freq. Range (fundamentals)	No. of Bands	Cal. Harmonics		Output		Modulation Freq. (cps)	Provision for Ext. Mod.	Audio Output		Price	Remarks
				Freq.	No. of Bands	Voltage	Z			Volts			
ALLIED CONAR EICO	83Y953	160 kc.-112 mc.	5	none	—	.4	—	400	yes	yes	10	\$19.95	
	280	170 kc.-60 mc.	6	none	—	.1	50Ω	400	no	yes	5	\$21.50	
EICO	315	75 kc.-50 mc.	5	13-150 mc.	2	.1	—	400	yes	yes	—	\$49.95	
	320	150 kc.-34 mc.	5	22-102 mc.	2	.1	—	400	no	yes	1.5-2	\$24.95	Model 322 with 5 cal. bands \$27.95
	324	150 kc.-145 mc.	6	111-435 mc.	1	.1	50Ω	400	yes	yes	10	\$28.95	
EMC HEATH	502	115 kc.-110 mc.	6	—	—	.1	—	400	yes	no	—	\$17.95	
	FMO-1	90, 100, 107 mc.	3	—	—	—	—	400	no	yes	—	\$34.95	three switch-selected freq. var. 10.7 mc. sweep, 200 kc. to over 1 mc., 10.7 mc. crystal mark, 100 kc. submarker
	16-42	100 kc.-31 mc.	5	—	—	.1	50Ω	400	yes	no	—	\$56.95	panel meter indicates output voltage or percent modulation
LAFAYETTE OLSON PRECISE	16-102	100 kc.-110 mc.	6	110-220 mc.	1	.1	50Ω	400	yes	yes	10	\$27.95	
	KT-208	250 kc.-120 mc.	5	—	—	—	—	400	yes	—	—	\$19.95	also a signal tracer
	KB-141	250 kc.-120 mc.	5	—	—	—	—	400	yes	—	—	\$19.95	also a signal tracer
RADIO SHACK	610K	300 kc.-110 mc.	5	60-330 mc.	2	—	—	60, 400	—	—	—	\$27.50	available with precalibrated r.f. head as 610KA, \$34.95
	22-068E	100 kc.-330 mc.	6	—	—	1.0	—	20-20,000	yes	20-20,000 cps	2.5	\$39.95	meter indicates r.f., a.f. output; r.f., a.f. volts; db in 3 ranges; 0-1, 10, 100 v. a.c.
	22-026	160 kc.-110 mc.	5	—	—	.1	50Ω	400	yes	—	—	\$18.95	

TUBE TESTERS

Mfr.	Model	Type		Shorts, Opens, Leakage	Tests		Line-Voltage Adjust	Charts	*Sockets	Meter Scale	Special Tube Tests	Price	Remarks
		Emission	G _{nuv}		Grid Current	G _{nuv}							
ALLIED	400*	X		shorts only				book	7- & 9-pin miniature, oc., lok.	good-bad	—	\$ 19.95	
	600B	X		X			X	roll	4, 5, 6, 7L, 7S, oc., lok, 9, com., nov., nuv., 10	good-bad	CRT with adapter	\$ 39.95	counter model \$35.95 performs gas check
CONAR	221	X		Shorts, opens, leakage			X	roll	4, 5, 6, 7L, 7-, 9-, 10-pin miniature, oc., lok., nov., com., 5-, 7-pin nuv.		CRT with adapter, VR, tuning eyes	\$ 48.75	12 test levers, book for foreign tubes
EICO	625	X		X			X	roll	4, 5, 6, 7L, 7S, oc., lok. nov.	good-bad	VR's, "eye," CRT with adapter	\$ 34.95	
	628	X		X			X	roll	7-9- & 10-pin miniatures; oc., lok., 5- & 7-pin nuv., com., nov.		VR's "eye" color & monochrome CRT's with adapter	\$ 44.95	
	666		X			X	X	roll	4, 5, 6, 7L, 7S, miniature 7- & 9-pin, subminiature 5, 6, 7-pin (in-line base), oc., lok.	good-bad	CRT with adapter, VR's, "eye," ballast tube	\$ 69.95	direct indication of leakage in ohms; transistor leakage and beta test
	667		X	X		X	X	roll	7-9- & 10-pin miniatures; 5-6- & 7-pin sub-miniature, sub-miniature 8-pin, oc., lok., 5- & 7-pin nuv., com., nov.		VR's, "eye" ballast, color & monochrome CRT's with adapter	\$ 79.95	direct indication of leakage in ohms; transistor leakage and beta test
EMC	205	X		X			X	roll	9 sockets	good-bad	"eye," VR, CRT with adapter	\$ 34.50	
	209	X		X				book	7- & 9-pin miniature, oc., lok.	good-bad	CRT with adapter	\$ 25.90	rejuvenates CRT's
	211	X		X				book	7- & 9-pin miniature, oc., lok.	good-bad	—	\$ 14.90	
	213	X		X				book	7- & 9-pin miniature, com., nuv., nov., 10-pin, oc., lok.	good-bad	VR's, "eye"	\$ 18.9c	\$21.90 in wood carrying case
	301	X		X				book	7- & 9-pin miniature, oc., lok.	good-bad	CRT with adapter	\$ 32.60	\$33.20 in wood cabinet; rejuvenates CRT's
	302	X		X				book	7- & 9-pin miniature, oc., lok.	good-bad	CRT with adapter	\$ 47.90	\$49.90 in wood cabinet; rejuvenates CRT's
HEATH	TT-21	X		X			X	roll	4, 5, 6, 7L, 7S, 7, 10-pin miniature, oc., lok., nov., com., 5, 7-pin nuv.	good-bad	CRT with adapter	\$ 44.95	
	TT-1A		X	X	1/4 μ a. sensitivity	X	X	roll	4, 5, 6, 7L, 7S, 7- & 8-pin sub-miniature, oc., lok., 9-pin miniature, com., nuv., nov., 10-pin	0-3000 μ mhos, VR test volts, 0-1 v. a.c.	VR's, low-power thyatrons, "eye" tubes	\$149.95	
LAFAYETTE	KT-209	X		X				book	7 sockets	good-bad		\$ 17.95	
	KB-142	X		X				book	7 sockets	good-bad		\$ 17.95	
PACO	T-60	X		X			X	roll	7- & 9-pin miniature, oc., lok.	good-bad	VR's, "eye," CRT with adapter, gas rectifiers	\$ 42.95	
	T-62	X		X	X			book	7, 9 & 10-pin miniature, 12 com., 5- & 7-pin nuv., oc., lok, nov.	good-bad	CRT with adapter	\$ 49.95	has 0-1000 VTVM megohmmeter for external checking resistors, capacitor leakage, etc.
RADIO SHACK	22-064M	X		X			X	roll	4, 5, 6, 7L, 7- & 9-pin miniature, oc., lok., com., nuv., 10-pin	good-bad	CRT with adapter	\$ 44.50	
	22-2001E		X	X		X	X	roll	4, 5, 6, 7L, 7S, 7 subminiature, oc., lok., 8-subminiature, 9- & 10 miniature, nuv., nov., com.	good-bad 0-30,000 μ mhos		\$ 94.50	tests transistors & zener diodes; fil. current indicated on meter

*com. = compactrons; nuv. = nuvistors; nov. = novars; oc. = octal; lok. = loktal.

OSCILLOSCOPES

Mfgr.	Model	Vertical Channel			Horizontal Channel			Sweep	CRT Size	Price	Remarks
		Freq. Resp.	Sensitivity	Input Z (meg.—pf.)	Freq. Resp.	Sensitivity	Input Z (meg.—pf.)				
ALLIED	83YU913	5 cps-5 mc. ±3 db	25 r.m.s. mv./in.	3.4-12	down 4 db @ 1 mc.	600 r.m.s. mv./in.	—	15 cps- 600 kc.	5"	\$ 69.95	
	83YZ945	—	—	—	d.c. to 2.5 mc. +0 —3 db	.1 v./cm.- 1. v./cm.	—	.5 sec./cm.- 50 nsec./ cm.	5"	\$395.00	intensity modulated time marks @ 10, 100, & 1000 μsec.
	83YZ946	differential amp. for 83YZ945: vert. chan. freq. resp. d.c.—100 kc., 0 to —3 db; sensitivity, 1 p.p.v./in.; input Z, 1 meg., 40 pf.								\$ 59.95	5000:1 diff. ratio
	83YZ948	dual-trace preamp for 83YZ945: vert. chan. freq. resp. d.c.—10 mc., 0 to —3 db; sensitivity 50 p.p.mv./cm.; input Z, 1 meg., 40 pf.								\$ 79.95	switching rate: 100 kc. chopped or alternate sweeps
	83YU910- -J	d.c.-5 mc. +0, —3 db	d.c.-coupled .05 v. p-p/cm.; a.c.-coupled .005 v. p-p/cm.	1-40	d.c. to 500 kc. +0, —3 db	.15 v./cm. has variable attenuator	1	.05 sec./cm.- 200 nsec./cm.	5"	\$184.95	85 nsec. rise time
CONAR	250	flat 13 cps- 2.5 mc., down 3.5 db @ 4.5 mc.	.023 r.m.s. v./in.	2.7 meg. @ 1 kc.	flat 20 cps-90 kc. down 3 db @ 250 kc.	1 r.m.s. v./in.	4.9 meg. @ 1 kc.	10 cps- 500 kc	5"	\$ 89.50	built-in pulse for flyback, yoke tests, etc.
EICO	427	d.c.-1 mc. +0, —6 db	10 p-p mv./cm.	1-30	2 cps-450 kc. +0, —3 db	.5 p-p v./cm.	10-40	10 cps- 100 kc.	5"	\$ 69.95	
	430	2 cps-500 kc. +0, —3 db.	25 r.m.s. mv./cm.	1-30	2 cps-300 kc. +0, —3 db	.25 r.m.s. v./cm.	10-40	10 cps- 100 kc.	3"	\$ 65.95	
	460	flat d.c.-4.5 mc. down 10 db. @ 10 mc.	25 r.m.s. mv./in.	3-35	flat 1 cps-400 kc.	.6 r.m.s. v./in.	5-35	10 cps- 100 kc.	5"	\$ 89.95	.06 μsec. rise time
FEILER	TS-7	20 cps-75 kc.	.5 r.m.s. v./in.	1-50	—	.5 r.m.s. v./in.	1-50	10 cps- 32 kc	5"	\$ 53.48	
HEATH	10-10	d.c.-200 kc. (2 db point)	.1 p-p v./1/4"	3.6-35	same as vert.	same as vert.	3.6-35	5 cps- 50 kc.	3"	\$ 79.95	
	10-21	2 cps-200 kc. ±2 db	.25 r.m.s. v./in.	10-20	same as vert.	same as vert.	10-20	20 cps- 100 kc.	3"	\$ 49.95	
	10-12	3 cps-5 mc. +1.5 db to —5 db	.025 r.m.s. v./in. @ 1 kc.	3.3-12	1 cps-400 kc. ±3 db	.3 r.m.s. v./in. @ 1 kc.	4.9 @ 1 kc.	10 cps- 500 kc.	5"	\$ 76.95	.08 μsec. rise time 2 preset sweep freq. positions
PACO	S-51	5 cps-1.2 mc. ±3 db, to 2 mc. ±6 db	90 r.m.s. mv./in.	1.5-25	±6 db to 700 kc.	250 r.m.s. mv./in.	10-25	20 cps- 150 kc.	5"	\$ 69.95	
	S-55	a.c. & d.c. within 5 db @ 5 mc.	25 r.m.s. mv./in.	1.5-23	within 3 db 1 cps- 400 kc.	.6 r.m.s. v./in.	5-23	10 cps-100 kc.	5"	\$ 95.95	.08 μsec. rise time
PRECISE	300K	d.c.-5 mc. ±3 db	3.9 p-p mv./cm.	—	—	—	—	1 cps-80 kc.	7"	\$169.95	
	308K	d.c.-5 mc. ±1.5 db	10 p-p mv./cm.	—	—	—	—	1 cps-80 kc.	8 1/2"	\$179.95	
	315K	a.c. coupled within —6 db to 500 kc.	250 mv./in.	—	—	250 mv./in.	—	10 cps- 100 kc.	5"	\$ 59.95	
	3151K	flat to 5 mc.	10 mv./cm.	—	—	10 mv./cm.	—	—	5"	\$ 69.95	
RCA	WO-33A	flat 5.5 cps- 5 mc. within —3 db	.3 p-p v./in.	1-50	flat 3.5 cps- 350 kc. within 6 db	.9 r.m.s. v./in.	10-	15 cps-75 kc.	3"	\$ 79.95	wideband response .1 μsec. rise time
		3 cps-1.5 mc. flat within —6 db	.01 p-p v./in.	1-50	flat 3.5 cps- 350 kc. within —6 db	.9 r.m.s. v./in.	10-	15 cps-75 kc.	3"	\$ 79.95	narrow band response .1 μsec. rise time
RADIO SHACK	22-072E	10 cps-3 mc. ±5 db to 5 mc.	100 r.m.s. mv./in. single trace; 200 r.m.s. mv./in. dual trace	500 k. single trace; 100 k dual trace	flat to 100 kc. —6 db @ 1 mc.	100 r.m.s. mv./in.	—	10 cps- 100 kc.	5"	\$ 69.95	
	22-086E	d.c.-75 kc.	25 r.m.s. mv./in.	5-100	20 cps-70 kc.	.6 r.m.s. v./in.	.5-100	20 cps-20 kc.	3"	\$ 34.50	

TRANSISTOR TESTERS

Mfgr.	Model	Tests				Voltage-Current Ranges	Price	Remarks
		Shorts	Gain	Leakage	Forward & Reverse Current			
ALLIED	83Y149	X			X		\$ 8.95	checks leakage-to-gain ratio checks diodes & rectifiers
EICO	680	X	d.c. beta directly—2-30, 2-300 a.c. beta indirectly	I_{cbo} , I_{ceo}	X	50, 500 μa., 5, 50, 500 ma.	\$25.95	d.c. voltage ranges 5, 50 v.; three res. ranges, 2000, 200 k, 20 meg.; checks diodes & rectifiers
EMC	212		d.c. in three ranges to 200	X		80 ma., 12 v.	\$13.50	checks transistors as a.c. current amplifiers & in-circuit
HEATH	1M-30	X	d.c. beta directly 0-300 d.c. alpha directly 0-.9967	I_{cbo} , I_{ceo}		15, 150 μa., 1.5, 15, 150 ma., 1.5, 15 a., 1.5, 5, 15, 50, 150 v. (100 k ohms/volt)	\$54.88	collector current to 15 a.; provision for external d.c. supply; checks diodes & rectifiers
	1T-10	X		X	X		\$ 6.95	
LAFAYETTE	KT-223		d.c. in 3 ranges to 200	X		80 ma., 12 v.	\$12.75	in-circuit transistor checks include power types

Study for a profitable career ...in the place you like best!

LET RCA TRAIN YOU IN ELECTRONICS



LOS ANGELES



NEW YORK CITY

Prepare yourself for a profitable future in the ever-growing field of electronics while enjoying the advantage of the city you prefer. Whether you study at the RCA Institutes in Los Angeles or in New York City, you'll be getting the finest of training in electronics. RCA Institutes is recognized throughout the United States as a leading technical institute devoted exclusively to electronics. You have a broad selection of courses to choose from... each one the finest of its kind... each one preparing you for an exciting career in the fascinating field of electronics.

Coeducational day and evening courses start 4 times each year

SEND COUPON FOR FREE RESIDENT SCHOOL CATALOG

Home Study Courses also available. Catalog free on request. For further information see our Home Study ad on Page 11.



RCA INSTITUTES, INC.
A Service of Radio Corporation of America

The Most Trusted Name in Electronics

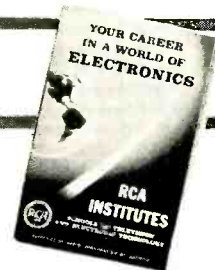

For **Los Angeles School** send this coupon. ➡

For **New York School** send this coupon. ➡

610 S. Main St., Dept. EWR-83
Los Angeles 14, Calif.

Please send me your FREE catalog of Resident School courses.

Name _____
(please print)

Address _____

City _____ Zone _____ State _____

350 West 4th St., Dept. EWR-83
New York 14, N. Y.

Please send me your FREE catalog of Resident School courses.

Name _____
(please print)

Address _____

City _____ Zone _____ State _____

GENERAL PURPOSE V.T.V.M.'s

Mfr.	Model	Ranges*		No. of Ranges	D.C. Input Res. (meg.)	A.C. Input Z (meg.-pf.)	Accuracy (full-scale)		Frequency Response	Price	Remarks**
		D.C., A.C. (r.m.s.)	Ohms/mid-scale				D.C.	A.C.			
ALLIED	83Y911	1.5-1500	1000/10 1000m./10m.	7	11	—	± 3%	± 5%	30 cps-5 mc. ± 3 db.	\$26.95	db range -10 to + 65; a.c. p-p ranges 4, 4000
ARKAY	VT-10	3-1500	1000, 1000m.	7	11	—	—	—	30 cps-5 mc.	\$25.95	db range -10 to + 58
CONAR	211	3-1200	1000/10 1000m./10m.	6	12.2	1.5-	± 2%	± 3%	30 cps-6 mc.	\$31.95	uses switchless single probe lead
DEVRY	—	1 d.c., 5 a.c.-1000	100/100k. 4 ranges	4	10	1.85—	—	—	—	\$64.50	d.c. current 50-500 µa., 5-50ma. transistorized, battery operated
EICO	221	5-1000	1000, 1000m.	5	25	3-	± 3%	± 5%	20 cps-200 kc.	\$25.95	db range -20 to + 55
	214	—	—	—	—	—	—	—	—	\$34.95	same as 221 but 7 1/2" meter
	222	3-1500	1000m.	5	11	1-	± 3%	± 5%	30 cps-3 mc.	\$27.95	p-p with special probe
	'32	1.5-1500	1000m.	7	—	—	—	—	30 cps-3 mc.	\$29.95	a.c. p-p ranges 4, 4200
	49	—	—	—	—	—	—	—	—	\$39.95	same as 232 but 7 1/2" meter
EMC	06	1.5-1000	1000, 1000m.	5	16.5	2-	—	—	25 cps-100 kc.	\$23.90	db range -24 to + 55
	107	1.5-1000	1000, 1000m.	6	16.5	1.5-	—	—	—	\$34.50	a.c. p-p ranges 4, 2800; capacity 50 pf.-5000 µf.; inductance 1.4-140,000 hy.
	107A	—	—	—	—	—	—	—	—	\$36.50	same as 107 but 6" meter
FEILER	T5-9	5-1000	1000m.	5	26	3-	± 2%	± 2%	—	\$26.39	db range -20 to + 16; 0-1 ma. d.c. range
HEATH	IM-13	1.5-1500	1000/10 1000m./10m.	7	11	1-30	± 3%	± 5%	25 cps-1 mc. ± 1 db	\$32.95	db range -10 to + 65
	IM-11	1.5-1500	1000/10 1000m./10m.	7	11	1-35	± 3%	± 5%	25 cps-1 mc. ± 1 db	\$24.95	
LAFAYETTE	KT-174	1.5-1500	1000, 1000m.	7	11	150 v.-1.3 meg; 500 v., 1500 v.-1.5 meg; other scales 50-83 meg.	± 2%	± 5% (5v.) ± 3% (others)	20 cps-4 mc. ± 1 db	\$44.50	low a.c. ranges 50, 150, 500 mv.; 4.2, 4200 p-p ranges
	KT-202	3-1500	1000/10 1000m./10m.	7	11	—	—	—	30 cps-5 mc.	\$25.95	db range -10 to + 18; a.c. p-p ranges 8, 2000
OLSON	KB-140	3-1500	1000/10 1000m./10m.	5	11	—	—	—	30 cps-5 mc.	\$25.95	db range -10 to + 58; a.c. p-p ranges 8, 2000
PACO	V-70	1.5-1500	1000/10 1000m./10m.	7	11	—	—	—	40 cps-4 mc. ± 1 db	\$31.95	db range -6 to + 66; a.c. p-p ranges 4, 4000
PRECISE	904K	1.5-1500	1000/10 1000m./10m.	7	—	—	—	—	—	\$39.95	
	909K	5-1000	1000/10 1000m./10m.	5	25	—	—	—	—	\$29.95	
	9071K	5-1000	1000/10 1000m./10m.	5	25	—	—	—	—	\$39.95	7 1/2" meter
RADIO SHACK	22-070M	1.5-1500	1000/10 1000m./10m.	6	11	—	± 3%	± 5%	flat to 2 mc.	\$38.20	15, 150 mv. ranges; .15, 5 a. a.c. ranges; 0-1600 w. a.c. ranges 15, 30, 60 watts across 16, 8, 4 ohm loads
	22-078	3-1500	1000/10 1000m./10m.	—	11	—	± 3%	± 5%	flat to 3 mc.	\$26.95	db range -10 to + 38; a.c. p-p ranges 8, 2000
RCA	WV-77E	1.5-1500	1000/10 1000m./10m.	7	11	—	± 3%	± 5%	40 cps-5 mc. ± 5 db on 1.5, 5, 15 v. ranges	\$29.95	a.c. p-p ranges 4, 4000
	WV-98C	5-1500 d.c.	1000, 1000	7	11	.83-70	± 3%	± 3% (± 5%, 1.5-5v.)	30 cps-3 mc.	\$62.50	a.c. p-p ranges 4, 4200 .5 v. d.c. range

*Figures are highest scale markings for lowest and highest ranges.
**Peak-to-peak ranges, where shown, are true readings of complex waveshapes.

A.C. POWER SUPPLIES

GRID-DIP METERS

Mfr.	Model	Output Voltage	Output Current	Meter Ranges		Price
				V.	A.	
EICO	1073	0-140	1, 3 a.	140	1, 3	\$35.95
	1078	0-140	2.5, 7 a.	140	2.5, 7	\$42.95
HEATH	1P-22	90-130 in .75 v. steps	300 w. (cont.) 500 w. (inter.)	90-140	—	\$54.95
RADIO SHACK	22-902E	0-150	5 a.	0-150	—	\$20.21

Mfr.	Model	Range (mc.)	No. of Bands	Power	Price	Remarks
ALLIED	G-30	1.5-300	6	a.c.	\$22.95	
EICO	710	.400-250	8	a.c.	\$29.95	
HEATH	HM-10A	3-260	6	batt.	\$34.95	tunnel diode

D.C. POWER SUPPLIES

Mfr.	Model	Output Voltage Ranges	Current Ranges (amps)		Meter Scales	Price	Remarks
			Continuous	Intermittent			
ALLIED	83YX912	8, 15	15 (6 v.) 10 (12 v.)	17.5 (6 v.) 12.5 (12 v.)	15 v. d.c. 20 a. d.c.	\$38.95	
EICO	1020	6, 30	150 ma. (0-12 v.) 200 ma. (12-24 v.) 300 ma. (24-30 v.)		6 v. d.c. 30 v. d.c.	\$23.99	.005% 120 cps ripple at full load
	1050	8, 16	10 (8 v.) 6 (16 v.)	20 (8 v.) 12 (16 v.)	20 v. 20 a.	\$29.95	not recommended for transistor work; accessory filter #1055 available
	1060	8, 16	10 (8 v.) 6 (16 v.)	20 (8 v.) 10 (16 v.)	20 v. 10, 20 a.	\$39.95	ripple 16 v. range: 3% @ 2 a., 1% @ 6 a., 1.5% @ 10 a.; 8 v. range: 1.5% @ 2 a., 2% @ 6 a., 4.5% @ 10 a.
	1064	8, 16	10 (8 v.) 6 (16 v.)	20 (8 v.) 10 (16 v.)	20 v. 10, 20 a.	\$45.95	ripple same as 1060; lightweight version of 1060
EMC	905	6, 12	—	—	2 meters	\$28.90	with extra filtering for transistor applications \$34.90
HEATH	IP-12	8, 16	10 (6 v. unfiltered) 5 (6 v. filtered) 5 (12 v.)	15 (6 v. unfiltered) 7.5 (12 v. unfiltered)	2 meters	\$47.50	ripple .3%
	IP-32	0-400 v. 0 to 100 v. (bias voltage)	100 ma. 1 ma.	125 ma.	150, 400 v. 150 ma.	\$56.95	6.3 v. @ 4 a. a.c. output; ripple 10 mv. d.c. output impedance 10 ohms; output regulation 1% from no load to full load, $\pm .5$ v. for ± 10 v. line voltage variation from 117 v.
	IP-2D	0-50 in 5 v. steps	1.5	—	15, 50 v. & amp.	\$72.50	transistorized, ripple & noise 150 μ v. max., overload protection, load regulation ± 15 mv., output imp. .01 ohm to 10 kc. — .5 ohm 10 kc. & up
PACO	B-10	8, 16	10 (8 v.) 6 (16 v.)	20 (8 v.) 12 (16 v.)	2 meters	\$43.95	low ripple output; 8 & 16 v., 5 a., 3%
	B-12	0-400 v. 0 to 150 v.	150 ma. 2 ma.	—	150, 400 v. 200 ma.	\$69.95	6.3 v. @ 3 a. and 12.6 v. @ 3 a. a.c. outputs; d.c. output impedance 10 ohms; regulation .33% from no load to full load; .4% for ± 10 v. line voltage variation from 117 v.
PRECISE	711	15 v. 30 v. 110-180 v.	10 10 .750	20 20 1	—	\$59.95	90-140 v. a.c. (isolated) output @ 1 a.; Model 713 90-140 v. a.c. @ 3 a. output \$69.95; other a.c. output on both models: 24 v. @ 20 a., 90-140 v. @ 10 a. continuous (not isolate ¹)
	760	140-450 v. 0- +1000 v. @ 1 ma.	100 ma.	—	2 meters	\$49.95	6.3 v. @ 4 a. and 375 v. @ 50 ma. o.c. outputs; ripple .01%

SIGNAL TRACERS

Mfr.	Model	Indicators		Test Speaker Function	Out. Trans. Function	Wattmeter Function	"B+" Output	Component Noise-Test Function	Price	Remarks
		Speaker	Eye							
ALLIED	83Y955	X	X	X	X	X	X	X	\$26.95	
CONAR	230	X	X						\$39.95	calibrated attenuator for r.f. & a.f. gain measurement, tuned & calibrated 175 kc. to 1500 kc. in two bands
EICO	145A	X		X	X		X	X	\$23.95	
	147	X	X	X	X	X	X	X	\$29.95	
EMC	802	X	X	X	X		X		\$24.95	generates 400 cps and modulated 455 kc. signals
FEILER	TS-1K	phone							\$ 7.76	meter, phone, battery extra
	TS-3K	X							\$26.16	can be used to convert v.o.m. to r.f. v.i.v.m.; battery operated TS-2K \$17.95
	TS-5K	X							\$23.52	can be used to convert v.o.m. to r.f. v.t.v.m.
HEATH	IT-12	X	X	X	X		X	X	\$19.95	
LAFAYETTE	KT-208	X							\$19.95	also signal gen., see listing; output for v.t.v.m. & phones
OLSON	KB-141	X							\$19.95	also signal gen., see listing
PACO	Z-80	X	X	X	X	X	X	X	\$32.95	calibrated attenuator for gain measurement

SWEEP AND MARKER GENERATORS

Mfr.	Model	Freq. Range	No. of Bands	Output		Sweep Width	Cal. Marker Ranges (fund.)	No. of Bands	Provision for Marker Crystals	Provision for Ext. Markers	Price	Remarks
				Voltage	Z							
ALLIED	83YX123	300 kc.-250 mc.	4	.15		0-13 mc.	—	—	2	yes	\$44.95	
EICO	360	500 kc.-228 mc.	—	—	—	0-30 mc.	—	—	1	no	\$39.95	
	368	3-216 mc.	5	—	50 Ω	0-15 mc.	2-225 mc.	3	1	yes	\$69.95	
	369	3.5-216 mc.	5	—	50 Ω	20 mc.	2-75 mc. to 225 mc. on harm.	3 fund. 1 harm.	1	no	\$79.95	post marker adder
HEATH	IG-52	3.6-220 mc.	4	.1	50 Ω	0-42 mc.	19-60 mc.	1	1	yes	\$54.95	
PACO	G-32	3-220 mc.	5	—	—	0-20 mc.	—	—	1	yes	\$85.95	marker adder

AUDIO GENERATORS

Mfr.	Model	Range	No. of Bands	Output		Output Waveforms	Accuracy	Distortion	Price	Remarks
				Max. Volts	Load Ω					
ALLIED	83YX137	20 cps-1 mc.	5	10	600	sine	—	.25% from 100 cps through audible range into high Z	\$35.95	
EICO	377	20-200 k (sine) 60-50 k (square)	4	10	1000	sine-square	$\pm 3\%$	less than 1%	\$37.95	
HEATH	1G-72	10 cps-100 kc.	sw. sel. freq.	1 v. 10 v.	600 10,000	sine	$\pm 5\%$	less than .1% from 20-20,000 cps	\$41.95	output meter calibrated in volts and db
	1G-82	20 cps-1 mc.	5	10 v. (sine & square)	high Z	sine-square	± 1.5 db 20 cps-1 mc.	.25% from 20-20,000 cps	\$51.95	square-wave output voltage is p-p; rise time .15 μ sec.
PACO	G-34	6 cps-750 kc.	6	10 v. (sine) 18 v. (square)	600 600	sine-square	—	—	\$64.95	square-wave output voltage is p-p; rise time .15 μ sec.
PRECISE	635	20 cps-200 kc.	5	—	—	sine-square	—	—	\$39.95	
	630	20 cps-20 kc.	5	—	—	sine	—	—	\$44.95	has additional r.f. band .3 mc.-100 mc.

A.C. V.T.V.M.'s

Mfr.	Model	Range* A.C. (r.m.s.) v.	No. of Ranges	A.C. Input Z (meg.—pf.)	Accuracy (full-scale)	Frequency Response	Price	Remarks
ARKAY	AV-20	.01-300	10	1 meg. @ 1 kc.	—	10 cps-400 kc. ± 1 db (.01-100 v. range) 10 cps-40 kc. ± 2 db (300 v. range)	\$29.95	db range -52 to + 52
	AW-30	5 mw.-500 w.	6	4, 8, 16, 600 ohms	—	10 cps-250 kc. ± 1 db	\$29.95	audio wattmeter 25 w. continuous, 50 w. intermittent
EICO	250	.001-300	12	10-15	$\pm 3\%$	10 cps-600 kc. ± 0 db	\$49.95	amp. output 5 v.; max. gain 60 db
	255	.001-300	12	10-15	$\pm 3\%$	10 cps-600 kc. ± 0 db	\$44.95	db range -80 to + 52
	261	.01-1000	11	2-15	$\pm 4\%$	10 cps-150 kc. ± 0 db	\$49.95	wattmeter ranges (7) .15 mw.-150 w.; loads: 4, 8, 16, 600 ohms @ 40, 80, 40 + 40 watts
HEATH	1M-21	.01-300	10	(10-300 v.) 10-12 (.01-3 v.) 10-22	$\pm 5\%$	10 cps-500 kc. ± 1 db 10 cps-1 mc. ± 2 db	\$33.95	db range -50 to + 50
RADIO SHACK	22-027 (TK-111)	.01-300	10	1 @ 1 kc.	—	10 cps-400 kc. ± 1 db (.01-100 v. range) 10 cps-40 kc. ± 2 db (300 v. range)	\$25.95	db range -52 to + 52

* Figures are highest scale markings of the lowest and highest ranges.

CAPACITOR CHECKERS

Mfr.	Model	Out or In-Circuit Check	Capacitance Test Range	Resistance Test Range	Power-Factor Function	Test Voltages	Tests		Price	Remarks
							Shorts	Open		
ALLIED	83Y952	in	20 pf.-2000 μ f.				X	X	\$14.95	
	83Y901	out	10 pf.-1000 μ f.	100 ohms-5 m.	0-50%	30, 150, 250, 350, 450 volts d.c.	X	X	\$19.95	
ARKAY	CA-40	out	1 pf.-1 μ f.						\$29.95	
CONAR	311	out	10 pf.-1500 μ f.	1 ohm-150 m.	0-50%	0-450 volts d.c.	X	X	\$21.95	
EICO	955	in	.1 μ f.-50 μ f.			6.3 v. a.c.	to 2000 μ f.	from 5 pf.	\$19.95	
EMC	801	in	10 pf.-5000 μ f.	.5 ohm-500 m.	0-60%	0-500 volt d.c.	to 20 μ f.	from 50 pf.	\$24.95	will not check electrolytics for short
HEATH	1T-22	in					to 20 μ f.	from 50 pf.	\$10.95	
	1T-11	out	10 pf.-1000 μ f.	5 ohms-50 m.	X	3-600 v. d.c.	X	X	\$29.95	direct reading scales; input provision for 10 kc. signal
PACO	C-20	out	10 pf.-2000 μ f.	.5 ohm-200 m.	0-60%	0-500 v. d.c.	X	X	\$23.95	bridge circuit for determining transformer turns ratio
	C-25	in	2 μ f.-400 μ f.				X	from 5 pf.	\$19.95	
RADIO SHACK	22-088	in	4 μ f.-400 μ f.				X	X	\$19.95	

NEW ALL-TRANSISTOR ALL-MODE TUNER by HEATHKIT®



new Heathkit AM-FM-STEREO transistor tuner kit **\$119⁹⁵**

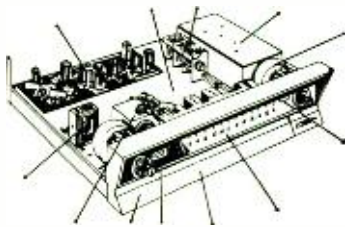

THE LATEST IN FEATURES:

- 24 transistors, 9 diodes • Built-in stereo circuitry • Automatic stereo indicator • Automatic switching to eliminate manual switching to receive stereo • Built-in Automatic Frequency Control and Automatic Gain Control • Adjustable FM squelch • Stereo phase control • Filtered stereo tape recorder outputs • Built-in AM & FM antennas • Separate AM & FM tuning meters • Lighted slide-rule dial • Flywheel tuning • Regulated power supply • Factory assembled FM tuning unit and 4-stage IF circuit board • Concealed secondary controls behind hinged lower front panel

It's new, it's deluxe, *and* it's all transistor! That's the Heathkit AJ-43 Transistor Tuner featuring the very latest in solid-state circuitry for more features, greater listening pleasure. Sensitive, automatic, and ready to capture any broadcast your choose . . . up-to-the-minute AM . . . beautifully quiet FM . . . *and* thrilling, natural FM Stereo! Truly deluxe . . . styled in tasteful tan vinyl-clad steel to complement any decor, quietly . . . to match other deluxe Heathkit stereo equipment. If you prefer the finer things, the latest in the state of the art you'll love the Heathkit AJ-43!

Kit AJ-43, 18 lbs., no money down, \$11 mo. \$119.95

Matching All-Transistor Stereo Amplifier

For balanced performance and appearance, choose the Heathkit AA-21 . . . 28 transistors, 10 diodes, 70 watts! 28 lbs.

Kit AA-21, \$13 mo. \$139.95
Assembled AAW-21, \$16 mo. \$167.95



FREE HEATHKIT CATALOG
Fully describes over 250 exciting, easy-to-build Heathkit products for Stereo/Hi-Fi, Amateur Radio, Test, Marine, Educational, and Home Entertainment. See how you can save up to 50% on equipment and have fun doing it! Send for your free copy today!

- Enclosed is \$_____ plus postage, please send Model AJ-43 Transistor Tuner
- Enclosed is \$_____ plus postage, please send Model AA-21 Transistor Amplifier
- Please send FREE 100 page Heathkit Catalog

HEATH COMPANY
Benton Harbor 15, Michigan

Name _____
Street _____
City _____ Zone _____ State _____

V.O.M.'s

Mfr.	Model	Ranges*			No. of Voltage Ranges	Sensitivity ohms/volt		Accuracy		Price	Remarks
		A.C.—D.C.	Ohms/ mid-scale	D.C. Current †A.C. Current		D.C.	A.C.	D.C.	A.C.		
ALLIED	83Y128	1-5000	1000/60 100,000/150 1 meg./1500	a.c. & d.c. 1, 10, 100 ma., 1 a.	7	1 k	1 k	±2%	—	\$15.95	db scale -20 to + 69;
	83Y149	same as 128 but with 5% resistors								\$13.95	
	83Y140	2.5-5000	2000/12 200,000/1200 20 meg./120 k	.1, 10, 100 ma., 1, 10 amp.	6	20 k	5 k	±2%	—	\$29.95	db scale -30 to + 63; output function
	83Y708	5-500 15-500 (a.c.)	30 k/1200	5, 10, 100 ma.	5	1 k	—	—	—	\$ 7.95	
ARKAY	M4	1-5000	55-150-1500	a.c. & d.c. 1, 10, 100 ma., 1 a.	7	1 k	1 k	—	—	\$13.50	db scale -20 to + 69; in 6 ranges
	MT-50	1.5-5000	15-150-15 k	150 μa., 15, 150, 500 ma., 15 a. d.c.	7	20 k	5 k	—	—	\$29.50	db scale -12 to + 65 db
CONAR	240	6-600	1000, 10 m.	—	3	20 k	5 k	±3%	±5%	\$17.95	
EICO	536	1-5000	5000, 1 m.	a.c. & d.c. 1, 10, 100 ma., 1 a.	7	1 k	1 k	—	—	\$19.95	db scale -20 to + 69; with 1% res. Model 526
	565	2.5-5000	2000, 20 m.	100 μa., 10, 100, 500 ma., 10 a.	6	20 k	5 k	—	—	\$24.95	db scale -12 to + 55; output function; with 1% res. Model 555
	566	1-5000	5000, 1 m.	1, 10, 100 ma., 1 a.	7	1 k	1 k	—	—	\$16.95	db scale -20 to + 69 output function; with 1% res. Model 556
EMC	102K	6-3000 12-3000 (a.c.)	1000, 1 m.	6, 30, 130 ma., 1.2 a. †30, 150, 600 ma.	5	—	—	±2%	±2%	\$12.50	
	103K	6-3000	1000, 1 m.	6, 30, 120 ma. †30, 150, 600 ma.	5	—	—	—	—	\$14.90	db scale
	109K	6-3000 12-3000 (a.c.)	20 k-20 m. (3 ranges)	6, 60, 600 ma.; †30, 300 ma., 3 a.	5	20 k	10 k	—	—	\$19.25	db scale
HEATH	HM-20	15-500 (d.c. only)	—	1 ma.	4	1 k	—	±10%	—	\$14.95	cap. & res. substitutions; signal generator
	HM-1	1.5-5000	—20 m.	150 μa., 15, 150, 500 ma., 15 a.	7	20 k	5 k	—	—	\$29.95	db scale -10 to + 65; output function; polarity rev. switch
LAFAYETTE	TK-10	10-1000	10 k, 1 m.	500 μa., 10, 250 ma.	5	20 k	10 k	—	—	\$11.95	db scale -20 to + 36;
PACO	M40	1.5-6000 3-12k (a.c.)	2000/8.5 20 m./85 k	60 μa., 1.5, 15, 150 ma., 1.5, 15 a.	7	20 k	10 k	—	—	\$31.95	db scale; output function
RADIO SHACK	22-079	1-5000	1000-1 m.	a.c. & d.c. 1, 10, 100 ma., 1 a.	7	1 k	—	—	—	\$16.95	db scale -20 to + 69 output function
RCA	WV-38A	.25-5000 2.5-5000 (a.c.)	2000/12 20 m./120 k	50 μa., 1, 10, 100, 500 ma., 10 a.	d.c.—8 a.c.—6	20 k	5 k	±3%	±5%	\$29.95	db scale -20 to + 50; output function; polarity rev. switch

*Figures are highest scale markings for lowest and highest ranges.

CAPACITOR & RESISTOR SUBSTITUTION & DECADE BOXES

Mfr.	Model	Resistance					Capacitance					Price
		Range (ohms)	Steps	Decades	Tolerance	Wattage	Range	Steps	Decades	Voltage Rating	Tolerance	
ALLIED	83Y138	—	—	—	—	—	.0001 μf.- .22 μf.	18	—	600 v., .15 & .22 μf. are 400 v.	±20%	\$ 5.95
	83Y139	15-10 k 15 k-10 m.	18 18	—	±10%	—	—	—	—	—	—	\$ 5.95
EICO	1100	15-10 m.	—	—	±10%	1	—	—	—	—	—	\$ 7.95
	1120	—	—	—	—	—	.0001 μf.- .22 μf.	18	—	600 v.	±10%	\$ 6.95
	1140	—	—	—	—	—	—	—	—	—	—	\$14.95 (com- bination of 1100 & 1120)
	1171	0-99,999	1 ohm	5	½%	1	—	—	—	—	—	\$24.95
	1180	—	—	—	—	—	100 pf.- .111 μf.	100 pf.	3	350 v.	±10%	\$17.95
EMC	900	15-10 m.	2	—	±10%	1	.0001 μf.- .22 μf.	18	—	—	—	\$10.25
HEATH	IN-22	—	—	—	—	—	.0001 μf.- .22 μf.	18	—	600 v., 400 v. for three highest steps	—	\$ 5.50
	IN-21	—	—	—	—	—	100 pf.- .111 μf.	100 pf.	3	—	±1%	\$17.95
	IN-11	1-99,999	1 ohm	6	±½%	—	—	—	—	—	—	\$24.95
	IN-12	15-10 m.	36	—	±10%	1	—	—	—	—	—	\$ 5.95



Why We Make the Model 211 Available Now

Although there are many stereo test records on the market today, most critical checks on existing test records have to be made with expensive test equipment.

Realizing this, HiFi STEREO REVIEW decided to produce a record that allows you to check your stereo rig, accurately and completely, **just by listening!** A record that would be precise enough for technicians to use in the laboratory—and versatile enough for you to use in your home.

The result: the HiFi STEREO REVIEW Model 211 Stereo Test Record!

Stereo Checks That Can Be Made With the Model 211

- ✓ Frequency response—a direct check of eighteen sections of the frequency spectrum, from 20 to 20,000 cps.
- ✓ Pickup tracking—the most sensitive tests ever available on disc for checking cartridge, stylus, and tone arm.
- ✓ Hum and rumble—foolproof tests that help you evaluate the actual audible levels of rumble and hum in your system.
- ✓ Flutter—a test to check whether your turntable's flutter is low, moderate, or high.
- ✓ Channel balance—two white-noise signals that allow you to match your system's stereo channels for level and tonal characteristics.
- ✓ Separation—an ingenious means of checking the stereo separation at seven different parts of the musical spectrum—from mid-bass to high treble.

ALSO:



- Stereo Spread
- Speaker Phasing
- Channel Identification

PLUS SUPER FIDELITY MUSIC!

The non-test side of this record consists of music recorded directly on the master disc, without going through the usual tape process. It's a superb demonstration of flawless recording technique. A demonstration that will amaze and entertain you and your friends.

August, 1963

NOW...GET THE FINEST STEREO TEST RECORD ever produced

for just...**\$4.98**

Featuring Tests Never Before Available
Outside Of The Laboratory

UNIQUE FEATURES OF HiFi/STEREO REVIEW'S MODEL 211 STEREO TEST RECORD

- Warble tones to minimize the distorting effects of room acoustics when making frequency-response checks.

Warble tones used are recorded to the same level within ± 1 db from 40 to 20,000 cps, and within ± 3 db to 20 cps. For the first time you can measure the frequency response of a system without an anechoic chamber. The frequency limits of each warble are within 5% accuracy.

- White-noise signals to allow the stereo channels to be matched in level and in tonal characteristics.
- Four specially designed tests to check distortion in stereo cartridges.
- Open-air recording of moving snare drums to minimize reverberation when checking stereo spread.

All Tests Can Be Made By Ear

HiFi STEREO REVIEW's Model 211 Stereo Test Record will give you immediate answers to all of the questions you have about your stereo system. It's the **most complete test record** of its kind—contains the widest range of check-points ever included on **one** test disc! And you need no expensive test equipment. All checks can be made by ear!

Note to professionals: The Model 211 can be used as a highly efficient design and measurement tool. Recorded levels, frequencies, etc. have been controlled to very close tolerances—affording accurate numerical evaluation when used with test instruments.

DON'T MISS OUT—SUPPLY LIMITED

The Model 211 Stereo Test Record is a disc that has set the new standard for stereo test recording. Due to the overwhelming demand for this record, only a limited number are still available thru this magazine. They will be sold by ELECTRONICS WORLD on a first come, first serve basis. At the low price of \$4.98, this is a value you won't want to miss. Make sure you fill in and mail the coupon together with your check (\$4.98 per record) today.

FILL IN AND MAIL TODAY!

Stereo Test Record
Electronics World—Dept. SD
One Park Ave., New York 16, N.Y.

Please send me _____ test records at \$4.98 each. My check (or money order) for \$_____ is enclosed. I understand that you will pay the postage and that each record is fully guaranteed.

Name _____
(Please Print)

Address _____

City _____ Zone _____ State _____

SORRY—No charges or C.O.D. orders! EW 83

UNCLASSIFIED TEST EQUIPMENT

Audio Analyzer

Heath: Model IM-22, \$56.95. a.c. v.t.v.m. freq. resp. 10 cps-100 kc. ± 1 db; range .01, .03, .1, .3, 1, 3, 10, 30, 100, 300 r.m.s. v.; input impedance 1 meg. or 4, 8, 16, or 600 ohms. Wattmeter: 10 cps-50 kc. ± 1 db.; .15, 1.5, 15, 150 mw., 1.5, 15, 150 w.; 4, 8, 16, 600 ohm internal loads, 10,000 ohms across external load. IM analyzer: high-pass filter, 2000-12,000 cps, low-pass filter 10-600 cps; 1, 3, 10, 30, 100 per-cent full scale. Input impedance a.c. v.t.v.m., 1 meg. or 4, 8, 16, or 600 ohms switch-selected. Internal-generator frequencies: 60 cps, 6 kc. DBM: -40, -30, -20, -10, 0, 10, 30, 40, 50. Reads from -65 ± 52 db n. Accuracy: a.c. v.t.v.m. and wattmeter within 5% full-scale; IM analyzer within 10% of full-scale.

Battery Tester

Eico: Model 584, \$9.95. Test positions (volts): 1.5, 4.5, 6.0, 7.5, 9.0, 22.5, 45, 67.5, 75, 90, spare.

CRT Checker

Eico: Model 630, \$19.95. Bridge circuit measures peak beam current. Model 632, \$54.95. Checks for opens, shorts, beam current, gas. Uses 1000 v.d.c. for rejuvenate-welding and to remove shorts.
Paco: Model T-63, \$44.95. Checks screen brightness under high or low line voltage conditions; simulates the effect of a booster; can be used as a rejuvenator. Beam current type test circuit.

Bar and Dot Generators

Eico: Model 352, \$19.95. TV channels 2-6; 16-23 vertical bars, 13-22 horizontal bars; output voltage .4 mv.
Heath: Model IG-62, \$64.95. TV channels 2-6. Output voltage 100-100,000 μ v. Sound carrier: crystal-controlled, unmodulated, 4.5 mc. away from picture carrier. Positive or negative video output variable from 0-10 v. p-p open circuit. Modulation: white-dot pattern, cross-hatch pattern, horizontal bars, vertical bars, 10 vertical color bars, shading bar pattern.
Paco: Model G-36, \$119.95. Produces color bars, white dots, vertical bars, horizontal bars, and crosshatch. Crystal controlled.

Electronic Switches

Eico: Model 488, \$23.95. Switching rate 10-2000 cps continuously variable in 3 ranges. Frequency response d.c.-30,000 cps (-2 db); maximum gain 10 times (continuously variable gain control); input impedance 100,000 ohms; max. input at greatest attenuation 400 v. p-p; output impedance 50,000 ohms.
Heath: Model S-3, \$23.95. Freq. resp. to 100 kc. ± 1 db.

Filament Tester

Eico: Model 612, \$4.95. Checks filament continuity. Sockets are provided for 9 pin, octal, loctal, and 7 and 9-pin miniature tubes. Adapter provided for checking 14-, 12-, and 8-pin picture tubes.

Flyback Transformer and Yoke Testers

Allied: Model 83Y118, \$21.95. Indicates shorts in coil with a "Q" greater than 1, and inductance from .0003-2 hy. Checks continuity of circuits with 0-.5 meg. resistance.

Eico: Model 944, \$23.95. Checks all flyback transformers and yokes in- or out-of-circuit.

Harmonic Distortion Meter

Heath: Model IM-12, \$54.95. Frequency 20-20,000 cps in three ranges; distortion 1, 3, 10, 30, 100 per-cent full-scale; voltmeter 1, 3, 10, 30 volts full-scale; input resistance 300,000 ohms; minimum input voltage for distortion measurements 0.3 v.; output voltage for monitoring 2.5 at full-scale meter reading. Meter scales calibrated in volts r.m.s., per-cent distortion, and db. When used with Heathkit IG-72 or IG-82, the IM-12 will measure harmonic distortion at any frequency between 20 and 20,000 cps.

Impedance Bridges

Eico: Model 950, \$23.95. Measures capacity from 10 pf.-5000 μ f. in four ranges, resistance from .5 ohm-500 meg. in four ranges. Comparator: ratio from .05-20 (400 to 1). D.c. polarizing voltage 0-500 v.
Heath: Model IB-2A, \$69.95. Measures resistance from .1 ohm-10 meg., capacitance from 100 pf.-100 μ f., inductance from .1 mhy.-100 hy., dissipation factor .002-1, storage factor ("Q") .1-1000. Built-in 1000 cps generator and provision for input from external generator.
Paco: Model C-20, \$23.95. Capacitance 10 pf.-2000 μ f. in four ranges, resistance .5 ohm-200 meg., capacitor leakage test at 500 v. Ratio tests from .05-1 and 20-1 on capacitors, inductors, and resistors; power factor range from 0-60% at .1 μ f.-2000 μ f.

Q Meter

Heath: Model QM-1, \$54.95. Frequency: 150 kc.-18 mc. in four bands. Inductance: 1 μ hy.-10 mhy. "Q": 250 full scale x 1 or x 2. Capacitance: actual, 40 pf.-450 pf.; effective, 40 pf.-400 pf.

RF Power Meter

Heath: Model PM-2, \$12.95. Frequency range 100 kc.-250 mc., sensitivity .3 v. r.m.s. at antenna input terminals for full-scale deflection.

Vibrator Tester

EMC: Model 906, \$17.05. Checks 6- and 12-volt vibrators with external power supply. Six sockets. The Model 905-6A, a combination of the 906 and the 905 battery eliminator, costs \$44.90.

Voltage Calibrators

Allied: Model 83Y136, \$12.95. .01-100 v. square-wave output.
Eico: Model 495, \$19.95. Semi-square (clipped sine-wave) output wave-shape at line frequency. 0-1, 0-1, 0-10, 0-100 p-p v. Dial reading accuracy $\pm 5\%$.

Manufacturers of Kit Test Equipment

Allied Radio Corp.
100 N. Western Avenue
Chicago 80, Illinois

Arkay International, Inc.
2372-82 Linden Blvd.
Brooklyn 8, N.Y.

Conar Instruments Div.,
National Radio Institute
3939 Wisconsin Avenue
Washington 16, D.C.

DeVry Technical Institute
4141 Belmont Ave.
Chicago 41, Ill.

Eico Electronic Instrument Co., Inc.
3300 Northern Blvd.
Long Island City 1, N.Y.

EMC
Electronic Measurements Corp.
625 Broadway
New York 12, N.Y.

Feiler Engineering & Mfg. Co.
8026 N. Monticello Avenue
Skokie, Illinois

Heath Company
Benton Harbor, Michigan

Lafayette Radio Electronics Corp.
111 Jericho Turnpike
Syosset, L.I., N.Y.

Olson Electronics, Inc.
260 S. Forge Street
Akron 8, Ohio

Paco Electronics Co., Inc.
70-31 84th Street
Flendale, L.I., N.Y.

Precise Electronics & Development Corp.
76 E. Second Street
Mineola, L.I., N.Y.

RCA: Radio Corporation of America
415 S. Fifth Street
Harrison, New Jersey

Radio Shack Corp.
730 Commonwealth Avenue
Boston 17, Mass.

Two outstanding products by the HIDDEN

600*

who plan for your future:



DIFILM[®] BLACK BEAUTY[®] CAPACITORS

molded tubular



DIFILM[®] ORANGE DROP[®] CAPACITORS

dipped tubular

TWO GREAT TUBULARS . . . TAKE YOUR CHOICE!

(±10% Capacitance Tolerance is standard at no extra cost)

● Sprague Difilm Capacitors can't be beat! Dual-dielectric construction combines the best features of both Mylar[®] polyester film and special capacitor tissue. And for additional reliability, Difilm capacitors are impregnated with Sprague's HCX[®], a solid impregnant which produces a rock-hard capacitor section—there's no wax to drip, no oil to leak!

● **BLACK BEAUTY Molded Tubulars** are actually low-cost versions of the famous Sprague high-reliability capacitors used in modern military missiles. They're engineered to withstand 105°C (221°F) temperatures . . . even in the most humid climates! And their tough, molded phenolic cases can't be damaged in handling or soldering.

● **ORANGE DROP Dipped Tubulars** are the perfect replacement for radial-lead capacitors now used by leading manufacturers of TV sets. Leads are crimped for neat mounting on printed wiring boards. Extremely small in size, they'll fit anywhere, work anywhere. And they're double-dipped in epoxy resin for extra protection against moisture.

*The "Hidden 600" are Sprague's 600 experienced researchers who staff the **largest research organization in the electronic component industry** and who back up the efforts of some 8,500 Sprague employees.

Get your copy of Catalog C-614 from any Sprague distributor, or write Sprague Products Co., 51 Marshall Street, North Adams, Massachusetts.



WORLD'S LARGEST MANUFACTURER OF CAPACITORS



JOHN RYDE

Mac and Barney discuss the practical and philosophical considerations in servicing transistorized equipment.

SEMICONDUCTOR SEMINAR

STOPPING short in the doorway of the service department, Barney did an exaggerated Jackie Gleason double-take of Mac, his employer.

"Since when did you take up welding?" he demanded, looking curiously at the strange black object jutting from Mac's forehead and covering his eyes.

"These aren't welding goggles," Mac explained, pushing the object up on his forehead a bit and peering from beneath it at his assistant. "It's a 'Magna-Sighter,' manufactured by the Fairchild Optical Company in Chicago. It's really a binocular eye loupe with a magnification of 2½ times. A prism is ground into each magnifying lens so that the eyes can converge at the proper focal distance. In this particular model, Model 5, that's ten inches; but they make other models that focus all the way from fourteen inches to four inches—from the eyes, not the lenses. Magnification in other models ranges from 1½ times to 3½ times, with the greater magnification having shorter focal distance and also less depth of focus."

"How come the lenses are so far from the eyes? They must be at least a couple of inches in front of them."

"For one thing, that allows you to wear glasses, even bifocals, with the 'Magna-Sighter.' The instrument is adjusted so that the bottoms of its lenses are directly in line with the eyes. When you look up slightly, you peer through the upper section of the bifocals and the 'Magna-Sighter' lens. When you glance down, you see through the lower section of the bifocals as you do normally. Here, see for yourself."

Barney adjusted the headband to accommodate his slightly larger head and took a look at the printed circuit of a transistor radio.

"Wow!" he exclaimed. "That certainly makes things stand out sharply. The joints look kind of 3-D, if you know what I mean."

"I know. It reminds me of the way things used to look through the old stereoscopes every proper family kept in the front parlor. It gives you an almost exaggerated impression of depth."

"This thing is going to be the old berries for working on transistor sets," Barney exclaimed enthusiastically. "I can even read that postage-stamp-sized diagram pasted in the cover. I thought our jeweler's loupe and our illuminated magnifier were good, but this gadget has some definite advantages. For one thing, my unaristocratic eye gets tired of trying to hold that loupe in place like a monocle. Too, I have to take it out every time I want an unmagnified view of things. With this, I simply lower my head for a magnified view and raise it to see normally."

"If it helps your young eyes that much, think what it does for these tired old orbs," Mac suggested. "Transistor radios and accompanying printed circuits have really placed a premium on good eyesight. Visual inspection alone can spot many difficulties in these receivers. It used to be a technician's joke that customers were always suspecting a 'loose connec-

tion' or a 'broken wire.' These faults were actually rarely found in wired-chassis tube radios, but they account for a high percentage of difficulties in transistor receivers, probably because these little hand-carried receivers are more often dropped and subjected to other abuse. But a hairline crack in a printed circuit or a tiny break in a solder joint of one of these miniature receivers is darned hard to see."

"You're in phase there," Barney agreed. "The first thing I do after I've checked out the battery of a transistor set is to give it a really good looking over, no matter if the complaint is a dead radio, weak reception, distortion, or what have you. This eyeball inspection very often saves a lot of time. Of course, through experience, I've learned certain spots are hotbeds for these cracked-joints-and-broken-lead troubles."

"One good hunting place is where a comparatively heavy component is soldered to the board. This includes transformers, tuning capacitors, and occasionally speakers. A heavy impact that occurs when the radio is dropped is likely to break either the soldered connection to the component or the printed circuit in the vicinity of that component. A cracked board, naturally, usually means one or more broken leads. Sometimes rough handling of the tuning control knob or the volume control knob is all that's needed to fracture the board. I might mention the modern tough plastic used in the cases of these little receivers won't tattle on the owner for dropping his set. A jar that really messes things up inside often fails to leave a telltale mark on the case."

"Yes, and isn't it strange how reluctant most customers are to confess the set has been dropped? Either they must think we automatically up the bill when we hear the radio has been dropped, or they simply don't want to admit to having butterfingers. Wonder if you've noticed leads running along the edge of a printed circuit—quite often such leads are a part of the set ground system—are especially likely to develop hairline cracks. I suppose this is because the edge of the board is subjected to more flexing."

"I sure have," Barney agreed, "and a crack in one of these leads will often leave the set dead as a mackerel. Other spots I favor with close attention are those where wire leads connect to the printed circuit, especially if those leads are likely to be subjected to some pulling and bending. Battery leads are a good example. So are antenna leads, speaker leads, and leads going to the earphone jack. Some of these are subjected to stress simply by careless removal of the back of the case and changing the batteries; others have strain put upon them in the assembly of the receiver."

"I find a surprising number of sets in which those little hair-like leads from the antenna are broken off," Mac commented. "Apparently the owner doesn't see them when he's changing a battery and accidentally breaks them loose. I might mention it's much easier to break one of these leads off than it is to find quickly where that lead originally connected to the printed circuit, especially if the receiver is an import for which we have no diagram. I'm hoping the

'Magna-Sighter' will be a help in locating that little stub of broken wire sticking up out of a solder joint.

"Getting away from broken leads," Barney said, "I've decided that when the service data calls for a matched pair of transistors in the output stage and one of them goes bad, it's usually better to replace both with another matched pair. I've tried using a single general replacement transistor for the bad one, and it will work after a fashion, but checking the outputs of the two transistors with a v.t.v.m. reveals they are seldom close to equal. When the transistors have sockets and you have a good supply of substitutes on hand, you can try them one after the other and *may* find one that will match closely the one in the set; but if the transistors are soldered in, it's better not to fool around. Just remove both and put in a new matched pair."

"Those foreign imports for which we have no service data are a real pain," Mac mused; "but electronics magazines are doing their best to help. I cut out and save the pages giving American substitutes for foreign transistors and the names and addresses of importers who can furnish service data and special parts for the brands they import. Even so, when a customer insists on a preliminary estimate on one of these, I make it good and stiff to protect myself. I know from experience I'm likely to spend twice as much time locating the trouble as would be the case with an American-made receiver for which we have complete and detailed service information."

"You remember Dave, the salesman who used to call on us from Electronic Equipment," Barney said. "I ran into him at a lunch counter yesterday, and he tells me he's doing a good business servicing transistor radios for radio and TV shops. Most of the big TV shops consider transistor radio service a 'nuisance' business; yet they have to do it; so they're glad to give the work to Dave. He charges a flat five dollar service fee per set, no matter what's wrong with it. Parts, of course, are extra. He says he's doing very well and has all the business he can handle. He says he turns out the sets faster and faster as he gains experience."

"Sure he does, and he's a lot smarter than the fellows for whom he is working," Mac replied. "They are paying him to acquire experience they should be getting themselves. It doesn't take a seventh son of a seventh son to see that eventually transistors are likely to replace tubes in almost all household electronic equipment. They have a lot of things going for them: small size, long life, little heat, high efficiency, and small-size-low-voltage accompanying components. When transistorized TV

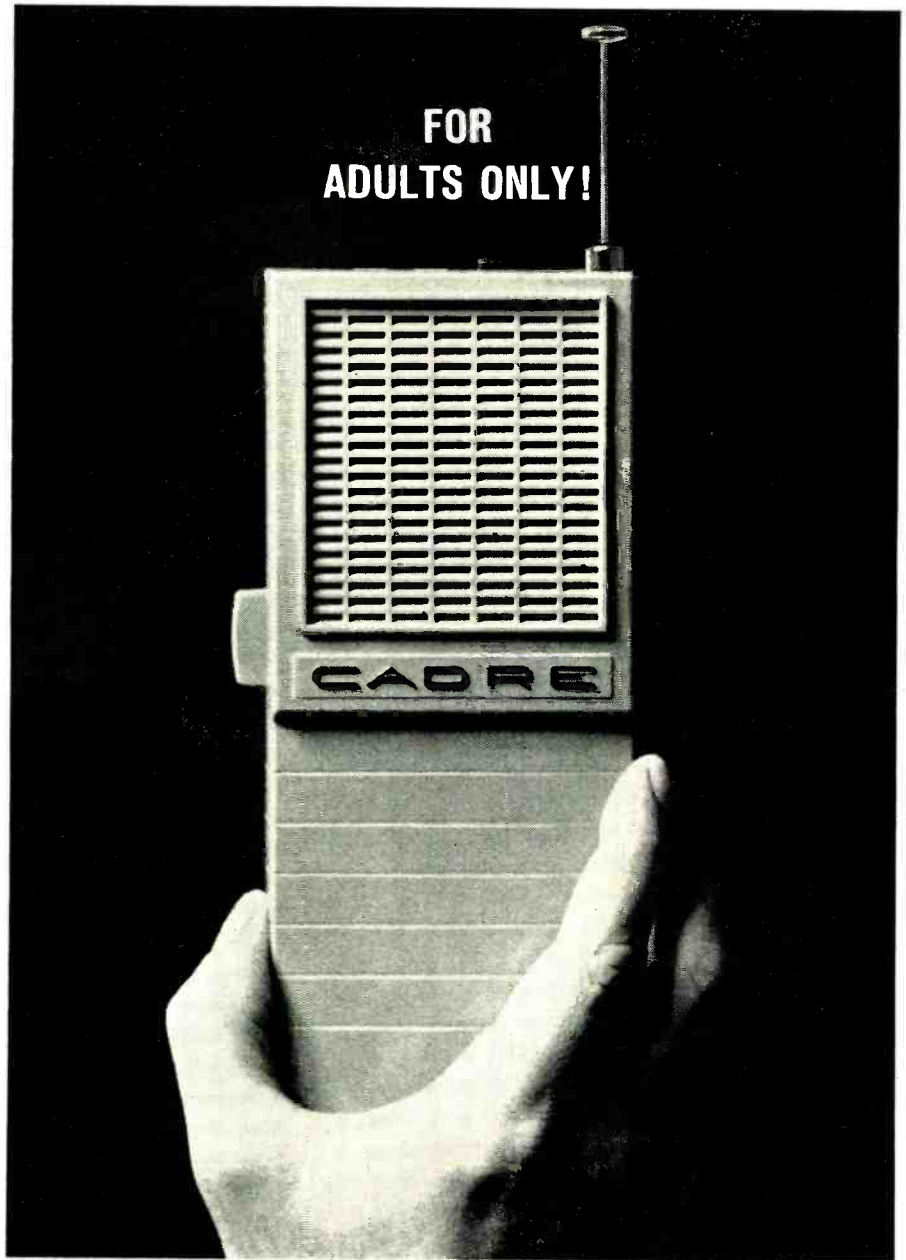

**FOR
ADULTS ONLY!**

NEW CADRE C-75 CB TRANSCEIVER

The new Cadre C-75 1.5-watt, 2-channel transceiver is 15 times too powerful for youngsters (under 18 years of age) to operate, according to FCC regulations. Clearly, it's not a toy. It's designed for serious CBers who need 'big set' performance that can be used conveniently anywhere.

The new C-75, weighing less than 2 lbs; provides clear, reliable 2-way communications up to 5 miles and more. All solid state design creates an extremely rugged transceiver to absorb rough handling, stays on frequency. Two crystal-controlled channels spell perfect communications contact every time. Sensitive superhet receiver (1 μ v for 10 db S/N ratio) brings in signals in poor reception areas. Powerful transmitter has one watt output to the antenna. Adjustable squelch silences receiver during standby. AGC assures proper listening level. In a word, the C-75 has all the features you'd look for in a quality full size CB unit.

The C-75 has all the portable conveniences: operates on alkaline or mercury penlite cells (8-hour rechargeable nickel-cadmium battery available); earphone and antenna jacks; built-in retractable antenna; jack for base

operation while recharging.

Use the Cadre C-75 anywhere in the field, for vehicle, office, boat or plane. Use it constantly too, because its all-transistor modular circuit (11 transistors and 2 diodes) is virtually maintenance free. \$109.95. Recharger and 2 nickel-cadmium batteries \$31.85.

FOUR CADRE 5-WATT ALL-TRANSISTOR TRANSCEIVERS



5 crystal-controlled transmit and receive positions; automatic gain control, maximum receiver sensitivity; built-in squelch and noise limiting are just a few of the features.

CADRE 510 Variable tuning in addition to crystal control. Power supply for 110 VAC and 12 volt DC. \$209.95

CADRE 515 Power supply for 110 VAC and 12 volt DC. \$194.50

CADRE 520 For DC mobile operation and fleet use. \$187.50

CADRE 525 In portable case with built-in battery power supply, recharger, AC cord, telescoping antenna. \$269.95

See your Cadre distributor or write:

CADRE INDUSTRIES CORP. / COMMERCIAL PRODUCTS DIV. / ENDICOTT, N. Y. / (607) 748-3373
Canada: Tri-Tel Assoc., Ltd., 81 Sheppard Ave. W., Willowdale, Ont. Export: Morhan Exporting, 458 B'way, N. Y. 13

WITH THE **LAMPKIN** 105-B FREQUENCY METER

CHECK
CITIZENS-BAND
TRANSMITTERS

- **INEXPENSIVE—ONLY \$260.00 NET.**
- **EVERY CB CLUB SHOULD HAVE ONE.**
- **CALIBRATIONS FREE FOR ALL 23 CB CHANNELS. WITH NEW METER.**
- **PORTABLE AND RUGGED—WEIGHS 8 LBS.**
- **ACCURACY BETTER THAN 0.0025%, AMPLE FOR CB.**
- **FLEXIBLE—CAN BE USED FOR OTHER MOBILE-RADIO MEASUREMENTS FROM 100 KC TO 175 MC AND UP.**
- **NO ADDITIONAL CRYSTALS OR FACTORY ADJUSTMENTS EVER NEEDED FOR OTHER FREQUENCIES.**
- **TIME PROVED DEPENDABILITY. THOUSANDS IN USE—SINCE 1938.**

TO LEARN MORE, AND HOW YOU CAN EARN MONEY CHECKING FREQUENCIES FOR OTHERS...

MAIL COUPON TODAY!

LAMPKIN LABORATORIES, INC.
MFM Division, Bradenton, Florida

At no obligation to me, please send free booklet "HOW TO MAKE MONEY IN MOBILE-RADIO MAINTENANCE" and data on Lampkin meters.

NAME _____

ADDRESS _____

CITY _____ STATE _____



THE MOST WIDELY USED MOBILE-RADIO FREQUENCY METER—THE LAMPKIN 105-B

LAMPKIN LABORATORIES, INC.
MFM Division BRADENTON, FLORIDA

CIRCLE NO. 125 ON READER SERVICE PAGE

ELECTRONICS' & TV TECHNICIANS! "It's Got To Be In Your Pocket!"

MINITEST I, a transistorized blocking oscillator for every electronics technician or engineer. Handy signal transmitter for finding defective circuits in LF, IF and HF oscillatory circuits, transformers and chokes as well as in sound pick-ups and transmitters of all types.



... and its Twin: MINITEST II, a transistorized blocking oscillator for every TV Technician. A signal generator for finding defective circuits in VHF and UHF tuners and converters, as well as video i.f. and output stages. Can also be used as bar pattern or net pattern generator.

EACH TWIN:

- is the size of a ball-point pen
- is switched on & off like a ball-point pen
- weighs less than 1 oz.
- works on a 1.5 V battery
- is guaranteed for six months
- is imported from Germany (W)

MINITEST I Net \$7.95 MINITEST II Net \$8.95
 TWIN-MINS (I & II if purchased together) Net \$16.50

Clip coupon and mail with check or Money Order. We pay the postage—Sorry, no COD shipments.

AZTEC ENGINEERING COMPANY
P.O. Box 158, Lebanon, N.J.

Name: _____

Address: _____

Dealer & Jobbers' inquiries invited.

CIRCLE NO. 143 ON READER SERVICE PAGE

SAY YOU SAW IT IN

Electronics World



Send for NEW
FREE CATALOG # 952
with oscillator
circuits

Citizen Band Class "D" Crystals

\$2.95
EACH



CITIZEN BAND CLASS "D" CRYSTALS
3rd overtone — .005% tolerance — to meet all FCC requirements. Hermetically sealed HC6/U holders. 12" pin spacing. .050 pins. (Add 15c per crystal for .005 pins).

All 23 megacycle frequencies in stock: 26.965, 26.975, 26.985, 27.005, 27.015, 27.025, 27.035, 27.055, 27.065, 27.075, 27.085, 27.105, 27.115, 27.125, 27.135, 27.155, 27.165, 27.175, 27.185, 27.205, 27.215, 27.225, 27.235.

Matched crystal sets for ALL CB units (Specify equipment make and model numbers) **\$5.90 per set**

RADIO CONTROL CRYSTALS in HC6/U HOLDERS—SIX FREQUENCIES

In stock for immediate delivery (frequencies listed in megacycles): tolerance .005%, 12" pin spacing, .050 pin diameter, .005 pins available, add 15c per crystal. Specify frequency desired.
26.995, 27.045, 27.095, 27.145, 27.195, 27.255 **\$2.95**
(add 5c per crystal for postage-handling) **EACH**

ENGINEERING SAMPLES and small quantities for prototypes now made at either Chicago or Fort Myers plants with 24 hour service. IN CHICAGO, PHONE Gladstone 3-2355

IF YOUR PARTS DEALER DOESN'T STOCK Texas Crystals, order direct and send us his name.

RUSH YOUR ORDER NOW TO

TEXAS CRYSTALS
Div. of Whitehall Electronics Corp. Dept. R-83
1000 Crystal Drive, Fort Myers, Florida Ph. WE 6-2100

FOR SHIPMENT VIA FIRST CLASS MAIL AT NC EXTRA COST ATTACH THIS ADVT. TO YOUR ORDER!

hits its stride, as it surely must, Dave will be in on the ground floor."

"I wonder why so many of the old-timers hate transistor radio servicing," Barney said. "Lots of them would rather horse a heavy TV chassis around half a day than troubleshoot one of the little jobs."

"Mostly, I suspect, it's a case of unfamiliarity breeding contempt," Mac suggested. "All of us tend to fear and distrust and even hate the unfamiliar. We have to learn some new things to understand it, and that requires effort, which is always distasteful. Exactly the same thing happened when the a.c.-d.c. receivers came on the market. Service technicians applied all sorts of contemptuous names to them: 'cigar-box radios,' 'punch-board radios,' etc. But eventually they wound up servicing these sets almost exclusively and doing just as well as they had done working on the big transformer-type console radios."

"You think the same thing will happen with transistor radios?"

"I have no doubt about it. But it would be well if all of us quit down-grading transistor receivers and began to appreciate their good points. I firmly believe a man has to like his work to do his best, and as long as we dislike transistor radio service we're not going to be very good at it—not really good."

"If you have visual aids, special soldering equipment for the printed circuits, adequate service data, a good grounding in transistor fundamentals, and the proper attitude, transistor radio servicing can be very rewarding, both in money and in personal satisfaction." Mac concluded as he slid the binocular eye loupe over his head and picked up the little transistor receiver chassis. ▲

"CUSTOM" CERAMIC CAPACITORS

By IRWIN MATH

OCCASIONALLY it is desirable to use values of capacitance that are not standard, as in certain types of wide-band amplifiers or phase-shift oscillators. Also, at times, it is necessary to match two capacitors rather closely.

When ceramic capacitors are used, it is a simple matter to vary the capacitance. Grinding the edge of the capacitor will lower its value, until the correct value is obtained. A good quality bridge should be used for exact values, however, an inexpensive capacity checker can be employed for less critical tolerance requirements.

After grinding the capacitor, the edges should be checked for shorts and cleaned with a fine emery paper. Sealing wax or paraffin can then be put on to seal the capacitor from moisture. It should be pointed out that a similar operation can be carried out with carbon composition resistors. ▲

FCC ESTABLISHES FEES FOR RADIO LICENSES

Amounts range from \$100 for TV broadcasters down to \$4 for radio amateurs.

EFFECTIVE January 1, 1964 the FCC will begin charging fees for handling radio station and operator license applications and renewals. Public hearings held early this year disclosed an almost unanimous opposition to setting up such charges. Probably the most vigorous opposition came from hams who felt that the fees would discourage experimentation and technical development which the Commission has the responsibility of promoting. As a result of the outcry, some of the charges were reduced and some were killed altogether. However, a good many users of radio will have to pay a nominal fee for this use beginning next year.

Some of the amounts to be charged are: For license application of a new broadcast station or for renewal of license, \$50 for AM or FM stations and \$100 for TV stations. For TV translator application, \$30. For initial construction permit for land mobile radio system (including base station and mobile units), \$100. For renewal of this license, \$25.

In the amateur radio service a fee of \$4 will be charged for initial and renewed licenses. For modification of license, \$2 and for a request for a special call sign, \$20. In the Citizens Radio Service, the fee is \$10 for class A station authorization. For class D and all other classes of Citizens Radio stations, the fee will be \$8.

Applications for commercial radio operator examinations must be accompanied by a fee of \$5 for First Class License, \$4 for Second Class, and \$3 for Third Class. Application for license renewals, endorsements, and duplicates call for a \$2 fee. Restricted Radiotelephone Permit applications also require a \$2 fee.

Exempted from charges are all types of educational radio and TV broadcast stations and closed-circuit educational systems. Fees are not required for Novice Class applications in the amateur radio service nor for applications filed in the Radio Amateur Civil Emergency Service (RACES). There are also no fees for the experimental radio services (other than broadcast), nor for such safety radio services as those used by police, fire departments, highway maintenance, State Guard, hospitals, disaster relief organizations, school buses, and non-profit ambulance operators. ▲



If you're willing to pay anything for professional quality.....but would rather not

The Concertone 605 is for the one man in several who can't stand less than perfection...but can't see why professional quality should cost so much. Never before have so many features and so much professional quality been available at this price. Read ahead carefully and see: Precision plug-in head assembly...includes four precision heads; Separate microphone and line controls (input can be mixed); Delay memory control circuit (never spill or break tape); Automatic glass tape lifters, including electric cue feature; Sound on sound and add sound; Solenoid operated brakes; Three motors, including 2-speed hysteresis synchronous drive; Automatic rewind; Exclusive Reverse-O-Matic®. Learn all about the 605 in complete detail. Ask your dealer for a demonstration or send for free literature today.



CONCERTONE 607

Broadcast version

The Concertone 607 with higher impedance is for the true professional or broadcaster. Remote control optional. This superb tape recorder is constructed to 19" x 14" dimensions, permitting it to be used as an exact replacement for old or outdated tape recorders.

CONCERTONE 400 COSMOPOLITAN

For people on the go...it's the Cosmopolitan - Combination Tape Recorder with AM Radio. A versatile companion and co-worker for business or pleasure travels. 5" reel capacity. Push-button operation. Amazing fidelity. Remote mike. Foot-pedal control. This all-transistorized recorder has big recorder features in miniature form.

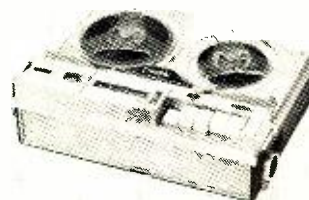

for further information write:



AMERICAN CONCERTONE, INC.
A DIVISION OF ASTRO-SCIENCE CORP.
9449 W. JEFFERSON BLVD. • CULVER CITY • CALIF.

Export: J. D. Marshall International, 170 W. Washington, Chicago, Illinois

HOW can you make a priceless family heirloom for \$2.10?

This question, and many others about tape quality, tape use, and tape recording for fun, education, and profit, are answered in Tarzian Tape's new booklet, "Lower the Cost of Fun With Tape Recording."

It's free when you mail the coupon below.



Sarkes Tarzian, Inc.

Dept. EW-3
Magnetic Tape Division
East Hillside Drive
Bloomington, Indiana

Please send a free copy of "Lower the Cost of Fun With Tape Recording" to:

Name _____

Address _____

City _____ State _____

I Have Have Not used Tarzian Tape
I Own Plan to Buy A Tape Recorder
I Buy Blank Recording Tape From:

Name _____

Address _____

He Does Does Not Stock Tarzian
Tape

Radiation Devices (Continued from page 42)

depends on the rate of diffusion and, thus, by proper calibration, the change in current gain can be used to determine the total amount of radiation received by the transistor.

In a semiconductor diode, neutron radiation damage can result in a change in the forward current for a certain applied voltage, hence monitoring this current can give an indication of total radiation. The diode can then be employed as a neutron dosimeter. It is not necessary for the voltage to be applied continuously—it can be applied only when measurements are required. Readings can be taken as often as desired without affecting accuracy. An experimental diode of this kind is shown schematically in the diagram of Fig. 4.

Production of Electricity

Extensive tests conducted at *Bell Laboratories* indicate that silicon solar cells are very simple and useful devices for measuring high-intensity radiation. Cells of the *n-p* type are employed, as they are much more resistant to radiation damage than the formerly employed *p-n* type.

For most applications, it is only necessary to connect the solar cell to a relatively inexpensive microammeter. This microammeter can then be calibrated directly in intensity (rads per hour, for example). In a typical solar cell, an intensity of a million rads per hour of *x-* or *gamma* radiation would produce a current of 37 μ a. With more elaborate instrumentation, 100 rads per hour can be measured, and intensities as high as a billion rads per hour can be measured if the radiation that is involved is not too energetic.

Commercial Devices

We will now describe briefly some of the commercial solid-state radiation counters currently available from a few companies. It should be clearly understood that this section is by no means complete, either as to manufacturers or as to products. However, the descriptions will provide some indication of the type of semiconductor radiation detectors on the market.

Most of the devices made by *Oak Ridge Technical Enterprises Corp.*¹ are of the surface-barrier type. A wide variety of depletion depths is available, including totally depleted units with thicknesses from 50 to 500 microns. All use a very thin gold electrode on the surface of *n*-type silicon. The devices can be employed for neutron detection using appropriate converter foils, such as lithium. Some of the company's detectors are so constructed that they can be stacked for work requiring greater depletion depths.

*Molechem, Inc.*² manufactures surface-barrier detectors with *n*-type silicon having a nominal resistivity of 1000 ohm-cm., and capable of being operated at bias voltages of 200 to 500 volts and even higher for selected units, producing depletion layers upwards of 1 mm. thick. Units with very large active areas up to 2.2 cm.² are available. These detectors can be provided with an evaporated layer of lithium fluoride for neutron detection.

*Solid State Radiations, Inc.*³ makes silicon-junction detectors primarily. The *p*-type silicon with a resistivity of about 1000 ohm-cm. is the base material and phosphorus is diffused into the surface to form a very thin *n*-layer, less than one micron thick. Some of the company's detectors have a coating which makes them sensitive to neutrons. Different coating materials are used, including boron-10, lithium-6, uranium-235, and others, depending on whether fast or slow neutrons are to be counted and to be measured.

*Ferranti Electric, Inc.*⁴ also specializes in silicon-junction detectors. The base material is *p*-type silicon having a resistivity of 5000 ohm-cm. and the *n*-layer is formed by phosphorus diffusion. A cross-sectional drawing of a typical unit is shown in Fig. 5. A bias as small as 10 volts in these units will produce a depletion layer which will absorb 10-million electron-volt *alpha* particles. Maximum operating voltages vary from 50 to 200 volts for the different units in each series.

*Nuclear Diodes Inc.*⁵ specializes in large-area silicon surface-barrier detectors, with active areas as large as 3.4 cm.² in standard units. These detectors are made from nominal 300 ohm-cm. *n*-type silicon. Also available is the lithium-drift detector. This unit can be combined with a conventional detector to form a system for determining the energy of the units and combinations of units which are included in the company's line.

This account has given a general, over-all picture of the uses which can be made of semiconductor materials, particularly silicon, in detecting and measuring nuclear radiation. There is much interest in this field at present, and it may be expected that great strides will be made in the near future, both in the improvement of present devices and in the development of new materials and techniques. ▲

REFERENCES

1. Oak Ridge Technical Enterprises Corp., P.O. Box 485, Oak Ridge, Tenn.
2. Molechem, Inc., P.O. Box 531, Princeton, N.J.
3. Solid State Radiations, Inc., 2261 S. Carmelina Ave., Los Angeles 64, Calif.
4. Ferranti Electric, Inc., Plainview, Long Island, N.Y.
5. Nuclear Diodes Inc., 1640 Old Deerfield Rd., Highland Park, Ill.

ELECTRONIC CROSSWORDS

By JOHN D. OWENS

(Answer on page 91)

ACROSS

1. Video bandwidth.
9. Remains quiet.
13. Anthropoid.
14. Cathode-ray, for instance.
15. Part of a speaker enclosure.
16. Follower of (suffix).
17. As (Latin).
18. Numerical equivalent of red.
20. Non-drinkers' group (abbr.).
21. Power dissipating device.
23. Openly.
25. Common schematic notation.
26. Equals voltage in Ohm's Law.
27. Cold.
28. Request.
29. Vacuum tube heater.
33. Notoriety.
34. For example (Latin).
35. Substance used to coat coils.
36. It's used in some hermetically sealed capacitors.
38. Freudian term.
39. Finishes.
41. Movement of electrons through a conductor.
44. Use a shovel.
45. Some transistor heat sinks have several of these.
46. Poetic contraction.
47. Seminary degree.
48. Potting material used in early radio transformers.
50. inductance: property of coil which opposes any change in current flow.
53. Inert gas (abbr.).
54. Sash.
55. Western state (abbr.).
57. Equals watts in Ohm's Law.
58. Part of a loudspeaker.
60. Potential characterized by excess electrons.
64. Tangle.
65. Connected to earth or some conducting body.

DOWN

1. Moan.
2. facto (Latin).
3. Itemize.
5. Unit of heat.
6. Vehicle.
7. Pay attention (Latin abbr.).
8. Demodulation stage in a radio receiver.
9. Luminous area on a cathode-ray tube screen.
10. Chemical abbreviation.
11. Send a radio signal.
12. Describing some dipoles.
19. Sour.
22. Uses current (colloq.).
24. Wine in Paris.
28. All after (c.w. abbr.).
29. Transmission system whereby a fraction of the output is returned to the input.
30. Mercury-vapor control tube.
31. Thousandths of an ampere (abbr.).
32. Current in the primary of a transformer when the secondary is open-circuited.
33. Escapes.
37. Old name of engineering society (abbr.).
40. Unit of weight (abbr.).
42. Family member (colloq.).
43. Compass reading.
45. Small lie.
48. Lyricist.
49. French novelist.
51. Describing a wire that is carrying current.
52. Drive the following stage.
56. Greek letter.
59. Negative reply.
61. Schematic notation.
62. Chemical abbreviation.
63. The same (Latin abbr.).

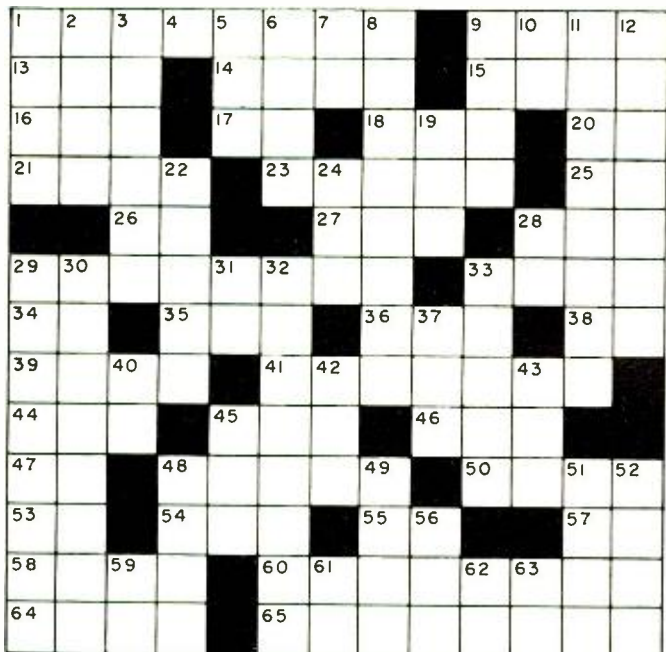

"Messenger" CB Transceivers...rated BEST in Nation by Electronic Distributor Salesmen*

*New impartial survey by leading electronic magazine shows Johnson "Messenger" Transceivers rated "BEST"—BEST BY NEARLY 50% OVER SECOND CHOICE BRAND.

4 feature-packed "Messengers" . . . and Selective Call System outperform everything!

Compact, Hand-Held—100 milliwatt or 1 watt "Personal Messengers". Rugged and reliable—11 transistors, 4 diodes! Twice the sensitivity and 40% more range than similar units with conventional circuitry—more output than similar units with same rated inputs!

Mobile or Base Stations—performance proved Viking "Messenger" and new "Messenger Two". Punches your signal across the miles—high efficiency design makes full use of maximum legal power. Excellent receiver sensitivity and selectivity. Automatic "squellch" control—5 or 10 channel coverage—easy to install anywhere!

Tone Alert—37 tone selective call system mutes speakers until one unit calls another—then automatically your stations receive audio note and indicator light flashes "On".



NEW! 4-color BROCHURE—write for your free copy!



E. F. JOHNSON CO

1102 10th Ave. S.W., Waseca, Minnesota

Please rush "Messenger" details to:

NAME _____

ADDRESS _____

CITY _____ STATE _____

Manufacturers of the world's most widely used personal communications transmitters.
CIRCLE NO. 123 ON READER SERVICE PAGE

GENERAL MC-5
COMMERCIAL 11-METER
2-WAY RADIOTELEPHONE

\$199.95

3.25 Watts minimum output — High level modulation transformer — Ultra-low drift oscillators — High level tone signal — Illuminated "S" Meter — 15 Watt Construction*

*UNDER PRESENT RULES PART 19.32 THE FCC DOES NOT PROVIDE FOR MORE THAN FIVE (5) WATT INPUT IN THE CITIZENS RADIO SERVICE (26.965-27.255 MC BAND.)

For free, complete technical information see your General dealer or write: Dept. 4

General

RADIOTELEPHONE COMPANY

3501 West Burbank Boulevard, Burbank, California

Telephone: 849-6891, Area Code: 213

CIRCLE NO. 118 ON READER SERVICE PAGE

FOR SHARP, CLEAR 2-WAY COMMUNICATION

Fixed or mobile,
business or pleasure
Get the new, low-cost

RCA MARK VIII

27-Mc Citizens Band Radio-Phone



Here's the LOW-COST C-B radio-phone for car, boat, home, office, or shop. High sensitivity receiver pulls in weak signals. 2½ watt speaker output delivers ample volume to overcome engine noise. Automatic noise suppressor minimizes ignition interference. Light and compact—only 3½ inches high, weight only 9 pounds; fits easily under the dashboard of even compact cars.

PLUS THESE PREMIUM FEATURES— RCA MARK VIII RADIO-PHONE

- 9 crystal-controlled transmit and receive channels
- Tunable receiver permits reception of all 23 C-B channels; dial marked in both channel numbers and frequency
- Exceptionally good voice reproduction—high intelligibility
- Excellent modulation characteristics
- Operates from standard 117-volt AC; separate 6- and 12-volt DC power supplies (optional) for mobile installations
- Electronic switching—no relay noise or chatter
- Illuminated "working channel" feature plus many more features to increase usefulness and efficiency.

AC Unit only **\$149.50***

DC Power Supplies, Where Needed, \$19.95*

*Optional list price



The Most Trusted Name
in Electronics

---MAIL COUPON FOR MORE INFORMATION---

RCA Electronic Components and Devices
Commercial Engineering Dept. H-41-R
415 South Fifth Street, Harrison, N. J.

Please send more information on the RCA
Mark VIII 27-Mc 2-Way Radio-Phone.

Name _____

Address _____

City _____ Zone _____ State _____

Direct-Reading Instruments (Continued from page 27)

of the wave analyzer, oscilloscope, and sweep generator in a sophisticated system extremely useful not only in electrical waveform measurements, but, with transducers, in studies of sound, vibration, heartbeats, and analogous phenomena.

The graphic level recorder is another type of voltmeter. A pen marks the voltage level on a piece of graph paper. Then, as the paper is moved under the pen, with the motion of the paper corresponding to changing time or frequency, the pen continues to plot the voltage level. The result is a response plot of the input voltage vs frequency or time.

The graphic recorder is widely used for spectrum analysis. Although it can't keep up with the sweeping rates of an oscilloscope, it has its own advantages, principally the permanence and greater resolution of its record.

Graphic level recorders measure a.c. or d.c. voltages. There is a wide variety of chart speeds, writing speeds, and voltage and frequency ranges. Some write with ink, some electrically. When the recorder is used with a variable-frequency source, a primary consideration is the means for transferring the frequency scale onto the chart paper. Some means of linking the oscillator frequency dial to the recorder drive mechanism must be provided, as well as chart paper especially calibrated for the setup.

Microwave Measurements

At microwave frequencies, where circuit dimensions approach wavelength, measurement techniques often differ from those at lower frequencies. The importance of physical dimensions makes partners of the development engineer and the machinist, especially at the higher microwave frequencies, where waveguide is employed to replace coaxial line.

Power Measurement. Voltage and current vary widely along a transmission line at microwave frequencies, and power becomes a fundamental quantitative measurement. In microwave power meters, the power is converted into heat and measured either in terms of temperature rise or of resistance change in a bolometer. The first type—the calorimetric power meter—is generally used for measurements above 10 watts, while bolometers are limited to lower levels.

Frequency Measurement. The effects of physical dimensions at microwave frequencies are used to advantage in several instruments unique to the microwave part of the spectrum. The cavity-type frequency meter is the microwave

version of lower-frequency tuned-circuit wavemeters. The cavity is a simple waveguide or coaxial section that can be sharply tuned to resonance. The signal to be measured is coupled to the cavity, the cavity adjusted, and the resonant point noted on a finely calibrated scale. The mechanical nature of such a device limits accuracy to about $\pm 0.01\%$; for higher-accuracy measurements, multipliers, mixers, and transfer devices are added to lower-frequency precision instruments.

V.S.W.R. and Impedance Measurement. Another important instrument peculiar to the microwave region is the slotted line. The slotted line is a section of coaxial line or waveguide that is slotted, with a movable probe sampling the field in the line. The slotted line can hardly be considered a direct-reading instrument; like the cavity frequency meter, it is simply a device for "coupling into" a transmission line to sample the standing-wave pattern. But whereas the cavity includes a calibrated frequency scale, the results of the slotted-line measurement (v.s.w.r., impedance, and associated parameters) are usually taken off a Smith Chart, slide rule, or auxiliary detector.

The admittance meter and reflectometer are alternate instruments for the measurement of impedance, v.s.w.r., etc. The admittance meter uses a bridge technique, in which pickup loops in the bridge arms are oriented to balance the unknown admittance against conductance and susceptance standards. The reflectometer is basically a power meter used to measure the ratio of incident to reflected power, or reflection coefficient.

There have been few changes in the fundamentals of microwave measurement over the past decade. Of course, the frequency range of interest is always expanding, and the instrument developer must keep pace. But the old bolometer and calorimeter still reign supreme in power measurements, even though they are now associated with the greater convenience of self-balancing bridges.

There is constant improvement in measurement accuracy throughout the spectrum, but one cannot expect the same accuracies at microwave frequencies as at 100 kc. Once you have entered the gigacycle area (1 gigacycle = 1000 mc.), you no longer talk about parts per million, and are very happy to measure within parts per thousand. A tenth of a percent is a very decent accuracy for a cavity frequency meter at 15 gc., and commercial microwave power meters are typically in the 3 to 5% class. ▲

REFERENCES

1. "A Program to Provide Information on the Accuracy of Electrical Measurements." Proceedings of the IEEE, Vol. 51, No. 4, April 1963.
2. McAlear, H.T.: "Digits Can Lie," General Radio Experimenter, Vol. 36, No. 12, December 1962.

EW Lab Tested
(Continued from page 12)

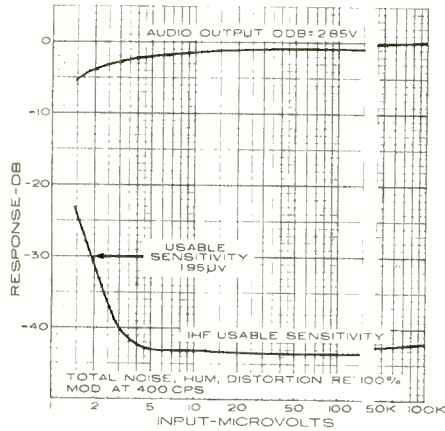

receiver circuits are altered to generate harmonics of the 19-ke. pilot carrier in a received signal, and the internal 38-ke. oscillator is shifted slightly in frequency. The beat note between the oscillator and the second harmonic of the pilot signal is heard in the speakers as an audio tone. If there is no pilot carrier present, only a slight hissing sound is heard.

Unlike visual indicators, the "Sonic

Monitor" cannot be triggered by noise or high-frequency modulation peaks. When the signal is tuned in for the loudest and clearest tone, and the switch is returned to "Listen," the stereo program is heard with the best channel separation of which the tuner is capable. This is another advantage over visual stereo indicators, which give no clue as to the optimum tuning point. However, the "Sonic Monitor" does not signify a stereo broadcast automatically, but only when the switch is operated.

Our lab measurements on the 350-B showed an IHF usable sensitivity of 1.95 μ v. Distortion at 100% modulation was -43.2 db or .69%. The steep limiting characteristics of this tuner provided quiet, low-distortion reception of signals as weak as 5 μ v. The stereo channel separation was excellent, around 40 db at 400 cps, and averaging better than 25 db from 30 to 10,000 cps. Hum was -60 db, the residual level of our FM signal generator, and warm-up drift was negligible.

The Model 350-B is very easy and non-critical to tune. It has a happy combination of high sensitivity and stability, combined with excellent stereo performance. The tuner is priced at \$219.95. ▲

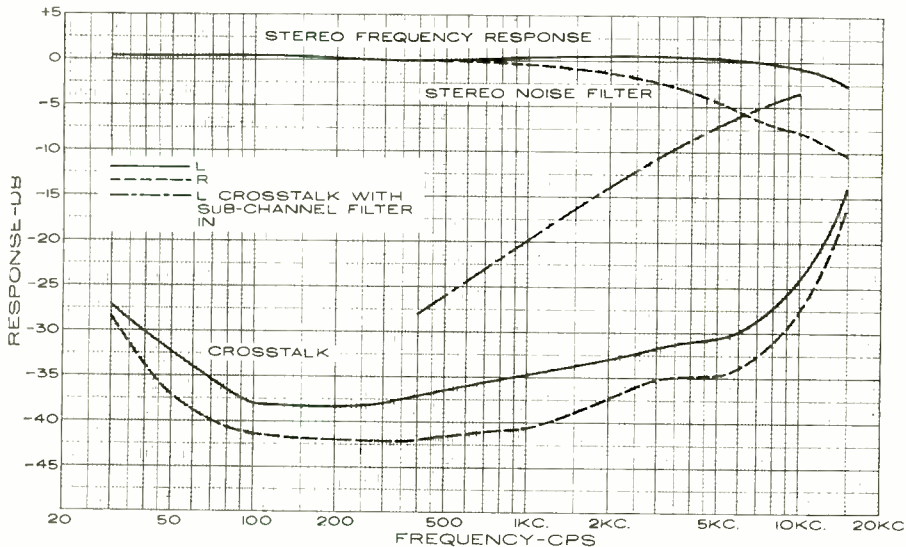

NEON LAMP HOLDER

By ROBERT K. RE

THE mounting of pigtailed light bulbs, such as the NE-2 series, can be quite a problem, especially if extreme vibration is expected in the equipment.

A small, clear plastic cable clamp, as shown in the photo, not only serves as an inexpensive holder or mounting bracket, but also a lens to magnify the light. This feature is extremely useful if the lamp's "glow" must serve as an indicator.

Made in several colors (clear, amber, black) and diameters, these clamps are available from many radio parts distributors.

This handy clamp can also be used to hold other lamps or items, such as Sylvania's "Mite-T-Breaker" (in same NE-2

glass package), that are difficult to mount or require transparent holders. ▲



New AEC 77
TRANSISTORIZED ELECTRONIC IGNITION

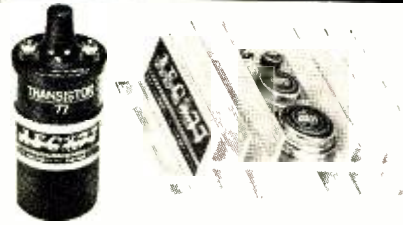

Increases engine power up to 10% . . . assures fast starts at low rpm . . . full power at high rpm . . . up to 20% more mpg . . . prevents fouled plugs . . . increases spark plug life 3 to 5 times . . . insures 75,000 mile breaker point life . . . gives instant starting in sub-zero weather . . . eliminates frequent tune-ups . . . simple 20 minute installation.

In conventional ignitions, high voltage at the spark plugs falls off from 28,000 volts to 13,000 volts as engine speeds increase. The result is a weak spark causing incomplete combustion, fouled plugs, loss of power, and poor gas mileage. AEC 77 Transistor Ignition increases and maintains high voltage at 30,000 volts, to guarantee a strong "hot" spark for complete combustion, delivering full engine power beyond 10,000 rpm, and up to 20% more m.p.g..

WORLD CHAMPION RACING DRIVER, PHIL HILL, USES AEC 77 . . . REPORTS—
"AEC 77's strong spark can make up for worn points and spark plugs. It will make your car run smoother at low speeds and appreciably improve its performance and economy."



AEC 77's use quality components such as General Motors Delco type 2N1100, high voltage, 15 ampere transistors, and Motorola type 1N2836B, 50 watt zener diodes . . . while others use two low voltage transistors in series with two 1 watt zener diodes, that can cause synchronization problems and premature failures. Every Transistor 77 (400:1) Ignition Coil is epoxy-oil impregnated and hermetically sealed for maximum insulation and cooling, while others use inferior tar filled coils that cannot handle the power loads AEC 77 delivers.

Proven in over 2,000,000 miles of testing, AEC 77 is so dependable in performance, design, and engineering, that every unit is registered and guaranteed for 3 full years.

FREE TRANSISTOR TUNE UP METER

Available only from AEC . . . at no extra cost . . . with every AEC 77 system ordered.



COMPLETE DO IT YOURSELF KIT!

- AEC K4 Negative Ground only \$32.95
- NEED COILS & BALLAST RESISTORS ONLY?**
- Transistor 77 (400:1) Ignition Coil \$11.95
- Ballast Resistor (.5 ohm—90 watt) \$ 1.25

COMPLETE FACTORY WIRED SYSTEMS!

- AEC 77 with (400:1) Ignition Coil . . 6/12 volt systems . . \$39.95
 - AEC 77 Positive Ground for British Cars only . . 6/12 volt . . \$54.95
- Please add 75¢ for postage and handling!

AUTOMOTIVE ELECTRONICS CO.

387 Park Ave. So., N.Y. 16, N.Y. EW-83

Name.....
Address.....
City..... Zone..... State.....
 AEC-77 For Negative ground 6/12v \$39.95
 AEC-77P For Positive ground 6/12v \$54.95
 Kit \$32.95 400:1 Coil \$11.95 Ballast \$1.25
 FREE INFORMATION ON AEC 77 SYSTEMS

COLUMBIA GEMS!

GRC-27
TRANSMITTER-RECEIVER
 Special! 225-400 Mc. Complete with antenna, rack, cables, etc. 100 W. output. Remounted like new.
 Original cost \$16,000.00. **\$4,750.00**
 ONLY

MOTOROLA 30-D TYPE
FM BASE STATION
 30-40 Mc. Transmitter-Receiver, 50 W. output. Housed in beautiful 52 1/2 ft. metal cabinet with 4 meters and built-in speaker. Power input 110 VAC. 60 cyc. Desk console remote amplifier. This is a superb unit in excellent cond. Great buy!
\$149.50

NAVY MODEL RAX RECEIVER
 Unit No. 1 200 Kc-1300 Kc. Like new. ONLY **\$24.95**

AN ARC-3 MAINTENANCE MANUAL
 Late edn. **\$9.95**

TAMAR TRANSMITTER BOOSTER
 5 to 1 gain! Freq. 118-128 Mc. Ideal for aircraft or 2 meters. Has built-in 12 V transistorized power supply! 12-8 ft. x weighing only 82.50 lbs. New condition. Model TT-5 **\$49.50**

COMMAND TRANSMITTERS
 2.1-3 Mc. New! \$5.95 4-5.3 Mc. New! \$7.95
 3-4 Mc. Excel! 7.95 4-5.3 Mc. (Less tubes) 2.95

TRANSISTOR TAPE RECORDERS
 So low in price—so high in value! Importers' closest! These units record, play back and erase. Built-in speaker, single speed, volume control, etc. Comes with mike, batteries and case. Recv. power. Size 8 1/2 in. x 4 1/2 in. x 3 1/2 in. and SAME AS ABOVE, but less case and mike. As Is! **\$3.95**

GARAGE DOOR TRANSMITTER-RECEIVER
 This remote control radio activates garage door motor (not supplied). Small compact transmitter mounts under car dash. 12 V. in. Recv. power. 110 V. 60 cyc. Original price was \$19.95. Includes schematic. **\$24.95**
 BRAND NEW

TRANSMITTING TUBE SPECIALS!
 All new, unused — guaranteed!

1-25A	5.95	811	3.95
1-125A	19.95	811A	13.95
1-400A	24.95	813	13.95
8-7W	2.95	813	4.95

COLLINS ART-13 RADIO TRANSMITTER
 5.18 Mc. 100 W. output. This is the famous one! Excellent condition. A terrific buy at only **\$49.95**
 (GOOD CONDITION) **\$39.95**

APN-4 LORAN SETS FOR MARINE USE
 All excel. cond. checked out & Guaranteed!
 10-6B APN-4: 3-inch indicator **\$39.95**
 R-9B/APN-4 4-channel recv. Exc. cond. **29.95**
 SET OF CONNECTORS AND MOUNTING **9.95**
 BACKS FOR ABOVE **9.95**
 MG-149F INVERTER: 24 V. in. **14.95**
 Exc. cond. COMPLETE PACKAGE OF ABOVE. SPECIAL **89.50**

HEADSET & MIKE BARGAINS
 HS-23 HEADSET: 4,000 ohms. New! **3.95**
 HS-33 HEADSET: 600 ohms. Brand new! **3.95**
 T-17D CARBON MICROPHONE: Brand new! **3.95**
 RS-38 CARBON MIKE: With coil cond. and 11-08 Plug. Brand new and bargain buy! **3.95**

COLUMBIA ELECTRONICS
 4365 WEST PICO BLVD. LOS ANGELES 19, CALIF.
 CIRCLE NO. 109 ON READER SERVICE PAGE

GET INTO **ELECTRONICS**



V.T.I. training leads to success as technicians, field engineers, specialists in communications, guided missiles, computers, radar and automation. Basic & advanced courses in theory & laboratory. Electronic Engineering Technology, an ECPD accredited Technical Institute curriculum. Assoc. degree in 29 mos. B.S. also obtainable. G.I. approved. Graduates in all branches of electronics with major companies. Start Sept. Fcb. Dorms. campus. High school graduate or equivalent. Write for catalog.

VALPARAISO TECHNICAL INSTITUTE
 Dept. RD, Valparaiso, Indiana

JUST STARTING IN TV SERVICE?

-- then you need us!
 GET STARTED RIGHT by writing for **FREE** 8 page catalog illustrating over 30 business forms and systems designed specifically for TV-Radio Service.
 ON SALE AT YOUR PARTS JOBBER
 Oelrich Publications • 6556 Higgins Ave., Chicago 31, Ill.

Cathode-Ray Oscilloscopes (Continued from page 53)

ment. In general, the instrument which has the widest bandwidth is desired. However, when working with very sensitive oscilloscopes on the order of 200 μ v. per division or less, the noise level goes up as the bandwidth increases. Excessive bandwidth in this particular case is a hindrance, since the minimum discernible signal is increased.

5 *What sensitivity must the scope possess?* Generally an oscilloscope is used with a high-impedance attenuator probe. Therefore, when the question of sensitivity arises, the requirement of a probe must first be determined. Ideally the sensitivity of the oscilloscope should be such that the smallest signal that will be applied will produce full screen deflection. A good rule of thumb would be the more sensitivity the better, down to 5 mv. per division. Below 5 mv./div. excess gain will produce a widening of the trace.

6. *What effect will the scope input impedance have on the item being tested?* The input impedance of an oscilloscope is a paralleled RC network. Its resistive component should always be high as possible (say, 1 megohm or more). If a 10 to 1 probe is used, this will be increased to 10 megohms. The importance of the capacitive component will depend upon the bandwidth of the instrument. Higher frequency scopes should have lower input capacities. The use of a probe will cut the input impedance of most high-frequency scopes, above 25 mc. to 10 or 12 pf.

7. *How will the scope be triggered?* The scope should be able to be triggered either from an external source or from a sample of the internal signal. A trigger level and slope selector are also desirable. This provides the selection of the voltage level at which the sweep will be triggered, and the sense (positive or negative) which this triggering signal must have to start the sweep.

8. *What sensitivity should the trigger circuits possess?* Normally a trigger sensitivity of 1/2 a major division is sufficient. Some manufacturers provide more sensitive systems. However, this extra sensitivity may cause false firing (starting) of the sweep on the random noise of the system under test.

9. *Is a switched input or dual-beam scope required?* Dual-trace scopes which time-share the sweep, having two vertical inputs, can normally be used in most applications where two signals are to be displayed simultaneously. This arrangement is usually smaller and less costly than the dual-beam scopes available. However, if each signal must be displayed at different sweep rates, a dual-beam scope generally is needed. Dual-beam scopes are really two oscillo-

scopes built into a single case. The only exception to the above is the Fairchild-DuMont Type 425, which is a time-shared scope that has the switching done in such a manner as to provide two sweep rates which can be switched in unison with the switching that occurs in the vertical channel.

10. *Will the instrument be useful 5 years from now?* This is hard to evaluate since no one really knows for certain what type of test equipment will be needed in the future. However, plug-in oscilloscopes can be adapted to new requirements readily. Scopes which have plug-ins in both horizontal and vertical channels extend the useful life of the unit still further. ▲

HORIZONTAL PUZZLER

By DON DUDLEY

SOFT focus and an oversized, washed-out picture marked a severe case of raster blooming on a Sparton 21S214 TV set. Also, one side of the picture was marred by a clearly evident horizontal sync bar, which could not be eliminated.

Replacement of the high-voltage, horizontal-output, and damper tubes made no difference. A ringing test, conventionally used to check the flyback transformer and associated components, was performed. It indicated that transformer and yoke were in good condition. Suspicious capacitors and resistors were replaced, but the symptoms remained. A continuity check of the transformer with an ohmmeter, usually less reliable than the ringing check, was then tried. Sure enough, the winding indicated in the schematic was open. In addition, capacitor C80 showed leakage.

The partly shorted capacitor, by restoring some continuity to the open primary, permitted the transformer to function, after a fashion, and to pass the ringing check. However, circuit constants changed by the two defects altered the phase of the a.f.c. system enough to shift the horizontal sync bar into a visible portion of the raster. Replacing the flyback and the capacitor cleared up this unusual and baffling problem. ▲

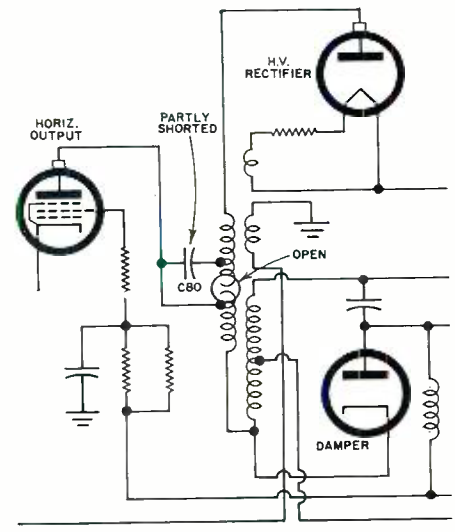

Frequency Measurement

(Continued from page 47)

is 259.00 cps. Using the same 1000-cps standard, it is obvious by inspection that the nearest fraction giving a sine-wave pattern is $f/4$, or 250.00 cps. However, it is also obvious that this choice will give a 9-cps drift. It is a rare individual who can count at the rate of 9 per second. But if we notice that this rapid drift is occurring, we can go back to Step 1, and instead of selecting one cycle, we can pick one-half cycle. Going to Step 2 will reveal that the nearest pattern is $f/8$, or 125.00 cps. The drift rate is going to be $(259/2) - 125$ cps, or $129.5 - 125.0 = 4.5$ cps. This rate is easily counted. One merely remembers to convert the final frequency back to the correct range by multiplying by the same factor used to obtain the desired patterns; in this case, a multiplication by two.

If one wishes to use Lissajous figures, the usefulness of a single standard frequency is greatly extended. Such patterns (ratios) as 5:3, 5:4, 6:5, can provide additional known fractional values of the standard, to overcome the difficulties of rapid drift.

Perhaps an even better way, short of going into more sophisticated and complex aggregations of equipment, is to employ an auxiliary audio-frequency oscillator. If this oscillator is known to have excellent short-term stability, it can be employed with satisfactory results in place of the WWV tones or the accurate tuning fork. The continuously variable feature of the audio oscillator offers the tremendous advantage of furnishing many basic values for the standard frequency. Of course it is necessary to synchronize, or compare, the oscillator with a known standard, just before making a measurement, and proceed directly to make the measurement. Dial readings are valueless and not used except possibly as guides, say, for the 100-cycle dial increments. The actual oscillator setting, if used as a standard, must in every instance be derived by comparison with a standard, just before use. ▲



NOW
receive ALL
channels

All-transistorized SONY Micro-TV and UHF Adaptor for all-channel reception

Now you can tune the full range of television—standard 2-13 VHF channels and the new world of UHF television. All you need is the Television of the Future, the remarkable 25-transistor SONY Micro-TV, plus the new UHF adaptor that is fully transistorized and has its own built-in antenna. Powered by the Micro-TV, the 13-oz. adaptor makes use of the new mesa transistor for stepped up sensitivity, and accepts an external antenna. Micro-TV, itself a truly portable 8 lbs., operates on its own rechargeable battery pack, auto/boat power, and AC. Micro-TV only **\$189.95**. UHF adaptor complete with antenna **\$49.95**. Rechargeable battery, luggage carrying case, other accessories extra.

SONY
RESEARCH MAKES THE DIFFERENCE

SONY CORPORATION OF AMERICA
580 Fifth Avenue, New York 36, N. Y.

Regional Offices
Western: 500 West Florence Avenue, Inglewood, Calif.
Central: 4959 W. Belmont Ave., Chicago 41, Ill.

Please send me more information on SONY MICRO-TV with UHF

Name _____

Address _____

City _____ Zone _____ State _____

SONY Corp. of America, Dept. EW-8 580 Fifth Ave., New York 36, N. Y.

CIRCLE NO. 137 ON READER SERVICE PAGE

SEND **ELECTRONICS WORLD**
EVERY
MONTH

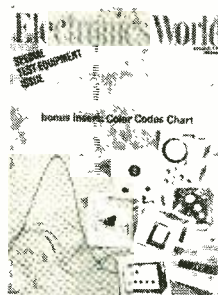

name _____

address _____

city _____ zone _____

state _____

Check one: 2 years for \$9 3 years for \$12 1 year for \$5

In the U.S., and possessions.

Payment enclosed Bill me

Foreign rates: Canada and Pan American Union countries, add 50¢ per year; all other foreign countries, add \$1.00 per year.

New Renewal

Mail to: **ELECTRONICS WORLD**
Dept. 1-8608, 434 S. Wabash Ave.
Chicago 5, Ill.

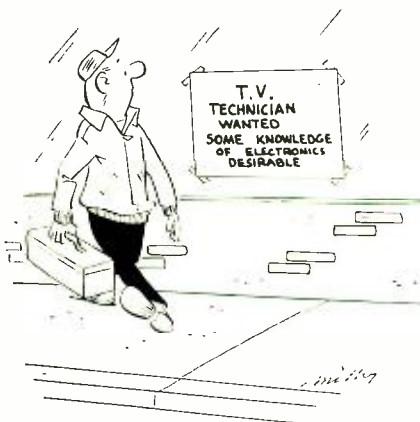

MICRO

ELECTRON TUBE
FABULOUS LOW PRICES!
LARGE SELECT STOCKS!
DEPENDABLE, FAST SERVICE!

- Each and every tube is tested in our own laboratory for mutual conductance and life test.
- We guarantee FREE replacement for one year of any tube purchased from us which fails to function efficiently under any or all operating conditions. Prompt refunds are made on any defective merchandise.
- The advertised tubes are not necessarily new, but may be electrically perfect factory seconds. Used tubes—each is clearly so marked.

37 ea. **\$35** PER HUNDRED ASSTD.

0A2	6X8	6DH6	6SF5	7Z4	19B66G
0Z4	6Y3GT	6DJ6	6SF7	12A8	19J6
1A7GT	6Y4G	6DM5	6S1T	12A05	19T8
1B3CT	6A7	6B7	6SK7	12AT6	24A
1H4G	6AB	6BL7GT	6SL7GT	12AT7	23AV5
1H5GT	6AB4	6BN6	6SN7GT	12AU6	23B06
1L4	6ACT	6B06GT	6S07	12AU7	23DN6
1L4	6AF4	6BQ7	6S2T	12AV6	25L6GT
1M5GT	6AG5	6B15G	6T4	12AV7	25W4GT
1O5GT	6AG7	6B2C	6TR	12AX4GT	25Z5
1R5	6AH4GT	6B2Z	6UR	12AX7	25Z6
1S2	6AH6	6C4	6VV	12AZ7	26
1T4	6AN8	6C5	6W4GT	12B4	32A5
1U4	6AL5	6C6	6W6GT	12BA6	32B5
1U5	6AL7	6CB4	6X4	12B7	35C5
1V2	6AM8	6CD4G	6X5	12BE6	35L6GT
1X2	6AN8	6CF6	6X8	12BF6	35W4
2A3	6A45	6C0T	6Y6G	12BH7	35Y4
2AF4	6AQ4	6CL6	7A4 XXL	12B06	35Z5GT
3BC5	6AQ7GT	6CM6	7A5	12BR7	37
3BN6	6ARS	6CM7	7A6	12B7	38-44
3B76	6AS3	6CM7	7A7	12CA5	42
3CB6	6AT8	6C98	7A8	12J5	43
3CF6	6AT8	6C98	7M4	12K7	48
3C56	6AU4GT	6D65	7M5	12L6	49A5
3LF4	6A15GT	6D06	7M8	12Q7	50B8
3Q4	6AUG	6F6	7B7	12S47	50C5
3S4	6AUB	6H6	7B8	12S07	50L6GT
3V4	6AV5GT	6I4	7C4	12S17	50X6
4BQ7A	6AV6	6J5	7C5	12SK7	58
4B27	6AW6	6J7	7C6	12SN7GT	57
4S58	6A4GT	6KGT	7C7	12S07	58
5A78	6AX5GT	6K7	7E8	12V6GT	71A
5A78	6B8	6H8	7E7	12W6GT	75
5AW4	6BAG	6LT	7F7	12X4	76
5B7	6BES	6NT	7F8	12Z3	77
5J6	6BEC	6O7	7H7	1447/12B7	80
5T8	6BEG	6RL	7H7	1486	80
5U4G	6BEG	6S4	7Q7	14Q7	84-8Z4
5U8	6BFS	6S47	7Q7	19	117B3
5V4G	6BFS	6S47	7Y7/XXFM	19A4GT	117Z6
5V6GT	6BSC7	6SC7	7Y4		

SEND FOR OUR FREE COMPLETE LIST OF TUBES & SPECIAL PURPOSE TUBES

ALL TUBES SENT POSTAGE PAID. Please send 35¢ handling for orders under \$5. Send 25% deposit on C.O.D. orders. Send approximate postage on Canadian and foreign orders.

MICRO ELECTRON TUBE CO.
 P.O. Box 55 Park Station, Paterson 3, N. J.

CIRCLE NO. 127 ON READER SERVICE PAGE

ENGINEERING B.S. DEGREE SCIENCE IN 36 MOS. MATH

U.S. NEEDS 50,000 NEW ENGINEERS A YEAR!
 EARN ACCREDITED B.S. DEGREE in Science or Engineering in 36 months—year-round program optional. 27-month engineering diploma also available. Classes start September, January, March, June. QUALITY EDUCATION. Graduates employed throughout the U.S. and foreign countries. Government approved for veteran training. Students from 50 states, 40 countries. 20 buildings; dorms, gym, Campus, New library and laboratories. Employment help provided. SAVE TIME AND MONEY. Write for catalog and full information.
 1608 E. Washington Blvd., Fort Wayne 2, Indiana

Indiana Institute of Technology
 formerly Indiana Technical College

Calibrating Test Equipment (Continued from page 45)

to 0.1 microvolt is available. An instrument of this type is also useful in laboratory applications other than calibration.

A less complex resistance voltage divider is shown in Fig. 4. Designated model RD-1 by its manufacturer, *North Hills Electronics*, it is available for \$425. Used in conjunction with an external voltage source, its output is that fraction of the input which is indicated by the numerals above each of the decade switches.

For precise resistance calibration, Thomas-type standard resistors (named after the person who developed them) are available from *Leeds & Northrup*. The one shown to the left in Fig. 5 is a 1-ohm unit certified to an accuracy of 0.0001% if temperature is controlled. Shown with it are other standard resistors with values of 1 ohm and less.

While d.c. standards and calibration methods have traditionally lent themselves to greater accuracy than is obtainable for a.c., recent developments have improved a.c. techniques considerably. Since there is no a.c. equivalent of the standard cell, most sources of a.c. voltage and current are refined, electronic signal generators. One company, for example, offers an a.c. standard at 400 cps that is accurate to $\pm 0.1\%$ in frequency and $\pm 0.025\%$ in voltage.

Aside from voltage, one dealing with a.c. may want to check such other parameters as impedance and power factor. Precise units of inductance and capacitance are called for. Figs. 6 and 7 show devices in this category made by *Leeds & Northrup*. Fig. 6 is a capacitor box made up of precisely calibrated, highly stable mica capacitors mounted on high-quality decade switches. Its rated accuracy is $\pm 0.1\%$, $+0.5$ pf. Calibrating capacitors more precise than this set, although they will seldom be required, are available.

The Brooks "Inductometer" of Fig. 7, available for \$550, consists of three sets of carefully wound coils. One set is mounted in the rotating disc, which is calibrated in millihenrys. One set of fixed coils is located above the disc, another below it. When the disc is rotated, mutual-inductance changes provide the variety of inductance readings possible. The coils have been carefully designed and shaped so that rotation over 170 degrees produces an almost linear change. At 1000 cps, the "Inductometer" is accurate to $\pm 0.3\%$.

Conclusion

The relatively crude procedures outlined for the simple v.o.m. and v.t.v.m. in the early portion of this article can be improved considerably and also

made easier with some of the devices described subsequently. Also, with these more refined standards, other types of instruments and parameters can be checked. Yet, of necessity, the special devices available have only been touched on. The complex matter of frequency calibration and standards, for example, has not been treated at all. Actually it would take more than one volume to give the broad area of calibration and standards comprehensive treatment.

Nevertheless, much has been achieved if interest in the subject has been aroused. On the practical level, further information can be obtained from the National Bureau of Standards and the manufacturers mentioned in this article on the following: standards, their prices, and organizations that specialize in providing calibration service.

Another practical alternative is available for individuals or small organizations that prefer to do their own work but cannot justify the required investment. If calibration checking is not done on a steady schedule, it is possible to rent precisely calibrated equipment on a short-term basis, either for a particular job that requires exceptional accuracy or to check regular equipment. *General Electric's* Instrumentation Service in Schenectady, N.Y., for example, offers a long list of rental equipment. While the manufacturer's own line is, of course, fully represented, instruments from other sources are included on the list. A Wheatstone bridge by *Leeds & Northrup*, to cite one example, is available for \$18 a month. *G-E* also maintains, as do other manufacturers, an instrument repair and calibration service shop from which trained technicians are available on an outside-call basis.

Any firm interested in maintaining precision of its measuring instruments has a wide choice of alternatives that may be fitted in with its needs and its budgetary considerations. ▲



SIMPLE HUM-BUCKING CIRCUIT

By G. R. GILBERT

THE simple addition of a hum-bucking circuit to any high-gain amplifier is well worth considering. In almost all cases, residual hum will be reduced to virtual inaudibility and in every case substantial reduction will result.

Hum troubles usually occur when the preamplifier is connected, particularly if the compensation circuits have to cope with a pickup head with very small output. The simple circuit shown in Fig. 1 operates by feeding hum in opposite phase from the heater of the first preamplifier tube into the suppressor of the same tube. As there is a phase reversal between the control grid and the suppressor grid, hum voltage fed to the suppressor bucks the control-grid hum.

R1 is a wirewound pot of from 100 to 500 ohms with a preferred value of about 200 ohms. The potentiometer is wired as close to the V1 tube socket as is convenient with the variable arm going to the suppressor. The usual pair of 100-ohm fixed resistors, R2 and R3, are connected as shown, forming a center-tapped ground for the remaining tube heaters.

When wiring this circuit into an existing amplifier, or even when wiring a new amplifier, V1's suppressor should not be connected to the cathode, as is usually the practice.

The adjustment is simple. Turn the volume control up so that the residual hum is clearly audible, then rotate R1 until the hum either vanishes or is at a minimum. A well-defined null usually occurs.

This circuit is far more effective as a hum-reducer than the more commonly used "humdinger," which consists of a low-value pot connected across the heater supply with the moving arm going to ground.

The circuit can be applied to as many tubes as required, as adjustment is made to each stage independently. ▲

Fig. 1. Circuit used to feed hum to the suppressor grid in order to buck it out.

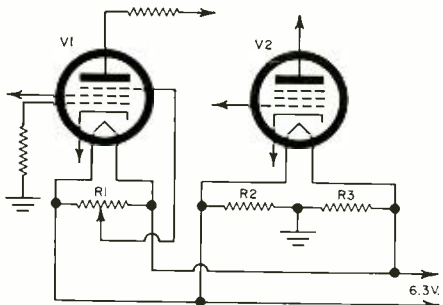

August, 1963

NEW

CG* SPHERICAL SOUND IS COMING!

*CAVITY GENERATOR

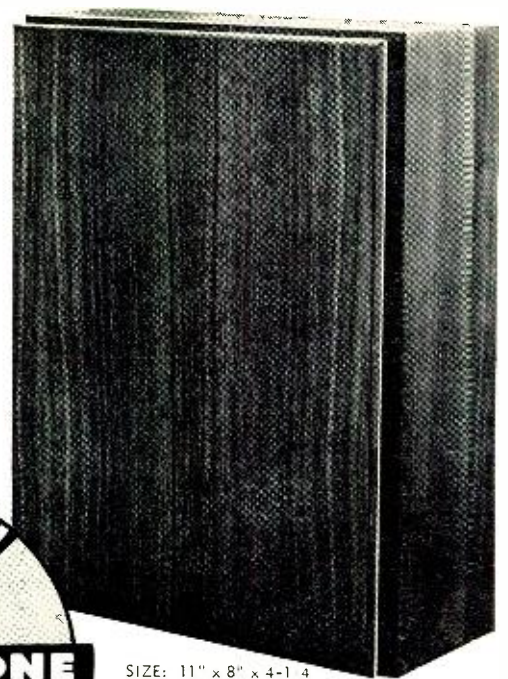

SIZE: 11" x 8" x 4-1/4"
FULL FREQUENCY RANGE (WITH-
OUT BOOM) 8 WATTS (MEASURED)

FOR LITERATURE AND
DEALER INFORMATION
WRITE

Murray-Carson Corporation

2424 E. 55th STREET, DEPT. 3A, INDIANAPOLIS 20, INDIANA

NEW

NEW

CIRCLE NO. 128 ON READER SERVICE PAGE

NEVER FAIL — ZONE YOUR MAIL

The Post Office has divided 106 cities into postal delivery zones to speed mail delivery. Be sure to include zone number when writing to these cities; be sure to include **your** zone number in **your** return address—after the city, before the state.

FLORIDA ELECTRONIC TECHNICAL INSTITUTE

IN THE HEART OF MISSILELAND
TRAINS MEN FOR SUCCESSFUL CAREERS IN ELECTRONICS WITH IMPORTANT COMPANIES AT THE WORLD'S BEST KNOWN MILITARY INSTALLATION, CAPE CANAVERAL.

APPROVED VETERANS TRAINING PROGRAMS
Take Advantage of This Opportunity NOW

FLORIDA ELECTRONIC TECHNICAL INSTITUTE, INC.
105 King Street Cocoa, Florida

NEW! LAFAYETTE 12-TRANSISTOR 2-WAY "WALKIE TALKIE" WITH SQUELCH

only 39.95 2 for 78.88



More fun . . . better performance . . . greater value than ever. Superb for fishing, hunting or business use. No age restrictions or license requirements when used as per Part 15 FCC regulations. Features: separate microphone and speaker for better sending and receiving, excellent noise squelch; crystal controlled receive and transmit, positive action push-to-talk switch and 46" telescoping antenna. As a bonus feature, the HE-100 may be operated in the home with an AC power pack. (Optional see below) Saves batteries too! Includes crystals, earphone, leather carrying case and batteries. Shpg. wt., 22 oz. Imported

HE-100L Walkie-Talkie Net 39.95
Pair for 78.88

NEW! AC POWER PACK
Converts 117VAC to 9V DC.
Plugs into HE-100.
HE-97 Net 7.45

**ORDER A
PAIR TODAY!**

LAFAYETTE Radio ELECTRONICS
Dept. RH-3, P.O. Box 10,
Syosset, L.I., N.Y.

Send me: Walkie Talkie (HE-100L)
AC Power Pack (HE-97),
Shipping charges collect, \$ enclosed.

Name
Address.....
City Zone State

CIRCLE NO. 124 ON READER SERVICE PAGE

TEST EQUIPMENT

PRODUCT REPORT

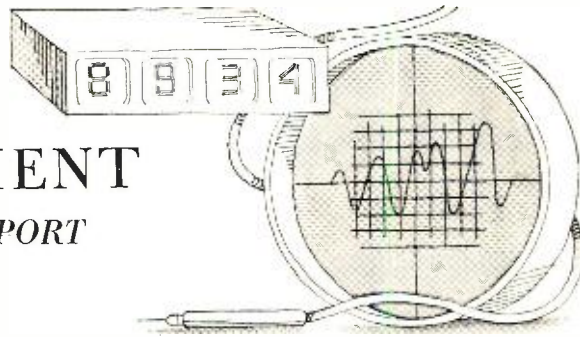

RCA Model WR-51A FM Stereo Signal Generator

For copy of manufacturer's brochure circle No. 58 on coupon (page 19)



A VERY specialized signal generator is required for servicing and maintenance of FM stereo adapters, tuners, and receivers. The new RCA WR-51A is such a generator; it produces all the signals needed for proper adjustment of stereo circuits. This unit must be used in conjunction with a scope to observe response and output waveforms of the equipment being adjusted.

The generator produces a composite stereo output signal with either left-only or right-only modulation. A special left-plus-right signal is also available for accurate phase adjustment of subcarrier transformers. Various audio frequencies (400 cps, 1 kc., and 5 kc.) are utilized for modulation. A 19-kc. crystal-controlled subcarrier signal is provided for

checking the lock-in range of stereo receivers. Sine-wave outputs at 28 kc., 38 kc., and 67 kc. are generated for band-pass and SCA filter network adjustment.

Built into this unit is a 100-mc. r.f. oscillator that may be frequency modulated with the above signals. This permits the stereo information to be applied to the front ends of FM tuners and receivers for over-all r.f.-i.f. alignment checks. In the event that there is an FM station right at 100 mc., it is possible to shift this frequency slightly by means of a front-panel control.

Another crystal oscillator in the generator (at 5.35 mc.) is used to produce a 10.7-mc. i.f. marker for the tuner's i.f. response curve. In addition, harmonics of this oscillator may be picked up at 90.95 mc., 96.30 mc., 101.65 mc., and 107 mc. for a check of a tuner's r.f. and oscillator alignment.

The instrument also includes a zero-center meter that measures 1.4 v. r.m.s. either side of zero. This meter is used to check the electrical balance of a stereo amplifier audio output. Two cables at the rear of the instrument are connected to the voice-coil output terminals of the amplifier. With a mono or an L+R signal applied to the amplifier, there should be equal outputs from both channels and the meter will read in the exact center.

With a left-only signal, the meter will deflect to the left; with a right-only signal, it will deflect to the right.

A block diagram of the instrument is included. Considering all the functions provided, the unit is remarkably simple. It uses only 6 dual-purpose tubes, 4 crystal diodes for the balanced 38-kc. modulator and meter rectifiers, 2 crystals for frequency control, and a silicon rectifier.

Accompanying the WR-51A is an excellent manual. This not only goes into complete details on the operation and use of the generator, but also includes a fine section on maintenance and adjustment of the unit itself. Some of our test-equipment manufacturers would do well to study this manual to see how it should be done.

The generator is fairly portable, weighing 14 pounds and measuring 13½" x 10" x 8". The price of the unit is \$249.50. ▲

Associated Research 2850 Megohmmeter

For copy of manufacturer's brochure, circle No. 59 on coupon (page 19).



A NEW test instrument designed for field and bench testing of insulation on electrical components and equipment has been introduced by Associated Research, Inc. as the "Vibrotest" Model 2850. This is a megohmmeter that is able to measure resistances as great as ten million megohms at 500 volts d.c., or one million megohms at 50 volts d.c. Accuracy of ±2 percent is achieved over most of the range at 500 volts, and ±5 percent over most of the range at 50 volts.

The meter can be used to measure resistance between conductors on a printed circuit, as well as insulation resistance of transistors, miniaturized parts, cables, and motors. It also measures leakage resistance of capacitors and can be used for measuring grounded and ungrounded sections of three-terminal resistors.

Many megohmmeters use a hand-cranked generator or batteries to pro-

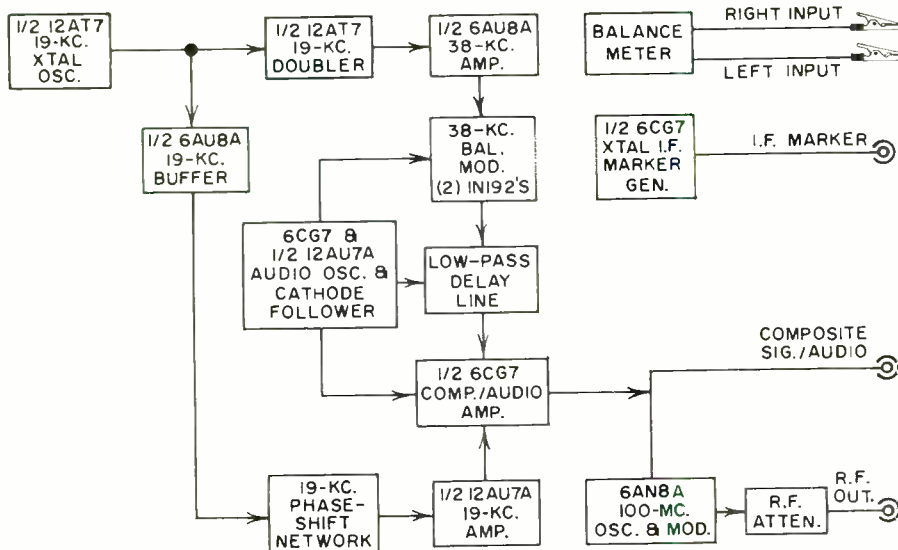

duce the test voltages. In this instrument, a.c. line power is rectified by silicon diodes to produce the d.c. required. To prevent line-voltage variations from affecting the readings obtained, a cathode-follower voltage-regulator circuit is used (see block diagram).

A fused three-wire a.c. line cord grounds the case for shock protection. The instrument is protected from overload damage, even in cases of direct shorting, by an electronic overload circuit. The metering circuit uses miniature

vacuum tubes, and the meter itself is a 200- μ amp. unit.

Guard circuits are employed to control stray and leakage currents to assure accuracy at maximum sensitivity. A terminal for external guard use is provided, and a selective-return grounding circuit offers maximum guarding flexibility when the instrument is utilized to test production components or permanently installed equipment.

The instrument weighs about 10 pounds and is available for \$250. ▲

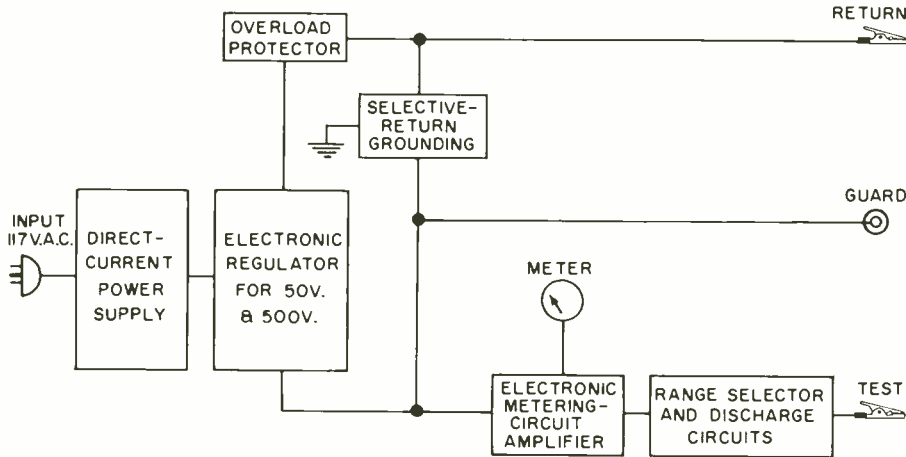

Sencore CR125 Cathode-Ray Tube Tester

For copy of manufacturer's brochure, circle No. 60 on coupon (page 19).

THE most expensive component in a TV set is the picture tube. Fortunately, modern picture tubes are quite ruggedly built and they ordinarily last a long time. Although the tube's heater does burn out or open up completely, it is far more common for the tube to operate month after month but at reduced emission (and consequently, a darkened picture). Another common defect is the depositing of cathode or other foreign material between the tube's electrodes, resulting in inter-element leakage. This has many effects, ranging from lack of brightness control, poor contrast, dark picture, bright picture, and others,

depending on the location of the leakage and the circuitry.

The new Sencore CR125 not only is a complete tester for picture tubes, but it also is frequently able to remove inter-element shorts, restore emission by rejuvenation, and weld together open cathodes. The instrument can check tubes ranging from an 8-inch tube, and this includes color-TV picture tubes as well. The tests performed include those for inter-element shorts, cathode emission, and a check on the operation of the control grid. For these tests, d.c. is used on all tube elements (except for the

heater) and emission of over 300 μ a. is indicated as "good" on the meter scale. New tubes normally measure 900-1500 μ a., but since the high end of the 500- μ a. meter is suppressed by a crystal diode, the meter does not go off scale. The grid bias can be adjusted from 0 to -100 v., and the effect can be noted directly on the emission meter.

Suppose the tube you are testing shows leakage or a short between control grid and cathode. The tester can then be used to remove this short. It does this by applying momentarily to these electrodes a high voltage (450 v.) from a large electrolytic capacitor (C5-B in the diagram). The length of time that this voltage is applied depends on the amount of leakage; with high leakage (low resistance) a large current flows for perhaps 1/6 second or so; with low leakage, less current flows for a second or more. If the material causing the leakage is burned away during this process, you may see a momentary flash in the neck of the tube. This procedure can be tried several times until the short is burned out.

If the tube being tested shows low emission, then the CR125 is set up for rejuvenation. During this procedure, we attempt to bring new active emitting material to the surface of the cathode and to enlarge the aperture in the control grid. There are three steps available for the rejuvenation procedure. In the first step, a high voltage is momentarily applied to the control grid. If this does not do the job, then the second step is tried. Here, the heater voltage is raised slightly while the high voltage is applied. If the tube still does not respond, then the third step is tried. The heater voltage is raised still more and the length of time that the high voltage is applied is lengthened.

When color-TV picture tubes are tested or rejuvenated, each of the three guns is checked and connected to the tester separately, as determined by the position of the "Color Gun" switch.

Like all Sencore's instruments for the service technician, the cathode-ray tube tester is designed for convenience and portability. It is available at the company's distributors for \$69.95. ▲

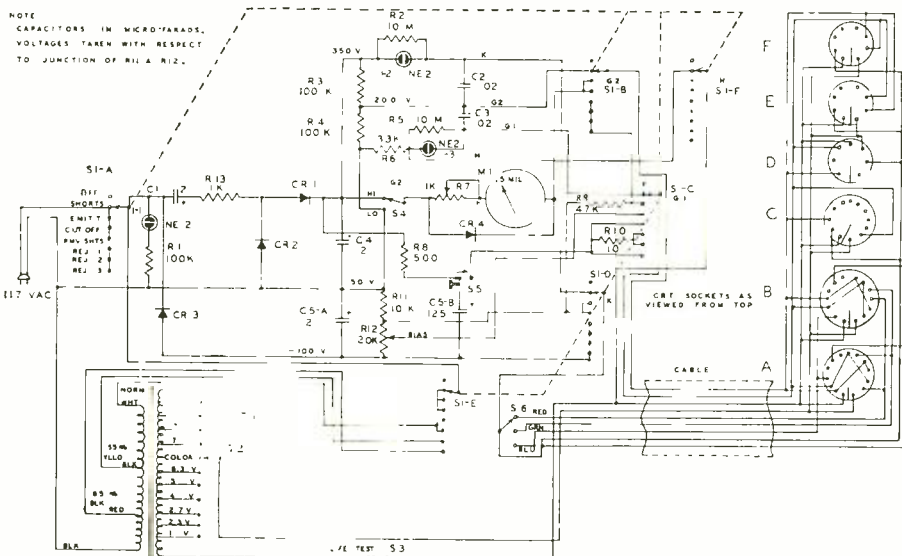

Tarzian offers
**FAST, DEPENDABLE
 TUNER REPAIR
 SERVICE (ALL
 MAKES)**



**ALL PARTS
 (except tubes)
 and LABOR**

**24-HOUR SERVICE
 1 YEAR WARRANTY**

Sarkes Tarzian, Inc. maintains two complete, well-equipped Factory Service Centers—assisted by Engineering personnel—and staffed by specialized technicians who handle ONLY tuner repairs on ALL makes and models. Tarzian-made tuners received one day will be repaired and shipped out the next. Allow a little more time for other tuners.

One year guarantee against defective workmanship and parts failure due to normal usage. Cost —\$9.50 per unit. \$15 for UV combinations. Absolutely no additional, hidden charge for ANY parts, except tubes. You pay shipping costs. Replacements on tuners beyond practical repair are available at low cost.

When inquiring about repair service, always give TV make, chassis and Model number. Tuners repaired on approved, open accounts. Check with your local distributor for Sarkes Tarzian replacement tuners, replacement parts, or repair service. See your distributor, or use the address nearest you for fast factory repair service:

SARKES TARZIAN, INC.

537 South Walnut Street
 Bloomington, Indiana
 Tel: 332-6055

10654 Magnolia Blvd.,
 North Hollywood, Calif.
 Tel: 769-2720

CIRCLE NO. 134 ON READER SERVICE PAGE

BC-221 FREQUENCY METER with original Calibration Book and Crystal. Lab. checked out. Xint. condition	\$ 69.50
MAGNESYN COMPASS, complete remote reading system, for plane or boat. 12 V-DC input. Xint. condition. With schematic	24.95
AN/APN-9 LORAN RECEIVER-INDICATOR. Completely lab. realigned and checked out. With 24 Volt DC Inverter, mount and plug. Xint. condition	124.50
BC-455 COMMAND RECEIVER. 6-9 MC. Xint. condition	8.95
BC-458 COMMAND TRANSMITTER. 5.3 to 7 MC. Brand new	9.95
All above items subject to prior sale. Don't wait!	
Send Money Order or Check with Order Write for Latest Flyer—LOADS OF BARGAINS!	
R W ELECTRONICS	
2430 S. Michigan Avenue Chicago 16, Illinois	Dept. 873 Phone: CAIumet 5-1281

Signal-Generating Equipment
 (Continued from page 34)

Crystal-controlled calibrators provide a 100 times improvement at frequencies corresponding to harmonics of the calibrator. This accuracy does not hold at other frequencies, though, simply because the tuning dials of the instruments cannot be read with that kind of precision.

However, frequency can be monitored with an electronic counter to a far higher degree of accuracy. With the aid of a precision transfer oscillator and heterodyning techniques, counters can determine frequencies as high as 18,000 mc./sec. (and higher) to an accuracy of 8 decimal places.

If an oscillator can be voltage controlled, phase-locking techniques can be used to maintain the output frequency at the same stability as a reference crystal oscillator. This can be done, though, only at spot frequencies corresponding to harmonics of the crystal oscillator frequency.

Precisely known signal frequencies are available from frequency synthesizers, which obtain various r.f. frequencies by dividing, multiplying, adding, and subtracting other frequencies derived from crystal-controlled oscillators. The newest signal source of this type generates frequencies all the way from 0.01 cps to 50 mc. in 0.01-cps steps by push-button control. All of these 5 billion discrete frequencies are derived from one highly precise 1-mc. crystal oscillator and all are accurate to better than 0.0000003%! This is three ten-millionths of one percent.

The accuracy of signal-generator output amplitude indications can't approach accuracies such as those available for frequency—primarily because highly precise standards of r.f. power never existed until only recently. High-quality generators have had output accuracies in the neighborhood of 1 to 2 db. Now that more accurate r.f. power monitors are becoming available, the trend is towards the use of power leveling for signal-generator output amplitude control. In these systems, the power monitor maintains constant output power by means of a wide-band, direct-coupled feedback loop which controls an amplifier control grid, or one of the new electrically controlled *p-i-n* diode modulator/attenuator units. Output power flatness can be held to within 0.2 db with this technique. The accuracy of the power monitoring system is typically ± 0.5 db over-all, however an additional ± 1 db should be added because of attenuator accuracy throughout the frequency range of the equipment.

Little effort has been expended on controlling the accuracy of pulse generators with respect to pulse width and

amplitude; the major design effort being directed towards achieving good pulse shape. Pulse generator calibrations are used for no more than a rough initial indication of pulse amplitude, width, or repetition rate. Because pulse generators are most often used with an oscilloscope, the pulse generator controls are usually adjusted exactly while monitoring on the oscilloscope.

Choosing Equipment

The first thing to do is to take a good, hard look at what the equipment is intended to do. What frequency ranges are needed and which can be omitted? What kind of signals are desired—sine wave, pulsed, FM, AM, or what?

What stability does the generator have? That is to say, if you set it at one frequency how confident can you feel that the generator will stay exactly at that frequency? What is the amplitude stability? If you set the output for 1 volt r.m.s., will it stay at the exact 1-volt setting all afternoon, or if you change frequency?

A design engineer is very much concerned with these matters. When designing an i.f. strip, for instance, he needs a generator with an output that is flat across the band, so that the detected response will show him where the i.f. strip isn't flat. The serviceman repairing the same strip can get by with a generator of lesser quality. About all that he can do is to set the traps to the right frequencies, get about the right slope to the band edges, and take excessive tilt off the passband. A few humps in the generator output won't affect these adjustments significantly.

Check the performance of the attenuators, which are needed to prevent overdriving high-gain equipment. Is the attenuator accurate, and is its attenuation constant with frequency? And watch out for r.f. leakage. A big attenuation factor doesn't tell you anything if r.f. power leaks into the tested circuit anyway.

How much harmonic content is present if you are supposed to be getting pure sine-wave output? If there are harmonics, you may think that a filter circuit is passing a certain frequency when it is really passing a harmonic. With r.f. generators, the standing wave of a harmonic may be much higher than the fundamental, providing a false indication.

Certainly, the reputation of a manufacturer is of considerable importance. Reputable manufacturers check the performance of many production units and then set specifications beyond the widest deviations. Sometimes their specifications may not appear spectacular, but with this kind of equipment performance will always be better than claimed. ▲

RADIO & TV NEWS

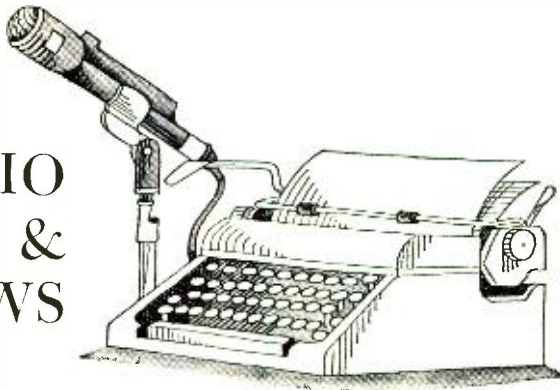

SPEAKING at a meeting of NATESA in Kansas City, Frank W. Mansfield, Director of Market Research for *Sylvania Electric Products*, said that their three-month national survey of color-TV set dealers and owners showed that at least 20 brands of color sets are available on dealer floors. About 70% of dealers indicated that their customers had little or no trouble with color repairs and set owners generally were not critical of tuning problems previously associated with color sets. The *Sylvania* survey also indicated that the average repair bill on a color set amounted to about \$30.50 per year or less than 9¢ a day. About 40% of the set owners said that the cost of color repairs were no more than they had experienced with black-and-white sets. An additional 22% were so unconcerned that they could not recall what their repair bills were in the previous 12 months.

Mansfield also pointed out growth of American households from the present 55 million to an estimated 77 million in 1977 will be a factor in increasing color sales. At least 90% of these households can receive colorcasts on their black-and-white sets and about 45% have annual incomes in excess of \$6000 which means that they can be considered prime prospects for color-TV receiver sales. This also means quite an upswing in sales of antennas, transmission lines, and test equipment for use by service technicians.

Soviet TV Expands

The 130th TV station in the Soviet Union has been opened in Krasnovodsk, a town on the Caspian Sea. The first broadcast coincided with the 25th anniversary of Soviet TV, which started March 9, 1938. Since then, the number of TV sets in the Soviet Union has climbed to over 8,000,000 serving a population of about 100,000,000. In addition to 130 TV stations, a large number of relay stations cover remote rural areas. Moscow TV programs are carried by 63 stations on a network that covers most of the country.

Color programs are already being carried in both Moscow and Leningrad, but according to Soviet authorities, further development is hampered by the high

price of color sets. Like their American counterparts, Soviet engineers are currently engaged in a cost-cutting program. At present, color-TV sets are being used only in hotels, rest homes, clubs, and "Palaces of Culture."

Space—Far and Near

Those who followed Gordon Cooper's space flight on TV would be interested to know that at the lift off, a TV camera coupled to a telescope located about 20 miles from the launch site was used to supply TV networks with pictures of the launch.

Heart of the system is the BX-7 image orthicon developed by *Bendix*. Tests of the TV-telescope show it capable of spotting a basketball at 100 miles and resolving objects less than one-half mile long on the moon.

Electronics and Mud

A Cornell University research team is currently seeking the solution to a problem that has plagued humans since the first man got bogged down in the mud. The group is trying to develop a technique to electrically reduce the water content of soil then combine it with certain chemicals to stabilize the soil so it can bear a heavy load. Past experiments have shown that water in the soil attaches itself to positively charged particles and these particles, together with the water, would be attracted to a negative charge. The group is testing the feasibility of using a metal grid about 15 to 20 feet wide and as long as practicable over the muddy area. Buried beneath the grid would be a pipe or series of pipes. The grid would serve as one pole, either positive or negative, and the submerged pipe as the other pole. Conceivably, with a negatively charged grid and positively charged pipes, the water would move to the surface under the grid and be carried away in drainage ditches. At the same time, soil-stabilization chemicals are introduced through the submerged series of pipes.

The work is currently being conducted in the laboratory and if it works OK, it will then be field tested.

Give this some thought next time you get bogged down in the family wagon. ▲

TRANSFIRE®

TRANSISTOR IGNITION

READY-TO-INSTALL CONVERSIONS

YOU can get TOP MILEAGE, HIGHEST PERFORMANCE, LONGER POINT & PLUG LIFE, BETTER WINTER STARTING, and MANY OTHER ADVANTAGES with one of our INEXPENSIVE TRANSFIRE systems. These include HERMETICALLY-SEALED AMPLIFIER, HIGH-RATIO COIL, BALLASTS, Leads & hardware.

MODEL T 6 or 12v. neg. grd. \$39.95

MODEL T2 TWO TRANSISTORS,
250:1 coil \$44.95

MODEL TP 6 or 12v. pos. grd. direct
installation wo. insulating points . . \$54.95

MODEL TS Special, 40kv system . . . \$59.95

MODEL TS2 TWO TRANSISTORS,
400:1 coil \$49.95

TWO-TRANSISTOR KITS Everything needed to build conversion. Includes transistors, coil, ballasts, heat sink, decal, etc.

KT2 with TX250 coil for 30kv output . \$34.95

KTS2 with T400 coil for 40kv output . \$39.95

KT1 one transistor with 400:1 coil . \$27.95

6 or 12v. Negative-ground only. Point insulation kit adapts to positive ground, \$2.50 pp.

1 oz. Epoxy potting plastic in mixing bag \$1.95 pp.

HIGH-RATIO IGNITION COILS with free circuit diagram.

TX250 Heavy duty coil 250:1 ratio . . . \$ 9.95

T400 HIGH EFFICIENCY 400:1 coil for
HIGHER OUTPUT and/or LOWER
TRANSISTOR VOLTAGE \$11.95

FULL LINE of PARTS at NET PRICES.
Free lists. Dealer opportunities. Marine models available. When ordering, specify voltage and car. Add postage for 4 lbs. on kits and conv's; 3 lbs. on coils. \$5.00 deposit with COD's.

PALMER ELECTRONICS LABORATORIES Inc.
CARLISLE 1, MASS. 617—AL 6-2626

CIRCLE NO. 144 ON READER SERVICE PAGE

Winegard YAGI COUPLERS

The new low-cost way to tailor-make your own special antenna system using a single down-lead!

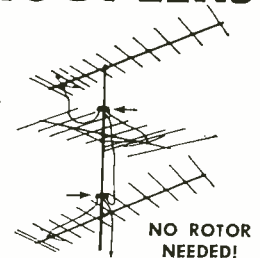

No interaction. No loss. Couple 2 or more cut-channel yagis to each other, or couple cut-channel yagi(s) with any other VHF broadband or all-channel antenna. Eliminates "mixing networks", rotors, switches. Convenient, automatic. Write for Fact-Finder #231.

WINEGARD COMPANY
3003-8 Kirkwood Ave., Burlington, Iowa

CIRCLE NO. 140 ON READER SERVICE PAGE

NEW MULTIPLEX VERSION OF FAMOUS SCOTT 310 "TELSTAR" FM TUNER



Scott's 310 tuner has long been admired for exceptional sensitivity and selectivity. It is used as a broadcast monitor by FM stations throughout America and was selected by Bell Laboratories for receiving signals from Telstar orbiting in outer space. The new 310E includes exclusive Scott Time-Switching multiplex circuitry, silver-plated front-end, Auto-Sensor for fully automatic reception, precision meter and many other exclusive features. Sensitivity is 1.9 μ V! \$279.95*

H. H. Scott, Inc. Dept. 160-08
111 Powdermill Road, Maynard, Mass.



Rush me complete technical details on new 310-E FM Stereo Tuner.

Name _____

Address _____

City _____ Zone _____ State _____

*Slightly higher West of Rockies. Accessory Case Extra. Export: Morhan Exporting Corp., 458 Broadway, N.Y.C. Canada: Atlas Radio Corp., 50 Wingold Ave., Toronto.

CIRCLE NO. 135 ON READER SERVICE PAGE

THE INDUSTRY'S ONLY COMPLETE "LOOK-ALIKE" LINE

Exact Replacement
Needles/Cartridges



Highest quality guaranteed! At your E-V distributor's or write for FREE replacement guide, today! Electro-Voice, Inc., Buchanan, Michigan. Dept. 837N

Electro-Voice

CIRCLE NO. 112 ON READER SERVICE PAGE



The original products of its kind.

An Industry



Used by every segment of the industry. Those who know, know the difference that makes it the best. Imitations are only poor substitutes.



Supplied in 2-4-8 oz. bottles and 6 oz. Spray-Pack with extender.



manufactured by

QUIETROLE COMPANY

Spartanburg, South Carolina
In Canada: CROSS CANADA ELECTRONICS
12 Laurel Street, Waterloo, Ontario

CIRCLE NO. 131 ON READER SERVICE PAGE

Naval Time Signals (Continued from page 30)

the signal is a series of rhythmic c.w. signals or "beeps," beginning 5 minutes before the hour and providing the listener with five separate time checks—one at the 56th minute; one at the 57th; one at the 58th; one at the 59th; and one on the hour. Due to mechanical or operator variance, the signal may not necessarily begin at the 55th minute, however, this is of no consequence, since the beginning is not to be used as a marker. As the signal proceeds through the 55th minute, the halfway point is indicated by the omission of the 29th second. As the "beeps" continue, you will also note a blank at the 51st second, followed by signals on the 52nd, 53rd, 54th, and 55th seconds. These four "beeps" following the 51st second is a code reference alerting the listener of the approaching 56th minute time signal. The 55th second c.w. signal is followed by a 4-second silent period, which is ended by the time signal, precisely indicating the 56th minute. This is the end of the first time check.

The 1-second "beeps" continue through the 56th minute as indicated in Fig. 1, with the 29th second blank as in the preceding minute; again denoting the halfway point. As the signal approaches the end of the 56th minute, the 52nd second is omitted (instead of the 51st second as in the preceding check), followed by the 53rd-, 54th-, and 55th-second markers, and then by the 4-second silent period. The silent period is ended by the time signal, precisely indicating the 57th minute. During this second time check, the three 1-second signals at the 53rd-, 54th-, and 55th-second markers serve as the code reference for the 57th-minute check.

This procedure is repeated for the 58th- and 59th-minute time checks with the 53rd and 54th seconds omitted respectively. A long dash, preceded by the 9-second silent period, composed of the omission of the 51st through the 59th second "beep," denotes the hour. The beginning of the long dash indicates the "on time."

To summarize, the listener need not laboriously count the "beeps" throughout the entire time signal, but only to note the number of second markers preceding each of the 4-second silent periods. If four 1-second indications are heard, he is alerted to the 56th-minute time check. If the listener hears three "beeps" preceding the 4-second blank period, he will know that the 57th minute is coming up, etc. And when he hears the 9-second silent period, he will be ready to set his watch or chronometer to the exact hour.

The time signals transmitted from

NSS Washington, D.C. are regulated to an accuracy of 0.01 second. This precision is obtained by observation of the stars, using special telescopes and transits. Accuracy is further enhanced by enclosing the equipment in environmental chambers, which maintain the delicate instruments at a constant temperature and humidity, thereby minimizing metal distortion. The signals from NBA, NPG, NPM, and NPN are re-broadcast from Washington by automatic relay and are correct to 0.25 second. Thus we have precise time signals being transmitted by radio at frequent intervals throughout the day on frequencies ranging from 114 kc. in the l.f. range to 23,650 kc. in h.f. range. ▲

ODD A.G.C. FAULT

By DON DUDLEY

THE COMPLAINT, a snowy picture, was not an unusual one. The trouble persisted on this Sylvania 21C407 after replacement of the r.f., i.f., and keyed a.g.c. tubes. Tuner a.g.c. voltage was found to be high, but there was no indication of any a.g.c. voltage on the i.f. grids. At this point, it was noticed that a 100k resistor in the a.g.c. line, R13, was burned out. It accounted for the absence of a.g.c. on the i.f. tubes, but it did seem odd that a resistor with so little voltage across it could burn up.

After R13 was replaced, the set seemed repaired. A finger placed on that resistor was pulled away quickly, however—because R13 was quite hot. A quick voltmeter check showed no more than a normal a.g.c. d.c. voltage present. C50, which couples the keying pulse from the horizontal-output system, was checked and found to have a small amount of leakage. It measured 20 megohms resistance. However, it could not pass d.c. into the a.g.c. line, because the keying pulse was derived from a separate, isolated, a.g.c. winding on the fly-back transformer. Nevertheless, when C50 was replaced, R13 no longer overheated. The defective capacitor evidently coupled a keying pulse of too great an amplitude into the a.g.c. system. The resistor was being burned out, not by d.c., but by a.c. ▲

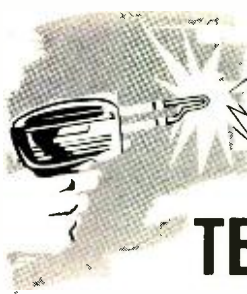
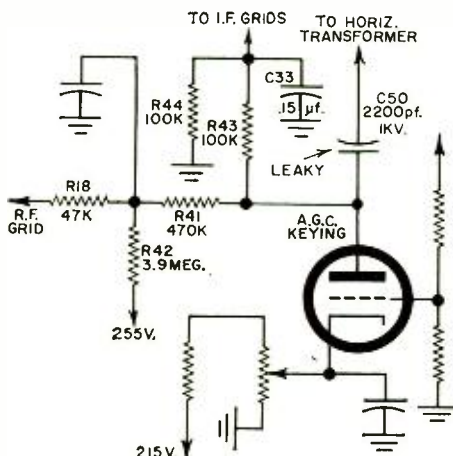

hallicrafters quality is the BIG NEWS in TEST INSTRUMENT KITS

... and hallicrafters engineered quality means outstanding specifications and performance ... plus simplified construction!



NEW "Fail-Proof" soldering terminal strips simplify making of positive connections.

NEW assembly ease. Mechanical parts are riveted to the chassis at the factory.



CAPACITANCE DECADE Kit HD-1

Ideal for experimental and service work requiring precision capacitors. Sixteen commercial slide switches give total variability in 100 pf steps. Uses silv. mica capacitors and long lasting stable defilm capacitors. Range .0001 to 1.0 mfd in four decades. Price \$14.95



RESISTOR DECADE Kit HD-2
Use to substitute known-value precision resistors in a circuit. Resistors are one-watt, 10%. Twenty-eight commercial slide switches give total variability in 1-ohm steps. Range: 1 ohm to 10 ohms in seven decades. Price \$14.95



CONDENSER TESTER Kit HC-1

Handy service bench instrument for checking unknown condenser and resistor values under operating conditions. Has precision tuning eye for easy operation. Four capacitance ranges: 10 mmf to 2,000 mfd. Three resistance ranges: 0.5 ohm to 5 megohms. Price \$29.95



R.F. GENERATOR Kit HG-1

Generates frequencies from 50 kc. to 55 Mc. in six steps. Calibrated harmonics in two steps from 55 Mc. to 220 Mc. Low frequency range exceptionally stable. Accuracy 1 1/2% of the reading. R.F. output .1-volt. Bandswitch assembly pre-wired and calibrated. Price \$29.95



5-INCH OSCILLOSCOPE Kit HO-1

A perfect scope for servicing color TV sets. Has full 5 Mc. bandwidth. Tube is 5 UPI. One-volt peak-to-peak source attenuator permits voltage measurements over range of 10,000 to 1. Retrace blanking amplifier provided. Phasing is continuously variable from 0 to 140°. Has two axis (beam) modulation. Price \$84.95



VACUUM TUBE VOLT MILLIAMMETER Kit HM-1

Has an exclusive built-in milliammeter circuit, available at the turn of a switch. Illuminated meter and separate front panel On-Off switch. Has seven AC, DC voltage ranges, from 1.5 to 1500; seven ohmmeter ranges, 0 to 1,000 megohms; and six milliammeter ranges, 1.5 to 500. Price \$29.95



BATTERY ELIMINATOR Kit HP-1

Reliable source of 6- or 12-volt DC power for servicing car radios, including transistor and "hybrid." AC ripple less than .25%; exceptionally low. Voltage ranges 0-8 volts and 0-16 volts. Also use as battery charger. Has voltage and current panel meters. Price \$49.95

Look for this display



at your Authorized Hallicrafters Kit Headquarters!



hallicrafters Master Kits

For FREE Catalog, write Dept. 14-H, 5th & Kostner Aves., Chicago 24, Ill.

CIRCLE NO. 141 ON READER SERVICE PAGE



IT'S A "SNAP"

to save big money on all of your high fidelity component requirements. Simply mail us your list for a special quote.

Write for discount catalog A-17, full of snappy audio bargains.

KEY ELECTRONICS CO.
120 Liberty St., New York 6, N.Y.



Convert any television to sensitive. **BIG-SCREEN OSCILLOSCOPE** with minor, inexpensive changes. Ingenious circuit. No electronic experience needed to follow our clearly illustrated plans. **TECHNICIANS, HAMS, EXPERIMENTERS, BROADCASTERS.** Use in shop, school, lab. Any set—any size screen.
FULL PLANS \$2.

RELCO, Dept. EW-7, Box 10563, Houston 18, Tex.

engineering degree in 27 mos.

Become an Electronics Engineer. College graduates enjoy higher income . . . advancement. Major corporations visit us regularly to interview and employ seniors. **BACHELOR OF SCIENCE DEGREE IN 27 MONTHS** in Electrical (Electronics or Power major), Aeronautical, Chemical, Mechanical, Civil Engineering. **IN 36 MONTHS** a B.S. Degree in Business Administration. One-year Drafting-Design Certificate Program. Small classes. Well-equipped labs. Campus. Dorms, new library. *Moderate Costs.* Enter Sept., Jan., Mar., June. Founded 1884. Write J. H. McCarthy for Catalog and "Your Career in Engineering and Commerce" Book.



TRI-STATE COLLEGE

1683 College Avenue • Angola, Ind.

FREE Catalog
OF THE WORLD'S FINEST
GOV'T. SURPLUS
ELECTRONIC BARGAINS

SUMMER SPECIALS:

SHURE MICROPHONE 1/2 PRICE
TEN FOUR MODEL CR4M

150-250 Ohms 50 DB Controlled Reluctance Microphone with high impact "ARMO-DUR" case, as designed for the Armed Services. Response 200-8000 CPS. Semi-Directional. Ideal for mobile use. Complete with coiled cord, four prong plug, push to talk SW, and hanger. Shpg. Wt.: 2 lbs. Regular Net Price: \$19.20



OUR PRICE: \$9.60

TRANSFORMERS:
6.6 VOLTS—HIGH AMPS

ALL PRIMARIES: 115 V / 120 V / 125 V / 132 V—60 Cycle:

SEC.: 6.6 volts 35 Amp. Size: 5x4x6", Wt.: 24 lbs. . . . Price: **\$6.95**

SEC.: 6.6 Volts 25 Amp. Size: 4 1/2x6x4". Wt.: 17 lbs. . . . Price: **\$4.95**

SEC.: 6.6 Volts 18 Amp. Size: 4 1/2x5 1/4x4". Wt.: 12 lbs. . . . Price: **\$3.95**

SEC.: 6.6 Volts 10 Amp. Size: 4x3 1/4x4". Wt.: 9 lbs. . . . Price: **\$2.95**

PARABOLIC ANTENNA & MICROWAVE REFLECTORS—As previously advertised are still available. Write and tell us your needs. Ask for our CATALOG!

Address Dept. EW • Prices F.O.B. Lima, O. • 25% Deposit on C.O.D.'s • Minimum Order \$5.00 • SEND FOR BIG FREE CATALOG!

FAIR RADIO SALES
2133 ELIDA RD. • Box 1105 • LIMA, OHIO
CIRCLE NO. 115 ON READER SERVICE PAGE

ADVANCE ELECTRONICS

SILICON CONTROLLED RECTIFIERS TESTED!

PRV	7AMP	25 AMP	PRV	7AMP	25 AMP
200	2.50	3.75	400	4.25	4.95
300	3.35	4.35	500	5.10	5.60

Other Sizes Available on Request

NPN-Germanium Mesa Transistors
F max—250 Mc-BV-10V . . . 10/\$5. 100/\$39.

VARIACS
1 amp \$5.50—1 1/4 amp \$6.25—3 amp \$8.95
10 amp \$18.95—20 amp \$24.95

PANEL METERS
0-150 VAC 2" \$3.95—0-250 DCV 4" Sq. \$5.95
0-1 MA DC 1 1/2" Sq. \$3.95—0-1 DC MA 2"
ARB. SCALE \$3.95—0-150 DC MA 3" \$3.95—
0-25 DC MA 4" Sq. \$5.95

RG-8/U CABLE—RG-8/U CABLE—
\$7.75/C FT. \$70.00/M FT. — CONNECTORS —
PL-259 — 6/\$2.70 50-239 — 6/\$2.49

All Shipments FOB NYC

ADVANCE ELECTRONICS

79 Cortlandt St., New York 7, N.Y. RE 2-0270

Converts home or car radios to receive Fire, Police, Aircraft, CB, SW, etc. Excellent sensitivity on High & Low Bands. High Band type adjusts to bracket 150-160 MC. Low Band type should be ordered for 33-47 MC, 40-52 MC, 26-30 MC, 9-12 MC, etc. Adaptable for transistorized car radios.



315-B 5-54 MC \$17.95
115-160 MC 18.95

Order today or send for free catalog on full line of converters and receivers for every application.

KUHN ELECTRONICS
CINCINNATI 17, OHIO

SAVE MONEY **HI-FI COMPONENTS**
TAPE RECORDERS
SLEEP LEARN KITS

MERITAPE Low cost, high quality recording tape, in boxes or cans.

FREE 1963 CATALOG

DRESSNER 1523 JERICHO TPKE.
NEW HYDE PARK 16 N.Y.

Operational Amplifier
(Continued from page 49)

Fig. 2C adds hysteresis to the transfer function. Now the input must exceed a value determined by the output voltage, R_1 , and R_2 to cause the amplifier to switch to its negative limit, and then must become less than some more negative new value to cause the amplifier to switch into its positive limit.

Fig. 2D is one type of free-running multivibrator using the above principles. The circuit starts out in one of its limits, but the voltage at C , being charged through R , eventually becomes great enough to cause the amplifier to switch to its other limit. Then C is charged through R in the opposite direction and the amplifier eventually switches back to the first condition described above and so on.

Waveform Generators

Fig. 4A is a highly refined circuit that simultaneously generates square waves and triangular waves with perfectly straight ramps of equal positive and negative slopes. The output of an integrator with a d.c. input, E_{in} , is a perfectly linear ramp whose slope in volts-per-second equals $-E_{in}/RC$. In Fig. 4A, when the positive-going voltage out of amplifier No. 1 reaches some value determined by the setting of R_1 - R_2 , amplifier No. 2 will switch to its positive limit. This output is clipped to plus 1 volt by diode action. This voltage is re-applied to the integrator, amplifier No. 1, and causes its output to decrease linearly to a new value. This causes amplifier No. 2 to switch to its negative limit. This, in turn, causes the integrator to produce a positive-going ramp, and so on.

The slope of the integrator in volts-per-second with the ± 1 volt clipping action of the diodes is $1/RC$. The amplitude and frequency of the triangular wave output are both affected by the setting of R_1 - R_2 . This circuit has been used successfully from 1 cycle-per-minute to 1000 cycles-per-second. Typically, R_1/R_2 will be from 4:1 to 20:1.

By putting a diode in parallel with R , the waveform is changed from a triangle to a saw-tooth with the fast rise or fast fall determined by the polarity of the diode. Connecting a diode directly from the output of the integrator to ground, as shown, makes the device monostable, and it can be triggered by capacitively coupling a negative voltage spike into the secondary input of amplifier No. 2. This arrangement then makes a device capable of providing a perfectly linear slow triggered sweep for inexpensive oscilloscopes. The high-level square wave is then used to provide retrace blanking for the scope. Obviously, the above waveforms must be

direct-coupled to the oscilloscope vertical-input terminals.

Timing Computer

In the foregoing section it was mentioned that the output of an integrator with a d.c. input is a perfectly linear ramp voltage whose slope in volts-per-second equals $-E_{in}/RC$. Because of this an integrator can be used as a timing device, with output voltage being proportional to time. Such an application is shown in Fig. 4B. In operation S_1 is opened first. The output voltage, as measured on the meter, then increases from zero at a perfectly linear rate in respect to time. When S_2 is opened, the output voltage will hold its last value. Then time, the interval between the opening of S_1 and S_2 , equals $(E_{out} \times RC)/150$.

It is necessary to carefully zero-adjust the amplifier immediately prior to use. To do this, open S_2 first and then S_1 . The meter reading should remain at zero volts. If it drifts off, reset the zero-adjust control to cause it not to drift off. C must be a low-leakage unit, preferably polystyrene, silver mica, or Mylar. Otherwise the d.c. leakage will cause errors and drift.

This circuit was used to measure the muzzle velocity of a *Crossman* carbon-dioxide pellet pistol. S_1 and S_2 were actually two strips of aluminum foil 1/4 inch wide and 2 inches long mounted on cardboard frames with cellophane tape. They were placed exactly one foot apart. The gun was then placed a few inches from S_1 , aimed to first break S_1 and then S_2 , and fired. The anticipated time interval was about 3 msec. R was chosen as 100,000 ohms and C as .15 μ f. After the gun was fired, the meter indicated 22 volts. Time was then calculated to be 2.2 msec. and velocity to be 1/.0022 or 455 feet-per-second.

Some of the circuits in this article were taken from material supplied by *George A. Philbrick Researches Inc.*, Boston, Massachusetts. ▲



"That's what IT says! 'In MY opinion...'"

NEW PRODUCTS & LITERATURE

Additional information on the items covered in this section is available from the manufacturers. Each item is identified by a code number. To obtain further details, simply fill in the coupon appearing on page 19.

COMPONENTS • TOOLS • TEST EQUIPMENT • HI-FI • AUDIO • CB • HAM • COMMUNICATIONS

PORTABLE HUMIDITY METER

1 Laucks Laboratories, Inc. is now offering a portable humidity meter which provides instantaneous direct reading of relative humidity from 20% to 95%. Featuring all solid-state circuitry, the unit incorporates a precision meter

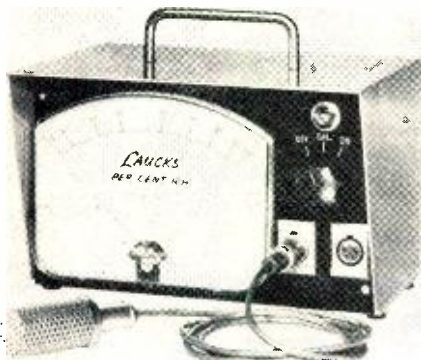

with damped d'Arsonval movement and full-range accuracy within $\pm 5\%$. An electrolyte-type transducer is mounted on a 5-foot cord.

The metal cabinet is 10" x 6" x 7" and has a transistor-type self-contained power source. The rotary switch has "off," "on," and "calibrate" positions. The linear pot adjusts for voltage regulation.

V.O.M. FOR SEMICONDUCTORS

2 The Triplet Electrical Instrument Co. is now offering a v.o.m. specifically designed for semiconductor testing. The Model 630-L offers two special low-power ohms circuits on the X1 and X10 ranges. These ranges have been designed for safe testing of semiconductor circuits. The maximum open-circuit test voltage is only 0.140 volt. This allows testing below the breakdown voltage of the transistor or other semiconductor without damaging overloads. Maximum power dissipation in the semiconductor under test is less than 420 microwatts.

Housed in a molded case with transparent unbreakable Lucite window, the instrument measures $3\frac{1}{2}'' \times 5\frac{1}{2}'' \times 7\frac{1}{2}''$ and comes complete with leather carrying handle. Weight is 5 pounds.

TRANSISTORIZED CCTV CAMERA

3 North American Philips Company, Inc. is now offering an ultra-compact, self-contained, completely transistorized CCTV camera for surveillance of inaccessible or remote areas. The unit will adjust itself automatically to changing light intensities on the order of 1:15 and will produce a bright clear picture with light levels as low as 1 footcandle.

The camera measures 13" x 7" x 1" and weighs



11 pounds. It can be mounted almost anywhere as it generates virtually no heat. It is completely ruggedized and will withstand shock and vibration. It is tropic-proof, resistant to extreme humidity, and will operate in temperatures ranging from 14 to 113 degrees F, indoor or outdoors. With a weatherproof accessory cover, it can be used in any weather.

The camera is capable of feeding up to 30 standard TV receivers or a lesser number of video monitors without any accessories or amplification.

METERED-KNOB VARIABLE TRANSFORMER

4 The Superior Electric Company is now offering sixty of its "Powerstat" variable transformers with knobs incorporating a direct-reading voltmeter as standard equipment. Single units with enclosed construction, with and without cord-plugs, are available for 120- and 240-volt single-phase service with loads up to 3 kva. Conversion kits consisting of a metered knob, enclosure, and complete wiring instructions are available for converting currently catalogued types.

The voltmeter is insensitive to stray magnetic fields. The meter reads load voltage, but line voltage can be checked by matching marks on knob and enclosure.

U.H.F. CONVERTER

5 Standard Kollsman Industries, Inc. is now offering a deluxe u.h.f.-to-v.h.f. TV converter which features a two-speed, ball-bearing planetary drive permitting single-knob fine tuning of the picture.

Designed for screwdriver installation, the circuit uses a 6DZ4 tube and nuvistor for longer life

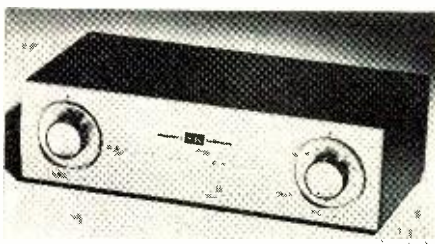

and improved reliability. Sliding contacts have been eliminated in the main tuning circuit through use of a three-gang tuning element. A power receptacle is built into the back of the chassis to plug in the TV power cord. The set carries UL approval.

Frequency range is channels 14 through 83, with good performance on translator channels 70 through 83. The device is housed in a high-style cabinet measuring $11\frac{1}{4}'' \times 5\frac{3}{4}'' \times 3''$.

TEMPERATURE RECORDER

6 F. L. Moseley Co. has introduced a new, compact strip-chart recorder for tracing temperatures in research, testing, and industrial work.

The "Autograf" Model 682 is a servo potentiometer type instrument designed for rack mounting singly or in pairs, or for bench-top operation. It measures $6\frac{1}{2}'' \times 7\frac{3}{4}'' \times 8\frac{3}{8}''$.

The input circuit features a plug-in unit incorporating a single cold junction compensated temperature range selected by the customer. The reference junction temperature is factory adjusted to any specified value. Accuracy, exclusive of thermocouple errors, is better than 0.2% of full scale.

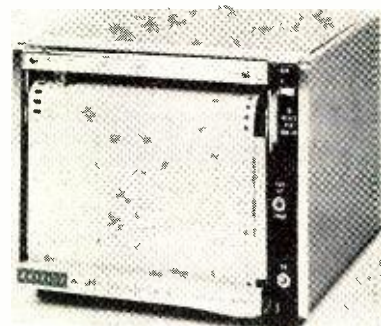

The record is produced by pen and ink from a cartridge type reservoir or by stylus on pressure-sensitive paper.

INDOOR U.H.F. ANTENNAS

7 Channel Master Corp. has recently introduced two new u.h.f. indoor antennas, the "Wonder Bow" and the "Double Wonder Bow."

The "Wonder Bow," Model 4170, is a single-bay bow and screen with a wire form dipole; while the Model 4160 is a stacked bow and screen, also using wire form dipoles. Rear pickup is eliminated because both antennas are reflector-designed and directional.

Both antennas are finished in a gold color and styled for use in the home.

DYNAMIC ALTERNATOR TESTER

8 Mar-Con Instrument Corporation is now marketing a dynamic alternator tester, the "Mark I" DAT-100.

The instrument, designed for use by the average auto serviceman, will test for shorted or open alternator field windings and slipping assembly, test for shorted or open alternator diodes, and test for shorted or open alternator stator windings. Controls are kept to a minimum. A meter marked with "good" and "bad" zones is used as the indicator. The instrument is powered by the 117-volt, 60-cps power line and consumes 7 watts. Accessories include a three-wire test lead cable six feet long and a 4" jumper. A .6-amp "Slo-Blo" fuse is built into the line. The instrument measures $10'' \times 6'' \times 3\frac{1}{2}''$.



DIGITAL MILLIVOLTMETER

9 Houston Instrument Corporation has developed a digital millivoltmeter which measures d.c. voltages from 1 μ v. to 1000 volts in six overlapping ranges. Known as the "Auto Data" Model 2660, the unit has 3- μ v. accuracy with 100-

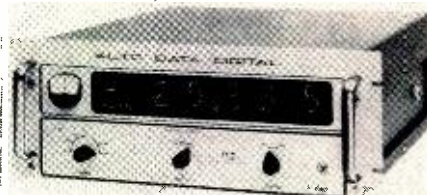

megohm input impedance on the lowest 00.000 to 29.999 millivolt range, making the instrument suitable for thermocouple, strain gage, low-level transducer, and small-signal semiconductor measurements.

Gold-contact, hermetically sealed reed relays are used in a decimal potentiometric bridge. Reed relays are switched under zero current conditions for long life. Accuracy is independent of changes in reed contact resistance. Floating input allows for operation at up to 500 volts above ground. Common mode rejection is greater than 100 db at 60 cps.

SEMICONDUCTOR TESTER

10 Fairchild Semiconductor is now offering a new "go/no-go" multiparameter tester, the Series 250. Capable of conducting tests at the rate of 900 units per hour, the new instrument features 16 various "go/no-go" tests per unit.

The tester features pulse testing and can be operated by non-technical personnel after only a few hours of training. The Series 250 is easily programmed with decade cards or fixed resistor cards. Accuracy at 1 μ a. is $\pm 0.5\%$ ($\pm 1\%$ at 100 μ a.). A system for priority sorting is optional.

TRANSISTOR IGNITION SYSTEM

11 Autotonics Inc. is now marketing a low-cost transistorized ignition system which is being offered in four different models to meet the re-



quirements of various 6- and 12-volt automotive systems.

The ignition system consists of two major components: a coil manufactured by Bosch of Germany and a dual transistor control unit. The electronic control unit which is mounted on a flat bracket is installed directly below the ignition coil. The electronic assembly is hermetically sealed and completely embedded in semi-rigid epoxy.

The kit includes the coil, transistor control unit, wire, necessary hardware, and complete installation instructions.

INSTRUMENT PANEL KIT

12 Electro-Kits is now offering a completely self-contained panel-production kit for the prototype electronics lab or the serious experimenter.

The kit produces up to four color-permanent aluminum panels in 20 minutes. No graphic skills are required and no darkroom or other special equipment are necessary. Since no dangerous chemicals are involved in the process, the complete operation can be performed on a table or lab bench.

PULSE ENERGY COMPARATOR

13 Electronics for Education, Inc. is now offering the Model 152 pulse energy comparator which provides a quantitative indication of the missing r.f. pulses coming from a magnetron. When used with a conventional external counter,

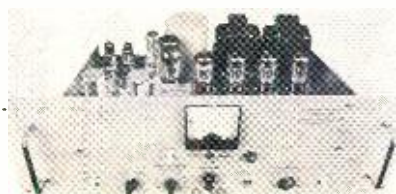

it provides for stability tests in accordance with military specifications.

The instrument contains provision for measuring: the number of pulses having an energy content less than a preselected percentage of the energy content of the preceding pulses; or the number of pulses having an energy content less than a preselected percentage of a "standard" pulse.

U.H.F. PREAMP/CONVERTER

14 Jerrold Electronics Corporation is now marketing the "Ultra-Vista," a u.h.f. converter that includes a built-in stage of u.h.f. preamplification.

A top-of-the-set converter, the unit features slide-rule tuning, a 6D14/EC88 frame-grid tube as the r.f. preamp, a K3D silicon diode as the



mixer, an A15300 nivistor as the oscillator, and a PAD1-28 high-frequency transistor operating as the post or i.f. amplifier.

Gain is at least 10 db over the translator bands (channels 70 to 83) and a minimum of 11 db over the MPAT stations (channels 72 to 76). The unit conforms to FCC rules for radiation. Input impedance is 300 ohms with a v.s.w.r. of 1.5 maximum. Output impedance is 300 ohms.

SOLID-STATE PULSER

15 Digital Electronics, Inc. has developed a solid-state pulser, the Model 522, which can be used to provide fast-rise pulses from input waveforms of any type. The unit can also act as a frequency divider or a pulse shaper. With no input signal a single pulse can be generated by pushing the button on the front panel.

The output pulse width may be divided from less than 0.5 μ sec. to greater than 0.1 second. Rise time is less than 50 nsec. for a negative pulse and



200 nsec. for a positive pulse. Fall times are the same. Amplitude of the output may be varied from 0 to 15 volts and is 5 volts into a load of 100 ohms.

HI-FI — AUDIO PRODUCTS

STEREO TAPE RECORDER

16 Roberts Electronics, Inc. has announced the availability of the Model 1057-PS stereo tape recorder with photo-sound-ync to provide sound-with-slide synchronization for amateur and professional photographers.

The fully automatic synchronizer which adapts to all automatic slide projectors utilizes a strip of special sensing tape on the shiny side of the recording tape to activate a "sensing" post. This automatically advances each slide in the projector.

The unit offers stereo and mono record/play; three speeds, 3.75, 7.5 ips with 15 ips available extra; sound-with-sound; sound-on-sound; sound-over-sound; four stereo outputs; 24-slot wave wound motor; full stereo record/playback system; stereo preamp outputs; stereo power amplifier

outputs; dual professional-type vu meters; stereo self-contained speakers; vertical or horizontal operation; automatic tape shut-off; and facilities for FM/stereo multiplex.

LOUDSPEAKER IN KIT FORM

17 Electro-Voice, Inc. is now marketing a pre-finished loudspeaker kit that can be put together in less than 20 minutes without tools. Designated the "Coronet," the system combines an 8" extended-range loudspeaker with a ducted-port acoustic phase-inverter enclosure.

Three versions of the unit are available: "Coronet I" includes the enclosure kit and an 8" MC8 "Michigan" speaker; the "Coronet II" with enclosure kit and "Wolverine" LS8 speaker; and the "Coronet III" which includes the enclosure materials and an SP8B, the company's deluxe 8" speaker. All systems feature exterior surfaces of select hardwood veneers, pre-finished in oiled walnut.

MONO/STEREO TAPE PREAMP

18 Allied Radio Corporation has recently introduced the "Knight" KN-4002, a stereo tape record/playback preamp of flexible performance in either mono or stereo sound recording and reproduction.

Response is 30-16,000 cps ± 3 db at 7.5 ips and 30-12,000 cps ± 3 db at 3.75 ips. Hum and noise is -50 db minimum on playback. Twin visual indicators and concentric dual playback



and record controls for each channel permit adjustment simultaneously or independently. A red "record" safety light shows when the preamp is set for the recording functions, while the indicator beacons permit peaking at correct levels on each channel for perfect tapes.

The unit measures 4 1/8" x 15 1/2" x 8 1/4". A grey metal case is available as an accessory.

TAPE-DUPLICATING SYSTEM

19 Ampex Corporation has recently introduced a tape duplicating system, the PD-10, which is designed to provide professional tape duplication facilities for schools. With the system, a single operator can produce up to 75 copies of 1200-foot tapes in an 8-hour day. The duplicating operation requires no technical training.

The standard system consists of one master and three slaves which will produce up to three duplicates at a time. Master and duplicate tapes can be half-track, two-track mono or two-track stereo. Master tapes may be any of the popular speeds from 1 1/8 to 15 ips, producing copies at 1 1/8, 3.75, 7.5, or 15 ips. Copies may be decreased in speed from the master by one standard speed.

STEREO TUNER-AMPLIFIER

20 Radio Corporation of America has recently introduced a high-fidelity FM multiplex stereo/AM tuner-amplifier which incorporates a nivistor FM front end.

Designated the MX-7, the unit includes FM multiplex, a high-fidelity FM tuner, AM tuner, and a "Master Control" 30-watt stereo amplifier. Special features include a new multiplex demodulation system, special high-fidelity tubes and



circuits, nuvistor r.f. amplifier tuner, and under-rated components for trouble-free operation.

The control unit features touch lever controls, multiplex indicator lights, dual volume controls, optional remote unit, dual bass and treble controls, a.f.c., phono input provision for mono or stereo phono connections, and impedance matching for 4-, 8- and 16-ohm speakers.

STEREO POWER AMPLIFIER

21 Dynaco, Inc. has added the "Stereo 35" to its "Dynakit" line of audio equipment in kit form.

This new stereo power amplifier delivers wide-band, low-distortion output of 17½ watts per channel. The full 35 watts is available continuously over the 20 to 20,000 cps spectrum. The



design features both positive and negative feedback plus specially engineered transformers. The amplifier is designed to be used with the company's PAS-2 or other high-quality stereo preamps. It matches the PAS-2 in appearance and size.

PORTABLE SOUND ANALYZER

22 B & K Instruments, Inc. has developed a portable noise analyzer for general industrial applications involving noise control and as a basic instrument in acoustical or vibration-measuring systems.

The Model 2203/1513 consists of the Model 2203 sound level meter and an octave-filter set. Accuracy is ±1 db from 20 to 15,000 cps over the full-scale range of 22 to 134 db. The unit provides accurate readings for eleven frequencies from 22 to 25,000 cps with center frequencies as specified by ASA S1.6-1960.

The unit weighs 11½ pounds and is housed in a cast-aluminum case. A leather carrying and holding handle and removable leather shoulder strap make the unit portable.

STEREO RECORDER KIT

23 Heath Company is now marketing a portable, four-track stereo tape recorder in kit form as the Model AD-72.

The kit comes complete with all amplifiers and speakers. The unit records and plays four-track



stereo and mono tapes, 7.5 and 3.75 ips speeds, has microphone and in-line inputs, concentric level and tone controls, bar-type level indicators, and dual two-way speaker systems.

The unit is housed in a factory assembled portable case with lift top lid and swing-out detachable speaker wings. A free head-alignment tape is included with the kit.

STEREO TUNER/AMPLIFIER

24 H. H. Scott, Inc. has recently introduced its Model 340B FM stereo tuner-amplifier. The new model features new panel styling, slide-rule tuning, convenient front-panel earphone receptacle, and "Auto-Sensor" circuitry which automat-

R FOR "DOCTORS OF SERVICING"



Where there's a contact... or a relay...

Service with Contact Shield! Protective! Corrective! It not only cleans and safeguards contacts better on TV, radio, and hi-fi sets; on all relay-operated electrical equipment, regular protective maintenance with this versatile cleaner prevents sticky relays—while corrective servicing unsticks them... in seconds. Promotes greater conductivity, keeps relays working smoother, longer. Contact Shield—the professional service man's cleaner.

APPLICATIONS INCLUDE:

- Bowling Alley Automatic Pin Spotters
- Vending Machines • Pinball Machines
- Slot Machines • Telephone Switchboards
- IBM Computers and other data processing equipment
- Industrial Equipment using relays, such as welding machines, etc.

For handy guidebook to better servicing, write Channel Master Corp., Ellenville, N.Y.

CIRCLE NO. 108 ON READER SERVICE PAGE

PLATE TRANSFORMERS

AMERTRAN—Primary 105-125 AC. 60
Cy. Secondary
3100-0-3100 V. AC @ 600 MA ea. \$75.00
22 KVA) Price
Primary 110V. 60 Cy. Secondary
1125-0-1125 @ 250 MA ea. \$9.95

FILAMENT TRANSFORMERS

All 110 VOLTS—60 CYCLES unless noted
Sec. 6.3 V. 4 A. 1.75 | Sec. 6.3 V. 25 A. 4.75
22 6.3 V. 5 A. 1.95
Sec. 12.6 V. 5 A. \$ 2.95
Sec. 5 V 52 Amps (16 KV ins) \$17.95
210 Pri. 60 cy. Sec. 1.6 V 1100 amp. \$18.95

RELAYS

6 VOLT DC 3PST—N.O.65
12 VOLT DC DPDT 1.35
110 V. AC SPDT Plug-in 1.50
Sens. 11,000 Ohm Coil 1 Ma. Adj. SPDT 1.95

SILICON RECTIFIERS

PIV	Current	Price	PIV	Current	Price
100	500 Ma	\$.25	400	2 Amps	\$1.00
200	500 Ma	.30	100	15 Amps	1.50
400	500 Ma	.50	200	15 Amps	2.75
750	500 Ma	.90	400	15 Amps	3.75
200	750 Ma	.30	50	50 Amps	3.50
400	750 Ma	.50	100	50 Amps	4.25
100	2 Amps	.35	200	50 Amps	5.00
200	2 Amps	.55			

BRAND NEW OIL CONDENSERS

50 MFD 200 VDC 4.50	2 MFD 3000 VDC 1.50
2 MFD 600 VDC .50	4 MFD 2000 VDC 3.50
3 MFD 600 VDC .50	6 MFD 2500 VDC 5.50
4 MFD 800 VDC .75	2 MFD 4000 VDC 6.25
5 MFD 800 VDC .80	3 MFD 4000 VDC 8.95
6 MFD 600 VDC .85	4 MFD 3000 " 12.95
8 MFD 600 VDC .95	1 MFD 5000 VDC 4.50
10 MFD 600 VDC 1.19	2 MFD 5000 VDC 8.50
12 MFD 600 VDC 1.50	4 MFD 6000 VDC 15.95
1 MFD 1000 VDC .50	5 MFD 7500 VDC 2.95
2 MFD 1000 VDC .70	1 MFD 7500 VDC 6.95
4 MFD 1000 VDC 1.35	2 MFD 7500 " 17.95
8 MFD 1000 VDC 2.50	1 MFD 10,000 " 29.95
10 MFD 1000 VDC 2.50	2 MFD 12,500 " 34.50
12 MFD 1000 VDC 2.95	1 MFD 15,000 " 42.50
1 MFD 1200 VDC .45	2 MFD 18,000 " 69.50
1 MFD 1500 VDC .75	1 MFD 20,000 " 59.50
2 MFD 1500 VDC 1.10	5 MFD 25,000 " 34.95
4 MFD 1500 VDC 1.95	1 MFD 25,000 " 69.95
3 MFD 1500 VDC 2.95	10 MFD 300 AC 1.95
1 MFD 2000 VDC .85	3 MFD 1000 VAC 1.95

SPECIALS

LOW IMPEDANCE DYNAMIC MICROPHONE ELEMENT 99¢
MINIATURE EARPHONE — Magnetic — with cord, plug and jack — American made 65¢
BC 442AM ANTENNA BOX 1.95
2½" Meter 100-0-100 Microamps 2.95
0-365 MMF VARIABLE CONDENSER ¼" Shaft 75c
2½" 0-100 MICROAMP METER 3.95
4" Rect. 100-0-100 Microamps 4.95

PEAK ELECTRONICS CO.

66 W. Broadway, New York 7, N. Y., WO-2-2370

CIRCLE NO. 130 ON READER SERVICE PAGE

CUT HOLES FAST

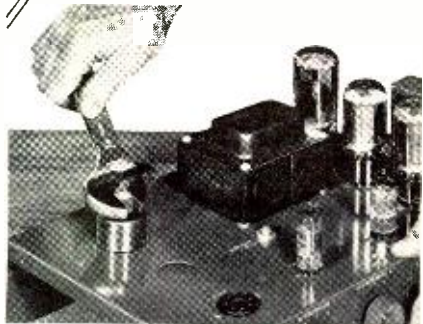

GREENLEE CHASSIS PUNCHES

Make accurate, finished holes in 1½ minutes or less in metal, hard rubber and plastics. No tedious sawing or filing—a few turns of the wrench does the job. All standard sizes . . . round, square, key, or "D" shapes for sockets, switches, meters, etc. At your electronic parts dealer. Literature on request.

GREENLEE TOOL CO. 
2027 Columbia Ave., Rockford, Illinois

CIRCLE NO. 120 ON READER SERVICE PAGE



ically switches to stereo or mono mode of operation depending on which type of broadcast is being received.

An illuminated d'Arsonval meter permits pinpoint tuning of all signals. There is a powered third channel for direct connection of remote speakers or for a three-channel system. Complete tape monitoring facilities are also provided. All controls operate on playback.

SOLID-STATE P.A. AMPLIFIER

25 Royce Electronic Developments, Inc. is now offering the "Audio Robot" line of miniaturized solid-state p.a. amplifiers including 25-watt models to operate from self-contained batteries, vehicle batteries, or a.c. power lines. Three-speed phonograph facilities are available on any model.

Accessories available for use with these ampli-



fiers include siren tone generators and automatic switch-over to batteries in the event of power failure.

INDUSTRIAL TAPE TRANSPORT

26 Viking of Minneapolis, Inc. is now offering the Model 230, a heavy-duty reel-to-reel tape transport designed for industrial and commercial applications. The unit will handle reels up to and including 7" and quarter-inch tapes of all types. Single tape speeds of 15, 7.5, 3.75, or 1 1/2 ips are available as is a two-speed model for 15 and 7.5, or 7.5 and 3.75 and 1 1/2 ips.

The transport is available with a wide choice

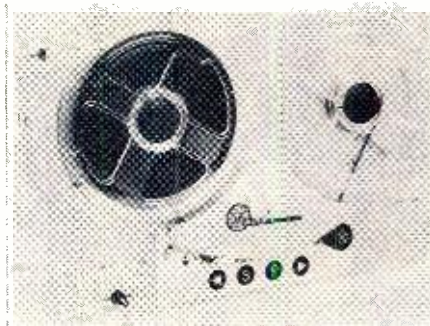

of head configurations, alternative choices of capstan drive motors, and with or without such features as digital counter or photoelectric or mechanical type run-out switches.

STEREO TAPE RECORDER

27 Inter-Mark Corporation is now offering a new stereo tape recorder which includes a heavy-duty detachable speaker system as its "CIPHER VII."

The unit features three-speed operation, two vu level meters, individual controls on each channel for volume and tone, instant stop lever which also operates when the machine is in the record mode, fast forward and rewind, digital counter,



automatic tape shut-off sound-on-sound recording, and stereo earphone connection. Jacks are also provided for radio, phono, and microphone.

Frequency response is 35-15,000 cps at 7.5 ips and signal-to-noise ratio is said to be better than 50 db. The unit can be operated in either a vertical or horizontal position. The control panel is finished in brushed chrome.

TRANSISTORIZED INTERCOM

28 Channel Master Corp. is now offering its Model 6555 transistorized two-way communications system for home and business uses.

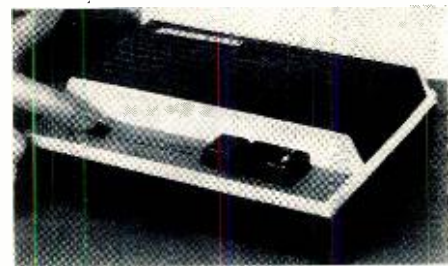

CORNELL

33¢ PER TUBE

100 TUBES OR MORE:
30¢ PER TUBE

TUBES
1 YR. GUARANTEED

Mutual Conductance Lab-tested, Individually Bored, Branded and Code Dated

OZ4	6AU4	6CZ5	6SH7	786	12BL6
1B3	6AU5	6D6	6SJ7	787	12BY7
1H5	6AU6	6DA4	6SK7	788	12C5
1L4	6AV6	6DE6	6SL7	7C5	12CA5
1T4	6AW8	6DQ6	6SN7	7Y4	12DQ6
1U4	6AX4	6EM5	6SO7	12AD6	12SN7
1X2	6BA6	6F6	6SR7	12AE6	12SQ7
2A5	6BC5				25L6
3CB6	6BD6				25Z6
5U4	6BG6				35W4
5V4	6BH6				35Z3
5Y3	6BJ6				35Z5
5Z3	6BL7				50A5
6A6	6BN4				50L6
6A8	6BN6				24
6AB4	6BQ6	6H6	6U7	12AF6	27
6AC7	6BZ6	6J5	6U8	12AT7	41
6AG5	6C4	6J6	6V6	12AU7	45
6AL5	6CB6	6K7	6W4	12AX7	47
6AN8	6CD6	6L6	6W6	12BA6	75
6AQ5	6CF6	6Q7	6X4	12BD6	77
6AS5	6CG7	6S4	6X5	12BE6	78
6AT6	6CG8	6SA7	7A7	12BF6	80
6AT8	6CM7	6SC7	7A8	12BH7	84/6Z4

If not shipped in 24 hrs
YOUR ORDER FREE!

Other tubes and CRT's at low prices—send for free list

LIVE IN THE EAST?
WAITED MONTHS FOR DELIVERY FROM OTHERS?
AIR MAIL AN ORDER TO CORNELL
AND RECEIVE DELIVERY TO THE EAST COAST
IN AS LITTLE AS 72 HOURS!!!
NO SUBSTITUTIONS WITHOUT YOUR PERMISSION
Tubes are new, seconds or used and so marked.

TERMS: FULL POSTAGE ON PREPAID USA ORDERS. Under \$5.00 add 50¢ for handling. Send 25% deposit on COD orders. No Canadian or foreign COD's—include postage. No 24 Hr. Free Offer on personal check orders. 5-DAY MONEY BACK OFFER!

Special!
With every \$10 Order
25¢ per tube
(No Limit) from this list.

6AG5	6SN7
6AU6	6J6
6CG7	6K3
	6V6
	6W4

CORNELL ELECTRONICS CO.
Dept. EW8 4217 University Ave., San Diego 5, Calif. • Phone: AT 1-9792

CIRCLE NO. 142 ON READER SERVICE PAGE

GREGORY ELECTRONICS

SUMMER SPECIALS

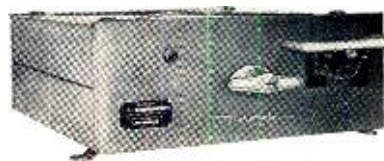

MOTOROLA

450-470 mc

T44A1, 12 volts, complete with all accessories, less crystals and antenna.

\$100

Same unit less accessories	\$ 70
T44A6, 6/12 volts, complete with all accessories, less crystals and antenna	\$125
Same unit less accessories	\$ 95
T44A6A, 6/12 volts, complete with all accessories, less crystals and antenna	\$155
Same unit less accessories	\$125

LINK 2365 FM 25-50mc
WIDE BAND TRANSCEIVER

12 volts \$49 6 volts \$39
30 watts 30 watts

Complete with all accessories, less crystals and antenna.

Add \$15 for crystals and tuning of receiver only. Makes an ideal mobile monitor receiver.

Tremendous Selections and Savings!

GUARANTEED RECONDITIONED FM 2-WAY MOBILE RADIOS
G-E, RCA, Motorola and Others! Low, High and UHF Bands.

WE BUY FOR CASH!

Late model 2-way radio equipment. State price, condition and quality.

Write for New '63 Catalog



GREGORY ELECTRONICS CORPORATION

110 Rt. 46 • Phone 773-7550 • Saddle Brook, N.J.

CIRCLE NO. 121 ON READER SERVICE PAGE
ELECTRONICS WORLD

The "Interphone" is battery powered and features push-button operation. The unit is light and compact and can be hung on a wall, if desired. Either unit, master or slave, can initiate calls. The master unit can be set to insure privacy, yet can be buzzed at any time. A volume control feature is included.

CB-HAM-COMMUNICATIONS

CRANK-UP ANTENNA TOWER

29 Rohm Manufacturing Company has announced the availability of its No. 6 crank-up type tower in heights from 18 feet to 54 feet for amateur and experimental applications.

The tower features a sturdy winch and cable which lifts the various sections upward easily and safely. The tower is available in heights of 18, 26, 37, and 54 feet. It is completely hot-dipped galvanized.

PRESELECTOR/CONVERTER

30 Lafayette Radio Electronics Corporation is now offering the Model HE-73, a crystal-controlled dual-function preselector/converter covering the 80, 40, 20, 15, and 10 meter bands. The unit operates on 80 and 10 meters as a preselector



only and on 20, 15, and 10 as either a preselector or converter.

Tuned interstage circuits and two stages of r.f. amplification are incorporated to insure a high signal-to-noise ratio. Front-panel controls include antenna trim, function, bandswitch, and gain. The unit comes with three crystals for 20, 15, and 10 meter bands. The "Precon" is self-powered, operates on 117 volts, 50-60 cps a.c. and measures 10"x 6"x 8".

SELECTIVE-CALLING CB UNIT

31 Webster Manufacturing is now offering a full-service, CB two-way radio wired for selective calling as its "Band Spanner 412."

Designed primarily for heavy-duty business use, the six-channel unit will accommodate most tone alert systems for noise-free standby operation between calls. An "S" meter on the front panel in-

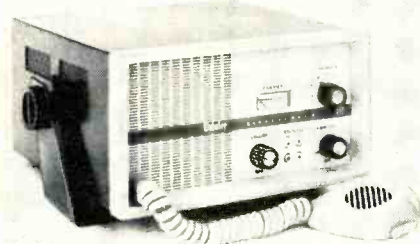

dicates the set's performance level at all times. A socket, built into the front of the transceiver, will accommodate an additional pair of crystals.

SIX-BAND PORTABLE RECEIVER

32 The Hallicrafters Co. has added a new six-band, battery-operated portable receiver to its line of communications equipment.

The Model WR-3000 is a general-coverage portable with extended low-frequency tuning, providing reception of consolan, aeronautical, and mobile frequencies as well as broadcast, amateur,



and international short-wave bands. The set has a drum dial with slide-rule tuning, b.f.o. tone control switch, and a fine-tuning control. There is a ferrite antenna for bands 1 and 2 and a whip antenna for short-wave reception. There is a self-contained 4"x6" speaker and a headphone jack. The circuit uses 10 transistors, 1 diode, 1 thermistor, and 1 zener diode. The set is powered by eight standard "D" cells plus one "D" cell for the pilot light. It measures 4 1/8"x 11 1/2"x 8" and weighs approximately 12 pounds.

R/C CONTROL UNIT

33 Perma-Power Company is now offering a complete radio control system for the automatic operation of doors, lights, signals, motors, and similar devices.

Known as the Model RT-100, the system is designed for short-range applications. Operating distance is up to 500 feet when used outdoors in unobstructed areas. Indoors, distance will vary from 50 feet to several hundred feet, depending on the structure of the building and the presence of metal conduits, piping, duct work, etc.

The system consists of a portable pocket-sized transmitter with self-contained antenna and battery and a receiver housed in a metal enclosure with flanges for wall mounting. It operates from standard 117-volt a.c. lines.

ONE-BAND SSB TRANSCEIVERS

34 Heath Company is currently marketing three new one-band SSB transceivers for 80-, 40-, and 20-meter amateur service.

Suitable for either mobile or fixed station operations, the new transceivers are compact and lightweight. Construction includes a heavy-duty

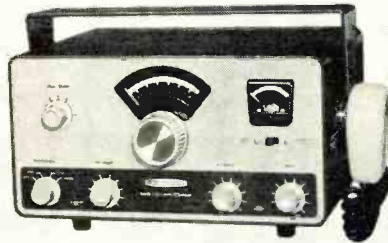

circuit board, one-piece steel chassis, and a gimbal bracket for under-dash mounting in cars.

The 80- and 40-meter models operate lower sideband with the 20-meter model operating upper sideband. Provision is made for use with linear amplifier and plug-in 100-ke. crystal calibrator.

The transceivers measure 6"x 12"x 10" and weigh 12 pounds net.

MONITOR RECEIVER DECODER

35 Hammarlund Manufacturing Company has announced the availability of its TD-10 decoder, an accessory unit designed to be used with a radio monitoring receiver. Under normal conditions, the decoder silences the receiver's loudspeaker so that unwanted transmissions are not heard. When a radio signal, which is modulated by a sustained audio tone of specific frequency and duration, is intercepted the decoder energizes an indicator lamp and activates the speaker. The speaker remains alive and the indicator lamp remains lighted until the reset switch is operated momentarily.

The unit, which measures 3"x 2"x 7 1/8", is normally equipped to respond to a 2805-cycle tone of 10-second duration. Filters for other frequencies

use your electronics experience to get into the new field of Nuclear Instrumentation

CREI can help you make this profitable move

Industrial use of nuclear energy is creating new careers, right in your own field of electronics. Men are needed to design, build, operate and maintain electronic instrumentation for practical application of nuclear energy. You can earn more money—with your present employer or with another company—if you supplement your electronics experience with specialized knowledge of the nuclear field.

OUR FREE BOOK tells you how you can do it—in your spare time—through CREI's unique Home Study Program in Nuclear Engineering Technology. For your copy, mail coupon or write:

CREI, Dept. 1108-A1, 3224 Sixteenth St., N. W., Washington 10, D. C.

FREE BOOK

CREI ATOMICS
A Division of The Capitol Radio Engineering Institute, Dept. 1108-A1, 3224 Sixteenth St., N. W., Washington 10, D. C.

Please send me FREE BOOK describing the CREI Home Study Program in Nuclear Engineering Technology. I have a technical background and a high school education.

Name _____ Age _____

Address _____

City _____ Zone _____ State _____

A-61

**NOW! CASTLE OFFERS YOU
THE BIGGEST BARGAIN IN
TV TUNER OVERHAULING!**



**ALL MAKES
ALL LABOR
AND PARTS
(EXCEPT TUBES)*
ONE PRICE** **9.95**
ONE LOW PRICE INCLUDES ALL LHM
VHF AND UV COMBINATION TUNERS

Fast Service . . . Simply send us your defective tuner complete, include tubes, shield cover and any damaged parts with model number and complaint.

*UV combination tuner must be of one piece construction. Separate LHM and VHF tuner with cord or gear drives must be disassembled and the defective unit sent in. 90 Day Warranty.

CASTLE TV TUNER SERVICE, INC.

5717 North Western Avenue, Chicago 45, Illinois
653 Palisade Drive, Cliffside Park, New Jersey
In Canada: 136 Main Street, Toronto 13, Ontario

*Vague Parts are additional in Canada

CIRCLE NO 107 ON READER SERVICE PAGE

**NO FREE premiums
NO PRIVATE labels
NO ineffective liquids
or carbon tet
ALL YOU GET IS
GENUINE**

"NO NOISE"

QUALITY

- formulas developed by chemists
- 14 years of recognized leadership

**BEWARE OF
CHEAP
IMITATIONS
INSIST ON
NO-NOISE**



- VOLUME CONTROL and Contact Restorer
- TUNER-TONIC for all tuners including wafer type
- FORMULA EC-44 for all electrical contacts

PLUS, FREE with all No-Noise products, 5" plastic extender push-button assembly for pin-point applications. Does not cause shorts!

ELECTRONIC CHEMICAL CORP.
813 Communipaw Ave., Jersey City 4, N.J.

CIRCLE NO. 113 ON READER SERVICE PAGE

are available and response time can be varied by replacing a capacitor. Power requirements are 225 volts d.c. (approx.) at 16 ma. standby, 23 ma. when tone is being received, and 22 ma. after actuation; and 6.3 volts a.c. or d.c. at 0.6 amp. continuous.

MANUFACTURERS' LITERATURE

BUSINESS ABBREVIATIONS

36 Raytheon Company has just released a second edition of its 32-page booklet, "Abracadabra" which contains abbreviations and related acronyms associated with defense, astronautics, business, and radio-electronics.

This glossary of space-age abbreviations has been expanded to almost three times the size of the first edition, many of which additions reflect recent organizational changes in the Armed Forces.

ELECTRICAL CONTROL METHODS

37 Ohmite Manufacturing Company is offering copies of its Bulletin 202 entitled "Sequence Coupled Rheostats" which describes a unique method of electrical control. The publication details a means by which two rheostats can be coupled to provide approximately 650 degrees of control rather than 325 degrees obtainable with a single unit.

ELECTRONIC WIRE CATALOGUE

38 Columbia Wire and Supply Company has issued a 44-page catalogue covering a variety of electronic items including TV wire and cables; coaxial cables; intercom and audio cables; TV service aids, rotator cable; hook-up wire; power cord and cable; cord sets; and antenna wire and kits.

The catalogue is indexed and a table listing the weight, diameter, and resistance of annealed bare copper wire is also included.

CARDIOID MIKE DATA

39 Shure Brothers, Inc. has issued a pocket-sized guide detailing specific unidirectional characteristics and performance features that should be expected of a true cardioid microphone.

In addition, the booklet describes six common sound problems caused by inefficient microphone rejection of unwanted sounds and microphone ineffectiveness in picking up the desired sound. Specific information for solving these problems is provided.

ANTI-R.F. LIGHTING PANELS

40 Corning Glass Works has issued a 22-page booklet explaining how r.f. interference can be drained from fluorescent lighting fixtures. The booklet points out that r.f. waves from fluorescent fixtures have been a frequent cause of interference with electronic equipment in laboratories, testing facilities, and schools.

The brochure then explains how the company's electrically conducting #70 glass lighting panels can be used to eliminate such r.f. waves. The product also meets MIL specifications MIL-I-16910A, MIL-I-26600, and MIL-I-6181D.

NEEDLE REFERENCE CHART

41 Dnotone Company has issued a new edition of its replacement needle wall chart which it will supply to distributors and their dealers and service technicians.

The 1968 Wall Reference Chart lists replacement needles by manufacturers' cartridge numbers, illustrates the correct needle replacement, the record speed, and the firm's replacement needle in diamond, synthetic sapphire, or osmium.

INTEGRATED CIRCUIT CATALOGUE

42 Signetics Corporation is now offering copies of its new condensed catalogue covering integrated circuits available in custom design or off-the-shelf.

The 8-page, 2-color booklet gives specification on 25 integrated circuits and several integrated

components. Also described are DTL elements, NAND/nor gates, diodes and gates, power gates, binary elements, line drivers, one-shot multivibrators, and buffer circuits.

INSTRUCTIONAL TELEVISION

43 Ampex Corporation is offering copies of its special "Head Lines" issue covering instructional television.

This 16-page publication is devoted to a discussion of the firm's "Vidiotape" recorder in education and a detailed outline of actual installations and the results which have been obtained with this type of instruction in both elementary schools and colleges and universities.

The text material is lavishly illustrated with photos of actual installations and the equipment used in such systems.

CAPACITOR SELECTOR CHART

44 Cornell-Dubilier Electronics has added "The Mica Minder" as the sixth item in its series of capacitor selector charts. This 17"x22" wall chart has been compiled to aid circuit designers in selecting mica capacitors for military, industrial, and commercial applications.

More than 40 types of mica capacitors are listed with line drawings and dimensions showing form factors and sizes. For each type, the chart shows capacitance, tolerance, voltage, operating temperature, temperature characteristics, and insulation resistance.

ENERGY DISCHARGE CAPACITORS

45 Sangamo Electric Company has issued a 10-page technical bulletin which provides detailed reference data for mechanical and electrical design criteria covering energy discharge capacitors. Graphs, tables, and definitions are utilized to clarify these highly specialized capacitor parameters.

Descriptive information and catalogue listings are given on an extensive line of energy discharge capacitors made by the company. The publication is Bulletin 2610.

ELECTRONIC TEST EQUIPMENT

46 Electronic Measurements Corporation has issued a 6-page product catalogue covering a complete line of electronic test equipment.

Pictured and described in this publication are transistor checkers, voltmeters, scopes, tube testers, substitution boxes, crosshatch generators, signal generators, battery eliminators and chargers, vibrator checkers, and other equipment of interest to service shops and small labs.

RADAR-TYPE ALARM SYSTEM

47 Pinkerton Electro-Security Corp. has issued a four-page brochure describing its "Radar-Eye Minuteman," a fully portable, self-contained burglar alarm system.

The unit itself consists of a bell alarm and detector which sets up a doughnut-shaped radar field covering a 30-foot circle. The device is powered by ordinary house current.

The brochure describes the equipment, various applications at home and industrial locations, and gives information on the operation of the device.

CARTRIDGE CROSS-REFERENCE

48 Sonotone Corporation has released a revised and updated edition of its cartridge cross-reference replacement manual. The data is divided into two sections: cartridge-to-cartridge and phonograph-to-cartridge. The manual is also indexed by models for fast and easy reference.

Over 4000 cartridges and phonograph models are listed. The final page of this 24-page manual lists all of the firm's replacement needles as well as cartridges. Other audio products made by the company are pictured and described briefly.

ELECTRONIC KIT CATALOGUE

49 Heath Company has just published a 48-page catalogue which provides an up-to-date listing of all electronic kits currently available in its extensive line. Included are photographs, complete technical data, mechanical

details, and price and shipping information on equipment for CB, the radio amateur, the boat owner, the car owner, plus radios of all types, intercoms, a transistor organ, stereo systems, TV chassis and cabinets, amplifiers, tuners, preamps, turntables and changers, tape recorders, cartridges, speakers and headphones, speaker systems and enclosures, and an extensive line of test equipment of all types for service, lab, and experimental applications.

INSTRUMENT CATALOGUE

50 Keithley Instruments, Inc. has issued a 44-page catalogue which covers a full line of sensitive electronic instruments for research and industry. The catalogue is arranged in convenient sections covering measurements of d.c. and a.c. voltage, d.c. current, low and high resistance, d.c. and a.c. amplification, as well as sections on d.c. high-voltage supplies, nuclear instrumentation, and space science instrumentation. Selection charts are also provided to serve as an aid in picking equipment.

TOUCH-CONTROL SWITCH DATA

51 Tung-Sol Electric Inc. is offering copies of its Form T-496 which illustrates how the "Dynaquad" touch-control module can be used in various applications.

The brochure discusses various ideas for the application of this device including its possible use in level indicators for liquid or bulk storage tanks, night lights, explosion-proof switches, machinery guards, limit switches, and variable lighting control.

Technical details on the module itself are included along with complete information on the wiring and installation.

TAPE HEAD REPLACEMENTS

52 The Nortronics Company, Inc. has just issued the third edition of its "Tape Head Replacement Guide" which includes all recorders listed in previous editions plus erase head replacement

data on several models which were formerly shown as not available.

More than 200 additional recorders have been incorporated in this new listing with a total of over 410 separate models being covered. Information is tabulated and listed by make and model number, original part function, and the firm's replacement suitable to that particular tape-recorder unit.

INDUSTRIAL TUBES

53 United-National Labs, Inc. has prepared a 24-page catalogue covering an extensive line of industrial tubes it is prepared to ship from stock. The distributor handles transmitting, special purpose, industrial, and receiving tubes as well as semiconductors. All tubes listed are nationally advertised brands and prices are provided for quantity lots as well as for orders from 1 to 99 tubes.

SEMICONDUCTOR GUIDE

54 Bendix Semiconductor Division has issued a four-page semiconductor guide which covers, in concise tabular form, pertinent parameters on the firm's line of silicon planar epitaxial "n-p-n" and silicon diffused mesa "n-p-n" power transistors; silicon power varactor diodes; silicon single-junction diffused power rectifiers; diffused alloy power μ sec. switching transistors; and high- and medium-power "p-n-p" alloy power transistors.

RECORDER CHART PAPERS

55 Brush Instruments has issued a four-page, two-color illustrated brochure describing its line of chart paper engineered for all types of direct-writing recorders. A pocket in the brochure contains specimens of chart paper with traces produced by ink, electric, pressure-thermal, and forced-fluid direct-writing techniques.

Engineering specifications for chart paper are tabulated. A detailed chart on the back of the folder lists the specific types of paper available for each recorder.

PHOTO CREDITS

Page	Credit
12 (top)	Shure Brothers Inc.
12 (bottom)	H. H. Scott, Inc.
28, 29	Federal Electric Corp.
40	American Telephone & Telegraph Corp.
42	Nuclear Diodes, Inc.
44 (Fig. 1)	The Eppley Laboratory, Inc.
44 (Figs. 2 & 4)	North Hills Electronics Inc.
44 (Fig. 3), 45	Leeds & Northrup
78 (left)	Radio Corporation of America
78 (right)	Associated Research, Inc.
79	Sencore

Answer to Electronic Crosswords

(Appearing on page 71)

W	I	D	E	B	A	N	D	S	I	T	S
A	P	E	T	T	U	B	E	P	O	R	T
I	S	T	U	T	T	W	O	A	A		
L	O	A	D	O	V	E	R	T	N	C	
	I	R		I	C	Y	A	S	K		
F	I	L	A	M	E	N	T	F	A	M	E
E	G	W	A	X	O	I	L	I	D		
E	N	D	S	C	U	R	R	E	N	T	
D	I	G	F	I	N	E	E	N			
B	T	P	I	T	C	H	S	E	L	F	
A	R	O	B	I	U	T	I	E			
C	O	N	E	N	E	G	A	T	I	V	E
K	N	O	T	G	R	O	U	N	D	E	D

MERIT CATALOG NOW AVAILABLE



Contains 20,000 "easy to find" Merit equivalents to manufacturer's part numbers. Merit's exact replacements means fewer call backs... easy installation... minimum field returns.

Form 830
1963-64

Most Complete Catalog & Replacement Guide

Order Your Merit Catalog & Replacement Guide Now.

Name _____ Position _____

Firm _____

Address _____

City _____ Zone _____ State _____

MERIT COIL & TRANSFORMER CORPORATION
Merit Plaza Hollywood, Florida

FAMOUS BC-645 TRANSCEIVER



BRAND NEW! 15 Tubes 435 to 500 MC
Can be modified for 2-way communication, voice or code, on ham band 420-450 mc, citizens radio 460-470 mc, fixed and mobile 450-460 mc, television experimental 470-500 mc, 15 tubes (tubes alone worth more than sale price!); 4—7F7, 4—7H7, 2—7E6, 2—6F6, 2—955 and 1—WE-316A. Now covers 460 to 490 mc. Brand new BC-645 with tubes, less power supply in factory carton.
Shipping weight 25 lbs. **SPECIAL! \$19.50**

PE-101C Dynamotor, 12/24V input \$7.95
UHF Antenna Assembly 2.45
Complete Set of 10 Plugs 5.50
Control Box 2.25

SPECIAL "PACKAGE" OFFER

BC-645 Transceiver, Dynamotor and all accessories above **COMPLETE, BRAND NEW** While Stocks Last. **\$29.50**

ARC-3 RECEIVER!



Complete with 11 Tubes Exc. Used **\$21.50**

Like NEW \$33.50
Crystal-controlled 17-tube superhet, tunes from 100 to 156 MC., AM., on any 8 preselected channels, 28-volt DC power input, Tubes: 1-9002, 6-6AK5, 1-125N7, 3-125G7, 1-9001, 1-12H6, 2-125N7, 1-125L7, 1-12A6.
110 V A.C. Power Supply Kit for above **15.00**
Factory Wired and Tested **19.95**

ARC-3 TRANSMITTER

Companion unit for above tunes 100 to 156 MC on any 8 pre-selected channels, 9 tubes, crystal controlled, provides tone and voice modulation, 28V DC power input, complete with all Tubes: 3-6V6, 2-832A, 1-125H7, 1-6J3. **\$18.95**
Like new condition Only
ARC-3 PUSHBUTTON CONTROL BOX **\$28.50**
ARC-3 PUSHBUTTON CONTROL BOX **\$5.95**

ASB-5 'SCOPE INDICATOR



BRAND NEW, including all tubes, together with SBP1 'Scope Tube. Originally used in Navy Aircraft RADAR equipment. Easily converted for AC operation.
VALUE \$250.00!
OUR LOW PRICE..... \$16.95



LORAN APN/4 OSCILLOSCOPE
Easily converted for use on radio-TV service bench.
LIKE NEW! Supplied with 5" Scope, type 5CPI only **\$14.95**

APN-12 3-INCH SCOPE



Has vertical and horizontal sweep with focus and intensity controls, coaxial antenna changeover motor. Complete with 11 tubes and SBP1 'R Tube. For 115 V, 400 cycle AC and 24 V DC. Circuit diagram included. **LIKE NEW \$14.95**

BC-906 FREQ. METER—SPECIAL

Cavity type 145 to 215 Mc. Complete with antenna, manual and original calibration charts included. **BRAND NEW, OUR LOW PRICE..... \$12.88**



BC-221 FREQUENCY METER
SPECIAL BUY! This excellent frequency standard is equipped with original calibration charts, and has ranges from 125 Kc to 20,000 Kc with crystal check points in all ranges. Excels! Used with original Calibration Book, Crystal, and all tubes—**LIKE NEW!**

Unmodulated **\$76.50** Modulated **\$115.00**
BC-221 1000 Kc Crystal Brand New **\$8.95**

LM FREQUENCY METER

Crystal calibrated modulated, Heterodyne, 125 Kc to 20,000 Kc With Calibration book **\$69.50**
Complete, Like New

2 VOLT BATTERY "PACKAGE"

1—2V, 20 Amp. Hr. Willard Storage Battery, Model #202, 3" x 4" x 5 1/2" high **\$2.79**
1—2 1/2" prong Synchronous Plug-in Vibrator **1.49**
1—Quart Bottle Electrolyte (for 2 cells) **1.45**
ALL BRAND NEW!
Combination Price **\$5.45**



WILLARD 6-VOLT MIDGET STORAGE BATTERY
3 Amp. Hour, **BRAND NEW**, 3 1/2" x 1 1/2" x 1 3/16" x 2 3/8" Uses Standard Electrolyte **Only \$2.95**

IMPORTERS—EXPORTERS of ELECTRONIC EQUIPMENT

We specialize in the export of military surplus electronic equipment:

- All at **LOWEST PREVAILING PRICES.**
- In addition to items shown on this page, we have in stock or can obtain for export customers, military electronic equipment made for World War II, Korean War, and later.
- Many thousands of items in our huge warehouse.
- IF YOU DON'T SEE WHAT YOU WANT HERE, WRITE US YOUR NEEDS. LET US QUOTE ON ANY GOVT SURPLUS ELECTRONIC EQUIPMENT YOU SEE ADVERTISED ANYWHERE. INQUIRIES WELCOME.
- All packing and shipping is made directly from our own warehouse in NYC to give you substantial savings in handling costs!

LORAN APN-4

FINE QUALITY NAVIGATIONAL EQUIPMENT

Determine exact geographic position of your boat or plane. Indicator and receiver complete with all tubes and crystal.

INDICATOR ID-6B/APN-4, and RECEIVER R-9B/APN-4, complete with tubes, Exc. Used. **\$69.50**

Receiver-Indicator as above, **BRAND NEW \$88.50**
Shock Mount for above **\$2.95**

INVERTER POWER SUPPLY for above APN-4. INPUT: 24 V DC @ 75 A. OUTPUT: 115 V AC @ 10.5 Amps, 800 cycles. Complete with two connecting plugs **BRAND NEW \$49.50**

12-Volt Inverter Power Supply for above APN-4. Like New. **P.U.R.**
We carry a complete line of spare parts for above.

LORAN R-65/APN-9 RECEIVER & INDICATOR

Used in ships and aircraft. Determines position by radio signals from known transmitters. Accurate to within 1% of distance. Complete with tubes and crystal. **IN LIKE NEW Condition \$79.50**

Used, with all parts, less tubes, crystal and visor **Special \$29.50**

INVERTER POWER SUPPLY for above APN-9. INPUT: 24 V DC. OUTPUT: 115 V AC. 800 cy. **NEW \$49.50**

12-V. Power Supply for APN-9, like New **P.U.R.**
Shock Mount for above **\$2.95**
Circuit diagram and connecting plugs available.
We carry a complete line of spare parts for above.

APR-1 Navy VHF-UHF radar search Receiver, 38 Mc to 1000 Mc in 3 bands. **LIKE NEW \$79.50**
TUNING UNITS for above: TN1, TN2, TN3, **IN stock**

SCR-274 COMMAND EQUIPMENT
ALL COMPLETE WITH TUBES

Type	Description	Used	Like NEW
BC-433	Receiver 100-550 KC	\$12.95	\$14.95
BC-434	Receiver 3-8 Mc	12.45	17.95
BC-435	Receiver 6-8 Mc	11.50	13.95
1.5 to 3 Mc. Receiver Brand New			\$17.95

110 Volt AC Power Supply Kit for all 374-N and ARC-5 Receivers. Complete with metal case, instructions **\$8.95**
Factory wired, tested, ready to operate **\$12.50**
SPLINED TUNING KNOB for 374-N and ARC-5 RECEIVERS. Fits BC-433, BC-434 and others. **Only 49¢**

2.1 to 3 Mc Transmitter, Brand New **\$12.95**
BC-457 TRANSMITTER—4.5-3 Mc. complete with all tubes and crystal, BRAND NEW..... \$7.95
Like New **\$7.95**
BC-458 TRANSMITTER—5.3 to 7 Mc. Complete with all tubes and crystal, BRAND NEW..... \$10.95
Like New **\$7.95**
BC-696 TRANSMITTER—3.4 Mc Complete with all Tubes & Crystal, Like New..... \$11.95
BC-456 Modulator **USED \$3.45 NEW \$5.95**
ALL ACCESSORIES AVAILABLE FOR ABOVE

ARC-5/T-23 TRANSMITTER 100-150 Mc., includes tubes: 2-832A, 2-1625 BRAND **\$21.50**
NEW, with tubes **\$5.95**
Excellent Used, less tubes **\$5.95**

ARC-5/R-28 RECEIVER, 2-meter superhet, 100 to 156 Mc in 4 crystal channels, complete with 10 tubes **\$24.95**
Excellent Used, with tubes

G & G RADIO SUPPLY CO.

Telephone: CO 7-4605

77 Leonard St. New York 13, N. Y.

AN/ART-13 100-WATT XMTR

11 CHANNELS
200-1500 Kc
2 to 18.1 Mc

\$7950
EXC. USED

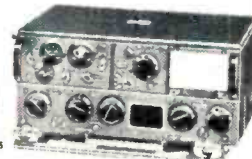

complete with Tubes

Famous Collins Autotune Aircraft Transmitter, AM (CW, SIG), quick change to any of ten preset channels or manual tuning. Speech amplifier clipper uses carbon or magnetic mike. Highly stable, highly accurate, VFO. Built in Xial controlled oscillator; PPS1 is modulate 813 in final up to 90% class AB. A Real "HOT" Ham buy at our low price!
AN/ART-13 XMTR, as above, in LIKE NEW \$89.50
condition, with all tubes and crystal.

0-16 Low Freq. Osc. Coll for ART-13 **7.95**
24V Dynamotor for ART-13 **11.95**
We Carry a complete line of spare parts for above.

AN/APR-4 RECEIVER only, 38 to 4000 Mc in 5 tuning unit ranges. High precision lab instrument. Input 115 V60 cy. Like New **\$89.50**
Tuning Units TN16, 17, 18 each **\$39.50**
Tuning Unit TN19, Brand New **\$89.50**
Tuning Unit TN54 **\$149.50**

ACCESSORIES FOR BC-603, 683 RECEIVERS

EXTRA SET OF 10 TUBES FOR ABOVE brand new in original boxes **\$4.95**

12 or 24V Dynamotor for Above, Brand New **\$5.50**
Exc. Used \$4.25

AC POWER SUPPLY FOR BC603, 683 Interchangeable, replaces dynamotor. Has On-Off Switch, NO RECVR. CHANGE NEEDED Provides 220 VDC @ 80 Ma, 24-VAC @ 2 Amps **\$12.95**

Complete 240-page Technical Manual for BC-603, 604 **\$3.45**

BC-604 TRANSMITTER—Companion unit for BC-603, 602 Receiver, 3500 Mc. With all tubes, BRAND NEW **\$8.95**
4-Section Antenna for BC-604, 684 Transmitters. Complete with mounting base, BRAND NEW **\$4.95**
We carry a complete line of spare parts for above.

LATEST TYPE COMMAND BROADCAST RECEIVER!

Like NEW, **\$34.50**
with Tubes

Model R-22 Broadcast Receiver, 530 Mc. With all tubes, BRAND NEW 100 to 1640 Kc., with control box and flexible mechanical tuning cable, 6 Tubes, 24 VDC operation.

110V AC Power Supply for above: Kit **\$8.95**; Wired **\$12.50**

BC1206-C BEACON RECEIVER

195 to 420 Kc. made by Satchel-Carlson. Works on 24-28 volts DC, 135 Kc. F. Complete with 5 tubes, size 4" x 4" x 6". Wt. 4 lbs. **BRAND NEW \$9.95**

USED, with tubes **\$6.95**
USED, less tubes **\$3.45**

SCR-625 MINE DETECTOR

Complete portable outfit in original packing, with all accessories. **\$275.00**
Brand New

EE-8 FIELD PHONES

Talk as far as 17 miles! Dependable 2-way communication at low cost! Ideal for home, farm, field. Up to six phones can be used on one line. Each phone complete with ringer. Originally cost govt. \$65.00 each. Excellent Condition, checked out, perfect working order, complete with all parts. Each **\$14.45**

MICROPHONES Checked Out, Perfect

Model F-71-D, Carbon Hand Mike **EXC. USED \$4.45 NEW \$7.95**
RS-38, Navy Type Carbon Hand Mike **3.95 5.75**

HEADPHONES Checked Out, Perfect

Model: Description EXC. USED BRAND NEW

HS-23	High Impedance	\$2.79	\$4.95
HS-30	Low Impedance	3.15	5.45
HS-30	Low Imp. featherwt.	.90	1.65
H-16 U	High imp. (2 units)	3.75	7.95

TELEPHONES—400 ohm low Impedance HEADSETS, BRAND NEW, PER PAIR **\$3.95**
BC-307A Cords, with P1.55 plug and JK20 Jack **.99**
Earphone Cushions for above—pair **.50**

OTHER DYNAMOTOR VALUES:

Type	Input	Output	Exc. Used	BRAND NEW
DM-32A	28V 1.1A	250V .05A	2.45	4.45
DM-33A	28V 5A	575V .16A		
DM-37A	28V 7A	540V .25A	2.95	4.45
DM-34D	12V 2A	220V .080A	4.15	5.50
DM-36	28V 1.4A	220V .080A	1.95	2.95
DM-37	2.5V 9.2A	925V .220A	2.95	4.22
DM-43	28V 23A	460V .185A		7.95
DM-53A	28V 1.4A	220V .080A	3.75	5.45
PE-73C	28V 20A	1000V .350A	8.95	14.95
PE-86	28V 1.25A	250V .050A	2.75	3.85

DM-37 DYNAMOTOR, Input 25.5 V DC @ 9.2 A, Output 925 V DC @ 225 Ma, BRAND NEW Each **\$3.25**

SCHEMATIC DIAGRAMS

For most equipment on this page, each **65¢**
Please include 25% Deposit with order—Balance C.O.D., or Remittance in Full. 50¢ Handling Charges on all orders under \$5.00. All shipments F.O.B. Our Warehouse, N.Y.C. All Merchandise subject to Prior Sale and Price Change.

ELECTRONICS MARKET PLACE

RATE: 60¢ per word. Minimum 10 words. October issue closes August 5th. Send order and remittance to: ELECTRONICS WORLD, One Park Ave., N. Y. C. 16, N. Y.

ELECTRONICS ENGINEERING AND INSTRUCTION

USED Correspondence Courses and Books sold and rented. Money back guarantee. Catalog Free. (Courses Bought.) Lee Mountain, Pisgah, Alabama.

ELECTRONICS! Associate degree—29 months. Technicians, field engineers, specialists in communications, missiles, computers, radar, automation. Start February, September. Valparaiso Technical Institute, Dept. N, Valparaiso, Indiana.

FCC LICENSE in six weeks. First class radio telephone. Results guaranteed. Elkins Radio School, 2603C, Inwood, Dallas, Texas.

HIGHLY-effective home study review for FCC commercial phone exams. Free literature! Wallace Cook, Box 10634, Jackson 9, Miss.

RADIO course only \$14.95. Includes all tubes, parts, tools, instructions. Write for full information. Progressive "Edu-Kits" Inc., Dept. 92E, Hewlett, N.Y.

ENGINEERING and Art Degrees earned through home study. Electronics, mechanical, liberal arts, major accounting. When writing specify course desired. Pacific International College of Arts & Sciences, primarily a correspondence school. Resident classes also available. 5719-C Santa Monica Blvd., Hollywood 38, California.

DIGITAL Computers Simplified. Basic, concept level introduction, clearly illustrated. Advent Editions, P.O. Box 124W, Sarasota, Florida. \$3.00. 25¢ postage.

FOR SALE

GOVERNMENT Surplus Receivers, Transmitters, Snooperscopes, Parabolic Reflectors, Picture Catalog 10¢. Meshna, Malden 48, Mass.

INVESTIGATORS, free brochure, latest submarine electronic listening devices, Ace Electronics, 11500 N.W. 7th Ave., Miami 50, Florida.

TV Tuners—Rebuilt or Exchanged \$9.95 complete—all types—fast, guaranteed service. Send tuner with all parts to: L. A. Tuner Exchange, 4611 West Jefferson Blvd., Los Angeles 16, California.

MILITARY Discount—Name Brands Free Recording Tape and Stereo Handbook. Include Rand and Serial Number. Electronics International, Inc., Box 3066, Charlottesville, Virginia.

Save dollars on radio, TV-tubes, parts at less than manufacturer's cost. 100% guaranteed. No rebrands, pulls. Request Bargain Bulletin. United Radio 1000-W, Newark, N.J.

FREE literature keeping you informed on the latest work-saving, money-making test equipment. Learn how Easy Budget Payment Plan lets you pay out of increased earnings. Top engineered test instruments are priced for tremendous value. Write today. Century Electronics, 352 Maple Ave., Westbury, N.Y.

CANADIANS—Giant Surplus Bargain Packed Catalogs. Electronics, Hi-Fi, Shortwave, Amateur, Citizens Radio. Rush \$1.00 (Refunded). ETCO. Dept. Z, 464 McGill, Montreal, Canada.

TRANSISTORIZED Products importers catalog, \$1.00. Intercontinental, CPO 1717, Tokyo, Japan.

"LISTEN-in-coil" picks up any telephone conversation in vicinity. No connection to telephone necessary. Easily concealed. \$2.98 complete. United Acoustics, 1302F, Washington St., Hoboken, N.J.

CONVERT any television to sensitive, big-screen oscilloscope. Only minor changes required. No electronic experience necessary. Illustrated plans, \$2.00. Relco, Box 10563, Houston 18, Texas

EMBOSSED Business Cards \$3.95M, Speedcard, 523 Atwood, S.W., Atlanta, Ga.

CB transmitters \$6.00. Other bargains send 10¢ for list. Vanguard 190-48 99th Ave., Hollis 23, N.Y.

WANTED

CASH Paid! Sell your surplus electronic tubes. Want unused, Clean radio and TV receiving, transmitting special purpose, Magnetrons, Klystrons, broadcast types. Want military and commercial lab/test equipment such as G.R.H.P., AN/UPM prefix. Also want commercial Ham Receivers and Transmitters. For a Fair Deal write: Barry Electronics Corp., 512 Broadway, New York 12, N. Y. (Walker 5-7000).

QUICKSILVER, Platinum, Silver, Gold. Ores Analyzed. Free Circular. Mercury Terminal, Norwood, Massachusetts.

TUBES

BEFORE you buy receiving tubes, test equipment, Hi-fi components, kits, parts, etc. . . send for your giant free Zalytron current catalog, featuring Standard brand tubes; RCA, GE, etc.—all brand new premium quality individually boxed, one year guarantee—all at biggest discounts in America! We serve professional servicemen, hobbyists, experimenters, engineers, technicians. Why pay more? Zalytron Tube Corp., 461 Jericho Turnpike, Mineola, N. Y.

TUBES—TV, Radio, Transmitting And Industrial Types At Sensibly Low Prices. New, Guaranteed, 1st Quality, Top Name Brands Only. Write For Free Catalog or Call WALKER 5-7000, Barry Electronics Corp., 512 Broadway, New York 12N, N. Y.

FREE Catalog—name brand tubes 65% discount, phono needles 80% or more discount, phono cartridges, picture tubes 75¢ inch, parts, parts kits, silicon and selenium rectifiers transmitting tubes, 7" T.V. test tube \$6.99, imported batteries, tube testers etc. Want to swap or sell tube inventory? Send us your offering. Arcturus Electronics Corp., Dept. Z.D., 502 22nd St., Union City, N.J.

TAPE AND RECORDERS

TAPE Recorders, HI-FI Components. Sleep Learning Equipment, Tapes, Unusual Values. Free Catalog. Dressner, 1523 EW Jericho Turnpike, New Hyde Park 10, N.Y.

RENT Stereo Tapes—over 2,500 Different—all major labels—free catalog. Stereo-Parti, 811-G, Centinela Ave., Inglewood 3, California.

SELF-Hypnosis. New concept teaches you quickly by tape or LP-record. Free literature. McKinley Publishers, Dept. T6, Box 3038, San Bernardino, California.

SAVE 30% Stereo music on tape. Free bargain catalog/blank tape/recorders/norelco speakers. Saxitone, 1776 Columbia Road, Washington, D.C.

4/TR Stereo Tapes—bought, sold, rented, traded! Bargain closeouts! Catalog/COLUMBIA, 9651 Foxbury, Rivera, California.

RECORDING tape, top quality by major U.S. manufacturer. 1800 feet, 1 mil, 7 inch reel, \$1.95 each, 10 for \$17.70 postpaid. Money-back guarantee. Western Magnetics, Box 3722, Portland 8, Oregon.

ANY 4-Track Stereo Tape at Dealer Cost. Factory-Sealed. Discount Tapes, Box 1601-E, Des Moines 6, Iowa.

RECORDING Tapes. Free sample. Mail 25¢ (Handling). Towers, Lafayette Hill, Penna.

HIGH-FIDELITY

Hi-Fi Components, tape recorders at guaranteed "We Will Not Be Undersold" prices. All brands in stock. 15-day money back guarantee. 2 year warranty. Write your requirements for quotation. No Catalog. Hi-Fidelity Center 1797L 1st Ave., New York 28, N.Y.

DISGUSTED with "Hi" Hi-Fi Prices? Unusual Discounts On Your High Fidelity Requirements. Write. Key Electronics, 120 Liberty St., New York 6, N. Y. D16-4191.

RECORDERS, Components! Free wholesale catalogue! Carston, 125-R, East 88, N.Y.C. 28.

LOW, LOW quotes: all components and recorders. Hi-Fi, Roslyn 9, Penna.

WRITE for lowest quotations, components, recorders. No Catalogs. Hi-Fidelity Supply, 2817-GC Third, New York City 55.

RECORDS

RARE 78's. State Category. Write Record-Lists, P.O. Box 2122, Riverside, Calif.

REPAIRS AND SERVICING

TV Tuners Rebuilt and Aligned per manufacturers specification. Only \$9.50. Any Make UHF or VHF. We ship COD Ninety day written guarantee. Ship complete with tubes or write for free mailing kit and dealer brochure. JW Electronics, Box 51B, Bloomington, Indiana.

TV Tuners rebuilt and aligned per manufacturer's specifications. Only \$8.50. Guaranteed. We ship cod. Valley Tuners, 5641-B Cahuenga, North Hollywood, Calif.

METERS—Multimeters Repaired and Calibrated. Free estimates—Catalog. Bigelow Electronics, Box 71-F, Bluffton, Ohio.

BOOKS

AUTHORS! Learn how to have your book published, promoted, distributed. FREE booklet "ZD," Vantage, 120 West 31 St., New York 1.

PATENTS

PATENT Searches, \$6.00! Free "Invention Record"/Information. Miss Hayward, 1029 Vermont, Washington 5, D.C.

GOVERNMENT SURPLUS

GOVERNMENT Surplus Direct From Government. Jeeps \$264.00. Radios \$2.53, Typical Prices. Guns, Typewriters, Cameras, Tools, Thousands More. Amazing Low Prices. How, Where To Purchase, Merchandise Available, Etc., Only \$1.00 To: Surplus, P.O. Box 50512, Dept. R, New Orleans 50, Louisiana.

GOVERNMENT Surplus Sales Bulletin—"Directory-Procedure"—50¢—Industrial, Box 770(A), Hoboken, N.J.

JEEPS—\$106.93, Transmitters—\$6.18, Typewriters—\$4.15, Receivers—\$5.65, Oscilloscopes, Multimeters, Speakers, Walkie-Talkies. Typical Government Surplus Prices. Exciting Details Free. N. Y. Enterprises, Box 402-B4, Jamaica 30, New York.

JEEPS \$111.68, boats \$6.20, airplanes, recorders, radios, electronics equipment, thousands of items typically at 90% savings or better. For complete information send \$1.00 to Surplus Service, Box 820, Holland 13, Michigan.

BUSINESS OPPORTUNITIES

EARN extra money! No investment required. Part-time selling; brand name hi-fi components at discount prices. Exclusive territories. To qualify you must be a hi-fi enthusiast or knowledgeable in field. Give full info. by letter including 3 business refs. & bank. Greatest opportunity for extra earnings ever offered. Write: I F A Electronics, P. O. Box 559, Encino, Calif.

HIGH income in your own wired-music business. Free details! CSOE, Box 10634, Jackson 9, Miss.

All rights for new commercial tube tester, for thyratrons. Development completed. Charles Broughton, 1039 Forest Home, St. Louis 37, Mo.

SHOPPING GUIDE CLASSIFIED

A HANDY GUIDE TO PRODUCTS, NOT NECESSARILY ELECTRONIC, BUT OF WIDE GENERAL INTEREST.

PHOTOGRAPHY — FILM, EQUIPMENT, SERVICES

MEDICAL FILM—Adults only—"Childbirth," one reel, 8mm \$7.50; 16mm \$14.95. International W, Greenvale, L.I., New York

SCIENCE Bargains—Request Free Giant Catalog "CJ"—144 pages—Astronomical Telescopes, Microscopes, Lenses, Binoculars, Kits, Parts. War surplus bargains. Edmund Scientific Co., Barrington, New Jersey.

STAMPS AND COINS

SMASHING collection free. Includes triangles, early United States, rockets, sports, British colonies, high value pictorials, etc. Complete collection plus big, illustrated magazine, all free. Send 10¢ for postage. Gray Stamp Co., Dept. 22, Toronto, Canada.

EDUCATIONAL OPPORTUNITIES

LEARN While Asleep, hypnotize with your recorder, phonograph. Astonishing details, sensational catalog free! Sleep-Learning Association, Box 24-ZD, Olympia, Washington.

HYPNOTISM—sleep learning—self hypnosis! Thirteen exciting modern methods. Learn or pay nothing! Air-mail name for free approval offer. Forum, Division H22-07, 608 South Dearborn, Chicago 5.

BUSINESS OPPORTUNITIES

INVESTIGATE Accidents—Earn \$750 to \$1,000 monthly. Men urgently needed. Car furnished. Business expenses paid. No selling. No college education necessary. Pick own job location. Investigate full time. Or earn \$6.44 hour spare time. Write for Free Literature. No obligation. Universal, C2-8, 6801 Hillcrest, Dallas 5, Texas.

\$100 weekly possible. Complete mailing lists and address envelopes for advertisers. Home—spare time. Particulars free. National Service, 81, Knickerbocker Station, New York City.

MAKE \$25-\$50 week clipping newspaper items for publishers. Some clippings worth \$5.00 each. Particulars free. National, 81, Knickerbocker Station, New York City.

I Made \$40,000.00 Year by Mail Order! Helped others make money! Start with \$10.00—Free Proof. Torrey Box 3566-N, Oklahoma City 6, Oklahoma.

ASSEMBLE artificial lures at home for stores. Materials supplied free. Profitable! Write: Lures, Ft. Walton Beach 1, Florida.

MISCELLANEOUS

HYPNOTIZE Unnoticed, quickly, effortlessly, or refund! Thousands delighted! \$2.00. Minter, Box 244-D, Cedarburg, Wisconsin.

WE buy and sell old Comic books, Science-Fiction, Aviation, Movie Magazines. Ostfeld, 343 N. Clark, Chicago.

EMPLOYMENT RESUMES. Earn more by presenting yourself to prospective employers effectively. Send only \$2.00 for resume writing instructions. Or send complete job, educational and personal facts plus \$20.00 (cash or money order) for your own complete, personal resume, \$30.00 for 200 copies printed on white bond paper. J. Ross, 63-61 Yellowstone Blvd., Forest Hills 75, New York, Dept. 6 J.

MOVING?



If you've recently changed your address or plan to in the near future, be sure to notify us at once. Place magazine address label here and print your new address below.

NEW ADDRESS:

NAME _____ PLEASE PRINT

ADDRESS _____

CITY _____ ZONE _____ STATE _____

MAIL COPIES TO NEW ADDRESS STARTING WITH _____ ISSUE.

If you have any other questions about your subscription be sure to include your magazine address label when writing us.

Mail to: ELECTRONICS WORLD, 434 So. Wabash Avenue, Chicago 5, Illinois

ELECTRONICS WORLD AUGUST 1963 ADVERTISERS INDEX

READER SERVICE NO.	ADVERTISER	PAGE NO.	READER SERVICE NO.	ADVERTISER	PAGE NO.
	Advance Electronics	84	123	Johnson Company, E. F.	71
100	Allied Radio	17, 18		Key Electronics Co	83
101	American Concertone, Inc	69		Kuhn Electronics	84
102	Automotive Electronics Co	73	124	Lafayette Radio Electronics	77
143	Aztec Engineering Company	68	125	Lampkin Laboratories, Inc	68
103	B & K Manufacturing Co	9	126	Merit Coil & Transformer Corporation	91
104	Benjamin Electronic Sound Corp	6	127	Micro Electron Tube Co	76
105	Blonder-Tongue	1	128	Murray-Carson Company	77
106	Cadre Industries Corp	67		National Radio Institute	SECOND COVER
	Capitol Radio Engineering Institute, The	7, 89	129	Nortronics	4
107	Castle TV Tuner Service, Inc	90		Oelrich Publications	74
108	Channel Master Corp	87	144	Palmer Electronics Laboratories Inc	81
	Cleveland Institute of Electronics	15	130	Peak Electronics Co	87
109	Columbia Electronics	74	131	Quietrol Company	82
142	Cornell Electronics Co	88		RCA Institutes, Inc	11, 57
110	Delco Radio	20		RW Electronics	80
	Dressner	84		Radio Corporation of America	FOURTH COVER, 2, 72
111	EICO Electronic Instr. Co. Inc.	22		Relco	83
112	Electro-Voice, Inc	82	132	Sams & Co., Inc., Howard W	21
113	Electronic Chemical Corp	90	133	Sarkes Tarzian, Inc	70
114	Eltec Laboratories, Inc	10	134	Sarkes Tarzian, Inc	80
115	Fair Radio Sales	84	135	Scott Inc., H. H.	82
116	Fisher Radio Corporation	13	136	Sencore	14
	Florida Electronic Technical Institute, The	77	137	Sony Corporation of America	75
117	G & G Radio Supply Co	92	138	Sprague Products Co	65
118	General Radiotelephone Company	71	139	Standard Kollsman Industries, Inc	THIRD COVER
119	Grantham School of Electronics	5		Texas Crystals	68
120	Greenlee Tool Co	87		Tri-State College	83
121	Gregory Electronics Corporation	88		Valparaiso Technical Institute	74
131	Grommes Div. of Precision Electronics	8	140	Winegard Company	81
141	Hallcrafters	83			
122	Heath Company	61			
	Indiana Institute of Technology	76			



STANDARD KOLLSMAN BRINGS

Beauty TO UHF CONVERTERS

The Model "A", the only UHF converter you can show and sell with pride. Designer styled in beige and tan to blend with today's decor . . . to harmonize with modern TV cabinet design. Standard waited . . . and tested, analyzed, and re-tested until they could bring you the quality instrument you and your customers have a right to expect from the leading manufacturer of tuners. As a result, you now have a converter which is beautiful, *profitable*, and *dependable*.

Contact your Standard representative . . . or write

standard kollsman INDUSTRIES, INC.

Formerly Standard Coil Products Co., Inc., Melrose Park, Illinois / WORLD'S LARGEST MANUFACTURER OF TELEVISION TUNERS

PERFORMANCE YOU CAN SEE

New low-noise, shielded tuner permits fine tuning for all 70 UHF channels. Functions perfectly with color or black and white sets. Two simple controls: one for VHF, UHF, and "off" . . . the other for channel selection and fine tuning. The "SK" installs in about a minute with just a screwdriver.



Feature this exciting counter-top display carton

POWER IN PROMOTIONAL SUPPORT

With a first order of 12 units or more, Standard supplies 3 newspaper ad mats . . . 3 radio spot scripts . . . materials for a powerful TV spot . . . 2-color catalog sheets . . . a giant (3' x 6') 2-color window banner . . . a counter card . . . as many pre-printed jumbo post cards as you can use PLUS hard hitting ads in TV Guide.

STEREO

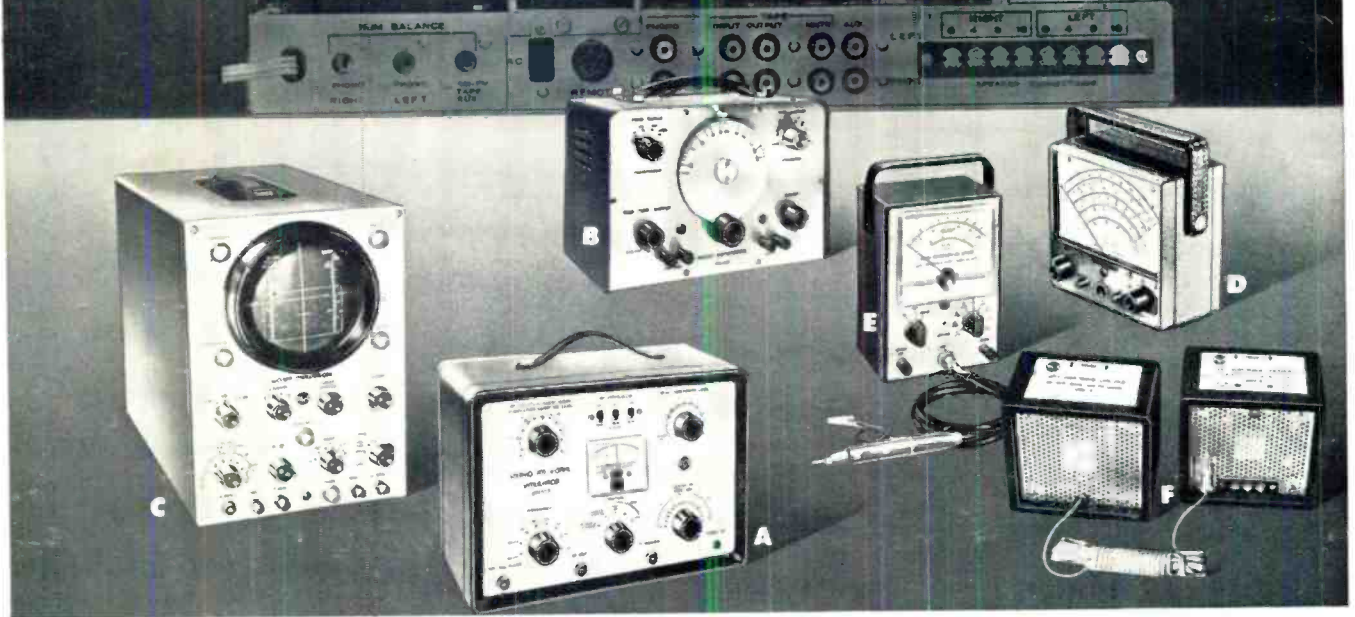

Let **RCA** equip you with **EVERYTHING YOU NEED FOR STEREO SERVICING**

RCA—entertainment leader of the world—now offers you a complete set of test instruments to put you in the stereo servicing business. And now's the time to get in because it's growing bigger and more profitable by the day.

A. NEW! RCA WR-51A FM STEREO SIGNAL SIMULATOR

Generates signals necessary to service and maintain stereo multiplex FM receivers and adaptors. Generates... Choice of 4 FM signals—Left Stereo, Right Stereo, Special Phase Test, Monaural FM • Choice of 8 sine-wave frequencies (400 cps, 1Kc, 5Kc, 19Kc, 28Kc, 38Kc, 48Kc, 67Kc) available separately or for modulating FM signals • 100 Mc carrier tuneable ± 0.8 Mc to permit selection of a quiet point in the FM band • 19 Kc subcarrier, crystal-controlled within ± 2 cps • 100 Mc sweep signal adjustable from 0-750 Kc at 60 cps rate • Choice of 3 composite stereo output signals—Left Stereo, Right Stereo, Special Phase Test • Choice of 3 sine-wave frequencies for composite stereo

signals • Crystal controlled markers for receiver if and rf alignment • Zero-center meter for checking the balance of stereo amplifier output. **\$249.50***

B. RCA WA-44C AUDIO GENERATOR

Generates sine-wave and square-wave signals over range of 20 to 200,000 cps to test audio systems. Can be used to measure intermodulation distortion, frequency response, input and output impedance, speaker resonance, transient response and phase shifts. Less than 0.25% total harmonic distortion over range of 30 to 15,000 cps. **\$98.50***

C. RCA WO-91A 5" OSCILLOSCOPE

A high-performance, wide-band 'scope—serves as a visual VTVM. Choice of wide band (4.5 Mc—0.053-volt rms/inch sensitivity)

or narrow, high-sensitivity band (1.5 Mc—0.018-volt rms/inch sensitivity). New 2-stage sync separator provides solid lock-in on composite TV signals. **\$249.50***

D. RCA WV-98C SENIOR VOLT-OHM-MYST®

For direct reading of peak-to-peak voltages of complex waveforms, rms values of sine-waves, DC voltages, and resistance. Accuracy: 3% full-scale on both AC and DC, with less than 1% tracking error. Color-coded scales differentiate peak-to-peak from rms readings. New 0.5 volt full scale DC range for use with low-voltage transistor circuits. $6\frac{1}{2}$ " meter. **\$79.50***

E. RCA WV-76A AC VTVM

Measures voltages down to 0.001 volt. Decibel scale for measure-

ments from -40 to +40 db. Built-in amplifier which may be used separately as a preamplifier. Typical applications include: frequency response tests of preamplifiers, power amplifiers and tone control circuits, signal tracing; measurements of audio level, power level and gain; amplifier balancing applications and general audio voltage measurements. **\$79.95***

F. RCA WG-360A STEREO PHASE CHECKER

A quick, simple, positive way to check phase alignment of low and mid-range speakers in stereo systems. Completely "sound-powered". Snag-proof recessed grille design. For use with a VOM, VTVM, or oscilloscope. **\$14.95***

See Them all at your Authorized RCA Electronic Instrument Distributor
RCA Electron Tube Division, Harrison, N. J.

*User price (optional)



The Most Trusted Name in Electronics