

# Electronics World

MAY, 1962

50 CENTS

DESIGN OF TRANSISTOR HI-FI POWER AMPLIFIERS

INDUSTRIAL NOISE AND ITS MEASUREMENT

BUILD A TRANSISTORIZED PHOTORHYTHMICON

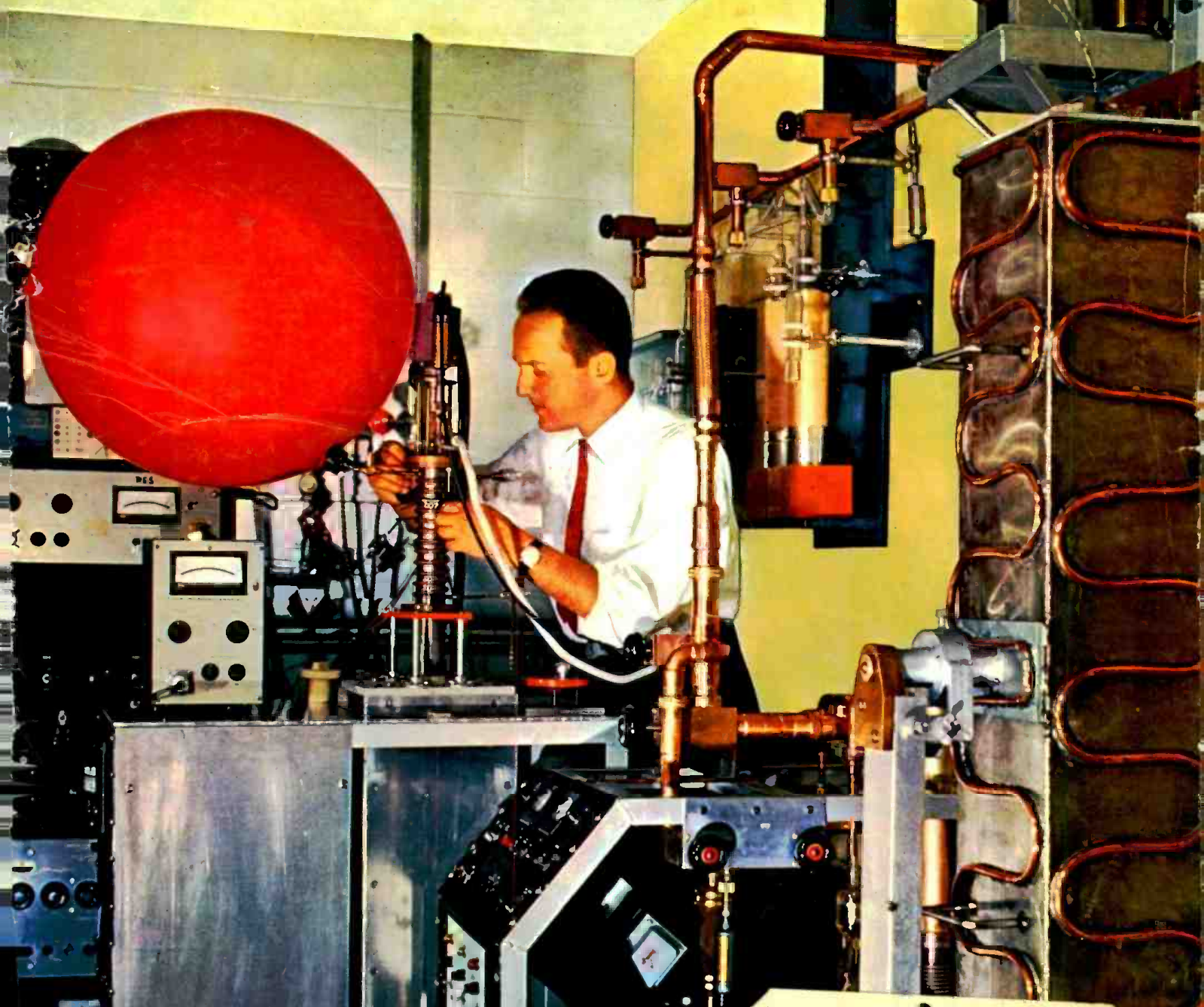

**Plus — CAN YOU MISMATCH HI-FI POWER AMPLIFIER**

**Power Story — STATUS OF HEAT-TO-ELECTRICITY CONVERTERS**

RNIORH938124  
W WITKOSKI  
70 PLEASANT ST  
THORNDIKE MASS  
BOX 299



# Now is the time to come to the aid of your <sup>outdoor</sup> party!

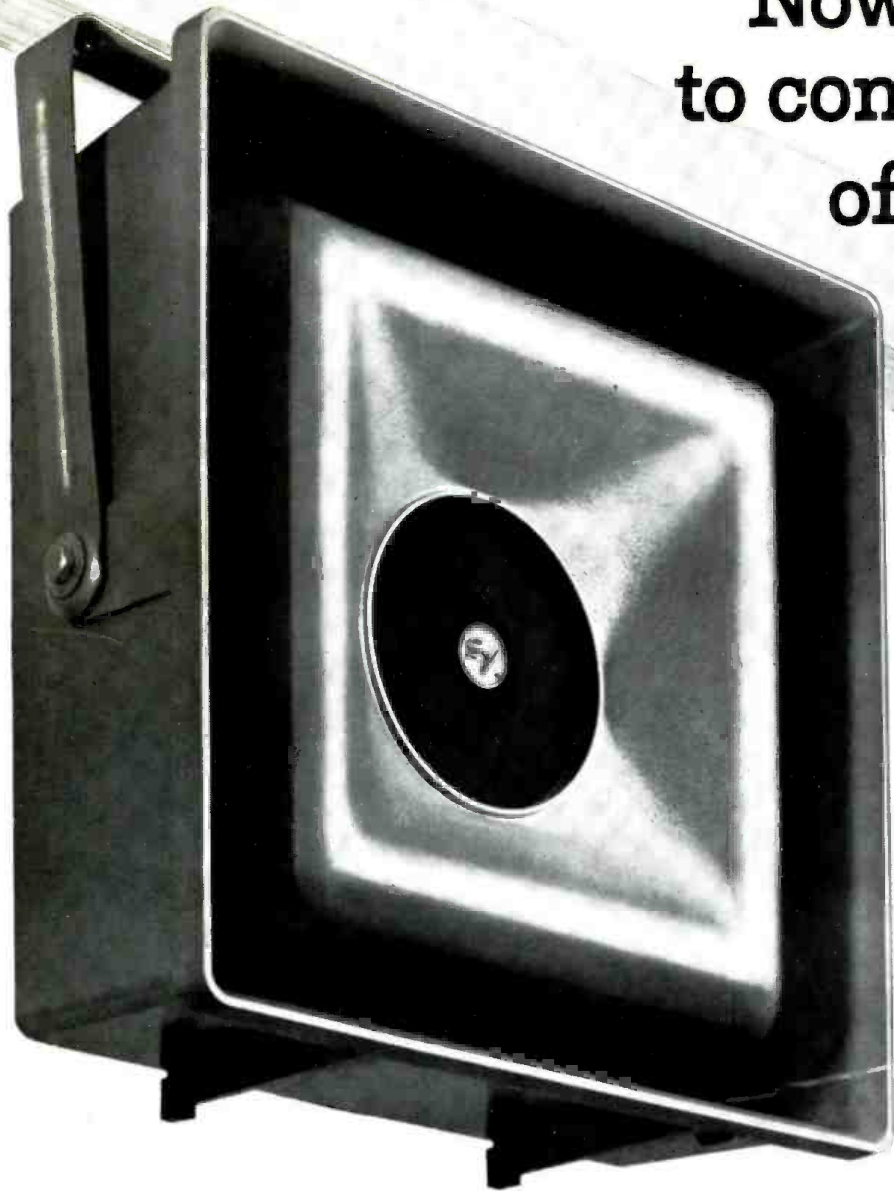

The more you enjoy outdoor living, the more you'll enjoy the Electro-Voice Musicaster—world's finest weather-proof loudspeaker system.

A Musicaster will add to your fun wherever you are. Whether you're dancing under the stars, swimming in the pool, or relaxing around the barbecue in the backyard, music from a Musicaster adds the pleasure of outdoor high-fidelity music from your present Hi-Fi system, radio, phonograph or TV set.

It's easy to connect for permanent use outside, or you can simply move your Musicaster into the recreation room for year-round pleasure.

Designed for indoor-outdoor use, the E-V Musicaster obtains high-fidelity response from a heavy-duty weather-proofed speaker mounted in a rugged aluminum die-cast enclosure. This combination insures long-lasting satisfaction under all conditions.

Now is the time to come to the aid of your outdoor party . . . with an Electro-Voice Musicaster. It's easy to install . . . send for full information and the name of your nearest E-V sound specialist.

## ELECTRO-VOICE High-Fidelity Speaker System . . . it's Weather-proofed!

*P.S. If your school, church or club needs a tough, high-quality, all-purpose speaker, the smart choice is an Electro-Voice Musicaster.*

### SPECIFICATIONS:

Frequency Response: 60-13,000 cps

Dispersion: 120°

Power Handling Capacity: 30 watts program

Impedance: 8 ohms

Size: 21½" H x 21½" W x 8½" D

Weight: 31 lbs. net

Price: \$54.00

Musicaster II available with additional tweeter to extend response to 18,000 cps. Price: \$75.00

Electro-Voice, Inc. Dept. 524N  
Buchanan, Michigan

Please send me your booklet, "How to Enjoy High-Fidelity Outdoors."

Name \_\_\_\_\_

Address \_\_\_\_\_

City \_\_\_\_\_

State \_\_\_\_\_

**Electro-Voice**®

ELECTRO-VOICE, INC., Consumer Products Division, Buchanan, Michigan



**C-25. IN-CIRCUIT CAPACITOR TESTER KIT.** Reveals shorted or open capacitors in the circuit, including electrolytics. Also reveals dried-out electrolytics through the Electrolytic Capacitance Dial. **Kit: \$19.95; Factory Wired, ready to operate: \$29.95.**



**V-70. VACUUM TUBE VOLTMETER KIT.** Uses stabilized bridge circuit to provide measurements on 7 DC and 12 AC voltage ranges, plus 7 decibel and 7 wide-spread electronic ohmmeter ranges. **Kit: \$31.95; Factory Wired, ready to operate: \$49.95.**



**G-30. RF SIGNAL GENERATOR KIT.** Highly accurate, stable. Also designed for use as a Marker Generator in sweep-alignment procedures. Eight frequency ranges: 160 kc to 240 mc. **Kit: \$32.95; Kit with Prealigned Tuner: \$39.95; Factory Wired, ready to operate: \$44.95.**



**MX-100. STEREO MULTIPLEX ADAPTER KIT.** All critical circuitry factory adjusted and prealigned. Maximum stereo separation between 20-15,000 cps, with low distortion. Stereo switch permits either front-panel separation control or maximum separation adjusted at factory. **Kit: \$49.95; Factory Wired, ready to operate: \$69.95.**

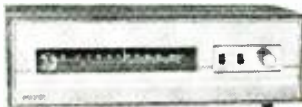

**ST-26. FM TUNER/AMPLIFIER KIT.** Low-cost combination hi-fi FM music system. Requires only the addition of external speaker (see L-3) to complete system. Pre-Built Front End fully adjusted and prealigned at factory. **Kit: \$54.95; Factory Wired, ready to operate: \$69.95.**



**L-3. SPEAKER SEMI-KIT.** Ultra-compact, graciously styled system. Lifelike response from high-efficiency speakers. Walnut-finished cabinet. Size: 13 1/4" L x 6 1/2" H x 7 1/4" D. **Semi-Kit: \$19.95.**

**PAGO KITS**

THE KITS YOU BUILD IN 1/3 LESS TIME



**FROM BOX...**

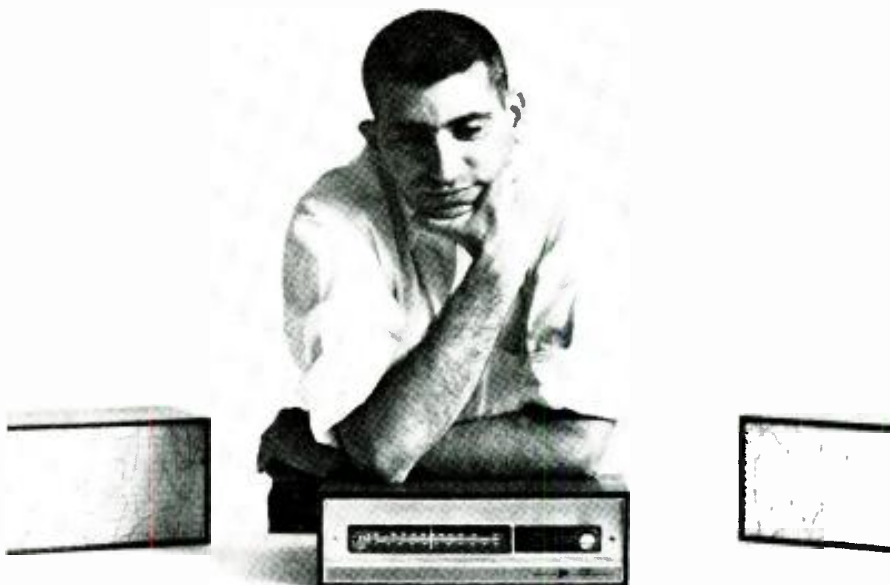

**TO BEETHOVEN IN 1/3 LESS TIME!**

In timed, competitive tests, twin brothers — with twin backgrounds and skills — proved that Paco kits are faster, easier and more fun to build than almost-identical kits sold by other kit makers. They discovered that there's no guessing with Paco: parts are neatly packaged and precisely labeled; instruction books are complete and easy to follow. Accurate drawings to actual scale and fold-out diagrams are printed right next to step-by-step directions. ■ The twins also proved that Paco pleasure doesn't end with the wiring. The ST-25 MX FM Stereo Multiplex Tuner®, for example, looks and performs like twice the price: frequency response is 30 to 20,000 cps within 2 db; sensitivity is 1.5  $\mu$ v for 20 db quieting. It features self-contained, prealigned and fully shielded front end, FM Stereo multiplex circuitry, dual limiters, AFC with panel switch for AFC defeat and "eye"-type tuning indicator. Why not put Paco to your test. **Kit: \$69.95 net.** (factory wired, ready to operate: \$99.95). See your dealer or write today for details to Paco Electronics Co., Inc., 70-31 84th Street, Glendale 27, New York, a division of Precision Apparatus Company, Inc. Export: Morhan Corporation, 458 Broadway, New York 13, New York. In Canada: Atlas Radio Corporation, 50 Wingold Avenue, Toronto, Canada.

AS PICTURED ABOVE

**PAGO KITS**

THE KITS YOU BUILD IN 1/3 LESS TIME

## New Heavy Duty RFI Suppression Kit For Mobile Radio



The Sprague Type SK-1 SUPPRESSIKIT— Easily installed on any truck, car, or boat engine using a 2-pole d-c generator.

**R**ADIO HAMs, fleet owners, and CB operators can now enjoy clearer, more readable, less tiring mobile communications at longer effective ranges.

Sprague's new Type SK-1 SUPPRESSIKIT provides effective RF Interference suppression—at moderate cost—up through 400 megacycles. Designed for installation on automobiles, trucks or boats with either 6-volt or 12-volt generators, the Suppressikit makes possible high frequency interference control by means of Sprague's new, extended range, Thru-pass® capacitors.

The components in the SK-1 Suppressikit are neatly marked and packaged, complete with easy-to-follow installation instructions. All capacitors are especially designed for quick, simple installation. Unlike general-purpose capacitors, these heavy-duty units are rated at 60 amperes, and will operate at temperatures to 125°C (257°F). This means you'll have no trouble with an SK-1 installation in the terrific temperatures found "under the hood" on a hot summer's day. There's no chance of generator failures from capacitor "short outs", as with 85°C general purpose capacitors.

The Deluxe Suppressikit is furnished complete with an 8-foot shielded lead on the generator capacitor which can be trimmed to necessary length for any car or small truck, preventing RF radiation from armature and field leads.

Containing only 5 easy-to-install capacitors, the Deluxe Suppressikit is truly a "do-it-yourself" kit. The net price of \$17.85 is a little higher than that of makeshift, thrown-together kits, but it saves you so much time and aggravation it's well worth the slight extra cost.

If the SK-1 Suppressikit is not available at your Sprague Electronic Parts Distributor, send your order to Sprague Products Company, 51 Marshall St., North Adams, Mass.

**Sprague TWIST-LOK® Capacitors give you**  
**2 tremendous advantages over**  
**all other twist-prong electrolytics**



**1**

**The right size, the right rating, for EVERY replacement job**

No need to compromise or improvise...the TWIST-LOK Line includes over 1690 different capacitors . . . It's the industry's most complete selection of twist-prong type capacitors, bar none!

**2**

**Exclusive, improved cover design for greater dependability**

Type TVL Twist-Lok Capacitors are now more dependable than ever! Sprague's new cover design provides a truly leak-proof seal and permits capacitors to withstand higher ripple currents.

### Compare internal construction of TWIST-LOK to ordinary 'Lytic!

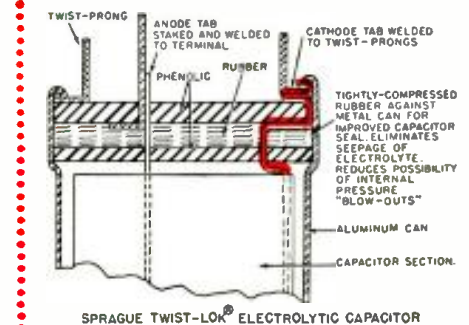
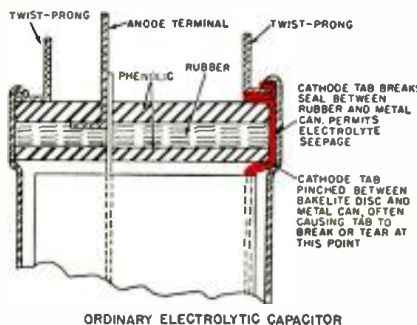

Complete listings are shown in handy Wall Catalog C-457. Get your copy from any Sprague Distributor, or write to Sprague Products Company, 51 Marshall St., North Adams, Mass.

**WORLD'S LARGEST**  
**MANUFACTURER OF CAPACITORS**



## CONTENTS

### INDUSTRIAL

Recent Developments in Electronics	32
Direct Heat-to-Electricity Energy Converters	Stoyan M. Zalar 39
Cover Story	40
Feedback Loops in Binary Scaler Design	J. Frank Brumbaugh 80

### TEST EQUIPMENT

Product Test Report (Eico 250 A.C. V.T.V.M. and Amplifier) EW Lab Tested	20
Testing the Tunnel Diode	Harold Reed 29
Transistor Characteristic Curve Tracer	Elton W. Anderson 30
Dynamic Transistor Bridge	Stanley E. Bammel 52
Neon Lamp Leakage Tester	J. Alan Hastings 74
Linearizing the Thyatron Timer	Ronald L. Ives 92
A.C. Calibration	R. G. Finkbeiner 95

### HI-FI AND AUDIO

Product Test Report (Sharpe Model HA-10 Stereo Phones, "Knight" KN-1020 Stereo Tonearm, Pioneer SH-100 "Stereoscope") EW Lab Tested	14
Noise and Its Measurement	Frederick T. Van Veen 25
Design of Transistor Hi-Fi Power Amplifiers	Dwight V. Jones 35
Mismatching Hi-Fi Amplifiers	Herman Burstein 54

### GENERAL

1962 Tube Inventory for Service Shops	Robert A. Larsen 42
High-Frequency Response of Cascaded Stages	Donald W. Moffat 44
Maintenance in Teaching Labs	Russ Pavlat 46
Check that Grid Bias	Charles B. Randall 72

### COMMUNICATIONS

Communications via Satellites (Editorial)	W. A. Stocklin 6
Ham of the Year	58
Golden Anniversary of Ham Licensing to Honor Old Timers	69
FCC Warns on Home Broadcasting	71

### ELECTRONIC CONSTRUCTION

Transistorized Photorhythmicon—Dancing Lights	Leon A. Wortman 49
Audio-Operated Fluorescent Lamp Display	John Potter Shields 73

### MONTHLY FEATURES

Letters from Our Readers	10
Mac's Electronics Service	John T. Frye 34
Technical Books	62
Service Industry News	64
Calendar of Events	66
Electronic Crosswords	Claude B. Green, Jr. 79
Within the Industry	88
New Products and Literature for Electronics Technicians	96

(For information on Next Month's Features, see page 4)

*Publisher*  
PHILLIP T. HEFFERNAN

*Editor*  
WM. A. STOCKLIN, B. S.

*Technical Editor*  
MILTON S. SNITZER, W2QYI

*Service Editor*  
SIDNEY C. SILVER

*Associate Editor*  
ROBERT D. FREED

*Associate Editor*  
P. B. HOEFER

*Editorial Consultant*  
OLIVER READ, D.Sc., W4TWV

*Industrial Consultant*  
WALTER H. BUCHSBAUM

*Art Editor*  
MILTON BERWIN

*Art and Drafting Dept.*  
J. A. GOLANEK

*Advertising Sales Manager*  
LAWRENCE SPORN

*Advertising Service Manager*  
ARDYS C. MORAN



ZIFF-DAVIS PUBLISHING COMPANY  
Editorial and Executive Office  
One Park Avenue  
New York 16, New York  
ORegion 9-7200

MIDWESTERN and CIRCULATION  
OFFICE  
434 South Wabash Avenue  
Chicago 5, Illinois  
WAbash 2-4911  
Midwestern Advertising Manager  
Gilbert J. Jorgenson

WESTERN OFFICE  
9025 Wilshire Boulevard  
Beverly Hills, California  
CRestview 4-0265  
Western Advertising Manager  
Bud Dean

FOREIGN ADVERTISING  
REPRESENTATIVE  
D. A. Goodall Ltd., London, England

May, 1962

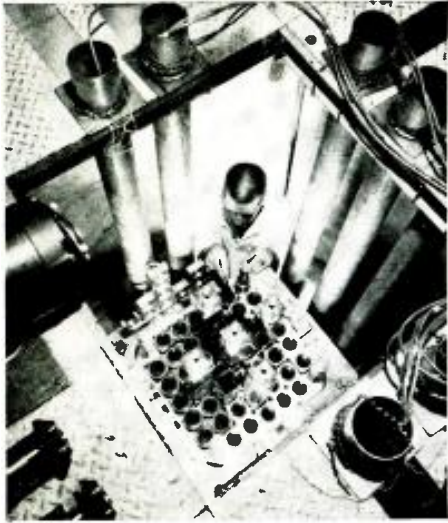

Coming  
Next Month

Electronics World

**SPECIAL  
TEST-EQUIPMENT  
ISSUE**

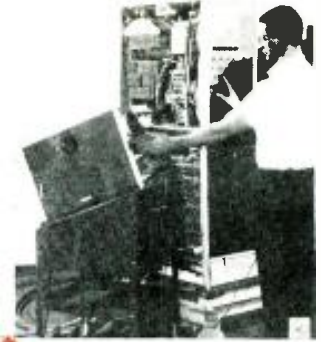

**PLUS WALL CHART on LISSAJOUS PATTERNS**

GET FACTS NOW...

**CREI can prepare you  
for Career Opportunities  
in Nuclear POWER**

WELL PAYING, EXCITING POSITIONS are created every day in the rapidly expanding nuclear field. Yet many are unfilled because industry cannot find qualified men.

**YOU CAN PREPARE YOURSELF** to take advantage of these opportunities. And build a rewarding career in this industry of the future through the CREI Home Study Program in Nuclear Engineering Technology. You can do it while on your present job.

**CREI HAS A WORLD-WIDE REPUTATION** earned in 35 years experience in advanced technical education. Thus, scientists in government and in private industry cooperated in preparing this vitally needed program.

**YOU CAN QUALIFY** for this program if you have a technical background and a high school education or the equivalent. For detailed information on career opportunities and CREI Programs, use coupon below.

MAIL COUPON TODAY  
FOR FREE 58 PAGE BOOK

**CREI**



A Division of  
The Capitol Radio Engineering Institute  
Dept. X1105-K, 3224 Sixteenth St., N. W.  
Washington 10, D. C.

Please send me details of CREI Home Study Programs and Free Book, "Your Future in Electronics and Nuclear Engineering Technology."

Name..... Age.....

Address .....

City..... Zone..... State.....

Education: Years High School.....

Other .....

30

**NUCLEAR RADIATION GAGES**

Radioactive isotopes plus electronic circuitry are being used in industry to measure and control a wide variety of processes. Learn about this new technique.

**TEST EQUIPMENT FOR THE SERVICE SHOP**

A practical "handbook" of test equipment needs for TV service shops operating on three different levels—based on shop size, type and diversity of work handled.

**DIRECTORY OF OSCILLOSCOPES**

Specifications on over 70 oscilloscopes designed for laboratory, manufacturing production line, and for service shop applications.

**TEST EQUIPMENT IN KIT FORM**

A run-down on most of the test instruments which can be purchased in kit form to save money for the industrial lab or production line and the radio-TV service shop owner.

**THE DOSIMETER**

One of the popular personal radiation detection devices—how it works and how to service and test it.

**TEST EQUIPMENT FOR COMMUNICATIONS SERVICING**

The Service Manager of a large manufacturer of communications equipment offers suggestions on the type of equipment needed by organizations handling all types of communications gear from CB to two-way land and marine mobile.

**AUTOMATION AND TEST PROCEDURES**

The rise in automated production lines has opened a new field in the development of specialized equipment involving automatic test devices. Here are some of the details.

**OXYGEN ANALYZERS**

While space flights have made such analyzers "glamorous," they also have other applications in various fields of industry and medicine.

**FM MULTIPLEX SIGNAL GENERATORS**

The proliferation of FM multiplex has triggered a new breed of signal generator for those who build and service such equipment. Who will need this equipment and why?

**PLUS . . . .**

**DISTORTION IN LOUDSPEAKERS**

A well-known speaker designer discusses how much distortion a hi-fi speaker produces, its causes, and measurement.

**TECHNICIANS & THE COMPUTER FIELD**

What is the future for the technician in the computer field? One well-known firm analyzes its personnel policies and potentials with respect to technicians.

**IN-HOME TV SERVICING**

How can a technician determine at just what point in-home servicing is impossible or impractical? Words of wisdom from a man who knows.

All these and many more interesting and informative articles will be yours in the June issue of **ELECTRONICS WORLD** . . . on sale May 22nd

**ZIFF-DAVIS PUBLISHING COMPANY**

William B. Ziff

Chairman of the Board (1946-1953)

William Ziff  
President

M. T. Birmingham, Jr.  
Vice President and Treasurer

W. Bradford Briggs  
Executive Vice President

Robert P. Breeding  
Circulation Director

Hershel B. Sarbin  
Vice President and General Manager

Charles Housman  
Financial Vice President

Member  
Audit Bureau of  
Circulations



**Net Paid Circulation 229,531**

Radio & TV News • Radio News • Radio-Electronic Engineering Trademarks Reg. U.S. Pat. Off.  
Copyright © 1962 by Ziff-Davis Publishing Company. All rights reserved.

**SUBSCRIPTION SERVICE:** All subscription correspondence should be addressed to Electronics World, Circulation Department, 434 South Wabash Avenue, Chicago 5, Illinois. Please allow at least six weeks for change of address. Include your old address, as well as new—enclosing if possible an address label from a recent issue.

**EDITORIAL CONTRIBUTIONS** must be accompanied by return postage and will be handled with reasonable care; however publisher assumes no responsibility for return or safety of art work, photographs, or manuscripts.

**ELECTRONICS WORLD**

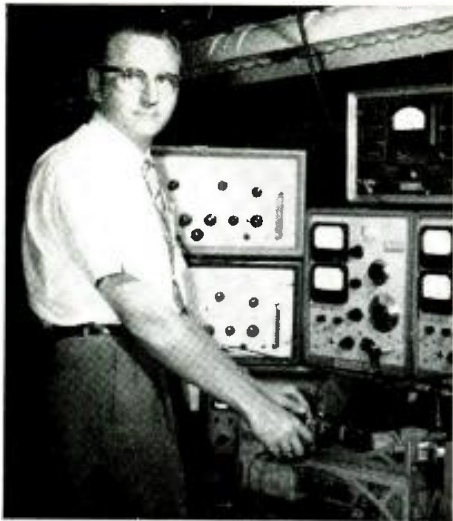

**RICHARD S. CONWAY** (CREI grad 1960) is Supervisor, Electronic Test Department Wilcox Electric Co., Kansas City, Mo.



**ROBERT T. BLANKS** (CREI grad 1960) is Engineer, Research & Study Div., Vitro Labs., Division of Vitro Corp. of America, Silver Spring, Md.



**MEARL MARTIN, Jr.** (CREI grad 1956) is a Senior Engineer and Field Support Manager, Tektronix, Inc., Portland, Oregon.

## Why do these men now enjoy profitable careers in electronics that others still dream about?

**SUCCESS IS NO ACCIDENT.** There is a reason why some men move ahead in electronics while others stand still, year after year, in routine, low-paid jobs. Responsible, rewarding positions in electronics require advanced technical knowledge. Without such knowledge, you cannot hope for success no matter how bright and ambitious you are.

**THE THREE MEN SHOWN ABOVE** realized that career opportunities would open up for them only if they gained the practical knowledge of electronic engineering technology demanded by industry. They gained this knowledge through CREI Home Study Programs and achieved the success they desired.

**YOU HAVE THE SAME OPPORTUNITY.** Through CREI Home Study Programs, you can acquire the practical working knowledge of advanced and up to date electronic engineering technology that will put you on the level of specialization where men are most in demand.

**YOU WILL FOLLOW THE FOOTSTEPS** of the thousands of CREI men who hold positions as associate engineers, engineering aides, field engineers, project engineers and technical representatives. They work in every area of electronics, from manufacturing to the space program.

**WHEN YOU ENROLL IN A CREI HOME STUDY PROGRAM,** you study courses to which a number of leading engineers and scientists have made substantial contributions. You are guided and assisted by CREI's staff of experienced instructors.

**YOU HAVE A CHOICE OF PROGRAMS** covering every field of electronics:

**RADAR • COMPUTERS • SERVOMECHANISMS • INSTRUMENTATION • AERONAUTICAL AND NAVIGATIONAL • COMMUNICATION • TELEVISION • AUTOMATION AND INDUSTRIAL ENGINEERING TECHNOLOGY • NUCLEAR ENGINEERING TECHNOLOGY**

**CREI EDUCATION IS RECOGNIZED** by many large corporations such as National Broadcasting Company, Pan American Airways, Federal Electric Corporation, The Martin Company, Canadian Broadcasting Co., Mackay Radio, and many others. These companies often pay all or part of CREI tuition for their employees.

**CREI HAS 35 YEARS OF EXPERIENCE** in advanced technical education through home study. CREI has de-

veloped electronics courses for the Army Signal Corps, special radio technician courses for the Navy, and group training programs for leading aviation and electronics companies. CREI also maintains a Residence School in Washington, D. C.

**YOU CAN QUALIFY** for a CREI Program, if you have basic knowledge of radio or electronics and are a high school graduate or the equivalent. If you meet these qualifications, write for FREE 58-page book describing CREI Programs and career opportunities in advanced electronic engineering technology. Mail coupon or write to: The Capitol Radio Engineering Institute, Dept. 1105-K, 3224 Sixteenth St., N.W., Washington 10, D. C.

Mail coupon today for FREE 58-page book



**THE CAPITOL RADIO ENGINEERING INSTITUTE**

Founded 1927

Dept. 1105-K, 3224 Sixteenth St., N.W., Washington 10, D.C.

Please send me details of CREI Home Study Programs and Free Book, "Your Future in Electronics and Nuclear Engineering Technology." My qualifications are noted to obtain immediate service.

**CHECK FIELD OF GREATEST INTEREST:**

- Electronic Engineering Technology       Nuclear Engineering Technology  
 Servo and Computer Engineering Technology       Automation and Industrial Electronic Engineering Technology  
 Aero and Navigational Engineering Technology

Name ..... Age .....

Address .....

City ..... Zone ..... State .....

Employed by .....

Type of present work .....

Education: Years High School ..... Other .....

Electronics Experience .....

Check:  Home Study     Residence School     G.I. Bill

28

**Preserve the Genius  
of the Masters with the**



**Natural Sound  
of Tandberg**

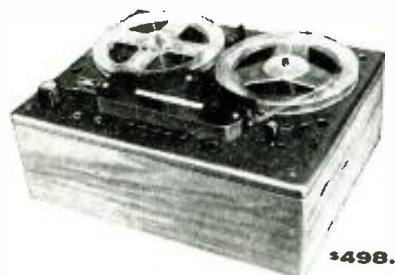

**MODEL 6 3 SPEED 4 TRACK  
STEREO RECORD/PLAYBACK TAPE DECK**

The remarkable features of this superb unit speak for themselves — records 4 track; plays back 2 and 4 track stereo and mono; records/plays back FM Multiplex Stereo-cast with magnificent clarity, even at 3¾ ips. Permits sound-on-sound, track adding, direct monitor from source or tape; has push button controls, three separate Tandberg engineered precision laminated heads, hysteresis synchronous motor; installs into HI-FI system. Price \$498. Remote control "F" model also available.



**MODEL 65 3 SPEED 4 TRACK  
STEREO PLAYBACK TAPE DECK**

Another Tandberg triumph — for pure playback of 2 and 4 track stereo and mono tapes with finest frequency response. Extremely versatile; facilities for adding erase and record heads. Price \$199.50.

*Tandberg remains unchallenged for clear, crisp, natural sound!*

**Tandberg** OF AMERICA, INC.,  
8 THIRD AVENUE, PELHAM, NEW YORK



**...for the Record**

By **W. A. STOCKLIN**  
Editor

## COMMUNICATIONS VIA SATELLITES

**E**XCITEMENT is at a fever pitch these days over the prospects of world-wide communications, by means of satellites, with many systems and ideas being explored simultaneously. High- and low-altitude satellites, active and passive types, for both military and civilian systems, are all in various stages of planning and execution.

Most of these projects are being paid for out of Government funds. There is, however, one outstanding exception and that is the *Bell System's* "Telstar" experimental satellite communications program. This is being financed entirely by *Bell System* funds, even to re-im-bursing the National Aeronautics and Space Administration for launching and tracking costs which will run around \$3,000,000 for each satellite.

Project "Telstar" will use an "active" satellite —one that can receive microwave signals and then amplify and re-transmit them. In essence, the satellite will function as a "microwave tower in the sky."

All the electronic equipment on the satellite, which will include a traveling-wave tube capable of producing 2½ watts output, will be powered by silicon solar cells.

Andover, Maine will be the site of an experimental ground station for "Telstar." The highly directional antenna for this station is of the horn-reflector type which was successfully used in Project "Echo." It has a beam width of .16 degree at 6000 mc. and can readily track a moving satellite despite its huge size of 161 feet in length, 60 feet across its mouth. Its over-all weight exceeds 300 tons. It will be protected by the largest inflatable radome ever built—a rubber-dacron structure 210 feet in diameter and 160 feet high. A 2-kilowatt traveling-wave tube will provide transmitting power at about 6390 mc. and a low-noise ruby maser amplifier will receive a 4170-mc. signal from the satellite.

The satellite itself is planned to travel in an elliptical orbit, with a maximum height of about 3000 miles and a minimum of about 500 miles.

"Telstar" is an experimental program and in itself does not represent design of an operational communications system. It will be used to collect and transmit all types of scientific data back to earth. Of the 2325 transistors and diodes in the satellite, about 94 per-cent will be used for command and telemetry functions.

There has been a great deal of controversy over the relative merits of many suggested systems. *AT&T* feels that with the present state of the art,

a medium-level altitude of about 7000 miles is most practical and a satellite system using this altitude stands the best chance of being developed into an operational system in the shortest time. Their proposed plan is to have 30 to 50 active satellites traveling in random polar circular orbits which will provide nearly continuous world-wide communications.

World-wide communications, which will include television, is a fantastic engineering project. It represents a peaceful application of our satellite program. It is so vast that, with the exception of *AT&T*, no single company could financially support such a project. This has led to much controversy in our industry. *AT&T* has indicated the desire to accept this challenge yet many companies fear such vast control vested in a single organization. Similar fears have been expressed over government control of such a monopoly. President Kennedy recently suggested a billion-dollar plan for a new satellite program. He has outlined a world-wide communications network in space which would be owned and operated by a number of private investors. One million shares of stock in this venture have been suggested, to be sold to the public at not less than \$1000 a share. Profits, if any, will be small for the first decade but the future looks extremely bright when one compares the capability of the satellite system with present-day cable systems. "Telstar" could provide 1000 voice channels compared to 100 for a single telephone cable. A single satellite system could provide one TV circuit which would normally require ten transatlantic cables.

Congratulations are in order to all those who have the knowledge and especially the foresight to plan a program of this magnitude. It is, literally, a "break-through" and will, in time, open a vast new area to augment our present communications facilities. We are not primarily concerned with the political aspects nor are we mainly interested in who will eventually operate and control this program. We would, however, be quite disturbed should any unnecessary delays hinder further development of a space communications system.

With the technological advancement achieved to date, further development should be encouraged, not hindered. The system will not only provide more channels for communications, and at great reliability, but a whole new branch of the communications industry will be opened up and will provide many more jobs for technically trained and competent people. ▲



# how to get a Commercial FCC LICENSE

## An FCC License, Or Your Money Back!

Completion of the Master Course (both Sections) will prepare you for a First Class Commercial Radio Telephone License with a Radar Endorsement. Should you fail to pass the FCC examination for this license after successfully completing the Master Course, you will receive a full refund of all tuition payments. This guarantee is valid for the entire period of your enrollment agreement.

# FREE!

find out how . . .

1. You can get job security. Specialized education is the road to higher salary and important jobs in the growing field of electronics.
2. You can solve the problems that stump other technicians. Problems in electronics are becoming more complex. Your ability to solve problems will help you get ahead in your field.
3. You can handle new electronic devices. Every day, advances are being made in electronics. Only through education can you find out how to keep up with these developments and how to use the new devices.

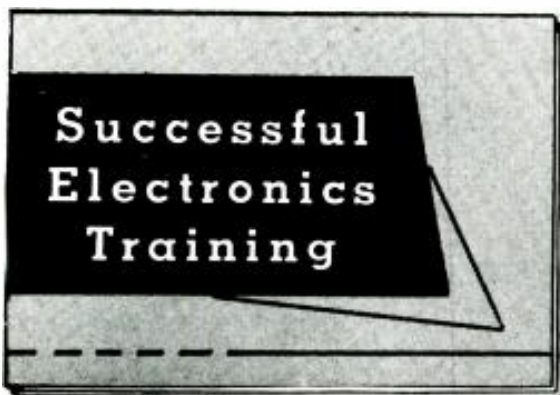

### Increase Your Technical Knowledge

Get a government license plus an understanding of such electronic applications as computers . . . industrial electronics . . . radar . . . communications . . . and many more.

**CLEVELAND INSTITUTE OF ELECTRONICS**

1776 E. 17th St. Desk RN 65 Cleveland 14, Ohio

May, 1962



good training  
doesn't cost . . .  
it pays!

## Get All 3 Booklets and This Handy Pocket Electronics Data Guide **Free**

Puts all the commonly used conversion factors, formulas, tables, and color codes at your fingertips. Yours absolutely free if you mail the coupon today. No further obligation.

### Sorry — Not For Beginners

Please inquire only if you really want to get ahead and to add to what you have already learned in school, in the service, or on the job. Some previous schooling or experience in electronics, electricity, or related fields is necessary for success in Cleveland Institute programs.

Accredited by the National Home Study Council

#### Cleveland Institute of Electronics

Desk RN 65, 1776 E. 17th St., Cleveland 14, Ohio

Please send Free Career Information prepared to help me get ahead in Electronics. I have had training or experience in Electronics as indicated below.



- |   |   |
|---|---|
| <input type="checkbox"/> Military           | <input type="checkbox"/> Broadcasting       |
| <input type="checkbox"/> Radio-TV Servicing | <input type="checkbox"/> Home Experimenting |
| <input type="checkbox"/> Manufacturing      | <input type="checkbox"/> Telephone Company  |
| <input type="checkbox"/> Amateur Radio      | <input type="checkbox"/> Other _____        |

In what kind of work are you now engaged?

In what branch of Electronics are you interested?

Name \_\_\_\_\_ Age \_\_\_\_\_

Address \_\_\_\_\_

City \_\_\_\_\_ Zone \_\_\_\_\_ State \_\_\_\_\_

RN-65

**FOR THE ULTIMATE  
IN AUDIO TAPE  
RECORDING**

**M**agnecord

... Known and used the world over to satisfy the most demanding requirements for performance and reliability in military and scientific recording in the space age.

- **SONAR RECORDING**
- **NATIONAL SECURITY**
- **COUNTER INTELLIGENCE**
- **SURVEILLANCE RECORDING**
- **OCEANOGRAPHIC RESEARCH**
- **ELECTRONIC COUNTERMEASURES**
- **SATELLITE DATA RECORDING**
- **ROCKET TEST INSTRUMENTATION**

**M**agnecord



**ALSO BRINGS YOU...**

... A full range of professional and home instruments for the ultimate in audio recording and reproduction... The Industry Standard at a price you can afford.

- **RECORDING QUALITY**
- **EXTENDED SERVICE**
- **MINIMUM MAINTENANCE**
- **CONSISTENT RELIABILITY**
- **FULL FIDELITY RESPONSE**

Represented by leading audio dealers and industrial electronics distributors the world over. Write today for additional information regarding your requirements.



For the dealer nearest you... write  
**MAGNECORD SALES DEPARTMENT**  
**MIDWESTERN INSTRUMENTS**  
P. O. BOX 7509 • TULSA 35, OKLAHOMA

# LETTERS

## FROM OUR READERS

**"ENGINEER" AND "TECHNICIAN"**

To the Editors:

The question of the use of the title "engineer" is a prickly one, particularly where the connotation is so varied. The legislatures of the various states and territories of the United States have enacted laws which define who may use the term "engineer," and what constitutes the practice of engineering. Briefly, no one may call himself an "engineer" or offer to practice engineering unless he complies with the following:

- (1) Have at least four years of college work and a degree of BS; or have at least four years of practical experience which the examining board may deem equivalent to a college education.
- (2) Have four years of practical experience, after graduation from college.
- (3) Pass an examination prepared by the Board of Registration.
- (4) Have received from the Board of Registration a license certifying that he has successfully met the requirements of the Board.

Having received such a license, the applicant may call himself an "engineer" and offer to practice engineering for whoever will hire him. The statutes generally define the practice of engineering (as in Ohio) to "include any professional service, such as consultation, investigation, evaluation, planning, design, or responsible supervision of construction or operation, in connection with any publicly or privately owned public utilities, structures, buildings, machines, equipment, processes, works or projects."

While some employers have restricted the use of the title "engineer" to those so licensed by the state, others still use it for unlicensed personnel who hold positions of authority and responsibility. However, in the event of the need for legal testimony, it is likely that the opinion of the licensed engineer would carry more weight than that of the technician.

I do not wish in any way to derogate the skill and knowledge of many extremely competent technicians, but I feel it necessary to explain the legal basis for the use of the title "engineer."

WILLIAM F. MCALLISTER, P.E.  
Cincinnati, Ohio

*Reader McAllister's letter was prompted by the editorial discussing the technician in our January issue. In addition to letters from professional engineers, like the above, giving us their use of the term "engineer" we have received letters from engineering university deans, who give us a different usage of the term, and from people in the field who are actually doing engineering and*

*design work, who have still a different way of using the word.*

*It seems that there is just as much confusion and difference of opinion over the use of the word "engineer" as there is for the word "technician."—Editors.*

**SPEAKER EFFICIENCY**

To the Editors:

Mr. George Augspurger suggests in his article "The Importance of Speaker Efficiency" which appeared in the January 1962 issue, that the high-compliance, "long-throw" woofer doesn't really produce more bass only less mid-range. Development work here tends to disprove this statement. By incorporating certain mechanical construction it is possible to build a loudspeaker that will produce a greater "undistorted" quantity of low-frequency energy. This statement disregards enclosure air loading and relative acoustical power in the middle "piston-band" frequencies.

A speaker designed for maximum low-frequency output will have a higher mechanical resonant "Q" by virtue of (a) higher moving-system mass and, (b) overhanging turns of voice coil wire above and below the magnetic gap. This situation tends to reduce harmonic distortion by both suspension non-linearity and non-linear electrical drive. In fairness it has to be admitted that transient response too may suffer because in achieving greater cone excursion the speaker is deliberately underdamped.

By contrast, the moving system of a speaker designed for maximum "efficiency" will have a lightweight moving system and a minimum of voice coil wire not immersed in the magnetic gap. In the middle "piston band" acoustical output will be large but the bass range will be overdamped if an efficient magnetic circuit is used. In addition, bass harmonic distortion will greatly reduce the usable bass output.

CHARLES L. MCSHANE  
Chief Engineer  
Cinaudagraph Acoustical Labs  
Chicago, Illinois

*There are a good many ways of designing loudspeakers depending on what the designer is after and what he feels the listener wants.—Editors.*

**BC-221 FOR CB**

To the Editors:

For a long time I intended to construct a power supply specifically for my BC-221 frequency meter but never got around to it. Recalling Mr. R. L. Conhaim's article "Using the BC-221 to Check CB Frequency" in the May 1961 issue of *ELECTRONICS WORLD* got me started, and I got all parts for the

# DOUBLES YOUR EFFECTIVE MANPOWER

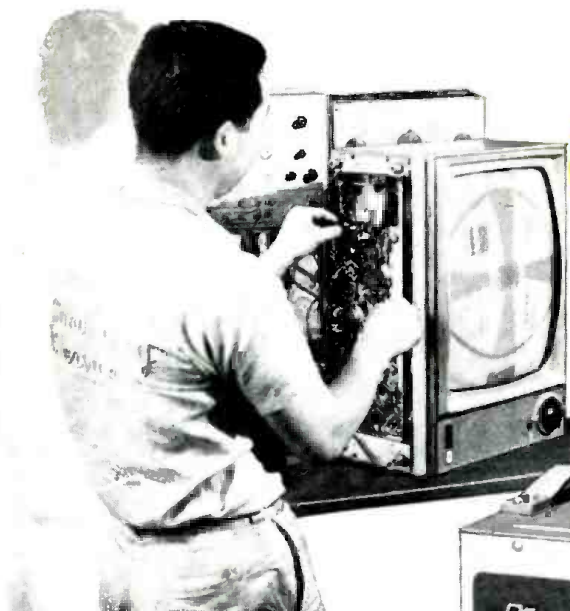

Fix "Tough Dogs" Fast!

Save Half Your Time!

Step Up Your Profit!

**B&K** NEW  
MODEL 1076

## TELEVISION ANALYST

for Black & White and Color



Check all circuits—Pinpoint any TV trouble...in minutes

**By Easy Point-to-Point Signal Injection,  
You See the Trouble on the TV Screen and  
Correct it—Twice as Fast and Easy!**

There's no longer any need to "lose your shirt" (and customers)—and worry about the lost hours you never recover—on "tough dogs" or even intermittents. *The remarkable B&K Analyst* enables you to inject your own TV signal at any point and watch the resulting test pattern on the picture tube itself. *Makes it quick and easy to isolate, pinpoint, and correct TV trouble in any stage throughout the video, audio, r.f., i.f., sync, and sweep sections of black & white and color television sets—including intermittents.* Makes external scope or wave-form interpretation unnecessary. Most useful instrument in TV servicing! Its basic technique has been proved by thousands of successful servicemen the world over.

The Analyst enables any serviceman to cut servicing time in half, service more TV sets in less time, really satisfy more customers, and *make more money.*

Model 1076. Net, \$29995

Available on Budget Terms. As low as \$20.00 down.

Combines all the features of both  
the Model 1075 and Model A107

- |  |                                      |
|--|--------------------------------------|
| COMPLETE R.F. and I.F.                       | HI-VOLT INDICATOR                    |
| VIDEO TEST PATTERN                           | YOKE and HI-VOLTAGE TRANSFORMER TEST |
| COMPOSITE SYNC                               |                                      |
| FM MODULATED AUDIO                           | <b>Also Now Provides:</b>            |
| COLOR PATTERNS                               | SWITCH-TYPE TUNER                    |
| HORIZONTAL and VERTICAL PLATE and GRID DRIVE | NEGATIVE BIAS SUPPLY                 |
| B+ BOOST INDICATOR                           | AGC KEYING PULSE                     |
|  | PICTURE TUBE MODULATION              |

**B&K**

**B & K MANUFACTURING CO.**

1801 W. BELLE PLAINE AVE • CHICAGO 13, ILL.

Canada: Atlas Radio Corp., 50 Wingold, Toronto 19, Ont.

Export: Empire Exporters, 277 Broadway, New York 7, U.S.A.

See Your B & K Distributor or Write for Bulletin AP18-N!

**RESIDENT SCHOOL COURSES  
IN NEW YORK AND LOS ANGELES**

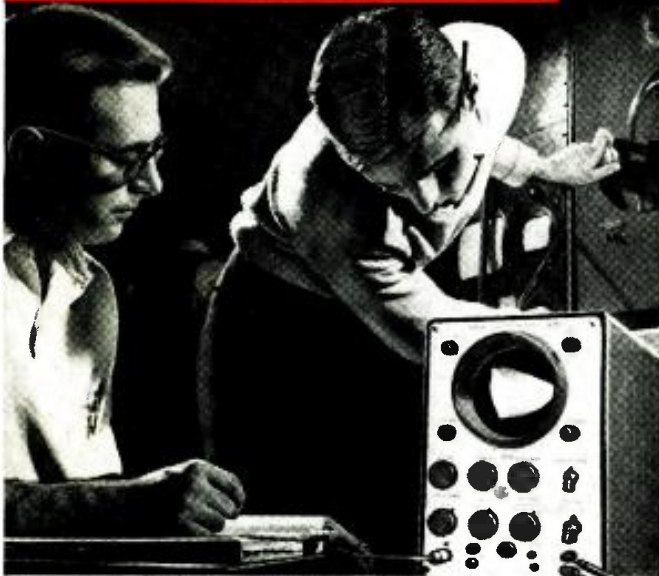

**Industry needs Electronic Technicians!**

**Let RCA  
train you in  
Advanced Electronics**

This is the college-level training you need to work with professional engineers on research, development, or production projects in such fields as: automation, guided missiles, radar, television, computers, and other advanced electronic applications.

RCA Institutes Resident Schools in New York City and Los Angeles offer this comprehensive course that prepares you for any field of electronics you may choose. Other courses in TV and General Electronics, Radio and Television Servicing.

Classes start four times each year. Applications now being accepted.



**RCA INSTITUTES**  
SCHOOLS OF TELEVISION & ELECTRONIC TECHNOLOGY  
A Service of Radio Corporation of America

—Send to the school nearest you!—

**RCA Institutes, Inc., Dept EWR-52**

350 West 4th Street  
New York 14, N.Y.

Pacific Electric Building,  
Los Angeles 14, Calif.

Please send me your FREE catalog of Resident School courses.

Name \_\_\_\_\_ (PLEASE PRINT)

Address \_\_\_\_\_

City \_\_\_\_\_ Zone \_\_\_\_\_ State \_\_\_\_\_

For Home Study Courses See Ad On Opposite Page

supply described were on hand the unit was built exactly as suggested. It is just what the BC-221 needed.

For the benefit of constructors to be, the 5-volt leads from the transformer should go to pins 2 and 8 on the 5Y3 socket and not to 1 and 8. When operating with a normal 117 v.a.c. supply line, a fixed resistor having a value of 4000 ohms may be used for R.

Mr. Paul S. Andrews, in the October 1961 issue, expressed concern about tube life under continuous use as suggested in the article. I have found from past experience that tube life is usually longer under continuous use than with intermittent operation as pointed out by Mr. Conhaim.

The article is an excellent treatment of the BC-221 and contains much helpful information. Anyone intending to use this instrument for CB should refer back to this issue of ELECTRONICS WORLD.

HAROLD REED  
Hyattsville, Md.

*We are still receiving requests for information on the use of the frequency meter discussed above for CB work. The article referred to by Reader Reed is certainly "must" reading for anyone who is interested in using the BC-221 for this purpose.—Editor.*

**SOLDER-FLUX RESIDUE**

To the Editors:

I have recently completed wiring a multiplex-adaptor kit which uses a printed circuit. Although the adaptor works very well indeed, I am a little worried about leakage through the residue of solder flux between the conductors on the printed board. The board doesn't look very neat this way, and I wonder if there is a simple way of removing the flux that remains on the printed-circuit board.

PETER SMEAD, JR.  
Phoenix, Arizona

*Although the board may not look too neat with the flux on it, Reader Smead can be assured that residue from any good rosin or resin-type flux need not be removed from any printed wiring terminal for reasons of electrical leakage. The Kester Solder Company, for example, has indicated to us that the resistance of such flux is so high that there should be absolutely no electrical leakage at all if the flux remains on the board. They go on to say that the only reason these residues are removed is to (1) enhance the appearance of the board, (2) secure some operating procedure with which the flux might physically interfere, or (3) conform to some specification.*

*Therefore, although rosin flux can be dissolved with alcohol, we feel that the use of an excessive amount of solvent of this type would probably do more harm to the other components than good. Hence, we suggest that the flux be left on the board.—Editors.*

**UNIVERSAL CONTROL CIRCUIT**

To the Editors:

By using the d.c. amplifier presented in the January, 1962 issue of ELECTRONICS WORLD in an article entitled "Universal Control Circuit" by Ryder Wilson, it is possible to devise a simple, low cost, direct-writing oscillograph. Depending on the method and precision of construction, one should be able to build a fairly accurate instrument which will operate from d.c. up into the audio frequencies. This should prove extremely useful in square-wave audio amplifier checking, product counting, flow metering, temperature recording, and a host of other "ings," all accomplished with one small amplifier.

This thought was fostered by the appearance of the excellent article on direct-writing oscillographs in the same issue. The co-publication of such articles does credit to the editors. It is just this mixture of technical articles and practical circuits that leads readers to appreciate this magazine and to find the extra value in it which makes it both informative and useful.

With the d.c. amplifier described, one way to construct the oscillograph writing unit (the problem child), is to use any old 100-ma. meter movement. This can be done by extending the pointer arm and fixing a small capillary pen, such as those used in water-flow recorders, to it.

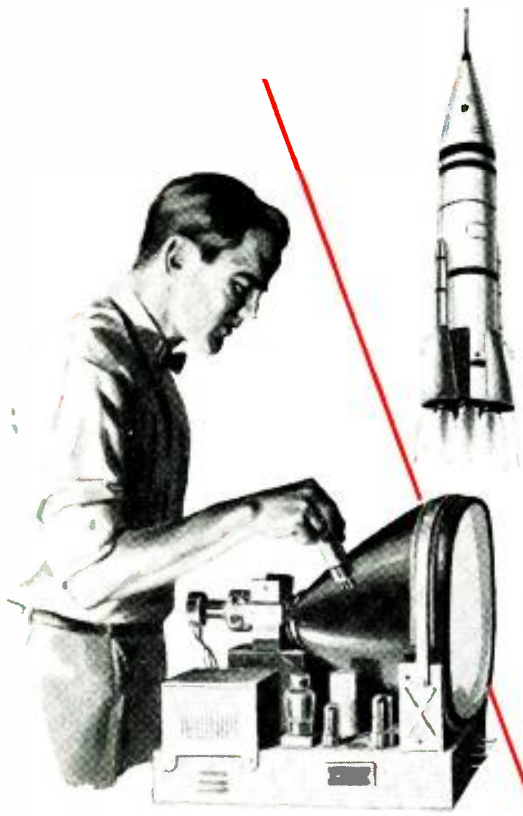

# 6 REASONS WHY RCA TRAINING IN ELECTRONICS can be the smartest investment you'll make in your *entire lifetime!*

**1. You get the finest training-at-home** under the supervision of the RCA INSTITUTES, experts in technical training for over 50 years. The very name "RCA" means dependability, integrity, and scientific advance.

**2. You get comprehensive training** in your choice of many complete up-to-date Courses . . . including Radio and Electronic Fundamentals, TV Servicing, Color TV, Transistors, Automation Electronics, Communications Electronics, Computer Programming.

**3. You get Theory, Experiment, and Service Practice** starting with the very first lesson . . . a complete training package throughout the course. No special technical background is required.

**4. You get prime quality equipment** as a regular part of your Course . . . equipment that you keep and use on the job. You never have to take apart one piece to build another.

**5. Voluntary Tuition Payment Plan.** You pay for each lesson only when you order it. If you interrupt your course *at any time, for any reason*, you owe nothing more unless you resume. You *never* have to pay for the whole course if you don't complete it.

**6. You get top recognition —** Graduates of RCA Institutes now work for leaders in the electronics field; many have their own businesses. This record is true tribute to the high quality of RCA Institutes training.

Send for this  
64-page Home  
Study Catalog  
**FREE!**



**RESIDENT SCHOOL** Courses in New York City and Los Angeles offer comprehensive training in Television and Electronics. Day and Evening classes start four times each year. Detailed information on request.

## RCA INSTITUTES, Inc. Home Study School

A Service of Radio Corporation of America Dept. EW-52  
350 West Fourth Street, New York 14, N. Y.

Please rush me your **FREE** illustrated 64-page book "Your Career in Electronics," describing your home training programs. No obligation. No salesman will call.

Name ..... Age.....  
please print

Address .....

City ..... Zone..... State.....

Korean Vets! Enter discharge date.....

**CANADIANS** — Take advantage of these same RCA courses at no additional cost. No postage, no customs, no delay. Send coupon to:  
RCA Victor Company, Ltd., 5581 Royalmount Ave., Montreal 9, Quebec  
To save time, paste coupon on postcard.

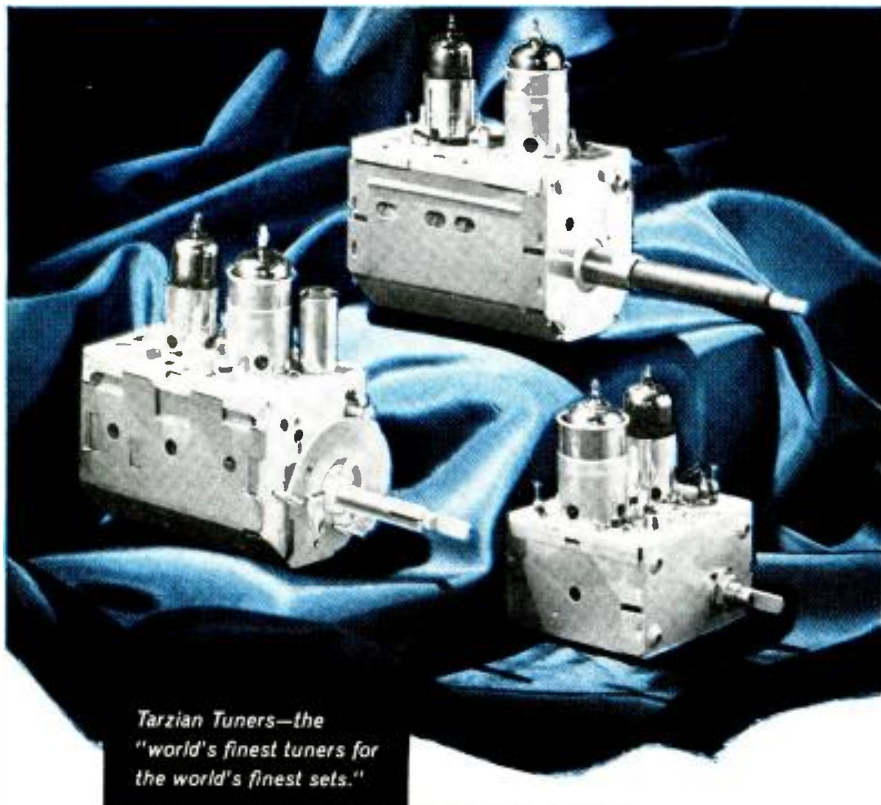

Tarzian Tuners—the  
"world's finest tuners for  
the world's finest sets."

## QUALITY... DEPENDABILITY AND EXCELLENT PERFORMANCE AT LOW COST

Engineering excellence, reliability and sensible pricing on ALL Tarzian products are a part of our approach to "Practical Ingenuity in Electronics." You'll find it in all of these electronic products from SARKES TARZIAN, INC.: TV and FM TUNERS . . . . SEMICONDUCTORS . . . . AIR TRIMMERS . . . . RADIO and TV BROADCAST EQUIPMENT . . . . CLOSED CIRCUIT TELEVISION for Educational and Commercial use . . . . MAGNETIC TAPE . . . . FM RADIOS and AM/FM RADIOS.

*Electronic Products of Tomorrow—Today*



# SARKES TARZIAN INC

east hillside drive • bloomington, indiana edison 2-7251

I would rather try something else. For instance, a fairly sensitive, long throw solenoid might do. The plunger is fitted with an aluminum strip into which the pen is placed. At the other end of the strip is a spring which serves to damp the solenoid and return the pen to zero. This arrangement would work for d.c. variations from zero on up but the swing could only be positive. With a little effort, perhaps two opposed solenoids with a pen between them would work for a.c. There is the added advantage of straight line pen movement with this system, thus eliminating curved graphs, a nuisance. A clockwork paper transport is easily built for slow changes in d.c. and a small motor could replace the clockwork for higher frequency work. Another d.c. amplifier like the one mentioned above could drive a small d.c. motor for speed variations. Put almost any pulser or electro-something-or-other transducer on the input of the amplifier and one should have a handy recorder costing practically nothing and having great versatility.

R. C. AMENDOLA  
Urbana, Illinois

*Thanks to Reader Amendola for his comments and his interesting suggestions. —Editors.*

#### TRANSISTORIZED METAL LOCATOR

To the Editors:

You may be interested in knowing that I am heading a group of 20 people who are going to the Caribbean area to look for some of the caches of treasure buried there. As part of our equipment we are taking with us six of the metal locators described in my article "Transistorized Metal Locator" which appeared in your March 1962 issue.

W. E. OSBORNE  
Whittier, California

*We know our readers are always interested in learning about some of the uses to which our construction projects are put. —Editors.*

#### TRANSISTORIZED SCOPE

To the Editors:

This is in reference to your article "A Miniature Transistorized Oscilloscope" which appeared in your February 1962 issue. On this nice-looking unit, I believe that the battery life will be extended greatly if the connection to the heater of the 913 (pin 7) is changed to the switched contact of  $S_{10}$ .

Prospective builders of the above unit might be interested in the 902P1 CRT which uses a lower maximum anode voltage and has a greater deflection sensitivity.

EDMUND SHEFFIELD, JR.  
San Francisco, California

*You are quite right about the incorrect connection from the CRT heater to switch  $S_{10}$  in Mr. Barmore's transistorized oscilloscope. Since this tube is the only part of the circuit requiring warm-up time, our draftsman was evidently carried away by the thought that "instant-on operation" could be obtained with this error. —Editors.* ▲

# ARE YOU "ON TARGET?"

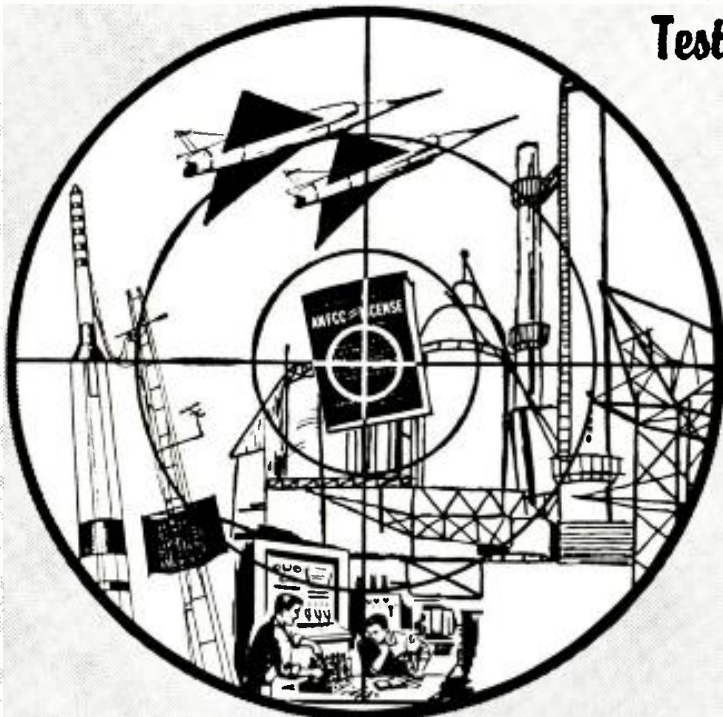

Test Yourself.....

## ANSWER THESE QUESTIONS:

- DO YOU want to get into ELECTRONICS?
- Do you have a SPECIFIC OBJECTIVE in mind ... Are you shooting at a particular target (such as an FCC License)?
- Do you want the kind of training that will take you straight to this objective QUICKLY... without wasting valuable time on non-essentials?

The Grantham Communications Electronics Course prepares you for your first class commercial

## F.C.C. LICENSE

**QUICKLY!**

CORRESPONDENCE OR RESIDENCE CLASSES

## Do Grantham Training for You?

### CHECK THESE FEATURES:

- Grantham teaches the *theory* of electronics. Every basic concept of electronics fundamentals is covered in the Grantham course...whether you take it in resident classes or by home study. Grantham training "makes electronics yours."
- You can get your First Class FCC license IN ONLY 12 WEEKS in Grantham resident classes (or, in a correspondingly short time in the Grantham home-study program). THINK OF IT! A commercial U.S. Government license...PROOF OF YOUR qualifications in meeting these U.S. Government requirements as an electronics communications technician... a nationally recognized certificate. By preparing you for this license in only 12 WEEKS, Grantham conserves YOUR TIME!
- Mature men select Grantham Schools for electronics training. (The average age of Grantham Students is 28.8 years.) MATURE MEN want a definite objective (not a pot of gold at the end of the rainbow). Grantham training has this specific objective: To prepare you for your First Class FCC license and greater earning capability. The Grantham Course is for mature men who know what they want.

- Grantham Schools' tuition rates are low, yet the instructional service is not equalled by many of the *most expensive schools!* Grantham can do this because of highly efficient instructional methods and because Grantham has a sincere desire to out-do all others in service rendered per tuition-dollar. Grantham has established *reasonable* tuition rates. And, the percentage of students who successfully complete the Grantham course — and who get their FCC licenses — is one of the highest in the nation.
- YOU GAIN RESPECT by showing your Grantham diploma, once you earn it. YOU GAIN RESPECT by showing and posting your First Class FCC License — a nationally recognized certification of your electronics knowledge. Many companies which employ industrial electronics technicians require them to have this license. YOU CAN GET IT IN ONLY 12 WEEKS. Let Grantham show you how!

### HERE'S PROOF: Here is a list of a few of our recent graduates, the class of license they got, and how long it took them:

	License Weeks
James C. Bailey, 217 Behrends Ave., Juneau, Alaska .....	1st 12
Edward R. Barber, 907 S. Winnifred, Tacoma, Wash. ....	1st 20
M. A. Dill, Jr., 20 Cherry St., Gardiner, Maine .....	1st 12
Bernhard G. Fokken, Route 2, Canby, Minn. ....	1st 12
Kenneth F. Foltz, Broad St., Middletown, Md. ....	1st 12
James C. Greer, Mound City, Kansas .....	1st 12

Get your First Class Commercial F.C.C. License Quickly by training at



## GRANTHAM SCHOOL OF ELECTRONICS

Accredited by the National Home Study Council

1505 N. Western Ave.    408 Marion Street    3123 Gillham Road    821-19th Street, N.W.  
 Los Angeles 27, Calif.    Seattle 4, Wash.    Kansas City 9, Mo.    Washington 6, D. C.  
 (Phone: HO 7-7727)    (Phone: MA 2-7227)    (Phone: JE 1-6320)    (Phone: ST 3-3614)

MAIL COUPON NOW — NO SALESMAN WILL CALL →

(Mail in envelope or poste on postal card)

**To: GRANTHAM SCHOOL OF ELECTRONICS**

1505 N. Western    408 Marion    3123 Gillham Rd.    821-19th, NW  
 Los Angeles    Seattle    Kansas City    Washington

Gentlemen:

Please send me your free booklet telling how I can get my commercial F.C.C. license quickly. I understand there is no obligation and no salesman will call.

Name \_\_\_\_\_ Age \_\_\_\_\_

Address \_\_\_\_\_

City \_\_\_\_\_ State \_\_\_\_\_

Interested in:  Home Study,  Resident Classes

26-E

## Product Test Report

AUDIO PRODUCTS TESTED BY HIRSCH-HOUCK LABS

**Sharpe Model HA-10 Stereo Phones**  
**"Knight" KN-1020 Stereo Tonearm**  
**Pioneer SH-100 "Stereoscope"**  
**Eico 250 A.C. V.T.V.M. & Amplifier**

### Sharpe Model HA-10 Stereo Phones

For copy of manufacturer's brochure, circle No. 57 on coupon (page 106).



**T**HE Model HA-10 "Live-Tone" stereo headphones, manufactured by E. J. Sharpe Instruments, Inc., of Buffalo, N. Y., are constructed with exceptional solidity, each earpiece being enclosed in

a high-impact rubber shell. The adjustable steel headband is rubber-covered for the wearer's comfort. A six-foot molded rubber-covered cord, firmly anchored to the earpieces, is terminated in a three-circuit phone plug, using a common ground for the two channels.

The phones have unique liquid-filled ear pads, made of a flexible plastic material. These conform to the head contours with remarkable effectiveness. In our listening tests, we found that these phones not only completely excluded external sounds, but also blocked radiation of sound from the phones into the room. No matter how loud the program (and surprisingly high sound levels can issue from these phones when they are not being worn), when the phones are pressed together along their seals, or placed on the head, absolutely no sound at all can be heard by anyone but the wearer.

Probably another factor contributing to their freedom from radiated sound,

and no doubt to their over-all performance, is the fact that the earpieces are well filled with damping material, both behind and in front of the radiating diaphragm.

Running up and down the spectrum with an audio oscillator revealed a smooth, peak-free response extending from 30 cps to over 15,000 cps. The low-frequency response was solid and free from audible distortion at reasonable listening levels, down to approximately 30 cps.

We measured the impedance of the phones as 8.8 ohms per channel at 1000 cps. It remained virtually constant from 20 cps to 8000 cps, rising slightly at higher frequencies. About 10 milliwatts of power is needed for good listening volume. To reduce hum and noise, which can be quite audible with the best of amplifiers when driving sensitive headphones, we placed a 220-ohm resistor in series with the output of each channel. The value is not critical, but some sort of attenuation is needed between amplifier and phones. The amplifier should be terminated in the correct load resistance to prevent damage to the output transformer or tubes.

In listening tests, the phones sounded very much like a high-quality loudspeaker system. Their smoothness and excellent transient response were clearly audible. The muddiness which sometimes occurs in headphones at high volume levels was refreshingly absent. The phones would seem to be ideal for the critical listener who wants to enjoy good music in complete isolation from his surroundings. They offer the realism which can only be achieved with headphones, without sacrificing the sound quality of a good loudspeaker.

The HA-10 phones are priced at \$43.50. ▲

### "Knight" KN-1020 Stereo Tonearm

For copy of manufacturer's brochure, circle No. 58 on coupon (page 106).

**T**HE "Knight" KN-1020 stereo tone arm is manufactured in Denmark by Bang & Olufsen and distributed in this country by Allied Radio Corporation of Chicago. It incorporates a number of desirable features not usually found in inexpensive arms.

The KN-1020 is a simple tubular arm with gimbal-type pivots. The vertical pivots appear to be of the needle type, isolated from the supporting gimbal ring by rubber bushings. Presumably these act as damping elements. The lower lateral pivot is a ball and socket type, with an indentation in the gimbal ring

resting on a ball which is part of the arm post. A pin passing through the upper part of the gimbal ring serves as the upper pivot. The shielded wire leads are carried through the lower ball pivot and the arm post, emerging under the motorboard.

The arm is fully balanced, with a calibrated spring to provide tracking forces from 1 to 4 grams. With the spring slack, the counterweight is adjusted for vertical balance. The mass of the counterweight is eccentrically distributed around the arm tube, and in the initial installation it is rotated to balance the arm laterally as well as vertically. When correctly balanced, the KN-1020 operates at any angle so that

accurate leveling of the turntable is unnecessary.

The friction of the stylus in the record groove produces a force tending to move the arm inward. This causes the stylus to lose contact with the outer groove wall at high recorded levels, producing distortion in one channel. The designers of the arm corrected this condition by offsetting the pivots so that they are not parallel and perpendicular to the plane of the record. They are tilted at a slight angle to the usual pivot orientation. This is intended to compensate for the inward frictional force and improve tracking of stereo records.

The cartridge shell snaps in and out of place on the arm without tools. It appears to be foolproof and positive in its action. The shell is wired with clips to fit most types of cartridges. A convenient finger lift is attached to the arm. The arm mounts in a single  $\frac{1}{2}$ " hole, at a distance of  $8\frac{1}{4}$ " from the turntable center. The shielded leads extend about 5" from the bottom of the arm post, and a terminal strip is provided for joining them to longer shielded cables connecting to the amplifier.

We measured the tracking error of the arm at less than 1.5 degrees over the entire record surface. The stylus





superb UHF pictures where other methods fail



**BLONDER-TONGUE**

**MAST-MOUNTED UHF BOOSTER / 5 models cover specific uhf channels from 14 to 83**



Model UB with remote power supply

The original Blonder-Tongue Ultra-booster covered only channels 70 to 83. When it was introduced in the MPAT and translator areas, it was so dramatically effective that installers throughout the country demanded units for their particular UHF channels. There are now five standard models, each covering a specific portion of the UHF spectrum: (1) UB 14 thru 29; (2) UB 25 thru 40; (3) UB 41 thru 55; (4) UB 56 thru 69 and (5) the original UB for 70 thru 83. In addition, other frequency ranges are available on a custom basis.

There's nothing like the Blonder-Tongue UB on the market today. Mast-mounted to take advantage of the maximum signal-to-noise ratio available at the antenna, it increases signal voltage by at least 14db. The UB uses two low-noise frame grid tubes. The remote power

supply sends a 'safe' 24 volts of AC power to the mast-mounted UB amplifier on the same downlead which carries the signal. The UB is enclosed in a weatherproof housing with swing-down chassis for easy servicing. The standard UB has 300 ohm inputs and outputs. It is available on a custom basis with 75 or 50 ohm inputs and outputs.

The UB may be used in master TV installations and for single sets in schools and homes. It delivers sharp, clear pictures in 'impossible' areas.

The Blonder-Tongue UB and either of the Blonder-Tongue UHF converters, models BTC-99r and BTU-2s, are the perfect team for superior UHF — anywhere. Today, contact the world's most experienced manufacturer of UHF products. For free 16-page Quick Reference Manual of TV Systems, write Dept. EW-5.

engineered and manufactured by

**BLONDER-TONGUE**

9 Alling St., Newark, N. J.

Canadian Div: Benco Television Assoc., Ltd., Tor., Ont. Export: Rocke Int'l. Corp., N. Y. 16—CABLES: ARLAB home TV accessories • closed circuit TV systems • UHF converters • master TV systems

force calibrations on the arm agreed exactly with a balance-type gauge from 2 to 4 grams, and read 0.75 gram at an indicated 1-gram setting. Using the CBS Laboratories STR-100 sweep record, we found no spurious resonances from 40 to 20,000 cps. The low-frequency arm resonance, whose frequency depends on the stylus compliance, occurred below 15 cps, and had an amplitude of about 2 db. This indicates effective damping action in the arm. The friction force correction worked perfectly, with both channels tracking identically at all parts of the record.

We had some reservations about the ball-type pivot used in the lateral plane. This would seem to be prone to higher friction than a needle pivot, for example. The friction is, in fact, somewhat higher than we have observed on other arms. If the arm is balanced and tapped gently, it moves and then stops abruptly, rather than drifting slowly to a stop. In spite of this, the friction is not high enough to interfere with the performance of most cartridges. Using one high-compliance cartridge, able to track at under 1 gram in the best arms, we obtained good tracking at 1.5 grams in the KN-1020. Most cartridges requiring 2 or more grams tracking force will not be limited by this arm.

The "Knight" KN-1020 is a well designed and constructed arm which matches the performance of many arms costing considerably more. It is fully flexible, easy to install, and convenient to handle. Additional plug-in shells are available, making cartridge changes a matter of seconds. The low rear overhang (less than 2½") permits its use in cabinets with limited space.

The "Knight" KN-1020 arm sells for \$19.95. Extra plug-in shells are \$2.95. ▲

**Pioneer SH-100 "Stereoscope"**

For copy of manufacturer's brochure, circle No. 59 on coupon (page 106).



**T**HE Pioneer SH-100 "Stereoscope," as far as we know the only device of its kind on the market, proves that some old-fashioned techniques still have their place. It is actually an acoustic phonograph pickup, coupled to a stethoscope earpiece for individual listening and designed to play stereo records.

The replaceable sapphire stylus is coupled to the acoustic transducers by a plastic yoke similar to those used to drive the elements of ceramic stereo cartridges. The transducers are connected to plastic tubes which are carried  
(Continued on page 20)



# Hermon Scott could make this new kit for \$30 less, If...

Hermon Scott faced a basic choice . . . bring out his new LK-48 amplifier kit at \$124.95 or make it to sell for \$30 less like many other amplifier kits. All his engineering department had to do was make a few compromises.

The LK-48 is rated at 48 watts. By using a smaller power supply, ordinary output transformers, and pushing the output tubes to their limits, the amplifier might still produce 48 watts at 1000 cycles where many amplifier kits are rated. But measured at 20 cycles, where Scott engineers feel power is really important, output would be down considerably. No compromise was made. The LK-48 *actually* produces 28 watts per channel at 20 cycles, and delivers full power throughout the audio range.

Many kits use a one color instruction book. Hermon Scott decided to continue to use full color to insure factory-built performance, even at the hands of a novice.

Important Scott engineering extras like the all-aluminum chassis, DC operated preamp heaters and unique hum-null balancing could have been eliminated. Hum would have been audibly higher and distortion at levels normal to many kits, but Hermon Scott felt that the kit builder was entitled to the same performance he has come to expect from Scott factory-wired units.

Yes . . . Hermon Scott could have made the LK-48 to sell for \$30 less . . . but it would have meant compromising life-long standards. This is something he would never do. You can choose any Scott kit with complete confidence — the LK-48, the LK-72 80 watt complete stereo amplifier, the LK-150 130 watt stereo power amplifier, the LC-21 professional preamplifier, the LT-110 multiplex tuner, LT-10 FM tuner or the LM-35 multiplex adaptor. These superb kits have all the features and performance you've come to expect from the world's leader in audio engineering.



## H.H. SCOTT

H. H. SCOTT INC., 111 Powdermill Rd., Maynard, Mass. Dept. 160-05

Please rush me your new full-color brochure telling about Scott's full line of superb stereo kits.

Name .....

Address .....

City ..... State .....

Export: Morhan Exporting Corp., 458 Broadway, N.Y.C.  
Canada: Atlas Radio Corp., 50 Wingold Ave., Toronto.  
Prices slightly higher West of Rockies.



## Special Training Equipment Included

Pick the field of your choice—and train at home with the leader—NRI. In addition to Industrial Electronics and FCC License training explained at the right, NRI offers comprehensive courses in Radio-TV Servicing and Radio-TV Communications. Except for the FCC course, all NRI courses include—at no extra cost—special training equipment for actual practice at home, building circuits and working experiments. Makes theory you learn come to life in an interesting, easy-to-grasp manner.

## Multiplexing, FM Stereo Broadcasting Included

NRI training keeps up with the times. New, additional profit opportunities exist for the Technician who understands the latest technical advances. Course material now covers FM Stereo Broadcasting, tells you about Multiplexing equipment, other recent developments.

## Learn More to Earn More

Act now. The catalog NRI sends you gives more facts about the field of your choice, shows equipment you get and keep. No obligation. Cost of NRI training is low. Monthly payments. 60-Day Trial Plan. Mail postage-free card today. **NATIONAL RADIO INSTITUTE, Washington 16, D.C.**

Send for  
64-Page  
CATALOG  
**FREE**

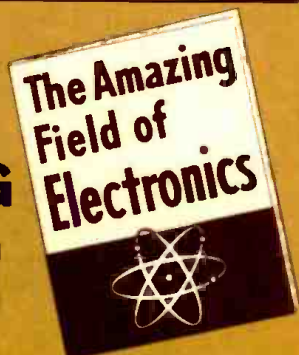

# NRI—Oldest and Largest Radio Television School Now Offers NEW HOME STUDY TRAINING IN INDUSTRIAL & MILITARY ELECTRONICS

This is the age of Electronics. Rapidly expanding uses for Electronic Equipment in industry, business, the military demands more trained men. Prepare now for a career as an Electronic Technician to assure advancement or to profit from your hobby. NRI now offers a complete course in **ELECTRONICS—Principles, Practices, Maintenance.** Computers, telemetry, automation, avionics are changing our world, yet all employ the same basic principles . . . and that is what this NRI course stresses with illustrated lessons and special training equipment. Mail card below.



## NEW HOME STUDY TRAINING FOR YOUR FCC LICENSE



An FCC Commercial License combined with NRI time-tested training can be the keys to a better future for you with higher pay, interesting work, more rapid advancement as the rewards. Prepare at home *quickly* for your FCC examinations through NRI's new, low-cost, special training. Like other NRI-trained men, you can be monitoring TV shows, radio broadcasts, operating shipboard and aviation radio, or holding down other important jobs. Get full details—mail the card below.

**FOR MORE INFORMATION-TURN PAGE**

## Cut Out and Mail—No Stamp Needed



**NATIONAL RADIO INSTITUTE  
WASHINGTON 16, D.C.**

Send me your Electronic, Radio-TV catalog without cost or obligation. I am interested in the course checked below: (No representative will call. Please PRINT.)

- INDUSTRIAL ELECTRONICS     COMMUNICATIONS  
 FCC LICENSE     SERVICING    **X**

Name \_\_\_\_\_ Age \_\_\_\_\_

Address \_\_\_\_\_

City \_\_\_\_\_ Zone \_\_\_\_\_ State \_\_\_\_\_

**ACCREDITED MEMBER NATIONAL HOME STUDY COUNCIL**

**ELECTRONICS NEEDS  
4 TO 7  
QUALIFIED TECHNICIANS**

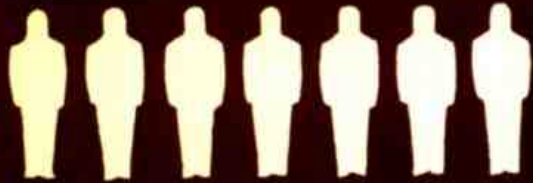

**FOR EVERY ENGINEER**



# Join The Thousands Who Trained For Advancement With NRI

Thousands of NRI graduates throughout the U. S. and Canada are proof that it is practical to train at home. NRI graduates are in every kind of Electronics work: inspectors, maintenance men, lab technicians, testers, broadcasting and mobile communications operators, Radio-TV service technicians, or in essential military and government posts. Catalog tells more about what NRI graduates do and earn. Mail postage free card.

## Choose from 4 Courses

- 1 INDUSTRIAL ELECTRONICS**  
Learn Principles, Practices, Maintenance of Electronic equipment used today by business, industry, military, government. Covers computers, servos, telemetry, multiplexing, many other subjects.
- 2 FCC LICENSE**  
Every communications station must have one or more FCC-licensed operators. New NRI course is designed to prepare you for your First Class FCC exams. You learn quickly, training at home in your spare time.
- 3 COMMUNICATIONS**  
Training for men who want to operate and maintain radio and TV stations; police, marine, aviation, mobile radio, etc. Includes FM Stereo broadcasting. Course also prepares you for your FCC license exam.
- 4 SERVICING**  
Learn to service and maintain AM-FM Radios, TV sets, Stereo Hi-Fi, PA systems, etc. A profitable, interesting field for a spare-time or full-time business of your own.



"THE FINEST JOB I EVER HAD" is what Thomas Bilak, Jr., Cayuga, N. Y., says of his position with The G. E. Advanced Electronic Center at Cornell University. He writes, "Thanks to NRI, I have a job which I enjoy and which also pays well."



**BUILDING ELECTRONIC CIRCUITS** on specially-designed plug-in type chassis, is the work of Robert H. Laurens, Hammonton, N. J. He is an Electronic Technician working on the "Univac" computer. Laurens says, "My NRI training helped me to pass the test to obtain this position."



"I OWE MY SUCCESS TO NRI" says Cecil E. Wallace, Dallas, Texas. He holds a First Class FCC Radio-telephone License and works as a Recording Engineer with KRLD-TV.



**MARINE RADIO OPERATOR** is the job of E. P. Searcy, Jr., of New Orleans, La. He works for Alcoa Steamship Company, has also worked as a TV transmitter engineer. He says, "I can recommend NRI training very highly."



**FROM FACTORY LABORER TO HIS OWN BUSINESS** that rang up sales of \$158,000 in one year. That's the success William F. Kline of Cincinnati, Ohio, has had since taking NRI training. "The course got me started on the road," he says.

**SEE OTHER SIDE**

FIRST CLASS  
PERMIT  
NO. 20-R  
(Sec. 34.9, P.L.&R.)  
Washington, D.C.

**BUSINESS REPLY MAIL**  
NO POSTAGE STAMP NECESSARY IF MAILED IN THE UNITED STATES

POSTAGE WILL BE PAID BY

**NRI** National Radio Institute  
3939 Wisconsin Avenue  
Washington 16, D.C.

## NRI IS OLDEST—LARGEST SCHOOL OF ITS KIND

Training men to succeed by home study has been the National Radio Institute's only business for over 45 years. NRI is America's oldest and largest Electronics home-study school. Don't delay. Cut out and mail POSTAGE-FREE CARD.



**MAIL POSTAGE-FREE CARD**

# FREE!

## LAFAYETTE

**340 GIANT-SIZE PAGE  
1962 ELECTRONICS CATALOG #620**

*"America's Hi-Fi & Electronics Shopping Center"*

Yours free for the asking — the biggest, best and most comprehensive catalog in the 41-year history of Lafayette Radio. Audiophile, Experimenter, Hobbyist, Technician, Engineer, Student, Serviceman, Dealer — you'll find what you want in this latest Lafayette catalog.



CATALOG # 620

**LARGEST STOCK SELECTION.** Stereophonic Hi-Fi equipment, Citizens Band, Ham and Amateur equipment, Radio & TV parts, Optics, Industrial Supplies, and much more, including all the favorite name brands.

**LAFAYETTE EXCLUSIVES.** Featured are the famous Lafayette Kits . . . dollar for dollar the best value for your money today. You'll also see hundreds of Lafayette specials . . . available only from Lafayette. And, as always, **SATISFACTION GUARANTEED OR MONEY REFUNDED.**

**LOWEST PRICES.** You'll save money too with Lafayette's low, low prices. The lowest prices are always in the Lafayette catalog.

**24-HOUR SERVICE.** Quick, courteous service is your guarantee at Lafayette. Most orders are fully processed within 24 hours after receipt in the mail Order Division.

**NEW EASY-PAY PLAN.**  
Now, **NO MONEY DOWN . . .**  
up to 24 months to pay.

NEW!



**NEW! CB TRANSCEIVER**  
with 8 CRYSTAL CONTROLLED CHANNELS.  
HE-208 ..... 109.50

**CB "WALKIE-TALKIE"**  
CRYSTAL CONTROL  
RECEIVE AND TRANSMIT.  
HE-29AL ..... Net 39.95  
2 for 78.88



**SUPERHETERODYNE COMMUNICATIONS RECEIVER**  
KT-200, Kit ..... 64.50  
HE-10, Wired ..... 79.95



**10,000 OHMS-PER-VOLT MULTITESTER**  
TE-10 ..... 9.95



**FM MULTIPLEX ADAPTOR Kit.** Fits wide-band tuners with or without MPX output jacks.  
KT-220 ..... Net 19.95

NEW!

**CITIZENS BAND MOBILE ANTENNA WHIP**  
HE-800WX ..... 6.95



### LAFAYETTE'S

**NEW MAIL ORDER and SALES CENTER**  
111 JERICHO TURNPIKE  
(2 Blocks West of South Oyster Bay Rd.)  
SYOSSET, LONG ISLAND, NEW YORK

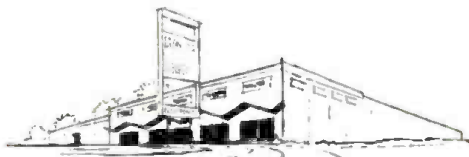

**LAFAYETTE RADIO DEPT. RE-2  
P.O. BOX 10, SYOSSET, L. I., N. Y.**

Rush my **FREE Lafayette 1962 Catalog 620**  
 Please send me # \_\_\_\_\_, shipping charges collect.

I am enclosing \$ \_\_\_\_\_

**340 PAGES**

Name \_\_\_\_\_

Address \_\_\_\_\_

City \_\_\_\_\_ Zone \_\_\_\_\_ State \_\_\_\_\_

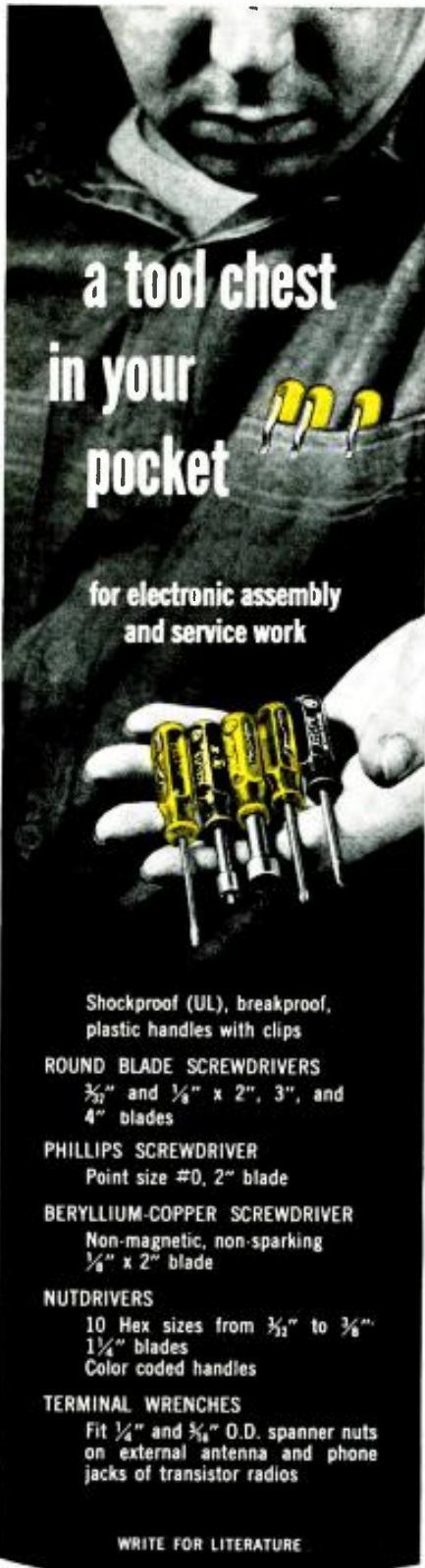

a tool chest  
in your  
pocket

for electronic assembly  
and service work

Shockproof (UL), breakproof,  
plastic handles with clips

**ROUND BLADE SCREWDRIVERS**

$\frac{3}{32}$ " and  $\frac{1}{4}$ " x 2", 3", and  
4" blades

**PHILLIPS SCREWDRIVER**

Point size #0, 2" blade

**BERYLLIUM-COPPER SCREWDRIVER**

Non-magnetic, non-sparking  
 $\frac{1}{4}$ " x 2" blade

**NUTDRIVERS**

10 Hex sizes from  $\frac{3}{32}$ " to  $\frac{3}{8}$ "  
 $1\frac{1}{2}$ " blades  
Color coded handles

**TERMINAL WRENCHES**

Fit  $\frac{1}{4}$ " and  $\frac{3}{8}$ " O.D. spanner nuts  
on external antenna and phone  
jacks of transistor radios

WRITE FOR LITERATURE

**XCELITE**®

**PROFESSIONAL  
POCKET TOOLS**

XCELITE, INC. • ORCHARD PARK, N. Y.  
Canada: Charles W. Pointon, Ltd., Toronto, Ont.

(Continued from page 16)

through the two parallel sections of the plastic arm to the yoke on which the arm pivots. These pivots are ingenious rotary joints, reminiscent of the rotary coaxial fittings used on radar antennas, which carry the signals to two metal fittings at the rear of the arm.

The stethoscope earpiece is connected to the arm by a pair of  $\frac{3}{8}$ " i.d. plastic tubes, about 7½ feet long. The stylus vibrations drive individual diaphragms in the transducers, which transmit pressure waves through the left and right channel tubes to the ears. Channel balance, volume control, and mixing are accomplished by a simple and foolproof system of valves, in a fitting inserted in the tubes. A pair of thumbscrew-operated valves regulate the volume in each tube, and their relative settings adjust channel balance. A third valve controls the coupling between the two tubes, mixing the signals before their arrival at the ears. It may be set for any condition from stereo to mono.

The arm, which includes a built-in rest, may be mounted on a motorboard in the conventional manner. If it is installed on a portable player which does not permit the required 7½" distance from arm pivot to turntable center, an extension bracket is supplied. A rubber suction cup can also be used for temporary installation on any smooth surface.

The stylus is protected against accidental damage by a pair of tiny rubber wheels on either side of it. When it is placed on a rotating record, the wheels retract, and are automatically reset each time the arm is returned to its rest. The normal tracking force of the SH-100 is 6 grams.

The tracking error of the arm varies from 0 degrees at a 2" radius to 6.5 degrees at a 6" radius. It is acceptably low, in view of the usual application of this device. When playing a frequency test record, the audible range of the SH-100 was approximately 30 to 10,000 cps. The response falls off above 1500 cps, to approximately equalize the usual RIAA recording pre-emphasis. Although there is some loss of volume below 100 cps, the lower bass is very full. These

are the only earphones we have used which make turntable rumble clearly audible.

Listening to stereo records with the Pioneer "Stereoscope" was, of course, the ultimate test. Most people who used the "Stereoscope" approached it with a certain amount of skepticism. Without exception, they were amazed at the quality of sound it produced. It wasn't "high fidelity," in the true sense of the term, but nonetheless was very pleasant, listenable sound. The stereo separation was as distinct as we have ever heard from earphones, and the blend control worked perfectly. Listening volume was excellent.

The general sound was on the "mellow" side, but sufficient highs were present so that the sound could not be considered as being muffled or "dead." The lows were truly remarkable, with pipe organ records producing a realistic pressure on the eardrums. Having recently had occasion to hear several "name brand" packaged phonographs selling in the \$200 to \$500 range, we can honestly say that the Pioneer "Stereoscope" reproduced a wider frequency range, had lower apparent distortion, a better stereo effect, and generally more pleasing sound than any of them.

The 6-gram tracking force of this pickup is rather high by current high-fidelity standards, and we wouldn't care to play our most treasured records with it. After several playings of some records, however, we could not hear any degradation of their sound on a good reproducing system. The "Stereoscope" also produces a large amount of needle talk, which makes much of its output audible to others in its vicinity.

This unusual reproducer seems particularly suited for use at the beach, or when camping, since it can be attached to any spring- or battery-operated turntable. Additional stethoscope earpieces and couplers are available so that up to four persons may listen simultaneously.

The Pioneer SH-100 "Stereoscope" is distributed by Lafayette Radio. It sells for \$9.95. Additional earphone kits are \$2.95 each. ▲

**Eico 250 A.C. V.T.V.M. and Amplifier**

For copy of manufacturer's brochure, circle No. 60 on coupon (page 106).

**T**HE Model 250 is another instrument in Eico's line of professional and industrial test equipment. This unit is a high-sensitivity, wide-band a.c. vacuum-tube voltmeter that is ideally suited for making audio measurements. Even the very low-level signals from magnetic phono cartridges and microphones can be easily read on the meter.

The instrument has 12 ranges, from 1 mv. to 300 volts full scale, and readings may be made directly in db, if desired. The meter actually responds to the average value of the applied a.c. signal, but the scale is calibrated to read r.m.s. values of a sine wave. The two voltage scales are perfectly linear making them easy to read. Input impedance of the meter is 10 meg. shunted by 15  $\mu$ mf.

The block diagram shows the circuit arrangement used in the instrument. On the six low

ranges, the input voltage is applied directly to a cathode-follower. On the six higher ranges, the signal goes through a frequency-compensated 60-db (1000:1) voltage divider before being applied to the cathode-follower. At the output of this stage is a 6-tap divider which is switched for the various ranges. Signal is then applied to a two-stage, wide-band pentode amplifier whose output contains a full-wave crystal-diode bridge circuit. This circuit rectifies the signal and applies it to the 200- $\mu$ m. indicating meter. Degenerative feedback is used to keep the amplifier stable and linear. New frame-grid tubes are used throughout for high gain. A voltage-regulated power supply keeps the readings constant in spite of line-voltage changes and d.c.-biased heaters, along with a hum pat, keep the internal hum from the heaters at a low value.

(Continued on page 60)

# In All the World Never a Kit Value Like This

FM STEREO BY **knight-kit**<sup>®</sup>

ONLY **\$19<sup>95</sup>** NO MONEY DOWN

**STEREO FM  
MULTIPLEX KS-10A  
ADAPTER KIT**



a pleasure  
to build...  
a revelation  
in performing  
quality

*enjoy beautiful Stereo FM reception at unbelievably low cost*

**IDEAL FOR USE WITH ANY FM OR FM-AM  
TUNER WITH MULTIPLEX OUTPUT JACK**

**PROOF OF SUPERIOR VALUE**

• Self-powered—installs out of sight • Separation control for precise stereo adjustment (23 db separation) • Input sensitivity 0.2 volts • Frequency response 50-15,000 cps, ±1 db • Noise filter (switchable) for use in weak signal areas • Top-performing circuit using 2 dual and 1 triple-purpose tubes • Power supply is transformer-operated; uses selenium rectifier • Pi-filter network for ripple-free B+ voltage — hum is practically inaudible • Prealigned coils • AC on-off switch • Three 36" connecting cables included.

Simply plugs into your tuner's Multiplex output and your amplifier's tuner inputs. With all connecting cables, tubes, parts, and famous Knight-Kit step-by-step instructions. 3 $\frac{3}{4}$  x 8 $\frac{1}{2}$  x 4". For 110-125 v. 60 cycle AC. Shpg. wt., 4 lbs.



*typical of the value and quality of over  
100 other great KNIGHT-KITS*

**KNIGHT ELECTRONICS DIVISION  
ALLIED RADIO**

Now you can have the pleasure of an easy kit-building experience. Now you can enjoy all the tonal beauty and realism of Stereo FM broadcasts just by adding this quality Knight-Kit Multiplex adapter to your present stereo music system. The savings simply can't be duplicated. The quality can't be matched for anywhere near the price. Order the KS-10A Knight-Kit Multiplex adapter today—*no money down* (just check coupon). An unbeatable value at only . . . **\$19<sup>95</sup>**

**Satisfaction guaranteed or your money back**



**ALLIED RADIO,**  
100 N. Western Ave., Chicago 80, Ill.

- Ship me \_\_\_\_\_ KS-10A Knight-Kit Multiplex Adapter(s) 83YX656F
- Ship on Allied's Credit Fund Plan—no money down
- \$.....enclosed (check) (money order)

Name \_\_\_\_\_

Address \_\_\_\_\_

City \_\_\_\_\_ Zone \_\_\_\_\_ State \_\_\_\_\_

# Superior Performance

These two words . . . perhaps more than all others, describe the

## **INTERNATIONAL MODEL 100 EXECUTIVE CITIZENS BAND TRANSCEIVER**

Superior performance is the product of efficient design, precision engineering, top quality components and construction. From interior to the clean attractive lines of its exterior, the Model 100 gives you that extra measure of reliability.



### **Check these outstanding features . . .**

Crystal filter for minimizing adjacent channel interference. Built-in calibration circuit ● 12-position crystal controlled transmit channel selector ● Front panel microphone jack ● Provision for connecting external speaker and S/meter ● Tunable dual conversion superheterodyne receiver covering all 23 channels. ● Two crystal controlled receive positions ● Push-to-talk operation ● Three way power supply for 6/12 vdc and 115 vac ● Five watts plate input ● Certified tolerance  $\pm .005\%$  ● Brown cabinet with brown and silver panel ● Dimensions: 5½" H. x 8½" W. x 9" D.

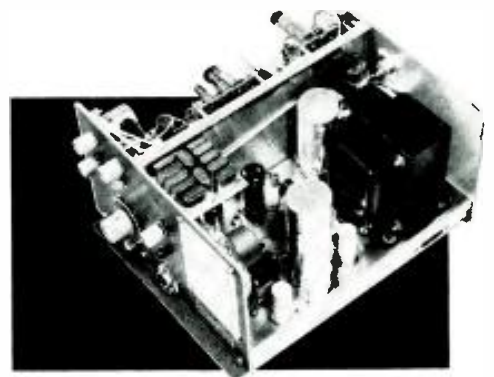

Complete with 1 transmit crystal, 1 receive crystal, new style ceramic microphone and coil cord **\$199.50**

### **External S/Meter and Speaker**

This external S/meter and speaker is the perfect companion for the Model 100. Constructed with the same clean lines and fine craftsmanship. Utilizes a high impedance vacuum tube volt meter circuit. Connects to socket on rear of transceiver. S/meter reads in three ranges.

Complete with  
interconnecting  
cable **\$49.50**



18 NORTH LEE • OKLAHOMA CITY, OKLAHOMA

The next time you visit your International dealer ask him for a demonstration of the Model 100 Executive and the system-engineered accessories. A complete catalog of International equipment and crystals may be obtained by writing International Crystal Mfg. Co.



# IT'S SOUNDCRAFT IN THE GREAT MOTION PICTURES!

FROM METRO-GOLDWYN-MAYER SAMUEL BRONSTON'S PRODUCTION OF "KING OF KINGS"



If you believe that all recording tapes are the same . . . read these facts about Soundcraft: today's great motion pictures depend on the most extensive stereophonic techniques and effects. To achieve them requires a magnetic product capable of satisfying the most critical demand. For years one name has consistently won virtually 100% acceptance of the uncompromising technicians of this industry. That name—Soundcraft. The fact is the development of the Soundcraft Magna-Stripe Process revolutionized the course of the entire industry—led to the advent of the stereo sound tracks of the great wide screen films. For this, Soundcraft was awarded the only Academy Award "Oscar" ever given to a recording tape manufacturer. Today the sound you hear in the great MGM (Camera 65), Todd AO, Cinemascope and other wide screen productions is reproduced on Soundcraft magnetic products. Motion picture producers investing millions of dollars can't afford to take chances. That's why "It's Soundcraft in the great motion pictures!" You, too, can have this same measure of superior performance and reliability in your own recordings by switching to Soundcraft—where professional performance is the standard and satisfaction the guarantee. See your Soundcraft Dealer today and let him put you on the right "sound" track with Soundcraft.



REEVES **SOUNDCRAFT** CORP.

Main Office: Great Pasture Road, Danbury, Connecticut • New York: 10 East 52nd St.  
Chicago: 28 E. Jackson Blvd. • Los Angeles: 342 N. LaBrea • Toronto: 700 Weston Rd.

# EICO®...UNCOMPROMISING ENGINEERING

## BEST BUYS IN SERVICE INSTRUMENTS: everything from Scopes to Probes

DC-5 MC  
5" Scope #460  
Kit \$79.95  
Wired \$129.50

Also Avail.—5" Push-Pull Scope #425  
Kit \$44.95 Wired \$79.95



Peak-To-Peak  
VTVM #232  
& Uni-Probe #  
Kit \$29.95  
Wired \$49.95  
VTVM #221  
Kit \$25.95  
Wired \$39.95



Pat. #2,790,051

Dynamic Conductance  
Tube & Transistor Tester #666  
Kit \$69.95 Wired \$109.95  
Complete with steel cover & handle



TV-FM Sweep Generator  
& Marker #368  
Kit \$69.95 Wired \$119.95

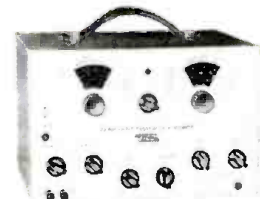

## BEST BUYS FOR INDUSTRIAL TESTING: everything from Bridges to Supplies

NEW Metered  
Variable  
Auto-Transformer  
AC Bench  
Supplies:  
#1073 (3 amp.)  
Kit \$35.95  
Wired \$47.95  
#1078 (7½ amp.)  
Kit \$42.95  
Wired \$54.95



NEW Extra-Low-  
Ripple 6 &  
12 Volt  
Battery  
Eliminator  
& Charger #1064  
Kit \$43.95  
Wired \$52.95

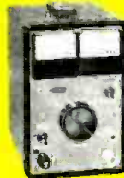

NEW AC  
Volt-Watt  
Meter #260  
Kit \$49.95  
Wired \$79.95



1350 Combinations!  
Series/Parallel R-C  
Combination Box #1140  
U.S. Pat. No. 2954518  
Kit \$13.95 Wired \$19.95



## BEST BUYS IN STEREO & MONO HI-FI: everything from Tape Decks to Speakers

TRANSISTORIZED  
Stereo/  
Mono  
4-Track  
Tape  
Deck  
Wired  
Model  
RP100W  
\$399.95  
Semi-Kit  
Model  
RP100K  
Electronics in Kit form \$299.95



NEW FM-Multiplier  
Autotuner #M292  
Kit \$39.95 Wired \$64.95  
Cover optional. \$2.95  
Designed for all EICO  
FM equipment (#FT150,  
#FT192, #196, and any  
other component quality,  
wide band FM tuner.



NEW FM-AM Stereo Tuner ST96  
Kit \$89.95 Wired \$129.95 Inc. FET

NEW 70-Watt Integrated  
Stereo Amplifier ST70  
Kit \$94.95 Wired \$149.95



NEW 40-Watt Integrated  
Stereo Amplifier ST40  
Kit \$79.95 Wired \$129.95



Bookshelf Speaker System HFS1  
Kit \$39.95 Wired \$47.95

## BEST BUYS IN "HAM" GEAR: from Transmitters to Code Oscillators

NEW 60-Watt CW Transmitter #723  
Kit \$49.95 Wired \$79.95



90-Watt CW Transmitter #720  
U.S. Pat. No. D-184776  
Kit \$79.95 Wired \$119.95



Universal Modulator Driver #730  
Kit \$49.95 Wired \$79.95  
Cover E-5 \$4.50



Grid Dip Meter #710  
Kit \$29.95 Wired \$49.95



Over 2 MILLION EICO instruments in use. Compare EICO side-by-side critically with products selling for 2 or 3 times more. Buy your EICO right "off the shelf" from 2000 neighborhood dealers coast to coast, most of whom offer budget terms.

## BEST BUYS IN CITIZENS TRANSCEIVERS AND TRANSISTOR RADIOS

Over 106 unique  
products to  
choose from!

EICO, 3300 N. Blvd., L.I.C. 1, N.Y. EW-5

Send free 32-page catalog & Distributor's name.

Send Free Schematic of Model No.

Send new 36-page GUIDEBOOK TO HI-FI for which I enclose 25c for postage & handling.

Name \_\_\_\_\_

Address \_\_\_\_\_

City \_\_\_\_\_ Zone \_\_\_\_\_ State \_\_\_\_\_



Citizens Band Transceivers  
From: Kit \$59.95 Wired \$89.95  
Superhet; prealigned xmitter  
osc; match different antennas  
by variable "pi" network.  
Single & multi-channel models.

NEW Walkie-Talkie  
Citizens Band  
Transceiver #740  
Kit \$54.95  
Wired \$79.95.  
Carrying Case \$3.95.  
Complete with rechargeable  
leakproof battery & charger.  
Operates 2500 hours on the battery.  
U. S.-made by EICO.



Transistor Portable Radio RA6  
Kit \$29.95 Incl. FET.



**M**ORALISTS may debate whether the world is better for the many technological advances of the past century, but no one can deny it is noisier. When man flies a jetliner, builds a skyscraper, or operates a factory, he makes noise—a lot of it. It seems that you can't do big things without making big noises.

But man the noisemaker is also man the noisechaser, spending many millions of dollars each year to reduce noise. The direct cost of devices, materials, and labor is large, but only part of the story; add the cost of efficiency sacrificed in automobile and jet engine noise mufflers, and you have an annual price tag well over \$100-million. Of this amount, the relatively small part spent on

urement, the reference quantity is a pressure of 0.0002 microbar (dynes/sq. cm.), which is about the pressure of the weakest sound that can be heard by a person with very good hearing in a very quiet place. One microbar pressure equals approximately one-millionth of normal atmospheric pressure. The range of pressures detectable by the human ear is so great that it is easier to use decibels than microbars to express sound pressure level. The relation is: *sound pressure level (db) = 20 log (P/0.0002)* where *P* is the root-mean-square sound pressure in microbars, for the sound in question.

When you use the term *decibel*, then, you should keep in mind the reference level you are using in the implied com-

Laboratory, Teddington, England. Note the peak response at about 4000 cycles and the substantial roll-off below a few hundred cycles. We can see from this chart that a sound of 80-db sound pressure level sounds 90 phons "loud" at 4000 cycles but only 60 phons "loud" at 45 cycles. (A phon is a unit of loudness level. By definition, the number of phons equals the number of db of an equally loud 1000-cycle tone.)

The information shown in Fig. 1 is based on many experiments using a pure-tone source. Since most noises are not pure tones, some experts prefer response data based on random-noise experiments. But all agree that some compensation for the loudness-frequency effect must be incorporated

# NOISE

## AND ITS MEASUREMENT

By **FREDERICK T. VAN VEEN** / General Radio Company

noise-measuring equipment must be considered a bargain, for measurement is the only way of telling whether the rest of the money is wisely spent.

### *Man—The Noise-Measuring System*

Man is really the ultimate noise-measuring system and the science of noise measurement is often an attempt to measure noise the way the human mechanism does. Of primary interest is the concept of loudness. Loudness is a purely subjective parameter, beyond direct physical measurement. But it is related to the pressure level of the sound (sound being a variation in normal atmospheric pressure), and this relation provides the starting point of noise measurement.

### *Sound Pressure Level & the Decibel*

Since the term "decibel" is often abused, we will first state what it is *not*. It is not a specific quantity, like a ton, or a mile, or a minute. It is really the logarithm of a ratio of one quantity to a reference quantity. In noise meas-

urement, the level is often stated as, for instance, *db re 0.0002 μbar*.

Most everyday sounds lie in the range from 50 to 90 db. It's doubtful that you've ever heard a noise louder than 140 db. Fig. 3 shows where some common noises lie on the db scale.

One last word about the decibel: You'll note from the above equation that it's logarithmic, and you must consider this when combining decibels. Two 60-db noises combine to produce a 63 (not 120) db noise.

### *Frequency*

The ear's sensitivity varies with frequency, and the response curve itself varies with sound pressure level. If we are to relate sound pressure level to the subjective concept *loudness*, we must compensate for the ear's frequency response. This response is shown in Fig. 1, where all points on any single curve represent equal sound pressure level. These curves are based on equal-loudness contours determined by Robinson and Dadson at the National Physical

laboratory in any realistic noise measurement that is used.

### *Microphones for Noise Measurement*

Noise measurement always begins at a microphone, the place where sound is converted to voltage. If the voltage output doesn't correspond to the sound input, the measurement will not give correct results. For this reason, proper choice of microphone is all-important.

Three types of microphones are used in noise measurement: piezoelectric, capacitor, and dynamic. Of these, the first two are most widely used in sound-level measurements.

The most popular microphone for sound measurement has long been the Rochelle-salt piezoelectric type, favored for its high output and good frequency response. Its major drawback, known by anyone who ever left one in a closed car on a hot summer day, is its sensitivity to temperature and humidity.

A fairly recent development is the PZT (for lead titanate-lead zirconate) piezoelectric microphone. The PZT offers out-

Man, the noisemaker, spends millions each year to reduce noise. In order to check on the effectiveness of his remedies, instruments must be used to measure noise level. Here is how these instruments do their job.



A sound-level meter being used to check the noise level inside an airliner.

put and frequency response comparable to those of the Rochelle-salt microphone, without the troublesome temperature characteristics. The PZT microphone is gaining fast acceptance for its electrical excellence and reasonable cost.

The capacitor microphone takes the prize for frequency response and also (wouldn't you know) for highest price. It requires a source of polarizing voltage and a preamplifier right at the microphone itself. For most measurements, the difference in frequency response between the measurement-type PZT and capacitor microphones would not justify the considerable difference in cost. Still, if you need optimum frequency response above 8 or 10 kc., the capacitor microphone may be worth the difference.

When a piezoelectric or capacitor microphone is used at the end of an extension cable (as is often desirable), correction factors must be applied for cable length. The dynamic microphone does not require these corrections and is, therefore, often used in such applications.

### Sound-Level Meters

The basic noise-measuring instrument

is the sound-level meter, an example of which is shown above. It includes a microphone to pick up the sound being measured, a calibrated attenuator, weighting networks, an amplifier, and an indicating meter. The weighting networks, based on frequency-response data similar to that shown in Fig. 1, represent an attempt to convert raw sound pressure into something more representative of the way we hear things. Specifications for weighting networks are standardized in the ASA "American Standard for Sound-Level Meters for the Measurement of Noise and Other Sounds" (S1.4, 1961). See Fig. 2.

Sound-level meters come in a variety of shapes and sizes. Perhaps the simplest is a sound-survey meter. Strictly speaking, this is not a sound-level meter (*i.e.*, it doesn't completely conform to the ASA specification mentioned above), but it does measure sound-pressure level and does include weighting networks. This instrument is small, inexpensive, and easy to use and is very popular with the many people who want merely to measure, say, relative loudness of two similar sounds, or who want to make "before" and "after" noise checks in the

process of noise-proofing a machine, office, etc. Because of its small size and battery operation, it is an excellent device for making spot checks of noise almost anywhere.

The true sound-level meter is a "must" for anyone who is undertaking serious noise measurements. A good sound-level meter boasts a sensitive, non-directional microphone, a precise attenuator, a built-in calibrator, a choice of fast or slow meter response, provision for using other input transducers (such as a vibration pickup or a special-purpose microphone), and an auxiliary output connector, so that the output can be fed to an analyzer or recorder. If the sound-level meter is to be used in the field, it should contain its own power supply and be lightweight and easy to carry.

The \$400 or \$500 paid for a good sound-level meter is an important investment in any anti-noise campaign.

### Analyzers

Knowledge of the frequency spectrum of a noise is often very valuable, especially when you are trying to track down a specific noise component. The sound-level meter, even with its weighting networks, reveals very little about frequency distribution. By feeding the output of the sound-level meter to an analyzer, however, you can "tune in" the noise in just about any part of the audio spectrum.

Sound analyzers may be classified by bandwidth, or selectivity, characteristics. The most common types have bandwidths that are a constant frequency or a constant percentage of frequency. A typical constant-frequency-bandwidth analyzer has a response with a four-cycle flat top and very high rejection outside the passband. The most common constant-percentage-bandwidth analyzer is the octave-band analyzer, which contains a set of bandpass filters, covering ASA-specified octave frequency bands. Other analyzers use half-octave, third-octave, and even narrower bandwidths. With some instruments, you can switch to any one of two or more characteris-

Fig. 1. Loudness for constant sound-pressure levels (SPL).

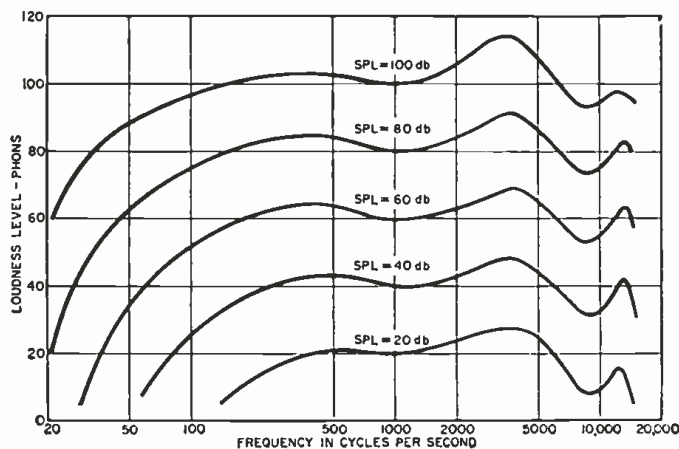
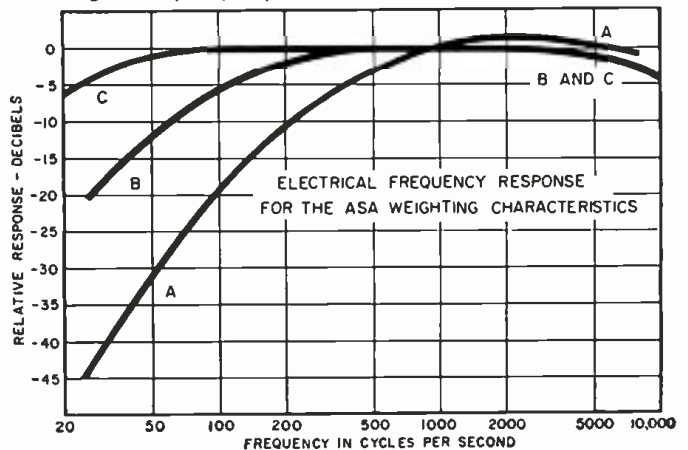

Fig. 2. Frequency response of standard weighting networks.



ties, depending on the application.

The narrower the bandwidth, the more information can be gained from the analysis. Therefore, the narrow-band analyzer reveals much more about the noise than does the octave-band analyzer. But for most noise studies, the octave-band analyzer is entirely adequate, and bringing in a narrow-band analyzer would be like bringing a telescope to a football game.

Impact-type noises require special handling and a special instrument, the impact-noise analyzer, is the only convenient way of measuring significant properties, such as peak level and duration.

### Recorders

Level recorders are widely used to chart data from sound-level meters and analyzers. The use of the recorder greatly increases the usefulness of noise-measuring equipment. For instance, a sound-level meter set up to monitor traffic noise at a certain spot can be left unattended while a recorder charts noise level vs time. By driving a recorder from a sound analyzer (in turn driven from a sound-level meter), you can plot the curve of amplitude vs frequency of noise. And, of course, in almost any type of measurement, it's nice to have a record on paper.

Another type of recorder—the tape recorder—can be used to preserve a noise for later playback for laboratory analysis. For this type of work, a high-quality magnetic tape recorder must be used.

Other accessories found in the well-equipped noise laboratory are calibrators, both electrical and acoustical, to insure accurate measurements, special-purpose microphones (for very high noise levels, for instance), tripod, extension cables, oscilloscope, and vibration-measuring apparatus.

### Measurement of Noise

Sometimes noise measurement simply means having a sound-survey meter tell you that the noise is so many db. Sometimes it involves much more. It all depends on the nature of the problem and how much it's worth to solve it. Whatever the measurement, you will be using a sound-level meter either to indicate noise level or to feed an analyzer for further interpretation.

A sound-level meter is deceptively easy to use. You turn it on, check its calibration, place its microphone at the desired point of measurement, switch to one of the weighting networks (A, B, or C), and turn an attenuator switch until the meter gives an on-scale indication. The sound level is indicated by the sum of the meter reading and the

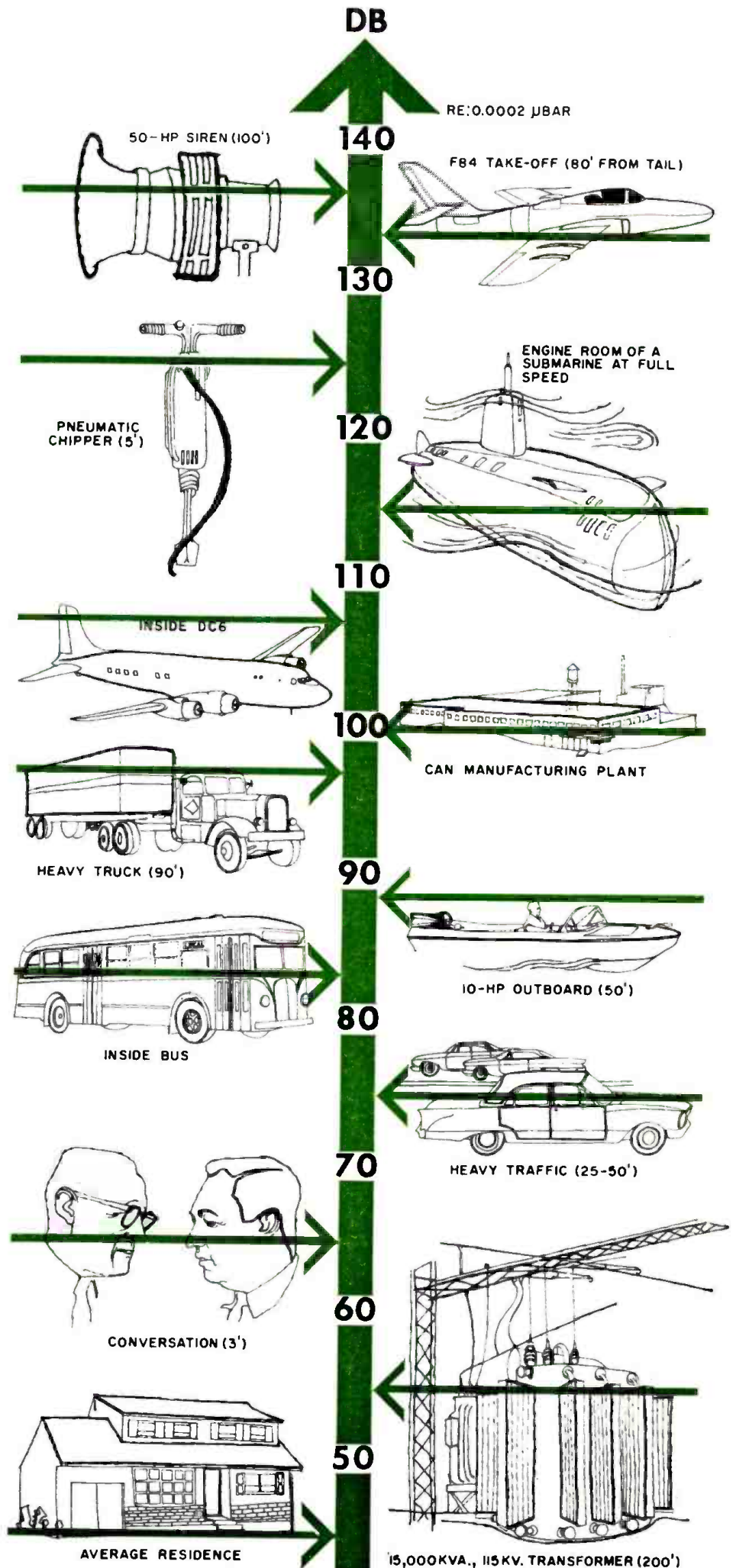

Fig. 3. Some typical noise levels. Figures in parentheses indicate the distances from the noise sources to the sound-level meter.

attenuator switch setting that is used.

As you can see, manipulating the controls of a sound-level meter is child's play. Positioning the microphone properly, determining the effects of background noise, and deciding which weighting network to use are slightly more complicated. And interpreting the results, assessing the validity and significance of data—these are things that take noise measurement out of the little-league class.

### Microphone Placement

Most microphones used in sound measurement are essentially non-directional at low frequencies, but show some directional effects up where the size of the microphone is comparable to the wavelength of the sound in air. Fig. 4 shows how the response of a typical measurement microphone varies with the incidence with which the sound strikes. Note a possible difference of 8 db between 0 and 90 degree incidence at 8000 cycles. Given a microphone with such response, you would place it to receive the sound at a grazing (90°) incidence, since the 90° curve is the flatter of the two responses.

There is a natural tendency for the measurer to face the noise source, hold-

ing the sound-level meter in front of him as if he were taking a snapshot of the noise. By "backstopping" the noise in this way, the measurer distorts the measurement. The recommended posi-



The sound-survey meter is small, easy-to-use, and battery-powered for portability.

tion is to one side of a line from noise source to microphone, with the measurer facing in a direction perpendicular to the noise path. Better still, remove the measurer from the microphone entirely, by using a tripod and extension cable.

If you're concerned with the noise level at one particular point only, that point is obviously where you make at least one of your measurements. If you're evaluating the speech-interference or hearing-damage capabilities of the noise, you would place the microphone where the subject's ear would normally be (but with the subject out of the way, where he won't interfere with the measurement).

Test codes on apparatus noise measurement specify the places of measurement, and the American Standard Test Code for Apparatus Noise Measurement

points out the wisdom of exploring the noise field before deciding on microphone locations.

One more thing on microphone placement: Keep it out of the wind. Wind on the microphone produces a low-frequency noise that can seriously affect measurements. One way of reducing the effect is by use of a wind screen.

### Weighting Networks

As mentioned earlier, any realistic noise measurement must take into account the frequency-response characteristics of the human ear. This is the historical foundation for the weighting networks found in all sound-level meters, although no one today suggests that weighting networks actually translate raw sound pressure level into the subjective notion of loudness. There are three ASA-specified weighting networks, whose characteristics are shown in Fig. 2. Some authorities suggest selection of weighting networks on the basis of the range of levels to be measured (e.g., B weighting from 65 to 75 db). Some advocate the use of A weighting for comparison of noises of different types, and certain noise-test codes specify the weighting network to be used in all cases. Perhaps the wisest course is to measure and record levels on all three weighting networks. For one thing, the three figures can be used to produce a rough frequency analysis.<sup>1</sup> For another, it is always a good idea to store such data; you never know when you might want it.

Now that you have measured noise level, what do you do with it? Well, if a test code specifies that the B-weighted level should be less than 80 db and you've measured it at 85 db, you know that the test has been flunked. Or you might have made the measurement to see whether certain noise levels are likely to cause hearing damage, in which case you might compare your findings with suggested criteria.<sup>2</sup>

But for many noise measurements, the sound-level meter by itself is not enough. Too much depends on the frequency distribution of the noise, and thus the octave-band analyzer has become the second tool of the trade.

The octave-band analyzer measures the noise level of any of eight ASA-specified frequency bands. These bands are: 20-75, 75-150, 150-300, 300-600, 600-1200, 1200-2400, 2400-4800, and 4800-9600 cps. These octave-band levels can be used to compute loudness level in phons.<sup>3</sup> Also by taking the average of the

(Continued on page 78)

1. Peterson & Gross: "Handbook of Noise Measurement," General Radio Company, West Concord, Mass. Fourth Edition, page 35 (after Cox).  
 2. We recommend that those concerned with noise-induced hearing loss request the latest information on this subject from the Research Center, Subcommittee on Noise of the Committee on Conservation of Hearing, American Academy of Ophthalmology and Otolaryngology, 327 S. Alvarado St., Los Angeles 57, California.  
 3. Stevens, S. S.: "Calculating Loudness," Noise Control, Vol. 3, No. 5, September 1957, pages 11-22.

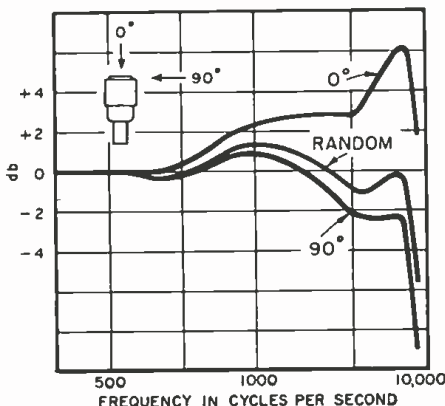
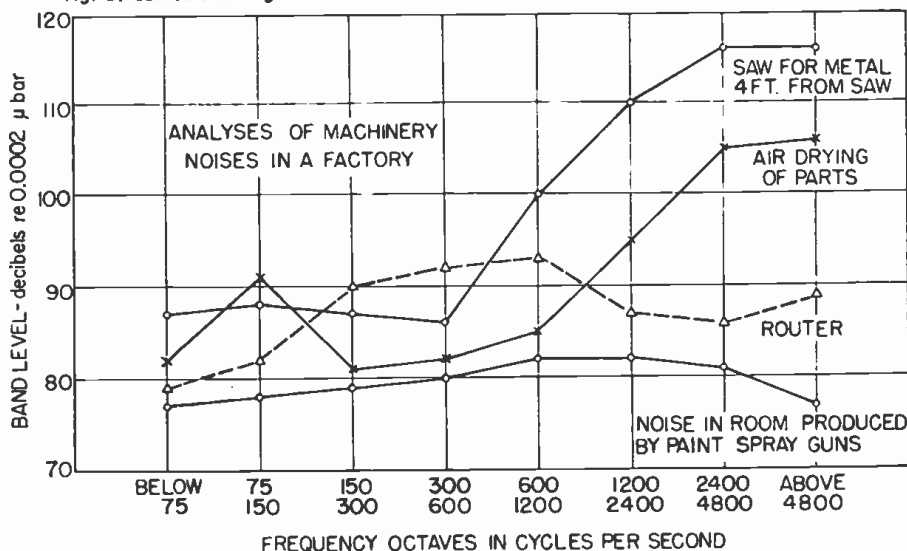

Fig. 4. Response of measurement microphone at various angles of the incident sound.

Fig. 5. Curves showing a number of octave-band analyses of common factory noises.



**T**HE tunnel diode, one of the recently developed semiconductor devices, will soon make its appearance in a wide variety of electronic circuit applications. Technicians, servicemen, and experimenters should, therefore, become familiar with the characteristics and operation of this solid-state device and should have available an inexpensive set-up for testing them. Testing any new electronic device is a basic step in learning something about it and how it is to be applied in various applications.

A tunnel diode is normally operated in the negative-resistance region of its characteristic curve. This region lies between its peak point current ( $I_p$ ) and the valley point current ( $I_v$ ). Current data for  $I_p$  and  $I_v$  is given in the manufacturer's specifications for any particular diode. We wish, then, to test any diode to see if it meets these specifications. This may be done with the test circuit shown in Fig. 1.

### Test Circuit

To operate properly in the negative-resistance portion of the characteristic curve the tunnel diode should work from a low-impedance d.c. supply. This is provided by the 18-ohm resistor  $R_3$  across which the diode to be tested is connected. Control  $R_1$  allows the bias to be varied to suit a given diode.

The 0-1 ma. test meter can be shunted by resistor  $R_4$ , which is inserted into the circuit by switch  $S_1$ , thus increasing the range of the meter by a factor of 10. This is a convenience when testing diodes rated above 1 ma.

The value given for the meter-shunt resistor is, of course, for the particular meter used by the author. Shunts for

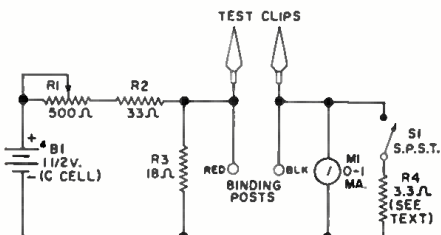

Fig. 1. Schematic of tester. Diode cathode is connected to the black binding post.

other meters may be found from the formula:  $R = R_m / (N - 1)$ , where  $R_m$  is the meter resistance,  $N$  is the full-scale reading wanted divided by the full-scale of the meter, and  $R$  is the shunt to be used.

The component parts of the circuit are assembled in a 6 1/4" x 3 3/4" x 2" Bakelite case fitted with a phenolic board panel. Any other type of housing may be used since there is nothing critical about this construction. Two "Mini-gator" clips are used to connect the diode. These are attached to the panel with small machine screws plus es-cutcheon pins to keep them from turning. Solder lugs are placed on the screws behind the panel for electrical connection.

Since the diode wire leads are of such a small gauge, the clips do not always grasp them firmly. To overcome this, the top and bottom of the jaws of the



Tester is built into a 6 1/4" x 3 3/4" x 2" Bakelite case.

# TESTING THE TUNNEL DIODE

By HAROLD REED

*Construction of simple combination tester and power supply to determine peak and valley current values.*

clips were cleaned, filled with solder, and then filed flat. With decals the clips are labeled "C" and "A" for cathode and anode connections respectively. The 1 1/2-volt flashlight battery is in a holder attached to the back of the Bakelite case.

### Operation

To test a tunnel diode, turn the bias control  $R_1$  to its extreme counterclockwise position. This control should be wired so this position places all its resistance in the circuit. Set the meter switch to "X1" or "X10" depending on the current rating of the diode to be tested. Connect the diode leads to the clips, observing proper anode and cathode connections. Reversing the leads will do no harm but correct test results will not be obtained.

Now, slowly turn the bias control clockwise and watch the meter. If the diode is functioning properly, when it reaches its peak point current  $I_p$ , the meter will suddenly drop to a point between  $I_p$  and the valley current point  $I_v$ . As the control is advanced farther,

the valley current point  $I_v$  will be reached and then the meter indication will start rising again. If available, it is desirable to consult the manufacturer's specifications to learn if current points approximate the specs.

Here are examples of typical ratings for two low-cost tunnel diodes. For the G-E 1N2940,  $I_p = 1$  ma. and  $I_v = 0.13$  ma. and for the G-E 1N2941,  $I_p = 4.7$  ma. and  $I_v = 0.6$  ma.

Suppose you want to check the peak point voltage  $V_p$  and the valley point voltage  $V_v$ . A black and a red binding post on the tester panel can be used for this purpose. A high-resistance input-type voltmeter should be used. For the diodes just mentioned,  $V_p$  and  $V_v$  are on the order of 350 mv. and 50 mv.

The tester can also be used as a power supply to provide the proper bias voltage for experimental tunnel-diode circuits. The binding posts can be used for this purpose and since they are red and black, correct polarity is evident. For experimental work, longer battery life can be obtained by using a mercury cell instead of the flashlight battery. ▲

Inside view of the tunnel-diode tester and power supply. All resistors can be half watters although author used one larger wattage unit since it happened to be on hand.

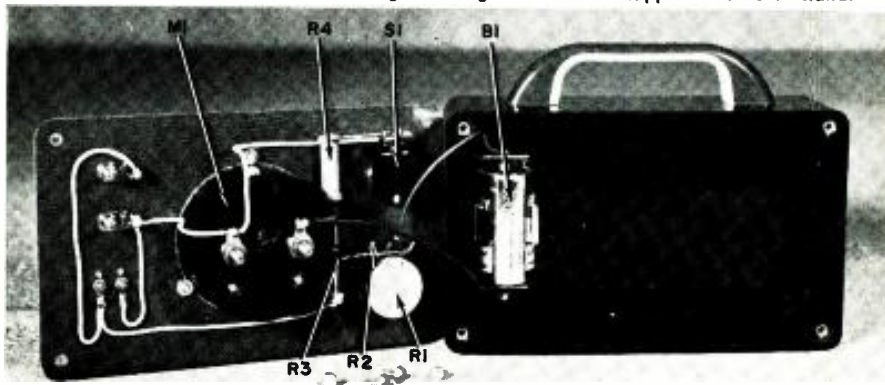

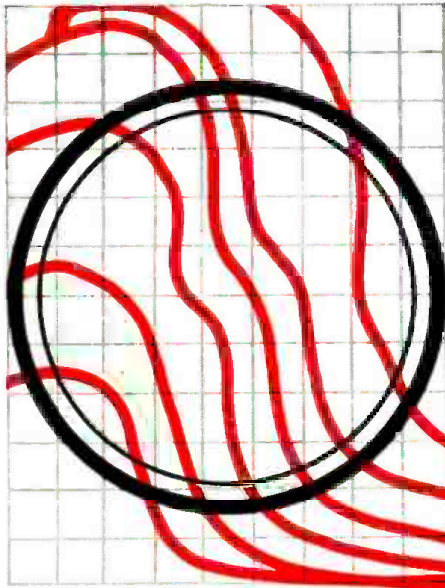

# TRANSISTOR CHARACTERISTIC CURVE TRACER

By ELTON W. ANDERSON

**Use this simple device and your oscilloscope to obtain curves for graphical circuit analysis.**

**T**RANSISTOR circuit design requires a combination of graphical and mathematical analysis. The graphical portion of the analysis is done with the aid of characteristic curves to determine the load line, bias, distortion, voltage and current swing, gain, quality, and uniformity for transistor matching. The most useful curves are the  $I_c$ - $V_{ce}$  or common-emitter curves shown in Fig. 1.

Characteristic curves can be drawn quickly and easily. The simplified circuit shown in Fig. 2 can be used to trace the common-emitter characteristic curves of a  $p-n-p$  transistor. Common-base or common-collector characteristic curves can be traced with the same circuit. To obtain a set of curves for an  $n-p-n$  transistor, the bias voltage, meter, and diode rectifier ( $SR_1$ ) polarity would have to be reversed.

One of the advantages of taking a set of curves with an oscilloscope is that the transistor has less time to overheat than it would if the curves were plotted on a point-to-point basis. In speeding up the process there is less chance of a change of characteristics.

## Operation & Construction

Potentiometer  $R_2$  controls the base current,  $I_b$ , supplied by battery  $B_1$  and  $R_3$  is a swamping resistor that limits the base current to a safe value. The parts specified provide a range of 10 to 500 microamperes. Transformer  $T_1$  supplies the collector and oscilloscope sweep voltage. Diode rectifier  $SR_1$  allows only the negative (in the case of a  $p-n-p$  transistor) half of the a.c. voltage to be applied to the collector. This results in a voltage drop across  $R_1$  that is proportional to the collector current. The

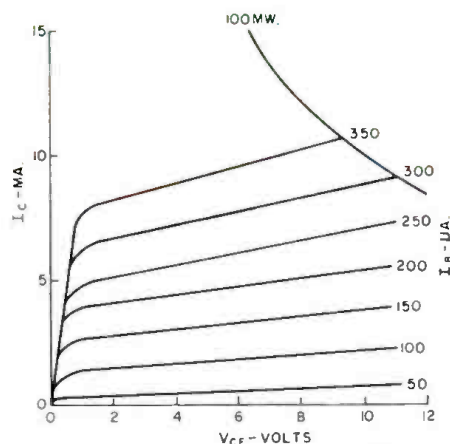
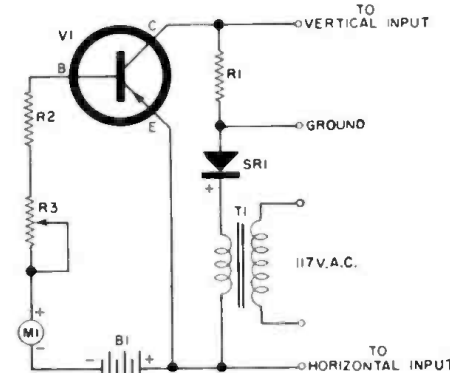

Fig. 1. Common-emitter characteristics.



- $R_1$ —100 ohm, 1 w. res.
- $R_2$ —10,000 ohm,  $\frac{1}{2}$  w. res.
- $R_3$ —500,000 ohm linear-taper pot
- $SR_1$ —1N1693 silicon rectifier
- $M_1$ —0-1 ma. meter (see text)
- $B_1$ —6-volt battery
- $T_1$ —Fil. trans. 10 v. @ 1 amp.
- $V_1$ —Transistor under test

Fig. 2. Basic curve-tracing circuit for a "p-n-p" transistor.  $R_3$  limits base current.

changing values of collector voltage and current trace the  $I_c$ - $V_{ce}$  curve on the face of the oscilloscope.

When the cathode of  $SR_1$  is positive,  $SR_1$  "opens," collector current does not flow, and there's no oscilloscope deflection. However, when the cathode of  $SR_1$  is negative at the other half of the cycle,  $SR_1$  is forward-biased, voltage is supplied to the collector causing current to flow, and the horizontal sweep starts.

The parts layout of the curve tracer shown in Fig. 3 is not critical. For greatest accuracy,  $R_1$  should be exactly 100 ohms or some other known value.

In the common emitter configuration the base current will be varied from about 20 microamperes to 300 microamperes. For this reason more accurate determination of the base current can be made if a microammeter is used. It would be almost impossible to read with any accuracy 20 or 30 microamperes on a 0-1 milliammeter.

Before calibrating the oscilloscope, the ranges of test current and voltage must be determined; they depend on the transistor being tested. A convenient set of maximum values for low-power transistors is 12 volts and 15 milliamperes.

The problem of plotting the tracings produced on the oscilloscope face can be solved by using a piece of clear plastic. Plastic page protectors sold by office supply stores are excellent for this purpose. Cut a disc from the plastic approximately the same size as the face of the cathode-ray tube. Prepare a writing surface on one side of the disc by sanding it lightly with fine sandpaper. Place the center of the disc over the "X" on the scale (Fig. 5) and trace the voltage and current axes and the maxi-



imum power dissipation curves. (Other maximum power dissipation curves depend on the transistor being tested and are determined from the formula:  $P = I_c \times V_{ce}$ .) Values for 50 and 100 milliwatts are shown. Place the plastic disc against the tube face. Set the horizontal and vertical gain controls to the minimum gain positions and position the spot at the origin of the graph. (The scale of Fig. 4 may have to be reversed or turned over depending on whether the transistor is *p-n-p* or *n-p-n* and on the deflection direction vs polarity of the oscilloscope.) The vertical and horizontal scope inputs can now be calibrated.

### Oscilloscope Calibration

Calibrate the vertical input first by setting the horizontal selector control to *external input*. Apply a 1-volt peak-to-peak calibrating voltage to the vertical input and adjust the vertical gain control so the vertical trace is the same size as the 10-ma. vertical scale on Fig. 4. Do not disturb the vertical gain control after this setting has been made.

Now apply a 10-volt peak-to-peak calibrating voltage to the horizontal input and adjust the horizontal gain control so the deflection is the same size as that marked on the scale of Fig. 4.

When the scope is properly calibrated, connect it to the circuit shown in Fig. 3. Set  $R_3$  to its maximum resistance position, insert the transistor in the socket, and apply the bias and collector voltages. The horizontal and vertical positioning controls on the scope will have to be adjusted to place the origin of the transistor curve at the origin of the scale. Adjust  $R_2$  for the desired base current for the first curve. (It may be necessary after re-adjusting  $R_3$  to re-adjust the position controls to keep the trace in proper alignment with the graph.)

Now trace the curve on the plastic

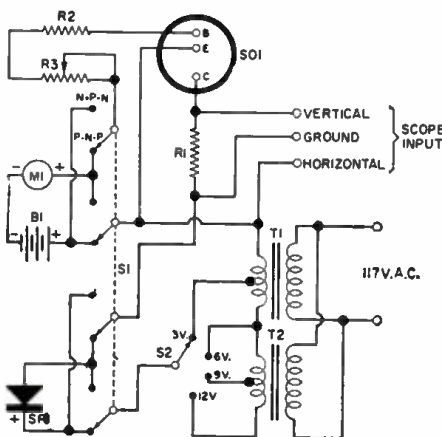

- R1—100 ohm, 1 w. res.  $\pm 1\%$
- R2—10,000 ohm,  $\frac{1}{2}$  w. res.
- R3—500,000 ohm linear-taper pot (Mallory U-50 or equiv.)
- SR—1N1693 silicon rectifier
- S1—4-pole, 2-pos. non-shorting miniature phenolic switch (Centralab 1011 or equiv.)
- S2—S.p. 4-pos. non-shorting switch (Mallory 3215J or equiv.)
- M1—0.500  $\mu$ a. d.c. meter
- B1—6-volt battery
- SO—Transistor socket (Elco 3301 or equiv.)
- T1, T2—Fil. trans. 6.3 v. c.t. @ 1.2 amp (Triad F-14X or equiv.)

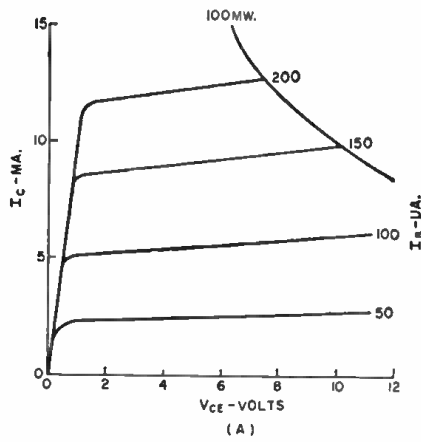

Fig. 4A. Common-emitter characteristic of an audio or a general-purpose transistor.

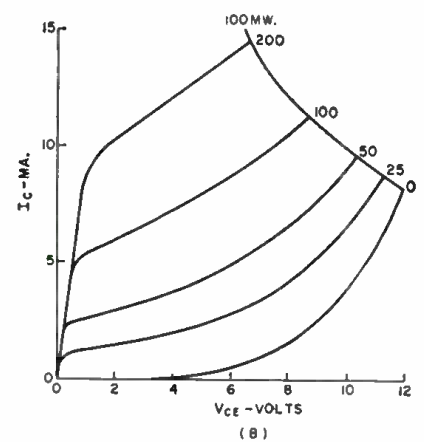

Fig. 4B. The common-emitter characteristic curves of a switching-type transistor.

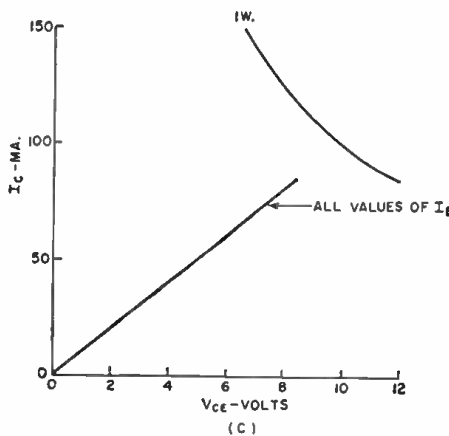

Fig. 4C. The trace of a shorted transistor.

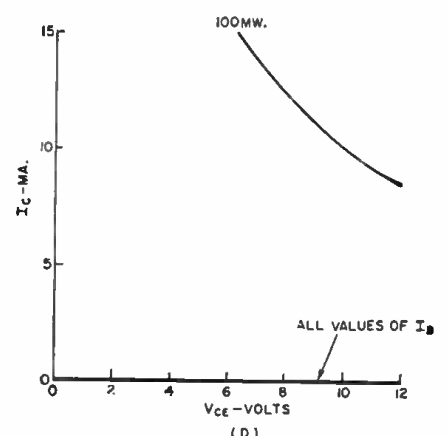

Fig. 4D. The trace of an open transistor.

disc. Adjust  $R_2$  for a different value of base current and trace the new curve. Design computations can be completed on the disc or the curves can be transferred by tracing them on a piece of graph paper.

Figs. 4A through 4D are curves that will be obtained with various transis-

tors. Fig. 4A shows the characteristics of an audio or general-purpose transistor. Although it resembles the curve of Fig. 1, the transistor gains differ considerably. Fig. 4B is the curve of a computer-type switching transistor while Figs. 4C and 4D are curves of defective transistors. ▲

Fig. 3. Curve-tracing circuit for "p-n-p" or "n-p-n" transistors in common emitter configuration. Be sure  $S_1$  is in correct position before inserting transistor in socket.

Fig. 5. Place "X" on this scale at the center of a plastic disc that is the same size as the scope face. Trace these axes and voltage and current markings onto the disc.

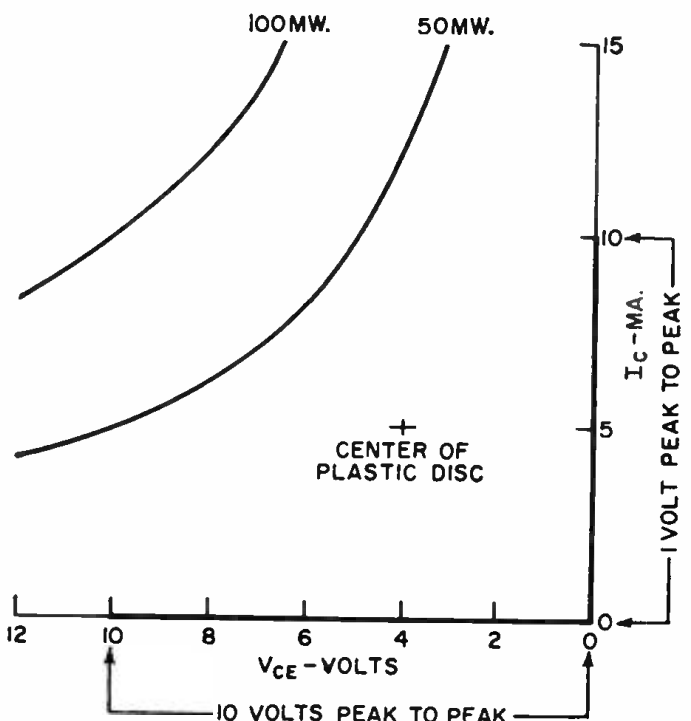

### Tunnel-Diode Computer

At the heart of a new computer system are these tunnel diode and transistor modules that operate at bit rates as high as 500 mc. Developed by G.E., the system is said to be capable of performing additions at least four times as fast as conventional computers while requiring only one-tenth the circuit components. The large increase in speed achieved by the new logic system has been attributed to the development of a hybrid circuit that uses the tunnel diode as the switching and gain element and a transistor as an isolator. The circuit modules are interconnected by terminated transmission lines eliminating the problems normally associated with reflections and permitting signal interconnections to be made over long distances.

## RECENT DEVELOPMENTS IN ELECTRONICS

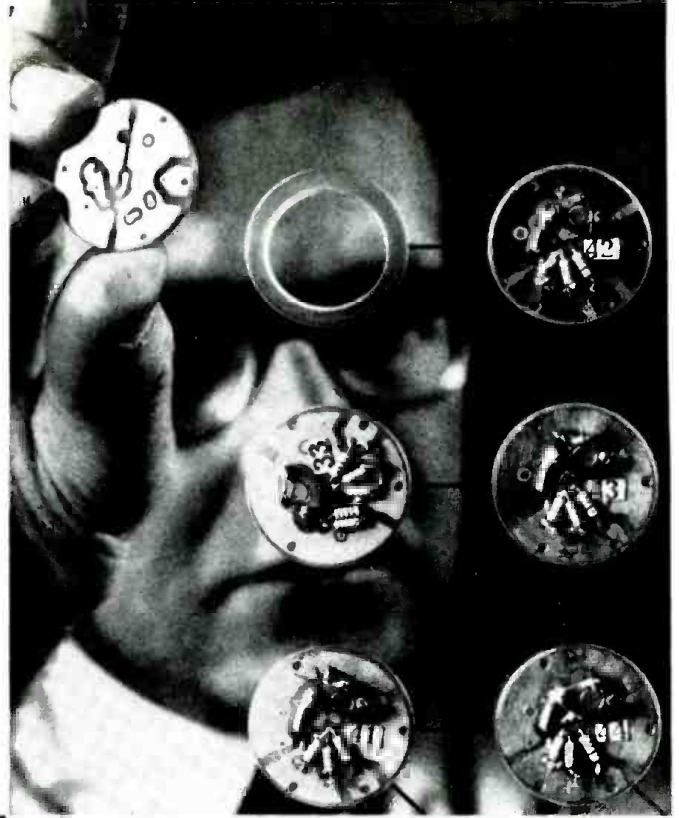

### Front-Line Facsimile

A new lightweight facsimile set that can flash battle sketches and pictorial data by radio directly from the front lines of combat is shown here. The experimental unit, first of its kind small enough to be carried on a soldier's back, was designed by Army scientists for Marine Corps use. In engineering tests, the new facsimile set transmitted maps from a radio-equipped jeep while the vehicle was in motion. All electrical power was supplied by the jeep's electrical system. The set, which weighs only 27 pounds, will transmit graphical information to a distant receiver through most standard portable combat radios or through a telephone line.

### Decision-Checking Computer

Subject (right) arrives at his decision on a unique machine developed for "Project Decision," a psychological research program conducted by ACF Electronics and The Catholic University of America. The subject, presented with a series of numerical problems, decides how much to risk (from a "points bet" column at the right of the matrix panel) to achieve a "payoff" (numbers on the display). Odds (at the bottom of the panel) determine the payoff.

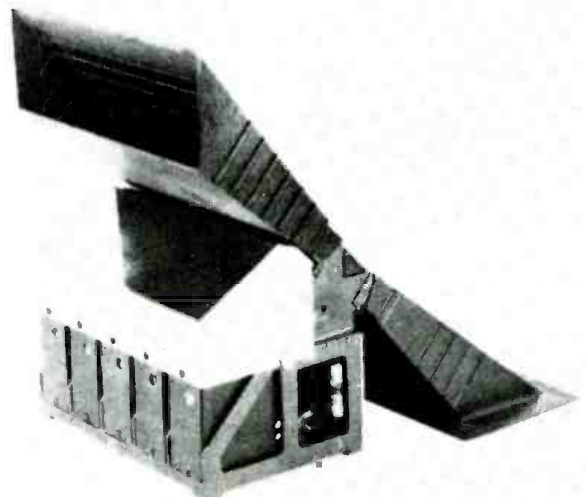
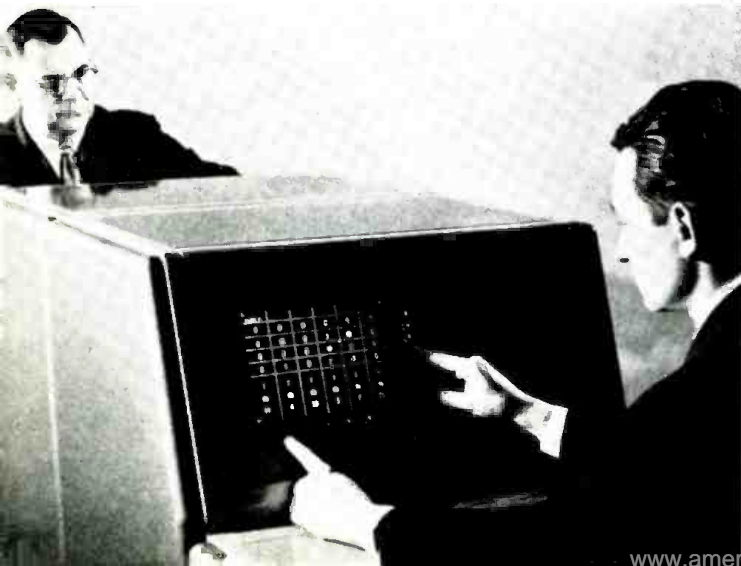

### Infrared Radiometer for "Tiros"

This 5-channel radiometer on the "Tiros IV" satellite measures radiation from the earth and its atmosphere in five infrared wavelength bands, to provide information for use in studying the earth and its weather. The instrument, developed by Barnes Eng. Co., utilizes outer space as a reference for its radiation measurements.

### Ultrasonic Corona Hunter

Aiming an ultrasonic "gun" at a high-voltage transmission line, a member of the Westinghouse research laboratories tests the line remotely for electrical leakage, or corona. If present, the corona produces high-frequency ultrasonic sound waves which are received by the "gun" and made audible through electronic circuitry. A telescopic rifle sight built into the instrument pinpoints the corona sources with unusual accuracy. This makes it easier for power engineers to reduce or eliminate corona, which wastes electric power and may sometimes cause static. The corona detector operates near 40 kc, and it is sensitive enough to locate the weak ultrasonic vibrations set up by a stream of running water from a faucet 20 feet away. At the same time, its accuracy is good enough to distinguish, from a distance of 75 feet, corona sources only a few inches apart on high-tension lines. This accuracy is made possible by the use of a beam width of less than 2 degrees and by precise spacing and placement of the ultrasonic transducers.

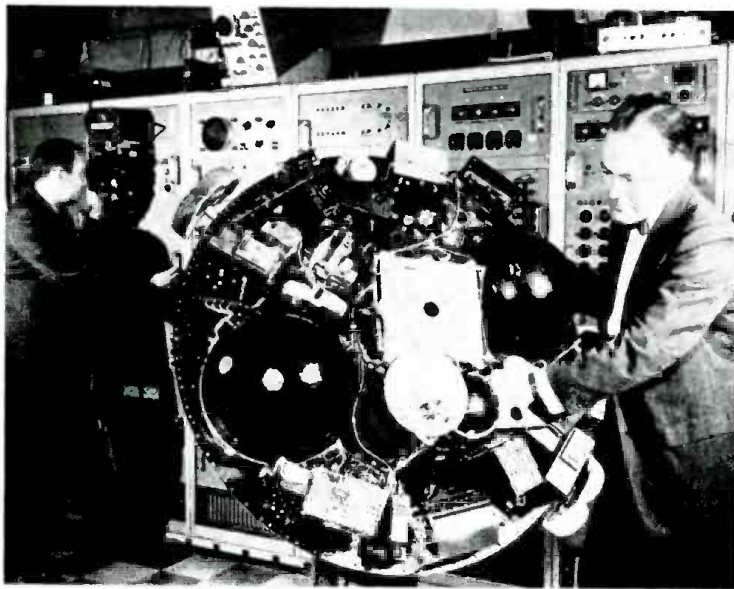
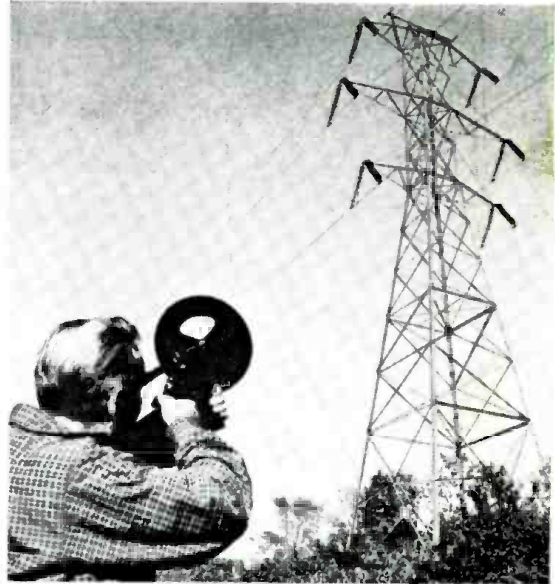

### "Tiros" and Recorder

The "Tiros IV" meteorological satellite, launched recently, is shown here undergoing final tests at RCA, Princeton, N. J. At the rear are the racks of ground equipment for commanding the satellite and acquiring the data. This ground station is for test and backup purposes. Primary ground stations are at Wallops Island, Virginia, and Point Mugu, Calif.

### Thermoelectric Ice Maker

The first commercial storage-type thermoelectric ice-cube maker, capable of producing 30 pounds of ice cubes a day, was previewed recently by the York Div. of Borg-Warner. The unit uses printed circuitry for interconnecting its thermoelectric modules. The new ice maker has no compressor, evaporator, or condenser. It creates cold by the passage of rectified a.c. current through special metallic compounds which make up the thermoelectric modules. Because of the absence of moving parts, the unit should operate indefinitely without maintenance or repair. Although the exact price is not available, it is expected to sell for between \$300 and \$1000.

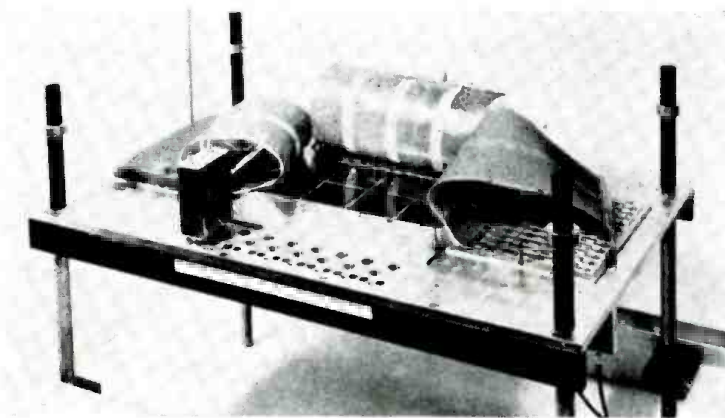

### Experimental Thin-Film Memory

An experimental high-speed magnetic thin-film memory, developed by IBM scientists, is shown disassembled. The eight squares (center) are magnetic thin-film substrates, each of which contains 2304 information bits. These squares measure 2" x 2". The driving and sensing lines of etched copper foil are shown curled away from the eight substrates. Memory devices such as this have size and speed advantages over magnetic ferrite-core memories that are presently employed in computers as fast memory devices. Information is stored on the film by the magnetization or demagnetization of tiny thin ferromagnetic nickel-iron alloy spots.



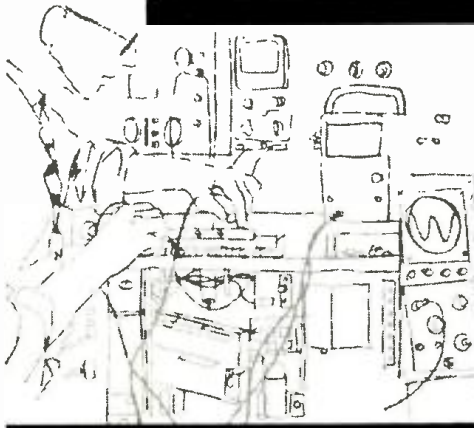

# MAC'S

# ELECTRONICS

# SERVICE

By JOHN T. FRYE

## A CLASSIC CASE

"HI, RED," Mac greeted the line superintendent of the city electric company standing in the open doorway of the service shop. "Come on in and take a load off your feet."

"Don't mind if I do," Red said as he joined Mac and Barney in the service department and slumped down on a stool. "Old Sol is really bearing down for this early in the year."

"What have you been up to?" Mac asked curiously. "We've not seen much of you lately."

"A lot of my time has been spent trying to keep our mutual customers happy," Red retorted as he rocked back until he could rest his elbows on the service bench.

"I suppose you mean running down radio and TV interference complaints," Mac said with a sympathetic grin. "I want you to know we never sic them on you except as a last resort and after we're sure the interference is widespread."

"I know and appreciate that, but not all your brother technicians are so thoughtful. Some bounce noise complaints from their customers over to us without even going out to make sure interference is causing the trouble."

"I'll bet you've had some interesting experiences running down interference," Barney suggested leadingly.

"Yes, although I'm not sure 'interesting' is the adjective I'd have chosen at the time," Red said slowly. "I think a case we had back during the Christmas holidays came about as near being a classic as any I can recall. It had everything."

"Well, go on!" Barney said impatiently.

"Sporadic complaints began coming in from an area in the East End about a week or so before Christmas. I didn't pay too much attention at first because we always get a rash of noise complaints when people start putting up their Christmas lights. Cheap flashers, bulbs not making good contact, haphazard extension cords—but you boys know as well as I do the potential sources of interference present in amateur-installed Christmas lighting. Usually, though, these complaints cure themselves. The

householder notices a connection between the operation of the lighting and the presence of the interference and corrects the cause, or the arcing that produces the interference commits suicide by destroying the equipment. At any rate, we've learned there's no point in rushing out immediately every time an isolated call comes in during this period.

"But this time the number of calls from that area kept increasing; so I sent a man out with our interference-locating receiver. As you probably know, this is a battery-operated all-wave receiver with a meter to indicate the strength of received signal or noise. It has a loop antenna designed to indicate the direction from which the interference is being received, but this does not work out too well in practice. The noise usually is carried on the wires and refuses to act like a point-source. We do better using a short whip antenna and moving around in the field of the interference while watching the meter. The closer we approach the source of the interference, the higher is the reading, and *vice versa*."

"Anyway the man came back after a couple of hours and reported a very juicy interference was present all right. It consisted of a rasping, arcing type of noise extending from the bottom of the broadcast band right on up through channel 13; but it seemed to peak on channel 6, our most popular channel, naturally! The interference cycled on for three seconds and then off for three, on for three and off for three, as regular as clockwork. It showed up in the TV picture as two broad horizontal bands of sparkles and streaks that blotted out all picture detail beneath. Sometimes these bands stood still; at other times they moved slowly up or down. Where the interference was most intense, the noise actually knocked the picture off the screen by throwing it out of sync—or I believe that's what you call it.

"The noise was not affected by daylight or darkness or by damp or dry weather. Intense cold seemed to make it worse. Occasionally, it would stop for as long as a half hour, but then it would be right back. The area covered was roughly a rectangle extending south-

ward from the river for seven blocks and covered the three blocks between 16th and 19th Streets. Oddly enough our receiver indicated the interference near the southern boundary of this area, but TV complaints centered well to the north of this."

"Well, what was causing it?" Barney demanded impatiently.

"Don't rush me. Either of you care to take a guess?"

"The two bands across the picture probably indicate some device arcing only on the peaks of the a.c. voltage," Mac remarked.

"Yeah, and the regular cycling indicates some sort of motor-operated or bi-metal switch," Barney chimed in eagerly. "My guess is a flashing commercial lighting display using neon or fluorescent lamps that only fire during portions of the a.c. cycle. I say 'commercial' because home lighting would be turned off during the day and late at night."

"It feels good to know I'm not the only one misled by the symptoms," Red said with a smile of satisfaction. "I wasted a lot of time hunting something exactly like you describe. I'd probably have found the trouble sooner if I hadn't received so much unsolicited help and advice. First I was told a radio amateur living at the edge of the noise area was causing all the trouble with his ham transmitter. Of course I knew from the nature and duration of the interference that he wasn't, but I called him because he had helped us with noise problems before. He said that the noise was really clobbering his sensitive receiver and that the directional qualities of his big twenty-meter beam showed the noise originating in the same southern part of the complaint sector that our receiver had fingered."

"Another tip told me one of your competitors who lives in the area was making the noise to provide himself with service calls! He uses a two-way radio in his truck to keep in touch with his wife at home, and that little transmitting antenna on his roof was all his good neighbors needed to suspect him."

"One anonymous caller told me an old lady in the neighborhood was in bed with a broken hip and her heating pad was undoubtedly causing the trouble. I should go right in there and turn that pad off! Another fellow was sure his neighbor was making the noise deliberately, probably with a spark coil. He was just the mean sort of guy who would do a thing like that. Remember: this was all taking place during the Season of Good Will!"

"Another lead really looked promising at first. A man who worked in a local factory told me the laboratory at the plant was life-testing some ignitors. They were cycled on for three seconds and then off for three, and they produced an arc during the 'on' time; but when the factory obligingly shut down the test, the noise kept right on."

"By this time the pressure was getting pretty high. One guy who had bought a new color TV for Christmas and had to enjoy it in three-second

(Continued on page 76)

Over-all view of the 12-watt amplifier constructed by the author. Four power transistors are used in all, with two being mounted on one of the chassis side panels shown and the other two being mounted on the other side panel.

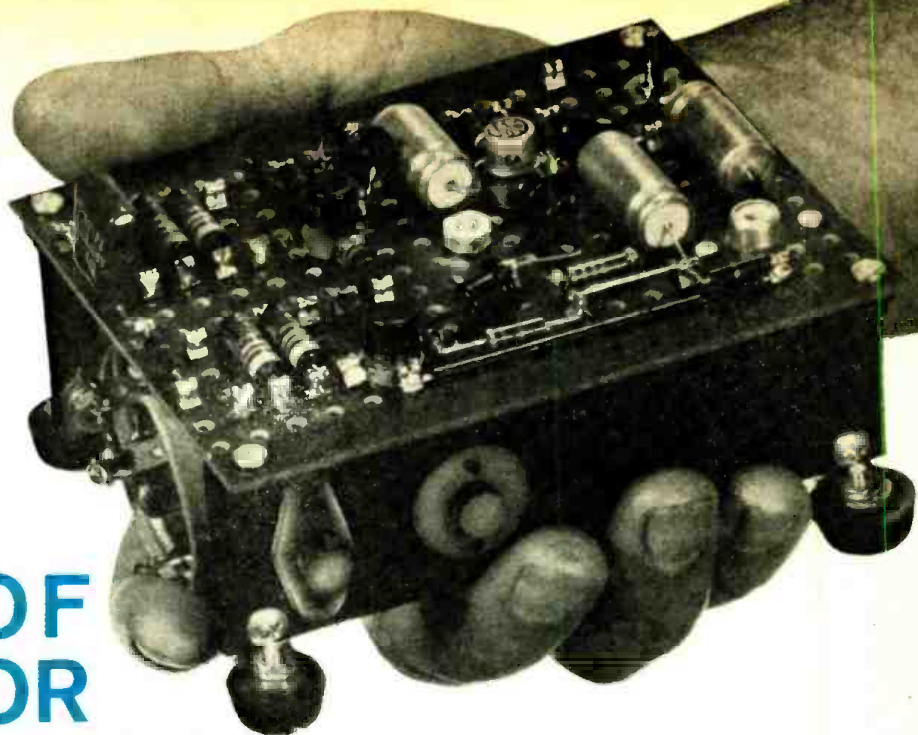

By DWIGHT V. JONES  
Application Engineering, General Electric Co.

# DESIGN OF TRANSISTOR HI-FI POWER AMPLIFIERS

RECENT advances in semiconductor technology have made available to the electronic industry an increasing number of power transistors that are suitable for hi-fi power-amplifier use. These transistors are capable of efficient operation at the upper end of the audio spectrum and above, as well as at the lower frequencies. Diffused semiconductor junctions are the basis for the higher frequency capability and this, combined with the more recent epitaxial process, promises even greater improvements in performance.

The power-handling capability of a transistor is limited by both its electrical and thermal ratings. The electrical-rating limit is a function of the transistor's voltage capability and the maximum current at which the current gain is still usable. The thermal rating is limited by the transistor's maximum junction temperature. Therefore, it is desirable to provide the lowest thermal impedance path that is practical from junction to air. The thermal impedance from junction to case is fixed by the design of the transistor; thus it is advantageous to achieve a low thermal impedance from case to ambient air.

The 2N2107 and 2N2108 are *n-p-n* diffused-junction mesa silicon transistors. They will be limited in their maximum power-handling ability by thermal considerations in many applications unless an efficient thermal path is provided from case to air.

These transistors are constructed

with the silicon pellet mounted directly on the metal header and therefore it is more efficient to have an external heat radiator in direct contact with this header than to make contact with the cap of the transistor package. Making contact with the cap for heat transfer means that the heat must flow from the header across the welded seam to the cap. This adds to the total thermal impedance from junction to air.

Fig. 1 is a practical method for achieving a maximum area of direct contact between the metal header and an aluminum fin for efficient heat transfer to the surrounding air. A plain washer with two holes drilled for the mounting hardware is simple but quite adequate for securing the transistor header to the fin. Since air is a relatively poor thermal conductor, the thermal transfer can be improved by applying a thin layer of silicone dielectric grease between the transistor and

the radiating fin before assembly. This heat-radiating fin has two holes for vertical mounting to a chassis. The fin may be anodized or flat paint may be used to cover all the surface except for the area of direct contact with the transistor header. An anodized finish would provide the insulation needed between the base and emitter leads and the sides of the feed-through holes in the aluminum fin. Fig. 3 shows the thermal rating for the 2N2107 as assembled on the radiating fin in Fig. 1.

The *beta* (current gain) hold-up is quite good at one ampere for both the 2N2107 and 2N2108. This means that considerable peak power can be handled.

## Power Amplifiers

It is difficult to obtain faithful reproduction of a square-wave signal with a transformer-coupled amplifier. A high-quality output transformer is required and it must be physically large, carefully made, and quite expensive in order to have good response at the low frequencies. Thus, a great deal of effort has gone into developing transformerless push-pull amplifiers using vacuum tubes. Practical circuits, however, use many power tubes in parallel to provide the high currents necessary for direct-coupling to a low-impedance loudspeaker load.

The advent of power transistors has sparked new interest in the development of transformerless circuits since the transistors are basically low-volt-

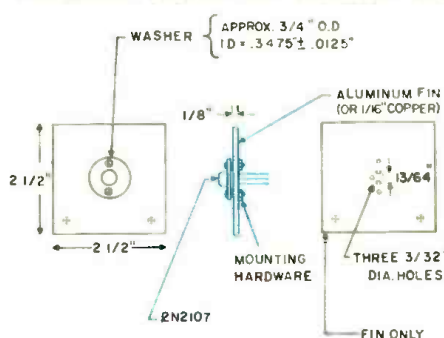

Fig. 1. Transistor heat-sink arrangement.

Solid-state amplifiers with performance that equals the best of their vacuum-tube counterparts, using new diffused silicon transistors in circuits delivering 7½ to 12 watts.

Fig. 2. Circuit arrangement for the 7½- to 10-watt audio amplifier.

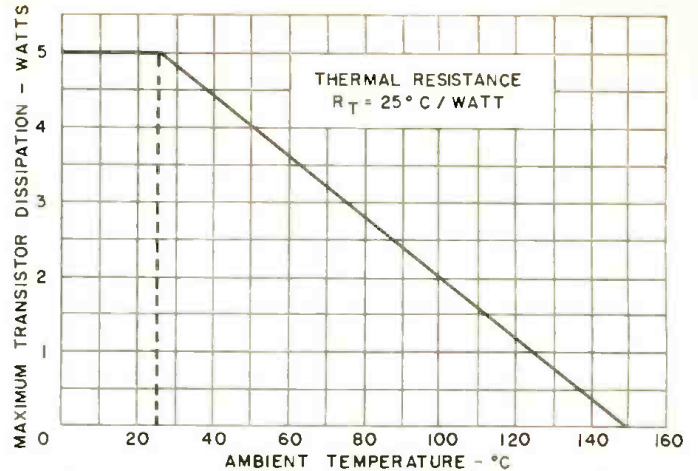
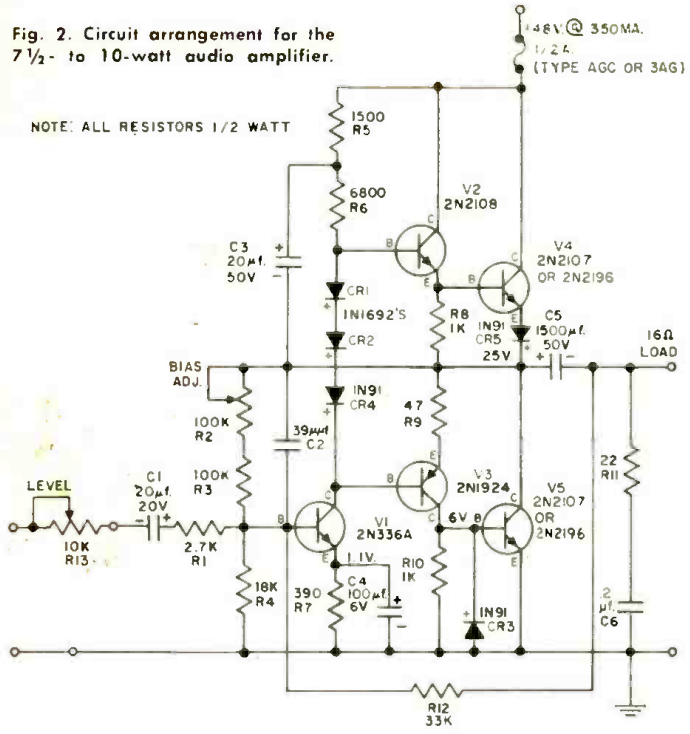

Fig. 3. Thermal characteristics of the assembly shown in Fig. 1.

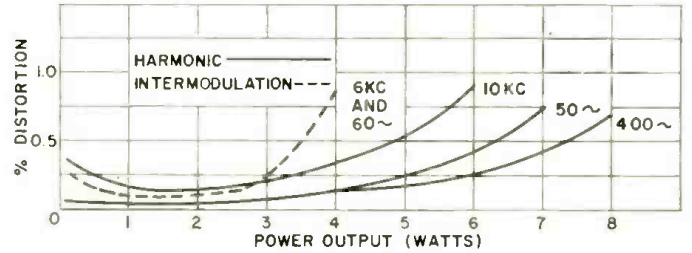

Fig. 4. Distortion versus power of the amplifier shown in Fig. 2.

age, high-current devices. Some of the transistor power amplifiers to date have been lacking in high-frequency performance and temperature stability. The diffused junctions of the 2N2107 permit good circuit performance even at high frequency. Silicon transistors are favored for power-output stages because of their ability to perform at much higher junction temperatures than germanium. This means smaller heat-radiating fins can be used for the same power dissipation. On the negative side, silicon has higher saturation resistance (which gives decreased operating efficiency) that becomes appreci-

able when operating from low-voltage supplies.

#### Circuit Analysis

Fig. 2 shows a direct-coupled power amplifier with excellent frequency response. It also has the advantage of a d.c. feedback arrangement for temperature stabilization of all stages. This feedback system also stabilizes the voltage division across power-output transistors  $V_4$  and  $V_5$  which operate in a single-ended class B push-pull arrangement. Transistors  $V_2$  and  $V_3$  also operate class B in the Darlington connection to increase the current gain. Using a  $p-n-p$

for  $V_1$  gives the required phase inversion for driving  $V_3$  and also has the advantage of push-pull emitter-follower operation from the output of  $V_1$  to the load. Emitter-follower operation has lower inherent distortion and low output impedance because of the 100% voltage feedback.

$V_1$  and  $V_3$  have a small forward bias of 10 to 20 ma. to minimize crossover distortion and it also operates the output transistors in a more favorable  $\beta$  range. This bias is set by the voltage drop across the 1000-ohm resistors ( $R_8$  and  $R_{11}$ ) that shunt the input to  $V_3$  and  $V_5$ .  $V_2$  and  $V_3$  are biased at about 1 ma. (to minimize crossover distortion) by the voltage drop across the two 1N1692 silicon diodes and the 1N91 germanium diode. The junction diodes have a temperature characteristic similar to the emitter-base junction of a transistor. Therefore, the three diodes also provide compensation for the temperature variation of the emitter-base resistance of the push-pull transistors. These resistances decrease with increasing temperature, thus the decrease in forward voltage drop of approximately 2 mv./degree C for each of the diodes provides temperature compensation. The 1N91 ( $CR_3$ ) connected to the emitter of  $V_1$  gives additional stabilization for this stage for variations in transistor  $\beta$  and temperature.

The 47-ohm resistor ( $R_9$ ) in the emitter of  $V_3$  aids the stabilization of this germanium transistor stage and also decreases distortion through local feedback. The 1N91 diode ( $CR_3$ ) at the base of  $V_3$  has a leakage current which increases with temperature in a manner similar to the  $I_{co}$  of  $V_3$ . The 1N91 can thus shunt this temperature-sensitive current to ground, whereas if it were

Top view of the circuit board on which the three driver transistors are mounted.

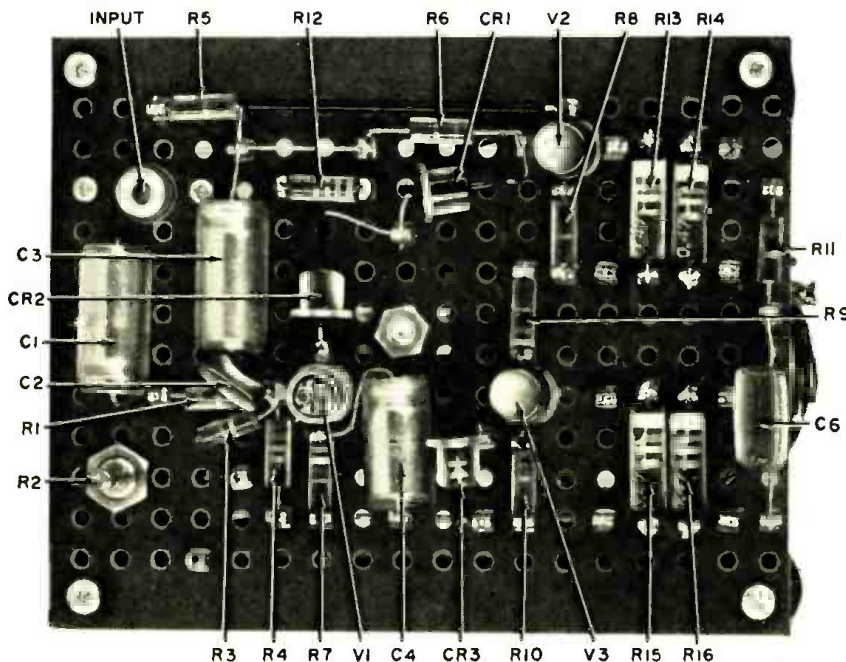

to flow into the base of  $V_6$ , it would be amplified in the output stage.

$V_2$  should have a minimum  $h_{fe}$  of 30 at 1 to 30 ma. collector current. Of the two output transistors, the higher  $\beta$  unit should be used for  $V_1$  to help compensate for the unsymmetrical output circuit.

$V_1$  is a class A driver with an emitter current of about 3 ma. Negative feedback from the output to the base of  $V_1$  lowers the input impedance of this stage. This requires a source impedance that is higher than the input impedance so the feedback current will flow into the amplifier rather than into the source generator. Resistor  $R_1$  limits the minimum value of source impedance. The bias adjustment,  $R_2$ , is set for one-half the supply voltage across  $V_1$ .

About 11 db of positive feedback is applied by way of  $C_2$ . This bootstrapping action helps to compensate for the unsymmetrical output circuit and permits the positive peak signal swing to approach the amplitude of the negative peak. This positive feedback is offset by about the same magnitude of negative feedback via  $R_2$  and  $R_3$  to the base of  $V_1$ . The net amount of negative feedback is approximately 20 db resulting from  $R_{12}$  connecting the output to the input.

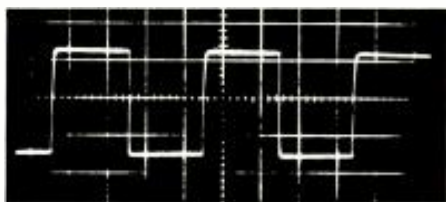

Fig. 5. The 2-kc. square-wave response.

In addition, there is the local feedback inherent in the emitter-follower stages. The value for the  $C_2$  feedback capacitor was chosen for optimum square-wave response (i.e., maximum rise time and minimum overshoot), as shown in Fig. 5.

If the load impedance has a reactive component, as with loudspeakers, it should be shunted by  $R_{11}$  and  $C_6$  as shown in Fig. 2 to prevent the continued rise of the amplifier load impedance at frequencies above 20 kc. and its accompanying phase shift.

### Performance

The over-all result, from using direct coupling, no transformers, and ample degeneration, is an amplifier with output impedance of .5 ohm for good speaker damping and very low distortion, as shown in Fig. 4. The square-wave response shown in Fig. 5 is indicative of an amplifier with good transient response and also good bandwidth. The bandwidth is confirmed by the frequency-response curve of Fig. 6 taken at  $\frac{1}{2}$ -watt output. The power response at 5-watts output is flat within  $\frac{1}{3}$  db from 30 to 15,000 cps. The amplifier exhibits good recovery from overload and the square-wave peak-power output without distorting the waveform is 12 watts.

An r.m.s. input signal of  $1\frac{1}{4}$  volts is

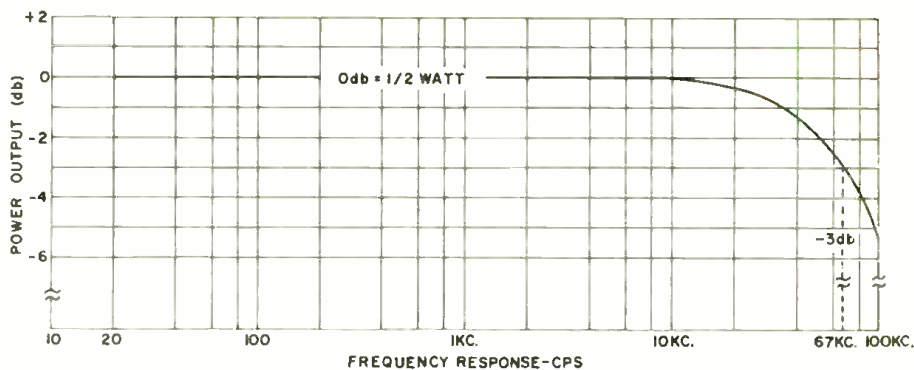

Fig. 6. Frequency response of the amplifier diagrammed in Fig. 2.

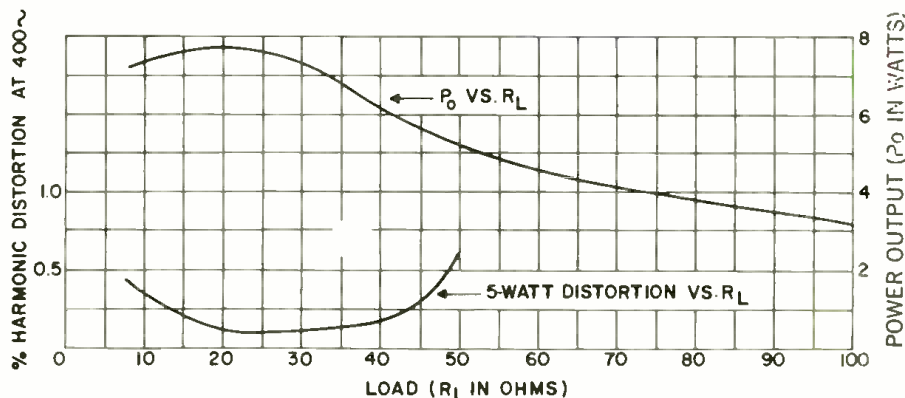

Fig. 7. Amplifier performance versus load for the Fig. 2 circuit.

required for 8-watts output with a supply furnishing 350 ma. at 48 volts. The 2N2107 output transistors,  $V_1$  and  $V_2$ , were mounted on heat-dissipating fins as shown in Fig. 1 and the amplifier operated successfully delivering 1-watt continuous power at 400 cps to the load with no increase in total harmonic distortion from room ambient temperature of 75 degrees F to 175 degrees F (approximately 80 degrees C). At 175 degrees F the d.c. voltage across  $V_2$  had decreased less than 15% from its room ambient value. Operation at higher temperatures was not attempted because

of  $V_2$  being a germanium transistor which has a maximum operating junction temperature of 85 degrees C. For operation at higher junction temperatures a  $p-n-p$  silicon transistor should be used for  $V_2$ .

The above performance tests were with a 16-ohm resistive load. The performance near maximum power output will vary somewhat with transistors of different  $\beta$  values, giving a range of maximum power output of  $7\frac{1}{2}$  to 10 watts before clipping. Varying values of saturation resistance for output transistors  $V_1$  and  $V_2$  also affect the maximum

Fig. 8. Complete schematic diagram of the author's 12-watt transistorized amplifier.

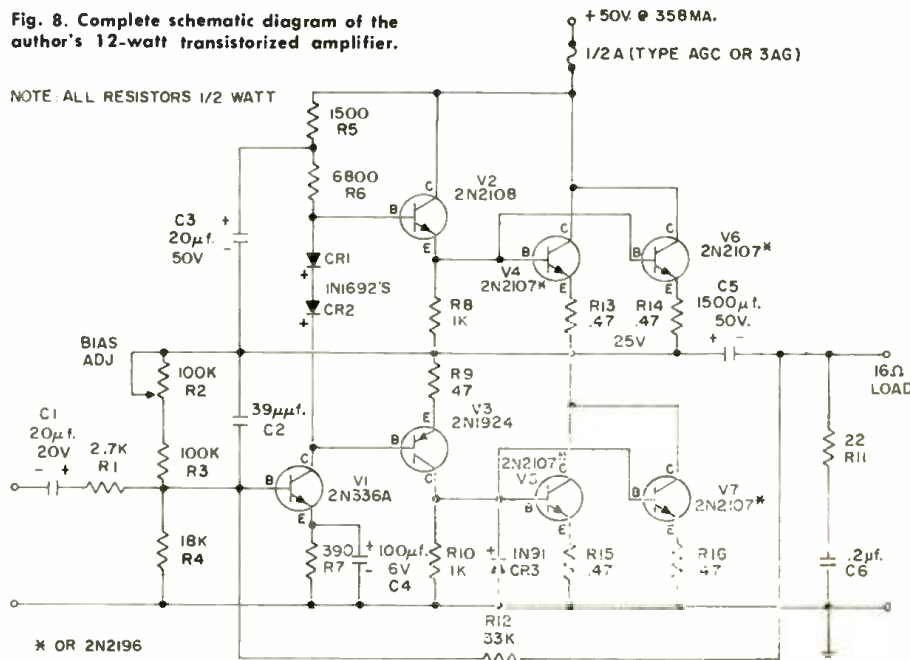

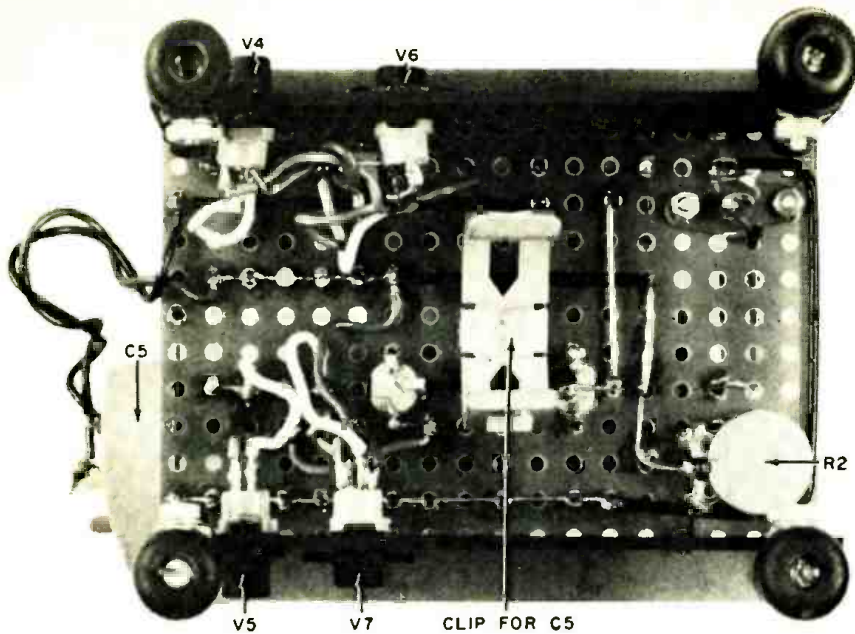

Bottom of the circuit board with large capacitor C<sub>5</sub> temporarily removed from clip.

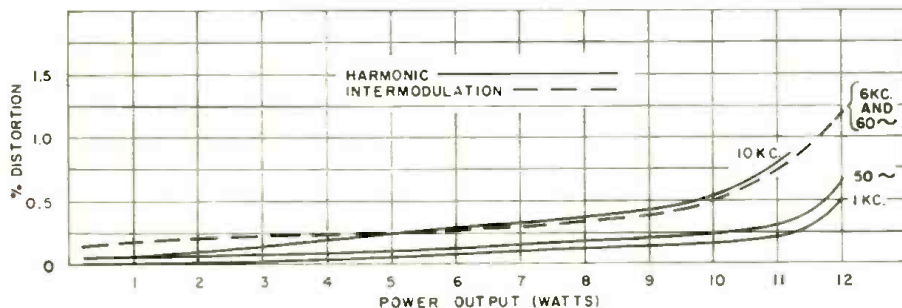

Fig. 9. Distortion versus power output for the 12-watt amplifier shown in Fig. 8.

power output that can be obtained.

Fig. 7 shows the load range for maximum performance. It indicates that for a varying load impedance, such as a loudspeaker, the most desirable range is 16 to 40 ohms. The 16-ohm speaker system operates in this range. At higher impedances (to 100 ohms), 1- to 3-watt servo motors could be driven or an impedance-matching autotransformer would permit higher power. A 20- to 600-ohm autotransformer should be used for driving a 600-ohm audio line.

The amplifier of Fig. 2 operates with an efficiency of 47 to 60% and has a signal-to-noise ratio of better than 98 db. This amplifier, when operated with the 2N2107 heat-radiator assembly shown in Fig. 1, can safely deliver up to 10 watts of continuous sine-wave power to the load at room temperature. When driving a loudspeaker with program material at a level where peak power may reach 10 watts, the steady-state power would generally be less than 1 watt.

When operated with 2N2196's in the output these can be mounted on smaller 2" x 2" fins because of the increased power capabilities of these transistors. The 2N2196 has a case that simplifies mounting on a heat radiator and it has electrical characteristics that equal or excel the 2N2107 for this application.

The power supply for this amplifier should have low impedance (less than

6 ohms) obtained either by regulation or high-output capacitance as in Fig. 10. This power supply has diode decoupling which provides excellent isolation between two stereo amplifier channels.

### 12-Watt Amplifier

The amplifier of Fig. 2 is limited in its maximum power output by the supply voltage and the saturation resistance of output transistors,  $V_1$  and  $V_2$ . The supply voltage cannot be increased much beyond 50 volts at maximum amplifier signal swing without making the  $V_{CE}$  rating for  $V_1$  marginal. Under these conditions the saturation resistance becomes the limiting factor for obtaining increased power output.

The circuit of Fig. 8 uses two transistors in parallel for each of the outputs. This enables the saturation resistance to be reduced by half and gives 12-watts output. The .47-ohm resistor used in each emitter of the paralleled transistors gives a more uniform input char-

acteristic for sharing of the input currents. These emitter resistors also give increased bias stabilization. The rest of the circuit is the same as Fig. 2 except the 1N91 ( $CR_1$ ) is not used in the collector of  $V_1$  since there is no  $CR_2$  diode voltage to offset in series with the output emitter.

The performance of the 12-watt circuit is like that given previously for the circuit of Fig. 2 except for distortion vs power output. Fig. 9 indicates the increased power output and also the lower distortion which is a second advantage of parallel operation of the outputs. Lower distortion results from parallel operation since the signal current swing in each transistor is approximately halved and thus confined to the more linear portion of the transfer characteristic.

The amplifier of Fig. 8 operates at maximum power output with an efficiency of 67%. This circuit can be packaged with minimum volume and weight without component crowding, as shown in the photos. One of the paralleled output transistors (a 2N2107) uses the mounting technique described in connection with Fig. 1 and the other uses the simplified mounting that is possible for a 2N2196. All four of the output transistors could be 2N2107's or all 2N2196's. Each mounting fin, which supports two output transistors, is  $\frac{3}{16}$ " x  $1\frac{1}{2}$ " x  $4\frac{1}{2}$ " aluminum.

A regulated 50-volt supply is recommended for best performance of this circuit. If the amplifier is powered by the supply of Fig. 10, it will provide 10 watts of continuous output or 12 watts of music power.

A pair of either one of the amplifiers described will give superb performance in a stereo system when used to drive 16-ohm speakers that have a least moderate sensitivity. These amplifiers fit ideally into the stereo tape playback system the author described in the July 1959 issue of this magazine.

The cost of the semiconductors required for the circuit of Fig. 2 is around \$29, and for the circuit of Fig. 8 is around \$38. Total parts cost for the power supply shown in Fig. 10 is around \$21. Although some of the transistor types used in the amplifier are quite new so that they are not yet listed in electronics parts catalogues, all these transistors should be available from larger G-E distributors.

### REFERENCES

1. Jones, D. V.: "Class B Power Amplifier Performance with Silicon Transistors," AES Convention paper presented October 1960.
2. Geiser, D. T.: "Using Diodes as Power Supply Filter Elements," *Electronic Design*, June 10, 1959.
3. Jones, D. V.: "All Transistor Stereo Tape System," *ELLECTRONICS WORLD*, July 1959. ▲

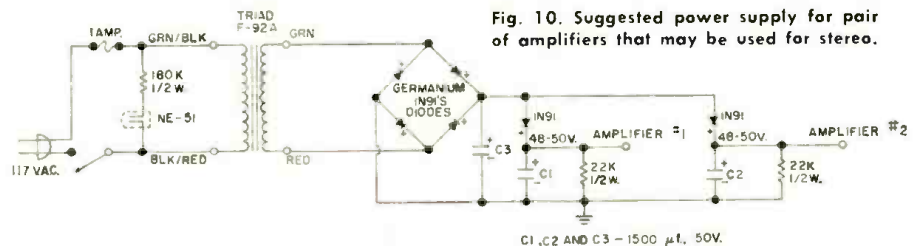

Fig. 10. Suggested power supply for pair of amplifiers that may be used for stereo.



# DIRECT → HEAT — TO — ELECTRICITY ENERGY CONVERTERS

By STOYAN M. ZALAR / Senior Research Scientist, Research Div., Raytheon Co.

A survey of unconventional energy sources that produce electricity without the use of moving parts or batteries.

**T**HE SEARCH for new, unconventional sources of energy has been intensified in the past decade. Much work has been done on direct heat-to-electricity conversion systems for use in military and industrial laboratories and in space vehicles. This article surveys some of these systems that produce electricity directly from heat without the use of moving parts or chemical batteries. Systems based on thermionic, magnetohydrodynamic, thermoelectric, and thermo-photovoltaic principles will be described and compared.

Fig. 1 summarizes the increase in the world's population and its rising need for energy in the period between 1800 and 2050. Also included is the total energy up to the present and some projections for the future. Because of the tremendously rapid rise in the world's population (note log scale), energy will have to increase at least at the same rate. How insignificant the total amount of energy produced by man is also shown in Fig. 1. Today's industrial production of energy in all countries is less than 0.01% of the amount of solar energy which falls on the earth's surface.

### Energy Conversion

Fig. 2 is a schematic summary of several possible energy conversions used to produce electricity. It is a direct result of the First Law of Thermodynamics which states that energy can be converted into various forms, but in a closed thermodynamic system, it can be neither destroyed nor created. In the conversion of heat to other forms of energy, there is a definite top limit, the so-called Carnot efficiency of the process. Heat-to-electricity energy converters behave like any heat machine in that the higher the temperature difference within which the converter is

operating, the higher will be its conversion efficiency.

In this article we will be concerned with the four most important direct heat-to-electricity conversion schemes: *thermionic*, *magnetohydrodynamic (MHD)*, *thermoelectric*, and *thermo-photovoltaic (TPV)* energy converters.

### Thermionic Converters

Thomas Edison, that wizard from Menlo Park, in order to prolong the life of his incandescent lamps, developed a bulb with two independent filaments, as shown in Fig. 3A. Only one filament was connected at a time and after this burned out, the second filament was brought into service. During the work on these bulbs Edison observed that a small electrical current was flowing through Ammeter 2 even though Filament 2 was not connected. He rightly concluded that some electrons were able to move through the vacuum from the hot filament to the cold one. This "Edison effect" actually was the discovery of the thermionic emission of electrons from hot cathodes and forms the basis for the operation of all electronic tubes.

If we want to use Edison's thermionic principle for the generation of electrical power, we have to obtain an intense flow of electrons from the hot cathode to the cold anode. This is not at all easy since electrons, being negatively charged, form a space charge in the vicinity of the cathode. This high, retarding potential barrier repels the electrons and blocks their

flow. Depending on the method being used to solve this problem, there exist three broad classes of thermionic energy converters: vacuum close-spaced diode (Fig. 3B), diode filled with cesium plasma (Fig. 3C), and magnetic triode (Fig. 3D).

One way to avoid the detrimental effect of the space charge is to move the cathode and anode very close together. For effective operation of the thermionic close-spaced diode, a gap of less than 0.01 mm. is necessary, since the maximum output power is inversely proportional to the square of the electrode spacing. The machining and maintenance of these close spacings is quite

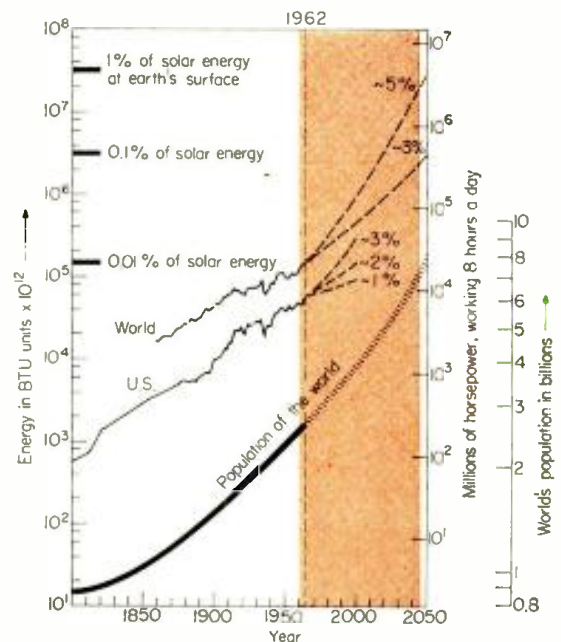

Fig. 1. Growth of world's population including predictions up to the year 2050.

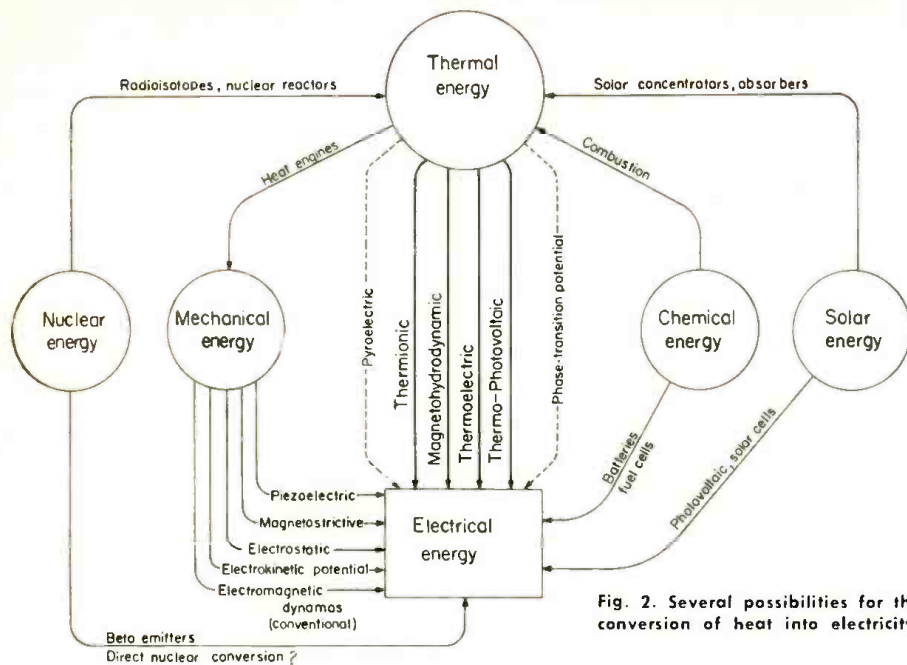

Fig. 2. Several possibilities for the conversion of heat into electricity.

a challenging problem, especially at cathode temperatures above 1200 degrees C and under conditions of shock and vibration. Close-spaced diodes were first developed at MIT's Research Laboratory of Heat Transfer in Electronics in 1956 and were called "thermoelectron engines." They are true heat engines in which the working fluid is the electron gas, delivering useful work to the surroundings as a result of its passage through the retarding electrostatic field.

The efficiency achieved for the heat-to-electricity conversion of close-spaced diodes is between 12 and 14 per cent. In the future, power outputs on the order of 10 to 30 watts/cm.<sup>2</sup> are anticipated. One of the best features of close-spaced diodes is that they weigh the least of all energy converters. With a possible weight of less than 1 pound per kw., they are a good choice for space vehicles. They could be very simply adjusted to nuclear reactors, with the fuel rods acting directly as cathodes and the cans serving as anodes. High-temperature operation of close-spaced diodes, however, presents serious materials problems. For a high emitter work function, cathodes have to operate at the highest possible temperature. This shortens the cathode life considerably and efficiency must be reduced to compensate for this.

A second way to minimize or completely eliminate the space charge is

to introduce an ionized gas. In diodes filled with cesium plasma the positive ions, to a great extent, neutralize the negative electron space charge and permit the electrons to flow toward the anode. One ion can effectively cancel the space charge of several hundred electrons. Ion current is thus only a small fraction of the electron current.

Cesium vapor is being used for several reasons. It is one of the most easily ionized plasmas. Cesium adsorbs readily to most metals and so reduces their work function, which is especially important for the anode (collector). On the other hand, high efficiency in gas-filled diodes, or "plasma thermocouples," requires extremely high work-function cathodes (emitters) and therefore operation at temperatures exceeding 2000 degrees C. This makes the question of cathode life a still more aggravating problem than in the case of vacuum-type thermionic diodes. Other fabrication difficulties are the corrosiveness of cesium vapor and the problem of metal-ceramic seals, which must survive a unified attack of cesium and of high-temperature radiation.

A low-pressure gas-filled diode, produced by RCA and using a tungsten ribbon cathode and a nickel anode, reached an efficiency of 10.4 per cent at a cathode temperature of 2600 degrees C. High-pressure (2 mm. Hg) diodes are now being developed which operate at

lower cathode temperatures (as low as 1100 degrees C) and could theoretically produce 40 watts/cm.<sup>2</sup> with an approximate efficiency of 25 per cent.

A third way to reduce the space-charge effect in thermionic converters is to use crossed electric and magnetic fields. This principle could be realized in a vacuum magnetic triode. Here a hot cathode and a cold anode are placed in the same plane, being separated by a space less than one-eighth the width of the electrode. Above, an accelerating anode is positioned a short distance from both electrodes. The battery produces an electric field in the space between the plates. An external magnetic field *B* is superimposed by placing the entire device between the poles of a big magnet so that the direction of *B* is normal to this page.

When an electron leaves the hot cathode (emitter), it finds itself in an electric field which speeds it toward the accelerating plate above. Simultaneously the magnetic field is acting upon the speeded up electron and deflects it in a cycloid arc toward the surface of the anode (collector). During its acceleration the electron takes the necessary kinetic energy from the electric field, but when it falls back to the anode it returns that energy, and no net energy is gained or consumed. Similarly, no energy is consumed from the magnetic field since the magnetic force on the electron is always perpendicular to the direction of its motion. The result is that the energies of electrons arriving at the anode are the same as they were when they left the cathode.

In theory the magnetic thermionic triode can produce more power than a similar close-spaced vacuum diode. The theoretical efficiency of a magnetic triode is 22 per cent as compared with 12 per cent for a diode under the same operating conditions. However, several practical magnetic triodes showed considerable electron losses to the accelerating plate, which lowered their expected higher efficiency. The most important factors influencing the possible net loss of electrons descending to the anode are: electron scattering, non-uniformity of electric and magnetic fields and, to a lesser extent, reflection of electrons at the anode surface and scattering of electrons by gas molecules.

In general, thermionic converters are low-voltage, high-current generators in which a very low load impedance is required for maximum power transfer. For example, load impedances of less than a fraction of one ohm are necessary for proper operation.

The newest development in the area of thermionic converters is the possibility of converting heat directly to a.c. current. One technique for generating a.c. could be the application of a small modulating signal to produce the a.c. output which can then be matched to a high-impedance load through the use of a transformer.

#### Magnetohydrodynamic Converters

More than a century ago, Faraday made the fundamental discovery that

## COVER STORY

**T**HE RED helium-filled balloon is part of the apparatus used for the determination of thermoelectric properties of thin-film structures at Raytheon Company's Research Division, Waltham, Mass. Dr. S. M. Zalar, senior research scientist, is shown using a special furnace for testing thermoelectric materials up to approximately 1000 degrees F. Samples to be tested are placed in a vacuum-tight stainless steel container, which is first evacuated and flushed several times with argon. Helium is then introduced, providing an inert atmosphere, and the

balloon helps maintain a fairly constant pressure, even when the temperature in the furnace is rising.

An electronic monitor (shown at the left) with a six-point recorder, automatically prints the electric signals from the sample area. The d.c. resistivities for two current directions, thermoelectric power, the temperature difference, and the average temperature of the sample are printed on a slowly moving chart in four-second intervals.

(Cover Photograph: Raytheon Company)

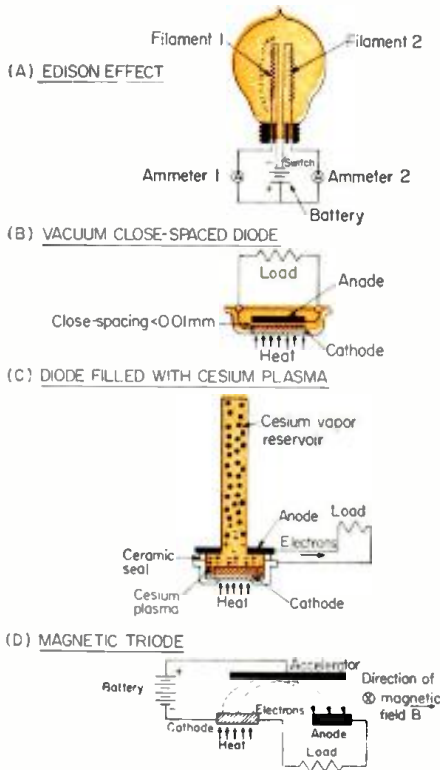

Fig. 3. Some thermionic energy converters.

if an electric conductor, for example a copper wire, is moved in a magnetic field, an electric current is generated. This principle is used on a big scale for the indirect generation of electricity by turbogenerators.

Today Faraday's principle of electric induction is utilized for a very new concept of direct magnetohydrodynamic (MHD) energy conversion. Here instead of a solid copper wire, the conductor is the working fluid, the ionized gas itself.

Fig. 4 is a closed-cycle MHD energy converter, most applicable for nuclear reactor operation. Heat coming from the burning of fossil fuels (wood, coal, oil) or from nuclear fission, is applied in the superheater to heat a gas to a very high temperature and pressure. The temperature of the gas is so high that gas molecules partly ionize, forming a plasma of positive ions and negative electrons.

The ionized gas is then led through a nozzle into a conversion chamber, where it expands and is pumped into the condenser area, lowering its pressure and its enthalpy. If this were a turbine, the pressure of the gas flow would be converted into the mechanical energy of rotation which, in turn, must be converted into electrical energy. In the MHD converter, however, the second indirect step is omitted.

The conversion chamber is equipped with electrodes and an external magnetic field  $B$  is applied, with the direction perpendicular to the page. The magnetic field deflects electrons toward the anode from which they flow through the load, doing electrical work, and then flow back to the cathode. The voltage developed in this way is proportional to magnetic field strength,

gas velocity, and spacing between electrodes. In a closed-cycle system the gas is condensed and pumped back to the superheater.

Unlike other direct energy converters described in this article, MHD converters can be built to produce huge amounts of electric energy. When and if perfected, they may very well eliminate present indirect sources of electrical power, turbogenerators and water turbines. The efficiencies of MHD converters have been predicted as approaching 60 per-cent as compared to 40 per-cent for conventional modern power plants.

The American Electric Power Service Corp. and Avco-Everett Research Labs are studying the application of MHD principles for pilot plants designed to produce 450,000 kw. of electricity. Two approaches are being considered. One is the open-cycle, coal-fired system with an estimated thermal efficiency of 55

per-cent or 6200 b.t.u./kw.-hr. The other is a closed-cycle nuclear reactor approach with an estimated efficiency close to 58 per-cent or 5800 b.t.u./kw.-hr., as compared to the 8500 b.t.u./kw. hr., or 40 per-cent efficiency of conventional turbogenerator electric power stations that are in present-day use.

One of the most important of the technological factors which determines the feasibility and characteristics of MHD converters is the plasma conductivity. Most gases, such as air, carbon dioxide, and the noble gases (argon, helium), do not ionize appreciably at the temperatures between 2000 and 3000 degrees C. The problem is solved by "seeding" the gas with potassium or cesium vapor, which markedly increases the conductivity of the working gas. Other critical factors are the materials which have to endure temperatures above 2000 degrees C as well as the heat sources capable of producing these

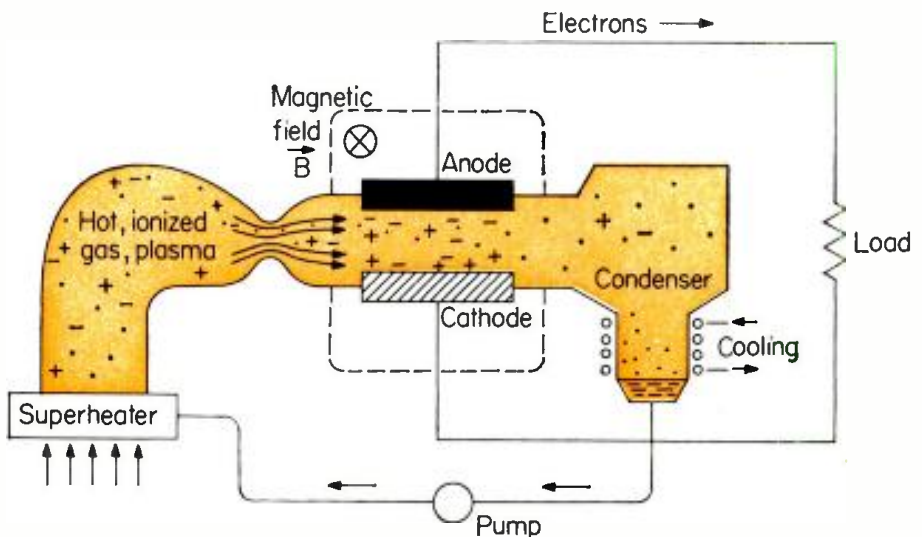

Fig. 4. Closed-cycle magnetohydrodynamic energy converter. It consists of a jet of hot ionized plasma (temperature above 2000°C, velocity above 1500 m.p.h.) in a strong magnetic field, which separates the electrons from the positive ions of the cesium plasma and then leads them directly to the external electrical load.

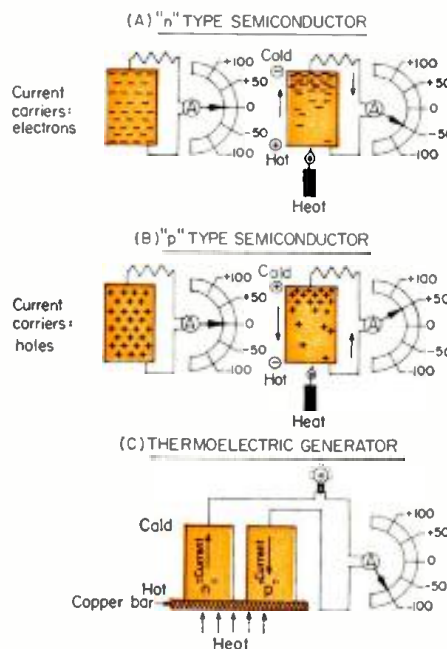

Fig. 5. Thermoelectric energy converters.

extremely high operating temperatures.

An MHD converter, successfully operated by Westinghouse, delivered 2.5 kw. from a chamber 1½" x 5" x 16". It was fueled from an oil and oxygen burner, with potassium soap dissolved in the oil for seeding purposes. A magnetic field of 14,000 gauss was used. Three pairs of graphite electrodes were separated by a gap of 4.6 inches. The velocity of the partly ionized gas was on the order of 2000 miles an hour, with a temperature of about 2500 degrees C.

### Thermoelectric Converters

Thermoelectric effects are reversible physical phenomena. An electric current is produced if a temperature difference is imposed upon a solid. Conversely, a temperature difference is produced if an electric current is sent through a solid. In the first case we have a thermoelectric heat-to-electricity converter; in the second case we have a thermoelectric refrigerator.

There are three basic reversible thermoelectric effects: Seebeck, Peltier, and

(Continued on page 85)



# Tube Inventory

By ROBERT A. LARSEN / Windsor Television, Inc.

Is your cash tied up in obsolete or dust-gathering types? Do you have all the types for which you get calls? Start controlling your tube stock.

**W**ITH THE stock of tubes being the largest, single capital investment in many a service shop, more and more owners are beginning to realize that obsolete and slow-moving types are tying up their profits. Furthermore, the problem grows worse from year to year. Current tube price lists, for example, contain over 600 tubes. Of these, less than 100 can be considered good movers. Over half may be considered obsolete. That is, if they are stocked, they will probably never move off the shelf.

Wise shop owners will attempt to survey their inventory needs and devise inventory control systems designed to cut down on seldom-encountered types while insuring that needed ones will be on hand. Our list has been prepared with this requirement in mind. It has been compiled from the actual records of a television service shop in a suburban, metropolitan v.h.f. area. These have been compared with the tube-movement statistics prepared by manufacturers to develop a list slanted toward the needs of the smaller, independent service shop.

Many of the tubes appearing on regular price sheets have been deleted because they would not normally be stocked. This has been done where the rate of movement is less than 1 in 10,000. Special-purpose types including tubes primarily used in color TV have also been deleted to make the list

applicable to the average shop. The turnover rate for these can vary much from one local situation to another, so that an average figure is rendered meaningless. On the other hand, the number of types involved in a specialized area of service is likely to be small. The specialist will have no trouble determining his requirements and adding them to the list.

For ease of use, the figures in the first column of "Quantity" listings is based on the movement of 1000 tubes. For instance, the number 40 after 6BQ7 indicates that, out of every 1000 tubes sold, 40 will be 6BQ7's. By estimating the number of tubes your shop will sell in a year, you can order to take advantage of the best quantity price without running the risk of overstocking. If you have not been doing a good job of keeping track of how many tubes you sell a year, remember that the average service technician accounts for 1500 to 2000 tubes a year. Thus, if your shop has two men, you can expect to sell about 3000 tubes in a year—of which 120 will be type 6BQ7.

Where the rate of movement falls below 1 per 1000 but the tube type cannot be considered obsolete, the type number has not been deleted. Instead it is listed and followed by a zero in the first "Quantity" column. Such tubes should not be neglected. Even when they do not move, they should be considered carefully for their usefulness as service aids.

TYPE	QUANTITY	TYPE	QUANTITY	TYPE	QUANTITY	TYPE	QUANTITY	TYPE	QUANTITY
OZ4	5	3BY6	1	5BK7	1	6AN8	2	6BE6	3
1AX2	0	3BZ6	3	5BQ7	1	6AQ5	13	6BG6	16
1B3/1G3	33	3CB6	3	5BR8	2	6AQ7	0	6BH6	0
1R5	3	3CF6	1	5CG8	1	6AR5	0	6BH8	1
1S4	0	3CS6	1	5CL8	4	6A55	5	6BJ6	0
1S5	1	3CY5	0	5CQ8	1	6A58	2	6BK5	1
1T4	0	3DK6	0	5GM6	0	6AT6	4	6BK7	11
1U4	1	3DT6	1	5J6	0	6AT8	4	6BL7	6
1U5	1	3S4	0	5T8	3	6AU4	12	6BN4	3
1V2	1	3V4	0	5U4	106	6AU5	1	6BN6	1
1X2	13	4AU6	0	5U8	7	6AU6	30	6BN8	0
2BN4	1	4BC8	1	5V3	1	6AU8	8	6BQ5	0
2CY5	3	4BQ7	3	5X8	1	6AV5	2	6BQ6/6CU6	36
2CW4	0	4BS8	1	5Y3	3	6AV6	8	6BQ7	40
2FH5	0	4BZ6	2	6AB4	1	6AW8	7	6BR8	1
3A3	1	4BZ7	1	6AC7	4	6AX4	50	6BS8	2
3AL5	2	4CB6	1	6AF3	0	6AX5	0	6BU8	1
3AU6	2	4CS6	0	6AF4	0	6AX8	0	6BX7	1
3AV6	0	5AM8	3	6AG5	3	6AZ8	0	6BY5	1
3BC5	0	5AN8	3	6AH4	1	6BA6	5	6BY6	0
3BE6	0	5AQ5	1	6AH6	1	6BA8	1	6BZ6	5
3BN4	0	5AS4	0	6AK5	1	6BC5	4	6BZ7	22
3BN6	1	5AT8	1	6AL5	16	6BC8	2	6BZ8	1
3BU8	1	5AV8	0	6AM8	2	6BD6	0	6C4	2

# 1962 1962

## for Service Shops

Remember that a common method of tube checking is by substitution, and a tube that is used as a test substitute a number of times during the year, although the type may not be sold once, will pay for itself in saved time.

The figure in the second "Quantity" column after the tube is intended as a guide for filling the tube caddy. Since the average caddy will hold about 160 tubes, the list has been restricted to that number. Many service technicians, however, carry two caddies or one extra large one. For such cases, the types indicated with asterisks (\*) may be added. This involves forty more tubes.

In order to be effective, an inventory control system is a business detail that must be handled on a regular basis. In the case of the tube caddy, for instance, it is essential that it be checked every day before it is taken out on calls. This is done not only so that tubes used and turnover can be checked; it provides an opportunity for comparing with the previous day's receipts for possible mistakes and shortages.

Many dealers find more than one advantage in maintaining an inventory list like the one shown, or their own revision of it, indicating the number of tubes of each type that they consider necessary to stock. The list can be a great convenience, for example, when the tube distributor's salesman calls. If he is given a copy of the master list, it is an easy matter for him to prepare the order for the shop owner, simply by comparing the number of tubes on the shelves with the figures on the list. Thus, in addition to having an accurate basis for keeping records, the shop owner has also acquired a time saver.

**EDITOR'S NOTE:** A superficial glance at this year's tube list will give the erroneous impression that little has changed since last year: the number of types carried has changed little, going up to 240 from 235 in 1961. But that is only part of the story. More than 20 numbers, dropped from last year's guide, were replaced by a greater group of new entries. Also there have been so many changes, up or down, in the quantity ratings that few entries remain as they were.

So many factors contribute to a tube's rating, aside from the frequency with which a designer uses it, that guessing at trends from the inventory changes is a tricky business. Unmistakable, however, is the continued disappearance of many types once popular in home and portable radios—and some of them are not exactly ancient tube types, this time. The transistorized receiver has unquestionably made its impact. Also dropped are a number of specialized TV types developed in recent years. Apparently they never really caught on.

The most noteworthy trend in the additions can be attributed to the popularity of wide-angle picture tubes. Many sweep-output types show up for the first time, particularly the twin triodes used for combined oscillator-output service in the vertical circuits.

While the total number of types in current manufacture may seem overwhelming, the dealer can find solace in an interesting statistic as he faces his inventory problem: more than half the tubes he is likely to sell this year (about 512 of every 1000) will involve only 13 types. These sturdy standards include 1B3/1G3, 5U4, 6AU6, 6AX4, 6BQ6, 6BQ7, 6BZ7, 6CB6, 6CG7, 6DQ6, 6SN7, 6U8, and 12AU7. ▲

TYPE	QUANTITY		TYPE	QUANTITY		TYPE	QUANTITY		TYPE	QUANTITY		TYPE	QUANTITY	
6CB6	43	3	6DQ6	20	2	6V3	1	*	12AX7	6	1	12W6	2	1
6CD6	14	2	6DR7	1	1	6V6	6	1	12AZ7	1	1	12X4	1	
6CE5	1	*	6DT6	1	1	6W4	17	2	12B4	2	1	13DE7	0	1
6CF6	1	1	6EA8	4	1	6W6	11	1	12BA6	8		13DR7	0	
6CG7	35	3	6EB8	1	1	6X4	2	1	12BD6	1		17AX4	12	1
6CG8	3	1	6EM5	1		6X8	10	1	12BE6	5		17D4	4	
6CH8	1	1	6EM7	3	1	7AU7	4	1	12BF6	0		17DQ6	7	1
6CL6	0	*	6ES8	0		8AW8	1	*	12BH7	12	1	17GW6	1	
6CL8	1	*	6EU8	1		8CG7	3	1	12BK5	0		19AU4	1	*
6CM6	0		6EV5	0		8CM7	0		12BQ6	6	1	25AX4	1	*
6CM7	11	1	6GH8	0		8CX8	0		12BR7	1		25BQ6	2	*
6CN7	1	*	6GM6	0		9AU7	0	*	12BY7	8	1	25CD6	1	*
6CQ8	4	1	6J5	3	1	10DE7	4	1	12BZ7	1	1	25DN6	2	1
6CS6	1	1	6J6	8	1	10DR7	0	*	12CA5	3	1	25L6	3	1
6CS7	2	1	6K6	6	1	11CY7	0		12CU5/12C5	1	1	25W4	1	*
6CU8	1	1	6L6	0		12AQ5	0		12CX6	0		35B5	1	
6CW4	0	*	6S4	10	2	12AT6	2		12D4	1		35C5	2	
6CX8	1		6SA7	0		12AT7	4	1	12DQ6	9	1	35L6	2	
6CY5	1	1	6SK7	0	*	12AU6	2		12L6	2	1	35W4	11	
6CY7	0	*	6SL7	0	*	12AU7	24	2	12SA7	1		35Z5	12	
6CZ5	0		6SN7	41	3	12AV5	0	1	12SK7	2		50B5	1	
6DA4	3	*	6SQ7	1		12AV6	4		12SN7	1	1	50C5	15	
6DE6	2	1	6T8	10	2	12AV7	3	1	12SQ7	1		50L6	6	
6DG6	1	*	6U8	32	4	12AX4	18	1	12V6	1	*	5642	0	

# High-Frequency Response of Cascaded Stages

By DONALD W. MOFFAT

*Useful nomogram for designers and technicians shows effect on over-all response of cascaded amplifiers.*

*Chart is especially useful for non-identical video stages.*

**J**UST AS resistors in parallel will have an effective resistance lower than that of the smallest, the over-all high-frequency response of amplifier stages in cascade is less than that of the narrowest stage. If the stages are identical, it is easy to calculate the over-all frequency response by simply selecting a shrinkage factor from Table 1.

Multiply the high-frequency response of one stage by the appropriate shrinkage factor and you have the over-all frequency response.

## Non-Identical Stages

Even if only two stages are involved, if the frequency responses are not identical, calculation of the over-all response becomes extremely complicated. When more than two stages are involved, an electronic computer is usually called for, but the accompanying nomogram reduces the calculation to drawing lines across the scales.

This problem of non-identical stages is especially important because of the increasing use of transistors. It is common to see a long string of identical vacuum-tube amplifiers but, because of the way transistors load down preceding stages, each stage in a transistor cascade is likely to have a different frequency response.

## Nomogram

Note that all frequency scales are marked 1 through 100 but no order of magnitude is given. You can therefore use the nomogram for any range of frequencies by adding any number of zeros to all scales. For instance, if you are working in the region of 100 kilocycles, you let the 10 in the middle of each frequency scale stand for 100 kc. and then the ends of each scale will be 10 Kc. and 1 mc.

There are two scales marked "Lowest Frequency." The slanted one is used in conjunction with the "Highest Frequency" scale and the other is used with both the "Middle Frequency" and the "Over-all Frequency" scales. Be

sure, when adding zeros, to do the same thing to all frequency scales.

Start by locating the high-frequency response of each stage on the appropriate scales. Then, at the bottom of the nomogram, draw a straight line through the points located on the "Highest Frequency" and the slanted "Lowest Frequency" scales, and extend the line to cross the horizontal axis of the graph at the top right.

Now, go over to the left-hand side of the nomogram and draw a straight line through the points located on the "Middle Frequency" and the "Lowest Frequency" scales. Where that line crosses the short scale, you will find a value of "Factor A," which will tell you the curve to use on the small graph. On the graph, locate a curve for the correct value of "Factor A" or, if the factor is an odd value, estimate its location between two curves.

From the point where the first line crossed the graph's horizontal axis, draw a vertical line to cross the curve for the appropriate factor A. Draw another line straight out from that crossing to the vertical axis of the graph. The dotted lines will serve as guides in drawing these vertical and horizontal lines.

The final step is to draw a straight line from this point on the vertical axis to the point previously used on the "Lowest Frequency" scale. That line will cross the "Over-all Frequency" scale at the correct value.

## Example

To clarify these instructions, we will determine the over-all response of three

Table 1. High-frequency shrinkage factor.

No. of Stages	Shrinkage factor when all stages have identical frequency response
2	0.644
3	0.510
4	0.435
5	0.386
6	0.351
7	0.323
8	0.301

stages whose individual responses are 20, 25, and 30 megacycles.

In order to give the scales the correct range of frequencies, let all numbers on the frequency scales be megacycles.

*Step 1.* Since the highest is 30 and the lowest is 20, draw a straight line through these values at the bottom of the figure and extend the line to cross the horizontal axis of the graph.

*Step 2.* On the left-hand side of the nomogram, draw a straight line through 25 on the "Middle Frequency" scale and 20 on the "Lowest Frequency" scale. This line crosses the "Find Factor A" scale at a point between 1 and 2 but closer to 1.

*Step 3.* Now go back to the graph and draw a line straight up from where the first line crosses the horizontal axis.

*Step 4.* Curves are shown for a factor A of 1, 1.5, 2, 2.5, 3, 4, and 5. Since the value we have found for factor A is between 1 and 1.5, estimate its position on the line drawn in Step 3. This point is shown as "B" on the graph.

*Step 5.* Draw a line straight out from "B" to the vertical axis.

*Step 6.* From that point on the vertical scale, draw a final line to 20 on the "Lowest Frequency" scale. That line will cross the "Over-all Frequency" scale at about 12 (megacycles), the response of these particular three stages in cascade.

## Two Stages

For the over-all response of two non-identical stages, use the "Highest Frequency" and "Lowest Frequency" scales at the bottom, but there will be no "Factor A." The next step, then, is to draw the line straight up from the crossing of the horizontal axis and locate point "B" on the "Two Stages" curve. Draw a line straight out to the vertical axis and from there to the "Lowest Frequency" scale. This last line will cross the "Over-all Frequency" scale at the correct value. ▲

## REFERENCE

Thomas, P. G.; Philco Corporation Application Lab Report 617, May 1961.

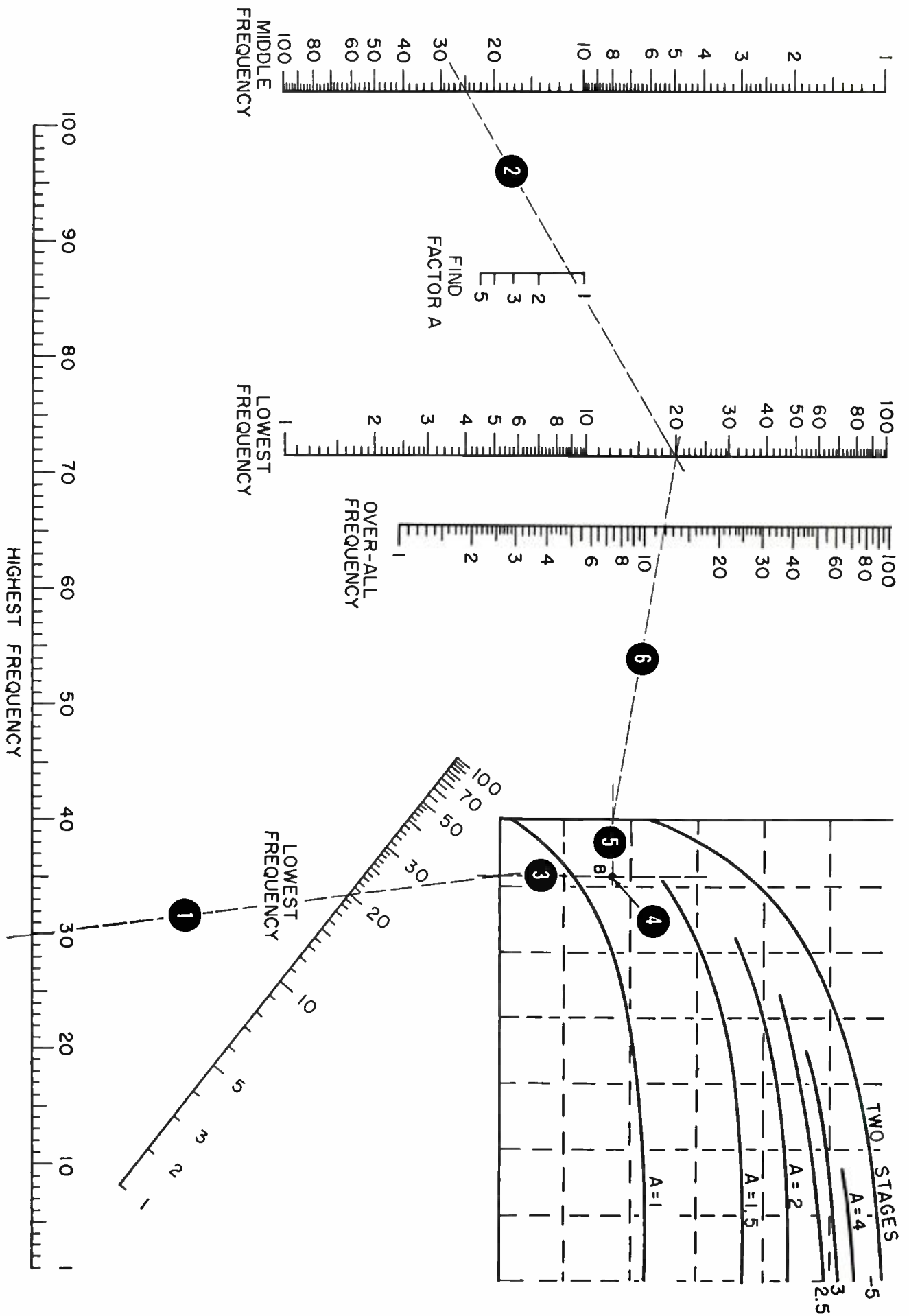



Fig. 1. Supervised group instruction in the laboratory of the high school at Elgin, Illinois.

# MAINTENANCE in TEACHING LABS

By RUSS PAVLAT

Background information for the technician on audio educational installations, including basic systems, equipment and performance standards, and service.

**I**N RECENT MONTHS, a large number of electronic teaching laboratories, especially language laboratories, have been installed in elementary schools, high schools, and colleges. Monetary aid from the federal government has provided considerable impetus to increased growth of such installations. Essentially, these laboratories, like the one at Elgin High School in Elgin, Illinois, shown in Fig. 1, are specialized sound systems. The service they require can be provided by a technician competent in sound and tape-recorder work who understands their operation and application.

Three types of systems are commonly used. The terms applied to them are "audio-passive," "audio-active," and "audio-active-compare." The latter may also be termed "audio-active-record." The "audio-passive" system (see Fig. 3) is the simplest and most economical of the three, but its relative simplicity somewhat limits its range of uses.

It consists essentially of a teaching console with one or more program sources (tape players, phonographs, radio sets, or an instructor), a means of

transmitting programs to students (amplifier and cabling), a means of student program selection (selector switches), and a means enabling students to receive the program (booths and headsets). It is used to conserve classroom space, since several different listening programs or classes may be conducted in a single room at the same time, or different levels of instruction may be conducted in a single room at the same time. Where close listening and concentration are required, the headset provides isolation, removes distractions, and aids concentration. A sound-absorbing booth (Fig. 2) may be used as a further means of isolation.

The "audio-active" system (Fig. 4) is more popular and more useful. In this system, a microphone and an amplifier are added to the student booth equipment used in the "audio-passive" system, and intercommunicating equipment is added to the teaching console. The student may now respond to the master program and also hear his own voice *via* his microphone, amplifier, and headset. In the case of language instruction, the student may repeat or answer

a master language program and hear his own responses, while the intercommunicating equipment provides the instructor with a means of monitoring and instructing individual students, groups of students, or all students. Recording facilities may be installed at the console to allow the instructor to record one or two students at a time. Additional wiring to provide intercommunicating facilities and power to student amplifiers is required.

For the "audio-active-compare" system, a dual-track tape recorder and switching is added in each booth (each student position in Fig. 4), enabling the student to record a master program on one tape track, record his own responses on the second tape track (while listening *via* his headset), and later listen to both the master program and his recording on the second tape track. In the case of language instruction, this system permits a student to repeat words and phrases, answer questions, and check himself (or be checked by an instructor) by listening to the master program and to his responses. Master language tapes are recorded with



pauses for student responses and answers. Once a master program has been recorded on the master track, the tape may be used repeatedly, with erasure and re-recording of the student's responses on the second track. The tape may also be used for self-improvement work outside regular class hours ("library study"). Additional power is required for record-playback amplifiers and tape decks.

### How Much Fidelity?

The servicing of electronic teaching laboratories requires consideration of frequency response, distortion, and noise, as is the case in conventional sound systems.

Intelligibility, in itself, can be achieved with a frequency range of 200 to 3000 cycles, a total harmonic distortion of up to 15%, and with considerable background noise. In electronic teaching laboratories, however, intelligibility is only one factor in effective teaching. Another major factor is student fatigue. Frequency response, distortion, and noise all have a definite influence on the amount of fatigue a student will experience in a normal class period.

A "natural" sound is the least tiring. Absence of part of the normal audio range is sensed and can be annoying. A voice that sounds hollow, forced, or strained because some frequencies are missing, or which sounds distorted, requires the listener to exert more effort to maintain concentration. Tests indicate that there is considerable energy in the human voice over a range of frequencies from 80 to 12,000 cps, with the range from 8000 to 12,000 cps being of primary importance only in Oriental languages. Therefore, an over-all teaching-laboratory response of 80 to 8000 cps within 3 db will retain all components necessary for a natural-sounding voice in applications where Oriental languages are not taught. A total distortion of less than 3% from 150 to 8000 cps and less than 5% from 80 to 150 cps will permit student attentiveness with little or no increased effort.

Noise, crosstalk, and hum are also distracting. Tending to mask desired signal, if excessive, they cause the student to exert extra effort in digging the information "out of the mud," resulting in a corresponding reduction in teaching-laboratory efficiency. Externally generated noises from student activity, fans, or air conditioners (mostly 200 cps and below) can be reduced by good acoustic design in booths and rooms. Headset ear pads can reduce external noises appreciably. An over-all signal-to-noise ratio of 45 decibels or better is required to avoid masking and distraction.

A competent sound and tape-recorder technician should be able to retain the original design features in a laboratory with respect to response, distortion, and noise. In some cases, he is able to improve laboratory performance by skillful maintenance and parts replacement. A suggestion to use ear pads on the headsets to reduce noise, for example, or the replacement of a marginal head-

set with a unit that has better frequency response, less distortion, or more comfort may be appreciated. The demonstration of a superior headset in the laboratory and comparison with existing headsets is a simple matter and a very effective one that does not require complicated test equipment and lengthy explanations.

Ordinary magnetic headsets have response peaks in the range from 2500 to 3500 cps and tend to cut out anywhere between 4500 to 5500 cps. A good crystal headset, a carefully designed magnetic headset, or a good dynamic headset will faithfully reproduce the frequencies required in a natural-sounding manner. This is valuable in increasing student concentration, student comfort, and laboratory efficiency.

Rough handling and bad treatment can seriously shorten the life of a headset: the suggestion to install a bracket in each booth to hang the headset when not in use might be appreciated. Headset cords, headbands, plugs, and jacks frequently require attention. Headset replacement is to be expected and, whether it is required as a result of misuse or normal wear, it represents a definite maintenance consideration. Headset sanitation is also a problem, and headset pad replacements are a source of business.

Microphone maintenance can be handled in a manner similar to headset maintenance. Roughly handled mikes can develop peaks and valleys in frequency response and/or low output. Similar technical conditions and demonstration possibilities apply. The mounting of the microphone on a sturdy gooseneck or mounting bracket, or the placement of the microphone in a more convenient position in the booths or at

the control console offer possibilities for improving a laboratory.

Both tube-type and transistorized amplifiers are currently being used in laboratory booths and control consoles. Newer designs tend toward transistorized equipment for its longer life and relatively low heat generation. The heat generated by a typical tube-equipped "audio-active-compare" laboratory is approximately equal to the body heat given off by the students using the equipment. In a transistorized set-up, this heat generation is reduced about 70%.

The ventilating and air-conditioning equipment in a tube-equipped laboratory may therefore have to be designed for a much larger capacity. The slight additional cost of transistorized amplifiers in a moderate or large laboratory may well be less than the cost of the additional ventilating and air-conditioning equipment which would be required with a tube-equipped system. From the maintenance standpoint, this means that transistorized amplifiers should not be replaced with tube-type equipment, unless it is certain that the ventilating and air-conditioning equipment can handle the increased load.

### Repair Considerations

In addition to normal tube and transistor replacements, the large number of volume controls and switches on these systems require attention. Volume controls at instructors' consoles and student positions are ordinarily the same type of carbon control used in radio and TV sets; these controls develop noise and contact troubles in a similar manner. Program and intercom switches become noisy and intermittent with normal use (especially in dusty



Fig. 2. Sound-absorbent booths provide desired physical and acoustic isolation.

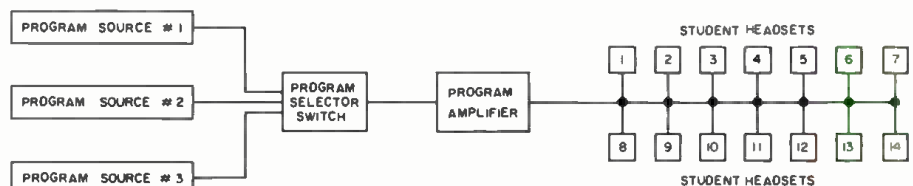

Fig. 3. In a basic "audio-passive" system, students can only receive communication.

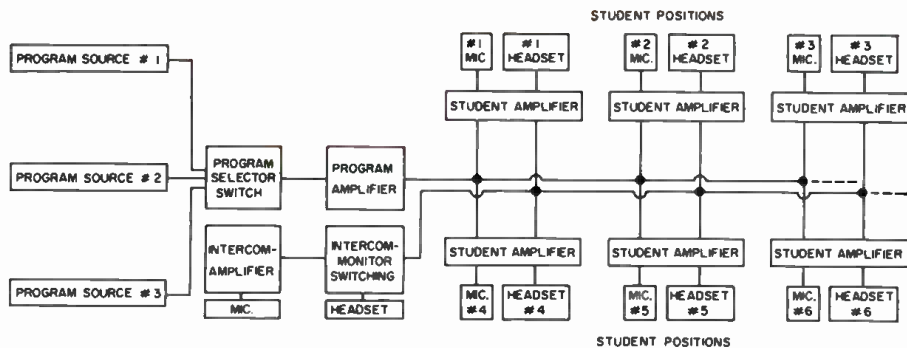

Fig. 4. Student response and monitoring are possible in an "audio-active" system.

locations) and, along with volume controls, respond to cleaning, lubrication, and adjustment in much the same manner as their radio and TV relatives. Care should be taken in replacing volume controls to maintain original design resistances and tapers, thus assuring the same smoothness of response and operation experienced when the laboratory was installed. Impedance mismatching will cause the same troubles found in conventional audio systems; *e.g.*, distortion, lack of adequate frequency response, and undesirable level changes.

The tape recorder-player parts of these installations (Fig. 5) are adaptations of commercial equipment. In general, they are full dual-track installations, but in some cases the erase equipment has been omitted from the master-tape track to avoid accidental

erasure of the program. This necessitates using clean tape in the booth when recording a master program being transmitted by the control console. To prevent or minimize this accidental program erasure by a student working in a booth, systems have been developed using special switches in the booths or remote switches at the control console to control bias on the master-track erase heads. These are preferred, since they avoid the additional time and work involved in using a bulk eraser or some special procedure to clean tape prior to use for master program recording. The tape decks may be dual speed and will normally incorporate fast forward and fast rewind with an interlock arrangement to prevent erasure in these modes.

All the usual tape-recorder maintenance procedures are required for these systems. Head demagnetization, head

cleaning, head alignment, pressure-pad adjustments and replacement, brake and tension adjustments, lubrication of motors, bearings, idlers, sliding parts and operating controls (avoid over-lubrication), replacement of rubber drives which have developed bumps or flat spots, belt adjustments and replacement, adjustment of erase bias and recording bias for best signal-to-noise ratio, adjustment of tape lifters and breakage controls, and checks of wiring, switching, plugs, sockets, and grounding may be required.

Cut-offs in case of tape breakage should be carefully checked and adjusted to avoid the introduction of flutter and wow by the cut-off during normal operation. If heads are replaced, alignment and bias adjustments should be made according to manufacturers' instructions. In case separate bias oscillators are used on a dual-track unit, oscillator synchronization is required to avoid beat notes. Dual-track portable tape units for instructor use or for making master tapes may be included in a laboratory. In electrically braked and tensioned tape units, switches should be cleaned and adjusted and any rectifier outputs should be checked to assure sufficient voltage for braking action.

#### Control Systems

One of two types of program control will be used in an electronic teaching laboratory. Central control systems incorporate a multi-position program selector switch at the control console for each student position (Fig. 6). The instructor has complete control of programming the entire laboratory, and knows at a glance which program is being transmitted to a student position. Audio wiring consists of two audio cables from the control console to each student position, one to carry the selected program to the student booth and one for monitoring and intercom. These two cables may be combined into a single jacket.

Student control systems contain a selector switch on the student amplifier in each booth which allows the student to select one of a number of programs. The instructor is relieved from programming each student but, to check a position, must monitor the particular booth to determine if the proper program has been selected. Audio wiring to each student position consists of a monitoring cable plus a cable for each available program. In a four-program system, this would require five audio cables (which could be contained in a single jacket) from the control console to each booth or student position. The quality of the intercom amplifiers and equipment should be kept as high as the quality of the program equipment. The instructor's effectiveness in teaching and correcting is reduced by poor intercom facilities.

Hum, crosstalk, and noise can result from poor cable characteristics, poor or improper shield grounding, or by placing the audio cabling close to a.c. power cabling. Good design requires a.c. power

(Continued on page 70)

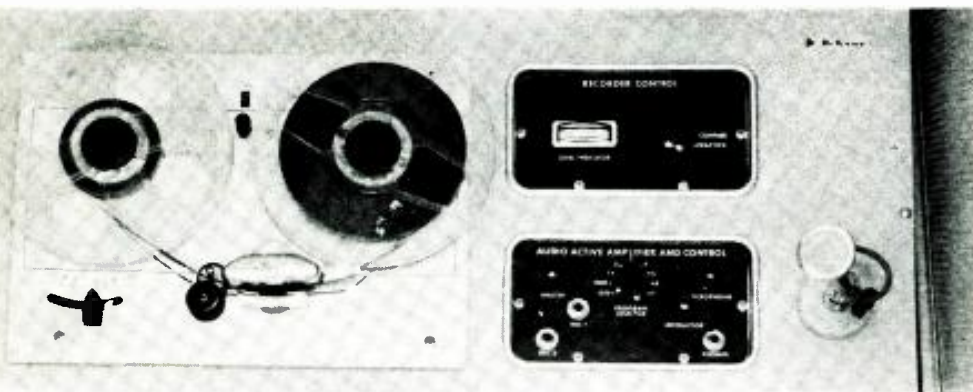

Fig. 5. Each booth adds recorder and control panel in "audio-active-compare" work.



Fig. 6. Instructor leads class from central control at Platteville State College, Wis.

# TRANSISTORIZED PHOTORHYTHMICON

By LEON A. WORTMAN

## DANCING LIGHTS

PRODUCING colored light that changes hue and intensity in automatic synchronism with sound is technically interesting to the design engineer and technician and emotionally satisfying to the music lover. The August 1958 issue of this magazine carried an article in which the author described a device he dubbed the "Photorhythmicon." When connected to the output of an audio amplifier, the device actuated a string of colored light bulbs. The effect was described as "dancing lights."

Many readers duplicated the unit and took time to write the author regarding their experiences. The majority of those who wrote described their individual techniques for arranging the light display. Each was unique in some respect. A few arranged their lights vertically, others in a circle, and still others in a random fashion. One constructor had gone so far as to mount each of the 45 bulbs in its own polished reflector!

Despite the general satisfaction expressed, the author is aware that there are two significant drawbacks inherent in the technique described: (1) low light-output level necessitated operation in semidarkness and (2) the control chassis circuitry proved complex to some readers. Advances in electronic technology since the original article appeared, particularly in the area of power transistors featuring relatively high current amplification, now make

it practicable to overcome both drawbacks. First, however, it would be a good idea to outline the concept and design objectives involved in this transistorized version of the circuit.

### Concept & Design

It has been recognized for many years that there are emotional and commercial dividends to be derived from combining light, color, and sound. Take the famous spectacle of the Garden of Versailles where the fountains are bathed

with colored lights to enhance the visual appeal of the display. Walt Disney's famous "Fantasia" is another outstanding example of light and color at work with sound. In the 1920's, a well-known amateur organist, Gertrude Greenewalt, developed a "color organ." It was, in fact, a theater organ that had been adapted to provide a special effect. The instrument was manipulated in the conventional manner. The special effect resulted from the fact that each key of the manual was wired as a switch in series with a lamp and a power supply.

One can readily visualize the enchantment created by the large display of lights, individually colored, one per organ key. The intensity of the individual lamps was fixed, that is, it did not follow the "swell" of the sound. Needless to say, mobility of the system was extremely poor. In addition, it could not be adapted to existing music systems or instruments without considerable design changes and laborious construction. One had to own and be able to play a theater organ in order to enjoy the pleasures offered by the invention. Mrs. Greenewalt's concept of light, sound, and color, however, is intriguing.

Many other techniques have been developed since her time. Unfortunately, few people today remember her name in connection with the "color organ"—a name which is employed by a good many experimenters to describe their

Fig. 1. Single-channel test circuit.

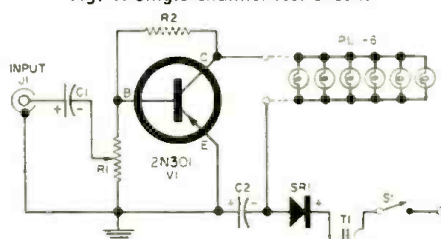

- R<sub>1</sub>—100 ohm wirewound pot
- R<sub>2</sub>—300 to 5000 ohms (see text)
- C<sub>1</sub>—100 μf., 15 v. elec. capacitor
- C<sub>2</sub>—1000 μf., 12 v. elec. capacitor
- SR<sub>1</sub>—Silicon rectifier, 200 p.i.v., 750 ma. (Sylvania 1N2069 or equiv.)
- PL<sub>1</sub>, PL<sub>2</sub>, PL<sub>3</sub>, PL<sub>4</sub>, PL<sub>5</sub>, PL<sub>6</sub>—249 pilot light, 2 v. @ 60 ma. (parallel connected)
- J<sub>1</sub>—Input jack
- S—S.p.s.t. toggle switch
- T<sub>1</sub>—Fil. trans. 6.3 v. @ 1.2 amps (Stancor P-6134 or equiv.)
- V<sub>1</sub>—"p-n-p" transistor (2N301)

**Construction of simple semiconductor color organ whose colored-light display varies in step with music signals.**

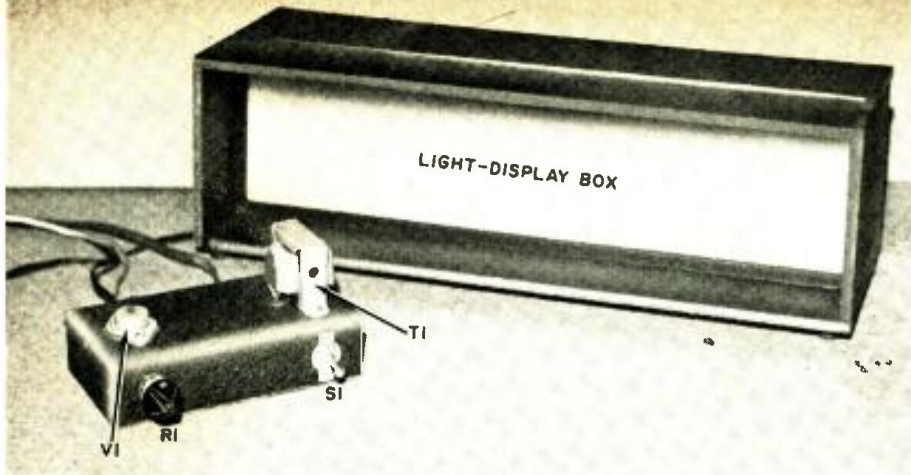

Basic single-channel unit uses one power transistor and low-voltage power supply.

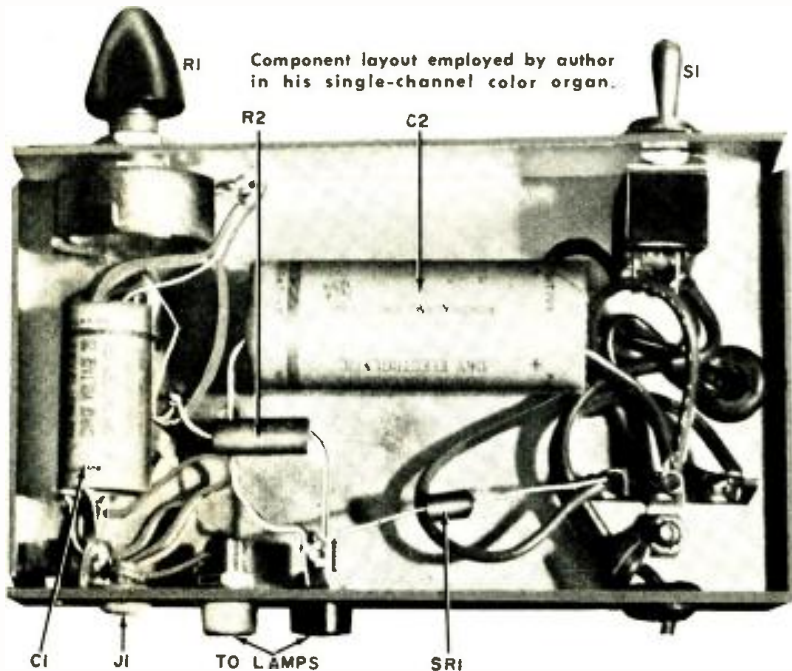

Component layout employed by author in his single-channel color organ.

own particular "dancing-light" units.

A highly mobile, instantly connectable device such as the circuit to be described offers broad appeal because there are more people willing to be spectators than performers, as witness the fantastic number of recordings of all kinds of homes own and use record players, radios, and high-fidelity systems. This "Photorhythmic" is capable of taking instant advantage of those ready-made sources of sound without involving the slightest modification, adaptation, rewiring, or adjustment either to itself or to the sound system. This is a convenient feature.

With respect to the design of this transistorized "Photorhythmic," it is desirable that it be capable of full operation at the audio level available at the loudspeaker terminals of a sound system because speakers are usually low-impedance devices and are common to virtually all sound systems intended for group listening.

There are several advantages in connecting this device to the voice-coil terminals: (1) preamplifier requirements are reduced internally for the "Photorhythmic" circuit; (2) low impedance eliminates the need for

matching or step-up transformers, and (3) makes it electrically practicable to use conventional loudspeaker crossover or even *R-C* networks for channel separation.

### Single-Channel Unit

In order to test the practicability of a transistorized "Photorhythmic," a single-channel unit was designed and constructed. This unit is diagrammed in Fig. 1. The circuit is that of a grounded-emitter-connected *p-n-p* power transistor. The lamps are connected in parallel with each other and then, as a group, in series with the collector of the transistor and the negative terminal of the power supply.

Resistor *R*<sub>2</sub> provides base bias and determines the resting or quiescent collector current. That current varies inversely with a change in the value of *R*<sub>2</sub>. If resistor *R*<sub>2</sub> were omitted from the circuit, the collector current would be at or near cut-off, assuming no signal voltage at the base of the transistor. *R*<sub>2</sub> can either be a potentiometer adjusted to optimum or a fixed resistor with a value determined by experiment. The optimum value is found by visual inspection of the light bulbs. The value is correct when the glow becomes visible under ordinary room light and the sound system to which it is connected is silent. (Note that no diode is used to rectify the audio before applying it to the transistor. Instead the bias on the transistor is such as to make it operate nearly as a class B amplifier. Hence, output current is low with no signal and high with signal.)

The value of *R*<sub>2</sub> is not critical and usually lies between 800 and 5000 ohms.

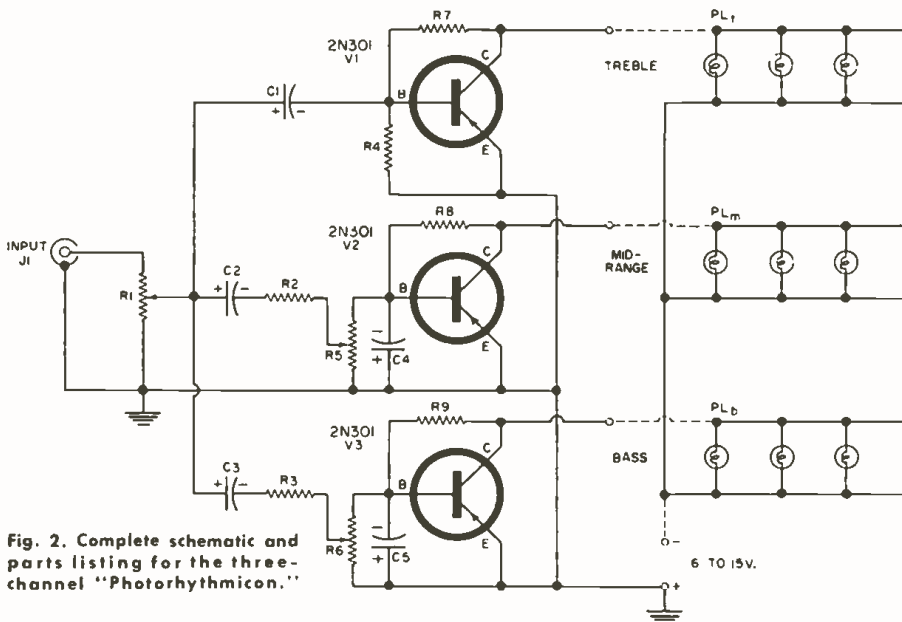

Fig. 2. Complete schematic and parts listing for the three-channel "Photorhythmic."

- R*<sub>1</sub>, *R*<sub>2</sub>, *R*<sub>3</sub>—100 ohm wirewound pot
- R*<sub>4</sub>, *R*<sub>5</sub>—15 ohm, ½ w. res.
- R*<sub>6</sub>—100 ohm, 1 w. res.
- R*<sub>7</sub>, *R*<sub>8</sub>, *R*<sub>9</sub>—800 to 5000 ohms (see text)
- C*<sub>1</sub>, *C*<sub>2</sub>—2 μf., 25 v. elec. capacitor
- C*<sub>3</sub>—10 μf., 25 v. elec. capacitor
- C*<sub>4</sub>—50 μf., 25 v. elec. capacitor
- C*<sub>5</sub>—25 μf., 25 v. elec. capacitor
- J*<sub>1</sub>—Input jack

- PL*<sub>t</sub>—Parallel-connected pilot lights ("Treble")
  - PL*<sub>m</sub>—Parallel-connected pilot lights ("Middle")
  - PL*<sub>b</sub>—Parallel-connected pilot lights ("Bass")
  - V*<sub>1</sub>, *V*<sub>2</sub>, *V*<sub>3</sub>—*p-n-p* transistor (2N301)
- \*For power supply voltage of 6 to 9 volts, use six 249 (2 v., @ 60 ma.) lights; and for power supply voltage of 12 to 15 volts, use five 247 (6-8 v., @ 150 ma.) lights.

depending on the individual transistor and the collector voltage. The higher the quiescent level or, within practical limits, the lower the value of  $R_2$  the lower is the requirement for audio power at the loudspeaker terminals to produce a large swing in collector current. Of course, since the lamps are in series with the collector, they will vary in light output in accordance with the collector's current. It must be remembered that as the quiescent collector current is increased, the average power dissipated in the form of heat is also increased. The metal chassis on which the unit is assembled serves as an adequate heat sink to keep the transistor quite cool to the touch when it is operated at the quiescent level described as correct.

The light display box can take many forms. Everyone who sees the device in operation has ideas on how this should be handled. The author's unit is, therefore, only a suggestion designed to demonstrate the principle. Shown in the photographs are "shadow boxes" that permit display of very low-level lighting under widely ambient conditions of external light. The bulbs are mounted in sockets on the interior face of the back wall of the box. The box used for the single-channel demonstrator measures 12" x 3" x 4". A sheet of translucent milk-white plastic is placed 2 to 3 inches in front of the bulbs.

The inside of the box behind the plastic and surrounding the bulbs is painted white to improve the reflective characteristics of the box and the portion in front of the plastic sheet is painted flat black to improve the contrast and enhance the apparent brightness of the bulbs.

The input of the circuit is connected directly across the loudspeaker terminals of the sound source. It is not necessary to shield the connecting cable. Ordinary lamp cord is fine.  $R_1$  is used as the sensitivity control. Of course, with this single-channel unit bass-middle-treble channel separation is not provided. The lights simply follow the varying composite signal voltage appearing at the loudspeaker voice coil. Relatively low driving voltage achieves maximum light capability. It can be achieved by connecting this unit to a small transistor radio operating at normal listening level.

### Three-Channel Display

An experimental three-channel display is diagrammed in Fig. 2. This is, in reality, merely the circuit of Fig. 1 in triplicate. Values for  $R_2$ ,  $R_3$ , and  $R_4$  are determined in the same way as the value for  $R_2$  was established in Fig. 1. The crossover or channel separation is provided by an  $R-C$  configuration. This, unfortunately, introduces some attenuation of the input signal voltage, therefore more driving power is required with this circuit than for the single-channel design. The small transistor radio was found to be capable of providing the increased power.

The light display is physically larger too. Three groups of bulbs are used in-

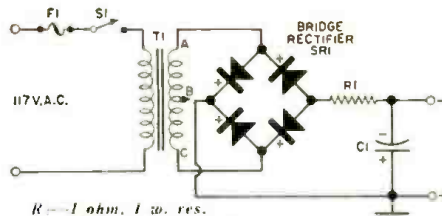

- $R_1$ —1 ohm, 1 w. res.  
 $C_1$ —2000  $\mu$ f., 15 v. elec. capacitor  
 $SR_1$ —Single-phase selenium rectifier bridge (International Rectifier 129B1. Max. a.c. input 36 v.; 1.5 amp. output current)  
 $F_1$ —1 amp fuse  
 $S_1$ —S.p.s.t. switch  
 $T_1$ —Fil. trans., 12.6 v @ 2 amps (Stancor P-8130 or equiv. For 12 to 15 volts d.c. output, secondary connections are made to terminals "A" and "C" and #47 pilot lights are used. For 6 to 9 volts d.c. output use terminals "A" and "B" or "B" and "C" and #49 pilot lights.)

Fig. 3. Circuit of power supply used.

stead of one. Each bank is in series with the collector of its respective transistor. The author places the bass at the left, treble at the right, and middle register at the center. This is done only because of its relationship to the engineer's visualization of the frequency spectrum as a straight, horizontal line with an increase in frequency indicated as moving from left to right. But, bear in mind, the layman has no preconceived notion such as this. In fact, the musician

visualizes and diagrams an increase in frequency or tone as a *vertical* concept.

Translucent colored lacquer was used as a dip to tint the individual lamps. Although the author used red, blue, and yellow as bass, middle, and treble coloration, there are no "rules" as to color or position. This, too, has proven to be quite subjective. Every viewer has his own preferences for color and position. Perhaps the rule should be: the color that pleases is the correct one.

The power supply for operating the three-channel display is shown in Fig. 3. It should present no problems.

The input circuit of the "Photorhythmicon" presents an essentially resistive load to the output of the amplifier to which it is connected. A fraction of a watt of power is drawn by that input circuit. It may not even be audibly detected. However, no audible distortion is introduced by connecting this device to a high-fidelity system.

It was stated that there were two significant drawbacks to the original "Photorhythmicon." The designs described here overcome the second drawback by simplifying the circuitry. In a subsequent article, the author will describe a high-power unit capable of providing sufficient light to permit operation in broad daylight. ▲

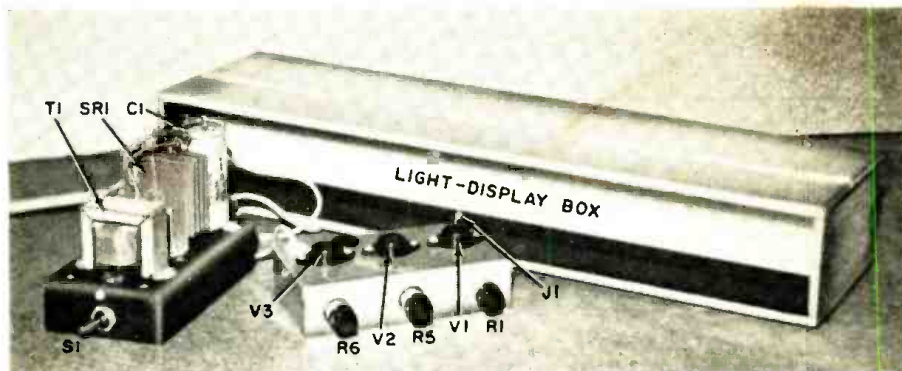

Three-channel "Photorhythmicon" built by author shown with its light display box.

Inside view showing the wiring and parts layout used in the three-channel unit.

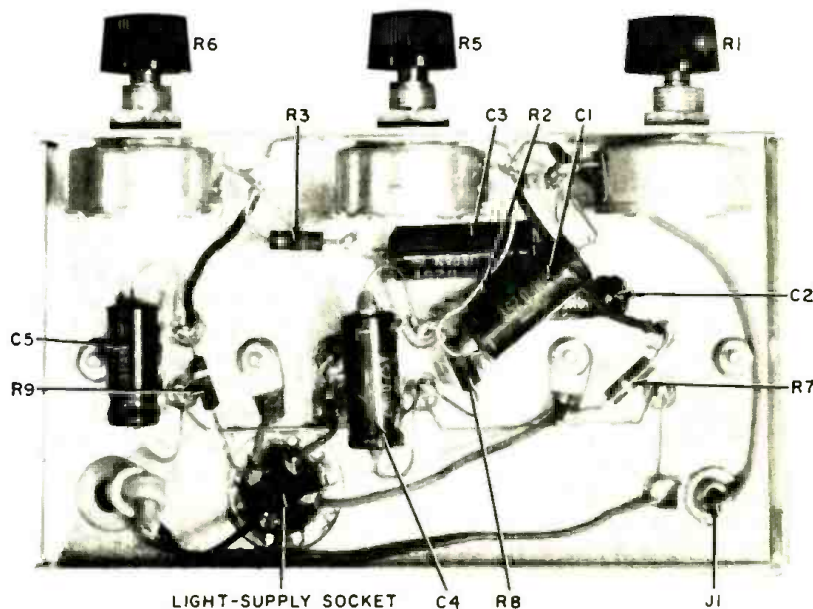

# DYNAMIC TRANSISTOR BRIDGE

By STANLEY E. BAMMEL

Handy for testing or circuit design, the checker determines beta and other characteristics under selected operating conditions with a test signal.

**W**HETHER one is replacing defective transistors in the course of service or designing circuits, it is often important to consider stage gain in selecting the transistors. One consideration in obtaining greatest gain is the matching of the source impedance to the input impedance of the transistor. This immediately raises the question: "What is the transistor's input impedance?"

A reliable answer is seldom easy to come by. Manufacturer's data may not be readily available. Little may be learned from it even if it is on hand. A check of an assortment of transistors of the same type (especially the inexpensive ones) shows wide variation

information that cannot be obtained with ordinary d.c. transistor testing. It uses an a.c. signal to measure dynamic input impedance, or  $h_{ie}$ , and current gain, or  $h_{fe}$ .

Strictly speaking, the actual input impedance and current gain in a circuit depend, to some extent, on the collector load; whereas  $h_{ie}$  and  $h_{fe}$  correspond to these values only when the collector load is zero. However, the collector load usually is considerably less than the collector impedance, especially in audio circuits. Under these conditions, there will not be an appreciable difference, for practical purposes, between the information desired and that measured. Furthermore, with the two characteristics established, it is relatively easy to determine other characteristics of the transistor in a particular circuit for an extensive test evaluation. How this is done will be considered later.

## The Circuit

Measurements are made in bridge fashion: that is, one signal is balanced against another until a null is obtained. A conventional impedance bridge for achieving this is shown in Fig. 1, with

the signal from the transformer being applied to a known resistance and also the unknown impedance. The potentiometer, which can be calibrated, is adjusted to produce the null. The ear-phone represents any null detector.

Fig. 2, the basic circuit used to determine  $h_{ie}$ , is an adaptation of the conventional impedance bridge. A transistor in the tester (which may be either  $V_3$  or  $V_4$ ) supplies the test signal in place of transformer  $T$  of Fig. 1. This signal is applied to the transistor under test and also to  $R_{12}$  and  $R_{11}$  (if  $V_3$  is used) or  $R_{12}$  and  $R_{13}$  (if  $V_4$  is used). The balancing potentiometer is  $R_{22}$ .

Fig. 3 is the basic circuit used to measure  $h_{fe}$ . The small-signal current in the base of the transistor under test is essentially the same as the current through  $R$ . The current through  $Z$  is the base current times the *beta* of the transistor under test. Therefore, the effective resistance of  $Z$ , as far as the bridge is concerned, is the base current of the transistor under test times its *beta*. Strictly speaking, this circuit measures grounded-collector current gain, or  $h_{fc}$ . However, since the latter quantity is equal to  $h_{fe} + 1$ , error is

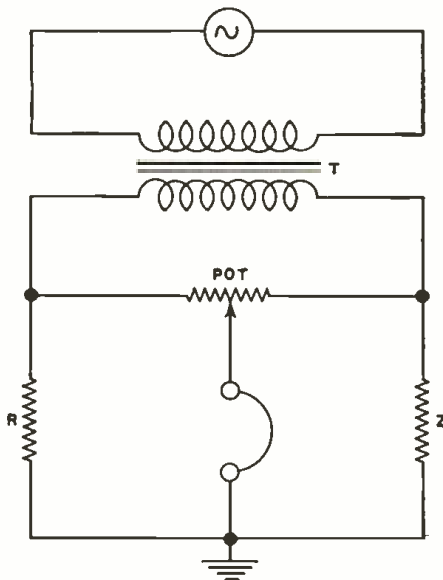

Fig. 1. A basic a.c. impedance bridge.

from one to the other. To complicate matters, the input impedance of an individual transistor need not be constant. It may vary considerably with different amounts of current.

Another important characteristic will be the *beta* of the transistor. Where an unbypassed emitter resistor is used, the input impedance is also dependent on *beta*. But *beta* itself is also subject to wide variation and may have to be determined individually.

For these special applications, and to evaluate transistors in general as well, the author devised the simple, inexpensive unit shown in Fig. 4. It provides

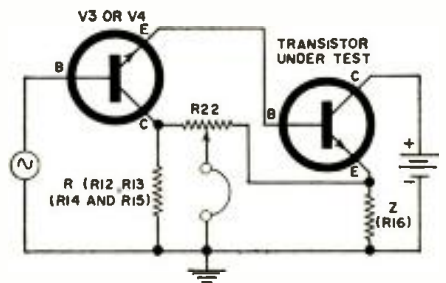
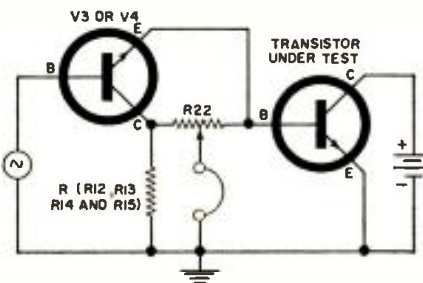

Fig. 2 (left). Circuit for reading  $h_{ie}$ .

Fig. 3 (right). Circuit for reading  $h_{fc}$ .

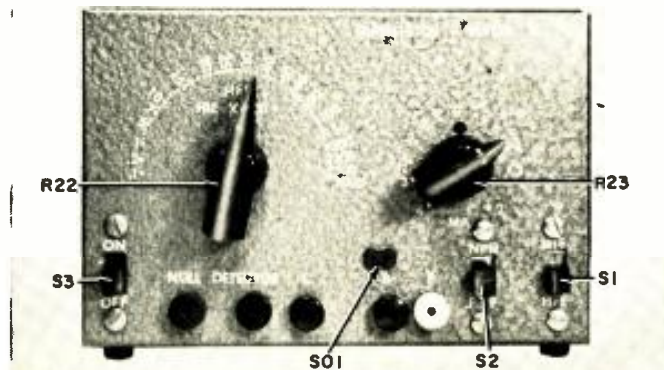

Fig. 4. The right-hand knob sets emitter current. Beta or input impedance is read on the left-hand knob after the bridge is balanced.

negligible unless  $h_{fe}$  is unusually low.

The manner in which the basic bridges of Figs. 2 and 3 are incorporated into the over-all circuit and selected by switching can be traced in Fig. 6. The role of  $V_3$  and  $V_4$  can also be followed here. As already noted, they take the place of the transformer conventionally used in a bridge circuit. One reason for using transistors as the signal source is the fact that all transformers tried had too much primary-to-secondary leakage to permit a sharp null. Another reason is that a low d.c. impedance is needed at the base of the transistor under test to bias it properly. This impedance could not be obtained with a transformer while maintaining other necessary circuit values.

$V_3$  and  $V_4$  do not function simultaneously. When a  $p-n-p$  transistor is being tested,  $V_3$  is forward biased by switch  $S_2$  to provide bias current. At the same time  $V_4$ , cut off by reverse bias, is effectively out of the circuit. When an  $n-p-n$  transistor is being tested, the situation is reversed:  $V_4$  conducts while  $V_3$  is cut off.

The signal applied through  $V_3$  or  $V_4$  is developed by an oscillator consisting

reference to collector current. The latter is simply emitter current minus base current. However, unless the  $h_{fe}$  of the transistor under test is very low, the difference will be negligible.

To obtain a sharp null, it is necessary to avoid any appreciable non-linearity in the operation of the transistor under test. This is achieved by keeping the a.c. test signal in the bridge circuit at a very low level. (The large value of  $R_{22}$  suggests this.) The low level, however, makes amplification necessary in order that the null may be detected readily and accurately.  $V_5$  and  $V_6$  pro-

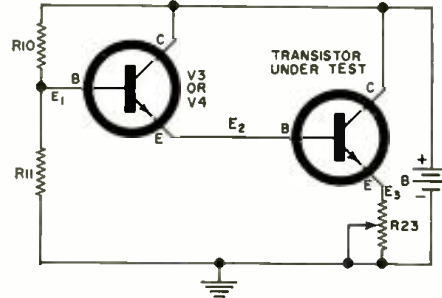

Fig. 5. Bias circuit for setting current through the transistor under test.

vide enough amplification so that a v.o.m., earphones, an oscilloscope, or any common indicator can be used as a null detector.

With the space conserved by the boards, there was ample room for mounting battery holders. Location of the boards and wiring to components mounted on the front panel are shown in Fig. 9.

To accommodate transistors that will not fit into test socket  $SO_1$ , jacks for test leads to the three transistor connections were mounted below the socket, as shown in Fig. 4. A glance at  $R_{22}$ , the current control, in this photograph shows that current settings increase in the counterclockwise direction. This resulted because a potentiometer with a standard log taper was used. If you don't like the reverse scale, use a control with a reverse log taper, as noted in the parts list. Otherwise an attempt to change the direction of readings will produce severe compression at the high-current end and unnecessary expansion at the low-current end.

In the completed version of the instrument shown in Fig. 4, note that there is also some compression at the extreme settings of  $R_{22}$ . Some later work indicated that the addition of  $R_{21}$  and  $R_{23}$ , shown in broken lines in Fig. 6, expanded the scale of  $R_{22}$ , especially at the

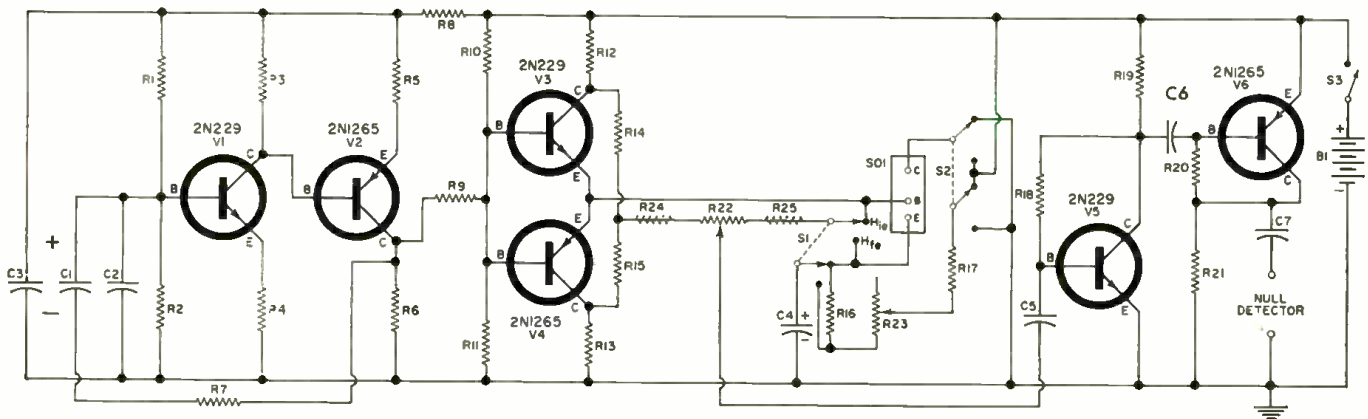

Fig. 6. The four transistors to the left develop test signal. The two to the right amplify bridge output for null detection.

$R_1$ —47,000 ohm,  $\frac{1}{2}$  w. res.  
 $R_2, R_{10}, R_{11}$ —10,000 ohm,  $\frac{1}{2}$  w. res.  
 $R_3, R_4, R_5$ —1000 ohm,  $\frac{1}{2}$  w. res.  
 $R_6$ —3900 ohm,  $\frac{1}{2}$  w. res.  
 $R_7, R_{13}, R_{14}$ —4700 ohm,  $\frac{1}{2}$  w. res.  
 $R_8, R_9, R_{12}$ —470 ohm,  $\frac{1}{2}$  w. res.  
 $R_{10}, R_{11}, R_{12}$ —170,000 ohm,  $\frac{1}{2}$  w. res.  
 $R_{13}, R_{14}$ —8200 ohm,  $\frac{1}{2}$  w. res.

$R_{15}$ —100 ohm,  $\frac{1}{2}$  w. res.  $\pm 5\%$   
 $R_{16}, R_{17}$ —3300 ohm,  $\frac{1}{2}$  w. res.  
 $R_{18}$ —500,000 ohm linear-taper pot  
 $R_{19}$ —10,000 ohm reverse-taper pot (see text)  
 $R_{20}$ —10,000 ohm,  $\frac{1}{2}$  w. res. (see text)  
 $R_{21}$ —1800 ohm,  $\frac{1}{2}$  w. res. (see text)  
 $C_1, C_2$ —.01  $\mu$ f. tubular capacitor  
 $C_3$ —10  $\mu$ f., 6 v. elec. capacitor  
 $C_4$ —50  $\mu$ f., 6 v. elec. capacitor

$C_5, C_6, C_7$ —.1  $\mu$ f., 10 v. disc ceramic (CRL UK10-105) or tubular capacitor  
 $C_8$ —.1  $\mu$ f. tubular capacitor  
 $S_1, S_2$ —D.p.d.t. slide switch  
 $S_3$ —S.p.s.t. slide switch  
 $SO_1$ —Transistor socket, in-line or universal  
 $B$ —6-volt battery (4 penlite cells)  
 $V_1, V_2, V_3, V_4$ —2N229 transistor  
 $V_5, V_6, V_7$ —2N1265 transistor

of  $V_1, V_2$ , and associated components. Output is close to a sine wave. The complementary characteristics of  $p-n-p$  and  $n-p-n$  transistors were used to advantage here to achieve direct coupling, resulting in fewer parts and lower cost. Oscillator frequency is determined by  $C_1$  and  $C_2$ .

The basic bias circuitry for the transistor under test is shown in Fig. 5. Since the potential difference between emitter and base of a transistor does not exceed a fraction of a volt, voltages  $E_1, E_2$ , and  $E_3$  are essentially equal. Since  $E_1$  remains basically the same,  $R_{22}$  can be calibrated in current and the calibration will be essentially the same for all transistors. Strictly speaking, this calibration is for emitter current whereas transistor ratings are usually given in ref-

vide enough amplification so that a v.o.m., earphones, an oscilloscope, or any common indicator can be used as a null detector.

### Construction

Little can be said about construction that is not better conveyed by the photos in Figs. 7, 8, and 9 and in the schematic. Other constructors may prefer another method, but the author found it convenient to mount all small parts on the two polystyrene boards of Figs. 7 and 8. The former essentially consists of the circuits that develop and apply the test signal, while the latter includes circuitry for null detection. Chassis ground was used, although this is not necessary. Four penlite cells make about the best and least expensive bat-

ends. This improved the accuracy of readings.

### Calibration

Calibration of  $R_{22}$  is quite simple. Just insert a milliammeter in series with this control and a good transistor in the test socket. Mark the milliammeter readings obtained by varying the control on the front panel.

To calibrate  $R_{22}$ , switch  $S_1$  to the  $h_{fe}$  function. Do not insert a test transistor. Instead, connect a series of known resistors from the base connection of the test socket to ground. With each resistor, adjust  $R_{22}$  until the bridge is balanced. Then divide the value of the known resistance by 100 and mark the quotient on the front panel for  $R_{22}$ . This

(Continued on page 68)

# MISMATCHING HI-FI AMPLIFIERS

By HERMAN BURSTEIN

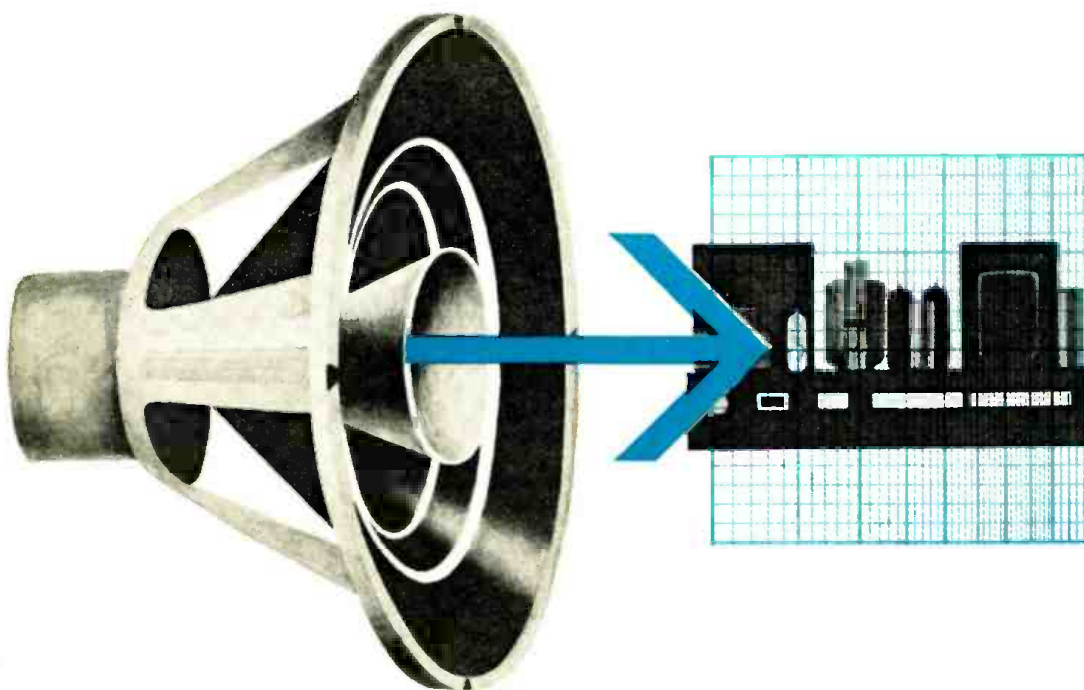

**T**HE POPULAR audio literature often gives warning about the dire peril of mismatching between power amplifier and speaker impedances, but gives little indication of just how dire. Therefore the author decided to investigate the matter by deliberately mismatching a typical power amplifier with a resistive load and measuring the effect upon power output, distortion, and frequency response. While about this, he also looked into two other related matters: (1) the result of using different output taps on the power amplifier, each properly loaded; and (2) the result of mismatching a crossover network with the speaker.

The amplifier employed in the tests is a mono unit of moderate power, capable of about 15 watts at 1000 cps and about 12 watts at 30 and 15,000 cps. The circuitry is quite conventional: a pentode voltage amplifier is directly

coupled to a triode split-load phase inverter, which feeds a pair of pentodes using self-bias and connected in "Ultra-Linear" fashion to the output transformer, as illustrated in Fig. 1. Negative feedback is taken from the transformer secondary to the voltage amplifier. Output taps of 4, 8, and 16 ohms are provided.

While the results obtained with one particular amplifier do not necessarily apply to all other amplifiers, still these results may be viewed as fairly indicative for modern amplifiers incorporating push-pull output and a substantial amount of negative voltage feedback.

#### Using Different Output Taps

Three successive measurements of intermodulation distortion were taken at 10-watts output (equivalent sine-wave power), each from a different output tap loaded with a matching resistor. When output was taken from a 4-ohm

tap (loaded with a 4-ohm resistor), IM at 10 watts measured 2.1%. The same measurement was obtained at the 8-ohm tap. At the 16-ohm tap, IM measured 2.0%, but this trivial difference might easily be due to error of the eye in reading a measuring instrument or to the fact that the load resistors that were employed were not precisely 4, 8, and 16 ohms.

In sum, for a given amount of output power, it appears that distortion is not significantly affected by the output tap employed, as long as the load impedance matches the tap impedance.

Frequency response between 50 and 15,000 cps was checked in a similar manner, and it was found that choice of output tap did have an effect on response but so slight as to be insignificant. At the 4-ohm tap, 50-cps response was down about 1/4 db compared with performance on the 8-ohm and 16-ohm taps. At 15,000 cps, response

**What happens to intermodulation distortion and frequency response when your power amplifier is mismatched? Here are some results of deliberate mismatching of the load as measured on a typical medium-power audio amplifier.**



was down ¼ db on the 8-ohm tap and ½ db on the 4-ohm tap compared with performance on the 16-ohm tap. To repeat, choice of tap had inconsequential effects on response.

### Effect of Load on Distortion

The effect of an upward mismatch was investigated first by loading the 4-ohm output tap with a 16-ohm resistor. Although one could still get 10 watts output with this arrangement, IM measured 34%, which would hardly do. On the other hand, it was found that IM could be kept down to the 2% level by reducing output to 5 watts. This means, for the same distortion level (2%), a power loss of 3 db when the correct 4-ohm load is replaced by a 16-ohm one. A loss of 3 db is not very serious inasmuch as it corresponds to a barely perceptible decrease in loudness.

In sum, an upward mismatch of as much as 4 to 1 is not necessarily disastrous. This is true if one doesn't try to drive his power amplifier to its limits. On the other hand, this doesn't mean that it is good policy to have a radical upward mismatch. Even though one keeps well below the power limits of the amplifier, such power as is drawn possibly contains more distortion than under matched loading. It all depends on the particular amplifier. Some amplifiers have a steadily rising distortion characteristic throughout their power range, while in others distortion remains

This means that the preamplifier has to supply twice as much signal voltage in order to drive the power amplifier to its original output level. Some preamplifiers can produce the additional signal voltage only at significantly higher distortion. Others, however, can handle the extra task with utter lack of strain, such as those which can turn out 3 volts or more at less than .1% IM distortion. (Keep in mind that most power amplifiers can be driven to full output, when properly loaded, by 1.5 volts or less.)

The effect of a downward mismatch was then examined, using a 4-ohm load on the 16-ohm tap. Surprisingly, there was no increase in distortion as the result of trying to get 10 watts output in these circumstances. IM measured 2.1%, very nearly the same as when 10 watts was extracted from the 16-ohm tap through a 16-ohm load. On the other hand, to prove that you don't really get away scot-free, there was an adverse effect on treble response, as discussed in the following section.

### Effect of Load on Response

A downward mismatch—4-ohm resistor on the 16-ohm tap—had no effect on bass response but adversely affected treble response, producing a loss of 2½ db at 15,000 cps. Still, this is a barely significant loss, one that you would have to attend very carefully to detect on an A-B comparison and which could be easily corrected by a slight twist of the

treble control on the preamplifier used.

The opposite result was obtained for an upward mismatch, using a 16-ohm resistor on a 4-ohm tap. Now treble response was improved, but very slightly; the rise measured 1 db at 15,000 cps. There was no effect on bass response.

In all, mismatching was not as consequential for frequency response as for distortion and power output.

### Mismatching the Crossover Network

What happens to frequency response if a crossover network designed for a given speaker impedance is loaded with a different impedance? To find out, the author used a network designed to provide a turnover frequency (response 3-db down) nominally at 800 cps when loaded with a woofer and tweeter each of 16-ohm impedance. Fig. 3 shows the configuration of this network.

Because of the normal tolerances of components employed in crossovers, the turnover frequency proved to be 950 cps instead of 800 for the tweeter and 920 cps for the woofer. The difference in crossover points between woofer and tweeter (920 cps *versus* 950) is of little consequence. So is the fact that the actual turnover frequency is upward of 900 cps instead of 800 cps. Now let's see what happened as the load on the network was changed from 16 ohms to other values.

The effect on treble response was measured first. As the load on the treble (tweeter) portion of the network was

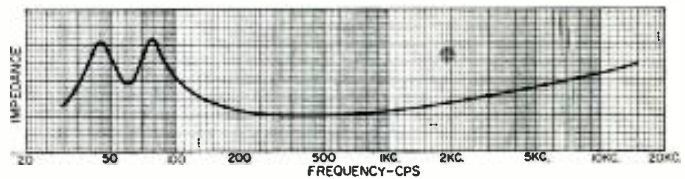
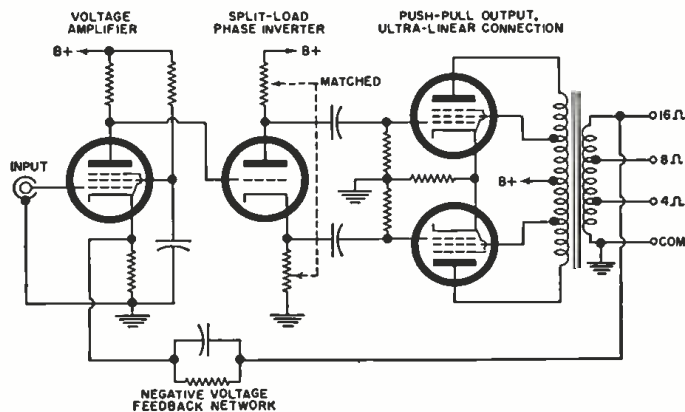

Fig. 2. Typical variation of impedance of a loudspeaker that has been mounted in a properly tuned bass-reflex type enclosure.

Fig. 1. Circuit of typical hi-fi power amplifier used in tests.

Table 1. The effect on output power and intermodulation distortion when the value of the load resistance and the output tap were changed. Note that an upward mismatch has a greater effect in the case of the particular amplifier used. Only a very slight change in frequency response occurs with mismatch.

quite constant and low over most of the range and then rises steeply as the upper limit of power output is approached. When using the latter type of power amplifier, it is conceivable that one could get away with a 4 to 1 upward mismatch at virtually no sacrifice in distortion at low power levels. But in the case of the amplifier tested by the author, an upward mismatch entailed an increase in distortion; properly loaded, the amplifier could produce 5 watts at 1.3% IM instead of 2% (when loaded by 16 ohms).

Even though one gets away with upward mismatching in the power amplifier, there is a possibility of undesirable consequences at the preceding stage—the preamplifier. When the power amplifier is loaded with 16 ohms instead of 4 ohms, power output is reduced about 6 db for a given input voltage.

	Amp.-Output Tap	Load	Equiv. Sine-Wave Output	IM Dist.	Remarks	
<b>A. Effects on Distortion</b>						
1. Choice of tap	4 ohm	4 ohm	10 watts	2.1%	No significant change	
	8 ohm	8 ohm	10 watts	2.1%		
	16 ohm	16 ohm	10 watts	2.0%		
2. Upward mismatch	4 ohm	16 ohm	10 watts	34.0%	Much higher distortion at high power Somewhat higher distortion at reduced power	
	4 ohm	4 ohm	5 watts	2.0%		
	4 ohm	4 ohm	5 watts	1.3%		
3. Downward mismatch	16 ohm	4 ohm	10 watts	2.1%	No significant change	
	Output Tap	Load	Output	Relative Response		Remarks
<b>B. Effects on Frequency Response</b>						
1. Choice of tap	4 ohm	4 ohm	1 watt	-¼ db*	-½ db*	No significant change
	8 ohm	8 ohm	1 watt	0 db*	-¼ db*	
	16 ohm	16 ohm	1 watt	0 db*	-¼ db*	
2. Upward mismatch	4 ohm	16 ohm	1 watt	0 db*	+1 db*	Slight high-freq. boost
3. Downward mismatch	16 ohm	4 ohm	1 watt	0 db*	-2¼ db*	Slight high-freq. roll-off

\* Relative to response on 16-ohm tap; \* Relative to response with a matched load.

reduced, the treble turnover frequency went up substantially. For an 8-ohm load the turnover was 1450 cps; for a 4-ohm load, 2000 cps. On the other hand, the turnover frequency fell as the load was increased, it was 700 cps for a 32-ohm load.

When the load on the bass (woofer) section of the network was changed, the opposite effects occurred. The turnover frequency went down as the load was reduced. For an 8-ohm load the turnover was 575 cps; for a 4-ohm load, 370 cps. But when the bass load was increased to 32 ohms, the turnover went up to 1070 cps.

Of what significance is all this? The most important thing appears to be the possibility of causing a big dip in response as the result of using speakers that have too low an impedance for a given crossover network. Let us assume that an 8-ohm tweeter and an 8-ohm woofer are used in conjunction with a 16-ohm network designed to cross over at 800 cps. The tweeter's response would fall rapidly (most crossovers produce

ing overworked. However, if they are required to reproduce upper frequencies for which they are not designed, some distortion may result.

### Mismatching Network & Amplifier

What happens if there is a mismatch between the output tap of the amplifier and the impedance of the crossover network? To check this, the 16-ohm crossover shown in Fig. 3, loaded with 16-ohm resistors, was successively connected to the various taps on the amplifier. The turnover frequency remained virtually constant for the bass portion of the network. However, it went up somewhat for the treble portion as connection was made to the 8- and 4-ohm taps. The treble turnover was 950 cps at the 16-ohm tap, 1050 cps at the 8-ohm tap, and 1080 cps at the 4-ohm tap. In most situations this amount of change in turnover frequency would not have audible results.

### Summary and Conclusion

With a modern power amplifier, im-

work's. This may open up a substantial hole in response in the vicinity of the turnover frequency. An upward mismatch may elevate response in the region of turnover, but not by more than the relatively slight amount of 3 db.

In the case of the crossover network vis-a-vis the amplifier, mismatches up to 4 to 1 appear to have inconsequential effects on frequency response. An upward mismatch (crossover impedance higher than the amplifier's) causes treble response to start falling off slightly above the nominal turnover. The author did not have the facilities for checking the effect of a downward mismatch (requiring an 8-ohm or 4-ohm crossover), but it may be inferred that such a mismatch would cause treble response to start falling off slightly below the nominal turnover.

Ordinarily one would not invite even the slight risk of trouble by deliberately incurring a mismatch. But is there a possibility that a mismatch can actually prove advantageous? The answer is yes. Following are three examples.

1. Typically, the impedance of a woofer or full-range speaker rises substantially at low frequencies, as indicated in Fig. 2. Therefore its ability to draw large amounts of power from the amplifier decreases at low frequencies. If one is trying to get thunder from his speaker and therefore drives the amplifier hard, it is possible that the increase in speaker impedance prevents the amplifier from supplying all the power of which it is capable. But a downward mismatch, such as putting an 8-ohm speaker on the 16-ohm tap, would enable the speaker to draw more power at low frequencies.

2. When dividing the frequency range between two speakers, the speaker characteristics may happen to produce an undesirable peak in the region of the crossover frequency. This can be more or less compensated by a downward mismatch between the crossover and the speakers, that is, using a crossover with a higher impedance than the speakers'. Thus if the speakers are rated at 8 ohms, one might design the network for 12 ohms in order to get a compensating dip in response. Conversely, if the speaker characteristics are such that the crossover region can profit by a little extra response, a crossover network might be constructed which produces an upward mismatch, perhaps by designing the network for an impedance of 6 ohms.

3. Sometimes a high-efficiency speaker is used with a power amplifier which can supply more power than is needed. With this goes the unnecessary danger of blowing out the speaker in case the power amplifier should go on a rampage (for example, if the input lead breaks). Also, there is excessive reproduction of hum and noise generated by the power amplifier and preamplifier. The speaker can be given considerable protection, and a slight reduction in hum and noise can be achieved, by an upward mismatch, such as connecting a 16-ohm speaker to the 8-ohm tap or perhaps even to the 4-ohm tap. ▲

	Crossover Impedance	Load on Each Section	Amp.-Output Tap	Treble Cross-over Freq.*	Bass Cross-over Freq.*	Remarks
A. Mismatch with Amplifier	16 ohm	16 ohm	16 ohm	950 cps	920 cps	Treble crossover freq. raised slightly. Bass crossover freq. remains constant.
	16 ohm	16 ohm	8 ohm	1050 cps	920 cps	
	16 ohm	16 ohm	4 ohm	1080 cps	920 cps	
B. Downward Mismatch with Load	16 ohm	16 ohm	16 ohm	950 cps	920 cps	Treble crossover freq. raised and bass crossover freq. lowered.
	16 ohm	8 ohm	16 ohm	1450 cps	575 cps	
	16 ohm	4 ohm	16 ohm	2000 cps	370 cps	
C. Upward Mismatch with Load	16 ohm	32 ohm	16 ohm	700 cps	1070 cps	Treble crossover freq. lowered and bass crossover freq. raised.

\* Response down 3 db.

Table 2. Changes in crossover frequencies as a result of deliberate mismatching.

a 12 db per octave slope) much before the turnover frequency was reached and so would the response of the woofer. Hence in the general area of about 500 to 1400 cps, which is nearly an octave and a half, response would be deficient. The listener would probably complain of "the absence of middle."

On the other hand, there appears to be less chance of going wrong with an upward mismatch, where the speaker impedance exceeds that of the crossover network. In this case the woofer and tweeter will each cover somewhat more audio territory than originally planned, resulting in a slight excess of response in the vicinity of the turnover frequency. But this excess is 3 db at most, which is barely detectable, is smaller than the hole in response which can result from downward mismatching, and is small compared with the peaks and dips usually exhibited by speaker systems.

However, a gross upward mismatch, such as loading a 4-ohm network with 16-ohm speakers, probably should be avoided, because it may overburden the tweeter. If the tweeter is forced to reproduce low frequencies for which it was not designed, its excessive excursions at these frequencies may cause serious distortion, and even destruction of the unit. The author has observed that some very fine tweeters go to pieces when required to produce an appreciable amount of sound not much below the turnover frequency.

Woofers are usually stronger beasts than tweeters and not as subject to be-

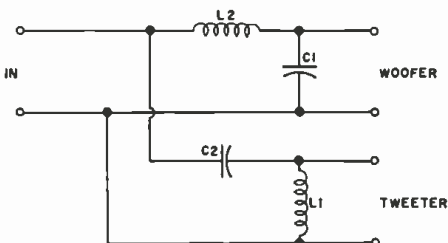

Fig. 3. Crossover-network circuit used.

pedance mismatches as great as 4 to 1 between amplifier and speaker do not usually have the dreadful consequences that are sometimes suggested. While it is generally safest and best to match impedances, it is quite possible to have a substantial mismatch and yet retain adequate power output at little or no sacrifice in distortion and treble response. With an upward mismatch (speaker impedance greater than the amplifier's), one must be prepared to lose up to about half of the amplifier's power capacity, which is but a 3-db loss. Depending on the particular amplifier, distortion will rise a little or none at all at reduced power levels; treble response will not suffer. With a downward mismatch, full power can be retained at apparently no increase in distortion and with relatively slight treble loss.

A mismatch as great as 4 to 1 is apt to have undesirable consequences when it occurs between the crossover network and the speaker. This is true mainly for a downward mismatch, when the speaker impedance is less than the net-



**JULIAN D. HIRSCH**  
of Hirsch-Houck  
Laboratories

Summing up his report  
for **HI-FI STEREO  
REVIEW**, Julian  
D. Hirsch wrote:

*"In my opinion,  
the **UNIVERSITY  
CLASSIC MARK II**  
... is one of a  
limited group of  
speakers to which I  
would give an  
unqualified topnotch  
rating."*

"Despite the popularity of bookshelf-size speaker systems, the big speaker system is far from extinct. There is still a great deal to be said for the sound quality of a really good large speaker system, one of which is University's new Classic Mark II.

In operation, the Classic Mark II handles low frequencies up to 150 cps through a 15-inch high-compliance woofer that is installed in a ducted-port cabinet. The bulk of musical program content, however, is handled by an 8-inch mid-range speaker, which covers from 150 to 3,000 cps. Above 3,000 cps, a Sphericon super tweeter takes over.

The measured indoor frequency response of the Classic Mark II was remarkably uniform. As a rule, such response curves are so far from flat that I do not attempt to correct them for the slight irregularities of the microphone's response. However, the measurements for the Classic Mark II prompted me to plot the microphone response also. This further emphasizes the uniformity of the system's frequency response. A 5-db increase in the setting of the tweeter-level control would probably have brought the range above 3,000 cps into nearly exact conformity with the microphone-calibration curve.

The low-frequency distortion of the woofer, even at a 10-watt input level, was very low, and it actually decreased at 20 cps, where the output was beginning to rise... Any good amplifier of 10 watts rating or better should be able to drive it satisfactorily.

In listening tests, the Classic Mark II sounded very clean... there was an undercurrent of bass, more often felt than heard, that was completely lacking in some other quite good speaker systems that I compared to the Classic Mark II. The speaker sounded at its best (to my ears) at moderate listening levels. At high levels the bass tended to be overpowering. A different listening room, of course, could easily alter this situation completely. Over-all, the sound was beautifully balanced, with wide dispersion and a feeling of exceptional ease. There was never a hint that three separate speakers were operating; the sound seemed to emanate from a large, unified source.

In my opinion the University Classic Mark II justifies the substantial claims that its manufacturer has made for it. It is one of a limited group of speakers to which I would give an unqualified topnotch rating. Anyone who is in a position to consider a system of its size and price would be well advised to hear it. The price of the system is \$295.00."

**WRITE TODAY FOR THE COMPLETE  
JULIAN HIRSCH HI-FI STEREO REVIEW  
REPORT** on the new **CLASSIC**, as well as the  
documented **CLASSIC** brochure and "Informal  
Guide to Component  
Stereo High Fidelity."  
Simply write: Desk S-5,  
University Loudspeakers,  
80 S. Kensico Ave.,  
White Plains, New York.



*A Division of Ling-Temco-Vought, Inc.*

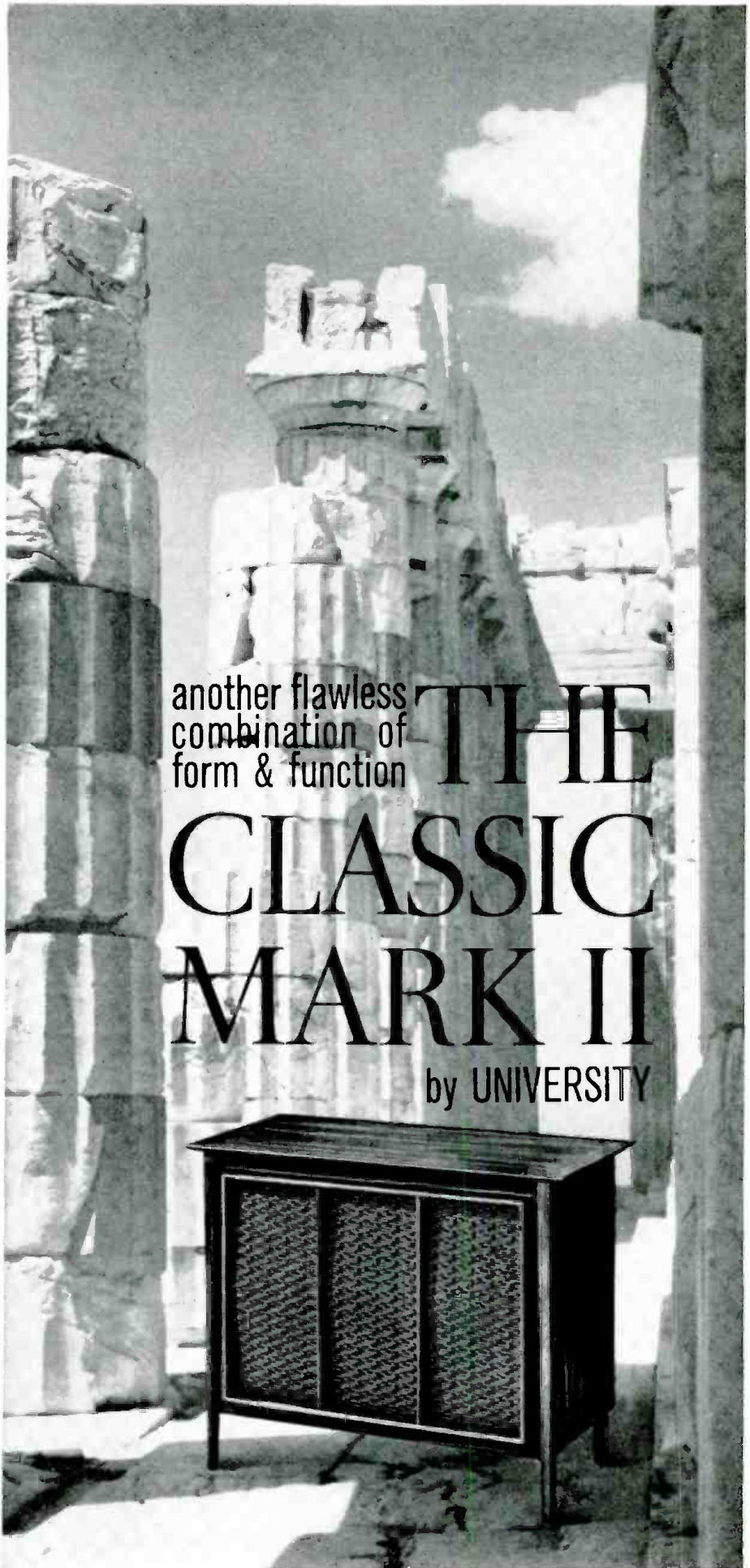

another flawless  
combination of  
form & function

# THE CLASSIC MARK II

by UNIVERSITY

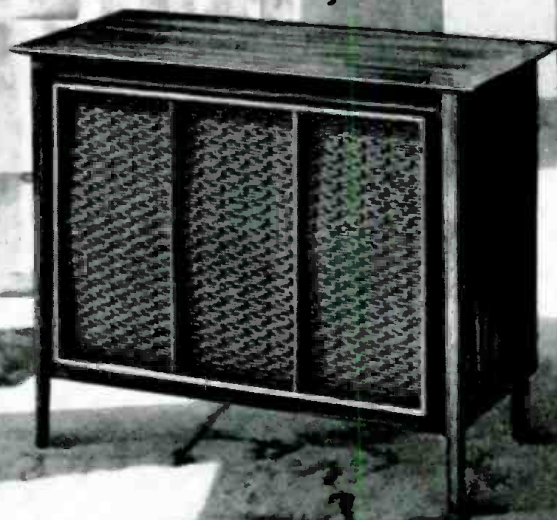

# HAM OF THE YEAR

*William G. Welsh, W1SAD/6, has been chosen to receive the 1961 Edison Radio Amateur Award for public service.*

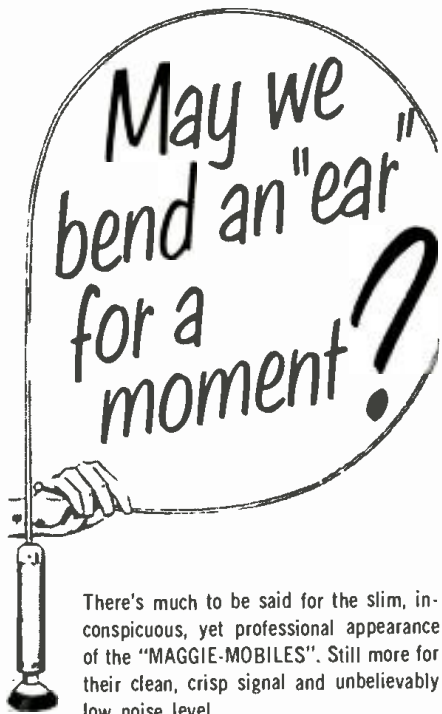

There's much to be said for the slim, inconspicuous, yet professional appearance of the "MAGGIE-MOBILES". Still more for their clean, crisp signal and unbelievably low noise level.

But the real point of this message is a hidden virtue you can't see or hear. It's called, "17-7 stainless steel", one of the most resilient alloys ever made. We use nothing else in our MAGGIE-MOBILES, even though it costs considerably more than the stainless steels used in run-of-the-mill whips. Here's why:

You can bend it full circle, from tip to butt; let go and it snaps back to a perfect vertical. (Don't try this with other brands). It slips around obstructions like an eel. No breakage . . . no "water shorts".

One more reason why Antenna Specialists' brand antennas are preferred by more citizens banders than any other kind.

Switch to a:

## "MAGGIE-MOBILE"

Base-loaded CB 27Mc

### ANTENNA

#### MOUNTING'S A SNAP, TOO!

Available in three simple and attractive mounts . . . 20 ft. cable with connectors attached . . . take your choice!

#### MODEL M-67

Roof mounted entirely from outside. Ideal omni signal pattern. Only \$15.68 (net)

#### MODEL M-74

Cowl or deck. Ingenious swivel base adjustable up to 35° angle. Only \$19.32 (net)

#### MODEL M-73

Trunk groove mount. No holes in body! Fits all makes and models. Only \$17.06 (net)

P.S. Your CB base station should have the famous big-gain, easy-to-install Magnum 27. It won't bend.



For complete information see your local citizens band supplier . . . or write for specifications to:

## the antenna specialists co.

12435 Euclid Avenue, Cleveland 6, Ohio  
Export Div., 15 Moore St., New York 4, N.Y.

AN AMATEUR radio operator who has voluntarily taught electronics to more than 2800 people—young and old—has been chosen to receive *General Electric's* 1961 Edison Radio Amateur Award for public service. He is William G. Welsh, 34, an engineering writer who recently moved from Cambridge, Mass. to Burbank, Calif. He operates amateur radio station W1SAD/6. Welsh received the Edison Award trophy and a \$500 cash prize at a presentation banquet in Washington, D. C. on March 1.

Welsh was chosen from among 23 candidates as the tenth winner of this award by a panel of judges consisting of Commissioner Rosel Hyde of the FCC, Chairman of the Board E. Roland Harriman of the American National Red Cross, and President G. L. Dosland of the ARRL.

Nominated by many persons in the Boston area—including the engineer-in-charge of the Boston FCC office, a Catholic priest, and the director of a vocational high school—Welsh is said to have devoted 20 to 30 hours each week to his voluntary instruction work during the past ten years.

He has devised comprehensive courses of instruction which include eight 1800-foot code-practice tapes as well as text material. He has run off hundreds of copies of his tapes free of charge and sent them to voluntary study groups in nearly every state in the nation and at least twelve foreign countries. In addition, he prepared a 70-page instructor's handbook to help others teach radio.

Welsh has taught radio classes in many locations in the Boston area including a course at M.I.T. sponsored by the state department of education. This

is the only course for which he was paid, and he used his pay to buy duplicating equipment and materials to extend his voluntary teaching work. For two seasons, he conducted classes seven nights a week, sometimes holding both early and late evening sessions.

His wife, Marie—also an amateur radio operator (W1COL/6)—has often graded examination papers and taught classes when her husband was away on business trips. The couple has five children, with the oldest, Richard, 12, a licensed radio amateur too.

Employed as an electronics engineering writer by the *Raytheon Co.*, Waltham, Mass. for some time, Welsh and his family decided to move to California in December of last year. Shortly after arriving, Welsh obtained a similar position with *Librascope, Inc.*, a Glendale electronics firm.

In addition to the award winner, special citations will go to:

Robert T. Herndon, W5URW, Port Lavaca, Texas, for providing emergency communications during the ten days following Hurricane Carla.

Eugene M. Link, W0IA, Boulder, Colo., for handling more than 9000 weather reports by radio in cooperation with the Denver Weather Bureau.

George L. Thurston, W4MLE, Tallahassee, Fla., for exceptional organization, planning, and coordination of civil emergency radio communications throughout Florida.

Master of ceremonies at the Washington presentation was L. Berkley Davis, president of the Electronic Industries Association and a vice-president of *G-E*, who served as chairman of the award council. ▲

Award winner William G. Welsh takes a few minutes to give pointers on electronics to neighborhood youngsters in San Gabriel, California.



# NOW! LEARN HOW TO SERVICE TRANSISTOR RADIOS

## THE QUICKEST, EASIEST WAY SO YOU CAN EARN BIG PROFITS!

*you'll get money-making know-how from the COMPLETE 16-LESSON*  
**"PRACTICAL TRANSISTOR RADIO SERVICING COURSE"**

*available as an exclusive BONUS FEATURE for*  
**PHOTOFACT® SUBSCRIBERS!**



**FIRST LESSON IN  
 PHOTOFACT  
 SET No. 581  
 (JUNE 1962)**

**HERE'S JUST  
 WHAT YOU NEED**

**TO CASH IN ON THIS HUGE SERVICING MARKET!**

Servicing small transistor radios can be a real headache and a financial loss to service technicians—UNLESS you have the knack of quickly locating and repairing troubles caused by faulty miniature components or defective printed boards.

The Howard W. Sams PRACTICAL TRANSISTOR RADIO SERVICING COURSE gives you the special knowledge and techniques you need to become an expert on transistor radios—so you can repair all types at a profit.

You get practical know-how, based on years of on-the-job experience. You get down-to-earth text on every phase of transistor radio servicing (see Lesson list at right), PLUS large pictorial photos showing you why, what and how.

The transistor radio servicing market is huge and growing, with millions of customers crying for service. There's big money to be made by those who know the shortcuts to quick, effective repair. The Sams PRACTICAL TRANSISTOR RADIO SERVICING COURSE can make you an expert, can give you the speedy know-how you need to earn big money consistently.

**Here's the Course you get with your Photofact Subscription!**

- Lesson 1. Transistor Radio Components. Description of transistors, diodes and thermistors in transistor radio circuits, and other components used in miniature portables.
- Lesson 2. Transistors in Operation. Biasing, loads, temperature effects, polarities, positive and negative grounds, heat dissipation.
- Lesson 3. Measurements in Transistor Circuits. Voltage resistance, and current measurements in audio, RF and IF amplifiers, oscillators, detectors and other circuits.
- Lesson 4. Transistor Circuit Checks. Reading schematics, using CircuTrace®, measuring voltages and resistances.
- Lesson 5. Transistor Radio Construction. Cabinets and case construction, chassis removal, care of plastics and use of solvents.
- Lesson 6. Special Tools. Soldering devices, miniature tools used in assembly, disassembly, and repair of transistor radios.
- Lesson 7. Troubleshooting Techniques. Preliminary tests, current and voltage checks, and signal-tracing techniques used in isolating troubles.
- Lesson 8. Making Effective Use of Test Equipment. Test equipment needs and applications.
- Lesson 9. Servicing Procedures. Where to start; step-by-step checks.
- Lesson 10. Analyzing Troubles by Symptoms. Commonly-found problems, recognizing the symptoms, and locating defective components.
- Lesson 11. Alignment and Adjustment. Step-by-step procedures plus time-saving hints.
- Lesson 12. Improving Performance. Techniques for improving the operation of noisy and/or weak receivers.
- Lesson 13. Repairing Printed-Boards. How to isolate printed-wiring defects and replace faulty components.
- Lesson 14. Transistor Replacement. Selecting and installing suitable types.
- Lesson 15. Auto Radios. Special requirements for servicing hybrid and all-transistor models.
- Lesson 16. Replacement Parts. How to repair defective components; sources for replacements.

**PLUS**—to-the-point Questions & Answers to help you check your progress!

**DON'T MISS A  
 SINGLE ISSUE!**

**Subscribe today through your Sams Distributor to receive all PHOTOFACT Sets as issued each month. Beginning in June, 1962, you will start receiving the 16-lesson Practical Transistor Radio**

**Servicing Course as a bonus with your subscription to PHOTOFACT—the world's finest tv-radio servicing data!**

**SUBSCRIBE  
 TODAY!**

**SUBSCRIBE TODAY—Get This Timely BONUS Course!**

**Are You Enjoying the Benefits of Membership in "PEET"?**

Join the thousands who have qualified and profited by membership in the "PEET" Program. If you now own a PHOTOFACT Library or plan to own one, you can apply for membership. It's the *only* program designed to build powerful public acceptance for you, which means increased business and profits. You get dozens of free promotional aids. Benefits cost you absolutely nothing if you qualify. Ask your Sams Distributor for the "PEET" details or mail coupon today.



Powerful national advertising monthly in TV Guide now carries the "PEET" message to over 8,000,000 TV families, building dynamic support and demand for the services of "PEET" members. Now more than ever it pays to qualify as a "PEET" member!

Howard W. Sams & Co., Inc., Dept. 5-E2  
 1724 E. 38th St., Indianapolis 6, Ind.

I would like to enter my subscription to Photofact, effective with Set No. 581

My Distributor is: \_\_\_\_\_

Send me details on how to become a "PEET" Member

Shop Name \_\_\_\_\_

Attn. \_\_\_\_\_

Address \_\_\_\_\_

City \_\_\_\_\_ Zone \_\_\_\_\_ State \_\_\_\_\_

# World's Only 'Portable Recording Studio'...



the all-in-one  
**Norelco**

## CONTINENTAL '400' 4-Track Stereo Tape Recorder

A recording studio in a suitcase—that's how NORELCO '400' owners describe this most advanced (and most popular) self-contained stereo tape recorder. **VERSATILITY:** 4-track stereo recording and playback, as well as 4-track monophonic recording and playback, at any of its 3 speeds. **PROFESSIONAL EXTRAS** (at no extra cost): mixing, monitoring and sound-on-sound facilities. **AUDIO FACILITIES:** completely self-contained, including dual recording and playback preamplifiers, dual power amplifiers, two NORELCO wide-range, stereo-matched speakers (one in the detachable lid) and stereo dynamic microphone. For complete specifications, write to NORELCO. In the meantime, see and hear the Continental '400' at any leading Sound or Photo Dealer.

High Fidelity Products Division  
**NORTH AMERICAN PHILIPS COMPANY, INC.**  
230 Duffy Avenue, Hicksville, L. I., N. Y.

### Product Test Report (Continued from page 20)



It is possible to switch the output of the meter amplifier directly to a pair of output terminals on the front panel. A scope may be connected to these terminals, for example, in order to observe

very low-level signals that lie beyond the scope's sensitivity. It is not possible to meter these output terminals while they are being used in this way.

The Model 250 is available either in kit form or factory-wired. The unit we checked was the kit version, the construction of which was simple and straightforward. It took us less than 6 hours to do the whole job from start to finish. After we built the instrument and calibrated it, we checked it on all ranges against an accurate lab-type a.c. v.t.v.m. The accuracy of the readings obtained ranged from  $-1.5\%$  to  $+3\%$  of full scale. The accuracy specified by the manufacturer is  $\pm 3\%$  of full scale. We next checked the frequency response of the meter amplifier with the range switch set to one of the lower voltage ranges and with an output voltage of 5 volts, the maximum output specified by the manufacturer. We found the low-frequency response to be down only .4 db at 30 cps, down .9 db at 15 cps, and down 2.5 db at 10 cps; hence, it would appear that the specification of  $-3$  db down to 8 cps would be met. At the high-frequency end, the amplifier was up no more than about .1 db at frequencies just over 100 kc., the limits of our measurements.

All in all, the Model 250 would appear to be a useful addition to the audio service bench, to the laboratory, or to an industrial troubleshooting department where audio equipment is being checked. The styling of the v.t.v.m. matches that used by Eico for their a.c. volt-watt meter and variable a.c. bench supply, and a grouping of these instruments is very much worth the small amount of bench space required for them. The meter sells for \$49.95 in kit form, or for \$79.95 completely factory-wired. . . . . E.W.

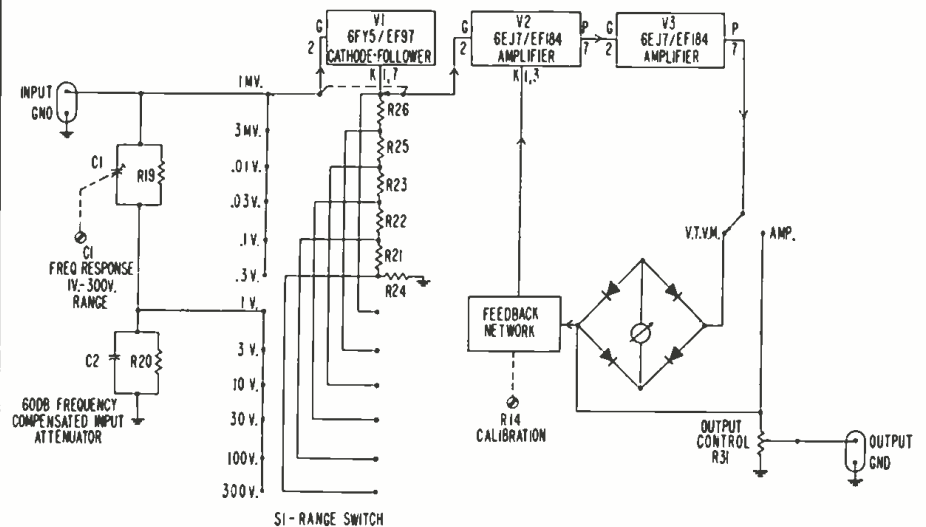

## Netherlands Fourth in Electrical Exports

**T**INY Holland with a population of only 11,600,000, has built up her electrical engineering industry during the past decade to fourth-place position among the nations of the world in exports of electrical and electronic equipment and products.

With 7% of the world's exports of electrical equipment, The Netherlands today ranks after the U.S. (23.5%), Great Britain (20.5%), and Western Germany (17%). In 1960, the latest year for which figures are available, the Dutch industry of about 210 firms attained a total production output valued at more than \$652,500,000. About 60 per-cent of this total was exported

throughout the world. Other European countries received two-thirds of these shipments.

Export statistics reveal that radio and television sets, sound recording and reproduction apparatus, amplifiers, microphones, and loudspeakers led the field of 1960 exports with a total value of \$150,000,000. Placing second were electronic tubes, photoelectric cells, and transistors, whose exports exceeded \$58,600,000.

The Netherlands industry has also played a significant role in producing and supplying all types of electronic equipment to the military establishment, both internal and NATO forces. ▲

# FREE!

## WORLD'S BIGGEST KIT CATALOG!

SEND FOR YOUR COPY TODAY!

You'll find hundreds of low-cost, easy-to-build Heathkit products in this value-filled catalog . . . the world's largest and most complete! Over 250 different Money Saving kits are shown with complete descriptions, schematics, big photographs and full specifications. Send for your copy today! Save up to 50% of the cost of comparable products by doing the easy assembly yourself! All kits are fully guaranteed and available on no money down terms! Use the handy coupon below.

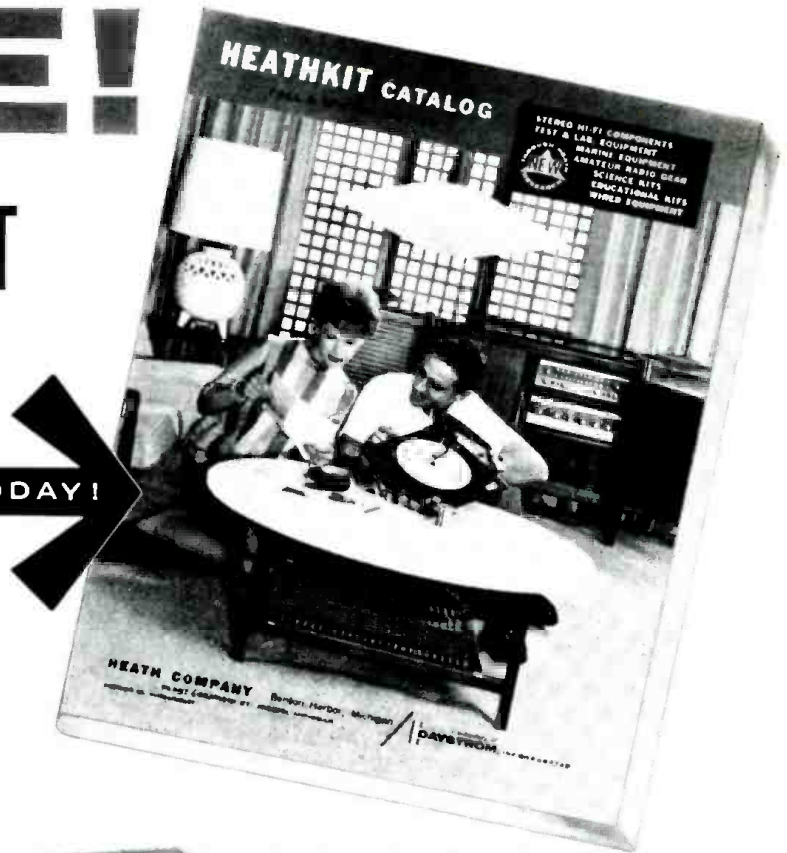

**DELUXE FM STEREO TUNER:** Brilliantly engineered. AM, FM and built-in FM Stereo Multiplex. Indicator light signals when FM stereo is being broadcast! Adjustable AFC and FM squelch; tuning meters, circuit boards.  
**Kit AJ-41...**no money down \$11 mo. **\$119.95**  
**Assembled AJW-41,** \$18 mo. . . . **\$189.95**

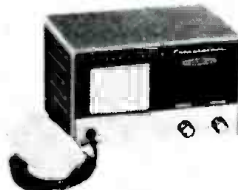

**CB TRANSCEIVER:** Low-cost, two-way radio! Crystal controlled superhet receiver and transmitter; squelch and automatic noise limiter; Push-to-Talk microphone; built-in AC power supply; provision for plug-in DC supply.  
**Kit GW-12A (AC only)** 8 lbs. \$5 mo. **\$39.95**  
**Kit GW-12D (AC & DC)** 11 lbs \$5 mo. **\$44.95**



**MARINE RADIO TELEPHONE:** Factory wired and tested! 50-watt transmitter. 5 crystal-controlled transmit and receive channels. Covers 2-3 mc marine and standard broadcast bands. Built in vibrator power supply. An outstanding value! 25 lbs.  
**Assembled MWW-11A,** no money down, \$24 mo. . . . **\$259.95**

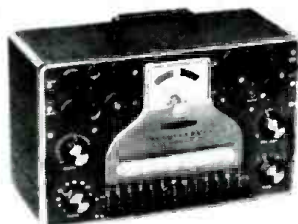

**TUBE CHECKER KIT:** Latest design. Tests all tubes including Compactron, Nuvistor, Novar and 10-pin miniatures! Built-in roll chart. Individual tube element switches. Perfect for service. 11 lbs.  
**Kit IT-21...**no money down, \$5 mo. **\$44.95**



**SSB MOBILE AMATEUR TRANSMITTER:** 90 watt input, 80 through 10 meters, crystal bandpass filter, dual conversion heterodyne circuitry, automatic level control, switch selection of USB, LSB and CW, VOX or PTT operation. 19 lbs.  
**Kit HX-20,** No money down, \$19 mo. **\$199.95**

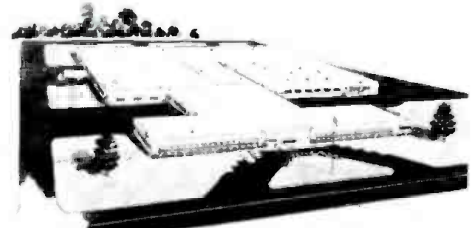

**HEATHKIT**  
by Davitron

World's oldest and largest manufacturer of do-it-yourself electronic kits



**HEATH COMPANY**  
BENTON HARBOR, MICHIGAN

All prices and specifications subject to change without notice.

### HEATH COMPANY

Benton Harbor 15, Michigan

Please send my free copy of the 100 page 1962 Heathkit Catalog

Name \_\_\_\_\_

Address \_\_\_\_\_

City \_\_\_\_\_

Zone \_\_\_\_\_

State \_\_\_\_\_

# MARK Static Sheath\*

Eliminates Precipitation Static\*  
Improves Signal-to-Noise Ratio  
Affords up to 20 db Operating Gain  
Increases Receiver Sensitivity  
Extends Intelligible Coverage  
Easiest to Install

**INCREASE  
COVERAGE**  
on Citizens Band

## MARK II SUPER BEACON FIXED STATION ANTENNA with Static Sheath\*

Design advantages of the new MARK II now make it possible to step up the efficiency of your CB operation, and maintain clearer communication over greater distances. 19 feet overall, the omnidirectional MARK II makes fullest use of the 20-foot legal length limit. Requires no radials or skirts. Provides 1 db gain over ground plane antennas.

Employs a full half-wave radiator voltage fed through a special launcher-matcher cable section for excellent impedance match over the entire 11-meter citizens band. Low angle radiation insures utmost efficiency and maximum contact with mobile units. Improved mechanical features and extra-rugged base support pipe add to its reliability. Simplified clamp mounting makes installation easy.

\* Precipitation Static is caused by charged particles in the air impinging in a continuous stream on metal antenna radiator surfaces. The patented Mark Static Sheath\* is a tough, durable, dielectric plastic covering that eliminates this static interference.

Write for Catalog HW19-EW

**MARK HELIWHIP®**

Another Fine Product Line by



**B&K MANUFACTURING**

Dept. EW-5, 1801 W. Belle Plaine, Chicago 13

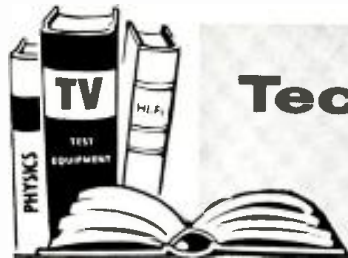

# Technical

# BOOKS



"RCA RECEIVING TUBE MANUAL" compiled and published by Electron Tube Division, *Radio Corporation of America*, Harrison, N.J. 480 pages. Price \$1.00. Soft cover.

This latest edition of the familiar Tube Manual (RC-21) provides technical data on over 900 receiving tubes including nuvistor, novar, and other new tube types. Data is also provided on more than 100 types of black-and-white and color picture tubes.

The Manual's text material on electron tube theory, installation, application, and interpretation of tube data has been augmented. A new receiving-tube chart has been added to aid in the selection of tube types for specific applications.

The circuits section has been expanded and now includes 26 circuits among which are several broadcast receivers, a 144-mc. receiver, a 10-meter nuvistor preamp, two two-channel stereo amplifiers, five amplifier circuits, preamp, mixer, and tone-control circuits, etc.

"TRANSISTOR CIRCUIT MANUAL" by Allan Lytel. Published by *Howard W. Sams & Co., Inc.*, Indianapolis. 255 pages. Price \$4.95. Soft cover.

This is a practical reference manual for the build-it-yourself fraternity since it carries several hundred circuit diagrams for building everything from AM radio receivers and audio amplifiers to switching and logic circuits, counters, and flip-flops.

Following an introductory text section on the use of transistorized devices in all types of electronic circuitry, the material is divided into 16 sections covering actual schematics and circuit applications. Each section contains a general introduction which discusses that specific class of circuits, plus from 6 to 27 individual circuit descriptions.

In all cases the parts values are included on the circuit diagrams to facilitate construction.

"101 MORE WAYS TO USE YOUR VOM AND VTVM" by Robert G. Middleton. Published by *Howard W. Sams & Co., Inc.*, Indianapolis. 123 pages. Price \$2.50. Soft cover.

Here is a completely new series of hints for using v.o.m.'s and v.t.v.m.'s presented in the same format as this author's earlier volume covering these same test instruments. The suggested applications in this book fall into one of six categories: testing household devices, special uses, test-equipment checks, circuit tests, component tests, and miscellaneous tests.

As was the case with the prior edition, instructions are included for hookup connections required, equipment needed, and proper test procedures. Typical test results are discussed and supplementary notes provided.

"MAGNETIC AMPLIFIER ANALYSIS" by David L. Lafuze. Published by *John Wiley & Sons, Inc.*, New York. 248 pages. Price \$9.75.

The volume, written by an engineer in the Specialty Control Department at *General Electric*, covers both half-wave and full-wave amplifiers and develops a systematic procedure for analyzing magnetic amplifier circuits in general. His treatment of magnetic amplifier analysis involves the equivalent circuit and the block diagram of servo theory. The book also includes simple relationships for calculating amplifier performance from basic core properties and treats transient function generation.

"WORLD RADIO-TV HANDBOOK" edited and published by O. Lund Johansen, Denmark. 228 pages. Price \$3.00. Soft cover. Available in the U.S. from *Gilfer Associates*, Box 239, Park Ridge, N.J.

This is the 16th Edition of this deservedly popular handbook for SWL's and DX fans. Like the previous editions, this volume lists all international short-wave broadcasting stations with full data on schedules, programs, frequencies, personalities, interval signals, etc.

In addition to 175 pages of information on international short-wave broadcasts, this volume carries articles on standard-frequency and time-signal stations, broadcasts in Esperanto, religious broadcasts, plus a comprehensive section on television stations through the world, including frequencies, programs, etc.

Confirmed dial twirlers wouldn't be without this Handbook and newcomers to the field will soon discover a copy essential to their hobby.

"SERVICING TRANSISTOR RADIOS" compiled by Sams Staff. Published by *Howard W. Sams & Co., Inc.*, Indianapolis. 160 pages. Price \$2.95. Soft cover.

This is the tenth volume in a continuing series which covers the servicing of transistor radios produced by 24 manufacturers during 1960. Some 57 models are included in this volume.

Like the other books in the series, this volume features the company's "Photo-fact" notation schematics, dial-cord stringing arrangements, cabinet and chassis photos, alignment instructions, parts lists, and replacement data. In addition, the firm's "CircuitTrace" fea-



ture has been included to facilitate printed-circuit troubleshooting. A cumulative index covering all ten volumes is appended.

**"MOST-OFTEN-NEEDED 1962 RADIO DIAGRAMS AND SERVICE INFORMATION"** compiled by M. N. Beitman. Published by *Supreme Publications*, Highland Park, Illinois.

This is the most recent release in this publisher's series of service manuals and covers both tube and transistor radio receivers from some 24 manufacturers.

As is the case with all of these manuals, each model or chassis type is represented by a schematic diagram, alignment data, special service notes and hints, a parts list, and various replacement data.

**"RADIO CONTROL HANDBOOK"** by Howard G. McEntee. Published by *Gernsback Library, Inc.*, New York. 300 pages. Price \$4.95. Soft cover.

This is a completely revised, enlarged, and up-dated edition of a work which originally appeared in 1954 and went through eight printings. Like the original edition, emphasis has been placed on the practical how-to-do it aspects of the subject. Included are construction details and circuits for a variety of radio-control applications. The author provides complete data on receivers, transmitters, servos, pulsers, escapements, controls, relays, in addition to installation, adjustment, and testing tips.

The text is lavishly illustrated with schematics, line drawings, and photos of both home-built and commercial R/C units.

**"ABC'S OF ELECTRONIC ORGANS"** by Norman H. Crowhurst. Published by *Howard W. Sams & Co., Inc.*, Indianapolis. 94 pages. Price \$1.95. Soft cover.

This handbook is designed for the layman who wants guidance in the selection of an electronic organ. The author discusses fundamentals and mechanics of playing, circuitry, maintenance, and troubleshooting of commercial units. Many photos and a glossary are included. ▲

## December Production Puts 1961

### Radio-TV Output Ahead of 1960

A SPURT in radio production in December moved the 12-month total for last year 247,328 sets ahead of output during 1960. A relatively good final month for television boosted 1961's production total 469,451 units above the previous year's, according to statistics released by the Electronic Industries Association.

The December output of 1,345,206 radios was the second highest monthly total for 1961 and brought year-end production to 17,373,846. In 1960, 17,126,518 sets were produced.

Production of 580,262 TV receivers in December raised total output last year to 6,177,797, against 5,708,316 in 1960.

During 1961, a total of 6,177,797 television sets were made of which 370,977 were equipped with u.h.f. tuners. Of the 17,373,846 radio receivers produced, 5,568,315 were auto sets, and 915,297 were FM radios. The TV sets equipped with u.h.f. tuners in 1960 were 428,527 while 1961 auto radio production topped 1960 by 863,867 sets. FM radios in 1961 were ahead by 915,297 to 901,766.

In the audio category, 1960 was a better year for both mono and stereo set sales. Last year 1,088,131 mono sets were made as against 1,183,608 in 1960 while the stereo figures were 2,900,249 versus 3,339,777 in the previous year.

Sales of television picture tubes, however, exceeded those of 1960 by a comfortable but not spectacular margin, while 1961 sales of receiving tubes dropped abruptly under the total for the previous year. The totals for TV picture tubes in dollars and units were: \$185,553,642 for 9,306,927 tubes in 1961 as against \$180,832,121 representing 9,013,671 tubes in 1960. The receiving tube picture is reversed with 375,006,000 tubes valued at \$311,098,000 in 1961 as against 393,055,000 valued at \$331,742,000 in 1960. ▲

May, 1962

A vest-pocket partner of thousands of engineers, the basic STETHOTRACER, an electronic high gain (1000x) signal tracer, extends its use with 7 all-new detachable wide range probes! Replacing cumbersome test equipment, this reliable and highly accurate transistorized STETHOTRACER is ideal for probing hard-to-reach areas in hydraulics, ultrasonics, chemical, acoustics and mechanical applications. Examine these handy new, precision-built attachments —

1. **MICROWAVE DEMODULATOR** — Detects, demodulates any modulated frequency signals from 300 MC up to 10 KMC.
2. **MAGNETIC TAPE HEAD (MONAURAL)** — Monitors recorded information of magnetic sheet or tape in motion — from simplest to most sophisticated magnetic tape recording devices.
3. **VIBRATION PICKUP** — Detects minute mechanical vibrations such as ticking of watch, flow of gases and liquids through pipes, and movement of bearings, shafts, etc. Range from 200 cycles through ultrasonic frequencies (oscilloscope and output adapter required for observation).
4. **MINIATURE MICROPHONE** — Frequencies cover speech range. Rugged, miniature, dynamic microphone may be used with STETHOTRACER as hearing aid. Handy for acoustical measurement.
5. **INPUT ADAPTER** — Connects STETHOTRACER to output of any device through any standard miniature phono pin plug.
6. **OUTPUT ADAPTER** — Connects STETHOTRACER to oscilloscope or recording instrument for accurate output measurement. Provides 600 ohms impedance with DC level of 0.80 volts (use AC input on scope). Excellent high gain (1000) preamplifier.
7. **TELEPHONE PICKUP** — Pickup attaches to receiver end of telephone by rubber suction cup. Used with input adapter.



See your local distributor or write for details to:

**Don Bosco**  
ELECTRONICS INC.  
Littell Road • Hanover, N. J. • TUCKER 7-5575

A Subsidiary of Howell Electric Motors Company



**NOW  
YOU CAN BUILD  
A FINE  
Schober Organ  
FOR ONLY  
\$550**

You can assemble this new Schober Spinet Organ for \$550 — or half the cost of comparable instruments you have seen in stores. The job is simplicity itself because clear, detailed step-by-step instructions tell you exactly what to do. And you can assemble it in as little as 50 hours.

You will experience the thrill and satisfaction of watching a beautiful musical instrument take shape under your hands. The new Schober Electronic Spinet sounds just like a big concert-size organ — with two keyboards, thirteen pedals and magnificent pipe organ tone. Yet it's small enough (only 38 inches wide) to fit into the most limited living space.

You can learn to play your spinet with astounding ease. From the very first day you will transform simple tunes into deeply satisfying musical experiences. Then, for the rest of your life, you will realize one of life's rarest pleasures — the joy of creating your own music.

For free details on all Schober Organs, mail the coupon now. No salesman will call.

**THE Schober Organ CORPORATION**

43 West 61st Street, New York 23, N. Y.  
Also available in Canada and Australia.

**MAIL THIS COUPON TODAY**

The Schober Organ Corporation  
Dept. RN-18  
43 West 61st Street  
New York 23, New York

Please send me FREE booklet and other literature on the Schober Organs.

Please send me the Hi-Fi demonstration record. I enclose \$2 which is refundable when I order my first kit.

Name.....  
Address.....  
City..... Zone.. State.....



**T**HE THREAT of food supermarket plans involving TV receivers and other major appliances appears to be just about over. At least three of the major "instant-dividend" plans have folded, just as independent dealers were bracing themselves for a tough fight against a serious menace, or what seemed to be one. Despite the many superficial attractions offered by such merchandising schemes, we felt that, like stamp plans (see this column, page 91, March 1962), there was an important, built-in limitation: the amount of money people spend for food. Sure enough, the various reasons given for disappointment in the plans add up to one factor: not enough merchandise was being moved.

Most attractive feature of the plans was that the customer, instead of waiting interminably to earn his merchandise (as after having saved many thousands of stamps), could get his TV or other appliance right away and earn it later. Actually, he was buying on the installment plan with one difference: A part of his purchases in the participating supermarket (usually 5.5 per-cent of what he spent in one month) was credited to his monthly payment. With a great deal of luck and management, he could wind up paying little and perhaps even nothing for the appliance, out of pocket.

A spokesman for one appliance manufacturer said the plan was not producing enough of a sales increase to offset its cost. One disillusioned food chain felt that, although the plan may have improved business somewhat, the same amount of money spent on other promotions would have been more effective.

It seems none of the principals — whether food chain, manufacturer, or participating dealer — realized much benefit from the merchandising brainstorm, but some may have been hurt by it. While the instigators seem eager to have everyone forget the whole thing, angry dealers are not likely to close the matter so quickly — especially those who have stopped handling the lines of participating manufacturers. The plans may persist on a short-term basis for a while, on a reduced scale, before they peter out entirely, but the backbone of the gimmick has been broken. For once, those involved in TV sales and service have not had to wage a major campaign. Common-sense economic laws did the job.

**Tube-Sales Dilemma Again**

Writing in "NATESA Scope," executive director Frank J. Moch comes up with some sharp observations on the matter of tube sales through non-electronic outlets. His analysis goes into two major questions: "To what extent

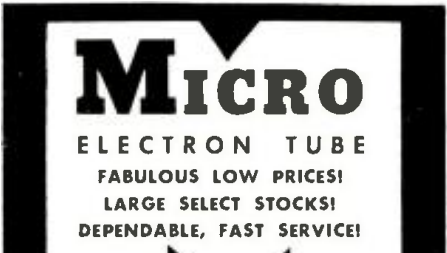

**FABULOUS LOW PRICES!  
LARGE SELECT STOCKS!  
DEPENDABLE, FAST SERVICE!**

- Each and every tube is tested in our own laboratory for mutual conductance and life test.
- We guarantee FREE replacement for one year of any tube purchased from us which fails to function efficiently under any or all operating conditions. Prompt refunds are made on any defective merchandise.
- The advertised tubes are not necessarily new, but may be electrically perfect factory seconds or used tubes — each is clearly so marked.

**37¢ ea. \$35 PER HUNDRED ASSTD.**

0A2	6X8	6BM6	6SP5	7Z4	19R28D
0Z4	6V30T	6BR8	6NF7	12A8	19J6
1A7GT	6Y40	6DM5	6H7	12AG5	19J0
1B3GT	6A7	6M7	6SR7	12AT6	2A
1H40	6H8	6BL7GT	6SL7GT	12AY7	25AV5
1A5GT	6H4	6NE	6HWOT	12A06	25008
1L6	6AC7	6RQ6GT	6SQ7	12AU6	250N6
1L6	6AP4	6B7	6S87	12AV6	25L6GT
1A5GT	6A5	6Y5GT	6T4	12AV7	25W6GT
1Q5GT	6A3	6B2	6T8	12AX4GT	25Z5
1R5	6AN4GT	6B2	6U8	12AX7	27Z6
1S5	6AM6	6C4	6V6	12AZ7	36
1T4	6A5	6C5	6W6GT	12B4	35A5
1U4	6AL5	6C8	6W6GT	12B6	35B5
1U5	6AL7	6C8	6X4	12BA7	35C5
1V2	6AN8	6C6GT	6X5	12BE6	35L6GT
1R2	6AR8	6CF8	6X8	12BF6	35W6
2A3	6A5	6C7	6Y6GT	12BH7	35Y4
2A4A	6A8	6CL8	7A6/XXL	12BQ6	35Z5GT
3BC5	6AQ7GT	6CM6	7A5	12BR7	37
3BM6	6A15	6CN7	7A6	12BT7	38/44
3BZ6	6A5	6CN7	7A7	12CA5	42
3CB6	6A76	6CR8	7A8	12J5	43
3CF6	6A78	6C18	7B4	12J7	45
3C8	6AL4GT	6C6	7B5	12L5	30A5
3F4	6A15GT	6C8	7B6	12Q7	30B5
3Q4	6A8	6F6	7HT	12SA7	50C5
3R8	6A18	6H6	7B8	12S07	50L6GT
3Y8	6AL5GT	6J4	7C4	12S7	60X6
4BQ7A	6A6	6J5	7C5	12SK7	50
4BZ7	6A8	6J7	7C6	12SN7GT	57
5A8	6A14GT	6K6GT	7C7	12T7	58
5A78	6A15GT	6K7	7E6	12V6GT	71A
5A8	6B8	6K8	7E7	12W6GT	78
5A74	6B4	6L7	7F6	12X4	76
5BK7	6B5	6M7	7F8	12Z3	78
5C6	6B8	6O7	7HT	14A7/12B7	78
5R8	6B6	6S8	7NY	14B6	80
5U6	6B6	6SQ7	7NY	14Q7	84/82A
5Y6	6B6	6A7	7NY/XXFM	19	11Z73
5V6GT	6B6GT	6SC7	7Y4	19AU4GT	11Z76

SEND FOR OUR FREE COMPLETE LIST OF TUBES & SPECIAL PURPOSE TUBES

ALL TUBES SENT POSTAGE PAID. Please send 25c handling for orders under \$5. Send 25¢ deposit on C.O.D. orders. Send approximate postage on Canadian and foreign orders.

**MICRO ELECTRON TUBE CO.**  
P.O. Box 55 Park Station, Paterson 3, N. J.

GET INTO **ELECTRONICS**



V.T.I. training leads to success as technicians, field engineers, specialists in communications, guided missiles, computers, radar and automation. Basic & advanced courses in theory & laboratory. Electronic Engineering Technology an ECPD accredited Technical Institute curriculum. Assoc. degree in 29 mos. B.S. also obtainable. G.I. approved. Graduates in all branches of electronics with major companies. Start Sept., Feb. Dorms, campus. High school graduate or equivalent. Write for catalog.

**VALPARAISO TECHNICAL INSTITUTE**  
Dept. RD, Valparaiso, Indiana

has the service dealer actually been hurt by this phenomenon?" and "What can be done to correct the damage?"

On the first point, he begins with available figures and estimates and tries to determine how much the average shop has lost. About \$25 million in tube sales are being handled annually by do-it-yourself tester operations in food, drug, liquor, and supermarket stores. He estimates at least as much is being handled by wholesale-to-everyone outlets and several million more by fringe "TV service" operations that are fundamentally tube test-and-sales plans, either in shops or on a home-call basis. All in all, he feels, this means about \$60 million per year in tube sales that are *not* going to the legitimate service industry. Broken down, even the small, one-man shop would be losing a few thousand dollars in annual gross and a couple of thousand or more in net income. This startling statistic could mean the difference between success and failure to many dealers, and must certainly constitute a great difference in the profit picture to all.

As to the second question, Moch evaluates the frequently argued matter of tube mark-ups. If service dealers reduce their presently high profit margins on tubes, it is often stated, the drug stores will not be able to compete economically. On the other hand, it is argued that such a reduction will enable the service dealer to sell more tubes without making more profit. Still worse, the dealer will be further victimized by his historical blunder—that of failing to charge enough for his labor, relying on the profits from tubes (and other parts) to make up the difference.

Moch acknowledges that there is something wrong, in theory, when dealers "have been subsidizing their ridiculous labor fees" with profit on sales. But he also knows that, in practice, an instantaneous change in policy is simply unworkable. He therefore suggests a new concept: dual pricing of tubes. The present list prices could be maintained for tubes sold in the normal course of rendering service, where the dealer is involved in such responsibilities as fault-finding, installation, and warranties. A second price schedule could be in force for direct, over-the-counter sales to the consumer, with no service rendered and no responsibility for exchange or warranty involved.

The consumer, of course, will balk at the higher price when he knows a lower one exists. Yet he also knows that, when it comes to auto repair, home repair, or any similar field, he pays one price for material if he undertakes the work himself but a higher price, in addition to labor, if he calls in a service contractor or repairman. Most important, Moch points out, this concept can only be put over if it is attempted on a national scale with the solid support that will be needed from tube manufacturers and suppliers in establishing the dual price list and educating the public. After this is done, the continuing job of getting labor fees up to where they should be will become that much easier. ▲



**STOCK**—Hang it on the wall, stand it on a shelf, slip it into your caddy. Cartridge model number is always visible for quick identification.

**SAVE**—Save money on purchase of any 6 SONOTONE cartridges—save time by always having the right replacements.

**SERVICE**—You always have the right replacement to service virtually every record player on the market.

**SELL**—In your shop, an eye-compelling display (unique bonnet fits over 6-Pak to remind your walk-in customers to modernize their record players). In your caddy—a variety of cartridges for nearly every replacement.

Every time you buy 6 SONOTONE cartridges from your distributor, they come in the new attractive 6-Pak cartridge sleeve. You can select any 6 SONOTONE cartridges, or one of three pre-selected 6-Paks which include the most needed cartridges for the most often faced replacement situations.

- **STEREO 6-PAK**—covers nearly every stereo replacement or conversion. Six stereo cartridges from the audiophile's favorite, the 9T, to the budget-priced stereo crystal cartridge, the 12T. Consists of models: 9T, 8T-A, 16T, 18T, 10T and 12T.

- **STEREO/MONO 6-PAK**—covers most stereo or mono replacement needs. Consists of 3 stereo ceramics models 8T-A, 9T, 16T; and 3 mono ceramics: 1P, 2T, 3T.

- **MONOPHONIC 6-PAK**—covers virtually all most called for monophonic replacements. "LB" denotes "less bracket" for slim tonearms. Consists of; 1P, two 2T's, 2T-LB, 3T and 3T-LB.

The 6-Pak is just another way that SONOTONE simplifies your inventory and makes it easier to sell cartridges. Order a SONOTONE 6-Pak today at your parts distributor.

**FREE:** The new SONOTONE cartridge cross-reference chart catalog is available at your distributor, or write: Dept. EW-5.

**SONOTONE® CORPORATION** ELMSFORD, NEW YORK  
ELECTRONIC APPLICATIONS DIVISION In Canada: Atlas Radio Corp., Ltd. Toronto  
Cartridges • Speakers • Tape Heads • Mikes • Electronic Tubes • Batteries • Hearing Aids

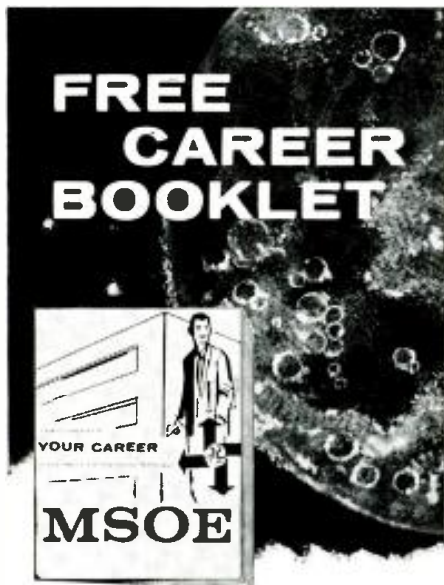

to guide you  
to a  
successful future  
in

## ELECTRONICS RADIO-TV COMPUTERS ELECTRICAL ENGINEERING

This interesting pictorial booklet tells you how you can prepare for a dynamic career as an Electrical Engineer or Engineering Technician in many exciting, growing fields:

**MISSILES • RADAR • RESEARCH  
ELECTRICAL POWER • ROCKETRY  
AUTOMATION • AVIONICS  
SALES • DEVELOPMENT**

Get all the facts about job opportunities, length of study, courses offered, degrees you can earn, scholarships, part-time work — as well as pictures of the Milwaukee School of Engineering's educational and recreational facilities. No obligation — it's yours free.

### MILWAUKEE SCHOOL OF ENGINEERING

#### MAIL COUPON TODAY!

**MILWAUKEE SCHOOL OF ENGINEERING**  
Dept. EW-562, 1025 N. Milwaukee St.  
Milwaukee, Wisconsin MS-113

Please send FREE "Your Career" booklet  
I'm interested in  Electronics  Radio-TV  
 Computers  Electrical Engineering  
 Mechanical Engineering  
(PLEASE PRINT)

Name.....Age.....

Address.....

City.....Zone.....State.....

I'm eligible for veterans education benefits.

Discharge date.....

Sun	Mon	Tue	Wed	Thu	Fri	Sat
		1	2	3	4	5
					11	12
					18	19
					25	26

## CALENDAR of EVENTS

### APRIL 25-29

Western Space Age Industries and Engineering Exposition & Conference. Cow Palace, San Francisco. Information from Lykke-Wilkins & Assoc., 681 Market St., San Francisco 5, Calif.

### APRIL 29-MAY 4

91st Convention SMPTE. Sponsored by Society of Motion Picture and Television Engineers. "Advances in Color Motion Pictures and Color Television." Ambassador Hotel, Los Angeles. Details from SMPTE at 55 W. 42nd St., New York 36, N.Y.

### MAY 1-3

Ninth Annual Cleveland Electronics Conference. Sponsored by IRE, AIEE, ISA, Case Institute of Technology, Western Reserve University, Cleveland Physics Society. Engineering & Scientific Center, Cleveland, Ohio. Program details from Lapine Enterprises, 310 Hotel Manger, Cleveland 14, Ohio.

### MAY 2-5

13th National Science Fair-International. Sponsored by Science Service. Seattle, Washington. Details from Science Service, 1719 N. Street N.W., Washington 6, D.C.

### MAY 3-4

International Congress on Human Factors in Electronics. Sponsored by the Los Angeles Chapter of PGHFE of IRE. Lafayette Hotel, Long Beach, Calif. Details from Dr. Charles Hopkins, Symposium Chairman, Hughes Aircraft Co., Culver City, Calif.

### MAY 8-10

1962 Electronic Components Conference. Sponsored by AIEE, EIA, and IRE. Morriott Twin Bridges Motor Hotel, Washington, D.C.

### MAY 14-16

Fourteenth Annual National Aerospace Electronics Conference. Sponsored by Dayton Section of IRE and PGANE. Dayton Billmore Hotel and Memorial Hall, Dayton, Ohio. Details from IRE, 1 E. 79th St., New York 21, N.Y.

### MAY 15-17

Fourth Annual Meeting of Council on Medical TV & Medical-Dental TV Workshop. Sponsored by

the Council on Medical Television, Clinical Center, National Institutes of Health, Bethesda, Md. and National Naval Medical Center, Bethesda. Details from Institute for Advancement of Medical Communication, 33 E. 68th St., New York 21.

### MAY 21-24

1962 Electronic Parts Distributors Show. Sponsored by EP&EM, EIA, PACE, WEMA, and ERA. Conrad Hilton Hotel, Chicago. Open only to qualified industry members.

### MAY 22-24

National Microwave Theory & Techniques Symposium. Sponsored by PGMITT of IRE. Boulder Laboratories of National Bureau of Standards, Boulder, Colorado.

### MAY 23-25

11th National Telemetering Conference. Sponsored by ISA, ARS, IAS, AIEE, IRE. Sheraton-Park Hotel, Washington, D.C.

### MAY 24-26

Seventh Region Conference. Sponsored by the Seattle Section of IRE. "Space Communications." Seattle, Washington. Program information from IRE, 1 E. 79th St., New York 21, N.Y.

### MAY 31-JUNE 7

International Television Conference. Sponsored by Electronics and Communications Section of the Institution of Electrical Engineers. Institution Bldg., Savoy Place, London W.C. 2, England.

### JUNE 11-15

Technical Writers' Institute. Rensselaer Polytechnic Institute, Troy, N.Y. Information on course from Prof. Jay R. Gould, RPI, Troy, N.Y.

### JUNE 24-28

Music Industry Trade Show. Sponsored by the National Association of Music Merchants. Hotel New Yorker, New York City.

### JUNE 25-30

Symposium on Electromagnetic Theory and Antennas. Sponsored by the IRE. The Technical University of Denmark, Copenhagen. Information from IRE, 1 E. 79th St., New York 21, N.Y. ▲

### INVITATION TO AUTHORS

Just as a reminder, the Editors of *ELECTRONICS WORLD* are always interested in obtaining outstanding manuscripts, for publication in this magazine, of interest to technicians in industry, radio, and television. Articles covering design, servicing, maintenance, and operation are especially welcome. Articles on Citizens Band, audio, hi-fi, and amateur radio are also needed. Such articles in manuscript form may be submitted for immediate de-

cision or projected articles can be outlined in a letter in which case the writer will be advised promptly as to the suitability of the topic. We can also use short "filler" items outlining worthwhile shortcuts that have made your servicing chores easier. This magazine pays for articles on acceptance. Send all manuscripts or your letters of suggestion to the Editor, *ELECTRONICS WORLD*, One Park Avenue, New York City 16, New York.



This is Sony

THE MOST COMPLETE LINE OF QUALITY TAPE RECORDING EQUIPMENT IN THE WORLD

▪ **SONY Stereo Tape Deck 262-D**—4 & 2 track stereo recording and playback tape transport to add tape to your existing hi fi system. \$89.50. (Also available, not pictured, the new SRA-2 stereo recording amplifier for the 262 D. \$89.50.) ▪ **SONY Stereorecorder 777**—All transistorized professional stereo recorder featuring exclusive Sony Electro Bi-Lateral 4 & 2 track playback head. World's finest tape recorder. \$595. ▪ **SONY Stereorecorder 300**—A complete professional-quality hi fi stereo tape system with 4 & 2 track recording and playback in one portable unit. \$399.50. ▪ **SONY Portable 101**—2 speed, dual-track, hi-fidelity recorder with 7" reel capacity. \$99.50. ▪ **SONY Stereorecorder 464-D**—Dual performance 4 track stereo tape deck with built-in recording & playback pre-amps for custom installations and portable use. \$199.50. ▪ **SONY Wireless Microphone CR-4**

—Pocket size mike and transmitter providing complete freedom from entangling microphone cables. \$250. ▪ **SONY Condenser Microphone C-37 A**—For purity of sound reproduction, the unqualified choice of professional studios throughout the world. \$295. ▪ **SONY Sound on Sound Recorder 262 SL**—The perfect recorder for language, music and drama students. With 4 track stereo playback. \$199.50. ▪ **SONY Tape recorder 111**—A popularly priced, high quality bantam recorder for everyday family fun. \$79.50. ▪ **SONY Condenser Microphone C-17 B**—Miniature size (3¼" x ¾" diameter) and exceptional background isolation unidirectional cardioid pattern. \$350. ▪ **SONY Newscaster Portable EM-1**—A professional on-the-spot battery powered portable recorder with precision spring wind constant speed motor. \$495. *All Sony Stereorecorders are Multiplex ready!*

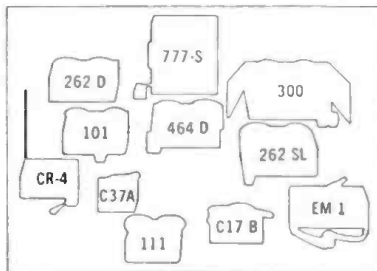

For additional literature and name of nearest franchised dealer write Superscope, Inc., Dept. M Sun Valley, California

**SUPERSCOPE** The Tapeway to Stereo



# DIGITAL COUNTERS and COMPUTERS

... an easily understood guide to theory, design and application including the interpretation and use of their output

Invaluable for technicians, students, and experimenters alike, this new, fully-illustrated 248-page book explains the "mysteries" of modern computer technology in clear, easily understood terms.

Actually, the complexity of computers is not because of any highly involved circuitry, but largely because so many circuits are needed to perform the necessary functions. Once a relatively few circuit configurations have become clear, you will have gone far toward understanding digital circuits, theory and operation in general! Written by an acknowledged expert, Ed Bukstein, Instructor in Advanced Electronics, Northwestern Television and Electronics Institute, the book contains much material never before published in book form.

## HERE ARE FULL DETAILS ON . . .

- Number systems - Binary counters - Readout indicators and special counter tubes - Decade counters - Storage devices - Computer control - Logic circuits - Input-output devices - Computer applications . . . and related subjects.

DIGITAL COUNTERS and COMPUTERS approaches computer technology first from the subject of electronic circuitry. Included are remarkably clear explanations of the basic "flip-flop," logic and switching circuits. Once these features have been thoroughly clarified, the book then explains the number theories and counting systems by which computers perform their work.

Subsequent chapters deal with the "readout" devices which translate a computer's results into usable form, memory equipment and all the other technical details so puzzling to those who have not made a particular study of computer development. A special section deals with the frequently discussed topic of digital-to-analog and analog-to-digital conversion.

623900

Dept. RN 52  
**HOLT, RINEHART and WINSTON**  
 P.O. Box 2334, Grand Central Station  
 New York 17, New York

Send Ed Bukstein's 248-page DIGITAL COUNTERS and COMPUTERS book (708131) for 10-day Free Examination. In 10 days, I will either send you \$8.75 (plus postage) in full payment or return book postpaid and owe you nothing.  
**SAVE!** Send \$8.75 with order and we pay postage. Same 10-day return privilege with money refunded.

Name \_\_\_\_\_  
 Address \_\_\_\_\_  
 City, Zone, State \_\_\_\_\_

OUTSIDE U.S.A.—Price \$9.25 cash with order.  
 10-day return privilege with money refunded.  
 Offer expires Dec. 31

## Dynamic Transistor Bridge

(Continued from page 53)

completes the calibration procedure.

### Using the Tester

Through the front-panel jacks, connect an appropriate indicator as the null detector. Set  $R_2$  to the desired test current and switch  $S_2$  to the *n-p-n* or *p-n-p* position to match the transistor.  $S_1$  is set to whichever test is desired. The transistor is then inserted in the test socket and  $R_2$  is simply varied until a null is obtained. The value of  $h_{fe}$  may

ever, power transistors can be checked fairly well, especially for *beta*. The 4 ma. of current is enough to bring a power transistor, for the most part, into its operating region.

If a transistor gives no null at all or fails to give a sharp null, the indication is that it is defective. However further checking, particularly for leakage current, is advisable. Absence of a sharp null may simply be an indication of extreme non-linearity.

While the instrument is very satisfactory as a transistor tester, its primary use by the author is to assist in designing transistor circuits. For those who will want to use it in like manner,

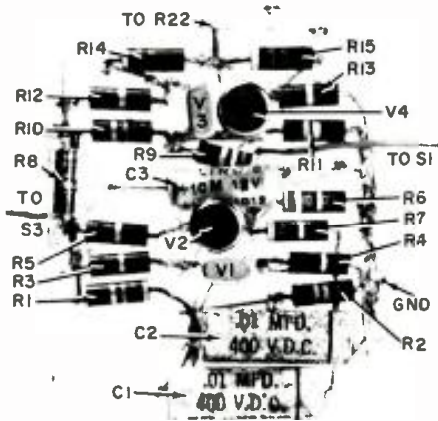

Fig. 7. Circuits for developing test signal are on this polystyrene board.

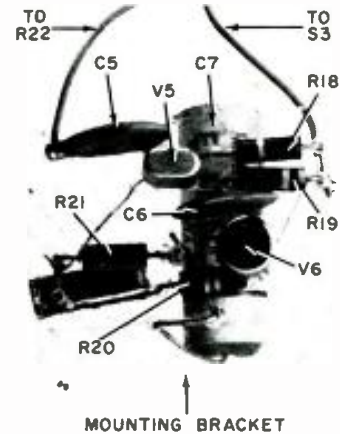

Fig. 8. A second board carries components for the null-detector amplifier.

now be read directly from the scale for  $R_2$ . The value of  $h_{fe}$  in ohms is obtained by multiplying the scale reading by 100.

Since the maximum current to which any transistor can be subjected is 4 ma. and the maximum test potentials are low, it is virtually impossible to damage a transistor at any setting of any control. Conversely, the tester itself will not be damaged by any test transistor, good or bad, or by any other passive connection made to it.

The unit was primarily devised for testing small-signal transistors. How-

the readings can be converted to provide other characteristics the user might want to know in various applications. Approximate grounded-emitter input impedance,  $Z_{in}$  is  $h_{ie} / h_{fe} R_L$ , where  $R_L$  is the unbypassed portion of any emitter resistance. Approximate grounded-collector input impedance,  $Z_{in}$  is  $h_{ie} + h_{fe} R_L$ , where  $R_L$  is the load resistance. Approximate grounded-collector output impedance,  $Z_{out}$  is  $(h_{ie} + Z_s) / h_{fe}$ , where  $Z_s$  is the source impedance. Approximate grounded-base input impedance,  $Z_{in}$  is simply  $h_{ie}$ . ▲

Fig. 9. Rear view shows two boards in place and wiring to components on front panel.

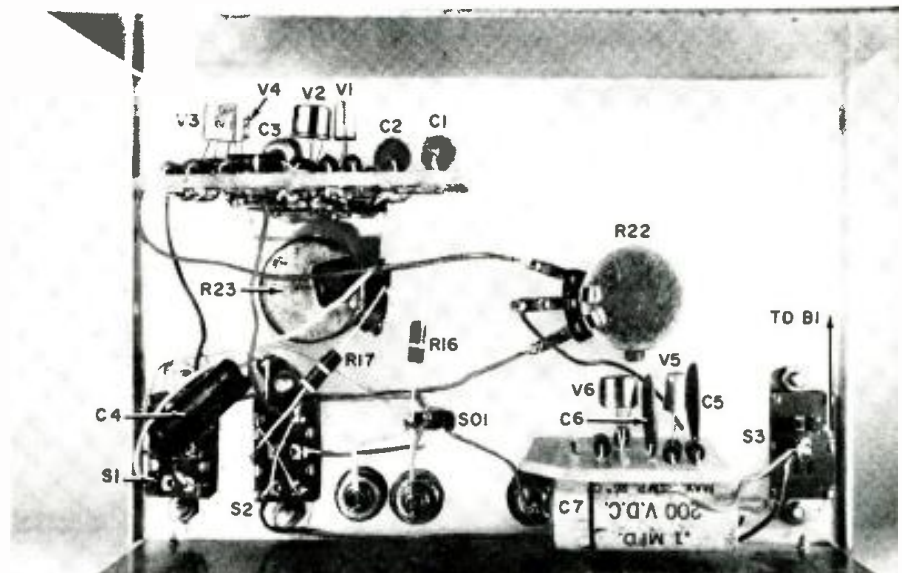

# Golden Anniversary of Ham Licensing to Honor Old Timers

**A**MATEUR radio operators who were first licensed in 1912 and who are still active today will be honored at a Golden Anniversary Banquet to be held in New York City on October 13, 1962 to celebrate 50 years of ham radio.

Fifty years ago Congress adopted the Radio Act of 1912, bringing order to the then-new but rapidly expanding art and science of wireless or radio communication. As one of its features, the Act required for the first time that amateur radio operators obtain a license from the Department of Commerce and Labor after passing an examination. The Secretary of Commerce and Labor at that time was Mr. Charles Nagel, who signed the first licenses.

The celebration of the Golden Anniversary of Amateur Radio Licensing is being handled by a special Committee comprising representatives of a number of sponsoring societies including the American Radio Relay League, Armed Forces Communications and Electronics Association, the IRE, Quarter Century Wireless Association, Radio Club of America, Hudson Amateur Radio Council, and the Single Sideband Amateur Radio Association.

Officers of the sponsoring committee include John DiBlasi, chairman, who is also president of the Quarter Century Wireless Association; John Huntoon, vice-chairman and general manager of the ARRL; and David Talley, secretary-treasurer, who is a member of all of the sponsoring societies.

A search is now in progress to locate those who obtained their ham "tickets" during the initial months of licensing in 1912 and are currently licensed by the FCC as amateur radio operators. Old-time hams who meet the requirements of the award should send documentary proof of eligibility to the ARRL, West Hartford, Conn., attention John Huntoon, before August 15th.

The award will be presented in person to those able to attend the Golden Anniversary Banquet which will be held in conjunction with the Hudson Division Convention of the ARRL at the Statler-Hilton Hotel, New York City, on October 13, 1962.

According to the Committee, in cases where the original 1912 license has been lost or destroyed, the listing of the ham's name and amateur station call letters in the July 1, 1913 edition of the government callbook, "Radio Stations of the United States," may be considered as satisfactory proof. ▲



**this Fisher Multiplex Adapter works with any brand of FM equipment**

Now everyone can enjoy FM Stereo with the only truly universal (and, you might say, impartial) Multiplex Adapter. Only the Fisher MPX-100 will convert to FM Stereo Multiplex operation any FM tuner or receiver ever made, regardless of age, brand or model.

What's more, the Fisher Universal MPX-100 recognizes FM Stereo Multiplex programs automatically with its 'electronic brain,' the exclusive Fisher Stereo Beacon. Whenever the FM station you have selected is broadcasting in stereo, the Stereo Beacon lights a signal and switches the equipment automatically from regular to stereo operation. This ingenious Fisher invention makes Multiplex a pleasure, not a problem. Price, less cabinet, \$119.50\*.

FREE! Write for 1962 Fisher Handbook—a 40-page illustrated guide and component catalogue for custom stereo installations.

**Fisher Radio Corporation**  
21-38 44th Drive  
Long Island City, N.Y.

Please send free 40-page Handbook, with complete specifications on the MPX-100.

Name \_\_\_\_\_

Address \_\_\_\_\_

City \_\_\_\_\_ Zone \_\_\_\_\_ State \_\_\_\_\_

EW506

\*SLIGHTLY HIGHER IN THE FAR WEST.

New Seco Model 88 Tube Tester is guaranteed against obsolescence. Gives you patented Seco GRID CIRCUIT, also CATHODE EMISSION tests — tests over 2,200 tube types including Nuvistors, Novars, Compac-trons, new 10-pin types and battery types. You also get:

- A check for troublesome grid emission and all common leakage and short faults in one operation. READ ON METER.
- A cathode emission test in special low impedance circuit.
- A burnout-proof meter employing a VTVM amplifying circuit.
- Few controls — simple operation — compact, lightweight size.
- Convenient fast-find setup information in cover.
- A check for filament continuity and open elements.

For full information write or send coupon below to Seco, originator of the famous Grid Circuit Test.

SECO ELECTRONICS, INC.  
5037 Penn Ave. So., Minneapolis 19, Minn.  
Please send free  Model 88 Information  "How to Test Tubes"

NAME \_\_\_\_\_

ADDRESS \_\_\_\_\_

CITY \_\_\_\_\_ STATE \_\_\_\_\_



**34¢** EACH  
**\$32** Per 100 TUBES

**ELECTRONIC MARKET**  
**1 YEAR**  
**GUARANTEED**  
**RADIO-TV TUBES**

All tubes not necessarily new, but may be electronically perfect factory 2nds or used. Each clearly marked. ELECTRONIC MARKET will replace FREE any tube that becomes defective in use within 1 year from date of purchase. All tubes individually boxed and marked. Partial Listing Only — Thousands More Tubes in Stock

074	5AV0	6AS5GT	6C90	6SR7	12BH6
1A7GT	5AZ4	6B8	6EL6	6SL7	12B06
1B3GT	5C50	6BA6	6C90	6SR7	12B05
1M5GT	5R8	6BC5	6C90	6T4	12B04
155	5T8	6AC8	6C90	6T8	12B08
174	5U4	6BD6	6C90	6U5	12B05
1U5	5UB	6BE6	6C90	6V6GT	12L6
1Y2	5V4G	6BF5	6E17	6V6GT	12L6
1X2	5V6GT	6BG6	6C90	6X4	12X7
2A74	5I8	6B6	6C90	6X5GT	12X5
2B4	5Y3	6B6	6C90	6X5GT	12X5
2C15	6A84	6BR5	6C90	6Y6	12Y7
3AL5	6AH4GT	6BR7	6C90	12AB	12Y7
3BC5	6AN6	6B7GT	6C90	12AB5	12Y7GT
3B6	6AL5	6B8	6C90	12AB5	12Y7
3B76	6AM8	6B86GT	6W6	12AT6	12Y6GT
3BC6	6A86	6B7	6C90	12AV6	12W6GT
354	6A87	6B8	6C90	12AV6	12X4
3V4	6A85	6B58	6R6GT	12AV7	19B4GT
4B07A	6A55	6B75G	6Q7	12B4GT	19B6G6
4B58	6AT6	6B76	6S47	12A27	19B8
4B77	6AU4GT	6B77	6S47	12B4	25B6GT
4C86	6AL5GT	6C4	6SD1GT	12B4	25B6
5A88	6AL6	6CAB	6SF5	12B4	25B5
5A88	6AT5GT	6C86	6S7	12B6	25B5
5A78	6AV6	6C90G	6S7	12B6	25C5
5A78	6AX4GT	6C76	6S7	12B6	25W4

ORDER SHIPPED SAME DAY RECEIVED  
 SHIPPING INSTRUCTIONS: ELECTRONIC MARKET PAYS YOUR POSTAGE on orders of \$10 or more in U.S.A. and Territories. Send approx. postage on Canadian and foreign orders. Any order less than \$10 requires 75¢ handling and postage charge. Send 25% on C.O.D.'s  
 ANY RECEIVER TUBE NOT LISTED ALSO AVAILABLE AT 34¢ EACH!

**25¢ QUANTITY DISCOUNT**  
 When purchasing lots of 50 or more same type tube per tube Applies to tubes below only

6B7	114	12A17	12C85	6J6	50C5
6A14	1R5	6A05	12B06	6K7	6AM8
6A04	654	6C67	12S87	6K7	6A74
6B8	12A07	6C68	12B77	6AC7	6A74
6A09	12A17	6A85	6U8	6W4	6A65

**74¢ SILICON RECTIFIERS**  
 EACH \$49 per 100  
 500 MA - 'TOP MAT' ALL PURPOSE  
 Epoxy construction

**COMPLETE LINE OF INDUSTRIAL TUBES**

ONE OF THE LARGEST INVENTORIES IN THE COUNTRY

**ELECTRONIC MARKET**

3750 E. 10th Ct., Hialeah, Florida  
 Phone: Oxford 1-5331

**Teaching Lab Maintenance**

(Continued from page 48)

cabling and audio cabling in separate conduits. Applicable codes require care in cabling and classroom codes are generally rigid. To avoid ground loops and trouble due to differences in potential among various available grounding points, shielding should be grounded at one point only, preferably at the control-console amplifier grounding point.

Unshielded bias lines to tape recorder heads (especially high-impedance heads) can cause beat notes in adjacent units. Tape-recorder heads are susceptible to a.c. fields generated by amplifier power transformers. Poor placement of amplifiers containing power transformers or replacement of defective transformers with inferior units can cause hum by induction in tape heads. Installation of a.c. power wiring subsequent to laboratory installation by persons unfamiliar with location of audio cabling can also cause hum troubles.

Interchannel interference and crosstalk on dual-channel equipment can be either electrically or mechanically caused. Aging of electrolytic capacitors in power supplies common to two or more amplifiers raises the power-supply output impedance and frequently causes trouble. Check head alignment and pressure-pad adjustments in stubborn cases.

The master console will ordinarily require maintenance on tape players, tape recorder-players, and program and intercom switching equipment. The control console may also contain annunciators and associated holding relays. Special program sources such as record players and radio tuners may be incorporated. Some installations include a separate room equipped for making master tapes.

The proper maintenance of electronic teaching laboratories will do much to increase the effectiveness of these installations and will encourage the further use of electronics in teaching. This maintenance may best be accomplished during the summer season when classes are not in session, and may be used by a capable and enterprising sound man to bolster a "slack" season. Equipment manufacturers are usually very willing to cooperate with local independents to assure satisfactory maintenance and operation of their installations. A technician interested in doing this type of work should contact the manufacturer of the equipment installed in a local laboratory and offer his services. The manufacturer may see the advantages in using local personnel and test equipment in carrying out any service contracts he has assumed. In any event, a school may prefer local service contracts after the expiration of the manufacturer's service contract.

This relatively recent adaptation of sound equipment to supply a tool which increases teaching effectiveness provides new opportunities for the serious technician in our rapidly expanding electronic industry.

**BIG SAVINGS**

FOR YOU!!!

In FAIR'S New Gov't. Surplus Bargains

Spring-Summer

**FREE CATALOG**

HUNDREDS and HUNDREDS of Today's "BEST BUYS"

Fill Out and Mail Handy Coupon Now for Your FREE Copy of CATALOG! Dept. EW

**FAIR RADIO SALES**  
 2133 ELIDA RD. • Box 1105 • LIMA, OHIO

DEPT. EW 62-5  
 Please send copy of FREE Catalog to:

NAME: \_\_\_\_\_  
 ADDRESS: \_\_\_\_\_  
 CITY: \_\_\_\_\_ STATE: \_\_\_\_\_

**ENGINEERING DEGREE IN SCIENCE MATH**  
 27 or 36 MOS.

B.S. degree - 36 mos. • B.E. degree - 27 mos.  
 Accelerated year-round program prepares for early employment in fields of Science and Engineering. Regular 4-year program for B.S. Degree completed in 36 months. special engineering degree program in 27. Classes start - June, July, September, January, March. Quality education. Graduates employed from coast to coast. Government approved for veteran training. Students from 50 states, 40 countries, 20 buildings: dorms, gym, campus. Save time and money. Earn board while studying. Write for catalog and complete information.  
 952 E. Washington Blvd., Fort Wayne 2, Indiana

**INDIANA TECHNICAL COLLEGE**

**MAIL ORDER HI-FI**  
 Recorders Components Tapes  
 at wholesale prices  
 Reliable. Prompt Delivery  
 (Free Catalogue)  
 We'll Air-Mail low quotes on your packaged hi-fi  
**CARSTON Studios**  
 125-TD E. 88 St. New York 28, N.Y.

**DOWN TO EARTH**  
 Everyone's going for Audion's "Down to Earth" Hi-Fi Values.  
 Write for free catalog.  
**audion**  
 25 E. OXFORD ROAD  
 MASSAPEQUA, L.I., N. Y.



# FCC WARNS ON HOME BROADCASTING

Unlicensed operation is allowed only under strict curbs to avoid interference.

THE Federal Communications Commission receives many letters from inexperienced radio-enthusiasts inquiring about the use of a purchased kit or home-assembled equipment to "broadcast" voice and phonograph records to the immediate neighborhood without an FCC license.

The Commission's rules do permit what are called "low-power communication devices" to be operated without a license in the AM broadcast and certain other bands, but under strict curbs to prevent interference to licensed radio services. These rules were established to enable individuals, for their personal convenience primarily, to use wireless telephones, phonograph oscillators, electronic "baby sitters," home communication systems, and to control garage-door openers, model airplanes, etc., provided the operation is extremely limited. These rules were not intended to cover "pee-wee" broadcasting.

FCC field engineers are having mounting difficulty with objectionable interference caused by "home broadcast stations," frequently operated by children. There is increasing evidence that such activities cannot be pursued in the AM broadcast band without causing trouble.

Many are not aware that certification by the manufacturer or a licensed commercial radio operator is required before low-power communication devices can be used on the air. Consequently, sale by some mail-order and retail stores of uncertified equipment can get an unsuspecting buyer in trouble and result in closing his operation. The FCC is continuing to seek the cooperation of makers, sellers, and users to see that such apparatus is certified as meeting the technical requirements, thus preventing interference before it starts.

In order to be certified, low-power communication devices must have less radiated field strength than 24  $\mu\text{V.}/\text{meter}$  in the middle of the AM broadcast band. In lieu of this requirement, the device must have a power input to the final r.f. stage of 100 mw. or less; must have less than -20 db harmonic or subharmonic output; must have an antenna and transmission-line length of 10 feet or less; and must have 200  $\mu\text{V.}$  or less of r.f. on the power line connected to the unit.

Anyone interested in obtaining practical radio experience is urged to qualify for either the Amateur or Citizens Radio services. There are no age limits on the former, and the six classes of licenses cover the entire gamut of interest from novice to advanced-class operators. ▲

May, 1962



Personal two-way radio is serious business. Wherever you plan to use it, your only important measures of performance are ruggedness, reliability and range. This was our target in designing the CB-4. No gadgets, no gingerbread. Just an extremely dependable 27 Mc. portable communications system.

*Littlefone* CB-4 \$89.95

Power input: 100 MW • Receiver sensitivity: 1 microvolt • Plug-in crystals and transistors for easy channel changeover and service • Shatter-proof, vinyl-clad aluminum cabinet • Fully transistorized • Mercury-type battery (not included)

the new ideas in communications are born at

**hallicrafters**  
Chicago 24, Illinois

No FCC license required

Dealers: A limited number of Authorized Hallicrafters Dealerships are available in some territories. See your Hallicrafters distributor, representative, or write to: The Hallicrafters Co., 4401 W. Fifth Ave., Chicago 24, Ill.

## Full Color Giant Fold-Out Charts Still Available!

Here's a complete series of colorful, authoritative fold-out wall-charts (originally appearing in the pages of ELECTRONICS WORLD)—yours for only 15¢ each. All in full-color—each suitable for framing.

2. **Hi-Fi Crossover Network Design Charts:** Tells how to build speaker nets for any crossover frequency. Complete coil-winding data, capacitor values given.
4. **Bass-Reflex Design Charts:** Complete data on building own bass-reflex enclosures for any speaker, including ducted-port enclosures.
5. **Radio Amateur Great Circle Chart:** For Hams and short-wave listeners—gives complete listing and map of amateur prefixes by calls and countries.

IMPORTANT: ORDER BY NUMBER! OUR SUPPLY OF THESE FOLD-OUT CHARTS LIMITED. OFFERED ONLY ON A FIRST COME, FIRST SERVED BASIS.

Send 15¢ per selection to ELECTRONICS WORLD  
Box 378, Church Street Station New York 8, New York



# AUDIO-OPERATED PANELESCENT LAMP DISPLAY

By JOHN POTTER SHIELDS

ONE OF the most interesting characteristics of the now quite inexpensive electroluminescent lamps on the market is that the intensity and color of their emitted light is largely dependent upon the frequency of the applied voltage. Because of this, a unique and eye-catching display can be set up by connecting one or more of these lamps across the output of an audio amplifier.

As shown in Fig. 1, an inexpensive *Sylvania* "plug-in" panelescent night light is connected to the high-impedance primary of an inexpensive audio output transformer; the secondary of which is connected to the amplifier speaker terminals. This transformer, which is necessary to step up the low audio signal voltage present at the speaker terminals to a value sufficient to excite the lamp, may be any small "garden variety" unit such as you might find in your junk box. Its primary impedance may be anywhere from 2500 to 10,000 ohms, and the secondary impedance between 3.2 and 16 ohms. The presence of the lamp and transformer will have negligible effect on the operation of the amplifier as the lamp draws but a few milliwatts.

Fig. 2 shows a set-up which may be used with amplifiers employing a single-ended output stage. The panelescent lamp is simply connected in series with a .01- $\mu$ f., 600-volt capacitor from the plate of the output tube to ground.

More than one lamp may be connected to the amplifier if desired. Simply connect additional lamps in parallel with the first lamp. ▲

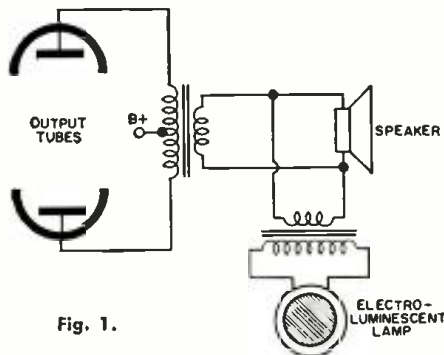

Fig. 1.

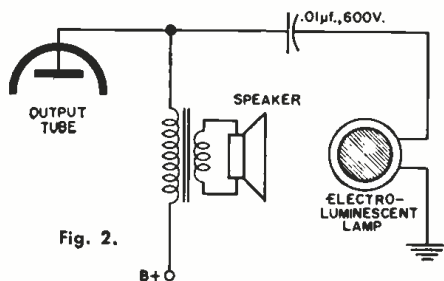

Fig. 2.

May, 1962

**R** FOR "DOCTORS OF  
SERVICING"



## cleans contacts CLEANER!

Want total cleaning power that helps you do a better servicing operation 3 ways? Spray electrical contacts and switches with triple action Contact Shield. Cleans, lubricates, and safeguards, like no other cleaner can! Gives lasting protection in seconds . . . thanks to Silicone base. Independent laboratory tests prove it! Technicians approve it! Write for handy guide-book to more efficient servicing . . . Channel Master Corp., Ellenville, N.Y.

THE PROFESSIONAL  
SERVICE MAN'S  
CLEANER

C 1962 CMC

# YOU SAVE MONEY!

RUSH US YOUR  
LIST OF HI-FI  
COMPONENTS  
FOR A SPECIAL  
QUOTATION  
WRITE FOR FREE  
AUDIO DISCOUNT  
CATALOG A-15

New low prices on amplifiers, tuners, tape recorders, speakers, etc.

**KEY** ELECTRONICS CO.  
120 LIBERTY STREET  
NEW YORK 6, N.Y.

Completely  
revised,  
expanded,  
enlarged . . .  
the Sixth  
Edition of

Milton S. Kiver's

## TELEVISION SIMPLIFIED

The only manual in the field to offer in as compact and easy-to-follow a presentation:  
• theory and analysis of various stages of a television receiver • television transmitting • servicing receivers.

New chapters, expanded discussions, latest advancements, newest techniques. Over 500 illustrations. An indispensable aid to all who want to understand the basic principles of television and their most recent applications. \$7.50

### FREE EXAMINATION COUPON

D. Van Nostrand Company, Inc.  
Dept. T-EW5  
120 Alexander Street, Princeton, N. J.

Please send me TELEVISION SIMPLIFIED for ten days' free examination. I will remit \$7.50 plus small delivery cost within ten days or return book and owe nothing.

Name.....

Address.....

City.....Zone.....State.....

SAVE! Remit with order and we pay delivery cost. Same return guarantee.

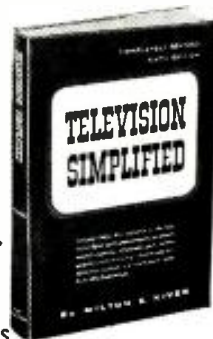



How's Your Frequency

RADIO-TRANSMITTER FREQUENCY. That is ?

A quick check with a tunable receiver in almost any populous area shows lots of activity on the Citizens Band . . . and a surprising proportion of transmitters which are off frequency.

TWO VERY GOOD REASONS FOR HOLDING REQUIRED FREQUENCY TOLERANCE ARE:

1. VOICE QUALITY AND DISTANCE COVERED WILL BE AT MAXIMUM . . . BECAUSE OFF-TUNING DOWNGRADES PERFORMANCE VERY QUICKLY.
2. NO TICKETS FROM THE FCC FOR VIOLATIONS. FCC TOLERANCE FOR CLASS D CITIZENS BAND IS 0.005%.

THE LAMPKIN 105-B FREQUENCY METER IS A NATURAL FOR CITIZENS BAND WORK. ACCURACY IS AMPLE (0.0025%). IT COVERS ALL CHANNELS (CALIBRATIONS FREE WITH NEW METER. ON REQUEST. FOR THE 23 CLASS D CHANNELS) . . . AND WILL OPERATE AS A SIGNAL GENERATOR (FOR ACCURATE RECEIVER ALIGNMENT). THE PRICE IS LOW (\$260.00 NET) AND DELIVERY IS IMMEDIATE! GET ONE YOURSELF—OR HAVE YOUR CB CLUB BUY ONE!

INFORMATIVE BOOKLET ON TWO-WAY RADIO. IT IS FULL OF FACTS AND FIGURES.



105-B FREQUENCY METER  
Reliable . . . since 1938!

LAMPKIN LABORATORIES, INC.  
BRADENTON  
FLORIDA

FREE

LAMPKIN LABORATORIES, INC.  
MFM Division, Bradenton, Florida

At no obligation to me, please send free booklet and information on Lampkin meters.

Name \_\_\_\_\_  
Address \_\_\_\_\_  
City \_\_\_\_\_ State \_\_\_\_\_

Guaranteed! Crystals!

BUY NOW AND SAVE!!

OVERTONES: 10 to 30 Meg. . . Tol. .005% . . .	\$2.95
AMATEUR & NOVICE Fundamental . . . Tol. .005%	
HC-6 Herm. Sealed . . . . .	2.95
HC-6—6 Meters (5th Overtone) . . . . .	4.25
MARINE FREQ. HC-6 (Herm. Sealed) Tol. .005% . . . . .	\$3.75

ALL MARINE FREQ.—FT-243, DC-34 Hold Tol. .005.	\$2.50
POLICE, C.A.P., CD, MARS, Tol. .01% . . . . .	\$2.00
CITIZENS BAND—11 METERS—.005% Tol.	
26.965 to 27.225 MC, 3rd Over. Herm. Seal. or FT-243 . . . . .	\$2.95
13.4825 to 13.6125 MC, 2nd Harm. Herm. Seal. or FT-243 . . . . .	\$2.95
6741.25 to 6806.25 Kc, 4th Harm. FT-243 only . . . . .	\$2.50

SPECIAL!  
STOCK CRYSTALS

\$119

FT-243 Holders 5700 KC to 8700 KC in steps of 25 KC's

SEND FOR FREE CATALOG

DC-34 Hold. 1690 KC to 4440 KC steps of 10 KC, ea. \$1.19

NOVICE BAND FT-243 Fund. ea. \$149

80 Met. 3701-3748—Steps of 1 KC. FT-243	
40 Met. 7150-7198—Steps of 1 KC. FT-243	
Dbl. to 40 Met. 3576-3599, Steps of 1 KC. FT-243	
15 Met. 5276-5312—7034-7083 Steps of 1 KC. FT-243	

FT-243—2 Meters (Steps of 1 KC) . . . . .	\$1.49
FT-243—6 Meters (Steps of 1 KC) . . . . .	\$1.49
FT-243—From 3000-4000 . . . . .	\$1.49
FT-243—From 1005-2999 (Steps of 5 KC) . . . . .	\$2.50
FT-243—.005% Tol. From 3000-8750 . . . . .	\$2.50
FT-243—.01% Tol. From 3000-8750 . . . . .	\$2.00
FT-241 SSB Low Xtals 370 to 540 KC (Steps of 1.852 and 1.388) . . . . .	\$.69
FT-241 SSB Matched Pairs . . . . .	\$2.39
FT-241—AN/TRC-1-721.167 KC-1040-625 (Steps of 1.042 KC—Except 1000 KC) . . . . .	\$.96

Include 5¢ per crystal postage. (U.S. only). Calif. add 4% tax. No C.O.D. Prices subject to chg. Ind. 2nd choice, sub. may be necessary. Min. Order \$2.50

"The House of Crystals"

U. S. CRYSTALS, Inc.

1342 S. La Brea Ave. Los Angeles 19, Cal.

Multicore Sales Corp. Port Washington, N.Y.

For information, write Department ME 42

# NEON LAMP LEAKAGE TESTER

Checks leakage resistance of capacitors and i.f.'s.

By J. ALAN HASTINGS

NEON lamps are ideal indicators for simple test equipment; their cost is low and their sensitivity is high. This leakage tester, though not particularly accurate, is simple, inexpensive, sensitive, and small enough to be built in a plastic hardware box. When it is connected to a capacitor, one flash of its neon lamp per second indicates a leakage resistance of approximately 400 megohms.

In addition to its high sensitivity, it tests capacitors at a fairly high voltage—closer to that at which they actually operate. While a v.t.v.m. ohmmeter may have high sensitivity, the test voltage is low and tests made with it are not as conclusive.

Another use for this tester is checking primary-to-secondary leakage in i.f. transformers. Grid circuits in i.f. amplifiers usually have a high a.c. impedance, and the primary is at a high voltage. Therefore, a small amount of leakage can cause trouble.

## Operation

The circuit uses a relaxation oscillator the frequency of which is determined by capacitor  $C_2$  and the external circuit resistance. The lower the resistance, the higher the frequency. Two flashes per second indicate 200 megohms; four flashes, 100 megohms; eight flashes, 50 megohms, etc. The d.c. for the oscillator is supplied by rectifier  $SR_1$  and filtered by  $C_1$ .  $R_1$  and  $R_2$  limit the current through  $PL_1$  and isolate the probes from the power so that contact with the probes will not give you an electrical shock.

For greatest accuracy, the component being tested must not have any shunting resistances. If a component is in a circuit, disconnect one end of it. Always connect probe 1 to the free end of the component otherwise leakage to ground may give a falsely high indication of leakage. ▲

$C_1$  filters rectified d.c.  $R_1$  and  $R_2$  isolate probes from a.c. to minimize shock.

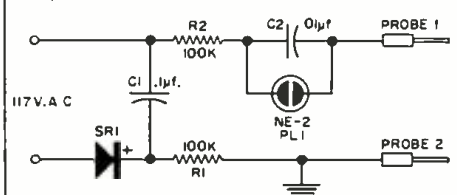

$R_1, R_2$ —100,000 ohm, 1/2 w. res.

$C_1$ —1  $\mu$ f., 400 v. capacitor

$C_2$ —.01  $\mu$ f., 1000 v. capacitor

$SR_1$ —Silicon, selenium, or germanium rectifier with p.i.v. greater than 200 volts.

$PL_1$ —NE-2 neon lamp

# Wake Up



**A new day is dawning in electronics. Transistors are here to stay... they are now being used everywhere; in radio, television, Hi-Fi, intercoms, and in nearly all new electronic equipment...**

**Why put off transistor circuit servicing any longer... there's gold in them thar hills. But you must be equipped to do the job fast and efficiently. Here are the tools that you will need.**



## NEW SENCORE TRANSI-MASTER

This Tester will analyze the entire circuit in minutes and test transistors in-circuit or out of circuit. Here is how you can pin point troubles step by step.

First, check the batteries with the 0 to 12 voltmeter. If the batteries are O.K., check the current drain with the 0 to 50 milliamp meter. A special probe is provided so that you do not need to break the circuit. Excessive current indicates a short; low current indicates an open stage or cracked board. All PF schematics indicate average current.

If trouble is not located by now, isolate the trouble to a specific stage by touching the output of the harmonic generator to the base of each transistor and note spot where sound from speaker (or scope where no speaker is used) stops or becomes weak. The generator becomes a sine wave generator for audio stages to help find distortion.

If trouble points to a transistor, check it in a jiffy with the exclusive in-circuit power oscillator check provided by the TR110. A special probe is also provided for this.

If the transistor checks bad in-circuit, remove it and give it an out of circuit check with the oscillator check or the more accurate DC check. The DC check is provided for comparison reasons, experimental or engineering work and to match transistors in audio output stages. Beta (current gain) is read direct or on a good-bad scale for service work.

**DEALER NET. ONLY \$4950**

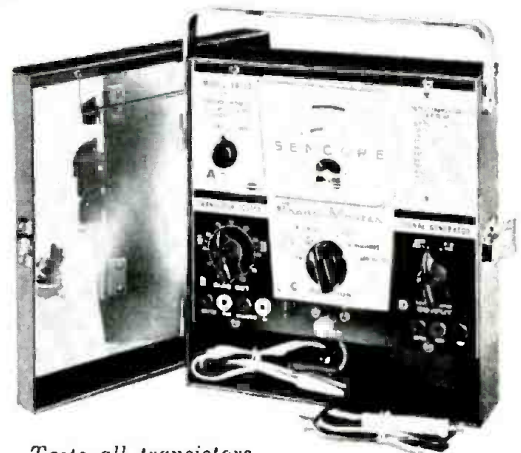

*Tests all transistors in-circuit or out-of-circuit*

### Model TR110

**It's a COMPLETE TRANSISTOR TESTER**

- SIGNAL TRACER • VOLTMETER
- BATTERY TESTER • MILLIAMMETER



## NEW SENCORE TRANSISTOR AND DIODE CHECKER

Here is a low cost tester that has become America's favorite. The TR115 provides the same DC out of circuit checks as the TR110; leakage and current gain. Beta (circuit gain) can also be read direct or as good or bad. Opens or shorts in the transistor are spotted in a minute. The TR115 checks them all from power transistors to the small hearing aid type. Japanese equivalents are listed also. This famous tester is used by such companies as Sears Roebuck, Bell Telephone and Commonwealth Edison. New circuits enable you to make service checks without set-up charts even though charts are provided for critical checks.

TR115K. Available in Kit Form. Dealer Net \$13.95

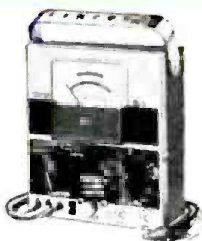

**Model TR115**  
Dealer Net  
**\$13.95**



## SENCORE BATTERY ELIMINATOR AND TROUBLE SHOOTER

For replacing batteries during repair. Many servicemen say that they wouldn't service transistor circuits without this power supply. The tried and proven PS103 is a sure fire answer. It can be used to charge the nickel cadmium batteries as well. Dial the desired output from 0 to 24 volts DC and read on meter. Low ripple insures no hum or feedback. Total current drawn can also be read on the PS103 by merely flicking the function switch to milliamps. The PS103 is the only supply that will operate radios with tapped battery supplies such as Philco, Sylvania and Motorola. No other supply has a third lead.



**Model PS103**  
Dealer Net  
**\$19.95**

Now in stock at  
your Authorized  
Sencore Distributor



# SENCORE

ADDISON, ILLINOIS

# TV Tuner Problems?

Simply send us your defective tuner complete; include tubes, shield cover and any damaged parts with model number and complaint.

Send for details and FREE Mailing Kit

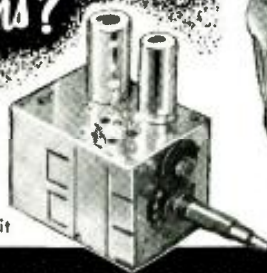

Castle Overhaul  
**ALL MAKES ONE PRICE**  
 90 Day Warranty **9.95**

Tubes and Major Parts Extra

## CASTLE TV TUNER SERVICE, INC.

5717 NORTH WESTERN AVENUE, CHICAGO 45, ILLINOIS  
 653 PALISADE DRIVE, CLIFFSIDE PARK, NEW JERSEY  
 IN CANADA: 136 MAIN STREET, TORONTO 13, ONTARIO

### BC-221 FREQUENCY METER, \$69.50

Like New, With original Calib. Book, Only	\$69.50
BC-603 FM Receiver 20-27.0 Mc. New	18.95
DM-34 Dynamotor, 12 volt, Brand New	3.95
BC-604 MF Transmitter with tubes, Brand New	6.95
DM-35 Dynamotor, 12 volt, Brand New	9.95
Makessyn Compass System Complete, Remote reading for plane or boat, Exc. condition, With Manual	24.95
AN/APN-9 LORAN Receiver-Indicator with 21 VDC Inverter, Checked out, Exc.	124.95
AN APN-4B LORAN Receiver-Indicator with 21 VDC Inverter, Checked out, Exc.	89.50
AN/APR-4 Receiver 28 MC - 2400 MC, 4 tuning units, Checked out, Exc.	259.50
AN ART-13 XMT, 100 Watt, with Oscillator, 11 channels, 200-1500 Kc, 2-18.1 Mc, Exc. Condition	49.50
T-22/ARC 5 Transmitter, Brand New	14.95
BC-455 Receiver, Good	9.95
BC-191 Transmitter with tubes, Excellent	14.95
ARR-2 Receiver, 41 tubes with 4 B conversion	4.95
ARC-3 AM Receiver 100-150 Mc, Excellent	12.95
ARC-3 AM Transmitter 100-150 Mc, Exc.	14.95
1-130A Signal Generator, 100-150 Mc	7.95
MD-7 Modulator with tubes	5.95
RT-100 A APS-19 "X" Band Transceiver with 2 J55 and Magnet—25 Tubes, etc.	79.50
T5-13 AP Portable Signal Generator, New	39.95
Hi-Fi Head Set—Fren. range 10 to 11,000 cps, 600 Ohm imp., Chamois cushion, Extension cord	9.95

Send Money Order or Check with Order  
 Write for Latest Flyer—LOADS OF BARGAINS!

### R W ELECTRONICS

2430 S. Michigan Avenue Dept. EW  
 Phone: CAIumet 5-1281 Chicago 16, Ill.

## ELECTRONICS WORLD HAS A BUYER FOR YOUR USED EQUIPMENT OR COMPONENTS!

The 245,000 purchasers of ELECTRONICS WORLD are always in the market for good used equipment or components. So if you have something to sell, let EW readers know about it through our classified columns. It costs very little: just 60c a word, including name and address. Minimum message: 10 words.

For further information write:

Martin Lincoln  
 ELECTRONICS WORLD  
 One Park Avenue  
 New York 16, N. Y.

# Now... Tomorrow and for years to come!

## Sonar CITIZENS BAND RADIO

- 8 Channels, crystal controlled transmitter and receiver
- Tunable receiver for 22 channels
- Transmitter 100% Class B modulated
- Adjustable squelch
- Automatic noise limiter
- R. F. Power indicator
- 1 Year guarantee
- Easy to install, ideal for home, boat, car or business. Weighs only 9 lbs. . . 4 3/4 x 9 1/2 x 11 1/4
- FCC Type accepted\*

with 1 pair of crystals, microphone and power cables

**\$179.50**



### Sonar RADIO CORPORATION

73 Wortman Avenue • Brooklyn 7, N. Y.

Please send me complete information on Model "E" CB Radio.

Dept. 123

NAME \_\_\_\_\_  
 ADDRESS \_\_\_\_\_  
 CITY \_\_\_\_\_  
 STATE \_\_\_\_\_

snatches was fit to be tied. The holiday radio and TV programs were ruined for those in the interference area, and they were calling everyone from the mayor on down. I heard some mention of this.

"I decided the only thing to do was to isolate the source of the interference by cutting off current to different areas one at a time. I hated to pull the primaries because of the heavy loads they were carrying with the Christmas season and the bitter cold weather; so I told the men to drop out the distribution transformers singly for a short space of time until they found one that would stop the noise. When they pulled a transformer in the alley between 17th and 18th and Market and Spear Streets, the noise stopped and they thought they had it; but when power was restored, the noise failed to start!

"However, cutting off other transformers close to the area had no effect whatever; so we came back to the one between 17th and 18th. Once again the noise stopped the instant power was cut off. True it did not start for several minutes after power was restored, but I felt sure we were on the right track at last. The transformer served about twenty houses, and we dropped them off one at a time until the noise stopped again. Now we had it pinned down to a single house. I waited until evening when the man of the house came home from work and then went calling with my receiver. He was most cooperative when I explained what we had discovered and told me to go ahead and do whatever necessary to find the trouble.

"The house had only two circuits, and pinning the noise-source down to one by unscrewing fuses was easy; but after we had pulled every plug in the whole house the noise continued. Finally we went down in the basement to look around. He had a stoker-fired coal furnace with thermostatic control, but cutting power off these did not help. I noticed, though, the bonnet limit switch was set as high as it would go. He said he had put it up there in an effort to get more heat out of the furnace in a hurry on cold mornings. While I was explaining this was a not-so-good practice and was peering at the floor joists above the furnace for signs of charring, I spied a new-looking little bell transformer mounted on one of the joists. On a sudden hunch I reached up and cut one of the primary leads. The noise stopped at once. The search was over!"

"You mean that little transformer was raising all that heck?" Barney questioned.

"Right. He said he had just put it in a few weeks back. It must have developed some shorted turns because of a defect or the high ambient temperature, for it becomes quite warm away from the furnace and without any load on the secondary. At some critical temperature that could only be reached by a combination of this heating and a high ambient temperature, voltage peaks arced

inside the windings. Added heat from this arcing raised the temperature rapidly, and the accompanying expansion stopped the arc after three seconds. Three seconds later the transformer cooled down enough for the cycle to start again. If power was cut off from the bell transformer for a short time, it cooled down sufficiently so that several minutes 'on' time was necessary for it to climb back up to the critical temperature."

"Why do you call this a 'classic case'?" Barney wanted to know.

"Because of the misleading nature of the interference, the critical time at which it happened, and the number of natural scapegoats living in the affected area. A radio amateur, a TV technician, an invalid and heating pad, or a 'mean neighbor' crops up in practically every

interference case; but it's rare to find all four. Incidentally, those who tried to sic me on these innocent persons act ashamed when they meet me now."

"I'd think they would, and I hope they remember the lesson," Mac remarked. "I can easily see why your worst TV interference was to the north of the bell transformer. Ninety-five per-cent of our reception is from the three stations at Center City to the south; so most antennas point that way. The interference, naturally, was much worse at the front of the antennas than at the rear or sides."

"Well, I better be going," Red said as he stood up, "but I thought you two would be interested. A few more cases like that and no stranger is going to be able to understand why my nickname is 'Red!'" ▲

### NBS OFFICIAL RECEIVES FLEMMING AWARD

**DR. LEWIS M. Branscomb**, Chief of the Atomic Physics Division of National Bureau of Standards, has been named recipient of one of the 1961 Arthur S. Flemming Awards.

Dr. Branscomb was cited for his outstanding contributions in the area of the atomic processes of stellar atmospheres, and for his leadership in a scientific program to obtain basic atomic data upon which the successful solution of problems in astrophysics and plasma physics depends.

The awards, originally suggested by Arthur S. Flemming, former chairman of the Civil Service Commission and Secretary of Health, Education, and

Welfare, were begun in 1948. They are sponsored by the Washington Junior Chamber of Commerce to honor ten outstanding men under age 40 in the Government service. Since the program's inception 14 years ago, nine NBS staff members have been selected for this distinguished national award.

Dr. Branscomb joined NBS in 1951 and was named Chief of the Atomic Physics Section then later, in March 1960, was appointed the first Chief of the Atomic Physics Division. He is a Duke University graduate and received his Ph.D. from Harvard in 1919. He was also recipient of a Rockefeller Public Service Award in 1957. ▲



**VARIACS • VARIACS • VARIACS**

**115 VAC Input, 0-135 VAC Output**

2 Amp	7.50	6 Amp	12.50
3 Amp (Powerstat)	8.95	20 Amp	39.95
20 Amp Powerstat Motor Driven			89.00
440 Volt—3 phase—3 Amp Motor Driven			39.50

**ESTERLINE-ANGUS RECORDER**

Model AW—0 to 1 ma—used  
Excellent Cond. .... \$225.00

**POWER SUPPLY KIT**

1 transformer 1000 V CT-150 ma; 6.3 V & 5V  
1 Choke, 10 Hy.—250 MA  
2 Capacitors—8mfd.—1000 V,  
ship weight—26 lbs. complete kit \$9.95

**Motors (All 115 VAC)**

1 RPM Cramer Sync w/1 1/2" gear attached (Used but excel. Cond)	1.69
5 for	7.50

Electric Motor Co.  
Motors—Open Frame type—High Torque

10 RPM	2.75	20 RPM	2.75
24 VAC—10 RPM			2.75

27 VDC Blower 1/100 HP—7000 RPM w/stand for Mounting—Filtered. Shipped in orig Can (Can Worth \$4.00) Will run on 30 VAC 4.25 ea.  
Fasco Motors—16 amp—Shaft 1/4" x 4 1550 RPM 2.75  
2 Speed 1550 & 1050 Dbie. Ended Shaft 3" x 5/16" & 1 1/2" x 5/16" 4.75

**METERS**

0-1 MA 1 1/2" sq.	3.50	0-5 MA 3" sq.	3.95
0-500 Microamps	3.75	0-20 MA	3.95

2" round

0-1 MA	3.75	0-100 MA	3.95
0-100 Microamps	3.95	0-150 MA	3.95
0-200 Microamps	3.50	0-200 MA	3.95
0-3 MA	3.50	0-250 MA	3.95
0-10 Amp DC	3.25	0-2.5 ADC	3.75
0-150 VAC	3.75	0-25 Amp DC	4.25
0-200 VAC	3.95	0-130 V AC	3.45
		0-150 V AC	4.45
		0-250 VAC	4.25

all 3" round

0-100 Microamps	4.95	200-0-200 V DC	3.95
0-1 MA	4.25	0-15 V AC	3.25
		0-25 VAC	3.75

Running Time Meters 150 V 400 cycl Haydon 1 1/2" R 9.99 hrs. 6.50  
115 V 60 cycl. used 3" round 6.95  
0-5 Amps AC (marked 0-200 amps) 6" sq. 10.95  
4 1/2" 0-50 VDC w/50, 100, 200, 300, V scales  
Basic Meter 1 MA 6.95  
9 Reed-Free. meter 380-420 cyc. 9.95

We Buy Surplus Inventories  
All Shipments F.O.B. N.Y.C.

**Advance Electronics**  
79 Cortlandt St., New York 7, N.Y. RE 2-0270

ALL NEW  
**SENCORE**  
component  
substitutor



MODEL RC121

## All your favorite Sencore Substitution Time-Savers in One Compact Unit

A complete range of carbon resistors, wire wound power resistors, capacitors, electrolytics, and universal selenium and silicon rectifiers.

Imagine, all of these hard to locate parts at your finger tips for on the spot substitution. Say goodbye to messy, crumpled parts, unnecessary unsoldering and soldering of components for testing purposes only. Save valuable servicing time and be sure, by substituting.

NEW . . . each section operates independently with a value close enough for every substitution need. Components in each section are isolated from chassis and from the other sections. For example, a complete power supply can be constructed using the RC121 Components only.

NEW . . . dual electrolytics provided. A new circuit enables you to substitute up to 25 single electrolytic values or 9 duals. Exclusive surge protector provides protection on both singles and duals for both you and the circuit.

You save space and money. Equivalent Sencore substitution pieces purchased individually (H36, PR111, RS106, ES102) cost you \$54.00

RC121 (all hand wired, all American made) only **39.95**  
RC121K (Kit) ..... 27.95

Now in stock at your Sencore Distributor. See him today!

**SENCORE**  
ADDISON 2, ILLINOIS

# MUSIC BIG AS LIFE

## Utah's High-Fidelity CONTINENTAL SPEAKERS



C12RD 12"  
WOOFER  
2 Lb. Alnico  
V Magnet and  
2" Voice Coil

YOU GET LIFE-SIZE SOUND in every range, from 20 to 20,000 CPS, with Utah's precision-engineered stereo/high-fidelity speakers. Tweeters and mid-range speakers feature a specially engineered horn formula to enhance "presence". Each speaker has color-coded 4-way terminals.



Please mail me prices, specifications and performance details of your Continental speaker line.

NAME \_\_\_\_\_  
ADDRESS \_\_\_\_\_  
CITY \_\_\_\_\_ STATE \_\_\_\_\_

### Noise and its Measurement

(Continued from page 28)

noise levels in three octave bands (600-1200, 1200-2400, and 2400-4800), you come up with the Speech Interference Level (SIL) of the noise, which you can compare with published criteria to find out the extent to which noise will interfere with conversation. The octave-band analysis offers still another way of rating noise, by Noise Criterion (NC) value,<sup>4</sup> sometimes used to evaluate acoustic properties of offices, school rooms, auditoriums, etc. Finally, octave-band levels can be converted to Noise Rating,<sup>5</sup> used to evaluate noise levels in residential areas.

An octave-band analysis, as you can see, is an essential part of most serious noise studies. Fig. 5 shows such an analysis of various noises in a factory. Growing in favor is the third-octave-band analyzer, which divides the over-all frequency range into three times as many bands as does the octave-band analyzer, and consequently gives more information (and takes more time).

A normal sound-level measurement is usually not adequate for impact noises. On a drop-forge impact, for example, the peak level may be as much as 30 db above the maximum reading that would appear on a sound-level meter. An oscilloscope could be used to show more complete information, such as rise and decay rates, but the technique is involved. Much more convenient is the impact-noise analyzer, which can measure peak value, instantaneous level, and a time-averaged level of the noise.

Standards for noise measurement are constantly changing as scientists gather new data. The best way to learn about human reaction to noise is by experiment, and the more subjects, the more useful the results are likely to be. Improved test procedures and larger samplings often force scientists to revise the standards. For this reason, and because the idea is good scientific practice, it's important to keep detailed records of all measurements. A complete record will probably include data of no apparent significance, but you never know what tomorrow's standards may bring. Here's a list of things you might record:

1. Description of the space where the measurements were made (nature and dimensions of floor, walls, and ceiling; description of nearby objects and personnel).

2. Description of noise source (dimensions, nameplate data, location, type

of mounting, and operating conditions).

3. Description of secondary noise sources (location, types, kinds of operations).

4. Type and serial numbers of all microphones and instruments used.

5. Positions of observer.

6. Positions of microphone (direction of arrival of sound with respect to microphone orientation, length of microphone cable).

7. Temperature of room and of microphone.

8. Results of maintenance and calibration tests.

9. Weighting network and meter response.

10. Measured over-all and band levels at each microphone location.

11. Background over-all and band levels at each microphone position (*i.e.*, with primary noise source shut off).

12. Cable and microphone corrections (for temperature and humidity, as specified by manufacturer).

13. Date and time.

14. Name of observer.

The more useful information you record, the better off you'll be in the next phase of the noise-control program. That's when you decide what to do about the noise you have just measured. Techniques of noise reduction constitute a story in themselves, beyond the scope of this article. After you've put rubber feet on the machine or changed motors, or installed sound-absorbing material, you'll want to re-measure to be sure of the improvement. Obviously, the before-after comparison will be most meaningful if the second set of measurements was made under the same conditions as was the initial set—another reason for keeping detailed records.

In the war against noise, careful measurement pays off. And the pay-off is a precious commodity that too often seems to be going out of style—quiet. ▲



"I was a TV serviceman once—too many relatives as customers put me out."

4. Beranek, L. L., ed.: "Noise Reduction." McGraw-Hill Book Co., 1960.

5. Rosenblith, W. A. & Stevens, K. N.: "Handbook of Acoustic Noise Control," Vol. II, "Noise and Man." WADC Technical Report 52-204, PB111274. Office of Technical Services, Department of Commerce, Washington 25, D.C., June 1953.



# ELECTRONIC CROSSWORDS

By  
**CLAUDE B. GREEN, JR.**

(Answers on page 104)

## ACROSS

1. Class of FCC license.
11. Small voltage (abbr.).
12. Electron's charge (abbr.).
13. An oscillator circuit.
16. Second grid in a pentode.
18. Transistor's "grid."
19. Type of oscillator (abbr.).
20. Capacitor plates should
21. Wire measure (abbr.).
22. Dielectric constant symbol.
23. Active part of a tube.
26. The band from 3-30 mc. (abbr.).
27. Unit of force in CGS system (abbr.).
28. The frequencies from 16 to 16,000 cycles (abbr.).
29. Type of rectifier tube.
31. The band from 3-30 kc. (abbr.).
32. Capacity causes current to
34. Unit of conductance.
36. Agency regulating communications activities in U.S. (abbr.).
37. Unidirectional current.
38. Another name for "voltage" (abbr.).
40. Amount of acidity.
42. Power ratio unit (abbr.).
44. P \_\_\_\_\_
45. Wire measure.
47. The band from .3-3 mc. (abbr.).
49. Type of oscillator circuit.
52. Unit of apparent power.
53. Transformer core loss.
54. 12 mc. is the \_\_\_\_\_ harmonic of 1.5 mc.
55. Indicates a million (prefix).

## DOWN

1. Effective value of a.c.
2. Receiver sensitivity control circuit (abbr.).
3. .001 amp is \_\_\_\_\_ ma.
4. 10,000 kc. is \_\_\_\_\_ mc.
5. Grid voltage (schematic abbr.).
6. Time relationship.
7. Radio static noises.
8. Mineral-bearing rock.
9. Early name for the element radon (symbol).
10. Uranium is \_\_\_\_\_.
14. Voltage collector (abbr.).
15. Coil on the neck of a CRT.
17. Push-pull cancels the \_\_\_\_\_ harmonics.
18. Method of reading color code on resistors.
20. Midwestern state (abbr.).
23. Heating value of a.c.
24. Heating value of a.c. (abbr.).
25. Radio aid to navigation (abbr.).
26. Two capacitors in series gives \_\_\_\_\_ the capacitance of one.
30. Sensitivity control.
31. A multimeter (abbr.).
33. Current (abbr.).
35. Unit of inductance.
37. Volume unit (abbr.).
39. Protective device.
40. Part of prefix meaning "five."
41. \_\_\_\_\_ frequencies are reflected best from the ionosphere.
43. Unit of work.
46. Inductive reactance causes the current to \_\_\_\_\_ the voltage.
48. Chemical symbol for iron.
49. If resistors are in series their values \_\_\_\_\_.
50. Solder is lead and \_\_\_\_\_.
51. Unit of resistance.

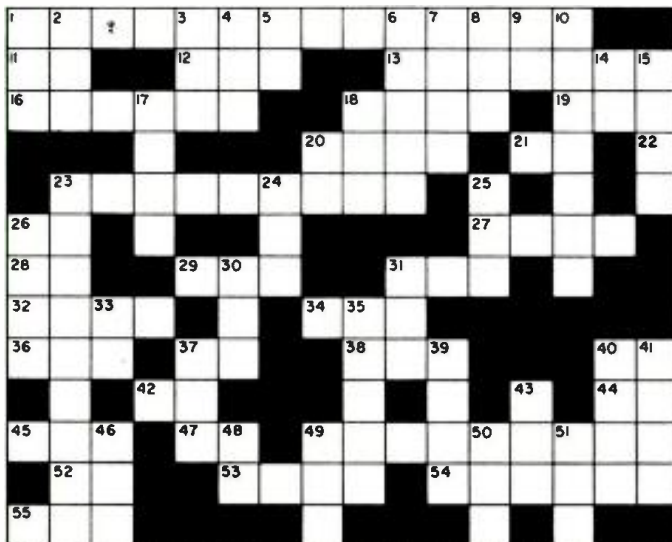

priced from \$109.50...

HAND-HELD, MOBILE, BASE STATION

## 2-WAY RADIO

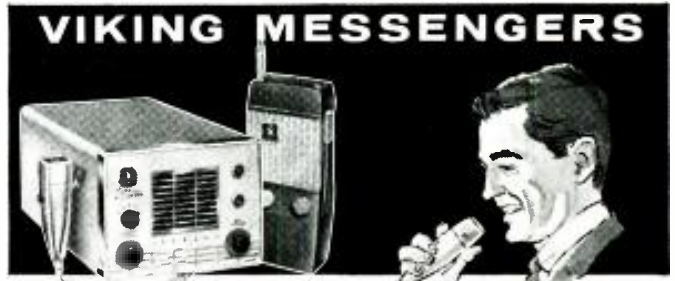

Now, 3 feature packed Johnson Messengers...  
outperforming everything else in the field!

Compact, hand-held 100 milliwatt or 1 watt "Personal Messengers". Rugged and reliable—11 transistors, 4 diodes! Superheterodyne receiver and exclusive tuned RF amplifier gives twice the sensitivity and 40% more range than similar units with conventional circuitry—more output than similar units with same rated inputs!

For mobile or base stations—performance proved Viking "Messenger" punches your signal across the miles! High efficiency design makes full use of maximum allowable legal power. Excellent receiver sensitivity and selectivity. Automatic "squelch" control—5 channel coverage. Only 5 1/2" x 7" x 1 1/2", easy to install anywhere!

WRITE TODAY  
for  
information packed  
4 Color Catalog



**E. F. JOHNSON COMPANY**

2505 10th Ave. S.W., Waseca, Minnesota

Please rush "Messenger" details to:

NAME \_\_\_\_\_  
ADDRESS \_\_\_\_\_  
CITY \_\_\_\_\_ STATE \_\_\_\_\_

Manufacturers of the world's most widely used personal communications transmitters.

## SUPERIOR'S NEW MODEL 85 TRANS-CONDUCTANCE TYPE TUBE TESTER

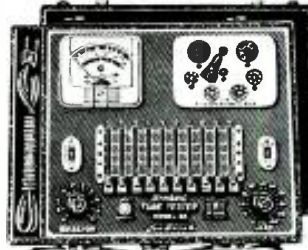

Model 85—Trans-Conductance Tube Tester. Total Price \$52.50  
Terms: \$12.50 after 10 day trial, then \$8.00 monthly for 5 months if satisfactory. Otherwise return, no explanation necessary.

● **FREE FIVE (5) YEAR CHART DATA SERVICE.** Revised up-to-date subsequent charts will be mailed to all Model 85 purchasers at no charge for a period of five years after date of purchase.

Model 85 comes complete, housed in a handsome portable cabinet with \$52.50 slip-on cover. Only

**SHIPPED ON APPROVAL  
NO MONEY WITH ORDER — NO C.O.D.**

Try it for 10 days before you buy. If completely satisfied then send \$12.50 and pay balance at rate of \$8.00 per month for 5 months—No interest or finance charges added. If not completely satisfied, return to us, no explanation necessary.

All prices net, F.O.B. N.Y.C.  
MOSS ELECTRONIC, INC.  
DEPT. D-931, 3849 Tenth Ave. New York 34, N. Y.  
Please rush Model 85. If satisfactory, I will pay on terms specified. Otherwise I will return tester.  
Name \_\_\_\_\_  
Address \_\_\_\_\_  
City \_\_\_\_\_ Zone \_\_\_\_\_ State \_\_\_\_\_

# FEEDBACK LOOPS in BINARY SCALER DESIGN

By J. FRANK BRUMBAUGH

Description of computer circuitry that is employed to produce division by means of any whole number.

**I**N THE design of discrete frequency-dividing circuitry, the basic building block is the bistable multivibrator or binary, commonly called a "flip-flop." This simple circuit, with the addition of feedback loops between plates and grids of cascaded stages, allows the engineer to design stable circuitry capable of dividing the input frequency by any specific number.

There are two approaches to this de-

eight and four stages by sixteen. If no division is desired (dividing by one), no binary circuitry is necessary.

To divide by two, a single stage is required. We also know we may divide by four with two stages, but let us assume we wish to divide by three instead (see Fig. 2). Since a single binary stage will deliver an output signal after only two input pulses, it is obvious that we must use two stages. However, since an

output pulse must be derived after only three input pulses, we must add a pulse to the two-stage counter during the period of the three input pulses. In other words, we must "trick the counter into believing" it is still dividing by four, which it is actually doing since we are adding the fourth (missing) pulse.

First, some means must be included to reset all stages so the left-hand triodes are non-conducting and the right-hand triodes are conducting. This is most easily accomplished by lifting the right-hand grids off ground momentarily and then re-grounding the grid resistors. This can be done either manually or automatically. The reset button shown in Figs. 2 and 3 does this manually. When the right-hand grids are momentarily lifted off ground, the right-hand triodes go into conduction, since their bias has been removed. The d.c. path between the right-hand plate and left-hand grid of each stage couples the negative-going plate voltage to these grids, driving them below the cathode voltage. This cuts off the left-hand triode sections, leaving them in the non-conducting state.

After the reset button has been activated, the counter is cleared and is ready to accept input pulses. The first input pulse, which must be negative, is applied across the common plate-load resistor of the first stage. This drives both plates more negative. This negative-going plate excursion is coupled to the grid of the conducting triode (it has no effect on the cut-off tube), driving the grid lower and increasing the amount of negative bias. This causes the plate voltage of the conducting triode to rise. This positive-going excursion is then applied to the grid of the non-conducting triode, decreasing its bias. This action is regenerative and practically instantaneous. This results in the initially conducting triode ( $V_2$ ) cutting off and the formerly non-conducting triode ( $V_1$ ) conducting. The positive excursion at the plate of  $V_2$  is applied across the common plate-load resistor of the second stage, but has no effect on  $V_3$  and  $V_4$ , since both plates and grids rise simultaneously.

When the second input pulse arrives, the action described previously for the first stage is reversed and the tubes will revert to the original condition which existed just after the reset button was depressed. However, now the plate of  $V_2$  supplies a negative-going excursion

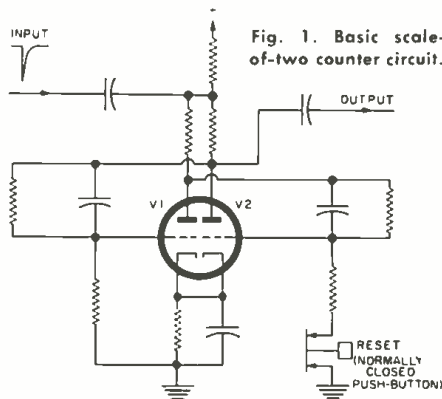

Fig. 1. Basic scale-of-two counter circuit.

sign problem: that of designing the over-all circuit to produce the desired division ratio by the use of feedback loops; and the design of modular circuits complete in themselves, each dividing by prime numbers, which are used in cascade to produce the same end results. In the author's experience the latter approach is simpler, both from a design and a troubleshooting standpoint.

In this article, simple methods of determining feedback paths are discussed and illustrated and the cascaded prime-number scaler approach is shown, as is the alternative of designing the over-all circuit as a unit. Circuits and explanations are given for every division ratio between one and sixteen as well as a suggested method of deriving any desired division ratio in excess of sixteen, using the principles discussed.

## Dividing by 2, 3, and 4

Considered alone, a single binary (flip-flop) will deliver an output pulse of the desired polarity from a specific output plate for every two input pulses, thus dividing by two (see Fig. 1). Followed by a similar binary, the output from the second stage will occur after four input pulses to the first stage. Similarly, three stages will divide by

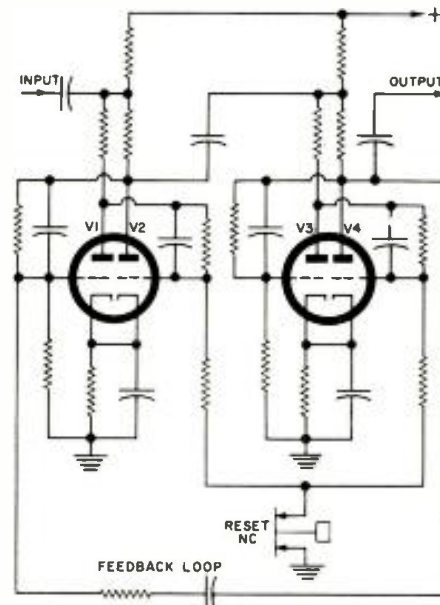

Fig. 2. Scale-of-three counter.

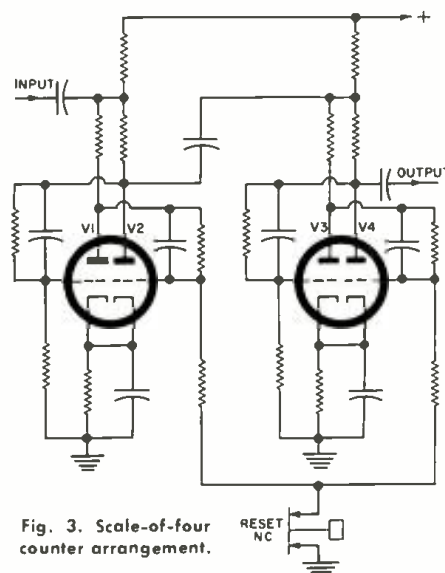

Fig. 3. Scale-of-four counter arrangement.

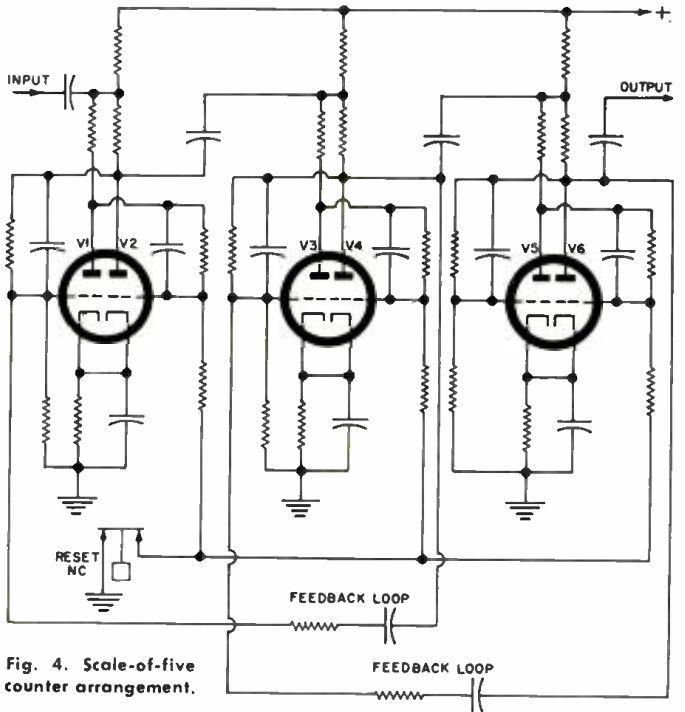

Fig. 4. Scale-of-five counter arrangement.

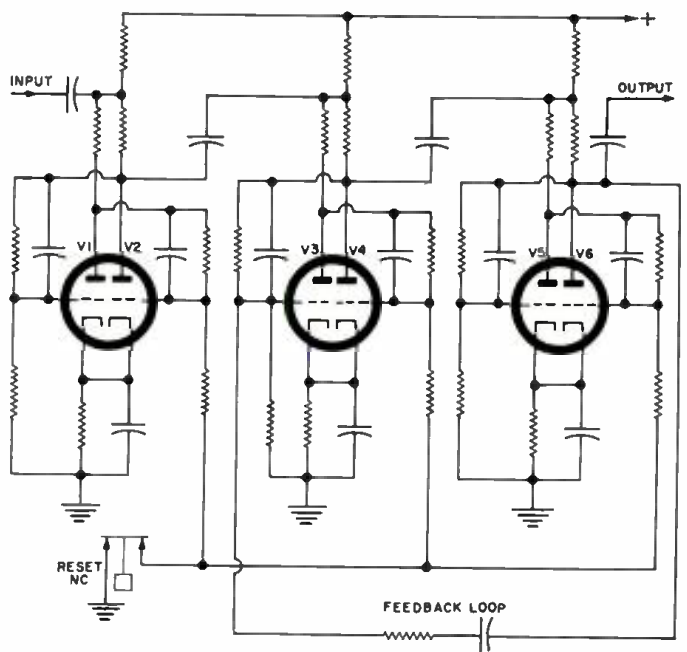

Fig. 5. Scale-of-six counter arrangement.

to the second stage. As described for the first stage, the second stage reverses its state and the right-hand triode ( $V_1$ ) is now non-conducting while the left-hand triode ( $V_2$ ) conducts. The positive-going excursion at the plate of  $V_1$  is fed back to the grid of  $V_1$  in the first stage. As the left-hand triode ( $V_1$ ) is non-conducting, this positive pulse drives it into conduction and, hence, accomplishes the same results as would a negative input pulse applied across the common plate-load resistor.

As the left-hand triode ( $V_1$ ) goes into conduction, the right-hand triode ( $V_2$ ) is cut off. Again, the resulting positive pulse from the plate of  $V_2$  has no effect on the second stage, but we have now succeeded in adding the missing pulse so that the counter is in the same state

it would be in had it received three instead of only two input pulses. This results because we added a feedback pulse to the two input pulses.

Now, when the third input pulse arrives, the first stage again reverses states and the negative-going excursion at the plate of  $V_2$ , which is applied to the input of the second stage, causes the latter to reverse its state. The negative-going excursion at the plate of  $V_1$  is delivered as an output signal. Thus, by adding a feedback loop to the scale-of-four counter, we have added the one pulse necessary and derived an output pulse at the end of three input pulses, dividing the input frequency by a factor of three.

To divide by four, of course, we use the same two stages, but eliminate the

feedback loop, requiring four input pulses for each output pulse. See Fig. 3.

#### Dividing by 5, 6, and 7

Dividing by five requires three stages. See Fig. 4. Now, however, since three stages are capable of dividing by eight with no feedback, we must add three pulses during the five input pulses, in order to secure an output pulse for each five input pulses. This requires two feedback loops—in this case between the plate of  $V_1$  and the grid of  $V_1$ , which will add one pulse, and another loop between the plate of  $V_1$  and the grid of  $V_2$ , which in effect adds two pulses. Actually, only one pulse is fed back to the grid of  $V_2$ , but the effect is the same as if two pulses had been fed to the input, since it requires two input pulses be-

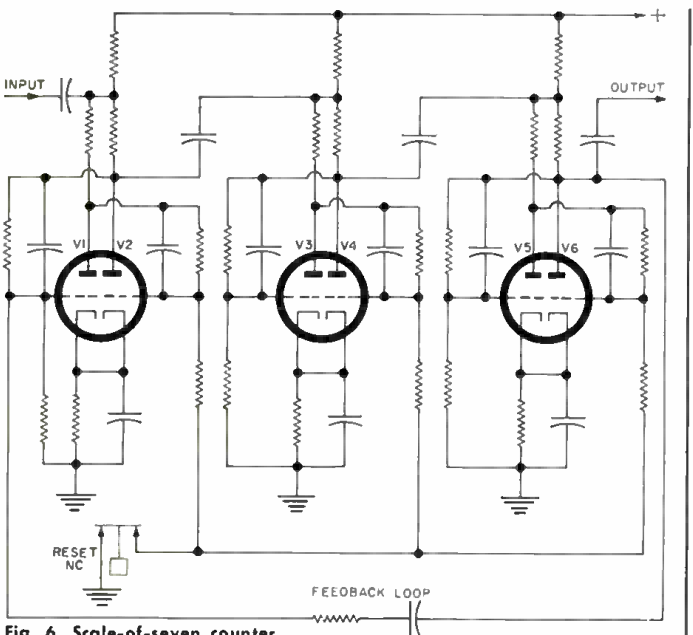

Fig. 6. Scale-of-seven counter.

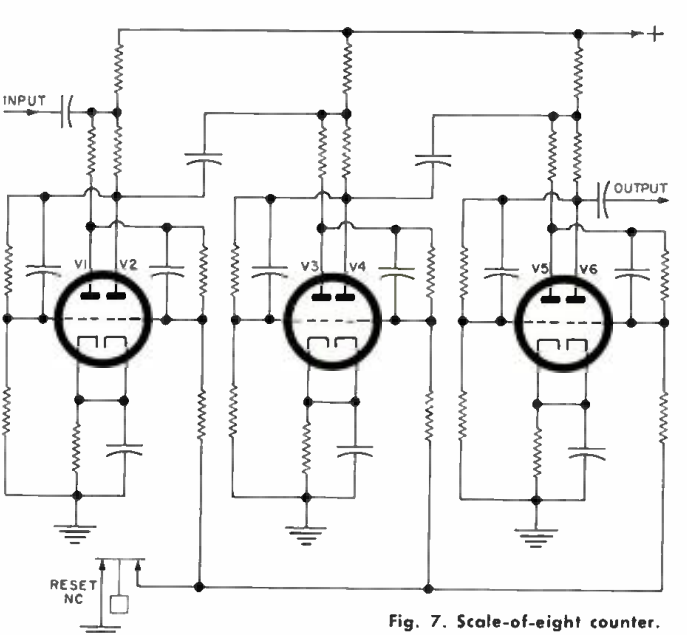

Fig. 7. Scale-of-eight counter.

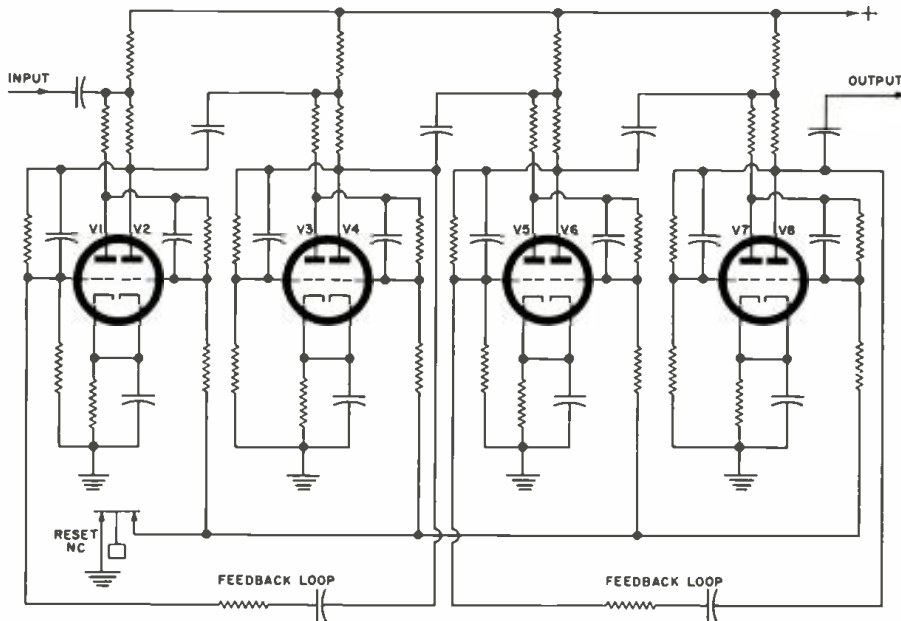

Fig. 8. Scale-of-nine counter.

sired ratio by combining scalars, the product of whose division ratios equal the division ratio desired. As demonstrated, in dividing by nine we actually use two scales-of-three in cascade, since  $3 \times 3 = 9$ . Also, in dividing by six, a scale-of-three was followed by a single scale-of-two binary, as  $3 \times 2 = 6$ .

When dividing by ten (see Fig. 9), as is commonly done in decimal counters, two feedback loops are required; one between the plate of  $V_2$  and the grid of  $V_7$ ; and the other between the plate of  $V_4$  and the grid of  $V_8$ . With this arrangement, we deviate from the simple method of using prime-number scalars to again indicate the basic method of adding missing pulses. (If we use a scale-of-five, with feedback loops between the plate of  $V_1$  and the grid of  $V_5$ , and between the plate of  $V_2$  and the grid

fore a trigger is applied to the second stage.

To divide by six (see Fig. 5), it is only necessary to feed back two pulses to secure an output at the proper time. As explained in the preceding paragraph, we can secure the effect of adding two input pulses by applying a single pulse to cause the second stage to reverse states. In this case, a single feedback loop is placed between the plate of  $V_2$  and the grid of  $V_3$ .

When dividing by seven (see Fig. 6), we need add only a single pulse. Thus, we again need only one feedback loop, which is connected between the plate of  $V_2$  and the grid of  $V_4$ .

#### Dividing by 8, 9, and 10

Dividing by eight is accomplished by using three stages without feedback. See Fig. 7.

Four stages are required to divide by nine. (Fig. 8). However, four stages are capable of dividing by sixteen so we must add (feed back) seven pulses in order to get an output pulse at the proper time. Two feedback loops are required, this time between the plate of  $V_1$  and the grid of  $V_3$ , and between the plate of  $V_3$  and the grid of  $V_5$ . The latter feedback loop effectively adds four pulses, since it triggers the third stage which normally requires four input pulses before being triggered. The feedback loop between the plate of  $V_1$  and the grid of  $V_3$  effectively adds three pulses in this instance since it will feed back a pulse three times during the input cycle.

As described when dividing by three, the second input pulse causes a pulse to be fed back. This also occurs when the fifth and eight pulses appear. Perhaps a simpler way of looking at this action is to consider the first two stages as a scale of three, followed by another scale of three formed by the last two stages.

Hence, it is only necessary to design scaling groups which divide by prime numbers, since we can secure any de-

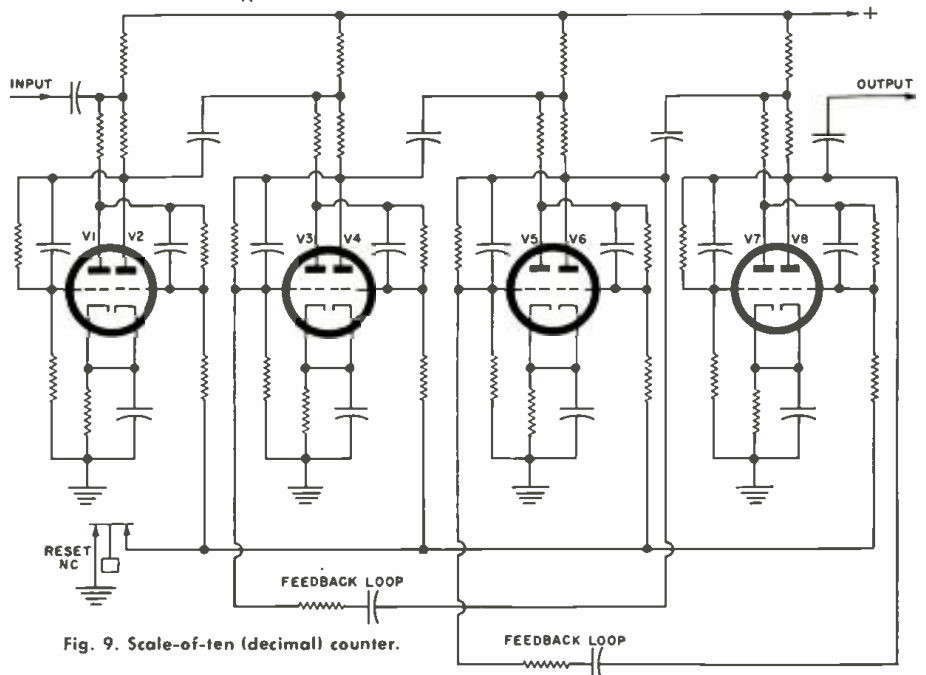

Fig. 9. Scale-of-ten (decimal) counter.

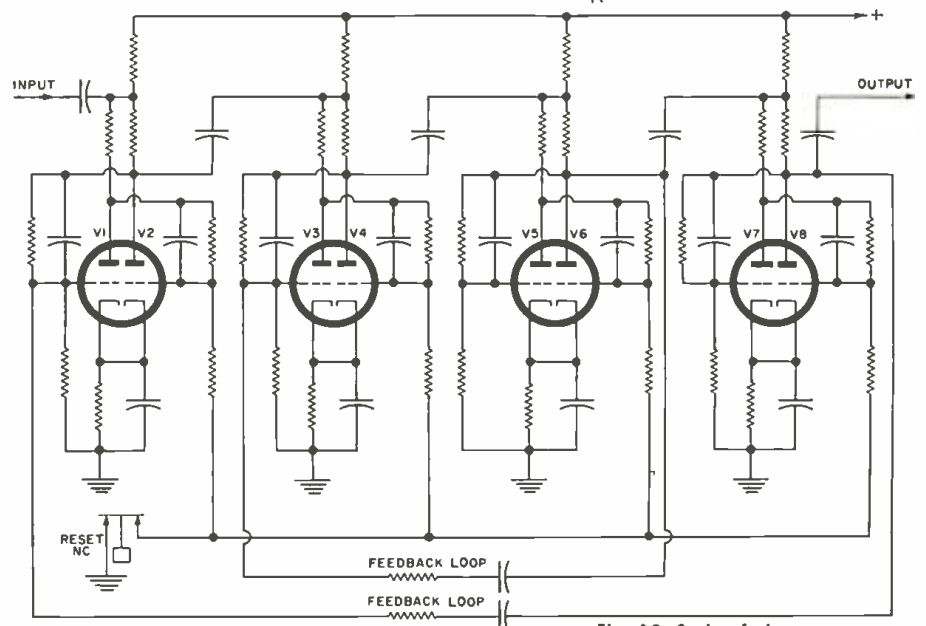

Fig. 10. Scale-of-eleven counter.

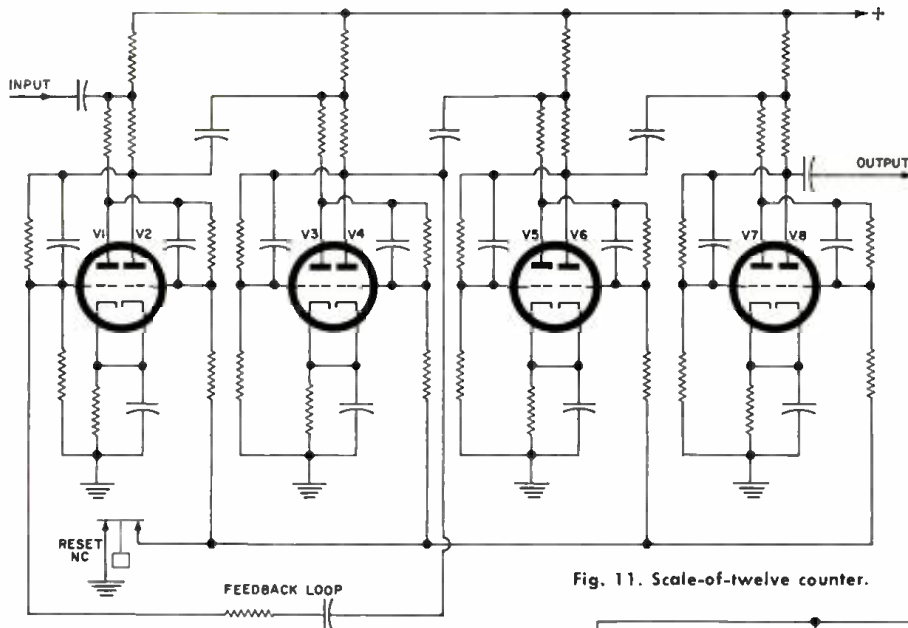

Fig. 11. Scale-of-twelve counter.

of  $V_8$ , followed by a single scale-of-two binary, we will also divide by ten, since  $5 \times 2 = 10$ .) Since we must add six pulses to the ten input pulses to deliver an output pulse, it is evident that the feedback loop going to the grid of  $V_1$  will effectively add two pulses, while the loop feeding the grid of  $V_3$  will add four pulses.

#### Dividing by 11, 12, and 13

To divide by eleven (see Fig. 10), which is a prime number, we must add five pulses during the input cycle. Again, two feedback loops must be used, the loop between the plate of  $V_1$  and the grid of  $V_1$  feeds back one pulse, and the loop between the plate of  $V_8$  and the grid of  $V_3$  has the effect of feeding back four pulses. Thus an output pulse will be delivered for every eleven input pulses.

When dividing by twelve (Fig. 11), we again use cascaded prime-number scalars. A scale-of-three followed by a scale-of-four (two binaries), or *vice versa*, is the simplest approach ( $3 \times 4 = 12$ ;  $4 \times 3 = 12$ ). A scale-of-six followed by a single binary would also produce the same result. If we follow the first method, we will use a scale-of-three feedback arrangement from the plate of  $V_1$  to the grid of  $V_1$ , followed by two cascaded binaries. We could also put the scale-of-three after the two binaries, in which case the feedback loop would be between the plate of  $V_8$  and the grid of  $V_3$ . If we use a single feedback loop between the plate of  $V_8$  and the grid of  $V_1$ , we also divide by twelve, since in this case a scale-of-two is followed by a scale-of-three, and this, in turn, by another scale-of-two ( $2 \times 3 \times 2 = 12$ ).

Thirteen is also a prime number. To divide by thirteen (Fig. 12) requires the addition of three pulses. A feedback loop between the plate of  $V_1$  and the grid of  $V_1$  feeds back one pulse and if this same pulse is also fed to the grid of  $V_3$ , using another feedback loop from the plate of  $V_1$ , this will effectively add

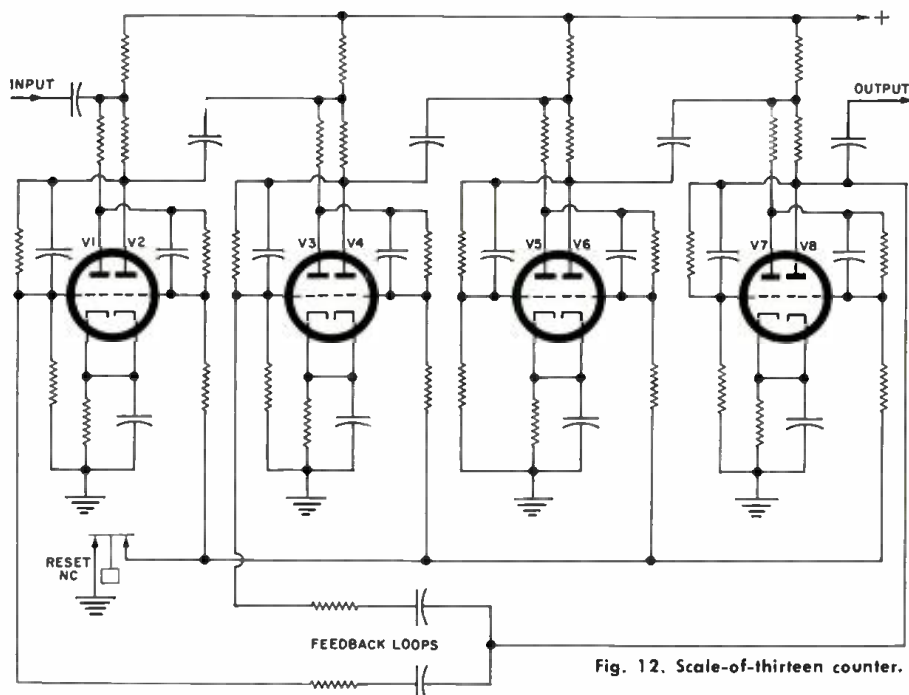

Fig. 12. Scale-of-thirteen counter.

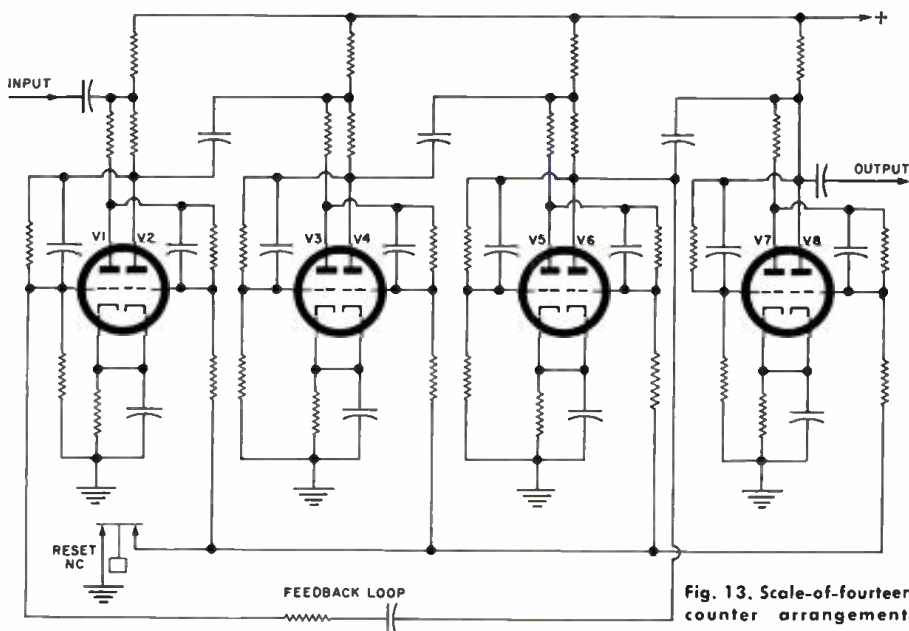

Fig. 13. Scale-of-fourteen counter arrangement.

two more pulses, thus permitting division by thirteen.

#### Dividing by 14, 15, and 16

Dividing by fourteen may be approached in much the same way as dividing by nine. We may use a scale-of-seven and a single binary, or we may merely treat it as we would a prime number, and feed back two pulses from the output. Here (see Fig. 13), a scale-of-seven is followed by a single binary, with a feedback loop between the plate of  $V_8$  and the grid of  $V_1$ . To feed back the effect of two pulses, we may place the feedback loop between the plate of  $V_8$  and the grid of  $V_3$ .

In order to divide by fifteen (see Fig. 14), we need add only a single pulse, with the feedback loop between the plate of  $V_8$  and the grid of  $V_1$ . While it might appear that it would be preferable to use a scale-of-three and a scale-

# BUILD THE FINEST Professional Quality CUSTOMIZED TV KIT

On Easy "Pay As You Wire" Terms  
Only \$15 for the Starting Package!

The  
"PROFESSIONAL"  
Series—designed for  
the perfectionist seeking  
the finest in TV performance.  
Easy to assemble. No technical  
knowledge required. An ideal  
"Learning" Kit with a Complete  
Course of Study is available.



Also available:  
**WIRED  
CHASSIS**  
for custom  
installations  
with a choice  
of vertical or horizontal  
controls and the newest  
19", 23" or 27"  
Picture Tube.



Beautiful Cabinets —  
designed to enhance sound quality and blend with  
modern decor. For TV or combination TV and Hi-Fi.

### A few of the Professional Quality Features:

Choice of push-pull 10-watt audio or output  
to your Hi-Fi system... D.C. restoration...  
Ultra-linear sweep circuits... Newest Stand-  
ard Coil Model PKO Automatic Fine Tuner...  
Super-sensitivity for fringe areas...  
Complete line of Accessories for Custom In-  
stallations.

Choice of 19", 23" or 27" CRT. Prices range  
from \$119 to \$199.

U.S. Armed Services and over 4000 schools and  
colleges have selected Transvision Receivers for  
educational television.

### Interested in Electronics?

Learn the basic principles of elec-  
tronics from the Course available with the Kit.

ASSEMBLY MANUAL—\$2.00

See how easy it is to assemble the Transvision  
Kit. Cost of Manual refunded on purchase of Kit.

**TRANSVISION** New Rochelle, N.Y.  
NE 6-6000

START NOW — MAIL THIS COUPON —  
TRANSVISION Electronics, Inc., New Rochelle, N.Y. Dept. EWT5  
 Send FREE 8-page Catalog...  I enclose \$2 for Assembly  
Manual, refundable on purchase of Kit.  
 I enclose \$15 for Starting Pkg. on pay-as-you-wire plan.  
(Complete Kits range from \$119 to \$199.)

Name \_\_\_\_\_  
Address \_\_\_\_\_  
City \_\_\_\_\_ Zone \_\_\_\_\_ State \_\_\_\_\_

of-five ( $3 \times 5 = 15$ ) in cascade, this  
would be uneconomical since it would  
require three feedback loops rather  
than the single loop actually used in  
Fig. 14.

Division by sixteen requires the same  
four stages and the elimination of all  
feedback. See Fig. 15.

### Conclusion

From all this we can see that any  
division ratio up to sixteen may be de-  
rived from a maximum of four dual  
triodes. The addition of another dual  
triode would permit the selection of  
division ratios up to 32, while a sixth  
stage would allow up to 64, etc. From  
the examples given, any desired division

ratio may be derived, using the logical  
method of determining feedback loop  
positions outlined. While it is usually  
preferable to design scalars and cas-  
cade them to produce the desired di-  
vision ratio, both from design and  
troubleshooting points of view, it may  
not always be economically feasible, as  
was demonstrated in the case of divid-  
ing by fifteen.

When designing scaling circuits for  
any division ratio, it is necessary to feed  
back the effect of the number of pulses  
which, when added to the desired di-  
vision ratio, will equal the maximum  
counting capability of the number of  
binaries used: e.g., 4 binaries for 16, 5  
for 32, 6 for 64, 7 for 128, etc. ▲

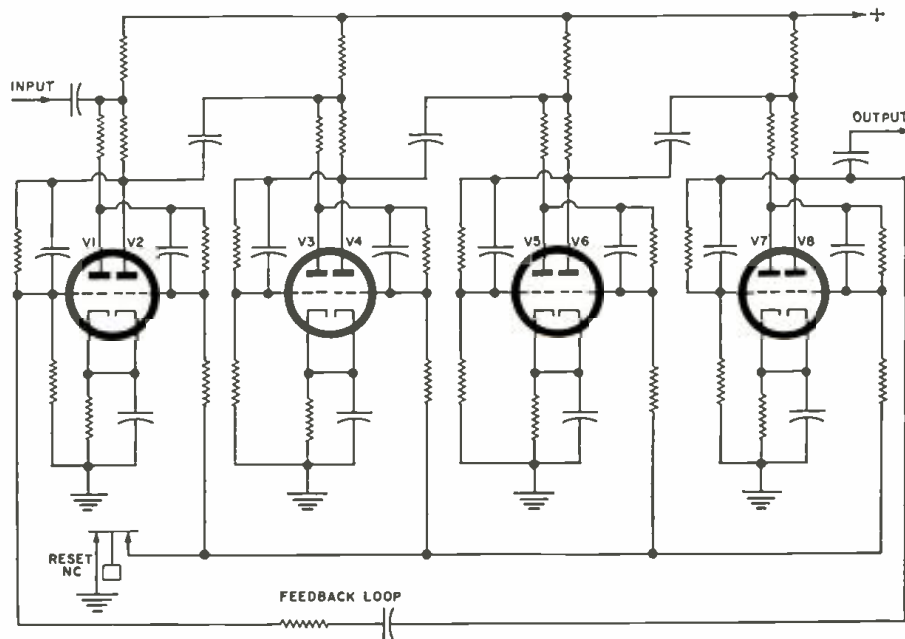
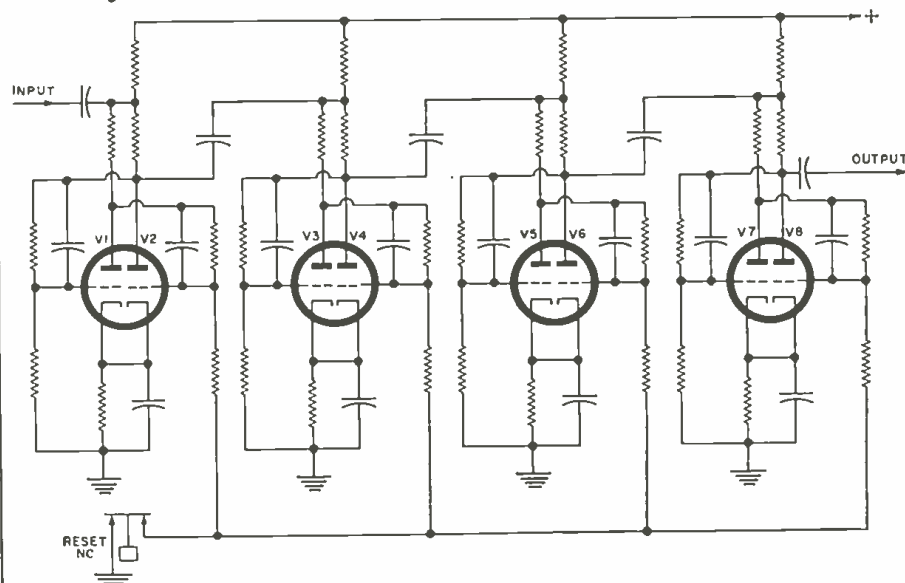

Fig. 14. Scale-of-fifteen counter arrangement. In order to divide by fifteen, it is necessary to add only a single pulse by means of the feedback loop shown connected between the plate of V7 and the grid of V1. Another technique would be to use a scale-of-three counter followed by a scale-of-five arrangement. However, this method would be more complex and uneconomical since it requires the use of three feedback loops instead of the single feedback loop that is shown.

Fig. 15. Scale-of-sixteen counter. No feedback loops are required here as each stage is able to divide the output of the preceding stage by a factor of two.





**NEED A  
110 VOLT  
A.C. OUTLET?  
In CAR, BOAT or TRUCK,  
YOU HAVE IT WITH A**

## terado POWER CONVERTER

Actually gives you 110 volt, 60 cycle A.C. from your 6 or 12 volt D.C. battery! Plug converter into cigarette lighter, and operate lights, electric shavers, record players, electric tools, portable TV, radios, testing equipment, etc.

Models from 15 to 300 watts, priced as low as **\$12.95** LIST

See Your Electronic Parts Dealer or Jobber, or Write:  
**terado COMPANY**  
1058 RAYMOND AVE.  
ST. PAUL 8, MINN.  
In Canada. ATLAS RADIO CORP. LTD. — Toronto, Ont.

**CROWN**  
Professional Tape Recorder

GUARANTEED PERFORMANCE

**SUPRA PROFESSIONAL**  
Unexcelled for broadcast use

3 Heads  
•  
3 Motors  
•  
3 Speeds

**Model BX801—Full Track**  
Also available in half track, two track and quarter track stereo.

All aluminum construction—10½" Reels  
Crown gives more performance per dollar

FREQUENCY RESPONSE	IPS SPEED	FLUTTER & WOV	NOISE RATIO
± 2 db 30 to 28,000 CPS	15	.06%	60 db
± 2 db 30 to 16,000 CPS	7½	.09%	60 db
± 3 db 30 to 8,000 CPS	3¾	.18%	55 db

Write Dept. EW-562 or phone JA 3-4919 for complete information. Some dealer franchises available.

**CROWN INTERNATIONAL**  
Division of  
**INTERNATIONAL RADIO & ELECTRONICS CORP.**  
ELKHART, INDIANA

## Energy Converters (Continued from page 41)

Thompson—each has a history more than a century old. Joule heating caused by the passage of electrical current through a conductor is, on the other hand, irreversible.

In 1822 Thomas Seebeck heated a junction of two different metals and discovered that a magnetic needle held close to the junction was deflected and that an electric current was produced.

A second thermoelectric effect was discovered in 1834 by a French watchmaker, Jean Peltier. He observed that if electric current is passed through a junction of two dissimilar metals, the junction becomes cooler or hotter, depending on the current direction.

Much later, in 1857, W. Thompson (Lord Kelvin) postulated and found a third thermoelectric effect in homogeneous materials. He observed that in a single solid in the presence of an electric current and a temperature gradient, a new reversible temperature gradient was created, dependent on the current direction.

Fig. 5 is a simplified version of the behavior of current carriers in *n*-type and *p*-type semiconductors in thermal equilibrium and after the heat was applied at one end of the respective materials. In the left-hand portion of Fig. 5A the semiconductor is at room temperature and the electrons are moving freely in all directions. If connected to a load and ammeter in a closed circuit, there is no electric current. By heating one end of the material, the electrons in that end also get "hotter," meaning that their velocity and their kinetic energies are increased. As seen in the right-hand portion of Fig. 5A, the "hot" electrons travel toward the cold end of the semiconductor and are piled up. This pile-up is soon terminated because the electrons form a space charge which repels the upcoming electrons back toward the hot end. Soon a dynamic equilibrium is established, with the result that the density of electrons at the cold end is greater than at the hot end. If we close the circuit, an electric current will flow, as observed on the ammeter, from the hot toward the cold end within the semiconductor.

In *p*-type semiconductors (Fig. 5B), in which the carriers are positive holes, we have a similar situation, but with a reversed sign. Holes also pile up at the cold end. The electrical current, however, flows in the opposite direction, from the cold toward the hot end within the semiconductor.

By connecting the two pieces of semiconductor material, an effective thermoelectric unit cell is assembled, as shown in Fig. 5C. This generator transforms heat, applied from the bottom, directly into electrical energy, capable of work. The double electric current will flow as long as the same temperature difference is maintained.

Research efforts in thermoelectric laboratories have steadily increased the efficiencies of semiconductors and made

**LEARN**  
electronics theory this easy way.  
No previous technical knowledge required.

**BUILD**  
the finest professional quality TV Set  
on a practical "pay-as-you-wire" plan.

**SAVE**  
up to 1/2 on cost of equivalent  
educational course plus TV set.

Build the Transvision "Professional" TV Kit described below and get this complete course of study for \$7.95 (available only to Transvision Kit builders.)

Requires no previous technical knowledge. Prepared by experts in teaching novices about electronics.

**YOU LEARN:** About block diagrams... How to read and follow electronic circuits... How to use basic measuring instruments... Theory and operation of basic electronic circuits... How to service TV, Radio, and other types of electronic equipment.



Prices range from \$119 to \$199.

**The Transvision "Professional" TV Kit**  
Choice of 19", 23", or 27" Picture Tube... Easy "Pay as You Wire" Terms... Only \$15 for the Starting Package.



A few of the Professional Quality Features of Transvision TV Kits:

Choice of push-pull 10-watt audio or output to your Hi-Fi System... D.C. restoration... Ultra-linear sweep circuits... Standard Coil Model PKO Automatic Tuner... Super-sensitivity for fringe areas... Complete line of Accessories for Custom Installations.

U. S. Armed Services and over 4000 schools and colleges have selected Transvision Receivers for educational television.

**ASSEMBLY MANUAL—\$2.00**

See how easy it is to assemble the Transvision Kit. Cost of Manual refunded on purchase of Kit.

**TRANSVISION** New Rochelle, N.Y.  
NE 6-6000

**START NOW — MAIL THIS COUPON —**

TRANSVISION Electronics, Inc., New Rochelle, N.Y. Dept. EW-L5  
 Send FREE 12-page Catalog...  I enclose \$2 for Assembly Manual, refundable on purchase of Kit.  
 I enclose \$15 for Starting Pkg. on pay-as-you-wire plan. (Complete Kits range from \$119 to \$199.)

Name \_\_\_\_\_  
Address \_\_\_\_\_  
City \_\_\_\_\_ Zone \_\_\_\_\_ State \_\_\_\_\_

# SURPLUS

**SILICON RECTIFIERS.** All rectifiers listed at maximum peak inverse voltage ratings; approximate forward voltage drop, 1.5 volts.

1N1450	5	amp.	100 volts	1.00
1N1451	5	amp.	200 volts	1.25
1N1452	5	amp.	300 volts	1.50
1N1453	5	amp.	400 volts	2.00
1N1454	25	amp.	100 volts	3.00
1N1455	25	amp.	200 volts	3.50
1N1456	25	amp.	300 volts	4.50
1N1458	35	amp.	100 volts	3.50
1N1459	35	amp.	200 volts	4.00
1N05P7	50	amp.	50 volts	6.00
1N1462	50	amp.	100 volts	7.00
1N1466	75	amp.	100 volts	10.00
1N1467	75	amp.	200 volts	11.00
1N1468	75	amp.	300 volts	12.50
1N05V7	150	amp.	50 volts	16.50
1N1474	150	amp.	100 volts	17.00

## X-BAND POWER LEVEL TEST SET, TS-36/AP

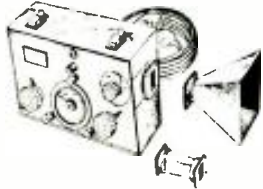

Brand new, in original pack-  
ing, with accessories. Measurements 10 to 30 dbm 87.00-93.00 mc

PRICE  
\$14.95 each

## OIL CAPACITORS

1 MFD. 25,000 V. DC Westinghouse Intertec Type FP Style 1313854.

\$39.95 each

10 or more, \$35.00 each.

## 8-Day Elapsed Time Surplus Aircraft Clock



Here's an accurate time-control center that'll help you win your next rally. It not only tells you the date and time of day right to the second. It's a stop watch that gives you elapsed time in seconds, minutes and hours! The 24-hour clock simplifies adding and subtracting elapsed time for your navigator. Manufactured by Elgin Watch Co. to military exacting specifications, it will remain accurate in spite of road bumps and vibrations. Uses no electrical connections. Does the job of high-cost equipment. Jewelled Sweep Second Hand/Luminous Hands and numerals/24-hr. Dial. Black face and plastic case. 3 1/8" mounting. Cost the Gov't \$185.

Postpaid Only... \$39.95

## TYPE AN/ARN-6 RADIO COMPASS



Receiver R-101/ARN-6. 100-17.50 kc in four bands. Excellent condition. Price ..... \$49.50  
Loop AS-113-B. Excellent condition. Price ..... \$27.50  
Indicator ID-91B/ARN-6. Excellent condition. Price ..... \$9.95  
Mounts MT-273 or MT-274. Excellent condition. Price ..... \$9.95 each

**MANUAL** Handbook of operating instructions, general installation adjustment plus 15 pages of diagrams & schematics. Price ..... \$3.50

## 1/100 SECOND TIMER, INTERVAL, 115 VAC, 60 CYCLE

Mfgd. by Standard Electric Time Co. accuracy .005 sec. w/ DC clutch first hand speed—1 RPM—totalizes 60 seconds short hand smallest graduations .01 sec. 115 VAC, 60 ohms, brake solenoid 27.5 VDC dial—white background w/ black characters, check meter to close set of contacts at one second intervals contact rating 1 amp, 28 VDC, non-inductive. Manual Paged. Outside dim. 3 1/2" sq. in. PRICE ..... \$25.00 EACH



NO C.O.D.'S. REMIT FULL AMOUNT WITH ORDER.

## C & H SALES CO.

2176 E. Colorado St. - Pasadena 8, Calif.

Temp. Region	Compound	Conversion Efficiency (%)
Up to 400° C	ZnSb, PbTe	3-8
	Bi:Te	5-11
	(Bi,Sb):(Te,Se)	8-16
Above 400° C	CeS, MnTe, Ge-Si oxides	below 8

Table 1. Proven thermoelectric materials.

them more and more attractive for application as power sources or refrigerators. Thermal efficiencies of a few proven thermoelectric materials are given in Table 1.

The main advantages of thermoelectric energy converters are: no moving parts, noiseless operation, no gyroscopic effects, no lubrication necessary, infinite shelf life, efficiency not proportional to output, and ability to operate on any heat source from combustion to nuclear and solar heat energy. To balance the picture, they also have certain weak points such as: relatively low efficiency, low-voltage, low-impedance output, relatively poor performance at high temperatures, and a need for encapsulation because of the possible oxidation effects.

Practical applications of thermoelectric conversion principles follow two main directions: as generators of electricity (Seebeck effect) and as cooling devices (Peltier effect). Research efforts to improve the thermoelectric parameters of materials and development efforts to reduce the fabrication costs of basic thermoelectric modules are unusually extensive. More than 800 companies and organizations in the U.S. are interested in or working on one or more phases of thermoelectricity. New approaches are now being studied in the realm of thermoelectric thin-film structures (see this month's cover).

## Thermo-Photovoltaic Converters

A very new concept for heat-to-electricity energy conversion was proposed by Pierre Aigrain during his lecture series at MIT in 1961. It has some resemblance to well-known silicon solar cells, in which photons from the solar light spectrum excite electrons in a *p-n* structure. In thermo-photovoltaic (TPV) converters photons are also used but they emanate not from the sun but from a hot incandescent source.

A schematic structure of a *p-i-n*

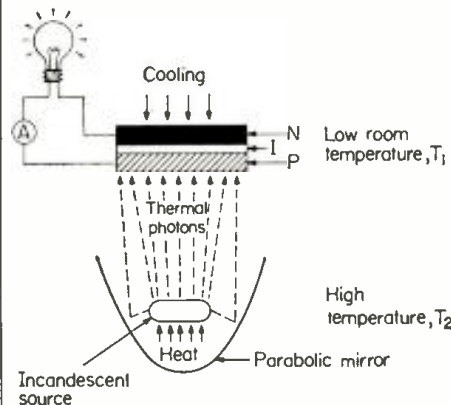

Fig. 6. Thermo-photovoltaic converter.

## SUBSCRIBE WITH CONFIDENCE AT YOUR DOOR

**CR** JOHN DOE  
(not valid if altered—not good for Credit Purposes)

has been registered with Central Registry of Magazine Subscription Solicitors at an authorized representative of

**SUBSCRIPTION AGENCY**

**EXPIRES**

As a member of Central Registry, this agency has posted surety of \$1,000 to guarantee delivery to publishers of all subscription orders sold on its official receipts and by its authorized representatives.

**CENTRAL REGISTRY OF MAGAZINE SUBSCRIPTION SOLICITORS**

170 N. LaSalle  
170 N. LaSalle, New York 22, N. Y.

*W. J. ...*  
Secretary

A-00000 SOLICITOR REGISTRATION

Subscription agency members of Central Registry have deposited a BOND with CR to guarantee delivery of orders to publishers. When their representatives call at your home, their credentials are your assurance of dependable service and continuing reading enjoyment.

## CENTRAL REGISTRY of Magazine Subscription Solicitors

(Sponsored by Magazine Publishers Assn., Inc.)  
444 Madison Ave., New York 22, N. Y.

## NEVER FAIL—ZONE YOUR MAIL

The Post Office has divided 106 cities into postal delivery zones to speed mail delivery. Be sure to include zone number when writing to these cities; be sure to include your zone number in your return address—after the city, before the state.

## TAPE HOBBY CLUB

Global Tape Recording Exchange Hobby Club. We bring the USA and world to your VCR. This is the most rewarding hobby known for all ages. Tape-sending can put you in contact with people all over the world for exchanges of ideas, music, educational knowledge or write to Mailway Co.  
216 W. Jackson Blvd., Chicago 6, Ill. or 51 W. 35th St., New York 1, New York or 601 S. Vermont, Los Angeles 5, Calif. or 2006 E. Courtland, Spokane 27, Wash.



**-- then you need us!**  
GET STARTED RIGHT by writing for **FREE** 8 page catalog illustrating over 30 business forms and systems designed specifically for TV-Radio Service.  
**ON SALE AT YOUR PARTS JOBBER**

Oelrich Publications • 4308 N. Milwaukee • Chicago 41, Ill.



TPV converter is shown in Fig. 6. The incandescent source, heated to a temperature above 1800 degrees C, generates photons, which are directed toward the converter surface by means of a parabolic mirror. The cell itself is a *p-i-n* germanium sandwich (*p* stands for *p*-type, *i* for intrinsic, and *n* for *n*-type).

The process of thermo-photovoltaic energy conversion is still very much unexplored. It has, however, several fundamental advantages over solar cells. It claims an unusually high theoretical efficiency, on the order of 70 per-cent for monochromatic light. A practical efficiency of 30 to 35 per-cent is expected. The system is being intensively studied at MIT under the direction of Professor J. Blair.

In thermoelectric and thermionic energy converters the working fluid is the electron "gas" which is heated through energy exchange with the crystal lattice. Relaxation times which regulate the heat exchanges between electrons and the lattice are extremely short, on the order of 10<sup>-12</sup> second. This means that when the desired electronic excitation is produced, lattice and electrons have practically the same high temperature. Since the thermal stability and the lifetime of materials deteriorate to a marked extent at high temperatures, especially those above 1500 degrees C, thermionic and thermoelectric generators cannot function over long periods of time without some loss in efficiency.

The thermo-photovoltaic converter offers the possibility of producing an effective electronic excitation and still keeping the lattice cool. The generation of electron-hole pairs by light in a semiconductor has a relaxation time for energy exchange that is at least a million times longer than the times for energy transfer in thermoelectric and thermionic conduction processes. Herein lies the most important advantage of TPV converters in which heat is converted to light through incandescence and, in turn, light is converted to electrical energy by a photocell maintained at room temperature.

Modern silicon solar batteries, widely used in satellites, have conversion efficiencies up to 14 per-cent. For efficient operation they depend on silicon, whose energy gap closely matches the spectral characteristics of the sun. Germanium actually would be a much better material for photovoltaic conversion if it were not for its low energy gap and, consequently, for its mismatch with the solar spectrum. In the TPV converter, on the other hand, it is possible to control the emissivity of the radiation (by adjusting the temperature of the incandescent source) and match it with the recombination spectrum of the photocell material that is used.

As has been shown, many new ideas on methods of power generation are being explored. Which of these will find the greatest use in the future remains to be seen.



### 19 D.B. GAIN! CUTS SNOW. BOOSTS SIGNAL

Make any TV or FM Antenna work better by amplifying signals with the new Winegard Tenna-Boost.

19 DB gain—no peaks and valleys. Linear frequency response—extremely low VSWR. All AC power supply.



Because of its extra power, the Winegard Tenna-Boost can be used to operate up to 6 TV sets from one antenna. Works perfectly for black and white and color . . . plus FM and FM stereo.

There's a big difference in antenna amplifiers! Ask your distributor or write for technical bulletin.



## Winegard

3003-5 Scotten, Burlington, Iowa

#### SPECIFICATIONS:

Size: 24" wide, 10" high, 9" deep.

Power Handling Capacity: Will operate at maximum efficiency with amplifiers from 8 to 50 watts.

Response: High sensitivity and compliance. 45—16,000 CPS.



### Thousands have been sold/Check these quality features

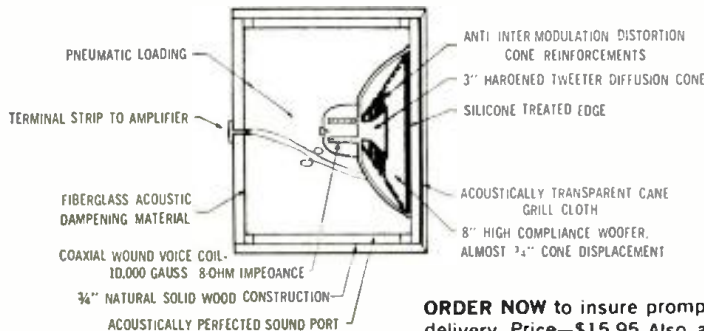

**ORDER NOW** to insure prompt delivery. Price—\$15.95 Also available the "Windsor"—an oil finished luxurious walnut cabinet at \$25.00. F.O.B. factory.

## the KENT

amazing value—only  
\$15<sup>95</sup>

After three years of extensive research and development, you can now enjoy the finest speaker system in a handsome bookshelf unit. Fits anywhere! Matches any decor! The "Kent" is unconditionally guaranteed to be the finest unit you ever heard, regardless of price, or your money will be cheerfully refunded. The "Kent" combines the craftsmanship of American cabinetmakers with the famous engineering skills of Great Britain.

Unlike cabinets of processed wood, the natural grained solid wood "Kent" can be stained, oiled or waxed in any finish of your choice.

Because of our amazingly low introductory price, the famous British manufacturer will not permit us to advertise the name of this ultra sensitive, costly speaker.

Anglo American Acoustics Ltd.  
129 Maryland Ave., Freeport, New York

EW-2

Gentlemen: Enclosed is my check for \$ . . . . .  
Please ship me:

..... "Kent"—natural wood cabinet at \$15.95.  
..... "Windsor"—oil finish walnut cabinet at \$25.00.

I UNDERSTAND THAT THESE SPEAKER SYSTEMS ARE GUARANTEED AND IF I AM NOT COMPLETELY SATISFIED I MAY RETURN FOR A FULL REFUND WITHIN TEN DAYS AFTER RECEIPT.

NAME . . . . .  
ADDRESS . . . . .  
CITY . . . . . ZONE . . . . . STATE . . . . .

# if YOU ARE AN ENGINEERING WRITER...

- who has a BSEE, or equivalent experience, plus at least two years' experience related to large-scale electronics systems . . .
- who is familiar with Army Ordnance specifications, radar theory, functional schematic diagrams . . .
- who possesses a high level of technical competence as well as writing skill . . .
- who has the leadership ability to direct and inspire support personnel . . .
- who is a professional in every sense of the word, and wants to be recognized—and paid—accordingly, then . . .

## YOU MAY QUALIFY FOR AN UNUSUAL PROJECT POSITION AT HMED

Several key openings exist now at General Electric's Heavy Military Electronics Department—an organization with responsibility for some of the Nation's most advanced, large-scale electronic development programs . . . and Engineering Writer needs that will continue—and grow—in years to come.

If selected, you'll be assigned to our long-range HIPAR program, with over-all project responsibility for related operating and service manuals. Your career potential will equal that for our top design and manufacturing engineers.

For full, confidential information—including a copy of this new brochure—send us a summary of your background. 175-12



Write: Mr. D. J. Carney, Engineering Administration Section R-1, Heavy Military Electronics Dept., Court Street, Syracuse, New York. (An Equal Opportunity Employer)

**GENERAL ELECTRIC**

# Within the Industry

**DR. T. A. LONGO** has been appointed director of research and engineering for the Semiconductor Division of *Sylvania Electric Products Inc.*



He joined the corporation in 1958 as head of the Semiconductor Engineering Group of the *Automatic Electric Co.* and in 1959 transferred to *Sylvania* as manager of the Telephone Semiconductor Group. Prior to his new assignment, he was manager of the Advanced Device Research Laboratory of the Semiconductor Division.

Dr. Longo received his B.S., M. S., and Ph.D. degrees from Purdue University, later teaching in the Physics Department of his alma mater. He is a long-time member of the American Physical Society.

**SYLVANIA ELECTRIC PRODUCTS INC.** will add 77,000 square feet to its Reconnaissance Systems Laboratory in Mountain View, California. Occupancy is expected to be completed by summer . . . **PARKER ELECTRICAL INSTRUMENT CORPORATION** has moved into a new plant at 200 Harvard Ave., Stamford, Conn. . . **ALLIED CONTROL COMPANY, INC.** has completed its new plant at Plantsville, Conn., doubling present production capacity . . . **INSULTRONIC CORPORATION OF AMERICA** has completed its new electronic testing laboratory at Farmingdale, New York.

**FRANK R. DEMCHOCK** has been named director of the sales and service division of *General Precision Inc.'s GPL Division.*



He has been serving as acting director prior to his appointment. He succeeds Robert Tate, who after a leave of absence due to ill health, has assumed a liaison position with the corporation's *Kearfott Division.*

Prior to joining the company, Mr. Demchock held sales management positions with *Magnavox Corp.* and *Chicago Aerial Industries.* He also spent seven years with the Air Force as chief of the Airborne Communication and Navigation Section at Wright-Patterson Air Force Base, Dayton, Ohio.

**DR. JOHN DOHERTY** has been named senior staff physicist in the research section of the *Bendix Computer Division's* engineering department . . . **PAUL D. ALLEY** has joined the *Internu-*

*tional Electronic Industries Division of Standard Pressed Steel Co.* as technical director. He will be responsible for the production engineering and administration of the firm's Nashville, Tenn. capacitor plant . . . **DR. PHILIP N. HESS** has joined *Litton Industries' Electron Tube Division* research laboratory as senior scientist in charge of crossed field research . . . *Haceltine Corporation* has named **WILLIAM KES** to the post of vice-president, administration of the electronics division . . . *Cornell-Dubilier Electronics* has appointed **GLENN E. RONK** and **ANTHONY A. DELISSE** vice-presidents . . . **JOHN THORN** is the new sales manager of the Commercial Division of *Jackson Electrical Instrument Co.* . . . **THOMAS J. MORRISSEY** has joined *United Aircraft's Norden Division* as chief—sales operations in the precision components department . . . **LAWRENCE MENDELSON** has been named vice-president, marketing, for *Assembly Engineers, Inc.* with headquarters in Los Angeles . . . **JAMES SMILEY** has been appointed sales manager of *B & K Instruments, Inc.*, Cleveland manufacturer of scientific and industrial measuring equipment . . . *Heller Roberts Instruments Corporation* has named **R. J. OLMUTZ** to the post of sales manager of the electronics-electrical division . . . **DR. RAMON J. RHINE** is the new head of management control system activities at *System Development Corporation*, Santa Monica, California . . . **GORDON L. FULLERTON** has been named vice-president and general manager of the parts division and **WALTER A. WEISS** vice-president and general manager of picture tube operations at *Sylvania Electric Products Inc.*

**JERROLD ELECTRONICS CORPORATION** has acquired **PILOT RADIO CORPORATION** in an all-cash transaction . . . **ELECTRO WINDINGS AND COMPONENTS, INC.** has been formed in Hillside, N.J. for the design and manufacture of toroidal coils and components . . . **SPRAGUE ELECTRIC COMPANY** has acquired controlling interest in the **TELEGRAPH CONDENSER COMPANY (CANADA) LTD.** of Toronto . . . **BRAYSHAW ELECTRONICS, INC.** has opened offices and a plant at Olivia Street, McKees Rocks, Pa. and will manufacture selenium rectifiers, silicon rectifiers, and other semiconductors and components . . . **ARCO ELECTRONICS, INC.** stockholders have approved the merger of their firm with **LORAL ELECTRONICS CORPORATION.** **LORAL** will be the surviving company but under the merger agreement **ARCO** will continue to operate with its own name, management, and functional identity . . . **INTERNATIONAL RESISTANCE CO.** has purchased the business and assets of **FRONTIER ELECTRONICS CO.**

# LIVELY READABLE HOW-TO BOOKS FOR THE EXPERIMENTER AND ELECTRONIC HOBBYIST

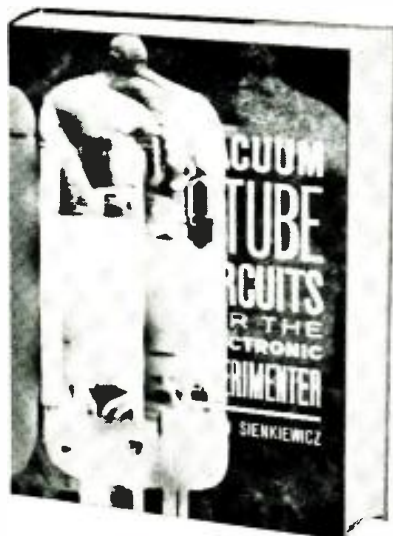

## VACUUM-TUBE CIRCUITS FOR THE ELECTRONIC EXPERIMENTER

by Julian M. Sienkiewicz

How many times has the experimenter wanted a diagram of a basic vacuum-tube circuit which he could use as a guide in building some practical electronic device? At last, in one book, he can find all the basic diagrams, schematics, and other vital information on vacuum tubes and their circuits. One hundred vacuum-tube schematic diagrams, plate-characteristic curves, simplified schematic diagrams, test circuits and other selected illustrations supplement the informative text to make this new publication one of the most useful and informative books available for the rapidly growing legion of experimenters and electronics hobbyists. 192 pages, 100 illustrations.

**\$4.95**



## CLASS D CITIZENS RADIO

by Leo G. Sands

The first and only book to be published in this important and rapidly expanding field. Leo Sands, author of almost 500 technical articles and 4 books, gives complete information on this important commercial class of radio and explains just what Citizens Radio service is and what are its many applications. Many illustrative circuits are shown and there is a special appendix of FCC rules and regulations. 181 pages, 72 illustrations.

**\$4.95**

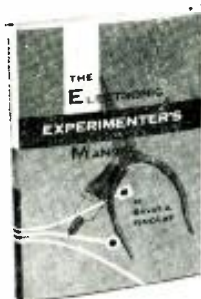

## THE ELECTRONIC EXPERIMENTER'S MANUAL

by David A. Findlay

The ABC's of electronics experimentation and project construction are presented in this book in such plain language and in a style so easy to read, that anyone will become absorbed from the very first chapter. The projects advance from the simple to the more advanced. Through these pages the reader will acquire the knowledge and skill to turn out his own short-wave receivers, intercom systems, transistor radios, etc. 169 pages, 170 illustrations. **\$4.95**

## COMPUTERS AND HOW THEY WORK

by James D. Fahnestock

A solid and acclaimed introduction to this ever-expanding field. A completely understandable and comprehensive study that describes in clear and precise terms computer principles, manufacture, operation and maintenance. Provides a solid foundation for the study of computer techniques. Discusses computer memories, flip-flops, programming, etc. The 113 special illustrations provide a visual explanation of computer operation and principles. 228 pages.

**\$4.95**

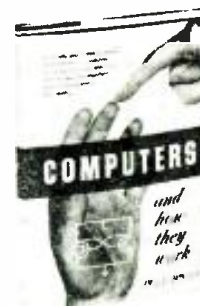

## USE THIS HANDY ORDER FORM

ELECTRONICS BOOK SERVICE—A. S. Barnes & Co. Inc.  
11 East 36th Street, New York 16, N.Y. EW 2A

Please send me the books I have checked below:

I enclose \$\_\_\_\_\_ (You pay all postal charges.)  Send C.O.D. (I pay charges)

\_\_\_copy(ies) VACUUM-TUBE CIRCUITS FOR THE ELECTRONIC EXPERIMENTER \$4.95

\_\_\_copy(ies) CLASS D CITIZENS RADIO \$4.95

\_\_\_copy(ies) COMPUTERS AND HOW THEY WORK \$4.95

\_\_\_copy(ies) THE ELECTRONIC EXPERIMENTER'S MANUAL \$4.95

NAME \_\_\_\_\_

ADDRESS \_\_\_\_\_ CITY \_\_\_\_\_ ZONE \_\_\_\_\_ STATE \_\_\_\_\_

If I am not fully satisfied I can return these books in seven days for a full and prompt refund.

# GET IT from GOODHEART!

## LOOK! New Arrivals:

### MEASURE E, I, R TO 4-FIGURE ACCURACY

and with ZERO current drawn from ckt being measured. Voltage reading. Potentiometric method. We supply 100 K & 5-dial Kelvin-CT 20K ohm Voltage Divider, accuracy .01%, plus .01% resistors for Divider connection as Wheatstone Bridge, plus 0-center uAmmeter, plus exact instructions, theory & practical cts. Divider & Potentiometer. You supply cheap batteries for 3-figure accuracy or standard cell for 4 figures. This is a \$1055.00 Test Set! All for only **\$79.50**

West. Elect. K5-10375 Null Voltage Test Set. 0.250 v. made by L & N. Is 4-dial 100 K ohm Voltage Divider, accuracy 1 part in 100,000. with sensitive L & N Galvanometer and convenient switching cts **\$199.50** built in. all in portable case

### WESTON STANDARDIZING POTENTIAL XFRMR

Mod. 311 Type 3. Adjust 120 v. 100-125 cy to wdr 1 to read 150.0 v on your meter at wdr 3. Get 1 1/2, 3, 7 1/2, 15 & 30 v at wdr 2. accurate 0.1%. **\$199.50** to 500 ma. Regular \$461.50. only

### MIL SPEC SILICON DIODES IN250A

Unused, contract termination. 200 PIV 20A at 150 deg. C. 1/2-28 stud. hex base. Max 1 1/2 v drop. 5 ma reverse. 250 A kg. Cy surge. Regular \$14.00. **\$2.50** Buy postpaid at only

### PRECISION PHASE METER AN/URM-67

Phase Monitor ME-63 U in chest w cords. Inputs 20-20,000 cy 2-30 v peak, reads 0-360 ± 1 deg. Similar Tech. Instr. = 322-A. Acquis. **\$275.00** cost \$1420.00. Like new, only

### HANDY-DANDY 3-PH 400 CY INVERTER

Ideal for labs. Instrument checkouts, breadboard assemblies, etc. Eclipse-Pioneer = 12142-1-A. In: 27 1/2 v f req. Out: 3 22A. Freq. 400 cy 250 mA. 1.0 PF. v. reg. regulated. Only 9 1/4" lg. 6 1/4" h. Very clean, checked, grtd. w/mating plug. **\$24.50** 14 lbs fob San Diego, only

### GRAPHIC RECORDERS AND AMPLIFIERS

Brush BL-262. 2-channel elect. wrtg. rack mtd. sensitivity 1.1 mm/v. 1450 ohms, 16 v rms FS. Switch selects 8 chart speeds from 1 to 250 mm/second. Regularly \$1650. Our price, checked OK **\$395.00**  
 Brush BL-202, same Denmotors, 2-chan. portable, ink wrtg. gear-chifted 5. 25 125 mm/sec. Regularly \$875.00. Checked, ready to use **\$250.00**  
 Same for electric wrtg w pwr supply **\$295.00**  
 Brush BL-530 2-chan. rack-mtg DC amplif. 50 mv max. sens. line regular \$750. only **\$150.00**  
 Brush RD-5621-01, same except max max. sensitivity 1 mv chart line. checked, ready to use **\$175.00**  
 Easterline-Ancus portable. Type AW. spring-wound chart drive. 2 1/2-0-2 1/2 ma dc. checked OK **\$175.00**  
 Est.-Ancus ditto 1 ma dc full scale, new **\$250.00**  
 Est.-Ancus ditto 20 pps record 24 v dc events with 400 ohm actuators, new, only **\$150.00**  
 Gen. Radio = 715AM DC Amplifier, new, only **\$97.50**  
 Sanborn = 154-100B rack-mtg 4-chan. recorder, elect. wrtg. plus time marker. Multiple chart-speed choice. Checked and certified 100% OK **\$450.00**  
 Sanborn = 150-290A, 2-chan. DC amplifier. **\$175.00**  
 Denmotors only. Similar in shape to Brush BL-9025, less pen holders. Unknown make, appear exc. **\$49.50**

### NEW COMPLETE MAGNETOMETER AN/ASQ-3

Osc. 0-3 & Converter CV-1 in Case CY-4; Head (with orienters) DT-2; Dynamotor Assly DY-6; Control C-8; Indicator ID-5 (is a 1/2-0-1/2 ma dc meter, may be paralleled by a resistor if required); set of plus/minus 160-page Handbook. Input 28 v dc 10A, starting surge 70A. At max. sensitivity, 5 gammas produce 1/2 ma dc. in Mir's packing, clean and fresh as day it left the factory. Shpg wt 250 lbs. **\$349.50** fob Phila., Pa.  
 Add for Recorder RD-4 ASQ, new **\$200.00**

### RADIO RECEIVER AND/OR SPECTRUM ANALYZER

AN APR-4 rcvr is the 11-tube 30 mc IF etc. for its plug-in tuning units; has 5-meter, 60 cy pwr sply. Pan. Video & Audio outputs. AM. Checked, aligned, with hands for 3R-1 book. fob Los Ang. **\$164.00**  
 Add \$59.50 for 1-2.2 kmc; add \$175.00 for 2.2-4 kmc; add \$150.00 for 30 mc Panadapter RDP; add \$79.50 for Test Oscillator TS-47/APR (40-3000 mc pwr plug & Handbook. fob Los Ang. **\$179.50** 1% CW, AM. Pulsed, w/built-in 60 cy sply)

### COMMUNICATIONS RECEIVER BARGAINS

BC453B: 190-550 kc 6-tube superhet w 85 kc IF's. Ideal as long-wave rcvr. Form 100. 2nd and 3rd conv. for other rcvrs. W/all data. checked. **\$12.95** rtd OK. fob Los Ang.  
 Same, in handsome Cabinet w pwr sply, spkr, etc., ready to use, is our QX-53 **\$37.50**  
 RBS: Navy's pride 2-20 mc 14-tube superhet has voice filter for low noise, ear-saving AGC, high sens. & select. IF is 1255 kc. Checked, aligned, w pwr sply, cords, tech doc. ready to use, fob Charleston, S.C. or Los Angeles **\$99.50**  
 R-45 ARR-7 brand new, 12-tube superhet .55-4.3 mc in 6 bands, 5-meter, 455 kc IF's, xtl filter, 6 sel. positions, etc. Mof and complete. It can be made still better by double-converting into the BC-453 or QX-535. Pwr sply includes DC for the automatic **\$179.50** tuning motor. FOB San Antonio

### 2-METER RECEIVER & 2/6/10 METER XMTR

SCR-522 rcvr, xmtr, rack & case, exc. cond. 19 tubes include 832A's, 100-156 mc AM. Satisfaction grtd. Less than cost of tubes alone in surplus! Shpg wt 85 lbs, fob Bremerton, Wash. **\$14.95** only

Add \$3.00 for complete technical data; Original schematics, Parts lists, IF, xtl formulas, AC pwr sply data, rcvr Continuum tuning, mtr 2-meter use & putting xmtr on 6 & 10.

### 0.1% SORENSEN LINE VOLTAGE REGULATOR

= 50005 holds setting 110-120 v to 0.1% despite line changes 95-130 v 1 ph 50/60 cy & load changes 0-5 kva. Max. harmonics 3%. Recovery 0.15 seconds. Regular \$69.95 less 1% off. **\$39.50** w/spares, 285 lbs fob Utica, N.Y.

See our ads in Feb., March, April issues for the BEST BUYS in Test Scopes, Freq. Meters, Pulse & Signal Generators, Scintillators, E. G. Counter, Tuning-Fork Standards, Solu C-V Xrfrms, etc., etc.

**R. E. GOODHEART CO.**

P. O. Box 1220-A Beverly Hills, Calif.

of Cleveland in an all-cash transaction... **THE TENNA MFG. CO., INC.** has acquired the **STROMBERG-CARLSON** auto radio operation from **GENERAL DYNAMICS CORPORATION**... **MODEL ENGINEERING AND MANUFACTURING CORP.** has acquired the deposited carbon resistor division of **TECHNOLOGY INSTRUMENT COMPANY** of Acton, Mass. All equipment and facilities are being moved from the Canton, Mass. plant to Huntington, Indiana.

**LOWELL S. PELFREY** has been named director of research and development for **Trans-Sil Corporation**, a wholly owned **Raytheon** subsidiary.



A key semiconductor engineer with the company when **Raytheon** pioneered the mass production of transistors in 1952. Mr. Pelfrey has held several responsible positions in the field of practical research. For the past eight years he has served as director of the research and development laboratory of **International Rectifier Corp.**

Mr. Pelfrey is a member of the American Physical Society and a graduate of the University of Kentucky.

**WILLIAM H. HUDSON** has been named manager of television product development in the electric products division of **Corning Glass Works**... **ROBERT J. MADZAR**, former marketing executive for **Sylvania Electric Products Inc.**, has joined the Data Systems Division of **Telex, Inc.** as government marketing manager... **HERSHNER CROSS** has been elected a vice-president of **General Electric Company**. He is general manager of the radio and television division with headquarters at DeWitt, New York...

The appointment of **ALBERT DeJOHN, JR.** as supervisor of mechanical engineering at **E D P Corporation** has been announced by the company... **LEWIS O. WARD, JR.** has been named manager of the **Hulltest Division of Instrument Systems Corporation**... **WILLIAM A. WHEATLEY** has been named general manager of the Industrial Instrument Division of **Electronic Assistance Corporation**. Plainview, Long Island... **CONANT PAUL HARPLEY** is the new chief engineer of the loudspeaker division of **Oxford Electric Corporation**... **Texas Instruments Incorporated** has added two scientists. **DR. PAUL KECK** and **DR. ROLF HABERRECHT**, to its central research and engineering staff... **DR. ANDREAS B. RECHNITZER** has joined the **Antonietics Division of North American Aviation, Inc.** to direct the research and development of new systems for undersea exploration and exploitation... **RALPH H. G. MATHEWS**, director of marketing at **Blonder-Tongue Laboratories**, has retired after 40 years in the electronics industry... **JOSEPH P. O'REILLY** has been elected president of **Ferroxcube Corporation of America**... **MARTIN HOFFMAN** has been named assistant to the president of **Designatronics, Inc.**... **ROYDEN F. ESTOPPEY** has been appointed staff engineer of **Weston Instruments Di-**

### SAXITONE RECORDING TAPE

\*Oxide guaranteed not to rub off or squeak—or money back. Compare ours with other "Bargain" tape. You'll find it's more than just "price" when you deal with us. We are original pioneers in the tape recorder business and our reputation means everything to us.

600' acetate (plastic), 5"	75
600' MYLAR 5" reel	95
600' MYLAR (Polyester), 6"	99
1200' MYLAR, 15 mil, 5" reel	119
1200' Acetate (plastic), 7"	119
1200' MYLAR, 15 mil, (Strong)	148
1800' acetate (plastic), 7"	179
1800' MYLAR 1 mil thick, 7"	199
2400' MYLAR, untempered, 7"	269
2400' MYLAR, tempered, 7"	299

(Large Users, Even Lower) Plus Postage

SAVE 4-track stereo 30% music on tape

### NORELCO SPEAKER

Famous ABBEYM, twin cone 8" (75,000 cycles) discontinued model, former list \$8.00, usual net 4.95 plus postage. (2 for \$9.00). Other Norelco speaker sizes at bargain prices—SEE LIST FOR SPEAKER SPECIFICATION SHEET.

**SAXITONE TAPE SALES**  
 Inc. Commission  
 Electronics, Inc.  
 1776 Columbia Rd., Wash., D.C.



## TAPE RECORDERS

**HI-FI COMPONENTS SLEEP LEARN KITS**

UNUSUAL VALUES! FREE 1962 Catalog DRESSNER 1523RA Jericho Tpke. New Hyde Park, N.Y.

MERITAPE. Low cost, high quality recording tape, in boxes or cans.

**WRITE FOR QUOTATION ON HI-FI COMPONENTS SOUND REPRODUCTION, INC.**  
 34W New Street, Newark 2, N. J.  
 Mitchell 2-6816



If you've recently changed your address, or plan to in the near future, be sure to notify us at once. We'll make the necessary changes on your mailing plate, and see to it that your subscription continues without interruption. Right now — print the information requested in the spaces below and mail it to: **ELECTRONICS WORLD, 434 So. Wabash Ave., Chicago 5, Illinois.**

Name *Please PRINT!*

\*Account No.

Old Address

City State

New Address

City Zone State

Mail copies to new address starting with \_\_\_\_\_ issue.

\* (Your Account Number appears directly above your name on the mailing label.)

vision... **C. W. FREDERICK** is the new manufacturing manager of the New Bedford plant of *Cornell-Dubilier Electronics*... **MEL BYRON** has joined the engineering department of *B&K Manufacturing Co.* as director of new product planning... *Ungar Electric Tools* has appointed **JERE R. DAVIS** to the post of advertising and sales promotion manager... **WILLIAM G. WHITE** is the new advertising manager of *Hy-Gain Antenna Products*... **H. A. SHEPARD** has been appointed president of *Thompson Ramo Wooldridge Inc.*, succeeding **DEAN E. WOOLDRIDGE** who has resigned.

**JAMES W. HART** has joined *Mark Products* as manager of the microwave division.



In this capacity he will assume responsibility for marketing, engineering, and production of u.h.f. grid parabolic antennas, solid spun microwave parabolas, and government research and development work.

Before taking up his new post, Mr. Hart was formerly associated with *Motorola Inc.* He is a graduate of Massachusetts Institute of Technology and served in the Army as an instructor in electronic countermeasures.

**SPRAGUE ELECTRIC COMPANY** has organized a new marketing research department which will provide directional aid for new product research, sales, and

product promotion activities. It will be under the direction of Robert E. Keck... **TRAK ELECTRONICS COMPANY** has added microwave instruments to its line of specialized electronics products and systems... **SYLVANIA ELECTRIC PRODUCTS INC.** has established a home and commercial electronics division which will be concerned with the development and manufacture of electronics products and systems for industry and commerce as well as entertainment and other types of electronics equipment for the home... A new products department designed to open new markets for distributors has been established by **ALPHA WIRE CORP.**

**GEORGE M. STAPLETON** has been elected president and general manager of *Ward Leonard Electric Co.* of Mount Vernon, New York.

He joined the company in 1935 and has served the firm as manager of research and development, executive engineer, and manager of engineering. He was elected vice-president in 1956 and has been a member of the board since 1950.

Mr. Stapleton graduated from Rensselaer Polytechnic Institute, and is a member of the American Institute of Electrical Engineers and the American Society of Naval Engineers. He holds several patents on electric control devices.



# LEARN MATH

Through Home Study

## ARE YOU WEAK IN MATH?

Today, to get ahead as a technical man, you must understand basic mathematics—logarithms, slide rule, algebraic notation and laws, algebraic functions, linear equations, quadratic equations, higher degree equations, applied geometry, applied trigonometry, progressions and series, transcendental equations, empirical equations, etc. Here is a home study course which can bring you up to date in these subjects.

## COLLEGE LEVEL? HIGH SCHOOL LEVEL?

This is definitely a pre-engineering math course. It starts at the high school level. There are only three requirements: Intelligence, an inquiring mind, and the desire to improve yourself as a professional man.

As a student of this course you should be able to commence smoothly with Lesson 1 and advance easily through all 15 lessons which comprise it. While doing this, you will gain new insight into familiar subjects and find yourself picking up new ideas as you go.

Don't let inadequacy in math hold you back. Write for details today.

Write: Dept. 260-E

**Grantham Schools, Inc.**

1505 N. Western Ave., Los Angeles 27, Calif.

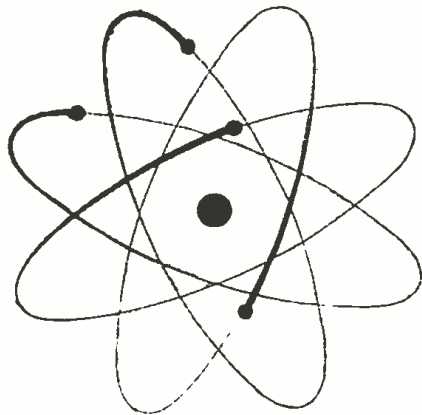

Transmitting Tube



Receiving Tube



Transistor



Silicon diode



Color TV set



Color Image Orthicon Camera

Asia's most experienced electrical manufacturer is

# FIRST AGAIN

First with the ultra-accurate miniaturized TV color IO gun! First with the single head color television tape recorder! And now — first again with direct soldered silicon rectifiers! First in electronics in the Eastern Hemisphere, Toshiba leads the industry it started! From the largest semiconductor plant in the world, Toshiba transistors find applications in thousand precision electronic products bearing the familiar Toshiba mark. 9 out of 10 TV stations in the world's third TV nation operate with Toshiba equipment. Four million electron tubes a month supply 40% of Japan's tube demand. At Asia's largest research facility, Toshiba scientists continue to develop new electronic products for the Space Age to come. Find out more about the complete line of Toshiba electronic products. Write today to Toshiba, Tokyo.



**TOKYO SHIBAURA ELECTRIC CO., LTD.**

Cable: TOSHIBA TOKYO

# LINEARIZING the THYRATRON TIMER



Front-panel view of the linearized thyatron interval timer.

By RONALD L. IVES

Complete construction details and design information on a wide-range interval timer that will provide 5 to 100 second time periods with good linearity.

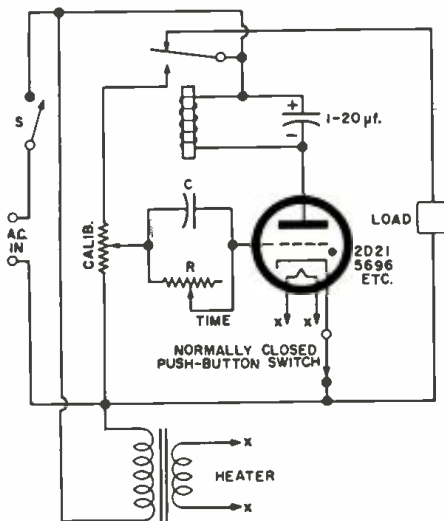

Fig. 1. Basic circuit of thyatron timer.

**I**N RECENT years, the thyatron interval timer has gradually replaced a variety of electromechanical and mechanical devices for darkroom and process timing, and for most functions where a simple and inexpensive settable timer is required.

## Basic Circuit

Although many variant circuits have been published, that of Fig. 1 is typical. Once this circuit is energized, grid and plate of the thyatron are in like phase and the relay is energized on each positive half cycle. "Buzzing" is prevented, during negative half cycles, by energy stored in the relatively large shunting capacitor. The timing network,  $R-C$ , carries line current to the grid of the tube, where it is rectified. In consequence, the capacitor within a very few cycles acquires an equilibri-

um charge approximating the peak value of the a.c. applied by the calibration potentiometer.

When the timing cycle is started, by pressing the push-button in the thyatron cathode circuit, which opens it, the tube ceases to conduct, the relay armature rises, connecting the line to the load terminals, and disconnecting the high end of the calibration potentiometer from the line. This effectively grounds the formerly positive end of the  $R-C$  timing network, making the thyatron grid negative, and preventing conduction until the charge on  $C$  leaks off through  $R$ .

When this charge has fallen to the firing value of the tube in use, the tube

starts conducting, the relay armature pulls down, the load is disconnected, and the calibration circuit is re-connected, permitting recharge of the timing network ( $R-C$ ).

This circuit is a consistent performer, the "time jitter" at a given setting being usually considerably less than one per-cent, and both construction and maintenance costs are at a minimum. Circuit constants can be determined from the formula:  $T = 2.303 RC \log_{10} (E_s/E_f)$ , where  $T$  = time in seconds;  $R$  = resistance in megohms;  $C$  = capacitance in microfarads;  $E_s$  = supply voltage (peak value at "Calib" arm, Fig. 1);  $E_f$  = firing voltage of thyatron. Now, if we want to use an extended

Inside view of the interval timer showing the placement of parts.

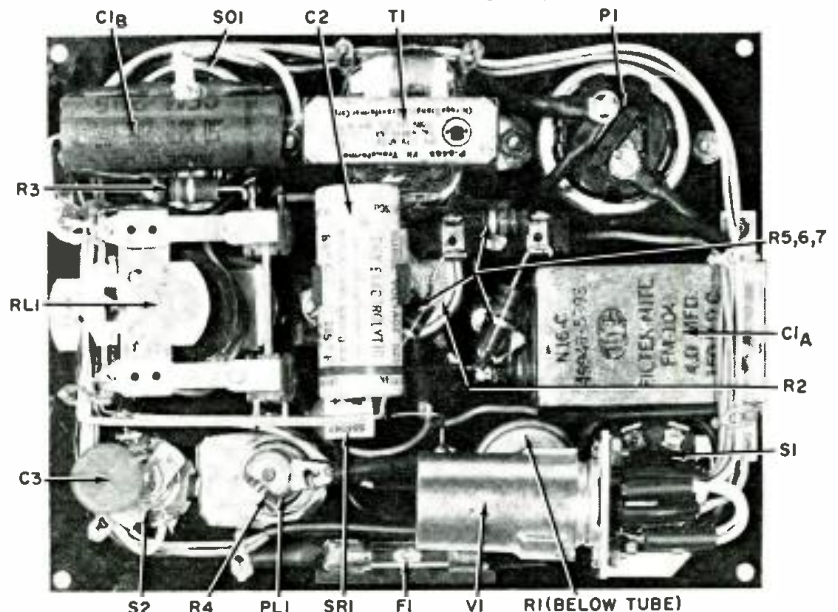

setting range, such as from 5 to 100 seconds, we find that the time is not linear with respect to  $R$ , particularly if, as is usual for reasons of economy, we use a large  $R$  and a small  $C$ . Circuit behavior is indicated in Fig. 2, an illustrative curve only.

### Compensating Methods

Previous methods of compensating for this nonlinearity include use of specially calibrated time dials; use of an enormous capacitor (such as 100  $\mu$ f.) and a small variable resistor; and use of a decade capacitor as the variable element and in conjunction with a fixed resistor. All of these expedients work and all are either troublesome, bulky, costly—or some combination of the three.

The major cause of the nonlinearity is the so-called "contact potential," which causes a negative bias on a grid separated from ground by a high resistance. With most tubes, this amounts to about 1.5 volts when the grid resistor is 5 megohms. In consequence of this contact potential, the extreme right-hand term of the formula is  $(E_c/E_r)$  when the value of  $R$  is small (short time interval); but becomes  $(E_c - E_r)/(E_r - E_c)$ ,  $E_c$  is contact potential, when  $R$  is large (long time interval). As  $E_c$ , the contact potential, may be more than one-third of the firing potential of the thyatron in some instances, its effect on the linearity of the timer should be obvious.

Of course it is possible, but neither expedient nor financially desirable, to make or have made a special nonlinear timing resistor to compensate for contact potential in the specific timer circuit used. Happily, there is a simpler procedure for obtaining a nonlinear timing resistor for this purpose. If the variable timing resistor ( $R$  of Fig. 1) is shunted by a relatively large fixed resistor, the resistance of the combination will vary in such a way as to compensate for the effects of contact

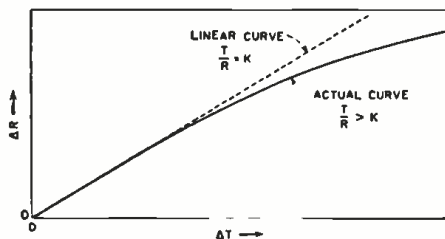

Fig. 2. Time-resistance relationship.

potential, giving a very close approximation of a linear timing calibration with a linear variable timing resistor. Although the computations become somewhat involved, it appears that linearity of approximately 1 per-cent is consistently attainable in the circuit to be used (Fig. 4) if the fixed shunt is approximately eleven times as large as the maximum value of the variable timing resistor.

### Linear Timer Circuit

The circuit of a linear interval timer, having a useful range of from 5 to 100 seconds, is shown in Fig. 4. This uses standard components exclusively and requires no special tricks in its construction. Its range may be varied through wide (but not infinite) limits without difficulty, although the value of the compensating shunt resistor may need recomputation in some instances.

This circuit differs from the fundamental circuit in two particulars. A linearizing shunt ( $R_2$ ,  $R_3$ ,  $R_4$ ) is connected from the high end of the timing potentiometer ( $R_1$ ) to ground, to compensate for contact potential effects; and the bias rectification function, performed by the grid-cathode circuit of the thyatron in Fig. 1, has been completely divorced from the thyatron circuit and is now performed by the silicon diode,  $SR_1$ .

With this arrangement, when the tube is conducting, the timing capacitor is charged from the calibration circuit, its equalization voltage being approxi-

mately the peak value of the pulsating d.c. supplied by the calibration potentiometer arm. This makes the initial value of the hold-off voltage,  $E_c$ , completely independent of the setting of the timing resistor,  $R_1$  (and its shunt).

When the timing cycle is started, by pressing the "Start" button—which stops thyatron conduction—the timing capacitor is switched from the charging circuit to the grid circuit of the thyatron by the relay, and discharge through the grid circuit resistors then takes place according to the formula.

### Construction

Construction of a timer, using this improved circuit, is quite simple and straightforward. One such unit, designed for darkroom use, is shown in the photographs. The container is a Bakelite meter case and all components are mounted on the lid to permit rapid construction and servicing and to eliminate festoons of internal connecting leads. Layout is not at all critical, that chosen by the author is a mere matter of convenience, with the pilot (which has a red window) adjacent to the "Start" button so that it provides a visible position marker under "safelight" conditions.

All components are standard over-the-counter items and many substitutions are possible. The only critical item is the timing potentiometer which must not only be linear but stable. The *Ohmite* 5-megohm Type CLU pot used by the author seems to be the best of the regularly available, reasonably priced items for this purpose.

Because neither high voltages nor high frequencies are involved, internal arrangement is not critical and no special precautions are needed with the wiring. Ordinary good workmanship is recommended, however, so that the timer will be in use most of the time, rather than out of service for repairs just when it is needed most.

In the photo of the internal view of

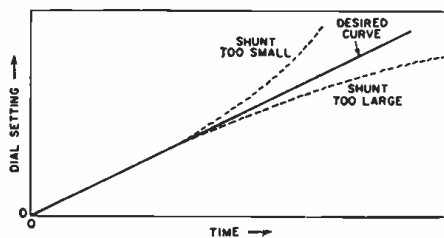
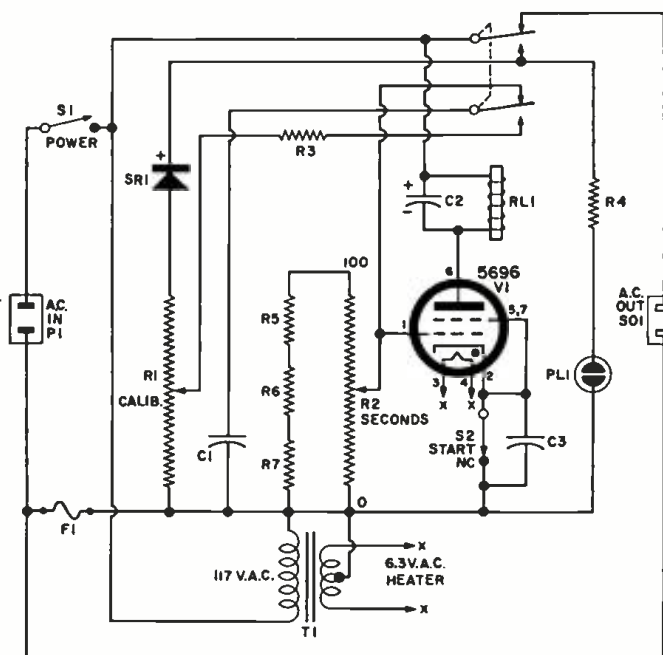

Fig. 3. Clues to linearity shunt values.

Fig. 4. Circuit diagram of the linear interval timer designed by the author.

- $R_1$ —25,000 ohm linear-taper pot, locking type (*Ohmite* Type CLU)
- $R_2$ —5 megohm linear-taper pot (*Ohmite* Type CU)
- $R_3$ —1500 ohm, 1 w. carbon res.
- $R_4$ —100,000 ohm, 1/2 w. carbon res.
- $R_5$ ,  $R_6$ —22 megohm, 1 w. carbon res.
- $R_7$ —10 megohm, 1 w. carbon res.
- $C_1$ —4.3  $\mu$ f., 150 v. paper capacitor *Tobe FM-104* shunted by .5  $\mu$ f. tubular paper capacitor)
- $C_2$ —8  $\mu$ f., 250 v. elec. capacitor
- $C_3$ —.02  $\mu$ f. disc ceramic capacitor
- $P_1$ —Male a.c. connector in sunk mount (*Amphenol 61 M 10*)
- $SO$ —Female a.c. connector in sunk

- mount (*Amphenol 61 F 10*)
- $PL_1$ —NE-51 neon pilot light
- $RL_1$ —117-volt d.c. relay (*Potter & Brunfield MR-11-D*, 117-volt coil)
- $S_1$ —S.p.s.t. bat-handle toggle switch
- $S_2$ —S.p.s.t. normally closed push-button switch (*Switchcraft 203*)
- $SR_1$ —150-volt silicon rectifier (*Sarkes Tarzian 40K*)
- $T$ —Fil. trans. 117-volt pri., 6.3-volt @ 6 amp c.t. sec. (*Stancor P-6465*)
- $V$ —Tetrode thyatron (*RCA 5696*)
- $F_1$ —1/2 amp. 3AG fuse
- 1—Bakelite meter box, 5-9/32" x 6-13/16" x 2-5/16", with cover (*H. H. Smith #2257*)



**"TAB" SILICON 750MA\* DIODES** Factory Tested Gtd!

**NEWEST TYPE! LOW LEAKAGE**

D.C. or Batty. Derate 20%

rms piv 35 50 .09	rms piv 70 100 .17	rms piv 140 200 .22	rms piv 210 300 .31
rms piv 280 400 .38	rms piv 350 500 .50	rms piv 420 600 .63	rms piv 490 700 .77
rms piv 560 800 .83	rms piv 630 900 1.08	rms piv 700 1000 1.35	rms piv 770 1100 1.60

Diode order \$10 shipped Post free

Low Priced T500 Silicon Diodes  
Rated 100 piv 280mA @ 300MA @ 100°C  
.25 each; 30 for \$7; 100 for \$22; 500 for \$100

**SILICON POWER DIODE STUDS\***  
Operation Up to 125°C Case Temp.

D.C. Amps	50Piv 35Rms	100Piv 70Rms	150Piv 105Rms	200Piv 140Rms
2	.25	.35	.45	.55
3	.60	.85	1.00	1.25
6	.70	1.00	1.25	1.50
12	1.80	1.20	1.70	1.70
35	1.85	2.15	2.50	2.90
70	3.75	4.50	4.95	5.60
240	4.50	5.70	6.90	8.40

D.C. Amps	300Piv 210Rms	400Piv 280Rms	500Piv 350Rms	5.70 600Piv 420Rms
2	.80	1.00	1.20	1.95
3	1.50	1.80	2.10	2.65
6	1.75	2.00	2.30	2.95
12	2.00	2.30	2.60	3.20
35	4.95	6.10	7.20	8.40
70	10.80	15.30	18.90	22.80
240	19.60	29.75	35.70	42.80

\*Derate 20% for Battery or Capacitive Load or D.C. Hocking! \*Stud mounted on Heat sink

D.C. POWER SUPPLY 115V 60 to 800 Cys Impl. 330 & 165VDC UP to 150 MA. CASED! SPECIAL \$5

**TRANSISTOR POWER CONVERTER**  
12VDC to 500VDC up to 200MA  
100W Tap at 250VDC DB500 \$33.  
12VDC to 250VDC up to 150MA  
Type C1225E \$30

"SUPERIOR" Powerstat #10 Variable Xfmr  
165 Watt 0 to 132V Special \$6 each; 2 for \$10

"TAB" FOR TRANSISTORS & DIODES!!!!  
Full Length Leads Factory Tested & Gtd! U.S.A. Mfg.

PNP Hi Power 15 Amp, TO3 & TO36 Pckr.  
2N441, 2N277 \$1.25 @ 10 for \$11  
2N442, 2N278 \$2 @ 10 for \$18  
2N677 \$1 @ 20 for \$18  
2N677 \$5 @ 3 Amp, 2N155, 2N156,  
2N255, 2N256, 2N307, 2N554, TO3GP .49 @ 5 for \$2  
PNP 2N123, 2N107, CK722 \$ for \$1; PNP 2N292,  
2N3, PNP 2N223 30C @ 12 for \$5; 100 for \$65;  
PNP 2N670/300MW 50c @ 10 for \$4  
PP 2N671/1 Watt 75c @ 10 for \$6  
Round or Diamond Base Mica Mtd Kit 30c @  
Power Heat Sink Fins 8D \$1.39  
Kit Glass Diodes equiv. 1N34A, 4E, 4B, 51,  
12 for \$1, 100 for \$6, 1000 for \$50

TWO 866A's and FILAMENT  
XFMR 10 Kv Insid SPECIAL \$6

**NEW BATTERY CHARGER**  
BC612X  
For 6 or 12 Volt Batteries.  
Flickle & Full Charge up to  
10 amps Charges 6 & 12 volt  
batteries.  
Built ready to use  
BC612X @ \$14.00  
BC612B up to 2 amps \$7.45

SEND 25c FOR NEW CATALOG!

**ZENER DIODES 150 to 400 MW Cased TO24 Pckr**  
Within 20% V-Range \$1, 3 for \$2, 20 for \$10.  
KIT ZENER DIODES up to 400 MW Single  
& DOUBLE ENDED ZENER DIODES 2 for \$1.

"TAB" BARGAINS  
New Variacs for equiv 0-135V 7.5A \$15.30  
New Variacs for equiv 0-135V 2A Amp \$10.65  
DC-AMPER 100W 100MA/25V \$3.60  
DC-AMPER 100MA/25V \$3.60  
SNOOPERSCOPE TUBE 2" \$5 @ 2/59  
MINI-FAN 6 or 12VDC 700 Cys \$2 @ 3/55

Gtd! Octal Silicon—5U4C—Tube Replacement 1120.  
Rms 1600 Piv \$4 @ 2 for \$6; 4 for \$10; 5R4  
Silicon 1900/2800Piv. \$4; 866A Silicon. 5000/  
10400Piv. \$9. Surge Protected.

TERMS: Money Back Guarantee!  
Our 18th year. \$2 min. order  
F.O.B. N.Y.C. Add shpg charges  
or for C.O.D. 25% Dep. Prices  
shown subject to change.

111-WE Liberty St., N.Y. 6, N.Y.  
Send 25c for Catalog

PHONE: RECTOR 2-6245

the timer note the use of a small bracket to support the thyatron socket and the use of tie points to hold the shunting resistors for the timing potentiometer. Cable ties are used to keep the leads from flopping about inside the timer when it is assembled.

When construction and wiring have been completed and checked, the circuit is energized and warmed up for a minute or so. If all is well, the relay armature should pull down after about 20 seconds and remain down, and the pilot light should be lighted. When the "Start" button is pressed, the relay armature should rise, remain in released position for a time, then pull down again. The pilot lamp will be lighted when the relay armature is down and off when the armature is up.

**Calibration**

Calibration is best accomplished using a sweep-second electric clock plugged into the "A.C. Out." receptacle of the timer. Set the "Seconds" control to 30 seconds, note the reading of the second hand of the clock, press the "Start" button, and let the timer run through its cycle. Note the elapsed time and adjust the "Calibrate" control until the elapsed time exactly equals the "Seconds" setting.

Next check the accuracy of the 60- and 90-second settings and, finally, that of the 15-second setting. All should be within about one second of the correct value. Over-all accuracy of the timer can be touched up, compensating for minor nonlinearities and eccentricities in the timing potentiometer, by a slight re-adjustment of the "Calibrate" control. When this is satisfactory, lock it in position.

Once set, the timer will retain its calibration for some hundreds of hours of use, the tube employed being a long-life computer thyatron which seems to be almost immortal under the operating conditions prevailing here. Interestingly, this timer is quite insensitive to changes in line voltage, for the time varies as the logarithm of the supply voltage (approx.), so that a 10 per-cent increase in line voltage produces only a 3 per-cent increase in time.

Extension of these same principles, to permit construction of thyatron timers for other time ranges and for use with other thyatrons, is entirely possible. Proper value of the fixed shunt for the timing resistor (variable), to secure approximately linearity, is most easily determined by experiment, using the clues indicated in Fig. 3.

In most instances, the variable timing resistor should not exceed approximately 5 megohms; and the time interval should not exceed five minutes. With longer time intervals and higher values of resistance, the circuit becomes too vulnerable to extraneous disturbances, which range from switching transients on the power line, through vibration, to cosmic rays and radioactivity.

In whatever form the timer is constructed, utility will be greatly enhanced by use of accessible controls, functional layout, and suitable labeling.

**COLUMBIA GEMS!**

**COMMAND RECVRS. & XMTRS.**

R-28/ARC-5 TWO-METER & AIRCRAFT RECEIVER  
100-150 Mc. Brand new. Special! Only \$22.50  
Q5'ER: 19-55 Mc. Excellent Cond. 9.95  
1-3 Mc. RECEIVER: Brand new and only 14.95  
3-6 Mc. RECEIVER: Excel. cond. Terrific buy 9.95  
6-9 Mc. RECEIVER: Excellent condition 9.95  
2-13 Mc. TRANSMITTER: Brand new 6.95  
4-4 Mc. TRANSMITTER: Excel. cond. 6.95  
4-5 Mc. TRANSMITTER: Excel. condition 4.95  
5-7 Mc. TRANSMITTER: Excel. condition 4.95  
5-7 Mc. XMTR: Low tubes and xtal. Fair 2.95  
MD-7/ARC-5 PLATE MODULATOR: Excel. cond. 4.95

**AMPLIFIER FOR REVERE SP-16 16 MM. SOUND MOVIE PROJECTOR:** 115 V. output. With screen. Excel. \$9.95

**FM TAXI RADIO-TELEPHONE**  
Great mobile rig! 150-170 Mc. Single channel. Crystal control. 6 V. compact, two-piece set. 25 W. output smtr. Dual conv. recvr. Complete with connecting cable and remote control panel. Mfg. by West Coast Electronics Co. Pair: \$24.95  
\$45.00. EACH With Schematic

**3 TEST EQUIPMENT BARGAINS! 3!**

TS-34 AP Oscilloscope: Lab. quality portable for radio-circuit maintenance & trouble-shooting. Prod. 40 cps to 1 Mc. Built-in saw-tooth gen. Power Input: 115 V. 50/60 cps. \$34.95  
EXCELLENT cond. Checked out & guar. 49.95  
TS-239 AP Oscilloscope: Lab. quality. bench type for all electronic test applications. Evid. 100 cps to 1 Mc. Built-in time base circuit and saw-tooth gen. Power input 115 V. 50/60 cps. \$59.50  
GOOD USED CONDITION. ONLY \$99.50  
CHECKED OUT AND GUARANTEED. \$124.95  
SPECIAL \$124.95  
BC-221 Frequency Meter: 105 Kc to 30 Mc. Lab. quality. Excel. checked out and guaranteed. w/ work. calibration book \$69.95

**TUBES! ALL NEW & GUARANTEED!**

2C39VA \$12.95	2507H \$22.50
4-65A 9.95	100Y 9.95
4-125A 19.95	8000 9.95
4x250B 22.50	829B 4.95
4-400A 24.50	832A 3.95
4-1000A 75.00	827 7.95

**BC-375 100 W. TRANSMITTER**  
Ideal for domestic use, as well as export marine and military. Frequency range 1.5 to 30 Mc. with product tuning knob. CW or M.W. Excellent! \$14.95  
and high

PE-73 DYNAMOTOR FOR ABOVE: Excel. 4.95  
TUNING UNITS: For BC-375 Each \$1.95

All orders FOB Los Angeles, 25c deposit and C.O.D. All items subject to prior sale. NOTE MIN. ORDER \$3.00. SEND FOR NEW CATALOG!

**COLUMBIA ELECTRONICS**  
4365 WEST PICO BLVD. LOS ANGELES 19, CALIF.

SAY YOU SAW IT IN  
**Electronics World**

**FIX ELECTRIC APPLIANCES**

PAYS \$3 TO \$5 AN HOUR

Spare Time, Full Time • Learn at Home

FREE BOOK offered below shows how YOU can now have a good-paying business of your own, right in your home. No experience needed, just simple tools. Learn to repair Electric Appliances. Pays \$3-\$5 an hour!

100 MILLION Appliances are in American homes right now. 76 Million MORE bought each year. People need them fixed, good times or bad. YOU make good money doing it. In your basement, garage, even on your kitchen table.

QUICK WAY TO GET STARTED  
For less than 20c a day our easy, pictured instruction — backed by 45 years of success in home training — prepares you for top earnings in this booming field. Earl Reid of Thompson, Ohio says: "Made \$510 in one month spare time. NRI course is priceless." At no extra charge you even get all parts for your own Appliance Tester, too. Finds trouble-spots, speeds and checks your work.

Get your FREE Book and FREE Sample Lesson! Mail coupon below, letter or postcard, now.

**FREE BOOK • FREE LESSON**

NATIONAL RADIO INSTITUTE, Appliance Division  
Dept. EE2, Washington 16, D.C.  
Send FREE Book, Free Appliance Repair Course Lesson. Am interested in:  
 Spare Time Earnings  My Own Business  
 Better Job

Name .....

Address .....

City .....

Zone .. State ..

Accredited Member National Home Study Council

**engineering degree in 27 mos.**

Become an Electronics Engineer. College graduates enjoy higher income... sure advancement. Major corporations visit us regularly to interview and employ seniors. **BACHELOR OF SCIENCE DEGREE IN 27 MONTHS** in Electrical (Electronics or Power major), Aeronautical, Chemical, Mechanical, Civil Engineering. IN 36 MONTHS a B.S. Degree in Business Administration. Small classes. Campus. New dorms. Low costs. Enter June, Sept., Jan., Mar. Founded 1884.

Write I. H. McCarthy for Catalog and "Your Career in Engineering and Commerce" Book.

**TRI-STATE COLLEGE**  
1652 College Avenue • Angola, Ind.



## A.C. CALIBRATION

By R. G. FINKBEINER

METERLESS d.c. calibration of a v.t.v.m. is quite simple, using batteries of known voltage. It is the a.c. calibration which presents a problem when an accurate meter is not available for comparison. Connecting the v.t.v.m. to the power line and assuming the voltage to be the average of 117 volts can lead to errors as high as 10%. The a.c. calibration method to be described is much more accurate.

First the d.c. calibration should be checked, preferably on the lowest range to avoid multiplier-resistor tolerance errors. A fresh standard flashlight cell has an average open-circuit potential of 1.57 volts within about 2% and may be used. Also, a typical mercury battery (potential is 1.35 volts; some are 1.40) is more accurate and will give an on-scale reading when the basic v.t.v.m. range is 1.5 volts. Check a catalogue for exact voltages.

The a.c. calibration is based on the fact that in a full-wave rectifier circuit the r.m.s. value of applied a.c. voltage is 0.707 of the d.c. output of the *unloaded* rectifier, which charges its filters to the peak value of the input a.c.

The transformer-operated full-wave tube rectifier circuit below is preferred over those using solid-state rectifiers because of the tube's infinite inverse resistance. This circuit is easily "borrowed" from existing receivers or amplifiers. A transformer with a high-voltage secondary of 350 each side of center-tap is ideal because the rectified d.c. will be approximately 500 volts, the full-scale deflection of many v.t.v.m.'s, and within the 525-volt peak rating of 450-volt electrolytics.

Disconnect all existing filter components and connect the v.t.v.m. common lead (G) to rectifier ground, with the positive lead to the rectifier cathode. Then substitute several 10- and 20- $\mu$ f. capacitors, one at a time, between these points (watch polarity) and note the exact readings. Pick the one which gives the highest reading, as its leakage is lowest, and multiply it by 0.707. Setting the d.c. to an even value with a "Variac" will simplify computation. Then switch the v.t.v.m. to "A.C.," put the probe on either of the points "A" and adjust the a.c. calibration control for a reading equal to the computed voltage. If a slight unbalance exists in the power transformer and the "A" voltages are not equal, use the higher reading.

Note that the accuracy of the a.c. calibration depends on the initial d.c. calibration accuracy but, despite this fact, the author has been able to make calibrations to within 2%. ▲

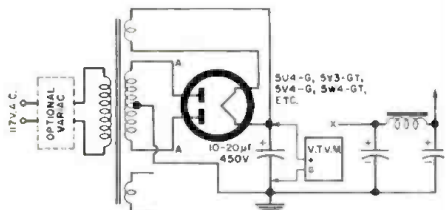

*Precision performance  
is your passport to  
the amazing world of  
short-wave listening*



# hallicrafters

5th and Kostner Avenues, Chicago 24, Illinois

"world-range" radio



**SX-110 Receiver—\$169.95.** Standard broadcast. Three short wave bands (1550 kc-34 Mc). Slide rule electrical bandspread dial. Built-in "S" meter, antenna trimmer, crystal filter. Uses R-48 speaker (\$19.95).

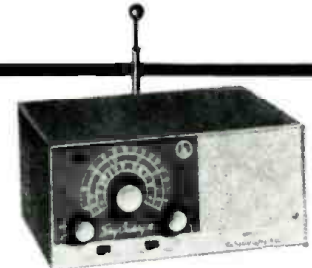

**S-119K Sky Buddy Receiver Kit—\$39.95.** S-119 (factory wired and tested) \$49.95. Standard broadcast. Two short wave bands (2-5.5 Mc. and 5.7-16.4 Mc.). Superheterodyne circuit. Transformer-type power supply.



**SX-62A Receiver—\$395.00.** Standard and FM broadcast. Three short wave bands. (1.62 Mc-109 Mc). Excellent audio. Slide rule dial. Single tuning control. Automatic noise limiter. Uses R-48 speaker. (\$19.95)

**S-120 Receiver—\$69.95.** Standard broadcast plus three short wave bands (1650 kc-31 Mc). Three-way antenna system. Slide rule electrical bandspread dial. B.F.O./selectivity control.

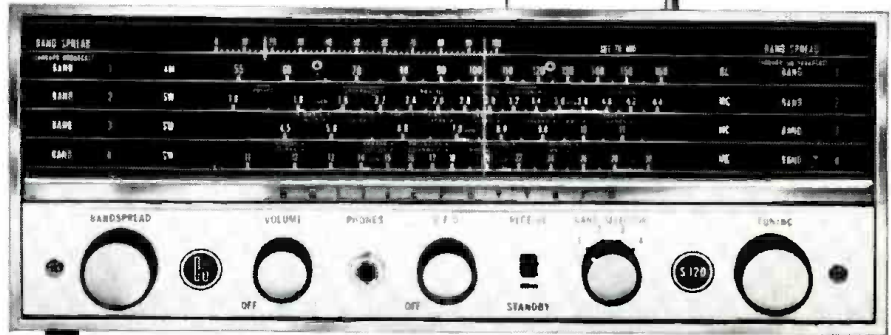

Export Sales: International Division, Raytheon Mfg. Co., Waltham, Mass. Canada: Goud Sales Co., Montreal, P.Q.

## COMPANION

CITIZEN'S BAND RADIO SUPREME!

by  
PEARCE-SIMPSON

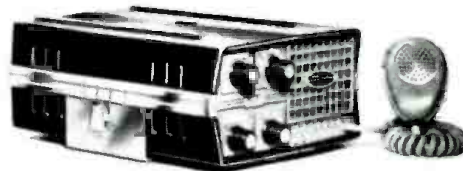

PEARCE-SIMPSON

**PS**  
SUPERIOR PRODUCTS

Drop a card in the mail for full color brochure on the Pearce-Simpson "Engineered for value" '62 line.

1385 N.W. 27th AVE.  
MIAMI 35, FLORIDA

# New Products and Literature for Electronics Technicians

Additional information on the items covered in this section is available from the manufacturers. Each item is identified by a code number. To obtain further details, simply fill in the coupon appearing on page 106.

## SOLID-STATE TIME-DELAY RELAY

**1** George Harmon Co., Inc., is now offering a new lightweight, solid-state, hermetically sealed time delay, the EL-100 series.

The relay actuates electronic circuitry or electrical devices at a predetermined interval after application of voltage. Uses include the starting

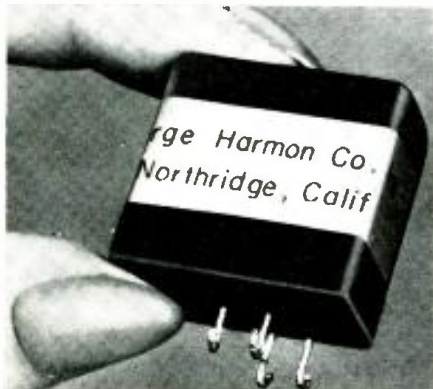

of a bank of motors without overload, drone parachute ejection, warming up banks of electronic tubes without causing cathode damage, etc.

Three basic types are available, with contacts either normally open or normally closed, with a delay range from .05 second to 950 seconds, with an accuracy tolerance of  $\pm 20\%$ ; .05 second to 90 seconds  $\pm 10\%$ ; and .30 to 60 seconds with an accuracy of  $\pm 5\%$ .

## PUSH-BUTTON SWITCHES

**2** Haydon Switch Inc. has engineered a new line of standard and special push-button switches which feature new configuration and switching control capabilities.

Standard push-button switches are available with momentary, maintained, alternate action, and solenoid-held actuation also available. Lighted, non-lighted, or colored push-buttons of various shapes serve built-in safety or reflex-identification functions.

Push-button switches are 2 to 6 pole, double-throw with solder hole, turret, or double turret. Hermetically sealed switches with terminals or potted leads are also available as part of the switch assembly. Flange, threaded bushing mounting, egg-crate, or bezel-type mountings are available to specification.

## PACKAGED CIRCUITS

**3** Clevite Transistor has developed a line of plastic encapsulated packaged circuits which will enable engineers to increase component



density on circuit boards by a substantial factor.

Employing a new milliminiature germanium diode, the new "millipak" packaged circuits can provide even greater component density by vertical mounting on circuit cards or by plastic encapsulation with other components.

Typical "millipak" circuit configurations include digital logic modules and various multiple gating circuits. Custom units can be provided in most circuit configurations such as phase detectors, matched pairs, and quads.

## ULTRASONIC CLEANER

**4** Electronic Assistance Corporation is now offering ultrasonic cleaning equipment which utilizes solid-state components. The cleaning action removes grease, oil, dirt and flux from metals, ceramics, glass, plastics, and other hard surfaces without damage to the most fragile materials. The action is set up by the rapid and rhythmic expansion and contraction of the liquid.

The cleaning equipment consists of two units—a solid-state generator with power output of 750 watts and a five-gallon tank with a transducer bonded to and covering its bottom so that cavitation is uniform, at a power density of 10 watts per square inch, in all parts of the tank.

## NUVISTOR FOR 1200 MC.

**5** RCA Electron Tube Division has announced a new double-ended high- $\mu$  nuvistor triode designed for use in cathode-drive amplifier service at frequencies up to 1200 mc.

Designated the RCA-8058, the thimble-sized tube is especially useful in industrial equipment where compactness, low drain, uniformity of characteristics, and the ability to withstand severe mechanical shock and vibration are primary design requirements.

The new tube utilizes all-ceramic-and-metal construction. It has a lightweight, cantilever-supported cylindrical electrode structure. It is less than 1" long, only .410 inch in diameter, and weighs approximately 2.2 grams.

## SERIES-REGULATOR PENTODE

**6** General Electric Company's Receiving Tube Department has developed a new high-voltage series-regulator pentode which is capable of handling more power and voltage than other previously available tubes of its size, according to the firm.

The Type 8068 has an octal base with glass T-12 envelope. It is designed for use as a series regulator in both fixed and variable power supplies. Maximum plate voltage rating is 3500 volts with a maximum plate dissipation of 35 watts.

## MINIATURE INDUCTORS

**7** Jeffers Electronics Division of Speer Carbon Company is in commercial production on a new line of tiny r.f. inductors known as the Type 09 "Mini-Stab."

The new unit has a body diameter of  $0.095 \pm .003$ , with a length of  $0.250 \pm .010$ . Inductance values from .10  $\mu$ h. to 100  $\mu$ h. are available. Inductance tolerance is  $\pm 10\%$  with a distributed capacitance of .5  $\mu$ f. to 2  $\mu$ f. The rated current, based on 90 degrees C ambient and 35 degrees C maximum temperature rise, ranges from 165 to 1660 ma.

## TRANSISTOR TEST TRAYS

**8** Delta Design, Inc. is now offering large capacity test trays which allow efficient and accurate testing of axial lead components and transistors over a temperature range of -100 degrees F to +400 degrees F. The trays are designed to mate directly with all of the com-



pany's small test chambers now in use.

Decade-type matrix switches permit quick and easy selection of any individual component under test. The test drawers are well insulated and all structural members are of stainless steel and aluminum. They are fitted with guides so they are protected from falling during removal from the chambers.

## "UNIVERSAL" INVERTER

**9** American Television & Radio Co. is offering a line of "universal" inverters designed to provide power for operating standard a.c. tape recorders, TV sets, dictating machines, record players, etc. from d.c. voltage sources in automobiles, buses, trucks, boats, trains, and planes.

All of the units in the line will provide 110 volts a.c. output at 60 cycles at output wattages ranging from 80 watts to 600 watts. The inverters feature r.f. interference suppression, instant starting, frequency stability, and built-in power factor corrector, utilizing a simple toggle switch.

Specifications on individual models are included in a data sheet which is available without charge on request.

## SINE-WAVE INVERTER

**10** Ortho Dynamics Inc. is now offering a solid-state precision-built a.c. sine-wave inverter, the Model 060AB2. Input voltage is 115 volts  $\pm 15\%$ , single phase, and frequency is 60 cps  $\pm 15\%$ . Output is 118 volts nominal with 1 phase and 60 cps  $\pm 0.1\%$  frequency. Current is 8.5 amps, power 1 kva., with a load power factor of 0.7 -1 lead or lag. Regulation is  $\pm 0.5\%$  line and  $\pm 0.5\%$  load. Harmonic distortion is less than 5%.

## INSULATED GLASS CAPACITORS

**11** Corning Electronic Components has developed printed-circuit glass dielectric capacitors that eliminate electrical shorts between components.

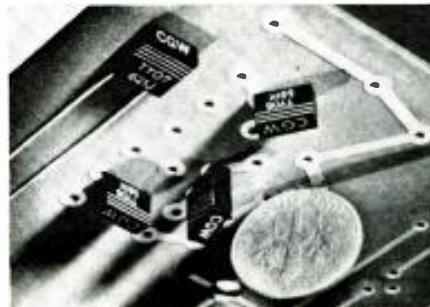

The new glass capacitors, equipped with radial leads, are encased in an insulating plastic shell. Dimensions are less than comparable CM-type capacitors. First units in the TY line are the TY-06 (1 to 560  $\mu$ fd.) and the TY-07 (561 to 1000  $\mu$ fd.). Nominal dimensions of the TY-06 are .3 inch long, .115 inch wide, and .200 inch high. For the TY-07 they are the same except that height is .3 inch. Operating temperatures are  $-55$  to  $+125$  degrees C with no derating and d.e.v.w. is 300 volts.

**PRECISION WIREWOUNDS**

**12** General Instrument Corp.'s Semiconductor Division is now offering a new series of bobbinless precision wirewound resistors for applications demanding extreme temperature stability and individual component accuracy.

Available in any value from 1000 ohms to 1 megohm, these 1/4-watt, 500-volt d.c. resistors exhibit a maximum guaranteed error from nominal value of only .02% over the full load operating ambient temperature range of  $-20$  to  $+85$  degrees C.

**SEMICONDUCTOR HEAT SINKS**

**13** Delco Radio Division has announced the availability of four new basic semiconductor heat sinks. The basic extrusions are supplied as three-inch blanks or punched with a double set of holes to accommodate either TO-3 or TO-36 transistors and also will accommodate other power devices such as silicon rectifiers, thermistors, controlled rectifiers, and power zeners.

The heat sinks range in thermal resistance from 1.5 degrees C/watt to 5 degrees C/watt. Under forced-air conditions they will exhibit less than 1 degree C/watt thermal characteristics.

**PROGRAMMABLE RATIO BOXES**

**14** North Atlantic Industries, Inc. has recently released two new programmable ratio boxes. Models PRB-506 and PRB-507.

The ratio setting for these induction voltage



dividers is externally established by binary coded decimal inputs from punched tape, cards, etc. The Model PRB-506, a miniature unit measuring 3 1/2" x 1 9/16" x 1 1/2", is designed to meet the need of high-speed automatic test equipment. The PRB-507 is a standard programmable ratio box. Both units are available with the optional feature of read-out lights that permit a positive check of the ratio setting.

**PROTOTYPE CIRCUITRY KIT**

**15** Alden Products Company is marketing a prototype circuitry construction kit for rack modules and portable instruments. Known as Kit #37, it includes all the circuitry mounting and packaging components needed to assemble various combinations of a functionally subdivided rack module and a rugged, quick access, portable instrument.

Complete subassemblies snap into modular, plug-in chassis which can be mounted in various combinations as separate "building block" functions in rack adapters or in portable case as test or control functions.

**AUTOMATIC VOLTAGE REGULATORS**

**16** The Superior Electric Company has introduced a new series of electro-mechanical

transistorized automatic voltage regulators as the EMS Series.

The new units feature a completely transistorized, plug-in type control circuit. Types are available for single- or three-phase duty with ratings from 25 to 275 kva. Several types have individual line control for greater application flexibility. All have zero waveform distortion, very low internal impedance, virtually zero phase shift, efficiency of approximately 99%, and high accuracy.

**LOW-NOISE TRANSISTOR CHOPPERS**

**17** Airpax Electronics, Inc. has added two new models to its 7000 line of miniature, low-noise, solid-state choppers.

Types 7001 and 7005 both feature an input signal rating of  $\pm 15$  volts and have an operating temperature range of  $-30$  to  $+100$  degrees C. Their wide drive range of d.c. to 5000 cps and extremely fast switching action permit their use as low-level commutators or switches, as well as choppers.

The choppers have a typical noise level of only 35  $\mu$ v. r.m.s. at 400 cps, working into a 10,000-ohm load. They are self-contained in molded packages which house all solid-state components and feature welded circuitry for reliability.

**PHOTOCONDUCTOR CELLS**

**18** Sylvania Electric Products Inc. has recently introduced two new cadmium sulfide photoconductor cells, Types 8142 and 8143.

The new units have an outside bulb diameter of .5 inch and are end illuminated. They feature high sensitivity and hermetically sealed-in-glass construction. The cells are gaseous back filled for a high dissipation safety factor and include a special confidence feature, a blue dot compound which turns pink if the cell envelope becomes damaged.

The Type 8142 features relatively low resistance (1500 ohms) while the Type 8143 has a

**27 MC CB ANTENNAS**

**BASE STATION ANTENNA** Cat. No. 314-509 is a coaxial antenna having high strength 6061-T6 tempered aluminum whip and skirt, a galvanized steel support pipe, factory attached RG-8 A/U internal feed line, and a PL-259 input connector.

**VEHICULAR ANTENNA** Cat. No. 249-509 is a cowl or body mount stub-tuned 56-inch long 17-7 PH stainless steel whip complete with mounting base and 15 feet of RG-58 A/U Cable attached.

**AIRCRAFT ANTENNA** Cat. No. 313-509 is a base-loaded whip approximately 18 inches long. The streamline fiberglass base houses a precision loading coil. The antenna comes complete with 15 feet of RG-58 A/U Cable.

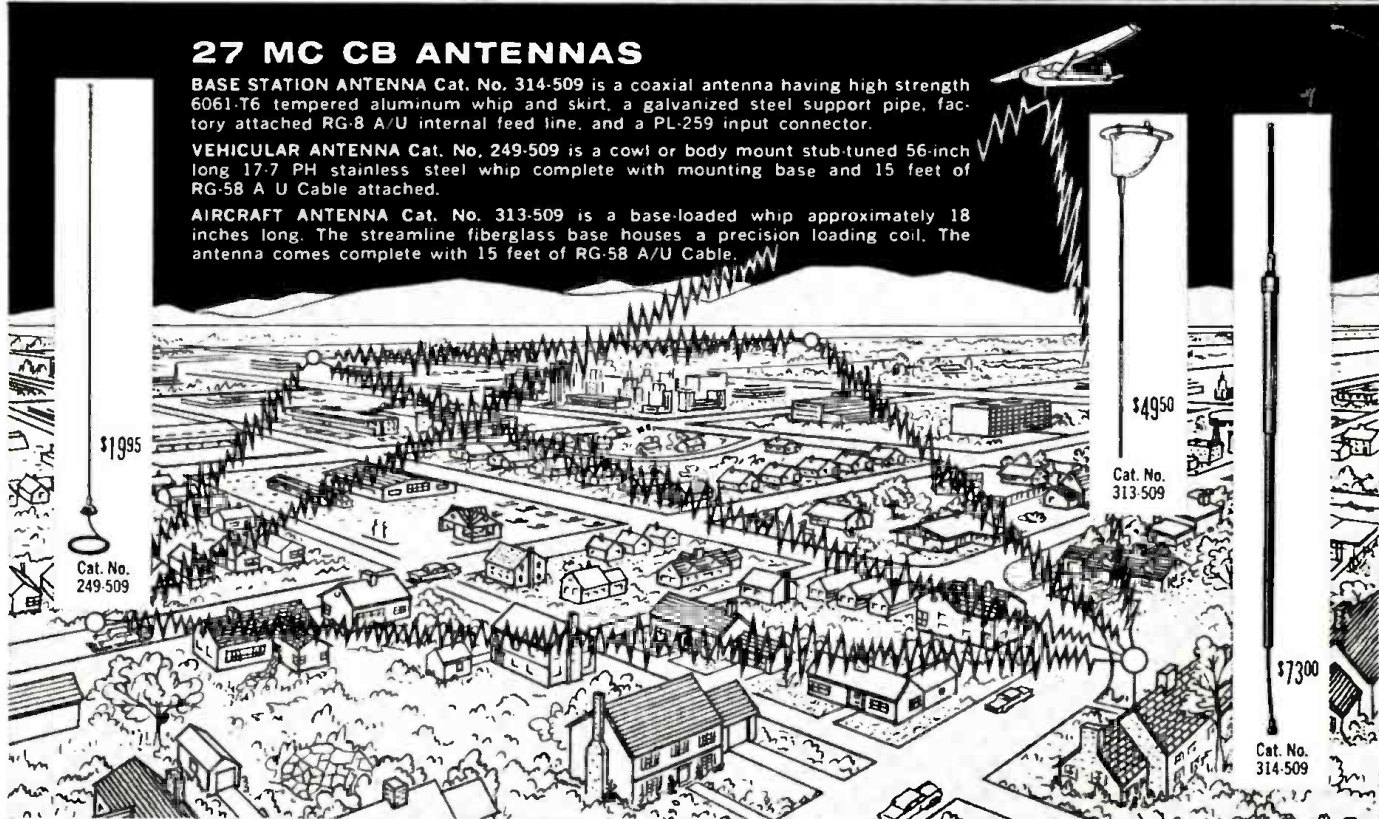

*Communication Products Company, Inc.*  
Communication Antenna Systems for American Business



Marlboro, New Jersey  
Tel. HOpkins 2-1880 (Area Code 201)  
Los Angeles 65, Calif.  
Tel. CHapman 5-1143 (Area Code 213)

**STEP DOWN TRANSFORMER**  
220 Volt 60 Cycle to 110 Volt  
60 Cycle, 500 Watt ..... Ea. **\$10.95**

**FILAMENT TRANSFORMERS**

INP. VOLTS AC	SEC. V.	CURRENT	INS.	PRICE
110	6.3	.8A	—	1.95
110	6.3	.8A	—	1.95
110	6.3	.8A	—	5.95
110	6.3	1.0A	—	2.75
110	5	.52A	10KV	17.95
220	5	.52A	8KV	14.95
110	5.5	6.5A	42KV	19.95
220	3x 5	11A	8KV	14.95
220	1.6	1100A	—	19.95

**AMERTRAN PLATE TRANSFORMER**

Primary 105-125 V. AC., 60 Cy.  
Sec. 6200 V. & 2 KVA or 340  
Ma. 1/2 Wave or use 2 for FULL  
WAVE at 4 KVA ea. .... 2 for \$120.00  
**\$65.00**

**BC 442 ANTENNA BOX (ARC 5)**  
Contains RF Meter (750 Ma.) Relay  
etc. See Coaxial Relay conv. "CQ"  
March 1960. Price **\$1.95**

**SILICON RECTIFIERS**

PIV	Current	Price	PIV	Current	Price
100	500 Ma	\$.28	400	2 AMPS	\$1.00
200	500 Ma	.30	100	15 AMPS	1.50
400	500 Ma	.50	200	15 AMPS	2.75
750	500 Ma	.90	400	15 AMPS	3.75
200	750 Ma	.30	50	50 AMPS	3.50
400	750 Ma	.50	100	50 AMPS	4.00
100	2 AMPS	.35	200	50 AMPS	5.00
200	2 AMPS	.55	75	240 AMPS	6.95

**CHOKES—FULLY CASED**

10 HENRY @ 250 Ma	2.75
10 HENRY 300 MII	3.00
4 HENRY 400 MII	3.95
4 HENRY 900 MII	8.95

**BRAND NEW OIL CONDENSERS**

50 MFD 200 VDC	4.50	4 MFD 2000 VDC	3.50
2 MFD 400 VDC	.50	6 MFD 2500 VDC	5.50
3 MFD 600 VDC	.60	2 MFD 3000 VDC	3.50
4 MFD 600 VDC	.75	2 MFD 4000 VDC	6.25
5 MFD 600 VDC	.80	3 MFD 4000 VDC	8.95
6 MFD 600 VDC	.85	4 MFD 4000 VDC	12.95
8 MFD 600 VDC	.95	1 MFD 5000 VDC	4.50
10 MFD 600 VDC	1.19	2 MFD 5000 VDC	8.50
12 MFD 600 VDC	1.50	4 MFD 5000 VDC	14.95
1 MFD 50 VDC	.25	2 MFD 7500 VDC	2.95
2 MFD 1000 VDC	.70	1 MFD 7500 VDC	6.95
4 MFD 1000 VDC	1.35	2 MFD 7500 VDC	17.95
8 MFD 1000 VDC	1.95	1 MFD 10000 VDC	12.95
10 MFD 1000 VDC	2.50	2 MFD 12,500 VDC	34.50
12 MFD 1000 VDC	2.95	1 MFD 15,000 VDC	42.50
1 MFD 1200 VDC	.45	2 MFD 15,000 VDC	89.50
1 MFD 1500 VDC	.75	1 MFD 20,000 VDC	59.50
2 MFD 1500 VDC	1.10	5 MFD 25,000 VDC	34.95
4 MFD 1500 VDC	1.95	1 MFD 25,000 VDC	69.95
10 MFD 1500 VDC	2.95	10 MFD 300 AC	1.95
8 MFD 1500 VDC	2.95	30 MFD 330 AC	3.25
1 MFD 2000 VDC	.85	50 MFD 330 AC	4.95
2 MFD 2000 VDC	1.50	8 MFD 600 AC	2.95

**RELAYS**

Coax Relay, SPDT-Coil 24 VDC	..... Ea.	<b>\$3.95</b>
WARD LEONARD Heavy duty relay coil 220V 60Cy., 2 phase, 5 HP.	..... Ea.	<b>\$6.95</b>
3 Pole ST. 25 Amp contacts	..... Ea.	<b>\$1.25</b>
6 Volt AC, SPDT	..... Ea.	<b>.95</b>
6 Volt DC, H.S. Relay DPDT	..... Ea.	<b>.95</b>
6 Volt DC, H.S. Relay 3 PST N.O.	..... Ea.	<b>.65</b>
GUARDIAN 110V AC, 2 Pole Single Throw (1 N.O. & 1 N.C.) Repl. BC-610.	..... Ea.	<b>\$2.50</b>
Potter-Brumfield 5MSLS 10,000 ohm, 2 Ma. Sens. vdr	..... Ea.	<b>\$2.25</b>
110 volt AC relay-4PST 60 cy., 15 amp. contacts	..... Ea.	<b>\$3.95</b>
Sens. Relay 11,000 ohm coil, 1 Ma Adj. cont. Armature Tension SPDT	..... Ea.	<b>\$1.95</b>
12 Volt SPDT MSDC Relay	..... Ea.	<b>.95</b>
12 Volt DPDT DC Relay	..... Ea.	<b>\$1.35</b>
SIGMA type 22RJC 5,000 ohm SPDT, small sealed relay	..... Ea.	<b>\$2.49</b>
Sealed Relay, SPDT, 6,000 ohm coil	..... Ea.	<b>\$1.95</b>
G. E. Relay Controls, contact 8000 ohm relay, sensitivity 2 milts. 10 for \$9.25 ea.	..... Ea.	<b>\$1.10</b>

**PANEL METERS**

<b>STANDARD BRANDS</b>	0-15 Volts AC	3.95
	0-2.5 KV	6.95
	West. Elapsed Time Meter 110V-60 cy.	0.95, 99.9 Mrs. Used—Guaranteed
	0-50 Ma	2.95
	0-10 Amps DC	2.95
	0-40 Volts	2.95
	18-36 Volts DC	1.99
<b>2" METERS</b>		
100-0-100 Micro	2.95	
0-1 Ma	3.50	
0-50 Ma	2.95	
0-10 Amps DC	2.95	
0-40 Volts	2.95	
18-36 Volts DC	1.99	
<b>3" METERS</b>		
0-500 V. DC	3.95	
<b>4" METERS</b>		
0-150 Amps AC (with current trans.)	5.95	
0-2500 V. DC	6.95	
100-0-100 UA	5.95	

**MISCELLANEOUS SPECIALS**

365 MMF Variable Condenser Single Section	..... Ea.	<b>.65</b>
EMAC—450 Ft. Brand New	..... Ea.	<b>\$35.00</b>
1821 VACUUM SWITCH, replacement	..... Ea.	<b>1.25</b>
ART 13	..... Ea.	<b>1.25</b>
9 Foot RC110 with 2-PL-259 attached	..... Ea.	<b>1.25</b>
1 AMP RF CHOKES	..... Ea.	<b>.95</b>
Small 10 MFD 200 VDC Oil Cap. (1/2")	..... Ea.	<b>.75</b>
1 Dia x 2 1/2" for Crossover network ea.	..... Ea.	<b>1.50</b>
Electrolytic (Mallory) 400 MFD, 350VDC	..... Ea.	<b>1.50</b>
Rin 5146 Tubes 50% cooler with heat dissipating tube shields. Base and Shield	..... Ea.	<b>.75c</b>

All merchandise sold on a 10 day money back guarantee  
Min. Order \$3.00—25% with Order—F.O.B. New York

**PEAK**

ELECTRONIC COMPANY  
66 W. Broadway, New York 7, N. Y., WO-2-2370

resistance of 8000 ohms. The rated dissipation of both units is 250 mw. and both units have a minimum dark resistance of 200,000 ohms.

**RESISTANCE WELDING HEADS**

19 Raytheon Company has just introduced a new line of miniature resistance welding heads designed for production welding of micro-

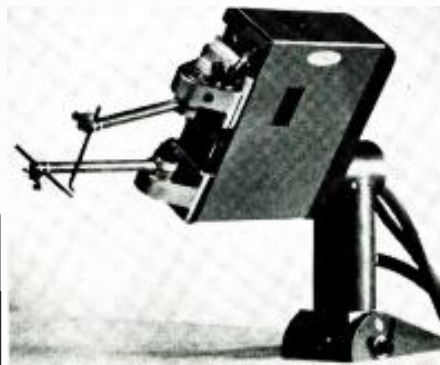

modules, high-density assemblies, and numerous electrical and electronic components.

The "O" series welding heads swivel, tip, and tilt to accommodate the work. They can even be used upside down. Electrode arms that rotate and swing provide optimum electrode positioning for greater operator visibility and more accurate high-speed welding.

**D.C. POWER SUPPLIES**

20 Research-Cottrell, Inc. is now offering a line of high-energy, high-voltage d.c. power supplies engineered to customer requirements. Applications for these new supplies include plasma research, dielectric testing, electrostatic processes, electron beam processing, radar, and other microwave equipment.

Power supplies can be provided with voltage control by conventional voltage-error techniques or control by external variables such as pressure, temperature, current, or frequency of load arc-over.

Output voltages up to 500 kv. and output currents to 100 amps d.c., or higher can be provided.

**FLIP-FLOP LOGIC CIRCUIT**

21 Rese Engineering Inc. has announced development of the Type 2013 FA flip-flop digital logic circuit.

The plug-in package is a 1 mc. transistor flip-flop register designed for logic applications where counting is not required. There are two independent flip-flop circuits mounted on each plug-in board. Two set and reset diode inputs are provided for each circuit and set and reset outputs of both flip-flops are brought out to test points on the package.

Specifications and engineering details on these units are available from the manufacturer.

**HI-FI—AUDIO PRODUCTS**

**AM/FM TUNER WITH MULTIPLEX**

22 Heath Company is now offering a deluxe AM-FM tuner kit which includes a built-in FM multiplex converter.

The Model AJ-41 features an FM stereo indicator light, adjustable a.f.c., individual tuning meters for AM and FM, FM squelch for low noise between stations, a stereo phase control for



maximum separation, and illuminated tuning dial.

Offered in both kit and assembled versions, the unit incorporates printed-circuit boards to facilitate construction. The instrument is housed in a tan vinyl-clad steel cabinet with polished anodized trim.

**"UNIVERSAL" MULTIPLEX ADAPTER**

23 Fisher Radio Corporation is now marketing a "universal" multiplex adapter, the Model MPX-200. The new unit is self-powered, compact, and designed for easy connection. It can be placed up to three feet from the tuner or receiver, thus the present front appearance and arrangement of a high-fidelity system need not be disturbed.

There are two controls to assure identical output levels from both channels. A selector switch makes it possible to record stereo program material monophonically. A special control has been provided for matching the unit to the tuner or receiver with which it is used, thus assuring maximum stereo separation. This control requires setting only at the time of original installation.

**DISC DE-LINTER**

24 Electro-Sonic Laboratories, Inc. is now marketing a new model of its "Dust Bug" designed specifically for use with automatic record changers. The unit consists of an electrostatic pickup unit which mounts on the changer tonearm, a cylindrical pad which is moistened with a special antistatic fluid, and a white nylon-bristle brush which helps to collect dust and lint.

Mounting is merely a matter of pressing the adhesive mounting pad to the proper spot on the tonearm. The effect of the unit on arm mass is less than 1/2 gram.

**AUTOMATIC RECORD CHANGER**

25 BSR (USA) Limited is now offering a new automatic record changer, the Model #UA16, which features a low sculptured silhouette and a special finish which permits coordination with various furniture styles.

The mechanism features a precision-built, dynamically balanced motor which has self-lubricat-



ing, lifetime bearings. To provide vibration-free performance, the motor is mounted with full rubber suspension. The tonearm is a one-piece aluminum die casting which is said to assure non-resonance and flat frequency response.

The unit has four speeds and automatically plays 12-, 10-, or 7-inch records. An exclusive selector permits playing all record sizes of the same speed intermixed. The changer plays mono or stereo records and may be operated manually or automatically.

**FM MULTIPLEX TUNER**

26 Lafayette Radio Electronics Corp. is now marketing a new FM stereo multiplex tuner which has been designated as the Model LT-700.

Featuring a low-noise front end with triode mixer followed by double-tuned dual limiters and a wideband Foster-Seeley discriminator, the circuit includes plate-follower output for remote use from the amplifier, a.f.c. with defeat, and less than .15% distortion at 100% modulation monophonically.

The multiplex section is switchable from the

front panel and has a stereo indicator light. Stereo separation is 35 db at 400 cps; harmonic distortion is less than 1% from 50-15,000 cps, and over-all frequency response is 50-15,000 cps  $\pm$  1%.

The unit measures 12 $\frac{1}{2}$ " x 10 $\frac{3}{4}$ " x 4 $\frac{1}{2}$ " and is housed in a beige vinyl enclosure with cream and brushed brass front panel.

**COMPRESSOR-LIMITER AMP**

27 Langevin is now marketing a miniature plug-in thump-free limiter which acts as an automatic-averaging or as a peak-level control

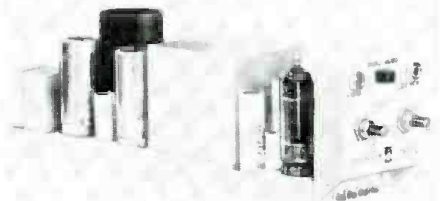

amplifier in recording, TV broadcast, microwave, or industrial sound applications.

The Model AM-5301 measures only 3 $\frac{1}{2}$ " high x 2 $\frac{3}{4}$ " wide x 10 $\frac{1}{4}$ " long. It controls level differences over a range of 30 db and gives a compression ratio which is variable up to 5 to 1. It also acts as an automatic gain control or it can control the level differences between turntables, network program, or microphone preamplifier sources. Attack time is 100  $\mu$ sec. to protect the transmitter against overloads. Frequency is 20-20,000 cps  $\pm$  .5 db.

**SPEAKERS FOR COMMERCIAL SOUND**

28 Jensen Manufacturing Company has released a complete family of 8-inch loudspeakers which have been specifically designed for distributed sound systems.

Currently this new line consists of 24 individual models to meet virtually all the require-

ments of the commercial sound system installer. The speakers are marketed in handy 10-packs with or without pre-attached 70.7- or 25-volt transformers. The speakers feature "Kwikon" instant connectors for input and power tap adjustment.

The line is offered in single-cone, dual-cone, and coaxial versions to meet various installation requirements.

**TRANSISTORIZED STEREO PREAMP**

29 Brown Electronic Laboratory is now marketing the Brown-Nobles transistorized stereo preamp and tone control unit, Model NT-108.

The circuit uses eight 2N190 transistors to provide frequency coverage from 20 to 20,000 cps. Harmonic distortion is below .2% at 1000 cps. The unit features individual vu meters for the two stereo channels, six dual-channel inputs, and two low-impedance and two auxiliary outputs.

The control unit may be operated from two 13.5-volt batteries. It will also operate from d.c. voltages ranging from 5 to 18 volts, with a maximum drain of only 10 ma.

The panel is silver finish with a choice of gold or copper trim. A hand-rubbed wood cabinet is



available at a slight additional charge in walnut, mahogany, or blonde oak finishes.

**MINIATURE ENCLOSURE**

30 Argos Products Co. has added "The Petite" to its line of speaker enclosures designed for use where space is limited. The enclosure meas-

**Ask By Name For GENUINE**

**"NO NOISE" PRODUCTS**

your assurance of brand name quality

No-Noise VOLUME CONTROL and Contact Restorer  
 • Cleans • Lubricates • Restores  
 • Protects • Restores  
 Not a Carbon Tet Solution  
 2 Oz. Pin Bottle \$100  
 6 Oz. Spray Can \$225  
 Net to Servicemen



No-Noise TUNER-TONIC with PERMA-FILM  
 • Cleans, lubricates, restores all tuners, including water type.  
 • Non-toxic, non-inflammable  
 • For TV, radio and FM use  
 • Economical—a little does a lot.  
 6 Oz. Aerosol Can \$325  
 Net to Servicemen

FREE with each Can of ELECTRONIC CHEMICAL products —  
 5" PLASTIC EXTENDER  
 Push Button Assembly For Applications—Does Not Cause Shorts  
 Electronic Chemical new formula EC-44  
 Lubricates, conditions, cleans all electrical contacts. Economical... a little does a lot!  
 6 oz. spray can \$350

**ELECTRONIC CHEMICAL CORP.**  
 813 Communipaw Avenue Jersey City 4, N. J.

NOW . . . AT LAST YOU CAN SAVE ON FAMOUS MAKE TUBES!

**BRAND NEW FAMOUS MAKE Radio & TV TUBES**

65 To 90% OFF LIST

GE  
 RCA  
 CBS  
 SYLVANIA  
 RAYTHEON  
 WESTINGHOUSE  
 PHILCO  
 HYTRON  
 PLUS  
 ALL OTHER  
 NATIONALLY  
 ADVERTISED  
 TUBES!

SPECIAL OFFER . . .  
 For Limited Time Only!

FREE SPANKING NEW

SILVER DOLLAR

With Order Of \$25 Or More!

\*PLUS . . . FREE Famous Make TUBE (of our choice) (List Price Up To \$10) With Every 10 TUBES Purchased!

ALL TUBES . . . \*FACTORY BOXED \*IMMEDIATE DELIVERY \*CODE DATED \*STANDARD R.M.A. GUARANTEE (90-Days)

Part Listing . . . Almost Every Famous Make Tube in Stock!

024	.70	5CL8A	1.10	6BA6	.69	6BE6	.85	8AV8A	1.27	12X7GT	.69
1A7GT	.89	5T8	1.15	6BC8	1.39	6DQ8B	1.39	8C17	.87	12X4	.65
1G3/1B3GT	.99	5U4GB	.59	6DE6	.77	6DT8A	.79	8C17	.95	13HE7	1.03
1H5GT	.89	5U8	1.15	6EQ8GA	1.99	6H8	.55	9AU7	.98	14A7	1.09
1N3GT	.89	5V4	1.25	6H8B	1.19	6J5GT	.49	9CA8A	1.15	14H6	1.06
1E5	.95	5V4GA	1.22	6HR7B	1.15	6J8A	.95	10HE7	.99	14Z7	1.09
1U4	.87	5X8	1.10	6HL7GA	1.15	6K6GT	.85	12AF8A	.69	17AX4GT	.64
1U5	.75	5Y3GT	.44	6H8C	1.10	6L6GB	.71	12AF6	.79	17H4	.65
1X2B	1.05	6AR4	.75	6H95	.79	6N1A	.71	12AT8	.57	17D6BH	1.17
2CY3	.95	6AC7	1.49	6HQ8TA	1.39	6S47GT	1.25	12AT7	.99	19AU4	1.19
3AL5	.65	6AF1A	1.40	6HQ7A	1.19	6SC7	1.25	12AU6	.75	19HG8GA	1.17
3AU6	.75	6AG5	.65	6BS8	1.29	6SK7GT	1.19	12AU7A	.85	19T8	1.17
3BN6	.69	6AH1GT	1.15	6BZ8	.78	6SL7GT	1.19	12AX4GT	.89	23C10GB	1.09
3I2B	.75	6AH6	1.00	6BZ7	1.40	6T8A	1.15	12AX7A	.85	25L6GT	.79
3R8B	.79	6AL5	.94	6C4	.64	6U8A	.69	12BA6	.57	25X4GT	.61
3V4	.85	6AM8A	1.40	6C85	2.59	6V6GT	.75	12BE6	.59	25Z5	.75
4BQ7A	1.40	6AN8	1.30	6CB6	.75	6W4GT	.79	12BH7A	1.05	35L6GT	.84
4H2HA	.75	6AQ5A	.69	6CD6GA	1.99	6W6GT	.68	12BQ6TA	1.40	35V4	.69
5X8B	1.15	6AS8	.85	6CG7	.85	6X1	.55	12BY7A	1.01	35Z5	.59
5AN8	1.19	6AS8	1.17	6C8	1.15	6X8	1.09	12C5	12C5	30A5	1.09
5AQ5	.75	6A8A	.69	6C8A	1.10	7A7	.59	12C6	1.49	50C5	.75
5AS4A	.60	6A8A	1.10	6CM7	1.19	7AU7	.59	12D6	.49	50H6	.59
5AT8	1.13	6AV3GA	1.00	6CN7	.59	7B3	.99	12L6GT	.87	117L7GT	2.09
5HR8	1.15	6AV6	.57	6CQ8	1.10	7E7A	.99	12A7	1.19	117Z3	.85
5CG8	1.19	6AX4GTB	.80	6E8	1.49	7F8	2.09	12BK7GT	1.19		
5J8	.65	6AW8A	1.30	6DA1A	.89	7NT	2.49	12SN7GT	.64		

Money cheerfully Refunded Within Five (5) Days. If Not Completely Satisfied!  
 FREE POSTAGE ON ORDERS OF \$5 OR MORE IN USA AND TERRITORIES.  
 25c Handling Charge required on any order less than \$5. Send 25% deposit on C.O.D.'s. Send approximate postage with Canadian and foreign orders.  
 NO MINIMUM PURCHASE REQUIRED . . . YOU GET THESE LOW PRICES ON ANY QUANTITY YOU BUY!

**STANDARD BRAND TUBE COMPANY**

ROMANCO BUILDING HARRISON, NEW JERSEY HU. 4-9848 Dept. EW-5

# CITIZEN BAND

## CLASS "D" CRYSTALS

All 22 Frequencies in Stock



3rd overtone, .005% tolerance—to meet all FCC requirements. Hermetically sealed HC6 U holders, 1/2" pin spacing—.050 pins. (.093 pins available, add 15c per crystal.) **2.95** each

We can supply matched sets for all CB units at \$5.90 per set. Specify transmitting frequency and make and model number of equipment.

Following frequencies in stock (frequencies listed in megacycles): 26.965, 26.975, 26.985, 27.005, 27.015, 27.025, 27.035, 27.055, 27.065, 27.075, 27.085, 27.105, 27.115, 27.125, 27.135, 27.155, 27.165, 27.175, 27.185, 27.205, 27.215, 27.225.

**RADIO CONTROL CRYSTALS** in HC6/U holders in stock for immediate delivery—all channels. Pin diameter .050. **\$2.95** ea. .093 pin spacing, add

**15c. SEALED OVERTONE CRYSTALS** Supplied in metal HC6/U holders.

Pin spacing .486, diameter .050  
15 to 30 MC .005 tolerance **\$3.85** ea.  
30 to 45 MC .005 tolerance **\$4.10** ea.  
45 to 60 MC .005 tolerance **\$4.50** ea.

## QUARTZ CRYSTALS

for every service



All crystals made from Grade "A" imported quartz—ground and etched to exact frequencies. Unconditionally guaranteed! Supplied in:  
FT-243 holders pin spacing 1/2" pin diameter .093  
CR1A/AR holders pin spacing 1/2" pin diameter .125  
MC-7 holders pin spacing 3/4" pin diameter .125  
FT-171 holder pin spacing 3/4 banana pins

## MADE TO ORDER CRYSTALS

1001 KC to 2600 KC: .005% tolerance **\$4.50** ea  
2601 KC to 9000 KC: .005% tolerance **\$2.50** ea  
9001 KC to 11,000 KC: .005% tol. **\$3.00** ea  
Specify holder wanted

## ANY AMATEUR, NOVICE, TECHNICIAN BAND CRYSTALS

80 meters 3701-3749 KC .01% tolerance  
40 meters 7152-7198 KC  
15 meters 7034-7082 KC  
6 meters 8335-8650 KC  
within 1 KC **1.50** ea.

**MARINE FREQUENCY CRYSTALS**—All marine frequencies from 2000-3200 KC .005 tolerance **\$2.50** ea. (supplied in either FT-243, MC-7 or FT-171 holders)  
**STOCK CRYSTALS** in FT-243 holders from 5675 KC to 8650 KC in 25 KC steps 75c each or 3 for **\$2.00**  
FT-241 Lattice Crystals in all frequencies from 370 KC to 540 KC (all except 455 KC and 500 KC) 50c ea. Pin spacing 1/2" Pin diameter .093

Matched pairs—15 cycles **\$2.50** per pair  
200 KC Crystals **\$2.00** ea.  
455 KC Crystals **\$1.25** ea.  
500 KC Crystals **\$1.25** ea.  
100 KC Frequency Standard Crystals in HC6/U holders **\$4.50** ea.  
Socket for FT-243 crystal 15c ea.  
Dual socket for FT-243 crystals 15c ea.  
Sockets for MC-7 and FT-171 crystals 25c ea.  
Ceramic socket for HC6/U crystals 20c ea.

FREE! Write for Catalog #961 with oscillator circuits.

**ASK YOUR PARTS DEALER FOR TEXAS CRYSTALS**  
See big red display . . . if he doesn't stock them, send us his name and order direct from our factory.

**NOW!** Engineering samples and small quantities for prototypes now made either at Chicago or at Ft. Myers Plant. 24 Hour Service!  
**IN CHICAGO, Phone Gladstone 3-3555**

## ORDER FROM OUR NEW FLORIDA PLANT

Use coupon below for 1st Class shipment  
**TEXAS CRYSTALS**  
Dept. R-52, 1000 Crystal Drive, Fort Myers, Fla.  
For Fastest Service, Phone WE 6-2100

FILL OUT AND ATTACH THIS COUPON TO YOUR ORDER FOR SHIPMENT VIA 1ST CLASS MAIL AT NO EXTRA COST!

NAME.....  
ADDRESS.....  
CITY.....ZONE.....STATE.....

TERMS: All items subject to prior sale and change of price without notice. All crystal orders must be accompanied by check, cash or M. O. with PAYMENT IN FULL. Dept. R-52



ures 18" wide x 12" high x 3 1/2" deep. The system, which is rated at 6 watts, features a Jensen high-compliance woofer which is matched to a Jensen tweeter through a crossover network with volume control. Impedance is 8 ohms.

The enclosure, built of 3/4" genuine hand-rubbed, oiled American walnut veneer with modern cane grille, is coordinated with the speakers to provide optimum results.

## FM STEREO TUNER

**31** Bogen-Presto Division has added a new FM stereo tuner, the Model 1P50, to its line of component hi-fi equipment.

The new unit features flat frequency response



to 75,000 cps and a sensitivity of .9  $\mu$ v. for 20 db of quieting. The tuner has a.g.c. which maintains  $\pm$  .5 db audio output level with a range of signal variations greater than 10 to 10,000  $\mu$ v. A recording filter is built into the multiplex circuit to eliminate whistle interference when taping a stereo program off the air.

The tuner features a brushed gold front panel, functional control locations, a "simple scanner" FM dial, the company's "Acutune" for precise stereo tuning, and dynamic a.f.c.

## CB-HAM-COMMUNICATIONS

### NOISE-SUPPRESSION KIT

**32** Sprague Electric Company is currently marketing a new r.f. interference suppression unit for use in mobile and marine radio installations. Designated as the Type SK-1 "Suppress-kit," the kit contains five basic components, is easy to install, and is designed to be used with CB, amateur, public service, and commercial mobile radio equipment.

Complete installation instructions are packed with each of the kits.

### MECHANICAL FILTER

**33** Collins Radio Company's Components Division has recently introduced a low-cost mechanical filter which has been especially designed for commercial and amateur communications equipment.

The new 455-ke. mechanical filter provides the same steep skirted selectivity as the firm's other mechanical filters with a 6-db bandwidth of 2.1



ke. and a 60-db bandwidth of 5.3 ke.—a shape factor of just over 2.5 to 1.

The filter is packaged in a durable, high-impact phenolic case and is especially suited for circuit-board manufacturing techniques involving dip soldering. The unit measures 2 1/2" long by slightly more than 1 1/2" wide and 1 1/2" high, not including mounting studs and terminals.

### LOG PERIODIC ANTENNA

**34** Hy-Gain Antenna Products has recently introduced a coplanar dipole-type log periodic antenna designed specifically for applications in commercial and amateur radio fields.

The system operates over the entire frequency spectrum of 13 to 30 mc. with a power handling capability of 2.5 kw. AM and 5 ke. p.e.p. The v.s.w.r. is claimed to be less than 1.5:1, average front-to-back ratio is 20 db, and forward gain is 8.7 db over an isotropic source.

The new unit is available either as an antenna alone or as a complete unit with heavy duty rotating system and direction indicator.

### NEW SSB GEAR

**35** Heath Company has recently introduced two new kits which provide SSB mobile facilities in compact, companion units.

The TX-20 transmitter features a hermetically sealed crystal bandpass filter, crystal-controlled dual-conversion heterodyne circuitry, automatic level control for maximum talk power, complete bandswitching of 80 through 10 meters, and convertibility for fixed-station use by means of an accessory power supply.

The companion receiver (photo) tunes SSB, AM, and c.w. signals 80 through 10 meters. It offers better than 1  $\mu$ v. sensitivity on all bands and features crystal bandpass filter for sharp selectivity. The receiver also has a built-in calibrated "S" meter and 30:1 gear drive tuning on a 5 1/2" slide-rule dial. The set can be operated



from a 12-volt car battery by using the firm's 11P-10 mobile power supply.

Both units are matched as to cabinet styling and general over-all appearance.

### BROADBAND AMPLIFIER

**36** Radio Engineering Laboratories, Inc. has announced a new amplifier for use in the 2 kmc. band as a principal component of a broadband tropospheric scatter communications system or a radio propagation test system.

The Type 90611 amplifier is designed to provide 125 watts of power in the r.f. range of 1700 to 2100 mc. A four-cavity klystron provides full output with less than 50 mw. drive power. The klystron tube employs permanent magnet focusing in order to simplify tuning procedures and adjustments. The beam power supply utilizes silicon rectifiers. The power of the a.c. input is single-phase, 120 volts, 50/60 cps, 10 amps.

### LOW-BAND MOBILE UNIT

**37** Aeronautical Electronics, Inc. has announced the availability of a new 20-watt, low-band (25-54 mc.) mobile radio set which provides a number of special features.

A single-unit "up-front-mounted" set, all operating controls are located on the brushed silver anodized front panel. The "Slimline" has provision for operation on a maximum of three channels and for "Unicall," the firm's subaudible, tone-actuated selective call system.

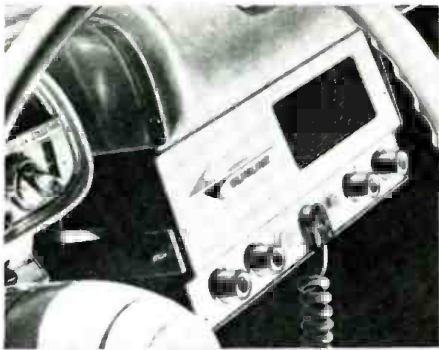

Available as an accessory is a mobile amplifier unit which boosts the power of the unit to 100 watts output. Where the mobile amplifier is used, the operator has instant choice of 20 watts output for normal communications needs or 100 watts output for maximum range under adverse conditions.

## MANUFACTURERS' LITERATURE

**38** Motor Generator Corp. is now offering a two-color folder which covers its complete line of power conversion sets to meet specialized needs. Illustrated and described are single- and three-phase alternators for producing odd voltages, phases, and frequencies. The units offer "on-the-spot" conversion from commercial power to the type power required for a particular application.

**39** The Superior Electric Company has available a 12-page condensed electronic electrical product reference guide which covers the firm's most frequently ordered products. The publication includes ratings and other essential technical data on an extensive line of variable transform-

ers, voltage regulators, synchronous motors and translators, electrical connectors, binding posts, etc.

**40** Electro Systems Corp. has issued a four-page brochure covering the applications and performance of its new operations monitor system, a solid-state system for checking and controlling low-level signals.

The unit was developed for continuous, precise monitoring of operating levels of industrial processes, instrumentation systems, and military checkout—all of which are detailed in the brochure.

**41** Trion Instruments, Inc. is now offering free of charge a bibliography of maser and laser references. The publication lists 117 references of a technical and semitechnical nature, including articles on maser and laser systems, materials, effects, phenomena, and potentialities.

**42** The Norronics Company, Inc. has issued an elaborate tape recording reference guide which includes, on separate data sheets, information on the principles of tape recording, how to convert to four-track stereo, a conversion chart, a cross reference table of heads, catalogue sheets on heads and accessories, circuit diagrams of transistorized record and playback circuits, supplemental head instructions, and instruction sheets for all of the firm's conversion kits.

The material is indexed for ready reference and well illustrated for easy comprehension.

**43** Don Bosco Electronics, Inc. has just published a single-page data sheet which pictures and describes in detail its "Mosquito" signal injector. The bulletin explains how this self-contained, fully transistorized signal gener-

ator can be used in checking a variety of circuits in radio, TV, recorders, sound projectors, telephones, sound systems, hearing aids, amplifiers, etc. Complete specifications, features, and typical output waveforms are included.

**44** Raytheon Company has published a 16-page brochure on ultrasonic machining which explains the theory of such a technique and details applications in drilling, slicing, engraving, retrimming, and shaping hard and brittle materials such as glass, ceramics, germanium, stainless steel, tool steel, and precious jewels.

Full specifications on the company's impact grinders are included as well as tables of cutting rates for different materials commonly cut by ultrasonic techniques.

**45** Cannon Electric Company has compiled a listing of its plugs designed especially for laboratory and switchboard applications. The plugs described provide quick disconnect switching and patching operations for switchboards, terminal boards, and panel ports.

**46** Lafayette Industrial Electronics Division has released a 24-page catalogue covering the General Radio "Variacs" stocked by the distributor.

Each of the manufacturer's autotransformers is described in detail as to construction, dimensions, and electrical specifications. Many of the models are illustrated.

**47** Technical Appliance Corporation has issued a 16-page catalogue covering its line of

(Continued on page 104)

# 1-YR. GUARANTEED RADIO & TV TUBES

## NEW LOW PRICE

# \$30

per 100 TUBES

R
B
\$

Factory Used or Factory Second Tubes! TRU-VAC will replace FREE any tube that becomes defective in use within 1 year from date of purchase!											
ALL TUBES INDIVIDUALLY BOXED! CODE DATED & BRANDED "TRU-VAC"											
Partial Listing: Only ... Thousands More Tubes in Stock!											
<b>SPECIAL! 6CB6 30¢ 6CQ8 30¢</b>											
0Y4	3Q4	6AC7	6AT6	6CF6	6J7	6V6GT	7F8	12BA6	12V6GT		
OZ4	354	6AF4	6AU6	6CC7	6K6GT	6W4GT	7C7	12BA7	12W6GT		
1A7GT	1A7	6AG5	6AU4GT	6CC8	6K7	6W6GT	7H7	12BD6	12X4		
1B3GT	4BQ7A	6AM4GT	6AU5GT	6CL8	6N7	6X4	7N7	12BE6	14A7/12B7		
1MSGT	4B5B	6AM6	6AU8	6CL6	6Q7	6X5GT	7Q7	12HF6	14B6		
1L4	4B27	6AK5	6AV5GT	6CM6	6S4	6X8	757	12BH7	14Q7		
1L6	4CB6	6AL5	6AV6	6CM7	6S7	6Y6C	7X6	12BL6	17A4		
1NSGT	5AM8	6AM8	6AW8	6CN7	658GT	7A5	7X7	12BR7	17D4		
1R5	5AN8	6AN8	6AX4GT	6C8	65A7	7A6	7A6	12BQ6	19AU4GT		
1S5	5AT8	6AQ5	6AX5GT	6CR6	65F7	7A7	7Z4	12BY7	19B5C		
1T3	5AV8	6AQ6	6BK5	6CS6	65D7GT	7A8	12A8	12CA5	19J6		
1U4	5AZ4	6AQ7	6BK7	6CS7	65F5	7B4	12AB5	12CN5	19T8		
1U5	5BR8	6AR5	6BL7GT	6CU5	65F7	7B5	12AB6	12D4	24A		
1V2	5CC8	6AU7	6BN6	6CU6	65G7	7B6	12AF6	12E5	25Z6GT		
1X2	5J6	6BH	6BO6GT	6D6	65H7	7B7	12AQ5	12F8	27		
2A4	5R4	6BA6	6BQ7	6DE6	65J7	7B8	12AT6	12G5	35A5		
2BN4	5T8	6BC5	6BR8	6DD6GT	65K7	7C4	12A7	12M7	35B5	43	
2CY5	5U4	6BC8	6BS8	6DF6	65L7	7C5	12AU6	12L6	35C5	50A5	
3A5	5B8	6ID6	6BY5G	6E5	65N7GT	7C6	12A7	12O7	35W4	50B5	
3AL5	5V4G	6IE6	6BZ6	6F5	65Q7	7C7	12AV6	12R5	35Z5	50C5	
3AU6	5V6GT	6BF5	6BZ7	6F6	65R7	7E5	12A7	12S4	36	50L6	
3BC5	5B	6DD6G	6C4	6M6	6T4	7E6	12AX4GT	12S7	38	56	
3BN6	5Y3	6BH6	6C4B	6J4	6T8	7A3	XXL 12A7	12SK7	39/44	80	
3BZ6	6A6	6BJ6	6C4	6J5	6U5	7E7	12A7	12SN7GT	41	84/624	
3C5	6AB4	6A55	6CD6G	6J6	6U8	7F7	12B4	12SQ7	42	117Z3	

**1-YEAR GUARANTEED TV PICTURE TUBES.** These tubes are made only from new parts and materials, except for the envelope which is re-used.

Below Listed prices do not include Post and Additional \$2.00 Discount on tube sizes 10" and 21" tubes—\$7.50. 10% refunded when dual is returned unused. Minimum Order—\$1.00 extra. Picture tubes shipped only to continental USA and Canada—F.O.B. Harrison, N.J.

10BP4	7.00	10KP4	11.00	17BP4	16.00	20BP4	17.00	21AVP4	17.00	21XP4	17.10
12BP4	10.00	12KP4	12.10	17BP4	16.00	21AP4	21.10	21FP4	17.20	21YP4	18.30
14E CP4	11.00	16BP4	11.00	17BP4	13.00	21ALP4	13.00	21ALP4	18.70	21ZP4	17.40
16AD4	16.00	17AVP4	15.10	20CP4	15.00	21AP4	18.70	21MP4	22.00	24AP4	30.10
18BP4	12.10	17BP4	13.10	18AP4	18.10	21AMP4	17.00	21VP4	18.00	21Y4	27.70
18CP4	13.00	17CP4	14.00	17BP4	16.00	21AU4	18.70	21WP4	17.00	21Y4	20.70
16BP4	12.10	17CP4	17.00	20BP4	15.00	21VP4	18.70				

**ATTENTION QUANTITY USERS:** Big Discounts Are Yours ... Call or Write For Our Tube Price-Volume Table! Special Attention Branding Dept. TRU-VAC Cheerfully Returned Within Five (5) Days, If Not Completely Satisfied!

**TRU-VAC PAYS YOUR POSTAGE**—On orders of \$5 or more in USA and Territories. Send approximate postage on Canadian and foreign orders. Any order less than \$5 requires 25¢ handling charge. Send 25¢ on C.O.D.'s. All orders subject to prior sale. Complying with Federal regulations, the following statement appears in all TRU-VAC advertising: Tubes in this ad may be FACTORY SECONDS or USED tubes and are clearly marked.

Sensational Offer!  
"Self Service"  
**TUBE CHECKERS**

\$37.95

F.O.B. Our Warehouse

Let your customers test their own tubes! These reliable, reconditioned socket tube checkers will return your investment in return your effort on your little or no effort on your part! Handsome, field-tested console models COMPLETE WITH KEY FOR BOTTOM DOOR AND NEON-LIGHTED HEAD!

LOOK! 1,000 USED TV'S

\$16.95

As Is

Costly, thousands make console models with little or no tube re-tube! Require only minor adjustment, per- minor adjustment, or as fact for resale, or as your own second set! 10", 12" and 14" sets—some smaller! Sets shipped from Harrison, N.J.

SPECIAL! TV Console 10", 12", 14" while they last, \$8.95, as vs.

R
B
\$

**TRU-VAC** Dept. EW5

Harrison Avenue • Box 107 • Harrison, N. J. HUmboldt 4-9770

May, 1962

www.americanradiohistory.com

101

### LORAN APN-4 FINE QUALITY NAVIGATIONAL EQUIPMENT

Determine exact geographic position of your boat or plane. Indicator and receiver complete with all tubes and crystal.

**INDICATOR ID-6B APN-4, and RECEIVER \$49.50**  
**R-9B APN-4, complete with tubes and crystal \$88.50**

Receiver, Indicator, and above, BRAND NEW

**INVERTER POWER SUPPLY for Loran.** Made by Empire Industries Div. INPUT: 24 V DC @ 7.5 A. OUTPUT: 115 V AC @ 10.5 Amps. 500 cycles. Complete with two connecting plugs. BRAND NEW \$49.50

12-Volt Inverter Power Supply, Like New \$29.95  
 Shock Mount for above \$2.95  
 We carry a complete line of spare parts for above.

### LORAN APN/4 OSCILLOSCOPE

Easily converted for use on radio-TV service bench.

LIKE NEW! Less tubes, but including 5" Scope, type 5CPI only \$14.50

### LORAN R-65/APN-9 RECEIVER & INDICATOR

Used in ships and aircraft. Determine position by radio signals from known stations. Accuracy in within 1% of distance. Complete with tubes and crystal. Use used. \$79.50

Value \$1200.00. Our Price \$79.50

Used, less tubes, crystal and glass, but with SBP1 C.R. tube \$29.50

**INVERTER POWER SUPPLY.** INPUT: 24 V DC. OUTPUT: 115 V AC. 800 cy. BRAND NEW \$49.50

12-Volt Inverter Power Supply, Like New P.U.R. Shock Mount for above \$29.95  
 Circuit Diagram and connecting plugs available. We carry a complete line of spare parts for above.

### BC-433 RADIO COMPASS RECEIVER

200 to 1750 Kc in 3 bands. 28 V DC power supply required. Complete with 15 tubes. BRAND NEW \$21.50

### ASB-5 'SCOPE INDICATOR

BRAND NEW, including all tubes, together with SBP1 'Scope Tube. Originally used in Navy's Air Craft RADAR equipment. Easily converted for AC operation. VALUE \$250.00! OUR LOW PRICE \$15.95

### BENDIX DIRECTION FINDERS

For commercial navigation on boats.

MN-20 140-325 Kcs 3-2-4-7 Mc. Complete with tubes, dynamometer. BRAND NEW \$19.50

MN-20 Receiver Control Box \$4.95

MN-20 Receiver 150-1500 Kc continuous tuning with 12 tubes and dynamometer. Used... 18.95

MN-20 Receiver as above. BRAND NEW 27.50

MN-20E Mountable Loop for above 4.95

MN-22 Azimuth Control Box 2.95

### APN-1 FM TRANSMITTER-RECEIVER

420 to 460 Mc Aircraft Radio altimeter equipment. Tubes: 4-955, 3-125J7, 4-125M7, 2-12H6, 1-VR150. Complete with tubes, brand new APN-1 exc. Used \$9.95

### ARN-3 C AIRBORNE EQUIPMENT

Equipment, to give correct guidance during landings. 11 tube superhet circuit. Tubes: 2N17, 12-07, 2-12SN7, 7-6A35. Crystal Controlled on 4 channels. Like new \$12.95

### BC-906 FREQ. METER-SPECIAL

Cavity type 145 to 235 Mc. Complete with antenna Manual and original calibration charts included. BRAND NEW

OUR LOW PRICE \$11.88

### BC-221 FREQUENCY METER

SPECIAL BUY! This excellent frequency standard is equipped with original calibration charts, and has ranges from 1.25 Mc to 20,000 Mc with crystal check points in all ranges. Excel. Used with original Calibration Book. Crystal, and all tubes, LIKE NEW.

Unmodulated \$72.50 Modulated \$99.50

### SCR-625 MINE DETECTOR

Complete portable outfit in original tincler, with all accessories. Brand New \$27.50

### TS-16/APN TEST SET

For adjusting and calibration of radio altimeters. May be used to check calibration of range or circuit, and modulator sweep frequency and bandwidth of transmitter. Amplifier range: 100 to 7500 cycles. 13/14 VDC Input. Complete with tubes, connecting cables. Instruction summary. BRAND NEW \$11.95

### 2 VOLT BATTERY "PACKAGE"

1-2V, 20 Amp. Hr. Willard Storage Battery, Model 2-20-2, 3" x 7" x 3 1/2" High \$2.79

1-2V, 7 prong Synchronous Plug-in Vibrator \$1.49

1-Quart. Bottle Electrolyte (for 2 cells) \$1.45

ALL BRAND NEW! Combination Price \$5.45

### WILLARD 6-VOLT MIDGET STORAGE BATTERY

3 Amp. Hour. BRAND NEW. 3 1/2" x 1 1/2" x 2 3/4". Uses Standard Electrolyte. Only \$2.95

### ATTENTION: IMPORTERS-EXPORTERS of ELECTRONIC EQUIPMENT

We specialize in the export of electronic equipment, Parts, and Electronic Tubes at LOWEST prevailing prices. Orders and shipping is made directly from our own warehouses in NYC, to give you substantial savings in handling costs! Your inquiries invited.

### BC-603 FM RECEIVER

20 TO 27.9 MC. \$2150

Exc. USED

BRAND NEW \$22.50

10-channel, pushbutton or continuous tuning. Complete with speaker, search, and ten tubes: 3-6AC7, 1-6A5, 2-12SG7, 1-6H6, 1-6X5, 2-6SL7

EXTRA SET OF 10 TUBES FOR ABOVE brand new in original box \$3.95

FT-237 MOUNTING BASE for BC-603 Rev and BC-604 Transmitter, Brand New \$5.95

12 or 24V Dynamometer for Above. Used \$4.25 Brand New \$5.50

BC-603 FM Receiver, 27 to 28.9 Mc. Complete with all tubes, USED \$33.33

1-Section Antenna for BC-603, 683 Receivers. Complete with mounting base. BRAND NEW \$4.95

BC-604 TRANSMITTER-Companion unit for BC-603 Rev above. With all tubes. BRAND NEW \$7.95

1-Section Antenna for BC-604, 684 Transmitters. Complete with mounting base. BRAND NEW \$4.95

We carry a complete line of spare parts for above.

### SPECIAL! BC-603 FM RECEIVER

CONVERTED FOR FREQ. RANGE 35 to 50 Mc. BRAND NEW! Checked out, perfect working condition, ready for operation. Continuous or Push-button tuning in 35 to 50 Mc. range. SPECIAL \$34.50

AC POWER SUPPLY FOR BC603, 683 Interchangeable tubes, dynamometer. Has On-Off Switch. NO TUBE CHANGE NEEDED. Provides 200 VDC @ 80 Ma. 21VAC @ 2 Amps \$10.25

Complete 240-page Technical Manual for BC-603, 604 \$3.15

### SCR-522 2-METER RIG!

Terrific buy! VHF Transmitter-receiver, 100-156 Mc, 3 channels, xtal-controlled. Amplitude modulated voice. They're going fast! Excellent condition. SCR-522 Transmitter-Receiver, complete with all 18 tubes, 100 rock and metal case. COMBINATION. Exc. Used \$29.50

New \$49.50

### FAMOUS BC-645 TRANSCEIVER

15 Tubes 435 to 500 MC

Can be modified for 2-way communication, voice or code, on ham band 430-450 mc. citizens radio 480-495 mc. fixed and mobile 450-460 mc. television experimental 470-500 mc. 5 tubes (more than sale price): 4-9F7, 4-7H7, 2-7E6, 2-6H6, 2-9Z5, and 1-W6-318A. Now covers 460 to 490 mc. Brand new BC-645 with tubes. Best power supply for laboratory control. SPECIAL! \$19.50

Shipping weight 25 lbs.

SCR-101C Dynamometer, 12/24V input \$7.95

UHF Antenna Assembly 2.45

Complete Set of 10 Plugs 5.50

Control Box 2.25

### SPECIAL "PACKAGE" OFFER:

BC-645 Transceiver, Dynamometer and all accessories above. COMPLETE, BRAND NEW. \$29.50

White Stocks Last.

### TS-100AP 'SCOPE

Exc. USED (worth \$750) OUR LOW PRICE \$39.50

Brand New \$69.50

Can be used with linear sweep or general purpose test scope. Cables included. Also used with circular sweep as precision range calibrator. Self-contained in metal case 8" x 12 1/2" x 16" deep. For 110 v. 50 to 120v. cycle AC. Excellent used. Like new, with all tubes including crystals and C.R. Tube.

### AN/ARN-6 RADIO COMPASS EQUIPMENT

Highly efficient airborne direction finding system. Frequency: 100 to 1750 Kc in 4 bands. 20.5 DC V Power input. LIKE NEW. \$79.50

### LIMITED QUANTITY SPECIALS!

BC-312 MOBILE RECEIVER 6 bands, 1500 Kc to 18 Mc. With Tubes and 11V Dynamometer, Like New \$79.50

BC-314 RECEIVER 150-1500 Kc continuous tuning. Input for 1.5 V DC operation. Like New \$69.50

BC-312 RECEIVER 1.5 to 18 Mc. AC only. Excellent Used \$79.50

BC-348 SUPERHET RECEIVER 200 to 500 Kc and 1.5 to 18 Mc Mc. Voice, Tones, CW. Self-contained dynamometer for 24 V DC. Like New \$49.50

ARW-26 RADIO REMOTE CONTROL RECEIVER fit to 20 Mc carrier freq. Battery operated. Less Batts. Includes tubes: 6002, 6003, 7-6A35. Brand New \$9.95

AN/APT-5 AIRBORNE RADAR SET, with tubes. Like New \$39.50

TG-34A KEYS, exc. used, like new \$24.50

Type for above, each \$1.85. Set of 15, P.U.R.

### SCHEMATIC DIAGRAMS

For most equipment on this page, each \$65c

Please include 25% Deposit with order-Balance C.O.D. or Remittance in Full. 50c Handling Charges on all orders under \$5.00. All shipments F.O.B. Our Warehouse, N.Y.C. All Merchandise subject to Prior Sale and Price Changes.

### G & G RADIO SUPPLY CO.

Telephone: CO 7-4605  
 75-77 Leonard St.  
 New York 13, N. Y.

### ARC-3 RECEIVER!

Complete with All Tubes Exc. Used \$1695

Like NEW \$21.50  
 Used \$14.95

Crystal-controlled 17-tube superhet, tunes from 100 to 156 MC. AM., on any 8 pre-selected channels. 28-volt DC power input. Tubes: 1-9002, 6-6A5, 1-125M7, 3-125G7, 1-9001, 1-12H6, 2-12SN7, 1-12SL7, 1-12A6.

### ARC-3 TRANSMITTER

Companion unit for above, same 100 to 156 MC on any 8 pre-selected channels. 9 tubes, crystal controlled, provides tone and voice modulation. 28V DC Power Input. Complete with all tubes: 3-6V6, 2-8A2A, 1-12SH7, 1-6A5, 2-6H6. Exc. Used, Like New Only \$1695

Like new condition \$26.50  
 Above, RESUBSTITUTION CONTROL BOX \$5.95

### R77/ARC-3 RECEIVER POWER SUPPLY

Operates from 110 V 60 cycle AC. OUTPUT: 275 V DC @ 150 Ma. and 12.0 V AC @ 4 Amps. Complete power supply, includes transformer, choke, capacitor, switch, pilot lights, line fuse, 2-wire terminal chassis, wiring diagram. Weight 12 lbs. COMPLETE KIT OF PARTS \$15.00

Wired, Tested, Ready for operation \$19.95

### AN/ART-13 100-WATT XMTR

11 CHANNELS  
 200-1500 Kc  
 2 to 18.1 Mc

Complete with Tubes \$6950

Exc. Used

Famous Collins Autotune Aircraft Transmitter, AM, CW, MCV. Quick change to any of ten preset channels or manual tuning. Speech amplifier, clipper uses carbon or magnetic mike. Highly stable, highly accurate VFO. Built in xtal controlled oscillator. P.P.S.T. module \$24.00 on final up to 600 cycles. 18.0 A Beam "HOT" Ham buy at our low price! Orig. cost \$1800.

AN/ART-13 XMTR as above, Like New \$69.50

0-16 Low Freq. Osc. Coil for ART-13 7.95

24V Dynamometer for ART-13 11.95

Same as above less meter 39.50

We carry a complete line of spare parts for above.

### APR-1 Navy VHF-UHF radio search Receiver, 80 Mc to 450 Mc in 2 bands. BRAND NEW \$79.50

TUNING UNITS for above: TN1, TN2, TN3. BRAND NEW, each \$39.50

### AN APR-4 RECEIVER only, 36 to 4000 Mc in 5 tuning unit ranges. High precision lab instrument. Input 115 V 60Hz cy. Like New \$79.50

Tuning Unit TN1, 17, 18, 19 each \$39.50

Tuning Unit TN3 \$149.50

### SCR-274 COMMAND EQUIPMENT

ALL COMPLETE WITH TUBES

Type	Description	Used	Like New
BC-453	Receiver 180-550 KC	\$12.95	\$14.95
BC-454	Receiver 3-8 Mc	\$10.45	\$12.45
BC-455	Receiver 4-8 Mc	11.50	13.95
1-3 to 4 Mc. Receiver	Brand New		\$17.95

110 Volt AC Power Supply Kit, for all 274-N and ARC-5 Receivers. Complete with metal case, instructions, factory tested, ready to operate \$11.50

SPLINED TUNING KNOB for 274-N and ARC-5 RECEIVERS. Fits BC-453, BC-454 and ARC-5. Only \$49c

2-1 to 3 Mc. Transmitter, Brand New \$12.95

BC-457 TRANSMITTER 4-5.3 Mc. complete with all tubes and crystal. BRAND NEW \$9.75

BC-458 TRANSMITTER 5-3 to 7 Mc. Complete with all tubes and crystal. BRAND NEW \$9.75

T19 TRANSMITTER 34 mc. complete with all tubes and crystal. Exc. Used \$9.95

BC-455 Modulator USED 3.45 NEW 5.95

MD7 Modulator, Like New \$9.95

ALL ACCESSORIES AVAILABLE FOR ABOVE

### MOBILE-MARINE DYNAMOTOR

Model DM35

Input 12V DC. Output: 825 V DC 225 Ma. for pre-talk intermittent operation. Shpg. wt. 14 lbs.

BRAND NEW \$24.50

### OTHER DYNAMOTOR VALUES: Excellent BRAND

Type	Input	Output	Used	BRAND NEW
DM-32A	28V 1-1A	250V .05A	2.45	4.45
DM-33A	28V 2A	575V 16A		
	28V 7A	540V 25A	1.95	3.75
DM-33D	12V 2A	220V 080A	4.15	5.50
DM-53A	28V 1.4A	220V 080A	3.75	5.45
DM-63A	12V 5.1A	275V 150A		7.95
PE-73C	28V 20A	1000V 350A	8.95	14.95
PE-86	28V 1.25A	250V .050A	2.75	3.85

DM-42A DYNAMOTOR, Input 12 V DC, 2000 Ma. Output 512 Ma. and 1000 V DC @ 200 Ma. wt. 38 lbs. BRAND NEW, each \$6.95

DM-37 DYNAMOTOR, Input 25.5 V DC @ 0.2 A. Output 250 V DC @ 0.2 A. BRAND NEW, each \$3.25

### MICROPHONES

Model	Description	Exc. Used	BRAND NEW
T-17	Carbon Hand Mike	\$4.45	\$7.95
RS-38	Navy Type Carbon Hand Mike	3.95	5.75

### HEADPHONES

Model	Description	Excellent Used	BRAND NEW
HS-23	High Impedance	\$2.19	\$4.49
HS-23	Low Impedance	2.95	4.59
HS-30	Low Imp. (featherwt.)	.90	1.65
W-16	U. High Imp. (2 tones)	3.75	7.95

TELEPHONES, 500 ohm, High Impedance, H.A. 32. Like New, PHIL 50R \$3.25

CD-307A Cords, with 11.5v plug and JK28 Jack .95

Earphone Cushions for above-part. .50



# ELECTRONICS MARKET PLACE

RATE: 60¢ per word. Minimum 10 words. July issue

## ELECTRONICS ENGINEERING AND INSTRUCTION

USED Correspondence Courses and Books sold and rented. Money back guarantee. Catalog Free. (Courses Bought.) Lee Mountain, Pisgah, Alabama.

ELECTRONICS! Associate degree—29 months. Technicians, field engineers, specialists in communications, missiles, computers, radar, automation. Start February, September. Valparaiso Technical Institute, Dept. N, Valparaiso, Indiana.

BACCALAUREATE Degree Correspondence Course Directory: \$2.00. College Research, North Highlands 15, Calif.

NEW Trade? Electronic, Mechanical Drafting pays \$150 week. Send \$2 first lesson, complete home study course \$25. Prior, Inc., 23-09 169 St., Whitestone 57, New York.

## FOR SALE

TV Tuners—Rebuilt or Exchanged \$9.95 complete—all types—fast, guaranteed service. Send tuner with all parts to: L. A. Tuner Exchange, 4611 West Jefferson Blvd., Los Angeles 16, California.

TUBES—TV, Radio, Transmitting And Industrial Types At Sensibly Low Prices. New, Guaranteed, 1st Quality, Top Name Brands Only. Write For Free Catalog or Call WALKER 5-7000, Barry Electronics Corp., 512 Broadway, New York 12N, N. Y.

DIAGRAMS for repairing radios \$1.00. Television \$2.00. Give make, model. Diagram Service, Box 672-E, Hartford 1, Conn.

GOVERNMENT Surplus Receivers, Transmitters, Snoopers scopes, Parabolic Reflectors, Picture Catalog 10¢. Meshna, Malden 48, Mass.

GOVERNMENT Sells Surplus: — Electronics; Oscilloscopes; Transceivers; Test Equipment; Radar; Sonar; Walkie-Talkie; Boats; Jeeps; Aircrafts; Misc.—Send for "U.S. Depot Directory & Procedures"—\$1.00—Brody, Box 425(RT), Nanuet, New York.

PROFESSIONAL Electronic Projects—Organs, Timers, Computers, Industrial, etc.—\$1 up. Catalog Free. Parks, Box 1665, Lake City, Seattle 55, Wash.

BEFORE You Buy Receiving Tubes or Hi-Fi Components send now for your giant Free Zalytron current catalog—featuring nationally known Zalytron First Quality TV-Radio Tubes, Hi-Fi Stereo Systems, Kits, Parts, etc. All priced to Save You Plenty—Why Pay More? Zalytron Tube Corp., 220 W. 42nd St., NYC.

PRECISION Resistors, carbon-deposit. Guaranteed 1% accuracy. Millions in stock. 1/2-watt, 8¢. 1-watt, 12¢. 2-watt, 15¢. Leading manufacturer. Rock Distributing Co., 902 Corwin Rd., Rochester 10, N. Y.

SAVE dollars on radio, TV-tubes, parts at less than manufacturer's cost. 100% guaranteed! No rebrands, pulls. Request Bargain Bulletin. United Radio, 1000-W, Newark, N. J.

ELECTRONIC IGNITION. Transistorized improved performance, saves gas, tuneups. Coils, Kits Conversions Literature. Palmer Electronics, Carlisle, Massachusetts.

INVESTIGATORS, write for free brochure on latest sub-miniature electronic listening devices. Dept. 6B, 11500 NW 7th Ave., Miami 50, Fla.

HIFI Amplifiers, tuners, speakers, radios, telescopes, microscopes, cameras. Free Catalog. GM Photoelectronics, 623 Gay, Knoxville 2, Tennessee.

BUY Shavers Wholesale: Remington Roll-A-Matic \$69, \$15.50; Remington Lektroline \$66, \$20.55; Remington Lady \$261, \$10.25; Norelco Floating Head \$7870, \$14.98. Send check or M.O. plus 50¢ postage and insurance. Fully Guaranteed. National Appliance Trading Co. Waterville, Maine.

"FREE"—R.C.A., G.E. etc. tubes catalog. Discount to 75% from list. Picture tubes at 75¢ inch up. Parts, parts kits at 1/10 original cost. Needles, tube testers, silicones, seleniums 7" TV bench test tube—\$6.99—and more." Arcturus Electronics Corp., E.W. 502-22nd Street, Nion City, New Jersey.

SIGNAL Generator—Measurements Model 84—300-1000 M.C. Engineering, Research purposes \$500.00 others. O'Keefe Surplus Aircraft, Box 284, Stanhope, New Jersey.

TRANSFIRE TRANSISTOR Electronics ignition. Save gas, tune-ups. Improved starting, high and low-speed performance. Parts, Complete Kits, Conversions, from \$34.95. Palmer Electronics, 2W, Carlisle, Massachusetts.

closes May 3rd. Send order and remittance to: ELECTRONICS WORLD, One Park Ave., N. Y. C. 16, N. Y.

DD secret investigative work with supersensitive, directional microphone. Detects a whisper at great distances. Easily constructed for \$7. Step by step plans \$2. Dee Company, Box 7263-D, Houston 8, Texas.

CONVERT any television to sensitive, big-screen oscilloscopes. Only minor changes required. Plans \$2. Relco, Box 10563, Houston 18, Texas.

TV-Radio Service Dealers. No investment—We furnish you complete consignment stock Raytheon tubes. Regular dealer discount plus premiums, free caddy, advertising. Write for information OMEGA Electronics, Dept.-E, 397 7th Ave., Brooklyn 15, N. Y.

SAVE Up To 60% On Heathkit's Big Discontinued-Kit Sale. Send for Free copy of special Heathkit Discontinued-Kit Sale Brochure! Lists dozens of brand new kits for hi-fi, stereo, amateur radio, test instruments, etc. you can buy at big savings. Write Heath Company, Benton Harbor 15, Michigan.

RAL-6 Receiver, \$42.50. List 10¢. Steller, 624 Drummwood, McMinnville, Oregon.

MICROPHONE kit, carbon—Complete with switch, cable, etc. \$2.75 each, 2 for \$5.00—Assembled \$3.00 each. Dart Electronics 6409 New Utrecht Avenue, Brooklyn, N. Y.

## WANTED

QUICKSILVER, Platinum, Silver, Gold. Dres Analyzed. Free Circular. Mercury Terminal, Norwood, Massachusetts.

CASH Paid! Sell your surplus electronic tubes. Want unused, Clean radio and TV receiving, transmitting special purpose, Magnetrons, Klystrons, broadcast types. Want military and commercial lab/test equipment such as G.R.H.P., AN UPM prefix. Also want commercial Ham Receivers and Transmitters. For a Fair Deal write: Barry Electronics Corp., 512 Broadway, New York 12, N. Y. (Walker 5-7000).

TRIGGER—W9IVJ We Buy Shortwave Equipment For Cash. 7361 W. North, River Forest, Ill. Phone PR 1-8616. Chicago TU-9-6429.

CASH or Ham Gear: For all types Military Surplus PRC-GRC, UPM and teletype. Philmar Electronics, Morrisonville, New York.

UPX-4 Wanted. Surplus IFF ground station. Advise best price. M. W. Pflaumer, The Hill School, Pottstown, Pennsylvania.

## TAPE AND RECORDERS

TAPE Recorders, Hi-Fi Components. Sleep Learning Equipment, Tapes. Unusual Values. Free Catalog. Dressner, 1523 EW Jericho Turnpike, New Hyde Park, N. Y.

RENT Stereo Tapes—over 2,500 Different—all major labels—free catalog. Stereo-Parti, 811-G, Centinela Ave., Inglewood 3, California.

DON'T Buy Hi-Fi components, kits, tape, tape recorders until you get our low, low return mail quotes. "We Guarantee Not To Be Undersold." Wholesale catalog free. Easy time payment plan, 10% down—up to 24 mos. to pay. Hi-Fidelity Center, 22DNC E. 23 St., New York 10, N. Y.

SELF-Hypnosis. New concept teaches you quickly by tape or LP-record. Free literature. McKinley Publishers, Dept. T6, Box 3038, San Bernardino, California.

4/TR Stereo Tapes—bought, sold, rented, traded! Free Catalog/bargain closeouts. (Columbia) 9651 Foxbury, Rivera, California.

SAVE 30% Stereo music on tape. Free bargain catalog/blank tape/recorders/norelco speakers. Saxitone, 1776 Columbia Road, Washington, D.C.

## HIGH-FIDELITY

PROMPT Delivery, We Will Not Be Undersold. Amplifiers, Tape Recorders, Tuners, Etc. No Catalogs, Air Mail Quotes. Compare. L. M. Brown Sales Corp., Dept. W. 239 E. 24 St., N. Y. 10, N. Y.

DISGUSTED with "Hi" Hi-Fi Prices? Unusual Discounts On Your High Fidelity Requirements. Write. Key Electronics, 120 Liberty St., New York 6, N. Y. Cloverdale 8-4288.

RECORDERS, Components! Free wholesale catalogue! Carston, 125-R, East 88, N.Y.C. 28.

PRICES? The Best! Factory-sealed Hi-Fi Components? Yes! Send for free catalog. Audion, Roslyn, N.Y.

USED—New HiFi Bought-Sold-Highest Prices Paid or Trade-In allowance. All guaranteed. Douglas Radio Bargain Basement, 128-P Greenwich Street, N.Y. 6, Worth 4-0470.

## MUSIC

SONGWRITERS, with publisher contacts, want song ideas. Share royalties. No fees. Send poems: Songwriters' Associates, 1650 Broadway, N.Y. 19-V.

## GOVERNMENT SURPLUS

JEeps \$278, Airplanes \$159, Boats \$7.88, generators \$2.68, typewriters \$8.79, are typical government surplus sale prices. Buy 10,000+ items wholesale, direct. Full details, 627 locations, procedure, only \$1.00. Surplus, Box 789-C97, York, Penna.

## PATENTS

PATENT Searches, \$6.00. For free Invention Record, and "Information Inventor's Need," Write: Miss Heyward, 1029 Vermont Avenue, N.W., Washington 5, D.C.

## SHOPPING GUIDE CLASSIFIED

A HANDY GUIDE TO PRODUCTS, NOT NECESSARILY ELECTRONIC, BUT OF WIDE GENERAL INTEREST.

## PHOTOGRAPHY-FILM, EQUIPMENT, SERVICES

SCIENCE Bargains—Request Free Giant Catalog "CJ"—144 pages—Astronomical Telescopes, Microscopes, Lenses, Binoculars. Kits, Parts, War surplus bargains. Edmund Scientific Co., Barrington, New Jersey.

FREE Photo Novelty Mirror or button with roll, 12 jumbo prints 4¢. EEDY, 5533H Milwaukee Avenue, Chicago, Illinois.

## STAMPS AND COINS

TERRIFIC Stamp Bargain! Israel-Iceland-San Marino-plus triangle set—Plus Antigua-Borneo-Virgin-Scouts-Congo-Russia-Plus large stamp book—all four offers free—Send 10¢ for mailing cost. Empire Stamp Corporation, Dept. Z2, Toronto, Canada.

## HELP WANTED

HIGH Paying Jobs in Foreign Lands! Send \$2.00 for complete scoop! Foreign Opportunities, Box 172, Columbus 16, Ohio.

EARN Extra money selling advertising book matches. Free Samples furnished. Matchcorp, Dept. MD-12, Chicago 32, Ill.

## EDUCATIONAL OPPORTUNITIES

LEARN While Asleep, hypnotize with your recorder, phonograph. Astonishing details, sensational catalog free! Sleep-Learning Association, Box 24-ZD, Olympia, Washington.

TAKE Bachelor's and Master's Degree correspondence courses from leading universities! Directory of 6,000 courses—\$2.00. College Research, North Highlands 15, California.

## BUSINESS OPPORTUNITIES

SECOND Income From Oil Can End Your Toil! Free Book and Oilfield Maps! National Petroleum, Pan-American Bank Building—PP, Miami 32, Florida.

MAKE \$25-\$50 Week, clipping newspaper items for publishers. Some clippings worth \$5.00 each. Particulars free. National, 81-DG, Knickerbocker Station, New York.

FREE Book "990 Successful, Little-Known Businesses." Work home! Plymouth-555W, Brooklyn 4, New York.

I Made \$40,000.00 Year by Mail Order! Helped others make money! Start with \$10.00—Free Proof. Torrey, Box 3566-N, Oklahoma City 6, Oklahoma.

"WANT to go in business"—will finance proposition of merit. Write Box 577, Electronics World, One Park Avenue, New York 16, N.Y.

## MISCELLANEOUS

PRINTING Presses, Type, Supplies. Lists 4¢. Turnbough Service, Mechanicsburg, Pa.

WRITERS!—Free list of top-notch USA markets for short stories, articles, books and plays. Write for your free copy today! Literary Agent Mead, 915 Broadway, N.Y. 10.

FREE "Do-it-Yourself" Leathercraft Catalog. Tandy Leather Company, Box 791—A43, Fort Worth, Texas.

2700 Novelties, Tricks, jokes, science, hobbies. World's biggest gadget catalog 10¢. Johnson-Smith, D-528, Detroit 7.

INDEPENDENT Thinkers—investigate Humanism! Free literature. American Humanist Association, Dept. EW-1, Yellow Springs, Ohio.

HOME BREWING! Beers, wines. Complete Instructions \$1. Guaranteed. Crystalco 28-BEW5, Millburn, New Jersey.

AUTHORS! Learn how to have your book published, promoted, distributed. FREE booklet "ZD," Vantage, 120 West 31 St., New York 1.

HYPNOTIZE Unnoticed, quickly, effortlessly, or refund! Thousands satisfied! \$2. Timmer, Box 244, Cedarburg, Wis.

HYPNOTIZE! Practical Instruction Course \$1 (guaranteed). Crystal's 28-PEW2, Millburn, New Jersey.

GIANT Arms." Dr. Young's, D.C. Revolutionary discovery. \$2. Satisfaction or refund. Gaucho, Box 9309-E8, Chicago 90.

"HYPNOTIZE . . . One word . . . One fingersnap." on stage. Satisfaction—or refund. \$2. Hypnomaster, Box 9309-E8, Chicago 90.

SEND  
ELECTRONICS WORLD  
EVERY  
MONTH

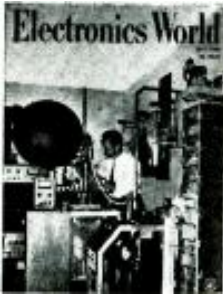

name \_\_\_\_\_

address \_\_\_\_\_

city \_\_\_\_\_ zone \_\_\_\_\_ state \_\_\_\_\_

Check one:

3 years for \$12  2 years for \$9

1 year for \$5

In the U. S., and possessions.

Payment enclosed  Bill me

Foreign rates: Canada and Pan American Union countries, add .50 per year; all other foreign countries, add \$1.00 per year.

New  Renewal

Mail to: **ELECTRONICS WORLD**  
Dept. EW 562H, 434 S. Wabash Ave.  
Chicago 5, Ill.

ruggedized vagis within the frequency ranges of 30 to 500 mc. Detailed electrical and mechanical descriptions of each type within the several antenna groups includes information on specific frequency, weight, nominal h.p.b.w. (in degrees) for E and H planes, number of driven elements, maximum v.s.w.r., maximum power input (watts), and nominal gain above isotropic source.

### RESISTOR DECADE BROCHURE

**48** Clarostat Mfg. Co., Inc. has issued a four-page brochure covering a new rack version of its power resistor decade as well as providing detailed information on its standard bench unit.

The brochure is virtually an instruction manual as well as a descriptive item. It provides theory, circuit diagrams, general application, operation information, plus parts and specification details on the product.

### FERRITE BEAD CHOKES

**49** National Radio Company is now offering a complete data sheet covering its newly developed ferrite bead chokes.

The sheet provides full technical details and information on this new type of choke. Typical curves for choke impedance and a.c. resistance are included. These chokes, functioning more as frequency-selective resistors than as conventional chokes, disappear electrically from a circuit at low frequencies.

### ELECTRIC CONNECTOR CLIPS

**50** Mueller Electric Company is now offering a copy of its comprehensive catalogue covering a complete line of electric connective clips and insulators. The new publication describes sizes, materials, characteristics, and capacities of the 66 products in the line, which ranges from miniaturized alligator clips to welding ground clamps.

Insulator sizes and dimensions are charted, as well as those of clips, with complete shipping information provided as well.

### SERVICE COMPONENT CATALOGUE

**51** Cornell-Dubilier Electronics Division has just issued a 40-page catalogue describing a complete line of capacitors, vibrators, rotors, decades, test instruments, and other standard-line components.

The publication includes selection data such as design features, temperature ranges, material construction, application, and prices. It is of special interest to radio and TV service technicians.

### SERVO INSTRUMENT BROCHURE

**52** North Atlantic Industries, Inc. has issued a general-type brochure covering its line of servo indicators, repeaters, and data converters. The instruments described in the four-page catalogue meet the system requirements of airborne, GSE, and industrial applications.

The brochure features a ready reference chart on the significant electrical and physical characteristics of eight servo instruments.

### POWER-SUPPLY BULLETIN

**53** Microdot Inc. has published a single-page, two-color data sheet which describes its new transistor-regulated a.c.-d.c. power supply. The supply is regulated to  $\pm 1\%$  from no load to full load and can be used with equipment modules or stations requiring independent d.c. power.

Full details and specifications are included in Bulletin ACPS-1.

### NEEDLE REFERENCE CHART

**54** Duotone Company has issued a 1962 edition of its replacement needle wall chart listing needles by manufacturer's cartridge number, indicates illustration of needle replacement, record speed, and needle number in diamond, jewel, or osmium. The list price for each needle is also given.

### ADHESIVE-SEALANT BROCHURE

**55** Hysol Corporation is now offering a new four-page bulletin covering hundreds of possible bonding and sealing jobs which can be handled with its "Epoxy-Patch Kits." The publication shows how the product may be used in the production and repair of parts made of metals, wood, glass, plastics, and ceramics. Complete information on the properties of five basic formulations are included in Bulletin A-300.

### ACCELEROMETER DATA

**56** Electra Scientific Corp. has published an illustrated, six-page brochure which carries performance characteristics on its new Series-6000 accelerometers and transistorized amplifiers for shock and vibration analysis.

In addition to the accelerometers, the booklet includes specifications on the Model ES-610 airborne type emitter-follower and the Model ES-680 laboratory amplifier. ▲

### WASHINGTON HAMFEST SET

**T**HE National Capitol V.H.F. Society of Washington, D.C. is holding its annual Hamfest at noon on May 27th, at the Marshall Hall Amusement Park, 20 miles southeast of Washington on the Maryland shore of the Potomac River.

All hams and their families are invited to attend what promises to be a fun-filled afternoon in May.

Additional details on this event can be obtained by contacting R. T. Niemeyer, W3MMC, 3323 Camden St., Wheaton, Maryland. ▲

### PHOTO CREDITS

Page	Credit
14 (top)	E. J. Sharpe Instruments, Inc.
14 (bottom)	Allied Radio Corp.
16	Lafayette Radio
26, 28	General Radio Co.
32 (top), 35, 36, 37, 38, 58	General Electric Co.
32 (center)	U.S. Army Photo
32 (bottom left)	ACF Electronics
32 (bottom right)	Barnes Engineering Co.
33 (top)	Westinghouse Electric Corp.
33 (center)	Radio Corporation of America
33 (bottom left)	IBM
33 (bottom right)	Borg Warner Corp.
47, 48 (bottom)	Taylor Electric Co.
48 (center)	DuKane Corp.
62	Eico Electrical Instrument Co.

### Answer to ELECTRONIC CROSSWORDS (Appearing on page 79)



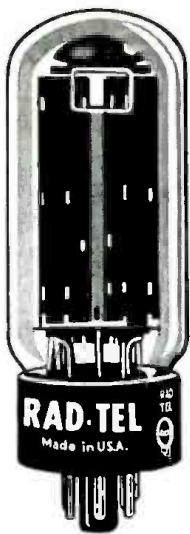

# RAD-TEL Sells Direct to You...At Low Prices The Leading "DIRECT-BY-MAIL" Tube Company



## RAD-TEL'S Quality Brand-New Tubes

The Sign of  
RAD-TEL'S  
RELIABILITY

# UP / TO 75% OFF

### 1-Year Guarantee-1 Day Service-Over 500 Types in Stock

**FREE!**

Send For New Tube  
& Parts Catalog

Send For Trouble  
Shooting Guide

NOT AFFILIATED WITH ANY OTHER MAIL ORDER TUBE COMPANY

EACH TUBE INDIVIDUALLY & ATTRACTIVELY BOXED & BRANDED RAD-TEL

Qty.	Type	Price	Qty.	Type	Price	Qty.	Type	Price	Qty.	Type	Price	Qty.	Type	Price	Qty.	Type	Price
—	0Z4	.79	—	5CL8	.76	—	6BJ7	.79	—	6EY6*	.75	—	12AE6	.43	—	12EN6	.78
—	1AX2	.62	—	5CM8*	.90	—	6BK7	.85	—	6F5GT	.39	—	12AE7	.94	—	12E26	.53
—	1B3	.79	—	5CQ8	.84	—	6BL7	1.00	—	6F8	.75	—	12AF3	.73	—	12F8	.66
—	1DN5	.55	—	5CZ5*	.72	—	6BN4	.57	—	6GH8	.80	—	12AF6	.49	—	12FA6	.79
—	1G3*	.79	—	5EA8	.80	—	6BN6	.74	—	6GK6*	.79	—	12AJ6	.46	—	12FM6	.43
—	1J3*	.79	—	5EU8	.80	—	6BQ6	1.05	—	6GN8*	.94	—	12AL5	.45	—	12FR8	.91
—	1K3*	.79	—	5J6	.68	—	6BQ7	1.00	—	6H6	.58	—	12AL8	.95	—	12FX8	.85
—	1R5	.62	—	5T8	.81	—	6BS8	.90	—	6J5GT	.51	—	12AQ5	.60	—	12G6C	1.06
—	1S4	.59	—	5U4	.60	—	6BU8	.70	—	6J6	.67	—	12AT6	.43	—	12J8	.84
—	1S5	.51	—	5U8	.81	—	6BX7	1.02	—	6K6	.63	—	12AT7	.76	—	12K5	.65
—	1T4	.58	—	5V3	.90	—	6BY5	1.15	—	6L6	1.06	—	12AU6	.51	—	12L6	.58
—	1U4	.57	—	5V6	.56	—	6BY6	.54	—	6N7	.98	—	12AU7	.60	—	12SA7	.92
—	1U5	.50	—	5X8	.78	—	6BY8	.66	—	6S4	.51	—	12AV6	.41	—	12SF7	.69
—	1X2B	.82	—	5Y3	.46	—	6BZ6	.55	—	6SA7GT	.76	—	12AV7	.75	—	12SH7	.49
—	2AF4	.96	—	6A8G	1.20	—	6BZ7	1.01	—	6SG7GT	.41	—	12AX4	.67	—	12SJ7	.67
—	2BN4	.64	—	6AB4	.46	—	6BZ8	1.09	—	6SH7GT	.49	—	12AX7	.63	—	12SK7	.74
—	2EN5*	.45	—	6AC7	.96	—	6C4	.43	—	6SJ7	.88	—	12AY7	1.44	—	12SL7	.80
—	3AL5	.42	—	6AF3	.73	—	6CB6	.55	—	6SK7GT	.74	—	12AZ7	.86	—	12SN7	.67
—	3AU6	.51	—	6AF4	.97	—	6CD6	1.42	—	6SL7GT	.80	—	12B4	.63	—	12SQ7	.78
—	3AV6	.41	—	6AG5	.68	—	6CE5*	.57	—	6SN7GT	.65	—	12BA7	.84	—	12U7	.62
—	3BA6	.51	—	6AH4	.81	—	6CF6	.64	—	6SQ7	.73	—	12B06	.50	—	12V6	.53
—	3BC5	.54	—	6AH6	.99	—	6CG7	.61	—	6T4	.99	—	12BE6	.53	—	12W6	.69
—	3BE6	.52	—	6AK5	.95	—	6CG8	.77	—	6T8	.85	—	12BF6	.44	—	12X4	.38
—	3BN6	.76	—	6AL5	.47	—	6CK4*	.70	—	6U8	.83	—	12BH7	.77	—	17AX4	.67
—	3BU8	.78	—	6AM8	.78	—	6CL8	.79	—	6VG6T	.54	—	12BK5	1.00	—	17BQ6	1.09
—	3BY6	.55	—	6AQ5	.53	—	6CM6	.64	—	6W4	.60	—	12BL6	.56	—	17DQ6	1.06
—	3BZ6	.55	—	6AR5	.55	—	6CM7	.66	—	6W6	.71	—	12BQ6	1.06	—	17W6	.70
—	3CB6	.54	—	6AS5	.60	—	6CM8*	.90	—	6X4	.39	—	12BR7	.74	—	18FW6*	.49
—	3CS6	.52	—	6AS6	.80	—	6CN7	.65	—	6X5GT	.53	—	12BV7	.78	—	18FY6*	.50
—	3DG4*	.85	—	6AT6	.43	—	6CQ8	.84	—	6X8	.80	—	12BY7	.77	—	18FX6*	.53
—	3DK6*	.60	—	6AT8	.79	—	6CR6	.51	—	7A8	.68	—	12BZ7	.75	—	19AU4	.83
—	3DT6	.50	—	6AU4	.82	—	6CS6	.57	—	7AU7	.61	—	12C5	.56	—	19B6G	1.39
—	3Q4	.63	—	6AU6	.52	—	6CS7	.69	—	7B6	.69	—	12CN5	.56	—		
—	3Q5	.80	—	6AU7	.61	—	6CU5	.58	—	7EY8*	.73	—	12CR6	.54	—		
—	3S4	.61	—	6AU8	.87	—	6CU6	1.08	—	7F8	.90	—	12CU5	.58	—		
—	3V4	.58	—	6AV6	.41	—	6CY5*	.70	—	7N7	.90	—	12CQ6	1.06	—		
—	4BQ7	1.01	—	6AW8	.90	—	6CY7	.71	—	7S7	1.01	—	12CX6	.54	—		
—	4BZ7	.96	—	6AX4	.66	—	6DA4*	.68	—	7Y4	.69	—	12D4*	.69	—		
—	4BZ8	1.10	—	6AX5	.74	—	6DB5	.69	—	8A08	.83	—	12D85	.69	—		
—	4CS6	.61	—	6AX7	.64	—	6DB6	.51	—	8A08	.93	—	12D88	.75	—		
—	4DT6	.55	—	6AX8*	.92	—	6DE6	.58	—	8BQ5	.60	—	12DL8	.85	—		
—	5AM8	.79	—	6BA6	.50	—	6DG6	.59	—	8CG7	.62	—	12DQ6	1.04	—		
—	5AN8	.86	—	6BA8	.88	—	6DK6	.59	—	8CM7	.68	—	12DS7	.79	—		
—	5AQ5	.52	—	6BC5	.61	—	6DN6	1.55	—	8CN7	.97	—	12DT5*	.76	—		
—	5AS8*	.86	—	6BC7	.94	—	6DQ6	1.10	—	8CS7	.74	—	12DT7*	.79	—		
—	5AT8	.80	—	6BC8	.97	—	6DT6	.53	—	8CX8	.93	—	12DT8*	.79	—		
—	5AV8	1.01	—	6BD5	1.25	—	6DT8*	.79	—	8EB8	.94	—	12DU7	1.01	—		
—	5BC8	.79	—	6BE6	.55	—	6EA8	.79	—	8SN7	.66	—	12DW8*	.89	—		
—	5BE8	.83	—	6BF5	.90	—	6EB5*	.72	—	9CL8	.79	—	12DZ6	.56	—		
—	5BK7	.82	—	6BF6	.44	—	6EB8	.94	—	11CY7	.75	—	12E05	.69	—		
—	5BQ7	.97	—	6BG6	1.66	—	6EM5*	.76	—	12A4	.60	—	12EG6	.54	—		
—	5BR8	.79	—	6BH6	.65	—	6EM7	.82	—	12AB5	.55	—	12EK6	.56	—		
—	5BT8*	.83	—	6BH8	.87	—	6EU8	.79	—	12AC6	.49	—	12EL6	.50	—		
—	5CG8	.76	—	6BJ6	.62	—	6EW6	.57	—	12AD6	.57	—	12EM6	.79	—		

New Tube Types Offered by Rad-Tel\*

**SPECIAL!**  
**RAD-TEL'S TRANSISTORS**  
AT NEW LOW PRICES

SET TESTED*—Family 2N155, 2N178, 2N242, 2N255, 2N256, 2N307, 2N554, etc. ea.	<b>49c</b>
SET TESTED*—Family 2N173, 2N277, 2N441, 2N442, DS501. ea.	<b>79c</b>
SET TESTED*—General replacement in Transistor Radios and experimenters projects. ea.	<b>29c</b>

\*Set tested in Amer. Car Radio. All Transistors PNP Germanium. Factory tested to Rad-Tel specifications.

**RAD-TEL TUBE CO.**  
Dept. EW-5 55 CHAMBERS ST., NEWARK 5, NEW JERSEY

TERMS: 25% deposit must accompany all orders, balance COD. Orders under \$5: add \$1 handling charge plus postage. Orders over \$5: plus postage. Approx. 8 tubes per 1 lb. Subject to prior sale. No COD's outside continental USA.

# ADVERTISERS' INDEX

MAY, 1962

Advertisers listed below with code numbers have additional information available on their products in the form of catalogues and bulletins. To obtain more detailed data, simply circle the proper code number in the coupon below and mail it to the address indicated. We will direct your inquiry to the manufacturer for processing.

CODE NO.	ADVERTISER	PAGE	CODE NO.	ADVERTISER	PAGE	CODE NO.	ADVERTISER	PAGE
100	Advance Electronics	77	129	Goodheart Co., R. E.	90	155	Rad-Tel Tube Co	105
	Allied Radio	21	130	Grantham School of Electronics	13		Radio Corporation of America	
101	Anglo American Acoustics Ltd.	87	131	Grantham Schools, Inc.	91			FOURTH COVER
102	Antenna Specialists Co., The	58	132	Gregory Electronics Corporation	72	156	Reeves Soundcraft Corp	23
103	Audion	70						
			133	Hallicrafters	71	157	Sams & Co., Inc., Howard W	59
104	B & K Manufacturing Co	9	134	Hallicrafters	95	158	Sarkes Tarzian Inc	12
105	B & K Manufacturing Co	62	135	Heath Company	61	114	Saxitone Tape Sales	90
106	Blonder-Tongue	16	136	Holt, Rinehart and Winston	68	159	Schober Organ Corporation, The	64
						160	Scott Inc., H. H.	15
107	C & H Sales Co	86	137	Indiana Technical College	70	161	Seco Electronics, Inc	69
108	Capitol Radio Engineering Institute, The	4, 5	138	International Crystal Mfg. Co., Inc.	22	162	Sencore	75
			139	International Radio & Electronics Corp	85	163	Sencore	77
109	Carston Studio	70	140	Johnson Company, E. F.	79	164	Sonar Radio Corporation	76
110	Castle TV Tuner Service, Inc	76				165	Sonotone Corporation	65
111	Channel Master Corp	73	141	Key Electronics Co	73	166	Sound Reproduction, Inc	90
112	Cleveland Institute of Electronics	7				167	Sprague Products Company	2
113	Columbia Electronics	94	142	Lafayette Radio	19	168	Standard Brands Tube Company	99
114	Commissioned Electronics, Inc	90	143	Lampkin Laboratories, Inc	74	169	Superscope, Inc	67
115	Communication Products Company, Inc	97						
			144	Magnecord Sales Department		170	TAB	94
116	Don Bosco Electronics Inc	63		Midwestern Instruments	8	171	Tandberg of America, Inc	6
117	Dressner	90	145	Micro Electron Tube Co	64	172	Terado Company	85
			146	Milwaukee School of Engineering	66	173	Texas Crystals	100
118	EICO (Electronic Instr. Co. Inc)	24	147	Moss Electronic, Inc	79	174	Tokyo Shibaura Electric Co., Ltd	91
119	Electro-Voice, Inc	SECOND COVER	148	Multicore Sales Corp	74	175	Transvision Electronics, Inc	84
120	Electronic Chemical Corp	99				176	Transvision Electronics, Inc	85
121	Electronic Market	70		National Radio Institute	17, 18	177	Tri-State College	94
	Electronics Book Service—A. S. Barnes & Co. Inc	89		National Radio Institute	94	178	Triplett Electrical Instrument Company, The	THIRD COVER
			149	North American Philips Company, Inc	60	179	Tru-Vac	101
122	Fair Radio Sales	70				180	U.S. Crystals, Inc	74
123	Fairchild Recording Equipment Corporation	72	150	Oetrich Publications	86	181	University Loudspeakers	57
124	Fisher Radio Corporation	69				182	Utah Electronics Corp	78
			151	Paco Electronics Co., Inc	1	183	Valparaiso Technical Institute	64
125	G & G Radio Supply Co	102	152	Peak Electronics Company	98	184	Van Nostrand Company, Inc., D	73
126	General Electric	88	153	Pearce-Simpson	95			
127	General Electric	72				185	Winegard	87
128	Global Tape Recording Exchange Hobby Club	86		RCA Institutes, Inc	10, 11	186	Xcelite, Inc	20
			154	R W Electronics	76			

The coupon below can also be used to obtain additional information on the new product items shown on pages 96 through 104 as well as on the ads as listed above.

<b>N</b> <b>VOID</b> <b>AFTER</b> <b>MAY 30, 1962</b>	5	NAME _____
		STREET NO. _____
		CITY _____ ZONE _____ STATE _____
<b>ADVERTISED</b> <b>PRODUCTS</b> (SEE INDEX ABOVE)		100 101 102 103 104 105 106 107 108 109 110 111 112 113 114 115 116 117 118 119
		120 121 122 123 124 125 126 127 128 129 130 131 132 133 134 135 136 137 138 139
		140 141 142 143 144 145 146 147 148 149 150 151 152 153 154 155 156 157 158 159
		160 161 162 163 164 165 166 167 168 169 170 171 172 173 174 175 176 177 178 179
		180 181 182 183 184 185 186 187 188 189 190 191 192 193 194 195 196 197 198 199
		200 201 202 203 204 205 206 207 208 209 210 211 212 213 214 215 216 217 218 219
		220 221 222 223 224 225 226 227 228 229 230 231 232 233 234 235 236 237 238 239
<b>NEW PRODUCTS</b> <b>&amp; LITERATURE</b>		1 2 3 4 5 6 7 8 9 10 11 12 13 14 15 16 17 18 19 20
		21 22 23 24 25 26 27 28 29 30 31 32 33 34 35 36 37 38 39 40
		41 42 43 44 45 46 47 48 49 50 51 52 53 54 55 56 57 58 59 60
<b>MAIL TO ELECTRONICS WORLD P.O. BOX 212</b> <b>VILLAGE STATION NEW YORK 14, N.Y.</b>		<b>INDICATE NUMBER</b> <b>OF ITEMS REQUESTED</b> <input type="checkbox"/>

 Make sure that your name and address are printed clearly.

**ELECTRONICS**  
**WORLD**  
**READER**  
**SERVICE**  
**COUPON**

 **ELECTRONICS WORLD**

# TRIPLETT

# ACTUAL SIZE

## USES UNLIMITED:

- Field Engineers
- Application Engineers
- Electrical, Radio, TV,  
and Appliance Servicemen
- Electrical Contractors
- Factory Maintenance Men
- Electronic Technicians
- Home Owners, Hobbyists



## MODEL 310

complete  
VOLT-OHM-  
MILLIAMMETER



## World's Largest Selling POCKET SIZE V-O-M

### FEATURES:

- 1 Hand size and lightweight, but with the features of a full-size V-O-M.
- 2 20,000 ohms per volt DC; 5,000 AC.
- 3 EXCLUSIVE SINGLE SELECTOR SWITCH speeds circuit and range settings. The first miniature V-O-M with this exclusive feature for quick, fool-proof selection of all ranges.

SELF-SHIELDED Bar-Ring instrument; permits checking in strong magnetic fields • Fitting interchangeable test prod tip into top of tester makes it the common probe, thereby freeing one hand • UNBREAKABLE plastic meter window • BANANA-TYPE JACKS—positive connection and long life.

■ Price—only \$37.50; leather case \$3.20.

Available For Immediate Delivery From Your Triplet Distributor's Stock

THE TRIPLETT ELECTRICAL INSTRUMENT COMPANY, BLUFFTON, OHIO

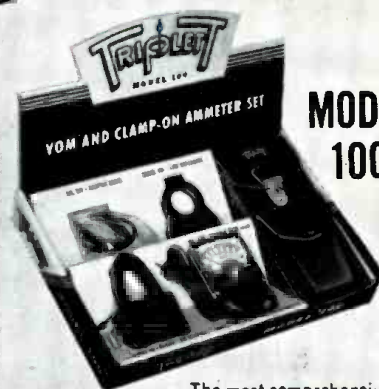

## MODEL 100

The most comprehensive test set in the Triplet line is Model 100 V-O-M Clamp-On-Ammeter Kit, now available at distributors. The world's most versatile instrument—a complete accurate V-O-M plus a clamp-on-ammeter with which you can take measurements without stripping the wires. Handsome, triple-purpose carton holds and displays all the components: Model 310 miniaturized V-O-M, Model 10 Clamp-On-Ammeter, Model 101 Line Separator, No. 311 Extension leads, and a leather carrying case, which neatly accommodates all the components. Model 101 literally makes it possible to separate the two sides of the line when using Model 10. Extension leads permit use of Model 10 at a distance from the V-O-M. Complete Model 100 is only \$64.50

MANUFACTURERS OF PANEL AND PORTABLE INSTRUMENTS; ELECTRICAL AND ELECTRONIC TEST EQUIPMENT



630



630-A



630-PL



630-APL



630-NA



630-T



631



666-HH



625-NA



666-R

FOR EVERY PURPOSE—THE WORLD'S MOST COMPLETE LINE OF V-O-M'S

www.americanradiohistory.com

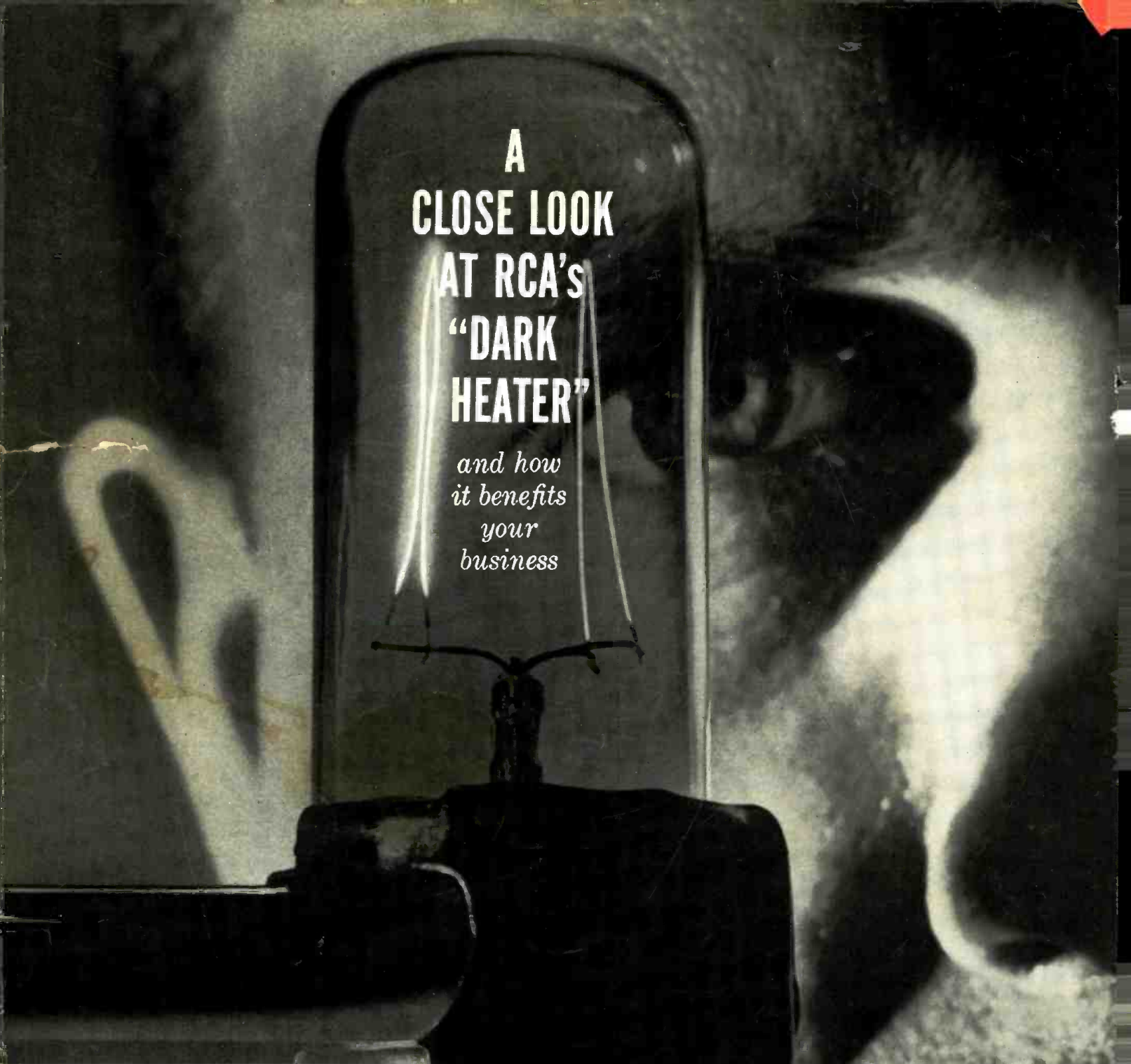

A  
CLOSE LOOK  
AT RCA'S  
"DARK  
HEATER"

*and how  
it benefits  
your  
business*

You are looking at a dramatic example of RCA leadership in tube technology.

The wire at the right in the demonstration envelope is the new RCA "Dark Heater"—an exclusive RCA development. Operating at about 350°K below the temperature of a conventional heater (left), the remarkable "Dark Heater" reduces chance of heater failure, increases heater-current stability during the life of the tube, eliminates "spike" or pulse-leakage current, cuts AC heater-cathode leakage and hum, and provides greatly improved overall mechanical stability.

RCA Electron Tube Division, Harrison, N. J.

NET RESULT TO YOU: *even greater assurance* of customer satisfaction with your work—*even greater freedom* from callbacks, and in-warranty failures.

Now available in an increasing number of RCA receiving-type tubes, the RCA "Dark Heater" will be incorporated in those receiving-type tubes where potential benefits of increased life and reliability can be realized. This new RCA development is further assurance that you are working with the best and latest receiving tubes when you specify and install RCA.



The Most Trusted Name in Electronics