

Electronics World

DECEMBER, 1961

50 CENTS

**THE USE OF X-RAY
FOR INDUSTRIAL TESTING**

**RELIABILITY—
SPACE AGE REQUIREMENT**

**BUILD YOUR OWN
STEREO FM MULTIPLEX ADAPTER**

**GETTING USABLE 35-CPS BASS
FROM AN 8-INCH SPEAKER
IN AN EXPERIMENTAL ENCLOSURE**

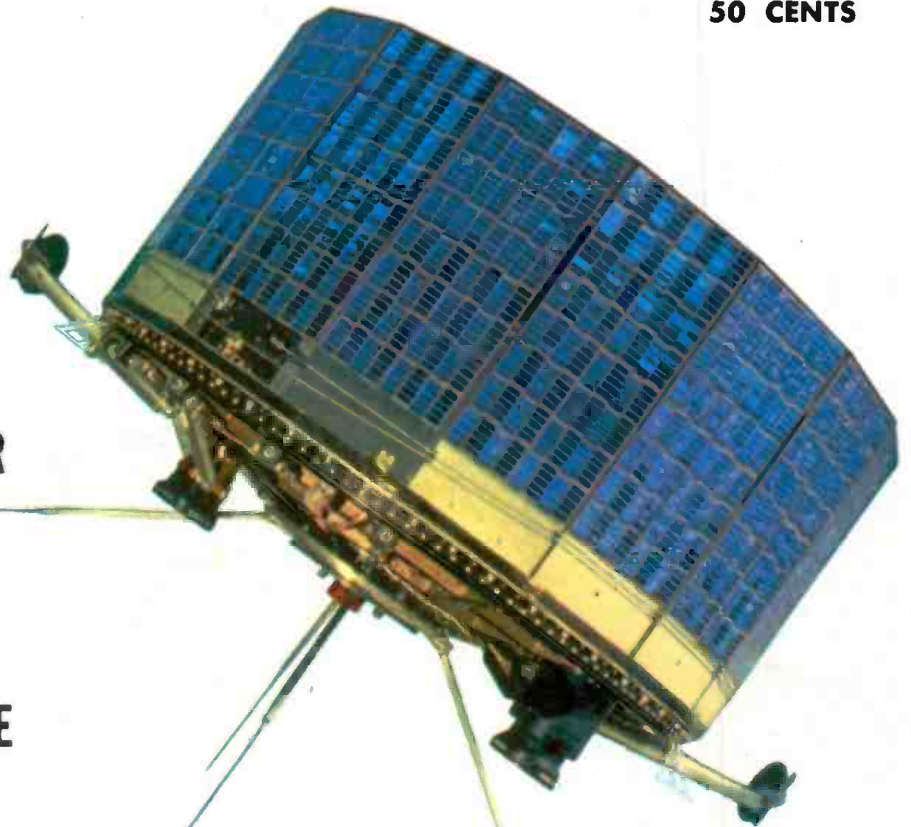

**CONVERTING SUN'S ENERGY
TO ELECTRIC POWER
WITH SILICON SOLAR CELLS**



W10D12249 23
L O GERLACH
6612 N 54TH ST
MILWAUKEE 23 WISC

New Sylvania Technique eliminates erratic pin soldering

Picture tube callbacks due to "open-pin connections" dramatically reduced

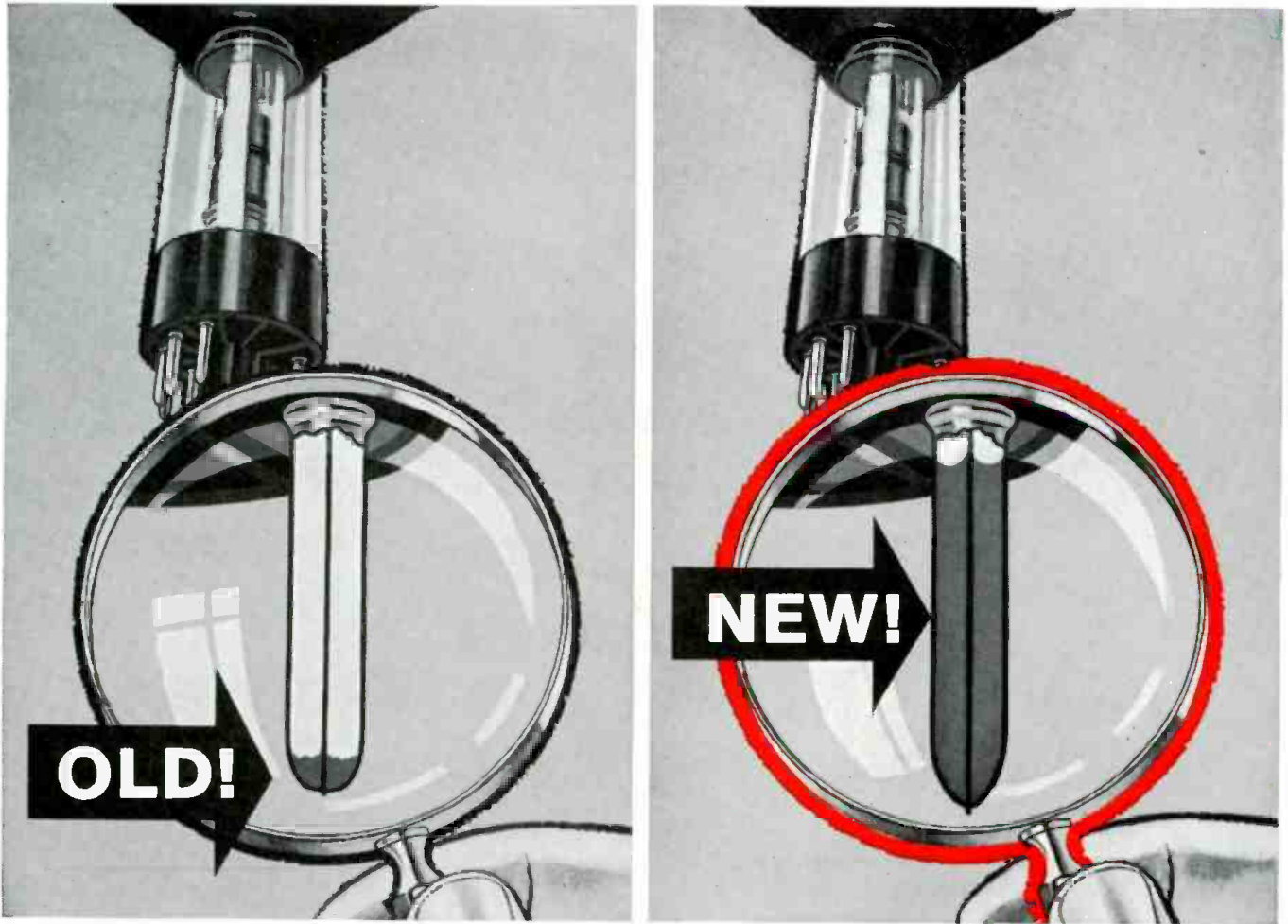

The "old" conventional pin soldering method relied upon contact between pin and wire only at their tips.

New Sylvania pin soldering technique extends solder far up into the pins—provides maximum contact with the wire—assures low electrical resistance and high mechanical strength.

What does the new Sylvania pin soldering technique mean to you? It means the solution of a long-standing, industry-wide pin soldering problem. Callbacks will be reduced—crimping and resoldering will be a thing of the past.

Thousands of service technicians have proven for themselves—in millions of service calls—that Sylvania SILVER SCREEN 85 TV PICTURE TUBES are the surest way to build a better business. You should, too. Electronic Tubes Division, Sylvania Electric Products Inc., 1740 Broadway, New York 19, N. Y.

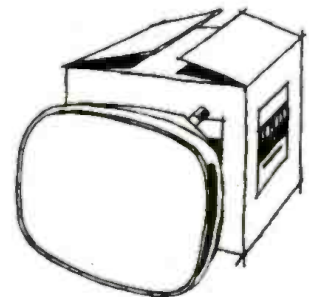

SYLVANIA

SUBSIDIARY OF

GENERAL TELEPHONE & ELECTRONICS



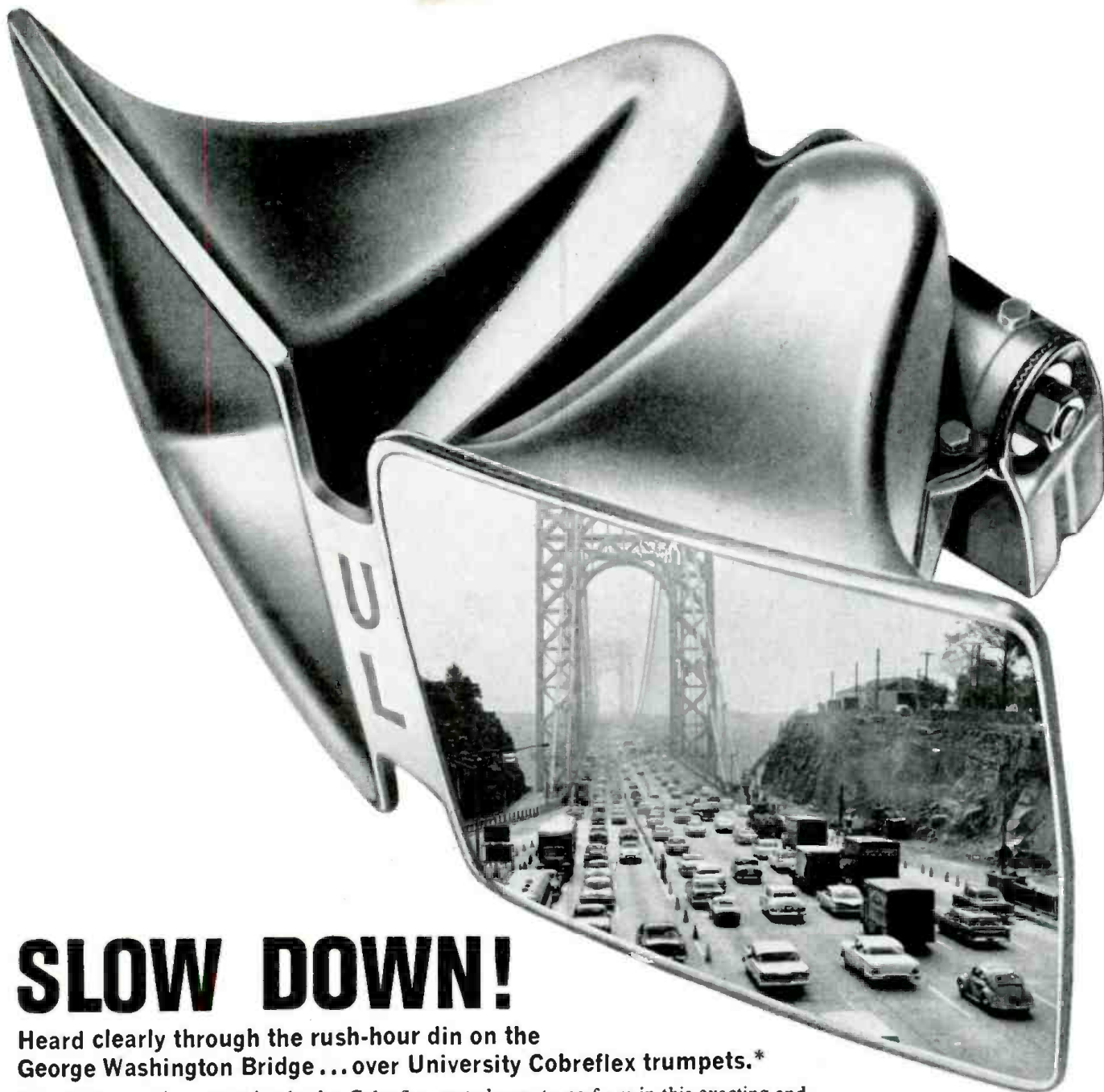

SLOW DOWN!

Heard clearly through the rush-hour din on the George Washington Bridge ... over University Cobreflex trumpets.*

But what's most important is *why* the Cobreflex was chosen to perform in this exacting and difficult location. One of the main reasons is that every Cobreflex embodies the unique combination of *battleship* construction and *Swiss watch* precision! This unexcelled ruggedness of construction paired with its exceptionally high articulation of speech makes the Cobreflex ideal for the most gruelling applications. Its wide angle projection over 120° is but another good reason why it is sought after in situations that call for ultra-wide projection. And this extremely smooth, wide radiation pattern over the full frequency range is the result of University having incorporated a pair of folded exponential horns having twin air columns onto a *single* assembly. These two identical one-piece heavy aluminum die-castings with integral tone arm and reflectors ensure there are no separate parts to loosen or vibrate. Resonant vibration is non-existent! Reasons enough?

And for installations requiring full-range wide angle coverage, there's the CLH, a rectangular reflex trumpet loaded with significant engineering refinements. A conoidal reflector at the critical final bend improves high frequency response, and a rugged, *ribbed and braced* fiberglass bell subdues resonances, providing more extended, natural response for the reproduction of music as well as speech. The wide horizontal coverage helps you get sound into dead spots that would not be reached by ordinary trumpets, while narrower vertical directionality lets you practically 'tune' the speaker during installation for minimum reverberation and feedback.

But for the complete story of University Public Address Speakers, Write Desk S-12, University Loudspeakers, Inc., White Plains, N.Y.

NOTE: All University P.A. Loudspeakers are F.C.D.A. approved.

*Engineered with HIGH 'A'—HIGH AUDIBILITY—exclusive with University!



A Division of Ling-Temco-Vought, Inc.

ELECTRONICS WORLD is published monthly by Ziff-Davis Publishing Company at 434 South Wabash Avenue, Chicago 5, Illinois. Subscription rates: one year United States and possessions \$5.00; Canada and Pan American Union countries \$5.50; all other foreign countries \$6.00. Second Class postage paid at Chicago, Illinois and at additional mailing offices. Authorized by Post Office Department, Ottawa, Canada as Second-Class matter, December, 1961; Vol. 66, No. 6.

SPRAGUE CERAMIC CAPACITORS

THE Complete LINE THAT OFFERS MORE THAN MERE "CAPACITY"

"Rated" capacitance is not enough . . . *actual* capacitance during operation is equally important. Excessively high or low values as well as capacitance change with temperature can foul up a TV or radio set. Therefore, characteristics such as Capacitance Stability, Capacitance Tolerance, and Temperature Coefficient of Capacitance must be considered in replacement applications.

That's why the Sprague Ceramic Line is varied and broad—it includes capacitors with electrical and mechanical characteristics to meet practically every replacement requirement.

See complete listings in the new Sprague Catalog C-614. Get your copy from any Sprague Distributor, or write to Sprague Products Co., 51 Marshall St., North Adams, Massachusetts.



CERA-MITE® CAPACITORS

Tiny, tough, dependable. Silvered flat-plate construction for high by-pass efficiency, high self-resonant frequency. Available in the following types to meet specific requirements:

- *General Application*, for by-pass and coupling
- *High-K*, for applications requiring guaranteed minimum capacitance values
- *Temperature-Stable*, for minimum capacitance change with temperature
- *Temperature-Compensating*, for applications requiring negative temperature coefficient
- *NPO*, for use where capacitance change with temperature is undesirable
- *AC*, rated at 125 VAC
- *Buffer*, rated at 2000 WVDC
- *Low-voltage*, for by-pass and coupling in transistorized circuitry
- *TV Yoke*, rated at 3000 and 5000 WVDC



HYPERCON® CAPACITORS

Ultra-miniature discs for use in transistorized circuitry. Designed for by-pass and coupling applications in low voltage circuits where high capacitance and low power factor are important considerations. Superior in size and performance to comparably-rated aluminum electrolytic capacitors.



"UNIVERSAL" CAPACITORS

Have multiple leads. Quick-fix capacitors for on-the-spot repairs. By using certain leads for terminals, connecting certain leads together, and removing certain leads, various ratings may be obtained. Available in General Application as well as High-K types.

DOORKNOB CAPACITORS



Available in 20 and 30 KV ratings. Molded guard rings lengthen surface creepage path. Complete with variety of screw-in terminals to meet all replacement requirements.

BUTTONHEAD CAPACITORS



Screw-mounting units with flat disc capacitor elements seated in hexagon head. This series includes feed-thru capacitors for filtering leads through chassis, as well as standoff capacitors for by-pass applications.

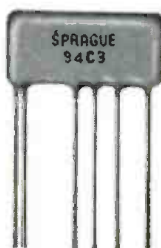

BULPLATE® CAPACITORS

Rugged multiple-section units which combine in one compact assembly all the capacitors used in one or more stages of a radio circuit. These space-saving capacitors are ideal for miniature sets.

SPRAGUE®

THE MARK OF RELIABILITY

WORLD'S LARGEST CAPACITOR MANUFACTURER

CONTENTS

INDUSTRIAL

The Technician and The Engineer (Editorial)	W. A. Stocklin	6
The Silicon Solar Cell	W. R. Baron	33
Cover Story		34
Reliability—Space-Age Requirement	D. S. Halacy	38
Recent Developments in Electronics		44
Industrial X-Ray Apparatus	John R. Collins	46
Electrically Operated Switches	Kenneth Bramham	52

Publisher
PHILLIP T. HEFFERNAN

Editor
WM. A. STOCKLIN, B. S.

Technical Editor
MILTON S. SNITZER, W2QYI

Service Editor
SIDNEY C. SILVER

Associate Editor
P. B. HOEFER

Editorial Consultant
OLIVER READ, D.Sc., W4TWV

Industrial Consultant
WALTER H. BUCHSBAUM

Art Editor
MILTON BERWIN

Art and Drafting Dept.
J. A. GOLANEK

Advertising Sales Manager
LAWRENCE SPORN

Advertising Service Manager
ARDYS C. MORAN

HI-FI AND AUDIO

Audio Test Report (Miracord 10H Automatic Turntable, Fairchild "Com-pander," Fisher XP-4 Speaker System) EW Lab Tested		20
Stereo FM Multiplex Adapter Circuit	W. R. Courtney	37
Double-Chamber Speaker Enclosure	George L. Augspurger	41
Testing Tape Recorders	Herman Burstein	58
Impedance Matching in Audio Circuits	Joel H. Levitt	70
Telephone Booster Amplifier	Harold Reed	82

GENERAL

Simple Sync Servicing	Wayne Lemons	40
Coast-to-Coast TV is 10 Years Old		49
A U.H.F. Nuvistor Tuner	Aaron E. Zimmerman	60
A New Broadband TV Antenna	Harold Harris	62
Capacitor Leakage Problems	Joseph D. Amorose	64
Component & Tube Trends in Great Britain	Patrick Halliday	80
Parallel Resistance Shortcut	A. K. Quinn	84
Electronics World 1961 Index (Vols. 65-66)		112

COMMUNICATIONS

Transistorized Citizens Band Converter	T. C. Sowers	50
Modulated 10-kc. Calibration Oscillator	Ronald L. Ives	55

MONTHLY FEATURES

Letters from Our Readers		10
Mac's Service Shop	John T. Frye	54
Technical Books		76
Calendar of Events		78
Electronic Terminology	William A. Plice	79
Within the Industry		88
Frequency Quiz	Joe Terra	90
Service Industry News		92
New Products and Literature for Electronics Technicians		106

(For Information on Next Month's Features, see page 4)



ZIFF-DAVIS PUBLISHING COMPANY
Editorial and Executive Office
One Park Avenue
New York 16, New York
ORegion 9-7200

MIDWESTERN and CIRCULATION
OFFICE
434 South Wabash Avenue
Chicago 5, Illinois
WAbash 2-4911
Midwestern Advertising Manager
Gilbert J. Jorgenson

WESTERN OFFICE
9025 Wilshire Boulevard
Beverly Hills, California
CRestview 4-0265
Western Advertising Manager
Bud Dean

FOREIGN ADVERTISING
REPRESENTATIVE
D. A. Goodall Ltd., London, England

December, 1961

DYNACO B & O

Wide-Band Ribbon Microphones

- SMOOTHEST RESPONSE
- PRECISE FIGURE 8 PATTERN
- FOR PROFESSIONAL AND HOME USE



FOR
STEREO
AND
MONO

STEREO SPACER

for consistently superior stereo recordings

Complete Data Available on Request

COMING!
A New Stereo Microphone



DYNACO Super Fidelity OUTPUT TRANSFORMERS

Advanced pulse techniques and Dynaco's patented para-coupled windings and massive grain-oriented cores insure superior square wave performance and near-perfect transients. All transformers handle full rated power from 20 cps to 20 KC, and are conservatively rated and guaranteed to handle double nominal power from 30 cps to 15 KC.

SPECIFICATIONS

Response: Plus or minus 1 db 6 cps to 60 KC.
Power Curve: Within 1 db 20 cps to 20 KC.
Square Wave Response: No ringing or distortion from 20 cps. to 20 KC.
Permissible Feedback: 30 db.

MODELS

A-410	15 watts	EL-84, 6V6, 6AQ5	14.95
A-420	30 watts	5881, EL-34, KT-66	19.95
A-430	60 watts	KT-88, EL-34	29.95
A-440	120 watts	KT-88, 6550	39.95
A-450	120 watts	pp par KT-88, EL-34	39.95
A-470	35 watts	pp par EL-84, EL-34	24.95

(all with tapped primaries except A-440 which has tertiary for screen or cathode feedback)
Write for complete data on Dynaco transformers including suggested circuits and modernization of Williamson-type amplifiers to 50 watts output.

DYNACO INC.

3912 Powelton Ave., Philadelphia 4, Pa.



COMING NEXT MONTH



ULTRASONICS IN TESTING

A new and fast-growing technique of non-destructive testing uses ultrasonic waves to pinpoint flaws in materials and measure thickness. Here's news about the latest equipment and how it works.

used? Even when possible, is a repair always worthwhile? The service technician must answer such questions himself in each case, but the material covered here provides much help.

IMPORTANCE OF SPEAKER EFFICIENCY

Do you believe high-efficiency speaker systems are "harsh" and "piercing" and that low-efficiency units are "flat" and "mushy"? Read this authoritative article which presents the case for the high-efficiency system and tells how it stacks up against its rival.

INDUSTRIAL ELECTRONICS VS TV SERVICE

A re-evaluation of the technician's dilemma based on the reactions of our readers to the article "From TV Service to Industrial Electronics" in the September issue.

DIRECT-WRITING OSCILLOGRAPH IN INDUSTRIAL INSTRUMENTATION

One of industry's most important instruments is discussed in detail in this comprehensive article. The technician is told just what the oscillograph will do and how it is used.

STEREO FM MULTIPLEX DETECTION

How do multiplex adapters recover the original left and right signals? Different manufacturers use different techniques—all of them of interest to the audiophile. The various methods are analyzed by an expert.

AMATEUR TRANSMITTING-TUBE TESTING

How far can a ham go in testing the transmitting tubes in his rig? The use of a slightly modified output stage can provide simple static emission information while a properly operating transmitter will do for dynamic tests. Here's how it is done.

DON'T OVERLOAD CAPACITORS

Choosing the right voltage rating for a replacement or for an original unit is not always simple, since the maximum voltage to which the unit may be subjected is not always obvious. Here is how to evaluate the application.

All these and many more interesting and informative articles will be yours in the January issue of **ELECTRONICS WORLD** . . . on sale December 16th

AILING PICTURE TUBES—REPAIR OR REPLACEMENT?

What defects can actually be repaired or compensated? What techniques are

ZIFF-DAVIS PUBLISHING COMPANY

William B. Ziff

Chairman of the Board (1946-1953)

William Ziff
President

M. T. Birmingham, Jr.
Vice President and Treasurer

W. Bradford Briggs
Executive Vice President

Robert P. Breeding
Circulation Director

Hershel B. Sarbin
Vice President and General Manager

Charles Housman
Financial Vice President

Member
Audit Bureau of
Circulations



Net Paid Circulation 229,531

Radio & TV News • Radio News • Radio-Electronic Engineering Trademarks Reg. U.S. Pat. Off.

Copyright © 1961 by Ziff-Davis Publishing Company. All rights reserved.

SUBSCRIPTION SERVICE: All subscription correspondence should be addressed to Electronics World, Circulation Department, 434 South Wabash Avenue, Chicago 5, Illinois. Please allow at least six weeks for change of address. Include your old address, as well as new—enclosing if possible an address label from a recent issue.

EDITORIAL CONTRIBUTIONS must be accompanied by return postage and will be handled with reasonable care; however publisher assumes no responsibility for return or safety of art work, photographs, or manuscripts.

ELECTRONICS WORLD

What Does F. C. C. Mean To You?

What is the F. C. C.?

F. C. C. stands for Federal Communications Commission. This is an agency of the Federal Government, created by Congress to regulate all wire and radio communication and radio and television broadcasting in the United States.

What is an F. C. C. Operator License?

The F. C. C. requires that only qualified persons be allowed to install, maintain, and operate electronic communications equipment, including radio and television broadcast transmitters. To determine who is qualified to take on such responsibility, the F. C. C. gives technical examinations. Operator licenses are awarded to those who pass these examinations. There are different types and classes of operator licenses, based on the type and difficulty of the examination passed.

What are the Different Types of Operator Licenses?

The F. C. C. grants three different types (or groups) of operator licenses—commercial radiotelePHONE, commercial radioteleGRAPH, and amateur.

COMMERCIAL RADIOTELEPHONE operator licenses are those required of technicians and engineers responsible for the proper operation of electronic equipment involved in the transmission of voice, music, or pictures. For example, a person who installs or maintains two-way mobile radio systems or radio and television broadcast equipment must hold a radiotelePHONE license. (A knowledge of Morse code is NOT required to obtain such a license.)

COMMERCIAL RADIOTELEGRAPH operator licenses are those required of the operators and maintenance men working with communications equipment which involves the use of Morse code. For example, a radio operator on board a merchant ship must hold a radioteleGRAPH license. (The ability to send and receive Morse is required to obtain such a license.)

AMATEUR operator licenses are those required of radio "hams"—people who are radio hobbyists and experimenters. (A knowledge of Morse code is necessary to be a "ham".)

What are the Different Classes of RadiotelePHONE licenses?

Each type (or group) of license is divided into different classes. There are three classes of radiotelePHONE licenses, as follows:

(1) **Third Class RadiotelePHONE License.** No previous license or on-the-job experience is required to qualify for the examination for this license. The examination consists of F. C. C. Elements I and II covering radio laws, F. C. C. regulations, and basic operating practices.

(2) **Second Class RadiotelePHONE License.** No on-the-job experience is required for this examination. However, the applicant must have already passed examination Elements I and II. The *second class* radiotelePHONE examination consists of F. C. C. Element III. It is mostly technical and covers basic radiotelePHONE theory (including electrical calculations), vacuum tubes, transistors, amplifiers, oscillators, power supplies, amplitude modulation, frequency modulation, measuring instruments, transmitters, receivers, antennas and transmission lines, etc.

(3) **First Class RadiotelePHONE License.** No on-the-job experience is required to qualify for this examination. However, the applicant must have already passed examination Elements I, II, and III. (If the applicant wishes, he may take all four elements at the same sitting, but this is

not the general practice.) The *first class* radiotelePHONE examination consists of F. C. C. Element IV. It is mostly technical covering advanced radiotelePHONE theory and basic television theory. This examination covers generally the same subject matter as the second class examination, but the questions are more difficult and involve more mathematics.

Which License Qualifies for Which Jobs?

The **THIRD CLASS** radiotelePHONE license is of value primarily in that it qualifies you to take the second class examination. The scope of authority covered by a third class license is extremely limited.

The **SECOND CLASS** radiotelePHONE license qualifies you to install, maintain, and operate most all radiotelePHONE equipment except commercial broadcast station equipment.

The **FIRST CLASS** radiotelePHONE license qualifies you to install, maintain, and operate every type of radiotelePHONE equipment (except amateur, of course) including all radio and television stations in the United States, and in its Territories and Possessions. This is the highest class of radiotelePHONE license available.

How Long Does it Take to Prepare for F. C. C. Exams?

The time required to prepare for FCC examinations naturally varies with the individual, depending on his background and aptitude. Grantham training prepares the student to pass FCC exams in a minimum of time.

In the Grantham *correspondence course*, the average beginner should prepare for his *second class* radiotelePHONE license after from 200 to 250 hours of study. This same student should then prepare for his *first class* license in approximately 75 additional hours of study.

In the Grantham *resident course*, the time normally required to complete the course and get your license is as follows:

In the **DAY course** (5 days a week) you should get your *second class* license at the end of the first 9 weeks of classes, and your *first class* license at the end of 3 additional weeks of classes. This makes a total of 12 weeks (just a little less than 3 months) required to cover the whole course, from "scratch" through *first class*.

In the **EVENING course** (3 nights a week) you should get your *second class* license at the end of the 15th week of classes and your *first class* license at the end of 5 additional weeks of classes. This makes a total of less than 5 months required to cover the whole course, from "scratch" through *first class*, in the evening course.

HERE'S PROOF that Grantham Students prepare for F. C. C. examinations in a minimum of time. Here is a list of a few of our recent graduates, the class of license they got, and how long it took them:

	License	Weeks
Don Fenimore, 1305 Ray Street, Dexter, Mo.	1st	12
Jim E. Miller, 8433 12th, S.W., Seattle 6, Wash.	1st	12
Robert R. Constance, 222 Sander St., Pineville, La.	1st	12
Michael J. Flaherty, 5 Wakefield Dr., Trenton, N.J.	1st	12
J. R. Pierce, Jr., Rt. 5, Kingsport, Tenn.	1st	12
Pias B. Jernigan, Rt. 2, Benson, N.C.	1st	12
Gordon Fritsch, Box 122, Edwall, Wash.	1st	12
Bert C. Erickson, P.O. Box 149, Arcadia, Fla.	1st	12
William F. Bratton, Jr., 435 Etna St., Russell, Ky.	1st	12
Richard P. Neal, 2 Carleton Place, Alexandria, Va.	1st	12

Resident Classes Offered at Four Locations

To better serve our many students throughout the nation, Grantham School of Electronics maintains four separate schools—located in Hollywood, Seattle, Kansas City, and Washington, D. C.—all offering the same resident courses in F. C. C. license preparation. (Correspondence courses are conducted from Hollywood.)

For further details concerning F. C. C. licenses and our training, send for our FREE booklet, "Careers in Electronics". Clip the coupon below and mail it to the School nearest you.

Get your First Class Commercial F. C. C. License Quickly by training at



GRANTHAM SCHOOL OF ELECTRONICS

1505 N. Western Ave. Hollywood 27, Calif. (Phone: HO 7-7727)
 408 Marion Street Seattle 4, Wash. (Phone: MA 2-7227)
 3123 Gillham Road Kansas City 9, Mo. (Phone: JE 1-6320)
 821 - 19th Street, N.W. Washington 6, D. C. (Phone: ST 3-3614)

MAIL COUPON NOW—NO SALESMAN WILL CALL →

MAIL COUPON TO SCHOOL NEAREST YOU

(Mail in envelope or paste on postal card)

TO: GRANTHAM SCHOOL OF ELECTRONICS

1505 N. Western Hollywood • 408 Marion Seattle • 3123 Gillham Rd. Kansas City • 821-19th, NW Washington

Please send me your free booklet telling how I can get my commercial F. C. C. license quickly. I understand there is no obligation and no salesman will call.

Name _____ Age _____

Address _____

City _____ State _____

I am interested in: Home Study, Seattle classes

Hollywood classes, Kansas City classes, Washington classes



try
triton
tape

If the quality of Triton Magnetic Recording Tape is deficient for any reason whatsoever, we will replace it with whatever brand you prefer. A complete no-risk Guarantee Certificate is included with every reel. For clean, full-response recordings that only a quality tape can give, try Triton.

Write for your free copy of *The Triton Story*.



triton®

TRITON ELECTRONICS, INC., DEPT. W-12
62-05 30th Avenue, Woodside 77, N. Y.



... for the Record

By W. A. STOCKLIN
Editor

THE TECHNICIAN AND THE ENGINEER

WHEN one speaks of an electronics technician as being engaged in service, operation, maintenance, installation, sales, inspection, quality control—and there are many other categories—there is no doubt as to his specific function. One might not know the exact type of electronic equipment involved nor the degree of knowledge and training required, but we do know that a service technician performs service functions; an operating technician, obviously, operates equipment; an installation technician installs equipment, and there is no ambiguity. In all these categories his function is so clearly defined that the technician's work in no way becomes confused with the work of other divisions nor is he directly involved with the engineering department.

This does not hold true when a technician is engaged in engineering, research, and development work. Some confusion does exist as to a technician's specific function in these categories simply because different companies assign different tasks to their technicians. We have seen, on many occasions during our visits to various plants, qualified engineers performing tasks which could be delegated to technicians. We have seen engineers, for example, building prototype models, performing extensive tests on equipment, and in some cases, actually installing electronic equipment. This is a situation that is both economically unsound and a waste of the engineer's training and talents. In most of these cases, we know that technicians, because of their special training, are better qualified to perform these tasks than are engineers.

One can not argue that at times the functions of the technician and engineer overlap, yet there is, usually, a definite line of demarcation.

The engineer, because of his educational background and extensive

training in mathematics, physics, and electronic circuitry design, should use his knowledge creatively in the fields of research, design, and development. The engineer should plan, create, and perfect. He should not use his time performing a technician's function.

There are, of course, exceptions to any rule. It is certainly advisable and, in fact we would strongly suggest, that inexperienced engineers just out of college be required to learn a technician's work as part of their training program. This not only will provide good practical experience for the engineer but help him understand the true function of the technician.

In industry, technicians are usually employed as supporting personnel helping the engineer create. The technician should serve as the practical arms for the engineer. In essence, he is more adept in "how-to-do" and he is highly qualified to execute the engineer's plans and designs. In such areas, the technician is better qualified than the engineer and his company should make full use of these skills. For example, the technician should be expert in building prototype models of electronic equipment, he should be very proficient in making tests and measurements accurately, and he should be able to troubleshoot equipment quickly once it has been developed.

In all cases, technicians should be used as supporting personnel in the engineering, research, and development departments of a company. This should be made unmistakably clear if the relationship between engineer and technician is to be maintained at its most productive level. The engineer must have the opportunity to follow his profession in his own area of specialization and, at the same time, the professional electronics technician must be allowed to perform those tasks for which he is best qualified. ▲

want to
boost
your pay?

move ahead
in
ELECTRONICS

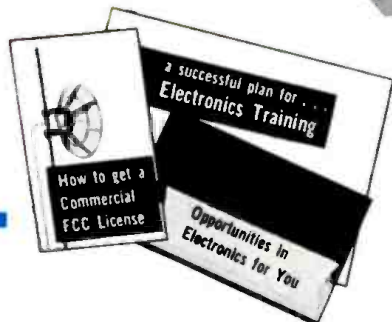

*Get All
3 Free!*

FREE!

FIND OUT HOW

- 1 You can get job security. Specialized education is the road to higher salary and important jobs in the growing field of electronics.
- 2 You can solve the problems that stump other technicians. Problems in electronics are becoming more complex. Your ability to solve problems will help you get ahead in your field.
- 3 You can handle new electronic devices. Every day, advances are being made in electronics. Only through education can you find out how to keep up with these developments and how to use the new devices.



Sorry, Not For Beginners!

Please inquire only if you really want to get ahead and to add to what you have already learned in school, in the service, or on the job. Some previous schooling or experience in electronics, electricity, or related fields is necessary for success in Cleveland Institute programs.

Mail This Coupon Today.

Cleveland Institute of Electronics
1776 E. 17 St. Desk RN60, Cleveland 14, Ohio

Your FCC License Or Your Money Back!

Completion of the Master Course (both Sections) will prepare you for a First Class Commercial Radio Telephone License with a Radar Endorsement. Should you fail to pass the FCC examination for this license after successfully completing the Master Course, you will receive a full refund of all tuition payments. This guarantee is valid for the entire period of your enrollment agreement.

**Investigate our NEW Training Program in
Computers, Servo Mechanisms,
Magnetic Amplifiers and others!**

**Get This Handy Pocket
Electronics Data Guide**

Free ...

Puts all the commonly used conversion factors, formulas, tables, and color codes at your fingertips. Yours absolutely free if you mail the coupon today. No further obligation!



Accredited by The National Home Study Council

Cleveland Institute of Electronics

Desk RN 60, 1776 E. 17 St., Cleveland 14, Ohio



Please send **FREE** career information material prepared to help me get ahead in Electronics. I have had training or experience in Electronics as indicated below:

- | | |
|---|---|
| <input type="checkbox"/> Military | <input type="checkbox"/> Broadcasting |
| <input type="checkbox"/> Radio-TV Servicing | <input type="checkbox"/> Home Experimenting |
| <input type="checkbox"/> Manufacturing | <input type="checkbox"/> Telephone Company |
| <input type="checkbox"/> Amateur Radio | <input type="checkbox"/> Other |

In what kind of work are you
now engaged? _____

In what branch of Electronics
are you interested? _____

Name _____ Age _____

Address _____

City _____ Zone _____ State _____

Desk RN 60

HERE ARE JUST A FEW OF
PACO'S NEWEST KITS:



V-70 VACUUM TUBE VOLTMETER KIT:
Employs balanced vacuum tube bridge circuit for all voltage and resistance measurements plus 3-way probe for accurate, rapid test. Includes: 7 DC voltmeter ranges, 7 AC voltmeter ranges (RMS) from 0 to 1500 volts, and 7 AC voltmeter ranges (peak to peak) from 0 to 4000 volts. Also 7 decibel ranges, -6 to +66 db and 7 electronic ohmmeter ranges from 0.2 ohms to 1000 megohms.
V-70 Kit with "Twin-Tested" operating assembly manual \$31.95 net
V-70W: Factory-wired \$49.95 net



C-25 IN-CIRCUIT CAPACITOR TESTER KIT:
Reveals dried out, shorted, or open electrolytics—in the circuit—with Paco's exclusive Electrolytic Dial.
Simple Sequential Test: reveals open or shorted capacitors, even electrolytics.
Electrolytic Dial: indicates in-circuit capacity from 2 to 400 mfd: condenser is proved non-shorted and not open if capacity reading can be obtained.
Model C-25 Kit: with Paco-detailed operating assembly manual ... \$19.95 net
Model C-25W: Factory-wired \$29.95 net

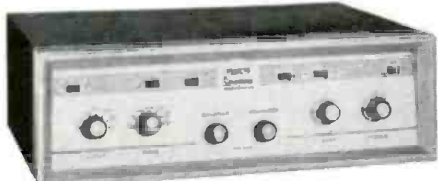

SA-40 STEREO PREAMP-AMPLIFIER: Power: 20W (RMS) per channel, 40W total. Peak, 40W with 80W total. Response: 30 cps to 90 Kc, within 1.0 DB. Distortion: within 0.5% at 20W per channel. Includes: 14 inputs and 14 Panel Controls, black and gold case.
SA-40 Kit with enclosure, "Twin-Tested" operating assembly manual \$79.95 net
SA-40W: Factory-wired, ready to operate \$129.95 net
SA-50: Stereo Kit as above with different styling, 25w per channel TBA*



ST-25 FM TUNER: Sensitivity: 1.5 microvolts for 20 DB quieting. Harmonic Distortion: less than 1%. Includes: Dual Limiters, AFC and AFC Defeat, "Eye" type tuning indicator, Multiplex jack. Black and gold case or walnut enclosure at slight extra cost.
ST-25 Kit with fully-wired prealigned front end. "Twin-Tested" manual ... \$42.95 net
ST-25W: Factory-wired, ready to operate \$59.95 net
ST-26 Tuner-Amplifier Kit: Same as ST-25, with built-in amplifier \$54.95 net
ST-26W Tuner-Amplifier: Factory-wired, ready to operate \$69.95 net



DF-90 TRANSISTORIZED DEPTH FINDER KIT: Protect your boat against shoals and underwater hazards with this compact, easy-to-read depth finder. Locates hard-to-find schools of fish, too.
Fully Transistorized: 5 transistors, low battery drain for very long battery life.
Fast, Easy Readings: over-sized scale with 1-ft. calibrations from 0-120 ft.
DF-90 Kit: Complete with "Twin-Tested" assembly operating manual. \$84.50 net
DF-90W: Factory-wired \$135.50 net



G-15 GRID DIP METER: Major Functions:
1-Variable Frequency Oscillator covering 400 Kc up to 250 Mc in 8 bands;
2-Absorption Wavemeter, 400 Kc to 250 Mc;
3-Modulation Indicator. Applications: antenna tuning, standing wave checks, neutralizing. TVI suppression, carrier monitoring, etc: RF signal source for visual alignment marking between 400 Kc and 250 Mc. Weighs only 3 lbs.
G-15 Kit: Complete with 8 plug-in coils, "Twin-Tested" manual \$31.95 net
G-15W: Factory-wired \$49.95 net

"I built the Paco SA-40 Stereo Preamp Amplifier."

Larry Taylor, 8 Stevens Place, Huntington Station, N. Y. "It took me one-third less time to build the Paco kit than it took Don to make the almost identical preamp-amplifier by another kit maker. But it wasn't just the time; it was knowing you're using the right part, and that you understand the instructions completely. Paco parts are all pictured and labelled, the resistors are neatly mounted on cards for easy identification. And Paco's instruction book doesn't leave you guessing. The fold-out diagrams and drawings are always right beside the instructions, so you're not reading one part of the book and following a diagram in another part. Photographs in Paco's book show how each assembly should actually look. I enjoyed building Paco kits, because I wasn't wasting time or worrying."



"I built a competing Stereo Preamp Amplifier."

Don Taylor, 39 Cross Street, Smithtown, N. Y. "Neither Larry nor I are speed demons because we're very meticulous about wiring and soldering. So I was even more surprised when it took me 50% more time to finish my kit. My problem began when I tried to separate the parts. The resistors were in boxes, but not in any logical way: identical resistors often wound up in different boxes. The instruction book was clumsy to work from. It caused wasteful mistakes. Once I lost 20 to 25 minutes because I misread a tiny key letter that meant not to solder a certain connection. A lot of the fun of kit-building was lost when I had to spend time making up for shortcomings of the packaging and the instruction manual."



THE PACO KITS YOU WANT ARE AT THESE DISTRIBUTORS:

*Hi-Fidelity Equipment Only †Test Equipment Only

ALABAMA

Annlston Southeastern Radio Parts
Birmingham Forbes Distributing Co., Inc.†
Gadsden Southeastern Radio Parts
Mobile Emrich Radio Supply
Montgomery Southeastern Radio Parts
Seima Southeastern Radio Parts

CALIFORNIA

Bellflower Giant Electronics*
Berkeley Electronic Suppliers
Canoga Park Sandy's Electronic Supply†
Culver City Arrow Sales, Inc.†
Hayward Hayward Electronics†
Hollywood Hollywood Radio & Elec., Inc.†
Inglewood Arrow Sales, Inc.†
Long Beach R. C. & L. F. Hall, Inc.
Los Angeles L. A. Electronic Supply
Millbrae T. V. Radio Wholesale†
Modesto Inland Electronic Suppliers†
Monterey Monterey Electronic Supply†
Mountainview Ray-Tel Industrial Co.
North Hollywood Arrow Sales, Inc.†
Honig Distributing Co.†
Palo Alto Peninsula Electronics Supply
Zack Electronics
Pasadena Arrow Sales, Inc.†
Dow Radio, Inc.
Reseda Dulco Sound Systems
Sacramento Lombards Electronics*
Salinas Peninsula Electronics Supply
San Diego Silvergate Radio Supply
San Francisco Market Radio Supply Co.
Zack Electronics
San Jose Electronic Center
Peninsula Electronics Supply
San Jose T. V. Supply
Schad Electronic Supply
United Radio & T. V.
San Mateo San Mateo Elec. Supply Co.
Santa Ana Arrow Sales, Inc.†
Stockton Dunlap Radio & Tele. Supply†
Sunnyvale Sunnyvale Electronics
Vallejo Electronics' Best Buy
Whittier Hi-Fi Haven*

COLORADO

Denver Electronic Parts Company
CONNECTICUT
Bridgeport Hatry Electronic Enterprises
Hartford Del Padre Supply of Hartford
Hatry Electronic Enterprises
Radio Shack Corporation
Signal Electronic Center
Seeli Electronics
New Britain United Electronics
New Haven American Television, Inc.
Hatry Electronic Enterprises
Radio Shack Corporation
Norwich Alkens Electronic Supply Inc.
Stamford Radio Shack Corporation
Waterbury Hatry Electronic Enterprises
Parts Unlimited Stores
See your classified phone directory

FLORIDA

Daytona Beach Hammond Electr., Inc.
Jacksonville Hammond Electronics, Inc.
Kinkade Radio Supply
Peard Electronic Supply Co.†
Lakeland Hammond Electronics, Inc.
Melbourne Electr. Wholesalers, Inc.
Miami Electronic Equipment Co., Inc.
Electronic Wholesalers, Inc.
Herman Electronics
Orlando Hammond Electronics, Inc.
Tampa Hammond Electronics, Inc.
Kinkade Radio Supply
Kithuro Electronics

GEORGIA

Athens Southeastern Radio Parts
Atlanta Southeastern Radio Parts
Gainesville Southeastern Radio Parts
La Grange Southeastern Radio Parts
Rome Southeastern Radio Parts
Savannah Southeastern Radio Parts

HAWAII

Honolulu Precision Radio Ltd.

ILLINOIS

Champaign Electronic Parts Co.
Chicago Arthur Nagel Inc.
Irving Joseph, Inc.
U. S. Radio & T. V. Supplies
Jacksonville Baptist Electronic Supply†
Joliet Mainline Industrial Supply Co.

INDIANA

Bloomington H. A. Williams Co.
Columbus H. A. Williams Co.
Evansville Hutch & Son, Inc.†
Ohio Valley Sound†
Indianapolis Graham Elec. Supply Inc.
Meunier Electronic Supply Co.
Van Sickle Radio Supply Co.
Lafayette Lafayette Radio Supply
Muncie Muncie Electronic Supply
Richmond H. A. Williams Co.

KANSAS

Kansas City Manhattan Radio & Equip.†

KENTUCKY

Lexington Radio Electronic Equip. Co.
Louisville P. I. Burks Co.

LOUISIANA

Baton Rouge Davis Electronic Supply†
Lake Charles Television Radio Supply†
New Orleans Crescent Radio & Sup. Inc.†
Epcort
Southern Radio Supply†
Shreveport Koelemay Sales Co., Inc.†

MARYLAND

Baltimore Hi-Fi Shops*
Revaco of Maryland†
Hagerstown Zimmerman Wholesalers
Salisbury Standard Electronics Supply†
Towson Baynesville Electronics†
Wheaton Key Electronics

MASSACHUSETTS

Boston Lafayette Radio Electronics
Radio Shack Corporation
Braintree Radio Shack Corporation
Brockton Tee Vee Supply Co.
Brookline Radio Shack Corporation
Chelsea Lektron, Inc.
Holyoke Kathleen Smith Music Shop Inc.
Jamaica Plain Tee Vee Supply Co.
Lynn Land Electronics Supply Inc.†
Milford Tee Vee Supply Co.
Peabody Tee Vee Supply Co.
Springfield Del Padre Music Shop Inc.
Del Padre Supply of Springfield

MICHIGAN

Battle Creek Electronic Supply Corp.
Dearborn Hi-Fi Studios, Inc.*
Detroit Hi-Fidelity Workshop*
Hi-Fi Studios, Inc.*
Radio Specialties Co.
Grand Rapids Bursa Radio Supply
Grosse Pointe Hi Fidelity Worksnop*
Kalamazoo Electronic Supply Corp.
Muskegon Western Elec. Supply Co.†
Pontiac Hi Fidelity Workshop*
Wyandotte Hi Fidelity Workshop*
Radio Specialties Co.

MINNESOTA

Minneapolis Ken Craft Hi-Fi*
St. Paul Electronic Market*

MISSOURI

Joplin Four State Radio Supply†
Kansas City McGee Radio Co.
Manhattan Radio & Equipment Inc.†
St. Louis Deltronics Distributing Co.†
Olive Electronic Supply

MONTANA

Billings Electronic Supply Co.†

NEBRASKA

Omaha Omaha Electronics Co.†
Scotts Bluff Tri State Electronics Inc.

NEW HAMPSHIRE

Concord Evans Radio

NEW JERSEY

Bergenfield Arco T. V. Parts Corp.*
Hackensack Emco Electronics Inc.*
Morris Plains Park Electronic Corp.
Newark Terminal-Hudson
Lafayette Radio Electronics
North Bergen Arco T. V. Parts Corp.*
Paramus Lafayette Radio Electronics
Passaic Ed's Electronics Inc.
Plainfield Lafayette Radio Electronics
Princeton Sun Radio & Electronics Co.
Springfield Disco Electronics, Inc.
Westwood Arco T. V. Parts Corp.*
Parts Unlimited Stores
See your classified phone directory

NEW MEXICO

Albuquerque Electronic Parts Co.†
Yucca Wholesaler†
Los Alamos Valley Engineering Co.

NEW YORK

Albany Greylock Electronics†
Selden Sound, Inc.†
Bayside Snyder Electronic Distrib. Inc.*
Binghamton Stack Electronics†
Brooklyn Wiltmal Electronics*
Benray Electronic Distributors
Bronx Adamson Electronic Corp.*
Buhalo Radio Equipment Corp.†
Standard Electronics, Inc.†
East Northport Arena Electronics, Inc.†
Elmont Great Eastern Mills-Electronics†
Hempstead Newark & Lewis*
Jamaica Harrison Radio Corp.
Lafayette Radio Electronics
Peerless Radio Dist. Inc.
Kingston Greylock Electronics†
Long Island City Electronics Supply Corp.
Middletown Artec Distributors Inc.†
Certified Electronics Inc.†
Mineola Arrow Electronics Inc.
New Hyde Park Dressner Audio Sales Co.*
Arrow Electronics
Consolidated Radio Sales Inc.†
Dale Electronics Co.
Grand Central Radio
Harrison Radio Corp.
Hi Fidelity Center*
Lafayette Radio Electronics
Magic Vue Television Corp.*
Magna Electronics Co.
Sun Radio & Electronics Co.
Terminal-Hudson
Wilmar Distributors Corp.*
Zalytron Tube Corp.
Poughkeepsie Greylock Electronics†
Rochester Rochester Radio Supply Co.
Rome Rome Electronics, Inc.†
Schenectady Grimms Elec. Parts Sup.
Syracuse L. Gordon Dist. Co.†
Syracuse Radio Supply Co.
Utica Grapac Electronics†
Parts Unlimited Stores
See your classified phone directory

NORTH CAROLINA

Concord Mac Victor Electr. Supply Inc.

(Continued on next page) →

BUILD A HI-FI MUSIC WALL! Don Brann's new book *How to Build a Hi-Fi Music Wall* gives you step-by-step instructions for building a decorator styled cabinet or an entire music wall. Send 50c and your name and address to: PACOTRONICS, INC., Dept. EW-12 70-31 84th Street, Glendale 27, New York.

PACO DISTRIBUTOR LIST (cont'd.)

OHIO

Columbus Whitehead Radio Co.*
Cincinnati United Radio, Inc.
Dayton Sregco Inc.
Toledo Lifetime Electronics
Warren Radio Co.
Warren Valley Electronics*
Youngstown Armies Electronics

OKLAHOMA

Oklahoma City Dulaney's†

PENNSYLVANIA

Allentown A. A. Peters, Inc.
Charleroi Barno Radio Co.
Erie Mace Electronics
Harrisburg Electronic Wholesalers, Inc.
Radio Distributing Co.
McKeesport Barno Radio Co.
New Brighton Television Parts Co., Inc.
Pittsburgh House of Audio*
Marks Parts Co.†
Metropolitan Distributors, Inc.
Opus One*

Reading George D. Barbey Co.
State College Aivo Electronics Dist. Inc.*
Tarentum Huston TV Parts Co.
Wilkes-Barre General Radio & Elec. Co.

RHODE ISLAND

Providence Electronic Distributors, Inc.
Radio Shack Corporation

SOUTH CAROLINA

Columbia Hi-Fi Sound & Records Co.*
Southeastern Radio Parts

SOUTH DAKOTA

Rapid City Dakota Electronics

TENNESSEE

Chattanooga Curie Radio Supply
Columbia Randolph & Williams†
Knoxville Smith Electronics Supply Inc.†
Nashville Electra Distributing Co.*
Randolph & Rice†

TEXAS

Abilene R & R Electronics Co.
Amarillo R & R Electronics Co.
Austin Modern Electronics Co.
Service Electronic Supply
Bay City R. C. & L. F. Hall, Inc.
Baytown R. C. & L. F. Hall, Inc.
Beaumont R. C. & L. F. Hall, Inc.
Conroe R. C. & L. F. Hall, Inc.
Corpus Christi Modern Electronics Co.
Wicks Radio Equipment Co.†
Dallas All State Distributors, Inc.†
Crabtree's Wholesale Radio & TV
Denison Denison Radio Supply
Freeport R. C. & L. F. Hall, Inc.
Galveston Electrotech
R. C. & L. F. Hall, Inc.
Houston Electrotech
Gilbert Co.
R. C. & L. F. Hall, Inc.
McAllen Rio Radio Supply Co.†
Midland R & R Electronics Co.
Odessa R & R Electronics Co.
Pasadena R. C. & L. F. Hall, Inc.
San Angelo R & R Electronics Co.
San Antonio Modern Electronics Co.
Radio TV Parts Co.†
Sherman Electronics Supply Inc.
Texas City Electrotech
R. C. & L. F. Hall, Inc.
Wichita Falls R & R Electronics Co.

UTAH

Salt Lake City Moore Radio Supply†

VIRGINIA

Norfolk Southern Television Corp.†
Richmond Banner Electronics, Inc.†
Industrial Electronic Tube Corp.†
Roanoke Dixie Appliance Co.†

WASHINGTON

Seattle Empire Electronic Supply Inc.
Northgate Cameras*
Pacific Electronic Sales Co., Inc.
Radio Products Sales Co., Inc.
Spokane E. M. Johnson Co.
Tacoma Branham Hi-Fi
Sound Center*

WASHINGTON, D. C.

Elec. Wholesalers, Inc.
Rucker Electronic Products Inc.
Arlington, Va., Key Electronics
Rucker Electronic Products Inc.
College Park, Md. Rucker Elec. Prod. Inc.
Silver Spring, Md. Kenyon Elec. Corp.†
Rucker Electronic Products Inc.
Silver Spring Electronic Supply

WISCONSIN

Milwaukee Acme Radio Supply
West Allis Hi-Fi Salon*

WEST VIRGINIA

Beckley Chemcity Electronic Dist. Inc.†

EXPORT:

Morhan Exporting Corp., New York, N. Y.

CANADA:

Atlas Radio Corp., Toronto, Ontario

*Hi-Fidelity Equipment Only

†Test Equipment Only

**PACO
KITS BY**



PACOTRONICS

For free illustrated PACO catalog write:
Paco Electronics, Dept. EW-12
70-31 84th Street, Glendale 27, N. Y.
A subsidiary of PACOTRONICS, INC.

LETTERS

FROM OUR READERS

REVERBERATION UNITS

To the Editors:

I have been a regular reader of your magazine for six or seven years. Generally, it is one of the best magazines that carry hi-fi articles. However, I take exception to Bert Whyte's recent biased views concerning reverb units.

1. Is it not safe to say that many recordings made with close mikes might be helped by proper use of reverb, provided the recording is dry and that the composition is one that would be suited to reverberation? What is wrong with adding reverb to better simulate the atmosphere of listening to a live orchestra from somewhere in the hall away from the conductor's very close location?

2. The argument that reverb units are just gimmicks and that they are no good because Joe Doakes might misuse them, doesn't hold water. This is like saying that automobiles are gimmicks and are no good because some people drive 70 mph in a 20-mph zone. Not all drivers are idiots and neither will all persons who own reverb units misuse them.

3. If the work of engineers is so sacred, do you also advocate that preamps should have no tone controls lest the engineer's work be altered the slightest bit? What is to prevent the same Joe Doakes from upsetting the engineer's balance with a treble control? Isn't it better to say that each type of control should have a purpose and none should be condemned because of one person's opinion.

DAVID OVERSON
Pittsburgh, Pa.

There is no objection to the use of properly controlled reverb as long as it does not "gimmick up" a performance and add distortion. The listener is still the final judge, and what controls he uses and how he uses them are up to him.—Editors.

CENTER SPEAKER FOR STEREO

To the Editors:

The addition of a center speaker for 2-channel stereo by the bridging technique was proposed by Steinberg and Snow in 1934 and elaborated upon by Snow and this writer. In spite of the age of this idea it is still not broadly understood.

For example, one writer of a popular article wrote, "To maintain the original listener-focal area orientation, the speakers have to be toe-in as the listening angle increases—" This is true but the same writer goes on, "—since balanced stereo can be heard only in the focal area." This is only partly true. The

toe-in is correct but for a different reason. As Snow (1953) expressed it, the toe-in reduces the shift of the virtual sound source for different listener locations. Thus the reason or purpose of toe-in is to *widen* the listener area, which makes the writer's reason correct if it is interpreted to mean a widening of the focal area. In practice it has been found this focal or listening area is the full width of the speaker array.

The purpose of a wide speaker array is thus seen to be three-fold, widening the listener area, widening the listening angle, and improving localization.

If the flanking speaker separation is sufficient to give optimum listening area and optimum listening angle, there will be a hole in the middle or a requirement for a bridged center speaker which, when fulfilled, accomplishes the third purpose of improving accuracy of localization of sounds.

Another widely misunderstood factor in stereo is the subject of "polarity." Snow points out that in stereo "—the channel spacings are so wide that only very low frequencies can be considered at other than random phase—" and with random phase, polarity has no meaning. If signals were "in-phase," polarity reversal would cause cancellation, but if phase is random, polarity reversal has no average effect on the sound; the center speaker may be switched from sum to difference on a true stereo recording and the difference is barely liminal when listening to the center speaker only, and subliminal when listening to all three speakers.

PAUL W. KLIPSCH
Klipsch and Associates, Inc.
Hope, Arkansas

The article referred to by Mr. Klipsch above is "Adding a Center Speaker for Stereo" by Heuly which appeared in our August, 1961 issue.—Editors.

OBSOLESCENT DOCTORS

To the Editors:

Mr. Ed Bukstein's article on "Electrical Activity of the Human Body" in your August issue was most interestingly authored.

A feeling of great pity overwhelms me for my colleagues in internal medicine who are shortly to be replaced by electronic computers which will diagnose the ailment and prescribe the indicated remedy. Before long, a kit will be available I am sure to replace these obsolescent diagnosticians.

We surgeons, however, are not worried. We may have to swallow our pride and permit an electronic device to tell us *where* to do the cutting, but I doubt

(Continued on page 14)

TESTS
All TV and Radio
Tubes—Old and New

TESTS
the Nuvisitors

TESTS
the New 12-Pin
Compactrons

TESTS
the New 10-Pin Tubes

TESTS
European Hi-Fi Tubes,
Voltage Regulators, and
Most Industrial Types

TESTS
for True Dynamic
Mutual Conductance (Gm)

**OBSOLESCENCE
PROOF**
Designed for Maximum
Use Today and
Tomorrow



**NEWEST
FINEST
MONEY-MAKER**

*for Professional
Servicemen*

Multiple-Socket Speed with Gm Accuracy PLUS OBSOLESCENCE PROTECTION

Model 700 DYNA-QUIK

*Fastest, Most Complete
Most Up-to-Date*

**DYNAMIC
MUTUAL CONDUCTANCE
TUBE TESTER**

*See your B&K Distributor, or
Write for Catalog AP18-N*

TESTS BOTH OLD AND NEW TUBE TYPES—SELLS MORE TUBES PER CALL
Again you benefit from proved B&K techniques! This up-to-date, obsolescence-proof, professional instrument is designed for maximum use *today and tomorrow*. Provides multiple-socket section to quick-check most of the TV and radio tube types the *true dynamic mutual conductance way*—plus simplified switch section to check new tube types in Dyna-Quik emission circuit. Also includes provision for future new sockets.

Makes test under set-operating conditions. Checks each section of multi-section tubes separately. Checks for *all* shorts, grid emission, leakage and gas. Makes quick “life” test. Exclusive adjustable grid emission test provides sensitivity to over 100 megohms.

Makes complete tube test in seconds. Checks average set in a few minutes. Discovers weak tubes that need replacement. *Satisfies more customers. Sells more tubes. Saves call-backs. Insures your reputation.*

Patented automatic compensation for line voltage variation. Large 4½” plastic meter with easy-to-read “Replace-Good” scale. Lists most commonly used tube types with settings directly on socket panel for fastest operation. Complete listing in reference chart in cover. Phosphor-bronze contacts for long life. 7, 9, and 10-pin straighteners on panel. Operates on 117 volts 50-60 cycle a.c. Hand-some leatherette-covered carrying case.
Size: 16½” x 15¼” x 5½” deep. Net wt: 15½ lbs. Net, \$169⁹⁵

NEW TUBE INFORMATION SERVICE

Available every 3 months, on subscription,
for all B&K Dyna-Quik Tube Testers



B & K MANUFACTURING CO.
1801 W. BELLE PLAINE AVE • CHICAGO 13, ILL.
Canada: Atlas Radio Corp., 50 Wingold, Toronto 19, Ont.
Export: Empire Exporters, 277 Broadway, New York 7, U.S.A.

Meet...and beat...the fringe-area challenge with the new **CHANNEL MASTER**

*Channel Master's world-famous Antenna Development Laboratory has done it again! By using a brand new concept in antenna design...
PROPORTIONAL ENERGY ABSORPTION...
 Channel Master meets the fringe area challenge with the most powerful TV antenna ever produced...the Crossfire!*

Proportional Energy Absorption works like this!

Each Crossfire element has a predetermined impedance, at each frequency, which determines its degree of energy absorption. This impedance, governed by the taper and spacing of the dipoles, decreases with the distance from the feed point. Each successive element therefore absorbs a larger percentage of the available energy.

Since the amount of available energy decreases as it progresses along the length of the antenna, each element, by absorbing a larger percentage, absorbs approximately the same amount of energy as the other elements in the array.

This means that the Crossfire...unlike other antennas...has a large group of driven dipoles actively working to increase gain on every channel...on both low and high bands.

More working elements provide more picture power! This is the key to the remarkable performance of the Crossfire.

Revolutionary New Dual Dipole System

Each parasite reverses phase of high band current on the adjacent low band dipole, so that it operates as three driven half-wave high band elements.

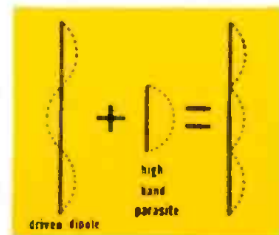

... And the Crossfire is Gold!

The Crossfire's performance is matched only by its beauty. Channel Master's exclusive E*P*C Process gives the antenna a lustrous golden coating that enriches its appearance and protects it for years against corrosion.

Channel Master's E*P*C Process is *not* anodizing! The disadvantage of anodizing is that the anodized film is an electrical insulator, and must be removed by *abrasion* wherever metal-to-metal contact is required. Therefore, anodized antennas have no surface protection on the very parts that need it most!

**THERE'S
 A CROSSFIRE TO MEET
 EVERY RECEPTION PROBLEM!**

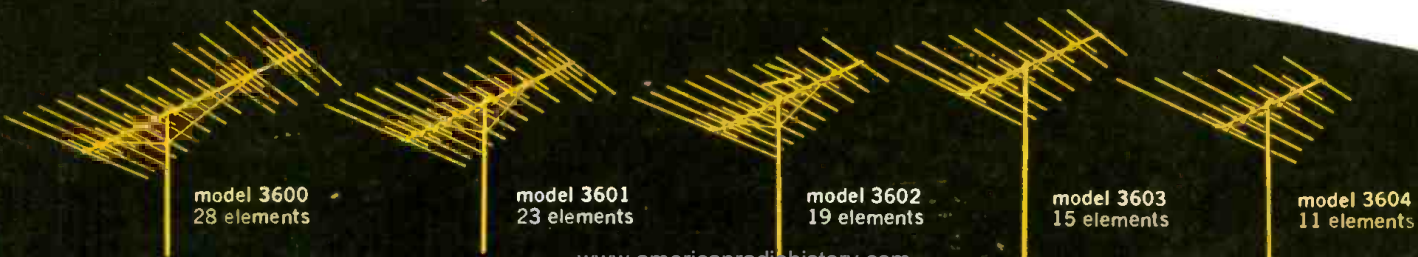

model 3600
28 elements

model 3601
23 elements

model 3602
19 elements

model 3603
15 elements

model 3604
11 elements

GOLDEN Crossfire

Transposed Feed Line Means Cleaner Gain!

Extremely high front-to-back ratios are accomplished by a Transposed Feed Line, from which the Crossfire gets its name. This feed line is transposed between each successive pair of elements. As a result, the radiations from each pair of adjacent elements are self-cancelling because they are 180° out of phase. This carefully engineered system is so efficient that the Crossfire needs no parasitic reflector element.

Because of these high front-to-back ratios, the Crossfire provides *cleaner* gain than any other all-channel antenna. It pulls in the signal you want while rejecting unwanted interference of every type (auto ignition systems, electrical noise, other TV signals, etc.) from both side and rear. See unretouched photo of actual horizontal polar pattern.

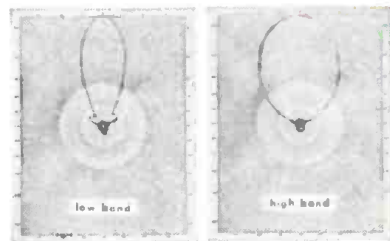
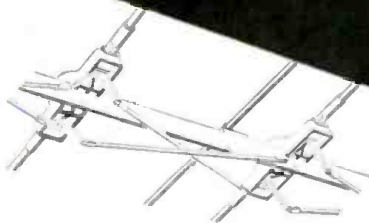

The Crossfire is the only antenna you can sell with full confidence that it will outperform anything your customer is now using!

For still more power... add the new

CHANNEL MASTER JETRON

Antenna-mounted transistorized signal amplifier and set coupler
Most effective...most dependable...lowest noise figure!



Power supply (with built-in 4-set coupler) is conveniently located in the home. Compact, only 5" x 3 3/4" x 1 3/4".

model 0020

* Patent Pending

Copyright 1963, Channel Master Corp.

model 3605
7 elements

The Professional Series
TRANSMISION TV CHASSIS

For Hi-Fi or Custom Installations

Designed for the perfectionist seeking maximum performance!

Available in 19", 23", and 27" Sizes

Also available in KIT form which anyone can assemble.

Designed for all types of Custom Installation, Walls, Bookcases, Cabinets, etc. Complete line of accessories facilitate custom installation.

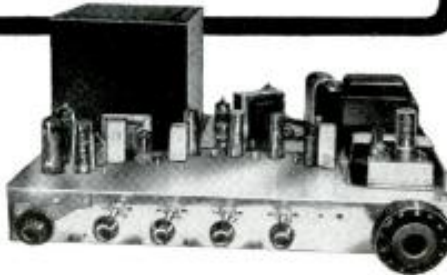

Top view of "Professional" Chassis with controls in horizontal position.

2 IMPORTANT TYPES

FOR HI-FI SYSTEM: Less Audio System, incorporates a Cathode Follower Circuit for operation into a Hi-Fi Audio System.

WITH ITS OWN HI-FI AUDIO: Includes its own Hi-Fi 10 Watt Push-Pull Audio Amplifier and Dual Hi-Fi Speaker system with 6" x 9" crossover, 6.8 oz. magnet, 3" tweeter, condenser crossover, extended range tone control.

OPTIONAL ACCESSORIES: Front panels for horizontal or vertical mounting of chassis (\$15.). For ease of servicing, front panel, tube, and chassis can be unitized with a "Rigidizing" assembly for sliding out from front. Slides included with "Rigidizing" assembly (\$10.).

TECHNICAL FEATURES:

Ultra-linear sweep circuits • D-C restoration • Newest Standard Coil Guided Grid Turret Tuner with automatic fine tuning, provisions for UHF • Special low noise tubes • 5 microvolt sensitivity • 4 megacycle picture bandwidth • Heavy-duty dual 5U4G transformer type power supply • Ruggedized construction, hand-wired for trouble-free long life • True FM sound circuits.

All Parts are premium quality. RCA, Sylvania tubes, Allen-Bradley resistors, Cornell-Dubilier condensers. ALL PARTS Guaranteed for FULL YEAR!

PRICES: CHASSIS or KITS

Item	Size	Description	Chassis	Kit
(Prices include Pic. Tube)				
1	19"	No audio, for use with HI-FI System	\$263.00	\$178.00
2	19"	With HI-FI Audio incorporated	293.00	194.00
3	23"	No audio, for use with HI-FI System	268.00	183.00
4	23"	With HI-FI Audio incorporated	298.00	199.00
5	27"	No audio, for use with HI-FI System	308.00	223.00
6	27"	With HI-FI Audio incorporated	338.00	239.00

Picture tubes are the new bonded tubes. The protective glass is fused to the tube face improving picture contrast, reducing reflections, and eliminating dust between glass and tube. All Chassis are completely factory-wired, carefully tested and rigidly inspected. This is the Chassis selected by thousands of school systems and U.S. governmental agencies when premium type performance is required.

Dealer Inquiries Invited.

TRANSMISION Electronics, Inc., New Rochelle, N. Y. Dept. E W
 Please send more information on TV Wired Chassis TV Kit. Enclosed is \$25 deposit.
 Please send Item No. _____ (Chassis or Kit), balance C.O.D. Enclosed is \$_____ payment in full
 for Item No. _____. I understand that freight is prepaid when payment is made in full.

Name _____ Address _____
 City _____ Zone _____ State _____

if many patients will permit the apparatus to do it, at least until the stage of the electronic art is reached where such things as flop-over on our video screens is licked.

It is horrible to contemplate what might happen in the event a tube became gassy or acoustic feedback developed in the surgical unit.

A word of encouragement to the internists. They might take comfort in the thought that they may perpetuate themselves by repairing the machines!

PAUL B. JARRETT, M.D.
 Practice Limited to Surgery
 Phoenix, Arizona

We feel sure it will be a long time before the diagnostician will be rendered obsolete by computers. However, the computer and other electronic devices can be extremely helpful in making a correct diagnosis. See the article "Advances in Medical Electronics" in our November issue.—Editors.

SUPER-POWER U.H.F. TUBES

To the Editors:

In your editing of our article "Super-Power U.H.F. Tubes" in the October issue to fit your space requirements, two points were covered in such a way as to leave a misleading impression. They are as follows:

1. The first paragraph notes that the tubes are capable of "... hundreds of kilowatts of average power output, ..." and the title states they are "u.h.f." tubes. To completely fulfill these statements the characteristics of the RCA-2054 must be included in addition to the RCA-7835. The type 2054 can produce 5 million watts of pulse power, 300 kilowatts of average power, at 400 mc. This is actually within the u.h.f. range. The characteristics shown in the article for the 7834 are for frequencies up to 300 mc. This frequency represents the top limit of the v.h.f. band (or the bottom limit of the u.h.f. band).

2. In the section entitled "Design Philosophy," the last sentence of the last paragraph is misleading. The statement, "For short-pulse service, 1800 amps at 1.3 volts is used ..." seems to imply that this lower heater power is applied to the thoriated-tungsten filamentary cathodes. The cathodes for short-pulse service are an entirely different material, matrix-oxide, as explained in the original paper. Thoriated-tungsten would not get hot enough to emit electrons under the conditions of reduced filament power described.

R. E. REED
 A. C. TUNIS
 Electron Tube Div.
 Radio Corp. of America
 Lancaster, Pa.



Chassis can be mounted "Horizontally" or "Vertically"



Beautiful Cabinets available.



Thanks to Authors Reed and Tunis for amplifying the two points mentioned above. Strictly speaking, the typographical errors on our cover and contents page referring to the tubes as "v.h.f." types were not errors at all if the 7835 tube is referred to. However, the design philosophy was to produce a superpower u.h.f. tube.—Editors. ▲

GET YOUR ELECTRONICS-TV-RADIO HOME TRAINING FROM N.T.S. RESIDENT SCHOOL

BREAK THROUGH TO HIGHER PAY, GREATER JOB SECURITY

START NOW! Break through the Earning Barrier that stops "half-trained" men. N.T.S. "All-Phase" Training prepares you . . . at home in spare time . . . for a high-paying CAREER as a **MASTER TECHNICIAN** in Electronics — TV — Radio. One Master Course at One Low Tuition trains you for unlimited opportunities in All Phases: Servicing, Communications, Preparation for F.C.C. License, Broadcasting, Manufacturing, Automation, Radar and Micro-Waves, Missile and Rocket Projects.

A MORE REWARDING JOB . . . a secure future . . . a richer, fuller life can be yours! As an N.T.S.

MASTER TECHNICIAN you can go straight to the top in industry . . . or open your own profitable business.

Over 1 City Block of Modern School Facilities, Laboratories and Shops Housing Over 1,000 Students.

50,000 Graduates — all over the World — since 1905

BETTER . . . MORE COMPLETE . . . LOWER COST . . . WITH NATIONAL SCHOOLS' SHOP-METHOD HOME TRAINING!

BETTER . . . Training that is proved and tested in N.T.S. Resident School shops and laboratories, by a School that is the **OLDEST** and **LARGEST** of its kind in the world.

MORE COMPLETE . . . You learn **ALL PHASES** OF Television — Radio — Electronics.

LOWER COST . . . Other schools make several courses out of the material in our **ONE MASTER COURSE . . .** and you pay more for less training than you get in our course at **ONE LOW TUITION!**

NATIONAL TECHNICAL SCHOOLS
WORLD-WIDE TRAINING SINCE 1905

THE SCHOOL BEHIND YOUR HOME-STUDY TRAINING

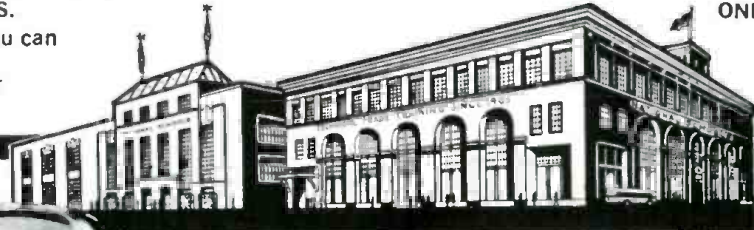

In these modern School Headquarters your Home Training is: Classroom-Developed, Lab-Studio Planned, Shop-Tested, Industry-Approved, Home Study-Designed.

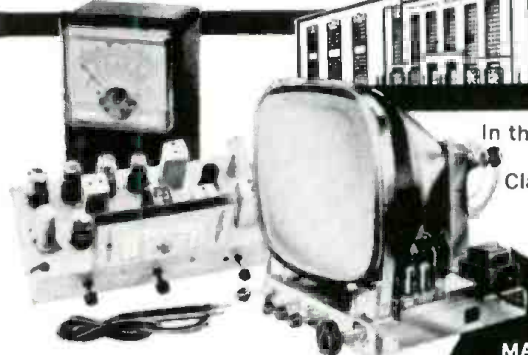

TRAIN AT HOME IN YOUR SPARE TIME . . . AT YOUR OWN PACE!

19 BIG KITS YOURS TO KEEP

- Friendly Instruction and Guidance
- Graduate Advisory Service
- Unlimited Consultation
- Diploma Recognized by Industry
- **EVERYTHING YOU NEED FOR SUCCESS**

N.T.S. IS NOT JUST A MAILING ADDRESS ON A COUPON
N.T.S. is a real school . . . a world famous training center since 1905. Thousands of men from all over the world come to train in our shops, labs, studios and Classrooms.

You learn quickly and easily the N.T.S. Shop-Tested way. You get lessons, manuals, job projects, personal consultation from Instructors as you progress. You build a Short-Wave, Long-Wave Superhet Receiver plus a large screen TV set from the ground up with parts we send you at no additional cost. You also get a Professional Multitester for your practical job projects. The Multitester will become one of your most valuable instruments in spare time work while training, and afterwards, too. Many students pay for their entire tuition with spare time work. You can, too . . . we show you how.

SEND FOR INFORMATION NOW . . . TODAY!
IT COSTS YOU NOTHING TO INVESTIGATE

After you graduate you can open your own TV-Radio repair business or go into high paying jobs like these: Communications Technicians, Hi-Fi, Stereo and Sound Recording Specialists, TV-Radio Broadcasting Technician, Technician in Computers & Missiles, Electronics Field Technician, Specialist in Micro-Waves and Servomechanisms, Expert Trouble Shooter, All-Phase Master Technician, TV-Radio Sales, Service and Repair.

RESIDENT TRAINING AT LOS ANGELES
If you wish to take your Electronics-TV-Radio training in our famous Resident School in Los Angeles — the oldest and largest school of its kind in the world — write for special Resident School catalog and information, or check special box in coupon.

MAIL COUPON NOW FOR FREE BOOK & ACTUAL LESSON

No obligation.
No salesman will call.



NATIONAL TECHNICAL SCHOOLS
WORLD-WIDE TRAINING SINCE 1905

Mail Now To
National Technical Schools, Dept. RH-121
4000 S. Figueroa St., Los Angeles 37, Calif.
Please rush **FREE** Electronics-TV-Radio "Opportunity" Book and Actual Lesson.

Name _____ Age _____
Address _____
City _____ Zone _____ State _____

Check here if interested **ONLY** in Resident Training at Los Angeles.
VETERANS: Give date of discharge _____



ACCREDITED MEMBER

NATIONAL TECHNICAL SCHOOLS
WORLD-WIDE TRAINING SINCE 1905

4000 SO. FIGUEROA ST., LOS ANGELES 37, CALIF., U. S. A.

FREE!

LAFAYETTE

**340 PAGE 1962
ELECTRONICS CATALOG**

*"America's Hi-Fi &
Electronics Shopping Center"*

Yours free for the asking — the biggest, best and most comprehensive catalog in the 41-year history of Lafayette Radio. Audiophile, Experimenter, Hobbyist, Technician, Engineer, Student, Serviceman, Dealer — you'll find what you want in this latest Lafayette catalog.



CATALOG # 620



**COMPLETELY WIRED,
FULL SIZE TUBE TESTER
TE-15.....19.95**



**10,000
OHMS-PER-VOLT
MULTIMETER
TE-10.....9.95**



**NEW! KDRDEX™
TRANSISTORIZED
SEMI-KIT TAPE RECORDER
RT-201.....17.95**



**SUPERHETERODYNE
COMMUNICATIONS RECEIVER
KT-200, Kit.....64.50
ME-10, Wired.....79.95**



**NEW!
FM MULTIPLEX
ADAPTER
LT-200.....39.50**



**CITIZENS
BAND
MOBILE ANTENNA WHIP
ME-800WX.....6.95**

LARGEST STOCK SELECTION. Stereophonic Hi-Fi equipment, Citizens Band, Ham and Amateur equipment, Radio & TV parts, Optics, Industrial Supplies, and much more, including all the favorite name brands.

LAFAYETTE EXCLUSIVES. Featured are the famous Lafayette Kits... dollar for dollar the best value for your money today. You'll also see hundreds of Lafayette specials... available only from Lafayette. And, as always, **SATISFACTION GUARANTEED OR MONEY REFUNDED.**

LOWEST PRICES. You'll save money too with Lafayette's low, low prices. The lowest prices are always in the Lafayette catalog.

24-HOUR SERVICE. Quick, courteous service is your guarantee at Lafayette. Most orders are fully processed within 24 hours after receipt in the mail Order Division.

NEW EASY-PAY PLAN.
Now, **NO MONEY DOWN...**
up to 24 months to pay.

LAFAYETTE'S
NEW MAIL ORDER HEADQUARTERS
111 JERICHO TURNPIKE
(2 Blocks West of South Oyster Bay Rd.)
SYOSSET, LONG ISLAND, NEW YORK



**LAFAYETTE RADIO, DEPT. RL-1
P.O. BOX 10, SYOSSET, L. I., N. Y.**

- Rush my **FREE Lafayette 1962 Catalog 620**
- Please send me # _____, shipping charges collect.

I am enclosing \$ _____.

340 PAGES

Name _____

Address _____

City _____ Zone _____ State _____



LAFAYETTE is America's Citizens Band Headquarters

Complete Portable Communications for Everyone



Ship to Shore



On the Farm



Construction Work

NO LICENSES, TESTS OR AGE LIMITS



HE-29A

PORTABLE—POCKET SIZE
Only 6 3/4" x 3 1/4" x 1 1/4"



Complete with Leather Carrying Case, Earphone, Antenna, Batteries, and Crystal

LAFAYETTE 9 TRANSISTOR CITIZENS BAND "WALKIE TALKIE"

39.95
2 for **78.88**
NO MONEY DOWN

- Completely Wired—Ready to Operate
 - Fully Transistorized—9 Transistors plus 1 Diode
 - Uses Inexpensive Penlight Batteries
 - No License, Tests or Age Limits
 - Comes with Leather Carrying Case, Earphone, Antenna, Batteries and Crystals
- As simple and easy to use as the telephone—and twice as handy. Receives and transmits up to 1.5 miles under average conditions. Weighs only 18-oz. and slips into your pocket. Push-to-talk button operates built-in speaker as sensitive microphone.

LAFAYETTE HE-20A Deluxe CITIZENS BAND TRANSCEIVER

ONLY **109.50**
NO MONEY DOWN

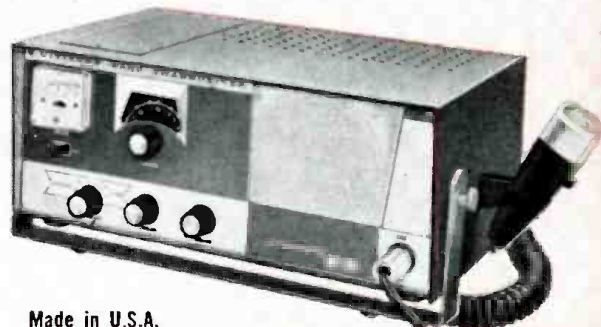

Made in U.S.A.

Now With Added Deluxe Features—

- Pi-Network for Greater Power Output
 - Calibrated "S" Meter
 - 14 Tube Performance, 3 Diodes
 - Built-in 12 Volt Power Supply for Mobile Use
 - Complete with Matched Crystals for Channel 9
- A highly efficient 2-way communications system operating over a distance of up to 20 miles or more depending on terrain. Features

4 crystal-controlled transmit positions and 4 crystal-controlled receive positions. Tuneable superhet receiver covers all 23 assigned channels. Other highlights include dependable push-to-talk ceramic mike & relay, adjustable squelch control, automatic series gate noise limiter and illuminated dial.

NEW! LAFAYETTE TE-20 RF SIGNAL GENERATOR



ONLY **27.95**
NO MONEY DOWN

Factory Calibrated and Tested. Six Bands: 120 KC-260 MC. Dual output RF Terminals

- Separate Variable Audio Output. Dial Calibration $\pm 2\%$. Etched Circular Dial — (Vernier Tuned)

A stable, wide-range signal generator engineered to fill the need for an accurate, low cost service instrument. Completely wired and ready to operate, the TE-20 features a large 4 1/4" etched circular dial calibrated to $\pm 2\%$ with a frequency output of from 120 KC to 260MC in 6 bands. Built-in audio oscillator, adjustable output to 8 volts, variable RF attenuator and a host of other features. Steel case with leather carrying handle.

EXCITING "EXPLOR-AIR" 4-BAND RECEIVER KIT

Complete Shortwave and Standard Broadcast Reception



- 4 Bands For Total Coverage
- Complete Bandswitching From Front Panel
- Built-in 4" PM Loudspeaker
- 550 KC — 30 MC

21.95 NO MONEY DOWN

Precision compact radio kit with everything you need for unexcelled reception. Size: 10x7x5".
KT-135 (less cabinet) 21.95
ML-150 Leatherette covered wood cabinet 2.75

Made In U.S.A.

LAFAYETTE RK-400WX SENSATIONALLY

LOW PRICED AT **49.50** NO MONEY DOWN



- Up to 2-hours at 3 3/4 ips on LP Tape
- Provision For External Speakers
- Permits Direct Recording From Radio or Phono

The perfect recorder for home, school or office. Complete recording facilities with built-in amplifier, 5" PM Speaker and sensitive crystal microphone. Footproof operation with facilities for direct recording from your radios or phonograph without accompanying noise or distortion. Finished in attractive scuff resistant pyroxylin material. Size: 11 1/4 x 9 7/8 x 7 1/2".

- 2 Speed; 3 3/4, 7 1/2 ips

LAFAYETTE RADIO

SEND MAIL ORDER TO LAFAYETTE RADIO
111 JERICHO TURNPIKE
SYOSSET, LONG ISLAND, NEW YORK

PLEASE INCLUDE SHIPPING CHARGES WITH ORDER.

OTHER LOCATIONS	NEW YORK, N. Y. 100 6th Avenue	NEWARK, N. J. 24 Central Avenue	PARAMUS, N. J. 182 Route 17
JAMAICA, N. Y. 165-08 Liberty Avenue	BRONX, N. Y. 542 E. Fordham Rd.	BOSTON, MASS. 110 Federal Street	PLAINFIELD, N. J. 139 W. 2nd Street



Get Extra Value at No Extra Cost

with this RCA WV-38A (K) VOLT-OHM-MILLIAMMETER KIT

Now you can get a professional-caliber V-O-M in kit form. Enjoy the self-satisfaction and sensible savings that kit assembly offers you. No professional know-how required. Clear step-by-step directions to follow. The result: years of precision service at low cost.

Whatever your reason for choosing a V-O-M kit, there's one basic reason for making that choice an RCA WV-38A (K)... extra value at no extra cost. Want examples?

- Extra 0.25-volt and 1-volt ranges
- Frequency response of low a-c ranges is flat within 1 db to 800,000 cycles
- Spring clips on handle for extra carrying convenience
- Jacks below switches keep leads out of way
- DB scale clearly marked: no squinting
- Easy-to-read meter measures 5" wide
- Non-breakable, sealed plastic window
- Red test lead has probe and slip-on alligator clip for added versatility

RCA WV-38A available factory-wired
and calibrated: \$43.95*

ONLY **\$29.95***
Attractive, scuff-resistant laminated-vinyl carrying case, \$4.95* extra

OTHER OUTSTANDING RCA KIT VALUES



RCA WV-77E (K)
VOLTOHMYST® KIT

Famous VoltOhmyst® quality and performance at a low price! Special test features include: separate 1.5-volt rms and 4-volt peak-to-peak scales for accurate low AC measurements. Tests AC and DC voltages to 1500 volts; resistance from 0.2 ohm to 1000 megohms. Complete with ultra-slim probes, long flexible leads, special holder on handle to store leads.

ONLY **\$29.95***

RCA WV-77E available factory-wired and calibrated: \$43.95*



RCA WO-33A (K)
**SUPER-PORTABLE
OSCILLOSCOPE KIT**

Here is a rugged, compact oscilloscope that weighs only 14 pounds. Easily portable for in-the-home or shop troubleshooting. Ideal for servicing black-and-white and color TV, radio, hi-fi components, tape recorders, etc. Ample gain and bandwidth for the toughest jobs. 3" graph-scale screen and internal calibrating voltage source for direct reading of peak-to-peak voltage.

ONLY **\$79.95***

RCA WO-33A available factory-wired and calibrated: \$129.95*



RCA WV-98B (K)
SENIOR VOLTOHMYST® KIT

A real money and time saver... now available in kit form! The etched-circuit-board and AC/DC ohms probe are pre-assembled. Separate color-coded scales measure DC voltages, 0 to 1500 volts; AC voltages, 0 to 1500 volts rms or 4200 volts peak-to-peak. Resistance from 0.2 ohm to 1000 megohms. 200-microampere meter movement with less than 1% tracking error. Precision multiplier resistors accurate to ± 1%.

ONLY **\$62.50***

RCA WV-98B available factory-wired and calibrated: \$79.50*

Call your Authorized
RCA Test Equipment Distributor



The Most Trusted Name in Electronics.

*User Price (Optional)

RCA Electron Tube Division Harrison, N. J.

NOW! HERE'S YOUR CHANCE TO QUALIFY AS AN EXPERT IN ELECTRONICS & COMMUNICATIONS!

ANNOUNCING A COMPLETE, PRACTICAL, UP-TO-DATE 20-LESSON

"SECOND-CLASS RADIOTELEPHONE LICENSE COURSE"

AVAILABLE AS AN EXCLUSIVE BONUS FEATURE TO

PHOTOFACT® SUBSCRIBERS!

DON'T MISS IT!
FIRST LESSON IN
PHOTOFACT
SET No. 561
(JANUARY 1962)



TO HELP YOU PASS THE F.C.C. LICENSE EXAM —
HERE'S THE COMPLETE COURSE YOU GET
WITH YOUR **PHOTOFACT SUBSCRIPTION:**

- Lesson 1. Introduction to Communications Electronics
- Lesson 2. Services and Frequency Assignments
- Lesson 3. Radio Communications Systems
- Lesson 4. Laws, Licensing, and Operating Practice
- Lesson 5. Class C Amplifiers
- Lesson 6. Oscillators and Multipliers
- Lesson 7. Antenna Systems
- Lesson 8. Microphones and Audio Amplifiers
- Lesson 9. FM Modulation Principles
- Lesson 10. AM Modulation Principles
- Lesson 11. Power Sources
- Lesson 12. Detectors
- Lesson 13. Receiving Systems
- Lesson 14. Two-Way Radio Circuit Descriptions (FM)
- Lesson 15. Two-Way Radio Circuit Descriptions (AM)
- Lesson 16. Test Equipment
- Lesson 17. Basic Transmitter Tuning Procedures
- Lesson 18. Citizens Band Installation and Adjustment
- Lesson 19. Two-Way Radio Installation and Adjustment
- Lesson 20. Two-Way Radio Maintenance and Guidance for FCC Examinations

PLUS—carefully-designed Questions and Answers to help reinforce your learning!

YES! YOUR PHOTOFACT SUBSCRIPTION CAN HELP YOU EARN A 2ND-CLASS LICENSE WHICH:

1. Upgrades your professional status in electronics...the Federal Government License is a nationally recognized "diploma" of proficiency...gains the recipient immediate respect as a qualified electronics technician.
2. Automatically identifies you as an expert in electronics... qualifies you to install, maintain and operate two-way communications equipment.

The two-way and CB radio market is expanding at a tremendous rate. Well over 1,500,000 transmitters (industrial, aviation, public safety, CB, etc.) are now licensed, with approximately 400,000 new license applications yearly. To help you get your share of this profitable new business, Howard W. Sams offers you with your PHOTOFACT subscription, his Second-Class Radiotelephone License Course that can be worth hundreds of extra dollars to you yearly!

SUBSCRIBE NOW—Get This Timely BIG BONUS Course!

DON'T MISS A SINGLE ISSUE!

Enter your subscription with your Sams Distributor today to receive all PHOTOFACT

Sets as issued each month. Beginning in January, 1962, you will start receiving the 20-Lesson Second-Class Radiotelephone License Course as a bonus with your subscription!

SUBSCRIBE TODAY!



Now! Powerful National Advertising Builds Prestige and Business for "PEET" Members!

TV GUIDE now carries each month to 7,500,000 TV families the "PEET" (Photofact-Equipped Electronic Technician) Program message...to build dynamic support and demand for the services of "PEET" members. There's never been a national ad program like this for the electronic servicing profession—with so many valuable tie-in promotional aids!

NOW MORE THAN EVER, IT PAYS TO QUALIFY AS A "PEET" MEMBER!

Howard W. Sams & Co., Inc., Dept. 5-M1
1724 E. 38th St., Indianapolis 6, Ind.

I would like to enter my subscription to Photofact, effective with Set No. 561

My Distributor is: _____

Send me details on how to become a "PEET" Member

Shop Name _____

Attn. _____

Address _____

City _____ Zone _____ State _____

Audio Test Report

PREPARED BY HIRSCH-HOUCK LABORATORIES

Miracord "Studio H" Automatic Turntable
Fairchild "Compander"
Fisher XP-4 Speaker System

Miracord "Studio H" Automatic Turntable

For copy of manufacturer's brochure, circle No. 58 on coupon (page 120).



THE NEW "Miracord" 10H record changer (referred to as the "Studio H" automatic turntable by its importer, Benjamin Electronic Sound Corp.) is one of that recent category of record players which combines the convenience of record-changer operation with the performance heretofore associated only with separate turntable and tonearm systems. The "Miracord's" claim to that title is by virtue of such features as a 7-pound, 11 $\frac{3}{8}$ -inch-diameter non-magnetic turntable, a hysteresis-synchronous motor, and a high-quality tonearm with low tracking error.

The "Studio H" has three distinct modes of operation. First, it can be used strictly as a manual player. The record is placed on the turntable, the arm is lifted by hand, and manually positioned on the desired portion of the record. The motor starts automatically as soon as the arm is lifted from its rest. After the record is played, the arm returns to rest automatically and the motor shuts off. The only respect in which this mode of operation differs from completely manual systems is in the trip action, which cannot be disabled and which therefore prevents the manual starting of the play near the end of the record.

A second mode is what might be termed a "semi-automatic manual player." The record is placed manually on the turntable and a button corresponding to the record diameter is pressed. The motor starts, the arm automatically lifts and is lowered on the lead-in grooves, and the record is played as described before. Automatic indexing is

provided for 7", 10", and 12" records. The operation of the push-buttons is exceptionally light (almost a feather touch) yet completely positive. If the removable center spindle is inverted, the record repeats indefinitely. A "Stop" button enables the player to be stopped, and the arm returned to rest at any time. The same effect can be had by simply picking up the arm by the finger lift and returning it to its rest, which shuts off the motor.

Finally, the "Studio H" can be used as a conventional record changer. A special spindle is inserted in the center of the turntable for this mode of operation. The appropriate button is pushed and the unit functions as in semi-automatic play except that after each record the next one drops gently into place and is played. After the last record the unit shuts off.

The tonearm is, for all practical purposes, the equivalent of a good-quality separate arm. It is long (8 $\frac{1}{2}$ ") and designed for minimum tracking error. The arm is parallel to the record surface and because of its length, the angle of the

stylus to the record surface changes only slightly over a stack of records. Tracking force is adjusted by a sliding counterweight, and no springs are used. A clever and foolproof means is provided to set stylus force to any value from 2 to 8 grams. A weight with a calibrated scale is inserted into the counterweight end of the arm and the counterweight is adjusted for a balanced condition. When the weight is removed, the tracking force is set to the pre-determined value.

The arm is metal with a removable plastic shell. To prevent hum pickup in the cartridge, a metal shield is fitted into the shell so as to surround the cartridge, and is grounded to the arm proper. The usual record-changer adjustments for indexing position and arm weight are provided.

The rumble level of the turntable was measured at -35 db relative to a velocity of 7 cm./sec. at 1000 cps. It was almost all lateral rumble, with vertical components well below that level. This rumble level is slightly better than the NAB broadcast turntable requirements and is not audible under ordinary listening conditions. The flutter was only 0.1% r.m.s. and wow was too small to be measured with our equipment (less than 0.01% r.m.s.). The speed was approximately 1% fast on all four settings (16, 33, 45, and 78 rpm), and was constant with varying record loads and with line voltage variations from 85 to 140 volts.

The arm, with a correctly installed cartridge, has a tracking error of less than 1 degree over a 2" to 5" record radius, rising to 3 degrees at a 6" radius. Any cartridge whose stylus is $\frac{3}{8}$ " to $\frac{7}{16}$ " from its mounting centers should prove satisfactory. Tracking force is limited chiefly by the cartridge, since as little as 2 grams will operate the changer mechanism.

Mechanically, the "Miracord Studio H" is a smooth performer, with the usual record-changer clicks during the change cycle but low noise at other times. It handles easily and with a feeling of precision engendered by the evident craftsmanship and fine finish on its operating controls and working parts. On our sample (an early production unit) the arm mechanism shut off after dropping the last record in a stack before playing it, but this presumably is not typical. (*Editor's Note: We actually checked several later samples of this changer and found that they operated properly.*)

The "Miracord Studio H" sells for \$99.50. It is available, as the "Studio Model," with a four-pole induction motor, for \$79.95. ▲

Fairchild "Compander"

For copy of manufacturer's brochure, circle No. 59 on coupon (page 120).

IT is an accepted fact that neither tape nor disc recording techniques can handle the full dynamic range of most musical programs. The limiting factors are noise at low levels and distortion or over-cutting at high levels. Even broadcasts of live music must be

amplitude-limited to prevent over-modulation of the transmitter. As a result, some degree of level compression or limiting is universally used, with either manual or automatic techniques. Most listeners are so used to compressed programs that they are completely un-

Earn Extra Money Soon

... while training at home for high-pay career or business of your own!

AMAZING PLAN FOR YOUR SUCCESS IN RADIO-TV-APPLIANCES and ELECTRONICS

Central will show you how to start making money soon . . . servicing AM-FM radios and television sets . . . repairing electrical appliances . . . building and installing electronic equipment in homes, factories, and business offices. Step-by-step, you'll learn how to get started in spare time at minimum cost; how to prepare for a bright future in servicing, audio, communications, broadcasting, or the gigantic electronic industry. Complete FCC license preparation included. High income, prestige, security, prosperity . . . all can be yours!

NO EXPERIENCE NEEDED!

You don't need high school diploma or previous knowledge of electronics to get started. Quick, low-cost home training for young and old. New illustrated lessons make learning easy. We supply equipment and *know how* you need to start making money soon. You learn by *doing*. You assemble useful, practical electronic projects—no incomplete "student" radios and testers—our kits meet commercial standards. Also recommended for citizen band and amateur radio operators, hi-fi and stereo enthusiasts, hobbyists, etc. Your personal pleasure and the savings you can make on home installations and repairs alone, make this course a profitable adventure. Keep your present job—set your own pace—add to your income—and find out how much fun Electronics can be!

New Frontiers Need You!

Cash in on growing demand for technicians in hundreds of exciting space-age fields: guided missiles, rocketry, outer space research and development, automation, nuclear power, computers, microwaves, radar, communications, oil field exploration, air traffic control, civil service, armed forces, etc. *Start now*. Get facts—mail coupon today for two FREE books!

NEW KITS!



You will build and keep this handy "transistorized" electronic and appliance tester that you'll use soon to start earning spare-time money. Many other practical and profitable electronic projects to choose from: 4 transistor portable radio—code oscillator—solar cell switch—RF signal generator—CB converter—oscilloscope—others! Fully described in our FREE 64-page catalog.



Central grad GLEN LEIRER, shown here, earned an attractive income from part-time Radio-TV Servicing. Now he's employed as a Computer Technician for RCA Service Co., Camden, N. J.

Over 50,000 Successful Graduates Since 1931!



"I averaged between \$60 and \$70 a month servicing radios and TV's part-time while taking your home study course. Plan to open my own shop soon." Student THEODOR SCHMIDT, Peshastin, Wash.



Central grads HOWARD EDMONDS & FLOYD CONKRIGHT are joint owners of EDCO FACTORY TV SERVICE CO., K. C., Mo., and RANCH MART TV & STEREO, Leawood, Kansas, have three service trucks, seven full-time employees.

Grad FRANK LEENKNECHT works in missile field for Convair Astronautics, San Diego, Calif., and as Transmitter Engineer for Station KDEO as a sideline.



RESIDENT TRAINING—Central also offers a full-time ECPD-Accredited Technical Institute program at its resident school in Kansas City, Mo., for qualified high school graduates. Details in FREE catalog.

FREE



We'll mail you FREE FCC License Prep Handbook that prepares you to pass the 3rd Class FCC Radiotelephone examination, and to qualify to operate radiotelephone transmitting stations used by airlines, police, railroads, emergency services, etc. You get FREE FCC Prep Book plus FREE 64-page catalog with facts about Central's practical electronics home study course.

NO OBLIGATION

TRADE THIS COUPON FOR 2 FREE BOOKS!

Central Technical Institute
1644 Wyandotte, Dept. EW121A,
Kansas City 8, Mo.

(PLEASE PRINT)

NAME _____

ADDRESS _____

CITY _____

ZONE _____ STATE _____



Accredited Member
National Home Study Council

Central Technical Institute

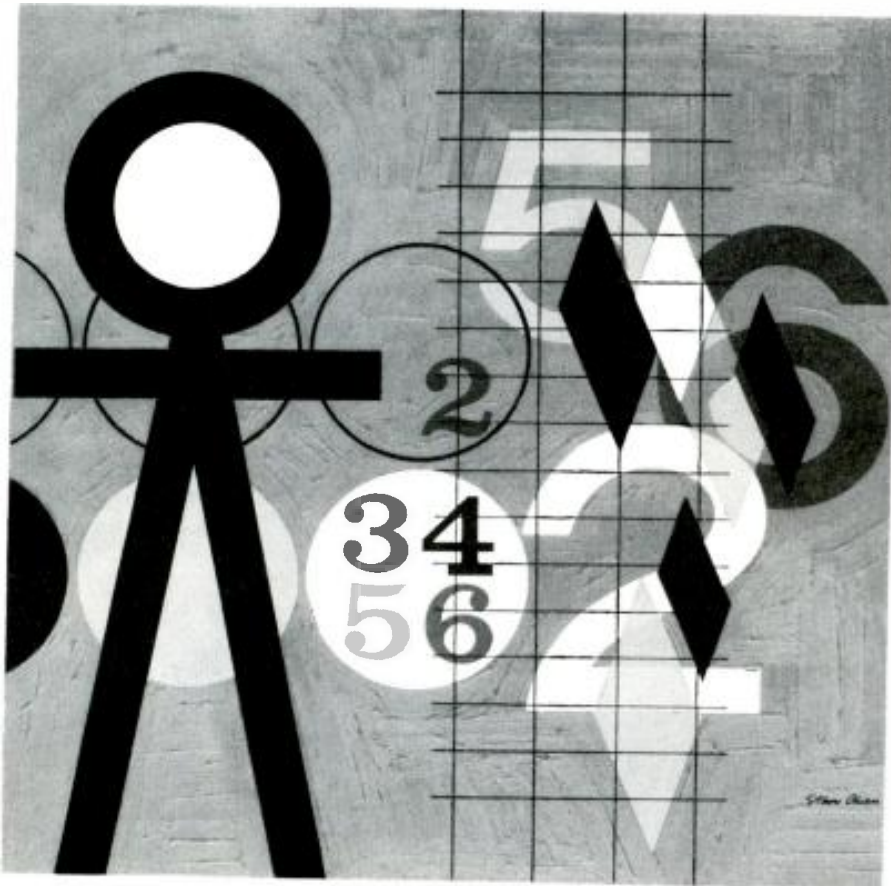

ELECTRONICS TECHNICIANS

EARN HIGH REWARD — ENJOY NEW ADVENTURE

To qualified, experienced communication and radar technicians who would like to gain priceless experience while earning high pay on a technically interesting assignment, Federal Electric Corporation offers immediate employment on the DEW Line. You will join one of Federal's highly skilled teams of technicians and engineers responsible for effective operation of this vast network of advanced electronic systems.

First, you will receive an intensive 12 to 15 week training course in the U.S. Then you will serve 15 months at a selected DEW Line site. While in training you will receive an excellent salary and expenses. On DEW Line, you will earn \$242 per week, based on a 54-hour week, plus free room and board. Upon completion of your assignment, you will receive a substantial bonus. All compensation subject to U.S. income tax.

You can qualify for employment if you have at least a Technical School diploma (military or civilian) and have two years' current maintenance experience in: COMMUNICATIONS — carrier, multiplex, scatter propagation, VHF or UHF; or RADAR — ground systems or warning systems.

Applicants are requested to send a resume of their training and experience to Mr. E. W. Broglio.

FEDERAL ELECTRIC CORPORATION

Service Division of International Telephone and Telegraph Corporation
Paramus Industrial Park, Paramus, New Jersey



An equal opportunity employer.

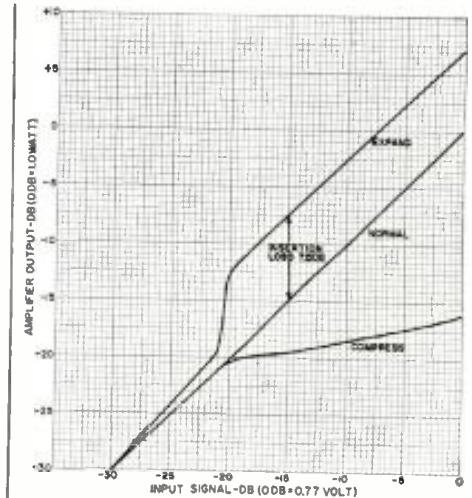

aware of the existence of the problem.

One method of overcoming the effects of compression is by use of a volume expander in the reproducing system. The expander increases the gain of the amplifier as the signal level increases. If the expansion curve is the inverse of the compression curve, it is possible (in theory at least) to re-create the original dynamics of the program. Expanders have been used for years, but have never been very popular in home music systems. They tend to be bulky, complex, and expensive and can contribute appreciable amounts of distortion.

The new Fairchild "Compander" is a fresh approach to this problem. It is a passive device, without transistors or tubes, and requires no power source. By its nature it cannot introduce non-linear distortion or hum into a system. The "Compander" is basically a simple resistive divider, in which one resistance is a photo-sensitive resistor. It is enclosed in a small tube with a lamp which is excited by the output of the power amplifier. As the amplifier output increases, the lamp glows brighter and the resistance of the control element decreases. In "expand" operation, the control resistance is in the series arm of the divider, which is placed in the signal path between the program source and the power amplifier input. Increasing signal levels cause the division ratio of the divider to decrease, which still further increases the amplifier output; hence the expansion. The amount of expansion is limited to the initial insertion loss of the divider, which is reduced to near zero at full expansion.

This is a somewhat over-simplified explanation of the operation of the "Compander." The lamp circuit has a rapid attack time (about 10 milliseconds), but takes nearly a second to decay. A threshold control adjusts the level at which expansion occurs. Neon lights glow to indicate the beginning of expansion, as well as showing the presence of full expansion. Two separate expander systems are located in the compact package (8 $\frac{3}{16}$ " x 5" x 2 $\frac{5}{16}$ "), for stereo operation. A switch on the "Compander" panel selects either expander operation, normal unexpanded operation, or compressor operation. As a compressor the control element is connected as the shunt arm of the divider,

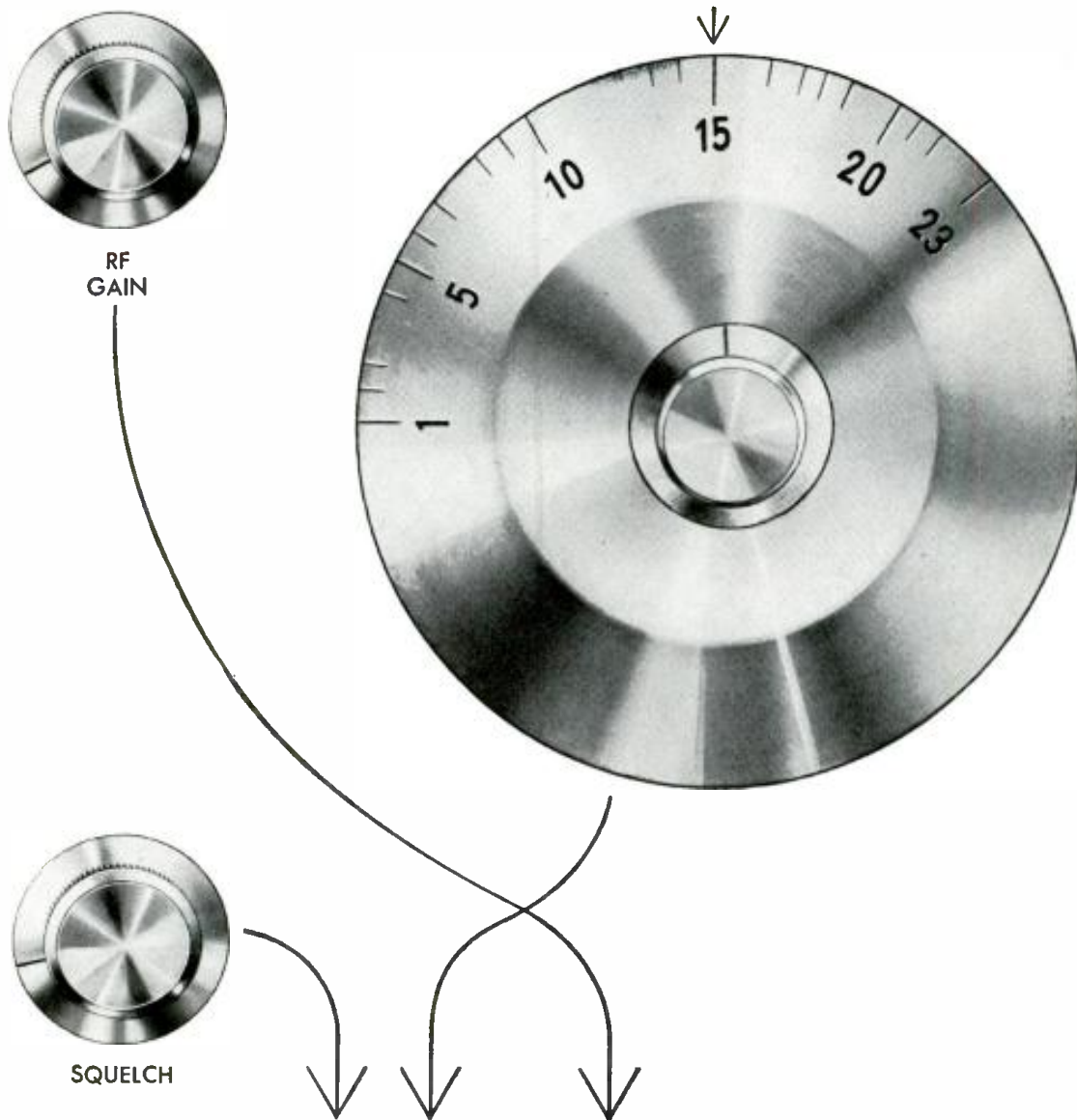

CB SELECTIVITY?



write for free brochure

\$189.50

Slightly higher west of Rockies



electronics communications, inc. 325 no. macquesten pkwy, mt. vernon, n. y.

Consider this situation . . . You own the exciting new Courier 1. You're transceiving on Channel 15 from your second floor den. Next door, a CB friend is working his set on Channel 14 with another party. Image response? Ghosting? . . . Never with Courier 1! It's truly selective, has maximum adjacent channel rejection and drift-free receiving! Now, check these other exclusive Courier 1 features . . . see for yourself:

- TRIPLE CONVERSION
- 12 CHANNEL TRANSMITTING
- UNITIZED CHASSIS, HAND-WIRED
- BUILT-IN NOISE LIMITER & SQUELCH
- ELECTRONIC SWITCHING (no relays)
- CADMIUM PLATED FOR MARINE USE
- FULLY MODULATED (100%)
- BUILT-IN "S" & "RF" METER
- LOWEST NOISE FRONT END
- MOBILE OR BASE (117 V AND 12 V)
- ENTIRE UNIT SLIDES OUT ON TRACKS
- OVER 3 WATTS OUTPUT



automatic turntable

M
I
R
A
C
O
R
D

the new Miracord is both

Here's the best of two worlds in one exciting package . . . the all-new Miracord automatic turntable and record changer. Enjoy perfect record reproduction only a professional turntable and tone arm offers . . . or the convenience of uninterrupted music, hours on end. Choose either model: the **STUDIO H** with hysteresis synchronous motor—**\$99.50**; or the **STUDIO** with heavy-duty, shaded 4-pole motor — **\$79.95**.



record changer

For complete information write:

BENJAMIN
ELECTRONIC SOUND CORP.
Dept. EW-12/61-97-03 43d Ave., Corona 68, N.Y.



reducing the gain as levels increase.

The insertion loss of the "Componder" (and thus its maximum expansion) varies from 5 to 8 db as the load resistance is reduced from 470,000 ohms to 47,000 ohms. The source impedance can be anything from 100 ohms to 100,000 ohms, so it can be placed in the pickup circuit or in a preamplifier output without affecting its performance. We tested the "Componder" by driving it from a 600-ohm audio generator and coupling it to a power amplifier, with the input loaded down to 47,000 ohms to get maximum expansion. The curve of the output/input characteristics shows both expansion and compression modes, as well as the straight-through operation of the "Componder." Notice that as an expander, the effect is that of positive feedback, so that the gain suddenly flips from the lower to the upper value. The level at which this occurs can be varied over wide limits with the dynamic sensing controls. At the most sensitive setting, it takes place with less than .25 volt from the amplifier output, which is less than 4 mw. on the 16-ohm speaker terminals. In compressor operation, the threshold is the same, but here the feedback is negative and there are no abrupt level changes. The available compression is about 20 db.

The "Componder" has no inherent frequency limitations, but external cable capacitance must be kept to a minimum. A pair of three-foot cables is supplied and should be used in the output of the "Componder." In our lab set-up, we

used some 8 feet of shielded cable, which resulted in a slight high-frequency loss. If the recommended cables are used, the Fairchild specification of ± 1 db flatness should be realized. With the full 20 db of compression in use, the time constant of the lamp circuit appears to reduce the effective compression at the low and high frequencies, giving the effect of a boost at these frequencies. No significant harmonic or IM distortion could be detected.

In listening tests, we inserted the "Componder" in the tape-monitor jacks of a preamplifier so that it could be used on all types of program material. It did a very effective job on orchestral music, where the 8 db of expansion definitely contributed to realism. On solo instruments or voices it was less satisfactory, since the sudden increase of level, unmasked by a complex program, was quite apparent. It is likely that the minimum expansion of 5 db would be more natural for most listeners. As a compressor, the "Componder" proved to be completely satisfactory. Its rapid attack and slow decay made its presence most inconspicuous, yet it enabled increased enjoyment of low-level background music without loss of the softer passages. It is possible to adjust the threshold controls so that music is only slightly compressed, but the commercials which come through at higher levels are "cut down to size," so to speak.

The Fairchild "Componder" sells for \$75.00. ▲

Fisher XP-4 Speaker System

For a copy of manufacturer's brochure, circle No. 60 on coupon (page 120).

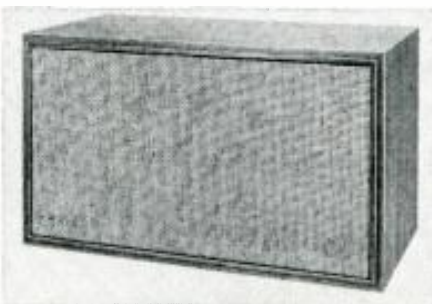

THE Fisher XP-4 is a bookshelf-size, three-way speaker system with several unusual design features. Like

most of the better compact speakers, it has a woofer with a very compliant cone suspension and a long linear cone excursion, which depends on the enclosed air volume to provide most of its restoring force. The physical design of the woofer is unique, since it uses no basket or similar device to position the cone relative to the magnet structure.

The six-pound magnet assembly is rigidly fastened to the rear and sides of the cabinet. The cone rim is bonded to the front panel of the enclosure, and a compliant spider holds the voice coil in the correct alignment. In essence, the entire cabinet acts as the basket. A
(Continued on page 96)



Special Training Equipment Included

Pick the field of your choice—and train at home with the leader—NRI. In addition to Industrial Electronics and FCC License training explained at the right, NRI offers comprehensive courses in Radio-TV Servicing and Radio-TV Communications. Except for the FCC course, all NRI courses include—at no extra cost—special training equipment for actual practice at home, building circuits and working experiments. Makes theory you learn come to life in an interesting, easy-to-grasp manner.

Multiplexing, FM Stereo Broadcasting Included

NRI training keeps up with the times. New, additional profit opportunities exist for the Technician who understands the latest technical advances. Course material now covers FM Stereo Broadcasting, tells you about Multiplexing equipment, other recent developments.

Learn More to Earn More

Act now. The catalog NRI sends you gives more facts about the field of your choice, shows equipment you get and keep. No obligation. Cost of NRI training is low. Monthly payments. 60-Day Trial Plan. Mail postage-free card today. NATIONAL RADIO INSTITUTE, Washington 16, D.C.

Send for
64-Page
CATALOG
FREE

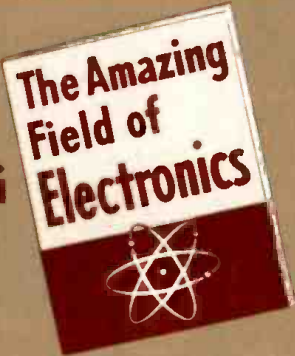

NRI—Oldest and Largest Radio Television School Now Offers NEW HOME STUDY TRAINING IN INDUSTRIAL ELECTRONICS & MILITARY ELECTRONICS

This is the age of Electronics. Rapidly expanding uses for Electronic Equipment in industry, business, the military demands more trained men. Prepare now for a career as an Electronic Technician to assure advancement or to profit from your hobby. NRI now offers a complete course in ELECTRONICS—Principles, Practices, Maintenance. Computers, telemetry, automation, avionics are changing our world, yet all employ the same basic principles . . . and that is what this NRI course stresses with illustrated lessons and special training equipment. Mail card below.



NEW HOME STUDY TRAINING FOR YOUR FCC LICENSE



An FCC Commercial License combined with NRI time-tested training can be the keys to a better future for you with higher pay, interesting work, more rapid advancement as the rewards. Prepare at home quickly for your FCC examinations through NRI's new, low-cost, special training. Like other NRI-trained men, you can be monitoring TV shows, radio broadcasts, operating shipboard and aviation radio, or holding down other important jobs. Get full details—mail the card below.

FOR MORE INFORMATION-TURN PAGE

Cut Out and Mail—No Stamp Needed



Send me your Electronic, Radio-TV catalog without cost or obligation. I am interested in the course checked below: (No representative will call. Please PRINT.)

- INDUSTRIAL ELECTRONICS
- FCC LICENSE
- COMMUNICATIONS
- SERVICING

Name _____ Age _____

Address _____

City _____ Zone _____ State _____

ACCREDITED MEMBER NATIONAL HOME STUDY COUNCIL

**ELECTRONICS NEEDS
4 TO 7
QUALIFIED TECHNICIANS**

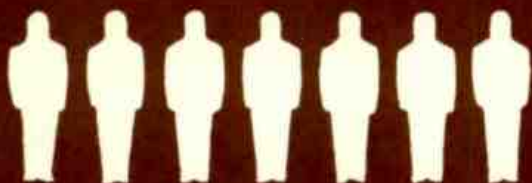

FOR EVERY ENGINEER



Join The Thousands Who Trained For Advancement With NRI

Thousands of NRI graduates throughout the U. S. and Canada are proof that it is practical to train at home. NRI graduates are in every kind of Electronics work: inspectors, maintenance men, lab technicians, testers, broadcasting and mobile communications operators, Radio-TV service technicians, or in essential military and government posts. Catalog tells more about what NRI graduates do and earn. Mail postage free card.

Choose from 4 Courses

1 INDUSTRIAL ELECTRONICS
Learn Principles, Practices, Maintenance of Electronic equipment used today by business, industry, military, government. Covers computers, servos, telemetry, multiplexing, many other subjects.

2 FCC LICENSE
Every communications station must have one or more FCC-licensed operators. New NRI course is designed to prepare you for your First Class FCC exams. You learn quickly, training at home in your spare time.

3 COMMUNICATIONS
Training for men who want to operate and maintain radio and TV stations; police, marine, aviation, mobile radio, etc. Includes FM Stereo broadcasting. Course also prepares you for your FCC license exam.

4 SERVICING
Learn to service and maintain AM-FM Radios, TV sets, Stereo Hi-Fi, PA systems, etc. A profitable, interesting field for a spare-time or full-time business of your own.



"THE FINEST JOB I EVER HAD" is what Thomas Bilak, Jr., Cayuga, N. Y., says of his position with The G. E. Advanced Electronic Center at Cornell University. He writes, "Thanks to NRI, I have a job which I enjoy and which also pays well."



BUILDING ELECTRONIC CIRCUITS on specially-designed plug-in type chassis, is the work of Robert H. Laurens, Hammonton, N. J. He is an Electronic Technician working on the "Univac" computer. Laurens says, "My NRI training helped me to pass the test to obtain this position."



"I OWE MY SUCCESS TO NRI" says Cecil E. Wallace, Dallas, Texas. He holds a First Class FCC Radio-telephone License and works as a Recording Engineer with KRLD-TV.



MARINE RADIO OPERATOR is the job of E. P. Searcy, Jr., of New Orleans, La. He works for Alcoa Steamship Company, has also worked as a TV transmitter engineer. He says, "I can recommend NRI training very highly."



FROM FACTORY LABORER TO HIS OWN BUSINESS that rang up sales of \$158,000 in one year. That's the success William F. Kline of Cincinnati, Ohio, has had since taking NRI training. "The course got me started on the road," he says.

← **SEE OTHER SIDE** →

FIRST CLASS
PERMIT
NO. 20-R
(Sec. 34.9, P.L.&R.)
Washington, D.C.

BUSINESS REPLY MAIL
NO POSTAGE STAMP NECESSARY IF MAILED IN THE UNITED STATES

POSTAGE WILL BE PAID BY



National Radio Institute
3939 Wisconsin Avenue
Washington 16, D.C.



NRI IS OLDEST—LARGEST SCHOOL OF ITS KIND

Training men to succeed by home study has been the National Radio Institute's only business for over 45 years. NRI is America's oldest and largest Electronics home-study school. Don't delay. Cut out and mail POSTAGE-FREE CARD.



← **MAIL POSTAGE-FREE CARD** →

WORTH SHOUTING ABOUT!

NEW IMPROVED
MIGHTY MITE

Reaching New Peaks in
Performance, Portability and Price

MIGHTY MITE II

They're shouting from the hill tops. Technicians, engineers and test labs all say that the original Mighty Mite finds the tubes that large expensive testers miss. And now . . . here is the new improved Mighty Mite! Designed for the present and far into the future. Tests all of your present tubes plus the new RCA Nuvistors and Novars, GE Compactrons and Sylvania 10 pin tubes.

A complete tube tester that is smaller than a portable typewriter yet outperforms testers costing hundreds of dollars. A real money maker for the serviceman and a trusty companion for engineers, maintenance men and experimenters.

Even though the Mighty Mite weighs less than 8 pounds, new circuitry by Sencore enables you to use a meter to check grid leakage as high as 100 megohms and gas conditions that cause as little as one half microamp of grid current to flow. Then too, it checks for emission at operating levels and shorts or leakage up to 120,000 ohms between all elements. This analytical "stethoscope" approach finds troublesome tubes even when large mutual conductance testers fail. And it does all this by merely setting four controls labeled A, B, C, & D.

Check these plus Sencore features: Meter glows in dark for easy reading behind TV set • Stainless steel mirror in ad-



67⁵⁰
DEALER NET

Remember . . . there is
only one Mighty Mite

justable cover for TV adjustments • Rugged, all steel carrying case and easy grip handle • Smallest complete tester made, less than one foot square. Mighty Mite II will test every standard radio and TV tube that you encounter, nearly 2000 in all, including foreign, five star, auto radio tubes (without damage) plus the new GE Compactrons, RCA Nuvistors and Novars and Sylvania 10 pin tubes.

Mighty Mite II also has larger, easy-to-read type in the set-up booklet to insure faster testing. Why don't you join the thousands of servicemen, engineers, and technicians who now own a Mighty Mite tube tester? Tube substitution is becoming impossible and costly with nearly 2000 tubes in use today. Ask your authorized Sencore Distributor for the New Improved Mighty Mite. Size: 10¹/₄" x 9¹/₄" x 3¹/₂" Wt. 8 lbs.

MODEL TC114

Sencore Sam says . . . "They all agree . . .
the Mighty Mite is the real answer for the man on the go."



SENCORE ADDISON, ILLINOIS

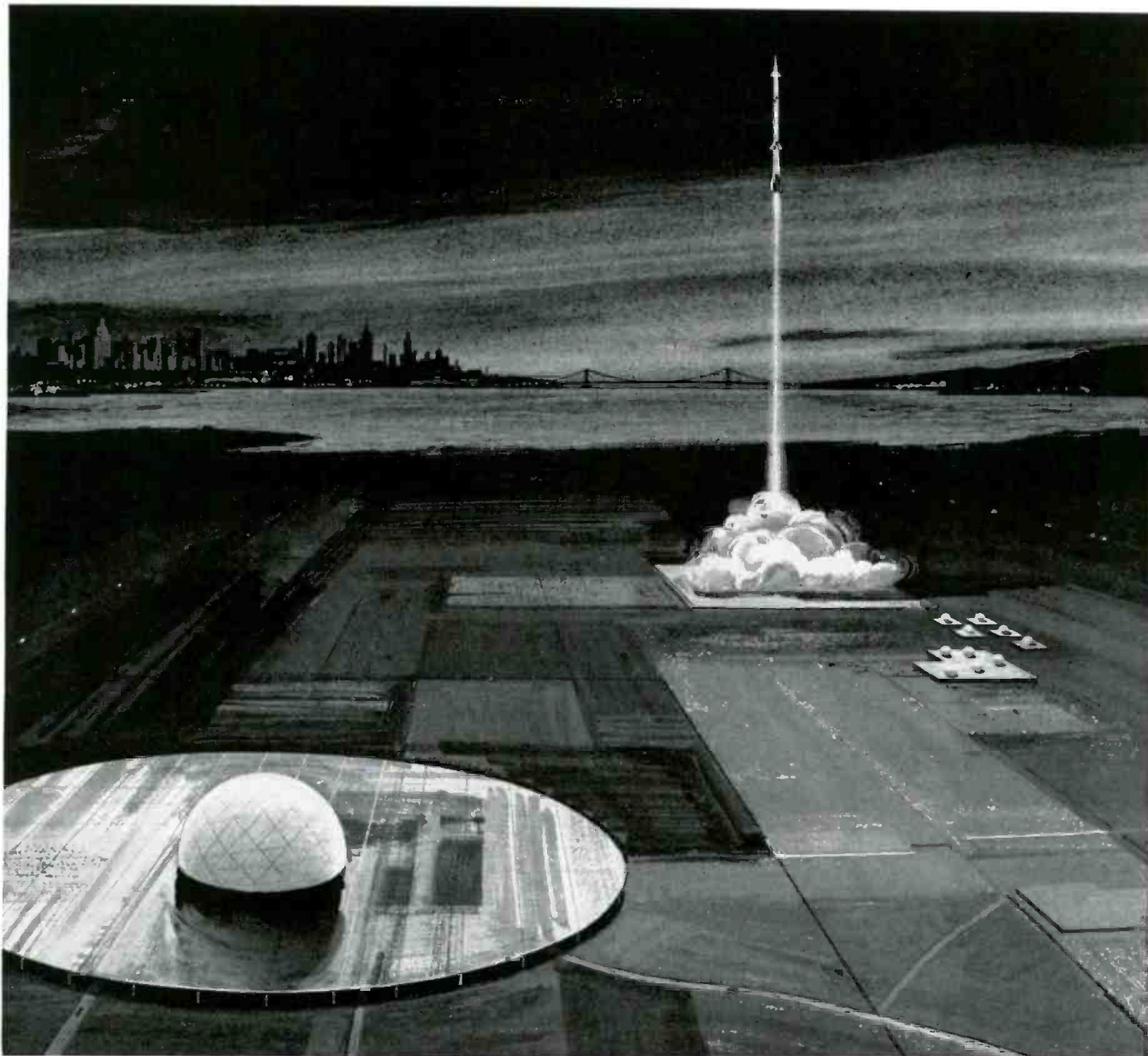

More than 450,000 pounds of thrust lifts the U. S. Army's Nike Zeus missile skyward in a cloud of vapor. The Nike Zeus missile being developed for the project by the Douglas Aircraft Company will be designed to intercept ballistic missiles traveling over 15,000 miles per hour, and destroy them at a safe distance from the defended area.

How do you stop an ICBM?

How do you detect, track, intercept—and destroy within minutes—an ICBM that is moving through outer space ten times faster than a bullet?

Bell Telephone Laboratories may have designed the answer: Nike Zeus, a fully automated system designed to intercept and destroy all types of ballistic missiles—not only ICBM's but also IRBM's launched from land, sea or air. The system is now under development for the Army Ordnance Missile Command.

Radically new radar techniques are being developed for Nike Zeus. There will be an acquisition radar designed to detect the invading missile at great distances. And a discrimination radar designed to distinguish actual war-

heads from harmless decoys that may be included to confuse our defenses.

The system tracks the ICBM or IRBM, then launches and tracks the Nike Zeus missile and automatically steers it all the way to intercept the target. The entire engagement, from detection to destruction, would take place within minutes and would span hundreds of miles.

Under a prime Army Ordnance contract with the Western Electric Company, Bell Laboratories is charged with the development of the entire Nike Zeus system, with assistance from many subcontractors. It is another example of the cooperation between Bell Laboratories and Western Electric for the defense of America.

BELL TELEPHONE LABORATORIES

World center of communications research and development



Free

ALLIED 1962 ELECTRONICS CATALOG 444 PAGES!

WORLD'S BIGGEST—MOST COMPLETE

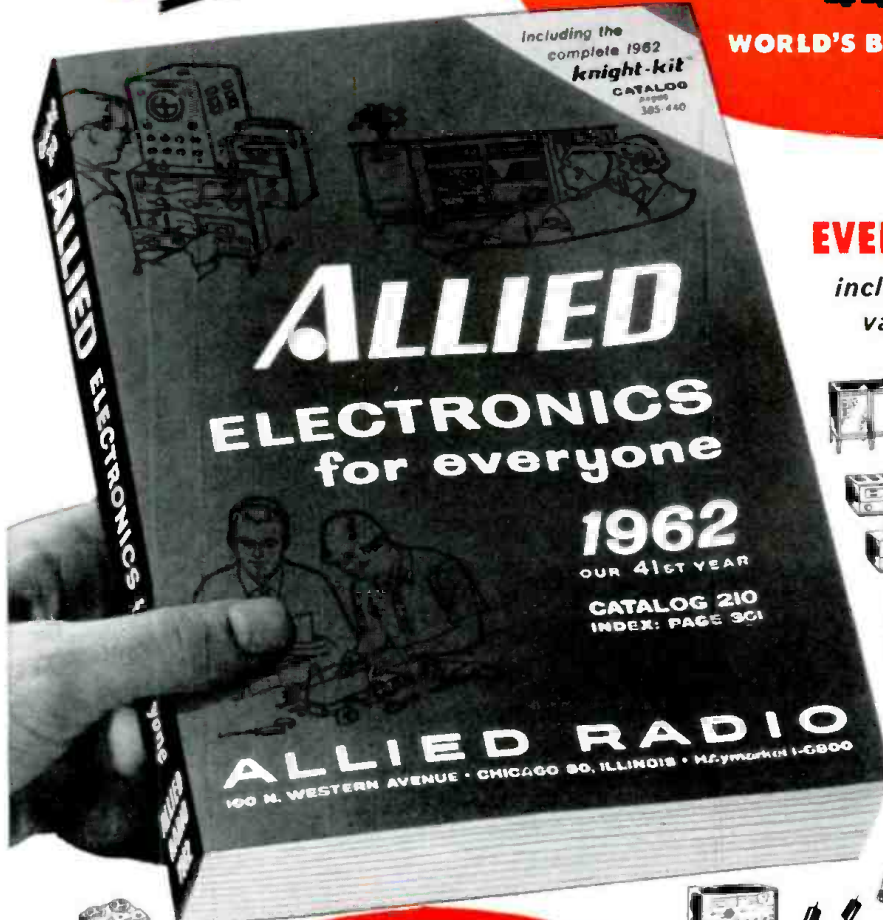

SAVE MOST ON

EVERYTHING IN ELECTRONICS

including exclusive products & special values available only from ALLIED



- New Multiplex Stereo FM—All-Transistor Stereo Hi-Fi
- New Stereo Hi-Fi Systems—Everything in Hi-Fi Components
- Money-Saving Build-Your-Own KNIGHT-KITS® for Every Need
- Best Buys in Tape Recorders, Tape and Recording Supplies
- Citizens Band 2-Way Radios
- Amateur Receivers, Transmitters, and Station Gear
- Public Address Systems, Paging and Intercom Equipment
- Test and Laboratory Instruments
- TV Tubes, Antennas, Accessories
- Batteries, Wire, Tools, Hardware
- Huge Listings of Parts, Tubes, Transistors, Technical Books

**NEW Multiplex Stereo FM
All-Transistor Stereo Hi-Fi**

NO MONEY DOWN on Allied's new Credit Fund Plan

Now—enjoy 50% more buying power—up to 24 months to pay—see our 1962 Catalog for simple details.

ALLIED exclusives:

MONEY-SAVING KNIGHT-KITS®. Enjoy the most satisfying do-it-yourself experience in the world! Build KNIGHT-KITS—lowest in cost, easiest to assemble, best for performance. Select from over 90 exciting KNIGHT-KITS—Stereo, Hi-Fi, Hobbyist, Amateur and Test Instruments. An exclusive ALLIED product.

BEST-BUY KNIGHT® PRODUCTS. Save most on famous KNIGHT Stereo Hi-Fi—comparable to the best in quality, styling, performance—yet priced far lower. Select super-value KNIGHT components or complete systems (including latest Multiplex Stereo and All-Transistor Hi-Fi). KNIGHT products are acclaimed by all who recognize integrity in design and manufacture and who appreciate value.

ALLIED RADIO

World's Largest Electronic Supply House

Satisfaction Guaranteed or Your Money Back

- World's Largest Stocks • Lowest Money-Saving Prices
- Fastest Shipment • Expert Personal Service

send today for the world's biggest electronics catalog!

Free

ALLIED RADIO, Dept. 223-M1
100 N. Western Ave., Chicago 80, Ill.

Send FREE 1962 ALLIED 444-page Catalog

Name _____
PLEASE PRINT

Address _____

City _____ Zone _____ State _____

BRING 'EM BACK ALIVE!



THE FIRST TRULY HIGH-QUALITY LOW-COST 3-WAY SPEAKER... ONLY \$29.50

It takes the most modern facilities in the industry to accomplish this:

*The most spectacular loudspeaker value ever offered—
a high-quality 3-way speaker at the cost of a coax!*

And only Electro-Voice has these facilities, plus the production "know-how" . . . all under one roof! Every vital process from die-making to die-casting, from wire-flattening through automatic voice-coil winding, precision grinding, plating and polishing, to a completely automated belt assembly is under E-V's continuous personal control.

Introducing the new Wolverine LT12—the latest addition to the famous Wolverine budget-priced line of quality speakers!

Imagine! A speaker that sounds better than speakers costing twice as much. With deep, rich bass and clean, clear treble from two cones, coupled by the famous E-V Radax principle. Plus smooth, peak-free highs that spread evenly throughout the room—without beaming—for outstanding stereo anywhere in the listening area . . . possible only with an E-V diffraction-horn compression-type tweeter.

The impressive list of LT12 "high-priced" features also includes a new ceramic magnet, plus edgewise-wound voice coil for highest efficiency . . . rugged die-cast frame to ensure perfect alignment of all moving parts . . . "deep-dish" bass cone design for higher power handling . . . long-throw suspension for minimum distortion . . . 3-position tonal balance switch that matches the LT12 to your acoustics . . . and a rich, jewel-like precision finish to all vital parts.

But, best of all, the LT12 is versatile: mounts in most high fidelity speaker enclosures, in the wall, ceiling, or even in a closet. And its wide dispersion makes placement far less critical than ordinary speakers—even for stereo!

See and hear the exciting new Wolverine LT12 at your nearby Electro-Voice/Wolverine high fidelity headquarters . . . today!



NOW, A COMPLETE LINE OF BUDGET-PRICED WOLVERINE® SPEAKERS

MODEL LS15 Big speaker sound at small speaker price! Radax 15" full-range speaker. Response, 35 to 13,000 cps. Power handling capacity, 20 watts. Impedance, 8 ohms. Diameter, 15½ inches. Depth, 6-11/32 inches. Shipping weight 12 pounds. Net each \$24.50.

MODEL LS12 Shallow design fits anywhere! Dual-cone 12" full-range speaker. Response, 40 to 13,000 cps. Power handling capacity, 20 watts. Impedance, 8 ohms. Diameter, 12¼ inches. Depth 3½ inches. Shipping weight 6 pounds. Net each \$19.50.

MODEL LS8 Ideal for hi-fi in every room of your house! Radax 8" full-range speaker. Shallow design. Response 55 to 13,000 cps. Power handling capacity, 20 watts. Impedance, 8 ohms. Diameter, 8¾ inches. Depth, 3½ inches. Shipping weight 5 pounds. Net each \$18.00.

HF1 STEP-UP KIT Add sparkling brilliance to LS8, LS12, LS15 or similar speakers. Improves response from 3,500 cps to 18,000 cps. Complete with crossover-level control, wiring harness, complete instructions. Shipping weight 3 pounds. Net each \$20.00.

MF1 STEP-UP KIT Mid-range kit to complete Wolverine three-way system. Improves presence and dispersion from 1,000 cps to 3,500 cps. Complete with crossover-level control, wiring harness, instructions. Shipping weight 5 pounds. Net each \$25.00.

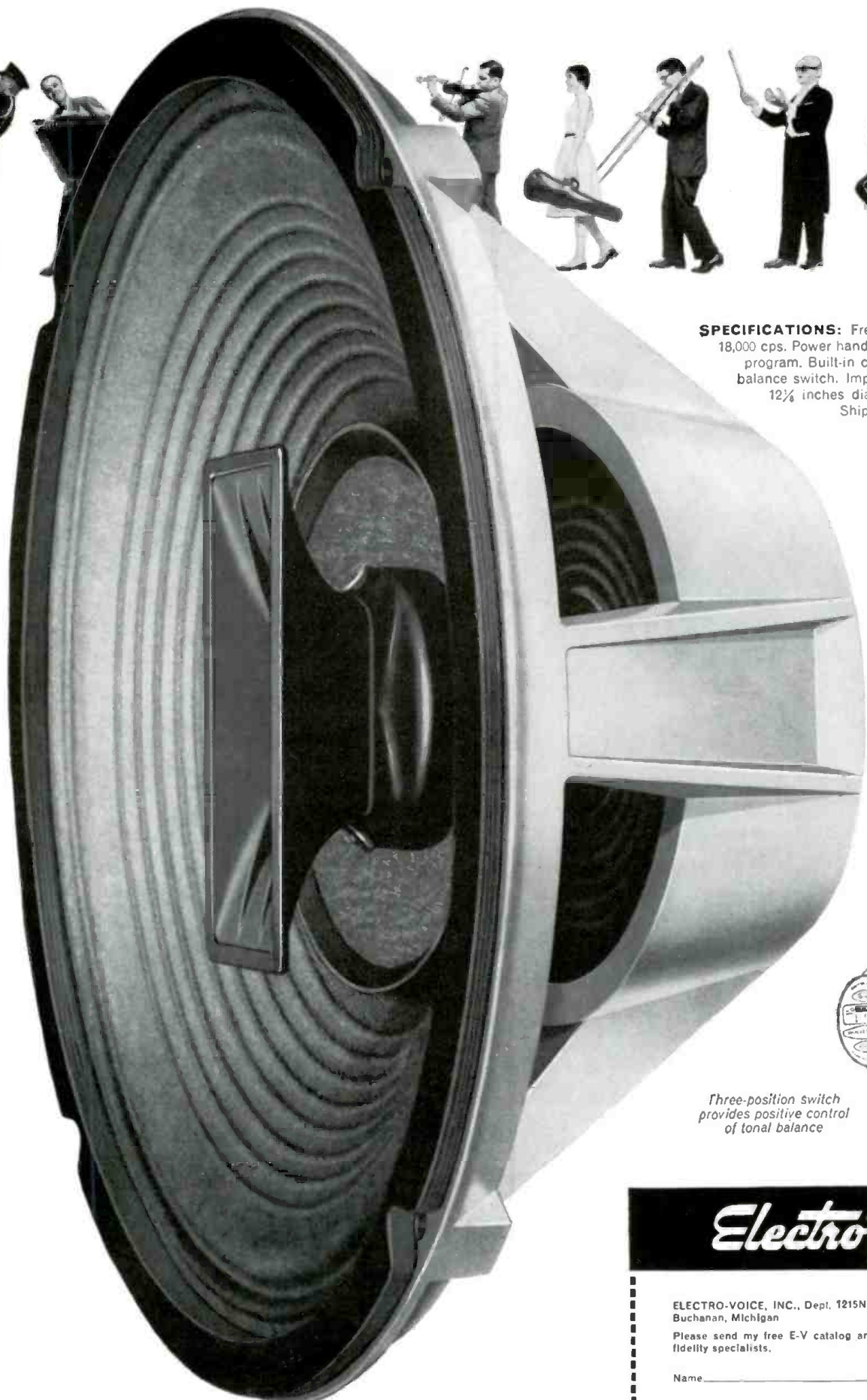

SPECIFICATIONS: Frequency response, 40 to 18,000 cps. Power handling capacity, 20 watts; program. Built-in crossover and 3-position balance switch. Impedance, 8 ohms. Size, 12 $\frac{1}{4}$ inches diameter, 6 inches deep. Shipping weight 15 pounds.

Model LT12
\$29.50

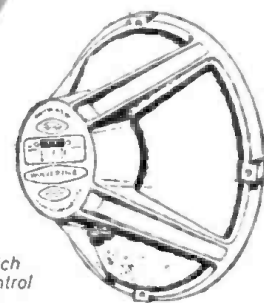

Three-position switch provides positive control of tonal balance

Electro-Voice[®]

ELECTRO-VOICE, INC., Dept. 1215N
Buchanan, Michigan

Please send my free E-V catalog and list of E-V/Wolverine high fidelity specialists.

Name _____

Address _____

City _____ State _____

ELECTRO-VOICE, INC., Consumer Products Division, Buchanan, Michigan

FM MULTIPLEX STEREO



**TRANSISTORIZED
4-TRACK STEREO TAPE DECK RP100**
Completely assembled, wired and tested.
\$399.95
Semi-kit includes a completely assembled and tested transport, electronics in kit form.
\$299.95
Luggage-type Carrying Case—\$29.95
Standard 19-inch Rack Mount—\$9.95

A top quality stereo tape recorder permits you to build a stereo tape library of your favorite music at low cost. As your musical interests change, you may record the new music that interests you at no additional cost. Perfected 4-track stereo/mono recording, 4 & 2 track playback. True high fidelity transistor electronics, individual for record & playback, plus separate record & playback heads permitting off-the-tape monitor. 2 recording level meters, mixing, mic & level controls, switched sound-on-sound recording. Electro-dynamically braked supply & take-up reel motors; hysteresis synchronous capstan motor. Individual solenoids for pinch-roller & tape lifters. All-electric, interlocked push-button transport control & interlocked safety "record" pushbutton. Precision tape guidance & sweep loading — no pressure pads. No slurring or tape bounce problems. Digital turns counter. Vertical or horizontal mounting. Modular plug-in construction. An original, exclusive EICO product designed & manufactured in U.S.A. (patents pending).



FM-AM STEREO TUNER ST96
Kit \$89.95 Wired \$129.95
Includes Metal Cover and FET



70-WATT INTEGRATED STEREO AMPLIFIER ST70
Kit \$94.95 Includes Metal Cover Wired \$149.95
40-WATT INTEGRATED STEREO AMPLIFIER ST40
Kit \$79.95 Includes Metal Cover Wired \$129.95

ST96: FM and AM stereo tuners on one compact chassis. Easy-to-assemble: prewired, pre-aligned RF and IF stages for AM and FM. Exclusive precision prewired EYETRONIC® tuning on both AM and FM.

FM TUNER: Switched AFC (Automatic Frequency Control). Sensitivity: 1.5uv for 20db quieting. Frequency Response: 20-15,000 cps ± 1 db. Multiplex-ready: Regular and MX outputs built in.

AM TUNER: Switched "wide" and "narrow" bandpass. High Q filter eliminates 10 kc whistle. Sensitivity: 3uv for 1.0V output at 20db S/N ratio. Frequency Response: 20-9,000 cps ("wide"), 20-4,500 cps ("narrow").

BOTH AMPLIFIERS: Complete stereo centers plus two excellent power amplifiers. Accept, control, and amplify signals from any stereo or mono source.

ST70: Cathode-coupled phase inverter circuitry preceded by a direct-coupled voltage amplifier. Harmonic Distortion: less than 1% from 25-20,000 cps within 1 db of 70 watts. Frequency Response: $\pm 1/2$ db 10-50,000 cps.

ST40: Highly stable Williamson-type power amplifiers. Harmonic Distortion: less than 1% from 40-20,000 cps within 1 db of 40 watts. Frequency Response: $\pm 1/2$ db 12-25,000 cps.



**NEW FM MULTIPLEX
AUTODAPTOR MX99**
Kit \$39.95
Wired \$64.95
An original EICO contribution to the art of FM Multiplex reception.

(Patent Pending)

Designed for all EICO FM equipment (HFT90, HFT92, ST96) and any other component quality, wide-band FM tuners having multiplex outputs, the new MX99 incorporates the best features of both matrixing and sampling techniques. It is free of phase-distorting filters and provides the required, or better-than-required, suppression of all spurious signals including SCA (67kc) background music carrier, re-inserted 38kc sub-carrier, 19kc pilot carrier and all harmonics thereof. This is very important for high quality tape recording, where spurious signals can beat against the tape recorder bias oscillator and result in audible spurious tones in a recording. This adaptor will synchronize with any usable output from the FM tuner and will demodulate without significant distortion tuner outputs as high as 7 volts peak-to-peak (2.5 volts RMS).

The MX99 is self-powered, provides entirely automatic stereo/mono operation and includes low impedance cathode follower outputs to permit long lines. An indicator lamp turns on when the station selected is broadcasting multiplex stereo. A separation of 35db between channels is typical across the entire audio spectrum. An over-all gain of unity is provided from input to output on both stereo and mono.

EW-12

EICO, 3300 N. Blvd., L.I.C. 1, N. Y.

Send free 32-page catalog & dealer's name

Send new 36-page Guidebook to HI-FI for which I enclose 25¢ for postage & handling.

Name

Address

City Zone ... State

Over 2 MILLION EICO instruments in use.
Most EICO Dealers offer budget terms.
Add 5% in West.



© 1961 Electronic Instrument Co., Inc.
3300 N. Blvd., L.I.C. 1, N.Y.



Listen to the EICO Hour, WABC-FM, N.Y. 95.5 MC, Mon.-Fri., 7:15-8 P.M.

Export Dept., Roburn Agencies Inc., 431 Greenwich St., New York 13

THE SILICON SOLAR CELL

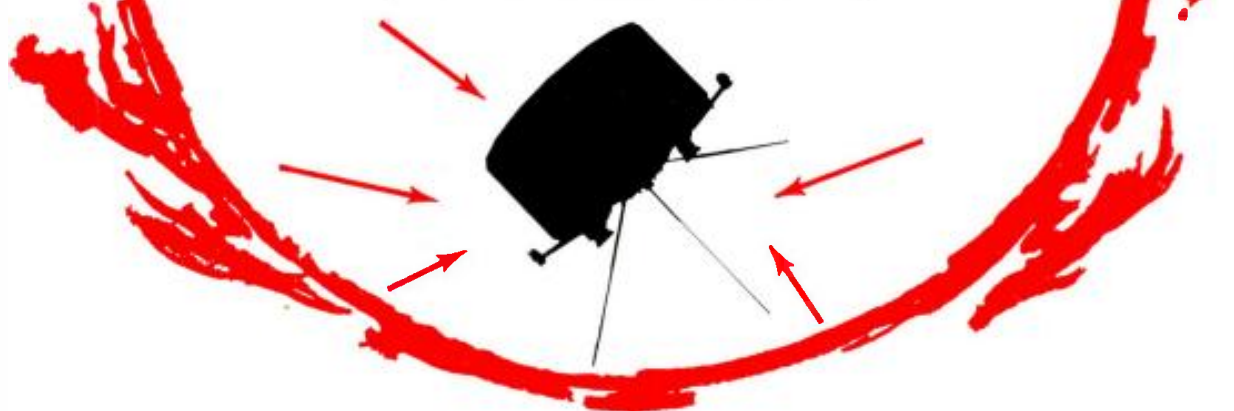

By W. R. BARON / Manager, Astro-Power Div., International Rectifier Corporation

A primary power source for the space age, this device makes possible direct, instantaneous, and efficient conversion of the sun's energy into useful electric power.

EDITOR'S NOTE: The silicon solar cell discussed below should not be confused with the selenium photovoltaic cell. The more expensive silicon solar cell is far more efficient in converting light to electricity. Silicon cells, currently being manufactured by Hoffman Electronics Corp. and International Rectifier Corp., were originally developed by Bell Telephone Laboratories.

WE ARE now living in the space age and the era of the semiconductor. One of the many thousands of different components used in satellites and space vehicles is the silicon solar cell, a product of the semiconductor industry. In addition to its sophisticated role in space travel (Fig. 2), the silicon solar cell has many industrial and commercial uses—some as yet unexplored—which are fulfilling man's dream of direct, instantaneous conversion of the sun's energy into useful electrical power.

This ability to convert light energy directly to electrical energy is worthy of considerable attention, especially since the cell has no moving parts, has great simplicity and reliability in operation, indefinite life expectancy, is extremely light in weight, mechanically strong, and can withstand humidity, shock, vibration, and a wide range of operating temperatures. Although other materials, such as selenium, are capable of converting light to electricity, silicon cells are capable of the highest electrical output and efficiency.

Not all silicon solar cell applications are as glamorous as those of satellites and space vehicles, and the cells are finding increased use in industrial and data-processing systems for light detection, response, and movement.

The sun gives us light and life and this fact has been recognized in various ways throughout the history of man. The energy received by the earth from the sun reaches fantastic proportions and, even with the considerable losses due to the atmosphere surrounding the earth, the solar energy falling on less than .01% of the earth's surface is approximately equal to present total world power consumption. By means of the silicon solar cell, solar radiation can be converted directly into electric power without an intermediate heat cycle.

At the present moment, economic and geographical considerations do not make this a practical proposition for converting large amounts of power to supply industrial and domestic needs and, in this respect, the application is at present limited to small power demands of up to approximately 100 watts continuously.

In the early days of development, a

cell conversion efficiency of 6% (ratio of electrical output to total illumination energy input) was worthy of acclaim, but now cells with conversion efficiencies of 12% and 13% are in regular production at *International Rectifier Corporation*. This improvement in efficiency is a remarkable achievement when one considers that the theoretical maximum conversion efficiency is only a little more than 20%.

Operating & Manufacture

The cell is manufactured from silicon, a metallic semiconductor which is a material intermediate between an insulator (such as glass) and a conductor (such as copper or aluminum). Chemically it is second only to oxygen as the world's most abundant element.

A finished silicon solar cell appears as a rectangular wafer of silicon, dark blue-gray in color, about .020 inch thick and usually 1 cm. x 2 cm. (about .4" x

Fig. 1. The composition and the basic operation of the silicon solar cell.

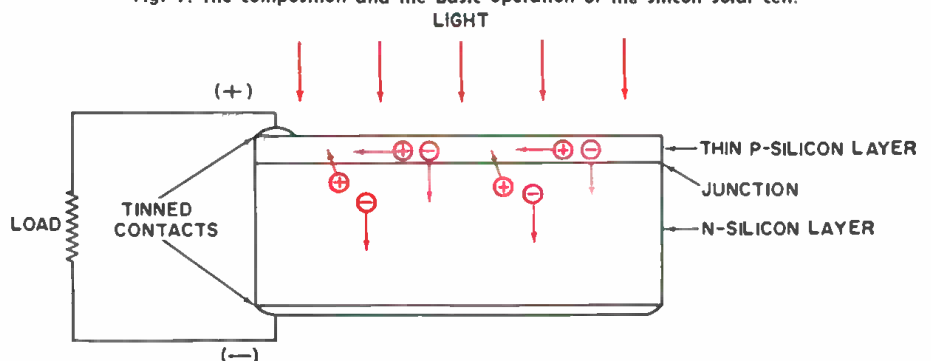

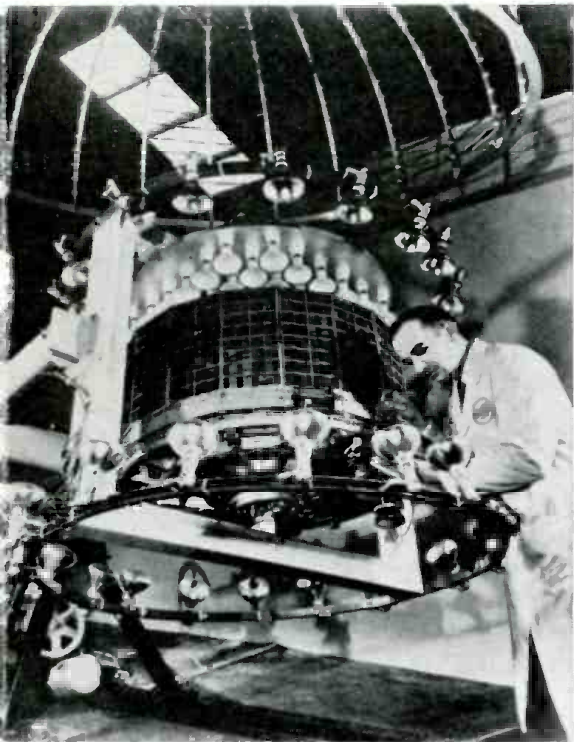

Fig. 2. The U.S. weather-eye satellite, "Tiros," was equipped with more than 9000 silicon solar cells. This represents one of the largest arrays of solar cells launched into orbit. In the illustration, a technician is taking measurements of the output of the solar cells prior to the launching of the weather satellite.

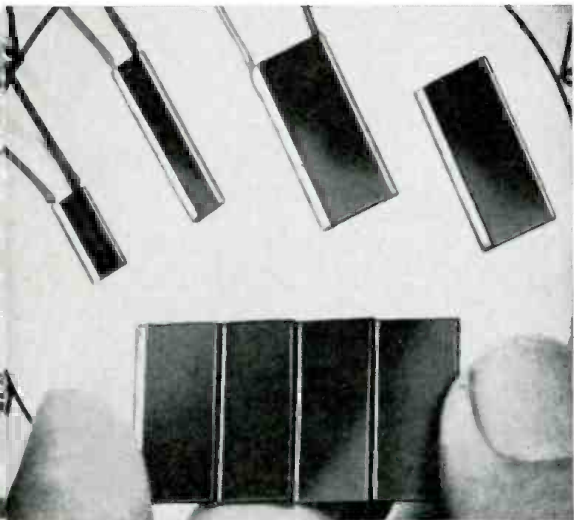
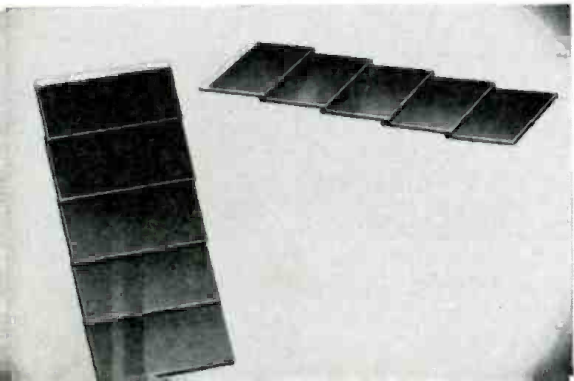

Fig. 3. Rugged, high-efficiency silicon solar-cell module (bottom) and unmounted cells.

Fig. 4. Cells may be equipped with extremely thin, optically coated coverglass to provide optimum reflection properties and high thermal emissivity. This technique is recommended for space-vehicle use.

Fig. 5. Shingled solar-cell assemblies.



.8") in size (Fig. 3). In processing, the cell undergoes a very complex manufacturing procedure, starting with the chemical refining and purification of silicon—often to impurity levels of 1 part per billion, the growing of a single crystal from the molten silicon or "melt" at a temperature approaching 2000 degrees C, cutting the crystal into wafers, formation of the junction or active layer, and finally connecting wires to the unit. In all, it passes through some forty different processes before the final cell is "born" and involves approximately twenty-five different chemicals during the process.

The cell consists of two layers of silicon, one of which is "impure" as compared to the other—but impure in a special chemical and molecular way. One layer contains a controlled chemical "impurity" rich in electrons (*n*-type silicon) and the other layer contains an impurity deficient in electrons (*p*-type silicon). These two layers are in intimate contact with each other and the junction formed between them exhibits the interesting property of a strong built-in electric field which contains the electrons in the *n* silicon and the holes in the *p* silicon, thus forming a barrier between the *n* and *p* layers. Photons of light are absorbed through the very thin *p* layer into the barrier region. There they liberate electrons and holes, the built-in electric field displacing the electrons to the *n* side, making it nega-

cycle within a furnace, a thin layer of *p*-type (positive) silicon is formed on the top of the wafer by allowing a doping material to react with the silicon wafer under intense heat in excess of 1000 degrees C.

As the *p* layer is formed in a gaseous atmosphere it completely covers all surfaces of the wafer. It is, therefore, removed from the back and all edges of the wafer to leave only the active side covered. The front collector and the back are then plated and tinned to provide solder points for assembly and connections. Each cell is finally tested for electrical output in carefully controlled temperature conditions under a calibrated simulated sunlight source and graded according to the measured conversion efficiency.

As the active area of the cell plays a very important part in the energy conversion, the contact on the *p*-layer side is usually in narrow strip form along one edge to present the maximum cell area for illumination and power conversion. In addition to a single front contact or collector strip, cells are now being manufactured with a number of secondary collectors protruding from the main or primary collector strip. The purpose of these is to afford better collection of the current from the active cell area and thus to increase the conversion efficiency or power output. These cells are called "gridded cells" because the collectors form a grid network over the top or active area of the cell.

Characteristics

Many factors influence the conversion efficiency of the cell, including the intensity of the light source, the spectral content or light wavelength, and its angle to the cell surface (angle of incidence), cell operating temperature, and the characteristics of the external electrical circuit.

It is interesting to note that the spectral content and intensity of sunlight on earth (air mass = 1) are different from those in space (air mass = 0) due to the filter effects of cloud, vapor, and air smog within our atmosphere. The electrical output from a given cell is about 15% greater in space compared with measurements made on earth.

In addition, the cell itself does not show a uniform response to all wavelengths of light shining on it. The com-

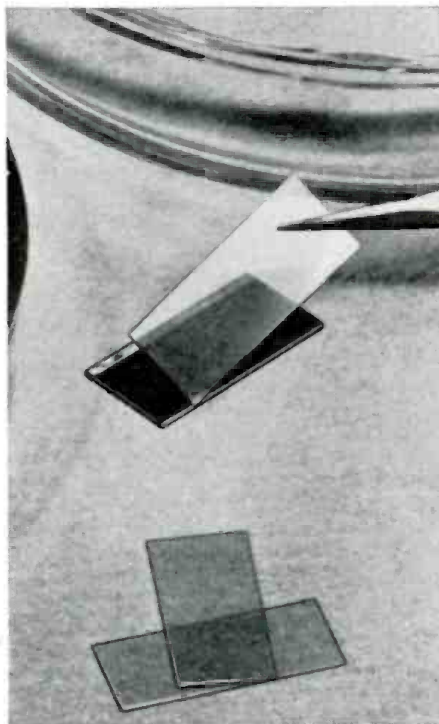

positive, and the holes to the *p* side, making it positive and causing a voltage to appear across the cell terminals. Connection to an external circuit causes current to flow and the direct conversion of light into electrical energy is obtained. See Fig. 1.

With present manufacturing techniques, a thin wafer of *n*-type silicon is first cleaned with acid, then, in a carefully controlled time and temperature

COVER STORY

OUR cover shows an important application of silicon solar cells, over 9000 of them in all, in providing the power to charge the storage batteries in "Tiros," our weather observation satellite. This satellite was developed by RCA for NASA. Below the satellite is a typical module consisting of a large number of interconnected silicon solar cells. A number of these modules may be used to supply the total power requirements of a space vehicle. To the left is a large single crystal ingot that has been grown from molten silicon. Wafers cut from this mother crystal are processed into silicon solar cells.

(Photos courtesy RCA and International Rectifier Corp.)

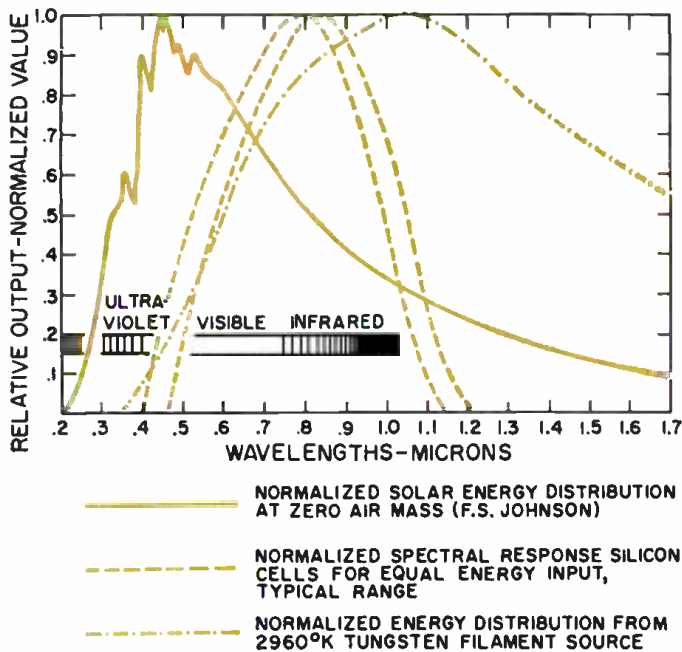

Fig. 6. Relative solar radiation spectral distribution compared to tungsten filament lamp radiation and cell response.

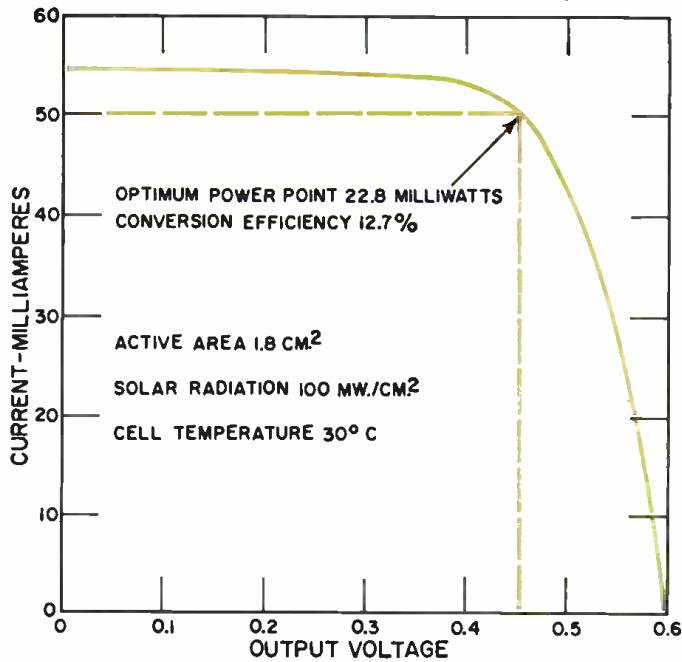

Fig. 8. Voltage-current output characteristics of high conversion efficiency silicon cell, showing optimum power point.

parison in Fig. 6 shows the spectral or wavelength content of sunlight compared to a tungsten filament lamp and the response curve of a typical silicon solar cell. From this it can be seen that the cell will only accept and convert to electrical energy that portion of the light energy embraced within the cell response curve. As would be expected, the output from the cell also depends on the intensity of the light shining on it. This is shown in Fig. 7 and, as can be seen, the short-circuit or maximum available current is a linear function of the light intensity.

The electrical output of a cell follows the typical curve shown in Fig. 8. The power output is the product of the voltage and the current at that voltage and is usually a maximum at only one point on the curve. This is the power point

at which the largest-area rectangle fits under the voltage-current curve of the cell.

Silicon solar cells suffer adversely from the effects of increasing cell operating or environmental temperatures. The power output from the cell decreases approximately .6% per degree centigrade increase in cell temperature. See Fig. 9. It is therefore vitally important in any application of these devices to ensure adequate control of the cell operating temperature.

In space, improvement in the control of cell operating temperatures can be achieved by cementing extremely thin cover glasses over the front of the cells. Typical cover glasses are about five thousandths of an inch thick. See Fig. 4. These cover glasses have special optical filters deposited on their surfaces

and are designed to decrease the transmission of the unwanted portion of the sunlight energy, *i.e.*, the energy outside the response of the solar cell. This has the effect of reducing the temperature rise of the cell under operating conditions, a most important point in the design of satellites where maximum power output is required for a minimum number of solar cells due to weight and structural considerations.

Silicon solar cells can be used singly or in groups and although the present standard commercial size is 1 cm. x 2 cm., they are also available in a wide variety of other sizes to meet special needs. For example, they can be supplied as small as .020 inch x .100 inch and as large as about .8 inch (2 cm.) square. They are also available as made-up sub-assemblies or shingles in a mul-

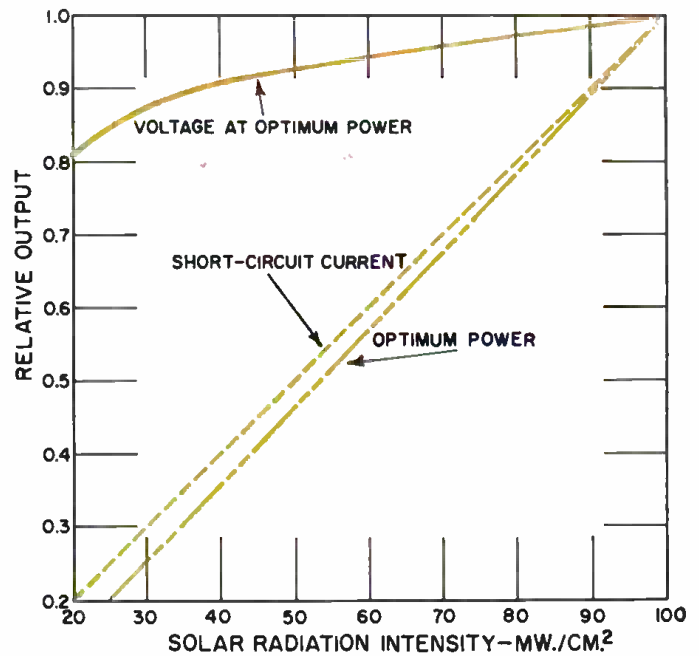

Fig. 7. Silicon-cell output versus solar radiation. 100 mw./cm.² intensity occurs with clear, bright, mid-day summer sun.

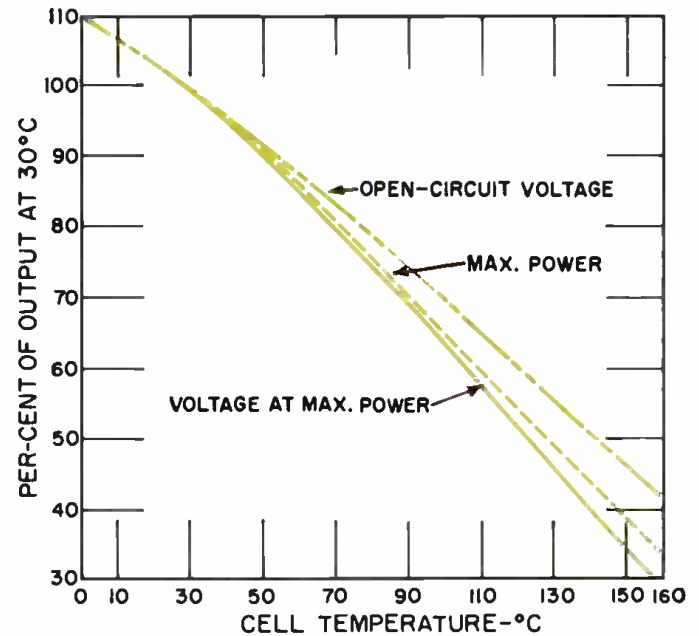

Fig. 9. Output of the silicon solar cell as a function of the cell temperature. Output is reduced with a rise in temperature.

titude of different cell configurations.

Cells can be connected in series to increase the voltage output and in parallel to increase the current output. Power output depends not only on the number of series/parallel cells used, but on the utilization of the space available for the cells as well. The shingling or overlapping cell method of series connection shown in Fig. 5 is very popular for large assemblies because it provides the highest output from a given area and is also a convenient subassembly for manufacturing purposes. A typical shingle of five average cells will give an output of approximately 2 volts at 40 ma. with optimum illumination. In such a series string the cell with the lowest output will determine the current available, hence great care must be exercised in selecting the cells to ensure accurate matching of their output characteristics.

Another type of cell gaining popularity is the gridded cell mentioned previously and shown in Fig. 10. Here the active surface has a network of collectors to assist the current flow. The effect of these extra collectors is to increase the electrical power output of a given cell beyond that available from a non-gridded cell, raising the conversion efficiency by 1% or so under given light and load conditions.

Applications

Silicon solar cells are finding increased and varied applications throughout industry, but by far the most glamorous role is to provide the power requirements of satellites and space vehicles. In such applications the solar cells are used to charge storage batteries and supply power during that portion of the orbit which is in sunlight, the storage battery providing continuity of power supply for the instrumentation, transmitters, and telemetry system during periods of darkness when the cells are inoperative. Solar-cell systems with peak-power outputs up to 250 watts have been designed and manufactured. A typical module for such an application is shown in Fig. 11. A number of these modules are used to provide the total power required.

Our weather-observation satellite, "Tiros," shown in Fig. 1 has a total of 9260 silicon solar cells to keep its nickel-cadmium storage batteries charged. Banks of 80 cells are connected in series and mounted on printed circuit boards for ease of assembly.

Silicon cells are also used extensively

to "read" punched tape, punched cards, and film. Here the cards pass between a bright light source and the cell read-out unit. These cells are extremely small with an active area per position of approximately .01 square inch and are spaced to correspond with the alignment of the card holes or information to be read.

A typical 8-position read-out is shown in Fig. 12 with over-all dimensions of only .676 inch long, .2 inch wide, and .025 inch thick. Movement of the punched card produces impulses of light upon the segments of the read-out unit and these are converted into electrical impulses which can be arranged to sort, print data, and convert information for accounting, statistical, and analysis purposes. This can be done very rapidly indeed as the read-out units have a response time of less than 20 μ sec.

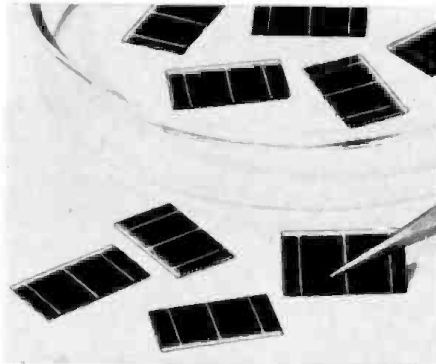

Fig. 10. "Gridded" solar cells. The central grid collection strips assist current flow and increase the power output.

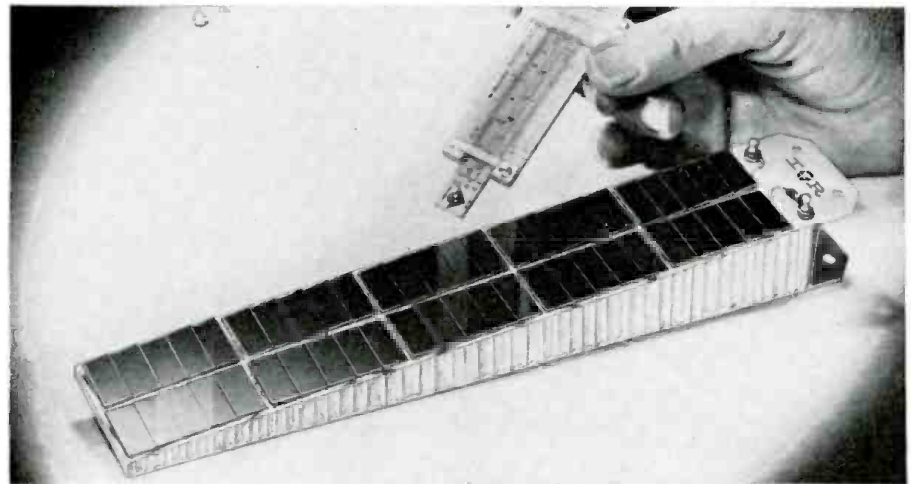

Fig. 11. This space-vehicle power-supply panel contains many interconnected cells.

Fig. 12. Eight-position fast-response read-out made from silicon cells.

Other typical uses for the cells include power supplies for remote and unattended radio stations, lighthouses, beacons, and telephone repeaters in sunny areas (such as the Polar Regions), and a machine to automatically change dollar bills into coins.

The advent of the transistor radio which requires only a small operating power, provides a ready application of silicon solar cells when the receiver is operated on a sunny beach. By using 10 or 12 cells connected in series, most transistor radios can be operated from bright sunshine. Light-controlled toys, automatic street-lighting controls, machine-tool control and positioning devices, level indicators, analogue-to-digital encoders, servomechanisms, gyrocompasses and other navigational aids, automatic door operators, tone and signal generators, light-operated burglar alarms, emergency radios and communications, modulated light-beam communications, vending machines all provide possible uses for these cells.

For these applications, the rugged simplicity, high output levels, indefinite life, and non-aging characteristic make the use of silicon cells attractive.

In common with other semiconductor devices the cost of the silicon solar cell has decreased considerably since its introduction nearly eight years ago. The cost of the cells varies with quantity and quality, but single cells of medium conversion efficiency (8%) are available for as little as \$4 each which, when spread over even a short lifetime, shows an energy cost figure less than we now pay for conventional chemical batteries.

The estimated 1961 market for solar cells is approximately \$2-million—most of which will have come from the spacecraft makers, but industrial and commercial uses are increasing at a very rapid rate. For example, the market for read-out devices nearly doubled during 1960 and is expected to duplicate this record in the current year.

The broad range of applications previously mentioned, coupled with present market trends, indicates continuing and increasing expansion in the industrial and commercial market for silicon solar cells. ▲

STEREO FM MULTIPLEX ADAPTER CIRCUIT

By W. R. COURTNEY / Chief Engineer, J. W. Miller Co.

Construction information on a simple stereo adapter that can be home-built using readily available parts.

CONSTRUCTION of a home-built FM stereo adapter has not been too convenient before this because of the unavailability of some of the special filters and transformers required. The circuit shown below, however, uses readily available coils and transformers, obtainable at electronics parts dealers who distribute *Miller* products.

The adapter unit is connected to an FM tuner at a point following the detector stage, but ahead of the de-emphasis network. Most recent FM tuners make this connection point available by means of a "multiplex output" jack. At this point we have a composite signal made up of the detected audio component of the main channel (left plus right, or L+R signal), a double-sideband suppressed-carrier signal (left minus right, or L-R signal) centered at 38 kc., and a 19-kc. pilot subcarrier.

All three of these components are amplified by the first triode section of the 12AU7 and they appear at the plate output circuit of this stage. The tuned circuit T_2 is a low-pass filter with a cut-off between 15 and 19 kc. This circuit permits only the L+R signal to pass on to resistor R_{10} . Tuned circuits T_3 and T_4

comprise a bandpass network that allows the sidebands of the L-R signal, from 23 kc. to 53 kc., to be applied to resistor R_{12} and the two crystal detectors.

The 19-kc. pilot subcarrier is amplified by the second triode section of the 12AU7. Then it is applied to transformer T_5 and the 6C4 oscillator stage. The output of the 6C4 is tuned by means of transformer T_6 to twice the input frequency, which is 38 kc., the frequency of the suppressed subcarrier that produces the L-R sidebands. The 38-kc. signal is then applied by way of the secondary winding of T_6 to the crystal detectors along with the L-R sidebands.

After detection a positive L-R signal is obtained from detector CR_1 , and a negative L-R signal is obtained from detector CR_2 . When these signals are combined with the L+R signal through matrixing resistors R_{11} and R_{10} , the result is a cancellation of the R portion at the output of CR_1 , and a cancellation of the L portion at the output of CR_2 . This leaves only the L signal at the upper output terminal and only the R signal at the lower output terminal.

To align the adapter, turn it on, allow it to warm up, then proceed as follows. Connect a v.t.v.m. between either L or

R output terminal and ground, and apply sufficient 19-kc. signal from an audio oscillator connected to the input terminal to produce a reading of .1 volt. Now adjust T_5 until a flicker is observed on the meter. This voltage variation indicates the point of synchronization and is the correct adjustment for this coil. Next adjust T_6 for maximum meter reading.

The oscillator is then disabled by shorting out the grid coil in T_5 . Adjust the audio generator to 27 kc. and peak T_1 for maximum v.t.v.m. reading. Then set the generator to 67 kc. and adjust T_2 for a null or minimum meter reading. Tuned circuit T_2 is normally adjusted by the manufacturer so that it need not be aligned. Now remove the short from T_5 .

Finally, tune in a stereo broadcast. If a steady beat note is heard, indicating that the oscillator is not locked in with the 19-kc. transmitted pilot signal, simply touch up T_5 to eliminate the beat. Control R_8 may then be adjusted for the desired stereo separation. If the stereo broadcast station is transmitting a suitable test signal or if a stereo signal generator is available, then both R_8 and T_2 can be adjusted exactly for proper L and R outputs and the correct separation. ▲

Complete circuit diagram, including power supply, for the FM stereo adapter that uses easily obtainable parts.

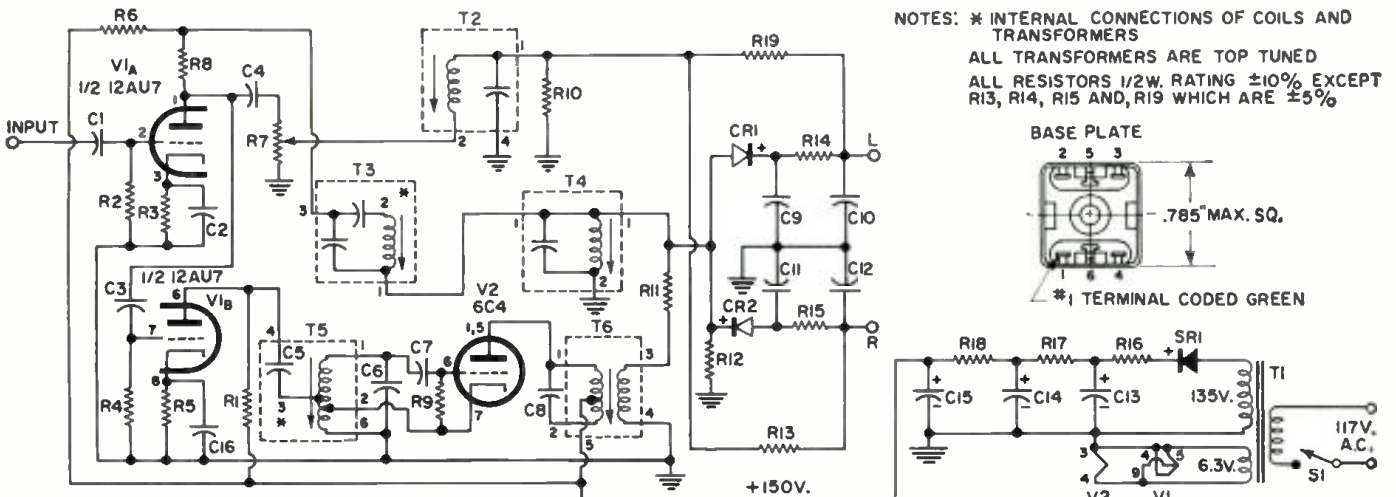

NOTES: * INTERNAL CONNECTIONS OF COILS AND TRANSFORMERS
ALL TRANSFORMERS ARE TOP TUNED
ALL RESISTORS 1/2W. RATING $\pm 10\%$ EXCEPT R_{13}, R_{14}, R_{15} AND R_{19} WHICH ARE $\pm 5\%$

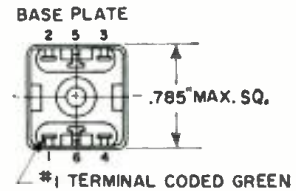

- R_1 —47,000 ohm, $\frac{1}{2}$ w. res.
- R_2 —470,000 ohm, $\frac{1}{2}$ w. res.
- R_3 —1500 ohm, $\frac{1}{2}$ w. res.
- R_4 —100,000 ohm, $\frac{1}{2}$ w. res.
- R_5 —3300 ohm, $\frac{1}{2}$ w. res.
- R_6 —33,000 ohm, $\frac{1}{2}$ w. res.
- R_7 —50,000 ohm pot.
- R_8, R_{10}, R_{11} —10,000 ohm, $\frac{1}{2}$ w. res.
- R_9 —220,000 ohm, $\frac{1}{2}$ w. res.
- R_{12} —27,000 ohm, $\frac{1}{2}$ w. res.
- $R_{13}, R_{14}, R_{15}, R_{19}$ —75,000 ohm, $\frac{1}{2}$ w. res. $\pm 5\%$
- R_{16} —47 ohm, $\frac{1}{2}$ w. res.
- R_{17}, R_{18} —470 ohm, $\frac{1}{2}$ w. res.
- C_1 —.1 μ f., 400 v. capacitor
- C_2 —.05 μ f., 400 v. capacitor

- C_3 —180 μ f. mica capacitor $\pm 10\%$
- C_4 —1 μ f., 200 v. capacitor
- C_5 —300 μ f. capacitor (part of #1354 trans.)
- C_6 —.01 μ f. mica capacitor
- C_7, C_{10}, C_{11} —.001 μ f. disc ceramic capacitor
- C_8 —.0015 μ f. mica capacitor
- C_9, C_{12} —100 μ f. disc ceramic capacitor
- C_{13}, C_{14}, C_{15} —40/40/40 μ f., 150 v. elec. capacitor
- C_{16} —.005 μ f. disc ceramic capacitor
- T_1 —Power trans. 135 v. @ 50 ma., 6.3 v. @ 1.5 amps (Triad R-30X, Stancor PA8421, or equiv.)
- T_2 —Low-pass filter (J. W. Miller #1351)
- T_3 —Bandpass filter series element (J. W. Miller #1352)

- T_4 —Bandpass filter shunt element (J. W. Miller #1353)
- T_5 —19 kc. locked oscillator coil (J. W. Miller #1354)
- T_6 —38 kc. output trans. (J. W. Miller #1355)
- Note: T_3 through T_6 are brand-new parts which may not as yet be listed in electronic parts jobber catalogues. They will be available on order from companies handling the J. W. Miller line.
- CR_1, CR_2 —1N60 crystal rectifier
- SR_1 —140 v., 200 ma. silicon rectifier (International Rectifier 2E4 or equiv.)
- S_1 —S.p.s.t. switch
- V_1 —12AU7 tube
- V_2 —6C4 tube



RELIABILITY

SPACE-AGE REQUIREMENT

THE notion of reliability as it has come to influence our technology is generally thought to be quite new, about the age of space satellites and other sophisticated equipment that requires ultra-reliability. Actually, Oliver Wendell Holmes had reliability on his mind in his poem "The One-Hoss Shay." This is a fine picture of what would actually happen with each part as reliable as the next: a thing that fortunately does not happen in fact. Ben Franklin's "For Want of a Nail," however, written a couple of hundred years ago, is an excellent example of hitting that nail on the head. One tiny defective component in a multi-ton missile has indeed caused the whole project to fail.

Rhymed or otherwise, reliability is now a part of the technician's and engineer's vocabulary and, for better or worse, we have reached the technological point where as much time is often spent to improve reliability as is spent to produce the equipment.

The reliability technician and engineer have taken their places with other specialists and have already developed a language of their own—a language seldom understood by "outsiders." This article will attempt to clarify "reliability" by definitions and illustrations.

Reliability Defined

"Reliability" is simply the probability that a device or piece of equipment will perform as required. The only catch to this statement is the word "probability." It has quite literally built an empire.

Using a weapon as an example, we can go back in history to the cave man and a boulder. This rock, if delivered on target, was 100% reliable—one part, and not a moving one at that, with no interconnections, no power source inside, nothing required as output except its weight and hardness. This state of affairs

Air Force Minuteman intercontinental ballistic missile being launched from Cape Canaveral. The goal is to make the missile as reliable a weapon as possible, approaching that of the first weapon, the caveman's rock. If delivered on its target, this weapon was 100% reliable, having no components that were subject to any type of a failure.

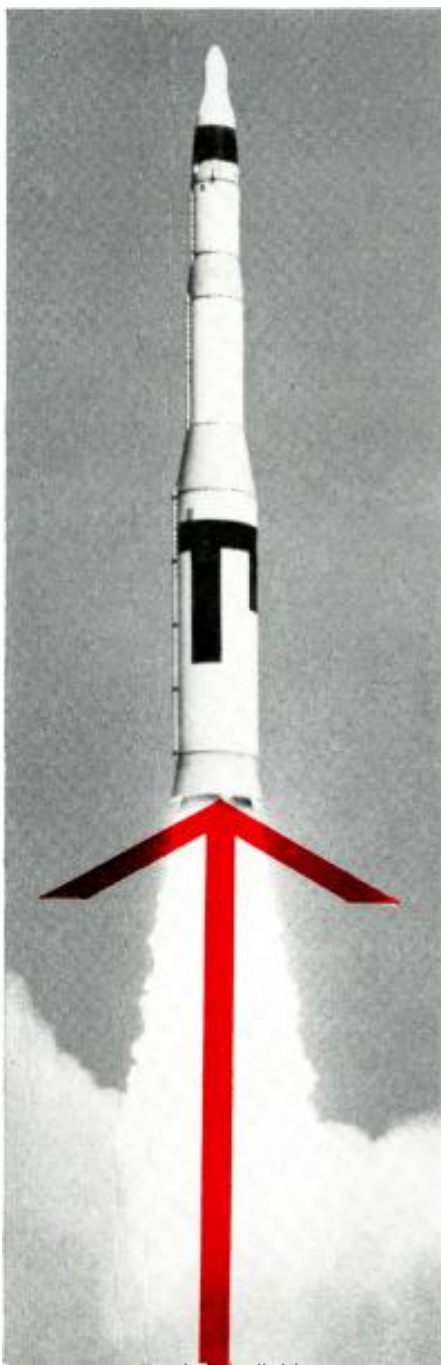

lasted until the advent of the bow and arrow, a superior weapon in all respects—except in the matter of *reliability*. The bow, the arrow, or the string could break. Any component failure meant total failure. Notice that all these events need not happen simultaneously, just as a wheel giving way on Holmes' shay would make one late for prayer meeting as surely as if it went to pieces all at once.

Right here we can mention the nemesis of the builder of complex systems—from bows and arrows to Minuteman missiles—the product rule. In essence, this inexorable rule says that the *reliability* of a series of components must be multiplied to find *total reliability*. Say our Cro-Magnon hunter has a rather poor bow which will work 8 out of 10 pulls. We assign it a *reliability* of 80%. The arrow, coincidentally, is just as reliable, as is the string. So what is the reliability of Mr. C's weapon system? Not 80% as we might like to think, but $.8 \times .8 \times .8$, or only 51%! Our cave man, not being trained in the science of reliability engineering would be stunned; both by the realization that his bow and arrow misfired every other time, and by a boulder lobbed by a less sophisticated but more reliably armed adversary.

A bow and arrow man watching the fight might resolve to do one of several things: leave the country, switch to rocks, carry spare bows and arrows, or improve the ones he had. Carrying spares, which the reliability engineer calls redundancy, would work. Its drawbacks are cost, weight and bulk, and inconvenience. So forward-looking warriors—and manufacturers—choose to improve their equipment.

Need for Reliability

Today we don't have much trouble with our bows and arrows. Automobiles, radios, and TV sets, however, are not

Table showing product rule for reliability.

Number of Components	Total Reliability with Component Reliability of		
	99 %	99.9 %	99.99 %
100	37 %	90 %	99.1 %
250	8 %	78 %	97.4 %
500	1 %	60 %	95.2 %

ELECTRONICS WORLD

By D. S. HALACY / *Motorola Semiconductor Products Inc.*

Frequently as much time is spent to improve electronic component reliability as to produce the equipment itself.

100% reliable. To most of us, this is a nuisance, made the more irksome by whisperings of "planned obsolescence." But many users of equipment must have high degrees of reliability for various reasons.

Telephone circuitry must function well or the companies providing this service would spend all the profits doing maintenance work. Uncle Sam must have defenses almost as reliable as the boulder, even if the boulder comes to cost like uranium. Space vehicles and many less exotic equipment are so complex and fast operating that individual failure rates must be fantastically low.

A good topical example of reliability in action (or not in action) is the missile programs currently in progress. The reliability designer's dilemma is one of degree: build a simple missile that is light but only 90% reliable, or build one that will operate perfectly every time. Even assuming that the 100% figure were possible, the missile would still not reach the target—it would not get off the ground because of its weight. A compromise is obviously in order and, as a talking figure, let us say the designers decide on 99.7% as the goal for over-all reliability.

It would seem that an individual component reliability of 99.9% would surely suffice to give us the 99.7% over-all figure. But using the product law, we find that 500 components, each 99.9% reliable, results in a total reliability of about 60%. Even 99.99% individual reliability yields only 95% when it is subjected to the product law. See table on opposite page.

Remembering the product rule, and reflecting on the fact that there are not 500 but thousands of parts in a missile, many operating in series, it is understandable that a transistor reliability of 99.9993% is the goal set by *Motorola Semiconductor Products Division of Autonetics' Minuteman Project*. Other firms are shooting for goals ranging as high as 99.9994% for simpler components like capacitors.

To illustrate a little more vividly what this means, the example has been used

that a device with a failure rate of 0.0007% would last, on the average, 15,000 years before failure. A transistorized Noah's Ark would still have a long life ahead of it. This quantitative statement should give rise to a question which leads us to another term in the reliability equation—that of time. Most reliability figures are given per 1000 hours, although some experts contend that this is a meaningless qualification. MTBF, the mean time between failures, is another expression of reliability. For the Minuteman this MTBF is 7000 hours, about the same as operating 30,000 TV sets for a year before one failed!

Failure Rate

This leads us to another term, that of *failure rate*. In our case of 99.7%, the failure rate, or probability of failure, would be:

$$100\% - 99.7\% = 0.3\% \text{ failure rate.}$$

While at first inspection a reliability of 99.7% is not particularly impressive, a popular soap having approached that figure long before the age of electronics, attainment of such a goal is a marvel, if not a miracle.

Confidence Level

There is another term we must learn and that is *confidence level*. Boiled down,

this simply means the consistency with which the desired reliability figure has been demonstrated. Since all reliability, no matter how good, is not a guarantee but a probability, demonstrating 99 successes out of 100 times, sets the 99% figure only for a very low confidence level. It is necessary to test and retest, or test simultaneously with many batches of parts to reach a confidence level as respectable as 60%, the figure set for many of the Minuteman components.

Quality Control

It is one thing to build a reliable product and something else to prove this reliability. This need for such testing gives rise to the Quality Control Department, a group whose testing includes highly sophisticated statistical methods and whose lexicon is studded with terms like "Monte Carlo," "chi-square," "AQL," and "4-dimensional matrices."

Although there are those who decry the whole reliability idea as a "cult" that can wreck the economy, reliability is surely with us to stay, at least until an ultra-reliable missile war puts us back in leopard skins, with rocks for weapons. An example of the importance of reliability is the spending of \$20-million by *Autonetics* for reliability studies of Minuteman components. ▲

Statistical reliability studies being made for parts used in Minuteman missile.



SIMPLE SYNC SERVICING

By WAYNE LEMONS

A few stubborn faults need elaborate testing—but most sync troubles will yield to this quick v.t.v.m. method.

EVERYONE, at one time or another, probably has trouble finding sync-circuit faults. Not everyone likes to use the scope for servicing this part of the receiver, although that instrument offers many advantages. After all, the path to profits is to make repairs in the quickest way, which is not necessarily the most sophisticated way.

This story is for those who prefer not to use the scope. Nearly everyone has a v.t.v.m. This instrument and maybe a little "cut and try" is all you need to make short work of all sync problems but the most unusual ones.

The secret of all troubleshooting is to narrow down or localize the fault to a few possible components. This applies to sync servicing too. To begin with, the cause of a sync fault can lie either in the sync stage (or stages), or it can be ahead of this circuit, in the video stages. Which is it? If you have no obvious clues, it is necessary to "prove" one circuit; that is, to determine that the sync stages are either defective or not defective. If you can prove that one of these sections (sync or video) is not defective, then you can concentrate on the other.

It is sometimes said that the v.t.v.m. is practically useless in sync circuits, that only the scope will do. This just isn't so! A sync circuit performs or fails to perform because of correct or incorrect voltages. What is more logical than using a v.t.v.m. to check voltages? Admittedly, the instrument has limitations in sync troubleshooting—but they are not as serious as one is often led to believe. Triode sync clippers almost always have fairly low d.c. plate voltages. (Most multi-grid sync tubes are essentially triode or pentode clippers.) Pentode clippers usually have low d.c. screen voltages. These low voltages allow the tubes to saturate easily so that clipping and limiting is realized.

The most common sync troubles, aside from tubes, include open coupling capacitors (no sync), leaky coupling capacitors (bending, tearing, instability), and open or changed-value resistors. What else is there? As far as major causes go, there is one more, which we'll discuss later on.

Now how do you check a capacitor that is suspected of being open? There is probably no quicker way than to shunt it with a good one. How about a leaky capacitor? Suppose, for example, that you suspect leakage in C_1 of Fig. 1. Simply leave the end of the capacitor

in the circuit that has "B+" voltage on it and disconnect the other end. Connect your v.t.v.m. (a medium d.c. range is a good start) from this dangling end to ground, as shown. If you get a steady reading with the set on, the capacitor is either leaky or shorted and must be replaced. A word of caution: tune the set to an inactive channel. If you are getting reception, arriving sync pulses will sometimes cause the v.t.v.m. to read even though a coupling capacitor is good.

Now for resistors. For these, measure plate and screen voltages in the sync stage or stages. In doing so, watch out for the voltage readings given on schematics and make sure you are using them properly. The plate voltage may be considerably higher when you're on channel than it is when you're off. This is because the "sync drive" biases the grid of the sync clipper more negatively when the set is operating on channel, causing the tube to conduct less and drop less voltage across itself. So, when comparing with schematic readings, make sure you note the conditions under which they were taken and the conditions under which you are taking readings.

If a plate voltage seems high, you probably have a defective resistor in the network that supplies it. In Fig. 1, for example, R_2 may be open or R_2 could be off value. Reduced voltages can also be traced to changes in these resistors.

This leaves only one common source of sync-circuit faults not yet covered: improper filtering. Note that the "B+" line to the sync clipper in Fig. 1 has an extra electrolytic filter, C_3 , to keep the ripple here low. Obviously this can be shunted with a good electrolytic and the effect can be observed.

Sometimes, however, this shunting will temporarily heal the defective capacitor—and you are not quite sure, then, that it was bad after all. You can

get around this possibility by using the a.c. function of your voltmeter to read ripple. If you have an instrument that reads peak-to-peak volts, connect it between the "B+" line and ground. If the meter reads more than 1 or 2 volts, you need additional filtering. (If the ripple is more than 3 volts, peak-to-peak, install a new electrolytic even though a sync fault is not yet apparent. The capacitor is going bad and you are going to have to replace it in a few weeks anyhow. It will be less troublesome to do it now.)

Suppose you have checked out the sync circuit and it "proves" OK. You now look for the trouble in the video circuit. For example, insufficient a.g.c. voltage may be responsible for the fact that your sync circuit is being driven too hard. Check the a.g.c. with the v.t.v.m., or use a substitute d.c. bias voltage and watch for improvement. The video signal may have "holes" in it due to inadequate bypassing of the a.g.c. line or of the screen of the video amplifier. Shunt the a.g.c. line with a .5- μ f. capacitor and see if there is improvement. The bypass for the video-amplifier screen filter (C_2 in Fig. 1) may be shunted with a 10- μ f. electrolytic. Excessive leakage or shorting in such filters, of course, reduce the d.c. voltages.

This covers most trouble spots in the video chain except for the video detector, which can be checked if the amplifier is cleared. When semiconductors are used in this application instead of tubes, remember that they often develop excessive reverse leakage. Use an ohmmeter to test. Disconnect one lead from the diode and measure it in both directions. Resistance should be low (say less than 500 ohms) in one direction and high (over 500,000 ohms) in the other. A defective diode that may read as low as 2000 ohms in the reverse direction could disturb sync action without having any other obvious effects on the picture or sound.

The outlined methods are not guaranteed to show up every single sync-related fault you will ever come across. But they will find the overwhelming majority of them, and quickly. Sync problems are least difficult if you don't waste time guessing and worrying about them. Start to localize the trouble immediately with the methods described. It's a lot like learning to fly. You're told, "Fly the airplane; don't let it fly you." For sync circuits it's, "Master the trouble; don't let it master you." ▲

Fig. 1. Popular triode clipper, with input from video amplifier. Test for leaky coupler, a common defect, is illustrated.

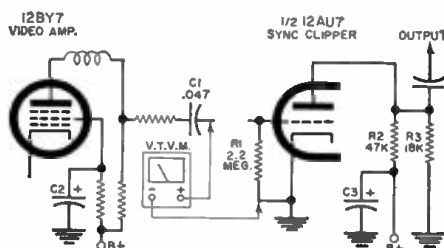

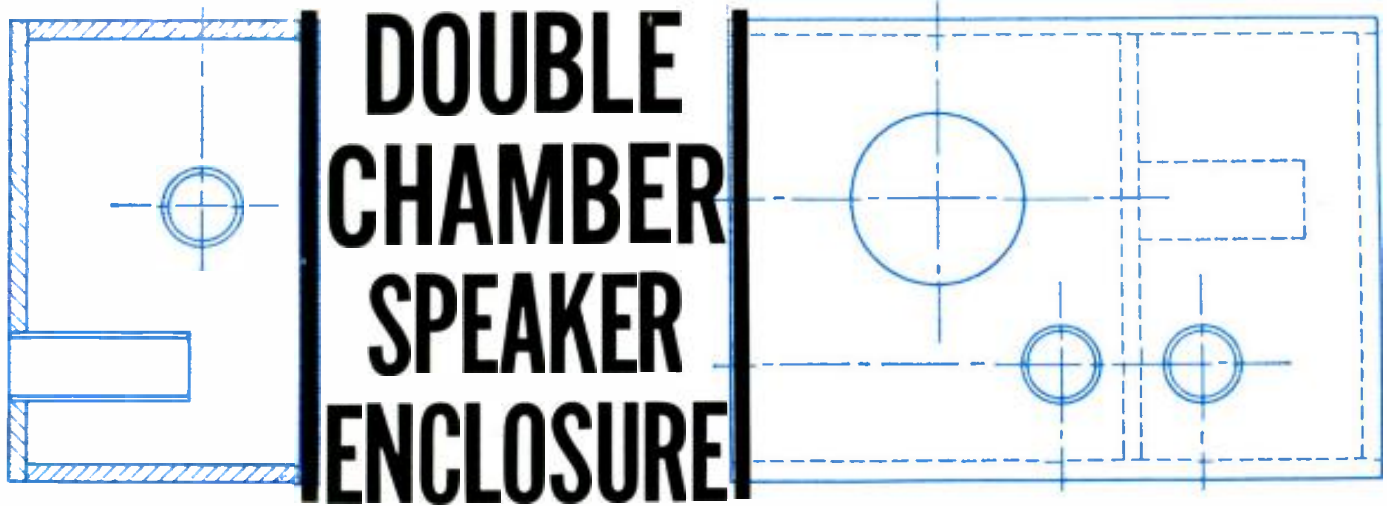

By *GEORGE L. AUGSPURGER*

**Construction details on an experimental enclosure
that will extend the bass response of almost any
good 8-inch loudspeaker down to a usable 35 cps.**

THIS enclosure will extend the bass of almost any good 8-inch loudspeaker to a usable 35 cps. With a good, high-efficiency speaker installed, performance in the very low bass region is excellent. The design is easy to build and dimensions are reasonable. The proportions lend themselves to a variety of styling treatments. It is, to put it briefly, a pretty interesting little box.

What Is It?

Basically, a double-chamber (or double-tuned) enclosure differs from the usual reflex configuration by having two tuned chambers instead of one. The idea is not new. Variations of the double-tuned reflex have been used by the *BBC* and *Quad*, among others. Considerable freedom in design is possible and results can also vary, depending on just what you are trying to do.

The configuration shown in the photographs is different from any other I've seen. It was worked out to allow maximum flexibility in experimentation while

trying to find out just how far the bass response of a standard 8-inch speaker could be extended.

How It Works

A normal reflex enclosure is matched to the characteristics of a specific loudspeaker or group of loudspeakers. It is essentially a Helmholtz resonator tuned to a suitable low frequency (35-70 cps) where the speaker, without help, can't move enough air to maintain uniform bass response.

At its resonant frequency, the reflex enclosure inverts the phase of the sound from the rear of the loudspeaker, adding it to that produced by the front of the cone. The enclosure also loads the speaker acoustically, reducing cone movement and distortion.

But above and below this resonant frequency, the reflex enclosure unloads its driver. As a consequence, if the resonant frequency is set too low, mid-bass response is weak and the speaker can be overloaded in this range. If the resonant

frequency is set too high, deep fundamental tones are lost and the speaker is easily overloaded by low-frequency signals.

In contrast, the double-chamber enclosure is tuned to *two* frequencies about an octave apart. The higher frequency gives acoustic loading in the mid-bass region, and the lower frequency maintains loading down to a suitable low-frequency limit.

The photos show the experimental enclosure built to house an 8-inch loudspeaker. The interior design and dimensions are shown in Fig. 1.

In this design, the larger chamber (in which the loudspeaker is mounted) is tuned to 70 cps. Its volume is about 1.8 cubic feet. The combined effect of two ducted ports is used to tune the chamber. One port is placed in the partition between the two chambers and the other exhausts outside.

Below 70 cps, the first chamber starts to unload the speaker and air moves freely through the port in the partition.

Front panel of the unfinished double-chamber enclosure.

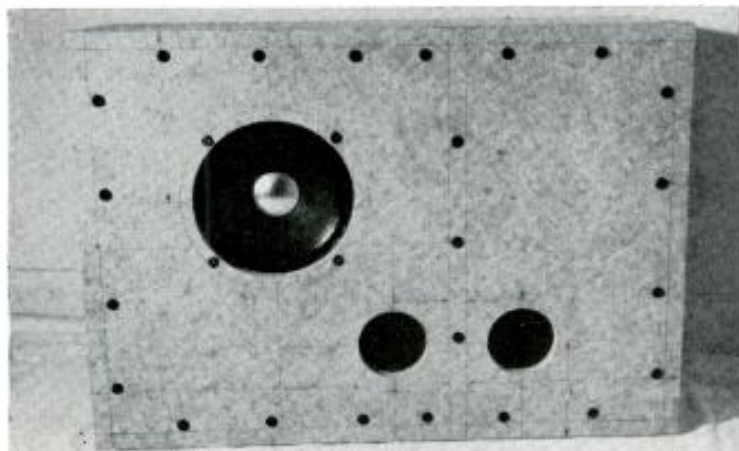

Finished version of enclosure constructed by the author.



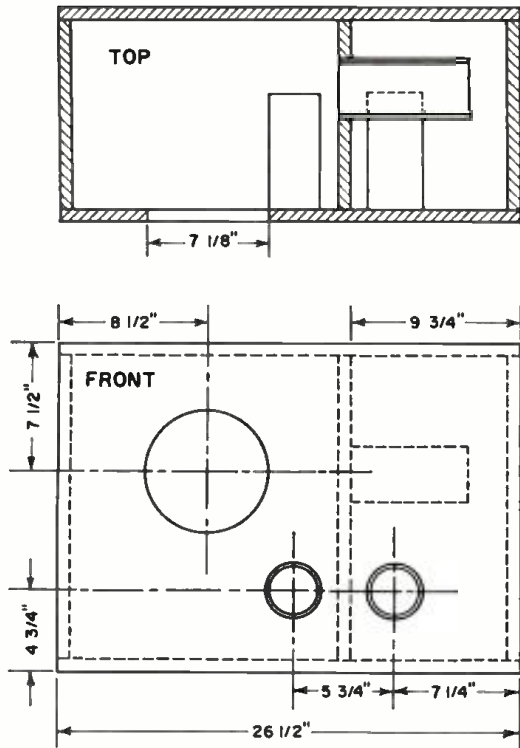

Fig. 1. Construction details of enclosure. Three-quarter-inch particle board is employed along with three 7 1/2" long 2 3/4" inside diameter cardboard mailing tubes.

As far as the speaker is concerned, the partition ceases to exist. Then, near 35 cps the combined volume of both chambers reacts with the two outside ports to establish the lower system resonance.

Effect on Impedance

By spreading reflex action over a band of about two octaves, the double-tuned enclosure eliminates the need for close matching to a particular loudspeaker.

To verify this, the experimental enclosure was tried with three 8-inch loudspeakers having free-air cone resonances of 39, 56, and 70 cps respectively. Impedance curves were run in each instance and these are shown in Fig. 2. Instead of the double-peaked impedance curve of a reflex system, there are three peaks and two dips. The dips at 35 and 70 cps indicate the two system resonances and they show up quite clearly on all three curves.

It's important to remember that impedance curves are useful only if you know what they are related to. A smooth impedance curve does not necessarily have any connection at all with smooth response. There have been a number of recent articles pointing with pride to smooth impedance curves achieved by stuffing a reflex port with an old Angora sweater or gluing a layer of thick felt to the speaker cone suspension.

This approach is a little like trying to improve the performance of a car by keeping your foot on the brake. It runs smoothly no doubt, but you've thrown away most of the power in the process.

The nice feature about a good reflex system is that the levelling-out of impedance is a result of acoustic loading on the speaker cone. This acoustic loading in-

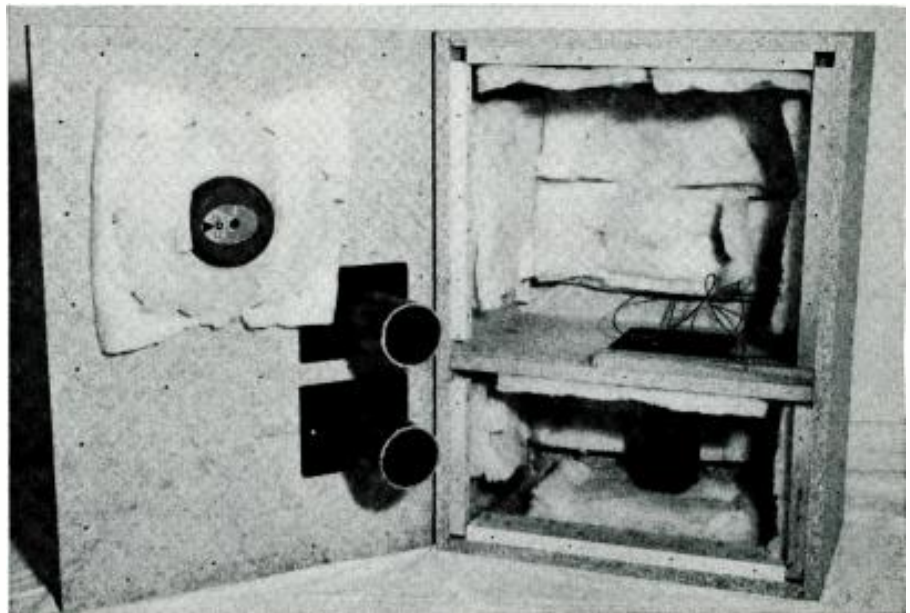

Interior of the enclosure, shown here in a vertical position. Three ducts are used.

creases efficiency while lowering distortion—a most worthwhile combination.

In the case of the experimental double-tuned enclosure, there is only one frequency at which some additional resistive damping might be desirable. Note the upper impedance peak which lies between 85 and 105 cps, depending on the speaker installed. In some cases, this peak will correspond to a slight boominess in reproduction. Fortunately, the cure is simple—tack a layer of damping material immediately behind the speaker. A single thickness of one-inch glass wool or a couple of layers of burlap will do nicely.

This bit of resistive damping is a good precaution against mid-bass boom and it

goes directly to the fundamental problem without noticeably affecting the efficiency of the system below 70 cps. The damping layer is clearly shown in one of the photographs.

Bass Performance

Fig. 4 shows free-field response curves of the experimental enclosure with a JBL LE8 and a JBL D216 installed. This leads us to issue a word of caution: I have a distrust of published "response curves" because no little squiggly line can possibly delineate the listening quality of a loudspeaker system. Consequently, if you must look at curves, please try to find out as much as possible about how they were made before comparing them. And then don't believe everything you see until you have a chance to hear the systems in question. Enough said!

The curves in Fig. 4 were run with the experimental enclosure lying on its back on a 12-foot-square platform on top of a building. A calibrated microphone was suspended 6 feet from the speaker 45 degrees off-axis.

The system was driven by 8 volts of pure sine-wave signal from a standard McIntosh 60-watt amplifier. There was no attempt to change the damping factor of the amplifier to get a better curve.

Now the JBL D216 is an extremely efficient 8-inch speaker with a very light cone assembly. The LE8 is a less efficient unit featuring a rather elaborate long-throw cone suspension. It is designed to deliver full-range response in small bookshelf enclosures.

Yet, although these are two quite different units, the curves of Figs. 2A and 2B are almost identical below 200 cps. This is further indication that the heavy acoustic loading and reflex action of the double-tuned enclosure are primary con-

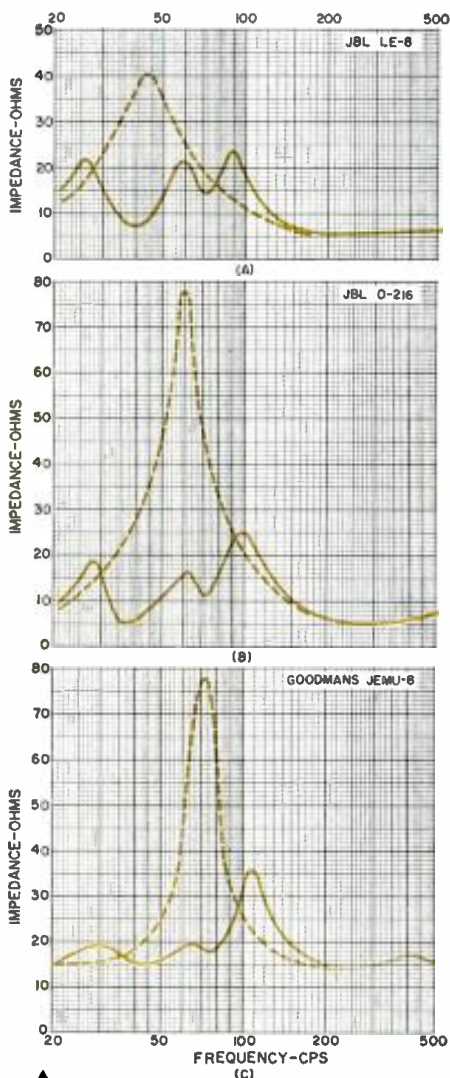

Fig. 2. Impedance curves of three of the loudspeakers used in the enclosure. The dashed curves are the impedances measured in free air, while the solid curves show the impedances of the three speakers when they were mounted in enclosure described. Two Jim Lansing and one Goodmans 8" loudspeakers were employed for these tests.

Fig. 3. Response and harmonic distortion of (A) JBL D-216 and (B) JBL LE-8 loudspeakers in the double-chamber enclosure. Power input was 15 watts in both cases.

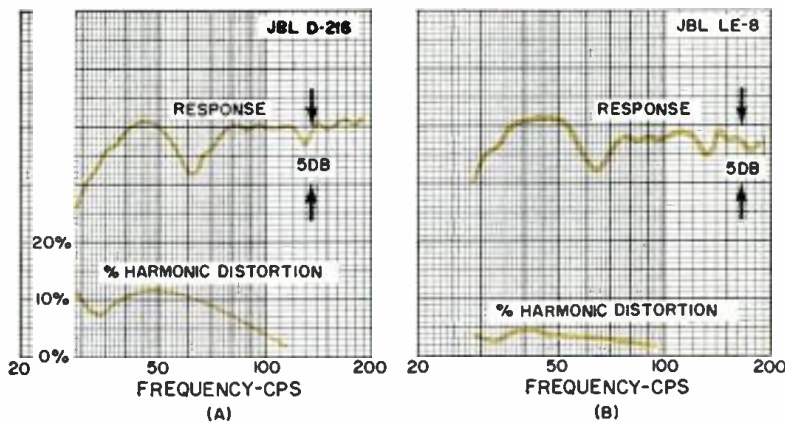
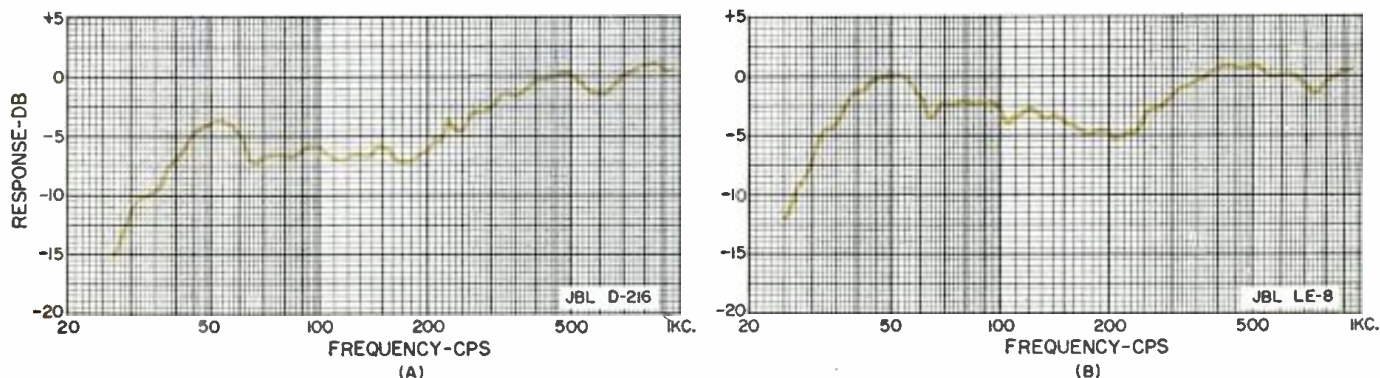

Fig. 4. Free-field response of two of the 8" loudspeakers used in the experimental enclosure. The loudspeaker whose acoustic response is shown in part (B) of the figure is about twice as expensive as the speaker whose response is shown at (A).



trolling factors in the bass response of the system.

Also note that even though the system is radiating into a 180-degree solid angle, both speakers maintain substantial output to about 32 cps. This is particularly impressive considering that we are talking about 8-inch speakers.

The main difference between the two speakers' performance lies above 200 cps. The LE8 is flat within about 5 db from 32 to 1000 cps. The D216, being the more efficient speaker, climbs gradually about 6 db up to its midrange level. This, incidentally, points up a common misconception about long-throw loudspeakers. Other things being equal, the less efficient speaker does *not* have more bass—it has *less* midrange.

Since the bass response of a speaker system in a room generally extends lower and is more efficient than outdoors, it is a toss-up as to which of the two speakers tested will have the smoothest bass under normal listening conditions.

In the double-tuned enclosure, the D216 has a crisp, firm bass characteristic. Bass is not particularly prominent until a really low fundamental comes along.

The LE8 in this enclosure has a more robust, rich bass which some people will prefer. In all honesty, however, this is really a case of gilding the lily since it will deliver comparable performance in smaller, less complicated enclosures.

Bass Distortion

Trying to coax 35 cps out of an 8-inch speaker doesn't accomplish much unless

it is an *honest* 35 cycles. If the output turns out to be mostly frequency doubling, far better to restrict the bass range to a more orthodox limit.

Fortunately, in the experimental system the lack of distortion at very low frequencies is even more surprising than the extension of frequency response.

Fig. 3 is a graph of response and distortion of the two systems below 200 cps. Fig. 3A is the D216 in the double-tuned enclosure while Fig. 3B is the LE8 in the same enclosure.

Again the tests were made outdoors. This time the speaker system was placed vertically against the wall of a building and the microphone was placed three feet away on-axis. The signal was a pure sine-wave and the speaker was driven by a standard 60-watt *Dynaco* amplifier. Again, there was no adjustment of the amplifier's normal damping factor.

For the distortion measurements, the speakers were deliberately overdriven. Eleven volts were fed to the D216. This represents 15 watts into 8 ohms. Why 8 ohms when the D216 is rated at 16 ohms? You must understand that the rated impedance of any loudspeaker is just a convenient figure to use when hooking it up to an amplifier. Its measured impedance will wander all over the place at various frequencies. *JBL*, like many other speaker manufacturers, uses an average impedance rating, that is, the measured impedance of a 16-ohm unit can be expected to vary from, say, 6 to 60 ohms at different frequencies.

So far so good. But the heavy acoustic

(Continued on page 72)

Semiconducting Synthetic Diamonds

Methods have been discovered at the General Electric Research Laboratory which make it possible for the first time to produce semiconducting diamonds. Such diamonds are extremely rare in nature, accounting for less than 1 per-cent of natural diamonds, but these diamonds can now be grown at will using a high-temperature, ultra-high-pressure process. In the photo a piece of semiconducting diamond is being held in a fixture so that its electrical characteristics can be tested.



RECENT DEVELOPMENTS IN ELECTRONICS



Infrared Motion Picture

These are frames from an infrared motion picture made from the display tube of an electronic infrared scanner by engineers of the ITT Federal Laboratories Div. The pictures, showing a man waving his arms, were taken at night using only the natural heat emanation from his body. The white fringe at the bottom of the pictures is beach sand which retained heat from the sun. The image is in a relief pattern because the system was designed to emphasize point sources of heat.

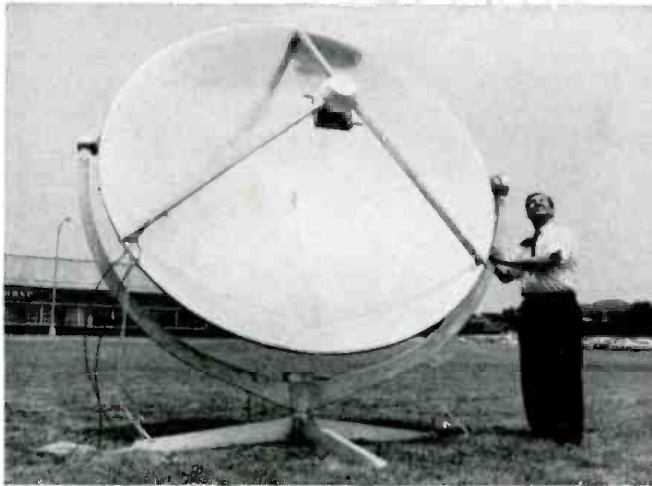

Sun-Powered Electric Plant

Prototype of a self-contained 50-watt power plant and irrigating unit has been built and tested by Westinghouse and the University of Wisconsin. The unit converts sunlight into electricity by means of a thermoelectric generator. The power generated drives an electric motor having a water pump connected directly to it. The device, designed for people in underdeveloped areas of the world, can sustain individual families or villages by irrigating the land they live on and supplying household water needs.

High-Speed Tape Terminal Unit

Newly developed RCA magnetic tape terminal units have been installed at San Francisco and Kansas City to speed Social Security data from the California city to an RCA 501 computer at Kansas City over standard telephone facilities. Speed of transmission is 3000 times faster than by teletypewriter.





◀ Closed-Circuit TV for Banking

A clerk at the recently expanded St. Paul Federal Savings & Loan Association of Chicago places a signature record card before a closed-circuit television camera (in cabinet), which takes a picture and relays it to one of ten TV monitors located at teller stations throughout the bank, including walk-in and drive-in windows. The closed-circuit system, designed by Dage, facilitates communication of ledger records, account balances, and payment records from any of three TV cameras to key departmental locations.

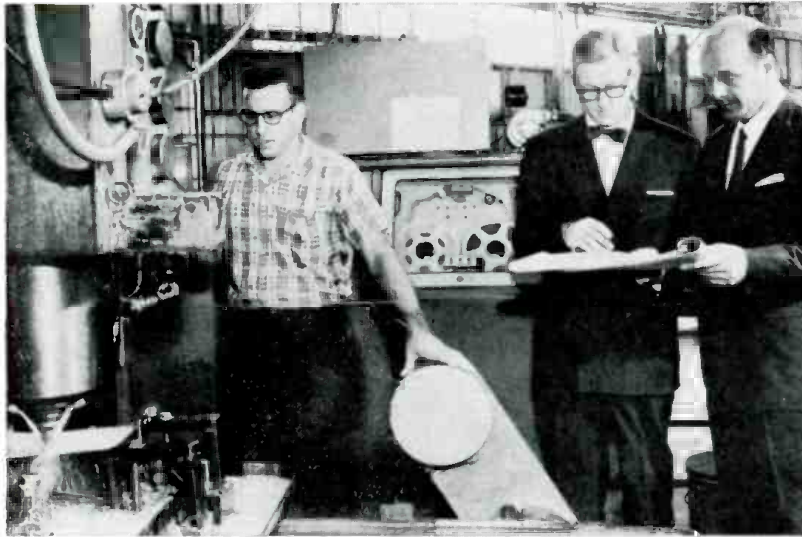

◀ Tape-Controlled Machine Tools

A profiler at Rohr Aircraft Corp. automatically mills out an engine-mounting box beam from a steel forging under the guidance of computer-generated numerical instructions. Checking over the drawing which originated these instructions prepared by a "Univac" solid-state computer are Rohr and Remington Rand executives. The operator now has little more to do than feed tape instructions into his machine. The new programming system applies high-speed computer techniques for automating production machinery and is especially suited to small- and medium-sized metal-working concerns. The system uses a part-programmer's manuscript, a simple statement of manufacturing information prepared from an engineering drawing of the part. Cards are punched from this manuscript and fed into the computer where they are interpreted. Punched cards used to control the machine tools are then produced automatically by the computer.

Computer-Directed Power Generators

A digital computer control system that directs the outputs of generators supplying electricity to 3½ million persons was placed into operation recently by the Philadelphia Electric Co. Developed jointly by Minneapolis-Honeywell and the utility, the computer "tells" 34 turbine-generators what share of the total power requirements each is to produce for most economical operation. The computer also calculates the amount of power exchanged with interconnected utility systems.

Submersed Hi-Fi Amplifier

Technician shown below is demonstrating the high dielectric strength of a "Freon" solvent by actually operating a hi-fi amplifier submersed in solvent bath. The liquid also helps cool electrical components of amplifier because of its high heat-transfer characteristics.

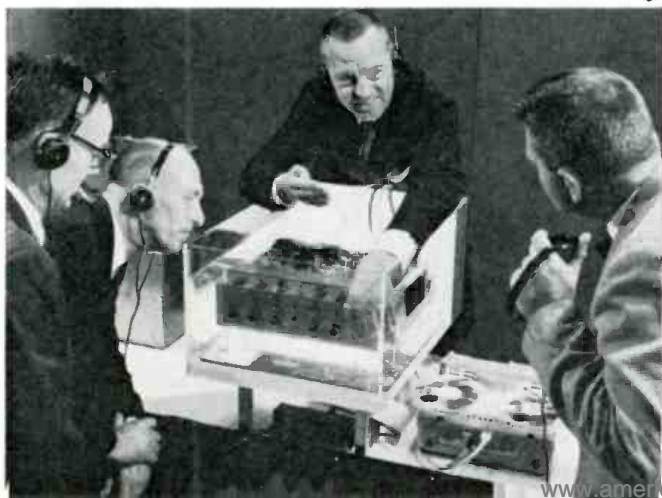

Not only living things, but metal parts, castings, and other manufactured objects can be examined internally. The equipment used and how it works.

AT ABOUT the same time that Marconi was experimenting with radio waves, a German scientist named Roentgen discovered x-rays, another kind of electromagnetic radiation. While less striking, perhaps, than developments in radio communications and radar, recent advances in x-ray techniques have multiplied the uses of x-ray for industrial purposes. Improvements have been made in traditional x-ray fields and, in addition, new applications have been found.

Although many of the rules are the same for x-ray as for other types of electronic equipment, radio technicians usually need help in adapting their

knowledge to the maintenance of x-ray apparatus.

Most people associate x-ray with its use in hospitals and doctors' offices for such things as detecting broken bones, diagnosing tuberculosis through chest x-ray, treating cancer, and fluoroscoping the stomach. Dental x-ray is also familiar.

The industrial use of x-ray has increased as a result of improved apparatus that permits the non-destructive examination of welds and castings of even the thickest steel, and portable equipment provides a convenient means of checking pipelines, bridges, and other construction projects on the spot. In

addition, x-ray spectrosopes and x-ray diffraction apparatus have opened up new avenues in basic research.

The method of locating a defect in a casting with x-ray is not very different from finding a break in a bone. An x-ray beam is directed through the casting and detected on the far side, usually by means of photographic film. For a beam of given intensity, the amount of radiation reaching the film in a given time depends on two factors: the kind of material used for the casting and its thickness. If the casting is uniform throughout, the developed film will be of uniform density. However, an air bubble, being less dense than the

By JOHN R. COLLINS

INDUSTRIAL X-RAY APPARATUS

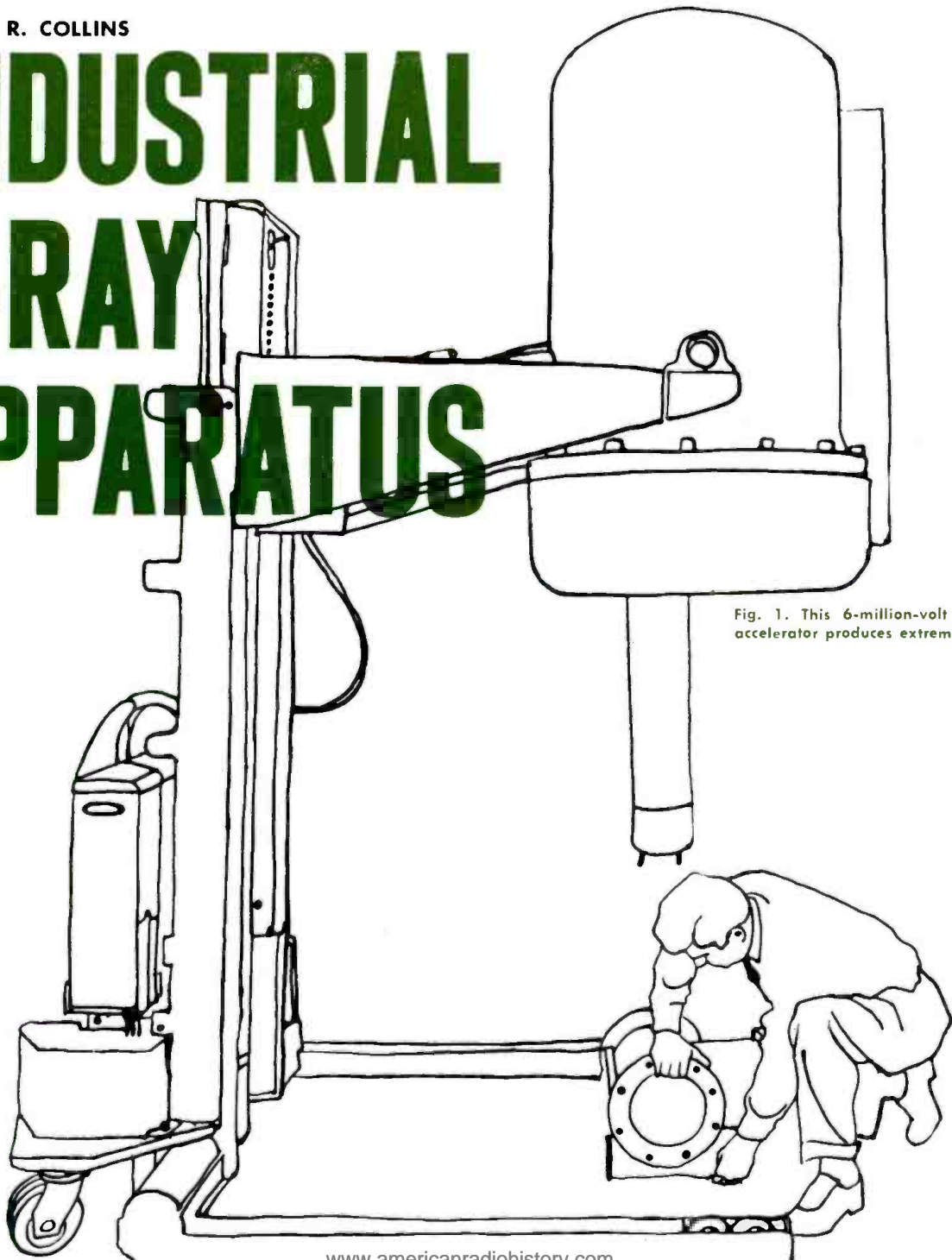

Fig. 1. This 6-million-volt Van de Graaff accelerator produces extremely "hard" rays.

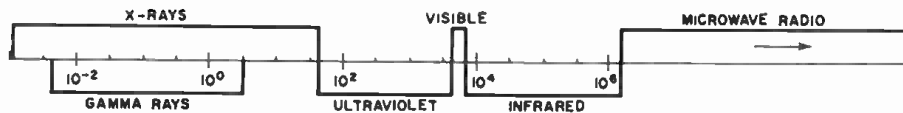

Fig. 2. Place of x-rays in electromagnetic spectrum. Wavelengths are in angstrom units.

steel, would permit more radiation to pass and would show up on the film as a dark spot. Similarly, any foreign matter having absorbing qualities different from steel and any irregularities in thickness would be displayed on the film as dark or light areas.

The process of producing x-ray photographs is called radiography. Micro-radiography concerns the x-raying of small objects, where the detail is too fine to be seen by the unaided eye, and the picture must either be enlarged or examined with a low-power microscope. The technique has been used for such diverse purposes as distinguishing between natural and cultured pearls, examining biological specimens (*e.g.*, insects, leaves, seeds) and in metallurgical laboratories for determining minute discontinuities and the separation of metals making up alloys.

Fluoroscopy is the same as radiography, except that the image appears on a fluorescent screen instead of a photographic film. It is fast and inexpensive, but lacks fine detail and does not provide a permanent record. It is most useful, therefore, for a fast examination for gross defects—like finding hairpins in candy bars.

General Theory

X-rays are a form of radiant energy having properties similar to visible light. Because of their extremely short wavelength, however, they are able to penetrate materials that absorb or reflect visible light. They are produced by collisions between electrons traveling at high speed and some form of matter.

Fig. 2 shows the place occupied by x-rays in the electromagnetic spectrum. Since they are far shorter than even the shortest radio or radar wave, it is inconvenient to measure their wavelength in meters. The usual standard of measurement is the angstrom unit, equal to 1/100,000,000 centimeter. The wavelength of visible light ranges from about 4000 to 7500 angstrom units. The wavelengths of x-rays vary from under 100 angstrom units to a tiny fraction of 1 angstrom unit.

The wavelength is related to the speed the electrons are traveling when they strike matter. So-called *soft* x-rays have relatively long wavelengths and are produced by moderate accelerating potentials. They have little penetrating power and have difficulty in escaping from the x-ray tube. *Hard* x-rays are produced by higher accelerating potentials. Extremely hard x-rays, such as those produced by Van de Graaff accelerators (Fig. 1), can readily penetrate many inches of steel.

You will notice that *gamma* rays cover much the same range as x-rays (Fig. 2). They have the same characteristics and are distinguished from x-rays by their source rather than by nature,

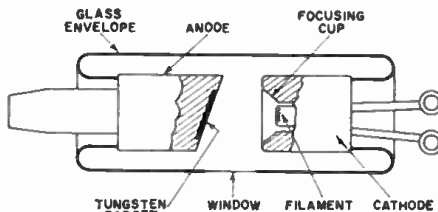

Fig. 3. The cut-away view shows the elements in a stationary-anode x-ray tube.

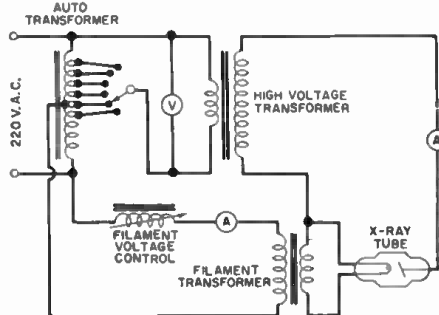

Fig. 4. Basic, high-voltage, x-ray circuit. Tube itself serves as rectifier.

being emitted by radioactive substances. Some *gamma*-ray sources are natural, such as radium; others, like cobalt-60, are artificially produced and do not occur in nature.

X-Ray Tubes

The principal features of an x-ray tube are shown in Fig. 3. It has a cathode to emit electrons and an anode to attract them. The electrons are concentrated in a narrow beam by the focusing cup and directed against the target on the anode. Their velocity is determined by the voltage applied to the anode. The sudden stopping of the electrons on striking the target causes x-rays to be produced.

Only about 1 per-cent of the energy resulting from the impact of the electrons on the target is given off in the form of x-rays, the rest being wasted as heat. Excessive heat can readily melt the tube and it is necessary to dissipate it efficiently. Tungsten is used as the target material not only because of its high melting point (3370 degrees C) but also because it has a high atomic number (74), and elements with the highest atomic numbers are most efficient in producing x-rays. The tungsten target is mounted on a copper base, a good heat conductor, which is brought out to external radiating vanes. In many tubes, oil or water is circulated through the anode to carry off heat.

A further aid to heat dissipation is the rotating-anode tube (Fig. 5). The anode is a large disc of pure tungsten with a beveled edge, connected to a motor. The electron beam is directed against the beveled edge while the disc rotates at high speed. The effect is to

increase the area of the target and to lessen the chance of overheating. It permits the use of a smaller focal spot and higher accelerating potential without damaging the tube than would be possible in a stationary-anode tube.

X-rays do not travel from the target in a single beam. Instead, they are scattered and, like light rays, "illuminate" a considerable area. To prevent scattered radiation from endangering operating personnel and others, x-ray tubes are encased in shockproof metal enclosures lined with lead. An aperture is provided through which the x-rays can emerge in the desired direction.

Tubes for low-intensity or soft x-rays are made with special windows to permit the radiation to escape with little loss. A window is usually either an exceptionally thin area in the glass or an insert of beryllium metal. Beryllium has the characteristic of being transparent to x-rays, just as clear glass is to light.

The high voltage applied to an x-ray tube is expressed in peak kilovolts (rather than r.m.s.) and is abbreviated k.v.p.

Circuits

An elementary circuit for an x-ray machine is shown in Fig. 4. Basically, it is simply a power supply designed to furnish the filament and plate voltages needed to operate the x-ray tube. The principal components, other than the x-ray tube, are an autotransformer, a high-voltage transformer, a filament transformer and, sometimes, a rectifier unit with one or more rectifier tubes. The autotransformer (so called because both primary and secondary are combined in a single winding) permits the 220-volt source to be varied in steps over a considerable range. The voltage thus selected becomes the input to the high-voltage transformer, which supplies plate voltage for the x-ray tube. In this way the plate voltage can be adjusted by adjusting the autotransformer.

The filament voltage for the x-ray tube is furnished by a low-voltage step-down transformer which provides from 4 to 12 volts at a few milliamperes. The secondary winding of the stepdown transformer is heavily insulated from the primary and from the iron core so that the high voltage to the x-ray tube will not get back into the supply lines of the machine.

The filament voltage is controlled by an adjustable iron core and coil in the primary circuit of the filament transformer. When the core is inserted all the way in the coil, its inductive reactance is high and a large part of the supply voltage is dropped across the coil instead of the transformer primary. When the iron core is withdrawn, the voltage drop is almost all across the transformer primary. A knob on the control panel usually provides this adjustment.

When only moderate power is handled, it is usual to employ self-rectification, in which the x-ray tube itself acts as a rectifier. The high voltage is applied directly to the x-ray tube, and the

anode becomes alternately positive and negative with respect to the cathode during each half-cycle. When the anode is positive, the electrons emitted from the cathode are attracted to it and there is current flow in the tube. When the anode is negative, the electrons are not attracted to it and there is no current flow. Self-rectification is common in portable, bedside, and dental units.

X-ray machines of greater power usually employ rectifier tubes to prevent the inverse voltage from being applied to the anode. The rectifier circuit and its operation are conventional. A rectifier tube absorbs little of the power that it handles, so the heating problem encountered with x-ray tubes is not present. More efficient circuits use four rectifier tubes for full-wave

handling. The control unit (right) is housed in a steel case and is connected to the power unit by means of a multi-conductor cable. The x-ray generator and tube are encased in a shockproof and radiation-proof steel tank weighing 55 pounds. The high voltage can be varied continuously from 30 to 100 k.v.p.

Some portable units employ *gamma* radiation from cobalt-60 instead of x-rays. Other materials (radium, thulium-170, iridium-192, cesium-137) are sometimes used, but cobalt-60 is popular because of its high-power continuous radiation. Cobalt-60 is produced in unlimited quantities by exposing cobalt to radiation in a nuclear reactor. Its characteristics are subject to change with age. Its half-life is 5.3 years, indicating that the original intensity de-

beam cannot be varied to suit the requirements of a particular job.

Maintenance

X-ray circuits are relatively simple and straightforward. Most difficulties result from the exceptionally high voltage and heat. While maintenance procedures will vary with individual units, certain principles are common to all and can be used for general guidelines.

It is good practice to check the operation of an x-ray machine whenever the x-ray tube has to be replaced. As far as possible, the circuit is examined without connecting the high voltage. Whenever the high voltage is on and the x-ray tube is operating, the technician must be especially careful to avoid exposure to radiation. This means keeping clear of the active beam and also making sure that all shielding is in place. Furthermore, when it is necessary to check an operating machine, it is good practice to observe the one-hand-in-the-pocket rule to minimize the chance of having the body form part of a circuit for the high voltage. Some x-ray machines use an arrangement of capacitors to aid in building up the high voltage; when these are encountered, care must be taken to discharge them before touching the high-voltage circuit, even when the machine is not operating and is disconnected.

Arcing in the high-voltage section, a problem familiar to all television technicians, is even more of a problem in x-ray since the high voltage is many times greater than in television. Arcing may appear in a cable insulator, a socket, or in a rectifier tube. It can trip a circuit breaker, and the trouble may be attributed to a defective x-ray tube unless the cause is discovered.

An examination of the tube to be replaced will often uncover a defect in the equipment or the way it has been operated. Early failure may be due to any one of a number of causes. If the tube seems otherwise in good condition but is filled with oil, the trouble may be a puncture, probably caused by overload, excessive voltage, or instability. A cracked or broken tube would suggest careless handling. Filament burn-out would indicate a check of the filament boost circuit. Target damage would point to work overloads, such as too long or too heavy an exposure, or an excessive number of exposures without time to cool. Stationary molten spots on the target of a rotating-anode tube would indicate that the motor or motor-control circuits are faulty.

A check may show that it is necessary to advance the filament voltage of the x-ray tube to a higher value than specified to obtain a certain current in the x-ray tube. When this occurs it may indicate a loss of emission in the rectifier tubes which, in turn, limits current flow in the x-ray tube. The remedy is to operate the rectifiers at a higher filament voltage or (usually) to replace them.

Most other checks are routine circuit-tracing that any good radio or TV technician can handle without difficulty. ▲

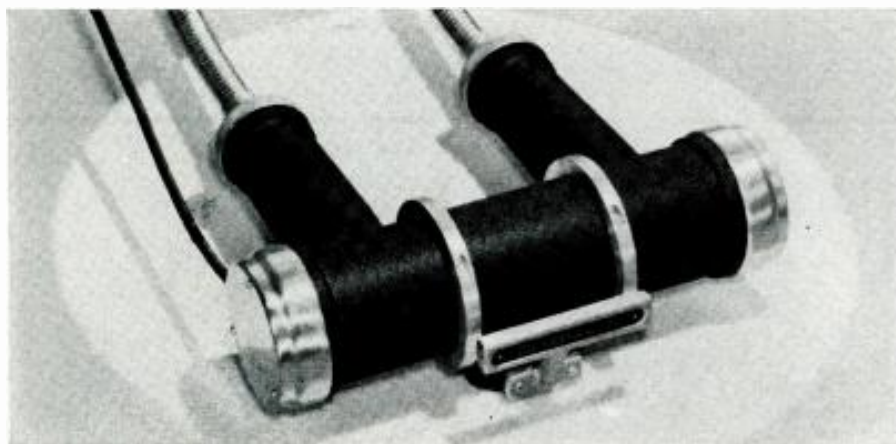

Fig. 5. A rotating-anode x-ray tube that can handle a high voltage of 100 peak kilovolts, made by Machlett Laboratories. It is suitable for general diagnostic service.

rectification, in order to utilize the inverse voltage.

Unlike other electron tubes, the operating voltages of x-ray tubes are adjusted for each individual job. When the voltage is increased on the filament, the effect is to cause more electrons to be emitted. This is equivalent to providing greater illumination, and the process can be visualized as increasing the brightness. The variations in the intensity of rays passing through the subject is not changed, however, so contrast remains the same. Since x-rays, like light rays, travel in diverging straight lines, the brightness can also be increased by moving the tube closer to the subject. Numerically, the variation is inverse with the square of the distance, so brightness is increased four times by reducing the distance by one half.

Increasing the anode voltage increases the penetrating power of the x-rays. However, it also results in a decrease in contrast, so the kilovoltage is not increased beyond the point needed to achieve the necessary penetration.

Portable Equipment

Special lightweight equipment that can be moved readily from place to place is valuable for use around airplane factories, shipyards, and similar places to inspect welds, joints, and parts during construction. The apparatus shown in Fig. 6 is made in two pieces for easy



Fig. 6. Portable x-ray apparatus of this type is common in industrial radiography.

clines to one half in that period.

Gamma-ray radiographic equipment is contrived so that the cobalt-60 capsule can be remotely withdrawn from its protective canister, exposed for any desired time, then drawn back into the shielded container. It is effective for x-raying even the heaviest castings when exposed for a sufficient period. About 15 minutes is normally needed to x-ray a 6-inch steel casting.

Gamma-ray apparatus has the advantage that no power supply is needed and it is therefore easily portable. The chief limitation is the fact that, unlike x-ray apparatus, the intensity of the

COAST-TO-COAST TV IS 10 YEARS OLD

Today's 93,000-mile network carries programs via microwave radio relay and coaxial cable to some 500 television stations in more than 300 cities.

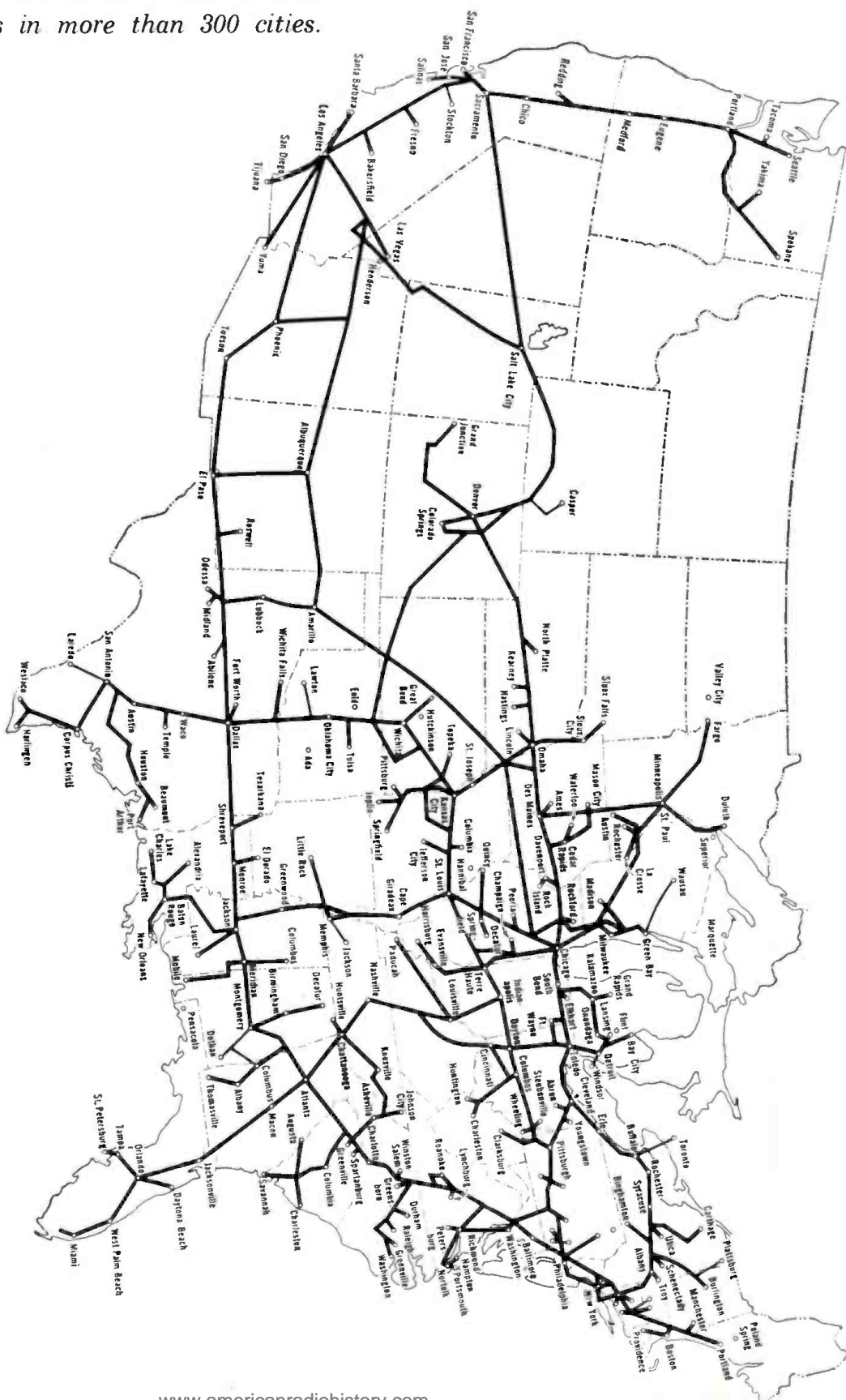

Coast-to-coast television became a reality a little more than ten years ago. On Sept. 4, 1951 an audience estimated at over 40 million viewed the first live telecast broadcast across the nation—President Truman's opening of the Japanese Peace Treaty Conference in San Francisco. The event was made possible by a transcontinental microwave radio relay system built by American Telephone and Telegraph Co. The program was fed simultaneously to 94 TV broadcasting stations in 52 cities.

At present, a program could be transmitted to some 500 TV stations and viewed at the same time in more than 300 cities across the land. Today, microwave radio relay and coaxial cable—in addition to supplying thousands of

circuits for telephone conversations and other transmission—provide some 93,000 miles of television circuits as shown on the above map.

The pioneering transcontinental microwave route initially offered only one TV pathway and 180 voice circuits. Today there are 12 coast-to-coast TV circuits over microwave and coax cable. The latest type of microwave system, recently added to one section of the transcontinental route, can transmit as many as 11,000 telephone conversations or 12 television programs at the same time.

A microwave link will also serve for future space communications. An orbiting satellite will serve as microwave relay station in the Bell System's space communications experiments planned for next year.

transistorized citizens band converter/

By T. C. SOWERS

A printed-circuit 2-transistor converter for the car's broadcast radio that permits it to pick up CB signals.

THIS article will describe the circuitry, construction, and operation of a transistorized converter for mobile reception of the 11-meter Citizens Band. The converter is crystal-controlled, constructed on a printed-circuit board, and has a built-in power supply.

This transistorized converter will work equally well with 6- or 12-volt automotive battery systems. The only necessary connection to the auto radio is a short piece of coaxial cable from the converter to the antenna jack of the radio. The regular broadcast antenna may be used with the converter but a whip of the proper length will give much better results.

The printed-circuit board is not difficult to make and the constructor should not encounter any problems if he follows the simple instructions given in this article. The entire converter was designed with the Citizen Bander in mind who wants the experience of building some of his own equipment. The project will give the builder experience with transistor circuitry, making printed-circuit boards, and the satisfaction of constructing a useful piece of gear.

The converter oscillator stage is crystal-controlled with a 26.3-mc. third-

overtone crystal and uses the car broadcast receiver as a tunable i.f. amplifier. The Citizens Band channels are selected by using the normal tuning knob on the auto receiver. Channel 1 is found near 660 and Channel 23 near 1000 on the receiver dial. The entire Citizens Band covers slightly less than .3 mc., therefore only one-third of the radio dial is used to tune the complete band. The converter may also be used with the auto radio for receiving the 10-meter amateur band. To receive this band requires changing the crystal to a 28-mc. third-overtone type and adjusting the slugs in the mixer and oscillator circuits. The auto receiver will tune 28.5-mc. at 500 and 29.5-mc. at 1500 on the dial.

Those who have an old auto radio available and have made or can make the a.c. conversion will find that, if used with the transistorized converter, it makes an ideal Citizens Band receiver for the start of a base station. The coaxial cable is the only necessary connection to the receiver, as was the case with the mobile installation.

The Circuit

The ready availability and the grati-

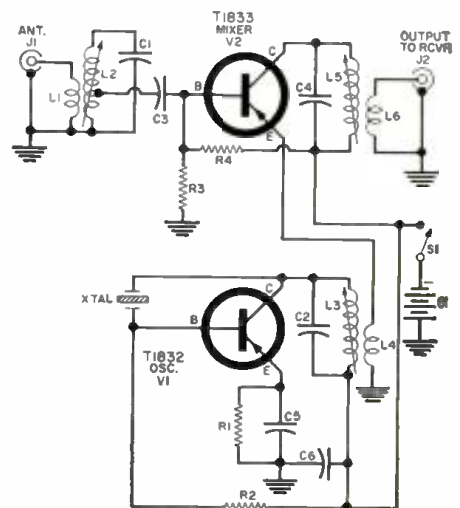

- R₁—1000 ohm, ½ w. res.
- R₂—470,000 ohm, ½ w. res.
- R₃—5600 ohm, ½ w. res.
- R₄—82,000 ohm, ½ w. res.
- C₁, C₂—10 µf, disc ceramic capacitor
- C₃, C₄—0.005 µf, disc ceramic capacitor
- C₅—27 µf, disc ceramic capacitor
- C₆—0.01 µf, disc ceramic capacitor
- J₁—Coax connector (Amphenol SO-239)
- J₂—RCA phono jack
- S₁—S.p.s.t. slide switch ("on-off")
- B₁—9-volt battery (Argonne BA-2, RCA-VS312)

- Xtal.—26.3 mc. third-overtone crystal
- V₁—"p-n-p" transistor (Philco MADT T1832)
- V₂—"p-n-p" transistor (Philco MADT T1833)
- I—3½" x 2¼" x 1½" chassis box.
- I₁—Crystal socket (National CS-7)

L₁—2 t. #28 en. wound over ground end of L₃.
Use small strip of plastic tape between windings.

L₂—25 t. #28 en. wound on ¼" Cambridge Thermionic coil form No. PLS6-2C4L/0. Tap 8 t. from ground end.

L₃—Same as L₂, but without tap.

L₄—Same as L₁, over ground end of L₃

L₅—1 mc. coil (Cambridge Thermionic Type LSM)

L₆—35 t. #36 en. scramble wound on L₅. Leave ¼" space below L₅ and wind to cover approx. 3/16".

Note: Coils L₂ and L₃ are both closewound. The tap on L₂ is made by twisting ¼" of coil wire at the appropriate place for the tap. The twist is then stripped by holding twist in a match flame and finishing with fine steel wool or emery paper. After stripping, the twist can then be solder tinned.

Fig. 1. Circuit of the CB converter. The entire Citizens Band is tuned over about one-third of the car set's tuning range.

Entire converter is built into a 3½" x 2¼" x 1½" chassis box as shown.

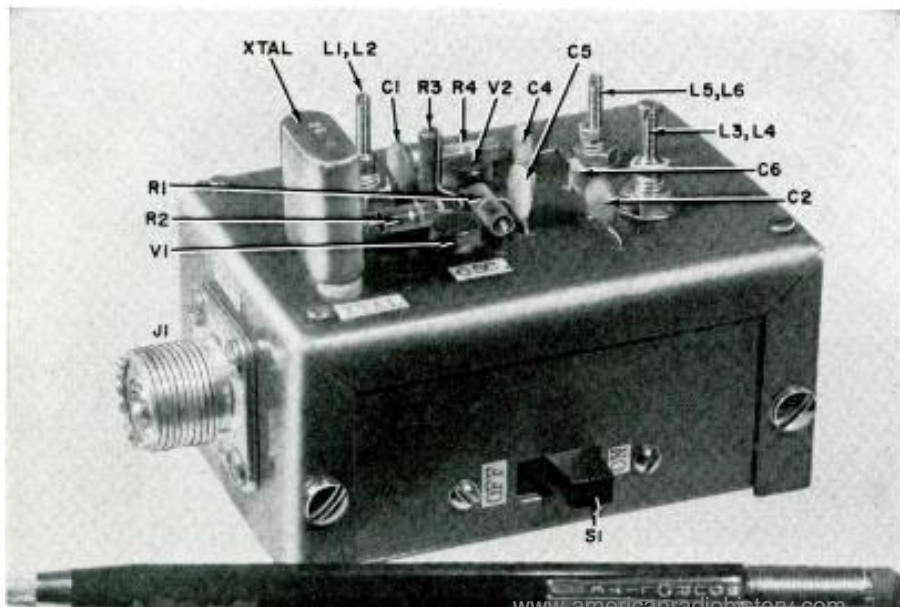

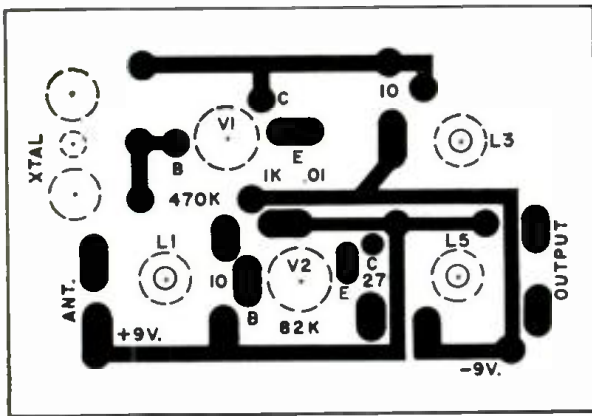
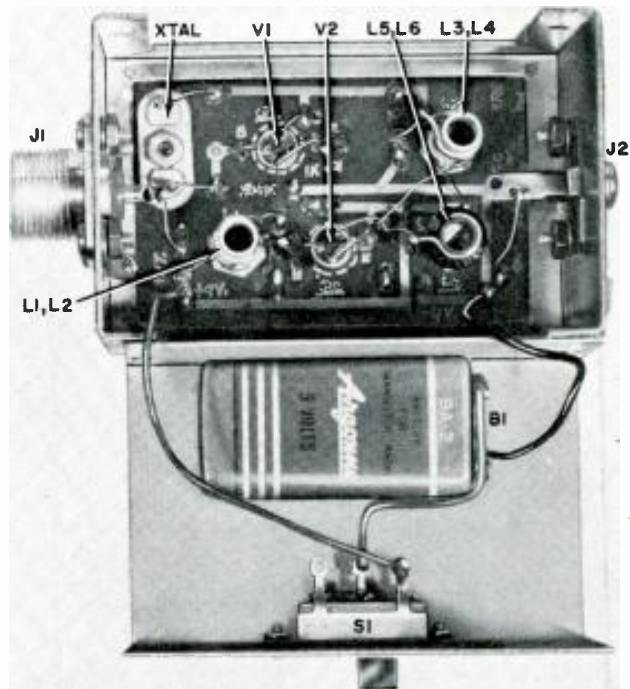

Fig. 2. This is a full-size template for the printed wiring board used by the author. A few of the parts values have been indicated to show the relative placement of the parts. Location of the coils as well as the emitter (E), base (B), and collector (C) terminals of the transistors have also been indicated. If the constructor does not wish to use the printed-wiring technique, more conventional point-to-point wiring may be used.



Chassis box has been opened up in this view in order to show underside of the printed board and the location of battery.

fyng decrease in the price of good high-frequency transistors, such as the Philco MADT types, make it possible for the amateur and experimenter to use these devices in high-frequency communications circuitry. The Philco MADT units will oscillate at well over 500 mc. and are being used in TV tuners and converters in the 420-mc. range. The transistorized converter described here uses two of the MADT transistors—the T1832 as an oscillator and the T1833 in the mixer stage.

The oscillator circuit is a transistorized version of the popular Pierce oscillator. The frequency of oscillation is determined by the values of L_3 and C_2 which comprise the collector tank circuit. Exact control of the frequency is maintained by the crystal in the base-collector circuit of V_1 . Crystals of the third-overtone type are used in the oscillator portion of the converter. Emitter stabilization is provided by resistor R_1 from emitter to ground.

The mixer circuit is conventional, utilizing injection voltage from the oscillator. The injection for the mixer is taken from L_2 by the link coupling of L_4 . L_4 is two turns of #28 wire wound over the ground end of L_2 .

From the schematic diagram of Fig. 1 it can be seen that the signal appearing at the antenna is link-coupled from coil L_1 to L_2 . The signal is then fed to the base of transistor V_2 from the tap on L_2 . A portion of the oscillation voltage is link-coupled by L_4 from L_2 to the emitter of V_2 and mixed with the incoming signal. The collector circuit of the mixer transistor is tuned by L_5 and C_1 to the frequency of the auto radio. This signal is then link-coupled through L_6 and transferred by coaxial cable to the antenna jack of the auto radio.

The circuit board, which is used in place of a chassis, should be made first.

There are many techniques and processes for making printed-circuit boards but the one to be described is probably the easiest for those without previous experience in this type of construction. No one should encounter difficulties if instructions are followed closely. Many of those constructing this converter will find that the making of printed-circuit boards opens up a whole new field for future construction projects.

The etchant used is not dangerous, but some care must be exercised to avoid staining your hands or the kitchen sink. Follow the instructions on the bottle and never attempt the etching process in a metal pan of any type. The author always uses a glass or plastic dish as the etchant will affect most metals and this will tend to weaken the solution. The four things you will need for the job are: (1) copper-clad laminated board $2\frac{1}{8}$ " x 3" cut from 3" x 4" piece—#MS-512; (2) tape resist $1/16$ " x 320"—#MS-735; (3) ball-point liquid resist tube (black)—#MS-728; and (4) a 6-ounce bottle of etchant—#MS-729. Although the materials for the printed-circuit board made by the author were purchased from Lafayette Radio (the catalogue numbers are theirs), other large electronics parts dealers also handle suitable materials for making printed circuits.

Two methods for laying out the circuit board are described in this article. The first method, which is the simpler, involves tracing Fig. 2 onto the copper while the second method involves placing the components and applying the resist tape and ink point-to-point.

The first method consists of taking the $2\frac{1}{8}$ " x 3" copper-clad board with the copper side up and placing a piece of carbon paper on top. Place Fig. 2 over the tracing paper and keep the 3 pieces together with cellophane tape.

The diagram of Fig. 2 is drawn to scale and may be used as a template.

Trace all holes for transistors and the crystal socket, then make the small dots representing the component connections. Run a single line for all connecting bars from dot to dot, as shown in Fig. 2. Trace small circles at points shown for mounting the three coils. Any printing that is to appear on the board may be lettered with a sharp pencil. If the printing is clear, it will etch well with the rest of the board. After the tracing is completed, apply the $1/16$ " resist tape for all connecting bars and use the ball-point pen for applying resist ink for small dots on the ends of the connecting bars. Use special care in applying the resist ink from the ballpoint tube. The dots should be neat and not touching each other as the etchant will only clean away copper that is not covered.

The second method is described for the benefit of those who may want to make the circuit board larger or smaller than that shown in Fig. 2. Starting with the basic board, drill holes and temporarily mount transistors, coils, and the crystal socket. Apply the resist tape and dots point-to-point, following Fig. 2 as closely as possible while still permitting enough space for mounting resistors and capacitors.

After the resist tape and dots have been applied, press the resist tape firmly with the head of a small nail, being careful not to smear any of the printing that was made on the board with the carbon tracing. When the resist ink is dry, the board is ready for etching.

Pour etchant solution into a suitable glass or plastic bowl and immerse the circuit board, copper side up. Agitate the circuit board slowly from time to time using a small wooden stick. The circuit board should be removed several

(Continued on page 94)

ELECTRICALLY OPERATED SWITCHES

By KENNETH BRAMHAM

Ranging from simple circuit breakers to electronic networks, they may use relays, vacuum tubes, thyratrons, or transistors. Characteristics of the various types.

ELECTRICALLY operated switches are the most important components in industrial and accounting electronics today. The familiar circuit breaker and the most elaborate "electronic brain" are both electrically operated switches. The circuit breaker must switch off a circuit when its current reaches a given maximum; the "electronic brain" must perform a multitude of switching operations to search for information, add, store new information, and finally switch on the correct electromagnet to operate a typewriter key or high-speed printer.

Vacuum tubes, soft tubes (thyratrons), relays, and transistors are all used as electrically operated switches. Each has its own characteristic advantages and disadvantages to make it more suitable for some applications than others. All have in common the ability to switch a much greater current than the input current controlling the switching. This of course is the equivalent of amplification.

An ideal switch responds instantly to its control voltage, has infinite resistance when "off," and no resistance when "on." In a practical switch these ideal conditions are never realized, but some of them may be approached closely at the expense of others. In every switch appli-

cation, the relative importance of each ideal condition must be considered and the most suitable type of switch selected. Compromises must often be made, as in the many cases where low contact resistance is sacrificed to gain switching speed. Concessions may be necessary in order to use one type of switch throughout an installation for the sake of standardization. In some cases, concessions are made merely to allow the words "transistorized" or "electronic" to appear in the advertising.

Plotting the control voltage or current, and the voltage or current being switched, enables us to compare the characteristics of different switches. Fig. 1A shows this graph using control or input voltage V_i and the voltage across the load V_L , for an ideal switch. Both input and output graphs are identical in time and shape, but not in amplitude. (Ideal amplitudes are not practical to portray, as the input voltage would be extremely small.)

Taking a "telephone type" relay as our first example and assuming the input voltage to be suitable for the relay coil, we see the resulting input-voltage and load-voltage graphs in Fig. 1B. There is a time lag due to electrical and mechanical factors after the input voltage is applied until the output contacts

close. First, the inductance of the coil does not allow an immediate surge of current; the current in the coil, building up the magnetic field, is opposed by the back e.m.f. generated in the coil. The current in the coil and field build up exponentially until a steady state is reached, and then the current is determined by the resistance of the coil wire and the input voltage across it. Mechanical delay is introduced by the mass of the moving parts (armature and contact assembly) and the friction of the pivot bearings.

The total delay in this type of relay is from five to ten milliseconds to the first time the output contacts close. Now the energy due to momentum in the moving parts must be absorbed if the contacts are to remain closed; but, as all this energy is not absorbed, the contacts bounce open before being closed again by the field. This happens four times in our example, each time for a shorter open period, as the bounce distance decreases, until finally the output contacts come to rest.

Once the contacts are at rest, virtually the full supply current is available at the output. This is shown in the graph by the load voltage (V_L) being almost equal to the supply voltage (V_s). The contact resistance is negligible for most applica-

Fig. 1. Simplified input and output voltage waveforms for six common switches, showing differences in response of the output circuit to similar inputs. Waveforms have been drawn to heighten distortion and other output characteristics.

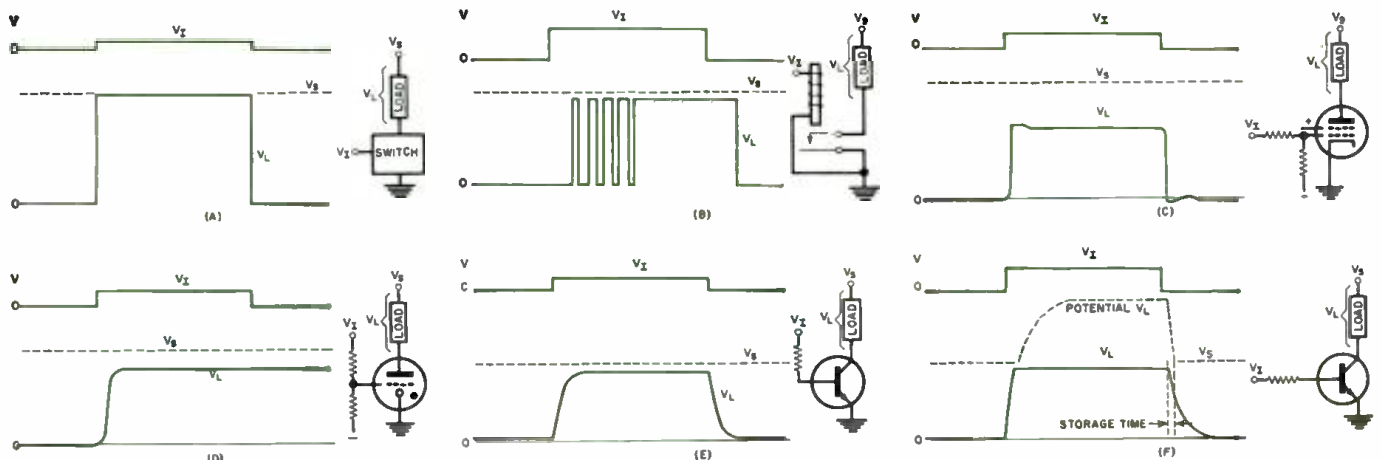

tions—providing the contact surfaces are in good condition. In use, a layer of oxide may form on the contacts and gradually increase the contact resistance, reducing the available output. Correct choice of contact material for the current and voltage to be handled, plus occasional cleaning, will overcome this problem in all but very low voltage circuits.

When the input voltage falls to zero, a time lag is again seen on the graph of Fig. 1B. First the energy in the magnetic field must be dissipated and then the mechanical factors must be overcome. The electrical portion of this delay can be varied over a wide range by introducing different circuits across the coil to slow the rate of energy dissipation in the coil. The mechanical factors are less predictable, being dependent on such matters as spring tension, lubrication, and temperature.

Other relay types have characteristics slightly different from the one shown. All have delay to a greater or lesser degree, and almost all but the mercury-wetted types exhibit a certain amount of contact bounce.

Vacuum tubes used as switches have an advantage over relays in speed and sensitivity. No mechanical parts are involved and inductance is negligible but, because of this, the circuit capacity (which can be neglected in the relay) now becomes the limiting factor in switching speed. Because grid (input) current is not needed in most applications, sensitivity is very high. For example, a voltage change of only 4 volts ($-5v.$ to $-1v.$) and negligible current will switch a 6AU6 from cut-off to deliver 10 ma.

The voltage-time graph of a typical vacuum-tube switch is shown in Fig. 1C. Although the input is again a square wave, the output has become slightly distorted, and it does not cover the full range of available current. The inter-electrode capacity of the tube, plus the capacity introduced by wiring, combine with the plate and load resistances to introduce slight delay in the output. If this delay were constant over a wide frequency range, all the frequency components in the output would be delayed equally and delay—but not distortion—would be the result. As this is not the case (unless special peaking circuits are employed), the delay varies across the frequency range and the result is a distorted output.

The plate resistance reduces the available output well below the level of the supply voltage and causes heat to be dissipated in the tube. This heat dissipation leads to a size problem, as large tubes must be used to handle currents of more than a few milliamperes. Against this, we have the advantages of speed and safe, reliable operation at relatively high voltages.

Thyratrons (multi-element, gas-filled tubes) are slower-acting than vacuum tubes, but have the advantage of lower resistance once they are switched on. A typical graph for a thyratron switch is shown in Fig. 1D, where some delay and a slight rounding out of the V_o curve are noticeable when the tube is switched on. This delay and distortion is due primarily to two characteristics of the tube, the inter-electrode capacity and the time taken to ionize the gas. The ionization phenomenon starts in the region between cathode and grid when the grid is made positive and spreads rapidly through the tube in an "avalanche," comparable to the breakdown of a zener diode. The low-pressure gas that, in its normal state, is an insulator, becomes a conductor when ionized to close the switch circuit. Gas pressure and the type of gas used determine the ionization time, which may be a fraction of a microsecond or several microseconds.

The most obvious difference between the thyratron and other switches is the "switch-off" characteristic. Once the tube has fired, the grid has no further control over the tube: the only way to restore it to an "off" condition is to remove the anode voltage for sufficient time to allow de-ionization. This may

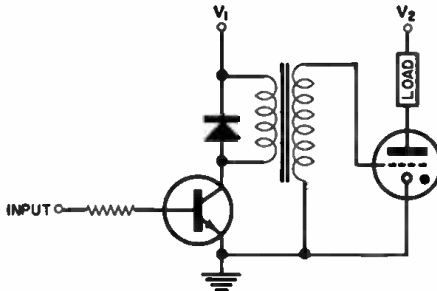

Fig. 2. A combination transistor and thyratron switch used to couple systems that have different supply voltages.

be from 1 to 10 milliseconds, depending on gas type, pressure, and temperature.

A switch that can be turned on but not off by its control element may seem to have very little use but, in fact, it is quite practical for many applications. Only a short pulse on the grid is needed to switch the thyratron on for an indefinite time; this can be used to advantage where a "hold" function is needed. To duplicate this effect and hold other types of switches "on," a flip-flop circuit must usually be used. This requires a minimum of two switch components. In another mode of operation, the thyratron plate is supplied from an a.c. or pulsating d.c. source that switches off the tube on each cycle and on again only when a voltage is present at the control grid.

Transistors, like vacuum tubes, are used both as signal amplifiers and as switches. The same transistor type may sometimes be used for either purpose but it is more likely that "steep-slope,"

special-purpose tubes or transistors would be used for switching applications. The requirements of a signal amplifier are that the output shall follow changes of input voltage or current very closely, while the switch requires only two states of output: "off" and "on."

Two basic switch conditions are used in transistor circuits, the low-level switch and the saturated switch. To simplify these conditions, the low-level switch can be regarded as being supplied with just the right amount of input drive current to give the required output current, while the saturated switch's input is overdriven. If, for example, the *beta* (current amplification factor) of a transistor is 20 and the required output is 200 ma., the low-level switch circuit would be supplied with 10 ma. to the transistor base in a grounded-emitter circuit. The same transistor used as a

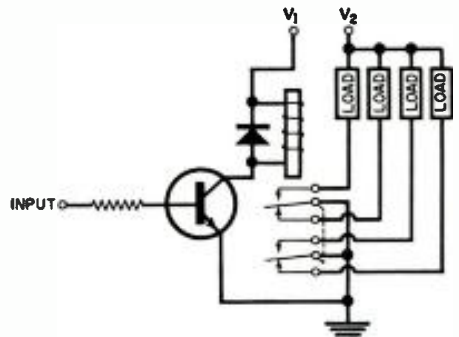

Fig. 3. Common office-machine combination. Transistor switch controls relay which, in turn, switches multiple loads.

saturated switch would be supplied with about 20 ma. to the base, twice the amount needed.

At first glance, it may seem that we are wasting the potential gain of the transistor by saturating it. There are, however, advantages to offset the reduced gain. First we have the advantage of reliability and non-critical circuitry. The output current is limited only by the load. Variations in transistors or input circuitry must be quite large to have any great effect. Another advantage is faster switching to give a much shorter rise time, although a delay is introduced in the switch-off conditions due to "storage time" (the time needed by a semiconductor to become unsaturated).

The input and output voltage-time graphs for an unsaturated switch are shown in Fig. 1E and those for a saturated switch in Fig. 1F. The improved rise time and the delay due to storage time are seen in comparing these graphs. The broken-line graph in Fig. 1F shows the unsaturated state that would exist if the output voltage (V_o) across the load were not restricted by the supply voltage (V_s) and the same input current were supplied to the base. This unsaturated curve is useful in determining the saturated values of rise and fall time and

(Continued on page 87)

By JOHN T. FRYE



Industrial Sampling

"HEY, MAC, what's so interesting about that booklet you're reading?" Barney asked his employer. "You've been goofing off with it for an hour while I sweat away here at the service bench paying the rent."

"Keep right on, Einstein; you're doing fine," Mac said as he took off his glasses and rubbed his eyes wearily. "This reading is heavy going because I don't know exactly what I'm doing. This morning the manager of that new defense plant west of town called me in and asked my advice about antennas for microwave communication equipment the plant intends to use in connection with some test work they're undertaking. It's a weird set-up. The whole thing is very hush-hush. In fact, I gather I was being consulted instead of a commercial communications engineer solely because of security reasons. I was told the frequencies to be used, the distances to be covered, the power of the transmitters, and the shapes of the transmitting antenna patterns required—that was all. I'm permitted to discuss the matter with you and no one else. You're to talk about it to no one except me."

"Just call me Zipper-mouth Barney, but why get tangled up in this in the first place? It's a long way from our work."

"That was my first reaction, too; but then I remembered an article called 'From TV Service To Industrial Electronics' that James T. Mendel authored in the September, 1961 issue of *ELECTRONICS WORLD*. In this article Mendel strongly urged qualified TV technicians to go into the field of industrial electronics. He argued the pay was better in the long run, there were more fringe benefits, the technician was under less constant pressure, and the work was more varied and challenging."

"You agree?"

"It would be presumptuous to agree or disagree without knowing more about industrial electronics than I do. But Mendel's article made me want to know more about the pasture on his side of the fence. That defense plant is chock-full of electronic gadgets, and this might be a toe-in-the-door for us."

"Then you do think we ought to get into industrial electronics," Barney insisted.

"I've always thought we should have a deep interest in all sorts of electronic equipment—you know that," Mac answered; "but quitting radio and TV service work entirely and taking a job as an industrial electronics technician is something else again—especially when, as in my case, this would mean changing from operating my own business to working for someone else. And incidentally, since you have such a soft-hearted, lenient employer, it's not much different with you."

"Soft-hearted like Simon Legree!" Barney scoffed. "I think it would be nice if we could do some of both."

"Exactly what I have in mind," Mac replied. "There're several comparatively small factories in this area using more and more electronic devices. Automation and its hand-maiden, electronics, is becoming quite a thing with these little plants. They have to use this equipment to compete price-wise with larger concerns, but they don't have enough of the equipment to warrant the full-time service of a qualified commercial electronics technician. They try to get by with the help of the plant maintenance personnel. These boys can take care of a simple trouble, such as replacing a bad tube; but they're lost when there is a serious breakdown in the electronic equipment—just as we should be lost if confronted with a tough job in their respective fields. When these men can't solve the problem, the plant manager has to call for help wherever he can get it—usually from the manufacturer of the device. That quite often means a long and costly wait during which, at best, the plant is deprived of the use of the device, or, at the worst, a whole production line may be shut down."

"And you're thinking that if he could just call us in and we could get the thing going again *my pronto*, it would be a great help to the plant manager, and it would mean money in our pocket and industrial electronic experience in our head."

"You're getting brighter all the time," Mac complimented. "I've been nosing around the past few weeks, and I'm confident we can get quite a bit of this work if we can handle it. An old school friend of mine is plant manager of that big relay and control factory on the far side of town. Of course this is a big factory, and they take care of their own equipment; but he gave me a lot of useful information on how the electronic equipment in their plant is handled. They have a complete electronics division within their maintenance group. This division is headed up by a college-trained engineer, but none of the technicians in the group are college-trained. Instead, an educational program is carried out right in the factory to train the technicians to handle the peculiar problems encountered in the manufacture of relays and controls. This electronics unit designs and builds electronic equipment, writes up installation and service manuals on it, and maintains the equipment."

"Where do they get these technicians?"

"Some come from our field; others come from the armed forces where they have received electronic training. My friend reports both groups are able to use their highly specialized training as a foundation for quickly acquiring the new knowledge needed in industrial electronics."

"You say they design and build a lot of their electronic equipment. Is this a usual practice in a large plant?"

"Yes. For industrial electronics to do the maximum job of which it is capable in a factory, many of the devices have to be tailored to the peculiar needs of that factory. Of course there are many counting, measuring, and sensing devices of universal application that can be bought ready for application; but there are many other cases where one of these devices must be modified to do a particular job or a completely new electronic apparatus must be built to do that job. I think this is an area in which we could be of great service to our small factory clients."

"You lost me," Barney admitted.

"I mean that if we really bone up on the electronic devices available for industrial application and if we familiarize ourselves with the operations in each of these small factories we serve, we should be able to (a) suggest where a piece of commercial electronic gear can be put to good use in the factory, or (b) design an electronic gadget of our own to do a particular job. In short, we could provide our clients with at least some of the advantages of having their own full-time electronics technician."

"I'm all for it," Barney said enthusiastically. "I'm not ready to give up radio and TV servicing yet—not with millions of sets that need servicing every year; but I'd like to know more about other branches of electronics and gain some experience working with various kinds of electronic devices. This scheme of yours would permit us to continue being our own boss in a field where we know we can make a living; yet we

(Continued on page 97)

MODULATED 10-KC. CALIBRATION OSCILLATOR

By RONALD L. IVES

Complete construction information on an accurate test oscillator that is able to provide tone-modulated check points on amateur and communications receivers.

CRYSTAL-controlled calibration oscillators have been regarded as a necessary part of most communications receivers for more than a decade and crystal calibrators of one sort or another are included in the armamentarium of almost every advanced electronics technician and engineer.

Unfortunately, the lowest frequency for which a crystal is commonly available is 100 kc. Although crystals for lower frequencies can be ground, they are extremely large and costly as the world supply of "optical quality" quartz crystals in the larger sizes is distinctly limited.

Because low-frequency crystals are not readily available, most needs for low-frequency standards are met by use of a relatively high-frequency crystal, which drives a chain of submultipliers—usually multivibrators, to produce the desired low frequency. The most common arrangement of this kind uses a 100-kc. crystal oscillator to drive a 10-kc. multivibrator, giving a 10-kc. output.

Many of the published circuits using this principle employ three triodes, one as a crystal oscillator and the other two as a multivibrator. This arrangement can be made to work, but is likely to "skip," giving an output of 9 or 11 kc.; and injection of an audio tone, to permit definite signal identification, is extremely difficult. Additional difficulty is sometimes experienced when the multivibrator "backfires" into the crystal oscillator circuit, altering its frequency.

All of these difficulties can be eliminated rather easily, using fairly conventional circuitry, so that a compact and dependable 10-kc. calibration oscillator, with optional audio modulation, can be constructed with standard components. The functional block diagram of this calibrator is shown in Fig. 1. The completed unit is shown in the photographs.

Basic Circuit

The functions of the various blocks in Fig. 1 are as follows: the oscillator produces an accurate 100-kc. sine wave. The submultiplier converts this into a 10-kc. square wave. The output tube isolates this square-wave circuit from the output load and permits insertion of an identifying audio tone, which is produced in the modulator.

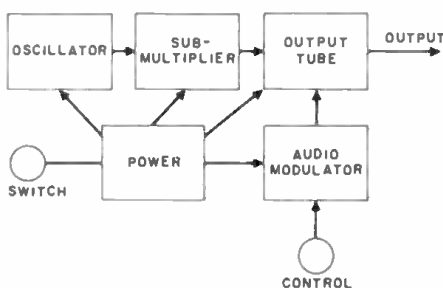

Fig. 1. Block diagram of calibration unit.

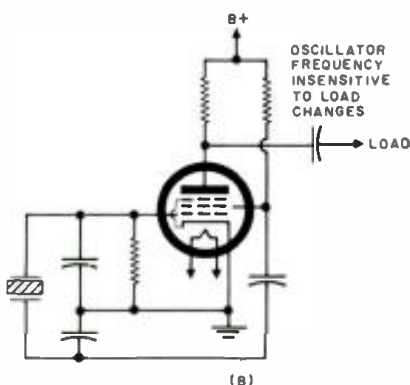
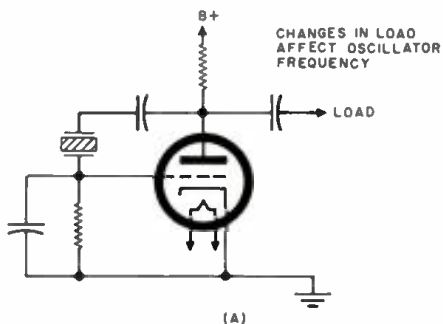
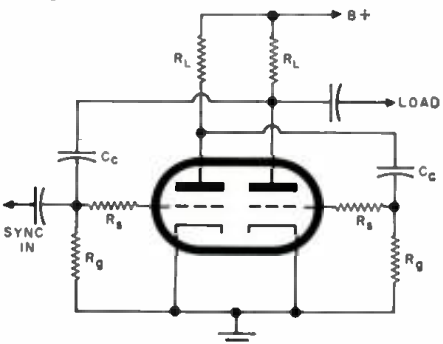

Fig. 2. Oscillator circuitry as described.

Fig. 3. The basic multivibrator circuitry.



Circuitry of the oscillator is so chosen that changes in the output load or injection of pulses at the output (from the submultiplier) do not affect the oscillator frequency. In a conventional Pierce oscillator (Fig. 2A), any change in the load characteristics or any pulse applied to the plate of the tube, as from a driven multivibrator, will have a definite adverse effect on the frequency stability. In consequence, isolation of the oscillator from the load is desirable. This can be done by use of a buffer amplifier or a cathode-follower, an effective isolation method that unfortunately requires another tube. A simpler and equally effective isolation method is by use of electron coupling, as shown in Fig. 2B.

Here the oscillator consists of the grid, screen grid, and cathode of the pentode, while the output is taken from the plate, which is coupled to the oscillator only by the electron stream in the tube. This method of coupling isolates the oscillator from the effects of changes in the load and from pulses externally applied to the plate circuit. Similar circuits are recommended by crystal manufacturers for use with precision calibration crystals.

The submultiplier here used is a symmetrical multivibrator, the circuit of which is shown in Fig. 3. Free-running frequency is determined principally by C_c and R_g , but the plate resistors, R_L , have a minor effect as does the plate voltage. Any coupled device, such as a synchronizing input or a load, becomes a part of the frequency-controlling circuit and must be compensated for by adjusting the other constants. If the load is inductive, or if it injects any sort of signal into the multivibrator, undesired outputs at spurious frequencies may result. It is for this reason that an output tube, which also permits injection of audio modulation, is desirable. The function of the series grid resistors, R_g , is to improve the waveform, producing more rapid rises and hence more useful harmonics.

The basic circuit of the output tube and audio modulator is shown in Fig. 5. The output tube is a conventional pentode amplifier with audio injection via the suppressor grid. The modulator proper is a conventional neon oscillator, with an output shunt capacitor, C_c , added to attenuate the higher audio harmonics.

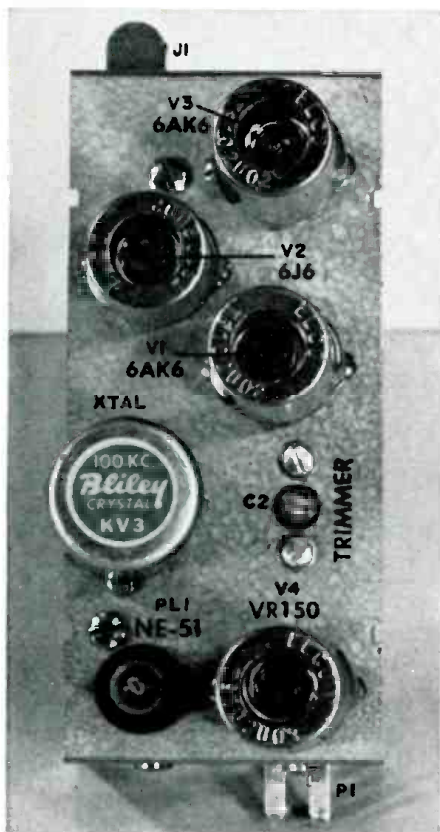

Top view of the calibration oscillator.

Because both frequency and power output are sensitive to changes in plate voltage, a regulated "B" supply is desirable with a calibrator of this type. A conventional 150-volt regulator tube performs this function satisfactorily.

By combining these elements, a consistently dependable calibration oscillator is produced. The circuit is shown in Fig. 6. Constants shown are those which worked consistently, but those in the crystal oscillator and output tube circuits are not at all critical. Five percent components are essential in the submultiplier circuit so that it will run at the desired frequency and these are suitable only because the multivibrator is controlled by the crystal oscillator, through the synchronizing coupling (C_1). Without this synchronization, the

Fig. 4. Behavior of submultiplier with and without sync input as constants are changed.

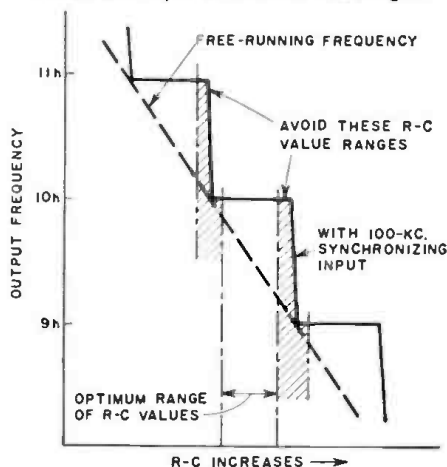

error in output frequency would be a direct function of the errors in the component values.

Construction

Construction is fairly simple and straightforward, as all frequencies involved are relatively low and there is no problem of critical lead dress. It is essential, however, that the oscillator be adequately shielded, to prevent interference with receivers as far away as several hundred feet or more.

A suitable enclosure for this calibration oscillator is an aluminum shield case approximately $2\frac{1}{4} \times 2\frac{1}{4} \times 5$ (LMB 108). All electronic components are mounted on the ends and face of the cover, and the base (also supporting the sides) is fastened to the chassis. Sockets used for V_1 , V_2 , and V_3 are Vector turrets, Type 8M12T, with S-7 shield shells. Pre-wiring of these, before mounting on the case, simplifies assembly greatly.

The output connector is made from a Weatherhead right-angle fitting (designed for automotive gas lines), to which has been added a miniature microphone connector (Switchcraft 5501-MP). This takes a shielded output cable, which is necessary to confine the calibrating signals.

Construction is facilitated if all holes

of V_2 to terminal 1 of V_3 . Next mount the turret for V_1 and connect coupling capacitor C_1 from terminal 5 of V_1 to the junction of C_3 , R_3 , and R_6 on the V_2 turret. This wiring and assembly procedure, using pre-assembled and pre-wired turrets and a definite order of installation, eliminates most "packing factor" problems and minimizes the number of tricky soldered connections.

Now, working toward the front of the chassis, mount all other components except the power input plug and R_{10} . Complete all possible wiring at this stage then mount and wire the power input plug and, finally, mount R_{10} and complete the plate wiring of the calibrator.

Wiring will be facilitated if a small tie-point is placed between the crystal socket (Millen 33102) and the socket for V_3 (Johnson 147-610). Insulation of the V_3 socket from the chassis by means of a $\frac{1}{2}$ " rubber grommet eliminates connection polarity problems. Other construction details can be seen in the photographs.

Testing

When wiring is completed and has been checked for errors, the calibrator is ready for testing. With all tubes and the crystal inserted in their sockets, connect power and let the calibrator warm

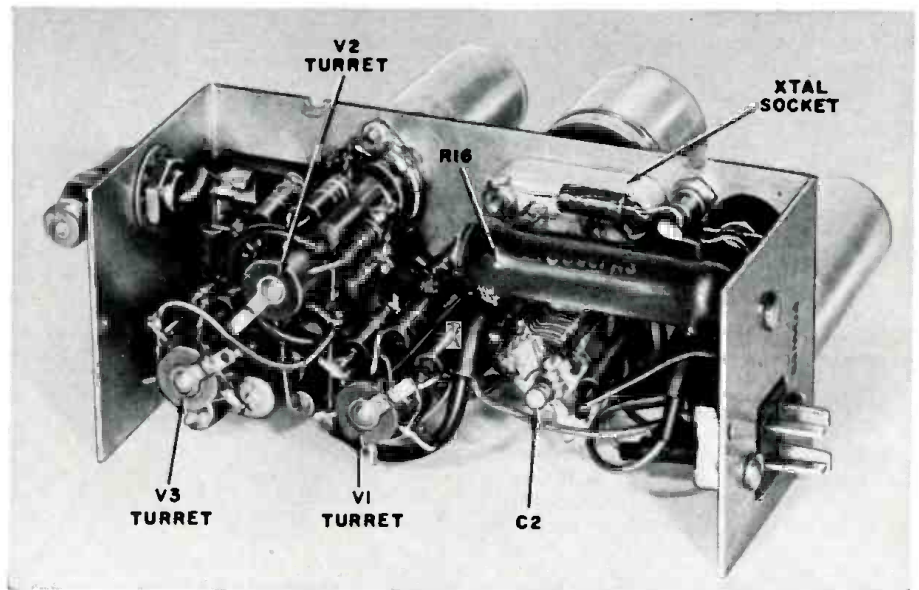

Inside view showing the turret-socket construction employed by the author.

are drilled in the case before any equipment is mounted and all possible components are mounted on their respective turrets and pre-wired before the turrets are bolted in place. The output connector is mounted first, followed by the tie-point for the output capacitor, then the turret for V_2 . The output circuit can now be completed by connecting the output connector to the tie-point and the output capacitor (C_{10}) from the turret to the tie-point.

Connect two wires to each filament terminal of the turret for V_2 , then mount the turret. Connect one wire from each filament terminal to the filament terminals of V_3 and connect the coupling capacitor, C_1 , from terminal 2

up for a few minutes. Output should be very close to 10 kc. and should be a symmetrical square wave.

To align the output exactly, remove V_2 from its socket so that the output is the amplified output of the crystal oscillator. Beat this with WWV as received in any convenient manner and adjust C_2 for zero beat. Although an audible zero beat is adequate for most purposes, a true zero beat, as measured on an oscilloscope, is a bit better as few of us can hear beats below about 70 cycles.

Replace V_2 in its socket and beat the output with a series of broadcast signals picked up on any convenient receiver. If all is working well, zero beats will be noted at each standard broadcast station

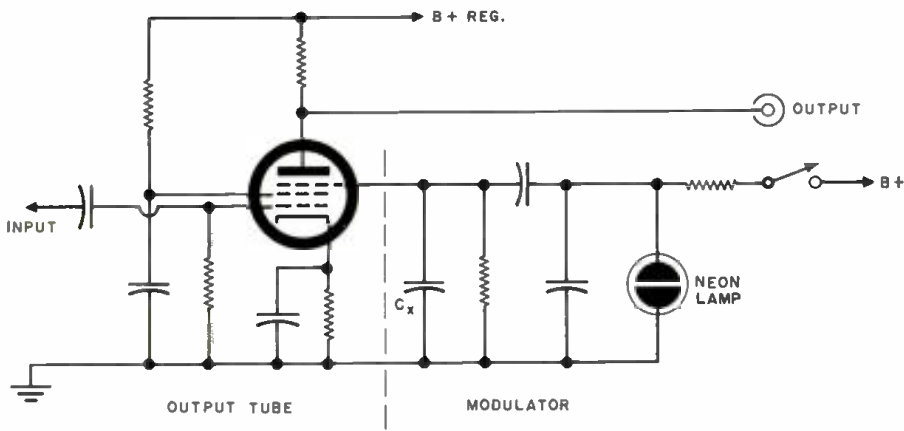

Fig. 5. The basic circuit arrangement of the output tube and the audio modulator.

and no further adjustment is necessary.

If deviant beats are noted, check for a resistor or capacitor in the submultiplier (V_2) whose value is off. Deviant beats are usually due to asymmetry in the square-wave output and this can be corrected by changing the value of C_6 slightly. Due to the injected synchronizing signal from the 100-kc. oscillator, the submultiplier will tend to "pull in" at 10 kc. through a wide range of RC values in the V_2 circuit, as shown in Fig. 4. This property of the multivibrator makes it possible to use components of medium precision to produce a high-precision output. As indicated in Fig. 4 and as demonstrated by experiment, the

free-running speed of the multivibrator should be about .95 of the desired synchronized speed.

The audio modulator, consisting of a neon lamp PL_1 and an RC network (R_{11} , C_{11} , C_{12} , and C_{13}), inserts an audio tone into the calibration signal when desired for identification purposes. The operating frequency, with the constants shown, is 350 cycles, with the higher harmonics suppressed by shunt capacitor C_{14} .

The 350-cycle modulating frequency was chosen because audio modulation "spreads" the calibration frequency by the audio frequency doubled, producing, in this case, a bandwidth of 700 cycles. Quite obviously, some other frequency

can be chosen, simply by altering the RC constants in the neon oscillator circuit, as frequency is an approximate function of $1/RC$.

Raising the modulation frequency, however, broadens the calibration signal and if the audio frequency, either fundamental or strong harmonics, exceeds 5000 cycles, a 10-kc. calibrator will give a continuous tone in the receiver, irrespective of tuning, and will not be very useful.

Regulated plate voltage is used throughout this calibrator so that switching transients and line noise will not enter the signal circuit and produce undesired deviant frequencies. With the regulation method shown, an electric drill can be operated from the same socket as the calibrator power supply without producing any changes in the output signal.

Coupling of the calibrator output to the receiver input should be very loose to prevent both interaction of circuits and overloading of the receiver, as the calibrator has a strong output at all frequencies up to about 50 mc. The circuit and constants shown in Fig. 7 appear satisfactory for most applications.

The control circuit shown in Fig. 6 is ideal for most installations. Here the toggle switch turns on both the plate and filament supply of the calibrator while the audio tone, used only for signal identification, can be inserted at will

(Continued on page 71)

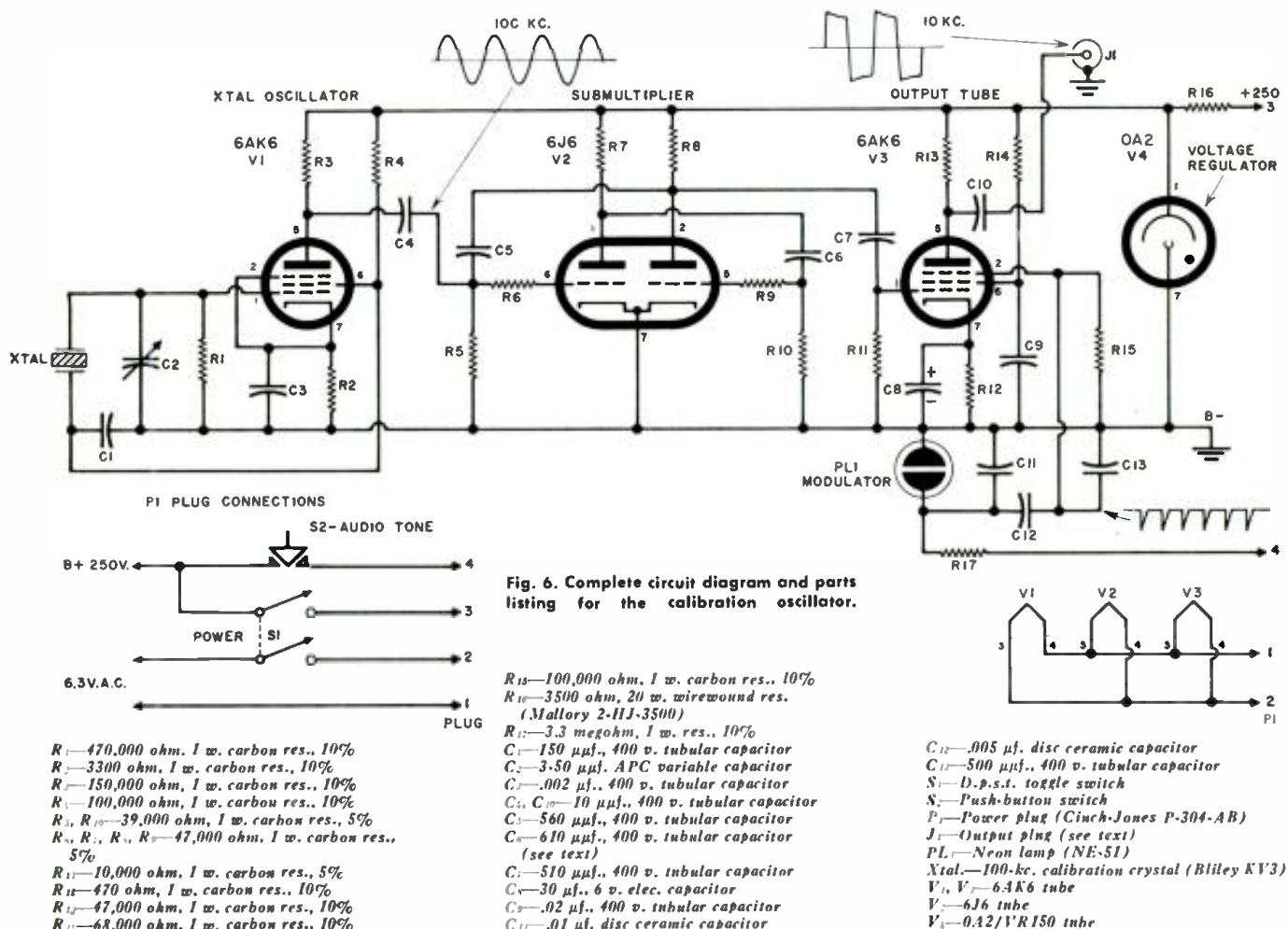

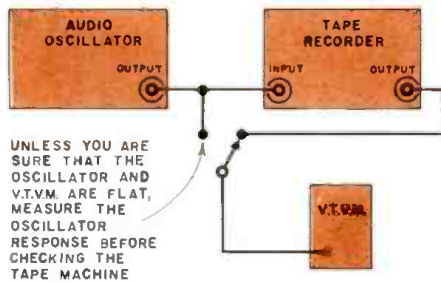

UNLESS YOU ARE SURE THAT THE OSCILLATOR AND V.T.V.M. ARE FLAT, MEASURE THE OSCILLATOR RESPONSE BEFORE CHECKING THE TAPE MACHINE

Fig. 1. Measuring the record-playback frequency response of tape recorder.

EVEN the simplest tape machine is a complex instrument and a variety of tests are required to assure that all is well; just one hitch can defeat the entire purpose of the machine. The most frequently used tests are covered in this article in general terms. It is desirable to consult the service manuals for specific instructions.

Tape recorder testing is not merely part of diagnosing and repairing faulty machines. When faithful reproduction is

expected of a tape recorder, performance checks are also part of the preventive maintenance that guards against "so-so" operation.

Inasmuch as certain tests are interdependent, an appropriate testing sequence may reduce one's work. To illustrate, one cause of poor treble response is improper azimuth. To have a correct picture of frequency response it is first necessary to be sure that azimuth is correct. Before checking azimuth one may wish to check vertical head alignment, because moving the head up or down will probably disturb azimuth. To illustrate further, treble response is also related to bias current and equalization. If frequency response is checked first and proves reasonably flat, this probably obviates the need for bias and equalization tests. On the other hand, this is not necessarily true, because compensating defects are possible, although unlikely; thus too little bias might be offset by too little treble boost in recording.

Before making any tests it is advisable to let the tape machine warm up for at least 15 minutes.

Record-Playback Response

The heads should be cleaned and demagnetized as the first step in frequency-response testing.

A speedy and effective check of record-playback response is to take a wide-range phono disc and A-B the tape against the record. Significant peaks and holes in response will be apparent.

An instrument check of record-playback response requires an audio oscillator and a v.t.v.m., as shown in Fig. 1. A v.o.m. may also be used if it has good frequency response. The oscillator and v.t.v.m. should each be flat within 1/2 db over the audio range. Barring this, the response measurement should be corrected for known errors of these instruments. Record a series of frequencies at constant amplitude over the audio range and measure the playback output. Record at least 20 db below maximum permissible recording level, as evidenced by the record-level indicator, otherwise the great amount of treble boost in recording will saturate the tape at high frequencies, causing a seeming loss of treble.

The recorded frequencies should be

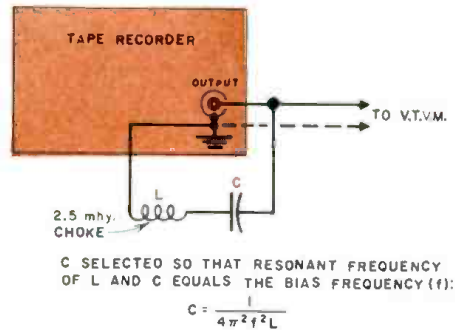

Fig. 2. Connecting a trap for bias signals across the output of a tape recorder that uses separate record and playback tape heads.

no more than an octave apart. A comprehensive test that will reveal any significant peaks or dips employs 10-cycle intervals from 20 to 100 cycles; 100-cycle intervals to 1000 cycles; and 1000-cycle intervals thereafter. A reasonably good picture of response at a saving in time can be had with these frequencies: 30, 50, 100, 200, 500, 1000, 2000, 3000, 5000, 8000, 10,000, 12,000 and 15,000 cycles.

The problem of frequency identification arises when the same head is used for record and playback. List the frequency sequence on paper and "mark" several key frequencies by turning the oscillator on and off rapidly at the start of each key tone. The key tones, serving as milestones, are preferably 100, 1000, and 10,000 cycles. In playback, several rapid, wide swings of the v.t.v.m. pointer will identify the key tones.

A machine with separate record and playback heads may present this problem: sometimes enough bias voltage is radiated to the output jack to obscure the audio signal. If so, shunt the bias frequency to ground through a series-resonant trap, as shown in Fig. 2. Given the oscillator frequency and using a 2.5 mhy. choke, the value of the capacitor is determined from the formula:

$$C = \frac{1}{4\pi^2 f^2 L}$$

In the case of a stereo machine, check record-playback response of each channel under two recording conditions: (1) with the other channel on and (2) with the other channel off. Response on one channel may change appreciably when the other is turned off, because of ac-

TESTING TAPE RECORDERS

By HERMAN BURSTEIN

Summary of the various tests used to check the performance specifications of a tape recorder.

companying changes in bias current.

Playback Response

Although the record-playback test proves response to be flat, this is no reason to omit the test of playback response. It can and does happen that a serious error in playback is compensated by suitable record equalization, yielding flat over-all response.

Playback response is checked by playing a standard test tape, such as the *Amper* 5563, at 7.5 ips and measuring the output signal with a v.t.v.m. The output must be simultaneously fed into a monitor amplifier and speaker (often present in the tape machine) so that the frequency announcements are heard.

If the output jack is preceded by tone controls, turn them to the position designated "flat" by the manufacturer. If there are outputs both before and after the internal power amplifier, measure response at the earlier location.

Equalization

To measure playback equalization, feed a very small signal into the playback head via its ground lead, which is temporarily lifted from ground, as shown in Fig. 3. Signal amplitude is measured at the output of the playback amplifier. Keep the input signal sufficiently low so that the maximum output signal (at the bass end) does not exceed 2 volts. A voltage divider at the input, as shown in Fig. 3, is advisable.

At high frequencies the output signal will be less than 100 millivolts, which may require a sensitive v.t.v.m. for clear and accurate measurement. If the v.t.v.m. is not sensitive enough, increase the input signal above 500 cycles and make a corresponding correction in the output measurement.

To measure record equalization, the technique of Fig. 4 is commonly employed. First, disable the oscillator by removing the oscillator tube. Temporarily disconnect the ground lead of the record head and place it in series with a 100-ohm resistor to ground. Feed constant-level signals from an audio oscillator into the tape recorder and measure the output voltage across the 100-ohm resistor. At 1000 cycles, the input signal should be about 15 to 20 db below maximum permissible recording level.

If the v.t.v.m. is not sensitive enough to give a clear reading, a 1000-ohm resistor can probably be safely used to provide a larger voltage output. The resistor must be less than one-tenth the impedance of the head plus other circuit elements (plate resistance of the driving tube and the "constant-current" resistor) in the audio range.

Azimuth

To adjust the gap of the playback head for maximum treble response, play a standard alignment tape bearing a prolonged high-frequency tone, such as 7500 or 10,000 cycles. Tilt the playback

head alternately to the left and right until maximum output is indicated by a v.t.v.m. connected to the output jack. Beware of "false peaks" which may occur on either side of the much larger true peak.

Some alignment tapes bear two tones. The lower frequency is used for preliminary adjustment of azimuth and the higher one for fine touch-up.

Azimuth alignment should be checked on both channels of a stereo head. Sometimes the two gaps are not exactly colinear and optimum alignment cannot be achieved simultaneously on both channels. It is then necessary to effect a compromise alignment, which results in about the same treble loss on both channels.

If the tape recorder has separate record and playback heads, the playback head is aligned first. The record head is adjusted for maximum output while simultaneously recording and playing back a signal of 10,000 to 15,000 cps.

Bias Current

Bias current can be checked by measuring the voltage across the record head and comparing this with the voltage specified in the service manual. However, this technique may lack the desired accuracy because bias current depends upon the impedance of the head, which varies with bias frequency and also with differences in inductance from one head to another of the same brand and type. A preferable method is to measure the voltage across a 100- or 1000-ohm precision resistor placed in series with the ground lead of the record head. Application of Ohm's Law indicates current.

In some recorders having a vu meter, the latter can be switched to indicate whether bias current is correct. Usually the meter is connected via a variable calibrating resistor to a resistor between the record head and ground. The calibrating resistor is set by the manufacturer so that zero vu corresponds to correct bias. From time to time it may be necessary to adjust the calibrating resistor itself on the basis of an alternate measurement of bias current.

For machines having separate record and playback heads and a bias control, the usual method of checking and adjusting bias is as follows. Adjust bias current to obtain maximum output when simultaneously recording and playing a specified frequency, usually 1000 cps at 7.5 ips. Sometimes the procedure calls for increasing bias current until output falls 1/2 db below the maximum. This tends to minimize the effect of slight changes in bias current upon treble response and distortion.

At a tape speed of 15 ips, one might indulge in the luxury of adjusting bias on the basis of minimum harmonic or IM distortion. Use a high recording level for sharp definition of the proper bias. A machine intended for 15-ips operation typically has variable recording equalization, which must then be adjusted for flattest response. Below 15 ips, the bias for minimum distortion causes excessive treble loss.

Distortion in the bias waveform produces noise in recording. Check for obvious distortion by placing an oscilloscope across the record head. Some tape oscillators include a balance control for minimum distortion. Adjust this control for least noise when simultaneously "recording" and playing a virgin or bulk-erased tape, but with no signal input and the record gain control at minimum.

Beat notes between harmonics of the audio signal and the bias frequency may occur if the latter is too low. But if the bias frequency is too high, the erase head may do a poor job. To check whether the bias frequency is at the

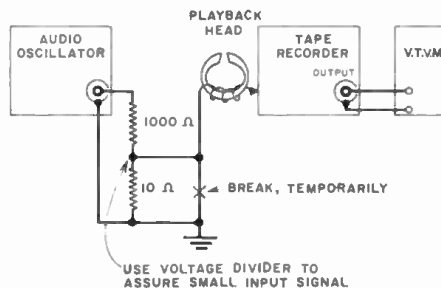

Fig. 3. Measuring the playback equalization.

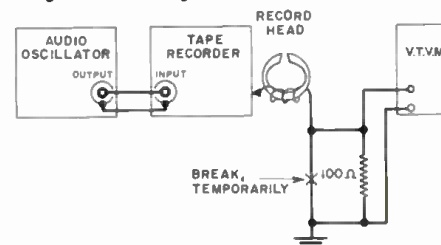

Fig. 4. Checking the record equalization.

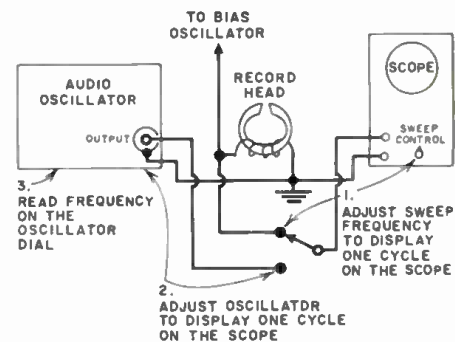

Fig. 5. Setup for measuring bias frequency.

optimum value specified in the service manual, follow the procedure of Fig. 5. Connect an oscilloscope to the record head to display one cycle of the bias waveform; keep the sync control low. Then connect the scope to a signal generator and adjust the frequency of the latter until one cycle is again displayed on the scope. The dial reading of the generator is the bias frequency. If an audio oscillator is used and cannot reach the bias frequency, do the following: obtain a four-cycle display at the record head, obtain a one-cycle display at the oscillator, and multiply the oscillator dial reading by four.

Vertical Head Alignment

The gaps of the record and playback
(Continued on page 99)

a **U.H.F.** *nuvistor tuner*

By AARON E. ZIMMERMAN, Sr. Engr., F. W. Sickles Div., General Instrument Corp.

A miniature triode that can oscillate at ultra high frequencies and renewed interest in this band have prompted reconsideration of front-end circuitry.

THE u.h.f. television band is once more the subject of comment in newspapers and magazines. This renewed interest has been fostered by the fact that the Federal Communications Commission is actively considering action to promote use of the band, including the possibility of transferring all television transmission to this frequency range. In fact, the agency is now carrying out air tests in New York City to evaluate u.h.f. transmission and reception in a metropolitan area and make comparisons with v.h.f.

With such prospects in mind, *General Instrument's F. W. Sickles Div.* has reviewed its past experience in u.h.f. tuner design. Out of this effort has come a new unit. No reasons were found for radical revision of the basic circuitry already developed. However, since that past effort, *RCA* announced the nuvistor. This device opened a way to overcome the major deficiency of exist-

ing u.h.f. tuners. A cooperative effort between the two manufacturers resulted in the development of a special u.h.f. nuvistor triode and a modification of the tuner to use the new device.

The Tuner Circuit

The design (Figs. 1 and 2) consists of two high- Q , end-tuned, coaxial transmission lines as r.f. preselectors and a vacuum-tube oscillator using another end-tuned, coaxial, transmission line. Tuning is accomplished by ganged, variable, air-dielectric capacitors (the three sections of C_1). The input is matched to a 300-ohm balanced impedance. Coil L_1 couples signal to the first preselector line. An interstage shield between the two preselectors has a hole in it, through which signal is coupled from the first to the second. A portion of loop L_2 , which lies parallel to the second preselector, then applies r.f. signal to the crystal mixer, a 1N82A diode.

Note that a small portion of the wire that makes up inductance L_2 projects through the shield into the oscillator compartment. Oscillator injection energy is picked up in this way, and also applied to the mixer, in common with the r.f. signal. The network at the output of the mixer, consisting primarily of C_2 and L_2 , is a tuned, unbalanced output for feeding a 43-mc. amplifier. While this output is at the intermediate frequency of the TV receiver, it is not fed directly into the i.f. strip. It is customary to couple it into the receiver's v.h.f. tuner which, in its u.h.f. position, is set up to serve as an added i.f. amplifier.

The means for controlling bandwidth differ somewhat from those used in lower-frequency r.f. amplifiers that are more commonly encountered. Three factors affect this characteristic and are used in combination to obtain the desired response. The coupling between antenna loop L_1 and the first preselector line is one of these. The size and location of the hole in the shield between the two preselectors is another factor. Finally, there is the coupling between the second preselector and L_2 , which is used to bring r.f. signal to the mixer diode.

The Tube Problem

Until recently, the oscillator tube in practically all u.h.f. tuners was in the -AF4A series. Transformer-powered receivers use the 6AF4A, while the 2AF4A (or B) and the 3AF4A (or B) are used in 600-ma. and 450-ma. series-heater circuits respectively. Although performance of these vacuum tubes, which were designed specifically for the job, was otherwise satisfactory, they exhibited one serious drawback: life in use is relatively short, with frequent replacement being required.

In March of 1959, *Radio Corp. of America* announced the nuvistor. In construction and appearance, this device is considerably different from the tubes normally found in TV sets. Internally, the elements are concentric cylinders supported in an open-ended, cantilever

Fig. 1. Inside view of the tuner "cradle" or subchassis shows most major components.

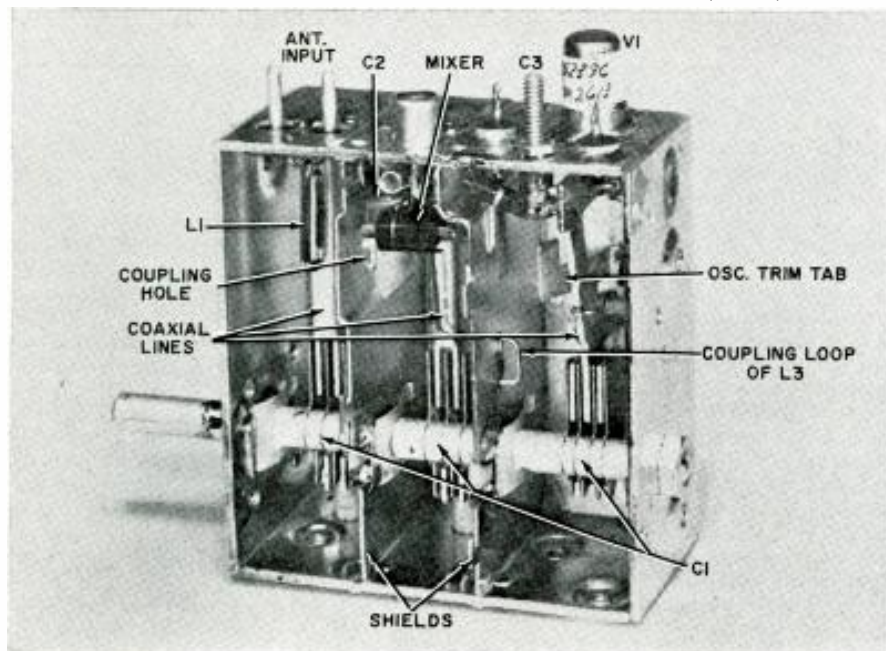

construction. They are mounted on a ceramic plate through which the tube pins pass. The ceramic plate is brazed to the metal envelope that houses the nuvistor. Seated in its socket, a typical nuvistor was slightly more than half an inch high and less than half an inch in diameter. In addition to its small size, the nuvistor offered the promise of being very rugged and having considerably longer life than conventional tubes.

The first versions available for experimental use included triodes that could operate at frequencies as high as the v.h.f. band. The original nuvistor, which had five pins protruding from its base, could not be made to oscillate at frequencies high enough to cover the u.h.f. band. This failure was due to the considerable inductance of the lead pins in the plate and grid circuits, which accounted for a large part of the oscillator inductance. The effect of each of these pins in tuning the circuit was reduced by shunting each one with the inductance of another lead.

Specifically, an additional pin was brought out from the grid and both were connected in parallel to the tuned oscillator line. An additional pin was also brought out from the plate and connected across the original plate pin to the plate bypass capacitor, C_5 . However, this was not as easy to accomplish as it may sound.

The small size of the nuvistor has already been indicated. The addition of two more pins to the tube meant that it was necessary to insert two more contacts in an already compact socket. The five-contact socket used for the original nuvistor was made of a mica-filled, phenolic material. With the reduced spacing between contacts that resulted from the use of seven pins, this insulating material was no longer satisfactory. Another was needed that could be molded to the desired tolerances and still provide the low dielectric constant and low-loss properties needed at ultra-high frequencies. The search ended with the only material available that meets these requirements: polychlorotrifluoroethylene, Kel-F.

The experimental type number assigned to the nuvistor during development was 15239, with suffix letters designating refinements added as work was in progress. (At this writing, RCA is offering experimental samples to manufacturers as type No. 15239G.—Ed.) Other advantages are offered by this u.h.f. triode in addition to its high life expectancy, which is several times that of the tubes it replaces. Its power consumption is low. Its rugged construction withstands shock and vibration very well. These two characteristics, in addition to its small size, are particularly important in portable receivers. In any type of receiver, its metal envelope and metal guide pins acting as grounds provide another advantage: the need for a separate tube shield is eliminated.

Other Considerations

The problem of keeping all extraneous inductance to a minimum is not confined to the nuvistor. For example, a

ceramic disc capacitor (C_2) is connected between the diode mixer and ground. This is a special unit in that ribbon leads are used in place of the wire leads normally found on such a unit. A special capacitor was also designed for use in the oscillator plate. Two wide, metal tabs provide a common connection from one side of this component for the two plate pins of the tube. The metal body of this capacitor is soldered directly to the tuner chassis, providing the shortest possible connection for the other side.

Other special measures are taken to obtain the desired performance characteristics and also to maintain them at the critical frequencies involved after the tuner has been subjected to use. The chassis cradle, for example, has been cadmium plated for protection against corrosion. Silver plating is used on the r.f. preselector lines and the oscillator line to provide high- Q elements. This results in circuits exhibiting low loss and low noise figures.

Alignment will not usually be necessary on this tuner. However, if it should be required after service in the field, the general procedure to be followed is similar to that used on a broadcast receiver. In each case, one is dealing with a continuously variable, superheterodyne device that uses ganged, air-dielectric capacitors.

The first step is to adjust the low-end oscillator trimmer (C_1 in Figs. 1 and 2) for an oscillator frequency of 505 to 510 mc. with C_1 set for maximum capacitance (plates closed). With an inter-

mediate frequency of 43 mc., this corresponds to an r.f. setting of 462 to 467 mc. for the low end of the band. The lowest u.h.f. broadcast frequency, on channel 14, is 470 mc.

C_1 is then rotated to minimum capacitance. The position of the oscillator trim tab, shown in the photograph, is then manually adjusted for the proper high frequency of 939 to 945 mc., corresponding to an r.f. setting of 896 to 902 mc. The highest frequency to be received, on channel 83, is 890 mc. With these first two adjustments completed, the end points for oscillator frequency are correctly established.

There is also a trim tab for each of the r.f. preselector lines. If it is necessary to re-adjust for acceptable band-pass, the adjustment is made with these tabs while the tuning capacitor is left in minimum-capacitance position. Starting in this same position, tracking may be checked and corrected by rotating the tuner slowly toward the low end of the band. Wherever deviation is noted, adjust the rotor blades in both preselector sections to bring tracking in line. Note that the oscillator blades are never adjusted. Doing so would change dial calibration substantially.

When it becomes necessary, the alignment procedure is not unduly elaborate or difficult. The reliability of the nuvistor and the measures taken to keep the entire tuner design relatively trouble-free should both contribute to minimizing the incidence of service problems in general. ▲

Fig. 2. For convenient reference, the tuner schematic follows actual layout closely.

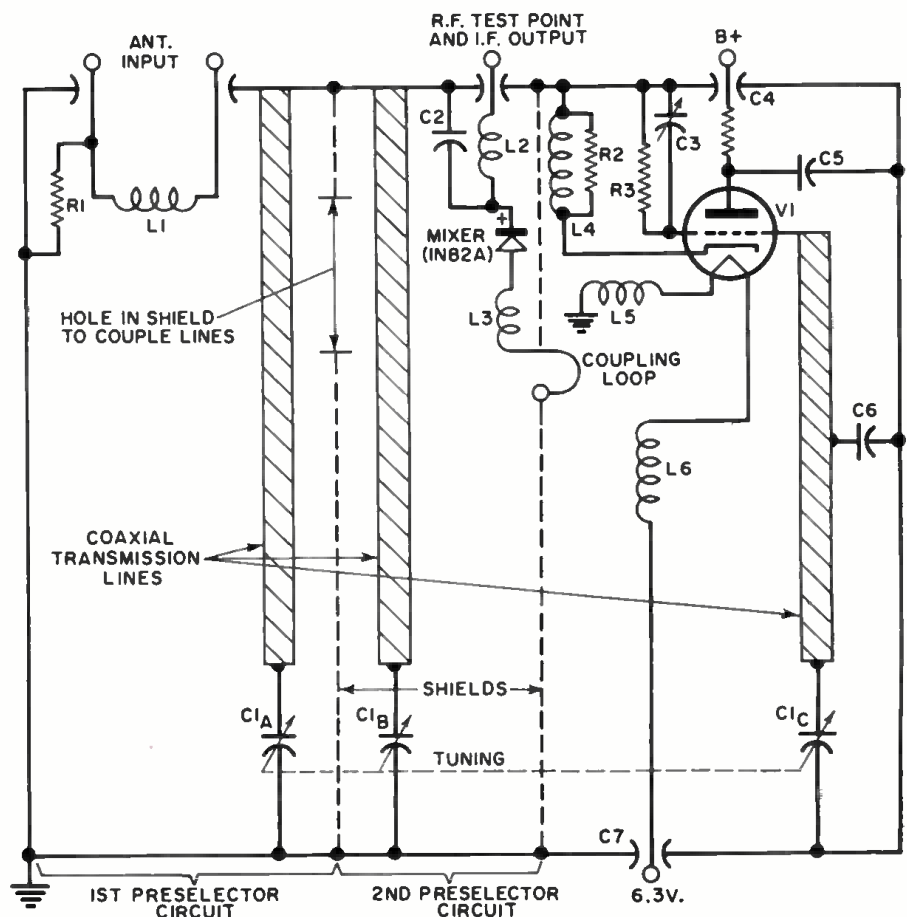

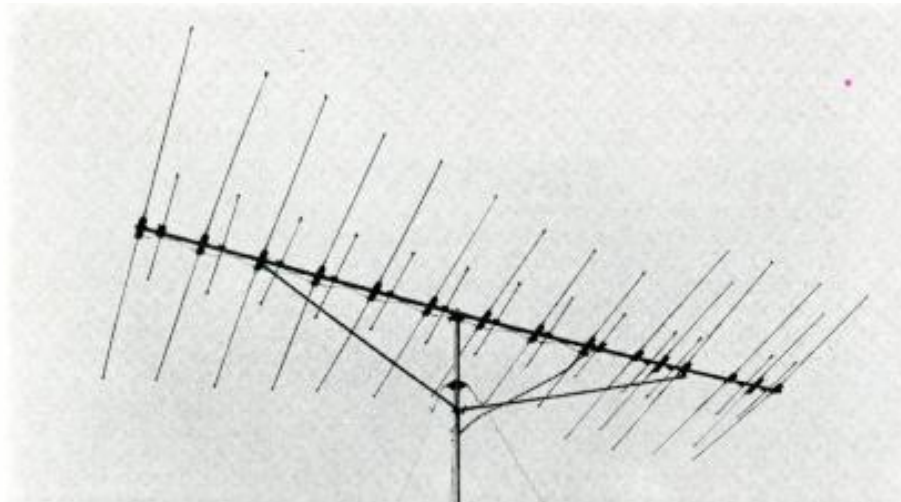

Fig. 1. Deluxe model of "Crossfire." Other available versions use fewer elements.

A NEW BROADBAND TV ANTENNA

By HAROLD HARRIS / V.P. Engineering, Channel Master Corp.

Proportional energy absorption by many elements permits high all-channel gain, sharp directivity.

MANY difficulties beset the engineer who would design a high-performance TV antenna for all-channel, v.h.f. use. Foremost among these is the manner in which channels have been allocated. They exist from 54 to 216 mc., encompassing a frequency ratio of 1 to 4. Furthermore the range, instead of being continuous, is divided into two, separated bands. This pattern of distribution is discouraging when one recognizes that antennas, because they are inherently frequency-selective devices, operate best over limited bandwidths.

High-efficiency, broadband designs, in one way or another, rely on a multiplicity of elements to obtain operation at all frequencies. This generally means that, at any given frequency, most of the elements are contributing little to the performance, with one or a few doing most of the work. Also, as a result of the compromises that are made, frequency

response is erratic, being good at some frequencies and poor at others, and antenna impedance may vary greatly on different channels.

A *Channel Master* research team, under the direction of Chief Engineer Harry Greenberg and including Project Engineer Charles Liu, sought to overcome these problems and to achieve effective dual-band operation with higher gain and higher front-to-back ratios than were realized heretofore. The result was the "Crossfire" design, which incorporates many noteworthy features.

The most elaborate version of the "Crossfire" appears in Fig. 1, with the forward portion of the antenna pointing to the right. From the rear of the antenna to the feedpoint, we find 18 elements in all. Actually, these are 9 dipoles, each with an associated, shorter parasitic element. From the feedpoint to the front of the antenna, the elements constitute a "director group." This re-

Fig. 2. The driven elements of the "Crossfire" (A) may be regarded as parallel impedances across the interconnecting harness. Addition of a high-band parasitic element (B) enhances harmonic-mode operation of a dipole cut to a lower band.

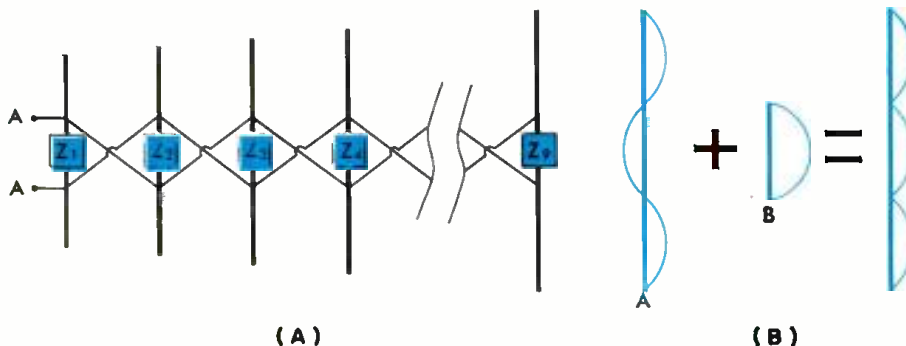

finement, which does not exist on all models, is not our main concern. Of principal interest are the 9 dipoles, which are interconnected with a single harness.

An obviously interesting feature of the system is the fact that it is front fed. Also, all 9 dipoles are driven elements, which are connected in parallel with the 2-wire feedline running from the transmission line. This feedline itself is transposed between each successive pair of elements. The antenna is so designed that, at any particular frequency, many elements are simultaneously active. This phenomenon is related to the use of the principle of "proportional energy absorption" on both bands. Finally, despite the high front-to-back ratios, the antenna does not employ a reflector element.

The key to the high gain is the fact that several dipoles rather than one function at any given frequency. This was obtained, in part, by departing from the conventional practice of making active elements individually resonant at particular channels or frequency ranges. Instead elements were designed so that their interaction at any given frequency would produce the desired result: the signal-gathering abilities of several active elements are combined. To accomplish this feature, in turn, great care was exercised in adjusting the impedances of the individual elements and maintaining critical impedance relationships at all frequencies.

To better illustrate the importance of

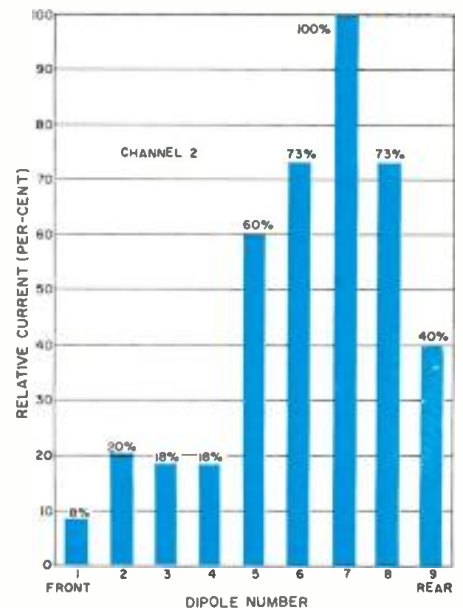

Fig. 3. Relative absorption of current in the 9 driven elements on channel 2.

impedance, we resort to the valid principle of reciprocity. That is, antenna operation during transmission rather than reception will be described; performance characteristics and patterns are identical in transmission and reception. In Fig. 2A, each driven element is represented as an impedance at a particular frequency and the elements, numbered beginning at the front of the

(Continued on page 100)



Only
General
Electric
gives
you
this:

New Orthonetic Stereo Cartridge

*Purest musical response—
even beyond 20,000 cycles!*

Compared with four other leading brands, the General Electric Orthonetic Cartridge gives flattest, widest frequency response of all . . .

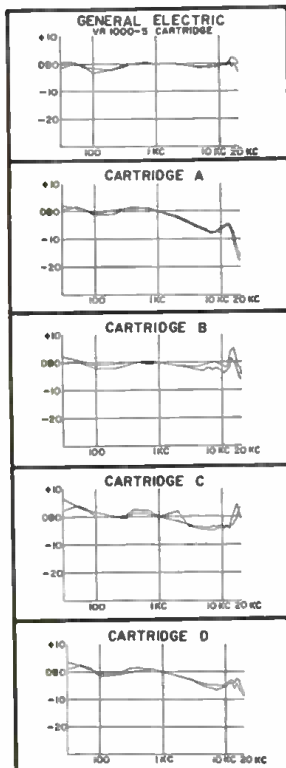

Breakthrough in musical reproduction! General Electric's new ORTHONETIC Cartridge gives precise, undistorted reproduction of every note on your high-fidelity records—even at frequencies above the normal range of human hearing!

Even the most subtle overtones come through . . . Ordinary cartridges fall off sharply in frequency response above 15,000 cycles per second. They shave off the higher overtones that give orchestral instruments their characteristic color.

To prevent the loss of the higher harmonics, General Electric engineers developed a revolutionary new suspension and damping system. This exclusive system ensures that all harmonic frequencies are

reproduced without loss, and in their proper relationship to the fundamental.

This means that every instrument has its true coloration; even the most sensitive ear can listen without the fatigue caused by musical distortion.

Tracks at pressures as low as one gram, prolongs record life . . . The mass of the moving system of the ORTHONETIC is less than one-thousandth of a gram. This minimal mass permits the stylus to trace faithfully record-groove patterns that require it to stop and start as frequently as 40,000 times per second! The low tracking pressure also minimizes wear on your valuable records.

Specifications for General Electric VR1000-5 .5 mil Diamond Stereo Cartridge (Also available with .7 mil diamond stylus, for record changers that track from 3-7 grams vertical force). **Application:** Professional-type turntable and tone arm, or any quality changer that tracks below 4 grams vertical force. **Recommended Tracking Force:** 1-3 grams. **Lateral Compliance:** 6×10^{-6} cms/dyne. **Vertical Compliance:** 9×10^{-6} cms/dyne. **Frequency Response:** 20 —20,000 cycles per second ± 3 db. **Recommended Load Resistance Each Channel for Flat Response:** 47K ohms. **Output:** 1 millivolt per cm/sec. minimum. **Separation between Channels:** 25-30 db per channel at 1000 cycles. Channel balance at 1000 cycles 2 db or better. **Resistance:** 1100 ohms per channel, nominal. **Inductance:** 400 mh, per channel, nominal. **Shielding:** Triple mu-metal. **Mounting Centers:** Standard 1/2" mounting centers. All measurements taken from RCA Victor stereo test record no. 12-5-71. Audio Products Section, Decatur, Ill.

GENERAL  ELECTRIC

CAPACITOR LEAKAGE PROBLEMS

DURING recent years, there have been vast improvements in the design and construction of all types of capacitors. Nevertheless, a recent examination of the records of one of the nation's largest TV servicing agencies reveals that the major cause of TV set failure, exclusive of tube defects, is the result of one or more faulty capacitors. In fact, capacitors were involved in over 63 per-cent of such cases. With a hundred or more capacitors in the modern TV receiver, this result should not be too surprising.

Some capacitors short; others open. These are easy to find. The real headaches and lost time are the result of leakage, which may be anywhere from slight to appreciable. The causes of leakage are varied. In tubular types, they include such imperfections as tiny, conductive particles in the dielectric; carbonization of portions of the dielectric resulting from repeated arc-overs; poor connections; and a number of other effects already familiar to the modern technician. In ceramic types, when the dielectric or silver-film plates crack or break, the capacitor will show a significant reduction in capacitance. This effect, instead of helping, further confuses and complicates troubleshooting.

Leakage is conveniently considered equivalent to having a d.c. resistance connected across the capacitor, the ohmic value of this resistance depending, of course, on the degree of leakage. Yet this degree is not the only factor that determines effects on circuit action. In some circuits, high leakage (a low leakage resistance) of 1000 ohms will cause no noticeable trouble. In other circuits, slight leakage, such as the equivalent of a high leakage resistance of 1000 megohms, may produce considerable woe. Such possibilities do nothing to simplify the matter of detection.

What Leakage Does

Let's consider the effects of various degrees of leakage in different circuit applications by citing specific examples. For instance, what is the result of a large leakage (low resistance) of 1000 ohms? If it occurs in bypass capacitor C_1 of Fig. 1, which is across a 100-ohm cathode resistor, it would cause very little disturbance. In fact, it would very

likely go unnoticed. The effective resistance in the cathode circuit would be about 91 ohms—an unimportant drop from the original 100. But introduce this same amount of leakage in a plate-to-grid coupling capacitor, like C_1 in Fig. 1, and serious disruption results. The effect in capacitors C_2 and C_3 would also be serious, but less severe.

All of this may seem quite elementary, so let us consider the condition of slight leakage, a subject on which all

technicians do not agree. What result would a leakage of one megohm have in a cathode-bypass or plate-bypass capacitor? The adverse effect would be small. In a plate-to-grid coupling application, however, it might be almost as detrimental as a short circuit. And what of a really high leakage resistance, in the order of 100 megohms? Assume this occurred in a plate-to-grid coupling capacitor. Many technicians would say this amount is insignificant. Actually it can disrupt the circuit seriously.

Observe the example in Fig. 2. The plate voltage of 300 v.d.c. from the preceding stage is dropped across the leakage resistance (100 megohms) of capacitor C and the 2 megohms of grid resistor R in series. A simple calculation shows that only about 6 volts is dropped across the grid resistor. But this positive drop cancels out most of the normal bias, dropping it from -8 to about -2 volts. The change is usually enough to cause unmistakable trouble.

But let's go one step further. Assume a fantastically small leakage, say 1000 megohms, in this same capacitor. Also assume the same circuit except that normal grid bias is -2 volts. Now we get a positive drop in the grid resistor of only .6 volt, reducing bias from -2 to -1.4 volts. This should not cause trouble, you might say. But consider a critical circuit, such as a video amplifier. The change could cause sync clipping and unstable sync action. Thus, even an extremely high leakage resistance should not be ignored, especially when one is involved in a difficult, puzzling job.

Testing for Leakage

Too many technicians, even those who know better, still rely on ohmmeter tests for capacitor leakage. High resistances, still low enough to cause trouble, often will not show up. Besides these instruments apply very low voltages to the component during the test. Leakage that may show up under the stress of the higher voltage used in the actual circuit may not even take place with the ohmmeter's potential applied.

These difficulties are easily overcome, however, by taking a voltmeter reading in the circuit. The instrument is used on a low d.c. scale, on which it should

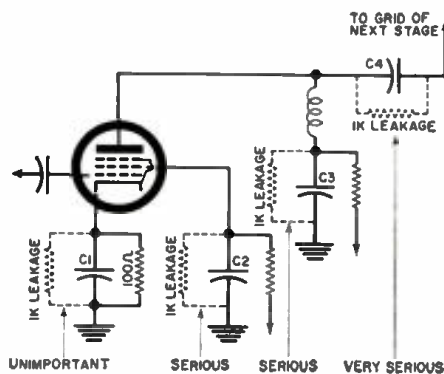

Fig. 1. Position and use of the component in the circuit determines whether the effects of leakage will be serious.

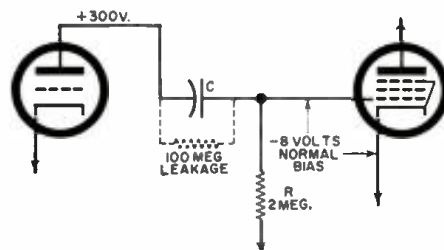

Fig. 2. Leakage in interstage coupling unit may disrupt bias in second stage.

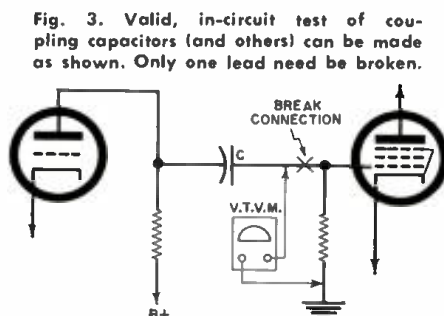

Fig. 3. Valid, in-circuit test of coupling capacitors (and others) can be made as shown. Only one lead need be broken.

A large amount may be unimportant, but a small amount may be serious. How to test and tell the difference

have a high input resistance. A v.t.v.m. is obviously recommended. The exact set-up for the test will depend on the circuit arrangement, but Fig. 3 is a general guide. Connections from the low-voltage side of the capacitor are severed and the positive v.t.v.m. lead is connected to this end, the other to circuit ground. If there is leakage resistance, it will form a series circuit with the meter's resistance across which the "B+" will be dropped. With input resistance and the value of "B+" on the capacitor's high side known, it would be possible to calculate leakage resistance from the instrument reading.

It is not always necessary to break the connection. If the circuit allows, as in the case of Fig. 3, one would merely have to remove the second tube from its socket. Although this method is more convenient, it is usually less sensitive; for the meter is shunted by the grid resistor, and total resistance is thus reduced.

When the meter probe is first touched to the capacitor, the needle will jump, but it should return to near zero promptly if the capacitor is sound. If the pointer fails to return close to zero—the capacitor should be replaced.

Often it is desirable to test a new capacitor before installing it in a critical circuit. For an effective check, connect the capacitor across a portion of the circuit that will provide a voltage equal to the working voltage of the component. One end of the capacitor is simply connected to the appropriate, positive potential. The positive lead of the d.c. v.t.v.m. is connected to the other end, and the negative lead from the instrument goes to ground or "B-." In effect, this sets up a condition similar to that of Fig. 3.

Erroneous Readings

Often a technician misleads himself with the manner in which he makes measurements. This frequently happens when he is taking bias readings at the grid of a stage. Such measurements tend to be closely related to the phenomenon we are discussing here. For example, note the relationship in Fig. 2, where capacitor leakage affects bias appreciably. Many technicians, lacking service data for the specific equipment

under consideration, will measure bias by taking a reading from grid to chassis. In some circuits, such as the one in Fig. 4A, a correct reading will be obtained.

In other cases, the method will not

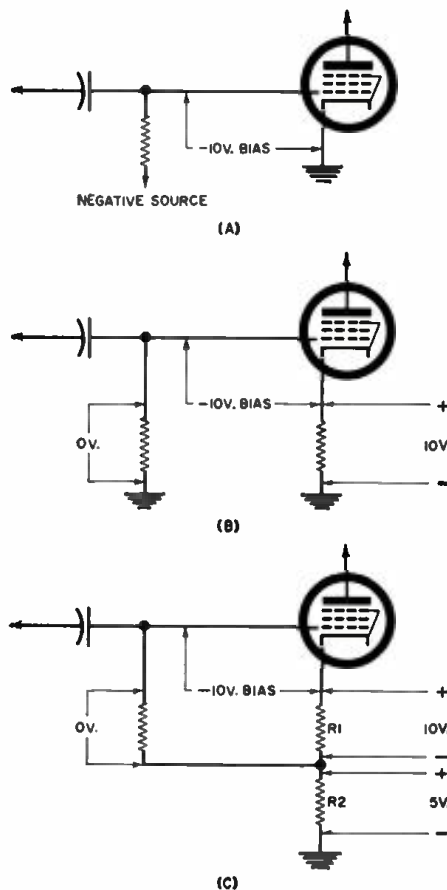
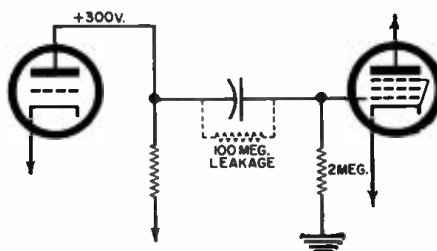

Fig. 4. While grid-to-ground readings may reflect actual bias (A), there are many cases (B, C) where this is not so.

Fig. 5. Circuit in which loading of low-resistance voltmeter may falsify reading.



work. In Fig. 4B, however, there is a 10-volt drop. Thus, although there is no significant drop across the grid resistor, leaving the grid virtually at ground potential, there is a grid-cathode bias of -10 volts that does not show up in a reading taken from grid to ground, across the grid resistor. The grid-cathode reading reflects actual working conditions. Another example that may mislead appears in Fig. 4C. The actual bias is -10 volts, obtained across the upper cathode resistor, R_1 . A reading from grid to chassis would yield 5 volts, which is misleading. The technician might begin a hunt for trouble where none exists. The best procedure is to consult service data for the equipment whenever it may be obtained and, when it is not available, to stop and think before plunging ahead.

Mention has been made of the preference for a v.t.v.m. over a v.o.m., even if the latter has a 20,000-ohms-per-volt rating. A review of the differences in readings obtained in high-impedance, critical circuits is worthwhile. Consider the circuit of Fig. 5. Assuming leakage resistance across the capacitor to be 100 megohms and normal voltage across the 2-megohm resistor to be zero, voltage at the grid of the second tube will be 6 volts positive. If a grid-to-ground reading is taken at the second tube with the v.t.v.m., the instrument will shunt down the grid resistance somewhat. As a result of this loading, the voltage will drop somewhat, but it will still be well above 5 volts. This is close enough to permit correct interpretation of what is happening. When the v.o.m., used on its 5-volt scale, is shunted across the grid resistor, ohmic value drops to approximately 100,000 and the measured potential is only .3 volt.

Suppose leakage resistance in the capacitor were 1000 megohms. The actual grid voltage would be .6 volt. A v.t.v.m. reading would show over .5 volt, which is still respectable. The v.o.m. reading would be .03 volt. Conclusion: stick to the v.t.v.m., with its high input resistance on low-voltage scales, for leakage tests, as you should do in any low-voltage, high-impedance circuits. You can trust your test instruments only if you know which ones are to be trusted and when. ▲

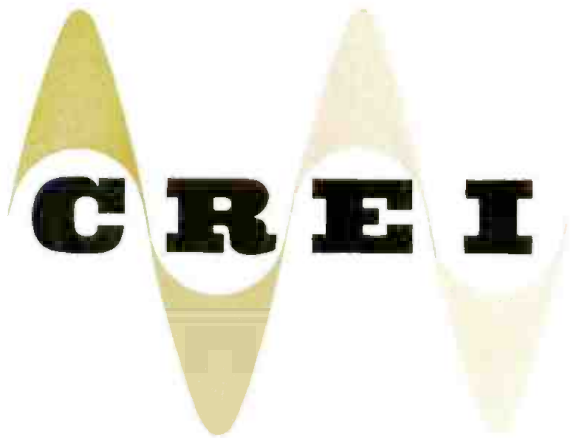

“a CREI home study program helped me increase my salary by a factor of four (4).”

“I am indeed grateful to CREI for my success. Since enrollment in a CREI Home Study Program in Electronic Engineering Technology, I have progressed from a Junior Technician to a recognized and licensed Senior Engineer. My present title is Field Support Manager and my salary has increased by a factor of four (4).”

*Mearl Martin, Jr., SENIOR ENGINEER
Field Support Manager, Tektronix, Inc.,
Portland, Ore.*

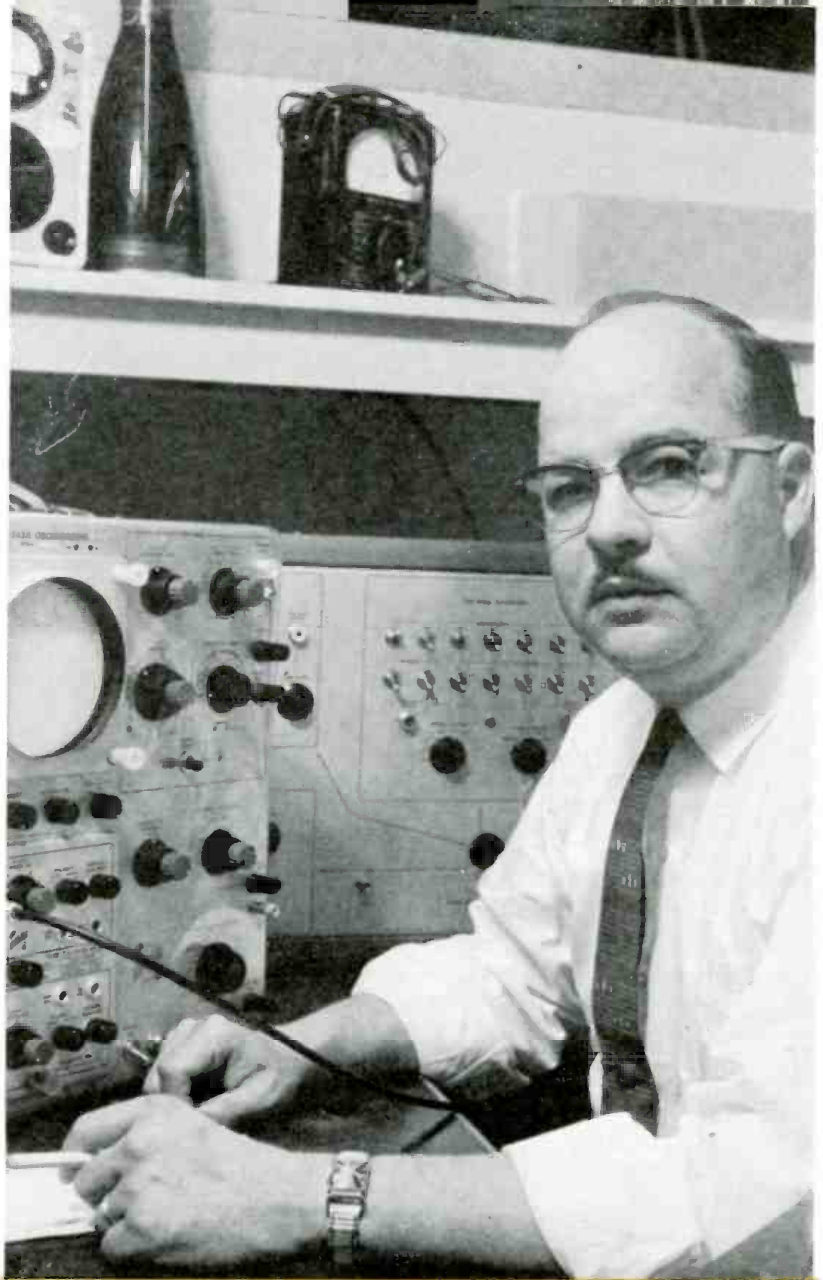

INCREASE YOUR EARNING POWER while you are on the job. Mearl Martin, Jr. made profitable use of his CREI-acquired knowledge in progressing from Junior technician to licensed Senior Engineer. His present position is Field Support Manager, Marketing Division of Tektronix, Inc.

INDUSTRY-RECOGNIZED CREI HOME STUDY PROGRAMS PREPARE YOU FOR INCREASED RESPONSIBILITIES AND HIGHER-PAYING POSITIONS IN ELECTRONICS.

THERE IS A CREI PROGRAM TO MEET YOUR NEED. Today thousands of advanced electronics personnel—engineering technicians, engineers, administrators, executives—attribute their present high salaries and positions to their home study of CREI Programs in Electronic Engineering Technology. Wherever you go—wherever thorough knowledge of electronic engineering technology is a prime requisite—you’ll find CREI Home Study students and alumni welcomed.

TOP SCIENTISTS CONTRIBUTE TO COURSES. When you enroll in a CREI Home Study Program, you join more than 20,500 students presently working in almost every phase of electronics in all 50 states and most countries in the free world. You study courses to which a number of today’s leading engineers and scientists have contributed. You are guided and assisted by CREI’s staff of experienced instructors. How long it takes to complete your CREI Home Study Program depends on your on-the-job experience, the amount of time you devote to study and the program or programs you choose.

DEMAND FOR CREI-PREPARED MEN IS GREAT. It far exceeds the supply—has exceeded the supply for many years. Specifically designed to prepare you for responsible positions in electronics, CREI Home Study Programs include the latest advancements in



EMPLOYERS RECOGNIZE THE BENEFITS they receive when employees increase their knowledge through educational programs. Industry need for better educated men increases by the day. Here Mearl Martin discusses education with W. K. Dallas, V.P., Manager, Marketing Division, Tektronix, Inc.

ASSURE A BETTER FUTURE with a CREI Home Study Program. Living is better when you prepare yourself for—and get desired promotions. CREI alumnus Mearl enjoys living in a comfortable home in Portland, Oregon. CREI Programs help you make living better wherever you are located.



GAIN NEW PROFESSIONAL STANDING. The CREI Home Study Programs help you form new associations with responsible members of your company. Above (L to R) is Mearl Martin with Robert Wruble, Group Manager and Rollie Smith, Field Training Manager at Tektronix, Inc.

YOUR WHOLE FAMILY BENEFITS from the success you can achieve from a CREI Home Study Program. They share in it. They enjoy it with you. It helps them realize and understand some of the values of a better education. Above Mearl Martin relaxes at home with his wife and his son and daughter.

electronics. We invite you to check the thoroughness and completeness of CREI Home Study Programs in the catalog provided on request. They include:

- INTRODUCTION TO ELECTRONIC ENGINEERING TECHNOLOGY
- ELECTRONIC ENGINEERING TECHNOLOGY • SPECIALIZED COMMUNICATIONS ENGINEERING TECHNOLOGY • SPECIALIZED AERONAUTICAL AND NAVIGATIONAL ENGINEERING TECHNOLOGY
- SPECIALIZED TELEVISION ENGINEERING TECHNOLOGY
- SPECIALIZED SERVOMECHANISMS AND COMPUTER ENGINEERING TECHNOLOGY • SPECIALIZED ENGINEERING MATHEMATICS
- AUTOMATION AND INDUSTRIAL ELECTRONIC ENGINEERING TECHNOLOGY • NUCLEAR ENGINEERING TECHNOLOGY

RATES HIGH WITH INDUSTRY. The high calibre of CREI Home Study Programs is attested to by America's biggest corporations, where CREI students and alumni attain positions ranging from engineering technicians to engineers to top officials. Such companies are National Broadcasting Company, Pan American Airways, Federal Electric Corporation, The Martin Company, Northwest Telephone Company, Mackay Radio, Florida Power and Light, and many others. These companies not only recognize CREI Home Study educational qualifications but often pay all or part of CREI tuition for their staff members.

ELECTRONICS HOME STUDY SPECIALISTS FOR 34 YEARS. CREI Home Study Programs are the product of 34 years of experience; CREI itself was among the first to have its curricula accredited by the Engineers' Council for Professional Develop-

ment. Each program is developed with the same painstaking skill and care that CREI put into its World War II electronics courses for the Army Signal Corps, its special radio courses for the Navy, and its post-war group training programs for leading aviation and electronics companies. For those who can attend in person, CREI maintains a Residence School in Washington, D. C., also offering ECPD accredited Technical Institute curricula.

REQUIREMENTS FOR ENROLLMENT. Pre-requisite is a high school education or equivalent *plus* electronics training and/or practical electronics experience. (Electronics experience and/or training not necessary for Residence School.) If you qualify, send for the latest CREI catalog at no cost. Veterans may apply under the G.I. Bill. If you're doubtful about your qualifications, let us check them for you. Use the coupon inserted between these pages or—if coupon has been removed—send qualifications to:



The Capitol Radio Engineering Institute
 ECPD Accredited Technical Institute Curricula • Founded 1927
 Dept. 1112-H, 3224 Sixteenth St., N.W.
 Washington 10, D.C.

BUILD THE FINEST
Professional Quality
 CUSTOMIZED
TV KIT

On Easy "Pay As You Wire" Terms
 Only \$15 for the Starting Package!

The
"PROFESSIONAL"
 Series—designed for
 the perfectionist seeking
 the finest in TV performance.
 Easy to assemble. No technical
 knowledge required. An ideal
 "Learning" Kit with a Complete
 Course of Study is available.



Also available:

**WIRED
 CHASSIS**

for custom
 installations
 with a choice

of vertical or horizontal
 controls and the newest
 23", 24" or 27"
 CRT.



Beautiful Cabinets —

designed to enhance sound quality and blend with
 modern decor. For TV or combination TV and Hi-Fi.

A few of the Professional Quality Features:

Choice of push-pull 10-watt audio or output to
 your Hi-Fi system... D.C. restoration...
 Ultra-linear sweep circuits... Standard Coil
 Guided Grid Turret Tuner... Super-sensitiv-
 ity for fringe areas... Complete line of Acces-
 sories for Custom Installations.

Choice of 23", 24" or 27" CRT. Prices range
 from \$119 to \$199.

U.S. Armed Services and over 4000 schools and
 colleges have selected Transvision Receivers for
 educational television.

Interested in Electronics?

Learn the basic principles of elec-
 tronics from the Course available with the Kit.

ASSEMBLY MANUAL—\$2.00

See how easy it is to assemble the Transvision
 Kit. Cost of Manual refunded on purchase of Kit.

TRANSVISION New Rochelle, N.Y.
 NE 6-6000

START NOW — MAIL THIS COUPON

- Send FREE 8-page Catalog... I enclose \$2 for Assembly Manual, refundable on purchase of Kit.
- I enclose \$15 for Starting Pkg. on pay-as-you-wire plan. (Complete Kits range from \$119 to \$199.)

Name _____
 Address _____
 City _____ Zone _____ State _____

IMPEDANCE MATCHING IN AUDIO CIRCUITS

By JOEL H. LEVITT

Some misconceptions on the optimum values of load impedances that are employed in audio amplifiers.

MANY people have the mistaken notion that a load impedance should always equal the impedance of the source driving it, since maximum power is then delivered. The confusion arises for two reasons: (1) maximum load power may be an irrelevant or even undesirable condition, and (2) the matching condition does not hold for non-linear circuits, such as an audio output stage.

Consider a 117-volt power generator matched to its load. The power delivered to the load will be the maximum that this generator can supply, but the power dissipated in the generator will be equal to the load power ($I^2 R_g = I^2 R_L$). We would have an efficiency of only 50%. Since efficiencies over 90% are essential to the power industry, generator output resistances are made much smaller than those of expected loads.

Cross-Coupled Inverter

Now, let's consider the often-used circuit of Fig. 1 which is part of the popular "cross-coupled phase inverter." Cathode-follower V_1 , which behaves as an equivalent resistance $r_{p1}/\mu_1 + 1$ works into R_K , in parallel with $(r_{p2} + R_L)/(\mu_2 + 1)$. It is not difficult to choose R_K and R_L so that $r_{p1}/(\mu_1 + 1)$ is matched. If we do this, as many people do, we get intolerable distortion. This has been pointed out with regards to cathode-followers but some people still insist on "matching."

A general rule here is that the highest gain and the lowest distortion from any vacuum-tube amplifier circuit—plate-loaded or cathode-follower—is obtained when the *minimum* power is drawn. Note that we are discussing signal

power not d.c. power. Thus we want V_1 to work into a load impedance many times greater than its equivalent impedance. The correct design approach here is to make V_2 a much lower g_m tube than V_1 ($g_m = \mu/r_p$) and to make R_L and R_K both as large as d.c. conditions will allow.

Output Matching

Let us now turn our attention to a power-output tube driving a loudspeaker through an output transformer. If the tube were completely linear, as it is for very small signals, we could represent it as having a constant open-circuit output voltage and a constant resistance r_p , and distortion would be no problem. Efficiency would be less than 50% but this would not be improved by any other impedance ratio since 50% is the ideal maximum for any class A amplifier.

However, because the tube is not linear, we have two problems. First we must find the load that will absorb maximum power and then we must consider distortion and find whether the optimum compromise load is a little bit higher or lower than this. Laborious trial and error calculations, using tube characteristics curves or experimental power output and distortion vs load-resistance measurements, show that the optimum load may be anywhere from a small fraction of the plate resistance (for pentodes) to several times the plate resistance (for triodes).

For pentodes an approximate recommended value of load is $R_L = .9E_b/I_b$ where E_b is the plate-to-cathode voltage and I_b is the plate (not total) current. For triodes $R_L = E_b/I_b - 2r_p$ is a reasonable value. For triodes or pentodes E_b is chosen as high as possible and I_b is as large as plate dissipation allows. An exception is the unusual triode for which the high plate current $I_b = \frac{1}{4}(E_b/r_p)$ is allowable in which case $R_L = 2r_p$ is recommended. (Do not forget that universal design equations of this type are only rough approximations.)

Another useful approximate rule is to double the optimum load to get the plate-to-plate impedance for push-pull operation. Happily, popular power tubes have their optimum loads tabulated by the tube manufacturer, making the job easy for the user.

REFERENCE

1. "Radiotron Designer's Handbook," Fourth Edition, pages 556-557. ▲

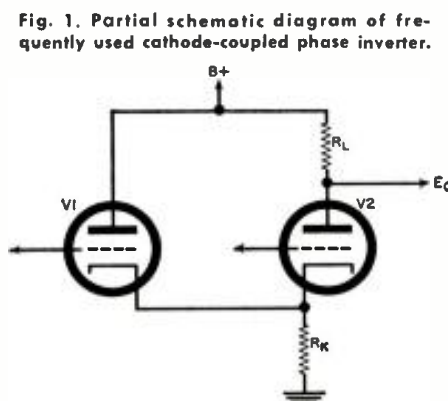

Fig. 1. Partial schematic diagram of frequently used cathode-coupled phase inverter.

Calibration Oscillator

(Continued from page 57)

by pressing the push-button. With this circuit there is a short warm-up interval after the calibrator is turned on and before it can be used. If "instantaneous" use is desired, the filaments should remain heated continuously and the plate voltage alone should be switch-controlled.

Calibrators of this general type have an average tube life exceeding 3000 hours of operation. Neon lamp life is nominally 10,000 hours and actually much greater. All other components, except the crystal, are substantially immortal. Service life of a lightly loaded crystal is finite but very long so the crystal should not cause problems.

Extensive testing of this calibrator shows that it is a very dependable and consistent performer—well worth the three evenings and \$30.00 invested in its construction. ▲

Fig. 7. Coupling calibrator to a receiver.

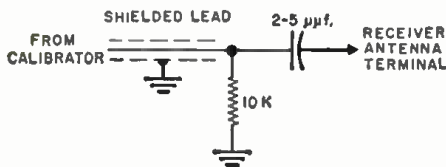

VOLUME EQUALIZATION

By RONALD L. IVES

IN MOST communications receivers, insertion of the headset plug disables and silences the loudspeaker. Unfortunately, in many receivers, the volume control adjustment suitable for headset operation is entirely too high for speaker operation. In unhappy consequence, if a signal is tuned in, using the headset, and the plug is then pulled—to put the signal on the speaker—the resultant volume blasts you out of the shack and gives the neighborhood a jolt.

This annoyance can be eliminated quickly and inexpensively by inserting a "T" pad in the speaker line. This is a standard, commercially made attenuator which is so designed that the circuit impedance remains constant at all settings, while the signal transfer is manually variable from zero to maximum. Impedance of the "T" pad selected should match that of the output transformer secondary, which should also be that of the speaker.

Suitable "T" pads for this application are available from Mallory ("T" series), Clarostat ("CIT" series), and IRC ("TP" series). All will handle at least 10 watts of audio. Clarostat also manufactures a miniature "T" pad, Series CIT43, which has a rating of 4 watts.

In operation, the signal is tuned to optimum value using the headset. Then the headset plug is pulled and the speaker volume adjusted to a comfortable level by means of the pad control. Thereafter, through a wide range of signal strengths, any signal adjusted to comfortable volume on the headset will also be at a satisfactory listening level when switched to the speaker. ▲

December, 1961

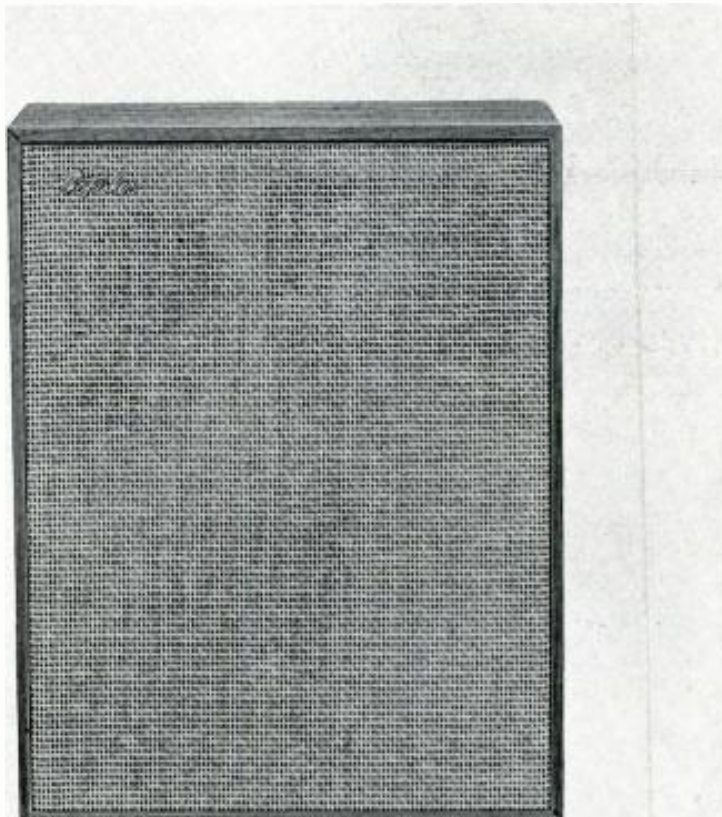

No one will believe

you built this Fisher Speaker System yourself!

Introducing the KS-1 Slim-Line Kit.

You will have to do some strenuous convincing before anyone believes that this superb-sounding and elegant-looking Fisher loudspeaker system was home-built. A three-way system of this caliber would be important news even if it were factory-assembled, especially as it is of the new slim-line form, which requires ultrasophisticated engineering for top results. But, thanks to exceptionally careful and imaginative planning by Fisher engineers, you can build the KS-1 and have Fisher performance at an important saving.

This is the only slim-line speaker system available in kit form and it is designed around the most advanced components: a 10-inch free-piston woofer with 30 cps free-air resonance and 4-lb. magnet structure; a 5-inch AcoustiGlas-packed mid-range unit; separate super-tweeter; fully wired and balanced three-way LC dividing network with 1400 cps and 5000 cps crossovers; 18" x 24" x 5" cabinet packed with AcoustiGlas padding; and matching grille cloth. You install the driver units, connect

the network, complete the preassembled cabinet—and you are the owner of a truly high-quality loudspeaker, which can be either wall-hung or placed anywhere on the floor to blend harmoniously with your decor.

The sound of the Fisher KS-1 will astonish you; it is extremely clear, with precise transients, as well as full and rich—quite unprecedented in a system of this size and price. Don't miss a demonstration at your Fisher dealer. Price, in birch or walnut, sanded and ready for your choice of finish, \$59.50*. Factory assembled, \$84.50*.

USE THIS COUPON FOR COMPLETE INFORMATION

Fisher Radio Corporation
21-38 44th Drive, Long Island City 1, N. Y.

Please send the following Fisher literature without charge:

- Specifications on the Fisher KS-1 Speaker Kit.
- 1962 Fisher Handbook, a 40-page illustrated reference guide and catalogue for custom stereo installations.

Name _____

Address _____

City _____ Zone _____ State _____

EW12SK1

*Factory assembled in oiled walnut, \$89.50. Prices slightly higher in the Far West. EXPORT: Telesco International Corp., 171 Madison Ave., N. Y. 16, N. Y. In Canada: Tri-Tel Associates, Ltd.

**BOOST
YOUR
INCOME**



**FREE
BOOKLET
TELLS YOU
HOW**

**HAVE
LESS
COMPETITION!**

A proven formula for success is to get in on the ground floor of a booming business. Mobile radio is a booming business. All around, you can see two-way mobile-radio antenna towers springing up—each one a possible new client for you. Most of this work is done on a contract basis with payment 12 months a year. There's little competition . . . few fussy customers to satisfy . . . a welcome change from AM/FM and TV repair! It's not too late to make a start toward bigger money!



Lampkin 105-B
Frequency Me-
ter, 0.1 to 175
MC and up. Price
\$260.00, net.

Type 205-A FM
Modulation Me-
ter, Range 25 to
500 MC. Price
\$270.00, net.

NEW! THE PPM METER—AN ACCESSORY FOR
THE TYPE 105-B. ACCURACY 0.0001%—FOR
SPLIT-CHANNEL FREQUENCY CHECKS ABOVE
50 MC. PRICE, \$147.00.

**LAMPKIN
LABORATORIES, INC.** MFM DIVISION
BRADENTON, FLA.

MAIL COUPON TODAY!

LAMPKIN LABORATORIES, INC.
MFM Division, Bradenton, Florida

At no obligation to me, please send free
booklet and information on Lampkin
meters.

Name _____

Address _____

City _____ State _____



those who
Serve Best
Use

QUIETROLE



6 oz. SPRAY PACK CAN
(with FREE Extender Tube)

2, 4, 8 oz. Bottles
(with dropper)

Product of

QUIETROLE
COMPANY

Spartanburg, South Carolina

in Canada: CROSS CANADA ELECTRONICS
12 Laurel Street, Waterloo, Ontario

There's never any doubt
with QUIETROLE . . . it
always says "Sh, Sh" to
noisy controls and
switches on TV, radio and
electronics instruments.
Now, Quietrole is even
easier to use . . . has
FREE EXTENDER TUBE
that hits those hard to
reach places right on the
button. It's Quality
Quietrole that makes
those once pesty repairs
easier than ever.
See how Quietrole can
ease the jangled nerves
of even your hardest to
please customers.
Quietrole, helps the
serviceman serve better
than ever.



**YOU
SAVE
MONEY!**

**RUSH US YOUR
LIST OF HI-FI
COMPONENTS
FOR A SPECIAL
QUOTATION
WRITE FOR FREE
AUDIO DISCOUNT
CATALOG A-15**

*New low prices on amplifiers, tun-
ers, tape recorders, speakers, etc.*

KEY ELECTRONICS CO.
120 LIBERTY STREET
NEW YORK 6, N.Y.

Double-Chamber Enclosure

(Continued from page 43)

loading of the double-chamber enclosure keeps the impedance of the speaker so low through the bass range that it really seems fairer in this case to call it an 8-ohm system for purposes of calculating rated power.

Now 11 volts (whether you agree that this represents about 15 watts or not) into a D216 produces an awfully loud noise. At 35 cps, even though the speaker was outside, all the windows in the building were rattling and the floor was vibrating perceptibly.

Yet, at this intensity the total harmonic distortion did not exceed 11% at any frequency above 30 cps. At 35 cps, the distortion actually dropped to 7% because this is the frequency at which the reflex action of the enclosure is most effective.

But if the low distortion of the D216 is impressive, take a look at the graph for the LE8 in the double-tuned enclosure, Fig. 3B. Again, 11 volts were required to produce the same intensity at 200 cps. Again, it seems legitimate to call this 15 watts of sine-wave power.

Notice that the distortion of the LE8 under these conditions is less than 5% at any frequency above 30 cps. At 35 cps, the total harmonic distortion is only 2%!

Once more, I want to point out that in this test the speaker was making a very loud noise. At any normal listening level, the performance of the LE8 is at least this good in a simple small vented enclosure. But for special applications such as electronic organ or string bass reproduction, the LE8 in a double-chamber enclosure makes an efficient, yet compact, system of truly outstanding bass performance.

What About Highs?

High-frequency reproduction is not affected by the enclosure, of course. But the exceptional bass possible from the double-chamber enclosure prompts the use of a high-quality 8-inch speaker having clean highs as well. A good high-efficiency speaker, such as the JBL D216, Electro-Voice SP8-B, or Altec 755C, will have good response up to 3000 cps or so before serious peaks and dips appear.

A good high-efficiency tweeter is therefore recommended to balance the full bass brought out by the enclosure. The finished system shown in one of the photographs uses a D216 crossing over to a JBL 075 ring radiator at 2500 cps. Considering size and money invested, the performance of the system is superb.

Construction

The exact dimensions of the double-chamber enclosure are not critical. The

main chamber should be 1.8 to 2 cubic feet in volume and the smaller chamber should be between .9 and 1 cubic foot. The dimensions shown in Fig. 1 are convenient and can be used for either a horizontal or vertical unit.

The two outside ports can be located on any surface. In the finished enclosure shown in the photograph, the ports are located on the bottom rather than the front of the cabinet.

The enclosure must be solidly put together of 3/4" stock. Particle board ("Novaply," "Timblend," etc.) is recommended because of its comparatively high density. Whichever panel you make removable for installation of the speaker, use plenty of screws to hold it in place. Note the "bank vault" appearance of the unit in the photos.

The interior surfaces of the main chamber should be liberally lined with glass wool or similar absorptive material. It is not necessary to line the second chamber, but it won't hurt to use the remaining scraps of padding here.

The drawings show three port tubes of circular cross-section. These are actually heavy cardboard mailing tubes with inside diameters of 2 3/4" and lengths of 7 1/2". If it is easier to build wooden tubes of rectangular cross-section, they will work just as well. The cross-sectional area of each tube is 6 square inches. Inside dimensions could thus be 2"x 3", 1 1/2"x 4", etc.

Any Questions?

Q. Can I install a 12-inch speaker?

A. Not in the enclosure shown. Why would you want to?

Q. What causes the "hole" at 65 cps?

A. Interaction between the two chambers which I was not able to foresee when I made the original design. The hole is only about 3 db deep and unnoticeable in listening tests, but it can probably be smoothed out by making the second chamber a little smaller in relation to the first, and then re-adjusting the lengths of the three port tubes.

Q. How good is the performance of a cheap 8-inch speaker in this enclosure?

A. A husky speaker in the \$8.00 to \$15.00 class can be expected to perform quite well down to about 40 cps in the double-chamber enclosure. But you naturally won't be able to get powerful bass with the low distortion afforded by better speakers.

Q. Will this design be made available commercially?

A. As far as I know—no. The general public is willing to accept an 8-inch speaker in a bookshelf enclosure, but once the cabinet grows to 3 or 4 cubic feet, people install a 12- or 15-inch speaker no matter what the experts say.

Q. Some of your statements sound pretty far-fetched for an 8-inch speaker. Aren't you really exaggerating a little?

A. No. ▲

Build Your Own Superb Scott Kits

Have fun . . . save money . . . get the best! Now you can build your own world-famous Scott components . . . and you can make substantial savings compared to the costs of the nearest equivalent factory assembled units.

H. H. Scott kits feature the same engineering, same high performance, same features and parts as do the factory wired components. Tuners have exclusive Scott Wide-Band design with factory aligned silver-plated front ends. Amplifiers use H. H. Scott's superb conservatively rated transformers.

Scott kits are fun to build, too. The wires are pre-cut to exact length and pre-stripped. Instruction books are in full color to help you see exactly what you're doing. Mechanical parts are factory-riveted to the chassis.

For a genuine H. H. Scott system at a real saving, choose from these fine kits:

LT-110 FM Multiplex Stereo Tuner Pre-wired and aligned front end and multiplex sections; Wide-Band design; 2.2 uv sensitivity (IHFM); \$159.95*

LK-48 48-Watt Stereo Complete Amplifier Kit A truly superior amplifier with power enough to drive even the most inefficient speaker systems. Only \$119.95*

LK-72 72-Watt Stereo Complete Amplifier Kit Fabulous Scott features never before available in a kit: derived center channel controls; tape monitor; \$159.95*

LT-16 FM Tuner Kit Unique Ez-A-Line alignment system. Sensitivity 2.2 uv (IHFM). \$99.95*

LC-21 Stereo Pre-Amplifier Kit Exceptional versatility. 16 front panel controls; frequency response for optional laboratory applications 8 to 50,000 cps! \$99.95*

LK-150 150-Watt Stereo Power Amplifier Kit Conservative design, massive transformers unsurpassed performance. \$169.95*

*slightly higher West of Rockies.



Rush me complete details on money-saving Scottkits.

FREE!

Colorful and detailed 20-page "Guide to Custom Stereo" including complete technical information on Scottkits.

Name
Address
City Zone State

H.H. SCOTT

H. H. Scott, Inc., Dept. 160-12
111 Powdermill Rd., Maynard, Mass.

Export: Morhan
Exporting Corp.,
458 Broadway, NYC

NOW! FAIRCHILD PRESENTS THE NEW

COMPANDER®

FOR THE RECREATION OF ORIGINAL PERFORMANCE DYNAMICS

A new, exciting and completely different development from Fairchild . . . a product so unusual that we believe every serious audiophile will want to know about the **Compander**. Briefly, the **Compander** is an automatic dynamic sensing device that overcomes the controls placed upon both disc and tape recordings and thereby restores the full dynamic range of the original performance. By freeing program material from the usual recording restraints the **Compander** brings you a giant step closer to the original performance. Accomplished without distortion, the **Compander** is easily integrated into any monaural or stereo quality component system. The **Compander** is priced at \$75.00. Write for our fully detailed bulletin.

FAIRCHILD RECORDING EQUIPMENT CORP., 10-40 45th AVE., LONG ISLAND CITY, N.Y.

*Do your
Christmas shopping
the easy, economical
satisfying way
with the
1962 HEATHKIT
Catalog*

World's biggest kit catalog—offers over 250 kit selections.
The big, new 100-page Heathkit catalog is the world's shopping center for kit builders. It offers over 40 completely new kits and a variety of products priced from \$7.95 up. Heathgift certificates are available in any dollar amount you wish.

New easy terms; order now—pay later!

Heathkit's new relaxed terms are the easiest ever. Now, no down payment is necessary . . . and take as long as 18 months to pay. See the order blank in the 1962 Heathkit catalog or write for application forms today.

Heathkits give a world of pleasure—at half the price!

With Heathgifts you provide more than just a remembrance. You open an exciting, challenging, satisfying new world of pleasure—that lasts a lifetime. What's more, you give the highest quality electronic equipment, but pay up to 50% less than the cost of ready-made units.



**New "value-packed"
FM Tuner in charcoal gray and ivory**

Performs in the true Heathkit quality tradition. Loaded with such features as flywheel tuning and slide rule dial, AFC control, assembled prealigned front end for easy kit completion. 9 tube function, ± 20 -20,000 cps. A honey for looks! Features multiplex jack for use with the Heathkit AC-11 Multiplex Converter to provide FM stereo.

Kit AJ-31 FM Tuner (shown) . . . 8 lbs. \$39.95
Kit AC-11 Multiplex Converter . . . 4 lbs. \$32.50

New HEATHGIFTS



**New Test Instruments
for the technician or serious amateur**

The IM-21 AC VTVM has clean design. Extended freq. response 1 db 10 cps to 500 kc. 10 megohm input imp.; 10 voltage ranges; -50 to +50 calibrated db scale.

Versatile IO-21 "general purpose" 3" oscilloscope perfect for industrial, medical and general use. Push-pull vert. and horiz. amplifiers; 20 to 100,000 cps sweep; automatic sync.

Kit IM-21 AC VTVM . . . 4 lbs. \$33.95
Kit IO-21 3" Oscilloscope . . . 14 lbs. \$49.95

**Deluxe
9 transistor
Walkie-Talkie
keeps you in touch
anytime, anywhere**



Units at twice the price can't compare! Operating range of 1 to 3 miles; meets FCC regulations. Crystal controlled superhet receiver; squelch noise limiter circuit; push-to-talk switch; rugged, 2-tone alum. case. Use for private reception, as wireless mike or for paging. 75 hours on 9 volt battery. Collapsible 35" whip antenna.
Kit GW-21... 3 lbs. \$44.95



**A Handsome Radio for every
room in the house**

Choose from 3 spanking new ivory and beige radios. Low cost AM set provides hours of pleasure. Economical FM table radio is noise-free; has preassembled tuner. AM Clock-Radio has Telechron unit, sleep switch, radio alarm, pillow speaker jack.
Kit GR-121 AM Clock-Radio, 8 lbs. \$29.95
Kit GR-11 FM Table Radio, 7 lbs. \$27.50
Kit GR-10 AM Table Radio, 7 lbs. \$19.95



**Learn as you build—an
Educational Kit on Transistors**

Teaches basic fundamentals of transistors while performing interesting experiments! Text is written in simple easy-to-understand language. Final product is highly useful two-station intercom. Textbook provides a storehouse of valuable reference material. Designed for youngsters and adults alike. All components and materials furnished.
**Kit EK-3 Basic Transistors...
4 lbs. \$16.95**

make it a merrier Christmas for anyone!



**New
Accessories
to make a "Ham" happy**

Ham accessories that sing performance, price, features! Spectacular, compact tunnel diode "dip" meter does everything a "grid dip" can do. New rugged VFO covers 80 thru 2 meters. New "Q" multiplier has 2 peak I. F. positions. Exceptional values!
Kit HG-10 VFO... 12 lbs. \$34.95
**Kit HM-10 "Tunnel Dipper"...
3 lbs. \$34.95**
**Kit HD-11 "Q" Multiplier...
2 lbs. \$14.95**



**Safe
cruising
for the Boating Enthusiast**

Compare for price, for quality! See why the 3-band "Mariner" gives you so much. Includes consolan, beacon, broadcast and marine phone bands. 10 transistor, 1 diode circuit. Functionally styled with "sense" antenna, waterproofed 4" x 6" speaker. Preassembled tuner. Bearing accuracy of $\pm 3^\circ$.
**Kit MR-11 3-band "Mariner"...
12 lbs. \$109.95**



**Short Wave Radios put the
world at your fingertips**

Hours of fascinating broadcast, amateur radio, and short wave pleasure await you in the GR-91. Covers 500 kc to 30 mc in 4-bands. Illuminated 7" slide-rule dial & meter. Versatile controls for top reception. "Velvet touch" tuning. Easy circuit board assembly. Beige & Aqua color.
Kit GR-91 SWL Radio... 9 lbs. \$39.95



**New Wireless Intercom
saves time, saves steps**

No home, office or factory should be without this transistorized all-master intercom system. Imagine, only 3c a month to operate. No wires between units, just plug in. Any station calls other stations. Easy to build. In beautiful two-tone beige.
Kit GD-51 Intercom... 4 lbs. \$22.95
Kit GD-51-2 (pair)... 8 lbs. \$45.90

HEATH COMPANY
Benton Harbor 15, Michigan



Yes, send me my free 1962 Heathkit catalog

NAME _____
 ADDRESS _____
 CITY _____ ZONE _____ STATE _____

Order direct by mail or see your Heathkit dealer.
 Ship Parcel Post Express C.O.D. Best Way

Ordering instructions: Fill out the order blank. Include charges for parcel post according to weights shown. Express orders shipped delivery charges collect. All prices F. O. B. Benton Harbor, Mich. A 20% deposit is required on all C.O.D. orders. Prices subject to change without notice. Dealer and export prices slightly higher.

ITEM	MODEL NO.	PRICE

Free Catalog!



Send in today for your free 100-page catalog. Over 250 kits (more than 40 are new) in this most complete catalog of kits. Every piece is top quality... save up to 50%. Get a catalog now and receive 1962 Heathkit supplements.

This Christmas Give a Heathgift... from the World's Shopping Center for Electronic Kits

Surprise!

WALTER ASHE TRADES HIGHER

(he always has since 1922)

You always save money dealing with Walter Ashe Radio . . . because we always offer you more for your used transmitters, receiver or other surplus amateur gear* Find out for yourself . . . tell us what you have to trade and what you want. We guarantee you'll be genuinely surprised by the Walter Ashe deal! Use the coupon below . . . mail it today!



**DO YOU HAVE OUR NEW
144 PAGE AMATEUR CATALOG?
... IT'S FREE**

Check the coupon... get the amateur's most complete catalog of the newest in equipment, parts and supplies... everything you need!

*Made Since 1945 Catalogs mailed only to U.S. and Canada.

Phone: Chestnut 1-1125

WALTER ASHE RADIO CO.

Dept. R-12-61
1123 Pine St.
St. Louis 1, Mo.

WALTER ASHE RADIO COMPANY

Dept. R-12-61, 1123 Pine Street, St. Louis, Missouri

I am interested in _____

What is the Ashe "Surprise" allowance on _____

Name _____

Address _____

City _____ Zone _____ State _____

Send New Catalog Send Reconditioned Bulletin

Full Color Giant Fold-Out Charts Still Available!

Here's a complete series of colorful, authoritative fold-out wall-charts (originally appearing in the pages of ELECTRONICS WORLD)—yours for only 15¢ each. All in full-color—each suitable for framing.

2. **Hi-Fi Crossover Network Design Charts:** Tells how to build speaker nets for any crossover frequency. Complete coil-winding data, capacitor values given.
4. **Bass-Reflex Design Charts:** Complete data on building own bass-reflex enclosures for any speaker, including ducted-port enclosures.
5. **Radio Amateur Great Circle Chart:** For Hams and short-wave listeners—gives complete listing and map of amateur prefixes by calls and countries.

Reprint of:

7. **"Build a Citizens Band Transceiver"**—complete details on building an 11-meter transceiver for Citizens Band service.

IMPORTANT: ORDER BY NUMBER! OUR SUPPLY OF THESE FOLD-OUT CHARTS LIMITED. OFFERED ONLY ON A FIRST COME, FIRST SERVED BASIS.

Send 15¢ per selection to
ELECTRONICS WORLD

Box 378, Church Street Station, New York 8, N. Y.



"101 KEY TROUBLESHOOTING WAVEFORMS FOR SYNC CIRCUITS" by Robert G. Middleton. Published by *Howard W. Sams & Co., Inc.*, Indianapolis. 122 pages. Price \$2.00. Soft cover.

This newest volume in the author's "101" series pinpoints trouble in sync stages by relating distorted waveforms to specific component defects. For each of the troubles there is an oscillogram plus a complete text description of the symptoms, as well as voltage and resistance changes, evaluations of tests, and troubleshooting procedures to be followed to clear up the fault.

The text is practical, down-to-earth, with all extra verbiage and frills eliminated in the interest of providing the technician with fast answers to his service problems.

* * *

"OSCILLATOR CIRCUITS" by Thomas M. Adams. Published by *Howard W. Sams & Co., Inc.*, Indianapolis. 118 pages. Price \$2.95. Soft cover.

This is a basic explanation of how oscillator circuits work and is the first in a projected series on circuit fundamentals. The text covers crystal, Hartley, Colpitts, tuned-plate tuned-grid, electron-coupled, phase-shift, and blocking oscillators, plus multivibrators and thyatron saw-tooth generators.

A unique feature of this text is the use of four-color diagrams to indicate circuit action during successive half-cycles or quarter-cycles. Each electron current is identified and discussed in detail so its path can be followed through all parts of the circuit.

* * *

"TELEVISION AND RADIO REPAIRING" by John Markus. Published by *McGraw-Hill Book Company, Inc.*, New York. 558 pages. Price \$8.95. Second edition.

This is a revised and up-dated version of the author's 1953 book and includes several new chapters to cover recent advances in the state of the art such as printed circuits, transistors, selenium and germanium rectifiers, wire-wrap connections, remote-control devices, clock-radio timers, etc.

Like the earlier volume, the text is based on the assumption that the reader has had no previous experience in television or radio but is of average intelligence and electronically oriented. Emphasis is on simple, practical procedures and how-to-do-it information which can be applied to actual receiver circuits right from the start.

Entirely suitable for home study, the book also includes information on tools and components with which the reader may or may not be familiar.

* * *

"TELEVISION TUBE LOCATION GUIDE" by Sams Staff. Published by *Howard W. Sams & Co., Inc.*, Indianapolis. Price \$1.25. Soft cover.

This is the eleventh volume in this publisher's series of service handbooks designed to eliminate the necessity for removing the TV chassis for preliminary diagnosis. The layout diagrams show the location, type number, and function of all tubes in the various chassis covered.

In addition to the information about tubes, the volume includes data on fuses in the receivers covered. This book also contains the combined index for Vol. 9 through 11, covering receivers produced from 1958 to 1961.

* * *

"MICROWAVE FERRITES" by P. J. B. Clarricoats. Published by *John Wiley & Sons, Inc.*, New York. 255 pages. Price \$8.00.

This volume is intended for microwave engineers and designers and serves as a guidebook and introduction to the microwave properties of ferrites. Since this represents the first unified source of information on developments in this field, those concerned with the uses and behaviour of ferrites in the microwave region will find this book invaluable.

The text material is divided into six chapters dealing with an introduction to the field, the general properties of ferrites, microwave behaviour of ferrites, loss mechanisms

in ferrites, propagation through ferrites and ferrite-loaded waveguides, and microwave components employing ferrites.

Since the text is written for engineers, no concessions have been made to those without the requisite mathematical and engineering background.

"PLASMAS AND CONTROLLED FUSION" by David J. Rose & Melville Clark, Jr. Published jointly by MIT and John Wiley & Sons, Inc., New York. 474 pages. Price \$10.75.

The text, by two nuclear engineering professors at MIT, is prepared for students at the graduate level and covers the principles underlying plasma physics and controlled fusion. Prerequisites include a moderate knowledge of atomic physics, differential equations, electricity and magnetism, and thermodynamics.

The first twelve chapters cover plasma physics, hydromagnetics, and elementary gaseous electronics in association with transport and electromag-

netic theories. The last four chapters deal more specifically with the controlled fusion problem, including experimental and theoretical approaches, and methods of eventual energy recovery.

"ESSENTIALS OF RADIO-ELECTRONICS" by Morris Slurzberg & William Osterheld. Published by McGraw-Hill Book Company, Inc., New York. 696 pages. Price \$10.00. Second edition.

In the authors' earlier volume published in 1948, the emphasis was on radio. Now some 13 years later the text has been expanded considerably to include the burgeoning field of electronics.

The text material is written at an intermediate level and since mathematical treatment has been kept to a minimum, the book is suitable for home study as well as classroom use.

The book is divided into sixteen chapters covering an introduction to radio, vacuum tubes, AM detector circuits, tuning circuits, r.f. amplifier circuits, a.f. voltage-amplifier circuits, power-

amplifier circuits, vacuum-tube oscillators, power supplies, audio units and hi-fi reproduction, AM and FM receiver circuits, transistors, transistor amplifiers, transistor receiver circuits, and test equipment. Nine appendices containing useful reference material make this self-contained volume doubly helpful to the student.

"A GUIDE TO FORTRAN PROGRAMMING" by Daniel D. McCracken. Published by John Wiley & Sons, Inc., New York. 86 pages. Price \$2.95.

This is a workbook for those interested in learning how to use a computer in the solution of problems in science and engineering without the necessity for learning details of computer operation.

Written as a basic text for use in courses in engineering, science, or mathematics, the book can also be used by the individual to amplify and/or clarify other Fortran programming manuals or texts. Graded exercises and answers

NEXT BEST THING TO THE
WINEGARD ELECTRONIC
POWERTRON TV ANTENNA

NEW TRANSISTOR TV-FM WINEGARD TENNA- BOOST

MOUNTS ON ANY ANTENNA

MOUNTS ON
ANTENNA



Model
MA-300

\$**34**⁹⁵
only LIST

INSTALL IT... FORGET IT!

ALL ELECTRIC, ALL-AC POWER SUPPLY costs less than 27c a year to operate. Many exclusive features.

No costly, nuisance batteries!



Built-in two set coupler.



Exclusive Gain Control Switch

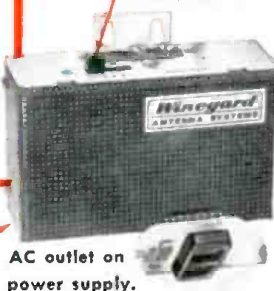

19 DB GAIN! CUTS SNOW...BOOSTS SIGNAL!

Now you can make any TV or FM antenna work better by magnifying signals with the new Winegard transistor Tenna-Boost.

Tenna-Boost has up to 19 DB gain, no peaks and valleys. Ultra low noise. Linear frequency response. VSWR input better than 1.5:1 across all frequencies. Output VSWR 1.8:1 or better. This fine frequency response plus the very low VSWR make Tenna-Boost excellent for color.

Winegard's exclusive input band-pass filter eliminates interference from citizen's band, Hams, garage door openers, etc. Only TV and FM signals are amplified.

All metal parts are anodized, irradiated or stainless steel. Completely weather-proof, trouble-free. Install it... forget it.

There's a big difference in antenna amplifiers! Ask your distributor or write for technical bulletin.



FOR THE ULTIMATE IN
TV RECEPTION

Winegard Transistorized Electronic Powertron TV Antennas. 3 Models to Choose From.



Winegard

ANTENNA SYSTEMS

3003-12B Kirkwood • Burlington, Iowa

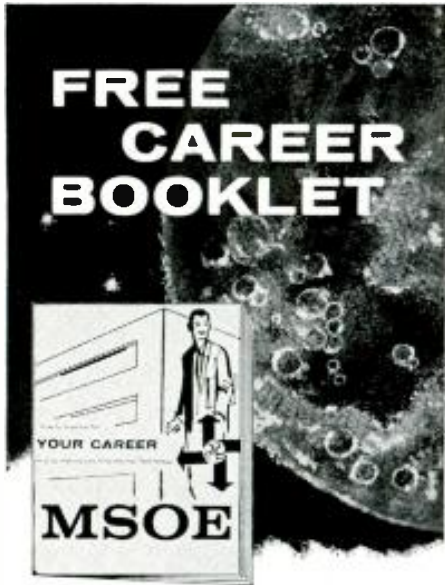

to guide you
to a
successful future
in

ELECTRONICS RADIO-TV COMPUTERS ELECTRICAL ENGINEERING

This interesting pictorial booklet tells you how you can prepare for a dynamic career as an Electrical Engineer or Engineering Technician in many exciting, growing fields:

**MISSILES • RADAR • RESEARCH
ELECTRICAL POWER • ROCKETRY
AUTOMATION • AVIONICS
SALES • DEVELOPMENT**

Get all the facts about job opportunities, length of study, courses offered, degrees you can earn, scholarships, part-time work — as well as pictures of the Milwaukee School of Engineering's educational and recreational facilities. No obligation — it's yours free.

MILWAUKEE SCHOOL OF ENGINEERING

MAIL COUPON TODAY!

MILWAUKEE SCHOOL OF ENGINEERING
Dept. EW-1261, 1025 N Milwaukee St.
Milwaukee, Wisconsin MS-113

Please send FREE "Your Career" booklet
I'm interested in Electronics Radio-TV
 Computers Electrical Engineering
 Mechanical Engineering
(PLEASE PRINT)

Name _____ Age _____

Address _____

City _____ Zone _____ State _____

I'm eligible for veterans education benefits.

Discharge date _____

have been included along with eight case studies illustrating practical applications of the technique.

"SENSORY COMMUNICATION" edited by Walter A. Rosenblith. Published by MIT Press and *John Wiley & Sons, Inc.*, New York. 824 pages. Price \$16.00.

This volume represents the contributions of 42 participants in the International Symposium on Principles of Sensory Communication held July 19 through August 1, 1959 at Endicott House, Massachusetts Institute of Technology. Drawing on the experiences of an international group of life scientists, physical scientists, and communications and computer engineers, the symposium considered the problems of interest to those working in the field of telephone communication, radio, television, and photography.

This volume is a distillation of the group's deliberations.

"ABC'S OF TAPE RECORDING" by Norman H. Crowhurst. Published by *Howard W. Sams & Co., Inc.*, Indianapolis. 92 pages. Price \$1.50.

This is basically a primer for the new or prospective owner of a tape recorder. The language is non-technical and the explanations of the applications and operation of the machine are simple and lucid. We do, however, take issue with the author when he flatly states that open-reel type machines are "older models" and that cartridges are characteristic of "more modern machines," citing *RCA* and the *CBS/3M* as examples

of such units. In this the author is a bit premature, to say the least, since the *CBS/3M* machine is not even on the market.

The text is elaborately illustrated with line drawings and photographs of actual equipment. The six chapters deal with the components basic to all tape recorders, how to choose a tape recorder, how to use it, simple things that can be done with a recorder, practical applications, and advanced uses for such equipment. A glossary of terms is also appended.

"COLOUR TELEVISION" by P. S. Carnt & G. B. Townsend. Published for "Wireless World" by *Iliffe Books Ltd.*, Dorset House, Stamford Street, London SE1, England. 480 pages. Price 86 s./9 d. postpaid.

This book describes the British version of our NTSC color-TV system with emphasis on the 405-line version but also taking into account the differences among the 405-525-, and 625-line systems. In this way the authors have eliminated the threat of obsolescence since the standards for color TV have not been officially established in Europe.

A thorough working knowledge of black-and-white television theory is prerequisite and although, on the whole, the treatment is non-mathematical, a familiarity with mathematical processes and procedures would prove helpful.

There is a section prepared specifically for service technicians as well as chapters on circuit theory and practical color-TV circuits. ▲



JANUARY 9-11, 1962

Eighth National Symposium on Reliability & Quality Control. Sponsored by PGRQC, AIEE, ASQC, and EIA. Statler-Hilton Hotel, Washington, D.C. Program information from E. F. Jahr, IBM Corp., Dept. 351, Owego, N.Y.

JANUARY 18

Transformer Testing. Sponsored by N.Y. Metropolitan Chapter of Institute of Environmental Sciences. U.S. Testing Co. Laboratories, Hoboken, N.J. For program information contact Carl Hanne-mann, 214 E. 105th St., New York 29, N.Y.

JANUARY 23-27

Third Annual ERA Convention & Management Conference. Sponsored by Electronic Representatives Assn., Hollywood Beach Hotel, Hollywood Beach, Fla. Details from ERA headquarters, 600 S. Michigan Ave., Chicago 5, Ill.

FEBRUARY 7-9

1962 National Winter Convention on Military Electronics. Sponsored by PGMIL and I.A. Section of IRE. Ambassador Hotel, Los Angeles. Details from IRE Los Angeles Office, 1435 S. La Cienega Blvd., L.A., Calif.

FEBRUARY 9-11

Pacific Electronic Trade Show. Shrine Exposition Hall, Los Angeles. Information on exhibits and program available from PETS, 2216 S. Hill St., Los Angeles 7, Calif.

FEBRUARY 27-MARCH 1

Symposium on Application of Switching Theory in Space Technology. Sponsored by Lockheed Aircraft Corp. and AFOSR/General Physics Div. Contact Dr. J. P. Nach, c/o Lockheed, Sunnyvale, Calif. for details.

MARCH 1-2

Eighth Scintillation and Semiconductor Counter Symposium. Sponsored by PGNS, AIEE, AEC, NBS. Shoreham Hotel, Washington, D.C. Program information from Dr. George A. Marton, RCA Labs, Princeton, N.J.

MARCH 14-16

Twelfth Annual Conference on Instrumentation for the Iron & Steel Industry. Sponsored by Instrument Society of America. Hotel Roosevelt, Pittsburgh, Pa. Details from H. M. Gravatt, Allegheny Ludlum Steel Corp., Research Lab., Brock-ridge, Pa.

ELECTRONIC TERMINOLOGY

By **WILLIAM A. PLICE**

(Answer on page 98)

ACROSS

1. Degree of movability—critical in performance of speakers.
6. Frequencies usually handled by a tweeter (abbr.).
7. A horn baffle matches the _____ of the speaker to the room.
13. Approximately 52 weeks (abbr.).
14. An important component of the stereo illusion.
15. A type of hookup wire (abbr.).
16. Semiconductor used in modern power supplies (abbr.).
17. Delayed sound waves.
18. Musical notation directing a slowing of tempo.
20. Distortion caused by one frequency modulating another.
22. The base metal of the cathode in a vacuum tube (Chem. symbol).
23. Any unwanted or unrelated component of the program.
24. Chemical symbol for sodium.
25. A two-way radio service (abbr.).
26. Thoroughfare, for short.
28. Process intended to compensate for changes made in transmission or recording (pl.).
32. Small receiving antenna.
34. Frequencies present on each side of the carrier in AM transmission (abbr.).
36. Electrical element of a speaker.
38. Science of sound.
41. A few bits of this material may someday replace tubes in an amplifier (Chemical symbol).
42. Usually the frequencies below 260 cps.
43. Lightest inert gas (Chemical symbol).
44. Standard form of output transformer employs a _____ in the primary (abbr.).

DOWN

1. Distortion occurring when maximum input is reached.
2. An additional boost given to frequencies in the 3000 to 5000 cycle range.
3. The "Gem State" (abbr.).
4. Signal given as a direction.
5. An equalization curve.
6. Type of motor used in high-quality turntables.
8. 1/1000 of the basic inductance unit.
9. Early hi-fi experimenters built rigs from modified _____ amplifiers.
10. 1/10 of a bel.
11. Level indicator used in some recorders.
12. Hookup wire type (abbr.).
18. The Record Industry's trade group (abbr.).
19. Equals.
21. Small unit of current (abbr.).
27. Musical notation directing repetition from the sign.
29. Larger end of a horn.
30. This agency is responsible for the mail service (abbr.).
31. Drive motors for recorders are only fractional _____ (abbr.).
33. The broadcasters en masse.
34. Distress signal.
35. Wire or bar used for power or ground.
36. Reciprocal of a sine (abbr.).
37. Fifty-four (Roman numerals).
39. Calcium (Chemical symbol).
40. Power, according to Ohm's Law.

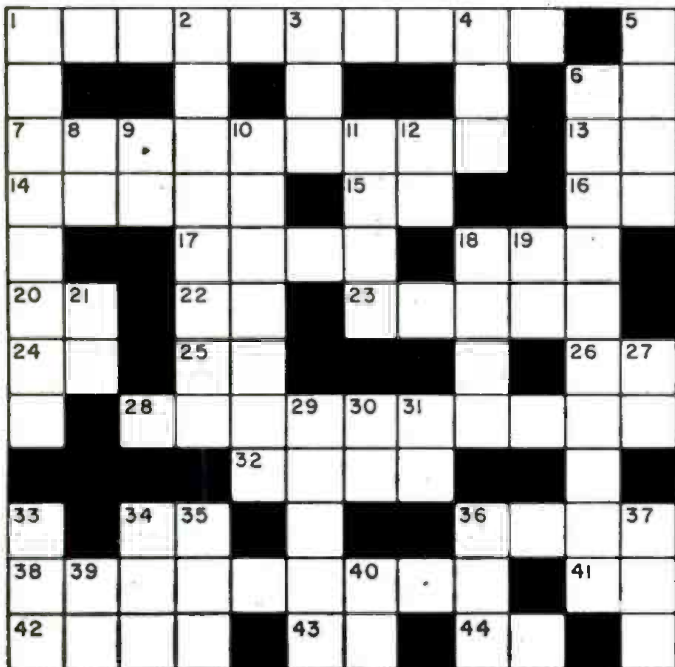

December, 1961

New transistor Home TV and FM System!

Winegard BOOSTER-PACK & 'SIX-SET' COUPLER



BOTH
for the price
of the amplifier
\$34.95*
A \$42.90 value



DRIVE UP TO 6 TV AND FM SETS

Cut snow . . . improve contrast . . . deliver sharper, clearer pictures to each set. New low noise, high gain transistor combined with advanced circuitry gives Winegard AT-6 "Booster-Pack" a flat gain of 16 db on low and FM bands . . . a flat 14 db gain on high band.

Shock-proof, full AC chassis with AC isolation transformer (NOT AC-DC). Draws 1.2 watts. Gain control switch prevents overdriving sets on local stations. No heat. Can be mounted remote from coupler. Also ideal as single set booster.

New, Winegard 300-ohm "Six-Set" coupler has low insertion loss, positive isolation between sets. No need to terminate unused outputs.

You get both AT-6 "Booster-Pack" and LTS-63 "Six-Set" for the price of "Booster-Pack" alone: a \$42.90 value for only \$34.95 list. Ask your distributor.

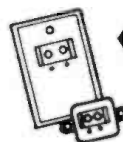

For real convenience, add Winegard flush or surface mount 300-ohm plug-in outlets. Even folks with only one TV set appreciate being able to move it from room-to-room.

For finest all-channel reception, use a Winegard "Teletrcn" antenna with your "Booster-Pack".



*Limited Time Offer



Winegard

ANTENNA SYSTEMS

Winegard Co., 3003-12C Kirkwood St., Burlington, Iowa

COMPONENT & TUBE TRENDS IN GREAT BRITAIN

By PATRICK HALLIDAY

A rundown of some of the items shown in London at the largest electronic component show ever held in Europe.

THE largest component show ever staged in Europe, held in London recently, pinpointed the international tie-ins in the component industry. Many of the 250 British component, semiconductor, and tube firms represented now have close financial or technical links with their counterparts in the United States. The importance of this European market is indicated by the figure that, in Britain alone, more than seven million electronic components are manufactured daily.

For the TV and radio consumer industries, several new transistor and u.h.f. tuners were noted. One compact u.h.f. tuner by *Cydon* uses two triodes, the first as a grounded-grid r.f. amplifier, the second as a grounded-grid self-oscillating mixer (single-tube self-oscillating mixers are very popular in Europe for FM radio). The three u.h.f. tuned circuits consist of short Lecher sections tuned by a slow-motion ganged capacitor over the range 470-790 mc. TV tuners generally have swung rapidly away from rotary "detent" knob controls and there is now great emphasis on push-button mechanisms, usually providing four channels per receiver. Motorized tuners also seem to have come to stay, often in conjunction with remote control.

In the past, the series-cascode circuit has been almost universal in European TV tuners but the trend is toward more neutralized-triode and tetrode amplifiers. A new beam-triode (PC97) by *Mullard* features frame-grid construction with only the active area of the plate in close proximity to the grid to give the unusually low grid-plate capacitance of .5 $\mu\text{f.}$; this technique is similar to that of the 6ER5 tube. Another TV tuner innovation is an *Ediswan* TV frequency converter tube with the mixer section designed for connection to the receiver a.g.c. line.

Among recent European domestic tubes shown was the ELL80 (*Brimar*), a miniature double-pentode output suitable for stereo equipment either as two single-ended output tubes or as a 6-8 watt push-pull output stage. Another new output tube for stereo is the triode-pentode type ECL86. *Mullard* has described an inexpensive high-fidelity unit with total harmonic distortion well under 0.1 per-cent at 10 watts, using for each channel a single high-slope pentode (EF86) followed by two ECL86 triodes as phase-splitter and the two pentode sections as an "Ultra-Linear" output stage.

Garrard, whose phono equipment is well-known in the U.S., has a new, very slim auto-changer requiring only $4\frac{3}{8}$ " mounting space above and $2\frac{7}{8}$ " below the motorboard.

Silicon rectifiers have not thus far been widely used in British TV receivers mainly because of their low p.i.v. for the 240-volt standard line voltage. *Lucas* has a new 330-ma. unit rated at 800 p.i.v. for this application. Several firms, including *Hughes International*, featured silicon variable capacitors for remote tuning and "signal seeking" circuits.

In the transistor field, new releases tumbled over one another. Emphasis now seems to be on the epitaxial types in which a layer of semiconductor material is built up by the deposition of a gas at high temperature onto a seed crystal at lower temperature. An *S.T.C.* display showed an interesting unit containing three epitaxial transistors delivering an r.f. output of 9 watts at 10 mc. with 50% efficiency, compared with 5 watts at 5 mc. with 45% efficiency of corresponding double-diffused transistors.

Eddystone, makers of ham and other communications receivers, showed for the first time an entirely transistorized high-performance communications receiver covering 500 kc. to 30 mc. in six

ranges. It uses 12 transistors and 6 diodes; the r.f. amplifier, mixer, and oscillator being h.f. alloy-diffusion transistors now readily available in Britain. With bandpass crystal filter and operating from 12-volt batteries, the price tag is in the region of \$360.00. Other receivers in this exhibit go down to 10 kc. and up to 1000 mc.

The hybrid TV receiver with transistors for a few functions such as sync separation has already arrived on the British market and the gradual extension of transistors in TV rather than all-transistor models has been forecast for the mass market.

The panel space taken up by most meters is a problem well-known to all designers of amateur and commercial equipment. A new series of small rectangular meters, taking little more than one square inch of panel space, was shown by *M.I.P.* The edgewise mounting of the movement provides a very clear scale for such a small meter.

Among the myriad small components, this visitor was impressed by the many new miniature trimmers and fixed capacitors as well as by the promise of more reliable miniature switches. Recent techniques for plating switch contacts with a layer of gold, rhodium, or palladium only a few millionths of an inch thick should take these components off their present low rating in the reliability stakes. Some of the types shown are said to retain their performance even after more than one million operations.

A good deal of research into solid-circuit micro-miniaturization is going on in government and industrial research centers. Some of the progress being made in the formation of resistive and capacitive circuit elements by successive vacuum evaporation onto thin glass substrates was also exhibited at the component show.

A tiny *Mallory* mercury-cell battery has been developed for use in radio pills, swallowed by the patient to transmit information on the intestinal tract. It has a capacity of about 37 ma.-hours and measures only $\frac{1}{2}$ inch in diameter and $\frac{1}{8}$ inch high.

At high power, *English Electric* has introduced tunable klystron u.h.f. TV transmitting tubes capable of 10 kw. output with an efficiency of 40%. For two-way mobile v.h.f. equipment, *Mullard* has medium-power transmitting tubes up to 85 watts output which take less than one second to heat up fully. These use either short, coated ribbon cathodes of large cross-section or else a number of thin oxide-coated wires connected in parallel. ▲



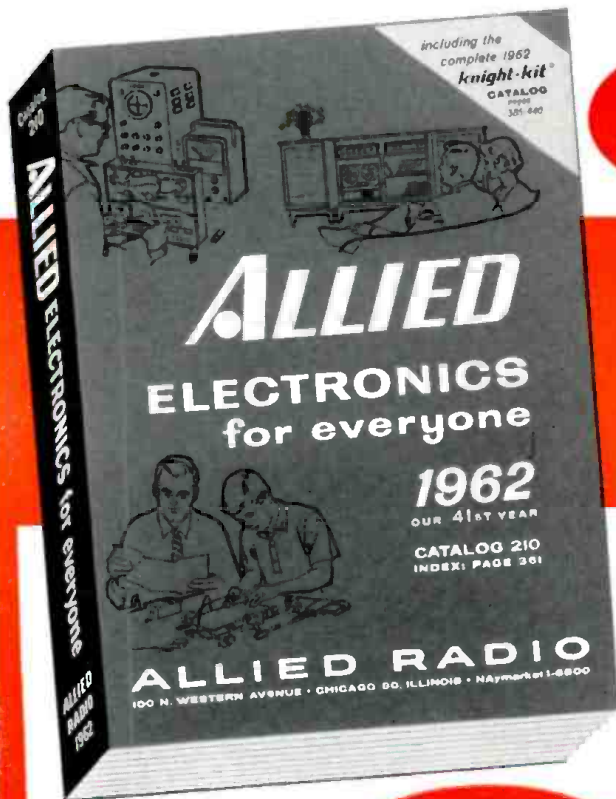

Free ALLIED 1962 CATALOG

includes complete catalog featuring over 90 exciting

knight-kits

A PRODUCT OF ALLIED RADIO

New! Original! Only from Allied!



AMAZING 100-in-1 Electronic Science Lab Kit, an open door to the exciting world of electronics; absolutely unique.....\$29.95

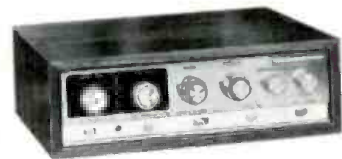

ALL-TRANSISTOR 50-Watt Stereo Hi-Fi Amplifier Kit—a revelation in sound performance, less case.....\$79.95

only kits of their kind!

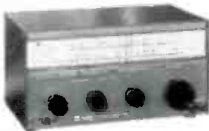

ALL-TRANSISTOR 2-Band AM-Shortwave DX'er Radio Receiver Kit.....\$19.95

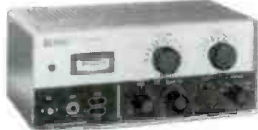

SENSATIONAL PHONE & CW 60-Watt Ham Transmitter Kit for only...\$49.95

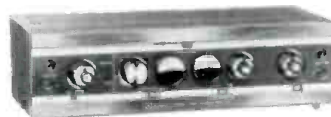

STEREO TAPE Record-Playback Preamplifier Kit, with professional features, less case.....\$89.95



MULTIPLEX Self-Powered Adapter Kit, for Stereo FM reception. A tremendous value at.....\$19.95

simply great for '62!



TRANSISTORIZED Electronic Tachometer Kit.....\$24.95



ALL-TRANSISTOR Wireless Intercom System Kit (2 units).....\$45.90



DELUXE STEREO FM-AM Tuner Kit with latest built-in MULTIPLEX Stereo FM; case included.....\$99.95



ALL-IN-ONE FM-AM Tuner-Amplifier with latest built-in MULTIPLEX Stereo FM; less case.....\$129.95

building a Knight-Kit is the most satisfying do-it-yourself experience in the world!

5 BIG REASONS WHY:

- Convenience Designed
- Wonderful to Build
- You Own the Best
- You Save So Much
- Easiest to Buy—NO MONEY DOWN!

MONEY BACK GUARANTEE: Buy any Knight-Kit. Build it! Use it! You must be satisfied or you get your money back!

see more than 90 KNIGHT-KITS
HI-FI • HOBBY • AMATEUR • INSTRUMENT

ALLIED RADIO

December, 1961

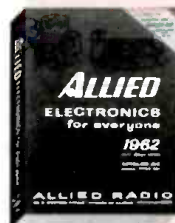

Send for it today!

KNIGHT-KITS are also available in Canada

- World's Largest Stocks • Lowest Money-Saving Prices
- Fastest Shipment • Expert Help • Easiest-Pay Terms
- Satisfaction Guaranteed or Your Money Back

send for the world's biggest electronics catalog!

Free

ALLIED RADIO, Dept. 226-M1
100 N. Western Ave., Chicago 80, Ill.

Send FREE 1962 ALLIED 444-page Catalog

Name _____
PLEASE PRINT

Address _____

City _____

Zone _____ State _____

TELEPHONE BOOSTER AMPLIFIER

By HAROLD REED

Designed for persons with a hearing impairment, this compact and portable transistorized unit includes several novel features.

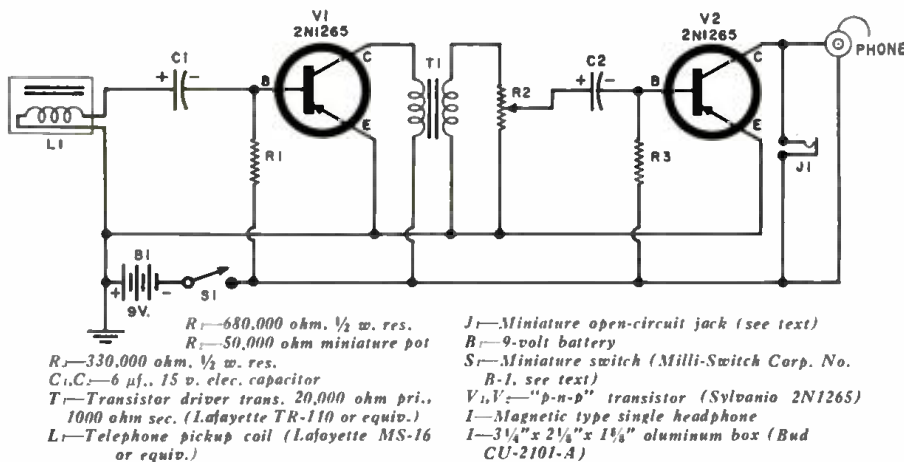

Fig. 1. Schematic diagram of the two-stage telephone booster amplifier.

straightforward. See Fig. 1. Signal from the telephone pickup coil is fed to transistor *V₁*, which is transformer-coupled to a second transistor, *V₂*. A volume control is connected between these two stages. The booster headphone is in the collector circuit of the second transistor. Power is obtained from a 9-volt battery, *B₁*. *S₁* is a miniature switch which disconnects the battery from the transistorized circuit when the receiver is hung on the hook.

Construction Details

The booster is constructed in a 3¼” x 2¼” x 1¼” aluminum box. A thin aluminum strip is secured to the bottom of the box by small machine screws. The telephone pickup coil is cemented to this

VOICE amplification of incoming telephone communications is certainly not new, however some novel features are incorporated in this version of a telephone booster which should be of interest to electronic technicians and constructors. The following desirable features have been included in this unit.

It can be used on different phones, making it possible for a person with a hearing impairment to be accommodated on both main and extension phones. It is compact—offering portability with ease and having no long wire to contend with. There is no power switch to be operated as the unit is turned off automatically. Although battery life will be long, there is no point in leaving the unit operating continuously, hence the cut-off feature.

A miniature output jack is provided for connection to the high-impedance input of a power amplifier or recorder, thus the booster can also be used for speaker operation or tape recording. Nothing is attached to the telephone. At first it was planned to provide an arrangement whereby the booster headphone could be clipped over the telephone receiver. This idea was discarded since it resulted in hearing in one ear only, whereas by using the telephone receiver normally for one ear and the booster headphone for the other ear, an increased hearing facility is provided. This also avoids attaching anything to the telephone—which is frowned upon by the telephone company.

The Booster Circuit

The circuit itself is quite simple and

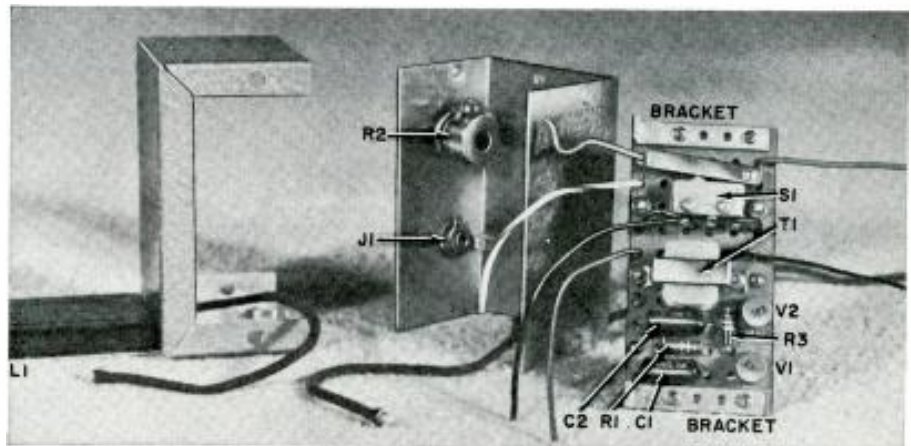

The phenolic board with its components mounted and wired, is ready to be attached to the box section next to it by the two brackets. The volume control and output jack are already mounted on box section while the pickup coil is attached to cover.

The booster amplifier is shown here completely assembled and ready to use. For battery replacement, which will not be often, box sides are pressed in and pulled out.

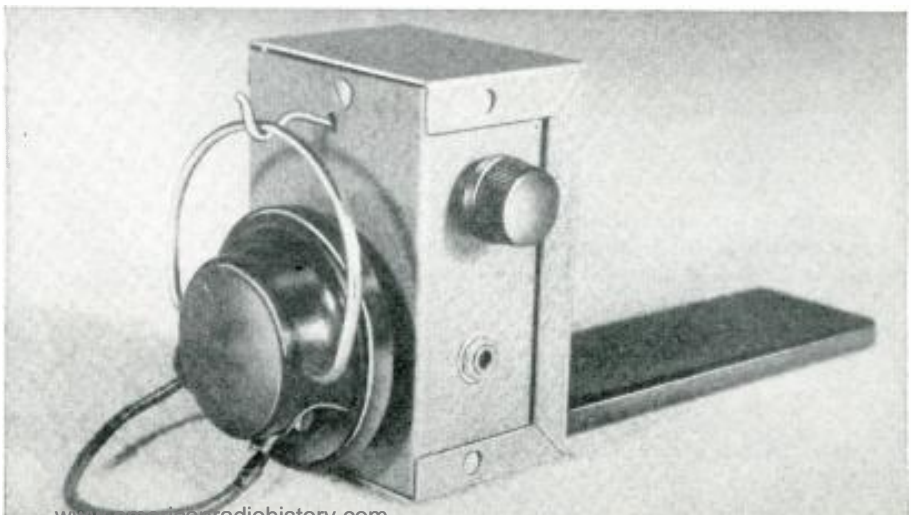

strip, as can be seen in the photographs. It should be noted that the outer section of the box faces toward the pickup coil. This is done so that the inner portion of the box may be removed easily for battery replacement.

The miniature switch specified in the parts list just happened to be on hand. There are other units of this type available that can be used just as well. An actuator arm was devised for the switch from a $\frac{3}{16}$ " x $\frac{3}{16}$ " x $1\frac{1}{4}$ " piece of brass. A hole drilled in one end accepts a stiff wire that is solder-sweated to the brass. The other end of the wire is fashioned into a hook on which the headphone can be hung. The arm is pivoted at the switch end and rests on the actuator button of the switch. The weight of the headphone on the arm produces sufficient pressure to operate the switch. When the weight of the headphone is removed, the switch returns to normal in which position the switch contacts close, connecting the battery to the circuit.

The single headphone is a surplus item. It was fitted with a wire band made from a shower curtain hook, available at variety stores. The wire has sufficient spring to remain secured in place. This is for hanging the phone on the wire hook but, also, the wire is fashioned so it will slip over the user's ear, making it unnecessary to hold the headphone when engaged in long conversations or when taking notes.

All small parts, except the volume control and output jack, are mounted on a piece of phenolic board measuring 3" x $1\frac{1}{2}$ ". Wire leads of the parts are pulled through holes in the board and soldered on the opposite side. The switch is also attached to this board near the top. A thin metal strap holds the battery to the board behind the switch and transformer. The small output jack is insulated from the box with fiber washers.

To use the booster it is only necessary to slip the pickup coil under any telephone, lift the headphone off the hook, and adjust the volume control for the level desired. The phone may be hand-held or hung on the ear.

The constructor can make the following modifications. The switch and actuator arm, although desirable, need not be used. The miniature volume control is available with an attached switch which can be used instead. Also, if the booster is constructed for a person with a considerable hearing loss, the volume control can be eliminated entirely and a small toggle or slide switch employed for battery cut-off. However, in making tests with persons having a moderate hearing loss there were complaints that speech reception was too loud without the volume control. If it is not intended to use the device for speaker operation or tape recording, the output jack will not be required.

The cost of this booster is low. The transistors were purchased for 49 cents each, the transformer was 89 cents, and the pickup coil \$1.95... which all adds up to a lot of convenience for little money. ▲

YOU NEED THIS...

FREE GIANT ALL NEW 1962 BA CATALOG

SAVE UP TO 50% ON B-A SELECTED KITS

TOP VALUES IN POWER AND HAND TOOLS

HI-FI AND STEREO SYSTEMS & COMPONENTS

30 PAGES OF BARGAINS NOT IN ANY OTHER CATALOG

RUSH COUPON TODAY!

BURSTEIN-APPLEBEE CO. Dept. EW
1012-14 McGee St., Kansas City 6, Mo.

Rush me New 1962 B-A Catalog No. 621

NAME _____
ADDRESS _____
CITY _____ STATE _____

RADIO PARTS STORES & HI-FI SALONS!

Hundreds of dealers across the nation profit by selling **ELECTRONICS WORLD** each month to their customers. Are you one of them? **ELECTRONICS WORLD** helps build store traffic... keeps customers coming back month after month for the merchandise you sell—and, best of all, you earn a neat profit on each copy sold—**NO RISK INVOLVED**. So get details on selling **ELECTRONICS WORLD**, the world's largest selling technical electronics magazine. Or, order your copies now. Just use the handy coupon.

Retail Sales Department, **Electronics World**
One Park Avenue, New York 16, New York

Att: Jerry Schneider

- Send me _____ copies of **ELECTRONICS WORLD** for resale in my store each month. No risk involved on my part.
- Send me details on selling **ELECTRONICS WORLD** in my store.

STORE NAME _____
ADDRESS _____
CITY _____ ZONE _____ STATE _____
SIGNATURE _____ EW 1261

Memory Unlimited

I JUMPED into the first railway compartment which seemed empty: my eyes fell on a book left on the seat opposite by a previous passenger.

I took it up absent-mindedly and ran through the first lines. Five minutes later I was reading it as eagerly as a clue to a hidden treasure. I learned that everyone's memory is capable of fantastic feats; that an ordinary person if he has taught himself to control the way in which his brain stores impressions can memorize accurately long and complicated lists of facts after reading them over only once or twice. I thought I would test the truth of the statement.

I took a timetable out of my suitcase and began reading quietly in the manner prescribed, the names of about one hundred railway stations. I observed that, after reading them over a few times, I could recite the whole list off with hardly a mistake. With a little more practice I found I had committed them so completely to memory that I could remember them in the reverse order and even pick out one station from the list and say which number it was, and what were the names of the towns before and after it.

I was astonished at the memory I had acquired and spent the rest of my journey on more and more difficult experiments in memory, and reflecting how this new control I was achieving over my mind would materially help me to a greater success in life. After this, I worked hard at this wonderful memory system, and within a week I found I could recall passages from books and quote them with ease; names, addresses and business appointments were remembered immediately; and in four months I had succeeded in learning Spanish.

If I have obtained from life a measure of wealth and happiness, it is to that book I owe it, for it revealed to me the workings of my brain.

Three years ago, I had the good fortune to meet its author, D. U. Borg, and I promised him to propagate his method, and today I am glad of this opportunity of expressing my gratitude to him.

I can only suppose that others wish to acquire what is, after all, the most valuable asset towards success in life.

Borg's address is: D. U. Borg, c/o Aubanel Publishers, 14 Highfield Road (Rathgar), Dublin 6, Ireland. Apply to him for his little book, "The Eternal Laws of Success." (Postage 5¢ for a postcard to Ireland by surface mail). It is free to all who wish to develop their memory.

F. ROBERTS.

(ADVERTISEMENT)

PARALLEL RESISTANCE SHORTCUT

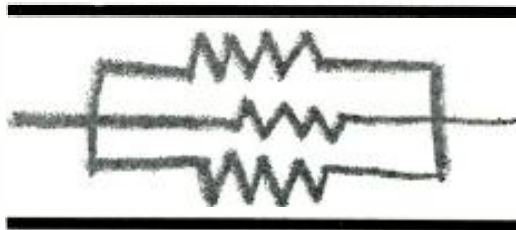

By A. K. QUINN

Simple arithmetic replaces cumbersome calculations for determining needed shunts, finding other values.

AS THE SERVICE shop owner often puts it, "How can I find the value of a blasted resistor which, in parallel with some other blasted resistor, will give me the value of a blasted resistor I need but don't have on hand?" More plainly, suppose you need but don't happen to have a 500-ohm resistor. Nor do you have a pair of 250-ohm units to put in series or a pair at 1000 ohms each to shunt.

Trying to find a series pair from a random collection is not the toughest job in the world, but looking for a parallel pair is another matter. You already know what resistance you want, R_1 , but the trouble is that you are looking for two unknowns, R_1 and R_2 . From those on hand you pick a likely (you hope) resistor for R_1 and use the parallel resistance formula to derive R_2 . But you don't have the latter value in the shop either. Trying several possible combinations in this way with the formula is a messy, time-consuming business. However, there is a short cut, based on simple arithmetic, so easy that you can work out several possible parallel combinations quickly before looking for suitable resistors.

To find the first resistor, R_1 , simply multiply desired value R , by any simple number. To find the matching value of R_2 , divide R , by a number that is one less than the first number chosen. If you want 500 ohms, for example, multiply that value by, say, 5. This gives 2500 ohms for R_1 . Dividing 2500 by 4 now gives you 625 ohms for R_2 . A multiplier of 7 and a divisor of 6 gives you another pair, 3500 and 583. Using 4 and 3 yields 2000 and 666. You now have several possibilities before checking your stock.

Tolerances being what they are, converting your answers to the nearest standard values will give little trouble. In the last pairing cited, for example, suppose you shunted a 2000-ohm resistor across a standard, 680-ohm unit. You would theoretically have 507 ohms instead of 500. Is this error of slightly more than 1 per-cent significant in the light of available tolerances and actual requirements? Also, while the use of simple, whole numbers as factors is convenient, you can get as fancy as you like.

You might use 7.5 and 6.5 as factors, for example, to get more possible pairs.

So far, so good; but there is still more to the basic technique. Suppose you have such a limited resistor assortment on hand that you can't find a parallel pair, even now, and you have to try it with three units in shunt. Let's say you need 60 ohms. You have multiplied by 7 to give you 420 ohms for R_1 (which you have) but you can't find a matching R_2 . You take your second factor (7 minus 1 equals 6) and split it up into any two numbers that add up to it. For example, 4 and 2 make 6. Divide each of these new numbers separately into R_1 . The two answers will be the values for R_2 and R_3 . In this case, $420/4$ gives you 105; and $420/2$ gives you 210.

Sure enough, 420 ohms, 105 ohms, and 210 ohms in parallel will come down to 60 ohms exactly. Using standard values, 430, 100, and 220 would provide 59.3, less than 2 per-cent off. This method can be extended for any number of parallel units. If it is not practical to do so, neither should it be necessary.

Finally, a variation of the method works wonders in reverse; that is, when you start out with a number of resistors and wish to determine what they will come to in parallel. It is much simpler than using the reciprocal formula. (Oh, those least common denominators for large numbers!) Assume you want to know what four resistors, whose ohmic values are 540, 270, 180, and 90, will come to in parallel.

First divide each resistor's value into that of the largest one in the group. You quickly find that $540/540=1$, $540/270=2$, $540/180=3$, and $540/90=6$. You add up your four quotients as follows: $1+2+3+6=12$. Now divide the highest value by this sum. This division, $540/12$, gives you an answer of 45 ohms. If you don't think this works, you can test it for yourself by working out a combination in the recommended manner and trying the same set of values with the reciprocal formula. What you accomplish will be more than the confirmation of this method's validity by getting the same answers both ways. You will also find out why this method is easier. ▲

RCA training at home can be the smartest investment you ever made

Look what you get in the Course in Radio and Electronic Fundamentals

40 Fascinating THEORY LESSONS



Containing all the basic principles of radio and electronics in easy-to-understand form.

40 EXPERIMENT LESSONS

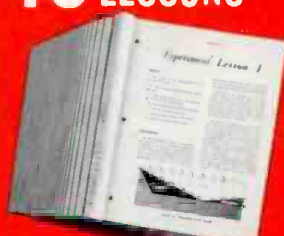

Each containing absorbing, practical experiments, bound together in 20 books.

40 SERVICE PRACTICES

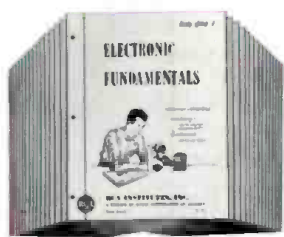

Full of practical, time-saving and money-saving servicing tips, bound into 20 books.

PLUS ALL THIS AT NO EXTRA COST...

15 KITS

to build a Multimeter, AM Receiver and Signal Generator. Kits contain new parts for experiments, integrated so as to demonstrate what you learn in the lessons and to help you develop technical skills. Each kit is fun to put together!



MULTIMETER

A sensitive precision measuring instrument you *build* and *use* on the job. Big 4½" meter with 50 microamp meter movement. 20,000 ohms-per-volt sensitivity d-c. 6,667 a-c.



AM RECEIVER

Have the satisfaction of building your own radio receiver with this high-quality 6-tube superheterodyne set. Big 5" speaker, fine tone!



SIGNAL GENERATOR

A "must" for aligning and trouble-shooting receivers. Build it for your own use. 170 KC to 50 MC fundamental frequencies for all radio and TV work.

Practical work with the very first lesson! Pay-only-as-you-learn! No long-term contracts to sign! No monthly installment payments. Pay only for one study group at a time if and when you order it!

Stake out your future in electronics now!
SEND FOR OUR FREE HOME STUDY CATALOG TODAY!

Just fill out this card and drop it in the mail—no postage needed. →



RCA INSTITUTES, INC.
A Service of Radio Corporation of America
350 West Fourth Street
New York 14, N. Y.



The Most Trusted Name in Electronics

RCA INSTITUTES INC. Home Study School, Dept. EW-D1
A Service of Radio Corporation of America
350 West Fourth Street, New York 14, N. Y.

Without obligation, rush me the FREE 64-page illustrated book describing your electronic training program (check one). No salesman will call.

Home Study Los Angeles Resident School New York Resident School

Name (Please Print)

Address

City Zone State

Veterans: Enter discharge date.....

CANADIANS—Take advantage of these same RCA courses at no additional cost. No postage, no customs, no delay. Enclose this card in envelope and mail to: RCA Victor Company, Ltd., 5581 Royalmount Ave., Montreal 9, Quebec.

HOME STUDY SCHOOL



RCA TRAINING CAN BE THE SMARTEST INVESTMENT YOU EVER MAKE

With RCA Institutes Home Study training you set your own pace in keeping with your own ability, finances and time. You get prime quality equipment as a regular part of the course . . . and you never have to take apart one piece to build another. Perhaps most important, RCA's liberal Pay-As-You-Learn Plan is the most economical home study method *because you pay only for lessons as you order them . . . one study group at a time!* If you drop out at *any* time, for *any* reason, you do not owe RCA one penny! No other obligations! No installment payments required! Licensed by New York State Education Department.

Choose YOUR FUTURE from this list of courses:

- Radio and Electronic Fundamentals (see reverse side)
- Television Servicing
- Color Television
- Electronics for Automation
- Transistors

RESIDENT SCHOOLS

START YOUR CAREER IN ELECTRONICS NOW AT RCA INSTITUTES in Los Angeles-New York City

CHOOSE FROM THIS LIST . . .

	Course	Qualifications	Length of Course
A	Advanced Electronic Technology (T-3)	High School grad, with Algebra, Physics or Science	Day 2 1/4 yrs. Eve. 6 3/4 yrs. (N.Y.) 4 1/2 yrs. (L.A.)
B	Television and General Electronics (V-7)	2 yrs. High School, with Algebra, Physics or Science	Day 1 1/2 yrs. Eve. 4 1/2 yrs. (N.Y.) 3 yrs. (L.A.)
C	Radio and Television Servicing (V-3)	2 yrs. High School, with Algebra, Physics or Science	Day 9 mos. Eve. 2 1/4 yrs. (N.Y.) 1 1/2 yrs. (L.A.)
D	Transistors	Radio background	Eve. 3 mos.
E	Electronic Drafting (V-11 V-12)	2 yrs. High School, with Algebra, Physics or Science	Eve. Basic: 1 yr. Advanced: 2 yrs.
F	Color Television	Television background	Eve. 3 mos.
G	Radio Telegraph Operating (V-5)	2 yrs. High School, with Algebra, Physics or Science	Day 9 mos. Eve. 2 1/4 yrs. (N.Y.) 1 1/2 yrs. (L.A.)
H	Computer Programming (C-1)	College Graduate or Industry sponsored.	Eve. 24 weeks Sat. 30 weeks
I	Technical Writing (V-10)	High School Graduate	Day 9 mos. (L.A.) Eve. 2 1/4 yrs. (L.A.) 3 mos. (N.Y.)
J	Automation Electronics (V-14)	Background in Radio Receivers and Transistors	Eve. 9 mos. (N.Y.) Sat. 44 weeks (N.Y.)
K	Digital Computers	Electronics background	Eve. 3 mos. (L.A.)
L	Preparatory Math & Physics (P-0)	1 yr. High School	Day 3 mos. or 6 mos.
M	Preparatory Mathematics (P-0A)	1 yr. High School	Eve. 3 mos.

FIRST CLASS
PERMIT NO.
10662
NEW YORK, N. Y.

BUSINESS REPLY MAIL
No Postage Stamp Necessary if mailed in U. S.

Postage will be paid by —

RCA INSTITUTES, INC., Dept. EW-D1
350 West Fourth Street
New York 14, N. Y.



RCA Institutes is one of the largest technical institutes in the United States devoted exclusively to electronics. Co-educational Day and Evening classes. Free Placement Service. Applications now being accepted.



SEND FOR THIS FREE ILLUSTRATED BOOK TODAY. Fill in the other side of the postage-free card and check Resident School.

RCA INSTITUTES, INC. A Service of Radio Corporation of America
350 W. 4th St., N.Y. 14, N.Y. • 610 S. Main St., Los Angeles 14, Calif.



The Most Trusted Name in Electronics

Electrical Switching
(Continued from page 53)

the storage time. Note that it is also possible to *overdrive* the switch "off," by applying a negative input voltage. In this way, storage and fall time are reduced.

Voltage limitations of transistors usually require that only transistors, or transistors and relays, be used throughout a system. It is sometimes necessary to couple two systems that use different switch components and work from different supply voltages. Special circuits are used to couple these systems without damaging the lower-voltage system. One such circuit is shown in Fig. 2, where a transistor switch is used to trigger a high-voltage thyatron. The transistor switch load is a step-up transformer, suppressed with a diode to prevent damage to the transistor from the kickback voltage; the output pulse from the secondary fires the thyatron. A very common combination, shown in Fig. 3, is the transistor switch used to control a relay. The relay, in turn, may be used to switch several circuits which would otherwise each require a heavy-current transistor or tube-switching circuit.

Temperature sensitivity is a disadvantage of transistor switches that must be overcome to achieve reliability. Heat

generated in the transistor, due to the voltage drop across it while it is switched on, can cause the junction to fuse; while heat from the surrounding air can cause the switch to turn on even though the control pulse has not been applied to the base. A heat sink (a chunk of copper or aluminum) fastened to the transistor will conduct away the heat generated in the transistor. Careful circuit design must be used to prevent any sudden variations in the wattage dissipated by the transistor that the heat sink may not be able to handle, even though it is capable of handling the average dissipation. Correct biasing gives protection during the "off" time and prevents heat runaway.

The switches described are the ones most frequently used in automation and computer systems today. There are other switches, not described, that are being used to an increasing degree as new techniques are developed. Among these is the magnetic amplifier, used for years in heavy current and servo control systems and now finding new applications with the development of ferrites and multi-aperture cores. Esaki diodes and avalanche transistors are also taking over some of the work now done by older switch types. As each new switch is developed, it should take over where it is best suited, reducing the number of compromises made when a switch is selected, and increasing the reliability and efficiency of the systems of the future. ▲

CROWN
Professional Tape Recorder

NEW!
"1000" Series
The World's Finest
Recorder in the \$1000 Class



The Ultimate in Performance
Those seeking the best
are buying CROWN
"The New Standard in the Industry"

Foreign Dealers Wanted
Write Dept. EW-12

CROWN INTERNATIONAL
Division of
INTERNATIONAL RADIO & ELECTRONICS CORP.
ELKHART, INDIANA

ANNOUNCING NEW
BROWNING
23
S-NINE CB TRANSMITTER



**Now with built-in 23 channel selector switch
and Standing Wave Indicator!**

\$144.00
(with one crystal)
\$189.00
(with 23 matched crystals installed)

Browning presents a new concept in Citizen's Band radio communications. It's the 23/S-NINE base station transmitter with built-in all-channel selector that lets you transmit on any of the 23 CB channels at the flick of a switch! Also new is the built-in Standing Wave Indicator for perfect matching of transmitter and antenna system for more powerful, long-range transmissions.

Among other outstanding 23/S-NINE features: special audio circuitry with speech clipper and splatter filter for perfect modulation; advanced design power supply with silicon rectifiers for low operating temperatures and maxi-

mum component life; highly efficient output circuitry using Pi network for maximum transfer of energy to antenna. Order your Browning 23/S-NINE Transmitter now for home or business use.



browning
102 UNION AVENUE, LACONIA, N.H.

Send today
for FREE
CB Information Kit:
Dept. E

FOUR CONVENIENT PURCHASE PLANS

named president and chief executive officer of *Ampeex Corporation*, succeeding **GEORGE I. LONG, JR.** who has resigned.

MERLE W. KREMER has been named vice-president of the electronic tube division of *Sylvania Electric Products Inc.*



In his new capacity, Mr. Kremer assumes full responsibility for the operation of the division and will also continue as vice-president and general manager of the firm's parts division. He has been with the firm since 1955 and has maintained headquarters in Warren, Pa. since 1960.

He succeeds Matthew D. Burns, senior vice-president, who has been assigned to assist the president in corporate and interdivisional activities.

SANGAMO ELECTRIC COMPANY is building a 65,000-square-foot addition to its Pickens, South Carolina plant and will transfer the capacitor production now located at Marion, Illinois to the new location. The Marion plant will be closed. In addition, the firm announced that construction has started on a new 150,000-square-foot plant in Walhalla, S.C. for the manufacture of certain types of single-phase electric meters now produced at the company's plant in Springfield, Illinois... **DELCO RADIO DIVISION** has broken ground for a new semiconductor manufacturing building in Kokomo, Ind. The new 150,000-square-foot facility is expected to be completed by May 1962... **MILLER-STEPHENSON CHEMICAL COMPANY, INC.** has moved its headquarters to larger facilities at 16 Sugar Hollow Road, Danbury, Conn... The acoustical engineering firm of **LEWIS S. GOODFRIEND AND ASSOCIATES** has moved into new offices and laboratories located at 48 Notch Road, Little Falls, N.J... **GENERAL PRECISION, INC.** has consolidated its Washington operations in new offices at 808 Seventeenth St., N.W. and re-located its Boston offices to 166 Bear Hill Road, Waltham... **AIRTRONICS, INC.** has dedicated its new plant at 5221 River Road, Bethesda, Maryland. It is one of the few manufacturing plants in the metropolitan area specifically designed and built to meet government regulations for handling classified projects... Construction has started on a 40,000-square-foot addition to **MINNEAPOLIS-HONEYWELL'S** inertial guidance facility at St. Petersburg, Fla. It is scheduled for completion January 1962... **HAZELTINE CORPORATION** has built a 50,000-square-foot warehouse and production facility adjacent to its manufacturing plant in Greenlawn, Long Island, New York.

KENNETH A. HATHAWAY, treasurer of EP & EM and a well-known figure in the electronic industry for more than 30 years, died recently in Chicago at the age of 66... *Jensen Manufacturing Company* has promoted **KARL KRAMER** to the post of manager commercial sound products and **EUGENE G. VAN DEVEER** as

Now You Can Check All The New Tubes, Too!

**Nuvistors—5 and 7 pin • Compactrons • Novars • New 10 pin
New 12 pin—large and small—plus all older radio and TV tubes**

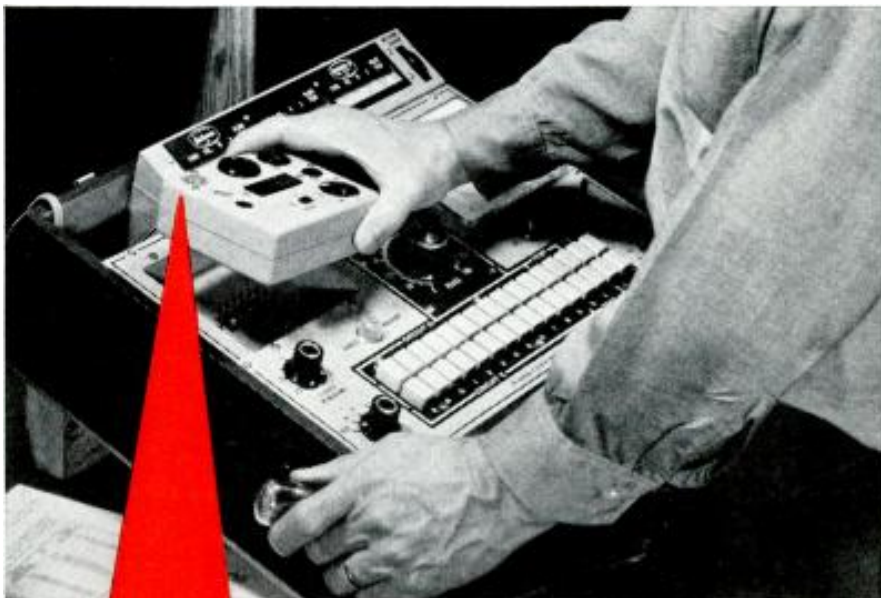

JACKSON 648S DYNAMIC® TUBE TESTER
\$154.95 net

**Exclusive compact, double-face reversible socket assembly—7 different sockets on one side for popular and newest tubes—7 different sockets for regular tubes on the other side. No adapters... you simply lift out and reverse socket assembly to accommodate tube being checked.*

This new Jackson 648S Dynamic Tube Tester lets you check all the newest tube types and all other popular tubes with profit-making speed and accuracy.

These features make it best for busy servicemen

- Push-button sequence switching for fastest set-up time
- Semi-conductor rectifier for instant warm-up
- 23 Separate Heater voltages from .75 to line voltage
- Variable Sensitivity Shorts test to 2 megohms
- Angled view zig-zag roll chart
- Automatic line voltage indicator
- Guaranteed Jackson accuracy and quality

See the new 648S at your distributors . . . or write for Bulletin 107.

*If you own a Jackson 648R or 658 Tube Tester you can modify it with a Socket Kit available from your distributor.

New tube test data appears every month in PF Reporter and Photo-Fact Folder



ELECTRICAL INSTRUMENT COMPANY

124 McDonough St., Dayton, Ohio

In Canada: Tri-Tel Associates Ltd., Willowdale, Ontario

SURPLUS

SILICON RECTIFIERS. All rectifiers listed at maximum peak inverse voltage ratings; approximate forward voltage drop, 1.5 volts.

1N1446	.750	amp.	100	volts	.60
1N1447	.750	amp.	200	volts	.70
1N1448	.750	amp.	300	volts	.80
1N1449	.750	amp.	400	volts	.95
1N1551	1	amp.	100	volts	.80
1N1552	1	amp.	200	volts	.95
1N1553	1	amp.	300	volts	1.10
1N1450	5	amp.	100	volts	1.00
1N1451	5	amp.	200	volts	1.25
1N1452	5	amp.	300	volts	1.50
1N1453	5	amp.	400	volts	2.00
1N1454	25	amp.	100	volts	3.00
1N1455	25	amp.	200	volts	3.50
1N1456	25	amp.	300	volts	4.50
1N1458	35	amp.	100	volts	3.50
1N1459	35	amp.	200	volts	4.00
1N05P7	50	amp.	50	volts	6.00
1N1462	50	amp.	100	volts	7.00
1N1466	75	amp.	100	volts	10.00
1N1467	75	amp.	200	volts	11.00
1N1468	75	amp.	300	volts	12.50
1N05V7	150	amp.	50	volts	16.50
1N1474	150	amp.	100	volts	17.00

X-BAND POWER LEVEL TEST SET, TS-36/AP

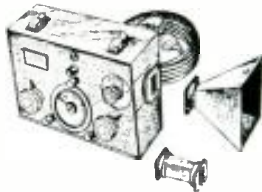

Brand new, in original packaging, with accessories. Measures 10 to 30 dbm. 8700-9500 mc.

PRICE \$14.95 each

Brand new power unit, PE182C. Lightweight; approx. 56 lbs. Output 7 volts DC at 3.5 amp and 550 volt DC, 200 mil. Governor controlled with filter. Driven by Jacobsen single cylinder 2 cycle 1 h.p. engine. Units are complete with set of tools, spare parts and manuals. Dim.: 16 3/4" wide, 18 1/2" long, 10 7/8" high. Over-seas packaged.

Shipping weight: 90 lbs.



PRICE \$39.95 each

SELENIUM RECTIFIER

full wave
input 12-24-36 volt
will handle approx. 1/2 amp D.C.
1 1/2" dia.; 3 1/4" long



PRICE \$1.00 ea.

POWER TRANSFORMER

output 12-24-36 volts
input 100 volts, 60 cycle, single phase
will handle 2 1/2 amps
steel case hermetically sealed
3 1/2" long x 2 3/4" wide x 4 1/4" high;
weight: 3 1/4 lbs.



PRICE \$2.95 ea.



MINOR SWITCH

10 position, 3 pole with stepper coil and reset coil 6-12 volts D.C. off-normal non-bridging wiper approx. dimensions: 4" long x 4 1/2" high x 1 5/8" wide; weight: 1 lb.

PRICE \$9.95 ea.



NAVIGATION SPECIAL! Radio Compass Receiver RS/ARN7

frequency 100 to 1750 KC

PRICE \$17.50



Loop LP21 LM

PRICE \$12.50



Control Box C4/ARN7

PRICE \$7.50



Indicator 181A

PRICE \$4.95

NO C.O.D.'S. REMIT FULL AMOUNT WITH ORDER.

C & H SALES CO.

2176 E. Colorado St. - Pasadena 8, Calif.

manager of the export division . . . **ROBERT H. BEISSWENGER** has been named general manager of *Jerrold-Philadelphia . . . Cadre Industries Corp.* has appointed **JOSEPH H. GIBBS** to the post of commercial sales manager . . . **RICHARD F. POST** has been named head of the military and industrial products department of *Aircraft Radio Corporation* . . . **ROBERT E. HOUSE** has been appointed executive vice-president and **HERBERT N. GOLDMAN** vice-president of engineering of *Semicon, Inc.* . . . **RICHARD B. SABIN** is the new advertising and sales promotion manager of *Eldon Industries, Inc.* . . . *Melpar's Applied Science Division* has named **DR. BERNARD FRIEDLAND** to the post of senior staff consultant . . . *Assembly Engineers, Inc.* has appointed **C. R. POSSELL** to the post of chief engineer . . . *Instruments for Industry, Inc.* has promoted **LAWRENCE I. ALGASE** to director of engineering. He was formerly chief engineer of the firm . . . **WALTER A. MAINBERGER**, former manager of the electronic systems department of *National Co., Inc.*, has been named technical assistant to the vice-president for technical operations at *Dunn Engineering Corp.* . . . **O. B. HANSON**, pioneer radio and TV broadcasting engineer, died recently at the age of 67. He retired in 1959 as vice-president, engineering serv-

ices, of *RCA* but continued to serve as a consultant. He was with *RCA, NBC*, and predecessor companies for approximately 38 years.

NEIL P. WHITNEY has been appointed president of *Aircraft Radio Corporation*, a wholly owned subsidiary of *Cessna Aircraft Company*.

He joins the Boonton, New Jersey firm after serving as general manager of the parent company's industrial products division. He has been with the organization since 1948 following his release from the Quartermaster Corps where he served during World War II.

DAVID R. HULL, former president of *EIA*, has been elected to the Board of Directors of *Globe-Union Inc.* . . . The appointment of **ROBERT W. CARR** to the post of manager of product development has been announced by *Shure Brothers, Inc.* . . . **FREDERICK WALZER** is the new quality and reliability manager of the *Allen B. Du Mont Laboratories* . . . *Rudion Receptor Company, Inc.* has made four key staff appointments: **M. MICHAEL**

Frequency Quiz

By **JOE TERRA**

(Match terms in first column with definitions given in the second column.)

- | | | |
|---------------------|-----|--|
| 1. Beat | () | A. Frequency in a woofer-tweeter loudspeaker at which both speakers receive equal power. |
| 2. Carrier | () | B. The lowest frequency component of a complex electrical signal. |
| 3. Center | () | C. Portion of the TV color signal which carries the finer details of the transmitted image. |
| 4. Critical | () | D. Produced in a superregenerative detector stage to prevent oscillation during reception of strong signals. |
| 5. Crossover | () | E. In superheterodyne reception, a frequency resulting from the combination of the received frequency and the locally generated frequency. |
| 6. Cut-off | () | F. Pulsation of amplitude resulting from the combination of two waves of different frequency. |
| 7. Field | () | G. In TV, 30 frames per second and 525 lines per frame. |
| 8. Frame | () | H. Resting frequency of an FM transmission system. |
| 9. Fundamental | () | I. Lowest resonant frequency of an antenna or circuit. |
| 10. Half-power | () | J. Variable capacitor characteristic. |
| 11. Image | () | K. Audio amplifier frequency which is equal to the square root of the product of the two half-power frequencies. |
| 12. Intermediate | () | L. Frequency of the original unmodulated radio wave produced by the transmitter. |
| 13. Intermodulation | () | M. Frequency in a filter at which rapid, if not complete, attenuation takes place. |
| 14. Mean-carrier | () | N. In TV, the number of times per second that the picture area is completely screened. |
| 15. Mid-band | () | O. A radio signal appearing as an unwanted component in the output of a receiver. |
| 16. Mixed highs | () | P. In sound recording, the changeover frequency from constant-amplitude recording to constant-velocity recording. |
| 17. Natural | () | Q. Assigned frequency of an FM station from which deviation takes place in step with the audio signals impressed. |
| 18. Quenching | () | R. In TV, the number of complete downward sweeps of the scanning element per second. |
| 19. Scanning | () | S. Highest frequency at which radio waves directed to the ionosphere will be reflected back. |
| 20. Straight-line | () | T. The two values of frequency on the sloping shoulders of an amplifier response curve. |
| 21. Transition | () | U. Sum and difference frequencies generated in a non-linear element. |

(For correct answers, see page 96)

MOSS, director of reliability; WILLIAM BOREN, manager of finance; JOHN FELTMAN, director of materiel; and ALBERT SIKORSKY, manager of government relations . . . *The Bendix Corporation* has announced the appointment of JACK D. KOSER and J. A. OGLE to special areas of long-range planning. Both are former military officers . . . *Acoustic Research, Inc.* has announced the promotion of ROY F. ALLISON to the post of plant manager . . . PROF. A. R. VON HIPPEL, director of the Laboratory for Insulation Research at MIT, has been elected vice-president in charge of fundamental materials research of *U.S. Sonics Corporation* . . . ROY L. ASH has been elected president of *Litton Industries, Inc.* He was one of the founders of the corporation . . . CARTIS F. KOEFOD has been named instrumentation tapes sales manager for the magnetic products division of *Minnesota Mining and Manufacturing Co.* . . . GRAFTON P. TANQUARY, director of marketing for the components group of *Litton Industries, Inc.*, has been named chairman of the RF Transmission Components Section of the EIA. . . The appointment of R. E. WHIFFEN as general manager of the *Bendix Products-Aircraft Division* has been announced by the corporation . . . *ACF Electronics* has named A. C. SUGALSKI to the post of manager of professional employment . . . ALFRED J. GIRARDOT, JR. has been promoted to the post of director of marketing for the Semiconductor Division of *Hoffman Electronics Corporation*.

JOSEPH P. FOLEY has been named vice-president of marketing, a newly created position at *Bay State Electronics Corporation*, Boston.



In his new position, Mr. Foley will be responsible for all sales, sales promotion, and marketing with particular emphasis on implementation of the corporate marketing plans, including expansion by acquisitions.

Prior to joining the firm, he was marketing manager at the electronics division of *Van Norman Industries* and, earlier, sales manager of the electronics division of *Baldwin-Lima-Hamilton Corp.*

EDWARD A. JOYNER has been appointed to the newly created position of sales promotion manager for the *Amphenol Distributor Division*.



He was formerly Chicago District sales manager for the division and in his new post will be responsible for a training program to familiarize management, sales, and purchasing personnel of industrial distributors with the firm's products and policies. He will also have a liaison responsibility for division advertising and other sales promotion activities. ▲

INVITATION TO AUTHORS

Just as a reminder, the Editors of *ELECTRONICS WORLD* are always interested in obtaining outstanding manuscripts, for publication in this magazine, of interest to technicians in industry, radio, and television. Articles covering design, servicing, maintenance, and operation are especially welcome. Articles on Citizens Band, audio, hi-fi, and amateur radio are also needed. Such articles in manuscript form may be submitted for immediate decision or projected articles can be outlined in a letter in which case the writer will be advised promptly as to the suitability of the topic. We can also use short "filler" items outlining worthwhile shortcuts that have made your servicing chores easier. This magazine pays for articles on acceptance. Send all manuscripts or your letters of suggestion to the Editor, *ELECTRONICS WORLD*, One Park Avenue, New York City 16, New York.



PERSONAL Messenger

- No license required—may be used at once!
- Meets FCC requirements for use with licensed Citizens' Band stations, too!

This is the new "Personal Messenger"—a superbly engineered 2-way crystal-controlled transceiver so compact it fits in your hand—so flexible it can be used in thousands of applications! 11 transistors and 4 diodes—superheterodyne receiver with exclusive tuned R.F. amplifier gives you twice the sensitivity and more than 40% more range than units with conventional circuitry! Powerful two-stage transmitter delivers more power output than similar units with the same rated input! Unmatched audio intelligibility and razor-sharp voice reproduction—automatic noise limiter—automatic volume control—positive squelch control—elastic hand strap—operates on penlight or rechargeable nickel-cadmium batteries. **\$109⁵⁰**

ILLUSTRATED AT LEFT—The Viking "Messenger"—maximum legal power Citizens' Band crystal-controlled transceiver. Excellent receiver sensitivity and selectivity—highly efficient transmitter punches your signal home! Built-in squelch—AVC—ANL. With tubes, push-to-talk microphone and crystals for 1 channel. **FROM \$134⁹⁵**



Delivery or fleet operation



Your own personal use



Construction or Business

FREE
Color Brochure



WRITE TODAY



E. F. JOHNSON COMPANY

2511 Tenth Avenue S. W. • Waseca, Minnesota

• Please rush me your full color brochure.

NAME _____

ADDRESS _____

CITY _____ STATE _____

Manufacturers of the world's most widely used personal communications transmitters

TAPE RECORDER TERMINATION

Once in a life-time opportunity to purchase production parts and spares for operating equipment from one of the largest PROFESSIONAL TAPE RECORDER MANUFACTURERS!

STOCKS LIMITED

Shipments will be made in order of receipt.



DRIVE MOTORS

BODINE NCI-33 induction drive motor, 115 v, 60 cy, .45 A, 340/1080 RPM 1 1/2" dia by 3 1/2" long. Rear shaft: 7/8" long. Front shaft: 1 1/2" long and ground for 7 1/2 and 15 ips tape speed. Guaranteed rebuilt, like new. **\$17.50**

Same, except **BRAND NEW**, with unground shaft. **\$17.50**

FASCO reeling and rewind motors. Can be used in conjunction with above drive motors, 115 v, 60 cycle, 3 1/2" dia by 1" long shaft, 2 1/2" long and finished for standard reel lock. Best quality available for professional use. Completely rebuilt, like new. **\$9.50**

BODINE NCI-42 reeling and rewind motors, 115 v, 60 cycle, 1/30 HP, 1400 RPM, 2 3/4" square body by 4 3/4" long and finished for standard reel lock. Tapped plate on bottom for mounting. Rebuilt, like new. **\$9.50**

PLEASE ADD \$1.75

Per motor for postage and handling.

SPECIAL Motor starting capacitor for above drive and other motors, 2 x 5 mfd at 330 VAC. With mtg bracket. **\$1.75**

EXTRA SPECIAL . . . REEL LOCKS

Bright plated, standard NAB reel locks. Will center and lock 101 1/2" or larger, reels or will retain 7" reels. Most secure center compression locking devices with top knob. Per pair. **\$3.50**

PHIL-TROL SOLENOID. Ideal for mechanical braking, 17.5 ohms, 24 VDC, long stroke, 2 1/2 lb. in. pull. **\$2.00**

TERADO Series 6000. Miniature plate relay (3" dia x 1 3/4" long), SMDT, hermetically sealed, 7-pin miniature base, 5000 ohm coll., 1 amp contacts, 1 ma. **\$2.25**

PROFESSIONAL

TAPE RECORDER HEADS

BT-1 Full track erase	\$10.00
BT-3 Full track record	10.00
BT-5 Full track playback	10.00
BT-2 Half track erase	8.00
BT-2B Lower half track erase	10.00
BT-4 Half track record	8.00
BT-6 Half track playback	6.00
BB-3 Stereo record (stacked)	12.00
BB-5 Stereo playback (stacked)	10.00
SP-1 Sync-pulse	30.00
Michigan Mag. stacked stereo records	6.00
Michigan Mag. stacked stereo playback*	6.00

"VU" METERS

2 3/4" by 2 1/2" rectangular, with clear plastic escutcheon, 500 micro-amp basic movement with standard 2-color "VU" scale. Requires 2 1/2" mtg. hole. **\$5.95**

2 for **\$11.00**

MINIATURE 1 1/4" square, clear plastic escutcheon, 500 micro-amp basic movement with 2-color calibrated "VU" scale, 1" mtg. hole, threaded case for single nut mounting. **\$7.95**

2 for **\$15.90**

WESTON model 882 illuminated DB meter, 4 1/2" rectangular case, 0 DB—0.639V. New price \$41.00. Special. **\$24.50**

California residents add 4% sales tax. Terms: Cash with order or 25% deposit, balance C.O.D. All prices FOB Los Angeles. Minimum order \$5.00.

H. D. STERN CO.

3000 S. Main St., Los Angeles 7, Calif.

MINE DETECTOR AN-PRS/3

Portable Device for locating metallic objects buried in the ground. This is the most recent type, extremely sensitive. Presence of metal will be indicated on meter or phones. Special circuit eliminates false responses. Exc. oper. cond.—60 Lbs. **39.95**

NEW BATTERIES 5.00

FIELD TELEPHONES—EEB-A. Dependable phone system over miles of wire—Recond.—OK—PAIR **23.95**

GAS ENGINE GENERATOR—Output variable from 0-24VDC at 30 Amps. Voltmeter, Ammeter, self contained gas tank—Used—Gd. Cond. **49.95**

GAS ENGINE GENERATOR—Output 550 VDC, 220 Mils. and 6.3V—5 Amp. Like New—50 Lbs. **29.95**

SCR 522. W/All tubes—Gd. Cond. **24.95**

BC 1306—TRANSCIVER—3800—6500 KC. M.O. and Crystal Control—New—W/All tubes. **29.95**

RCA GEIGER COUNTER WF15A—10 Geiger tubes—List \$750. Closeout Special W/Batteries—New **99.50**

VACUUM TUBE MEGOHMMETER—CALN—60089-A. 4X4X4 10,000 Megs. Battery operated—Like new. **29.95**

REX RADIO, 84 Cortlandt St., N.Y. 7, N.Y.



At its 1961 convention held in Chicago, the National Alliance of Television and Electronic Service Associations elected new officers, welcomed 18 new affiliates since the preceding convention, settled some internal problems, and advanced a good deal of other business.

New officers include Ralph J. Woertendyke, president; John H. Stefanski, secretary general; and C. Nelson Burns, treasurer. Regional vice-presidents are Irving Toner (eastern), T. R. Nabors (east central), B. R. Moon (west central), and Patrick Barr (western). Regional secretaries are George Carlson (eastern), John Graham (east central), Earl Steffes (west central), and Leslie A. Quigley (western).

The internal problems stemmed from differences of opinion that finally took the form of charges and counter-charges among individuals and affiliated groups within the national body in a number of letters, bulletins, and other publications. With feelings running high, the executive council decided to air the strife completely on the floor of the general directors' assembly at the start of the convention, but with the doors barred to outsiders. Insider Mac Meoyer, a past NATESA president, reports that an effort was made not only to eliminate existing differences but to prevent recurrences: "All charges were resolved to the satisfaction of all parties involved . . . our assembly did not partake of the figurative banquet of crow. . . There was no figurative blood-letting and no scars left. . . I also sincerely feel that all individuals involved have been exonerated of the charges levied against them."

Out of this incident came a constitutional amendment setting up machinery, through divisional officials and the executive council, for reviewing communications deemed to be harmful or unjust, for the issuance of restraining orders, and for suspensions where there is no compliance with orders.

Progress reports were delivered on 33 subjects including pay-TV, wholesale practices, caddy thefts, and the all-industry panel. The spring directors' conference was set for April 28-29, 1962, at the Americana Hotel in Miami, Fla., with TESA-Miami hosting.

Be-Kind-to-Distributors Week

President Charles McBroom of the North Carolina Federation of Electronic Associations has been throwing reverse English at his members, of late, in the NCFEA "Printed Circuit." Instead of

helping them duck their own responsibilities with the sometimes overdone practice of dumping their woes on the shoulders of everyone else, he is taking them to task for their own deficiencies. His latest subject is the charges levied against that favored scapegoat, the distributor:

"The Distributor Sells to the Public—Of course, it's okay for you to buy electrical and plumbing supplies (from distributors), but *your* distributor shouldn't do this. Why not? Where will the public buy the odd tubes now in their sets? Certainly not from you because you refuse to stock them. You don't have the stock because you laughed when the distributor's man talked to you about inventory control.

"Your distributor also urged you to stock and sell Citizens Radio—most of them even offered an extended billing policy so you wouldn't have your money tied up—but you weren't interested. You have forced your distributor to sell this gear to the public. Admit the truth. *You* made the situation you're complaining about."

For those who would bypass the distributor with a co-op buying scheme, McBroom has this to say: "The supply of parts is the smallest of the distributor's problem. *You* cause the biggest portion of his work. Who do you depend on to know about and stock test equipment . . . to finance this equipment? . . . Do you pay him in full, on time, every month? . . . Your distributor is working and planning right now . . . figuring how much money he will have to borrow to take care of you next year. Tell me, Mr. Co-op Promoter, how do you go about not paying *yourself* on time?"

Coincidence or not, other re-appraisals of the distributor-dealer relationship and the matter of dealer loyalty to a co-operative distributor appear in the NATESA "Scope" and the bulletin of the Alameda County TV & Radio Association of California. Both remind readers that co-operation is a two-way street and that they also have some obligations in the matter.

Color Prospects

In a speech to Chicago dealers, RCA President John L. Burns stated that his company's color-TV production lines are operating at high capacity with heavy back orders, that dealer orders virtually doubled over last year, and that Chicago sales, in actual dollars, "were substantially greater for color than they were for black-and-white." Furthermore, he foresees a color TV market for

RCA "surpassing in volume and profitability our greatest years in black-and-white." In terms of receiver and equipment sales, broadcasting—and service—he foresees, by 1970, a dollar volume for color alone that will exceed the present volume for the entire industry.

Is this just some more pie in the sky for service? Possibly not. For many years to come, at least, color will continue to be more expensive and more involved, in the eyes of the public, than monochrome TV. Set owners may become hesitant about do-it-yourself experimentation and reluctant to look for the cheapest service call. The unwillingness to gamble with an expensive, quality product bodes well for shops with good reputations.

Paid Association Executives

To become big, you have to think big. Many associations have reached the stage of growth at which they must grapple with the problem of having their affairs properly managed by individuals, however dedicated, whose first duties are to their own businesses. The North Carolina group mentioned earlier is wondering whether it can continue to "depend on our elected officers to do the terrific amount of detail work required without some compensation. In the past many officers have accomplished the work of the federation at the sacrifice of their own personal activities and frequently at a financial loss to their businesses.

"Those who are unable or unwilling

to spend of their time should be willing to contribute financially to help build a strong federation for their own good." In short, NCFEA is considering a constitutional amendment to set up the salaried position of executive secretary: a paid administrator who could devote unstinting effort, without worry about personal sacrifice, to advancing the aims of the group.

Tube Pricing Policy

President E. Russell Goode of the Television Service Association of Michigan, in a recent issue of "TSA News," has his say on the much-discussed matter of whether service dealers should insist on list prices for receiving tubes or fight to get back the lost business by offering discounts. His starting point is "the tremendous loss of over-the-counter tube sales in the past two years."

"Discount merchandising is an accomplished fact in the Detroit area and most other large cities in the United States," he states. "Whether you approve or disapprove of this concept," he adds, "it is here to stay."

Many Detroit dealers, says Goode, have tried discounting for trial periods ranging to a year or more—but could not get the necessary volume to justify continuation nor could they see enough profit to allow a consistent advertising program." This result is particularly disconcerting since, as Goode adds, "tube sales are the logical leads to the service customer." He has no easy answers. ▲

Guaranteed! Crystals!

BUY NOW AND SAVE!!

OVERTONES: 10 to 30 Mc... Tol. .005%... \$2.50
 AMATEUR & NOVICE Fundamental... Tol. .005%
 HC-6 Herm. Sealed... \$2.50
 HC-6—6 Meters (5th Overtone)... \$3.75
 MARINE FREQ. HC-6 (Herm. Sealed)
 Tol. .005%... \$3.50

ALL MARINE FREQ.—FT-243, DC-34 Hold Tol. .005... \$2.00
 POLICE, C.A.P., CD, MARS, Tol. .01%... \$1.89
 CITIZENS BAND—11 METERS—.005% Tol.
 26.965 to 27.225 MC, 3rd Over. Herm. Seal. or
 FT-243... \$2.50
 13.4825 to 13.6125 MC, 2nd Harm. Herm. Seal. or
 FT-243... \$2.50
 6741.25 to 6806.25 Kc, 4th Harm. FT-243 only... \$2.00

SPECIAL! STOCK CRYSTALS

\$1.19

FT-243 Holders 5700 KC to
 8700 KC in steps of 25 KC's

SEND FOR FREE CATALOG

DC-34 Hold. 1690 KC to 4440 KC steps of 10 KC, ea. 79c

NOVICE BAND FT-243 Fund. ea. \$1.49

80 Met. 3701-3748—Steps of 1 KC. FT-243
 40 Met. 7150-7198—Steps of 1 KC. FT-243
 Dbl. to 40 Met. 3576-3599. Steps of 1 KC. FT-243
 15 Met. 5276-5312—7034-7083 Steps of 1 KC. FT-243

FT-243—2 Meters (Steps of 1 KC) \$1.19
 FT-243—6 Meters (Steps of 1 KC) \$1.19
 FT-243—From 3000-4000 \$1.19
 FT-243—From 1005-2999 (Steps of 5 KC) \$2.39
 FT-243—.005% Tol. From 3000-8750 \$2.39
 FT-243—.01% Tol. From 3000-8750 \$1.89
 FT-241 SSB Low Xtals 370 to 540 KC
 (Steps of 1.852 and 1.388) \$.69
 FT-241 SSB Matched Pairs \$2.39
 FT-241—AN/TRC-1-721.167 KC-1040-625
 (Steps of 1.042 KC—Except 1000 KC) \$.96

Include 5c per crystal postage. (U.S. only). Calif. add 4% tax. No C.O.D.'s. Prices subject to chg. Ind. 2nd choice, sub. may be necess. Min. Order \$2.50

Open Friday Evenings until 9 P.M.

"The House of Crystals"

U. S. CRYSTALS, Inc.

1342 S. La Brea Ave. Los Angeles 19, Cal.

TRU-VAC

FREE

UP TO 100
 1-YR. GUARANTEED
 TRU-VAC TUBES
 TO QUANTITY BUYERS!

Now quantity buyers get a FREE
 assortment of individually-boxed, regular
 stock TRU-VAC tubes
 with each
 order.

PLACE YOUR ORDER TODAY!
 GET UP TO 100 TUBES FREE!

Here's how this FREE offer works!

15 FREE TUBES With Order of \$25
 25 FREE TUBES With Order of \$50
 50 FREE TUBES With Order of \$100
 100 FREE TUBES With Order of \$500

LOOK! 1,000 USED TV'S
 Costly, famous make
 console models with
 little or no tube re-
 placement! Perfectly
 perfect for resale, or as
 your own second set!
 16", 13" and 19"
 screens—none shipped
 smaller! Sets shipped
 FOB, Harrison, N.J.

\$16.95
 As is

1-yr. guaranteed Radio & TV Tubes

Factory Used or Factory Second Tubes!
 TRU-VAC will replace FREE any tube that
 becomes defective in use within 1 year
 from date of purchase!

ALL TUBES INDIVIDUALLY BOXED!
 CODE DATED & BRANDED "TRU-VAC"

Partial Listing Only... Thousands More Tubes in Stock!

SPECIAL! 6SN7GT		30c		6W4GT		30c	
DY4 3Q4	6AC7 6B6GG	6BY5C	6D6	6D7GT	7A5	7A6	25Z6GT
DZ4 3S4	6AF4 6BM6	6BZ6	6DE6	6SF5	7A7	7A8	27
1A7GT 3V4	6AC5 6B16	6BZ7	6DC6GT	6SF7	7B7	7B8	35A5
1B3GT 4BQ7A	6AM4CT	6AS5 6C4	6DF6	6SG7	7B9	7C7	35B5
1M3GT 4B5B	6AM6	6AT6 6C8B	6E5	6SH7	7B5	7C7	35C5
1L4 4B27	6AK5	6AU6CT 6C8G	6F5	6SJ7	7B5	7C7	35W4
1L6 4CB6	6AL5	6AUSCT 6C8G	6F6	6SK7	7B6	7C7	35Z5
1NSGT 5AM8	6AM8	6AUS 6C8G	6H6	6SL7	7B7	7C7	36
1RS 5AN8	6AN8	6AV5CT 6C7	6J4	6ST7	7B8	7C7	39/44
1S5 5AT8	6AQ5	6AV6 6C8	6J5	6SR7	7C4	7C5	42
1T4 5AV8	6AQ6	6AW8 6C8B	6J6	6T4	7C5	7C6	43
1U4 5AZ4	6AQ7	6AX4GT 6CL5	6J7	6T8	7C6	7C7	44
1U5 5BR8	6AR5	6AX5CT 6CM6	6K6GT	6U5	7C7	7C8	50A5
1V2 5C68	6AU6	6BK5 6CM7	6K7	6U8	7E5	7E6	50B5
1X2 5J6	6B8	6B7 6CMT	6N7	6V6GT	7E6	7E7	50C5
2AF4 5R4	6BA6	6BL7GT 6CQ8	6Q7	6W6GT	7A4	7A5	50L6
2BN4 5T8	6BC5	6BN6 6CR6	6S4	6X4	7E7	7E8	56
2CY5 5U4	6BC6	6BQ6GT 6CS6	6S7	6X5GT	7F7	7F8	80
3A5 5U8	6BD6	6BQ7 6CS7	6S8GT	6X8	7F8	7F9	84, 6Z4
3AL5 5V4G	6BE6	6BR8 6CUS	6SA7	6Y6G	7G7	7G8	117Z3
3AU6 5V6GT	6BF5	6BS6 6CUG	6SC7	7A5	7H7	7H8	
3BC5 5X8							
3BN6 5Y3							
3BZ6 6A6							
3C6 6A84							

Sensational Offer!

"Self Service"

TUBE CHECKERS

\$37.95 FOB Our Warehouse

Let your customers test their own tubes! These reliable, reconditioned 22-socket tube checkers will return your investment in one week or less with little or no effort on your part! Handsome, field-tested console models COMPLETE WITH KEY FOR BOTTOM DOOR AND NEON-LIGHTED HEAD!

BRAND NEW 1-YEAR GUARANTEED TV PICTURE TUBES

Below Listed prices do not include dnd Addtional \$5.00 Deposit on tube sizes to 20" on 21" and 24" tubes—\$7.50. Deposit refunded immediately when dnd is returned prepaid. (Luminized tubes)—\$4.00 ea. Picture tubes shipped only to continental USA and Canada—All tubes F.O.B., Harrison, N.J.

103P4 7.00	10KP4 11.00	17H14 16.99	20HP4 17.80	21AWP4 17.49	21XP4 17.49
121P4 10.49	10LP4 12.19	17P4 16.99	21AP4 21.40	21EP4 17.20	21Y4 18.39
131P4 11.99	18P4 11.99	17QP4 13.80	21ALP4 18.79	21FP4 18.39	21Z4 17.40
16A04 16.99	17AVP4 15.49	20CP4 15.89	21AP4 18.79	21H4 22.30	21AP4 36.49
16D4 15.19	17BP4 13.49	19AP4 13.39	21AMP4 17.09	21YP4 18.39	24CP4 27.79
18C4 16.09	17CP4 16.09	17EP4 16.09	21AU4 18.79	21WP4 17.49	24DP4 29.79
18H4 12.19	17HP4 17.89	20P4 15.89	21AVP4 18.79		

ATTENTION QUANTITY USERS! Big Discounts Are Yours... Call or Write For Our 1000 Tube "Private Label" Special Attention Branding Dept. NGR. Money Cheerfully Refunded Within Five (5) Days, If Not Completely Satisfied!

TRU-VAC (IT) PAYS YOUR POSTAGE—On orders of \$5 or more in USA and Territories. Send approximate postage on Canadian and foreign orders. Any order less than \$5 requires 25c handling charge. Send 25c on C.O.D.'s. All orders subject to prior sale. (Complies with Federal regulations, the following statement appears in all TRU-VAC advertising: Tubes in this ad may be FACTORY SECONDS or USED tubes and are clearly marked.)

TRU-VAC

Harrison Avenue • Box 107 • Harrison, N. J. HUmboldt 4-9770

FAST, DEPENDABLE TUNER REPAIR SERVICE

It just makes sense that a manufacturer of tuners should be better-qualified, better-equipped to offer the most dependable tuner repair and overhaul service.

Sarkes Tarzian, Inc., pioneer in the tuner business, maintains a complete, well-equipped Factory Service Dept.—assisted by Engineering personnel—and staffed by specialized technicians who handle **ONLY** tuner repairs . . . on **ALL** makes and models.

Tarzian-made tuners received one day will be fixed and shipped out the next. Cost is only \$8.50 and \$15 for UV combinations. That includes **ALL** parts and labor, and a 6-month guarantee against defective workmanship and parts failure due to normal usage. Replacements available at low cost on tuners beyond practical repair.

Tarzian-made tuners are identified by this stamping. When inquiring about service on other tuners, always give tube complement . . . shaft length . . . filament . . . voltage . . . series or shunt heater . . . IF frequency . . . chassis identification. All tuners repaired on approved, open accounts. Check with your local distributor for Sarkes Tarzian replacement tuners, replacement parts, or repair service.



ALL
MAKES

**ONLY \$8.50 INCLUDING
ALL PARTS and LABOR
24-HOUR SERVICE
6-MONTH WARRANTY**
Tuners Repaired on
Approved, Open Accounts

SERVICE MANAGER • TUNER DIVISION • DEPT. 6
SARKES TARZIAN INC
east hillside drive • bloomington, indiana
edison 2-7251
MANUFACTURERS OF TUNERS . . . SEMI-CONDUCTORS . . . AIR
TRIMMERS . . . FM RADIOS . . . AM FM RADIOS . . . AUDIO
TAPE . . . BROADCAST EQUIPMENT and SHISH-KABOB GRILLS

Citizens Band Converter

(Continued from page 51)

times for checking and then re-immersed. The entire etching time will run from 20 to 30 minutes, depending on the strength of the solution. When all the excess copper has been dissolved, remove the board from the etchant and rinse well in clear water. Do not leave the board in the etchant any longer than is necessary as additional time will tend to undercut the resist ink and tape. After rinsing, remove tape and ink with a knife or razor blade and finish by polishing lightly with any good household cleansing powder. The board is now completed and if instructions have been followed closely the results should be "professional."

Mounting Components

After etching the circuit board, drill a 1/32" hole in the center of each copper dot for component leads. Drill a 5/16" hole inside the dotted circles for the body of transistors V_1 and V_2 . Drill two 1/4" holes and one 3/32" hole for mounting the crystal socket. Drill 3/32" holes for coils L_1 , L_2 , L_3 . After all the holes have been drilled, mount the coils and crystal socket. The resistors and capacitors are mounted and soldered in place next.

When soldering to printed-circuit boards use a small iron and a good grade of rosin-core solder. The transistors are the last to be put in place and soldered. Slip the transistor through from the top of the board and carefully shape the leads in place with tweezers or small pliers. The leads are long on these transistors and will have to be cut. When cutting transistor leads, place leads as far back in the cutters as possible and try to squeeze the cutters without snapping. Cut one lead at a time. After the leads are shaped and cut, solder each lead in place using a pair of small pliers on the transistor lead near the base as a heat sink. After all components have been soldered in place, recheck the circuit board by tracing the circuit of Fig. 1 to eliminate any possible errors.

For those who are not interested in making the printed-circuit board, the more conventional point-to-point wiring technique may be used.

Final Assembly

Mounting of the circuit board, power supply, switch, and input and output jacks is clearly indicated in the photographs. A rectangular opening, 1 3/4" x 2 3/4", is made in the top cover of the chassis box. The printed-circuit board is mounted over this opening and held in place with small self-tapping screws or with 2-56 machine screws and nuts. The circuit board must be mounted without grounding any of the connecting bars or input-output points to the metal. A 5/8" hole is made in the center of one end of the top cover for the coaxial SO-239 jack and a 3/8" hole drilled in the center of the other end for the RCA phono jack.

Save 30% on 4-track
Stereo Music on Tape!

Only 1 in. plastic reels 76 ea.

BARGAIN PRICES!

SEND FOR OUR FREE

Tape Recorder/Blank/Pre-recorded Tape Catalog
SAXITONE TAPE SALES
(Div. of Commissioned Electronics Co., Inc.)
1776 Columbia Road Washington, D.C.

MAIL ORDER HI-FI

You can now purchase all your HI-FI from one reliable source and be assured of perfect delivery. We deliver most hi-fi components, recorders & tape within 24 hours. SEND US YOUR LIST OF HI-FI REQUIREMENTS FOR OUR WHOLESALE QUOTATION and FREE catalogue. WE WILL NOT BE UNDERSOLD. Write us for proof of this statement.

CARSTON

125-7D E. 88 St.
New York 28, N.Y.

VOCATIONAL STUDENTS

It Took Us 2 Years To
Design This TV Kit
Especially For You

**VIDEOLA by Tech-
Master**

Every Part Custom-
Engineered Exclusively
For This Chassis



With this kit you build more than a chassis . . . You build a career in electronics. Tech-Master's VIDEOLA guarantees you the ultimate in training and development. For this is the most up-to-date professional kit available. Every possible improvement in tubes and circuitry is included. Each and every component is absolutely related . . . engineered precisely for this kit . . . designed for flawless assembly and maximum performance. There are no printed circuits. You build everything yourself. Step-by-step instructions with easy to follow pictorial and schematic diagrams.

FEATURES: Advanced and improved, super-selective, 12 channel tuner—Full power transformer for safe cold chassis operation—Operates new low-voltage electrostatic focus kinescope (17" to 27" . . . including 19" and 23" sizes) . . . 110 to 114 degree deflection—18 to 20 KV anode voltage—High efficiency circuit—sensitivity of 9uv at 20V peak-to-peak—High power audio output—Three-stage stagger-tuned IF using high-gain bi-filar coils—Keyed automatic gain control—Adjustable noise cancellation circuit—Bright spot eliminator circuit—Ceramic core horizontal output transformer with beam power amplifier—Chassis constructed so that tuning and related controls are on separate panels. Can be placed away from chassis proper to accommodate custom requirements—Sockets, terminal strips and connectors riveted on chassis. 6x17x1 3/4 chassis size—Weight 21 lbs.

MODEL 1561 PRICE \$99.95

COMPLETE CONSTRUCTION MANUAL \$3.75
Cost of Manual Refunded With Kit Purchase

Videola by Tech-Master
75 Front St., Brooklyn 1, N. Y.

Now It's Easy and Fun to BUILD YOUR OWN SUN POWERED RADIO

with Satellite-Type Solar Cells



25¢

24-Page handbook gives you detailed instructions, schematic diagrams, where-to-get-parts information.

Use solar cells that convert sunlight into electricity to power your own radios, transistorized receivers, Citizens Band 27 mc transmitter . . . sun powered audio and tunnel diode oscillators, sun relays . . . clear descriptive text gives you step-by-step directions and explanations for each project. Get these interesting projects in the all new IR "EXPERIMENTER'S HANDBOOK!"

MAIL 25¢ ALONG WITH COUPON TO

IOR DEPT. EW-1
INTERNATIONAL RECTIFIER CORP.
222 KANSAS STREET, EL SEGUNDO, CALIFORNIA

Name _____ Age _____
Address _____
City _____ Zone _____ State _____

A small "on-off" slide switch is mounted on one side of the bottom section of the chassis box. The 9-volt battery is held in place by means of several dots of Duco cement.

After the circuit board, jacks, and battery have been mounted, run the necessary wires from the battery to the circuit board and connect the input and output jacks to the designated points. The converter is now ready for preliminary adjustments.

Adjustment & Operation

Before installing the converter it will be necessary to make certain that the oscillator is operating. This test is simplified if a receiver that will tune to 26.3 mc. is available. Turn the converter on, tune the receiver to the crystal frequency, and adjust the slug in L_1 until the signal is heard. The oscillator will function when the slug is properly adjusted so that the collector tank circuit (L_2 and C_2) is resonant.

With the oscillator checked out, install the converter in the car. A short length of coax is required. It should have a phono plug on one end and an auto antenna plug on the other. Turn the auto radio on and set the dial to 800. Turn the converter on and adjust the slug in L_2 for maximum background noise in the speaker. Next, adjust the slug in L_1 for maximum noise or select a weak signal and peak the slug for maximum gain. The final adjustments are made with the slug of L_2 at the center frequency, which is Channel 11. If either extreme of the Citizens Band is favored in your locality, additional gain can be realized by peaking the coils for those particular channels.

Two of these converters have been built by the author. One is being used as a base station and the other is installed in the author's car. An r.f. amplifier was omitted for simplicity's sake and to reduce the cost of construction. Gain of the converter is 19 db at the center frequency with a loss of 1 to 2 db at either end. The ends can be peaked up by adjusting coil slugs if either end is used more than the center frequencies. Signals of S6 or better are easy arm-chair copy for the Citizens Bander. ▲



"What ever happened to Eddie's crazy idea to install closed-circuit television?"

Now... Tomorrow and for years to come!

Sonar CITIZENS BAND RADIO

- 8 Channels, crystal controlled transmitter and receiver
- Tunable receiver for 22 channels
- Transmitter 100% Class B modulated
- Adjustable squelch
- Automatic noise limiter
- R. F. Power indicator
- 1 Year guarantee
- Easy to install. Ideal for home, boat, car or business. Weights only 9 lbs. . . 4 3/4 x 9 1/2 x 11 1/4
- FCC Type accepted*

*in preference to only certification

with 1 pair of crystals, microphone and power cables

\$17950



Sonar RADIO CORPORATION

3050 West 21st Street • Brooklyn 24, N. Y.

Please send me complete information on Model "E" CB Radio.

NAME _____

ADDRESS _____

CITY _____

STATE _____

The Battery That's Used in Guided Missiles Now Released as Government Surplus

For Photography, Aircraft, Models, Searchlights, Radios, etc. **\$1.95 ea.**



Sintered-plate Nickel-Cadmium alkaline storage batteries designed for "NIKE" Missile and now surplus due to design change. A lifetime battery with no known limit of service (over 5000 recharges on test without loss of capacity). Other features: Virtually indestructible, compact & lightweight, withstands heavy shock and vibration. Flat voltage curve during discharge retains charge year or more, high discharge rate up to 50 amps, for this cell, no corrosive fumes to harm clothing or equipment, spill-proof construction, discharge in any position, indefinite storage without deterioration, operates in temperatures -60° F to +200° F. Each cell is approx. 4 ampere hour capacity. Nominal voltage per cell is 1.2 volts. (A 6 V. battery requires 5 cells.) Cell size 6" H. x 2" W. x 1 1/2" T. Wt. 6 oz. ea. Uses Potassium-Hydroxide (30%) electrolyte. Negligible loss during lifetime service. Add only distilled water once a year. A fraction of Government cost.

Used Test Cells \$1.95 ea. Postpaid
Brand New Cells 2.95 ea. Postpaid
4 AMPERE HOUR CELLS size 4 1/2" H. x 2 5/8" W. x 3/4" T. Used test cells..... \$2.95. New cells \$3.95 ea.
All cells guaranteed to your satisfaction or money refunded (less postage).

ESSE RADIO COMPANY Dept. EW
42 W. South Street Indianapolis 25, Indiana

BC-221 FREQUENCY METER.	\$69.50
Like New Condition	Only
85kc IF Transformers	2.25
ARC-12, New	70¢ ea. 3 for
BC-603 FM Receiver	14.95
20-27.9 Mc. Exce. cond.	
B-603 FM Receiver 20-27.9 Mc. Brand New	18.95
Instructions supplied for changing over to 2 meters	
BC-923 A FM Receiver	29.95
27-38.0 Mc. Brand New.	
ART-13 Transmitter	49.50
with tubes & meters. Good condition.	
BC-604 MF Transmitter	4.95
with tubes. Brand New	
Antenna Mast Base	2.95
& 3—35" Mast Sections	
BC-191 Transmitter	14.95
with tubes. Excellent condition	
GE Computer Tester	12.95
with VOM, Selsyns, W.W. pots, switches, and a load of other parts.	
Servo Amplifier Assembly	3.00
has 2-0A05's and 6J6. Only . . . 3 for	
ID-6 APN-4 Indicator	2.95
less tubes	
B-442 Antenna Relay	1.95
with Meter & Vacuum Capacitor	
ARR-2 Receiver,	4.95
11 tubes with CB conversion	
ARC-3 AM Receiver	12.95
100-158 Mc. Excellent	
ARC-3 AM Transmitter	14.95
100-158 Mc. Excellent	
1-130A Signal Generator,	7.95
100-158 Mc.	
1-95B Field Strength Meter,	7.95
100-158 Mc.	
MD-7 Modulator with tubes.	5.95

Send Money Order or Check with Order
Write for Bulletin No. 33—LOADS OF BARGAINS!
R W ELECTRONICS
2430 S. Michigan Avenue Dept. EW11
Phone: CALumet 5-1281 Chicago 16, Ill.

SEND ELECTRONICS WORLD EVERY MONTH

Electronics World



name _____

address _____

city _____

zone _____ state _____

Check one:

- 3 years for \$12 2 years for \$9 1 year for \$5

In the U.S., and possessions

- Payment enclosed Bill me

Foreign rates: Canada and Pan American Union countries, add .50 per year; all other foreign countries, add \$1.00 per year.

Mail to:

ELECTRONICS WORLD

Dept. EW 1261H, 434 S. Wabash Ave., Chicago 5, Ill.

Advance

BEST BUYS OF THE MONTH!

ASTRO COMPASS

The Astro Compass is a precision instrument measuring $8\frac{1}{4}$ " high x $5\frac{1}{4}$ " wide. Furnished in Carrying Case. Designed to provide accurately (a) True heading of Aircraft or boat. (b) True bearing of a distant object. (c) The relative bearing of distant objects.



Of special interest to Astronomers, Yachtsmen, & Experimenters.

\$14.50 ea.

Brand New w/instruction booklet.

G-R VARIACS

1 1/4 Amp	115 VAC Input, 0-135 VAC Output	10.95
2 Amp	85.50 5 Amp	22.95
3 Amp	7.50 10 Amp	39.95
7 1/2 Amp	8.95 20 Amp	\$35.00

VIBRATOR POWER SUPPLIES

OUTPUT 117 VAC, 60 CYC.	100 WATTS-FILTERED	24.95
INPUT 210-240 VDC		24.95
INPUT 32-40 VDC		

TRANSFORMERS

ALL Primary 115 VAC, 60 cycles		
Sec. 460 VCT, 50 MA; 6.3 V, 2.5 A		\$3.25
Sec. 1250 VCT, 200 MA; 2 X 10 VCT		6.95
1 A; 3 X 5 VCT; 1.2 A; 5 V, 2 A		5.95
Sec. 1050 VCT, 200 MA; 6.3 VCT, 3 A; 6.3 VCT, 4 A; 5 VCT, 3 A		5.75
Sec. 800 VCT, 200 MA; 6.3 V, 6 A; 5 V, 3 A		7.95
Sec. 1100 VCT, 212 MA		2.45
Sec. 12.6 VCT, 3.5 A; 15.6 V, 1 A		5.95
Sec. 6.3 BA-6.3 BA-6.3 10A Total 26A @ 6.3		
—230 V, 450 MA		

CAPACITOR SPECIALS!

1 Mfd—1500 V. DC	\$.75
1 Mfd—2500 V. DC	1.25
1 Mfd—1000 V. DC	1.75
2 Mfd—6000 V. DC	12.95

SILICON RECTIFIER
35 A, 200 P I V full wave 25.95

METERS

0-1 MA (2")	\$3.45	0-150 MADC (3")	\$3.75
0-130 VAC (3")	\$3.45	0-200 MADC (3")	\$3.25
0-150 VAC (3")	\$4.45	0-250 MADC (3")	\$3.75
0-75 VDC (3")	\$3.95	0-1 MADC (3")	\$4.45
4 1/2" 0-50 VDC w/50, 100, 200, 300 volt scales Basic Meter 1 MA			7.95
9 Reed—Freq. meter, 380-420 Cyc			9.95

RELAYS

6 VDC, DPST, 10 A, cont.	3.75
6 VDC, DPDT, 10 A, cont.	1.50
12VDC, DPDT, 10 A, cont.	1.75
28 VDC, DPDT, 10 A, cont.	1.95
Stepping Relays	
3 Deck, 10 pos. reset type, 12 VDC	7.95
4 Deck, 11 pos., 48 VDC	14.95

FASCO MOTORS

115 VAC 1550 rpm 4 1/4" x 1 1/4" shaft	\$3.95
115 VAC Dbl ended shaft 3 1/2" x 1/4" x 1 1/2" x 1 1/4"	each \$4.95

Inquire about other Fasco Motors

Advance Electronics

79 Cortlandt Street

New York 7, N.Y. RE 2-0270

CITIZEN BAND CLASS "D" CRYSTALS



3rd Overtone; Hermetically Sealed .005% tolerance—Meet F.C.C. requirements, 1/2" pin spacing—.050 pin diameter. (.093 pins available, add 15c per crystal.)

ALL 22 Frequencies in Stock! \$2.95 EACH (add 5c per crystal for postage and handling)

The following Class "D" Citizen Band frequencies in stock (frequencies listed in megacycles):	26.965, 26.975, 26.985, 27.005, 27.015, 27.025, 27.035, 27.055, 27.065, 27.075, 27.085, 27.105, 27.115, 27.125, 27.135, 27.155, 27.165, 27.175, 27.185, 27.205, 27.215, 27.225.
---	---

Matched crystal sets for all CB units \$5.90 per set. Specify make and model numbers.

RADIO CONTROL CRYSTALS

In stock for immediate delivery (frequencies listed in megacycles): tolerance .005%—.1/2" pin spacing—.050 pin diameter. (.093 pins available, add 15c per crystal.) Specify frequency desired.

26.995, 27.045, 27.095, 27.145, \$2.95 EACH (add 5c per crystal for postage and handling)

NOW! Engineering samples and small quantities for prototypes now made either at Chicago or at Ft. Myers Plant, 24 Hour Service!

IN CHICAGO, PHONE GLadstone 3-3555

Send for FREE CRYSTAL CATALOG #961 WITH OSCILLATOR CIRCUITS

ASK YOUR PARTS DEALER FOR TEXAS CRYSTALS

See big red display . . . if he doesn't stock them, send us his name and order direct from factory.

Rush your order to:

TEXAS CRYSTALS

Dept. R-101—1000 Crystal Drive, Fort Myers, Fla. All orders shipped 1st Class Mail. For faster service phone WE 6-2100

Audio Test Report

(Continued from page 24)

cheesecloth cover protects the rear of the cone and the entire cabinet is filled with fiber glass. Fisher claims that the elimination of the basket, and consequent packing with absorbent material almost up to the cone, eliminates internal reflections which affect the smoothness of response of conventional speakers.

Middle frequencies, from 1000 to 2500 cps, are handled by a pair of 5" cone speakers packed with fiber glass. Above 2500 cps a 2" hemispherical tweeter, with a six-pound magnet structure, takes over and provides an omnidirectional 120-degree coverage. The user has a wide range of control over the response of the XP-4, since the mid-range and high-frequency speakers each has its own level control. Positions are indicated for average settings of the control knobs, which we found agreeable and which were used during our tests.

The cabinet of the XP-4, finished in oiled walnut, is extremely rigid. Rapping it with the knuckles produces a

adequately by a 15-watt amplifier, and one-watt input produces an uncomfortably loud sound level.

Transient tests, using tone bursts, confirm the excellent transient response of the XP-4, which can be inferred from its smooth and hole-free response curve. The two typical photos, taken at 560 cps and 3.5 kc., show the type of tone-burst picture we found.

In listening tests, the Fisher XP-4 acquitted itself admirably. It has no tendency toward boominess and, in common with all low-distortion speakers, seems to be lacking in bass in most program material. When any real bass is present, the XP-4 leaves no doubt in the listener's mind as to its capabilities. The ability to adjust the balance of middles and highs gives the user a worthwhile increase in flexibility, allowing him to suit his personal taste and specific room environment.

The hemispherical tweeter of the XP-4 has a very wide dispersion, with little evidence of the beaming of high frequencies usually found with cone-type tweeters or with some horns. This can also be inferred from the relatively flat response curve, which represents the average response throughout a typ-

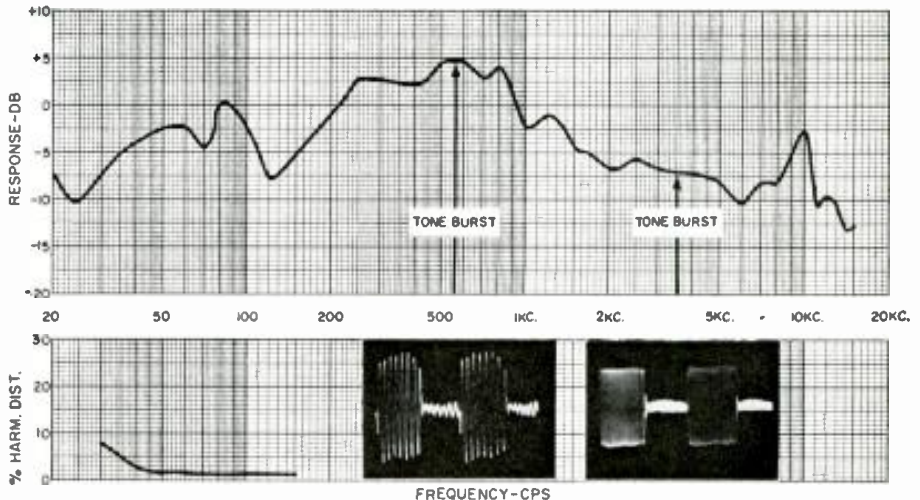

ical live listening room. A speaker with very directional high-frequency response can measure reasonably flat on its axis, in an anechoic chamber or out of doors, but will show an appreciable loss of highs when measured in the manner we use.

The XP-4 was tested in a live room, with the plotted curve showing the average of the response measurements made at eight different microphone locations. Allowing for the microphone calibration, the response is within ± 7.5 db from 20 to 15,000 cps, which is very good. This is the total integrated response of the speaker throughout the room, a more realistic and less flattering curve than the usual axial pressure response taken in an anechoic chamber.

The low-frequency harmonic distortion, measured with one-watt input to the speaker, shows the XP-4 to be very clean. It has less than 2% distortion down to 40 cps, and only 7.5% at 30 cps. The XP-4, unlike some other compact speaker systems, is a moderately high-efficiency unit. It can be driven very

The XP-4 sounds very nearly the same at any listening angle, which is the way it should be. It is a little difficult to verbally describe its sound, since it can be tailored by the user, but it is definitely in the upper echelon of speakers.

The Fisher XP-4 sells for \$199.50. It is available in oiled-walnut, cherry, mahogany, and unstained sanded birch. ▲

Answers to Quiz on Page 90

1. F	8. N	15. K
2. L	9. B	16. C
3. Q	10. T	17. I
4. S	11. O	18. D
5. A	12. E	19. G
6. M	13. U	20. J
7. R	14. H	21. P

Mac's Service Shop
(Continued from page 54)

could be acquiring new knowledge and skills at a gait more or less of our own choosing. Later, if we decided to go into industrial electronics completely, we would have some experience under our belt and not have to start as green hands. But what have you decided about your antenna problem?"

"Yeah! Seeing you're a ham, antennas should be right up your alley. Suppose you wanted to maintain a good reliable communication circuit over a distance that was barely line-of-sight on a frequency around 900 megacycles. You want to do it with a minimum of power. For this and security reasons, you want as narrow a beamwidth as possible. What kind of antennas would you use?"

"I better explain first that my ham experience only extends up to 144-megacycle work; so nothing I say can be used against me," Barney hedged. "Off-hand, though, I'd think a high-gain beam of some sort would be in order. If I remember rightly, you can get a little better than 16 db gain over a reference dipole from a 13-element yagi. A 12-element colinear-broadside array will give you 10.5 db."

"Building and adjusting such complicated antennas at this frequency would be quite a job," Mac demurred. "What would you say to a 2-element antenna providing nearly 17-db gain with a half-power beamwidth of less than 7.5°?"

"I'd say there ain't no such animal," Barney answered promptly.

"How about a ten-foot parabolic reflector?" Mac asked as he spread open the booklet he had been reading. "This is the catalogue of Microwave Parabolic Antennas and Accessories produced by *Prodelin, Inc.* of Kearny, New Jersey. As you can see, it has complete information and pictures of their spun aluminum parabolic antennas of 4-, 6-, 8-, and 10-foot diameters."

"Hey, this is even better than you said!" Barney exclaimed. "This ten-foot job gives a gain of 27.7 db at 890-960 megacycles."

"That's gain above an isotropic source," Mac explained. "A half-wave dipole has a gain of 1.64 over an isotropic source; so you have to divide the gain figures in the catalogue by that number to arrive at the gain over a reference dipole we are accustomed to using in radio and TV work. I think this points up something we are going to have to watch in industrial electronics work: some of our radio and TV experience can be applied directly to the new problems, but there will be other cases where this experience will not apply at all or where it will have to be modified to be used. We'll have to be constantly on the alert to know which case is which."

"OK, but was that all your antenna problem?"

"No, that was to take care of a communication link between the lab and a control center at the testing range. They

COMING UP!

Giant step toward tone-arm perfection... 20-20,000 cps response!

Now for the first time you'll be able to get the world-renowned Ortofon arms and stereo cartridge at your hi-fi dealer's... a superb companion to your Thorens TD-124... a giant step forward in eliminating residual distortion and response deficiencies from even the finest music systems.

Only Ortofon, supplier of studio recording equipment to the world's foremost recording companies, both in the U. S. and abroad, has achieved the perfection of balance, the precision of tracking, the absolute minimum of inertia needed to play your finest records and preserve their superlative brand-new quality.

See and hear the Ortofon arms and stereo cartridge at your dealer or the New York Hi-Fi Show Room of ELPA Marketing Industries—sole U. S. Representatives for Thorens and Ortofon products.

Guaranteed for one full year. Sold only through carefully selected franchised dealers.

Ortofon

WORLD FAMOUS STUDIO EQUIPMENT



A Division of ELPA Marketing Industries, Inc., New Hyde Park, New York

MICRO

ELECTRON TUBE
FABULOUS LOW PRICES!
LARGE SELECT STOCKS!
DEPENDABLE, FAST SERVICE!

- Each and every tube is tested in our own laboratory for mutual conductance and life test.
- We guarantee FREE replacement for one year of any tube purchased from us which fails to function efficiently under any or all operating conditions. Prompt refunds are made on any defective merchandise.
- The advertised tubes are not necessarily new, but may be electrically perfect factory seconds or used tubes—each is clearly so marked.

37¢ ea. **\$35 PER HUNDRED ASSTD.**

0A2	3X8	6BH6	6FS	7Z4	18B00G
0Z4	5Y3GT	6E4	6SF7	12A8	19J8
1A7GT	5Y4G	6BK3	6SJ7	12A95	19TB
1B3GT	6A7	6BK7	6SK7	12A78	2A4
1N4G	6AB	6SL7GT	6SL7GT	12A77	2BRX8
2W5GT	6AB4	6BN6	6BN7GT	12A68	2SRQ4
3L6	6AC7	6BQ6GT	6BQ7	12A77	250NR
3L6	6AF6	6B07	6B57	12A78	25L6GT
3N1GT	6AD5	6BY5G	6Y4	12A77	25W4GT
1Q5GT	6AGT	6B26	6T8	12A44GT	25Z3
3R3	6AH4GT	6B27	6U8	12A77	25Z6
3X5	6AH6	6C4	6V5	12A77	2B
3T6	6AK3	6C5	6W6GT	12A77	35A5
3U4	6AL5	6C5	6W6GT	12B46	35B5
3U5	6AL7	6C6	6X1	12B47	35C5
1V2	6AM5	6CD6G	6X3	12B66	35L6GT
1X2	6AN8	6CF8	6X8	12B76	35W4
2A3	6AQ5	6CD7	6X8	12B77	35Y4
2A4	6AQ6	6CL8	7A5 XKL	12B06	35Z5GT
3BC5	6AQ7GT	6CM6	7A5	12B87	37
3BN6	6AR5	6CM7	7A5	12B77	3W/44
3BE6	6AS5	6CM7	7A7	12CA5	42
3C86	6AT6	6C66	7B8	12J5	43
3CF6	6AT8	6C66	7B4	12K7	45
3C66	6AU4GT	6DE6	7B5	12L6	50A5
3L4	6AU5GT	6DE6	7B6	12Q7	50B5
3Q4	6AU8	6F6	7BT	12A77	50C5
3B4	6AU8	6H6	7B6	12S07	50L6GT
3V4	6AV5GT	6J4	7C4	12B77	50X6
4B07A	6AV6	6J5	7C5	12B87	5B
6B27	6AW8	6J7	7C6	12B7GT	57
6B58	6AX4GT	6K6GT	7C7	12B07	58
6AT8	6AX5GT	6K7	7C8	12V6GT	73A
6AV8	6B5	6N8	7E7	12V6GT	75
6AW4	6B6	6L7	7F7	12X4	76
6B7	6C5	6N7	7F8	12Z3	77
6J6	6C6	6O7	7H7	14A7/12B7	78
6T6	6D6	6P4	7H7	14B8	80
6U6G	6E6	6P5	6S0GT	707	84/824
6U8	6E6	6P5	6S0GT	707	117Z3
6V4B	6E6	6P5	6S0GT	707	117Z3
6V6GT	6E6G	6C7	7F4/XXFM	19A4GT	117Z6

SEND FOR OUR FREE COMPLETE LIST OF TUBES & SPECIAL PURPOSE TUBES

ALL TUBES SENT POSTAGE PAID. Please send 25¢ handling for orders under \$5. Send 25% deposit on C.O.D. orders. Send approximate postage on Canadian and foreign orders.

MICRO ELECTRON TUBE CO.
 P.O. Box 55 Park Station, Paterson 3, N. J.

ENGINEERING DEGREE IN SCIENCE MATH 27 or 36 MOS.

B.S. degree - 36 mos. • B.E. degree - 27 mos. Accelerated year-round program prepares for early employment in fields of Science and Engineering. Regular 4-year program for B.S. Degree completed in 36 months, special engineering degree program in 27. Classes start January, March, June, July, September. Quality education. Graduates employed from coast to coast. Government approved for veteran training. Students from 50 states, 40 countries, 20 buildings: dorms, gym, Campus. Save time and money. Earn board while studying. Write for catalog and complete information.
 9121 E. Washington Blvd., Fort Wayne 2, Indiana

INDIANA TECHNICAL COLLEGE

also want to have two-way communication between this control point, located at one side of the testing range, and mobile units scattered over the ten-square-mile area of the range. This is on about 150 megacycles. Just to make it tougher, they want to confine as much of the signal from the control station as possible to the test-range itself. In other words, they want an antenna pattern that has nearly uniform gain to the right, left, and straight ahead but with a deep null to the back.

"Very fortunately I had received Prodelin's two-way antenna catalogue along with the one on parabolic reflectors, and this 'Cardioid-3' ground-plane antenna looks like just the ticket. It has a 3-db gain over about a 180° arc, but the front-to-back ratio is 27 db minimum. See, this is the antenna pattern. Looks like the response pattern of a cardioid microphone, doesn't it?"

"Sure does. Say, I want to read this dope here in the back of the catalogue about how you figure the coverage in miles when you know the power input to the transmitter and the gain figures of the transmitting and receiving antennas. I see it is figured for 30, 150, and 450 megacycles and at two different antenna heights. I'll bet I could use those figures for estimating coverage on our ten- and two-meter bands. I see the charts even take a shadow-loss and are prepared for use with omni-directional, bi-directional, and uni-directional antennas. I haven't seen some of these charts in antenna handbooks."

"Lots of these commercial equipment catalogues contain a great deal more information than just sales pitches," Mac commented. "One of the first moves we can make toward getting into industrial electronic service is to acquire and study all of these catalogues we can get. Some of the electronics magazines are starting to publish good articles on the nature and servicing of various kinds of industrial electronic equipment. These articles will be 'must' reading for us from now on. I'm going to start soliciting service work from some of the small plants tomorrow; so brace yourself. It's Mac's Electronics Service from now on!"

Answer to Puzzle
 Appearing on page 79

C	O	M	P	L	I	A	N	C	E	F
L	I	M	P	E	D	A	N	C	E	Y
P	H	A	S	E	E	C	S	R		
P	E	C	H	O	R	I	T			
I	M	N	I	N	O	I	S	E		
N	A	C	B	A	R	D				
G	D	E	E	M	P	H	A	S	E	S
N	S	B	U	L	O	O	P	S		
A	C	O	U	S	T	I	C	S	S	I
B	A	S	S	H	E	C	T	V		

THE WHOLE WORLD OF PHOTOGRAPHIC EQUIPMENT IS YOURS IN



Your guide to what to buy... how to buy... where to buy!

Featuring over 176 pages of vital information on all the products on the photo market — cameras, projectors, flash attachments, lighting and sound equipment, darkroom supplies, accessories, and film. Makes selecting your new equipment as easy as

1 COMPARE

performance data on still and movie cameras, movie projectors, and electronic flash equipment with easy-to-read charts.

2 CHECK

the detailed specifications on each and every product. Get prices, manufacturers, and distributors.

3 SEE

clear, accurate pictures of everything from gadget bags to underwater apparatus.

It's all yours in the 1962 Photography Directory and Buying Guide — now on sale at your favorite newsstand. Or order your copy with this handy coupon.

ONLY 1.00

Ziff-Davis Publishing Company
 Dept. 1060 P.O. Box 1187
 Brooklyn 1, New York

Please send me a copy of the 1962 PHOTOGRAPHY DIRECTORY AND BUYING GUIDE. I enclose \$1.00, the cost of the DIRECTORY, plus 10¢ to cover mailing and handling charges. (Canada and Foreign \$1.25 plus 10¢ postage)

NAME _____
 ADDRESS _____
 CITY _____ ZONE _____ STATE _____

EF 2044

Testing Tape Recorders

(Continued from page 59)

(or record-playback) and erase heads must span the same portion of the tape. Improper vertical positioning causes signal loss, crosstalk (particularly in the case of quarter-track stereo heads), and incomplete erasure.

Except, perhaps, in the case of mono heads and half-track stereo ones, it is not a good idea to rely on visual alignment, that is, adjusting the heads by eye so that the edge of the tape and the edge of the gap appear at the same level.

For mono and half-track stereo heads, vertical alignment can be performed with a test tape bearing a relatively low tone (such as 400 cycles) so that moderate changes in azimuth as the head is moved do not significantly affect signal output. If the tape runs from left to right, move the playback head up, then lower it until output (on the left channel in the case of a stereo head) reaches maximum. If the tape runs from right to left, lower the playback head, then raise it until output reaches maximum. If the machine has a separate record head, first align the playback head, then adjust the record head for maximum output while simultaneously recording and playing a low frequency. The erase head is aligned last by adjusting it for maximum erasure of a tape recorded at high level.

A more accurate technique is needed for quarter-track heads to avoid crosstalk. A test tape such as RCA No. 12-5-64T is useful here. The entire width of this tape is recorded except for a band corresponding to track 3, the right channel. The recorded signal is 1000 cycles at 3.75 ips and 2000 cycles at 7.5 ips. The playback head is moved vertically to achieve minimum signal output on the right channel.

Another precision technique employs "Magna-See" made by Reeves Soundcraft Corp. Starting with virgin or bulk-erased tape, record one or both channels with a quarter-track head, then immerse the tape in "Magna-See" solution. When the tape dries, the recorded tracks become visible and can be measured for proper position. If necessary, the record head can be adjusted accordingly. Where there is a separate playback head, this is adjusted afterward by positioning it for maximum output while simultaneously recording and playing a signal. The erase head can be aligned by using "Magna-See" to view the results of erasure on a previously recorded tape.

Distortion

Conventionally, tape recorders are tested only for harmonic distortion. IM tests sometimes give results that are too embarrassing to mention in print.

Harmonic distortion measurements are ordinarily made at 250 or 400 cycles at maximum permissible recording level as shown by the record-level indicator. When the indicator is a vu meter, keep in mind that on a steady signal it usually reads zero vu when the signal is about

6 db below maximum permissible level.

Signal-to-Noise Ratio

Signal-to-noise ratio is usually measured on the basis of a 250- or 400-cycle signal recorded at a level producing 3% harmonic distortion. Machines with magic-eye tubes are often calibrated so that the eye closes at 3% harmonic distortion. Machines with a vu meter are typically adjusted so that 3% distortion occurs when a steady signal is 6 db above that which produces a zero vu reading.

Using virgin or bulk-erased tape, record the signal, play it back, and measure the output level. Rewind the tape, repeat the procedure but without an input signal, and measure the output. The signal-to-noise ratio is that between the first and second measurements, expressed in decibels. The ratio takes into account the noise and hum of the tape amplifiers, hum picked up by the playback head, tape hiss, noise resulting from bias waveform distortion, and imperfect erasure.

For a playback-only tape machine, use a test tape bearing a signal recorded at the 3% harmonic distortion level. Measure the output level when playing this tape. Then play a virgin or bulk-erased tape and measure the output. Compare the first and second measurements in terms of decibels. If the tape has a signal recorded at the 1% harmonic distortion level, add about 6 db to the measured signal-to-noise ratio.

Tape Speed & Erasure

To measure tape speed, use a tape stroboscope, consisting essentially of a wheel with strobe markings, which is held against the moving tape. View the strobe bars under a 60-cycle light source and count the number of bars per minute that appear to move past a fixed point. At any tape speed, 72 bars per minute correspond to a speed error of 1%. Other errors are proportional—thus 36 bars per minute denote an error of .5%.

To check the erase head, record a low frequency at maximum permissible level on virgin or bulk-erased tape and repeat the process without signal input. Then play the tape with gain well up to ascertain how the head performs.

Wow & Flutter

Equipment for measuring wow and flutter is seldom encountered in the average service shop; therefore, this test will be discussed on the basis of the device most frequently used—the human ear. Play a tape containing a tone of 3000 cps or thereabouts—either a test tape or one recorded at moderate level on the machine under examination. At this frequency the human ear is quite sensitive to deviations from constant speed. Wow produces a quavering or sour effect, while flutter is manifest as graininess or coarseness of tone.

All the tests outlined herein will help you to judge the over-all performance of the tape recorder and determine whether or not it is operating in accordance with its manufacturer's specifications. ▲

ALL
NEW!

High
Quality
Performance
Low in
Cost

Grommes
STEREO-MONAUROAL
HI-FIDELITY
TUNERS &
AMPLIFIERS



24LJ Stereophonic Amplifier... Complete 24 watt stereo pre-amplifier and amplifier in one low cost unit. Net. \$79.95 (Enclosure \$10.00 Extra).

10LJ Amplifier... Low priced stereo and monaural amplifier. Net. \$59.95 (Enclosure \$10.00 Extra).



12LJ Amplifier... 12 watt monaural amplifier with built-in pre-amplifier. Net. \$39.95 (Enclosure \$10.00 Extra).

501A Receiver... AM-FM Tuner, Stereo and Monaural Amplifier. Net. \$149.95 less Multiplex (Enclosure \$10.00 Extra).

Write today for FREE literature on the complete Grommes Line.

GROMMES Div. of Precision Electronics, Inc.,
9101-N King Ave., Franklin Park, Illinois
Please rush details on the Grommes Line.

Name _____
Address _____
City _____ Zone _____ State _____

Now It's Easy and Fun to

**MAKE SUNLIGHT
WORK FOR YOU**

with Satellite-Type Solar Cells



24-Page handbook
gives you detailed
instructions, schematic diagrams,
where-to-get-parts information.

25¢

Use solar cells that convert sunlight into electricity to power your own radios, transistorized receivers, Citizens Band 27 mc transmitter... sun powered audio and tunnel diode oscillators, sun relays... clear descriptive text gives you step-by-step directions and explanations for each project. Get these interesting projects in the all new IR "EXPERIMENTER'S HANDBOOK."

Mail 25¢ along with coupon to

DEPT. EW

IR

INTERNATIONAL RECTIFIER CORP.
222 KANSAS STREET, EL SEGUNDO, CALIFORNIA

Name _____ Age _____
Address _____
City _____ Zone _____ State _____

**7-TUBE, 14 WATT
STEREO \$29⁹⁵**

AMPLIFIER
WITH 6 SPEAKERS AS SHOWN \$45.95
IDEAL FOR CUSTOM INSTALLATION

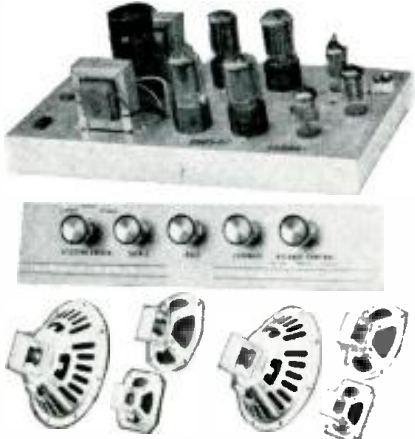

PUSH PULL OUTPUT ON EACH CHANNEL

McGee offers \$100,000 worth of stereo amplifiers at a fraction of their original cost. 14 watts (7 watts per channel) 7 tubes. Push Pull output on each channel matches any 8 ohm hi-fidelity speaker. Response 35 to 15000 cps. Full tone control circuits, separate sanded base and treble tone controls, balance control, loudness control, plus input selector switch for any crystal phono cartridge, or radio tuner. Controls are mounted on a 3 1/4" x 15" gold eutectic plate. A 30" lead plugs the control system into the amplifier for easy custom installation. Amplifier size 12 1/2" long, 4 1/2" tall and 7 1/2" wide, operates on 110 volts 60 cycle a. c. Smp. wt. 8 lbs. Shipped complete with instructions. Stock no. H-1400, McGee sale price \$29.95 with tubes, less speakers. Price with 6 speakers as illustrated \$45.95. The 6 speakers included are 2 10 inch heavy alnico V woofers, 2 matched 6" mid-range and 2 matched 4" alnico V tweeters. Stock No. H-1400-6S. VM 4 speed record changer with Astatic 13TX diamond needle stereo cartridge \$24.95 extra.

DECCA 2-TRACK STEREO TAPE SALE

PETE FOUNTAIN—King of the clarinet recorded in New Orleans. I GOT RHYTHM, JA-BA, CHINA BOY, AVALON, SHINE, TIGER RAG, DON'T BE THAT WAY, OOR BUTTERFLY, SOMEDAY SWEETHEART, 'S WONDERFUL. Coral 2 track stereo tape regularly \$9.95, from McGee at \$3.95. Stock No. 57313.

WRITE FOR MCGEE'S 1962 172 PAGE CATALOG

MCGEE RADIO CO.

1901 McGee St., Kansas City 8, Missouri

**Ask By Name For
GENUINE**

"NO NOISE" PRODUCTS

your assurance of brand name quality

VOLUME CONTROL
and Contact Restorer
• Cleans • Lubricates
• Protects
Not a Carbon Tet Solution
2 Oz. Bottle \$1.00
4 Oz. Spray Can \$2.25
Net to Servicemen

No-Noise TUNER-TONIC
with PERMA-FILM
• Cleans, lubricates, restores all tuners, including water type.
• Non-toxic, non-inflammatory
• For TV, radio and FM use.
• Economical—a little does a lot.
3 Oz. Aerosol Can \$3.25
Net to Servicemen

FREE
with each can of ELECTRONIC CHEMICAL products—
5" PLASTIC EXTENDER
Push Button Assembly For Pin Point Applications—Does Not Cause Shorts

Electronic Chemical new formula EC-44
Lubricates, conditions, cleans all electrical contacts. Economical—a little does a lot!
6 oz. spray can \$3.50

ELECTRONIC CHEMICAL CORP.
813 Communipaw Avenue Jersey City 4, N. J.

A New Broadband TV Antenna

(Continued from page 62)

antenna, are interconnected by a transposed feedline. We will assume that a signal at the frequency of channel 2 is applied to input terminals A-A. Let us also make the assumption, which is not true in the actual case, that the impedances of all elements are equal at channel 2. It is important to recognize that, in this condition, the various elements will not absorb (and radiate) equal amounts of power.

Take as an example the case where the impedance of each element is such, in relation to the impedance of the transmission line, that each element absorbs one half the power supplied to it. Omitting reflections, element 1 would absorb one half the total power; element 2 would then absorb one half of the balance (or one quarter of the total); element 3 would thus absorb only one eighth of the total, and so on.

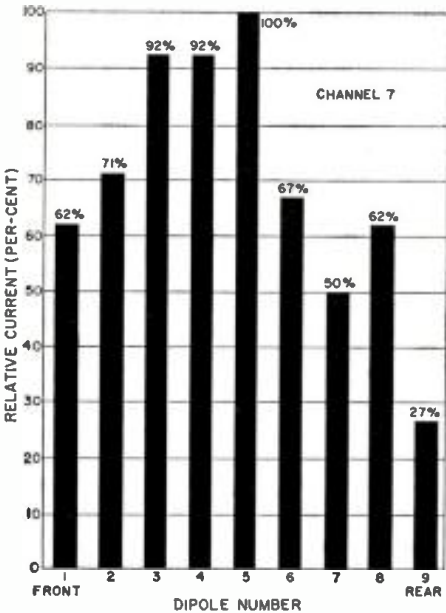

Fig. 4. Relative absorption of current in the 9 driven elements on channel 7.

Only the first few elements would be significantly active.

Since the elements (and their impedances) are in parallel across the transmission line, it is also true that any high-impedance element will absorb relatively little power, while any low-impedance element will absorb relatively more. In other words, if the impedances of elements toward the front of the antenna, such as Z_1 and Z_2 , are kept relatively high and such impedances as Z_4 and Z_5 are kept relatively low, power will tend to be distributed more evenly through the driven elements. With more elements kept active, greater gain is achieved. To maintain a uniform distribution of power across most of the array, the critical impedance values at each element were adjusted to obtain the lowest percentage of absorption in those elements nearest the feedpoint and the greatest relative absorption in those elements farthest away.

The exceptional broadband gain is due to the fact that this principle of proportional energy absorption from the transmission line was maintained for a large number of elements at all v.h.f. frequencies. Although the degree of absorption for any given element does not remain the same at all frequencies, the combined effect is always that of several active elements. For example, in the case of channel 2 (Fig. 3), element 7 is most active. However, elements 6 and 8 are also extremely active and elements 5 and 9 make substantial contribution. Each element contributes some amount of gain.

If we were to examine a similar graph for channel 6, we would find that element 1 absorbs the greatest amount of current, that dipoles 3 and 2 respectively are close behind it, and that elements 4 and 5 also show appreciable absorption. In the graph for channel 7 (Fig. 4), the pattern of absorption is still different, but note that virtually every dipole is significantly active. However, mention of channel 7 gets ahead of the story, since it is in the high v.h.f. band. The series of driven dipoles used, as illustrated in Fig. 2A, were designed for the low v.h.f. band.

For the high band, harmonic-mode operation is used. This is made possible by the fact that the high band (174 to 216 mc.) falls within the range of third harmonics of the low band (54 to 88 mc.). Element A of Fig. 2B is a half-wave dipole on the low band. Let us say that it is resonant at 60 mc. (channel 3). Current distribution is shown for the third harmonic, 180 mc., which corresponds to channel 8 on the high band. The out-of-phase half-cycle of current at this frequency tends to cancel effectiveness. If a parasitic element resonant at 180 mc. (B in Fig. 2B) is added, its strong forward current overcomes the effect of the out-of-phase component. The combined effect of dipole and parasite on the higher frequency is shown at C.

As may be noted in the photograph of Fig. 1, each driven, low-band dipole has its own associated high-band parasite. The impedance of the parasites is so high that they have virtually no effect on low-band impedance and therefore on low-band operation. The dipole system was thus developed for optimum low-band performance. Length and spacing of the parasites were then independently worked out to maintain the desired performance characteristics in the high band.

The use of a transposition type of feedline maintains phase relationships of signal in the various driven elements so that there is reinforcement in the forward direction but out-of-phase cancellation to the rear. In principle, this can provide extremely high front-to-back ratios. However, for this to occur in practice, signal amplitudes in the driven elements must be matched. Otherwise the pattern of re-inforcement and cancellation can be extremely erratic. Due to the proportional energy absorption at all frequencies, high ratios are obtained at all channels without reflectors.

Now you can build almost any kind of electronic device!

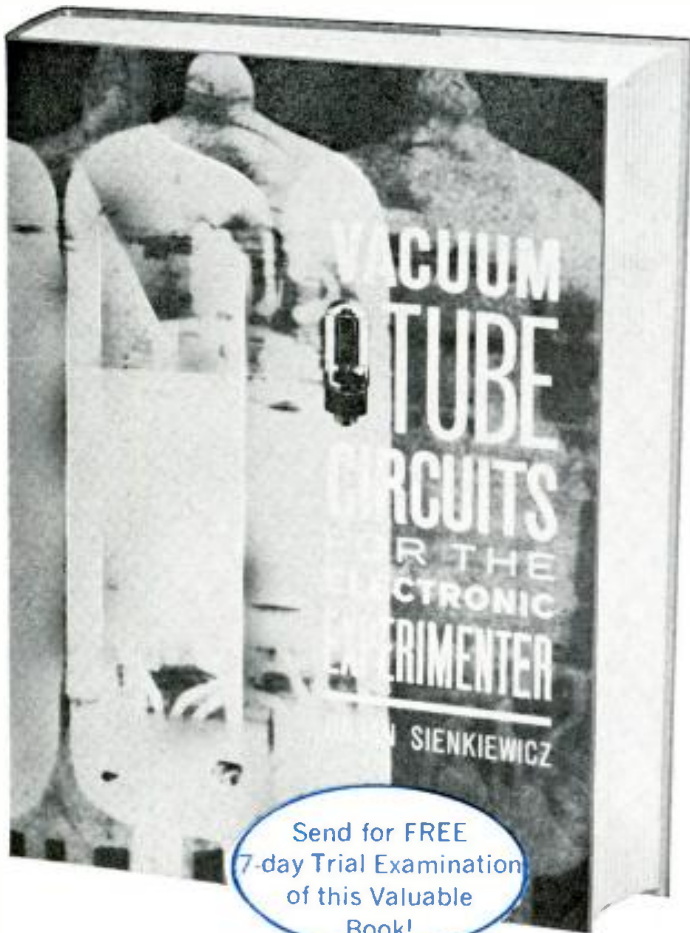

Send for FREE
7-day Trial Examination
of this Valuable
Book!

PARTIAL CONTENTS:

DIODE VACUUM TUBES. Emission—Diode Operation—Diode Characteristics—Rectification Power—Supply Filters—Detection (AM and FM).

TRIODE VACUUM TUBES. Triode Operation—The Triode Test Circuit—Control—Grid Effect—Triode Characteristics—Plate Characteristic Curves—Plate Resistance—Transconductance—Amplification Factor—Interelectrode Capacitance.
TRIODE AMPLIFIERS. Load Lines—Operating Point—Cathode Bias—Cathode Load Lines—Signal Amplification—Signal Inversion—Voltage Gain—Computing Voltage Gain—Cathode Bypass Capacitor—Distortion—Summary.

MULTIELEMENT TUBES. Miller Effect—Tetrodes—Tetrode Plate Characteristic Curves—Output Signal vs. Secondary Emission—Pen-

todes—Suppressor Grid—Pentode Plate Characteristic Curves—Tetrode and Pentode Characteristics—A. C. Plate Resistance—Transconductance—Amplification Factor—The Pentode Voltage Amplifier—Operating Point—Cathode Bias—Cathode Bypass Capacitor—Distortion—Beam-Power Vacuum Tubes—Audio Output Stages.

CIRCUIT CONSTRUCTION HINTS. Checking Components—Fixed Resistors—Potentiometers—Capacitors—Transformers and Coils—Vacuum Tubes—Where to Buy—Test Equipment—Multimeter—Vacuum Tube Voltmeter—Oscilloscope—Signal Generators—Other Test Equipment—Tools—Tools You Will Need—Soldering—Chassis Construction.

BASIC VACUUM TUBE CIRCUITS.

Here are the ABC's of 50 vacuum-tube circuits for electronics experimentation and project construction— all fully diagrammed, complete with parts list.

HOW many times have you wanted a diagram of a basic vacuum-tube circuit which you could use as a guide in building hi-fi components, receivers, transmitters, intercom systems, test equipment and other electronic gear? At last, in one book, you can find all the basic diagrams, schematics, and other vital information on vacuum tubes and their circuits essential for such projects!

Beginning with the Edison effect (the birth of the diode), Julian M. Sienkiewicz, Managing Editor of Popular Electronics, leads you right up to the multi-element vacuum tubes used in everyday circuits. Vacuum-tube circuit design is described in understandable, down-to-earth language. Plate resistance, transconductance, gain, load lines, characteristic curves and the like will no longer be mysterious terms but useful tools for your work or hobby.

You'll Become An Expert On All Types Of Vacuum Tubes

The first four chapters are devoted to the operation of diodes, triodes, tetrodes, and pentode and beam-power tubes. Chapter five covers construction practices, tools, and test equipment, along with workshop hints that will be a real boon to all who want to get the most out of their equipment. Chapter six contains a collection of fifty vacuum-tube circuits that gives you a basic library of useful circuits for quick and trouble-free reference.

One hundred vacuum-tube schematics, plate-characteristic curves, simplified diagrams, test circuits and other selected illustrations supplement the informative text to make this book one of the most useful and invaluable manuals for your electronic experiments and hobby projects.

192 pages, 100 illustrations \$4.95

ZIFF-DAVIS PUBLISHING COMPANY

ELECTRONICS BOOK SERVICE

P.O. Box 1187
Brooklyn 1, N.Y.

Please send me VACUUM-TUBE CIRCUITS FOR THE ELECTRONIC EXPERIMENTER for a free 7-day trial examination. I understand that if I am not completely satisfied, I may return the book and owe you nothing. Otherwise, I will remit \$4.95 plus small charge for postage, packaging and handling.

Name _____
(please print)

Address _____

City _____ Zone _____ State _____

EF 568

SAVE MONEY! Enclose \$4.95 in check or money order, and we will pay for postage, packing and handling. Same return privilege and prompt refund guaranteed!

EXAMINE ANY OF THESE TESTERS BEFORE YOU BUY!!

Yes, we offer to ship at our risk one or more of the testers described on these pages.

SUPERIOR'S NEW MODEL 770-A

VOLT-OHM MILLIAMMETER



FEATURES:

- Compact—measures 3 1/8" x 5 7/8" x 2 1/4".
- Uses "Full View" 2% accurate 850 Microampere D'Arsonval type meter
- Housed in round-cornered, molded case.

SPECIFICATIONS:

- 6 A.C. VOLTAGE RANGES: 0-15/30/150/300/1500/3000 Volts.
- 6 D.C. VOLTAGE RANGES: 0-7.5/15/75/150/750/1500 Volts.
- 2 RESISTANCE RANGES: 0-10,000 Ohms, 0-1 Megohm.
- 3 D.C. CURRENT RANGES: 0-15/150 Ma., 0-1.5 Amps.
- 3 DECIBEL RANGES: -6 db to +18 db, +14 db to +38 db, +34 db to +58 db.

The Model 770-A comes complete with test leads and operating instructions. Price is \$15.85. Terms: \$3.85 after 10 day trial then \$4.00 monthly for 3 months.

SUPERIOR'S NEW MODEL 79

SUPER-METER

WITH NEW 6" FULL VIEW METER



SPECIFICATIONS:

- D.C. VOLTS: 0 to 7.5/15/75/150/750/1,500.
- A.C. VOLTS: 0 to 15/30/150/300/1,500/3,000.
- D.C. CURRENT: 0 to 1.5/15/150 Ma. 0 to 1.5/15 Amperes.
- RESISTANCE: 0 to 1,000/100,000 Ohms. 0 to 10 Megohms.
- CAPACITY: .001 to 1 Mfd. 1 to 50 Mfd.
- REACTANCE: 50 to 2,500 Ohms. 2,500 Ohms to 2.5 Megohms.
- INDUCTANCE: .15 to 7 Henries. 7 to 7,000 Henries.
- DECIBELS: -6 to +18, +14 to +38, +34 to +58.

The following components are all tested for QUALITY at appropriate test potentials. Two separate BAD-GOOD scales on the meter are used for direct readings.

All Electrolytic Condensers from 1 MFD to 1000 MFD.
All Selenium Rectifiers. All Germanium Diodes.
All Silicon Rectifiers. All Silicon Diodes.

Model 79 comes complete with operating instructions, test leads and carrying case. Price is \$38.50. Terms: \$8.50 after 10 day trial then \$6.00 monthly for 5 months.

SUPERIOR'S NEW MODEL 77

VACUUM TUBE VOLTMETER

WITH NEW 6" FULL VIEW METER



Compare it to any peak-to-peak V.T.V.M. made by any other manufacturer at any price!

SPECIFICATIONS:

- DC VOLTS—0 to 3/15/75/150/300/750/1500 volts at 11 megohms input resistance.
- AC VOLTS (RMS)—0 to 3/15/75/150/300/750/1500 volts.
- AC VOLTS (Peak to Peak)—0 to 8/40/200/400/800/2000 volts.
- ELECTRONIC OHMMETER—0 to 1000 ohms/10,000 ohms/100,000 ohms/1 megohm/10 megohms/100 megohms/1,000 megohms.
- DECIBELS—10 db to +18 db, +10 db to +38 db, +30 db to +58 db. All based on 0 db = .006 watts (6 mw) into a 500 ohm line (1.73v).
- ZERO CENTER METER—For discriminator alignment with full scale range of 0 to 1.5/7.5/37.5/75/150/375/750 volts at 11 megohms input resistance.

Model 77 comes complete with operating instructions, probe and test leads and carrying case. Price is \$42.50. Terms: \$12.50 after 10 day trial then \$6.00 monthly for 5 months.

SUPERIOR'S NEW MODEL 80

20,000 OHMS PER VOLT ALLMETER



6 INCH FULL-VIEW METER provides large easy-to-read calibrations. No squinting or guessing when you use Model 80.

MIRRORED SCALE permits fine accurate measurements where fractional readings are important.

SPECIFICATIONS:

- 7 D.C. VOLTAGE RANGES: (At a sensitivity of 20,000 Ohms per Volt) 0 to 15/75/150/300/750/1500/7500 Volts.
- 6 A.C. VOLTAGE RANGES: (At a sensitivity of 5,000 Ohms per Volt) 0 to 15/75/150/300/750/1500 Volts.
- 3 RESISTANCE RANGES: 0 to 2,000/200,000 Ohms. 0-20 Megohms.
- 2 CAPACITY RANGES: .00025 Mfd. to .3 Mfd., .05 Mfd. to 30 Mfd.
- 5 D.C. CURRENT RANGES: 0-75 Microamperes, 0 to 7.5/75/750 Milli-amperes, 0 to 15 Amperes.
- 3 DECIBEL RANGES: -6 db to +18 db, +14 db to +38 db, +34 db to +58 db.

NOTE: The line cord is used only for capacity measurements. Resistance ranges operate on self-contained batteries.

Model 80 Allmeter comes complete with operating instructions, test leads and portable carrying case. Price is \$42.50. Terms: \$12.50 after 10 day trial then \$6.00 monthly for 5 months.

SUPERIOR'S NEW MODEL 70 UTILITY TESTER

FOR REPAIRING ALL ELECTRICAL APPLIANCES MOTORS * AUTOMOBILES



UTILITY TESTER INCLUDED FREE

64 page condensed course in electricity. Profusely illustrated.

Written in simple, easy-to-understand style.

As an electrical trouble shooter the Model 70:

- Will test Toasters, Irons, Broilers, Heating Pads, Clocks, Fans, Vacuum Cleaners, Refrigerators, Lamps, Fluorescents, Switches, Thermostats, etc.
- Measures A.C. and D.C. Voltages, A.C. and D.C. Current, Resistances, Leakage, etc.
- Incorporates a sensitive direct-reading resistance range which will measure all resistances commonly used in electrical appliances, motors, etc.
- Leakage detecting circuit will indicate continuity from zero ohms to 5 megohms (5,000,000 ohms).

As an Automotive Tester the Model 70 will test:

- Both 6 Volt and 12 Volt Storage Batteries • Generators • Starters • Distributors • Ignition Coils
- Regulators • Relays • Circuit Breakers • Cigarette Lighters • Stop Lights • Condensers • Directional Signal Systems • All Lamps and Bulbs • Fuses • Heating Systems • Horns • Also will locate poor grounds, breaks in wiring, poor connections, etc.

Model 70 comes complete with 64 page book and test leads. Price is \$15.85. Terms: \$3.85 after 10 day trial then \$4.00 monthly for 3 months.

DID YOU EVER?

- ▶ Order merchandise by mail, including deposit or payment in full, then wait and write...wait and write?
- ▶ Purchase anything on time and sign a lengthy complex contract written in small difficult-to-read type?
- ▶ Purchase an item by mail or in a retail store then experience frustrating delay and red tape when you applied for a refund?

Obviously prompt shipment and attention to orders is an essential requirement in our business... We ship at our risk!

NO

**CONTRACT TO SIGN
CO-MAKERS
EMPLOYER
NOTIFICATION**

The simple order authorization included in this offer is *all* you sign. We ask only that you promise to pay for or return the goods we ship in good faith.

**EXAMINE ANY ITEM YOU SELECT
IN THE PRIVACY OF YOUR OWN HOME**

Then if completely satisfied pay on the interest-free terms plainly specified. When we say interest-free we mean not one penny added for "interest" for "finance" for "credit-checking" or for "carrying charges." The net price of each tester is plainly marked in our ads—that is all you pay except for parcel post or other transportation charges we may prepay.

SUPERIOR'S NEW MODEL 82A
MULTI-SOCKET TYPE

TUBE TESTER

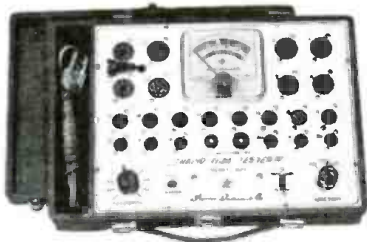

Model 82A comes housed in handsome, portable case. Price is \$36.50. Terms: \$6.50 after 10 day trial then \$6.00 monthly for 5 months.

SPECIFICATIONS:

- Tests over 1000 tube types.
- Tests OZ4 and other gas-filled tubes.
- Employs new 4" meter with sealed air-damping chamber resulting in accurate vibrationless readings.
- Use of 22 sockets permits testing all popular tube types
- Dual Scale meter permits testing of low current tubes.
- 7 and 9 pin straighteners mounted on panel.
- All sections of multi-element tubes tested simultaneously.
- Ultra-sensitive leakage test circuit will indicate leakage up to 5 megohms.

SUPERIOR'S NEW MODEL TW-11
STANDARD PROFESSIONAL

TUBE TESTER



The Model TW-11 comes housed in a handsome, portable, saddle-stitched Texon case. Price is \$47.50. Terms: \$11.50 after 10 day trial then \$6.00 monthly for 6 months.

- Uses the new self-cleaning Lever Action Switches for individual element testing. Because all elements are numbered according to pin-number in the RMA base numbering system, the user can instantly identify which element is under test.
- Free-moving built-in roll chart provides complete data for all tubes. All tube listings printed in large-easy-to-read type.
- **NOISE TEST:** Phono-jack on front panel for plugging in either phones or external amplifier will detect microphonic tubes or noise due to faulty elements and loose internal connections.
- **SEPARATE SCALE FOR LOW-CURRENT TUBES**—Previously, on emission type tube testers, it has been standard practice to use one scale for all tubes. As a result, the calibration for low-current types has been restricted to a small portion of the scale. The extra scale used here greatly simplifies testing of low-current types.

SUPERIOR'S NEW MODEL 83A

C.R.T. TESTER

**Tests and Rejuvenates
ALL PICTURE TUBES**



Model 83-A comes housed in handsome portable Saddle-stitched Texon case—complete with socket for all black and white tubes and all color tubes. Price is \$38.50. Terms: \$8.50 after 10 day trial then \$6.00 monthly for 5 months.

ALL BLACK AND WHITE TUBES
From 50 degree to 110 degree types—from 8" to 30" types.

ALL COLOR TUBES
Test ALL picture tubes—in the carton—out of the carton—in the set!

Model 83A provides separate filament operating voltages for the older 6.3 types and the newer 8.4 types.

Model 83A properly tests the red, green and blue sections of color tubes individually—for each section of a color tube contains its own filament, plate, grid and cathode.

Model 83A will detect tubes which are apparently good but require rejuvenation. Such tubes will provide a picture seemingly good but lacking in proper definition, contrast and focus.

Rejuvenation of picture tubes is not simply a matter of applying a high voltage to the filament. Such voltages, improperly applied can strip the cathode of the oxide coating essential for proper emission. The Model 83A applies a *selective* low voltage uniformly to assure increased life with no danger of cathode damage.

SUPERIOR'S NEW MODEL 85

TRANS-CONDUCTANCE TYPE TUBE TESTER

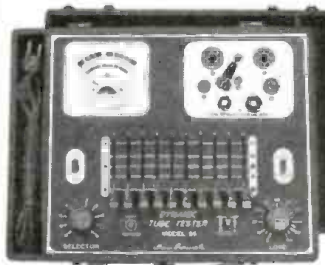

Model 85 comes complete, housed in a handsome portable cabinet with slip-on cover. Price is \$52.50. Terms: \$12.50 after 10 day trial then \$8.00 monthly for 5 months.

- Employs latest improved **TRANS-CONDUCTANCE** circuit. Test tubes under "dynamic" (simulated) operating conditions. An in-phase signal is impressed on the input section of a tube and the resultant plate current change is measured as a function of tube quality. This provides the most suitable method of simulating the manner in which tubes actually operate in radio, TV receivers, amplifiers and other circuits. Amplification factor, plate resistance and cathode emission are all correlated in one meter reading.
- **SYMBOL REFERENCES:** Model 85 employs time-saving symbols (P, A, B, C, D, E, F, G, H, I, J, K, L, M, N, O, P, Q, R, S, T, U, V, W, X, Y, Z) in place of difficult-to-remember letters previously used. Repeated time-studies proved to us that use of these scientifically selected symbols speeded up the element switching step. As the tube manufacturers increase the release of new tube types, this time-saving feature becomes necessary and advantageous.
- **"FREE-POINT" LEVER TYPE ELEMENT SWITCH ASSEMBLY** marked according to RETMA basing, permits application of test voltages to any of the elements of a tube.
- **FREE FIVE (5) YEAR CHART DATA SERVICE.** Revised up-to-date subsequent charts will be mailed to all Model 85 purchasers at no charge for a period of five years after date of purchase.

SUPERIOR'S NEW MODEL TV-50A

GENOMETER 7 Signal Generators in One!



- ✓ R.F. Signal Generator for A.M.
- ✓ R.F. Signal Generator for F.M.
- ✓ Audio Frequency Generator
- ✓ Bar Generator
- ✓ Cross Hatch Generator
- ✓ Color Dot Pattern Generator
- ✓ Marker Generator

A versatile all-inclusive **GENERATOR** which provides **ALL** the outputs for servicing:

A.M. Radio • F.M. Radio • Amplifiers • Black and White TV • Color TV

The Model TV-50A comes absolutely complete with shielded leads and operating instructions. Price is \$47.50. Terms: \$11.50 after 10 day trial then \$6.00 monthly for 6 months.

SUPERIOR'S NEW MODEL 88

TESTS ALL TRANSISTORS AND TRANSISTOR RADIOS



AS A TRANSISTOR RADIO TESTER

An R.F. Signal source, modulated by an audio tone is injected into the transistor receiver from the antenna through the R.F. stage, past the mixer into the I.F. Amplifier and detector stages and on to the audio amplifier. This injected signal is then followed and traced through the receiver by means of a built-in High Gain Transistorized Signal Tracer until the cause of trouble is located and pinpointed.

AS A TRANSISTOR TESTER

The Model 88 will test all transistors including NPN and PNP, silicon, germanium and the new gallium arsenide types, without referring to characteristic data sheets. The time-saving advantage of this technique is self-evident. A further benefit of this service is that it will enable you to test new transistors as they are released!

Model 88 comes housed in a handsome portable case. Complete with a set of Clip-on Cables for Transistor Testing; an R.F. Diode Probe for R.F. & I.F. Tracing; an Audio Probe for Amplifier Tracing and a Signal Injector Cable. Complete—nothing else to buy! Price is \$38.50. Terms: \$8.50 after 10 day trial then \$6.00 monthly for 5 months.

SEND POSTCARD TODAY (NO POSTAGE NECESSARY)

Try any of the instruments on this or the facing page for 10 days before you buy. If completely satisfied then send down payment and pay balance as indicated on coupon. No interest or Finance Charges Added! If not completely satisfied return unit to us, no explanation necessary.

MOSS ELECTRONIC, INC., DEPT D-917 3849 TENTH AVENUE, NEW YORK 34, N.Y.

New Products and Literature for Electronics Technicians

Additional information on the items covered in this section is available from the manufacturers. Each item is identified by a code number. To obtain further details, simply fill in the coupon appearing on page 120.

PC GRID BOARDS

1 Corning Electronic Components has recently developed two new configurations in its "Fotoceram" printed-circuit grid boards. One has new corner mounting holes while the other has the mounting holes plus a plug section useful for computer design work.



The grid boards consist of copper-clad "Fotoceram" glass-ceramic with a grid of .052-inch through-plated holes set .1-inch on center. The new boards, equipped with silicone rubber mounting groutmets, are available in 4" x 6" and 6" x 8" sizes.

and 6" x 8" sizes.

MICROMINIATURE PLUG

2 Cannon Electric Company has designed a new microminiature plug which is being used to form an ingenious diode matrix by Delta Semiconductors, Inc.

The plugs incorporate new twisted wire pin contacts which assure maximum contact surface and provide high reliability compared to welded connections. The "Micropins" are self-aligning and individually "shrouded" in the insulator for protection.

Designed to resist severe environmental conditions, the entire mated plug can be constructed as small as .395" deep (excluding terminations).

A.C./D.C. PREAMP

3 Kin Tel Division of Cohu Electronics, Inc. is now in production on a new a.c.-d.c. pre-amplifier, the Model 458 C/N.

The unit is a versatile, chopper-stabilized, single-ended, wideband d.c. amplifier which can be used as a general-purpose laboratory amplifier

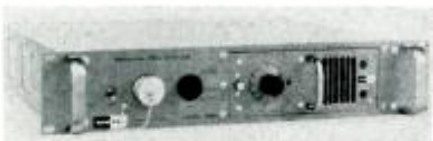

or as a preamplifier. In this latter use, the unit has precision d.c. and a.c. gain positions of 100 to increase the sensitivity of the firm's digital voltmeters to 1 μ v. d.c. and 10 μ v. a.c.

Front panel controls provide four modes of operation. Output capability is \pm 45 volts d.c. into a 10,000 ohm or greater load, 35 volts peak (25 volts r.m.s.) a.c. into 1000 ohms or more.

HIGH-FIELD SOLENOID MAGNETS

4 The Magnetics Division of Harvey-Wells Corporation has designed a new type of solenoid magnet in conjunction with Prof. F. Bitter of MIT's Magnet Lab.

The Model HF-26 provides ultra-high field strengths across large working diameters with lower power requirements and utilizes a low carbon steel jacket around the solenoid as a return path to achieve a new breakthrough in high-field solenoid performance.

A 2" diameter by 6" long bore size provides ample room for samples on the order of one-half inch cube, together with any necessary low-temperature apparatus. A special steel stand facilitates easy access to the entire bore area.

SAMPLING OSCILLOSCOPE

5 Hewlett Packard Company is now offering a new sampling oscilloscope which provides calibrated, high-resolution measurement of nanosecond pulse phenomena.

The Model 185B features conventional con-



trols, direct-reading and bright-trace observation, and a standard 5" mono-accelerator CRT. The unit, when equipped with a Model 187B plug-in dual-trace amplifier, has a passband from d.c. to 1000 mc., can be synchronized up to 1000 mc., and permits full screen presentation of signals from .3 nanosecond to 100 μ sec.

TV BIAS SUPPLY

6 Sencore, Inc. is marketing a dual TV bias supply, designated as Model BE113. This supply is designed to replace batteries that are frequently used to substitute for a TV set's bias supply during alignment. The supply is also suitable for a.g.c. troubleshooting and for checking the operation of a TV receiver under conditions of different a.g.c. bias voltages.

The bias supply operates directly from the 117-volt a.c. line. It has two separately adjustable d.c. outputs which may be connected to the TV set being checked by means of the clip leads supplied. Each output is variable from 0 to 22 volts negative. By using fairly large electrolytic capacitors for filtering, the impedance of the supply is kept low and the percentage of ripple is said to be only .1%.

The supply, which the manufacturer calls an "Align-o-pak," is contained within a compact, flat metal case which measures 4 1/2" wide by 1 3/4" high by 3 1/2" deep.

DIFFUSED-SILICON TRANSISTOR

7 Texas Instruments Incorporated has announced the availability of the developmental type T1X 690 field-effect transistor, an "n"-channel diffused silicon device featuring dual gate control.

The unit is a voltage-operated amplifying device which uses the depletion regions of back-biased "n-p" junctions to control the conductive thickness of a semiconductor layer. The result is

a high-input-impedance, high-gain unit that will find application in the input stages of audio and d.c. amplifiers, switching, voltage-controlled resistances, a.g.c. circuits, voltage-controlled bandwidth amplifiers, analogue multipliers, among other uses.

POWER TRANSISTOR

8 Westinghouse Electric Corporation has developed a 10-ampere silicon power transistor with a current gain of 1000 at 2 amps and a .35-ohm saturation resistance.

The WX118 has voltage ratings up to 150 volts and a power dissipation rating of 150 watts. It is applicable in high-power, high-efficiency regulators, amplifiers, and switching circuits.



AIRBORNE RECORDER

9 Westrex Recording Equipment Div. of Litton Systems, Inc. is now in production on a 13-pound airborne magnetic tape recorder that records 14 tracks with laboratory precision in missile environments.

The 2101 data recording system consists of a precision tape transport and an electronic module assembly. Choice of 14 tracks of wideband FM recording or seven tracks of wideband FM and seven tracks of direct analogue recording can be made by changing plug-in modules.

TV FIELD-STRENGTH METER

10 Sadelco Inc. is now offering a compact, portable TV field-strength meter for service applications.

The unit's six transistors are operated from a zener diode voltage-regulated battery supply. Separate tuning is provided for all v.h.f. picture



and sound carriers, which can be measured from 20 μ v. to 1 volt. It can also measure power output of low-power v.h.f. transmitters from .1 to 1.5 watts.

The instrument measures 8" x 4 1/4" x 2 1/2" and weighs 3 pounds. It comes complete with a leather carrying case.

MINIATURE CHOPPER

11 Oak Manufacturing Co. has announced the development of an improved miniature 60-cycle chopper designed for operating d.c. amplifiers for computer applications.

In compact electronic equipment, the lightweight moving element and armature reduce

audible noise and vibration due to chopper operation. It eliminates vibration in the chassis and is designed to prevent transmission of vibration to tubes in the chassis.

Nominal drive frequency and voltage are 60 cps \pm 5 cps at 6.3 volts aperiodic from 10 to 100 cps.

FAST-SWITCHING DIODE

12 Rheem Semiconductor Corporation is now offering a new silicon diode, the RD750, which provides a 5 to 1 improvement in conductance and a 2 to 1 improvement in recovery time, making possible significant design improvements in computers and other electronic systems.

Conductance of the RD750 is typically 1000 ma. at 1 volt, permitting new levels of high-current switching for applications such as thin-film computer memories. At low current levels, the voltage drop is very low, being only .65 volt at 10 ma.

POWER-TRANSISTOR TESTER

13 Hickok Electrical Instrument Company has announced development of the Model 1885 which has been designed to test transistors to 50 amperes of I_r power diodes to 5 amps forward current, and tester diodes to leakage current of 150 ma.

The new tester will measure the following



parameters: I_{cbo} , I_{cbo} , I_{cbo} , d.c. beta, input impedance, Z_{in} , output impedance H_{re} , G_m in μ hos and mhos. It will also determine alpha and collector voltages.

This fully transistorized instrument can be set up through use of the built-in roll chart or direct from transistor manufacturers' handbook specifications.

CRT REJUVENATOR-TESTER

14 B&K Manufacturing Co. has recently introduced a low-cost "compact" model CRT rejuvenator-tester as the Model 420.

The new unit tests and rejuvenates picture tubes at correct filament voltage at 2, 6, and 8 volts, including 110-degree tubes and the new 19" and 23" tubes. The instrument checks for leakage, shorts, and emission and removed interelement shorts and leakage.

There is an easy-to-read "Good-Bad" scale. The



unit operates on 117-volts, 50-60-cycle a.c. and measures 8 $\frac{3}{4}$ " x 6 $\frac{3}{4}$ " x 3 $\frac{3}{4}$ ". It comes in a lightweight, two-tone carrying case.

R-C ANALYZER

15 Lafayette Radio Electronics Corporation is now offering a capacitance-resistance analyzer as the Model TE-25.

The unit features a large functional dial and



easy-to-read milliammeter. Resistance and capacitance is read in four separate ranges: from 1 μ f. to 5000 μ f. and from .5 to 500 megohms. The unit will also measure the power factors of electrolytics, shorts, opens, and leaky capacitors. The d.c. voltage is continuously variable up to 600 volts. The meter has two ranges, 0-6 and 0-60 ma.

MULTIPLE SWITCHING DIODES

16 Radio Corporation of America has announced the development of multiple silicon switching diodes which are expected to simplify computer design and manufacture while extending performance and reliability.

Housed in a subminiature package the size of a match head and thinner than a nickel, the multiple units consist of two or three ultra-high-speed silicon diodes having a common cathode connection.

The new units are currently available in sampling quantities for industry evaluation.

SCOPE AMPLIFIER

17 Keithley Instruments is now in production on a new a.c. preamplifier which is designed to provide the best possible signal-to-noise ratios to oscilloscopes and recorders.

The Model 103 has a noise level of less than .8 μ v. r.m.s. between 10 and 10,000 cps. The unit lowers the microvolt measurement threshold over a bandwidth of .1 cps to 100 kc. Applications include measurement of piezoelectric crystal outputs, a.c. Hall effect studies, a.c. bridge null indicators, and investigations of i.f. noise in semiconductors.



ETV DISTRIBUTION SYSTEMS

18 Jerrold Electronics Corporation has developed a complete master antenna system for use in areas where the MPATI telecasts are being received.

The system includes a master antenna or "J-jacks" unit, plus the 503HX crystal-controlled converter. The J-jacks system permits the reception of all radio and TV signals in the area (including MPATI and FM) and functions as a flexible and expandable closed-circuit system that accommodates both video and r.f. transmissions. Thus TV broadcasts may originate at any desired J-jacks outlet and may be received at all J-jacks outlets.

TRANSISTOR TESTER

19 Heath Company is now introducing a low-cost, laboratory-quality transistor tester as its Model IM-30 kit. Designed for the servicing field and industry, the circuit features four level switches which permit instant selection of the

COLUMBIA GEMS!

COLLINS MBF TRANSCEIVER
Freq.: 60-80 Mc. 3 W. output. AM. Complete self-contained unit with speaker and built-in 110 V. a.c. DC power supply. Easily converted to 220 V. at 10 or 11 meters. Excel. cond. **\$49.95**

TF-239/UP OSCILLOSCOPE
This is a portable, general purpose, lab type scope for minute fraction of its original cost which was \$2,000.00! 10 cps, SMC response. You can't go wrong. Excel. cond. **\$99.50**

I-100B ADF TEST SET For ARN-7 and SCR-269 aircraft ADF. Excel. condition. Special \$149.50
TS-251 LORAN SIG. GENERATOR Bench simulator for AN/APN-4 and AN/APN-5. Excel. **\$59.50**

AN/APN-4B LORAN RECEIVING SET FR for boats! Gives exact fix with relation to LORAN stations. Consists of indicator, receiver, mounting rack, connectors, and inverter for 24 V. system. Excellent. ONLY **\$79.50**

TCS REMOTE CONTROL UNIT Universally speaker alone worth \$15.00! P.L.U.S.: volume control, switches, etc. Complete. Like new **\$4.95**

TDQ 50 W. AM TRANSMITTER FOR 2 METERS: Complete modular power supply. RF and mod. sections. Final uses 825-B driven by 829-B. 115 V. 330 V. 800 cps. No conversion necessary. Good cond. Sensational! buy @ **\$95.00**

COMMAND RECEIVER SPECIALS
R-28/ARC-5 2 METER & AIRCRAFT RECVR.: 100-150 Mc. Excellent condition. Only... **\$22.50**
ARC-27 100-150 Mc. Excellent cond. With meter... **9.95**
1-3 Mc. This Recv'r is brand new! Only... **13.95**
1-6 Mc. Excellent cond. Excellent buy!... **7.95**
6-9 Mc. Excellent condition. Bargain!... **7.95**

AN/PRC-6 FM TRANSMITTER-RECVR. 30-40 Mc. Crystal control. 50 W. 115 V., 80 cps. Contained in 8 ft. enclosed cabinet. With meter and speaker. This is a military version of Motorola Model B11. Only **\$99.50**

COLUMBIA'S CLASSIFIED CORNER

TCS SET: Complete. 12 V. Recond... **\$150.00**
TCS SET: Complete. 110 VAC... **199.50**
ARC-27 TRANSCEIVER. Excel. This month only... **395.00**
PP-109 12 V. POWER SUPPLY: Excel. cond... **99.50**
PP-112 24 V. POWER SUPPLY: Excel. Only... **89.50**
PRC-6 HANDIE TALKIE: Comp. w/book... **125.00**
BC-312 RECEIVER: Excel. Our special... **89.50**
PE-110 VOLT POWER SUP. For B-100. Excel... **49.50**
SPARES! Complete spares for GRC, PRC, Equip. etc. WHAT DO YOU NEED?
R101A ARN-6 COMPASS RECEIVER: Excel. Only **\$79.50**
SA 142 GSA-6 SWITCH BOX: With 100-150 Mc. Cond. Excel... **3.95**
GN-58 GENERATOR: Excellent. New low price! **35.00**
GN-175 BAG: For above generator. Only **1.00**
BC-375 100 W. XMTR. With all accessories. Like new **49.50**
AN/UPM-4 IFF TEST SET: Excel. cond. **950.00**

APR-4 TUNING UNITS
TN-18/APR-4: 300-1000 Mc. Like New. Ea. **\$35.00**
TN-19/APR-4: 475-725 Mc. Like New. Ea. **49.50**

APR-1 TUNING UNITS
TN-1: 30-90 Mc. Excellent condition. Only **19.95**
TN-2: 80-100 Mc. Excellent condition. Only **19.95**
TN-3: 300-1000 Mc. Excellent cond. Only **19.95**

ORIG. CASE FOR BC-611 HANDIE-TALKIE
Leak switch, top and bottom covers. New... **\$4.95**
PP-109 THERMAL RELAY: 227598-129. 20c Brand new. Ea. **2.00**

FACSIMILE TRANSMISSION MODULATOR: Model MD-108/EX. Permits transmission of facsimile signals via air or wire. BRAND NEW **\$99.50**

RT-82 APX-6 TRANSCEIVER. 1215 Mc.
Less tubes... excellent condition **\$3.95**

MOBILE RADIO-TELEPHONE
150-170 Mc. single channel, crystal control. FM. 6 V. Input; out, 25 W. Consists of transmitter, receiver, antenna, connecting cable and other accessories. Mfg. by West Coast Elect. Good condition. Only **\$24.95**

All orders FOB Los Angeles. 25% deposit required. All items subject to prior sale. NOTE MINIMUM ORDER \$3.00. WRITE TO DEPT. R.

COLUMBIA ELECTRONICS

4365 WEST PICO BLVD. LOS ANGELES 19, CALIF.

twenty to one dividend...

That's the return you can receive from investment in a college education in engineering or business. Rapid advancement, too. Important firms like Tri-State College graduates... so they interview seniors on campus. Quality faster as an Electronics Engineer. Bachelor of Science Degree in 27 Months in Electrical Engineering (Electronics or Power major). Mechanical, Chemical, Aeronautical, Civil Engineer. In 36 Months in Business Administration. For earnest, capable, mature students. Small classes. More professional class hours. Well-equipped labs. Dorm. Modest costs. Founded 1884. Enter Jan., Mar., June, Sept. Write J. H. McCaithy, Director of Admissions, for Catalog and "Your Career" Book.

TRI-STATE COLLEGE

16121 College Ave., Angola, Indiana

NOW MULTIPLEX!

What do you need to get stereo on your present FM radio? How much will it cost? Which manufacturers produce FM stereo adapters and tuners? Find the answers in the



IN ADDITION...

The 1962 edition of the **STEREO/HI-FI DIRECTORY** is the complete buyers' guide to over 1300 component listings! Get specifications, prices, and performance data on:

- tape recorders and players
- speakers and cabinets
- AM, FM tuners and receivers
- phonograph equipment
- accessories—cabinets, antennas, microphones

Now on sale—pick up your copy at your favorite newsstand or electronics parts store. Or mail the coupon below and a copy will be sent you **Only \$1.00.**

Ziff-Davis Publishing Company
Dept. 2040
P. O. Box 1187
Brooklyn 1, N.Y.

Please send me a copy of the 1962 **STEREO AND HI-FI DIRECTORY**. I enclose \$1.00, the cost of the **DIRECTORY**, plus 10¢ to cover mailing and handling charges. (Canada and foreign, \$1.25 plus 10¢ postage.)

NAME _____

ADDRESS _____

CITY _____ ZONE _____ STATE _____

Department EF-2045



desired test after proper conditions are set by the voltage and current range switches.

Tests include base current, gain, collector current, collector voltage, leakage voltage, short test, diode or collector-to-emitter leakage, collector-to-base leakage, all selectable by the lever switches. The four rotary switches, one for voltage and one for current on both gain and leakage, set the desired conditions.

TUBE TESTER FOR SERVICE

20 Mercury Electronics Corp. has recently introduced a popularly priced tube tester which will check all tube types including novistors, com-

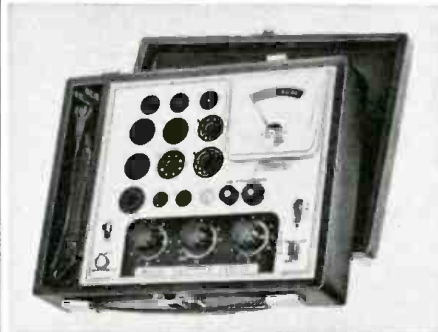

patrons, novars, and the new 10-pin tube types. The Model 1100 will also handle battery tube types, auto-radio hybrid tubes, voltage regulators, foreign and hi-fi tubes, thyratrons, and industrial tube types.

The instrument tests for dynamic cathode emission, shorts and leakage, grid leakage, and gas content. As a multiple-socket tube tester, it tests tubes quickly and accurately with no time-consuming multiple-switching or roll-chart checking required.

The Model 1100 measures 10 $\frac{1}{2}$ " x 8 $\frac{1}{4}$ " x 3 $\frac{1}{4}$ " and comes in a leatherette covered case.

HI-FI—AUDIO PRODUCTS

TRANSISTORIZED RECORDER

21 American Gelsco Electronics, Inc. has added a transistorized tape recorder to its line as the "Unicorder 61."

This transistorized tape recorder will operate on either a.c. or d.c.—works on 10 penlight batteries or on 60 cycles without an a.c. adapter.

Small and compact and weighing only 5 pounds, the recorder can be played in its carrying case in any position. There are two 2 $\frac{1}{4}$ " dynamic speakers, it provides speeds of 1 $\frac{1}{8}$ and 3 $\frac{3}{4}$ ips, has a signal-to-noise ratio of better than 20 db, and a frequency response of 80-7000 cps.

RING-RADIATOR TWEETER

22 Stephens Trusonic Inc. is now offering a popularly priced ring-radiator-type tweeter, the "RT-1."

The unit is efficient in the 5000-20,000 cps range and continues to provide good response far beyond audibility. The entire diaphragm, voice-coil form, and compliant areas are manufactured to achieve a non-metallic unit, eliminating directional grain characteristics. The

edge-wound aluminum ribbon voice coil is attached to its form by a thermal-pressure method developed by the firm.

The RT-1 comes complete with a 5000 cps crossover network and attenuator control.

MAGNETIC CARTRIDGES

23 Shure Brothers, Inc. has added two new magnetic cartridges to its line of "Dynetic" units.

The M33 cartridge is recommended for turntable and record-changer arms capable of tracking at 1 to 3 grams. Frequency response ranges from 20 to 20,000 cps. It is available with either a .0005 or .0007-inch stylus. The M77 is designed for record-changer arms tracking above 3 grams. It is available with a .0007-inch stylus and has a frequency response of 20 to 17,000 cycles-per-second.



PUSH-BUTTON STEREO PREAMP

24 Heath Company has added a deluxe stereo preamp to its audio equipment line as the AA-11 kit.

As a master control center, all switches and controls are divided into two distinct groups: the first group consists of basic controls which are located on the plastic front panel while the other group is composed of secondary controls located behind the hinged cover on the lower front panel. The primary controls include 9 push-button switches for selection of five stereo inputs, three



mono inputs and "on-off" switch; a dual-tandem volume-loudness control; and separate dual-concentric bass and treble controls for individual channel adjustment.

CONSOLETTA ORGAN

25 The Schober Organ Corp. is now offering its consolette model electronic organ in a redesigned console with a new set of 17 pedals. The



new console avoids the boxy look with shaped outward curves at the front and legs which are integral parts of the sides rather than attached.

The standard finish is dark walnut with other finishes available on a custom basis at an additional charge. The unit measures 46" wide, 26 $\frac{1}{2}$ " deep, and 36" high. It has 5-octave keyboards and 22 pipe-organ-type voices. The consolette is offered in kit form only.

FOUR-TRACK TAPE DECK

26 Kimberley Industries, Ltd. is now distributing the Korting 114 four-track stereo tape deck which features three separate heads for record, playback, and erase.

Precision-made in West Germany, the new unit is equipped with a preamp equalizer for both recording and playback which allows use with an external power amplifier only. When the deck



is used for mono recording or playback, the internal preamp equalizer may be bypassed permitting use of an external preamp equalizer.

Frequency response is 40-15,000 cps at 3.75 ips and 30-20,000 cps at 7.5 ips. Wow and flutter are less than .2% at 7.5 ips.

P.A. AMPLIFIER LINE

27 Precision Electronics, Inc. is now offering a re-designed line of public-address amplifiers with new exterior features as well as improved circuitry.

The new line includes 10, 20, 30 and 60 watt



public-address units, a 25-watt mobile transistorized version, and a 30-watt mobile three-way unit which operates from 6, 12, and 117 volts a.c.

BATTERY-OPERATED RECORDER

28 North American Philips Company, Inc. has announced the availability of a new portable, fully transistorized, battery operated tape recorder, the "Continental 100."

Weighing only 8 pounds and using six "D" flashlight cells, the unit records at 1 1/2 ips and will provide up to two hours playing time on a



single four-inch reel. Frequency response is 100-6000 cps. The instrument includes recording and playback preamps, a power amplifier, and loud-speaker. It comes equipped with a Norelco dynamic cardioid microphone which fits into a recess in the recorder.

MONO TAPE RECORDER

29 Superscope Inc. is handling the U.S. distribution of the Sony Model 111 "Tapeorder"—a compact, two-speed, a.c.-operated mono tape recorder.

Decorator styled in coral and white, the unit features a sturdy drive mechanism with dynamically balanced flywheel-capstan assembly. Simplified one-knob control for all functions (stop, play, fast forward, rewind, and pause) is easy enough for a child to operate.

The instrument measures 8 1/4" x 4 1/2" x 7 1/2" and weighs 9 pounds. It comes complete with microphone and flight-type carrying case.

CB-HAM-COMMUNICATIONS

POCKET-SIZE TRANSCEIVER

30 Oneida Electronic Mfg. Co. is now in production on a pocket-sized, aluminum-cased transceiver which operates license-free on the Citizens Band.

Measuring a mere 2 1/8" x 4 3/4" x 1 1/2", the circuit uses four transistors and provides 100 mw. input. Standard production models are set on channel 7, with other channels available on request. The receiver is superregenerative with the tuning range factory tuned from 26.695 mc. to 27.225 mc. The unit is powered by a single battery and weighs 12 ounces.

D.C. POWER SUPPLY

31 H. O. Boehme, Inc. has developed a versatile and dependable d.c. power source which will operate under a wide variety of input conditions.

The Model 10-C is especially suited to communication's equipment and features a special panel switching system which provides a constant 115-volt d.c. output at load currents up to 3 amps under a.c. input voltages ranging from 115 volts \pm 10 volts and 230 volts \pm 20 volts, single phase, at 25 to 60 cps.



HAND-HELD CB UNIT

32 Heath Company has added a 9-transistor hand-held CB transceiver to its line of communications kits.

The GW-21 includes a crystal-controlled superhet receiver with r.f. amplifier, squelch and noise limiter circuit, and has better than 1 μ v. sensitivity for 10 db signal-to-noise ratio. The audio output and modulator section delivers 150 mw. of power to the 2 1/2" speaker which also doubles as a mike when transmitting. The transmitter section consists of a crystal-controlled oscillator/driver stage and a high-efficiency modulated r.f. output amplifier. Maximum power input to the final is 100 mw. allowing use without an FCC license.

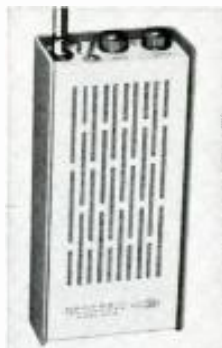

5-BAND MARINE RECEIVER

33 Nova-Tech, Inc. is now marketing a five-band marine-home receiver as the "AM-FM Trans-ocean."

The receiver covers the beacon and weather (200-400 kc.), AM broadcast (550-1600 kc.), marine and police (1.6-5 mc.), short-wave (5-15 mc.), and FM (88-108 mc.) bands.

The instrument features built-in antennas,



TV-RADIO Servicemen or Beginners

SEND FOR

Coyne's
7-Volume Job Training Set
on 7-Day FREE TRIAL

The First Practical
TV-RADIO-ELECTRONICS
Shop Library



Answers ALL
Servicing Problems QUICKLY...

Makes You Worth More On The Job!

Examine Coyne's all-new 7-Volume TV-RADIO-ELECTRONICS Reference Set for 7 days at our expense! Be convinced it gives you the way to easier TV-Radio repair—time saving, practical working knowledge that helps you get the BIG money! See how to install, service and align ALL radio and TV sets, even color-TV, UHF, FM and transistorized equipment. New photo-instruction method is quick and easy to understand. No complicated math or theory—just practical facts you can put to use immediately right in the shop, or for ready reference at home. Over 3000 pages; 1200 diagrams; 10,000 facts!

Like An Electronics Expert At Your Side!

VOL. 1—EVERYTHING ON TV-RADIO PRINCIPLES! 300 pages of practical explanations; hundreds of illustrations.

VOL. 2—EVERYTHING ON TV-RADIO-FM RECEIVERS! 403 pages; fully illustrated.

VOL. 3—EVERYTHING ON TV-RADIO CIRCUITS! 336 pages; hundreds of illustrations, circuit diagrams.

VOL. 4—EVERYTHING ON SERVICING INSTRUMENTS! How they work, how to use them. 368 pages; illustrated.

VOL. 5—EVERYTHING ON TV TROUBLE-SHOOTING! Covers all types of sets. 437 pages; illustrations, diagrams.

VOL. 6—TV CYCLOPEDIA! Quick and concise answers to TV problems in alphabetical order. Including UHF. Color TV and Transistors; 868 pages.

VOL. 7—TRANSISTOR CIRCUIT HANDBOOK! Practical Reference covering Transistor Applications; over 200 Circuit Diagrams; 410 pages.

DIAGRAM BOOK FREE!

For prompt action, we'll also send you this big book, "150 Radio-Television Picture Patterns and Diagrams Explained" ABSOLUTELY FREE just for examining Coyne's 7-Volume Shop Library on 7-Day FREE TRIAL! Shows how to cut servicing time by reading picture-patterns, plus schematic diagrams for many TV and radio sets.

SEND NO MONEY

Just mail coupon for 7-Volume TV-Radio Set on 7-Day FREE TRIAL! We'll include the DIAGRAM BOOK FREE. If you keep the set, pay only \$3 in 7 days and \$3 per month until \$27.25 plus postage is paid. Cash price only \$24.95. Or return set at our expense in 7 days and owe nothing. Either way, the FREE BOOK is yours to keep. Offer is limited, so mail the coupon TODAY!

FREE BOOK—FREE TRIAL COUPON

Educational Book Publishing Division
COYNE ELECTRICAL SCHOOL
1455 W. Congress Parkway, Dept. C1-EW, Chicago 7, Ill.
Yes! Send me COYNE'S 7-Volume Applied Practical TV-RADIO-ELECTRONICS Set for 7-Days FREE TRIAL per your offer. Include "Patterns & Diagrams" book FREE!

Name Age.....
Address
City Zone State.....
 Check here if you want Set sent C.O.D. Coyne pays postage on C.O.D. and cash orders. 7-Day Money-Back Guarantee.

URNS COUNTING DIAL

Duo dial Model RB, Mfg by Helipot, 100 divisions per turn, will count to 15 turns. Dial suitable for helipots, Var. Inductors etc. With mounting hardware. PRICE

\$2.95

BC 442 ANTENNA BOX (ARC 5)

Contains RF Meter (750 Ma.) Relay, etc. Sec. Coaxial Relay conv. "CQ" March 1960. Price

\$1.95

POWER TRANSFORMER

110V-60 Cy.-Sec 385-0-385 V. @ 200 Ma. Fil 6.3V 6 Amps. 5 V. 3 Amps. Ea.

\$3.50

FILAMENT TRANSFORMER

Input 110V. 60 cycle. Secondary 6.3V. @ .6 Amp. Small Size. Ea.

\$1.25

Input 110V 60 cy. Output 6.3V @ 5 Amps. 6.3V @ 10 Amps., 5V @ 5 Amps. Ea.

\$2.75

CARDWELL TRANSMITTING VAR. COND.

Dual Section 211 UUF per section. 5700 Volts AC. Each

\$5.95

DYNAMOTOR SPECIALS

Input 5.5V—Output 405V @ 280Ma. Carter small size. Ea.

\$5.95

12 Volts Input-Output 440V. @ 200Ma. 12 Volts Input-Output 225V. @ 100Ma. All in one Dynamotor. BRAND NEW. Ea.

\$5.95

SILICON RECTIFIERS

PIV	Current	Price	PIV	Current	Price
100	500 Ma	\$.25	200	2 Amps	\$.75
200	500 Ma	.30	400	2 Amps	1.25
400	500 Ma	.50	100	15 Amps	2.50
750	500 Ma	.90	200	15 Amps	4.50
*Items above are Hi-Efficiency Gold Plated!					
200	750 Ma	.30	400	15 Amps	8.50
400	750 Ma	.50	100	50 Amps	7.50
100	2 Amps	.50	200	50 Amps	9.50

POWER TRANSISTORS

PNP GERMANIUM — Similar to following trans. types

2N1320	70c	2N1355	70c
2N1328	70c	2N1373	2.50
2N156	70c		

CHOKE—FULLY CASED

5 HENRY @ 200 Ma	1.95
5 HENRY @ 250 Ma	2.25
10 HENRY 300 Mil	3.00
4 HENRY 400 Mil	3.95
4 HENRY 900 Mil	8.95
4 HENRY—1 amp.	11.95

BRAND NEW OIL CONDENSERS

50 MFD 200 VDC	4.50	4 MFD 2000 VDC	3.50
2 MFD 600 VDC	.50	6 MFD 2000 VDC	4.95
3 MFD 800 VDC	.60	1 MFD 3000 VDC	1.85
4 MFD 800 VDC	.70	2 MFD 3000 VDC	3.50
5 MFD 800 VDC	.80	2 MFD 4000 VDC	6.25
6 MFD 800 VDC	.85	3 MFD 4000 VDC	8.95
8 MFD 800 VDC	1.25	4 MFD 4000 VDC	12.95
10 MFD 800 VDC	1.19	1 MFD 5000 VDC	4.50
12 MFD 800 VDC	1.50	2 MFD 5000 VDC	8.50
15 MFD 800 VDC	1.70	4 MFD 5000 VDC	15.95
1 MFD 1000 VDC	1.95	5 MFD 7500 VDC	49.50
2 MFD 1000 VDC	.70	1 MFD 7500 VDC	6.95
4 MFD 1000 VDC	1.35	2 MFD 7500 VDC	17.95
8 MFD 1000 VDC	2.50	8 MFD 7500 VDC	29.95
10 MFD 1000 VDC	2.50	2 MFD 10,000 VDC	29.95
12 MFD 1000 VDC	2.95	5 MFD 10,000 VDC	49.95
15 MFD 1000 VDC	3.50	8 MFD 10,000 VDC	34.50
1 MFD 1200 VDC	.45	1 MFD 15,000 VDC	42.50
1 MFD 1500 VDC	.75	5 MFD 25,000 VDC	34.95
2 MFD 1500 VDC	1.10	1 MFD 25,000 VDC	69.95
4 MFD 1500 VDC	1.95	10 MFD 3000 AC	1.95
8 MFD 1500 VDC	2.95	30 MFD 330 AC	3.25
1 MFD 2000 VDC	.85	50 MFD 330 AC	4.95
2 MFD 2000 VDC	1.50	8 MFD 600 AC	2.95

RELAYS

WARD LEONARD Heavy duty relay coil 220V 60CY., 2 phase, 5 HP.	
3 Pole 5T, 25 AMP contacts. Ea.	\$6.95
6 Volt DC. H.S. Relay DPDT	.95
6 Volt DC. H.S. Relay 3 PST N.O.	.65
GUARDIAN 110V AC. 2 Pole Single Throw (1 N.O. & 1 N.C.) Repl. BC-610	\$2.50
Potter-Brumfield SMSLS 10,000 ohm, 2 Ma. Sens.	\$2.25
110 Volt AC Relay-DPST 60 Cy. Ea.	\$1.50
10 Amp. Contacts	
Sens. Relay 11,000 ohm coil, 1 Ma Adj. cont. Armature Tension SPDT. Ea.	\$1.95
12 Volt DPDT DC Relay	\$1.35
SIGMA type 22RJ 8,000 ohm SPDT, small sealed relay.	\$2.49
Sealed Relay, SPDT, 6,000 ohm coil	\$1.95
G.E. Relay Control, contains 8000 ohm relay, sensitivity 2 mils, 10 for \$9.25 ea.	\$1.10

PANEL METERS

STANDARD BRANDS	3" METERS
2" METERS	0-1 Mil DC
100-0-100 Micro	2.95
0-1 Ma	3.50
0-50 Ma	2.95
0-500 Ma	2.95
0-10 Amps DC	2.95
0-20 Volts DC	2.95
0-40 Volts DC	2.95
18-36 Volts DC	1.99
0-150 V. AC	2.95
0-5 amps RF	2.95
0-1 Mil DC	3.95
0-500 Mills DC	3.95
0-500 V. DC	3.95
0-15 Volts AC	3.95
0-1.5 KV	6.95
0-2.5 KV	6.95
0-1 Amp DC	3.95
0-150 Amps AC (with current transf.)	5.95
0-2500 V. DC	6.95
100-0-100 UA	5.95

All merchandise sold on a 10 day money back guarantee Min. Order \$3.00—25% with Order—F.O.B. New York

PEAK

ELECTRONICS COMPANY
66 W. Broadway, New York 7, N. Y., WO-2-2370

panel lighting, slide-rule tuning, and interstation muting. Headphones can be used for private listening. The receiver operates from house current and can be plugged in anywhere. It can be used on a boat with 115-volt power or a d.c. converter.

GENERAL-COVERAGE RECEIVER

34 Hammarlund Manufacturing Company, Inc. has recently introduced a re-designed version of its HQ-145 general-coverage receiver which has now been designated as the HQ-145X. Crystal accuracy is now possible through the addition of



a single crystal-controlled channel that can be fixed at any desired point of the entire frequency range of the instrument.

The circuit includes a crystal filter and adjustable 60-db slot filter, 11-tube superhet circuit with improved noise limiter, frequency coverage of 540 kc. to 30 mc. in four bands, and dual conversion on 10-30 mc. band for maximum image rejection.

CB NOISE SUPPRESSOR

35 Business Radio Co., Inc. is offering a self-contained noise suppressor that may be connected to any Citizens Radio transceiver that uses a superhet receiver. The unit, known as the Model 612 "Noistop," not only prevents ignition interference from the CB operator's own unsuppressed car or boat—but it effectively blocks ignition interference from cars, trucks, outboard motors, or from any other nearby source of pulse-type electrical noise.

The "Noistop" is a later version of a circuit



used by mobile radio amateurs for a number of years. It has been designed into a compact package, 1½" high x 2½" wide x 4" long, suitable for universal mounting on the outside of the transceiver. The unit is furnished complete with step-by-step installation instructions for wiring it into more than a dozen of the most popular CB transceivers.

V.H.F. MOBILE SET

36 Aeronautical Electronics, Inc. has announced a new high-powered, two-way mobile radio set for operation in the v.h.f. mobile band.

The 100-watt "Slimline" Model 6N100/SLT



provides flexibility and reliability by combining a compact under-dash transmitter-receiver unit with a high-powered amplifier unit placed in the trunk or other convenient location. Only one small coax cable is needed to connect the two units. A second model for low-band operation is also available.

The under-dash unit weighs less than 9 pounds; the amplifier less than 14 pounds. Both are transistor powered and constructed entirely of heavy gauge aluminum.

CITIZENS BAND UNIT

37 Hallmark Instruments Corporation is now offering its H1-104 for two-way communications in the Citizens Band.

The company claims the unit has a range of up to 25 miles, depending on terrain and type of installation. The transmitter and receiver are constructed with rugged, harness-type wiring for trouble-free operation.

Power consumption is 5.5 amps on 12 volts d.c. or 55 watts on 117 volts a.c.

FULL-COVERAGE V.F.O.

38 Electronic Instrument Co. Inc is now offering a self-powered, highly stable v.f.o. which provides full coverage of the ham bands from 80



to 10 meters (10 meters covered in two ranges).

The Model 722 features anti-backlash tuning, a low-heat silicon diode doubler power supply, a buffer-multiplier output stage, large easy-to-read slide-rule dial, and reliable drive. Output is high enough to drive any modern transmitter on all bands.

The company is offering this new unit in both kit and factory wired versions.

MANUFACTURERS' LITERATURE

MULTIPLE CONNECTORS

39 AMP Incorporated has issued a six-page folder describing three separate lines of multiple connectors, with specific data sheets for each of the lines. Included are connectors designed for the appliance and automotive industries, major appliances, and TV and commercial electronics applications.

The publication also describes the firm's compression-crimp technique and tooling, both hand and automatic, for attaching terminals to circuit leads and for stripping wire preparatory to crimping.

ELECTRONIC COMPONENTS

40 Herman H. Smith, Inc. is now offering copies of its 60-page catalogue covering a wide variety of electronic components.

The line covers clips, ham equipment, cable accessories, connectors, dial plates, fuse holders, grommets, hi-fi accessories, panel indicators, jacks, knobs, meter cases, patchcords and plugs, sockets, switches, terminal strips, etc.

Complete specifications and photographs are given on the products covered.

MEASURING EQUIPMENT

41 M. C. Jones Electronics Co., Inc. has just issued a 64-page catalogue covering an extensive line of r.f. power and v.s.w.r. measuring equipment.

Complete electrical and mechanical specifications are provided on r.f. power and v.s.w.r. in-

struments, absorption-type r.f. wattmeters, calorimetric-type r.f. wattmeters, r.f. load resistors, coaxial tuners, station guardians, and accessories.

INDUSTRIAL TOOL CATALOGUE

42 Mathias Klein & Sons has available copies of its Industrial Catalogue 105A covering a complete line of tools for the electronics industry, general industry, linemen, and electricians.

In addition to the extensive selection of hand tools of all types, the catalogue lists and describes pocket tool kits, tool pouches in leather and plastic, safety belts, knives, harnesses, and tool bags.

PARTS CATALOGUE

43 Allied Radio Corporation has announced the availability of its 1962 general catalogue of electronic parts and equipment, including a complete line of stereo hi-fi components.

The new 441-page catalogue lists over 60,000 items and includes 288 pages in rotogravure. Both product and manufacturer indexes are included to facilitate locating specific items.

SERVICE COMPONENTS

44 Centralab has just issued a 16-page illustrated booklet which gives detailed specifications and prices for some 40 lines of controls, switches, ceramic capacitors, and printed-circuit packaged circuits.

Also included is a full range of control, switch, capacitor, and packaged-circuit kits. All items are indexed inside the front cover of the catalogue. Two control-taper charts are also provided for quick reference.

PORTABLE MULTI-RANGE METERS

45 Weston Instruments Division of Daystrom, Inc. is now offering copies of its new Bulletin No. 06-209 "Portable/Panel Instruments" which discusses the features and specifications of the Model 911-912 line of a.c. and d.c. voltmeters and ammeters developed by the firm.

SPEAKER CATALOGUE

46 Acoustic Research, Inc. has just published a comprehensive speaker catalogue which includes general information, technical specifications, and surveys of press comment on the various models of the firm's loudspeakers.

INDUSTRIAL CATALOGUE

47 J. W. Miller Company has issued a complete 48-page catalogue which includes specifications on molded r.f. chokes, i. f. transformers, adjustable coils wound on stable ceramic and resin materials, exact replacement coils, and other related items.

More than 1500 items are shown in Industrial Catalogue No. 62.

ELECTRONIC KIT CATALOGUE

48 Heath Company is now offering copies of its 1962 catalogue which covers an extensive line of electronic kits in its 100 pages. Photographs of the equipment, complete descriptions, full specifications, as well as many schematic diagrams are included.

The kits covered include products for the audiophile, the radio amateur, the hobbyist, the service technician, and the electronics experimenter.

SEMICONDUCTOR DATA

49 Rheem Semiconductor Corporation has issued three booklets covering semiconductor products and processes. The first discusses the company's products and facilities, while a second provides full technical details on the firm's Rb750 ultra-high conductance nanosecond diode. The third booklet describes the manufacturer's master test specification for high reliability silicon diodes, known as the "Mark X."

SPEAKER SYSTEM DATA

50 Advanced Acoustics Co. has announced the availability of a new two-color catalogue sheet covering descriptive material on the "Wa-

fare Bi-Phonic Coupler" full-range, thin speaker system.

The publication includes full specification data, descriptive material, prices, and other pertinent information.

ELECTRONIC PARTS CATALOG

51 Barry Electronics Corp. has announced the current availability of its "Green Sheet" which lists hundreds of electronic tubes, semi-conductors, transformers, chokes, meters, wire, test equipment, and other components and equipment for the industrial market.

One unusual feature is the listing of many hard-to-find and unique electronic products.

PRECISION RESISTORS

52 Key Resistor Corp. has issued a new short-form catalogue, Bulletin SF 200, which lists complete up-to-date information on its precision resistor line.

The publication tabulates electrical and mechanical characteristics on a new line of epoxy molded carbon and metal film precision units as well as information on resin coated and hermetically sealed precision carbon films and precision and micro-miniature wirewound resistors.

CAPACITORS FOR SERVICE

53 Sprague Electric Company has just published a new edition of its popular hanging wall catalogue which contains a full listing of the company's products for radio, hi-fi, and TV service, including capacitors such as tubular and can-type electrolytics, paper and film tubulars, disc and plate ceramics, as well as ceramic-base printed circuits and miniature wirewound resistors.

Catalogue C-457 is clearly indexed and supplied with a string to hang it from the shop wall or above the service bench.

RADIO STATION GUIDE

54 Bendix Corporation's Marine Department has issued a completely revised edition of its radio station guide which reveals more than 50 changes in frequencies, locations, or call signs of broadcast and airways beacon stations since the guide was first published about a year and a half ago.

The guide lists exact locations of broadcast and airways beacon stations by latitude and longitude, their frequencies and call signs on the Atlantic, Gulf, and Pacific coasts and the Great Lakes area.

In addition, the marine weather broadcasts by telephone company and Coast Guard stations are listed, showing the radio frequency and time of the broadcasts.

INSTRUMENTATION TAPES

55 Reeves Soundcraft Corp. has just issued a colorful folder which describes in great technical detail its line of instrumentation tapes for industry. In addition to providing full physical and magnetic characteristics on six types of tape, the folder includes separate data sheets on each tape category.

EDUCATIONAL TV DATA

56 Community Engineering Corp. has prepared a four-page bulletin entitled "Tele-Quest" which explains the new educational TV system that allows students to put their questions to the television instructor and receive answers via the classroom TV set.

The detailed step-by-step procedure is diagrammed pictorially and technical specifications are given for systems of from six to 24 stations (classrooms).

VARIABLE CAPACITORS

57 Hammarlund Manufacturing Co. has announced the availability of a new 16-page catalogue which lists mechanical and electrical specifications of 20 different variable capacitor types. The list includes a broad selection of military trimmer type variable air capacitors available to the industry.

GET IT from GOODHEART!

2-METER RECEIVER & 2/6/10 METER XMTR

SCR-522 rcvr, xmtr, rack & case, exc. cond. 19 tubes include 832A's, 100-156 mc AM. Satisfaction grtd. Sold at less than the tube cost in surplus! Specify whether job Bremerton, Wn., or Buffalo, N.Y. Only **\$16.95**



Add \$3.00 for complete technical data Kroup including original schematics & parts lists. F. xtl formulas, instruct. for AC pwr sply, for rcvr continuous tuning, for xmtr 2-meter use, and for putting xmtr on 6 and 10 meters. For readymade AC Pwr sply, add for RA-62-C in excellent cond., job San Diego, Calif. **\$49.50**

COMMUNICATIONS RECEIVER BARGAINS

BC-453-B: 190-550 kc w/85 kc IF's. This rcvr is ideal as a tunable IF or to double-convert other rcvrs having 455 kc IF's. Checked, aligned, grtd 100% OK, not as-is junk. W all needed tech data. Pwr sply data, etc. job Los Ang. **\$12.95**

Same, in handsome cabinet w pwr sply, spkr, etc., ready to use, is our QX-535 **\$37.50**

RBS: Navy's pride 2-20 mc 14-tube superhet has voice filter for low noise, ear-saving AGC, high sens. & select. IF is 1255 kc. Checked, aligned, w/pwr sply, cords, tech dat., ready to use, job Charleston, S.C. or Los Angeles **\$99.50**

R-45 ARR-7 brand new, 12-tube superhet .55-43 mc in 6 bands, 5-meter, 455 kc IF's, xtl filter, 6 sel. position, etc. Not and complete, it can be made still better by double-converting into the BC-453 or QX-535, pwr sply includes DC for the automatic tuning motor. FOB San Antonio **\$179.50**

AN APR-4 rcvr is the 11-tube 30 mc IF etc. for its plug-in tuning units: has 5-meter, 60 cy pwr sply, pan., video & audio outputs, etc. Pan output is ideal to feed 50 mc to the R-45 ARR-7. Checked and aligned, job Los Angeles **\$69.50**

Plug-in tuning units for above convert RF to 30 mc: TN-16, 38-94 mc, \$25.00. TN-17, 74-320 mc, \$25.00. TN-18, 300-1000 mc, \$25.00. TN-19, 975-2200 mc, \$59.50. TN-54, 2175-4000 mc, \$175.00. Power Plug for rcvr: \$2.00. Tech. Handbook: \$7.50.

NAVY LM FREQ. METER, .01% ACCURATE

Crystal-calibrated every 1000 kc w/data to use many minor xtl checks in between. Xtl is .005% or better. 125-20,000 kc w/usable harmonics far beyond. W/ matching serial-No. callb. book, xtl, schematic, pwr sply, & select. condit. job Pensacola, Fla. **\$49.50** Same, less the callb. book. Use as an ultra-stable VFO. Only **\$25.00**

0.1% SORENSEN Line Voltage Regulator

#3000S. Brand new at low surplus priced input 95-130 V ac, ph., with taps for 50 or 60 cy. Use for any power up to 5000 watts. Output adjustable 110-120 V and holds to $\pm 0.1\%$ at line frequency, or to $\pm 0.25\%$ if line frequency drifts 5%. Regulates against line changes 95-130 V and against load changes from 0 to 5 KVA. Maximum harmonics less than 3%. Recovery time: 0.15 seconds. Input to the control section can be moved to the point where you will use power, thus compensating for line drop. In rack cabinet 20" x 22" x 15" dp. Net wt 190 lbs. Shpg wt 285 lbs FOB Utica, N.Y. in original factory pack suitable for export, including SPARE PARTS group. Sorensen Catalog net price is \$995.00 **\$349.50** less spares. Our Price, WITH SPARES. Write for details on Sorensen #3000S, 1000-25, #10,000S; also on Sola C-V transformers.



NAVY'S MULTIPLE-USE IMPEDANCE BRIDGE

#60007. Easy-to-use AC bridge, bench or portable. Measures: Capacitance 10 uuf to 100 uf, Electrolytic leakage 0 to 1, to 25, to 5 mc insulation resist. to 250 megohms. Power Factor 0 to 50%. Resistance 1 ohm to 1 megohm. Transformer turns ratio .001 to 1000, impedance ratio 1 milliohm to 1 million. Built-in 115 v 50/60 cy pwr supply, adjustable polarity. Voltage 0 to 550 v dc. With very educational instruct. book. Accuracy 5% or better is guaranteed. Standards-Lab OK tag dated 1961. Shpg wt 19 lbs. job Los Angeles **\$37.50**

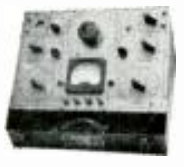

NAVY VERSION OF GENERAL RADIO #605-B

LP Microvoltage, 9 1/2 kc -30 mc dial-calibrated $\pm 1\%$, 7 bands & 30-50 mc Graph-calibrated. CW or mod. 1000 cy. 0-50", read on VTVM. Output calibrated 1/2 uv to 0.1 v at lower plug & 1.0 v at upper plug. Logging scale w/300 divisions & vernier knob w/135 divisions provide super-accurate resetability. Stability is phenomenal. Holds a zero beat with WWV for 12 hours with less than 100 cy drift. Aligned, built, ready to use. 120 v. 60 cy. only **\$197.50**



Time Pay Plan: \$47.50 down and 11 mos. at \$15.19.

MISCELLANEOUS SURPLUS BARGAINS

See our Nov. ad page 78 for TUNING FORK Oscillators, BRUSH INSTRUMENT Co. Graphic Recorders, VHF & UHF Standard Signal Generators, MEASUREMENTS CORP. Pulse Generator, HEWLETT-PACKARD Distort. Analyzer, LEEDS & NORTHROP Voltage Divider, BOONTON Q-Meter, LAVOIE Test Scope, BENDIX Licensable Commercial 2-Way Radio, Etc.

Write for your needs in schematics, conversion information, and tech. manuals on surplus electronic equipment.

Time Pay Plan: Send us your list of material. We will quote terms.

R. E. GOODHEART CO.

P. O. Box 1220-A Beverly Hills, Calif.



Heliwhip® Antennas

Exclusive "Static Sheath"™ Helps You Hear Weak Signals over Greater Distances!

Mark HELIWHIP® Plastic Covered Fibre Glass Antennas noticeably improve mobile Citizens Band communications! Outperform long whips or base loaded antennas! Mark Mobile's exclusive "Static Sheath"™ plastic covering reduces precipitation static—improves signal/noise ratio up to 20 db. High radiation efficiency with near-perfect 50 ohm match at resonant frequency. Broadband over all C/B channels with very low VSWR. Length only 4 feet overall—mount on trunk or cowl like broadcast antenna. Get out farther—improve your reception . . . switch to a HELIWHIP!®

*HELIWHIP is a registered trademark
U.S. Patent 2,966,679 *U.S. Process Patent 2,938,210

Write for technical data or visit your nearest CB equipment supplier

MARK MOBILE, Inc.
Dept. EW-12, 5441 WEST FARGO AVE.
SKOKIE, ILLINOIS

SAY YOU SAW IT IN

Electronics World

FIX ELECTRIC APPLIANCES

PAYS \$3 TO \$5 AN HOUR
Spare Time, Full Time • Learn at Home

FREE BOOK offered below shows how YOU can now have a good-paying business of your own, right in your home. No experience needed, just simple tools. Learn to repair Electric Appliances. Pays \$3-\$5 an hour!

400 MILLION Appliances are in American homes right now. 76 Million MORE bought each year. People need them fixed, good times or bad. YOU make good money doing it. In your basement, garage, even on your kitchen table.

QUICK WAY TO GET STARTED
For less than 20¢ a day our easy, pictured instruction — backed by 45 years of success in home training — prepares you for top earnings in this booming field. Earl Reid of Thompson, Ohio says: "Made \$510 in one month spare time. NRI course is priceless." At no extra charge you even get all parts for your own Appliance Tester, too. Finds trouble-spots, speeds and checks your work.

Get your **FREE Book** and **FREE Sample Lesson!** Mail coupon below, letter or postcard, *now!*

FREE BOOK • FREE LESSON

NATIONAL RADIO INSTITUTE, Appliance Division
Dept. EN1, Washington 16, D.C.
Send **FREE Book, Free Appliance Repair Course Lesson.** Am interested in:
 Spare Time Earnings My Own Business
 Better Job

Name

Address

City Zone State

Accredited Member National Home Study Council

1961 INDEX

VOLUMES 65-66

As a service to our readers we are again presenting a complete listing of all feature articles which appeared in **ELECTRONICS WORLD** during 1961. We suggest you keep this for reference.

AMATEUR

ANTENNAS

Antennas for Low-Band DX (Briskman, K2IEG) June 44

Bats Bat Antenna (Smith, W8VVD) Feb. 126

Mac's Service Shop (Frye) Apr. 60

Throw Away Your Antenna Pulley Block (Pyle, W7OE) June 95

Vertical Antenna Base Insulator (Pyle, W7OE) Oct. 80

HAM GEAR

Eico Model 723 Amateur Transmitter Kit (EW Lab Tested) Apr. 96

"Simple-Talkie" (Smith, W8VVD) Sept. 50

Transistorized Converters for 10 to 20 Meters (Stoner, W6TNS) Aug. 56

Ultra-Stable High-Z V.F.O. (Robberson, W2FRQ) July 58

MISCELLANEOUS

Equipping the Amateur Radio Station (Pyle, W7OE) May 86

Hamming in Britain (Halliday) Jan. 116

Hams of the Year May 84

Improving Receiver Sensitivity (Kyle, K5JKX) June 50

Lightning Protection for the Ham Station (Pyle, W7OE) May 36

Operation "Deep Freeze '61" Feb. 93

Single-Turn Coil Adjustment (Pyle, W7OE) June 84

AM-FM

RECEIVERS

Dynaco FM-1 (EW Lab Tested) Sept. 20

Eico ST96 Stereo AM-FM Tuner (EW Lab Tested) Aug. 93

Fisher "Microlune" Circuit (Gilison) July 98

Fisher Model 202-R AM-FM Tuner (EW Lab Tested) June 93

High-Quality T.R.F. AM Tuner (Shields) Apr. 36

H. H. Scott Model LT-10 FM Tuner Kit (EW Lab Tested) Mar. 110

How to Select an FM Tuner (Gilison) Aug. 50

Non-Interference Seals for TV and FM Sets Aug. 65

Paco Model ST-45 AM-FM Stereo Tuner (EW Lab Tested) Jan. 104

SERVICING

Auto Radios for 1961 (Alth) May 34

Auto Radios for 1961 (Alth) June 47

Mac's Service Shop (Frye) Jan. 60

Mac's Service Shop (Frye) Mar. 60

Mac's Service Shop (Frye) Aug. 52

Reducing FM Multipath Distortion (Halliday) Oct. 104

Transistor Audio Distortion (James) Mar. 109

BUSINESS MANAGEMENT

Do You Want Warranty Work? June 34

Easter Boosters for Service Business (Dufer, Jr.) Mar. 38

Electronics "Technician" (Editorial) Oct. 8

"Filing" System for Parts (Poine) Jan. 52

From TV Service to Industrial Electronics (Mendel) Sept. 34

Get the New Customer First (Fair) June 86

Insurance for Service Shops (Saunders) July 44

Mac's Service Shop (Frye) Feb. 44

Mac's Service Shop (Frye) May 60

Mac's Service Shop (Frye) Oct. 52

Mac's Service Shop (Frye) Nov. 60

Practical Repair Estimates (Marsh) May 54

Service Technician and "Do-It-Yourself" Repair (Kinckiner) May 33

Small Appliance Service: Toasters (Anderson) May 70

Symbols for Symptoms (Lemons) Jan. 48

Tricky Service Customers (Phillips & Van Ininger) Feb. 49

Tube Inventory for Service Shops (Larsen) Apr. 46

Understanding the Balance Sheet (Flippin) Apr. 52

GENERAL

CIRCUIT DESIGN

Complementary Emitter-Follower (Belanger) May 102

Hum Elimination (Diehl) Apr. 106

Miller Effect & Its Uses (Bishop) Aug. 64

Negative Resistance—What It Is & How It's Used (Turner) May 56

Packaged-Circuit Service Problems (Holtz) Jan. 41

Radio-Frequency Plasma Torch (Roddy & Green) Feb. 29

Transistor Bias Circuit Design (Jackson) Nov. 42

CITIZENS BAND

Add a Handset to Your Citizens Radio (Sands) Feb. 54

FCC to Keep 5-Watt CB Limit May 82

Five-Minute CB Timer (Morgan) Jan. 114

Hand-Held CB Transmitter-Receiver (Barmore) Mar. 47

How the FCC Monitors the Citizens Band (Conhaim, 19W7577) June 99

Impedance Matching CB Antennas (Smith, 19W1375) July 31

"Knight-Kit" Model C-27 CB Transceiver (EW Lab Tested) Jan. 102

Reducing Citizens Band Ignition Noise (Sands) Aug. 36

Reducing Interference to Hand-Held CB Transceivers (Smith) May 101

Speech Clipper for CB Transceiver (Krause & Wilner) Apr. 32

This Month's Cover Aug. 38

Transistorized Citizens Band Converter (Sowers) Dec. 50

Using the BC-221 to Check CB Frequency (Conhaim, 19W7577) May 48

Voice Procedure for CB Operators ("Brother Art") June 110

COMPUTERS & COUNTERS

Computer Arithmetic Circuits (Bukstein) June 52

Computer Logic Circuits (Bukstein) Jan. 46

Computer Registers and Accumulators (Bukstein) Nov. 54

Computers & The Semiconductors That Make Them Count (Halacy) Sept. 31

Cover Story Sept. 32

Industrial Counting Techniques (Bukstein) June 39

CONSTRUCTION PROJECTS

Accurate Transistorized Tachometer (Larsen) June 59
 Aluminum Dials and Nameplates (Friedman) Nov. 94
 Automatic Photo-Enlarger Timer (Horwitz & Marsh, Jr.) May 61
 Below the Broadcast Band (Genaille) . . . Sept. 54
 Electronic Overload Relay (Shields) . . . Aug. 39
 Ion Generator & Electrostatic Air Filter for the Home (Pairie) Oct. 48
 Novel Uses for Photoconductive Photo-cells (Shields) Aug. 46
 Radio-Control "Beep Box" (Curtis) . . . July 90
 Sensitive Electronic Relay (Garner) . . . Jan. 62
 Simple Metal Locator (Calvert) July 73
 Temperature Meter for the Boatsman (Wisner) May 51
 Transistorized Headlight Dimmer (Martin) July 56
 Transistorized Phono Oscillator (Potter) . . Jan. 97
 Transistorized Regulator for Auto Alternator (Lawson) Aug. 58
 Transistorized Theremin (Moog) Jan. 29
 TV Commercial Silencer (Mack) Apr. 48
 Variable Time-Delay Relay (Faust, Jr.) . . Oct. 107
 V.H.F. Demonstration Oscillators (Blevins) Jan. 36

INDUSTRY

Automation (Editorial) Sept. 6
 British Electronic Component Output Up in 1960 July 8
 Columbia Hydrosonics "Aqua-Probe" Depth Finder (EW Lab Tested) Oct. 86
 Coming Breakthrough in Thermo-electricity (Kelly) July 39
 Cover Story July 42
 Cover Story Dec. 34
 Demand for Electronics Monpower to Exceed Supply in N.Y.C. Area July 16
 Electrically Operated Switches (Bramham) Dec. 52
 Electro-Mechanical Switching in Automation (Bramham) Oct. 58
 Electronically Controlled Clothes Dryer (Britson) Oct. 57
 Electronic Industries Outlook for 1961 vs. 1960 May 44
 Electronics for the Jet Age (Editorial) . . Apr. 6
 Fuses and Fuseholders: The New Look (Pafenberg) Feb. 60
 Great Britain's Radio Hobbies Show (Halliday) Mar. 107
 Industrial X-Ray Apparatus (Collins) . . . Dec. 46
 Mac's Service Shop (Frye) July 38
 Mac's Service Shop (Frye) Dec. 54
 Marine Electronic Service: Depth Sounders (Part 1) (Roetger) Sept. 44
 Marine Electronic Service: Depth Sounders (Part 2) (Roetger) Oct. 60
 Measuring Conductivity of Solutions (Collins) Mar. 52
 New Batteries—Progress or Confusion? (Comeran) Oct. 33
 Parallel-Resistor Chart (Kyle) Nov. 41
 Radio and Electronics Convention in Australia Aug. 86
 Reliability—Space Age Requirement (Halacy) Dec. 38
 Silicon Solar Cell (Baron) Dec. 33
 Solid-State I.F. Transformer Oct. 64
 Tape Recording in Industrial Instrumentation (Shiver & Stillwell) Apr. 61
 Technician and Engineer (Editorial) . . . Dec. 6
 Third-Quarter Component Output Declines Apr. 8
 Universal Time-Constant Chart (Kyle) . . Sept. 37
 Uses of New Satellites (Lytel) Mar. 54
 Versatile Voltage, Power, and Decibel Nomograms (Kyle) July 34

MEDICAL ELECTRONICS

Advances in Medical Electronics (Buchsbaum) Nov. 33

Order your Melodia Theremin now for the most in holiday enjoyment.

Enjoy the satisfaction of creating.

Imagine building an electronic musical instrument in a few hours. The Melodia Theremin is available as a kit, with complete, step-by-step directions.

Enjoy the thrill of performing.

The Melodia Theremin has no buttons or keys, and is played without being touched. You move your right hand to control the pitch and your left hand to control the volume. After a few practice sessions, you will amaze and mystify your friends by playing real melodies.

Give Enjoyment to someone on your gift list.

Is there an aspiring musician or scientist in your family? Or perhaps you know of an electronics hobbyist who takes his home music system seriously. The Melodia Theremin will make a perfect gift. The Melodia kit is priced at \$49.95, and the fully assembled Melodia is priced at \$75.

R. A. MOOG CO., BOX 263, ITHACA, N. Y.



"... I could not wish for a more delightful instrument than the one I have just completed."

says Howard Mossman of Swarthmore, Pa. Mr. Mossman wrote us an enthusiastic letter of praise as soon as he finished assembling his MELODIA THEREMIN kit. Here are a few more of Mr. Mossman's comments:

on the quality of the components

"I was very pleased to find that the quality of the material in your kit was extremely good."

on the ease of adjustment

"The instrument tuned up like a charm. I commend you for the lucidness of your instructions."

on the overall design

"A great deal of hard work and careful engineering must have gone into this kit and you do credit to your profession."

The Theremin is the electronic musical instrument played without touch. The R. A. Moog MELODIA THEREMIN is completely transistorized, and designed to operate in conjunction with any amplifier and loudspeaker. If you have ever assembled an electronic instrument, you can build a MELODIA THEREMIN. And if you can hum or whistle a tune, you can play this most unique musical instrument. For holiday enjoyment, order your MELODIA THEREMIN today.

MELODIA THEREMIN KIT \$49.95
 COMPLETELY ASSEMBLED MELODIA \$75.00
 (Add postage for 10 pounds. We refund any overpayment.)

R. A. MOOG CO., BOX 263, ITHACA, N. Y.



HIGH-GRADE "HAM" EQUIPMENT FROM LOW-COST SURPLUS ITEMS



Volume III

— Surplus Radio Conversion Manual contains all data needed for putting surplus equipment to practical use.

Contents, Volume III

VOLUME III — APN-1; ARC-5; ART-13; BC-191, 312, 342, 348, 375, 442, 453, 455; 456 to 459, 603, 624, 696, 1066, 1253; CBY-52000 series; COL-43065; CRC-7; DM-34D; DY-8 or DY-2A/ARR-2; FT-241A; LM; MBF; MD-7/ARC-5; RM-52, 53; R-9/APN-4; R-28/ARC-5; RT-19/ARC-4; RT-159; SCR-274N series; SCR-508, 522, 528, 538; T-15 to T-23/ARC-5; URC-4; WE-701-A. Schematics only: APA-10; APT-2; APT-5; ARR-2; ASB-5; BC-659, 1335A; CPR-46ACJ.

*Order from your favorite electronic parts distributor.

If he cannot supply, send us his name and your remittance, and we will supply; foreign, add 10%.

EDITORS and ENGINEERS, Ltd.

Summerland 2, California



Dealers: Electronic distributors, order from us. Bookstores, libraries, newsdealers order from Baker & Taylor, Hillside, N. J. Export (exc. Canada), order from H. M. Snyder Co., 440 Park Ave. So., N.Y. 16.

QUICKLY CUT HOLES
 in metal, plastics,
 hard rubber...

ROUND SQUARE KEY "D"



GREENLEE CHASSIS PUNCHES

Make smooth, accurate openings in 1½ minutes or less . . . for sockets, plugs, controls, meters, panel lights, etc. Easy to use . . . simply turn with wrench.

Many sizes and models.

Write for literature.



GREENLEE TOOL CO.
 1916 Columbia Ave., Rockford, Illinois



LEARN TRANSISTOR, COMPUTER OR RADAR ELECTRONICS AT HOME!

□ Prepare now for a profitable career in one of these growing fields. Learn theory and practical application of all makes and types with proven home study courses from the Philco Technological Center.

For FREE information write:

PHILCO
TECHNOLOGICAL CENTER
P.O. Box 4730, Dept. W-2, Philadelphia 34, Pa.

GET INTO ELECTRONICS



V.T.I. training leads to success as technicians, field engineers, specialists in communications, guided missiles, computers, radar and automation. Basic and advanced courses in theory and laboratory. Associate degree in electronics in 24 months. B.S. in electronic engineering obtainable. ECPD accredited. G.I. approved. Graduates in all branches of electronics with major companies. Start February, September. Dorms, campus. High school graduate or equivalent. Catalog.

VALPARAISO TECHNICAL INSTITUTE
Dept. RD, Valparaiso, Indiana

Detect Police Radar Traps Before They Detect You Plans \$1.00 • Kits \$19.95
Wired Units \$29.95

RADAR KING

Both S and K Band Operation Kits and wired units shipped with S band antennas unless otherwise specified.

Extra antennas \$4.50 each
WARDELL SMITH, ELECTRONIC DESIGNS
65 Glenwood Road
pat. pending Upper Montclair, New Jersey est. 1974

BARGAIN HUNTING? TV SERVICEMEN!
Write for SENSATIONAL CATALOG
HENSHAW RADIO SUPPLY
3619 TROOST KANSAS CITY, MO.

OUT OF SPACE?
You bet we'd be... if we were to tell you all about AUDION'S "Out of this World Hi Fi Values"
Write for free Catalog
audion
25-W Oxford Road
Massapequa, New York

TV PICTURE TUBES All Aluminized Glass Types BUY DIRECT AND SAVE
• 12LP4—\$8.95 • 17BP4—\$9.95 • 21AL/ATP4—\$16.75 • 24DP4—\$24.50 • 27EP4—\$39.95
All Types Available
These tubes are made from reprocessed glass. All materials including Electron Gun are brand new.
PICTURE TUBE OUTLET FREE... Write for complete Picture Tube list.
2922 MILWAUKEE • Chicago 18

Detecting Microwave-Radiation Hazards (Jaski) June 31
Electrical Activity of the Human Body (Bukstein) Aug. 27
Electronic Air Purifiers (Buchsbaum) July 27
Electrophoresis—Techniques, Applications, Maintenance (Collins) Sept. 52
How Solutions are Analyzed Electrically (Collins) June 36

POWER SUPPLIES
Adjustable D.C. Power Supply (Hartkopf) June 56
Designing a Transistor Power Converter (Blair) Feb. 62
Eico Model 1064 Power Supply (EW Lab Tested) Oct. 86
Eico Model 1073 Variable A.C. Power Supply (EW Lab Tested) May 67
Emergency Power Supply (Diehl) Feb. 81
Multi-Purpose Low-Voltage Supply (Caringella) Aug. 44
Power Supplies for Transistor Circuits (Burgess) May 58

TUBES & TRANSISTORS
"Banana" Color Tube (Halliday) Sept. 88
Bonded-Shield TV Picture Tubes (Evans) Aug. 32
Diodes are Different (Hazlehurst) Apr. 50
Domestic Replacements for Imported Transistors (Eimbinder) Sept. 58
New Motorola Color CRT Nov. 66
Super-Power U.H.F. Tubes (Reed & Tunis) Oct. 37
Technician Solves Transistor Mysteries (Davis) Mar. 36
Tunnel Diodes Simplified (Stoner) Mar. 44
Voltage Regulator Diode-Tube Combinations (Stone) Apr. 104

TWO-WAY RADIO
Adjusting Communications Transmitters (Part 1) (Noll) Mar. 33
Adjusting Communications Transmitters (Part 2) (Noll) Apr. 44
Marine Radios to Double in 5 Years Oct. 103
Power-Line Carrier Communications (Murrell) Jan. 58
Reducing Transmitter Interference—Harmonics & Spurious Signals (Part 1) (Arnold) Jan. 53
Reducing Transmitter Interference (Part 2) (Arnold) Feb. 52
Transistors in Two-Way Radio—Basic Circuits (Part 1) (Noll) Aug. 53
Transistors in Two-Way Radio—Circuits Used in Commercial Equipment (Part 2) (Noll) Sept. 47

HIGH-FIDELITY & AUDIO

AMPLIFIERS
Acrosound Stereo 120 Amplifier (EW Lab Tested) July 78
Bell 2445 Tuner-Amplifier (EW Lab Tested) Aug. 93
Compact Hi-Fi Power Amplifier (Leibowitz) June 38
Cover Story June 30
Dual 35-Watt Stereo Amplifier (Jacobs & Jariwala) Mar. 29
Economy Hi-Fi Amplifier (Glaser) July 36
Eico ST40 Integrated Stereo Amplifier (EW Lab Tested) Sept. 18
Harman-Kardon "Citation IV" Stereo Control Center (EW Lab Tested) Apr. 92
Improving the Williamson Amplifier (Wright) June 104
"Knight" 75-Watt Stereo Amplifier (EW Lab Tested) May 66
H. H. Scott Model LK-72 Stereo Amplifier Kit (EW Lab Tested) June 90
Lafayette Model KT-550 100-Watt Stereo Power Amplifier (EW Lab Tested) June 91
Transistorized Audio Line Amplifier (Stone) Jan. 61

CIRCUITS
Dimension Control for Stereo (Glasgal) Apr. 56

SILICON RECTIFIERS Factory Direct



**750 MA
TOP HATS
Mfg. Prices**

PIV/RMS 50/35 .10 ea.	PIV/RMS 100/70 .19 ea.	PIV/RMS 200/140 .24 ea.	PIV/RMS 300/210 .33 ea.
PIV/RMS 400/280 .41 ea.	PIV/RMS 500/350 .55 ea.	PIV/RMS 600/420 .65 ea.	PIV/RMS 700/490 .78 ea.
PIV/RMS 800/560 .85 ea.	PIV/RMS 900/630 .99 ea.	PIV/RMS 1000/700 1.10 ea.	PIV/RMS 1100/770 1.40 ea.

General Purpose 400PIV at 300MA
Special 2 for .50 25 for 6.00
Factory LOW PRICES

100 Different prec. res., 1/2 W. 1 W. 2 W only 1.25
of 1/2 %, 1 % Tolerance

General Electric 1N91 Power Junction Diode 10 for 1.00

Int. Rect. Selenium PIV440/RM5160 DC Current 10MA 10 for 1.50

PIV	Current	Price	PIV	Current	Price
200	2 amps	5¢	400	15 Amps	2.25
400	2 Amps	1.10	50	50 Amps	2.50
100	15 Amps	1.25	100	50 Amps	3.25
200	15 Amps	1.75	200	50 Amps	4.25

All material guaranteed. \$2.00 min. order. Orders F.O.B. NYC. Include check or money order. Shpg. charges plus. C.O.D. orders 25% down.

WARREN DIST. CO.
NYC 7, NY 87 Chambers St. WO 2-5727

MOVING?

If you've recently changed your address, or plan to in the near future, be sure to notify us at once. We'll make the necessary changes on your mailing plate, and see to it that your subscription continues without interruption. Right now—print the information requested in the spaces below and mail it to: **ELECTRONICS WORLD, 434 So. Wabash Ave., Chicago 5, Illinois.**

Name Please PRINT!

*Account No.

Old Address

City State

New Address

City Zone State

Mail copies to new address starting with _____ issue.

***(Your Account Number appears directly above your name on the mailing label.)**

Fairchild Model 510 "Compander" (EW Lab Tested)	Dec. 20
Intercom Adopter (Gardenghi)	Feb. 122
"Knight" KN-701 Reverberation Unit (EW Lab Tested)	July 76
Squelch Circuit for Wireless Intercom (Dezettel)	Nov. 91

MISCELLANEOUS

A. D. Blumlein—Fother of Modern Stereo (Halliday)	Mar. 80
British Audio Trends (Halliday)	Nov. 76
Hirsch-Houck Labs Joins Electronics World (Editorial)	Aug. 6
How to Make Music-Power Measurements (von Recklinghausen)	June 27
Los Angeles Hi-Fi Show (Editorial)	June 6
TV Music and the Broadcast Technician (Brondt)	Oct. 45

PHONO

Directory of Hi-Fi Turntables	Feb. 46
Fairchild Model 440 Turntable (EW Lab Tested)	Feb. 104
Manual & Semi-Automatic Hi-Fi Turntables (DeMotte)	Feb. 45
Miracord Model 10H Record Changer (EW Lab Tested)	Dec. 20
Pickering Model 381A Stereo Cartridge (EW Lab Tested)	Apr. 94
Rumble Filters for Stereo—Their Design & Use (Timmerman)	May 40
Shock-Proof Record-Player Suspension System (Gaylord)	Aug. 42
Sonotone 9T Ceramic Stereo Cartridge (EW Lab Tested)	Sept. 18
Weathers K-803 Professional Stereo Pickup System (EW Lab Tested)	July 76

PUBLIC ADDRESS

Commercial Sound System Fundamentals (Part 1) (Pavlot)	Feb. 37
Commercial Sound System Fundamentals (Part 2) (Pavlot)	Mar. 61
Impedance Matching in Public-Address Systems—Part 1 Low-Z Loudspeaker Lines (Sumberg)	Sept. 38
Impedance Matching in Public-Address Systems—Part 2 High-Z Loudspeaker Lines (Sumberg)	Oct. 53
Impedance Matching in Public-Address Systems—Part 3 Constant Voltage Method (Sumberg)	Nov. 61

SERVICING

Cover Story	Mar. 32
Listening Center Technician (Crane & White)	Feb. 58
Mac's Service Shop (Frye)	June 58
Service Technician and Hi-Fi (Editorial) ..	Feb. 6
Servicing Tape-Recorder Oscillators (Burstein)	Nov. 58
Testing Tape Recorders (Burstein)	Dec. 58

SPEAKERS & HOUSINGS

Adding a Center Speaker for Stereo (Healy)	Aug. 40
Channel Master CM-10 Speaker System (EW Lab Tested)	Apr. 94
Double-Chamber Speaker Enclosure (Augsburger)	Dec. 41
DuKane "Ionovac" Tweeter (EW Lab Tested)	May 68
DuKane Model DuK-30 Speaker System (EW Lab Tested)	Oct. 20
Fisher XP-4 Speaker System (EW Lab Tested)	Dec. 24
Hartley "Holton" Speaker System (EW Lab Tested)	Oct. 24
How to Check Speaker Characteristics With a Scope (Kyle)	June 68
Kay Model DV-210 Speaker System (EW Lab Tested)	Feb. 105
Loudspeaker Testing and Measurement (Villchur)	Oct. 42
Standard For Speaker Phasing	Feb. 80

(Continued on page 118)



**FREE Catalog of The WORLD'S
FINEST GOV'T
SURPLUS ELECTRONIC BARGAINS**

12—24 Volt CONVERTER

PP-18/AR VIBRATOR POWER SUPPLY—12 Volt DC Input; 28 Volts DC Output @ 1.5 Amps.

Unit uses a nitrogen-filled vibrator that is hermetically sealed. Input and output are well filtered for hum and hash and ext. interference. Used by Navy and Airforce to operate ARC-5 and Command Receivers, using 24 Volt Dynamotors, from 12 Volts. Also can be used to operate any 24 Volt device, or Units can be wired in parallel to supply a higher current output. Complete with connecting plugs, spare vibrator and mounting. **NEW: \$7.95**

**AM-142/AIC
MIXER AMPLIFIER**

Used in large aircraft inter-communication systems as a booster. 500 ohm input; 600 ohm output, operates from 21 VDC with one 20A7 Dual Tube. Size: 5 x 5 x 2". Wt.: 2 lbs. Price—**\$1.95**



**75 MC MARKER BEACON
RECEIVER**

**R-122/ARN-12
RECEIVER—75 MC**

fixed freq. Used in aircraft to receive modulated radio signals, aural and visual indication. From these indications the pilot can accurately check his position with respect to the Radio Range Station. When the signal is being received the tone can be heard in the headset, and the signal lamp on the instrument panel will light. Complete with tubes: 5/6AJ5, 2/6AL5W, 2/28D7W. Has crystal controlled oscillator and 6.9 MC I.F. Operates from 24 VDC. Size: 10 x 5 x 6". Wt.: 8 lbs. Price—Used..... **\$4.95**



**AIRCRAFT AMPLIFIER
AM-26/AIC**

Audio Amplifier used in aircraft for inter-communication. Carbon Microphone input. High and low impedance output with volume control. Normally requires DM-32 Dynamotor for operation with 24 Volt DC input and 250 VDC 60 MA output. Complete with tubes: 2/12J5 & 2/12A6. (For conversion to 9 Watt Amplifier, see Surplus Conversion Manual #21). Size: 9 3/4 x 5 1/4 x 5 1/4". Wt.: 6 1/2 lbs. Price—Used..... **\$3.95**

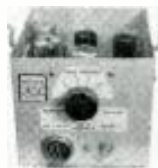

HUGE SELECTION:

Hundreds and hundreds of quality surplus items—Receivers, Transmitters, FM Equipment, Telephones, Headsets, Mics., Generators, Motors, Amplifiers, Dynamotors, Power Supplies, Antennas, Transformers, Meters, Test Equipment, Inverters, Cable—Etc. Etc. Previously advertised items still available. Write us your needs. We probably can supply!

SEND FOR FREE CATALOG!

Address Dept. EW • All Prices F.O.B. Lima, Ohio. \$5.00 Minimum Order. 25% Deposit on all C.O.D.'s.

FAIR RADIO SALES
2133 ELIDA RD. • P.O. Box 1105 • LIMA, OHIO



-- then you need us!

GET STARTED RIGHT by writing for **FREE** 8 page catalog illustrating over 30 business forms and systems designed specifically for TV-Radio Service.

ON SALE AT YOUR PARTS JOBBER

Delrich Publications • 4308 N. Milwaukee • Chicago 41, Ill.

TAPE RECORDERS



**HI-FI COMPONENTS
SLEEP LEARN KITS**

UNUSUAL VALUES MERITAPE. Low cost, high quality recording tape, in boxes or cans.
FREE 1962 Catalog DRESSNER
1523RA Jericho Tpke. New Hyde Park, N.Y.

NEW...TUNEABLE CB BY KAAR!



Kaar's four "quality-engineered" units now represent the most complete line of CB equipment available.

The TR327B "D" Phone is the CB enthusiast's dream... with 23 tuneable CB channels. Up to five transmit channels — your choice of crystal controlled or precision tuned receive channels.

The TR327 offers four crystal controlled CB channels.

The TR327A adds Standard AM broadcast Band for extra convenience and fun.

The TR330 Han D Phone is the compact, fully-transistorized, portable unit that completes the Kaar CB line. Now available with 400 mw audio for maximum "talk power."



KAAR ENGINEERING CORP.
2997 Middlefield Road, Palo Alto, Calif.
Please send more details about Kaar CB

Name _____
Address _____
City _____ State _____

LORAN APN-4

FINE QUALITY NAVIGATIONAL EQUIPMENT

Determine exact geographic position of your boat or plane. Indicator and receiver complete with all tubes and crystal.

INDICATOR ID-68/APN-4, and RECEIVER \$49.50
R-98/APN-4, complete with tubes. Exc. used \$88.50

Receiver-Indicator above. BRAND NEW \$29.95

INVERTER POWER SUPPLY for Loran. Made by Bell Telephone Div. INPUT: 24 V DC @ 7.5 A. OUTPUT: 115 V AC @ 10.5 Amps. 800 cycles. Complete with two connecting plugs. BRAND NEW \$49.50

12-Volt Inverter Power Supply, Like New. T.U.R. Shock Mount for above \$29.95
 We carry a complete line of spare parts for above.

LORAN APN/4

OSCILLOSCOPE

Easily converted for use on radio-TV service bench.

LIKE NEW! Supplied with 5" Scope, type SCPI only \$14.50

LORAN R-65/APN-9 RECEIVER & INDICATOR

determines Position by Radio signals from known Xmitters. Complete with tubes and crystal. Exc. Used \$79.50

BC-433 RADIO COMPASS RECEIVER

200 to 1750 Kc in 3 bands. 28 V DC power supply required. Complete with 15 tubes. BRAND NEW \$21.50

ASB-5 'SCOPE INDICATOR

BRAND NEW, including all tubes, together with 5BP1 'Scope Tube. Originally used in Navy aircraft RADAR equipment. Easily converted for AC operation. VALUE \$250.00! OUR LOW PRICE \$15.95



APN-1 FM TRANSMITTER-RECEIVER

420 to 460 Mc Aircraft Radio altimeter equipment. Tubes: 4-95S, 3-125J7, 4-125M7, 2-12HG, 1-V1R50. Complete with tubes, brand new APN-1 exc. Used \$6.95 \$9.95

ARN-5 C AIRBORNE Equipment.

to give vertical guidance during landings. Tube superhet circuit. Tubes: 2B07, 2-12N7, 2-12N7T, 7-6A5. Crystal Controlled on 6 channels. Like new. \$12.95

BC-906 FREQ. METER—SPECIAL

Cavity type, 145 to 235 Mc. BRAND NEW, complete with antenna. Manual and original calibration charts included. OUR LOW PRICE \$10.88



BC-221 FREQUENCY METER

SPECIAL BUY! This excellent frequency standard is equipped with original calibration charts and has ranges from 125 Kc to 20,000 Kc with crystal check points in all ranges. Excel. Used with original Calibration Book, Crystal, and all tubes—LIKE NEW! Unmodulated \$72.50 Modulated \$99.50 RA-133 original A.C. power supply made for Govt. For use with BC-221. Wired and tested \$18.95



BC-638A FREQUENCY METER 100-156 Mc.

Xtal controlled. Rack mounting. For 110V AC operation. Less crystals. BRAND NEW \$29.50

TS-15/APN TEST SET

For aligning and calibration of radio altimeters. May be used to check calibration of count or circuits and modulator sweep frequency and bandwidth of transmitter. Audio-oscillator range: 340 to 750 cycles. 19/14 V DC input. Complete with tubes, connecting cables. Instruction summary. BRAND NEW \$11.95



AN/ARN-6 RADIO COMPASS EQUIPMENT

Highly efficient airborne direction finding system. Frequency: 100 to 1750 Kc in 4 bands. 28.5 DC V Power Input. LIKE NEW \$79.50

MICROPHONES

Model	Description	BRAND NEW	Exc. Used
T-17	Carbon Hand Mike	\$5.45	
RS-38	Navy Type Carbon Hand Mike	4.75	

HEADPHONES

Model	Description	Exc. Used	BRAND NEW
MS-23	High Impedance	\$2.19	\$4.49
MS-33	Low Impedance	2.69	4.59
MS-30	Low Imp. (featherwt.)	.90	1.65
H-16 U	High Imp. (2 units)	3.79	7.95

TELEPHONICS—600 ohm impedance HEAD-SETS. BRAND NEW. PER PAIR \$3.25
 CD-307A Cords, with PL35 plug and JK20 Jack .99
 Earphone Cushions for above—PAIR .50

SCR-625 MINE DETECTOR

Complete portable outfit in original packing, with all accessories. Brand New \$27.50

ATTENTION: IMPORTERS-EXPORTERS

of ELECTRONIC EQUIPMENT

We specialize in the export of electronic equipment at LOWEST prevailing prices. All packing and shipping is made directly from our own warehouses in NYC, to give you substantial savings in handling costs! Your inquiries invited.

ARC-3 RECEIVER!

Complete with All Tubes Exc. Used \$1695

Like NEW \$21.50
 Used \$14.95

Crystal-controlled 17-tube superhet. Tunes from 100 to 156 MC. AM., on any 8 pre-selected channels. 28-volt DC power input. Tubes: 1-12Q6, 6-6A5, 1-125M7, 3-125G7, 1-9001, 1-12H6, 2-12N7, 1-125L7, 1-12A6.

ARC-3 TRANSMITTER

Companion unit for above. Tunes 100 to 156 MC in any 8 pre-selected channels. Tubes. 8 crystal controlled. Provides tone and voice modulation. 28V DC Power Input. Complete with all tubes. 6-6A5, 1-125M7, 3-125G7, 1-9001, 2-12N7, 1-125L7, 1-12A6. Only \$1695

Like new condition \$22.50
 ARC-3 PUSHBUTTON ON/OFF BOX \$5.95

AN/ART-13 10-WATT XMTR

11 CHANNELS
 200-1500 Kc
 2 to 18.1 Mc

\$5850 exc. used



Complete with Tubes

Emmits Collins Autotune Aircraft Transmitter, AM, CW, MCW. Quick change to any of ten preset channels or manual tuning. Speech amplifier/clipper uses carbon or magnetic mike. Highly stable. Highly accurate VFO. Built in Xtal. Controlled oscillator. PPM1 is modulate 818 in final up to 90% class-B. A real "HOT" item buy at our low price! Orig. cost \$1800

AN/ART-13 XMTR as above. Like New \$69.50

0-16 Low Freq. Osc. Coil for ART-13 \$7.95
 24V Dynamotor for ART-13 \$11.95
 Same as above less meter \$39.50

We carry a complete line of spare parts for above.

SCR-274 COMMAND EQUIPMENT

ALL COMPLETE WITH TUBES

Type	Description	Used	Like NEW
BC-453	Receiver 100-550 KC	\$12.95	\$14.95
BC-454	Receiver 500-8 Mc	0.45	12.45
BC-455	Receiver 6-8 Mc	11.50	13.95
	Marine Receiver 1500-3000 KC Brand New		\$16.95

110 Volt AC Power Supply Kit, for all 274-N and AIC-5 Receivers. Complete with metal case, instructions. Exc. Used \$11.50
 Factory wired, tested and ready to operate \$11.50

SPLINED TUNING KNOB for 274-N and ARC-3 RECEIVERS. Fits BC-453, BC-454 and others. Only \$49c

BC-457 TRANSMITTER—4.5-3 Mc. complete with all tubes and crystal. BRAND NEW \$9.75

BC-458 TRANSMITTER—5.3 to 7 Mc. Complete with all tubes and crystal. BRAND NEW \$9.75

T19 TRANSMITTER 34 mc. complete with all tubes and crystal. Exc. Used \$9.95

BC-456 Modulator. USED \$4.95 NEW \$9.95

MD7 Modulator. Like New. \$9.95

ALL ACCESSORIES AVAILABLE FOR ABOVE

UNIVERSAL POWER SUPPLY KIT

For All Command Xmitters and other receiving.

INPUT: 117V 60 cycles AC
 OUTPUT: 450V D.C. @ 150 Ma.
 24V D.C. @ 2 Amps.

Carefully designed, using top quality components. A really substantial, good-looking unit.

BARGAIN PRICED AT \$29.50



GAS-ENGINE DRIVEN GENERATOR

Navy Model EF-8 rated at 1/2 HP, 2250 RPM. Supplies 500 VDC @ .085 Amp and 215 VDC @ 2 Amps. Overall length 21 1/2", height 16", width 10". SWS wt 130 lbs. Complete with 50-ft generator cable. VER. 50 FT. CABLE. NEW \$69.50



LIMITED QUANTITY SPECIALS!

AN/ARC-27 RECEIVER-TRANSMITTER for AM phone communication 225 to 399.9 Megacycles. Transmitter may be tone-modulated at 1020 cps. Provides 1750 frequency channels. Provisions for remote selection of 18 or 40 preset frequencies. Operates from 27.5 Volts DC. SPECIAL \$195.00

BR-312 MOBILE RECEIVER 6 bands, 1500 Kc to 18 Mc. With Tubes and 14 V. Dynamotor. Like New \$72.50

BC-314 RECEIVER 150-1500 Kc Continuous Tuning, 4-band, for 14 V DC operation. Like New \$59.50

BC-342 RECEIVER 1.5 to 18 Mc. AC only. Excellent Used \$72.50

BC-348 SUPERHET RECEIVER 300 to 500 Kc and 1.5 to 1800 Mc. Voice and CW. Self-contained dynamotor for 24V D.C. Like New \$79.50

ARW-26 RADIO REMOTE CONTROL RECEIVER 60 to 75 Mc carrier freq. battery operated. Less Battery. Includes tubes, coils, 500K, 700K Ohms. Brand New \$9.95

AN/APT-5 AIRBORNE RADAR SET, with tubes. Like New \$49.50

AN/PRC-6 WALKIE-TALKIE Transceiver with external connected handset, for FM voice communication from 47 to 33.4 Mc. 43 channels (11 pre-set). Operating range 1.5 miles. Uses dry battery. Complete. Like New. Less batt. Each \$89.50

TG-34A KEYS, exc. used, like new \$21.50
 Tape for above, each \$1.85. Set of 15, P.H.I.

G & G RADIO SUPPLY CO.

Telephone: CO 7-4605

Mail Order Retail Sales
 51 Vesey St. 75-77 Leonard St.
 New York 7, N. Y. New York 13, N. Y.

BC-603 FM RECEIVER

20 TO 27.9 MC.

Excellent Used \$1495

BRAND NEW \$18.95

Interchange, pushbutton or continuous tuning. Complete with speaker, speaker, and ten tubes: 3-6AC7, 1-6J5, 2-12SG7, 1-6H8, 1-6V6, 2-6SL7

EXTRA SET OF 10 TUBES FOR ABOVE brand new in original boxes \$39.95

FT-237 MOUNTING BASE for BC-603 Revr and BC-604 Xmitter. Brand New \$5.95

12 or 24V Dynamotor for Above. Exc. Used \$1.25 Brand New \$5.50

BC-683 FM Receiver, 27 to 38.0 Mc. Complete with all tubes. Like New \$33.33

4-Section Antenna for BC-603, 683 Receivers. Complete with mounting base. BRAND NEW \$4.95

BC-604 TRANSMITTER—Companion unit for BC-603 Revr above. With all tubes. BRAND NEW \$6

4-Section Antenna for BC-604, 684 Transmitters. Complete with mounting base. BRAND NEW \$4.95

We carry complete line of spare parts for above.

SPECIAL! BC-603 FM RCVR CONVERTED FOR ANY FREQ.—30 TO 50 MC.

BRAND NEW! Checked out, perfect working condition, ready for operation. Specify Frequency desired (between 30-50 Mc) when ordering. \$2950

AC POWER SUPPLY FOR BC603, 683 Interchangeable, replaces dynamotor. On-Off switch. NO BATTERY. 110V AC Input. Provides: 225 VDC @ 80 Ma, 24VAC @ 2 Amps \$10.25

Complete 240-Page Technical Manual for BC-603, 604 \$3.15

BC-605 INTERPHONE AMPLIFIER for above. BRAND NEW Each \$4.95

SCR-522 2-METER RIG!

Terrific buy! VHF Transmitter-receiver, 100-150 Mc. 4 channels. Xtal-controlled. Amplitude modulated voice. They're going fast! Excellent condition.

SCR-522 Transmitter-Receiver, complete with all 18 tubes, top rack and metal case. \$295.00

COMBINATION. Like new \$295.00

FAMOUS BC-645 TRANSCEIVER

15 Tubes 435 to 500 MC

Can be modified for 2-way communication. Voice or code, on ham band 430-450 mc. citizens radio 460-475 mc. fixed and mobile 450-460 mc. television experimenters 470-500 mc. 15 tubes (tubes alone worth more than sale price): 4-7E1, 4-7H7, 2-7E6, 2-6F6, 2-4E5 and 1-WE6 316A. Now covers 400 to 490 mc. Brand new BC-645 with tubes, less power supply in factory carton. Shipping weight 25 lbs. SPECIAL \$19.50

PE-101C Dynamotor, 12 24V Input \$7.95

UHF Antenna Assembly \$2.45

Complete set of 10 Plugs \$2.25

Control Box \$2.25

SPECIAL "PACKAGE" OFFER:

BC-645 Transceiver, dynamotor and all accessories above. COMPLETE, BRAND NEW. \$29.50

White Stacks Last.

MOBILE-MARINE DYNAMOTOR

Model DM35

Input 12V DC. Output: 625 V DC @ 225 Ma. for press-to-talk intermittent operation. SWS, wt. 14 lbs.

OUR LOW PRICE \$9.45

BRAND NEW



OTHER DYNAMOTOR VALUES: Excellent BRAND

Type	Input	Output	Used	NEW
DM-32A	28V 1.1A	250V .05A	2.45	4.45
DM-33A	28V 5A	57V .16A		
	28V 7A	540V .25A	1.95	3.75
DM-34D	12V 2A	220V .080A	4.15	5.50
DM-53A	28V 1.4A	220V .080A	3.75	5.45
DM-64A	12V 5.1A	275V .150A		7.95
PE-73C	28V 20A	1000V .350A	8.95	14.95
PE-86	28V 1.25A	250V .050A	2.75	3.85

SMALL DC MOTORS

All 27.5 DC Input
 Overall 3 3/4" x 1 1/4" Dia.

5069790 100 RPM Delco \$3.95
 58A10AJ52 145 RPM GE 4.25
 5068750 160 RPM Delco 3.95
 5072735 100 RPM Delco 3.95
 5067127 250 RPM GE 4.25
 5069800 575 RPM Delco 3.75
 58A10F5226A 575 RPM GE 3.75



2 VOLT BATTERY "PACKAGE"

1-2V 20 Amp. Hr. Willard Storage Battery Model #2012-3 52.79

1-2V 7 prong Synchronous Plug-in Vibrator \$1.49

1-Quart Bottle Electrolyte (for 2 cells) \$1.45

ALL BRAND NEW! Combination Price \$5.45



WILLARD 6-VOLT MIDGET STORAGE BATTERY

8 Amp. Hour. BRAND NEW. 3 3/4" x 1 1/2" 13/16" x 2 3/8". Uses Standard Electrolyte. Only \$2.95



SCHEMATIC DIAGRAMS

For most equipment on this page, each 65c

Please include 25% deposit with order—Balance C.O.D., or Remittance in Full. 50c Handling Charge on all orders under \$5.00. All shipments F.O.B. Our Warehouse, N.Y.C. All Merchandise subject to Prior Sale and Price Change.

WE HAVE IN STOCK many, many other Wonderful Buys in Surplus Govt Electronic Equipment, not shown here. Your inquiries are invited. Send Name & Address on postal Card for our latest FREE BULLETIN!

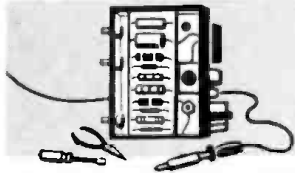

ELECTRONICS MARKET PLACE

RATE: 60¢ per word. Minimum 10 words. February issue closes December 1st. Send order and remittance to: ELECTRONICS WORLD, One Park Ave., N. Y. C 16, N. Y.

FOR SALE

TV Tuners—Rebuilt or Exchanged \$9.95 complete—all types—fast, guaranteed service. Send tuner with all parts to: L. A. Tuner Exchange, 4611 West Jefferson Blvd., Los Angeles 16, California.

TUBES—TV, Radio, Transmitting And Industrial Types At Sensibly Low Prices. New, Guaranteed, 1st Quality, Top Name Brands Only. Write For Free Catalog or Call WALKER 5-7000, Barry Electronics Corp., 512 Broadway, New York 12N, N. Y.

DIAGRAMS for repairing radios \$1.00. Television \$2.00. Give make, model. Diagram Service, Box 672-E, Hartford 1, Conn.

GOVERNMENT Surplus Receivers, Transmitters, Sniperscopes, Parabolic Reflectors, Picture Catalog 10¢. Meshna, Malden 48, Mass.

GOVERNMENT Sells Surplus:— Electronics; Oscilloscopes; Transceivers; Test Equipment; Radar; Sonar; Walkie-Talkie; Boats; Jeeps; Aircrafts; Misc.—Send for "U.S. Depot Directory & Procedures"—\$1.00—Brody, Box 425(RT), Nanuet, New York.

PROFESSIONAL Electronic Projects—Organs, Timers, Computers, Industrial, etc.—\$1 up. List Free. Parks, Box 1665 Lake City, Seattle 55, Wash.

BEFORE You Buy Receiving Tubes or Hi-Fi Components send now for your giant Free Zalytron current catalog—featuring nationally known Zalytron First Quality TV-Radio Tubes, Hi-Fi Stereo Systems, Kits, Parts, etc. All priced to Save You Plenty—Why Pay More? Zalytron Tube Corp. 220 W. 42nd St., NYC.

"SURPLUS Electronics, Optics. Free Catalog. Thermo-electric Devices, Inc. 302 Massachusetts Ave., Cambridge, Mass."

FREE Confidential Bargain Sheets Electronic Components—Lowest Prices Guaranteed—Knapp—3174 1/2 8th Ave. S.W., Largo, Florida.

WRITE for stereo component prices, no catalogues. We ship anywhere in the U.S. (We say: "If you can beat our Prices, You're lying.") Masterpiece, 1801 Kings Highway, Brooklyn. In business 16 years—Custom made Cabinets for TV, Stereo, Bars & Hi-Fi.

CIRCUITS—FM Booster, 3-Inch Scope, \$1 each. List. Ko-Lab, Box 62, Lake Jackson, Texas.

INFRA-Red!! Sniperscopes, Optics, Lamps, Parts. World's largest stock Infra-red components. Write for Free Infra-red Catalog. McNeil Electric & Equipment, Dept. 11, 4736 Olive, St. Louis 8, Mo.

SEND for flyers listing Transmitters, Receivers, Teletype converters, Tubes, components. Spera Electronics, 37-10 33 St. L.I.C. N.Y.

INVESTIGATORS. Write for Free Brochure on Latest Submarine Electronic Listening Devices/Dept. 2B Ace Electronics, 11500 NW 7th Ave., Miami 50, Fla.

TRANSISTORIZED police radar detector kits. Free Diagram and literature. Deekit Co., Box 7263, Houston 8, Texas.

ELECTRIC Engraver permanently engraves tools, any metal. \$2.00 postpaid. Relco, Box 10563, Houston 18, Texas.

SUPERSENSITIVE Directional microphone picks up a whisper at great distances. Used by investigators to record faint sounds without being detected. Easily constructed for about \$7. Step by step plans, \$1.95. Dee Company, Box 7263-D, Houston 8, Texas.

CONVERT any television to sensitive big-screen oscilloscope. Only minor changes necessary. Plans \$1.95. Relco, Box 10563-A, Houston 18, Texas.

"CITIZENS Band High Gain-Low Noise preamplifier, Cascade Nuvistor circuit boosts receivers in Heath GW10, Knight C-27, Globe 100 & 200, Brownling R2700, etc. Extends range up to 50% further. Full details sent for dime. Raydar, Box 363-E, Farmington, Ct."

GARAGE Door Operator Kits—Edwards famous KR-50 kit. Easily assembled and installed. Available with or without remote car control. Thousands sold. Priced from \$59.95. Write for literature. Edward T. Fink Co., Inc., 284 Nepperhan Ave., Yonkers, N.Y. Dept. EW.

BC 603 Converted to Fire Police Frequencies Motorola Used Receivers. 6 Volt, 12 Volt, 110 Volt, High Band, Low Band, R C A Mobile High Band, 148 to 174, 6 or 12 Volt. For Price List Send 10¢. Murray Brother's, 195 High Street, Boston 10, Mass.

BUY/Rent—Comedy, Party Records. Sampler: \$1.00. The D.R.C.—11024 Magnolia Blvd., North Hollywood, California.

TRANSISTORIZED Test Equipment. Perfect Christmas Gifts. New Products. Popular Price Range. Pel Electronics, Box 555A, Ridgewood, N.J.

ALUMINUM Distance Finder—Sights yardage to objects. Determines navigational, hunting, golfing distances. Perfect gift! \$2.00 postpaid. Shang's, 223 Walter Court, Elgin 12, Illinois.

HI-FI Strobolamp & Disc \$3.00, Transistor Hearing Aid \$39.95, \$10.00 down, \$3.00 month. C. James, P.O. Box 929, Indio, California.

DIAGRAMS, Servicing Information, Practically any radio, television, \$1.00. Specify manufacturer, model. Supreme Publications, Highland Park, Illinois.

ORGAN Pulse Transformers. Master Oscillator Coils. R. E. Pavelka, P.O. Box 5985, Cleveland 1, Ohio.

WALKIE-Talkie radiophones from \$24.98. Free literature. Vanguard Labs., 190-48 99 Ave., Hollis 23, N.Y.

PRECISION Resistors, carbon-deposit. Guaranteed 1% accuracy. Millions in stock. 1/2-watt, 8¢, 1-watt, 12¢, 2-watt, 15¢. Leading manufacturers, Rock Distributing Co., 902 Corwin Rd., Rochester 10, N.Y.

ELECTRONICS ENGINEERING & INSTRUCTION

ELECTRONICS! Associate degree—29 months. Technicians, field engineers, specialists in communications, missiles, computers, radar, automation. Start September, February, Valparaiso Technical Institute, Dept. N, Valparaiso, Indiana.

EARN \$150 Week Mechanical, Electronics Drafting Send \$2 first Lesson, \$25 Complete Home Study Course. Prior, Inc., Dept. 123, 23-09 169 Street, White-stone 57, New York.

HIGHLY-Effective Home-Study Review For FCC Commercial Phone Exams. Free literature. Wallace Cook, Box 10634, Jackson 9, Miss.

WANTED

QUICKSILVER, Platinum, Silver, Gold, Ores Analyzed. Free Circular. Mercury Terminal, Norwood, Massachusetts.

CASH Paid! Sell your surplus electronic tubes. Want unused, Clean radio and TV receiving, transmitting special purpose, Magnetrons, Klystrons, broadcast types. Want military and commercial lab/test equipment such as G.R.H.P., AN/UPM prefix. Also want commercial Ham Receivers and Transmitters. For a Fair Deal write: Barry Electronics Corp., 512 Broadway, New York 12, N. Y. (Walker 5-7000).

INVENTIONS Wanted for immediate promotion! Patented, unpatented. Outright cash; royalties! Casco, Dept. BB Mills Building, Washington 6, D.C.

TRIGGER—W91VJ We Buy Shortwave Equipment For Cash. 7361 W. North, River Forest, Ill. Phone PR 1-8616. Chicago TU-9-6429.

DOES Your Product, Invention Need Capital, Manufacturer, Distributor? Patent Engineers Have Nation-wide contacts. Give details. Inventors Creative Service, 354 South Spring, Los Angeles 13, California.

WANTED: Tubes, Diodes, Transistors, Military, Commercial Lab-Grade Test Equipment, Components, PRC, GRC Equipment, Aircraft Equipment by Collins. Top Prices. Write details, Bob Sanetti, W6REX, V & H Radio & Electronics, 2053 Venice Blvd., Los Angeles 6, California.

FLORIDA manufacturer desires inventions or ideas for immediate production. Box 971, Fort Lauderdale, Florida.

TAPE & RECORDERS

TAPE Recorders, HI-Fi Components. Sleep Learning Equipment, Tapes, Unusual Values. Free Catalog. Dressner, 1523 EW Jericho Turnpike, New Hyde Park, N.Y.

RENT Stereo Tapes—over 2,000 Different—all major labels—free catalog. Stereo-Parti, 811-G, Centineia Ave., Inglewood 3, California.

DON'T Buy Hi-Fi components, kits, tape, tape recorders until you get our low, low return mail quotes. "We Guarantee Not To Be Undersold." Wholesale catalog free. Easy time payment plan, 10% plan—up to 24 mos. to pay. Hi-Fidelity Center, 220NC E. 23 St., New York 10, N. Y.

SELF-Hypnosis. New concept teaches you quickly by tape or LP-record. Free literature. McKinley Publishers, Dept. T6, Box 3038, San Bernardino, California.

AMPEX, Bozak, Citation, Concertone, Crown, Magnecord, Presto, Norelco, Tandberg, Sherwood, Thorens, Scott, Shure, others. . . Trades. Boynton Studio, Dept. RT, 10 Pennsylvania Ave., Tuckahoe, New York.

4TR Stereo Tapes—we buy, sell, rent and trade! Free Catalog listing bargain closeouts. Columbia, 9651 Foxbury Way, Rivera, California.

STEREO Playback Tape Deck. Professional Quality Precision Made Telefunken Heads. Dual Speed. Special Price \$59.95. Send for details. Universal Dist. Co., P.O. Box 204, Richmond Hill, N.Y.

HIGH-FIDELITY

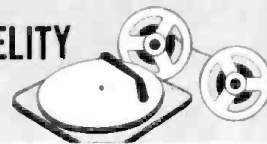

PROMPT Delivery, We Will Not Be Undersold. Amplifiers, Tape Recorders, Tuners, Etc. No Catalogs, Air Mail Quotes. Compare. L. M. Brown Sales Corp., Dept. W, 239 E. 24 St., N. Y. 10, N. Y.

DISGUSTED with "Hi" Hi-Fi Prices? Unusual Discounts On Your High Fidelity Requirements. Write. Key Electronics, 120 Liberty St., New York 6, N. Y. Cloverdale 8-4288.

RECORDERS, Components. Free wholesale catalogue. Carston 125-R, East 88, N.Y.C. 28.

PRICES? The Best! Factory-sealed Hi-Fi Components? Yes! Send for free catalog. Audion, 25T Oxford Road, Massapequa, N.Y.

WANT to buy good equipment and accessories? Place a low-cost classified ad in this space.

SOUNDASTIC! That's what our customers are saying upon receiving our prices on our latest High Fidelity Stereo and Monaural, amplifiers, tuners, turntables, speakers, tape recorders, kits. All brand new with factory guarantee. Individual quotations only. No catalogues. Audio World, 117-20 14th Road, College Point 56, New York. Dept. HR.

GOVERNMENT SURPLUS

JEEPS \$278, Airplanes \$159, Boats \$7.88, generators \$2.68, typewriters \$8.79, are typical government surplus sale prices. Buy 10,001 items wholesale, direct. Full details, 627 locations, procedure, only \$1.00. Surplus, Box 789-C9Z, York, Penna.

PATENTS

PATENT Searches, \$6.00. For free Invention Record, and "Information Inventor's Need," Write: Miss Heyward, 1029 Vermont Avenue, N.W., Washington 5, D.C.

MISCELLANEOUS

BAR-Bells, Exercise Equipment, Courses. Catalogue 10¢. Good Bar-Bell Co., Dept. E, Siloam Springs, Arkansas.

"SWISS Musical Movements. Mechanical-Electrical. Spielman, 131 West 42nd, New York 36."

INDEPENDENT Thinkers—investigate Humanism! Write American Humanist Association, Dept. EW, Yellow Springs, Ohio.

JOB Hunting? Mailing Resumes? Sales Leads? Invest \$1.00 for each of the following: 1. Mailing address directory of over 500 R&D, Engin. & Manuf. Firms located at these Industrial Centers: Route 128 & 3, Burlington, Natick, Waltham Needham, Newton, Cambridge, Boston. 2. Instructions on "Aids to Better Employment and Interview Behavior and Procedure." 3. Sample Resume incl. Write It Yourself Aids. Vocational Publications, 520 Comm. Ave., Boston 15, Mass.

SHOPPING GUIDE Classified

A HANDY GUIDE TO PRODUCTS, NOT NECESSARILY ELECTRONIC, BUT OF WIDE GENERAL INTEREST.

PHOTOGRAPHY—FILM, EQUIPMENT, SERVICES

SCIENCE Bargains—Request Free Giant Catalog "CJ"—144 pages—Astronomical Telescopes, Microscopes, Lenses, Binoculars, Kits, Parts. War surplus bargains. Edmund Scientific Co., Barrington, New Jersey.

STAMPS & COINS

GIGANTIC Collection Free! Includes triangles, early United States animals, commemoratives, British Colonies, high value pictorials, etc. Complete collection plus big illustrated magazine all free. Send 5¢ for postage. Gray Stamp Company, Dept. Z2, Toronto, Canada.

155 DIFFERENT U.S. commemoratives \$1.00. Car-stamps, 739 Orway, Freeport, Illinois.

TWO Brilliant Uncirculated Mexican Silver Dollars—\$1.00 (Refundable). Universal Services, Box 866, San Antonio 6—212, Texas.

HELP WANTED

HIGH Paying Jobs in Foreign Lands! Send \$2.00 for complete scoop! Foreign Opportunities, Box 172, Columbus 16, Ohio.

EARN Extra money selling advertising book matches. Free Samples furnished. Matchcorp, Dept. MO-112, Chicago 32, Ill.

TANDBERG of America has an exceptional opportunity for an experienced tape recorder service man to work on the world famous Tandberg Tape Recorder at our main office in Pelham. Right person will receive training on our units. Good starting salary, excellent working conditions, rapid advancement. Please write... Tandberg of America, Inc., 8 Third Ave., Pelham, N.Y.

ENGINEERING Opportunities — Broadcast Equipment Sales Engineer, Broadcast Equipment Design Engineer, Tuner Design Engineer, Sales Engineer (Tuner), Research Chemist. Midwest location. E. M. Sears, Box 62, Bloomington, Indiana.

EDUCATIONAL OPPORTUNITIES

LEARN While Asleep, hypnotize with your recorder, phonograph. Astonishing details, sensational catalog free! Sleep-Learning Association, Box 24-ZD, Olympia, Washington.

USED Correspondence Courses and Books sold and rented. Money back guarantee. Catalog Free. (Courses bought.) Lee Mountain, Pisgah, Alabama.

BUSINESS OPPORTUNITIES

FREE Book "990 Successful, Little-Known Businesses." Work home! Plymouth-455R, Brooklyn 4, New York.

MAKE \$25-\$50 Week, clipping newspaper items for publishers. Some clippings worth \$5.00 each. Particulars free. National, 81-0G, Knickerbocker Station, New York.

SECOND Income From Oil Can End Your Toil! Free Book and Oilfield Maps! National Petroleum, Pan-American Building—PP, Miami 32, Florida.

FREE Book "711 Bizarre, Successful Ventures." How I retired. Work Home! Haylings-MP, Carlsbad, Calif.

MAILMAN Brings Us \$150 Daily. Operate Home Mail Order Business. Write Publicity, Box 727ZE, Kalamazoo, Michigan.

MISCELLANEOUS

BOOK 200 Electric Stunts \$1.00. Cutziff, 875 Arastradero, Palo Alto, Calif.

1000 PRINTED, Gummed, Name & Address Labels, \$1.00. Labels, Box 80, Wall Street Station, N.Y. 5, N.Y. "WINEMAKING," "Beer, Ale." Strongest methods. Illustrated. \$2.20. Eaton Beverage Supplies, Box 1242-X, Santa Rosa, California.

FINGERNAIL Size-Up Method 25¢. Waynes, Box 3, Jefferson, Iowa.

WITH a few dollars worth of basic tools and the book "Electronic Experimenter's Manual" to guide you, explore the wonderful world of electronics experimentation. Book features ten big sections, exciting projects and to build and use. \$4.95. Electronics Book Service, One Park Avenue, New York 16, New York.

"COMPUTERS and How They Work" is must reading for career-minded students and electronics pros who want a more complete knowledge of the computer field. A great book. \$4.95. Electronics Book Service, One Park Avenue, New York 16, New York.

Tailor Your Loudspeaker to Your Room (Augsburger) Jan. 38
University "Medallion XII" Speaker System (EW Lab Tested) Nov. 20

STEREO

AcraSound Stereo 120 Amplifier (EW Lab Tested) July 78
Bell 2445 Tuner-Amplifier (EW Lab Tested) Aug. 93
Dual 35-Watt Stereo Amplifier (Jacobs & Jariwala) Mar. 29
Eico ST40 Integrated Stereo Amplifier Sept. 18
Fisher X-1000 Integrated Stereo Amplifier (EW Lab Tested) Nov. 20
Harman-Kardon "Citation IV" Stereo Control Center (EW Lab Tested) Apr. 92
H. H. Scott Model LK-72 Stereo Amplifier Kit (EW Lab Tested) June 90
"Knight" 75-Watt Stereo Amplifier (EW Lab Tested) May 66
Lafayette Model KT-550 100-Watt Stereo Power Amplifier (EW Lab Tested) June 91
Listening to Stereo with Headphones (Hahn) Nov. 48
Phasing the Stereo System (Glasgal) Nov. 52
Reverberation in Principle & Practice (Owen) Jan. 44
Stereo-Headphone Amplifier (Voss) Aug. 31
Stereosonic Model PH-1 Phase Coordinator (EW Lab Tested) Oct. 22

STEREO FM MULTIPLEX

FM Multiplexing (Editorial) July 6
N.Y. Hi-Fi Show & FM Multiplex (Editorial) Nov. 6
Stereo FM Multiplex Adapter Circuit (Courtney) Dec. 37
Stereo FM Multiplex Adapter Circuits (Snitzer) Oct. 40
Stereo FM Multiplex Adapter Circuits (Snitzer) Nov. 37
Stereophonic FM Multiplex System (van Recklinghausen) July 51

TAPE RECORDING

Automatic Sound Switch for Tape Recorders (Calvert) July 74
Checking Tape Recorder Heads (James) Jan. 86
Dynaco Models 50 & 53 Stereo Microphones (EW Lab Tested) Mar. 111
Four-Channel Stereo Adds Depth to Tapes (Hogan) May 29
Four-Channel Tape & Reader-Service Coupon (Editorial) May 6
Four-Track Tape System—Record Preamps (Part 1) (Buegel) Mar. 39
Four-Track Tape System—Playback Preamps (Part 2) (Buegel) Apr. 58
Selecting a Tape Machine (Burststein) Sept. 62
Tape Loops for Language Labs (Fajardo) Sept. 61

TELEVISION

MISCELLANEOUS

Challenge of Color (Editorial) Mar. 6
Coast-to-Coast TV is 10 Years Old Dec. 49
Color TV Service Today (Tepfer) Apr. 29
Mac's Service Shop (Frye) Sept. 60
Making Colors Electronically (Cover Story) Apr. 43
New Broadband TV Antenna (Harris) Dec. 62
New TV Designs for 1961 (Buchsbaum) Feb. 34
Sets of the Seventies Aug. 85
Soviet Radios & TV Sets: How Good Are They? (Hannah) Mar. 58

SERVICE NOTES

Add A.F.C. to TV Sets (Wilson, Sr.) July 48
Home-Call TV Diagnosis (Buchsbaum) Apr. 33
Interference Tough Dogs (Oberto) Apr. 40
New Horizontal Oscillator for TV (Stern) Sept. 57
1 Compactron, 3 Circuits (Silver) July 43
Personal, Portable TV (Cover Story) Nov. 38
Series "B+" Circuits (Webster) Aug. 34
Simple Sync Servicing (Lemons) Dec. 40

Speed-Checking I.F. Systems (Webster) May 38
U.H.F. NuVistor Tuner (Zimmerman) Dec. 60
Where Did the Gain Go? (Bramham) Jan. 42

TEST EQUIPMENT

APPLICATIONS

Accurate Peak A.C. Measurements (Barn) Jan. 66
Calibration Standards for the V.O.M. (Jaski) Oct. 51
Changes in WWV Standard Broadcasts Apr. 51
Eico Model 260 A.C. Volt-Watt Meter (EW Lab Tested) Nov. 105
Hum Elimination in Scapes (Rauscher) July 46
Is Your Multimeter Accurate? (Jaski) Feb. 32
Knowing and Using the Signal Tracer (Dezettel) Feb. 50
Lafayette KT-174 V.T.V.M. Kit (EW Lab Tested) Aug. 94
Measure D.C. With Your Scope (Bishop) June 42
New Tube Tester Data (RCA Model WT-110A) May 106
New Tube Tester Data (Triplet Model 3423) Jan. 80
RCA Model WV-120A Power-Line Monitor (EW Lab Tested) Nov. 104
R-C Bridges: Operation and Repair (Anderson) Jan. 50
Sencore "Mighty Mite" TC109 Tube Checker (EW Lab Tested) Jan. 103
Sencore "Transi-Master" (EW Lab Tested) July 79
Tips on Tuning-Eye V.T.V.M.'s (Shields) Feb. 66
Ultra-Low Resistance Measurements (Jaski) Mar. 56
Voltage Dividers Made Easy (Kyle) Mar. 42
World Adopts New Length Standard Feb. 107

CONSTRUCTION

"Audio Check" (Shields) Jan. 56
Citizens Band Crystal Checker (Reed) Nov. 57
D.C. Voltage Calibrator (Morgan) May 43
Electronic Resistive Load (Gephart) Mar. 50
Expanded-Range Voltmeter Reads R.M.S. (Lederer) Feb. 41
Modulated 10-kc. Calibration Oscillator (Ives) Dec. 55
Novel Glow-Lamp Pulse Generator (Robbins) June 46
Outboard VU Meter (Reed) June 54
Resistance Substitutor (Bernstein-Bervery) Feb. 57
Simple Crystal Mixer (David) Apr. 85
Simple Electronic Engine Analyzer (Lebowitz & Sonkin) Apr. 38
Simple Square-Wave Generator (Miller) July 54
Standing-Wave Indicator for CB Testing (Reed) Nov. 51
Transistor Frequency Standard (Stoner, W6TNS & Earnshaw, ZL1AAX) Sept. 36
Transistorized Megohmmeter (Jeffries) May 52
"Trans-Select" Audio Generator (Bammel) Nov. 46
Variable Line-Voltage Isolator (Stone) Jan. 93
Versatile Impedance Checker (Reed) Jan. 33
Wide-Range Inductance Meter (Bethany) May 45

PHOTO CREDITS

Page	Credit
34 (top), 44 (bottom)	RCA
34, 36	International Rectifier Corp.
38	Boeing
39	Motorola Inc.
44 (top)	General Electric Co.
44 (top center)	ITT Federal Labs.
44 (bottom center)	Westinghouse Electric Co.
45 (top)	Dage Div.
45 (left center)	Remington Rand
45 (right center)	Minneapolis-Honeywell
45 (bottom)	E. I. Du Pont
48 (left)	The Machlett Laboratories
48 (center)	Philips Electronic Instruments
60, 61	F. W. Sickles Div.
62	Channel Master Corp.

Servicemen:
**Look to Rad-Tel for the
 newest tube types**

**UP TO 75% OFF
 RAD-TEL'S Quality**

**Brand New
 Tubes**

**1-year
 Guarantee**

**FAST
 ONE-DAY
 SERVICE**

**Every Serviceman
 Should Stock These
 Popular New Tube Types
 Offered by RAD-TEL**



Qty.	Type	Price	Qty.	Type	Price	Qty.	Type	Price
—	1G3	.79	—	GCE5	.57	—	7EY6	.73
—	1J3	.79	—	GCK4	.70	—	12D4	.69
—	1K3	.79	—	GCM8	.90	—	12DT5	.76
—	2EN5	.45	—	GCY5	.70	—	12DT7	.79
—	3DG4	.85	—	GDA4	.68	—	12DT8	.79
—	3DK6	.60	—	GDT8	.79	—	12DW8	.89
—	5AS8	.86	—	GE85	.72	—	12EM6	.79
—	5BT8	.83	—	GEM5	.76	—	12EN6	.78
—	5CM8	.90	—	GEY6	.75	—	18FW6	.49
—	5CZ5	.72	—	GGK6	.79	—	18FX6	.53
—	6AX8	.92	—	GGN8	.94	—	18FY6	.50

**SEND FOR FREE TROUBLE SHOOTING
 GUIDE AND NEW TUBE & PARTS CATALOG**

TERMS: 25% deposit must accompany all orders, balance C.O.D. Orders under \$5: add \$1 handling charge plus postage. Orders over \$5: plus postage. Approx. 8 tubes per 1 lb. Subject to prior sale. Prices subject to change. No C.O.D.'s outside continental U.S.A.



RAD-TEL TUBE CO.

DEPT EW-1261 55 CHAMBERS STREET, NEWARK 5, NEW JERSEY

EACH TUBE INDIVIDUALLY & ATTRACTIVELY BOXED & BRANDED RAD-TEL

Qty.	Type	Price	Qty.	Type	Price	Qty.	Type	Price	Qty.	Type	Price
—	DZ4	.79	—	6AF4	.97	—	6EW6	.57	—	12C5	.56
—	1AX2	.62	—	6AG5	.68	—	6F5GT	.39	—	12CN5	.56
—	1B3	.79	—	6AH4	.81	—	6F6	.69	—	12CR6	.54
—	1DN5	.55	—	6AH6	.99	—	6FE8	.75	—	12CU5	.58
—	1L4	.68	—	6AK5	.95	—	6GH8	.80	—	12CU6	1.06
—	1R5	.62	—	6AL5	.47	—	6H6	.58	—	12CX6	.54
—	1S2A	.76	—	6AL7	1.43	—	6J5GT	.51	—	12DB5	.69
—	1S4	.59	—	6AM4	1.50	—	6J6	.67	—	12DE8	.75
—	1S5	.51	—	6AM8	.78	—	6K6	.63	—	12DL8	.85
—	1T4	.58	—	6AQ5	.53	—	6L6	1.06	—	12DQ6	1.04
—	1U4	.57	—	6AR5	.55	—	6N7	.98	—	12DS7	.79
—	1U5	.50	—	6AS5	.60	—	6S4	.51	—	12DU7	1.01
—	1V2	.50	—	6AS6	.80	—	6SA7GT	.76	—	12DW8	.89
—	1X2B	.82	—	6AT6	.43	—	6SG7GT	.41	—	12DZ6	.56
—	2AF4	.96	—	6AT8	.79	—	6SH7GT	.49	—	12E05	.69
—	2BN4	.64	—	6AU4	.82	—	6SJ7	.88	—	12EG6	.54
—	2EA5	.70	—	6AU6	.52	—	6SK7GT	.74	—	12EK6	.56
—	2E55	.68	—	6AU7	.61	—	6SL7GT	.80	—	12EL6	.50
—	3A3	.76	—	6AU8	.87	—	6SM7GT	.65	—	12EZ6	.53
—	3A4	.60	—	6AV6	.41	—	6SQ7	.73	—	12F8	.66
—	3AF4	1.02	—	6AW8	.90	—	6T4	.99	—	12FAG	.79
—	3AL5	.42	—	6AX4	.66	—	678	.85	—	12FME	.43
—	3AU6	.51	—	6AX5	.74	—	6U8	.83	—	12FR8	.91
—	3AV6	.41	—	6AX7	.64	—	6VGGT	.54	—	12FX8	.85
—	3BA6	.51	—	6BA6	.50	—	6V8	.86	—	12GC6	1.06
—	3BC5	.54	—	6BA7	.84	—	6W4	.60	—	12H8	.84
—	3BE6	.52	—	6BA8	.88	—	6W6	.71	—	12K5	.65
—	3BN6	.76	—	6BC5	.61	—	6X4	.39	—	12L6	.58
—	3BU8	.78	—	6BC7	.94	—	6X5GT	.53	—	12SA7	.92
—	3BY6	.55	—	6BC8	.97	—	6X8	.80	—	12SF5	.50
—	3BZ6	.55	—	6B05	1.25	—	6Y6G	.65	—	12SF7	.69
—	3CB6	.54	—	6BE6	.55	—	7A8	.68	—	12SM7	.49
—	3CF6	.60	—	6BF5	.90	—	7AU7	.61	—	12SJ7	.67
—	3CS6	.52	—	6BF6	.44	—	7B6	.69	—	12SK7	.74

NOT AFFILIATED WITH ANY OTHER MAIL ORDER TUBE COMPANY

—	3DT6	.50	—	6BG6	1.66	—	7F8	.90	—	12SL7	.80
—	3Q4	.63	—	6BH6	.65	—	7N7	.90	—	12SN7	.67
—	3Q5	.80	—	6BH8	.87	—	7S7	1.01	—	12SQ7	.78
—	3S4	.61	—	6BJ6	.62	—	7Y4	.69	—	12U7	.62
—	3V4	.58	—	6BJ7	.79	—	8AU8	.83	—	12V6	.53
—	4AU6	.54	—	6BK7	.85	—	8AW8	.93	—	12W6	.69
—	4BA6	.51	—	6BL7	1.00	—	8BQ5	.60	—	12X4	.38
—	4BC5	.58	—	6BN4	.57	—	8CG7	.62	—	17AX4	.67
—	4BC8	.96	—	6BN6	.74	—	8CM7	.68	—	17BQ6	1.09
—	4BN6	.75	—	6BQ5	.65	—	8CN7	.97	—	17D4	.69
—	4BQ7	1.01	—	6BQ6	1.05	—	8CS7	.74	—	17DE4	.74
—	4BS8	.98	—	6BQ7	1.00	—	8CX8	.93	—	17DQ6	1.06
—	4BU8	.71	—	6BR8	.78	—	8EB8	.94	—	17L6	.58
—	4BZ6	.58	—	6BS8	.90	—	8SM7	.66	—	17W6	.70
—	4BZ7	.96	—	6BU8	.70	—	9CL8	.79	—	19AU4	.83
—	4BZ8	1.10	—	6BX7	1.02	—	11CY7	.75	—	19B66	1.39
—	4CS6	.61	—	6BY5	1.15	—	12A4	.60	—	19C8	1.14
—	4DE6	.62	—	6BY6	.54	—	12AB5	.55	—	19T8	.80
—	4DK6	.60	—	6BY8	.66	—	12AC6	.49	—	19Y8	.79
—	4DT6	.55	—	6BZ6	.55	—	12AD6	.57	—	21EX6	1.49
—	4EW6	.58	—	6BZ7	1.01	—	12AE6	.43	—	25AV5	.83
—	5AM8	.79	—	6BZ8	1.09	—	12AE7	.94	—	25AX4	.70
—	5AN8	.86	—	6C4	.43	—	12AF3	.73	—	25BK5	.91
—	5AQ5	.52	—	6C8	.90	—	12AF6	.49	—	25BQ6	1.11
—	5AT8	.80	—	6CB6	.55	—	12AJ6	.46	—	25C5	.53
—	5AV8	1.01	—	6C06	1.42	—	12AL5	.45	—	25CA5	.59
—	5AZ4	1.41	—	6CF6	.64	—	12AL8	.95	—	25CD6	1.44
—	5BC8	.79	—	6CG7	.61	—	12AQ5	.60	—	25CU6	1.11
—	5BE8	.83	—	6CG8	.77	—	12AT6	.43	—	25DN6	1.42
—	5BK7	.87	—	6CL8	.79	—	12AT7	.76	—	25EH5	.55
—	5BQ7	.92	—	6CM6	.64	—	12AU6	.51	—	25L6	.57
—	5BR8	.79	—	6CM7	.66	—	12AU7	.60	—	25W4	.68
—	5CG8	.76	—	6CN7	.65	—	12AV6	.41	—	25Z6	.66
—	5CL8	.76	—	6CQ8	.84	—	12AV7	.75	—	32ET5	.55
—	5CQ8	.84	—	6CR6	.51	—	12AX4	.67	—	32L7	.90
—	4CY5	.71	—	6CS6	.57	—	12AX7	.63	—	35B5	.60
—	5EA8	.80	—	6CS7	.69	—	12AY7	1.44	—	35C5	.51
—	5EU8	.80	—	6CU5	.58	—	12AZ7	.86	—	35L6	.57
—	5J6	.68	—	6CU6	1.08	—	12B4	.63	—	35W4	.42
—	5T4	.79	—	6CY7	.71	—	12BA6	.50	—	35Z5	.60
—	5T8	.81	—	6D85	.69	—	12BA7	.84	—	36AM3	.36
—	5U4	.60	—	6D86	.51	—	12B06	.50	—	50B5	.60
—	5U8	.81	—	6D86	.58	—	12B66	.53	—	50C5	.53
—	5V3	.90	—	6D86	.59	—	12B66	.44	—	50EM5	.55
—	5V6	.56	—	6D86	.59	—	12BH7	.77	—	50L6	.61
—	5X8	.78	—	6D86	1.55	—	12BK5	1.00	—	57A4	1.50
—	5Y3	.46	—	6D86	1.10	—	12BL6	.56	—	57G3	1.00
—	5Y4	.59	—	6D86	.53	—	12BQ6	1.06	—	57H4	1.50
—	6AG8	1.20	—	6EA8	.79	—	12BR7	.74	—	70L7	.97
—	6BA4	.46	—	6E88	.94	—	12B77	.78	—	70Z5	.69
—	6AC5	1.05	—	6EM7	.82	—	12B77	.77	—	84/624	.46
—	6AC7	.96	—	6EU8	.79	—	12BZ7	.75	—	807	.70
—	6AF3	.73	—			—			—	117Z3	.61

ADVERTISERS' INDEX DECEMBER, 1961

Advertisers listed below have additional information available on their products in the form of catalogues and bulletins. To obtain more detailed data, simply circle the proper code number in the coupon below and mail it to the address indicated. We will direct your inquiry to the manufacturer for processing.

CODE NO.	ADVERTISER	PAGE	CODE NO.	ADVERTISER	PAGE	CODE NO.	ADVERTISER	PAGE
100	Advance Electronics	96	134	General Electric	63	164	Philco Technological Center	114
101	Allied Radio	29	135	Goodheart Co., R. E.	111	165	Picture Tube Outlet	114
102	Allied Radio	81	136	Grantham School of Electronics	5			
103	Ashe Radio Company, Walter	76	137	Greenlee Tool Co.	113	166	Quietrole Company	72
104	Aubanel Publishers	84	138	Grommes Div. Precision Electronics, Inc.	99			
105	Audion	114				167	RCA Institutes, Inc.	85, 86
			139	Heath Company	74, 75	168	R W Electronics	95
106	B & K Manufacturing Co.	11	140	Henshaw Radio Supply	114	119	Rad-Tel Tube Co.	119
	Bell Telephone Laboratories	28					Radio Corporation of America	FOURTH COVER
108	Benjamin Electronic Sound Corp.	24	141	Indiana Technical College	98		Radio Corporation of America	18
109	Browning	87	142	International Radio & Electronics Corp.	87	171	Rex Radio Supply Co.	92
110	Burstein-Applebee Co.	83	143	International Rectifier Corp.	94			
				International Rectifier Corp.	99	172	Sams & Co., Inc., Howard W.	19
111	C & H Sales Co.	90	144	Jackson Electrical Instrument Company	89	173	Sarkes Tarzian Inc.	94
112	Capitol Radio Engineering Institute, The	66, 67, 68, 69	145	Johnson Company, E. F.	91	118	Saxitone Tape Sales	94
113	Carston	94				174	Scott Inc., H. H.	73
114	Central Technical Institute	21	146	Kaar Engineering Corp.	115	175	Sencore	27
115	Channel Master	12, 13	147	Key Electronics Co.	72	176	Smith, Electronics Designs, Wardell	114
116	Cleveland Institute of Electronics	7				177	Sonar Radio Corporation	95
117	Columbia Electronics	107	148	Lafayette Radio	16, 17	178	Sprague Products Co.	2
118	Commissioned Electronics Co., Inc.	94	149	Lampkin Laboratories, Inc.	72	179	Standard Kollsman Industries, Inc.	THIRD COVER
119	Coyne Electrical School	109				180	Stern Co., H. D.	92
			150	McGee Radio Co.	100		Sylvania Electric Products	SECOND COVER
120	Dressner	115	151	Mark Mobile, Inc.	112	182	Tech-Master	94
121	Dynaco Inc.	4	152	Micro Electron Tube Co.	98	183	Texas Crystals	96
			153	Milwaukee School of Engineering	78	184	Transvision Electronics, Inc.	14
122	E.C.J. Electronics Communications, Inc.	23	154	Moog Co., R. A.	113		Transvision Electronics, Inc.	70
123	EICO	32	155	Moss Electronic, Inc.	102, 103, 104, 105	185	Tri-State College	107
124	Editors & Engineers, Ltd.	113				186	Triton Electronics, Inc.	6
125	Electro-Voice, Inc.	30, 31		National Radio Institute	25, 26	187	Tru-Vac	93
126	Electronic Chemical Corp.	100	158	National Radio Institute	112			
127	Electronics Book Service	101		National Technical Schools	15	188	U. S. Crystals, Inc.	93
128	Esse Radio Company	95	159	Oelrich Publications	115	189	University Loudspeakers, Inc.	1
			160	Olson Electronics	88	190	Valparaiso Technical Institute	114
129	Fair Radio Sales	115	161	Ortofon	97			
130	Fairchild Recording Equipment Corp.	73	162	Pacotronics, Inc.	8, 9, 10	191	Warren Dist. Co.	114
131	Federal Electric Corp.	22	163	Peak Electronics Company	110	192	Winegard Antenna Systems	77
132	Fisher Radio Corporation	71				193	Winegard Antenna Systems	79
133	G & G Radio Supply Co.	116						

The coupon below can also be used to obtain additional information on the new product items shown on pages 106 through 111 as well as on the ads as listed above.

VOID AFTER DEC. 31, 1961	NAME _____
	STREET NO. _____
	CITY _____ ZONE _____ STATE _____
ADVERTISED PRODUCTS (SEE INDEX ABOVE)	100 101 102 103 104 105 106 107 108 109 110 111 112 113 114 115 116 117 118 119 120 121 122 123 124 125 126 127 128 129 130 131 132 133 134 135 136 137 138 139 140 141 142 143 144 145 146 147 148 149 150 151 152 153 154 155 156 157 158 159 160 161 162 163 164 165 166 167 168 169 170 171 172 173 174 175 176 177 178 179 180 181 182 183 184 185 186 187 188 189 190 191 192 193 194 195 196 197 198 199 200 201 202 203 204 205 206 207 208 209 210 211 212 213 214 215 216 217 218 219 220 221 222 223 224 225 226 227 228 229 230 231 232 233 234 235 236 237 238 239
	1 2 3 4 5 6 7 8 9 10 11 12 13 14 15 16 17 18 19 20 21 22 23 24 25 26 27 28 29 30 31 32 33 34 35 36 37 38 39 40 41 42 43 44 45 46 47 48 49 50 51 52 53 54 55 56 57 58 59 60
NEW PRODUCTS & LITERATURE	
MAIL TO ELECTRONICS WORLD P.O. BOX 212 VILLAGE STATION NEW YORK 14, N.Y.	INDICATE NUMBER OF ITEMS REQUESTED <input type="checkbox"/>

 Make sure that your name and address are printed clearly.

ELECTRONICS WORLD READER SERVICE COUPON

Standard Made It...

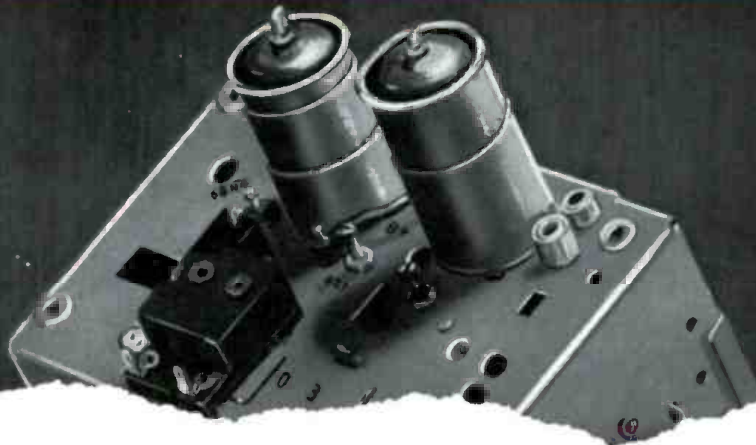

STANDARD CAN FIX IT BEST



\$11⁵⁰ Plus Parts . . . \$13.50 Maximum Total Cost

FREE Specially designed shipping cartons to prevent damage in transit

**6 Months
GUARANTEE**

Only BRAND NEW PARTS Used • 48 Hour
Service on All STANDARD Tuners • Latest
Testing Techniques Assure Proper Alignment •
\$3.00 Defective Tuner Trade-In Allowance
Against a New STANDARD Replacement Tuner
Carrying a 12 MONTH GUARANTEE

IN TV IT'S *Standard*

STANDARD has maintained uniform mounting centers for the last 13 years. Over 50% of the TV sets in existence today have STANDARD tuners—in the case of most other tuners one of the 8 STANDARD replacement models can be easily adapted or will fit directly in place of these units. All STANDARD replacement tuners carry a 12 Month Guarantee.

**SEE YOUR AUTHORIZED
STANDARD DISTRIBUTOR**

MORE PROFIT FOR THE SERVICE DEALER • GREATER CUSTOMER SATISFACTION
GUARANTEED BY THE WORLD'S LARGEST TV TUNER MANUFACTURER

standard kollman INDUSTRIES INC.

FORMERLY STANDARD COIL PRODUCTS CO., INC., MELROSE PARK, ILLINOIS



HOW SILVERAMA BECOMES "SILVER"

High-Vacuum Aluminizing Assures Sharpest TV Picture Possible

Here RCA Silverama picture tubes become "silver" at the aluminizing station on our Marion, Indiana, production line. In a burst of light, aluminum is vaporized in a high vacuum and is deposited over the entire inner surface of the tube. Then the operator, with an RCA-designed electronic gauge, checks to be sure the aluminum film is of proper thickness. If it is not, the tube is rejected.

Such extra care in manufacture is an important reason why the Silverama you install today is free from "picture-spoiling" dark centers caused by an excess of aluminum deposited on the tube face. This extra care is the reason, too, why Silverama delivers

the brightest, sharpest picture your customers' sets can produce. Obviously, Silverama picture tube service is the surest way toward satisfied customers, repeat business, favorable word-of-mouth advertising for you—plus freedom from call backs and costly in-warranty failures.

Equally important is the fact that RCA is a picture tube manufacturer. This means that your customers can take advantage of the latest innovations in picture tube design and manufacture when they buy RCA Silverama. It is made with a precision electron gun, the finest parts and materials, plus a reused envelope.



Final checkout before shipment. Here Silverama tubes receive final focus check before being shipped to customers.



Packing for final shipment. Before it can go into this box, RCA has made certain this Silverama is the best picture tube modern science and technology can produce.

RCA ELECTRON TUBE DIVISION, HARRISON, N. J.



The Most Trusted Name in Television

www.americanradiohistory.com