

Electronics World

OCTOBER, 1961
50 CENTS

**NEW BATTERIES —
Designs & Applications**

**FM MULTIPLEX
ADAPTER CIRCUITS**

**ION GENERATOR
FOR THE HOME**

**LOUDSPEAKER TESTING
AND MEASUREMENTS**

**SUPER-POWER
V.H.F. TUBES**



MADE IN U.S.A.
SACHS
2244 N. 15TH ST.
PHILADELPHIA, PA.





18FW6A
 18FX6A
 18FY6A
 32ET5A
 36AM3B

SYLVANIA BEATS THE HEAT

Familiar numbers, aren't they? But the "A" and "B" versions are brand-new . . . introduced by Sylvania to help you hold onto your home radio service profits.

The 100-mA heater concept, pioneered by Sylvania, offers "cool" operation in series-string connection. But "series-string," as you know, can be pretty hard on heaters at the instant of "turn-on"; can shorten tube life; can mean a callback. Now, Sylvania has incorporated significant controls on warm-up time of the heaters. Surge voltages on any one heater in this 5-tube complement are therefore minimized, expectant tube life is extended. Benefits to you? Obvious . . . high probability of mighty few callbacks due to *Sylvania tube* failure.

You too can beat the heat of profit-burning callbacks. Don't just order "tubes." Always order SYLVANIA TUBES. Electronic Tubes Division, Sylvania Electric Products Inc., 1740 Broadway, New York 19, N. Y.

New, improved 100-mA AC-DC tubes feature controlled heater warm-up time . . . increased heater life . . . defeat profit-burning callbacks!



SYLVANIA

SUBSIDIARY OF

GENERAL TELEPHONE & ELECTRONICS



It's taking the country by storm

THE MIGHTY MITE



With thundering applause... here's what they say...

- "It is the best tube tester I have ever owned."
F. M., MONROE, LA., TV TECHNICIAN
- "It's a real asset to any serviceman." (35 years in servicing)
C. H. W., EAST PRAIRIE, MO., TV TECHNICIAN
- "This is the best checker I have ever used."
E. L. R., HASTINGS, MICH., TV TECHNICIAN
- "A must for every serviceman. A real Time Saver at a reasonable price."
W. P., ERIE, PA., TV TECHNICIAN
- "The most complete and reliable instrument I ever bought for this price."
H. P. R., QUEBEC, CANADA, TV TECHNICIAN
- "I already own one. This is my second Mighty Mite."
PHILCO DISTRIBUTOR, ST. LOUIS, MO.
- "Mighty Mite has paid for itself the first month."
W. C., UNIONTOWN, PA., TV REPAIR
- "I have found the Mighty Mite all that you say it is and more. It tests tubes that my other tester, costing twice as much, will not test."
L. K. E., W9PWQ, CHICAGO, HAM

Don't be misled... there's only one Mighty Mite!

MAGAZINE TEST LABS SAY...

PF Reporter, Nov., 1960, page 65...
"When putting the Model TC109 to work in the lab, I tried to 'trip up' the tester by throwing a few curves at it. Using my prized collection of rejected tubes that have mostly 'tough dog' defects, I proceeded with the tests given in the Sencore instructions." The results: The Mighty Mite found every trouble, even the toughest.

Les Deane

Electronics World, Jan., 1961, page 103...
"We checked two dozen tubes known to be defective. Many had been passed as 'good' by other testers. Each failed at least one of the three tests provided by the TC109. On the other hand, every new tube previously known to be in good condition checked good on the Mighty Mite."



In a nut shell... here's why the Mighty Mite finds them all. It checks tube grid circuits with the same high sensitivity as the indispensable Sencore LC3 Leakage Checker; yet it checks emission, leakage and shorts just like the big, expensive testers. That's why we call it the Mighty Mite... you can't miss!

ONLY **59⁵⁰**
DEALER NET

Your Distributor

has them in stock



ALL PARTS MADE **SENCORE** IN AMERICA

SENCORE
ADDISON 2, ILLINOIS

Announcing... **NEW MIGHTY MITE II**
Identical to TC 109 Mighty Mite with addition of 4 sockets for testing compactrons, nuvistors, novars and 10 pin tubes.
Model TC114... Dealer Net **67⁵⁰**

Here's the
one and only
speaker system
you will
ever want



Compare the
new University
Classic Mark II
to all other systems—
regardless of price.

We could list the new CLASSIC's complete specifications. We could commission a poet to describe the sound and the cabinet. Both good ideas, but quite inadequate to the task, for the new CLASSIC is a *living* instrument. You must *hear* it to know why it is the most important speaker system available today. You must compare it to *all* other makes to eliminate any doubt that here is the only system you will ever want.

For large rooms, small rooms—for today and tomorrow—here is the first *sensibly* designed big sound system in

years. It creates a sense of spaciousness typical of yesterday's massive systems—but without making their space demands, and without sacrificing the intimate sonics and texture necessary for the full enjoyment of soloists and small musical ensembles.

A "major acoustic achievement," as many experts have declared. But you decide for yourself. At any quality high fidelity dealer. \$295.00.

3-WAY SPEAKER SYSTEM: high compliance 15" woofer; 8" direct-radiator mid-range; Sphericon super-tweeter. RESPONSE: 20 to 40,000 cps. POWER

REQUIREMENTS: any quality amplifier rated from 10 to 60 watts. DIMENSIONS: 35" x 28 1/4" and 17 1/2" deep!

Write for the fully-documented CLASSIC MARK II brochure and University's "Informal Guide to Component High Fidelity." Desk S-10, University Loudspeakers, Inc., 80 S. Kensico Ave., White Plains, New York.

Timeless Beauty and the Sound of Truth



A Division of Ling-Temco Electronics, Inc.

CONTENTS

INDUSTRIAL

| | | | |
|---------------------------------|--|--------------------------|------------|
| | The Electronics "Technician" (Editorial) | W. A. Stocklin | 8 |
| | New Batteries—Progress or Confusion? | D. B. Cameron | 33 |
| | <i>Design, characteristics, and applications of the new alkaline-manganese and sealed-nickel-cadmium type batteries.</i> | | |
| | Super-Power V.H.F. Tubes (Cover Story) | R. E. Reed & A. C. Tunis | 37 |
| | Recent Developments in Electronics | | 38 |
| <i>Publisher</i> | Electronically Controlled Clothes Dryer | John C. Britson | 57 |
| PHILLIP T. HEFFERNAN | <i>A new electronic circuit which "feels" the fabric to determine moisture content.</i> | | |
| <i>Editor</i> | Electro-Mechanical Switching in Automation | Ken Bramham | 58 |
| WM. A. STOCKLIN, B. S. | Solid-State I.F. Transformer | | 64 |
| <i>Technical Editor</i> | Marine Radios to Double in 5 Years | | 103 |
| MILTON S. SNITZER, W2QY1 | Variable Time-Delay Relay | C. J. Faust, Jr. | 107 |

Service Editor
SIDNEY C. SILVER

Associate Editor
P. B. HOEFER

Editorial Consultant
OLIVER READ, D.Sc., W4TWV

Industrial Consultant
WALTER H. BUCHSBAUM

Art Editor
MILTON BERWIN

Art and Drafting Dept.
J. A. GOLANEK

Advertising Sales Manager
LAWRENCE SPORN

Advertising Service Manager
ARDYS C. MORAN

TEST EQUIPMENT

| | | |
|---|-----------|-----------|
| Calibration Standards for the V.O.M. | Tom Jaski | 51 |
| Product Test Report (Eico Model 1064 Power Supply) EW Lab Tested | | 86 |

HI-FI AND AUDIO

| | | |
|---|---------------------|------------|
| Product Test Report (DuKane DuK-30 Speaker System, Stereosonics PH-1 Phase Coordinator, Hartley "Holton" Speaker System) EW Lab Tested | | 20 |
| Stereo FM Multiplex Adapter Circuits | Milton S. Snitzer | 40 |
| <i>Schematics of four commercial units with details on their operation.</i> | | |
| Loudspeaker Testing and Measurement | Edgar Villchur | 42 |
| <i>While listening tests are important, a speaker's performance can be predicted from properly made and interpreted test measurements.</i> | | |
| TV Music and the Broadcast Technician | Wayne Brandt | 45 |
| <i>Complete job analysis of what an audio technician encounters in the way of equipment, working conditions and promotion opportunities in a television studio.</i> | | |
| Impedance Matching in Public-Address Systems— | | |
| Part 2 High-Z Loudspeaker Lines | Mortimer S. Sumberg | 53 |
| Reducing FM Multipath Distortion | Patrick Halliday | 104 |

GENERAL

| | | |
|---|---------------|-----------|
| Ion Generator & Electrostatic Air Filter for the Home | R. E. Patrie | 48 |
| <i>Design and construction of a unit that can be home-built. Unit cleans air and generates ions and can be installed in any warm-air furnace.</i> | | |
| Marine Electronic Service: Depth Sounders (Part 2) | R. E. Roetger | 60 |

COMMUNICATIONS

| | | |
|---|----------------------|-----------|
| Vertical Antenna Base Insulator | Howard S. Pyle, W70E | 80 |
| Product Test Report (Columbian Hydrosonics "Aqua-Probe") EW Lab Tested | | 86 |

MONTHLY FEATURES

| | | |
|---|------------------|------------|
| Letters from Our Readers | | 10 |
| Mac's Service Shop | John T. Frye | 52 |
| Within the Industry | | 74 |
| Service Industry News | | 100 |
| Acoustics Anagram | John A. Comstock | 108 |
| New Products and Literature for the Electronics Technician | | 116 |
| (For Information on Next Month's Features, see page 4) | | |



ZIFF-DAVIS PUBLISHING COMPANY
Editorial and Executive Office
One Park Avenue
New York 16, New York
ORegon 9-7200

MIDWESTERN and CIRCULATION
OFFICE
434 South Wabash Avenue
Chicago 5, Illinois
WAbash 2-4911
Midwestern Advertising Manager
Gilbert J. Jorgenson

WESTERN OFFICE
9025 Wilshire Boulevard
Beverly Hills, California
CRestview 4-0265
Western Advertising Manager
Bud Dean

FOREIGN ADVERTISING
REPRESENTATIVE
D. A. Goodoll Ltd., London, England

PREPARE NOW FOR A
SECURE AND PROFITABLE CAREER
IN ONE OF THESE GROWING FIELDS
OF ELECTRONICS



Learn with proven home study courses from the Philco Technological Center. Get practical knowledge with courses developed by specialists in electronics and training . . . men who know the kind of knowledge you need.

Choose from five courses:

1. Semiconductors—Transistor Principles and Practices. Learn theory, construction, applications of all types of transistors.
2. Introduction to Analog Computers—Covers theories and fundamentals of analog computers.
3. Analog Computer Systems (Advanced Level)—Covers the analog system concepts and methods.
4. Automatic Digital Computers—Digital computer theory, maintenance, installation, basic programming.
5. Programming for Digital Computers—Covers encoding, set-up and operation.

**MAIL COUPON TODAY
FOR FREE INFORMATION**

Philco TechRep Division
P.O. Box 4730
Philadelphia 34, Penna.

E-4

I'm interested in Semiconductors Analog computers Analog computer systems Digital computers Computer programming. Please send free information to:

Name _____
Address _____
City _____ Zone _____
State _____

PHILCO
TECHNOLOGICAL CENTER
P.O. Box 4730, Philadelphia 34, Pa.



**COMING
NEXT MONTH**

Electronics World

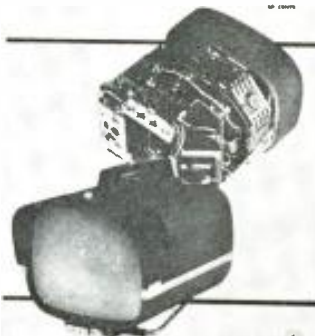

PERSONAL PORTABLE TV

Details on the Sony 8-301 transistorized 8-inch television receiver. Since it can operate from either the a.c. power line or rechargeable batteries, the set is a true portable.

ADVANCES IN MEDICAL ELECTRONICS

Here are some of the unusual ways in which electronics is being teamed with medicine in order to give us a better understanding of life processes.

**LISTENING TO STEREO
WITH HEADPHONES**

This method has advantages of lower cost, reduced power requirements, and freedom from room acoustics problems. A complete directory of available headphones with prices and specifications is included.

**COMPUTER REGISTERS
AND ACCUMULATORS**

Circuits and techniques for holding and transferring binary information and for performing basic mathematical operations.

INDUSTRIAL X-RAY APPARATUS

Many tests on materials can be made in no other way or no better way than by

radiographic examination. The variety of methods and equipment are covered, along with details on how such equipment works.

IMPEDANCE MATCHING IN P.A. SYSTEMS

The concluding article in this series covers the constant-voltage method of matching—simple arithmetic is all that is needed to do the job.

**STANDING-WAVE INDICATOR
FOR CB TESTING**

Design of a compact antenna-matching bridge for most efficient power transfer. The circuit requires a minimum number of parts.

**SERVICING TAPE-RECORDER
OSCILLATORS**

In order to insure top performance from a tape recorder the oscillator circuit must operate at peak efficiency. Here is how to check and adjust it.

All these and many more interesting and informative articles will be yours in the November issue of **ELECTRONICS WORLD . . . on sale**

October 17th

ZIFF-DAVIS PUBLISHING COMPANY

William B. Ziff

Chairman of the Board (1946-1953)

William Ziff
President

W. Bradford Briggs
Executive Vice President

Hershel B. Sarbin
Vice President and General Manager

M. T. Birmingham, Jr.
Vice President and Treasurer

Robert P. Breeding
Circulation Director

Charles Housman
Financial Vice President

Member
Audit Bureau of
Circulations



Net Paid Circulation 235,895

Radio & TV News • Radio News • Radio-Electronic Engineering Trademarks Reg. U.S. Pat. Off.

Copyright © 1961 by Ziff-Davis Publishing Company. All rights reserved.

SUBSCRIPTION SERVICE: All subscription correspondence should be addressed to Electronics World, Circulation Department, 434 South Wabash Avenue, Chicago 5, Illinois. Please allow at least six weeks for change of address. Include your old address, as well as new—enclosing if possible an address label from a recent issue.

EDITORIAL CONTRIBUTIONS must be accompanied by return postage and will be handled with reasonable care; however publisher assumes no responsibility for return or safety of art work, photographs, or manuscripts.

ELECTRONICS WORLD

NOW! GRANTHAM SCHOOLS OFFER FIVE DYNAMIC COURSES

F.C.C. LICENSE PREPARATION

WHAT'S IN YOUR FUTURE?

Are you *planning* your future or just drifting into it? Now is the time to get an F.C.C. license. Now is the time to prepare for higher pay — make your future secure.

F.C.C. LICENSE—THE KEY TO BETTER JOBS

An F.C.C. *commercial* license is your ticket to higher pay and more interesting employment. This license is Federal Government evidence of your qualifications in electronics.

GRANTHAM TRAINING PREPARES YOU

Grantham School of Electronics specializes in quality training in communications electronics, preparing students to pass F.C.C. license examinations.

The Grantham Communications Course teaches you to understand electronic theory — teaches you the "why" of electronics.

If you already have practical experience in radio-electronics, the Grantham course can add a knowledge of theory and an F.C.C. license to that practical experience. This should qualify you for higher pay and greater job security.

This course can prepare you *quickly* to pass F.C.C. examinations because it presents the necessary principles of electronics in a simple "easy-to-grasp" manner. Each new idea is tied in with familiar ideas. Each new principle is presented first in simple, everyday language. Then after you understand the "what and why" of a certain principle, you are taught the technical language associated with that principle. You learn more electronics in less time, because we make theory easy and interesting. *NOTE: All necessary math is included in the course.*

INDUSTRIAL ELECTRONICS

TECHNICIANS NEEDED

Today, the need for industrial technicians is greater than ever. There is a particularly great need for technicians who are trained in electronics.

To meet this need, Grantham Schools now offer a complete course in electronics technology. When you graduate from this course, you will be qualified as an Industrial Electronics Technician—you will have a good background of theoretical knowledge and laboratory training.

COURSE DEVELOPED FOR INDUSTRY

As a student of this course you will study subjects that have been prescribed by selected industrial people, who assisted Grantham Schools in developing this course. You will gain knowledge of industrial equipment through a planned program of theory and lab work. You will work on actual industrial control equipment!

ADVANCED ELECTRONICS COURSE

This is an advanced industrial electronics course. This course will qualify you for electronics employment in such fields as aeronautics, computers, industrial controls, manufacturing, microwave, communications, and others. Entrance requirements include basic math, and basic electronics. You may qualify for entrance by successfully passing our entrance examination. (Note: Successful completion of the Grantham F.C.C. License Course qualifies you for entrance without examination.) Write for details.

INSTRUMENTATION

Following completion of the Grantham Industrial Electronics course you will also be qualified for entrance into the Grantham course in Industrial Instrumentation. Write for details.

PRE-ENGINEERING MATHEMATICS

ARE YOU WEAK IN MATH?

Here is a course which provides all the necessary mathematical background for practically any technical course of instruction one may desire to take. It is designed specifically to qualify you for the Grantham course in Engineering Analysis. Starts out with simple arithmetic — covers logarithms, slide rule, algebra, geometry and trigonometry.

COLLEGE LEVEL? HIGH SCHOOL LEVEL?

This is definitely a pre-engineering math course. It starts at the high school level. There are only three requirements: Intelligence, an inquiring mind, and the desire to improve yourself as a professional man.

If you are a high school graduate, you should be able to commence smoothly with Lesson 1 and advance easily through the 15 lessons which comprise this course. While doing this, you will gain new insight into familiar subjects and find yourself picking up new ideas as you go.

ENGINEERING ANALYSIS

A MODERN ENGINEERING COURSE

Engineering Analysis represents a space-age approach to technical education. It presents the entire field of *analysis* in a unified and practical manner. All the mathematics, graphics, applied mechanics and dynamic system analysis that the engineer needs to engage in the exacting and demanding work of our advancing technology are included.

A high school diploma or equivalent, plus completion of the Grantham Pre-Engineering Mathematics course, is required for entrance into this section of the Grantham Engineering Series.

Write for details on this modern approach to technical education.

Grantham Schools

LOS ANGELES

KANSAS CITY

SEATTLE

WASHINGTON

FOUR RESIDENT SCHOOLS

To better serve our many students throughout the entire country, Grantham School of Electronics maintains four Divisions — located in Hollywood, California; Kansas City, Mo.; Seattle, Wash.; and Washington, D.C. Grantham offers rapid courses in F.C.C. license preparation, either by home study or in resident classes.

LOS ANGELES • SEATTLE • KANSAS CITY • WASHINGTON

CORRESPONDENCE OR RESIDENCE CLASSES

Grantham training is available by correspondence or in resident classes. Either way, you are trained quickly and well. Write, or mail the coupon for details on the course you select.

ACCREDITED BY THE NATIONAL HOME STUDY COUNCIL

October, 1961

MAIL COUPON FOR LITERATURE

TO: GRANTHAM SCHOOLS, INC.

NATIONAL HEADQUARTERS OFFICE

1505 N. Western Ave., Hollywood 27, Calif.

16-R

Please send me full details on the course indicated below. I understand that there is no obligation and no salesman will call.

NAME _____ AGE _____

ADDRESS _____

CITY _____ STATE _____

Send details on:

F.C.C. License

Industrial Electronics

Instrumentation

Engineering Math

Engineering Analysis

I am interested in: Home Study Resident Classes



"a CREI home study program helped me feel at home with electronics engineers."

"Since I took a CREI Home Study Program in Electronic Engineering Technology, my pay has increased a great deal and my responsibilities tripled. At present I am Supervisor, Electronic Test Dept. Your course has given me the background to feel at home with Electronics Engineers on the job."

Richard S. Conway
Supervisor, Electronic Test Dept.
Wilcox Electric Co.
Kansas City, Missouri



ELECTRONICS KNOWLEDGE YOU CAN USE. *CREI Home Study preparation gives R. S. Conway the technical background to deal with Engineers as Supervisor, Electronic Test Dept., Wilcox Electric Co.*

INDUSTRY-RECOGNIZED CREI HOME STUDY PROGRAMS PREPARE YOU FOR INCREASED RESPONSIBILITIES AND HIGHER-PAYING POSITIONS IN THE EXPANDING ELECTRONICS FIELD.

THERE IS A CREI PROGRAM TO MEET YOUR NEED. Today thousands of advanced electronics personnel—engineering technicians, engineers, administrators, executives—attribute their present high salaries and positions to their CREI home study of Electronic Engineering Technology. Wherever you go—wherever thorough knowledge of electronic engineering technology is a prime requisite—CREI Home Study students and alumni are welcomed.

TOP SCIENTISTS CONTRIBUTE TO COURSES. More than 20,500 CREI students are presently working in almost every phase of electronics in all 50 states and most countries in the free world. They study courses to which a number of today's leading engineers and scientists have contributed. They are guided and assisted by CREI's staff of experienced instructors. How long it takes to complete a CREI Home Study Program depends on on-the-job experience, the amount of time devoted to study and the program selected.

DEMAND FOR CREI-PREPARED MEN IS GREAT. It far exceeds the supply and has for many years. Specifically designed to prepare you for responsible positions in electronics, CREI texts include the latest advancements in electronics. We invite you to check the thoroughness and completeness of CREI Home Study Programs in the catalog provided on request. They include:

INTRODUCTION TO ELECTRONIC ENGINEERING TECHNOLOGY • ELECTRONIC ENGINEERING TECHNOLOGY • SPECIALIZED COMMUNICATIONS ENGINEERING TECHNOLOGY • SPECIALIZED AERONAUTICAL AND NAVI-



EMPLOYERS GIVE YOU SPECIAL CONSIDERATION for advancement with CREI Home Study preparation. Quality Control Manager Ray V. Smith of Wilcox Electric Co. explains this to CREI alumnus Conway.



PREPARE FOR A SECURE FUTURE in electronics with a CREI Home Study Program. Richard Conway is shown relaxing in his yard with his children. CREI helped further his career, increase his income.

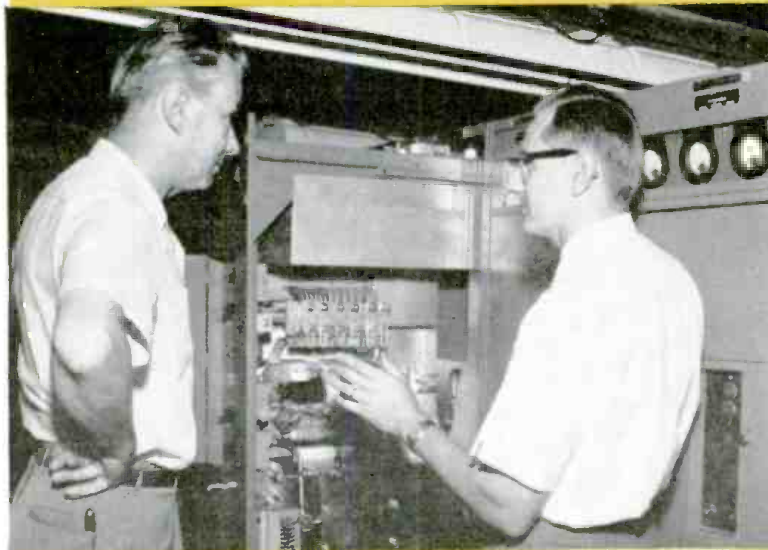

INCREASE YOUR PROFESSIONAL STANDING. A CREI Home Study Program helps you gain new authority and respect. Examining a complex installation with Conway is R. M. Soldanel, a technician at Wilcox Electric Co. who is currently studying a CREI Program at home.



YOUR WHOLE FAMILY SHARES YOUR SUCCESS. Living is better for everyone when you get promotions and advancements through CREI Home Study. Above, Mrs. Conway and their two children, Cynthia and David, share Richard Conway's success.

NATIONAL ENGINEERING TECHNOLOGY • SPECIALIZED TELEVISION ENGINEERING TECHNOLOGY • SPECIALIZED SERVOMECHANISMS AND COMPUTER ENGINEERING TECHNOLOGY • SPECIALIZED ENGINEERING MATHEMATICS • AUTOMATION AND INDUSTRIAL ELECTRONIC ENGINEERING TECHNOLOGY • NUCLEAR ENGINEERING TECHNOLOGY

RATES HIGH WITH INDUSTRY. The high calibre of CREI Home Study Programs is attested to by America's biggest corporations, where CREI students and alumni attain positions ranging from engineering technicians to engineers to top officials. Such companies are National Broadcasting Company, Pan American Airways, Federal Electric Corporation, The Martin Company, Northwest Telephone Company, Mackay Radio, Florida Power and Light, and many others. These companies not only recognize the educational qualifications of CREI men, but often pay all or part of the tuition.

ELECTRONICS HOME STUDY SPECIALISTS. CREI Home Study Programs are the product of 34 years of experience; CREI itself was among the first to have its curricula accredited by the Engineers' Council for Professional Development. Each program is developed with the same painstaking skill and care that CREI put into its World War II electronics courses for the Army Signal Corps, its special radio courses for the Navy, and its post-war group training programs for leading aviation and electronics companies. For those who can attend in person, CREI maintains a Residence School in Washington, D. C., also offering ECPD accredited Technical Institute curricula.

REQUIREMENTS FOR ENROLLMENT. Pre-requisite is high school education or equivalent plus basic electronics training and/or practical electronics experience. (Electronics experience and/or

training not necessary for Residence School.) If you qualify, send for the latest CREI catalog at no cost. Veterans may apply under the G.I. Bill. If doubtful about your qualifications, let us check them for you. Mail coupon or send your qualifications to: The Capitol Radio Engineering Institute, Dept. 1110-H, 3224 Sixteenth Street, N. W., Washington 10, D. C.

—Every COMPLETED Inquiry will be acknowledged.—



The Capitol Radio Engineering Institute

ECPD Accredited Technical Institute Curricula • Founded 1927
 Dept. 1110-H, 3224 16th St., N.W., Washington 10, D.C.
 I am interested in the opportunities offered by the CREI Home Study Programs in Electronic Engineering Technology.

- I believe my qualifications as listed below meet CREI requirements. Please send me your latest catalog at no cost.
- Please check my qualifications below and let me know if I am eligible for CREI Home Study Programs.

CHECK FIELD OF GREATEST INTEREST:

| | |
|---|--|
| <input type="checkbox"/> Servo and Computer Engineering Technology | <input type="checkbox"/> Automation and Industrial Electronic Engineering Technology |
| <input type="checkbox"/> Electronic Engineering Technology | <input type="checkbox"/> Nuclear Engineering Technology |
| <input type="checkbox"/> Aero and Navigational Engineering Technology | |

My educational and Electronics experience qualifications are: (All information held in confidence)

Employed by.....

Type of present work.....

Education: Years High School..... Other.....

Electronics Experience.....

Name..... Age.....

Address.....

City..... Zone..... State.....

Check: Home Study Residence School G.I. Bill

ENJOY THE ETHEREAL MUSIC of the THEREMIN Kits... only \$49.95

Play the THEREMIN without touching it—the movements of your hands around the THEREMIN control both pitch and volume. You, and your friends, will like the fascinating sound of the THEREMIN—the most mysterious, the most modern of musical instruments.

Kit features quality in components and appearance. Parts made by well-known manufacturers. Powered by a single small 6 volt battery. Solid hardwood cabinet with walnut finish. Size: 22 1/2" x 6" x 3 1/4". Antennas of solid aluminum, polished and anodized gold. Pitch range: 5 octaves. Can be used as a sound source with any hi-fi system.



Your THEREMIN is easily assembled from illustrated directions. Also included are suggestions on playing.

This transistorized THEREMIN kit, featured in the Jan. 1961 issue of this magazine, is only \$49.95 plus shipping costs for 9 lbs. Send check or money order to:



R. A. MOOG CO., BOX 263, ITHACA, N. Y.

NEW! Mark II SUPER BEACON with "STATIC SHEATH"

The Ultimate in Citizen Band Base Station Antennas

Improves signal/noise up to 20 DB
by eliminating precipitation static

The new MARK II Super Beacon with exclusive "Static Sheath"* is the most efficient, most rugged 27 mc. base station antenna made! 19 feet overall, MARK II places the radiated signal directly on the horizon for maximum contact with mobile units. The "Static Sheath"* is a protective, highly attractive gray plastic covering that virtually eliminates noisy precipitation static... increases receiver sensitivity up to 20 DB! Furnished with launcher-matcher cable and coax connector; eliminates ground radials or skirts. 50 ohm impedance. Easily installed with clamp mounting.

*U.S. Process Patent 2,938,210

Your Electronic Parts
Distributor has the MARK II in Stock
for Immediate Delivery.

MARK MOBILE, Inc.

Dept. EW-10, 5441 West Fargo Ave.
Skokie, Illinois

MMI



... for the Record

By W. A. STOCKLIN
Editor

THE ELECTRONICS "TECHNICIAN"

AN important fact—one that many of our present readers are not fully aware of—is that this publication has directed its efforts to the electronics technician ever since its founding in 1919. Over the years the industry has, of course, changed and so have the qualifications of the technician. Back in 1919, the electronics industry was confined to amateur radio activities.

From that point we moved rapidly through the hobby stage, to AM radio, FM radio, and television. Directly after World War II, the largest group of electronics technicians was working in servicing consumer products. To this day, this facet of the industry involves an impressive number of technicians and will continue to be an important segment of our readership.

Within the past few years the industry has shown signs of change and, in essence, has grown up. All of this can be attributed to military, government, missile, and industrial activities. This, for the most part, is history. Looking ahead, we foresee another stage. It is the period of "automation" when equipment controlled by "electronic brains" will perform many functions which are today handled manually. The technician will not be replaced but will, in fact, gain in stature. Technicians will be needed to operate and maintain this equipment and, in many cases, will serve as supporting personnel for original design engineers.

We know the industry, but who can actually define today's "technician"? Within the past year or two, dozens of surveys, statistical compilations, and various studies have been made of this group. Some of the reports have thrown a little light on the problem but, in essence, most of the material obtained has been so broad in nature that very little of it can be applied directly to the electronics industry.

We do know that there are about 125,000 full- and part-time servicemen maintaining consumer products and that there are approximately 100,000-125,000 electronics engineers and scientists. There are, in all, about 400,000 to 500,000 electronics technicians, not including military personnel. This is an impressive figure, and yet we know that there are not enough technicians.

Part of the responsibility of any publication is to eliminate confusion within the industry it serves. With this thought in mind, we propose to define and subdivide "technicians" as follows:

1. "Design Technician"—the man who works with the engineering department developing new designs and building prototypes.

2. "Service Technician"—the man who services or maintains electronic equipment in both the consumer and industrial areas.

3. "Operation Technician"—as the name implies, the man who operates electronic equipment.

In all cases, we would automatically eliminate any individual who lacks a basic, fundamental knowledge of electronic theory. A "technician" should have at least two years of technical training beyond high-school level, or have the equivalent amount of technical experience, and should be capable of reading circuit diagrams. This eliminates, for the most part, draftsmen, equipment operators who only know which buttons to push, and line testers who perform the same function day in and day out. There are, of course, cases where the job requires actual knowledge of electronic theory. Such men could then be granted the title of "technician" in recognition of their higher status.

We have used the word "technician" throughout this editorial, well aware of the fact that this term is frowned upon in some quarters. We agree that this word may not have as much prestige as it should have because of careless misapplication—but what other title more clearly identifies the technically trained professional we have been discussing?

We do know that with a number of companies "technician" is a clearly defined job category involving certain specific qualifications. In other companies the titles "Associate Engineer," "Assistant Engineer," and "Lab Assistant" are bestowed freely—adding to the general confusion. Obviously, being human, we all enjoy an impressive job title. However, we don't feel that it is fair to infringe on an engineering title without the degree and experience to back it up. In some instances an impressive title without the prestige and prerogatives is a disadvantage since it may involve a straight salary and deprive the technician of overtime pay.

We have given considerable thought to the task of coining a new title to replace the word "technician," but with little success.

Our goal, of course, is to eliminate confusion and increase the prestige of the technicians in our industry. Unlike Shakespeare who asked "What's in a name?"... we want the word "technician" to be specific and meaningful. As mentioned before, the points we have covered here are suggestions on our part. Needless to say, we will welcome your ideas—pro or con—on this important subject. ▲

exclusive!

only **Courier 1**

e.c.i.

CITIZENS BAND TRANCEIVER HAS A

UNITIZED CHASSIS

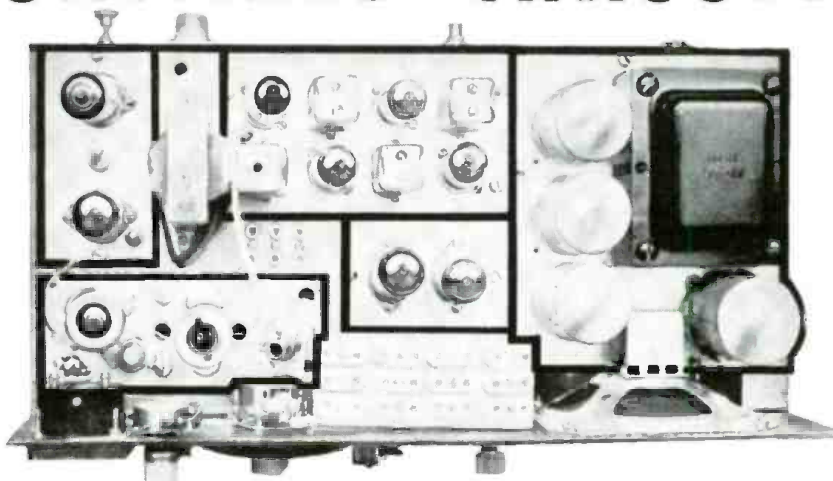

with 5 individual hand wired segments for simple installation, maintenance and parts replacement.

PLUS THESE OUTSTANDING FEATURES

- TRIPLE CONVERSION
- TWO IF STAGES (262 kc)
- 12 CHANNEL TRANSMITTING
- FIXED AND TUNABLE DRIFT-FREE RECEIVING
- OUTPUT EXCEEDING 3 WATTS
- ELECTRONIC SWITCHING (no relays)
- BUILT-IN "S" AND "RF" METER
- FULLY MODULATED (100%)
- MOBILE OR BASE (117 V. and 12 V.)
- AM RADIO (optional extra)

AND THESE EXTRAS

- Entire unit slides out easily on tracks
- Built-in noise limiter, built-in squelch
- Front panel RF gain control
- Lowest noise front end
- Gleaming chrome cabinet finish
- All metal parts cadmium plated for marine use

Dealer Note: Get full details on exclusive e.c.i. Franchise Plan.

\$189.50

slightly higher west of Rockies



e.c.i.

electronics communications, inc.

325 no. macquesten pkwy mt. vernon, n. y.

**EXTRA!
EXTRA!**

FANON

**FEATURES
GIVE YOU
MORE**



8 to 70 WATTS

1. More microphone inputs
2. Higher wattage output
3. 70 volt output line tap
4. Tamper-proof, concealed cable connections
5. Modern low silhouette
6. "Circuit Sentry" Fuse

The conservative ratings of Fanon amplifiers assure you optimum performance which provides you with more value per dollar spent. Typical is the Fanon Model 3320-20 watt:

| | Model 3320 | Brand A | Brand B |
|---------------------------|---------------|------------|------------|
| Rated output: | 20 W | 15W | 18W |
| Inputs: | 4 | 2 | 3 |
| Controls: | 4 | 3 | 4 |
| Concealed Connections: | Yes | No | No |

The big FANON line is complete with horns, speakers, baffles, mikes, mike stands and are available for FANON PA Amplifier Systems.

Write for detailed specifications
Dept. E2



Telephone
Intercom Systems



Home-
Business Intercom

FANON

ELECTRONIC INDUSTRIES, INC.
439 FRELINGHUYSEN AVENUE
NEWARK 12, NEW JERSEY

LETTERS

FROM OUR READERS

"DYNATUNER" LAB REPORT

To the Editors:

We would like to clarify a point or two in your excellent report on the "Dynatuner" in the September *ELECTRONICS WORLD*.

The circuit referred to as "a wide-band balanced ratio detector" is actually a wide-band *discriminator* design, although it bears superficial resemblance to a ratio detector. There is no electrolytic capacitor across the output (a characteristic of the ratio detector) although the balanced bridge discriminator does invert the diodes. There is no change of output level with signal strength, which is true of the ratio detector. In fact, the "volume sensitivity" of the "Dynatuner" is infinite.

We were quite surprised at the drift figure obtained in your measurements, as it is outside our acceptable tolerances, and may be the result of a defective component which slipped by. While this amount of drift may not be noticeable to the user, it is still more than the design intends.

ROBERT H. TUCKER
Dynaco, Inc.
Philadelphia, Penna.

We are glad to set the record straight concerning the detector circuit used in the tuner.—Editors.

FREE ESTIMATES

To the Editors:

First, let me congratulate you on the fine coverage you have given recently to the sticky problem of "free estimates." As a former TV technician and independent businessman I understand only too well the unrewarding and often costly policy of giving the customer something for nothing. Our free economy cannot operate successfully with such a policy; and no segment of that economy can long defy the simple logic of getting paid for services rendered.

Mr. Frye's approach to the problem is forthright and honest. But it can't succeed. "Free Estimates," as a slogan, has been too long identified with all types of repair services to be successfully bucked by the independent TV shop operator. Charging for estimates will not make the cash register tinkle a happy tune; instead, it will tend to make that cash box into a repository for lead nickels and tin quarters.

On the other hand, Mr. Marsh's solution is fine, as far as it goes. The trouble here is that it doesn't go far enough! The real solution is simple. Quote the customer a real healthy figure based on your past encounters with the equipment in question, and on the readily observable symptoms. When the job is

completed give him a square count in figuring up the bill. In most instances that bill will be anywhere from 30 to 50 per-cent lower than the estimate. This kind of treatment cannot help but put grins on the faces of your customers, and enlist their active participation in advertising your integrity.

H. M. LAYDEN
Bronx, New York

Two different ways of handling "free estimates" were covered in a recent "Mac's Service Shop" by John Frye, and in the article "Practical Repair Estimates" by Allan Marsh, both in our May issue. The above comments on free estimates together with Reader Layden's solution to the problem are quite interesting. However, he may simply have proved once more that there is no "real" solution. What happens to the customer who is driven away by a boosted estimate into the arms of a competitor who has given a deliberate under-estimate?

The customer may be quite unhappy when he gets a bigger bill than he expected, but the service technician will have lost the job.—Editors.

IMPROVING THE WILLIAMSON AMPLIFIER

To the Editors:

Talbot M. Wright's "Improving the Williamson Amplifier" in your June issue is an interesting and informative article. However, Mr. Wright isn't discussing what he says he is.

Mr. Wright apparently holds the opinion that virtually any amplifier employing feedback from the output transformer secondary to the input tube cathode is a "Williamson." But the Williamson amplifier, as designed by D. T. N. Williamson, differs significantly from the hybrid of Mr. Wright's article.

Much of Mr. Wright's discussion, for example, concerns the "capacitor bypassing the cathode resistor of the output stage," although there is no such component in the true Williamson. In fact, Williamson deliberately avoided the use of a bypass capacitor here. As he states in one of his *Wireless World* articles, the "common unbypassed cathode bias resistor . . . assists in preserving the balance of the stage under dynamic conditions." And he adds that such a capacitor, if used, would introduce still another source of phase shift and possible instability, a matter Williamson took great care to avoid.

Another author, Robert M. Mitchell, in discussing "The Effect of the Cathode Capacitor on Push-Pull Output Stages" (*Audio*, November, 1955), found this capacitor served no useful purpose with class A outputs, but "in the case of a class AB amplifier, the bypass capacitor

INDIVIDUAL
WIDE-VIEW
SCALE FOR
EACH RANGE
GIVES

Quick, Direct, Error-Free Readings *without Multiplying!*

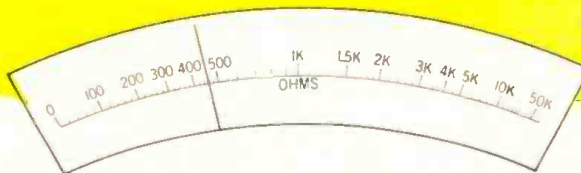

New VTVM DYNAMATIC 375 Automatic Vacuum-Tube Voltmeter

- Individual Full-Size Scale for Each Range
- Range Switch Automatically Sets Correct Scale
- Only One Scale Visible at Any One Time
- All Scales Are Direct Reading
- No Multiplying . . . No False Readings
- Includes DC Current Ranges, too

Here's another exciting first by B&K. With direct-reading single scales, this professional automatic VTVM makes it easier, faster than ever to read the exact answer accurately on the correct scale . . . without reading difficulty, calculation, or chance of error. Greatly simplifies true reading of peak-to-peak voltages of complex wave forms in video, sync and deflection circuits, pulse circuits, radar systems, etc.

All scales are direct reading. Every scale is the same full size, and only one scale is visible at any one time. Once you set the range switch properly, it is impossible to read the wrong scale.

The DYNAMATIC 375 utilizes a single DC-AC ohms probe, anti-parallax mirror, and other desired features . . . to make accurate measurements with utmost convenience and reliability in laboratory, factory production, or service shop.

Includes sturdy swivel stand which permits tilting "375" to any desired viewing angle, swings up as convenient carry-handle.

| | |
|-------------------------|---|
| Ranges: DC Volts | 0 - 1.5, 5, 15, 50, 150, 500, 1500 |
| AC Volts (rms) | 0 - 1.5, 5, 15, 50, 150, 500, 1500 |
| AC Volts (peak-to-peak) | 0 - 1.5, 5, 15, 50, 150, 500, 1500 |
| DC Current | 0 - 5 ma, 50 ma, 500 ma |
| Ohms | 0 - 500 ohms, 5 k, 50 k, 500 k, 5 meg, 50 meg, 1000 meg |

Input Resistance: 11 megohms on all DC ranges

Accuracy: $\pm 3\%$ full scale AC and DC

Meter Movement: Sensitive 100 microampere

Precision Multiplier Resistors with $\pm 1\%$ accuracy

Anti-Parallax Mirrored Scale for precise readings

Easy-to-See Iridescent Knife-Edge Pointer

Single DC-AC Ohms Probe (supplied)

Includes 1½ volt Battery. Operates on 117 volts 50-60 cycle AC

Sturdy, handsome metal case with convenient combination swivel stand and handle. Size: 10¾" x 6¾" x 4" deep. Net wt: 8 lbs.

Model 375 Net, \$89⁹⁵

See Your B&K
Distributor
or Write for
Catalog AP18-N

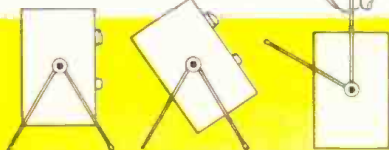

B & K MANUFACTURING CO.
1801 W. BELLE PLAINE AVE • CHICAGO 13, ILL.
Canada: Atlas Radio Corp., 50 Wingold, Toronto 19, Ont.
Export: Empire Exporters, 277 Broadway, New York 7, U.S.A.

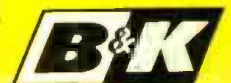

NOT A KIT!
FULLY ASSEMBLED
FULLY CALIBRATED
FULLY GUARANTEED \$89.95

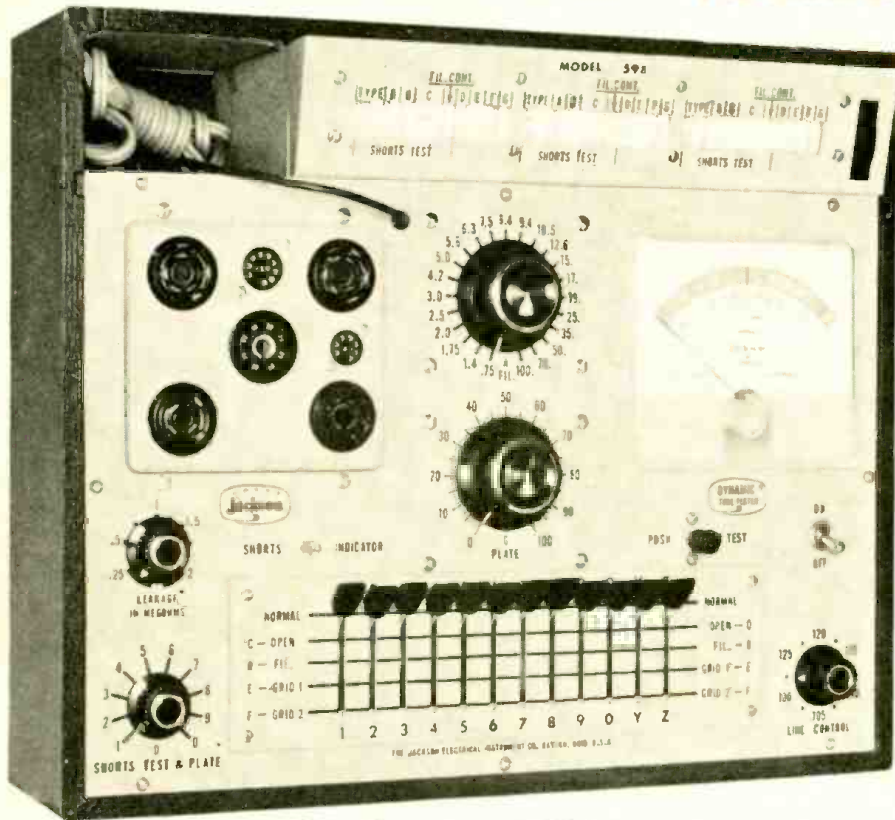

Jackson 598
Dynamic® Tube Tester

Don't let the price fool you. This is a genuine Dynamic tester . . . not a low quality emission type! The 598 is completely flexible . . . tests TV and Radio tubes under load to show you the true condition. It has all these famous Jackson "Service-Engineered" features:

- Variable Plate Voltage & Load
- 23 Separate Heater Voltages
- Variable Shorts Sensitivity Test
- Line Voltage Indicating Control
- Convenient Lever Switching
- Zig-Zag Roll Chart

This is the ideal low cost tube tester for profit-minded service-men. See it at your distributors . . . you'll recognize the value at a glance!

New tube test data appears every month in PF Reporter and Photo-Fact Folder



ELECTRICAL INSTRUMENT COMPANY
 124 McDonough St., Dayton, Ohio

In Canada: Tri-Tel Associates Ltd., Willowdale, Ontario

is absolutely necessary if the amplifier is to perform within the modern limits of high fidelity performance." This statement leads to another criticism of Mr. Wright, who notes that "any 'Ultra-Linear'-type Williamson . . . will display a drop in "B+" during extremely loud passages." But the Williamson uses triodes, not Ultra-Linear tetrodes, and in view of statements published in *Wireless World*, Williamson does not favor the Ultra-Linear connection. The damping factor of the Williamson, for example, is 30, a factor any "redesigner" would be hard put to approach with Ultra-Linear circuitry. Further, the output stage of the Williamson operates in class A, not class AB. In fact, Williamson pointed out some of the problems inherent in class-AB stages in his original (1947) article.

All in all, Mr. Wright seems to be discussing various revamped versions of Williamson's original circuit, rather than that circuit itself. In justice to Williamson and his renowned amplifier, might I ask whether Mr. Wright is also of the opinion that all that glitters is gold?

RICHARD A. FLANAGAN
 New York, New York

Strictly speaking, Reader Flanagan is correct. A better though longer title for the article might have been, "Improving the Ultra-Linear-Type Version of an Amplifier that was Based on the Original Williamson Design." The article's first sentence does tie down a little more closely than does the title just what circuit is being discussed.—Editors.

BC-221 TUBE REPLACEMENT

To the Editors:

I question the statement made in the article "Using the BC-221 To Check CB Frequency" (May issue) on replacing the 6SJ7 tubes with RCA Special Red ones. The audio output tube would present no problem, but the v.f.o. tube I think would be quite another thing. It would seem to me that the difference in tube interelectrode capacity would throw your dial calibration off with the book.

Having to replace this tube due to burn-out has worried me ever since I got the 221 and is one reason why I have not left my unit on all the time.

PAUL S. ANDREWS
 Rotterdam, New York

Here are Author Conhaim's interesting comments on this question.—Editors.

Dear Mr. Andrews:

I can understand your concern about replacing the 6SJ7 tube in the BC-221 with the RCA Special Red 5693. However, in actual practice, I found no difference in the operation of the BC-221. In checking the RCA Tube Handbook, you will find that there is only a very slight difference in the interelectrode capacitances of these two tubes. The input capacitance for the 5693 is listed as 4.8 μf . minimum to 5.8 μf . maximum, while the 6SJ7 input capacitance

(Continued on page 16)



Special Training Equipment Included

Pick the field of your choice—and train at home with the leader—NRI. In addition to Industrial Electronics and FCC License training explained at the right, NRI offers comprehensive courses in Radio-TV Servicing and Radio-TV Communications. Except for the FCC course, all NRI courses include—at no extra cost—special training equipment for actual practice at home, building circuits and working experiments. Makes theory you learn come to life in an interesting, easy-to-grasp manner.

Multiplexing, FM Stereo Broadcasting Included

NRI training keeps up with the times. New, additional profit opportunities exist for the Technician who understands the latest technical advances. Course material now covers FM Stereo Broadcasting, tells you about Multiplexing equipment, other recent developments.

Learn More to Earn More

Act now. The catalog NRI sends you gives more facts about the field of your choice, shows equipment you get and keep. No obligation. Cost of NRI training is low. Monthly payments. 60-Day Trial Plan. Mail postage-free card today. NATIONAL RADIO INSTITUTE, Washington 16, D.C.

Send for
64-Page
CATALOG
FREE



NRI—Oldest and Largest Radio Television School Now Offers NEW HOME STUDY TRAINING IN INDUSTRIAL ELECTRONICS & MILITARY ELECTRONICS

This is the age of Electronics. Rapidly expanding uses for Electronic Equipment in industry, business, the military demands more trained men. Prepare now for a career as an Electronic Technician to assure advancement or to profit from your hobby. NRI now offers a complete course in ELECTRONICS—Principles, Practices, Maintenance. Computers, telemetry, automation, avionics are changing our world, yet all employ the same basic principles . . . and that is what this NRI course stresses with illustrated lessons and special training equipment. Mail card below.



NEW HOME STUDY TRAINING FOR YOUR FCC LICENSE



An FCC Commercial License combined with NRI time-tested training can be the keys to a better future for you with higher pay, interesting work, more rapid advancement as the rewards. Prepare at home quickly for your FCC examinations through

NRI's new, low-cost, special training. Like other NRI-trained men, you can be monitoring TV shows, radio broadcasts, operating shipboard and aviation radio, or holding down other important jobs. Get full details—mail the card below.

FOR MORE INFORMATION-TURN PAGE

Cut Out and Mail—No Stamp Needed



NATIONAL RADIO INSTITUTE
WASHINGTON 16, D.C.

Send me your Electronic, Radio-TV catalog without cost or obligation. I am interested in the course checked below. (No representative will call. Please PRINT.)

- INDUSTRIAL ELECTRONICS COMMUNICATIONS
 FCC LICENSE SERVICING X

Name _____ Age _____

Address _____

City _____ Zone _____ State _____

ACCREDITED MEMBER NATIONAL HOME STUDY COUNCIL

**ELECTRONICS NEEDS
4 TO 7
QUALIFIED TECHNICIANS**

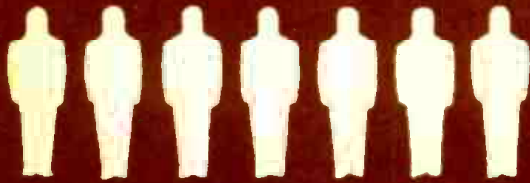

FOR EVERY ENGINEER



Join The Thousands Who Trained For Advancement With NRI

Thousands of NRI graduates throughout the U. S. and Canada are proof that it is practical to train at home. NRI graduates are in every kind of Electronics work: inspectors, maintenance men, lab technicians, testers, broadcasting and mobile communications operators, Radio-TV service technicians, or in essential military and government posts. Catalog tells more about what NRI graduates do and earn. Mail postage free card.

Choose from 4 Courses

- 1 INDUSTRIAL ELECTRONICS**
Learn Principles, Practices, Maintenance of Electronic equipment used today by business, industry, military, government. Covers computers, servos, telemetry, multiplexing, many other subjects.
- 2 FCC LICENSE**
Every communications station must have one or more FCC-licensed operators. New NRI course is designed to prepare you for your First Class FCC exams. You learn quickly, training at home in your spare time.
- 3 COMMUNICATIONS**
Training for men who want to operate and maintain radio and TV stations; police, marine, aviation, mobile radio, etc. Includes FM Stereo broadcasting. Course also prepares you for your FCC license exam.
- 4 SERVICING**
Learn to service and maintain AM-FM Radios, TV sets, Stereo Hi-Fi, PA systems, etc. A profitable, interesting field for a spare-time or full-time business of your own.



"THE FINEST JOB I EVER HAD" is what Thomas Bilak, Jr., Cayuga, N. Y., says of his position with The G. E. Advanced Electronic Center at Cornell University. He writes, "Thanks to NRI, I have a job which I enjoy and which also pays well."



BUILDING ELECTRONIC CIRCUITS on specially-designed plug-in type chassis, is the work of Robert H. Laurens, Hammonton, N. J. He is an Electronic Technician working on the "Univac" computer. Laurens says, "My NRI training helped me to pass the test to obtain this position."



"I OWE MY SUCCESS TO NRI" says Cecil E. Wallace, Dallas, Texas. He holds a First Class FCC Radio-telephone License and works as a Recording Engineer with KRLD-TV.



MARINE RADIO OPERATOR is the job of E. P. Searcy, Jr., of New Orleans, La. He works for Alcoa Steamship Company, has also worked as a TV transmitter engineer. He says, "I can recommend NRI training very highly."



FROM FACTORY LABORER TO HIS OWN BUSINESS that rang up sales of \$158,000 in one year. That's the success William F. Kline of Cincinnati, Ohio, has had since taking NRI training. "The course got me started on the road," he says.

SEE OTHER SIDE

FIRST CLASS
PERMIT
NO. 20-R
(Sec. 34.9, P.L.&R.)
Washington, D.C.

BUSINESS REPLY MAIL
NO POSTAGE STAMP NECESSARY IF MAILED IN THE UNITED STATES

POSTAGE WILL BE PAID BY



National Radio Institute
3939 Wisconsin Avenue
Washington 16, D.C.

NRI IS OLDEST—LARGEST SCHOOL OF ITS KIND

Training men to succeed by home study has been the National Radio Institute's only business for over 45 years. NRI is America's oldest and largest Electronics home-study school. Don't delay. Cut out and mail POSTAGE-FREE CARD.



MAIL POSTAGE-FREE CARD

BRING 'EM BACK ALIVE!



Now, Electro-Voice offers the finest acoustically-correct enclosures for your home music system ... and at a saving to you of up to 50%!

In just a few short hours, you can assemble an E-V KD6 Aristocrat or KD9 Marquis kit — without special tools or previous woodworking experience. And you'll obtain the same full sound as the factory-assembled models ... yet you'll save up to one-half!

Carefully pre-cut and complete with easy-to-follow instructions, each E-V enclosure kit features handsome birch veneer that can be easily finished to match any decor, with complete E-V Finishing Kits. For the final sparkling accent, an AK6 Grille can easily be added.

The KD6 and KD9 are each scientifically designed, acoustically correct enclosures that will add up to an extra octave of performance to any full-range speaker. The folded-horn KD6 uses the corner of the room as part of the horn, to increase performance without increasing size. The KD9 with its rear-facing ducted port provides similar range extension for along-the-wall applications.

Each kit is pre-cut for any 12" speaker. KD9 also accepts 15" speakers. For superb results, choose one of the six E-V 12" speakers ranging in price from \$19.50 to \$125.00. There is the precise model for your requirements. Both kits are also designed for simple addition of any E-V Building Block Kit. You can start with a coaxial speaker and easily build to a complete 3-way system in step with your budget.

For the perfect combination of performance and economy, put your high fidelity loudspeaker in an Electro-Voice kit enclosure. You'll bring 'em back alive — every favorite musical performance, and at lower cost than you dreamed possible! Write for your free E-V catalog today!

Now! Build the Biggest in High Bargain Fidelity!

MODEL KD6 ARISTOCRAT KIT
Finest corner enclosure for any 12" full-range or 3-way speaker.

MODEL KD9 MARQUIS KIT
*Superb response from 12" or 15" speaker when used along the wall.
(shown with AK6 grille)*

MODEL KD6 ARISTOCRAT KIT For any 12" speaker. Also pre-cut for E-V Building Block components and Wolverine Step-Up Kits. Uses folded-horn plus corner of room to extend range—save space. Size: 29½ inches high, 19 inches wide, 15¼ inches deep. Shipping weight 36 pounds. Net each \$39.00.

MODEL KD9 MARQUIS Similar to Aristocrat at left, but for 12" or 15" speakers. Ducted rear port design provides optimum bass response in along-the-wall installations. Size: 29½ inches high, 19 inches wide, 14½ inches deep. Shipping weight 38 pounds. Net each \$36.00.

E-V FINISHING KITS Complete with stain, filler, sealer, shellac, high gloss and satin varnishes, finishing papers, brushes and easy-to-follow instructions. Available in Walnut, Cordovan Mahogany, Fruitwood, Cherry, Golden Oak and Ebony. Net each \$6.00.

AK6 TRIM KIT Add a sparkling brass grille to KD6 or KD9. Net each \$4.80.

E-V DO-IT-YOURSELF INSTRUCTION BOOKS Complete, concise instructions help the home workshop enthusiast to build E-V high fidelity enclosures. Available for Aristocrat, Marquis, Regency or Baronet. Net each \$1.00.

Electro-Voice®

ELECTRO-VOICE, INC., Dept. 1014N
Buchanan, Michigan

Please send my free copy of the E-V high fidelity catalog.

Name _____

Address _____

City _____ State _____

 **ELECTRO-VOICE, INC.**, Consumer Products Division, Buchanan, Michigan

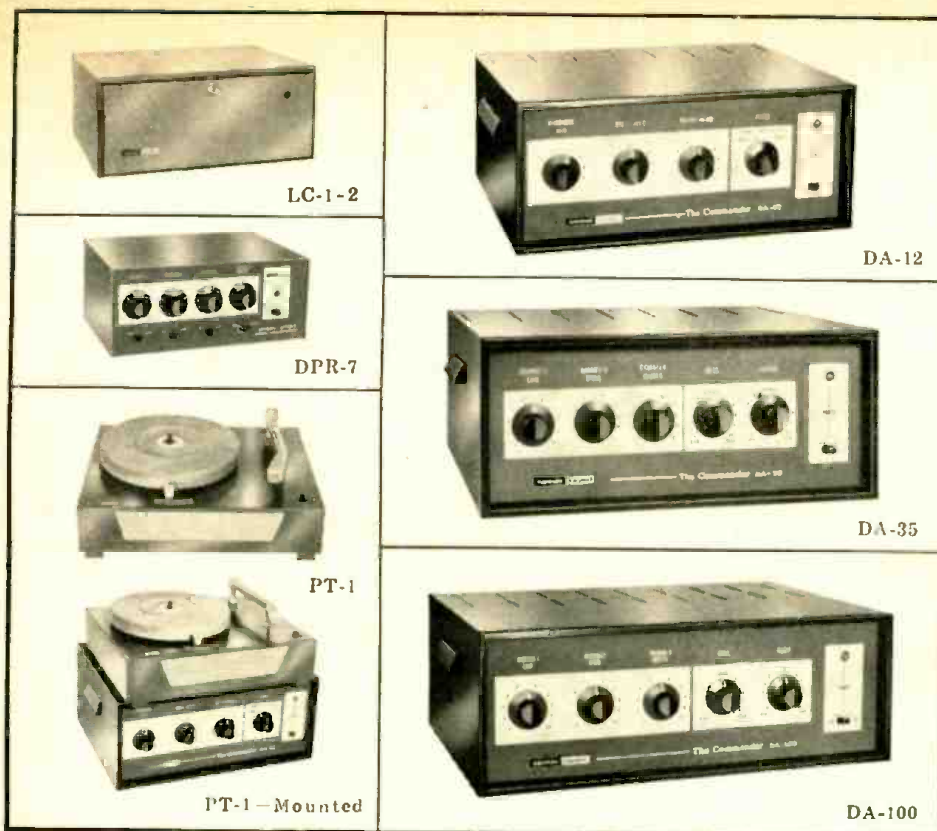

is listed as nominally 6 μf . Output capacitance for the 5693 is given as 5.6 μf . minimum to 6.8 μf . maximum and the 6SJ7 is listed as nominally 7 μf . As you can appreciate, there will be some variation from tube to tube in the 6SJ7, although the variability is not shown in the tube handbook. According to the BC-221 tech manual, tubes can be replaced without need for recalibration, so that the variation in the interelectrode capacitances apparently will not affect operation. In practice, I found this to be so.

Incidentally, the tube used in the v.f.o. is normally a 6SJ7Y, the "Y" indicating a special low-loss base. This tube is still being manufactured by RCA. Our local RCA distributor ordered 6 of these tubes for me and had no difficulty getting them.

Concerning your remarks about leaving the BC-221 turned on at all times, we feel, as do many tube engineers, that tubes last longer under such conditions than under on-off usage. Apparently, many on-off cycles are harder on the heaters of tubes than leaving them on at all times. My BC-221 has been operating more than a year, left on at all times. So far, I have replaced only a 5Y3 in the power supply because of a badly cracked base.

R. L. CONHAIM
Dayton, Ohio

A SOUND APPROACH to Commercial and Industrial Application... THE NEW COMMANDER SERIES BY HARMAN-KARDON

Flexible. Versatile. Dependable. That's the new Harman-Kardon Commander Series of amplifiers and systems for commercial and industrial sound use. They're ruggedly constructed for continuous duty. They include deluxe features at popular prices. They're designed and manufactured by Harman-Kardon—noted for the quality, reliability and superb performance standards of its high fidelity products, including the highly acclaimed Citation Kits. *In short:* the new Commander Series is built BY soundmen—FOR soundmen. Here are some of the exclusive features that make these the best instruments you can buy for the price.

MASTER VOLUME CONTROL: Enables total amplifier output to be varied without disturbing other control settings. **MIXER CONTROL:** Convenient ONE KNOB control permits fading and blending of signal from two channels, in any desired amount. (DA-35, DA-100) **MULTIPLE INPUTS:** All at the rear—allow for an unusually high degree of installation and operational flexibility. **ANTI-FEEDBACK FILTER:** Equalizes frequencies most sensitive to generation of feedback "howl" without reducing articulation—thus achieving maximum power output under difficult acoustical conditions. (DA-12) **25 AND 70 VOLT OUTPUTS:** Provides two constant voltage systems—70 and the newer 25 volt balanced system—for optimum flexibility and economy in speaker installation. **LOCKING COVERS:** Unique feature on units in this price class—designed to prevent tampering or accidental change of precise control settings. **PLUS:** Magnetic Cartridge Input; Tape Recorder Output; Independent Power Switches; and many other deluxe features.

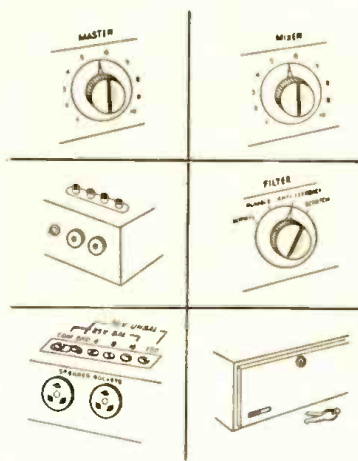

The Commander Series shown above includes the following: Model DA-12, 12 Watt PA Amplifier—\$75.00 List; Model DA-35, 35 Watt PA Amplifier—\$119.95 List; Model DA-100, 100 Watt PA Amplifier—\$187.50 List; Model DPR-7, Combination Mixer/Preamplifier—\$75.00 List; Model PT-1, Phonograph Top—\$37.50 List; Model LC-1 and LC-2, Locking Panel Covers: Model LC-1—\$8.50 List, Model LC-2—\$9.00 List.

For informative catalog on complete Commander Series write Dept. 10E.

Commercial Sound Division

harman kardon

Harman-Kardon, Inc.,
Plainview, N. Y.

SPEAKER CONE TREATMENT

To the Editors:

Here's another suggestion about treating the edge of speaker cones to make them more compliant. Try some castor oil that has been thinned with acetone. This combination applied to the cone edge will work just as well as glycerine and is less hygroscopic.

CHARLES F. WEIHER
University of Notre Dame
Notre Dame, Indiana

Still another suggestion that we have received recently came from a manufacturer of self-lubricating contact cleaners. This manufacturer claimed that if his slightly oily product were sprayed on the edge of the speaker cone, it would soften it up and lower its resonant frequency somewhat. We would not want to try any of these treatments on high-quality speakers, however, since it may do more harm than good.—Editors.

COMPACT HI-FI AMPLIFIER

To the Editors:

In the circuit diagram of the 6-watt amplifier ("Compact Hi-Fi Power Amplifier") in your June issue, you show the cathode connections for the 6BQ5's as pins 1 and 3. In tubes made by some manufacturers, pin 1 is an internal connection that is tied to the control grid (pin 2), therefore only pin 3 should be used for the cathode. Incidentally, I have built two of these units and am very pleased with their performance.

JOHN ROGERS
Harrison, N. J.

Reader Rogers is quite right. Those planning to build the amplifier please take notice.—Editors. ▲

want to
boost
your pay?

move ahead
in
ELECTRONICS

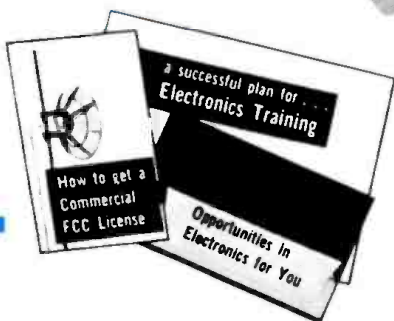

*Get All
3 Free!*

FREE!

FIND OUT HOW

- 1 You can get job security. Specialized education is the road to higher salary and important jobs in the growing field of electronics.
- 2 You can solve the problems that stump other technicians. Problems in electronics are becoming more complex. Your ability to solve problems will help you get ahead in your field.
- 3 You can handle new electronic devices. Every day, advances are being made in electronics. Only through education can you find out how to keep up with these developments and how to use the new devices.



Sorry, Not For Beginners!

Please inquire only if you really want to get ahead and to add to what you have already learned in school, in the service, or on the job. Some previous schooling or experience in electronics, electricity, or related fields is necessary for success in Cleveland Institute programs.

Mail This Coupon Today.

Cleveland Institute of Electronics

1776 E. 17 St. Desk RN58, Cleveland 14, Ohio

Your FCC License Or Your Money Back!

Completion of the Master Course (both Sections) will prepare you for a First Class Commercial Radio Telephone License with a Radar Endorsement. Should you fail to pass the FCC examination for this license after successfully completing the Master Course, you will receive a full refund of all tuition payments. This guarantee is valid for the entire period of your enrollment agreement.

**Investigate our NEW Training Program in
Computers, Servo Mechanisms,
Magnetic Amplifiers and others!**

**Get This Handy Pocket
Electronics Data Guide**

Free...

Puts all the commonly used conversion factors, formulas, tables, and color codes at your fingertips. Yours absolutely free if you mail the coupon today. No further obligation!



Accredited by The National Home Study Council

Cleveland Institute of Electronics

Desk RN 58, 1776 E. 17 St., Cleveland 14, Ohio



Please send FREE career information material prepared to help me get ahead in Electronics. I have had training or experience in Electronics as indicated below:

- | | |
|---|---|
| <input type="checkbox"/> Military | <input type="checkbox"/> Broadcasting |
| <input type="checkbox"/> Radio-TV Servicing | <input type="checkbox"/> Home Experimenting |
| <input type="checkbox"/> Manufacturing | <input type="checkbox"/> Telephone Company |
| <input type="checkbox"/> Amateur Radio | <input type="checkbox"/> Other |

In what kind of work are you now engaged? _____

In what branch of Electronics are you interested? _____

Name _____ Age _____

Address _____

City _____ Zone _____ State _____

Desk RN 58

Why the WINEGARD ELECTRONIC MOST EFFECTIVE TV ANTENNA...

**DESIGNED TOGETHER
TO WORK TOGETHER... WINEGARD
POWERTRON ANTENNA AND
BUILT-IN AMPLIFIER!**





TRANSISTORIZED!





MODEL SP-55X

"By FAR world's most powerful all-channel antenna"

WHY? BECAUSE...

-  **IT CAPTURES MORE SIGNAL** than any other all-channel antenna ever made. Patented design, electro-lens director system, dual "TAPERED T" driven elements, 30 precision-tuned elements in all.
-  **IT'S THE ONLY TRUE ELECTRONIC ANTENNA.** Only the Winegard Powertron is built with the amplifier as part of the driven element—not an "add-on" attachment.
-  **IT ELIMINATES ALL SIGNAL LOSS** that normally occurs between the driven element and the amplifier due to transmission and coupling mis-match.
-  **IT BOOSTS WEAK SIGNALS UP OUT OF THE SNOW** far better than any other antenna or antenna-amplifier combination made.

 **FOR VIVID COLOR, HIGH DEFINITION BLACK AND WHITE AND LONG DISTANCE RECEPTION,** nothing can compare to the Super Powertron. Thousands have been installed all over the country and our files are full of testimonials from grateful TV viewers and Service-Technicians alike.

 **WINEGARD IS THE ONLY MANUFACTURER THAT MAKES BOTH ANTENNAS AND RF AMPLIFIERS.** Because of this you can feel confident of getting the very best. But don't take our word for it—let your eyes and ears and field strength meter tell the story.



MODEL P-55
Powertron — transistorized, 14 elements.



MODEL P-55X
Powertron with Pack — Transistorized, 21 elements.



MODEL SP-55X
Super Powertron — transistorized, 30 elements.

POWERTRON is by far WORLD'S

Not 60%...Not 70%...but over 95% efficient

OUTFEATURES — OUTPERFORMS ORDINARY ANTENNAS WITH "ADD-ON" TYPE SIGNAL BOOSTERS!

THIS IS BETTER —

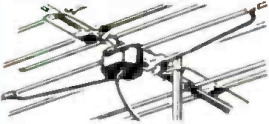

Exclusive amplified "Tapered T" driven element for perfect match and lowest possible signal-to-noise ratio. Only Powertron has it.

THAN THIS —

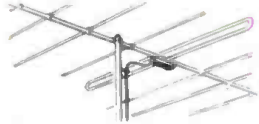

Not an after-thought "add on" signal booster hung on an ordinary antenna — not an old fashioned mast mounted booster.

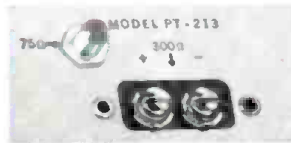

ONLY POWERTRON HAS BOTH 300 OHM TWIN LEAD OR 75 OHM COAX TERMINALS ON BUILT-IN AMPLIFIER.



ONLY POWERTRON GIVES YOU YOUR CHOICE OF TRANSISTORS OR TUBES (TUBE MODELS 300 OHM ONLY).

POWERTRON HAS COMPLETELY AC POWER SUPPLY

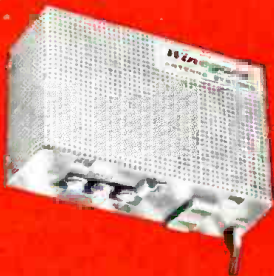

Transistorized Model has rectifier and filter in power supply — not in amplifier, where servicing is difficult. No batteries. Costs 27c to operate for full year. Battery types require \$5 to \$9 in batteries a year to operate continuously at maximum efficiency.



ONLY POWERTRON HAS RANGE CONTROL SWITCH TO PREVENT OVER-DRIVING TV SETS ON EXTRA STRONG CHANNELS.

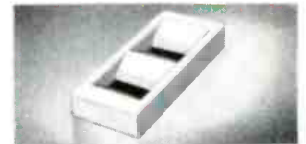

ONLY POWERTRON HAS AC PLUG-IN OUTLET FOR TV SET BUILT INTO THE POWER SUPPLY.

POWERTRON IS 100% CORROSION-PROOFED — ANTENNA IS GOLD ANODIZED, ALL HARDWARE IRRIDIZED, AMPLIFIER HOUSING OF HIGH IMPACT PLASTIC.

ONLY THE POWERTRON CAN DO ALL THIS!

1. Powertron will drive up to 10 TV sets and each set will have a better picture than an ordinary antenna will deliver to one set.
2. Powertron will drive a TV signal through one-half mile of lead-in with signal to spare—permits you unprecedented flexibility for remote installations.
3. Powertron will virtually eliminate snow and interference even on an old TV set.
4. Powertron will deliver superlative color reception far better than a non-electronic antenna.
5. Powertron brings in stations beyond the reach of non-electronic antennas—delivers greatest reception distance.

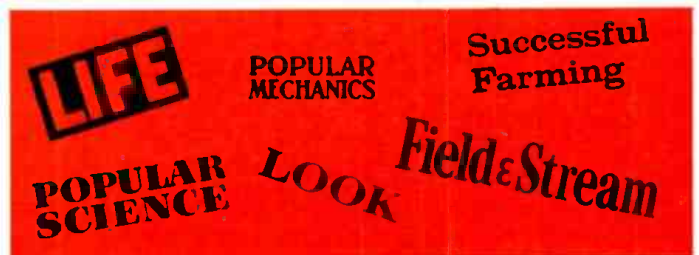

AND WINEGARD POWERTRON is the only antenna presold to your customers—nationally advertised in the biggest consumer advertising campaign yet! So stock up now—take advantage of the demand Winegard is building for you.

Write for free technical bulletins.



Winegard

ANTENNA SYSTEMS

Winegard Co., 3003-10 Kirkwood, Burlington, Iowa

Product Test Report

PREPARED BY HIRSCH-HOUCK LABORATORIES

DuKane Model DuK-30 Speaker System
Stereosonics Model PH-1 Phase Coordinator
Hartley "Holton" Speaker System
Columbian Hydrosonics "Aqua-Probe" Depth Finder
Eico Model 1064 Low-Voltage Power Supply

DuKane Model DuK-30 Speaker System

For copy of manufacturer's brochure, circle No. 56 on coupon (page 130).

SEVERAL years ago a French physicist announced the development of a revolutionary type of loudspeaker which had no moving parts. A cloud of ionized air particles, whose intensity was modulated by the program material, generated sound directly—eliminating voice coils, cones, and other vital portions of conventional loudspeakers. In its original form, the ionized air loudspeaker was a laboratory curiosity. Now, thanks to extensive development and refinement of manufacturing processes, it is available commercially. The U.S. manufacturing and distributing rights to the "Ionovac," as it is called, are held by *DuKane Corp.*, St. Charles, Ill.

Practical considerations limit the "Ionovac" to the role of a tweeter, operating at frequencies above 3500 cps. The heart of the speaker is a tiny quartz cell, about the size of a pencil eraser. The inside of this cell is ground out in the shape of a tiny exponential horn. A metal electrode extends from the rear of the cell into the horn mount. In operation, the cell is fitted into a metal sleeve which, together with the inner electrode, form the plates of a capacitor.

This capacitor forms part of the tank circuit of a power oscillator, operating

at a nominal frequency of 27 mc. It is in a series-resonant circuit, which causes a very high r.f. voltage to be developed across the capacitor. This voltage ionizes the air in the cell, forming a violet glowing cloud. The audio program modulates the screen grid of the 6DQ6 oscillator tube, thereby varying the intensity of the ionized cloud. The expansions and contractions of the cloud form sound waves directly in the air. The quartz cell is coupled to a dif-

fraction horn, which efficiently transfers the sound to the external surroundings.

Obviously, this unique speaker can have no problems with the mass of moving cones or diaphragms and should be capable of virtually perfect transient response. Of course, the ultimate performance of the system is dependent on the linearity and frequency response characteristics of the coupling transformer and the entire screen modulation process.

No matter how good a tweeter may be (and this one is available by itself to add to existing systems), it must be used with good lower frequency speakers if satisfactory results are to be obtained. *DuKane* has produced a rather unusual speaker system, the DuK-30, in which the "Ionovac" tweeter is combined with a 12" high-compliance woofer and a pair of small (4") midrange speakers to form a smooth, well-balanced system.

The DuK-30 is shaped like a tall upright column, measuring 48" high but only 15 $\frac{3}{4}$ " wide and 11" deep. At the bottom is the woofer and its port, while the midrange units are about half way up the column. At the top is the "Ionovac" tweeter with its oscillator and power supply. A built-in crossover network (3500 cps) and tweeter level control complete the system.

We measured the response of the system in a room approximately 12 feet by 30 feet, with the speaker installed along one of the long walls and along one of

the short walls. In each speaker position complete frequency response runs were made with four different microphone positions. The average of all eight readings was plotted *versus* frequency. Although the effects of room resonances cannot be completely eliminated from this type of measurement, it represents the actual frequency response of the speaker system in a normally reverberant room, rather than the unrealistic anechoic chamber response sometimes used.

The response curve shows an unusually smooth over-all frequency response, free from holes or peaks throughout most of the audio range. The irregularities between 100 and 200 cps are probably the result of room resonances, although they cannot be identified accurately. The tweeter level control was at approximately mid-position, and a considerable elevation of the region above 3500 cps was possible. However, the system sounded best with the level set at the point used in the tests. The low-frequency response is quite good down to about 60 cps, with relatively clean output down to 40 cps at reduced levels. We measured harmonic distortion of the acoustic output of the speaker at low frequencies, with 1-watt drive, and this data, when plotted, gives a good picture of the ultimate bass performance of the speaker.

Transient response, tested with tone bursts, confirmed the good impression we obtained from the response measurements. At 6 kc., in the operating region of the tweeter, the tone burst picture is nearly perfect. The ripples on the pattern are the result of hum in our equipment, not any deficiency in the speaker. At 500 cps, the woofer transient response is moderately good, although not exceptional.

Actually, all these measurements merely served to confirm our listening impressions. A very short period of listening to the DuK-30 makes it plain that this is a very clean, sweet-sounding speaker. The highs are unsurpassed, with a silky character rarely encountered except in some of the better electrostatic speakers. The polar dispersion of the tweeter virtually eliminates beaming effects. The lows are smooth, free from boxiness or boominess, and sound as though they go lower than they

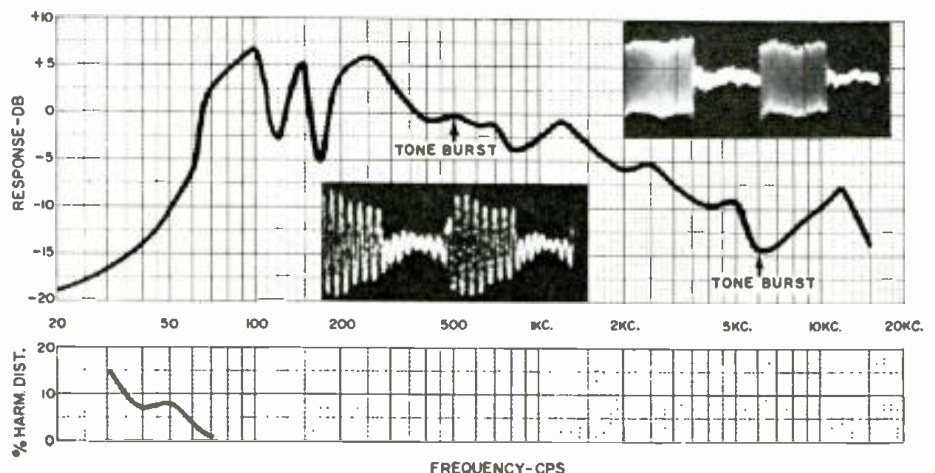

GET YOUR ELECTRONICS-TV-RADIO HOME TRAINING FROM N.T.S. RESIDENT SCHOOL

BREAK THROUGH TO HIGHER PAY, GREATER JOB SECURITY

START NOW! Break through the Earning Barrier that stops "half-trained" men. N.T.S. "All-Phase" Training prepares you . . . at home in spare time . . . for a high-paying CAREER as a **MASTER TECHNICIAN** in Electronics — TV — Radio. One Master Course at One Low Tuition trains you for unlimited opportunities in All Phases: Servicing, Communications, Preparation for F.C.C. License, Broadcasting, Manufacturing, Automation, Radar and Micro-Waves, Missile and Rocket Projects. **A MORE REWARDING JOB . . .** a secure future . . . a richer, fuller life can be yours! As an N.T.S. **MASTER TECHNICIAN** you can go straight to the top in industry . . . or open your own profitable business.

Over 1 City Block of Modern School Facilities, Laboratories and Shops Housing Over 1,000 Students.

50,000 Graduates — all over the World — since 1905

BETTER . . . MORE COMPLETE . . . LOWER COST . . . WITH NATIONAL SCHOOLS' SHOP-METHOD HOME TRAINING!

BETTER . . . Training that is proved and tested in N.T.S. Resident School shops and laboratories, by a School that is the **OLDEST** and **LARGEST** of its kind in the world.

MORE COMPLETE . . . You learn **ALL PHASES** OF Television — Radio — Electronics.

LOWER COST . . . Other schools make several courses out of the material in our **ONE MASTER COURSE . . .** and you pay more for less training than you get in our course at **ONE LOW TUITION!**

NATIONAL TECHNICAL SCHOOLS
WORLD-WIDE TRAINING SINCE 1905

THE SCHOOL BEHIND YOUR HOME-STUDY TRAINING

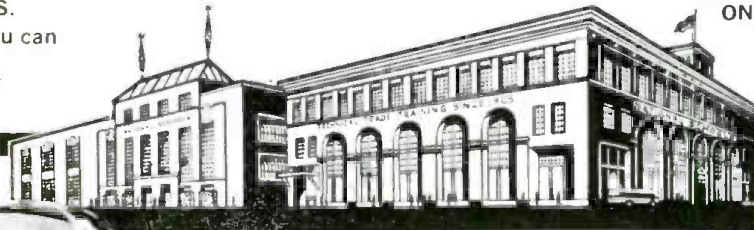

In these modern School Headquarters your Home Training is: Classroom-Developed, Lab-Studio Planned, Shop-Tested, Industry-Approved, Home Study-Designed.



TRAIN AT HOME IN YOUR SPARE TIME . . . AT YOUR OWN PACE!

19 BIG KITS YOURS TO KEEP

- Friendly Instruction and Guidance
- Graduate Advisory Service
- Unlimited Consultation
- Diploma Recognized by Industry
- **EVERYTHING YOU NEED FOR SUCCESS**

N.T.S. IS NOT JUST A MAILING ADDRESS ON A COUPON

N.T.S. is a real school . . . a world famous training center since 1905. Thousands of men from all over the world come to train in our shops, labs, studios and classrooms.

You learn quickly and easily the N.T.S. Shop-Tested way. You get lessons, manuals, job projects, personal consultation from instructors as you progress. You build a Short-Wave, Long-Wave Superhet Receiver plus a large screen TV set from the ground up with parts we send you at no additional cost. You also get a Professional Multitester for your practical job projects. The Multitester will become one of your most valuable instruments in spare time work while training, and afterwards, too. Many students pay for their entire tuition with spare time work. You can, too . . . we show you how.

SEND FOR INFORMATION NOW . . . TODAY!
IT COSTS YOU NOTHING TO INVESTIGATE

After you graduate you can open your own TV-Radio repair business or go into high paying jobs like these: Communications Technicians, Hi-Fi, Stereo and Sound Recording Specialists, TV-Radio Broadcasting Technician, Technician in Computers & Missiles, Electronics Field Technician, Specialist in Micro-Waves and Servomechanisms, Expert Trouble Shooter, All-Phase Master Technician, TV-Radio Sales, Service and Repair.

RESIDENT TRAINING AT LOS ANGELES
If you wish to take your Electronics-TV-Radio training in our famous Resident School in Los Angeles — the oldest and largest school of its kind in the world — write for special Resident School catalog and information, or check special box in coupon.



ACCREDITED MEMBER

NATIONAL TECHNICAL SCHOOLS

WORLD-WIDE TRAINING SINCE 1905

4000 SO. FIGUEROA ST., LOS ANGELES 37, CALIF., U. S. A.

MAIL COUPON NOW FOR FREE BOOK & ACTUAL LESSON

No obligation.
No salesman will call.



NATIONAL TECHNICAL SCHOOLS
WORLD-WIDE TRAINING SINCE 1905

Mail Now To
National Technical Schools, Dept. RM-01
4000 S. Figueroa St., Los Angeles 37, Calif.
Please rush FREE Electronics-TV-Radio "Opportunity" Book and Actual Lesson.

Name _____ Age _____
Address _____
City _____ Zone _____ State _____

Check here if interested ONLY in Resident Training at Los Angeles.
VETERANS: Give date of discharge _____

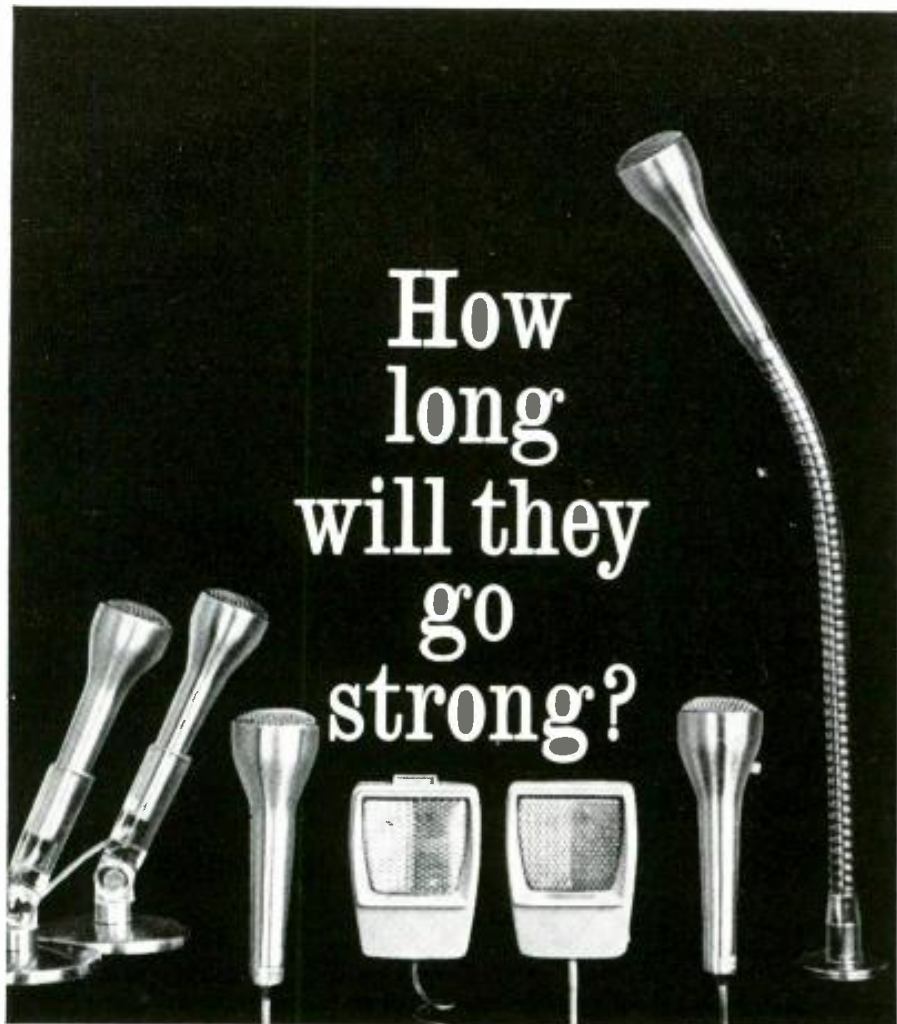

How
long
will they
go
strong?

Years! Any Sonotone "Ceramik[®]" stands up to all kinds of mistreatment...yet stays "fidelity" itself.

Until a few years ago, mikes were variable. If they were "hi-fi," chances were they were delicate. If they were sturdy, they didn't reproduce as well as they could. Then came the Sonotone "Ceramik" series.

All "Ceramik's" are shock-proof, impact-proof, shatter-proof, heat-proof and "bad-treatment"-proof. They will work even if you immerse them in water. The ceramic transducer at the heart is immune to changes of temperature and humidity. Extensive factory tests insure you that every "Ceramik" will keep on performing at its peak no matter what!

And fidelity? Look below, for specifications that would do anybody proud. Sell trouble-free, dependable performance and an installation that lasts for years. Be sure and stock the full line of "Ceramik's".

Specifications for Complete "Ceramik" Line

| | |
|--|--|
| CM-10A—For tape recorders, etc. Frequency response 50 to 11,000 cps Sensitivity -56 decibels ±2db | Frequency response 200 to 8,000 cps Sensitivity -63.5 decibels ±2db |
| CM-11A—Where greater sensitivity is desired Frequency response 80 to 9,000 cps Sensitivity -53 decibels ±2db | CM-17A—"Flex-Mike". For audio-visual labs, etc. Frequency response 50 to 11,000 cps Sensitivity -56 decibels ±2db |
| CM-T10A—For stereo taping Frequency response 50 to 11,000 cps Sensitivity -56 decibels ±2db | CM-30—Coiled Cord, Switch. For citizen's band use— Frequency response 100 to 6,000 cps Sensitivity -49 decibels ±2db |
| CM-T11A—For stereo taping, also greater sensitivity Frequency response 80 to 9,000 cps Sensitivity -53 decibels ±2db | CM-31—Coiled Cord. For communication use— Frequency response 100 to 6,000 cps Sensitivity -49 decibels ±2db |
| CM-12A—For long lead installations—PA systems, etc. with push-to-talk switch | CM-32—Standard Cord & Plug. For tape recordings— Frequency response 80 to 9,000 cps Sensitivity -49 decibels ±2db |

Sonotone

® C ELECTRONIC APPLICATIONS DIVISION,
O R Dept. P1-101, ELMSFORD, N. Y.
P. In Canada, contact Atlas Radio Corp., Ltd., Toronto

Leading Makers of Cartridges • Speakers • Tape Heads • Mikes • Electronic Tubes • Batteries

really do. The extreme low end of the DuK-30 is not as good as a number of popular speaker systems but is nevertheless very satisfactory. The middles are so subtle that one is not aware that a separate pair of speakers is handling them. The blending is perfect.

The DuK-30 (actually the "Ionovac" tweeter itself) does have two weaknesses, one minor and the other possibly more serious. It consumes some 55 watts and the quartz cell has a limited life (guaranteed for 1200 hours). Therefore, its power must be switched off when it is not used, unlike electrostatic speakers which may be left running indefinitely. This can cause problems in some installations, especially where a pair of these speakers are used for stereo. The cell, by the way, is easily replaced by the user at a nominal cost.

The most serious objection (in our view) is the harmonic radiation from the oscillator. A strong signal at about 103 mc. obliterates any FM station or near that frequency and some television interference on the lower channels has been observed. These effects are not likely to extend beyond the user's home, but can be troublesome anywhere in the vicinity of the speaker.

The price of the DuK-30 is \$199.50.

(Editor's Note: According to the manufacturer, all systems made after June 1, 1961, have a circuit change to reduce radiation by a factor of 20 times. Also, the fundamental frequency has been moved so that harmonics no longer fall in the FM band.) ▲

**Stereosonics Model PH-1
Phase Coordinator**

For copy of manufacturer's brochure, circle No. 57 on coupon (page 130).

THE problem of maintaining correct phase relationships in stereo recording and playback has plagued professional recording engineers, to say nothing of amateurs. Of course, most home stereo amplifiers are so designed that the two channels are in-phase if the proper output connections are made, but in commercial equipment, which may have low-impedance lines connecting preamplifiers with recording amplifiers, there is always a possibility of accidental phase reversal.

It is known that some stereo records and tapes have been issued with one channel incorrectly phased. There are no standards on the phasing of AM/FM stereo broadcasts, and no doubt there will be some confusion when FM multiplex stereocasts become popular. Some stereo control amplifiers are equipped with phase-reversing switches to cope with such situations. Even with this facility, it is not always easy to tell by listening whether the phasing is correct.

The Stereosonics Model PH-1 Phase Coordinator is a simple, inexpensive means of comparing the phase of any two signals in the audio range. It indicates on a meter whether the signals are essentially in-phase or out-of-phase. Signals whose phase relationship is random, or at least not predominantly in-

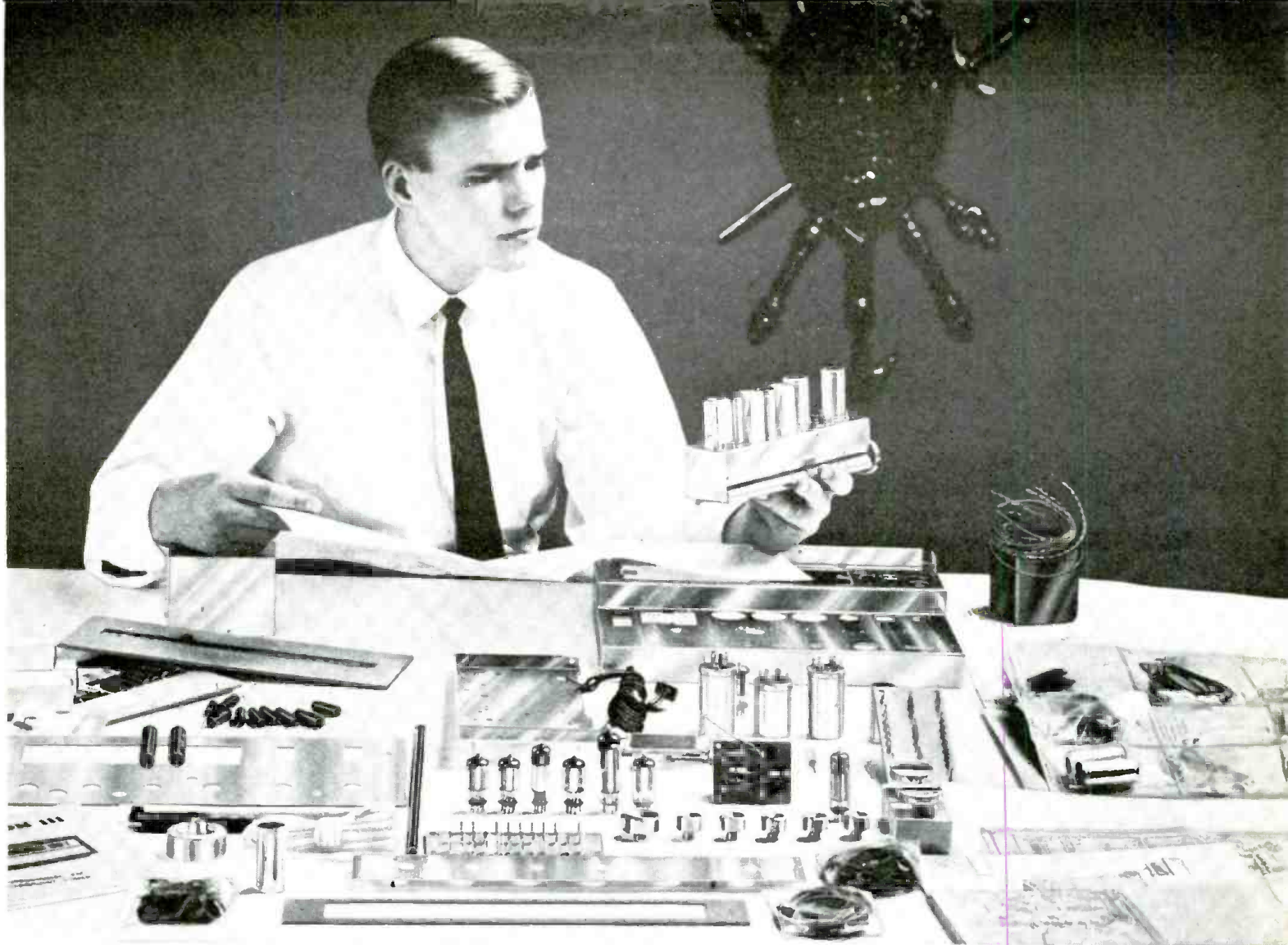

Can You Afford 15 Hours to Build The World's Best FM/Multiplex Tuner?

Fifteen hours. That's all it takes to build the world's best FM/Multiplex tuner.

Citation has the "specs" to back the claim but numbers alone can't tell the story. On its real measure, *the way it sounds*, Citation III is unsurpassed. And with good reason.

After years of intensive listening tests, Stew Hegeman, director of engineering of the Citation Kit Division, discovered that the performance of any instrument in the audible range is strongly influenced by its response in the non-audible range. Consistent with this basic design philosophy—the Citation III has a *frequency response three octaves above and below the normal range of hearing*. The result: unmeasurable distortion and the incomparable "Citation Sound."

The qualities that make Citation III the world's best FM tuner also make it the world's best FM/Multiplex tuner. The multiplex section has been engineered to provide wideband response, exceptional sensitivity and absolute oscillator stability. It mounts right on the chassis and the front panel accommodates the adapter controls.

What makes Citation III even *more* remarkable is that it can be built in 15 hours without reliance upon external equipment.

To meet the special requirements of Citation III, a new FM cartridge was developed which embodies every critical tuner element in one compact unit. It is completely assembled at the factory, totally shielded and perfectly aligned. With the cartridge as a standard and the two D'Arsonval tuning meters, the

problem of IF alignment and oscillator adjustment are eliminated.

Citation III is the *only* kit to employ military-type construction. Rigid terminal boards are provided for mounting components. Once mounted, components are suspended tightly between turret lugs. Lead length is sharply defined. Overall stability of the instrument is thus assured. Other special aids include packaging of small hardware in separate plastic envelopes and mounting of resistors and condensers on special component cards.

For complete information on all Citation kits, including reprints of independent laboratory test reports, write Dept. EW-10, Citation Kit Division, Harman-Kardon, Inc., Plainview, N. Y.

The Citation III FM tuner—kit, \$149.95; wired, \$229.95. The Citation III MA multiplex adapter—factory wired only, \$89.95. The Citation III X integrated multiplex tuner—factory wired, \$319.90. All prices slightly higher in the West.

*The
Citation
III*



Build the Very Best

CITATION KITS by

harman kardon



have you
heard
the

IONOVAC

hi-fi &
stereo
speakers?
... one of
the most
publicized
products in
the industry's
history



From coast to coast, editors and writers of the nation's top magazines and periodicals have been exuberant about the IONOVAC High Fidelity and Stereo Speaker Systems. The revolutionary "ionic cloud" which replaces the conventional speaker diaphragm has been lauded Nationwide—and why—because nothing moves but the sound waves. Only a "live" demonstration of the IONOVAC can thrill listeners with a quality of sound reproduction that far exceeds anything ever heard before. IONOVAC response amazingly flat from 3,500 to 20,000 cps and above.

IONOVAC High Fidelity and Stereo Speakers are available in a wide range of styles from add-on units to complete Columnar Speaker Systems. Choose from a broad selection of handsome finishes—or unfinished, if you desire. Consumer or dealer inquiries invited. Fill out the coupon below for full details, and the location of your nearest dealer.

IONOVAC DIVISION

DUKANE CORPORATION

ST. CHARLES, ILLINOIS
DEPT. EW-101

Where can I hear a demonstration?

Send free literature.

NAME _____

FIRM (IF DEALER) _____

ADDRESS _____

CITY _____ STATE _____



or out-of-phase, do not deflect the meter from its normal center position.

The meter may also be used as a balance indicator, moving to left or right of center in accordance with the levels in the left and right channels. In a balanced condition, the pointer remains in the center of the scale.

Each input channel of the Phase Coordinator has a pair of terminals identified by "+" and "-" markings. These may be connected to an amplifier's speaker output terminals or across a studio line system of from 4- to 600-ohms impedance. The Phase Coordinator may also be connected across the output of a preamplifier or tuner, but it is recommended that it be turned off with the front-panel switch provided for that purpose except when taking a reading. The impedance of the unit is low enough to adversely affect the frequency response and distortion of many preamplifiers. In the "Off" position of the switch the loading effect of the Phase Coordinator is entirely removed.

Each channel has a level control, located on the rear of the unit. This may be used to set the sensitivity of the meter for on-scale readings when a normal operating level is established in the rest of the system.

The manufacturer's specifications rate the frequency response of the Phase Coordinator as 60 to 14,000 cps with music, sine waves, or pulse waveforms. We made a check on this, observing the signal level needed to produce full-scale meter deflection at different frequencies. The response at 60 and 14,000 cps is down less than 2 db from the 1000-cps response and only slightly less at 20 and 20,000 cps. At maximum sensitivity, about .06 volt deflects the meter to its limits in the "Balance" mode of operation and less than .4 volt of in-phase or out-of-phase signal is needed for full indication in the "Phase" mode. Unfortunately, the level adjustments have a rather limited range and, at their minimum settings, a signal of 1.2 to 1.4 volts will drive the meter to full scale. We would like to see a greater

range of level control, particularly when the Phase Coordinator is used on speaker outputs which may reach several volts. (Editor's Note: If the deflection is excessive, the manufacturer suggests that the meter be connected across a lower impedance output tap.)

The impedance of the unit, at maximum sensitivity, varies from about 1000 ohms at 20 cps to over 20,000 ohms at 20,000 cps. It is 25,000 ohms higher when the level controls are turned down. Although this will not load line and speaker circuits significantly, it certainly is advisable, as the manufacturer suggests, to switch the unit off when it is driven from a typical preamp output.

In use tests, the PH-1 worked to perfection. Monophonic programs deflect the meter upward if they are in-phase or downward if they are out-of-phase. In monitoring a stereo program, an upward swing can be interpreted as in-phase (or sum) information, corresponding to sound originating between the speakers. The meter will normally fluctuate only slightly about the center position if there is considerable directionality. Consistent upward readings show that there is blending of the two channels. This is easily verified when using an amplifier having a blend control.

Apart from the obvious use in determining whether one's stereo records or broadcasts are phased correctly, it seems to us as though the Phase Coordinator should be most useful to the recording engineer in setting up his microphones, since it will quickly show up the sort of accidental phase reversal which can happen so easily if dissimilar microphones are used or if they have been wired incorrectly.

Other applications will no doubt suggest themselves. In playing various stereo discs, we were struck by the wide variations in directionality which the meter indicated. It seemed to be much more sensitive than the ear to the general separation of the two channels.

The price of the unit is \$29.50. ▲

Hartley "Holton" Speaker System

For copy of manufacturer's brochure, circle No. 58 on coupon (page 130).

THERE seems to be a trend away from bookshelf-sized speaker systems and the Hartley "Holton" system typifies the trend. It is a handsome, floor-type enclosure measuring 30" x 24" x 13". In the unit we tested was the new Hartley-Luth 220 MS "magnetic

suspension" driver. Few details were available to us on the workings of this system, except that it apparently uses the field of the speaker magnet to help restore the voice coil to its neutral position after an excursion. We will not (Continued on page 84)

Earn Extra Money Soon

.. while training at home for high-pay career or business of your own!

AMAZING PLAN FOR YOUR SUCCESS IN RADIO-TV-APPLIANCES and ELECTRONICS

Central will show you how to start making money soon . . . servicing AM-FM radios and television sets . . . repairing electrical appliances . . . building and installing electronic equipment in homes, factories, and business offices. Step-by-step, you'll learn how to get started in spare time at minimum cost; how to prepare for a bright future in servicing, audio, communications, broadcasting, or the gigantic electronic industry. Complete FCC license preparation included. High income, prestige, security, prosperity . . . all can be yours!

NO EXPERIENCE NEEDED!

You don't need high school diploma or previous knowledge of electronics to get started. Quick, low-cost home training for young and old. New illustrated lessons make learning easy. We supply equipment and *know how* you need to start making money soon. You learn by *doing*. You assemble useful, practical electronic projects—no incomplete "student" radios and testers—our kits meet commercial standards. Also recommended for citizen band and amateur radio operators, hi-fi and stereo enthusiasts, hobbyists, etc. Your personal pleasure and the savings you can make on home installations and repairs alone, make this course a profitable adventure. Keep your present job—set your own pace—add to your income—and find out how much fun Electronics can be!

New Frontiers Need You!

Cash in on growing demand for technicians in hundreds of exciting space-age fields: guided missiles, rocketry, outer space research and development, automation, nuclear power, computers, microwaves, radar, communications, oil field exploration, air traffic control, civil service, armed forces, etc. *Start now*. Get facts—mail coupon today for two FREE books!

NEW KITS!

You will build and keep this handy "transistorized" electronic and appliance tester that you'll use soon to start earning spare-time money. Many other practical and

profitable electronic projects to choose from: 4 transistor portable radio—code oscillator—solar cell switch—RF signal generator—CB converter—oscilloscope—others! Fully described in our FREE 64-page catalog.



Central grad GLEN LEIRER, shown here, earned an attractive income from part-time Radio-TV Servicing. Now he's employed as a Computer Technician for RCA Service Co., Camden, N. J.

Over 50,000 Successful Graduates Since 1931!



"I averaged between \$60 and \$70 a month servicing radios and TV's part-time while taking your home study course. Plan to open my own shop soon." Student THEODOR SCHMIDT, Peshastin, Wash.



Central grads HOWARD EDMONDS & FLOYD CONKRIGHT are joint owners of EDCO FACTORY TV SERVICE CO., K. C., Mo., and RANCH MART TV & STEREO, Leawood, Kansas, have three service trucks, seven full-time employees.

Grad FRANK LEENKNECHT works in missile field for Convair Astronautics, San Diego, Calif., and as Transmitter Engineer for Station KDEO as a sideline.



RESIDENT TRAINING—Central also offers a full-time ECPD-Accredited Technical Institute program at its resident school in Kansas City, Mo., for qualified high school graduates. Details in FREE catalog.

FREE

FCC PREP BOOK

Profits from Electronics

We'll mail you FREE FCC License Prep Handbook that prepares you to pass the 3rd Class FCC Radiotelephone examination, and to qualify to operate radiotelephone transmitting stations used by airlines, police, railroads, emergency services, etc. You get FREE FCC Prep Book plus FREE 64-page catalog with facts about Central's practical electronics home study course.

NO OBLIGATION

TRADE THIS COUPON FOR 2 FREE BOOKS!

Central Technical Institute
1644 Wyandotte, Dept. EW101A,
Kansas City 8, Mo.

(PLEASE PRINT)

NAME

ADDRESS

CITY

ZONE STATE



Accredited Member
National Home Study Council

Central Technical Institute

A PROPHECY

For men and women with a sincere desire to succeed



"In the years that have passed since my days on the faculty of RCA Institutes, I have become even more firmly convinced that the individual who continues his education . . . particularly his technical education . . . is the individual who profits both as a thinking man and as a working man. Science and industry will reward you for your talents and energy. Out of your efforts may come inventions, new products, processes and services. There is everything good yet to be accomplished in our lives and in our work. What man has done, man can do better."

David Sarnoff

Chairman of the Board,
Radio Corporation of America

RCA Institutes Offers the Finest of Home Study and Resident Training for Your Career in the Rapidly Expanding World of Electronics

RCA Institutes, founded in 1909, is one of the largest technical institutes in the United States devoted exclusively to electronics. A service of Radio Corporation of America, RCA Institutes offers unparalleled facilities for technical instruction . . . tailored to your needs. The very name "RCA"

means dependability, integrity, and scientific advance.

RCA Institutes Home Study School, licensed by the New York State Department of Education, offers a complete program of integrated courses for beginners and advanced students rang-

ing from electronic fundamentals to automation. All courses are designed to prepare you for a rewarding career in the rapidly expanding world of electronics. *The caliber of the training you receive is the finest!* And you get top recognition as an RCA Institutes graduate!

HOME STUDY COURSES *in* *Electronic Fundamentals • TV Servicing* *Color TV • Electronics for* *Automation • Transistors*

Voluntary Tuition Plan. The important thing to remember about RCA Institutes Training is the convenient, *no-obligation payment plan*. This plan affords you the most economical possible method of home study training because you pay for each study group only when you order it. If you interrupt your course *at any time, for any reason*, you owe nothing more. You *never* have to pay for the whole course if you don't complete it. No other obligations. No monthly installment payments!



RCA Instruction is Personal. With RCA Home Study training you set *your own pace* in keeping with *your own ability*, finances, and time. The Institutes allows you ample time to complete the course. Your lesson assignments are individually graded by

technically trained personnel, and helpful comments are added where required. You get theory, experiment, and service practice beginning with the very first lesson. All lessons are profusely illustrated. You get *a complete training package* throughout the entire course.

You Get Prime Quality Equipment. All kits furnished with the course are complete in every respect, and the equipment is top grade. You keep all the equipment furnished to you for actual use on the job... *and you never have to take apart one piece to build another!*

* * *

RESIDENT SCHOOLS *in* *Los Angeles and* *New York City* train you for any field of *Electronics you may* *choose!*

No Previous Technical Training Required For Admission. RCA Institutes Resident Schools in Los Angeles and New York City offer training that will prepare you to work in re-

warding positions on research and production projects in fields such as automation, communications, technical writing, television, computers, and other industrial and advanced electronics applications. Even if you did not complete high school, RCA will prepare you for such training with courses specially designed to provide the basic math and physics required for a career in electronics.

Free Placement Service. RCA Institutes graduates are now employed in important jobs at military installations such as Cape Canaveral, with important companies such as IBM, Bell Telephone Labs, General Electric, RCA, and in radio and TV stations all over the country. Many other graduates have opened their own businesses. A recent New York Resident School class had 92.06% of the graduates who used the Free Placement Service accepted by important electronics companies... *and had their jobs waiting for them on the day they graduated!*



Coeducational Day and Evening Courses. Day and Evening Courses are available at Resident Schools in New York City and Los Angeles. You can prepare for your career in electronics while continuing your normal full-time or part-time employment. Regular classes start four times each year.



**SEND POSTCARD FOR FREE
 ILLUSTRATED BOOK TODAY!
 SPECIFY HOME STUDY OR
 RESIDENT SCHOOL**

RCA INSTITUTES, INC. A SERVICE OF RADIO CORPORATION OF AMERICA, 350 W. 4th St., New York 14, N. Y., 610 S. Main St., Los Angeles 14, Calif.



The Most Trusted Name in Electronics

At Bell Telephone Laboratories, mathematician Sidney Darlington has contributed notably in developing the art of circuit analysis.

IT HAPPENS IN THE MIND...

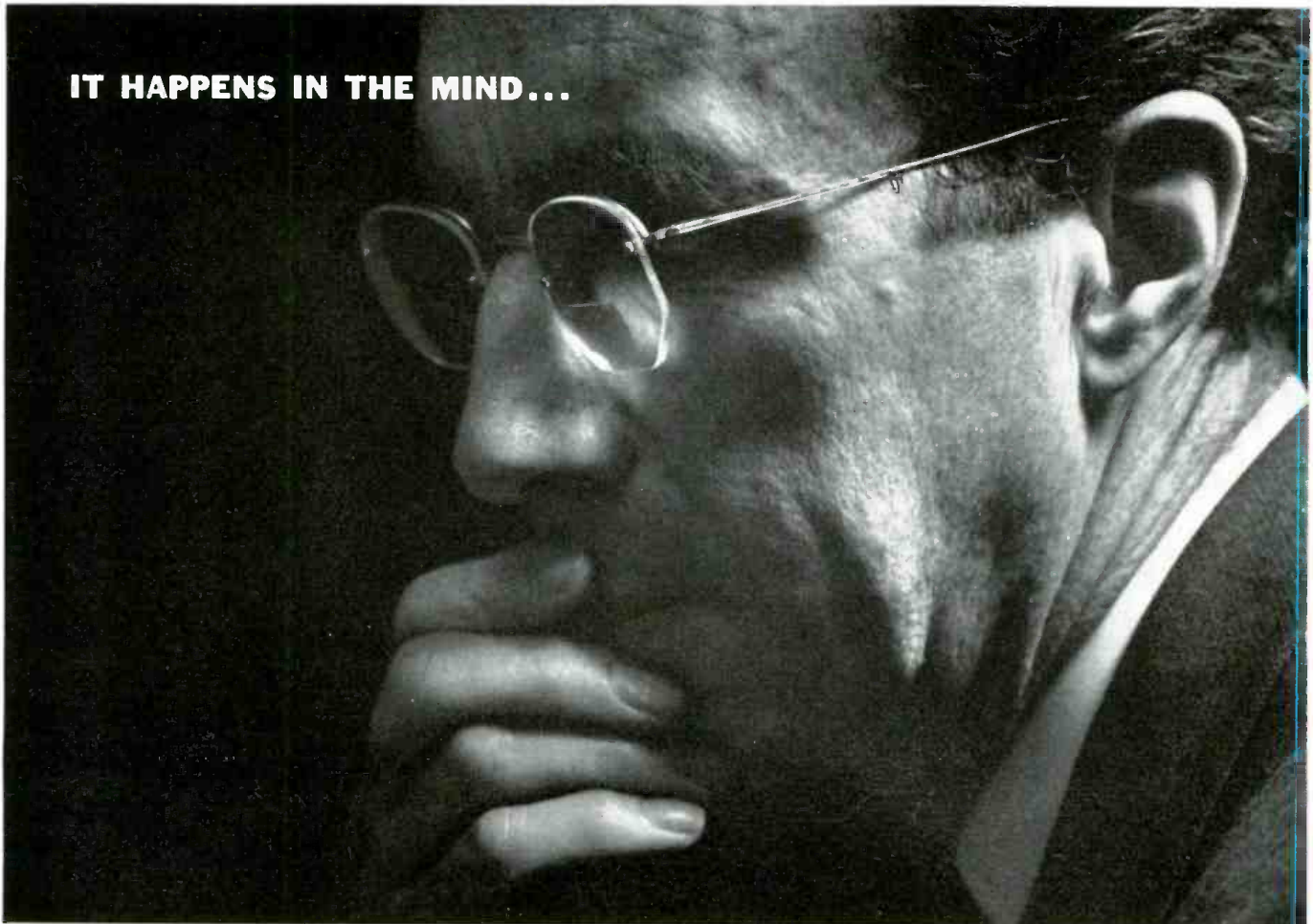

... It is essentially a thing of the mind for it works through concepts, symbols and relationships . . . it helps man to analyze and synthesize the complex phenomena of the universe and himself . . . it works in many ways to advance electrical communications:

IT IS CALLED MATHEMATICS

At Bell Telephone Laboratories mathematics works powerfully to solve problems involving complex data. For example, engineers must design and synthesize complex systems to process specific signals in precisely controlled ways. At the same time the technology provides a wide choice of circuits and components. Mathematical circuit analysis reveals the circuits which can do the job most efficiently and economically.

Intriguingly, too, the mathematical approach leads to basically new knowledge. For example, it led to the invention of the electric wave filter . . . disclosed a kind of wave trans-

mission which may some day carry huge amounts of information in waveguide systems . . . foretold the feasibility of modern quality control . . . led to a scientific technique for determining how many circuits must be provided for good service without having costly equipment lie idle.

In the continuing creation of new devices, technologies and systems, Bell Laboratories utilizes whatever serves best—mathematical analysis, laboratory experimentation, simulation with electronic computers. Together they assure the economical advancement of all Bell System communications services.



BELL TELEPHONE LABORATORIES

WORLD CENTER OF COMMUNICATIONS RESEARCH AND DEVELOPMENT

PHOTOFACT world's finest electronic service data now greater than ever!

with dozens of exclusive new features for fastest, easiest, more profitable servicing



OVER 50,000 LISTINGS: Only service data of its kind—prepared from analysis of the actual equipment. Complete, uniform, accurate. Over 21,000,000 PHOTOFACT Sets now in use! If you're not using PHOTOFACT, you're not realizing your full earning power. So get the proof—try PHOTOFACT on any job—see how much time you save, how much more you can earn daily! Your Parts Distributor has the PHOTOFACT Folder Sets you need. Have *all* the help you'll ever want for greater servicing success and bigger earnings!



COVERS:
 Black & White TV
 Color TV
 AM Radios
 FM Radios
 Transistor Radios
 Auto Radios
 Amplifiers, Tuners
 Recorder Changers
 Tape Recorders

FAMOUS "STANDARD NOTATION" SCHEMATICS

- Uniform symbols in each schematic; same circuit layout form each time



- Voltages at tube pins and test points
- Waveforms at appropriate points on TV schematics
- "CircuitTrace" identification numbers for printed circuits

- Schematic items keyed to chassis photos and parts lists
- Special capacitor and resistor ratings
- Coil and transformer color codes or terminal identification

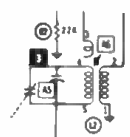

- Test points labeled
- Special currents shown (B+, horizontal output cathode, horizontal output screen)

- Alignment adjustments and test points labeled
- Tube functions shown
- Control and switch functions shown
- Switch sequence indicated
- Power supply "sources" shown
- Fuse ratings indicated
- Coil resistance over 1 ohm shown
- Coding of electrolytic capacitors shown

REPLACEMENT PARTS LISTS



- Lists standard, locally available replacement parts
- Includes notes for special installation or other considerations

- Includes ratings and/or measured values for assisting in selection of replacement parts
- All parts keyed to chassis photos and schematics for quick reference

TUBE PLACEMENT DIAGRAMS



- Shows tube types and functions; top and bottom views shown

- Includes filament connections on series string
- Indicates TV sound and sync paths
- Tube failure check charts included
- Shows blank pin or locating key on each tube
- Includes fuse locations and ratings.

ALIGNMENT INSTRUCTIONS



- Gives step-by-step easy-to-follow alignment data
- Procedure makes use of standard service-type equipment

- Alignment frequencies are shown on chassis photos near adjustment number—adjustments are keyed to schematic and photos

"CIRCUITTRACE" FEATURE



- Invaluable printed board servicing aid—indicates points on board photo and schematic for quick, easy measurement of components, or test locations

FULL PHOTO COVERAGE



- All chassis views are shown in actual photographs
- All ports are numbered and keyed to the schematic and parts lists
- Test and alignment points indicated

FIELD SERVICE NOTES

- Outlines procedure for "in the home" adjustments
- Gives hints on quick access to pertinent adjustments, safety glass removal, etc.

"BONUS" FEATURES

- Disassembly instructions
- Dial cord diagrams
- Record changer and tape recorder "exploded views" for easy mechanical parts replacement or service

"PLUS" ADVANTAGES

- ★ Citizens Band Radio coverage
- ★ Tube Test data—provides setting for testing new tubes
- ★ Color TV Course "Bonus" beginning in Set No. 541
- ★ Eligibility for membership in "PEET" with ownership of a PHOTOFACT Library

SEND FOR YOUR PHOTOFACT INDEX NOW!

FREE

ONLY \$10 DOWN

puts the complete PHOTOFACT Library in your shop—and you have up to 30 months to pay. Right now—keep up with the industry—sign up for a Standing Order Subscription to PHOTOFACT! See your Sams distributor for full details on a Library or Standing Order purchase!

FREE!

VALUABLE PHOTOFACT INDEX

YOUR GUIDE TO OVER 50,000 TV, Radio, Electronic Listings! Send for it today! Your guide to virtually every model produced since 1946. Helps you locate the proper PHOTOFACT Folder you need to solve any service problem in any model. Send the coupon today for your FREE copy of the latest PHOTOFACT Index to the service data you need!



HOWARD W. SAMS & CO., INC.

Howard W. Sams & Co., Inc., Dept. 5-K1
 1724 E. 38th St., Indianapolis 6, Ind.

- Send FREE Photofact Cumulative Index
 Send full information on: Easy Buy Plan
 Standing Order Subscription "Peet" Program

Shop Name _____
 Attn: _____
 Address _____
 City _____ Zone _____ State _____

FM Multiplex Stereo broadcasting has arrived!

A top quality stereo tape recorder will permit you to build a stereo tape library of your favorite music at low cost. As your musical interests change, you may record the new music that interests you at no additional cost. See your EICO dealer now for a demonstration of the EICO RP-100.

dedicated to perfection



**TRANSISTORIZED
4-TRACK STEREO TAPE DECK**

MODEL RP-100W
Completely assembled, wired and tested. **\$399.95**

MODEL RP-100K
Semi-kit includes a completely assembled and tested transport, electronics in kit form. **\$299.95**

Perfected 4-track stereo/mono recording, 4 & 2 track playback. True high fidelity transistor electronics, individual for record & playback, plus separate record & playback heads permitting off-the-tape monitor. 2 recording level meters, mixing, mic & level controls, switched sound-on-sound recording. Electro-dynamically braked supply & take-up reel motors; hysteresis synchronous capstan motor. Individual solenoids for pinch-roller & tape lifters. All-electric, interlocked push-button transport control & interlocked safety "record" pushbutton. Precision tape guidance & sweep loading — no pressure pads. No slurring or tape bounce problems. Digital turns counter. Vertical or horizontal mounting. Modular plug-in construction. An original, exclusive EICO product designed & manufactured in U. S. A. (patents pending).

NEW SUPERB SERIES.....

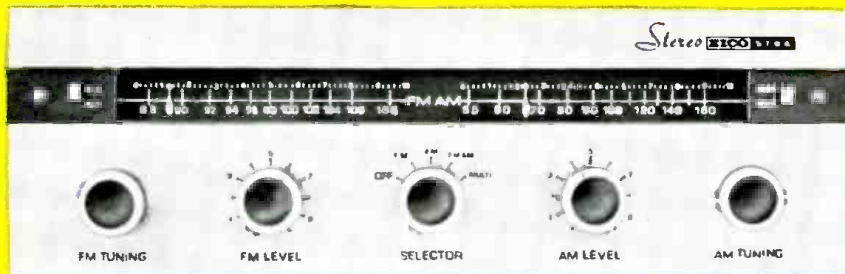

FM-AM STEREO TUNER ST96

Kit \$89.95 Includes Metal Cover and FET Wired \$129.95

FM and AM stereo tuners on one compact chassis. Easy-to-assemble: prewired, prealigned RF and IF stages for AM and FM. Exclusive precision prewired EYE-TRONIC® tuning on both AM and FM.

FM TUNER
Switched AFC (Automatic Frequency Control). Sensitivity: 1.5uv for 20db quieting. Frequency Response: 20-15,000 cps ±1db.

AM TUNER
Switched "wide" and "narrow" bandpass. High Q filter eliminates 10 kc whistle. Sensitivity: 3uv for 1.0V output at 20db S/N ratio. Frequency Response: 20-9,000 cps ("wide"); 20-4,500 cps ("narrow").

OF EICO STEREO.....



70-WATT INTEGRATED STEREO AMPLIFIER ST70

Kit \$94.95 Includes Metal Cover Wired \$149.95

40-WATT INTEGRATED STEREO AMPLIFIER ST40

Kit \$79.95 Includes Metal Cover Wired \$129.95

BOTH AMPLIFIERS: Complete stereo centers plus two excellent power amplifiers. Accept, control, and amplify signals from any stereo or mono source.

ST70: Cathode-coupled phase inverter circuitry preceded by a direct-coupled voltage amplifier. Harmonic Distortion: less than 1% from 25-20,000 cps within 1db of 70 watts. Frequency Response: ±1/2 db 10-50,000 cps.

ST40: Highly stable Williamson-type power amplifiers. Harmonic Distortion: less than 1% from 40-20,000 cps within 1 db of 40 watts. Frequency Response: ±1/2 db 12-25,000 cps.

Over 2 MILLION EICO Instruments in use. Most EICO Dealers offer budget terms. Add 5% in West.



EW-10

EICO, 3300 N. Blvd., L.I.C. 1, N. Y.
 Send free 32-page catalog & dealer's name
 Send new 36-page Guidebook to HI-FI for which I enclose 25¢ for postage & handling.
 Name
 Address
 City Zone State

Listen to the EICO Hour, WABC-FM, N. Y. 95.5 MC, Mon.-Fri., 7:15-8 P.M.
 Export Dept., Roburn Agencies Inc.,
 431 Greenwich St., New York 13, N. Y.
 © 1961 by EICO, 3300 N. Blvd., L. I. C. 1, N. Y.

FM MULTIPLEX ADAPTOR MX-99

Kit \$39.95 Wired \$64.95

An original EICO contribution to the art of FM Multiplex reception



The new EICO MX-99 Multiplex Adaptor incorporates the best features of both the matrixing and sampling techniques. It is free of phase-distorting filters and provides the required, or better-than-required, suppression of all spurious signals including SCA (67kc) background music carrier, re-inserted 38kc sub-carrier, 19kc pilot carrier and all harmonics thereof. This is very important for high quality tape recording, where spurious signals can beat against the tape recorder bias oscillator and result in audible spurious tones in a recording. This adaptor will synchronize with any usable output from the FM tuner and will demodulate, without significant distortion, tuner outputs as high as 7 volts peak-to-peak (2.5 volts RMS). The MX-99 is self-powered and provides entirely automatic stereo/mono operation. A separation of 35 db between channels is typical across the entire audio spectrum. Low impedance cathode follower outputs permit long lines. The MX-99 is designed for all EICO FM equipment (HFT-90, HFT-92, ST-96), and component quality, ratio detector FM equipment provided with a multiplex output.

See our other advertisement on page 111

NEW BATTERIES

PROGRESS OR CONFUSION?

Description, characteristics, and applications of the new alkaline-manganese and sealed nickel-cadmium types.

By D. B. CAMERON

Manager, Sales Engineering, Union Carbide Consumer Products Co.

SELECTING a battery for a radio or instrument is not merely a dollar-and-cents decision. Proper choice from the many types now available can have a marked effect on the operation of the device and on the user's satisfaction and convenience. Every battery type and electrochemical system offers certain advantages and limitations. A general understanding of battery characteristics can eliminate confusion and permit a wise selection.

Prior to World War II, practically all primary batteries were the LeClanché or carbon-zinc type. Both flat and cylindrical cells were available, but choice of a battery for a particular use presented few problems. Wartime military requirements stimulated fantastic advances in electronics and created a need for specialized battery-power sources. Battery research and development efforts mushroomed. Efficient miniature carbon-zinc batteries became practical, and new electrochemical systems were evaluated. The mercury battery system was one result of this research.

In the years since the war, these efforts have continued. The mercury battery system and miniature carbon-zinc batteries were perfected, the transistor was developed, and battery-operated devices, from toys to radios, gained wide

consumer acceptance. The need for compact, efficient, economical batteries has now brought two additional electrochemical systems into use: high-energy alkaline-manganese batteries and sealed nickel-cadmium rechargeable batteries.

The owner of a pocket radio powered by penlite cells has a problem. Shall he use standard flashlight cells, radio-type carbon-zinc cells, mercury batteries, alkaline-manganese energizers, or nickel-cadmium batteries? For example, there are eight different "Eveready" brand penlite cells, each designed for a particular use. The multiplicity of battery types has caused confusion. Has there also been progress?

Almost everyone, even a child, recognizes a battery and considers it a very simple device. Appearances can be deceptive. A battery is actually a small electrochemical plant. It must do nothing until power is needed and yet must start operating instantly when an electrical connection is made. It must operate in any position and withstand rough handling. A modern battery must be compact, efficient, foolproof, attractive, and economical; and it must operate under all sorts of adverse conditions. Consider the characteristics that would be desirable in an ideal battery: long shelf life, high energy, good light-drain performance, efficiency on heavy-drain use,

reliable intermittent operation, good continuous service, high amperage, low impedance, high-temperature stability, low-temperature capabilities, constant voltage, rechargeability, small size, freedom from leakage, attractive appearance, and last but not least, it must be inexpensive.

Unfortunately, it is not yet possible to maximize all of these characteristics in a single battery. In order to supply each type of user with the best possible battery for his particular application, a battery manufacturer must produce a number of different batteries of the same size and shape, each tailored to maximize the most essential characteristics for a specific end use. To obtain the best battery value and satisfaction, the consumer or the professional who advises and supplies him, should understand at least the basic characteristics of the new batteries now available.

Carbon-zinc and mercury batteries have been in use long enough for most interested technical people to have a general appreciation of their characteristics. The carbon-zinc system is the workhorse of the industry. These batteries have the widest availability, a broad range of desirable characteristics, and the lowest initial cost. Mercury batteries provide longer life, a more constant voltage, and lower impedance—but at a higher price. What do the alkaline-manganese and nickel-cadmium batteries offer?

Alkaline-manganese batteries have a total energy almost equal to mercury batteries and they are capable of delivering their rated capacity even on heavy continuous drains where both the carbon-zinc and mercury systems become inefficient. Furthermore, this newest electrochemical system provides high amperage, low impedance, outstanding temperature characteristics, and good shelf life at a price between carbon-zinc and mercury battery cost.

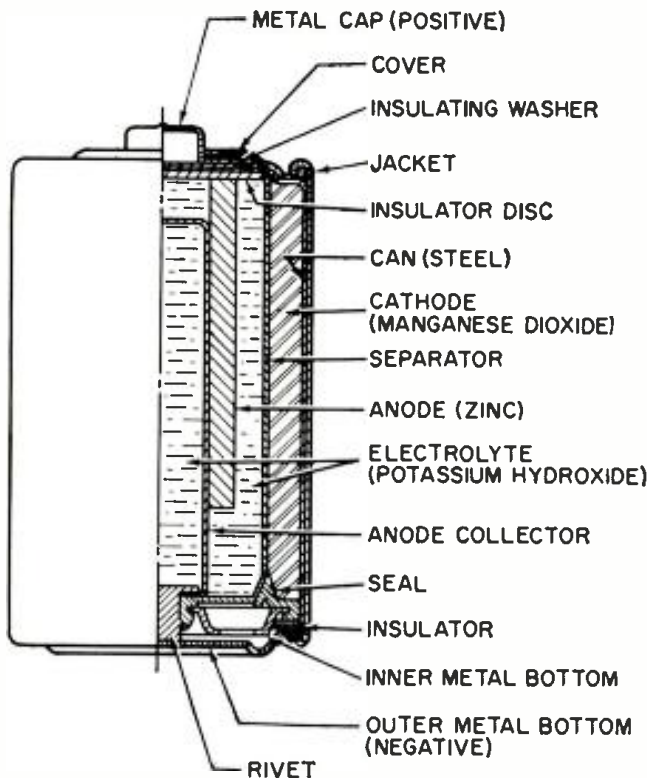
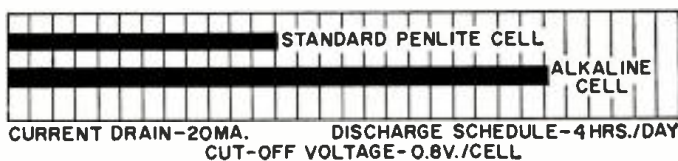

Fig. 1. Cut-away illustration of an alkaline-manganese cell.

Fig. 2. The type E91 alkaline cell provides twice the service life obtainable from the standard penlite-type cell.



The sealed nickel-cadmium system permits a maintenance-free battery that can be recharged hundreds of times and can be left discharged without damage. Unfortunately, practical areas of use are limited by high initial cost and by the fact that energy-per-charge is often much less than a primary battery can supply.

A discussion of battery performance and applications will help clarify the relative merits of the alkaline-manganese and nickel-cadmium battery systems.

Alkaline Primary Batteries

This cell differs from the conventional LeClanché cell primarily in the highly alkaline electrolyte used. The cell is a high-rate source of electrical energy. Its outstanding advantages are derived from the unique assembly of components and construction methods. See Fig. 1.

Two principal features are a manganese dioxide cathode of high density in conjunction with a steel can which serves as a cathode-current collector and a zinc anode of extra high surface area in contact with the electrolyte. These features, coupled with the use of a potassium hydroxide electrolyte of high conductivity, give these cells their very low internal resistance and impedance and high service capacity.

The cells are hermetically sealed and encased in steel, providing virtually a leakproof package. Each cell is a nominal 1.5 volts. The ampere-hour capacity is relatively constant over a range of current drains and a range of discharge schedules.

The primary advantage of the new system lies in its ability to work with a high degree of efficiency under continuous or heavy-duty, high-drain conditions where the standard round cell is unsatisfactory. Under certain conditions the new alkaline cells will provide more than ten times the service of standard round cells. Heavy current drains and continuous or heavy-duty usage impair the efficiency of the conventional carbon-zinc cell to the extent that only a small fraction of the built-in energy may be removed.

On light drains, such as portable radio or instrument use, alkaline-manganese cells often supply more than twice the service life (Fig. 2) of carbon-zinc batteries and very nearly equal mercury battery life. The low impedance of alkaline cells can improve radio performance by minimizing distortion and their low temperature characteristics result in good service life even under outdoor winter conditions.

The good low-temperature performance of alkaline-manganese batteries completely overcomes the temperature limitation of mercury batteries and far surpasses standard carbon-zinc cells. At light to intermediate drains, reasonable service can be obtained at -40 degrees F and below. This characteristic is particularly valuable in devices which may be stored or operated outdoors or in automobiles in winter.

The heavy-drain, high-amperage performance of alkaline-manganese batteries makes them particularly useful in toys and for photographic and hobby use. These cells will make practical completely new types of battery-operated equipment.

The E94 alkaline energizer is a new cell size. The diameter is the same as a "D" cell but it is only one-half the height. Two E94 cells will fit in a holder designed for a single "D" cell. Where it is desirable, and the device will stand the higher voltage, it is now possible to double the voltage in existing "D"-cell-powered units. The smaller alkaline cell has a service capacity equal to a standard "D" cell on heavy continuous drains. For example, four "½D" cells can be placed in a standard 2-cell flashlight. If the usual PR-2 lamp is replaced by a PR-13 lamp, designed for the higher voltage, the light output will be doubled. The brilliance will approach that of a 5-cell spotlight.

The E93 "C" size alkaline energizer, like the other alkaline-manganese cells, on heavy continuous drains will supply up to ten times the life of a comparable carbon-zinc flashlight cell.

Its first use was in the "Futuramic II" electronic flash unit manufactured by the *Heiland Division of Minneapolis-Honeywell Regulator Company*. The high energy and high amperage of the alkaline energizers made them ideal for this application.

Electrically powered toys are very hard on batteries because drains are heavy and the smallest possible cells are usually used. The majority of toys use "AA" or "C" size cells. The heavy drain capabilities of alkaline-manganese cells make them ideal for this use. They not only last several times as long as flashlight batteries, but they often improve toy performance as well.

When currents of one ampere or more are required for periods of several hours, larger alkaline-manganese cells must be used. Both "D" and "G" size cells are available, the latter both as a unit cell and series-connected to form the 6-volt No. 520 battery. Although the "G" size cell with insulated terminals ("Eveready" No. E97S) is about one-sixth the size and one-quarter the weight of the No. 6 cell used in the hobby field, it gives over 70 per-cent of the service of the No. 6 cell in glo-plug ignition operation for the engines of model airplanes.

In addition to electronic, toy, hobby, and other heavy-duty uses, the E95 "D" cell and the 6-volt battery (No. 520) are particularly adapted for emergency lighting use. Emergency flashlights or lanterns must be capable of supplying a bright light (high-drain bulb), they must be capable of continuous operation for the duration of the emergency (possibly many hours), and they must operate under adverse temperature conditions. Furthermore, the batteries must have a good shelf life so they will be capable of operation when an emergency occurs. These requirements spell out the important characteristics of alkaline-manganese cells. The flashlight in an automobile is an emergency light—and in winter it must be capable of operating when cold!

Battery Economics

The initial cost of alkaline-manganese batteries falls between that of carbon-zinc and mercury batteries. On all tests they deliver more service than carbon-zinc batteries and on heavy-drains or in low-temperature uses, service of alkaline-manganese batteries will exceed mercury batteries. Unless a flat discharge curve is essential, the cost-per-hour operation of alkaline-manganese cells is lower than for mercury batteries. It is also lower than carbon-zinc batteries in heavy continuous use, but may be somewhat higher in light intermittent uses. In some cases, superior electrical device performance, resulting from the better shelf life and lower impedance of alkaline-manganese batteries, may offset any increased operating cost.

Rechargeable Batteries

At first glance a rechargeable power source appears to offer the convenience of primary battery operation without the expense of replacement batteries. In some circumstances, this could be true and a rechargeable battery the only economical portable power source. In other applications a casual appraisal may be completely misleading. A primary battery may be less expensive for both the short and long term as well as being more convenient.

Consider the hypothetical case of two men who buy identical portable radios, operated by four penlite cells. Mr. A is a machinist working in a noisy shop. He operates his radio ten hours a day at high volume (45 ma. battery drain) so it can be heard above the ambient noise. Mr. B uses his radio an hour a day at low volume (15 ma. battery drain) in a quiet home. The radios can operate on any of the several types of primary batteries (assume No. 1015 radio grade carbon-zinc cells @ \$1.00 per set of four) or nickel-cadmium cells can be used (No. N46 @ \$11.00 per set of four plus approximately \$7.00 for a charger).

Mr. A can buy nickel-cadmium cells and a charger, recharge them every night and recover his investment (com-

pared to primary battery operation) in from 2½ to 3 months. A good investment. On the same basis Mr. B would have to remember to charge his batteries once a month and would require six years to recover his investment—and by that time he might well need new nickel-cadmium batteries because they do not last forever. Obviously a poor investment. Sealed nickel-cadmium batteries are a fine product but they should be used only where primary batteries are uneconomical or impractical.

For use in electronic equipment, any rechargeable bat-

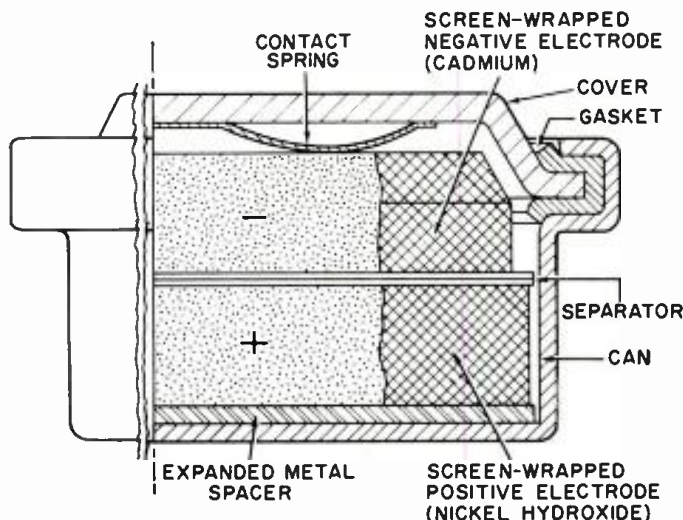

Fig. 3. Illustration above shows a cut-away view of a typical sealed nickel-cadmium button cell that is described in the text.

tery should be hermetically sealed so that it is not necessary to add water and so that gassing on overcharge cannot carry corrosive vapor into the instrument. Also, the battery should be undamaged by long periods of storage, charged or discharged, and should have a low self-discharge rate. Sealed nickel-cadmium batteries meet these requirements best.

Sealed Nickel-Cadmium Batteries

The nickel-cadmium battery is a remarkable device and more than fifty years of successful use have proved this point. Nickel-cadmium batteries may be recharged many times, have a relatively constant potential during discharge, and have excellent charge-retention properties. They will stand more abuse than any other cell, have good low-temperature performance characteristics, and are competitive with other systems in terms of cost-per-hour use. They are true storage batteries using one of the very best electrochemical systems.

The nickel-cadmium cell has been used in Europe for many years in its original form as an unsealed cell, for automobile and truck starting and for fixed installations. Recent technological advances have made possible the extension of the nickel-cadmium system to small, hermetically sealed batteries—rechargeable batteries that are free from the usual routine maintenance, such as the addition of water. These developments have brought the economic advantages of rechargeability to small batteries.

A conventional vented-type nickel-cadmium battery will liberate oxygen and hydrogen plus entrapped electrolyte (potassium hydroxide) fumes through a valve. In order to hermetically seal a nickel-cadmium cell, it is necessary to develop means of using up this gas inside the cell. This is accomplished as follows:

1. The battery is constructed with excess ampere-hour capacity in the cadmium electrode.
2. Starting with both electrodes in the fully discharged state, charging the battery causes the positive (nickel) elec-

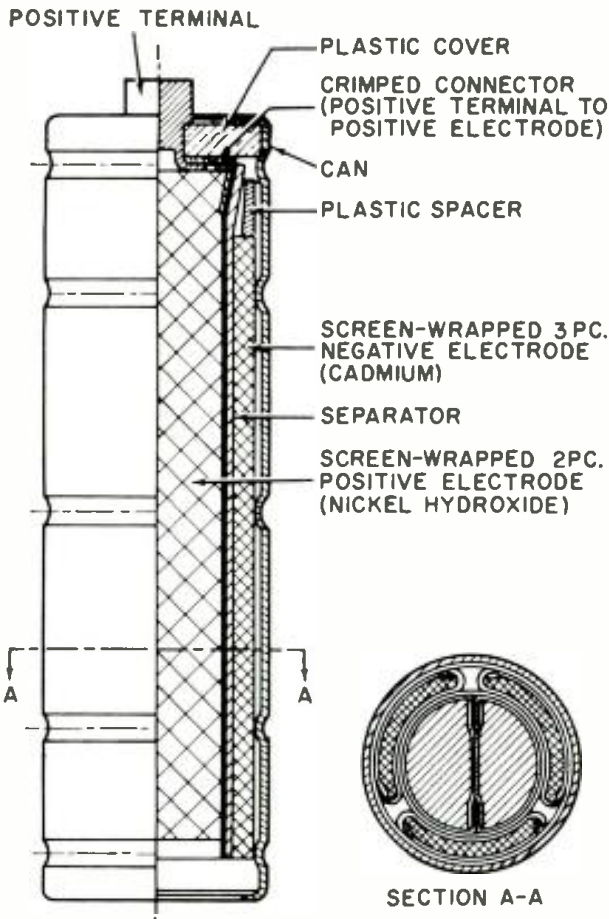

Fig. 4. Cut-away view of a cylindrical nickel-cadmium cell.

trode to reach full charge first and it starts oxygen generation. Since the negative (cadmium) electrode has not yet reached full charge it cannot cause hydrogen to be generated.

3. The cell is designed so that the oxygen formed can reach the surface of the metallic cadmium electrode where it reacts, forming electrochemical equivalents of cadmium oxide.

4. Thus, in overcharge, the cadmium electrode is oxidized at a rate just sufficient to offset input energy, keeping the cell in equilibrium at full charge.

This process can continue for long periods. The level of oxygen pressure thus established in the cell is determined by the charge rate used.

Sealed nickel-cadmium cells are available in a variety of sizes and capacities. See Figs. 3 and 4. These include: button cells (50-500 ma.-hour capacity), cylindrical cells (450-2000 ma.-hour capacity), and rectangular cells (2-23 ampere-hour capacity).

The capacity of most nickel-cadmium cells is specified at the 10-hour rate (current drain required to discharge the cell in 10 hours). When they are used at higher discharge rates, the capacity is reduced.

Nickel-cadmium cells have the desirable flat discharge

(constant-voltage) characteristic. As shown in Fig. 5, note that the average voltage is about 1.2 volts per cell. The initial voltage shown on the curves is designated as the voltage under load after 10 per-cent of the ampere-hour capacity has been removed from a fully charged cell.

Any rechargeable battery will lose charge when stored. Nickel-cadmium batteries have a lower self-discharge rate than any other present secondary battery system. More important, the batteries are not harmed even if not used for long periods of time.

Sealed nickel-cadmium cells experience a relatively small loss of capacity at operating temperatures, ranging from -20 to $+45$ degrees C. Within this range, stable discharge voltage is maintained.

With most nickel-cadmium cells, the 10-hour rate should not be exceeded in constant-current charging. Fourteen hours charging at this rate will fully charge the cell. Constant-voltage charging, which is also acceptable, results in a higher initial charging rate. At the start of charge the current may greatly exceed the 10-hour rate, but the charging circuit must be designed so that 10-hour current (or less) flows toward the end of charge.

The battery can be trickle-charged or floated. For maximum performance in situations of continuous overcharge, with occasional interruptions, the current should not exceed the 30-hour rate.

These cells will also stand extended overcharge at rates considerably higher than those recommended for floating. Although charging at the maximum rate (10 hours) is normally expected to be completed in 14 hours, cells will not be damaged by occasional charging at this rate even for several weeks. Continuous overcharging at higher-than-necessary rates accelerates general degradation of the cell but complete or sudden destruction will not result unless the 10-hour rate is exceeded.

A typical, yet simple, charging circuit is shown in Fig. 6. Values of charging current for button and cylindrical cells range from 5 to 150 ma., depending on cell size, for a 14-hour charge.

When used in an appropriate application where true advantage can be taken of their simplicity and rechargeability, sealed nickel-cadmium batteries can make possible new battery-operated devices which would otherwise be completely uneconomical.

Conclusion

Is the present multiplicity of batteries worthwhile? Has there been any real progress? The answer is an unqualified "yes." New battery systems supplement existing batteries. They improve the operation of many present devices, make possible new uses, and offer the consumer new choices so that he can obtain the best battery buy for his particular device and operating requirements.

Battery and portable-power research and development continue unabated. Future years will bring still better primary and rechargeable batteries and probably fuel cells and thermoelectric generators as well. Thus more new devices will be able to operate electrically without being tied to a power line. ▲

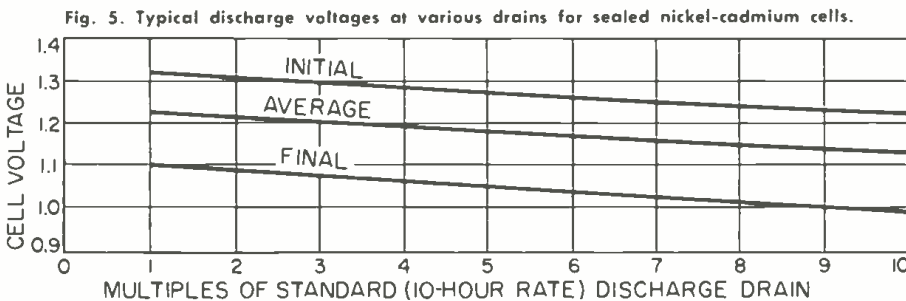
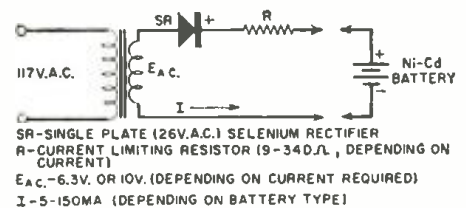

Fig. 5. Typical discharge voltages at various drains for sealed nickel-cadmium cells.

Fig. 6. Charging circuit for small sealed nickel-cadmium batteries.



COVER STORY

THE TERM "super-power" applied to a new family of grid-controlled amplifier tubes, developed to meet increasing demands for higher u.h.f. power output, is not a misnomer. These tubes, which are capable of producing megawatts of pulse power output and hundreds of kilowatts of average power output, are particularly well suited to applications such as long- and short-pulse long-range search radars and missile-tracking radars, particle-accelerator power sources, broadband radars, space-probe and satellite radars, satellite communications, and r.f. power sources for special-process and heating applications.

This new family of tubes includes the commercial types RCA-7835 (shown on this month's cover being inserted into an external resonant cavity), and RCA-2054, as well as several modified developmental versions used in government-procured or sponsored equipment. These tubes are the result of an integrated program designed to produce the world's most powerful u.h.f. power-output device in a single envelope. For example, the 7835 can produce 5-million watts of pulse power at 250 mc. (See Table 1)

Design Philosophy

Fundamentally, the new family of super-power tubes combines a number of triode units in parallel in a common ceramic-metal, water-cooled envelope. This is done to provide maximum emission-current capability without exceeding a practical electrical length for u.h.f. operation. A total of 96 triode units provide the total electron current required. The

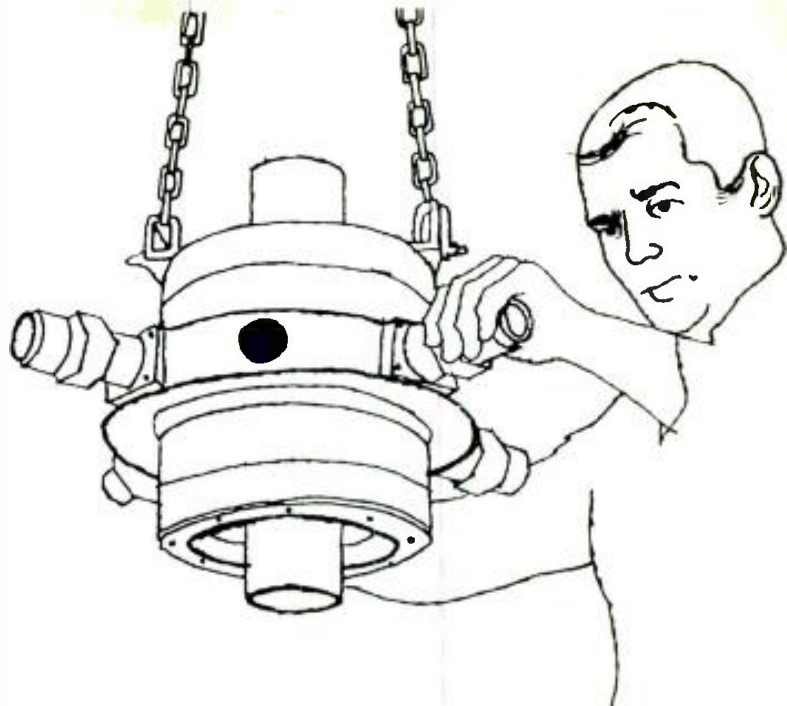

SUPER-POWER U.H.F. TUBES

By R. E. REED & A. C. TUNIS

Electron Tube Div., Radio Corp. of America

Capable of producing millions of watts of pulse power, these tubes are designed for the maximum amount of u.h.f. power output from a single-envelope device.

MAXIMUM RATINGS*

| | | |
|-----------------------------------|---------|--------------|
| Peak Positive-Pulse Plate Voltage | 65,000 | voltage max. |
| Peak Negative Grid Voltage | 500 | voltage max. |
| Peak Plate Current | 325 | amps max. |
| D.C. Plate Current | 3.25 | amps max. |
| Plate Input (average) | 212,000 | watts max. |
| Plate Dissipation (average) | 150,000 | watts max. |

*For frequencies up to 300 mc. and for a maximum "on" time of 25 microseconds in any 2500-microsecond interval.

TYPICAL OPERATION**

| | | |
|--|-----------|---------------|
| Peak Positive-Pulse Plate-to-Grid Voltage | 34,000 | 60,000 v. |
| Peak Cathode-to-Grid Voltage | 100 | 300 v. |
| Peak Plate Current | 260 | 280 a. |
| D.C. Plate Current | 2.6 | 2.8 a. |
| Peak Driver Power Output | 150,000 | 200,000 w. |
| Useful Power Output at Peak of Pulse (approximate) | 5,000,000 | 10,000,000 w. |

**In a cathode-drive circuit, with rectangular-waveshape pulses, at 250 mc., with a duty factor of .006, and a pulse duration of 25 microseconds.

Table 1. Operating characteristics of type 7835 super-power triode (shown on cover) as plate-pulsed class B power amplifier.

Fig. 1. Cross-section of a portion of the active region of the tube showing the relative positions of plate, grid, and cathode.

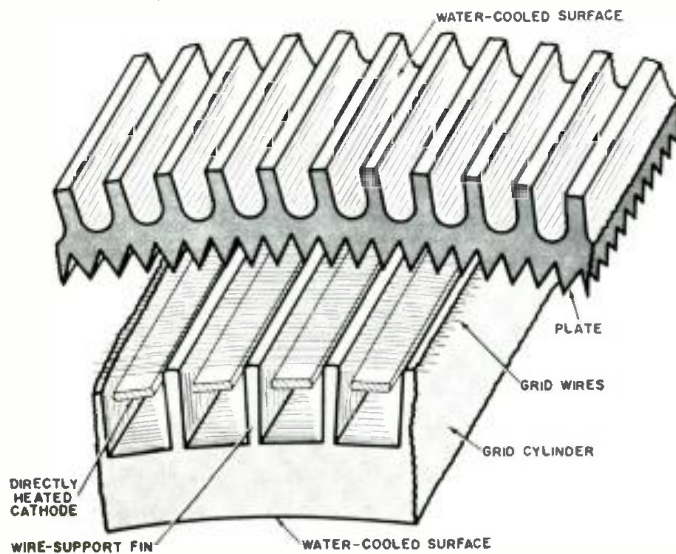

October, 1961

cross-section of the active region in Fig. 1 shows the relative positions of the elements in each unit triode and the relation of each unit to adjacent units.

The plate, which is centered about the electronically active region of the tube on insulating low-loss ceramic bushings, forms the outer conductor of a portion of a coaxial output circuit located within the tube. The plate face is made of oxygen-free high-conductivity copper which provides the high thermal conductivity necessary to conduct the heat dissipated on the plate face by impinging electrons to the cooling water on the reverse side.

The grid consists of .003-inch-diameter pure tungsten wire wound around the circumference of the grid cylinder. Each grid wire is located in tiny slots across the radial fins that extend outward from the grid block between the cathode, as shown in Fig. 1. A rolling operation firmly fastens the grid wires in position and molds the edges of the fins around the wires to provide the necessary electrical and thermal contacts. The fins are an integral part of the water-cooled grid cylinder.

The thoriated-tungsten filamentary cathode strands have rectangular cross-sections with appropriate reduction in area at either end to compensate for thermal conduction to the supporting structures. Approximately 70 amperes of filament current is required to heat each strand to the normal operating temperature. The total filament power required for long-pulse and c.w. service is 6800 amps at 3.5 volts. For short-pulse service, 1800 amps at 1.3 volts is used.

Mode of Operation

These super-power u.h.f. amplifier tubes are designed for use with external coaxial-cavity resonator circuits, as

(Continued on page 70)



RECENT DEVELOPMENTS IN ELECTRONICS

Infrared Binoculars

◀ One of the items under development by the U.S. Army Engineering Research & Development Labs, Fort Belvoir, Va., is an infrared binocular which will enable military personnel to see in the dark. The binoculars, made by American Optical Co., require an operating voltage of 12 kv. for the built-in infrared-converter tubes.

50-Watt Transistorized Hi-Fi Amplifier

This all-transistorized, 50-watt monophonic amplifier, using a new type of transistor for hi-fi sound systems, was exhibited by RCA recently. The key transistors are two new drift-field power types designated TA2017 and TA2048. In pilot production for the past several months, they are available in commercial quantities for a variety of consumer products.

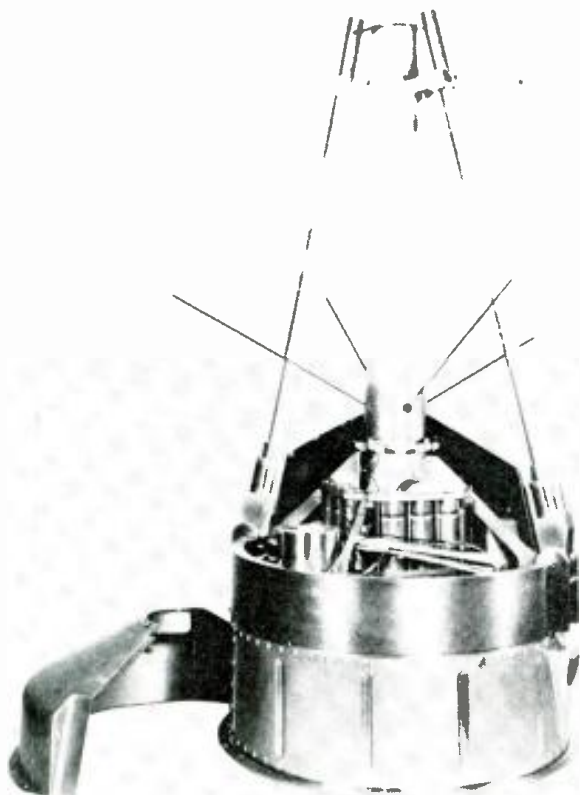
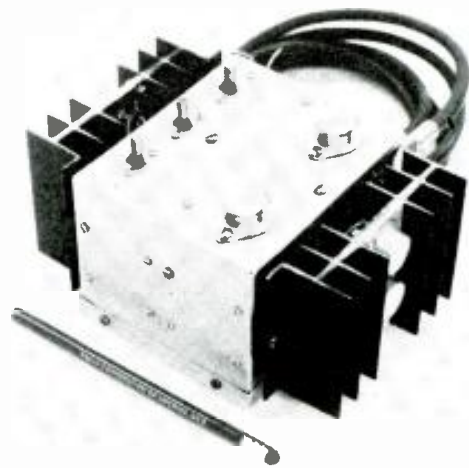

Ionosphere-Density Probe

◀ A sounding rocket launched from Wallops Island, Virginia, successfully made the first test of some equipment that will be used in the nation's "Topside Sounder" satellite. The satellite, scheduled for launch in late 1962, will determine the electron density of the ionosphere by sending radio signals downward into the ionosphere from above. The rocket, together with a payload of electronic equipment encased in its nose cone, was programmed to reach an altitude of about 700 miles and radio back to a ground station the measurements of the density of electrified particles as a function of altitude. The technique used for sounding involved the measurement of the time delay between pulsed r.f. transmissions from the payload and received echo signals reflected back from the ionosphere. Pulsed transmissions were made alternately and repetitively at about 1 and 6 mc.

The "Topside Sounder" satellite payload equipment (shown at left) is 15 inches in diameter, and contains storage batteries, a single transmitter-receiver and telemetry link. The central column supports a spring used to jettison the rocket nose cone. After the cone was dropped, the telescoped antenna poles clamped to the central column were brought into sounding position at right angles to the payload body. The four small projecting wires are telemetry antennas. The entire program is the work of Airborne Instruments Laboratory and the Central Radio Propagation Laboratory, both under contract with NASA.

775-kv. Line Tested by Tape

A record-breaking electrical power line, built by American Electric Power Service Corp. and Westinghouse, was energized recently at Apple Grove, W. Va., for a 5-year test program. Tests on the new line are completely instrumented, using magnetic-tape data logging equipment which records 50 test items every 20 minutes. Lineman on ladder in photo is working on one of the r.f. decoupling filters installed in the system to permit separate radio-influence measurements on the 3 main line sections.

Two-Dimensional Dipole Array

A two-dimensional array of crossed dipoles used as a telemetering, receiving, and tracking antenna is shown. The 237-mc. antenna can operate with vertical, horizontal, or circularly polarized signals. Designed by Rantec Corp., the array is said to have slightly more gain and lower side-lobes than a four-helix antenna.

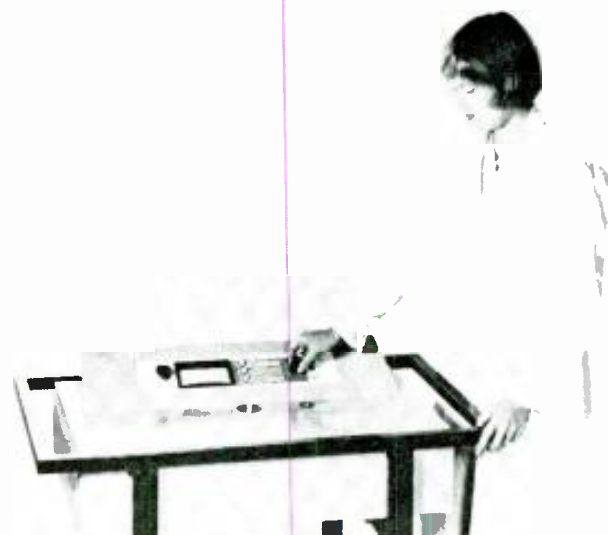
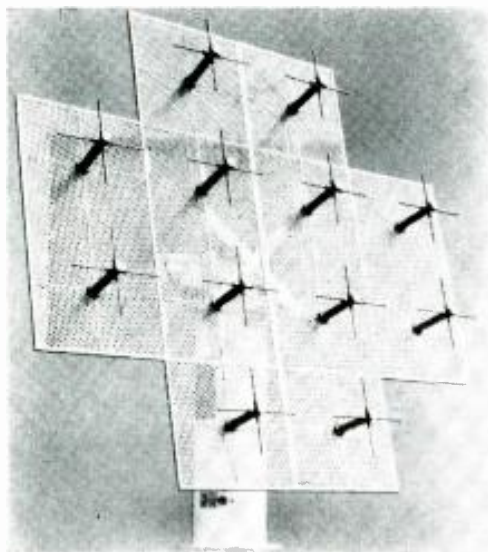

Transistorized Computer Measures Blood Volume

A new automatic instrument that determines the amount of blood in a person's circulation rapidly, repeatedly, and with great precision was demonstrated recently by Atomium Corp. The instrument operates by taking radioactivity measurements on a small blood sample from a person who has previously been given an injection of a known and harmless amount of radioactive iodine. Computer circuits in the instrument calculate the exact blood volume from the amount of dilution of the radioactive material. Total volume is read out on a directly calibrated meter. The instrument, called a "Volemtron," has been used in open-heart surgery, where it has shown precisely the amount of blood that must be transfused into a patient at the end of the operation.

Digital Transmission Equipment

A "house of cards" could describe ACF Electronics' new building-block communications equipment that adapts digital data machines, such as teletypewriters (foreground) and computers for simultaneous high-speed, long-range transmission. The equipment makes extensive use of a large number of plug-in printed-circuit cards for the various circuits.

STEREO FM MULTIPLEX ADAPTER CIRCUITS

Schematic diagrams and circuit descriptions of four new commercially available FM multiplex adapters.

By MILTON S. SNITZER
Technical Editor, ELECTRONICS WORLD

BELL SOUND Model MXA-1 adapter (right) consists of a triple-triode "Compactron" tube and a pair of crystal diodes. Power for the unit is obtained from the FM tuner with which the adapter is used. Signals from the tuner are applied to triode sections V_{1A} and V_{1B} . V_{1A} is a wide-band amplifier for the composite stereo signal, consisting of information on both the main channel and the subcarrier channel. A trap in the output circuit of this section removes any SCA (background music) signals. V_{1B} amplifies the 19-kc. pilot subcarrier and applies it to V_{1C} , operating as a locked oscillator whose output circuit is tuned to 38 kc. This 38-kc. signal is applied via the transformer directly to the crystal diodes along with the composite stereo signal. Because of the way that the crystals are connected, first one and then the other is switched on by the 38-kc. signal. This switching technique permits one crystal to sample the left channel and the other crystal to sample the right channel, without using any matrixing circuits, bandpass or phase-delay filters. Low-pass filters in the output of each crystal remove high-frequency signals that might interfere with tape-recorder circuits.

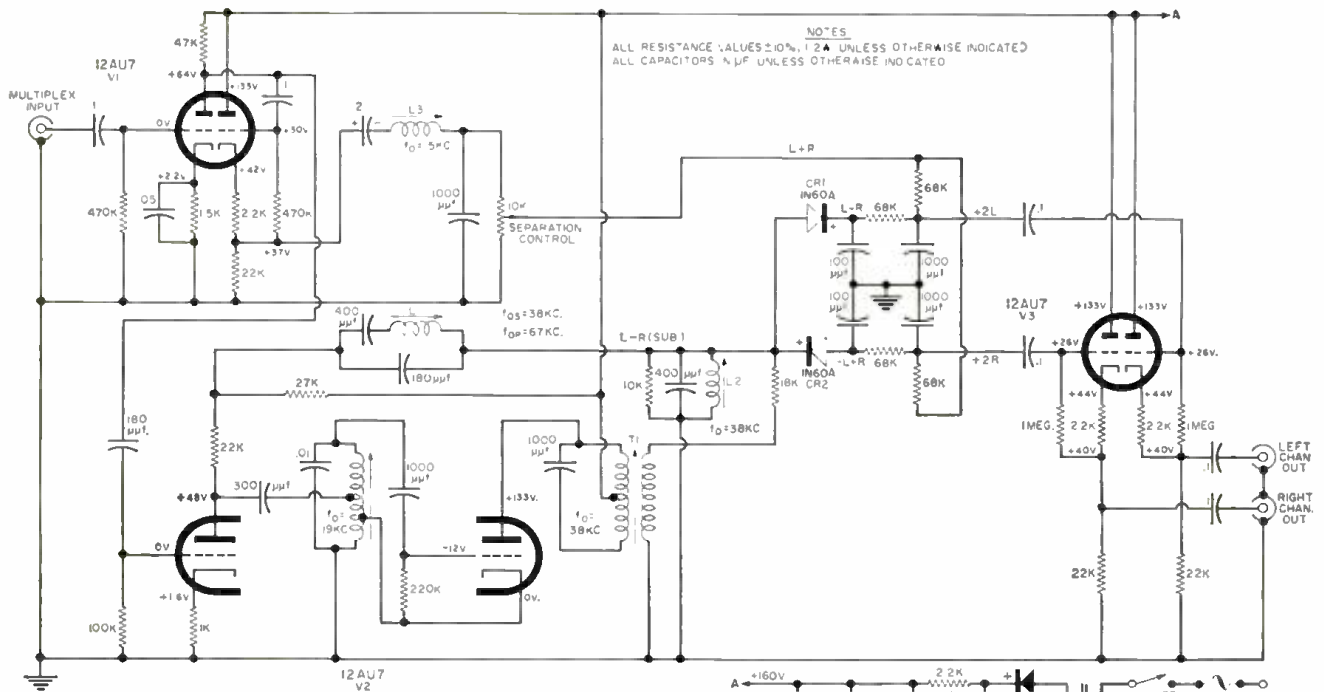
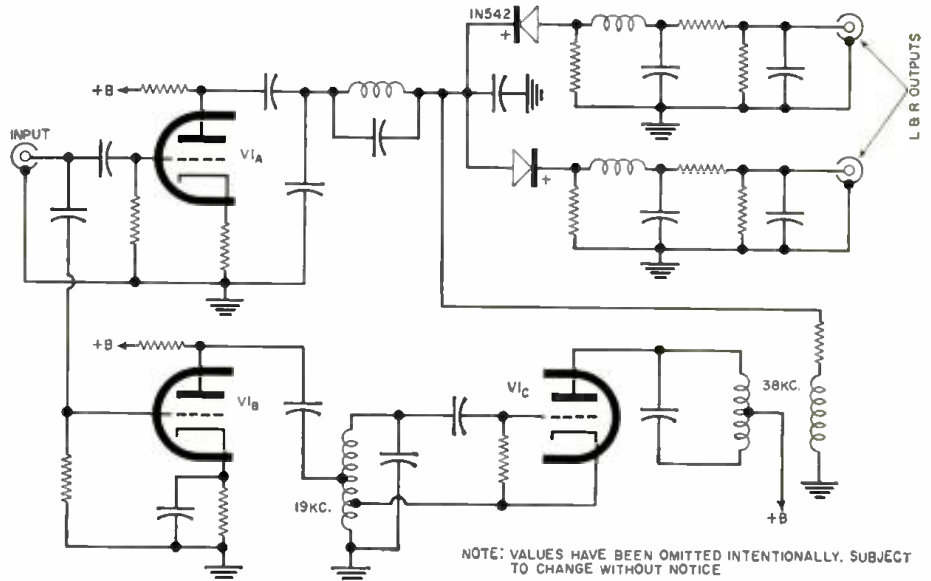

HEATH Model AC-11 self-powered adapter (above) uses three twin triodes, two crystal detectors, and a silicon-diode rectifier. Signals from the FM tuner are applied to isolating amplifier V_1 , whose output section is a cathode-follower. A low-pass filter (L_3) and associated capacitors permits only the sum ($L + R$) signal to be applied through a matrix network to the crystal diodes. Output from the first section of V_1 is also applied to the first section of V_2 , a bandpass amplifier whose tuned circuits accept only the pilot subcarrier and the difference ($L - R$) signal. SCA signals are rejected here as well. The 19-kc. pilot subcarrier keys an oscillator (second section of V_2) whose output is tuned to 38 kc. This signal is then applied to the balanced crystal detector through T_1 . The detected difference signal from the crystals is mixed with the sum signal (through the 68,000-ohm resistors) to produce the original left and right signals. These are then applied to a pair of cathode-followers (V_3) from which the two outputs are obtained. A conventional half-wave rectifier with R-C filtering supplies the "B+" voltage required for the circuit.

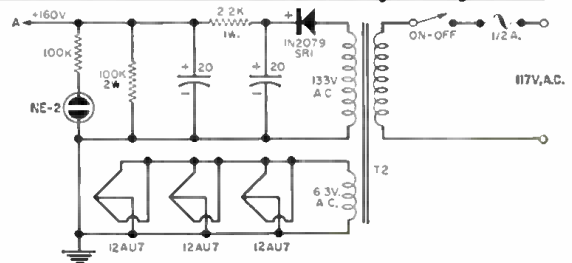

HARMAN-KARDON Model MX-500 (right) employs two tubes and a pair of crystal diodes in this multiplex adapter. Power for the unit is obtained from the associated FM tuner through the power plug shown. Detected signal from the tuner is applied from pin 1 of the plug to a broadband isolation amplifier V_1 . Filter circuits at the output of V_1 separate the sum-signal channel (including the 19-kc. pilot subcarrier) from the difference-signal channel. The filters also reject SCA signals. The sum signal is applied through a resistive matrixing network to the output of the crystal detectors. Output from V_1 is also applied to the triode section of V_2 , where the 19-kc. pilot subcarrier is amplified. The pilot subcarrier synchronizes an oscillator (the pentode section of V_2), whose output circuit is tuned to twice the input frequency—38 kc. This 38-kc. signal is then transformer-coupled to the balanced crystal detectors. These produce a difference signal along with an inverted difference signal which are then combined with the sum signal in the matrix network. The resultant outputs from the crystals, which are the original left and right signals, are then applied to pins 4 and 6 of the multiplex plug. From this point the signals are applied to the stereo amplifier in the conventional manner.

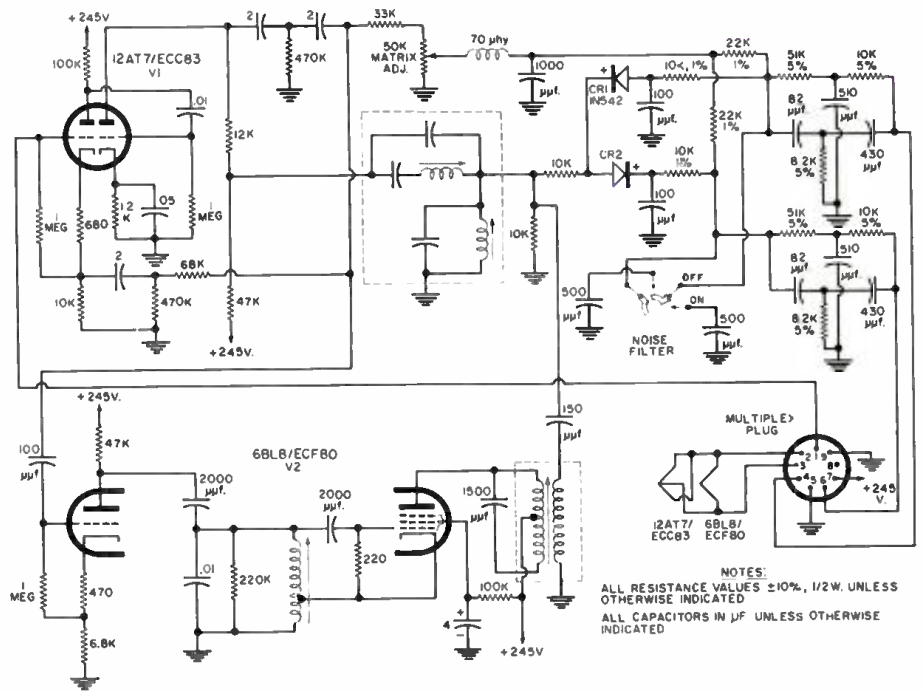

FISHER RADIO Model MPX-100 self-powered multiplex adapter (below) employs five tubes, two crystal rectifiers, and a crystal bridge power rectifier. Signals from the tuner are applied to V_{1A} , from which both cathode and plate outputs are taken. The cathode circuit of V_{1A} contains a bandpass filter for the difference-frequency signal, which is then passed on to V_{1B} , a product detector. The plate output of V_{1A} contains wide-band noise which is applied to V_2 , a relay amplifier, through a crystal-rectifier circuit. Also applied here is a 19-kc. signal from the plate of V_{1B} . When tuned to a station transmitting stereo, the relay is energized, a "stereo beacon"

lamp is on, and the adapter functions normally. When tuned to a mono station, the relay is de-energized and the subcarrier signal path is grounded. The noise input mentioned above prevents interstation noise from operating the "beacon." Cathode output of V_{1B} delivers the sum signal to the matrix. V_3 is an oscillator, synced by the 19-kc. signal from V_2 , whose 38-kc. output is applied to the product detector. V_{1B} serves as phase inverter for the detected difference signal as required by the matrix. Twin-triode V_4 is a pair of low-impedance anode-followers which deliver left and right signals to the stereo amplifier. ▲

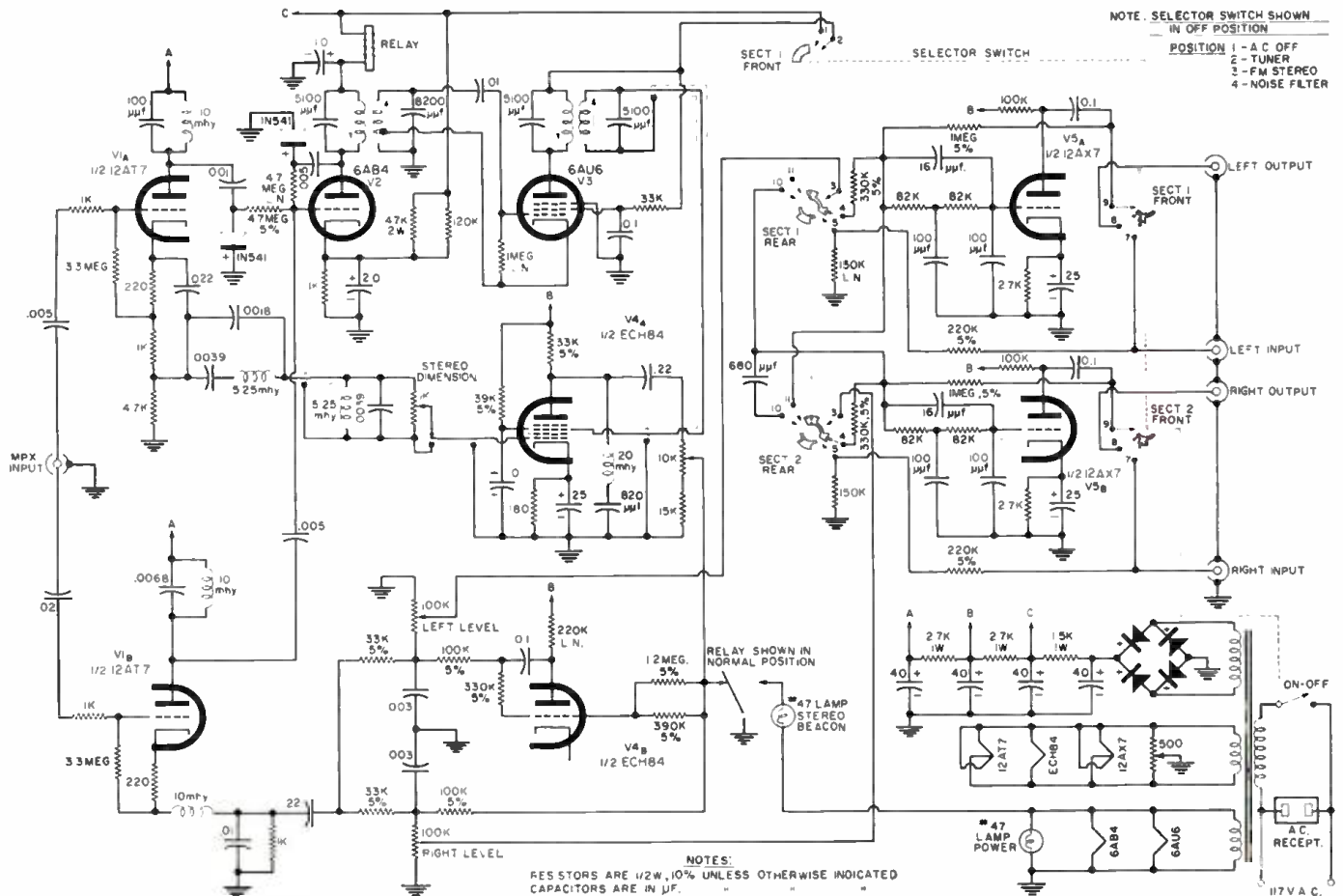

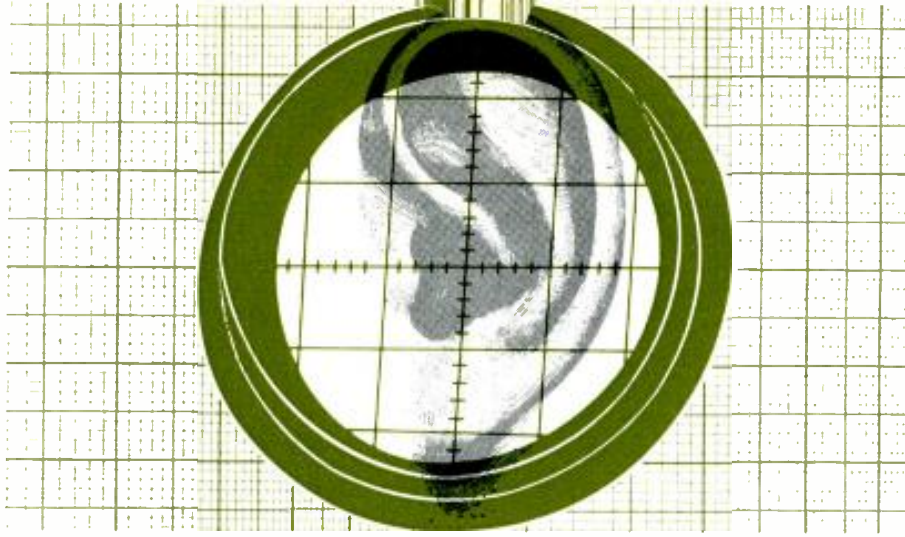

LOUDSPEAKER TESTING AND MEASUREMENT

By EDGAR VILLCHUR
President, Acoustic Research, Inc.

While listening tests are important, a speaker's performance can be predicted from properly made and interpreted test measurements, even before it is hooked up to a hi-fi system.

THERE is a widely accepted myth in the high-fidelity field that loudspeakers (unlike amplifiers, tuners, or pickups) cannot be tested objectively. It is frequently said that a listening test is the only way to check speakers.

Objective Testing

The objective testing of loudspeakers is more difficult and more complicated than the testing of other components and some writers have been led to the conclusion that such testing is not meaningful. However, the fact that meaningful speaker information is more difficult to come by, or that misleading information is easy to come by, does not invalidate objective investigations. As a matter of fact, the experienced person who can interpret properly made measurements can predict accurately what a speaker will sound like before it is even connected to the hi-fi amplifier.

A measured 1% distortion in an amplifier has the hi-fi enthusiast up in arms and writing indignant letters to the manufacturer. A measured 30% distortion in a loudspeaker, at the same frequency and signal level, is passed off as meaningless. It is how the loudspeaker sounds to *you* that counts, one is told, and never mind the distortion curves. One listens to music, not to curves.

It takes only a little bit of reflection to realize that such an argument can be used, with equal force, to disparage all electronic or acoustical measurements. One doesn't listen to tuner sensitivity

figures, but to the clarity of reception; one doesn't listen to amplifier watts, but to the volume of sound, etc. The argument is just as faulty in each case.

Objective measurements can describe the accuracy of reproduction of any of the components in a high-fidelity system. If one is looking for a speaker sound which is dramatic and exciting in its own right (over and above the drama and excitement of the music), evaluation is a matter of taste and objective testing has no place. But if one sets out to evaluate the degree to which an amplifier or speaker reproduces accurately the musical signal fed to it, there are test procedures which tell the story.

Frequency Response

The most talked about measurement, and certainly one of the most important, is frequency response. The frequency response of a loudspeaker has the same significance as the frequency response of a cartridge or amplifier; a 10-db peak in the midrange or a sharp cut-off below 80 cycles, will produce the same aberrations of sound in any of these three components. Yet it is a fact that there often seems to be little correlation between the frequency response "curve" of a loudspeaker and the character of its sound.

This does not mean that speaker performance relies on some elusive quality not subject to scientific observation. It means that the particular curve does not actually represent the frequency response of the loudspeaker in question.

The output of an amplifier or of a cart-ridge appears as an electrical signal at definite terminals and the characteristics of these devices can be measured at these terminals. The output of a loudspeaker, however, consists of sound radiated into the room in many directions. The frequency response of the speaker may be completely different at different angles to its axis. If one were to listen to a loudspeaker in an anechoic chamber or out of doors, one would hear the quality represented by a frequency response curve recorded from a microphone placed at the particular listening position. This isn't true in a normally reverberant room. The listener hears a combination of direct and reflected sound and the major part of the sound is reflected back and forth between the room surfaces before it is heard.

Therefore the character of a loudspeaker in a room is for the most part dependent on the *total power* radiated at different frequencies, not on the particular "pressure" frequency response that exists in a direct line from the listener to the speaker. Even though one were sitting on-axis to a speaker, one would perceive all of its off-axis frequency response characteristics because they would be heard in the reflected sound. Two speakers with identical on-

axis frequency response curves, but widely variant off-axis curves, may seem completely different in performance.

Off-Axis Performance

Frequency response curves which accurately represent the performance quality of a loudspeaker are not difficult to produce. It is necessary to measure a family of curves, both on and off the speaker axis. Experimental work may require that we take speaker frequency response curves for every 5 degrees between 0 and 90 degrees from the axis. Once it is established that there is a regular pattern to such a family, it is possible to represent the speaker's frequency response by a selected group of curves—for example, on-axis, 30 degrees off-axis, and 60 degrees off-axis.

Fig. 5 shows a midrange tweeter being clamped to a swivel board at one of AR's anechoic chambers. Fig. 1 is a family of curves made by the *General Radio* automatic level recorder at the left in the photo. The *power frequency response* of this speaker is represented by all of the curves taken together. Although the on-axis curve by itself would seem to indicate response within $\pm 1\frac{1}{2}$ db to about 15,000 cycles, the actual radiated power is considered as rolling off at about 7500 cycles. Hence this is the

crossover frequency employed for a super-tweeter that is used with the mid-range unit.

These considerations are most important for the treble range because it is here that the on-axis and off-axis characteristics of the speaker tend to be so different. There are also special problems with regard to representing the bass response of a loudspeaker.

Solid Angle

If a speaker were suspended by a rope in the center of the universe it would radiate bass sound in all directions and it would be said to "see" a solid angle of 360 degrees. Each time that this solid angle is reduced (by putting the speaker against a wall or at the junction of two surfaces) the cone is given a better bite of the air it engages and becomes more efficient in the bass range without the rest of the frequency response being affected. It is therefore not possible to place a speaker in an anechoic chamber—where it effectively radiates into 360 degrees—put a microphone in front of it, and procure a representative response curve of its bass range. (See references.)

The author once received a letter from a puzzled music lover who had originally reacted to the musical sound of his

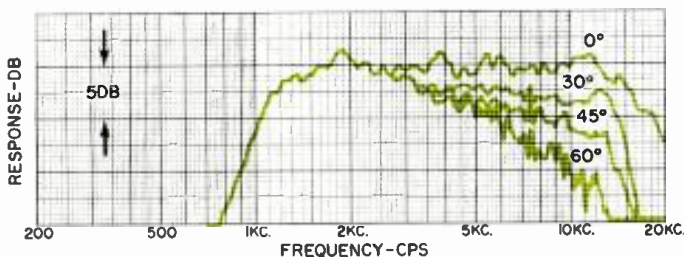

Fig. 1. Part of a family of curves for a midrange tweeter, recorded automatically by the equipment illustrated in Fig. 5.

Fig. 2. Graph sent in by dismayed music lover. Response was measured in anechoic chamber. Dashed lines show bass correction.

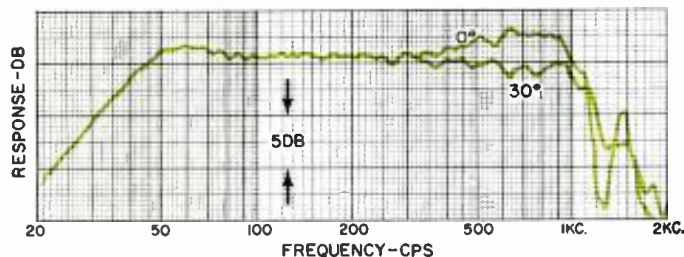
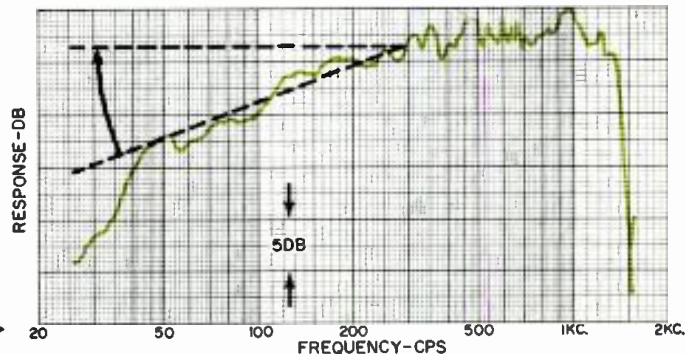

Fig. 3. Acoustic frequency-response curve of a woofer. This curve was recorded by the use of the outdoor testing setup that is illustrated in Fig. 6. Note that the diffraction dip that occurs at 1250 cps disappears when mike angle is changed.

Fig. 4. Two frequency-response curves of the same woofer taken indoors, in an uncontrolled acoustical environment. The speaker was in a corner, about five feet off the floor; the two curves represent responses at two different microphone positions. Note the lack of similarity in over-all curve shape, and in location of the worst peaks and dips. These curves give more information about the listening room than they do about the loudspeaker.

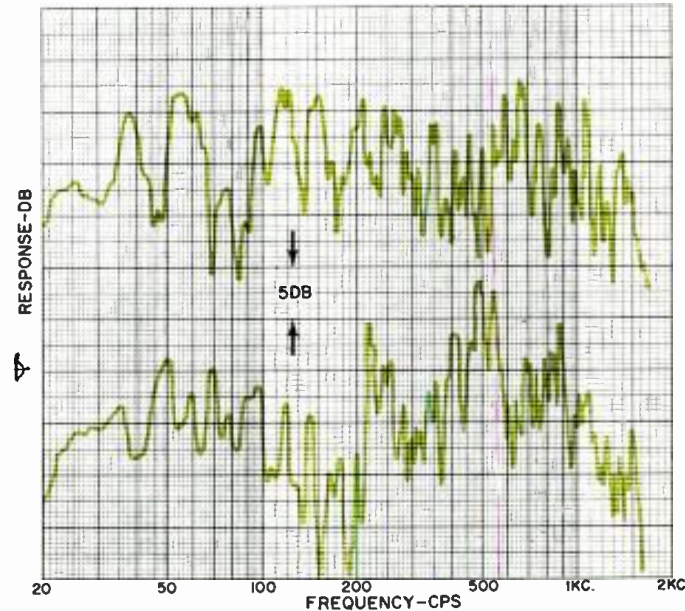



Fig. 5. Midrange tweeter is being clamped to swivel board at an anechoic chamber, in preparation for frequency-response measurements to be taken at various angles.



Fig. 6. Measuring frequency response of woofer at an outdoor test site with the speaker radiating into a controlled 180° solid angle. Mike is at 30° off-axis.

speakers with enthusiasm and delight. An engineer friend of his then got into the act and took the loudspeakers to be measured in an anechoic chamber. The friend, probably with an air of triumphant superiority, produced curves that he claimed made the speaker look very sick. The poor music lover was disturbed enough to send us the curves and this plaintive statement: "The enclosed curves seem to prove that my ears are wrong."

We were pleased to receive these curves because it is always good to have one's own measurement data confirmed by other sources and other test equipment. The bass curve which was interpreted as being so awful was, within very close tolerances for acoustic work, almost the same as our own anechoic chamber curves. If you take the curve shown in Fig. 2, representing radiation into a solid angle of 360 degrees, and convert it to represent normal room mounting (which usually involves something like a 90-degree solid angle), response in the bass range is increased; in the low bass the increase would be about 6 db. Applying further corrections for the chamber deficiencies in the very low range—including a chamber peak of

50 cycles—we have a woofer curve which is ± 2 db over its range.

A better way to test bass response in loudspeakers is to start out with a smaller solid angle and use an outdoor free field. Present speaker testing standards call for radiation into a solid angle of 180 degrees and this is often a very convenient method since the speaker can be buried in the ground as shown in Fig. 6. Fig. 3 shows the curves produced by the test setup illustrated, using the same model speaker as employed in Fig. 2. This outdoor measurement is more accurate than an anechoic chamber measurement for the bass range because test chambers cease to be anechoic at very low frequencies, but the results are very close to the original curve of Fig. 2, if one knows how to interpret the latter. The particular speaker shown in the photograph was also measured in an anechoic chamber for other characteristics; the uncorrected chamber curve was very similar to that produced by the music lover's engineer friend.

Controlled Acoustical Environment

Sometimes attempts are made to get a rough indication of speaker frequency response by taking microphone meas-

urements in an ordinary room. Such a method does not even give rough results because there will be far more variation caused by the room and by the particular positions of speaker and microphone than by the performance characteristics of the speaker itself. Fig. 4 shows two measurements of the frequency response of the same speaker in a live room, using different microphone positions. It will be noted that the peaks and dips in the two curves do not occur at the same places and it is these peaks and dips which, in a properly measured response curve, are the most significant elements that predict quality of performance.

One type of test that can be made without a rigorously controlled acoustical environment is the search for rattles, buzzes, "birdies," and other foreign noises which sometimes make their appearance at particular frequencies. The speaker is swept over the frequency spectrum by an audio oscillator, slowly, at a reasonable listening level. The tone should remain pure, without extraneous sounds and without the simultaneous production of tones different in frequency from the oscillator signal. It is important here to eliminate from consideration possible sympathetic vibrations of things in the room.

This is one kind of speaker deficiency which frequency response curves will probably not reveal, although tone-burst tests at the frequencies involved will display it clearly. The musical results are intermittent; blurring or a piercing shrillness is liable to occur only when the musical signal contains appreciable energy in the offending frequency region.

Interference

It is not possible, from the point of view of measurements, to treat a multi-speaker system as though it were a single unit. Interference patterns set up between different drivers, particularly in the crossover regions, produce a ragged curve which does not actually reflect performance. Merely moving the microphone position may convert a peak to a dip, or an elevated section to a depressed section. This interference effect, however, does not change the total power radiated by the system and therefore has little influence on the way the speaker actually sounds. If a multi-speaker system is to have its frequency response measured, one of three methods must be used—each driver must be measured separately, or the microphone must be placed at a great distance from the system to minimize path differences to the separate drivers, or the measurements must be taken in a reverberant rather than an anechoic chamber. The latter method produces a uniform sound field which relates to the total energy

(Continued on page 98)

TV MUSIC AND THE BROADCAST TECHNICIAN

By WAYNE BRANDT / CBS Television, Hollywood

The job and equipment of the technician who tapes the background music for network television shows.

THERE are many interesting areas of activity for the technician in broadcasting. We are all somewhat familiar, through our daily association with television entertainment, with the work of cameramen and audio men. Besides these more obvious jobs, there are many more technicians engaged in the recording, distribution, and transmission of television programming.

Most of the members of the technical operations staff at a television studio today have been actively employed in broadcasting for several years. Although requirements vary, many of the men have had communications experience and hold a commercial radiotelephone operator's license or else have a high degree of proficiency in a specific area, such as cameramen or as an equipment maintenance technician.

Let's look at some of the characteristics of this occupation. While a production facility can be large and rather complex, no one employed in such a plant is far removed from the final product and, therefore, there is little of the "small cog in a large wheel" feeling. There is also satisfaction in knowing that the close cooperation among technicians, production personnel, and talent, developed over the years, is an essential part of the job.

Working with the best equipment in

the field is another rewarding aspect. The pay is satisfactory and, while the author hesitates to use the term "show business," there is a certain muted excitement in the realization that all of the equipment and ability is used to provide entertainment for millions of people. For the men so employed, all these things outweigh the few disadvantages which include a certain amount of unusual working hours and a varying level of employment.

While the industry as a whole has a

certain fascination, individual areas, when carefully scrutinized, become even more interesting to the technically oriented individual. One such area is the Television Music Department. The men assigned to this department are drawn from the technical operations staff. In addition, it is desirable that they have an interest in and an ear for music since they must interpret, technically, the artistic desires of the musical supervisor assigned to each program. Let's see how this works.

Many of the shows presented on the CBS Television Network are action programs. In order to set and enhance scenes and maintain continuity, many small segments of music must be composed, recorded, and combined with picture and dialogue to form a complete story. In actual production, the most practical way is to tape these music

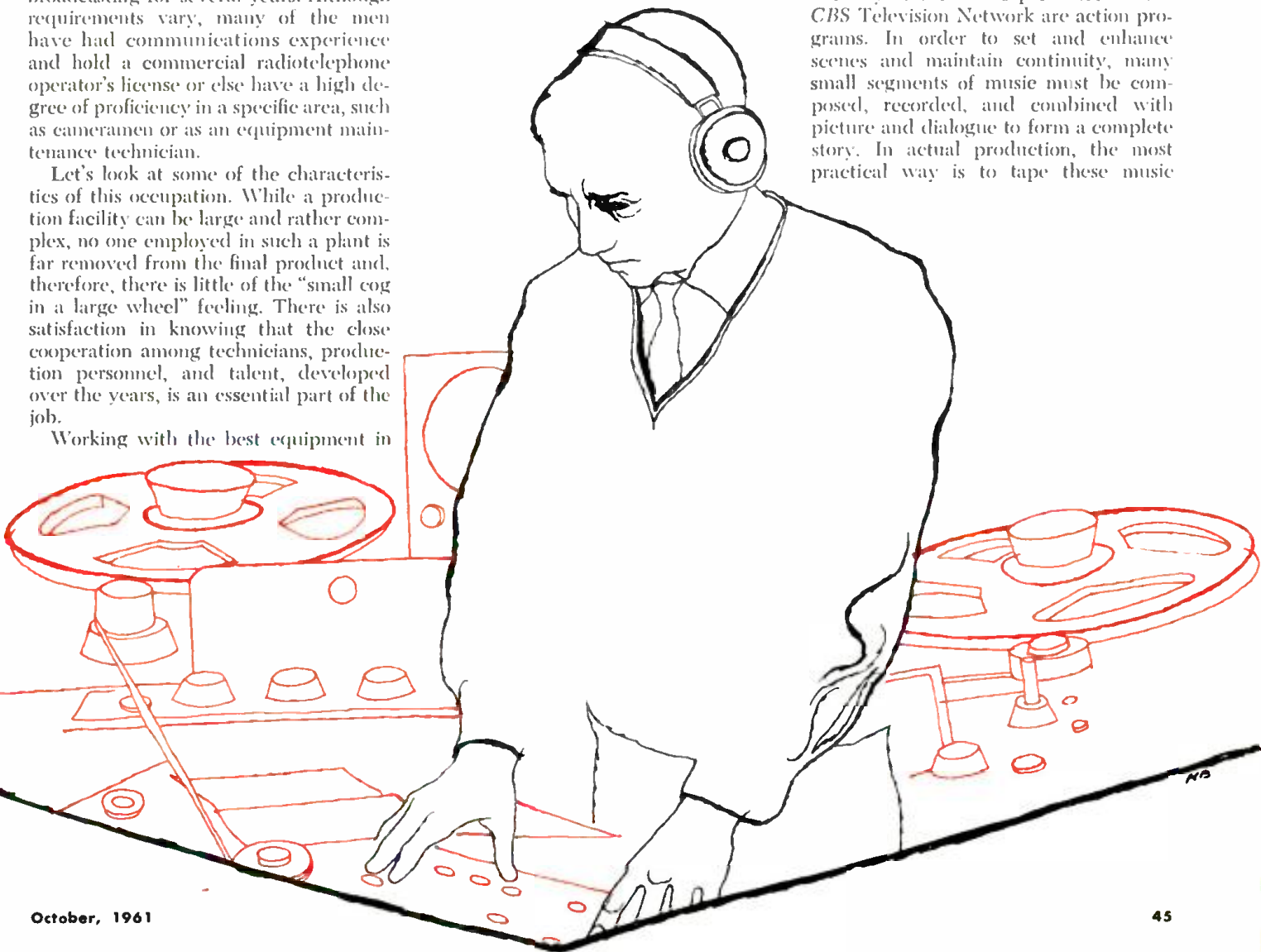



Fig. 1. The four Ampex recorders are mounted in two cabinets. These are on swivel casters and may be pulled away from the wall for access to the rear of the machines.

bridges or "cues" separately, at another time and place, and insert them later during the final dubbing or recording operation.

There is also a vast library of stock music inserts available for this purpose. These prerecorded bits and pieces must be timed and often edited to fit a smaller period of time or a portion of a "cue," perhaps just a few notes will be re-recorded and spliced into the original track to lengthen it and thus more nearly match the picture portion of the story.

It is sometimes necessary to make a composite track by mixing two or more cues and re-recording to obtain the desired effect. Also, blank leader stock must be spliced into the tape between

each cue, to insure quick location during the final dubbing process.

Finally, all the cues for a single program are rewound onto one reel and delivered to the film duplicating plant or video recording studio. The Television Music Department is responsible for all of this and the editing and dubbing facilities are of interest to us here.

Equipment

At Television City in Hollywood, there are two dubbing rooms, identically equipped. Fig. 1 shows the four Ampex 350 tape recorders. Each pair of tape machines has a cueing speaker which can be switched to the output of either machine. A safety switch bypass has

been added to enable the operator to spool waste tape off the machine into a convenient container, without the need for taping down or otherwise fastening the right-hand tension arm. The tape deck pivots upward for maintenance and the electronics chassis pulls out for access to the tubes and service adjustments.

The specially built mixing console and its associated pair of equipment racks, as seen in Fig. 3, are to the left of the tape recorders. The console has two output channels, each feeding a recording bus. Any combination of the four tape playback outputs, and up to four auxiliary signals, can be fed into either of the two channels. The control in the lower left of the photo is the "echo" or reverberation control. Its use will be described later.

The four controls in a group at the lower left are auxiliary input level controls. The first control is fed by a six-input push-button selector located in the upper left corner of the console. The corresponding inputs appear in the patch bay.

The remaining three auxiliary input controls have a microphone preamplifier preceding them, although this may be "patched out," that is, not used, if the auxiliary signal is of sufficient amplitude. The key switch directly above each control selects the channel to which its corresponding input is assigned. Each tape playback output goes to one of the vertical faders, located just to the right of the center of the panel.

The ease with which two or more signals can be simultaneously controlled with these straight-line potentiometers eliminates the need for a sub-mixing control. Above each vertical fader is the channel selector switch for the corresponding tape machine output. To the left of these keys are the keys which assign the tape machine record input to either recording bus of the console. To the right of these controls are the two master gain controls for the two output channels. The volume indicator for each channel is in the right-hand rack, directly above the console.

The far right end of the panel is occupied by the tape machine remote controls. These are included so an operator, when making multiple dubs, can start the recording machine, start one or more playback machines, and control levels with a minimum of leg work. In addition, a playback turntable is provided for disc-to-tape copying. Its output can be patched into one of the auxiliary inputs.

Directly above the console, in the left-hand rack, is the patch bay. Under usual conditions, a minimum of patching is required, since the circuits are "normalled" for routine requirements. However, almost every amplifier input and output, each tape recorder, and certain other cir-

Fig. 2. A complete block diagram showing one of the channels that are employed.

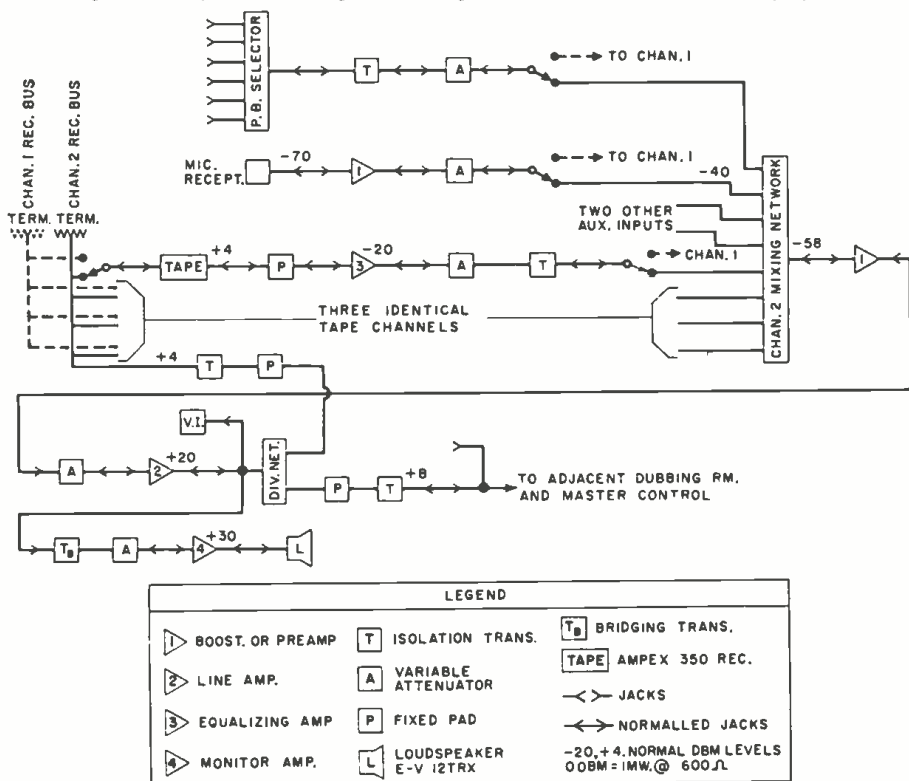

cuit points are available by patch cords to provide the needed flexibility.

Fig. 2 is the basic block diagram of one of the two channels of the system. Four basic amplifiers are used. The program or line amplifier provides sufficient power to distribute the signal of +8 dbm to the adjacent dubbing room or elsewhere in the plant. This amplifier must also feed the recording bus. A *Langevin* Type 117 is used here. This is a high-quality power amplifier of 50 decibels fixed gain and a maximum output of 8 watts. In this use, however, the normal output is about 1 watt. The booster amplifier raises the level out of the mixing network to that sufficient to drive the line amplifier. Since the input signal to the booster is quite low, on the order of -58 dbm, the booster must have a low inherent noise level. These conditions are similar to those for the microphone preamplifiers so the same amplifier, a *Langevin* Type 116B, is used here. This is a low-noise, two-stage amplifier of 40 decibels fixed gain, designed for low-level applications. The combined gain of 90 db for the line and booster amplifiers is necessary to make up the insertion loss of the mixing and output dividing networks and the variable attenuators and to insure adequate amount of reserve gain.

The specially built equalizing amplifiers are quite flexible, as Fig. 4 indicates. It is possible to boost or attenuate any three out of a possible 12 portions of the audio band, up to a maximum of 15 db correction. These amplifiers have a 6 db insertion loss when the controls are

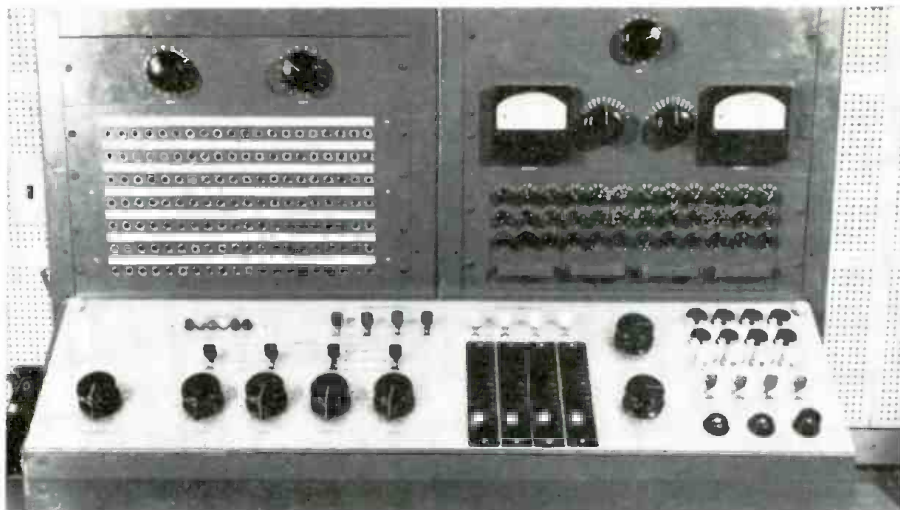

Fig. 3. The mixing console, with patch bay at left and equalizing amplifiers at right.

set for "flat" or unequalized response. Two 30-watt *McIntosh* amplifiers are employed for monitoring. These amplifiers have been adequately described in the past, so further description is unnecessary. Each monitor amplifier drives an *Electro-Voice* 12TRX monitor speaker, mounted in a bass-reflex cabinet. In tape editing, a speaker with good low-frequency response is quite helpful when locating the point at which a cut is to be made. These speakers are more than adequate.

Reverb & Speed Regulation

Certain other circuit elements call for more complete explanation. The one-knob reverb control is a time-saving feature. Each of the remotely

located echo chambers has its associated amplifiers adjusted so that there is unity gain between the jacks labeled "reverberation in" and "reverberation return." A multiple of the original signal is patched to the "reverberation in" jack. Then the "reverberation return" signal is fed to one input of a cross-fading potentiometer and the normal signal, i.e., without echo, is fed into the second input.

The cross-fade control consists of two ganged, linear-taper controls, whose outputs are combined and connected so that, in the counterclockwise position, the output from the control is original signal only and in the clockwise position, reverberation only. By rotating this con-

(Continued on page 66)

Fig. 4. The controls of the equalizing amplifier. The three knobs at the top, labeled "10," "100," and "1000," select the frequency that the operator wishes to equalize. The knob immediately below each frequency-selecting knob determines the amount of correction; the knob below that, labeled "D-O-R," selects either the "drop," "off," or "raise" characteristics.

Fig. 5. The tempo regulator in use with one of the regular tape machines. The revolving head drum is the part that looks like a small pulley in a cup, in the center of the panel. The large control at the left is the speed control, and the lever knob at the right of the panel engages the capstan idler, thereby setting the tape into motion through the machine.



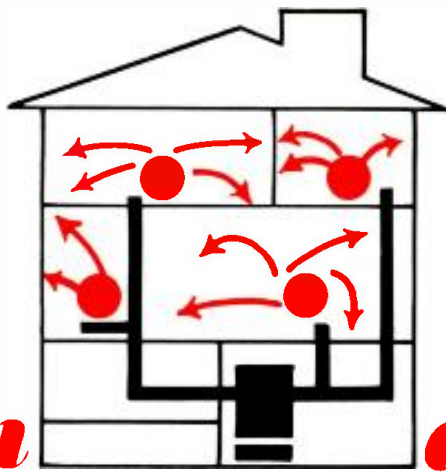

ion generator & electrostatic air filter for the home

By R. E. PATRIE / Technical Staff, Philco TechRep Div.

Design and construction of precipitation filter-ionizer for installation in warm-air furnace. Unit cleans air and generates ions that may give feeling of well-being.

EDITOR'S NOTE: Some investigators have found that concentrations of air ions, either negatively or positively charged, have little or no effect on general well-being or on respiratory ailments. There needs to be much more controlled data collected in order to substantiate some of the positive benefits claimed for negative ions, as outlined in this article. On the other hand, the air-cleaning ability of electrostatically charged surfaces has been definitely proven. The many commercial installations of equipment using this principle attest to this fact. For those of our readers who want to experiment with a means of generating negative ions along with electrostatic air cleaning, we offer the following article. Readers are also directed to the article "Electronic Air Purifiers" appearing in the July 1961 issue of this publication. **WARNING:** The voltages involved in this construction are extremely high and the precautions noted in the text must be taken to avoid serious shock.

WHAT PROMISES to be a far-reaching "modern miracle" of electricity is now unfolding as a result of a better understanding of electrically charged air ions and how they affect us through the air we breathe. These small particles, only a few molecules in size, are either positively or negatively charged. The lives of such ions, especially those that are negatively charged,

are very short as they are soon absorbed by the larger ions which have no charge.

Nature generates a constant and adequate supply of small ions through radiation from the sun and from the earth's crust. Under ideal conditions, such as exist in mountain areas, mineral springs, spas, etc., nature provides more ions with a negative charge than with a positive charge. A typical air sample might show about 1200 ions per cubic centimeter with 650 negative and 550 positive. Where air pollution is heavy, as in industrial centers, a typical ion count might be 100 negative and 300 positive, or even lower, as the air gets more polluted.

Dr. Kornbluh of the University of Pennsylvania, in cooperation with the *Philco Corporation*, has been conducting clinical tests and studies using measured concentrations of charged air ions—both negative and positive. It has been found that a predominance of negative ions in the air seems to promote a feeling of ex-

hilaration and well-being and permits optimum functioning of the respiratory organs. If the proportion of negative ions is low, a depressed feeling results and respiratory functions seem to be restricted.

The Russians have been using high concentrations of negative air ions in the treatment of respiratory and other ailments and have reported not only temporary relief but, in some cases, permanent cures. Although the concentrations they used were much greater (in some cases 1000 times) than employed here, there were, according to their reports, no ill effects.

The upshot of all this is that we really have a new parameter to consider in evaluating the air in our rooms. Not only is it necessary during hot and humid weather to cool and dry the air but it would also appear to be desirable to inject negative ions as well. The negatively charged ions which, as pointed out previously, are short lived, are quickly depleted through the process of recirculating the room air, and must be replaced if the resulting "climate" is to have all the ingredients of nature's pure, fresh air. The same holds true in cold weather when the room air must be heated and humidified. Again, it is necessary to replace the negative air ions which have been lost during the heating and circulating process.

Hot-air heating systems tend to absorb a large number of negative ions as the circulating air passes through the heat exchanger and ducts. Replenishing these negative ions can be accomplished by means of the device whose construction is described here. Installed in your hot-air furnace, it will generate a fresh supply of negative air ions each time the blower comes on. In addition to gener-

Fig. 1. Construction details of the ionizer assembly employed by the author.

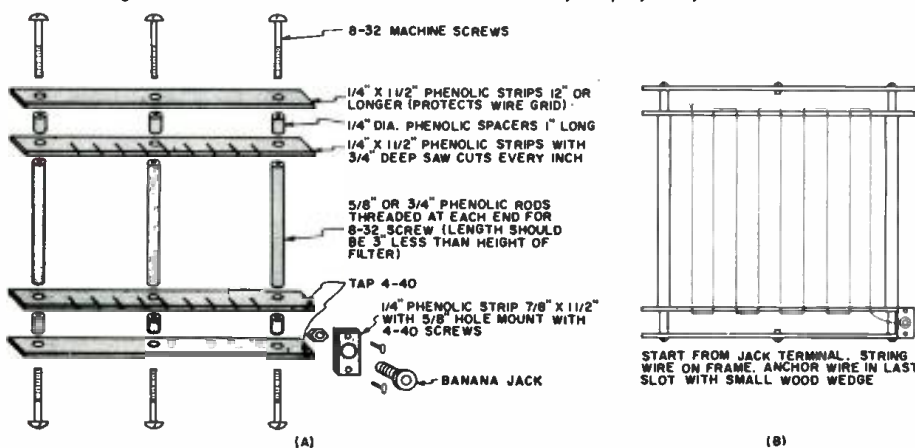

ating negative ions, this device will act as a precipitation filter by charging even the finest dust particles and cause them to be attracted to the metal filter in the furnace as the air is circulated through it. Smoke and most cooking odors resulting from minute air-borne particles, which ordinary filters cannot touch, are quickly dispelled by ionization and electrostatic precipitation.

Construction of Unit

The ionizer unit consists of a fine wire grid in close proximity to a flat expanded metal plate placed against the permanent type filter already installed in the blower compartment of the furnace. A d.c. potential of approximately 5000 volts is applied between the wire grid and the grounded plate and filter. By connecting the negative terminal of the power supply to the wire grid and grounding the positive terminal, the unit will give off negative ions to the air stream. The d.c. potential produced by the circuit to be discussed should not be exceeded by more than 20% and the spacing between the wire grid and the metal plate should be kept somewhere between $\frac{1}{2}$ " and $\frac{3}{4}$ ". By staying within these limits, ozone and other unwanted products will be kept to a negligible quantity. The a.c. input to the power supply is taken off the blower motor circuit so that the unit operates only when the blower is running.

The ionizer unit is constructed with a phenolic frame on which a fine steel wire, .003" or smaller, is strung. (Wire-recorder wire will do nicely.) The frame is made up of $\frac{1}{4}$ " x $1\frac{1}{2}$ " phenolic strips with $\frac{3}{4}$ " diameter phenolic rod as spacers. Details of the assembly are shown in Fig. 1A. Over-all dimensions are not given as they will depend on the size of the filter in the furnace. The height of the frame should be the same as that of the filter. The length need not exceed 15 inches even though the filter is longer

than this. If the ionizer frame is over 10 inches long, a center support, made from the same round phenolic stock, should be used to prevent sagging. Saw cuts are made one inch apart and half way through both of the inner strips. Approximately 2 inches should be left uncut at each end of the strips. The two outer strips serve only to protect and isolate the wire grid.

After the frame is assembled and the input banana jack installed, the fine wire can be strung. Begin by attaching one end of the wire to the terminal on the banana jack and wind back and forth through the slots as shown in Fig. 1B. Do not put too much tension on the wire as it is being wound. Because of its small cross-section, very little tension is required to keep it straight. Make sure that the wire rests at the bottom of each of the slots. Anchor the wire in the last slot by driving a small wooden wedge or matchstick in the slot against the wire. Give the frame only two

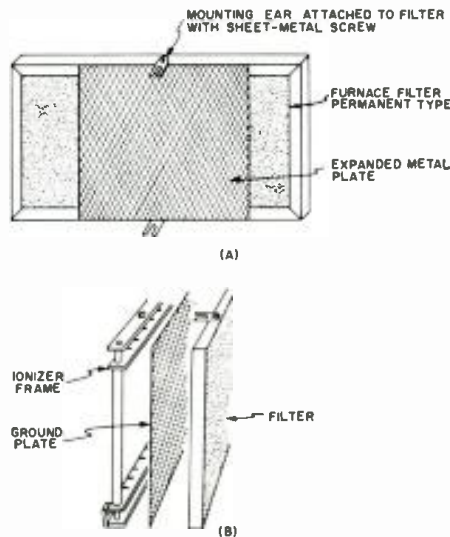
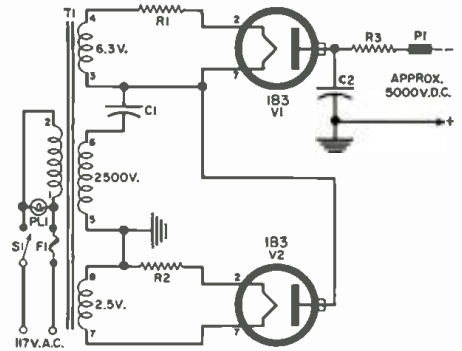
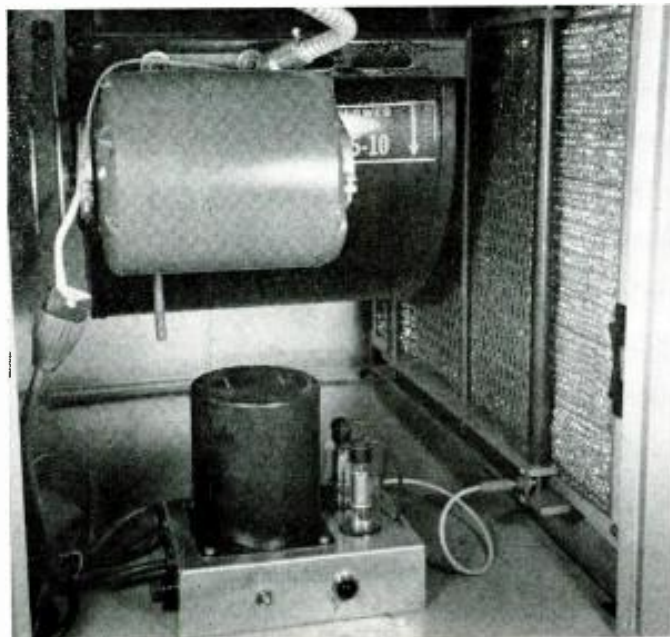

Fig. 2. Installation of ionizer to filter.

Ionizer and power supply installed in blower compartment of gas-fired hot-air furnace. Expanded metal plate is held firmly against filter by the ionizer frame. Ground lead is not visible.



- R = 25 ohm, 2 w. res.
- R₁ = 6 ohm, 1 w. res.
- R₂ = 16.5 megohm res. (Five 3.3-meg. $\frac{1}{2}$ w. resistors in series should be used.)
- C₁, C₂ = .005 μ f., 6000 v. capacitor (Aerovox P81CM)
- F₁ = $1\frac{1}{2}$ amp fuse
- S₁ = S.p.s.t. toggle switch
- P₁ = Banana plug
- P_L = 117-volt pilot lamp
- T₁ = Power trans. (Herbach & Rademan TM-9541 or equiv., see text)
- V₁, V₂ = 1B3 tube (miniature 1X2 may be used)
- *If transformer T₁, as specified, is used, R₁ and R₂ are required to drop filament voltage to 1.25 volts @ .2 amp for 1B3's. If other transformers having 1.25-volt filament windings are available, R₁ and R₂ may be omitted.

Fig. 3. Schematic of half-wave voltage-doubler power supply for the ionizer unit.

coats of clear Krylon, allowing one-half hour drying time between coats.

The unit is attached to the filter by thin metal straps cut to form mounting ears. These should be permanently attached to the top and bottom of the filter with sheet-metal screws, as shown in Fig. 2A. A piece of flat expanded metal, with $\frac{1}{2}$ " or $\frac{3}{4}$ " mesh, is cut to the over-all size of the ionizer frame and is sandwiched between the ionizer frame and filter when the two are fastened together (Fig. 2B). This sheet serves as the positive ground element of the ionizer and the surface which faces the ionizer grid should be thoroughly polished with fine sandpaper or emery cloth to

Ionizer grid is made with wire-recorder wire that runs vertically between the slotted strips. The number of wire "rungs" is not critical—ten to fifteen are usually quite adequate.

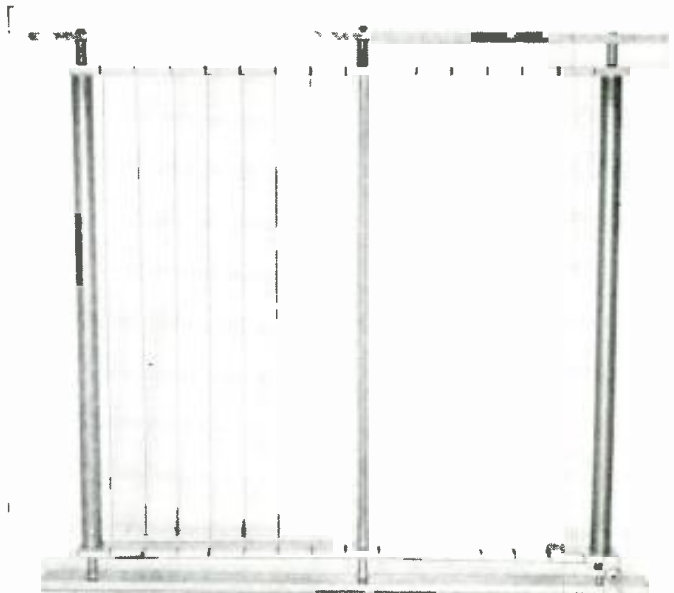

remove any sharp edges which would impair operation of the ionizer.

The Power Supply

The unit will work satisfactorily with any power supply that will provide a d.c. potential of from 4000 to 5500 volts. For this application, the positive terminal of the power supply must be at ground potential so that the high-voltage terminal will be negative with respect to ground. The current requirement of the unit is very small—less than a tenth of a milliamper (100 μ a.).

The power supply described here and shown schematically in Fig. 3, employs a half-wave voltage-doubler circuit. The power transformer has a 2500-volt secondary and three filament windings, only two of which are used. Although greatly over-rated, it was chosen because of its low price and excellent con-

struction. Any transformer with a 2500-volt secondary and two well-insulated filament windings or with a 5000-volt secondary and one well-insulated filament winding will do the job. The current rating of the high-voltage secondary need not be more than 1 ma. If the latter type is available, only one rectifier tube is required and a simple half-wave rectifier circuit may be employed.

The filament requirement of the 1B3 rectifier tube is 1.25 volts @ .2 ampere, so the value of a series resistor with a 6.3-volt filament winding will be approximately 25 ohms. The series resistor required with the 2.5-volt winding is 6 ohms. Ordinary composition resistors of one to two watts rating (see parts list) are adequate in either case. Exact resistance values required may be obtained by using a pair of resistors hooked in series or parallel, as needed,

to get as close to the values shown in the parts list as possible.

Specific chassis layout and details of construction will obviously vary considerably with the type of transformer used. The bottom view of the 2"x5"x7" chassis used by the author can serve as a guide in the placement of parts no matter what type of power transformer is employed. The builder can cut corners if he wishes by eliminating the pilot light and the switch. Likewise, the fuse and holder can be left off the chassis by substituting a fused plug in place of the regular a.c. plug.

The high value of resistance in series with the high-voltage output lead (approximately 16.5 megohms) serves to limit the current (and voltage) in the event of a short in the ionizer or high-voltage lead. In addition to protecting the transformer secondary, it will lessen the severity of shock in case of personal contact. *This does not alter the fact that the power-supply plug must be removed before handling the ionizer or power supply and that extreme caution must be exercised in testing or working with the unit.* Five 3.3-megohm, $\frac{1}{2}$ -watt resistors connected in series are recommended here rather than a single resistor. The high-voltage lead should be of the type used in TV high-voltage or automotive-ignition circuits.

Carefully check the wiring of the power supply before applying a.c. Place a $1\frac{1}{2}$ -ampere fuse in holder; make sure the plug end of the high-voltage lead is clear of the chassis; plug the unit in and turn on the switch. Measure the output voltage with a high-resistance d.c. voltmeter or a v.t.v.m. with a high-voltage probe. If neither instrument is available, an approximate check can be made as follows: slowly and carefully bring the exposed end of the high-voltage lead (banana plug) toward the chassis (*do NOT touch the exposed end*). A thin, continuous spark should be given off when the end of the plug is within approximately $\frac{1}{8}$ inch of the chassis. Do not prolong this test. If a spark is obtained, you can be sure that the power supply is operating normally. If no spark is obtained before the plug touches the chassis, check the fuse and wiring for possible wiring error. (*Unplug the unit during checking process, applying power only when specific tests are to be made.*)

Installation

A short length of a.c. cord should be brought out from the junction box supplying the blower motor and terminated in a cord-type a.c. receptacle. This lead can be brought out from the motor terminals instead if they are easily accessible. Test the receptacle by plugging in a lamp and observe that it comes on when the blower motor starts.

Before putting the ionizer and power supply in the blower compartment, a piece of Masonite should be cut to size, sprayed with two coats of lacquer or enamel and fitted in place at the bottom of the compartment. This helps to keep moisture and dirt from the ionizer unit and power supply, and also makes it

(Continued on page 90)

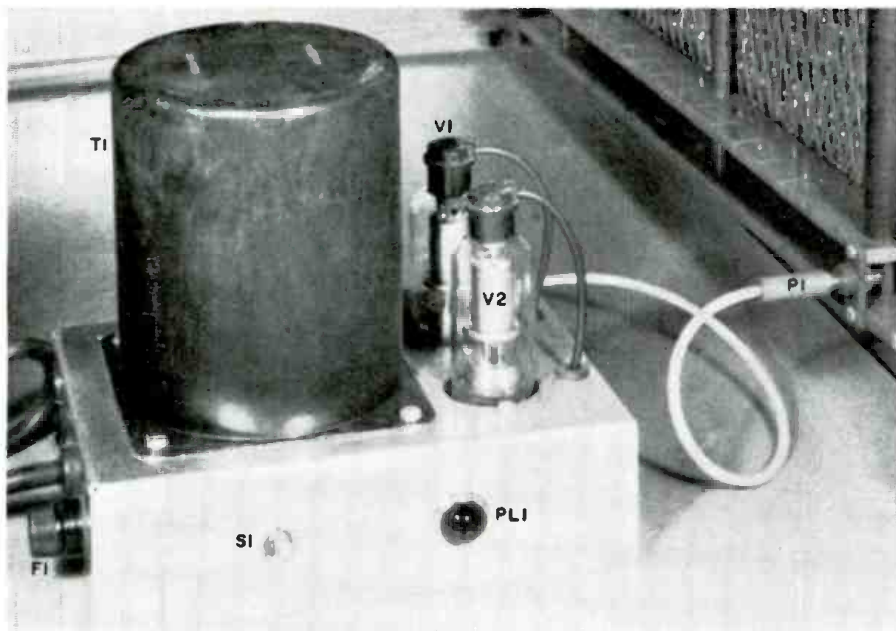

Close-up of the power supply showing power transformer and two rectifier tubes.

Underside of the power supply. At lower center are the five 3.3-megohm resistors that are wired in series with the high-voltage output lead connected to ionizer grid.

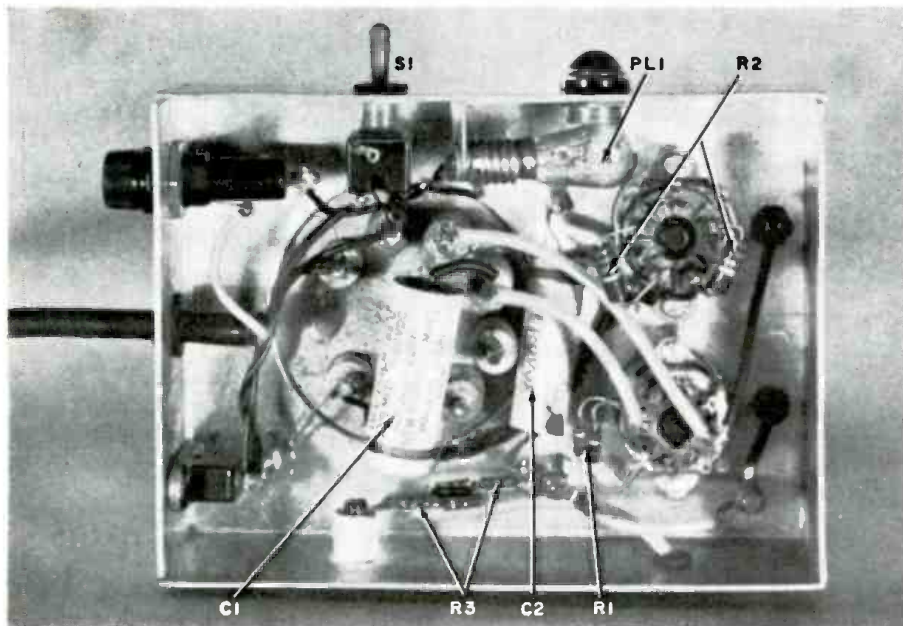

CALIBRATION STANDARDS FOR THE V.O.M.

By TOM JASKI

This instrument can give you commendable accuracy—if you know how to calibrate it and what standards to use.

THE ACCURACY of ordinary volt-ohm-milliammeters is far from that of precision, laboratory instruments, particularly if we consider the worst inaccuracies that may be present within the limits of the manufacturer's guarantee. (See "Is Your Multimeter Accurate?" in *ELECTRONICS WORLD*, February, 1961.) There are doubtless many occasions when you want the assurance of better reliability than this although you are not interested in the ultimate in precision. Fortunately the inherent capability of the instrument is such that, with calibration, a relatively high degree of accuracy is possible.

The simplest way to calibrate is to compare the instrument's readings on various functions and ranges with those of another, precise instrument and to record the deviations. However a second instrument of this order is seldom available. The next best procedure is to use the v.o.m. for reading quantities that are already known precisely. The chances of finding such quantities to serve as standards are quite good.

The most readily available standards will be certain d.c. voltage sources. These permit a direct check of the meter's d.c. voltage readings. These same sources can then be adapted to check the instrument's current readings. From the knowledge thus obtained, it is possible to extend into a check of a.c. and resistance scales. In this article, we will be concerned chiefly with the available standards and their use for calibrating direct voltage and current ranges. Other meter functions will be left for subsequent articles.

Source Voltages

The first question is where to obtain reasonably precise voltages. A number of sources, all useful but some more accurate than others, are available. The order in which they are listed here reflects the author's preference. If you do not agree, you may re-order them to your liking. Your own choice may depend on many factors aside from which is the most precise, if you are not seeking the ultimate. For example, you may be swayed by which is the least expensive, most readily accessible, or easiest to use. Here are eight possible sources:

1. A calibrated *Weston* cell produces an output of exactly 1.0183 volts—if you can read this closely on your instrument. The calibration has been performed by the National Bureau of

Standards. Sometimes these cells can be found in the laboratories of high schools and junior or senior colleges, sometimes in instrument repair shops. If you have access to the sources mentioned, you would not need a better standard.

2. An uncalibrated *Weston* cell is also rated at 1.0183 volts. However, without calibration, you have assurance that this source is accurate "only" to .1 per-cent. One of these may cost from \$15 to \$20, which may make it a worthwhile investment in some cases. Incidentally all *Weston* cells are designed to be used at a rated temperature of 20 C for the specified output, or 68 F. This is not a difficult condition to fulfill, and it is doubtful that any but unusual temperature deviations will introduce more error than you will tolerate.

3. *Mallory* has brought out a new voltage standard consisting of eight carefully selected mercury cells to make a total of 10.8 volts, in tapped steps of 1.35 volts each. This standard will hold to .5 per-cent accuracy over a number of years. The price of the assembly is about \$40, so it is hardly worth an investment unless you have an unusual number of meters to calibrate!

4. Any new mercury cells, at their rated voltage (usually 1.35 volts, but this may vary—check manufacturer's data). These will show the voltage stability with time that is characteristic of cells of this type. The initial, rated voltage may not be so precise as that for the selected cells used in the *Mallory* standard. Even so, accuracy will be high.

5. Rechargeable nickel-cadmium cells under a specified condition. Fully charged units of this type tend to show a somewhat high voltage output early in the discharge cycle, then settle down to rated voltage and maintain it almost to the end of the cycle, at which point

a rapid drop-off occurs. For example, a fully charged cell may read 1.3 volts or slightly higher. Put into service, it will soon settle down to a value usually between 1.2 and 1.25 volts, to which it will adhere closely until it approaches full discharge. A practical procedure is to charge the cell fully, then discharge it somewhat for use as a standard. The recommendation for certain *Burgess* nickel-cadmium cells, for example, is that they be charged fully, then discharged to half capacity, at which point output is very close to 1.2 volts. Capacity and output-voltage ratings may be obtained from manufacturers' specifications. Armed with this data, you can easily calculate how long you should permit a fully charged cell to discharge across a given resistive load to achieve reliable output.

6. A fully charged automobile battery is also a good source, if it is in good condition. The equipment for checking condition and state of charge is simple enough to use, if you have access to it. Output should be very close to 2.12 volts per cell. Thus, depending on the size of the battery, this single source can give you three check-points up to 6.36 volts or six points up to 12.72 volts.

7. A reasonably fresh flashlight battery that has never been used, accidentally shorted, overheated, or frozen is also useful. A good figure to assume for the output is 1.56 volts. Depending on whether the battery is right out of the factory or more than a year old and also depending on the size of the cell, there will be some variation around this value, but it is not likely to be more than 1 per-cent off. For greatest reliability, the literature of the particular manufacturer for the particular cell size should be consulted. For example, type 950 *Eveready* cells (size D), unused and properly stored, average 1.57 volts output 6 months after manufacture, 1.56 volts at the end of a year, and 1.55 volts after 18 months to three years.

8. *Sylvania* suggests the circuit of Fig. 1 as an accurate voltage standard. A low-voltage source and a potentiometer are used to adjust the current through a 1N34A diode to approximately 20 microamperes. Because of the nonlinear characteristic of the diode in this range, precision adjustment of the current in the circuit is not necessary to keep the voltage drop across the crystal very close to rated voltage. Thus a precise meter is not necessary to start out with. The chief disad-

(Continued on page 92)

Fig. 1. *Sylvania* suggests this circuit for an accurate, low-voltage standard.

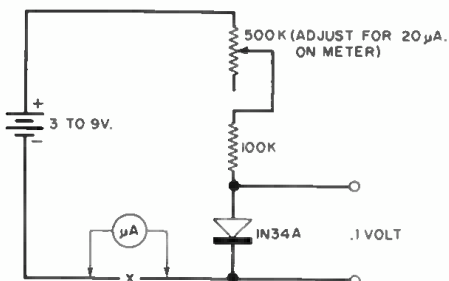

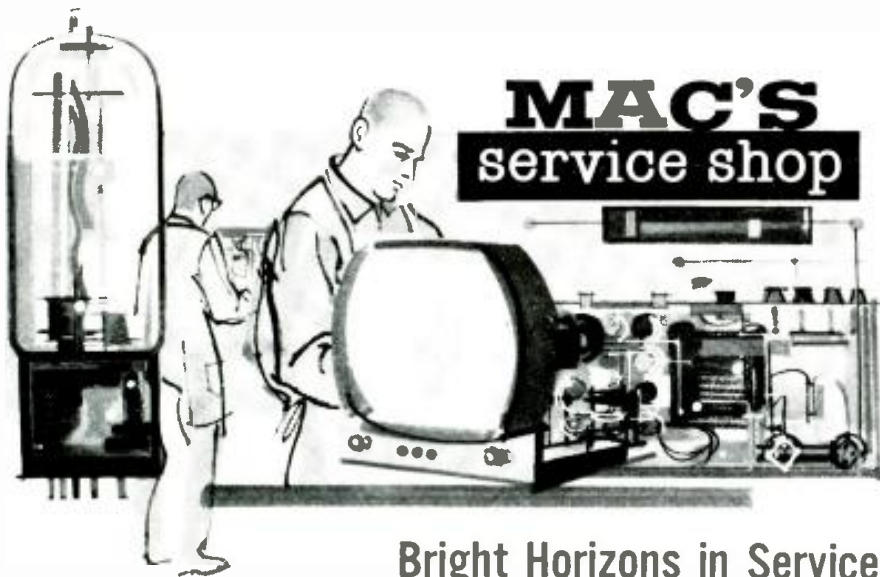

Bright Horizons in Service

BARNEY, the Number Two Man at Mac's Service Shop, listened a lot. Strictly speaking, this was not his idea. Things just worked out that way. He had a lot to learn, and he was bright enough to know he learned more listening than he did talking. Still and all, he was an Irishman with a natural love of talking; and he thoroughly enjoyed doing the "telling" when an opportunity presented itself.

Mac knew the youth pretty well; so he recognized the I've-gotta-talk-or-bust symptoms when Barney bustled into the service department and put on his shop coat.

"Say, Mac," the youth said with studied casualness, "how much of their disposable income do you suppose the American people spent for services last year?"

"I dunno; do you?" Mac asked innocently.

"Yes sir, I do," Barney said importantly as he pulled a little piece of paper from his shirt pocket. "I happened to run across a little brochure the other day that gave some figures especially interesting to anyone doing any kind of service work. The figures came from the Department of Commerce; so they should be reliable. Last year we spent around one hundred and thirty billion dollars for services. That compares with a hundred and fifty billion dollars spent for non-durable goods and forty-seven billion dollars for durable goods." He paused dramatically to let these figures sink in.

"What do you include in 'services'?" Mac asked.

"Aw, you know: electricity, gas, telephone, transportation by public carriers, film processing, radio and TV repairs, auto repairs, appliance repairs, and so on. I mean the same thing the panel of *What's My Line* does when it asks: 'Do you deal in a product or a service?' While those big figures shake you, the really significant thing is the way the percentage of disposable income spent for services is rising much faster than that spent for the other

two items. Take last year, for example. For the first time in history, nearly forty per-cent of our disposable income went for services. During the ten years between 1949 and 1959, while total personal expenditure for goods was rising 38%, the expenditure for services rose a whopping 105%. With people channeling more and more of their income into services, it looks as though we're in the right business, doesn't it?"

"Maybe," Mac agreed cautiously. "When you remember that in this period Americans have had more money to spend for fun, more ways to spend it, and more time to enjoy spending it, the figures are not too surprising. However, those figures you gave include a whole lot of services. I'm wondering how our particular brand of service stands up to some of the others."

"I can tell you that, too," Barney offered eagerly as he consulted his paper. "Here are some of the increases in consumer expenditures for different kinds of service in the 1949-1959 period:

| | |
|------------------------|------|
| Airline Transportation | 393% |
| Radio and TV Repairs | 290% |
| Gas | 180% |
| Electricity | 159% |
| Telephone | 132% |
| Auto Repairs | 92% |

As you can see, we're second in growth in that group; and those below us aren't exactly flyweights."

"Those figures are mighty encouraging," Mac commented; "but statistics are always dangerous if they are swallowed whole and not digested. That is what Disraeli probably had in mind when he remarked, 'There are lies, damned lies, and statistics!' Statistics are concerned with generalities or averages, and you probably have heard of the sad case of the man who drowned in a river that *averaged* only two feet deep. He stepped into a pothole that was ten feet deep.

"Those figures indicate that radio and TV service, as a whole, is marching ahead rapidly. More and more money is being spent on it. They *do not* mean that the individual service technician is going to share automatically in this

prosperity. Whether or not he gets his fair share of the increase will depend on how willing he is to work and to study. Unless he is at least average in technical knowledge and business ability, he has no right to expect his business to keep pace with the national average."

"Yeah, and that thing of staying 'average' gets tougher all the time," Barney offered. "As the service business becomes more lucrative, more and more people will be attracted to it. The slobs won't last long, but the fellows who stick it out are going to have to be pretty good to get a foothold. Thanks to these eager beavers, the average ability will be constantly pushed up. We fellows already in the game are going to have to run a little harder just to hold our place in line."

"I'm glad you realize there's no resting on the oars in radio and TV servicing—especially from here on in," Mac applauded. "Not to change the subject, I've been doing a little interesting reading, too. A couple of months back *Time* published a story that paid an oblique tribute to the power and influence of service technicians on the buying public. The story discussed the outstanding success of one TV receiver manufacturer. A few years back when TV sales slowed down, this company refused to go along with the crowd in trying to find cheaper ways to manufacture TV receivers so the price could be cut. Instead, it published full-page advertisements saying it was refusing to adopt automatic manufacturing techniques that cut manufacturing costs but made the sets more difficult to service. It refused to cut either the quality of its receivers or their selling price.

"The story went on to say that service technicians, in appreciation of the consideration thus given them, enthusiastically plugged the products of this manufacturer. What was the result? Today that company is the nation's biggest maker of TV sets. Last year its sales amounted to \$254,000,000, and its profits were \$15,200,000. If I were a radio or TV manufacturer, I should ponder those figures and their significance very carefully. The good will of the service technician is a very tangible asset to any manufacturer.

"But it is important to realize the good will of the service technician in this case was not won *only* by making the sets easier to service. Equally important was providing him with a product he could recommend in good conscience and repair with pride and satisfaction. You know what I mean. You have seen the contempt with which a mechanic regards a device that, instead of using bolts, is cheaply put together with rivets so it cannot be disassembled for inspection or the easy replacement of worn or broken parts. As he will quickly tell you, 'This thing is junk. It was made to be thrown away, not repaired.'

"Well, the radio and TV technician feels exactly the same way about a radio or TV receiver that may have been easy and cheap to assemble but is

(Continued on page 88)



IMPEDANCE MATCHING IN PUBLIC-ADDRESS SYSTEMS

PART 2. HIGH-Z LOUDSPEAKER LINES

By **MORTIMER S. SUMBERG**, Director of Sales
Bogen-Presto Div., The Siegler Corp.

The installation of more complex sound systems by the audio technician is covered in this article.

LAST month the importance of impedance matching was stressed and the basic techniques commonly employed for properly connecting an amplifier to loudspeakers were explored. Simpler sound-system hook-ups were reviewed—those which did not require line-matching transformers and which permitted the use of low-impedance speaker lines. In this article (and the succeeding one), our concern will be with more complex sound-system arrangements where one or more factors dictate the use of high-impedance lines.

Matching with High-Z Lines

As pointed out earlier, high-impedance transmission lines (*e.g.*, 250 or 500 ohms) should be used in a sound system where the loudspeakers are: (1) located at considerable distances from the amplifier, and (2) driven to unequal levels.

In the first instance we must avoid low-impedance lines because of the excessive line losses which result; the requirements of the second system would be virtually impossible to satisfy without the installation of a line-matching transformer at each speaker. High-impedance lines are usually terminated at a 500-ohm tap on the amplifier output terminal strip. Sometimes the equipment manufacturer provides 250 ohms and other output impedance values on the amplifier. The other end of the high-impedance line is brought to the primary of one or more line-matching

transformers whose secondary connects to the loudspeaker voice coil. This method of providing proper impedance match between load and amplifier is sometimes referred to as the constant-impedance method—to differentiate it from the constant-voltage method.

For a clear understanding of the manner in which the line-transformer type and its correct primary impedance tap are determined, the same matching

problems shown in Figs. 4 through 9 (Part 1) will be re-examined and it will be demonstrated how high-impedance speaker lines (*i.e.*, constant-impedance method) and line-matching transformers may be used instead of direct connections between amplifier and loudspeaker voice coils.

Single Loudspeaker: The sound system in Fig. 10 employs a 500-ohm speaker transmission line to interconnect an 8-ohm loudspeaker with the amplifier. The primary of the line-matching transformer (usually mounted directly on the loudspeaker) provides several taps at different impedance values.

In this instance, the 500-ohm tap is connected to the amplifier output tap of the same value to present a perfect impedance match. Since the loudspeaker voice-coil impedance is 8 ohms, the line-matching transformer secondary tap of the same value is used. If a 16-ohm loudspeaker were to be connected, then the 16-ohm tap on the secondary of the line-matching transformer would be hooked to the voice coil.

Referring back to Fig. 2 (Part 1), we find that this 500-ohm transmission line may be as long as 1300 feet if #20 A.W.G. conductors are installed. In the system shown in Fig. 4 (Part 1), a low-impedance line was required for connecting an identical speaker to the amplifier. With #20 A.W.G. conductors (see Table 1 in Part 1), the low-impedance line can be no longer than 60 feet before losses be-

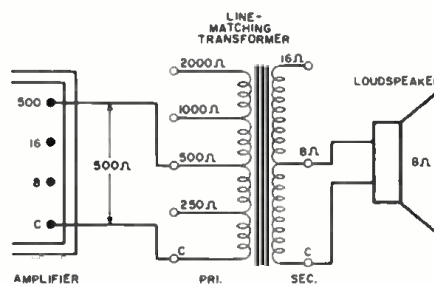
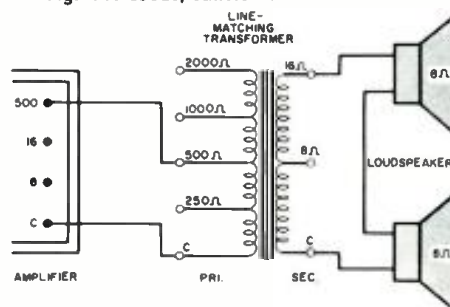

Fig. 10. Sound system using 500-ohm line.

Fig. 11. Loudspeakers connected in series.





A 3-channel sound system for schools, industry, and small institutions.

come excessive. To save the few dollars which the line-matching transformer costs, the sound installer would have to pay considerably more for the extremely heavy conductors required for a run of 1300 feet. Aside from cost considerations, the latter cable would be very difficult to work with because of its size and almost impossible to pull through small-diameter conduits. Obviously, the high-impedance line and transformer are selected as the practical impedance-matching method.

Loudspeakers in Series: This arrangement is somewhat unusual and not frequently found in actual field practice. Its only recommendation is the saving of one line-matching transformer. As shown in Fig. 11, two loudspeakers are wired in series and connected across the secondary of a single line-matching transformer. Since two 8-ohm loudspeakers in series constitute a 16-ohm load, the 16-ohm tap on the secondary of the line-matching transformer is used. The 500-ohm primary tap is then connected to a tap of identical value on the amplifier output terminal strip.

This arrangement would be used only where the two loudspeakers are mounted relatively close to each other. The line-

matching transformer would have to be rated to carry the power delivered to both loudspeakers. In other words, if each speaker were driven to a 5-watt level, then the line-matching transformer would have to be capable of handling 10 watts of power. The set-up to be described in the following paragraph is much more widely used where two or more loudspeakers constitute the load.

Loudspeakers in Parallel: (Driven to identical levels). Fig. 12 shows the conventional hook-up where several loudspeakers are connected in parallel through line-matching transformers to an amplifier with a 500-ohm output-impedance tap. The three line-matching transformers are identical and the 1500-ohm primary taps have been selected since the combined impedance equals 500 ohms.

each loudspeaker will be driven to the same output level, in this instance to one-third of the amplifier output rating.

If four loudspeakers were connected with identical line-matching primary impedance taps, then each speaker would be driven to one-fourth of the amplifier output rating.

Line-matching transformers are available with primary taps in the order of 15,000 ohms, making it possible to connect as many as 30 loudspeakers to a 500-ohm amplifier output tap. With a transformer providing a 15,000-ohm primary it would be possible to set up a system with as many as 60 loudspeakers—provided the amplifier had a 250-ohm output tap.

Loudspeakers in Parallel: (Driven to different levels). In all of the multiple speaker arrangements outlined pre-



An elaborate school sound system that is also utilized for speech instruction.

If four loudspeakers were to be connected across the 500-ohm output tap of the amplifier, then the 2000-ohm primary tap would be used on each line-matching transformer. As in the earlier diagrams, a secondary tap on the line-matching transformer is selected to correspond with the loudspeaker voice-coil impedance. It is important to note that

viously, the speakers have been wired to receive equal power. In many installations, however, it is highly desirable to be able to set up a multiple speaker arrangement so that the individual speakers operate at different power levels.

In a typical industrial installation, for example, it might be necessary to drive 15 reflex trumpets to a 15-watt level for each, 25 corridor cone loudspeakers to 3 watts each, and 6 flush-mounted small cone speakers to a level of 1 watt each. The difference in level is usually dictated by the background noise and the area of coverage required from each loudspeaker. As noted in Fig. 12, equal amounts of power were delivered to several loudspeakers by employing identical primary tap values on the line-matching transformers. From this it follows that unequal amounts of power may be delivered to loudspeakers if dissimilar primary taps are employed. Since the load impedance (represented

Fig. 12. Paralleled connection of three line transformers and loudspeakers.

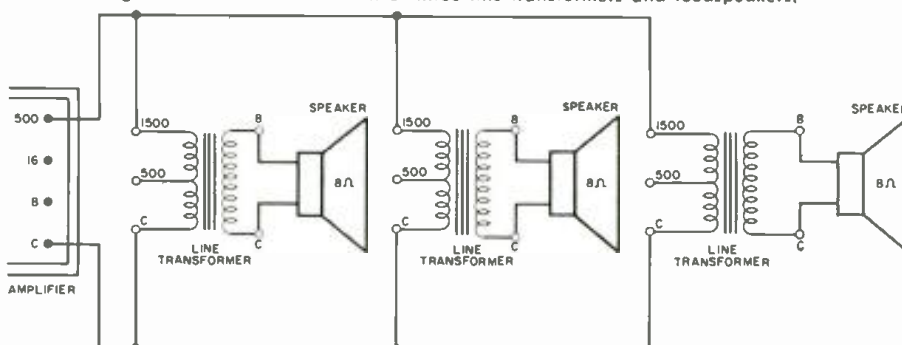

by the several line-matching transformers in parallel) must match the amplifier output-tap impedance, the need arises here for understanding how to compute the combined impedance of several paralleled transformers and the relationship between the value of the line-matching transformer primary tap and the amount of power delivered to its loudspeaker.

In Fig. 12 it was shown that one-third of an amplifier's rated power would be delivered to a loudspeaker through a line-matching transformer if a primary tap on the latter were three times the amplifier output impedance. In Fig. 13 we consider a typical practical impedance-matching problem which is easily solved by application of this relationship. It is noted that a total of five loudspeakers is required in the system and that, because of the varying background noise levels and extent of the areas to be covered, varying amounts of power must be delivered to each speaker. A preliminary sketch is drawn indicating the amount of power to which each speaker must be driven. From this we find that a total load of 40 watts is required—so a 40-watt amplifier is selected.

Loudspeaker No. 1 is to be driven to an output level of 20 watts which represents one-half the total amplifier output power rating. We must therefore select the impedance tap on the primary of the line-matching transformer which is double the amplifier output tap. Since, in this instance, we are using the 250-ohm tap on the amplifier, the correct primary tap on the line-matching transformer is 500 ohms.

Loudspeaker No. 2 is to be driven to a 10-watt level or one-fourth of the amplifier output rating. To do this, we deliberately mismatch upward by a ratio of 4 to 1, arriving at a value of 1000 ohms for the proper primary line-matching transformer tap.

Loudspeaker No. 3 is to be driven to a 5-watt output level which represents one-eighth of the amplifier output power. Mismatching upward by a ratio of 8 to 1, we find that the correct primary impedance tap on the line-matching transformer is 2000 ohms.

Loudspeaker No. 4 is to receive 4 watts of power or one-tenth of the available output power. Deliberately mismatching upward 10 to 1 from the 250-ohm output on the amplifier, we find that the 2500-ohm tap on the line-matching transformer should be used.

Loudspeaker No. 5, used in a very quiet office, is to receive only 1 watt of power or one-fortieth of the available amplifier output power. As above, we deliberately mismatch upward by a ratio of 40 to 1 and arrive at a value of 10,000 ohms for the correct primary tap on the line-matching transformer.

The five loudspeakers in combination will draw 40 watts of power from the amplifier. The total load impedance is 250 ohms, representing a perfect match to the 250-ohm output tap on the amplifier. To double-check the correctness of the computations, it is a good idea to apply the following formula which enables us to determine the combined speaker load impedance:

$$\frac{1}{Z_T} = \frac{1}{Z_1} + \frac{1}{Z_2} + \frac{1}{Z_3} + \frac{1}{Z_4} + \frac{1}{Z_5}$$

where: Z_T = combined impedance of loads (this should equal amplifier output impedance); Z_1 = impedance of Load #1 (transformer T_1); Z_2 = impedance of Load #2 (transformer T_2); Z_3 = impedance of Load #3 (transformer T_3); Z_4 = impedance of Load #4 (transformer T_4); and Z_5 = impedance of Load #5 (transformer T_5).

$$\frac{1}{Z_T} = \frac{1}{500} + \frac{1}{1000} + \frac{1}{2000} + \frac{1}{2500} + \frac{1}{10,000}$$

$Z_T = 250$ ohms (combined impedance of load)

$Z_{AMP.} = 250$ ohms (impedance of amplifier output tap)

In the above example we have chosen the 250-ohm output on the amplifier rather than the more commonly used 500-ohm tap. A simple calculation will reveal that had we used the 500-ohm

tap, the required primary tap value on the line-matching transformer for the 1-watt speaker would have been 20,000 ohms. Since transformers with primary taps ranging this high are uncommon, the 250-ohm tap was decided upon.

It should be noted that each of the five line-matching transformers discussed here is required to handle a different amount of power. For instance, transformer T_1 must include a 500-ohm primary tap and be husky enough to pass 20 watts of power to Loudspeaker No. 1. Transformer T_5 , however, must provide a 10,000-ohm tap on the primary and handle only 1 watt of power. Obviously, the transformers will vary in both size and cost.

Line-matching transformers, which will be discussed later, are readily available in ratings of 4, 8, 12, 15, 20, and 25 watts. In each instance, consideration should be given to the impedance value of the loudspeaker voice coil to make certain that it will present a proper match to the secondary of the transformer with which it is used.

Matching with Available Transformers: It is not always possible to provide a perfect impedance match and it was pointed out earlier that a mismatch of up to 25 per-cent is usually acceptable.

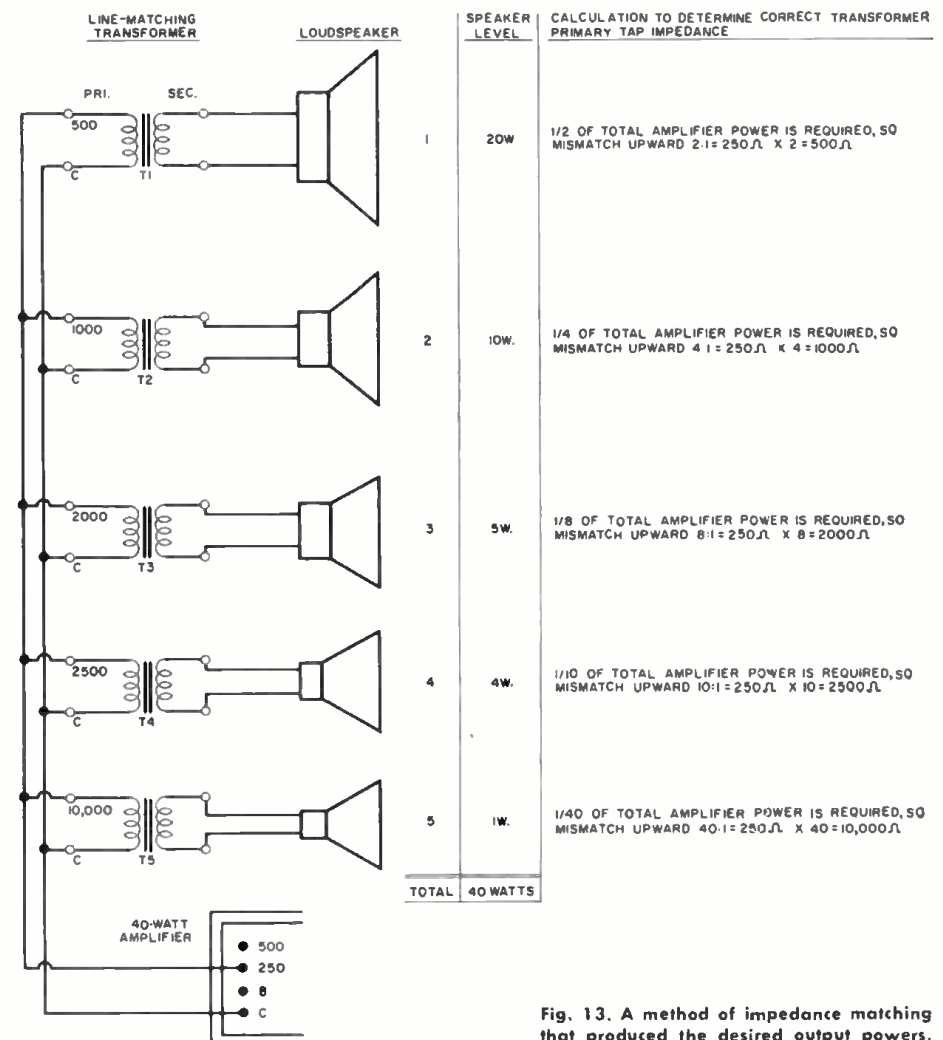

Fig. 13. A method of impedance matching that produced the desired output powers.

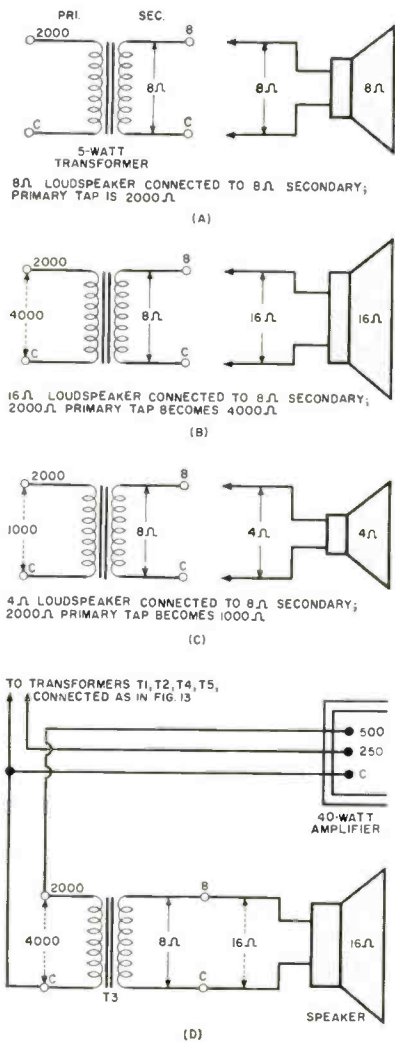

Fig. 14. An example of the mismatch produced by using available transformers.

If the only available line-matching transformers do not provide the exact impedance taps required, the closest one is selected. For example, had we used a small line-matching transformer which provided only a 12,000-ohm primary to drive Loudspeaker No. 5 in Fig. 13, we would have mismatched upward 48 to 1 and would, therefore, have driven the loudspeaker to .8 watt. The loss of 2/10th of a watt would have been impossible to notice.

Had we used a line-matching transformer with a 2500-ohm tap for matching Speaker No. 3 to the amplifier, the upward mismatch would have been 10 to 1 and the loudspeaker would then have been driven to a level of 4 watts (rather than 5). Again, the ear could not have detected the difference in levels.

Care should be exercised when selecting the closest available taps to make certain that the total drain in watts by

the loudspeakers does not exceed the amplifier output rating. When one considers that the ear can barely recognize a 2 to 1 change in power, concern over perfect impedance matching lessens. Loudspeakers driven to 5 and 3 watts respectively will have sound of almost equal loudness.

Frequently the sound installer, on a job, finds that he has several line-matching transformers whose secondary impedance values do not match the loudspeaker voice coil impedance. In a typical installation (see Fig. 14), a 5-watt line-matching transformer with an 8-ohm secondary is available for matching an 8-ohm loudspeaker to an amplifier through a 2000-ohm primary tap. From the 250-ohm output tap of a 40-watt amplifier (see Fig. 13) this arrangement would drive the loudspeaker to a 5-watt level. If the 8-ohm speaker were not available, however, and the installer had no choice but to connect a 16-ohm loudspeaker to the 8-ohm secondary of the transformer, a 2 to 1 mismatch would result and reflect a 2 to 1 mismatch in the primary. As shown in Fig. 14B, the primary impedance value would then become 4000 ohms.

In Fig. 14C, we have a similar arrangement where the loudspeaker presents a 2 to 1 mismatch to the secondary of the line-matching transformer. In this instance, however, the load is one-half of the transformer's secondary impedance. As a result, the reflected impedance to the primary of the transformer becomes 1000 ohms.

Since we have already determined that a 2000-ohm primary on the line-matching transformer is required to drive the loudspeaker to 5 watts, it becomes apparent that a 4000-ohm primary will drive the loudspeaker to 2½ watts and that the 1000-ohm primary will drive the loudspeaker to 10 watts. If we use the arrangement of Fig. 14C, we may exceed the amplifier output rating by 5 watts and overload the line-matching transformer by 100 per cent (e.g., passing 10 watts of power through

a 5-watt transformer). The use of a 16-ohm loudspeaker would, therefore, be preferable since neither the amplifier nor the line-matching transformer would be overloaded.

By use of another method we could still drive the 16-ohm loudspeaker to a 5-watt level (through a transformer with an 8-ohm secondary) if there were no objection to running a separate transmission line between the amplifier and this loudspeaker. In Fig. 14D we see exactly how this is accomplished. The 16-ohm loudspeaker is connected to the 8-ohm secondary of the line-matching transformer *T*. A 2 to 1 mismatch is reflected to the primary which has been marked "2000 ohms" by the manufacturer. Since the secondary mismatch is 2 to 1 in an upward direction, the primary impedance reflects this 2 to 1 change upward and becomes 4000 ohms. The 40-watt amplifier is connected to loudspeakers Nos. 1, 2, 4, and 5 (see Fig. 13) from the 250-ohm output tap. Loudspeaker No. 3 is connected through the line-matching transformer to the 500-ohm tap—which presents a deliberate mismatch of 8 to 1. From a 40-watt amplifier, the 8 to 1 mismatch drives the 16-ohm loudspeaker to a 5-watt level, precisely what the installation requires. In this illustration it will be seen that the 4-ohm loudspeaker (Fig. 14C) may likewise be driven to a 5-watt level, if the amplifier provides a 125-ohm output impedance tap.

Wherever possible, line-matching transformers should be used where the secondary impedance value exactly matches the loudspeaker voice-coil impedance. When we load a line-matching transformer with a loudspeaker having an impedance value higher than its designated value (as in Fig. 14B), we tend to impair the low-frequency response. Similarly, when the loudspeaker impedance is lower than the line-matching transformer secondary value (Fig. 14C), we tend to impair the high-frequency response. In a wide-range sound system, it is best, therefore, to limit mismatches of this kind to no more than 2 to 1, as in the illustrations above. For sound systems used only to make paging announcements, the need for wide frequency response is not great and we may, therefore, mismatch as high as 4 to 1.

Earphone Connections

The sound-system installer is sometimes called upon to provide earphones for use in schools, libraries, prisons, and other institutions and it is important, therefore, that he understand something of their characteristics and their requirements.

In a church sound system—a typical illustration—it is common practice to

(Continued on page 82)

Fig. 15. Circuit showing method of incorporating earphones for the hard of hearing.

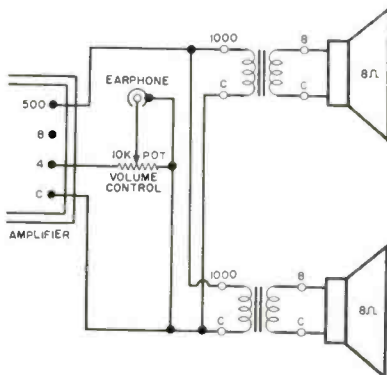

ELECTRONICALLY CONTROLLED CLOTHES DRYER

By JOHN C. BRITSON

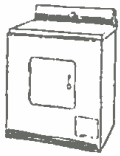

A simple circuit using few components eliminates guesswork by "feeling" fabric moisture directly.



EDITOR'S NOTE: *The electronics industry, with one voice, strongly proclaims its limitless future, but unanimity ends with the question, "What directions will that great future take?" For the technician engaged in consumer service, the question is eminently practical. Will activity in his present field fall off? Should he get into some "industrial" aspect? Many foresee as much expansion in consumer electronics as anywhere else. Our crystal ball is no more reliable than any other. However, the subject of this article suggests what could happen. Who could have predicted that a control system, relatively simple but genuinely electronic, would have popped up in such an out-of-the-way home device as the clothes dryer? It can happen anywhere.*

WITH SOME seventeen major brands of clothes dryers on the market, there are bound to be more ways than one of doing the same thing. The object of all such automatic devices is obviously to bring washed clothes and linens to a degree of dryness that will suit the needs of the user and to do so with the least amount of effort or supervision on the part of that user. This is accomplished by blowing heated air through the clothing for an appropriate length of time.

However, the degree of dryness is an important factor. Even "dry" linens have a certain, normal moisture content. If they are overdried, they may be

stiff and wrinkled. They may also be inadequately dried. The right degree differs from one type of fabric to another. It also depends on what the user wants to do with the dried clothes. Depending on whether they are going to be folded up and put away, ironed, or are of the wash-and-wear type, the proper amount of residual moisture will be quite different.

The simplest way of controlling dryness is with an automatic timer that shuts off the machine after a pre-set period. This requires experience and guesswork on the part of the user, and leaves much room for over- or under-drying. Another method, essentially thermostatic, relies on the fact that temperature inside the dryer rises when the contents are dry. However this technique is also subject to variables, such as the size and type of the load, humidity, outside temperature, and line-voltage fluctuations. A new control system developed by the *Maytag Co.*, found in its Models DE701C (all-electric) and DG701C (gas-heated) automatics, uses a relatively simple electronic arrangement, involving few additional parts, to overcome the difficulties mentioned. It is certainly the most direct method: the clothes themselves are "felt" by "electronic fingers" to sense their moisture content.

The control dial for these models, shown in Fig. 1, is relatively simple. It

provides two conventionally timed cycles: "Air Fluff" (without heat) for any period up to 30 minutes and "Time Dry" up to 50 minutes. The three positions that will be most used, however—"Damp Dry," "Wash 'n' Wear," and "Regular Fabrics"—have no timing adjustment. These rely on the "electronic fingers" or moisture-sensing elements.

The only evidence the consumer can see of the new method consists of three baffles mounted inside the dryer drum. One of them is shown in Fig. 2. It consists of a series of separated but closely spaced electrodes that are wired in pairs. That is, every other electrode is connected to one lead and those in between are connected to another lead. Not visible to the ordinary viewer is a "little black box" that includes a printed board and a handful of components.

The basic circuit used for the three automatic positions, somewhat simplified, is shown in Fig. 3. When the dryer is set to one of these positions, the timer actually operates the machine for the first few minutes, allowing the drum to come into regular rotation and also permitting the interior to heat. Then the timer is disconnected and the control circuit takes over. Diode *SR* rectifies a.c. voltage and begins to charge *C*, a large Mylar capacitor, through resistor *R*. Since the time constant is very long, the flow of charging current is low.

However, the flow of current through



Fig. 1. Single control offers choice of 2 regularly timed or 3 "automatic" cycles.

Fig. 2. One of 3 baffles in dryer drum on which "electronic fingers" are mounted.

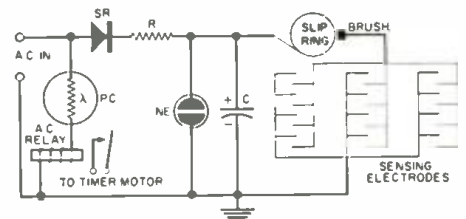
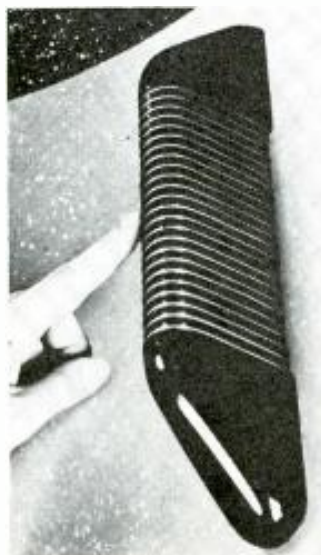

Fig. 3. Dry clothing blocks electrode current, lets *C* charge to cut off cycle.

a parallel path, the sensing electrodes, prevents the capacitor from developing an appreciable charge during most of the operating cycle. During this time, the circuit looks like a conventional constant-current "B+" supply, based on a half-wave rectifier, that is loaded by the electrodes.

"B+" is applied to one of the two sets of electrodes through a slip ring
(Continued on page 91)

Electro-Mechanical Switching in Automation

By KEN BRAMHAM

MODERN industrial automation depends almost entirely on effective methods of combining mechanical and electrical equipment. Automation in industry and accounting is often nothing more than the adaptation of manually operated machines to electrical operation. To make this adaptation we must duplicate those parts of the human operator that are

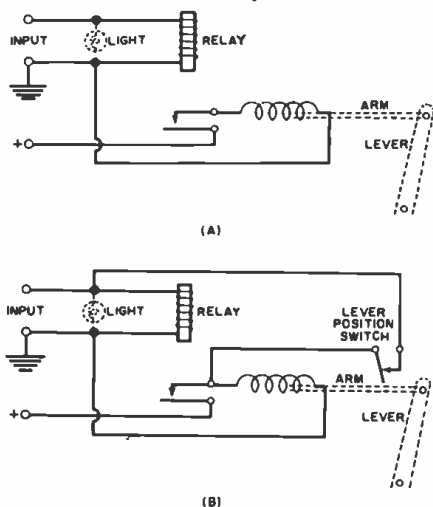
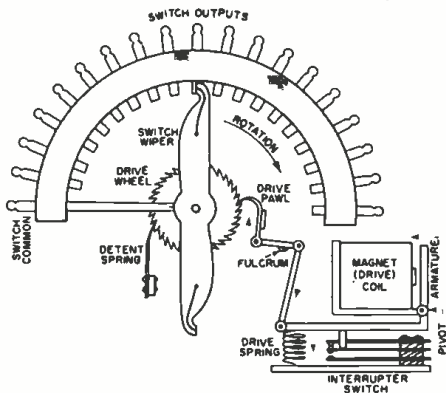

Fig. 1. Electro-mechanical "robot" (A), wired to original light circuit for signaling human worker, operates lever on command. Circuit can be elaborated (B) with added switch to improve reliability.

Fig. 2. This rotary stepping switch is a composite developed from versions by several manufacturers to illustrate typical operation. Although there are 19 contacts, 18 are used for sequence steps.



used to control the machine in which we are interested.

If the human operator is required to pull a lever when one of a group of lights flashes on, we can devise an electro-mechanical linkage to pull the lever and an electrical circuit to sense the correct light. Combining these gives us a robot that will pull the lever when the correct light is on. We are, in effect, duplicating the operator's arm and muscles to pull the lever, his eyes to see the indicator light, and his brain to decide when the lever should be pulled.

If it were necessary to synthesize the complete human operator, automation would be impossible. Fortunately we are concerned with duplicating only a few, specific functions. We do not have to reconstruct that part of the human brain used to appreciate the blond at the next machine. Our robot is interested only in the light, the lever, and the single bit of business in which these two elements are involved together.

Single-Function "Robot"

We know what our one-purpose mechanical operator must do; now let us see how simply it can be built. We can not give it eyes. Instead we will remove the light bulb and substitute a relay energized by the light circuit. Its arm will be steel and its muscle an electro-magnet wired through the relay contacts. The light circuit now energizes the sensitive relay, which takes no more current than the original bulb. This in turn closes the circuit to the magnet coil to actuate the arm and pull the lever. When the light circuit is de-energized, the relay will drop, open the magnet circuit, and release the lever. The electro-mechanical schematic for our robot is shown in Fig. 1A.

Our robot at this point is not very "bright." If the indicator light flashes on but goes out before the lever has been pulled all the way, the human operator would know to continue pulling the lever to the end of its travel. Our robot, not knowing this, would release the lever before the operation was complete. In Fig. 1B a switch is added to sense when the lever travel is complete and make the robot a little more intelligent. This locking circuit holds the relay energized until the lever-sensing mechanism

is actuated. With this circuit, the lever must complete its travel once the light circuit has energized the relay for the five to ten milliseconds needed to transfer the contacts.

The example described is a very simple application of electro-mechanical automation, but it does have the basic features characteristic of automatic control systems. These are (1) the ability to start a mechanical operation on command and (2) feedback from the mechanical components to control the operation once it has been started.

In automatic office systems, it is very seldom that an operation as simple as the one just described is complete in itself. It is more likely to be used as one of a sequence of operations following a pre-determined program. We may, as an example, require to press certain keys on a calculating or adding machine in a pre-set routine, or we may wish to punch holes in a paper tape or card as part of a batch of information to be fed to a computer. In these and many other applications, a rotary stepping switch can be used to energize a number of solenoids sequentially.

Many Steps—Automatically

Fig. 2 shows a simplified rotary stepping switch. It consists of an 18-position switch with two wipers spaced 180 degrees apart to give a continuous switching action over the 18 outputs as the wiper shaft is rotated. A ratchet (drive) wheel is keyed to the wiper shaft, and a drive pawl is provided to hook into the notches of the wheel and rotate the wiper. When the magnet coil is energized, the armature is attracted, transferring the interrupter switch contacts and, through the mechanical linkage, pushes the drive pawl to the next notch in the wheel. When the coil voltage is removed, the armature is forced back to its normal position by the drive spring, restoring the interrupter contacts and drive pawl to pull the drive wheel round 10 degrees. This moves the wiper to the next switch position. A detent spring is also added, in position to act on the drive wheel and hold the wiper in position until the next operating cycle. It is important to remember that this type of switch "steps" to the next position when the coil is de-energized—no

How multi-position switches can replace human operators in performing tasks that involve many steps in specific sequences.

movement of the switch wiper occurs when the coil is energized.

Rotary Contact Protection

To prevent damage to the switch contacts, it is important to work within the current ratings set by the manufacturer. Although these contacts may be rated to carry several amperes, the maximum current that may be safely switched (made or broken) is often limited to 50 or 100 ma. In order to stay within the current switching limit and still take advantage of the full current-carrying capacity, some special circuitry must be used. The interrupter contacts shown in Fig. 2 are of heavy-duty tungsten and are used to protect the switch wipers and contacts. These interrupter contacts transfer each time the coil is energized and restore just before the wipers move to the next contact, making it practical to use the wiper contacts in series with the interrupter switch. Current in a series circuit of this type will flow only when the switch wiper is stationary and the drive coil is energized. A simple circuit for this switch protection is shown in Fig. 3.

The Switch Put to Work

A possible use for a rotary stepping switch as a means of controlling a sequence of operations is shown in Fig. 4. In this example, six solenoids are to be energized in the sequence 1, 2, 3, 4, 5, 6, 2, 3, 4. A ten-position switch is used, which has normally open interrupter contacts. The mechanical action initiated by each solenoid includes the rotation of a shaft on which we can mount a cam-actuated switch to provide feedback from the machine to the stepping switch.

When the switch is in position 1, current will flow through the cam-actuated switch (S_1) to energize the drive coil. This in turn cocks the drive pawl and also closes the interrupter contacts to complete the circuit to solenoid 1. This solenoid and the drive coil remain energized until the mechanical action started by the solenoid is complete. The cam shaft then rotates, opening the switch contacts, de-energizing the drive coil and allowing the armature to restore. Restoration of the armature opens the interrupter contacts in the solenoid

circuit and then rotates the switch wiper to position 2 while no current is flowing in the circuit. The cam-shaft rotation continues during this time and finally allows S_1 to close and repeat the cycle, this time energizing solenoid 2. The sequence continues as long as power is applied to the circuit.

Controlling Stop and Start

In the last example, we have a continuous, free-running type of operation. In practice, it is more likely that the sequence would be started on command and would stop when the solenoids had all been energized. A circuit to include start and stop relays is shown in Fig. 5.

In this circuit, the "command" signal to start the sequence energizes the "start" relay, which in turn holds through its own (upper) contacts and through the normally closed contacts of the "stop" relay. A second pair of contacts (lower) on the "start" relay applies voltage to the stepping-switch circuit. The stepping action proceeds in the same manner as in the previous example, controlled by feedback from the cam-switch, until the last step is reached. When the coil is energized on this step, the output is taken to the "stop" relay coil, which energizes and opens the holding circuit to the "start" relay. The "start" relay now restores, opening the circuit to the stepping-switch drive coil and interrupter contacts. When the drive coil de-energizes on this last step, the switch wiper moves to position 1 and the circuit is ready for another cycle when the command signal is received again.

Rotary stepping switches were originally developed for use in automatic telephone exchanges, but high-speed exchanges are now being designed in which transistors replace the electro-mechanical components. Many automated applications, however, do not require high speeds; and for these stepping switches are used. Most low-cost stepping switches will operate at speeds up to 60 steps per second without feedback, but this is seldom required when mechanical operations are being controlled. Thus we see the stepping switch becoming obsolete in one field, but taking a leading position in another, that of automation and control. ▲

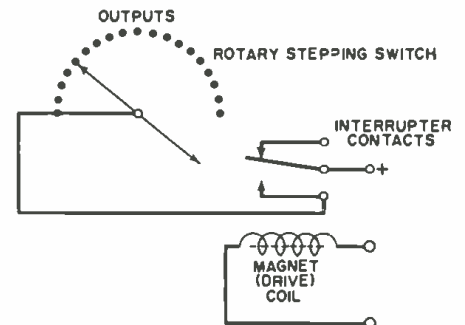

Fig. 3. Incorporation of an interrupter switch protects rotary-switch contacts.

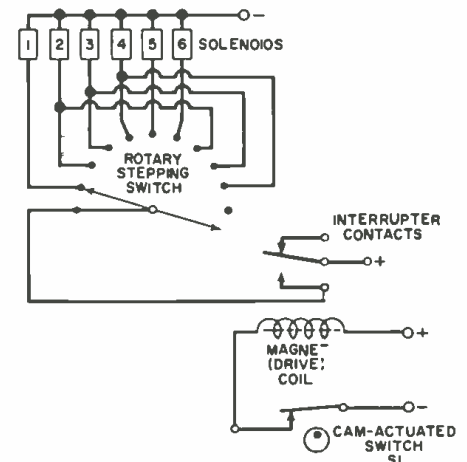
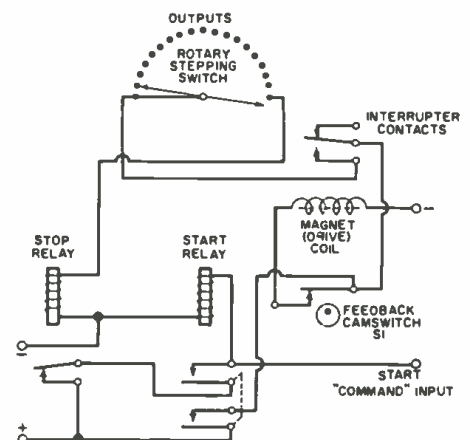

Fig. 4. Simple automated circuit. Six solenoids are pulsed in a pre-set order.

Fig. 5. Switched sequence starts on command, stops automatically on completion.



MARINE ELECTRONIC SERVICE:

DEPTH SOUNDERS

A GENERAL picture of how the various depth sounding and indicating instruments work and what basic elements they include has already been presented. Next is an investigation, in some detail, of the arrangements used for keying, displaying, and phasing.

Indicators: The arrangement for keying the transmitted pulse in a flasher using cam-operated contacts is shown in Fig. 8. The detent on the cam closes the contacts once in every revolution. The disc or arm carrying the neon lamp may be driven directly, by gears, or by a belt. The motor, frequently called the scanning motor, may be a.c. or d.c.

Two methods of "contactless" keying have been developed to eliminate the need for contact maintenance in shallow-water flashers, which run at higher speeds. In one, the pulse generator is triggered by the voltage developed when a small permanent magnet carried on the rotating arm passes over the iron core of a stationary inductance. Another type produces the triggering voltage by the meshing and unmeshing of the plates of a variable capacitor. In this case, one set of plates is fixed to the frame of the indicator and the other to the end of the rotating arm opposite the neon lamp.

Many flashers use small, bayonet-base neon lamps; however special U-shaped tubes are used in many of the higher-grade models to give greater illumination.

The spacing of the dial graduations is determined by the motor speed. Since calibration is necessarily limited to the 360 degrees of rotation, the neon lamp must rotate at a slower speed in deep-water units than in shallow-water types. Flashers incorporating an efficient electronic system will frequently sound deeper than can be indicated on the dial's calibration. Consider a flasher calibrated to read from 0 to 120 feet in 360 degrees. If the depth increases beyond 120 feet and the echoes are still being amplified sufficiently to fire the lamp, the flashes will start a second course around the dial. An indication at the 40-foot mark would then occur at a depth of 160 feet.

Recorders: In this type, a motor-driven, rotating arm (Fig. 9) swings arcs across a separately driven chart paper. The arm carries a stylus mounted at the end that sweeps across

the paper. At the other end of the arm is a wiper that bridges gaps between segments on a stationary commutator. The top view of Fig. 10 further illustrates the arrangement of the parts, with two variations being shown. The output segment of the disc-type commutator in Fig. 10A is connected to the amplifier output, and is at a positive potential high enough to fire the thyatron in the pulse generator but not sufficient to burn any marks on the paper. The keying segments are connected to the control-grid circuit of the thyatron. When the gap is bridged, the grid goes positive enough to cause firing and, if the stylus is over the chart, a zero mark will be burned at that point. When the echo returns, the wiper will still be on the output segment, and the echo will be marked a proportionate distance down the chart.

In the drum-type commutator of Fig. 10B, a continuous output ring is used instead of a segment, and the rotating, arm-mounted wiper is used only to pick up the signal from the amplifier, not for keying. A separate keying wiper on the other end of the arm rides over the keying segments of the fixed commutator. It fires the pulse generator by shorting out the grid bias. Obviously other mechanical arrangements are possible.

Suppose now that the electronic elements of such a recorder are designed for 120 fathoms. If the length of time it takes the stylus to move from the top of the chart to the bottom is equal to the round-trip travel time of the pulse at 120 fms, the zero line will be burned at the top of the chart and the depth indication will be burned at the bottom.

Were the stylus moving three times as fast, the depth indication would be at the bottom of the chart in only 40 fms. This would result in a 3:1 magnification of the contours of the bottom, which is important in many types of fishing, but the maximum depth at which the recorder could be used would be only one-third of the former value.

Now assume that the stylus is still moving at this faster rate but that, when the recorded depth reaches 40 fms, the keying point is changed to occur, not at the top of the chart, but one chart

width earlier. The position where the zero line would be is now above the chart, and the 40-fm depth indication is at the top of the chart. This shifting of the keying point is termed *phasing*, and each position is called a *range*. It is apparent that, in this hypothetical recorder, the second range would cover 40 to 80 fms. If the keying were again advanced one chart width, the third range would cover 80 to 120 fms. This illustrates how the magnification on any given width of chart may be increased without sacrificing maximum depth indication.

Fig. 11 illustrates two types of recorders in which the stylus is carried on an endless belt instead of an arm. It will be noted that the range in the conductive-belt type of Fig. 11A is determined by the location of the contacts

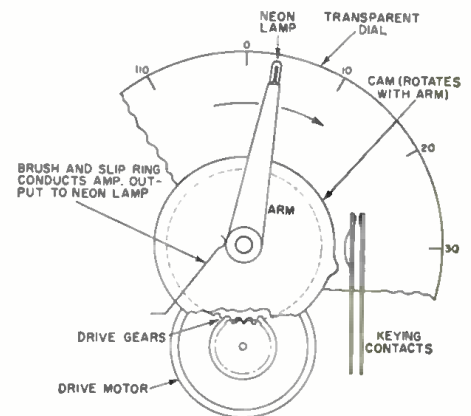

Fig. 8. Transmitted pulse is keyed by cam-operated contacts in this flasher.

affected by the carrier or wiper on the belt.

Most recorders use a separate motor similar to the electric-timer or clock type to drive the chart paper, which may be 2 to 12 inches wide; however, at least one manufacturer employs a mechanical linkage between the stylus-drive motor and the chart-feed rollers instead.

Scopes: Consider a scope with a 0- to 50-foot scale on the face of the CRT. As with a recorder, when the bottom-indicating blip (horizontal deflection) reaches the 50-foot mark, the keying point could be advanced one scale length. The spot would then be at the top of the tube when the depth was 50

Part 2. Keying, display, and phasing arrangements used in various types of instruments, including an extensive troubleshooting section covering all kinds.

By R. C. ROETGER

Sea Electronics

feet and the bottom of the scale would then indicate 100 feet.

The scope, however, is intended primarily to show fish and sea life above the bottom, so it is desirable to use the entire face of the tube, insofar as is possible. In other words, when the depth indication reaches the bottom of the scale, it should be maintained there. To accomplish this, the keying is made continuously variable. Thus, when the depth indication moves past the bottom of the scale, it can be brought back only just as far as is desired instead of jumping to the top of the tube, as would occur with a fixed point keying.

A depth-indicator dial may be attached to the scope's keying control so that, when the depth exceeds the maximum shown on the tube face, the dial will read the correct depth whenever the keying point is adjusted to make the bottom indication coincide with the bottom of the scale.

Many scopes include a means of reducing the sweep speed so that the face of the tube represents the full depth of water in which the instrument is capable of sounding. This enables the operator to "see" everything in the water from the surface (transducer position) to the sea bed, but at greatly reduced magnification.

Troubleshooting

Assuming a check of the tubes, transistors, and voltages does not disclose the source of a defect, the next step is to determine which element of the sounder is faulty.

Motors: If an a.c. motor fails to run, check for a defective motor capacitor, if any, and also for a bad capacitor across the 117-volt transformer winding supplying the motor. Also inspect for tight bearings or gears; the motors used in sounders seldom have any torque to spare and are easily stalled. On d.c. motors, make sure that the brushes are seating properly and that the governor is not binding. If the motor windings are shorted or open, it will have to be replaced, since necessary rewinding would be extremely difficult if not impossible.

Failure of the chart paper to move on a recorder is not always the fault of the chart-drive motor. Determine if the motor itself is running and, if so, look for slippage between the motor shaft and its pinion or roller, or for insufficient pressure of the paper rollers.

No Zero and No Echo Indications: When no zero flash appears on an indicator or no zero line on a recorder, first check the keying. If cam-operated contacts are used, see that they are closing properly; if the manufacturer's adjustment specifications are available, set accordingly. With commutator-type keying, be sure that the wiper or brush is bearing on the commutator during the entire revolution. If necessary, clean the commutator with carbon tet and remove any foreign matter from between the segments. In extreme cases of corrosion or roughness, use a very fine abrasive paper.

On recorders where keying is done by

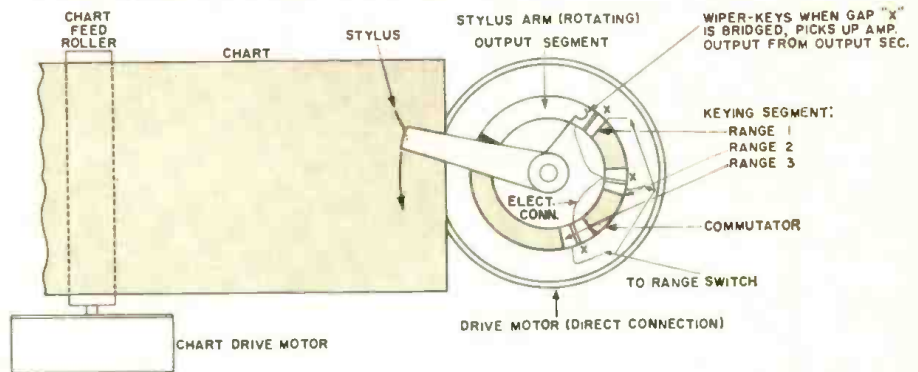

Fig. 9. Mechanics of one type of arm-and-commutator recorder. Arm sweeps stylus across separately driven chart paper. Arm wiper picks up signal from commutator.

fingers on the stylus belt riding over fixed contact bars (or fixed fingers on moving contact bars), revolve the belt by hand and watch for proper contact. Fig. 12 illustrates how maladjustment of a pair of contact fingers could prevent keying. Use a fine file to dress burned or out-of-square contact fingers. If a keying bar is used, file out any grooves that may have been cut by the wire stylus.

Most scopes have a means of bringing the zero blip down onto the face of the tube for test purposes. If not, it may be brought into view with the vertical centering pot or a permanent magnet held near the tube.

Note that, if the circuitry of the sounder is such that the pulse generator

includes a capacitor discharged through a magnetostriction transducer, no zero indication will be obtained unless the latter is connected. A 10-watt resistor of 5 or 10 ohms may be substituted for the transducer when shop-testing the keying of such a unit.

In connection with a keying check on indicators, consider the possibility of trouble with the brush or slip-ring arrangement supplying the neon lamp, the lamp itself, or the secondary of the output transformer, if one is used. The lamp seldom fails completely, but may age to the extent that its light output is very low.

Remember, too, that multi-range depth recorders will not produce a zero indication unless the range switch is in position for the shallowest range.

With the keyer known to be functioning, next consider the pulse generator. If it is operating, a v.o.m. set on the lowest a.c. scale and connected across the transducer terminals will show an appreciable kick each time the keying contacts close. If not, first determine that the keying signal is reaching the generator, i.e., the grid bias is being shorted to ground or bucked out by a positive voltage. Sometimes limiting resistors

open, and broken connections are a possibility. The 0A5's and 2D21 thyratrons used in many pulse generators are best checked by substituting known good tubes. Isolate the discharge capacitor and check for an open as well as leakage, for the tube socket voltages are rarely an indication of its condition.

In vacuum-tube generators, check the transformers with any tuning capacitors paralleling the windings removed,

for either component could be defective without causing an appreciable discrepancy in tube voltages.

The amplifier is the remaining element that could prevent the zero indication from appearing. The checking procedure to be followed is the same as it would be for a low-frequency i.f. amplifier. However, irrespective of voltage readings, be suspicious of coupling coils shunted with capacitors or resistors, coupling capacitors, and fixed-tuned capacitors across first-stage coupling coils. Windings of uncased, iron-cored coupling transformers are also prone to open.

It is also possible that ill-considered tinkering by the owner has mis-aligned the unit to the point where nothing could get through. Obviously, this necessitates a re-alignment job as will be described later.

Zero Indication but No Echo: This condition can usually be attributed to a faulty transducer; however, other possible causes are an insensitive amplifier, low output from the pulse generator, and improper stylus adjustment on recorders. The best way to learn if the transducer is responsible is to substitute a known good one. (See section on transducer checking.)

On recorders, examine the stylus to make sure it is riding on the chart all the way from top to bottom. If the recorder has a fix marker switch, depressing it will produce a black line from the top to the bottom of the chart when the stylus is correctly set.

Zero Indication and Weak Echo: If the echo flash is dim or the echo trace is gray rather than black; or if the echo disappears as the depth of water increases, the trouble is, again, very likely to be with the transducer. Nevertheless, do not overlook the possibility of amplifier difficulties.

Transducer Checking: As mentioned before, the best way to check for transducer trouble is by substitution. However, this does not mean that the substitute has to be mounted in its actual operation position. (Due mainly to frequency differences, transducers of various manufacturers are seldom interchangeable, even though they are of the same type.) Connected to a sounder in proper working condition, a good transducer will give an audible click each time the keying contacts make. Held two feet above and with its active face parallel to the deck or floor, it will cause a depth indication of eight feet. This is due to the fact that the speed of the

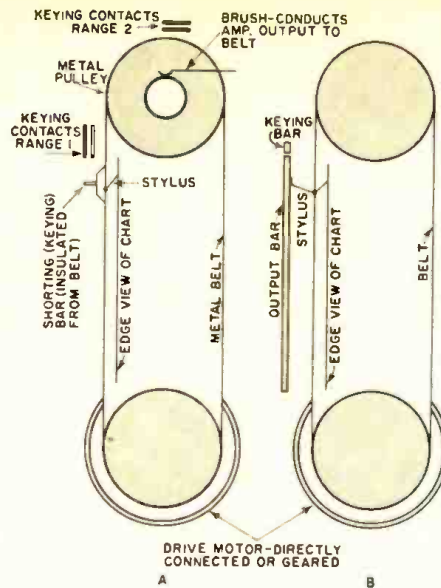

Fig. 11. Two of the stylus-and-belt arrangements in recorders. Conductive (A) and non-conductive (B) belts are used.

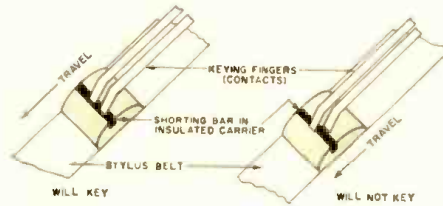

Fig. 12. Misaligned contact fingers (as at right) may prevent proper keying. Proper alignment is at left.

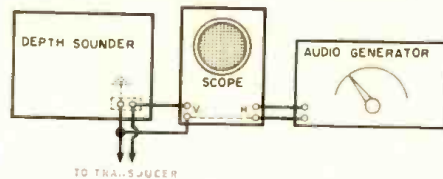

Fig. 13. Equipment arrangement for frequency alignment where a vacuum-tube oscillator serves as the pulse generator.

supersonic pulse is only one-fourth as great in air as in water.

To convince a customer that his transducer is bad, the good substitute may be held over the side of the boat on a temporary bracket.

A good crystal transducer connected across a v.o.m. set on its highest resistance scale will cause a slight kick, and the meter will return to infinity. These transducers will often function, at reduced sensitivity, even though the residual reading indicates a megohm or less. If the owner is satisfied with the maxi-

imum depth at which a transducer in such condition will operate, it need not be replaced.

Ceramic transducers that have a series capacitor incorporated will show a typical capacitor kick on the v.o.m.; any residual resistance reading is usually due to capacitor leakage. Some makes may be partially disassembled to permit replacement of this capacitor.

Magnetostriction transducers will show a very low resistance across the winding. When making a resistance check on these, the meter range must be low enough to distinguish between the actual coil resistance and a possible short between the cable shield and the winding.

Any check of a transducer should include an inspection of the cable for mechanical damage. If such damage has occurred inside the hull, it can usually be spliced out without had effect.

If the transducer is mounted inside the hull in a cofferdam, it is essential that it be covered with water. Likewise, where a sea chest is used, it must be filled with the acoustic fluid recommended by the manufacturer. The screws holding the transducer in the chest should be loosened slowly so that, if the diaphragm has ruptured, this can be detected without danger of flooding the boat.

Since transducers are priced from about 30 to several hundred dollars, it is unlikely that the service technician will wish to purchase a test unit for every type of sounder he is liable to encounter. Eventually he will learn which transducers it will pay to own, based on the work in his area. In the meantime, when a transducer is suspected, the sounder should, if possible, be tested on another boat having the same model. This is another way of showing a customer that his transducer is defective. Such boat-to-boat substitution is not difficult. Many sounders have plug-in connections for both power and the transducer; otherwise a pair of #12-wire clip leads will suffice for temporary power and, if the transducer cable will not reach the unit being tested, a shielded two-wire clip lead will serve as a jumper.

Alignment: Some manufacturers include alignment instructions in their manuals. If not, the following procedure will result in a satisfactory job provided the operating frequency is known.

If the sounder employs a capacitor-discharge type of pulse generator, first disable the generator. This may be done by pulling a cold-cathode discharge tube, removing the stylus, or disconnecting some part of the keying circuit; but not always by removing a thyratron, owing to series-parallel heater circuits.

Connect an audio generator, set to the proper frequency, across the transducer terminals, and a v.t.v.m. or scope to the amplifier output. The latter is the point feeding the neon lamp (on flasher types) or the stylus (on recording versions). On recorders, load the amplifier with a 10,000-ohm, 2-watt resistor and bend or remove the stylus so that it will

(Continued on page 109)

Fig. 10. Top views of (A) disc-type and (B) drum-type commutator with separate, continuous, output ring. Both types are used in chart-paper depth-recording instruments.

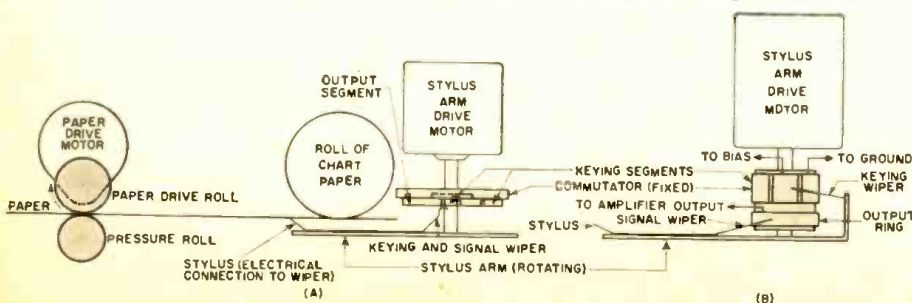

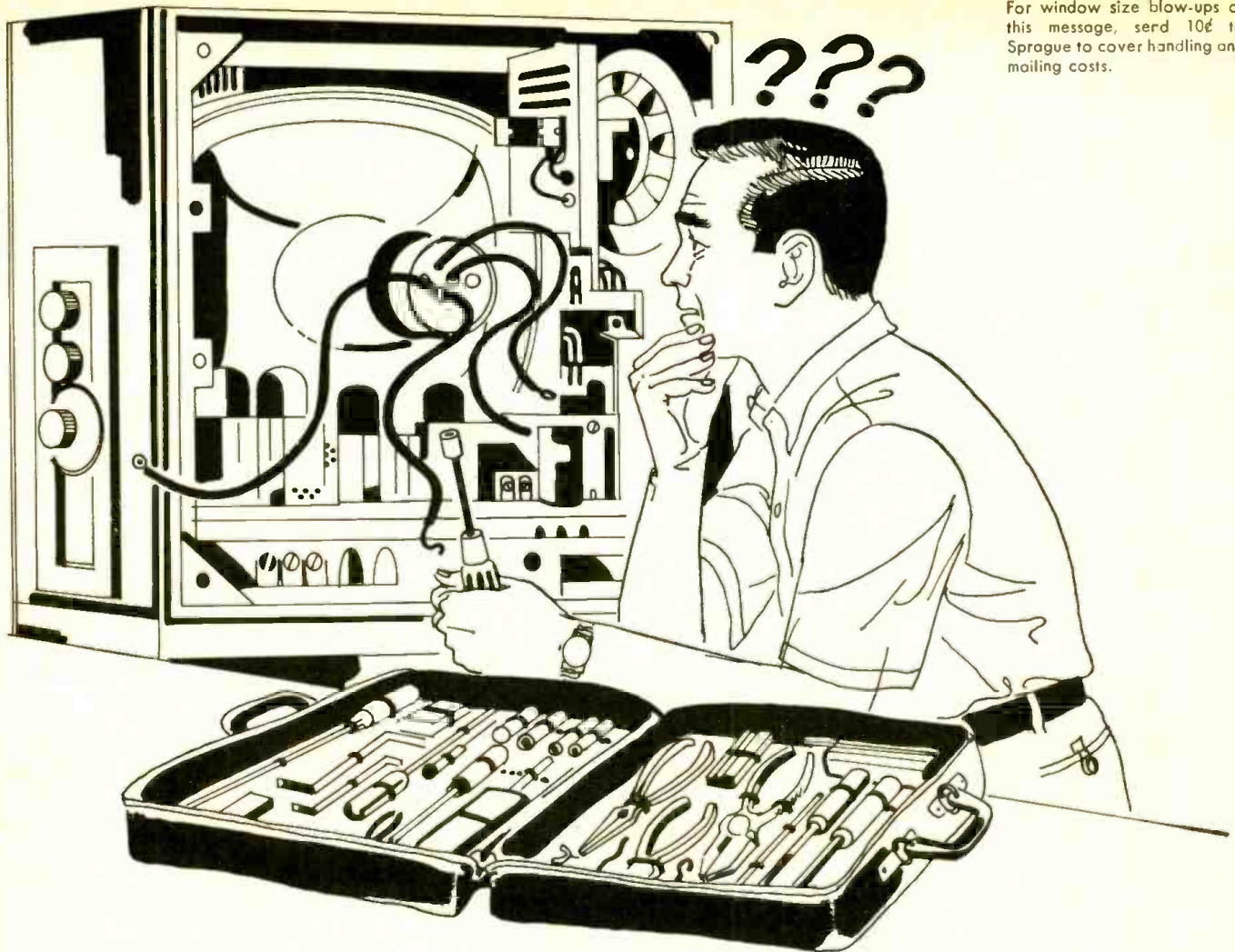

For window size blow-ups of this message, send 10¢ to Sprague to cover handling and mailing costs.

It takes MORE than TOOLS to be a TV Technician!

Just what IS the difference between the "screwdriver mechanic" and the expert TV-Radio Technician?

NOT expensive tools and test equipment—although they ARE essential.

TRAINING is the first big difference. The tinkerer guesses, but the expert technician KNOWS—because he spent years in the study of electronic theory and its application to television techniques.

EXPERIENCE is the next big difference. The professional TV specialist has repaired hundreds—perhaps thousands—of sets. He knows the complexities and the variations in circuits. He is familiar with the hundreds of parts which make up the "innards" of each type of TV. He can diagnose trouble and cure it quickly and safely.

PROGRESSIVENESS is another big difference. The expert TV Technician continually spends countless hours and hundreds of dollars on manuals, keeping up to date on new developments, new circuits, and new troubleshooting techniques. When trouble develops, he knows what to do about it.

Well-meaning, but poorly informed "screwdriver mechanics" and "do-it-yourself-ers," frequently unable to accurately diagnose TV trouble, often "butcher" a set to the point where it can be dangerous as well as expensive.

DON'T RISK YOUR SAFETY OR NEEDLESS EXTRA EXPENSE—CALL AN EXPERT TECHNICIAN AT THE FIRST SIGN OF TROUBLE! HIS FEE IS YOUR INVESTMENT IN SAFETY AND SATISFACTION.

**THIS MESSAGE WAS PREPARED BY SPRAGUE PRODUCTS COMPANY,
DISTRIBUTORS' SUPPLY SUBSIDIARY OF SPRAGUE ELECTRIC COMPANY, NORTH ADAMS, MASSACHUSETTS FOR . . .**

YOUR NEIGHBORHOOD TV-RADIO TECHNICIAN



110-Watts

The Fabulous
FISHER
X-1000
 Stereo Master
 Control-Amplifier

The FISHER X-1000 is the most powerful control-amplifier in existence! Its extremely flexible Master Audio Control is combined with a 110-watt dual-channel amplifier. A special feature is the exclusive Fisher internal switching system that permits the monitoring of tapes and the use of all tone controls and switches during playback without changing cable connections. The Center Channel Speaker Output eliminates the need for a third amplifier. A center channel output is provided for connection to a third amplifier and speaker permitting a remote installation. Precise blending of the two stereo channels is accomplished with the Stereo Dimension Control. The Space-Expander Control operation of a reverberation system. Attractive architectural brass-finish front control panel.

Fisher (20-UXF) and Malmgren® (20-UXM) Cabinets for the X-1000
\$329.50
\$24.95

USE THIS COUPON
FISHER RADIO CORPORATION
 LONG ISLAND CITY 1, N. Y.

Please rush FREE literature on the following:

- Specifications on the FISHER X-1000
- Complete Catalogues on FISHER equipment
- Illustrated Custom Stereo Installation Guide

Name _____

Address _____

City _____ State _____ EW-10

SOLID-STATE I.F. TRANSFORMER

Pea-sized ceramic filter introduced to take the place of the conventional bulky i.f. transformer.

A UNIQUE ceramic filter has been developed to take the place of conventional bulky i.f. transformers. Two models will be introduced initially by the U.S. Sonics Corp. of Cambridge, Mass. Both are 455-kc. i.f. filters, one for transistor circuits, the other for use with vacuum tubes. Because of the small size of the device, it is expected to find use in personal-portable receivers. The cost of the new i.f. filter is expected to be about 31 cents per unit in 10,000-unit runs. This compares favorably with conventional i.f. transformers, which currently cost the receiver manufacturer around 25 to 35 cents per unit in the same quantities.

In addition to i.f. applications, these ceramic filters can be supplied with a variety of other characteristics. For ex-

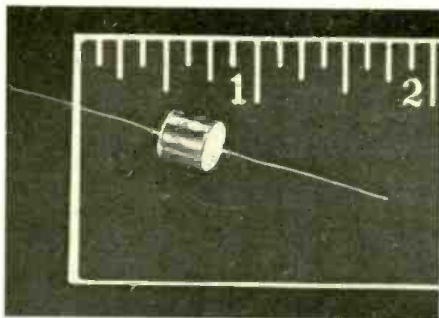

The solid-state i.f. transformer is shown above practically full size. The two leads are for input and output connections, while the ground connection is made to the case.

ample, ceramic filters may be designed for center frequencies from 100 kc. to 1 mc., bandwidths (at 6 db down) from 1 to 20 per-cent of the center frequency, and a wide range of input and output impedances. Ceramic filters can be designed to have characteristics equal to, or better than, those of many currently available quartz filters at prices as low as one-third of the quartz-filter prices.

In addition to its small size, the pea-sized zirconate device has many other advantages. The filters are permanently tuned to design characteristics. For the receiver manufacturer this means that the bandwidth and shape established during prototype design remains constant through production and the unit does not get out of alignment for the life of the set. Time-consuming tuning and alignment of i.f. strips is completely eliminated. On the other hand, circuit capacitance must be fairly carefully controlled in order to use fixed-tuned i.f. transformers. This should not pose too much of a problem with printed circuitry and with uniform electrical char-

acteristics in tubes and transistors.

Once the unit has been installed, no access is needed as there are no adjustments to be made. This simplifies set design. Because of the size and shape of the unit and its axial leads, it may be assembled automatically on circuit boards by the same standard production equipment now used for resistors and capacitors.

The ceramic i.f. filter can withstand repeated high shocks and vibration, and it is far less susceptible to microphonics than conventional i.f. transformers or mechanical filters.

Typical power loss of the ceramic unit is only 1 db compared with up to 12 db for conventional transformers. Low loss is in part due to the filter's high tolerance to impedance mismatch. A typical unit may be used with output impedances varying from 500 to 5000 ohms without appreciable change in resonant frequency or power loss.

The unit designed for transistor circuits has the following characteristics: input impedance, 10,000 ohms; output impedance, 1000 ohms; center frequency, 455 kc., ±1 kc.; power loss at rated frequency, 1 db; working voltage, 500 volts d.c. between any two terminals and signal voltage, 10 volts (r.m.s.) at

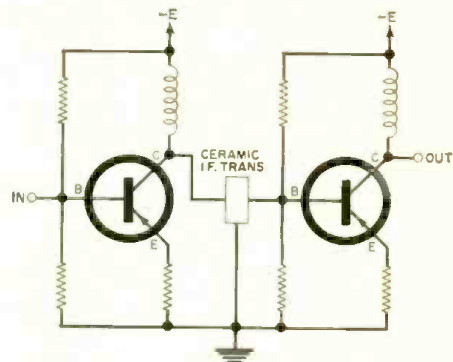

Simple circuit diagram showing the use of one of the new ceramic i.f. transformers for interstage coupling in transistorized broadcast receiver. A higher impedance model is also made for vacuum-tube circuits.

resonance. Bandwidth is 6 kc. at -3 db, 9 kc. at -6 db, and 50 kc. at -20 db. The unit designed for vacuum-tube circuits has these characteristics: input impedance, 25,000 ohms; output impedance, 200,000 ohms; center frequency, 455 kc., ±1 kc.; voltage loss at rated frequency, 1 db; working voltage, 500 volts d.c. between any two terminals and signal voltage, 10 volts (r.m.s.) at resonance. Bandwidth is 2 kc. at -3 db, 4 kc. at -6 db, and 24 kc. at -20 db. ▲

THE A. E. S. *Gigolo*

ONE OF THE MOST SOUGHT AFTER PRODUCTS IN THE HIGH FIDELITY INDUSTRY

At our present rate of sales and production, A. E. S. will sell nearly 100,000 Gigolos this year.

Imagine, now you can own a speaker with this quality for only \$15.00.

**TRY IT—WE GUARANTEE IT
100,000 PEOPLE CANNOT BE WRONG**

DESCRIPTION:

The Gigolo is constructed with a resonant resistant all wood product of at least $\frac{3}{4}$ " thickness throughout. Its outside dimensions are 24" long, 12" high, 9 $\frac{1}{2}$ " deep. The heavy construction and the fine workmanship suggest a value far exceeding its low, low price. All units sold on 100% MONEY BACK GUARANTEE.

Price \$15.00. Unfinished only.
F.O.B. Factory

SPECIFICATIONS:

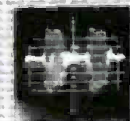
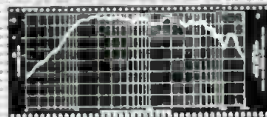

| | | | |
|--|-----------------------|-------------|-----------|
| Frequency response | -500 | Tone bursts | 3500 |
| Maximum frequency response | 19-21000 cps | | |
| Frequency response, ± 8 db | 45-18000 cps | | |
| Harmonic distortion | less than 3% 70-21 kc | | |
| Impedance curve | within -0 | 200% | of 8 ohms |
| Flux density | 11000+ gauss | | |
| Frequency response curve run at continuous | 10 watts. | | |

Power-handling capacity, the Gigolo may be used with small economy amplifiers of very low wattage, as well as with the highest power component amplifier with satisfactory results.

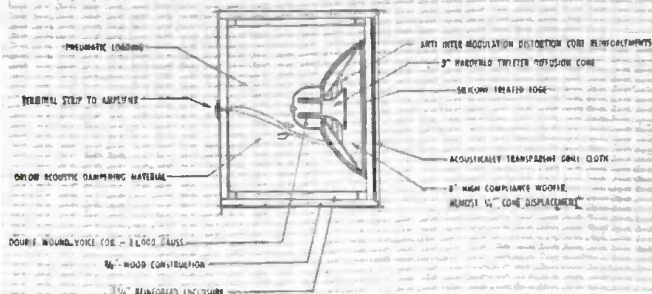

A.E.S., Inc.
3338 Payne Avenue, Cleveland, Ohio

Gentlemen please ship _____ GIGOLOs.

I understand these units are guaranteed and if I am not satisfied I may return for a full refund of sales price, \$15.00 each.

Name _____

Address _____

City and State _____

Enclosed find check _____ money order _____

per-cent without any change in pitch.

A complete analysis of this device is beyond the scope of this article but a brief explanation of the principles of operation is in order. As can be seen in Fig. 5, the tempo regulator is used with one of the regular tape machines, taking the place of the capstan and playback head. The reeling motors of the regular tape machine are used. The tempo regulator head assembly consists of four heads, mounted in the periphery of a small drum. These heads are connected in parallel and wired to slip rings. The brushes that bear on these slip rings connect by a short cable to the playback preamplifier, the output of which is connected to either of the recording buses at the console. In use, the tape to be played is threaded off of the left-hand reel, is guided around the head drum by an idler, past the capstan of the tempo regulator, then onto the right-hand, or take-up, reel. The tape wraps around the head drum slightly more than 90 degrees so that one head is always in contact with the tape. This head drum is capable of rotation in either direction, determined by the internal drive mechanism.

The tempo regulator capstan is driven through a variable-ratio idler drive which is adjusted by the technician for the percentage of timing change, or correction, required. When the capstan speed is adjusted to run *faster* than the standard 15 ips, the head drum rotates *with* the capstan, in the same direction as the tape movement. When the capstan is set to run *slower* than the standard speed, the head drum rotation is *counter* to the capstan rotation and the movement of the tape. The important factor here is that no matter what the capstan speed, the head-to-capstan difference is always 15 ips, therefore maintaining proper pitch. At the same time, the actual tape speed past a fixed point has been changed, thereby altering the tempo and, consequently, the timing.

There is still another function of this machine that became apparent during its operation. By using the rotating head only, in conjunction with the regular tape machine capstan, it is possible to achieve a pitch change *without* a tempo change. While the tempo regulator isn't in constant use, it is invaluable when there is no other simple solution to a music scoring problem. This machine is built by *Telefonbau and Normalzeit* of West Germany.

The combination of these components results in a flexible dubbing system incorporating many ideas of the technicians in the Television Music Department. This is a small department, employing only a few men, but it provides an important segment of the final product and, as a result, imparts a feeling of achievement to the technicians involved. ▲

October, 1961



**YOU
NEED
THIS...**

**FREE GIANT
ALL NEW 1962
BA CATALOG**



1962 RADIO-TV-ELECTRONICS BA
ANNUAL CATALOG 621
SINCE 1927
35th Anniversary

BURSTEIN-APPLEBEE CO.

RUSH COUPON TODAY!

BURSTEIN-APPLEBEE CO. Dept. EW
1012-14 McGee St., Kansas City 6, Mo.
 Rush me New 1962 B-A Catalog No. 621

NAME _____
ADDRESS _____
CITY _____ STATE _____

- SAVE UP TO 50% ON B-A SELECTED KITS
- TOP VALUES IN POWER AND HAND TOOLS
- HI-FI AND STEREO SYSTEMS & COMPONENTS
- 30 PAGES OF BARGAINS NOT IN ANY OTHER CATALOG

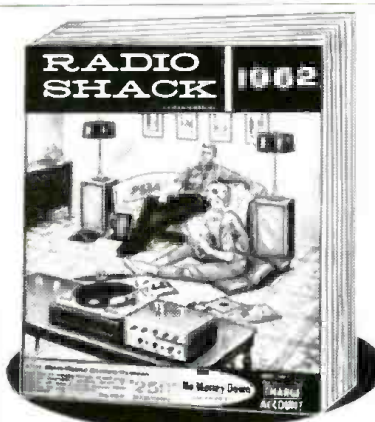

RADIO SHACK Corp.
Boston, Massachusetts

Send for your **FREE** personal copy of **RADIO SHACK'S 336-PAGE 1962 CATALOG**
Nationwide standard of excellence in Electronics, Music, Communications
Also receive all other issues for 1 year!
Our bigger, better catalogs offer the widest line of electronic parts and equipment in the world! Latest in Stereo, Hi-Fi, Ham Radio, Test Equipment, Pre-Recorded Tapes, Tape Recorders, Records, Component Parts—plus 30 pages of new fun-to-build kits. Every item is easy to own on new No Money Down Credit Terms. Every item is guaranteed to satisfy or your money back.

MAIL THIS COUPON TODAY

RADIO SHACK Corp. Dept. 61K6
730 Commonwealth Ave., Boston 17, Massachusetts

Please send me Radio Shack's new 1962 Electronics Catalog and every new issue for the next 12 months—all FREE and POSTPAID.

Name _____
Address _____
City & Zone _____ State _____

STEREO/Hi-Fi



New Deluxe Stereo Preamplifier
15 pushbutton-selected inputs; two sets of controls.
Kit AA-11, 19 lbs....\$84.95



Low Cost AM/FM Tuner
Has multiplex output jack, two tuning "eyes", adjustable AFC.
Kit AJ-11, 19 lbs....\$69.95



Hi-Fi Rated 14 watt Amplifier
Mono. amplifier and preamp. 3 inputs; Heath Ultra-Linear. ©
Kit AA-161, 15 lbs....\$33.54

HEATHKIT®

the only

GENERAL



Superhet. CB "Walkie-Talkie"
9 transistor crystal-controlled superhet. with RF stage; 1 uv sensitivity; squelch & noise limiter.
Kit GW-21, 3 lbs.\$44.95



Short Wave Radio
4 bands, 550kc-30mc; lighted dial & meter; circuit board.
Kit GR-91, 9 lbs....\$39.95



Telephone Amplifier
Hands-free phone calls; all-transistor; battery powered.
Kit GD-71, 2 lbs....\$19.95

EDUCATIONAL



Two-Part Basic Radio Course
each with authoritative textbook and parts for receiver.
EK-2A & 2B, 6 lbs. ea. \$19.95



VTVM Applications Course
First of a series; includes textbook & experiment parts.
EF-1, 3 lbs.....\$8.95



Educational Analog Computer
Ideal for school or industry; 9 amplifiers, complete manual.
Kit EC-1, 43 lbs....\$199.95

MARINE



3-Band RDF
10 transistor, 1 diode; covers Beacon, Consolan, Broadcast, Marine.
Kit MR-11, 12 lbs...\$109.95



Low Cost Depth Sounder
All-transistor, battery powered; depth 0-100'; transducer inc.
Kit MI-10, 9 lbs....\$69.95



Power Converter
Converts 6 or 12 v. battery power to 117 VAC; switched; fused.
Kit MP-10, 7 lbs....\$29.95

AMATEUR



7 Band VFO
Covers 80 thru 2 meters; vernier, regulated, isolated; xmtr powered.
Kit HG-10, 12 lbs....\$34.95



50 watt CW Transmitter
80-10 meters; low pass filter; single switch station control.
Kit HX-11, 17 lbs....\$43.50



"Tunnel Dipper"
Exclusive tunnel-diode osc.; works like grid-dip; 2.7-270mc.
Kit HM-10, 3 lbs....\$34.95

TEST & LAB.



AC VTVM
10 ranges, .01-300v.; response 10 cps-500kc; 10 megohm input.
Kit IM-21, 4 lbs....\$33.95



General Purpose 3" Scope
Push-pull amps; sweep 20 to 100,000 cps; sensitivity .25v.
Kit IO-21, 14 lbs....\$49.95



Deluxe Capacitor Checker
Direct reading; check all types completely, plus R and L.
Kit IT-11, 7 lbs....\$29.95

▶ TOP VALUE

Value is a relative thing. In electronic kits it relates to quality of design, components, ease of assembly, performance and price. Heathkit is world-famous as the value standard.

▶ BEST QUALITY

Quality begins with design and continues through performance. Heathkit engineering reflects our greater experience and no-compromise quality components. Result: quality performance.

▶ EASIEST TO ASSEMBLE

Millions of satisfied Heath customers attest to the superiority of Heathkit construction manuals . . . so easy to follow, so complete that we guarantee you can build any Heathkit!

▶ LOW PRICES

The Heathkit goal: to produce the highest quality kits at the lowest possible prices. Our devotion to this goal keeps Heathkit the world leader . . . the name you can trust for value.



complete line of Electronic kits!

OVER 250 KITS FOR EVERY NEED!

▶ WORLD'S LARGEST MFR.

of electronic kits. Since 1927, Heath has been producing do-it-yourself equipment. Today, the Heathkit line includes over 250 different kits for your every need, interest and budget.

▶ NEW GUARANTEE

We guarantee you can build any Heathkit! This money-back Heathkit guarantee, unprecedented in the kit industry, is made possible by our millions of satisfied customers who have proved that building a Heathkit requires no special background, experience, skills or training! Now, regardless of your mechanical ability or experience, you too can enjoy the immense satisfaction of creating with your own hands an electronic product that performs like the factory built models . . . you too can enjoy the great savings of Heath "do-it-yourself" kits.

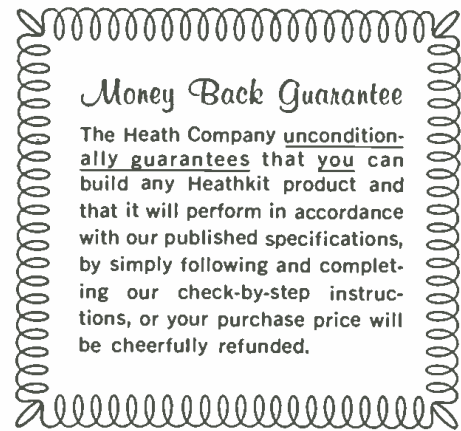

Money Back Guarantee

The Heath Company unconditionally guarantees that you can build any Heathkit product and that it will perform in accordance with our published specifications, by simply following and completing our check-by-step instructions, or your purchase price will be cheerfully refunded.

▶ NO DOWN PAYMENTS

It's easiest to buy Heathkit! No-money-down terms on your Heathkit order of \$25 to \$600! Take as long as 18 months to pay . . . reasonable carrying charges. Details in our '62 Catalog. These new, relaxed terms, coupled with our guarantee that you can build any Heathkit, are your assurance of complete satisfaction.



Send... FOR THIS NEW
100 PAGE CATALOG...
OVER 250 KITS

Free

1962 Heathkit Catalog. The world's biggest kit catalog . . . big new size, big photos, complete descriptions, specifications, schematics.

Details over 250 exclusive kits available only from Heath. We'll be glad to send your friends free copies too!

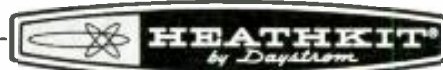

HEATH COMPANY

Benton Harbor 15, Michigan

Send FREE 1962 Heathkit 100 page Catalog

Name _____

Address _____

City _____ Zone _____ State _____



try triton tape

If the quality of Triton Magnetic Recording Tape is deficient for any reason whatsoever, we will replace it with whatever brand you prefer. A complete no-risk Guarantee Certificate is included with every reel. For clean, full-response recordings that only a quality tape can give, try Triton.

Write for your free copy of *The Triton Story*.



triton

TRITON ELECTRONICS, INC., DEPT. EW-10
62-05 30th Avenue, Woodside 77, N. Y.

Super-Power U.H.F. Tubes

(Continued from page 37)

shown on the cover, and require no neutralization in grounded-grid operation. The structural elements are arranged for r.f. operation in the fundamental coaxial mode with a voltage maximum occurring at the center of the electronically active portion of the tube. Such an arrangement permits double-ended operation with portions of two adjacent r.f. quarter-wavelengths in the active region of the tube. The double-ended arrangement provides twice as much plate current from a given peak-drive voltage, and power output may be as much as four times that obtained from a single-ended tube with the same load resistance. The d.c. supply voltage would have to be increased accordingly.

Double-ended construction also permits the tube structure to be considerably longer physically for a given operating frequency. Consequently, increased area is available for dissipation of d.c. power that is not converted to r.f. power, and structural limitations are less severe than those imposed by the compactness required for a single-ended device. In addition, a more rugged structure can be achieved by avoiding the cantilever support of tube elements so common in single-ended power tubes.

Applications

At present, these new super-power u.h.f. amplifier tubes are being used in seven types of government end-use equipment, including most of the types listed in the first paragraph. All of these applications use external-cavity circuits that were successfully designed by the equipment manufacturers. Careful cavity-circuit design to reduce voltage gradients and to locate spurious modes outside of the operating-frequency region has resulted in reliable operation at power outputs of 5,000,000 watts. Although it is premature for reports of extremely long life, one tube has already accumulated 6000 hours of service life and another has operated for 4800 hours.

Acknowledgements

Much of the tube development work described was done under the sponsorship of the Air Force. The Air Research and Development Command of the Rome Air Development Center contracted originally with RCA to engage in an electron-tube development program that produced the new design concept. Subsequent Air Force-sponsored programs for the device resulted in the commercial RCA-7835 and RCA-2054. Much of the credit for these developments should be given to the team efforts of numerous other engineers and technical specialists at RCA.

REFERENCES

1. Vennard, J. K.: "Fluid Mechanics," 1947, p. 126.
2. Hoover, M. V.: "Advances in the Techniques and Applications of Very-High-Power Grid-Controlled Tubes," *Proceedings of International Convention on Microwave Valves*, May, 1958.

KEEP CANDEE HANDEE!

R-19 ARC AIRCRAFT RECEIVER
28 V. 118-118 Mc. Mfg. by ARC—so it's tops!
Excellent cond. Removed from aircraft.
WITH DYNAMOTOR \$59.95
WITHOUT DYNAMOTOR \$49.95

R-22 ARC RECEIVER
Ideal for light plane user. Manufactured by
ARC. Excellent condition 28V.
340-1600 K C \$49.95

NAVIGATION Special!
TYPE AN/ARN-6 RADIO COMPASS
RECEIVER: R-101/ARN-6. Excellent
cond. \$99.95
LOOP: AS 413-B. Excellent cond. Only 37.50
INDICATOR: ID 91B ARN-6. Excellent
cond. 9.95
MOUNTS: MT-273 or MT-274. Excellent.
Each 14.95
Cords and Connectors also available.

APN-1 FM TRANSCEIVER
420-460 Mc. Compl. with tubes. Exc. Ea. \$2.95
Approx. shp. wt. per unit 25 lbs. **TWO** for 5.00

APX-6 TRANSFORMER
A midwest warehouse of parts! Blowers, three
Vanderbilt rotors, I.F. strips, cavity, over 30
tubes, etc. Includes 3E29 tube. Good \$9.95
cond. A STEAL AT ONLY
Conversion Manual Weight 40 lbs. \$1.50

R-4A/ARR-2 RECEIVER
234-258 Mc. 11 tubes. UHF. tunable receiver. See
Apr 750 C.Q. Magazine for conversion.
Excellent cond. **TWO** for \$5.00. Each \$2.95

YOU GOT IT! WE WANT IT! LET'S DEAL!
We're paying top \$\$\$ for GRC-9; PRC-6
-8, -9, -10; GN-58A. All electronic test
equip. Write us today! What Have You?

COMMAND GEAR
This is the fabulous one! 190-550 kc. The
receiver you've been looking for \$9.95
at only
BC-454: 3-6 Mc. 9.95
BC-455: 4-9.1 Mc. 9.95
MD-7 MODULATOR: Special. 3.95
T-18 ARC-5 Xmitr 3-1.3 mc. Excl. cond. 54.95
T-19 ARC-5 Xmitr 3-1 mc. Excl. cond. 7.95
T-20 ARC-5 Xmitr 4-5.3 mc. Excl. cond. 4.95
T-21 ARC-5 Xmitr 5-9.7 mc. Excl. cond. 4.95

A TRIO OF HEADSET BARGAINS!
MS-23: Hi impedance. Leather covered
headband. Brand new. Great buy. Only \$4.95
MS-33: Low impedance. Leather cov-
ered headband. Brand new. A. J. J.
Cantone Special. 5.95
Hi Fi Headset: 15,000 cycles! Brand
new with chamois cushions. It's ter-
rific! Only 8.95
CO-307A Headset Extension Cord: Ap-
proximately 5 ft. length. Only 49c

All items FOB Burbank, Calif., subject to
prior sale. In Calif. add 4%. Min. order \$3.95.

J. J. CANDEE CO. Dept. EW
509 No. Victory Blvd., Burbank, Calif.
Phone: Victoria 9-2411

CITIZEN BAND CLASS "D" CRYSTALS



3rd Overtone—Hermetically Sealed
005% tolerance—Meet F C C require-
ments, 1/2 pin spacing—.050 pin di-
ameters, (.093 pins
available, add 15c per
crystal.)

ALL 22 Frequencies
In Stock!
\$2.95 EACH

(Add 5c per crystal for postage and handling)

The following Class "D" Citizen Band frequencies
in stock (frequencies listed in megacycles): 26.965,
26.975, 26.985, 27.005, 27.015, 27.025, 27.035,
27.055, 27.065, 27.075, 27.085, 27.105, 27.115,
27.125, 27.135, 27.155, 27.165, 27.175, 27.185,
27.205, 27.215, 27.225.

Matched crystal sets for all CB units . . . \$5.90 per
set. Specify make and model numbers.

RADIO CONTROL CRYSTALS

in MC6/U HOLDERS—SIX FREQUENCIES
In stock for immediate delivery (frequencies listed in
megacycles tolerance .005%, 1/2 pin spacing,
.050 pin diameter, .1093 pins available, add 15c per
crystal. Specify frequency desired.)
26.995, 27.045, 27.095, 27.145, \$2.95 EACH
27.195, 27.255,
(add 5c per crystal for postage-handling)

NOW! Engineering samples and small quantities for
prototypes now made either at Chicago or at Ft.
Myers Plant, 24 Hour Service!
IN CHICAGO, PHONE Gladstone 3-3555

Send for FREE CRYSTAL CATALOG # 961
WITH OSCILLATOR CIRCUITS

ASK YOUR PARTS DEALER FOR TEXAS CRYSTALS
See big red display . . . If he doesn't stock them,
send us his name and order direct from factory.

Rush your order to:
TEXAS CRYSTALS
Dept. R-81—1000 Crystal Drive, Fort Myers, Fla.
All orders shipped 1st Class Mail.
For faster service phone WE 6-2100

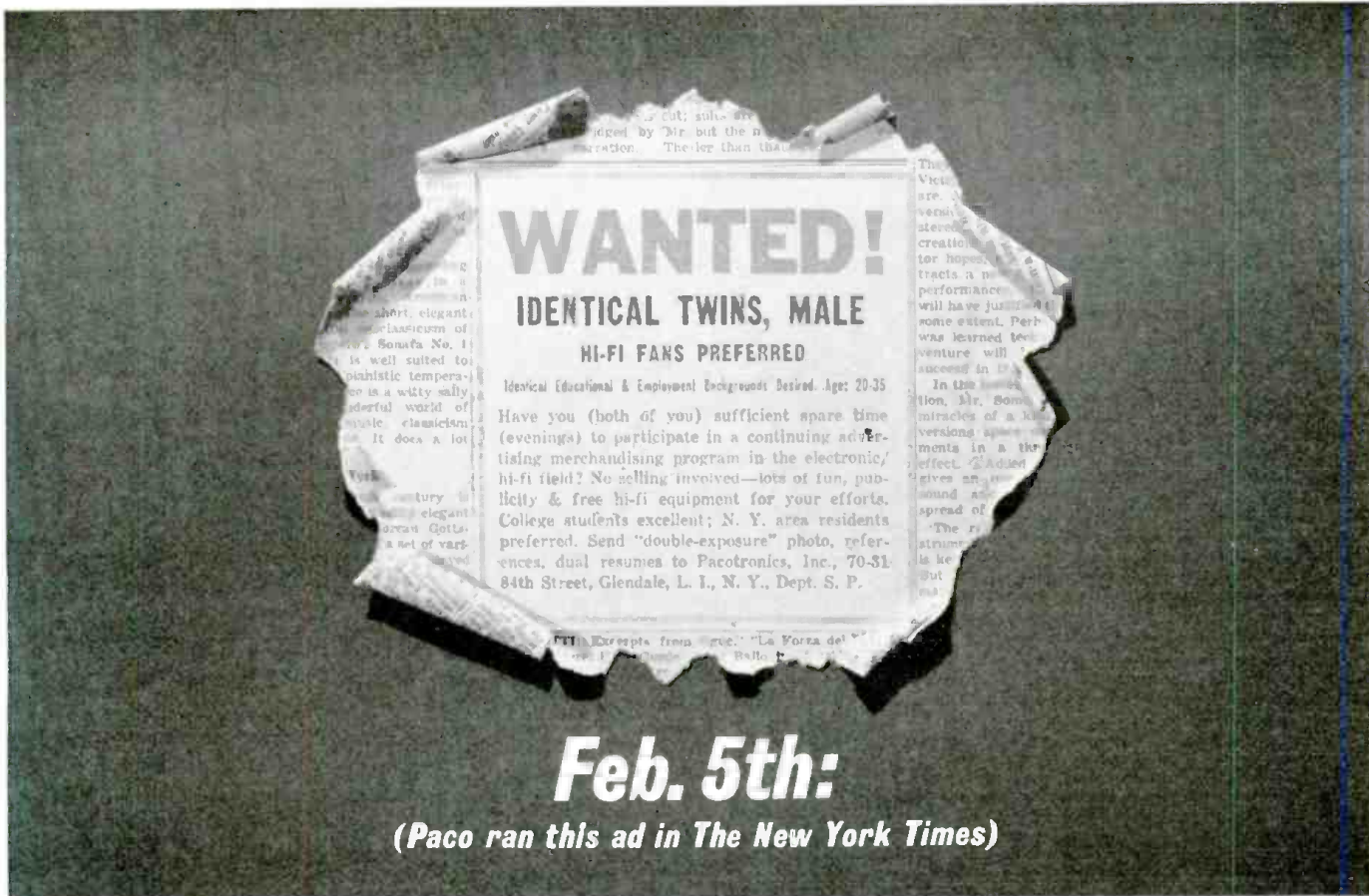

Feb. 5th:

(Paco ran this ad in The New York Times)

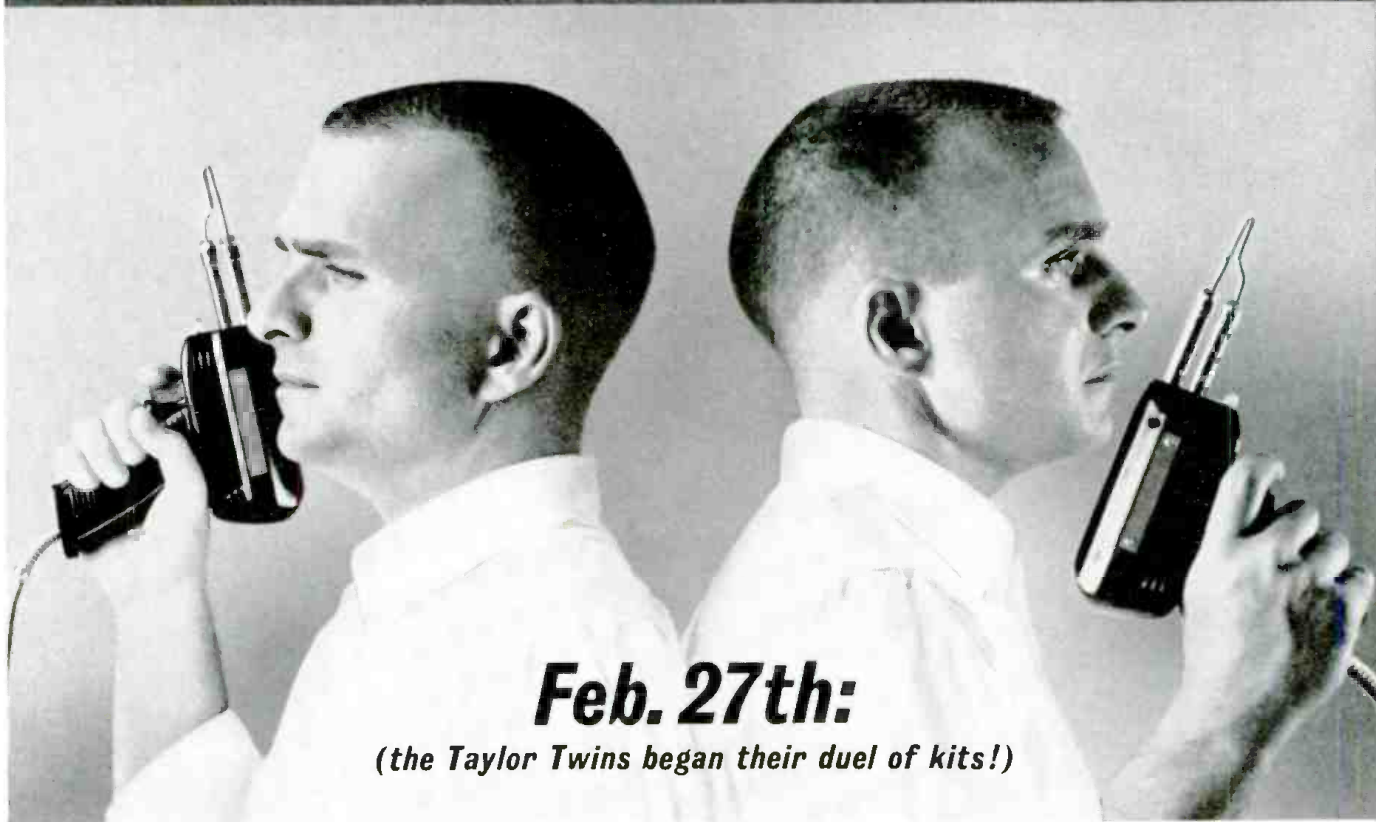

Feb. 27th:

(the Taylor Twins began their duel of kits!)

*Don and Larry Taylor, with twin backgrounds and skills, have competitively built kit after kit, Paco vs. other makes. In one test Don built the Paco, in the next Larry did. Net results: Paco kits proved faster, easier, and better in performance. **For a typical Twin-Test report turn the page.***

HERE ARE JUST A FEW OF
PACO'S NEWEST KITS:



V-70 VACUUM-TUBE VOLTMETER KIT:
Employs balanced vacuum tube bridge circuit for all voltage and resistance measurements plus 3-way probe for accurate, rapid test. Includes: 7 DC voltmeter ranges, 7 AC voltmeter ranges (RMS) from 0 to 1500 volts, and 7 AC voltmeter ranges (peak to peak) from 0 to 4000 volts. Also 7 decibel ranges, -6 to +66 db and 7 electronic ohmmeter ranges from 0.2 ohms to 1000 megohms.
V-70 Kit with "Twin-Tested" operating assembly manual \$31.95 net
V-70W: Factory-wired \$49.95 net

C-25 IN-CIRCUIT CAPACITOR TESTER KIT:
Reveals dried out, shorted, or open electrolytics—in the circuit—with Paco's exclusive Electrolytic Dial.
Simple Sequential Test: reveals open or shorted capacitors, even electrolytics.
Electrolytic Dial: indicates in-circuit capacity from 2 to 400 mfd: condenser is proved non-shorted and not open if capacity reading can be obtained.
Model C-25 Kit: with Paco-detailed operating assembly manual \$19.95 net
Model C-25W: Factory-wired \$29.95 net



SA-40 STEREO PREAMP-AMPLIFIER: Power: 20W (RMS) per channel, 40W total. Peak, 40W with 80W total. Response: 30 cps to 90 Kc, within 1.0 DB. Distortion: within 0.5% at 20W per channel. Includes: 14 inputs and 14 Panel Controls, black and gold case.
SA-40 Kit with enclosure, "Twin-Tested" operating assembly manual \$79.95 net
SA-40W: Factory-wired, ready to operate \$129.95 net
SA-50: Stereo Kit as above with different styling, 25w per channel TBA*



ST-25 FM TUNER: Sensitivity: 1.5 microvolts for 20 DB quieting. Harmonic Distortion: less than 1%. Includes: Dual Limiters, AFC and AFC Defeat, "Eye" type tuning indicator, Multiplex jack. Black and gold case or walnut enclosure at slight extra cost.
ST-25 Kit with fully-wired prealigned front end. "Twin-Tested" manual \$42.95 net
ST-25W: Factory-wired, ready to operate \$59.95 net
ST-26 Tuner-Amplifier Kit: Same as ST-25, with built-in amplifier \$54.95 net
ST-26W Tuner-Amplifier: Factory-wired, ready to operate \$69.95 net



DF-90 TRANSISTORIZED DEPTH FINDER KIT: Protect your boat against shoals and underwater hazards with this compact, easy-to-read depth finder. Locates hard-to-find "schools" of fish, too.
Fully Transistorized: 5 transistors, low battery drain for very long battery life.
Fast, Easy Readings: over-sized scale with 1-ft. calibrations from 0-120 ft.
DF-90 Kit: Complete with "Twin-Tested" assembly operating manual. \$84.50 net
DF-90W: Factory-wired \$135.50 net



G-15 GRID DIP METER: Major Functions:
1-Variable Frequency Oscillator covering 400 Kc up to 250 Mc in 8 bands;
2-Absorption Wavemeter, 400 Kc to 250 Mc;
3-Modulation Indicator. Applications: antenna tuning, standing wave checks, neutralizing, TVI suppression, carrier monitoring, etc: RF signal source for visual alignment marking between 400 Kc and 250 Mc. Weighs only 3 lbs.
G-15 Kit: Complete with 8 plug-in coils, "Twin-Tested" manual \$31.95 net
G-15W: Factory-wired \$39.95 net

©1961, PACOTRONICS, INC. ALL PRICES INCL. F.E.T. *Price to be announced

"I built the Paco SA-40 Stereo Preamp Amplifier."

Larry Taylor, 8 Stevens Place, Huntington Station, N. Y. "It took me one-third less time to build the Paco kit than it took Don to make the almost identical preamp-amplifier by another kit maker. But it wasn't just the time; it was knowing you're using the right part, and that you understand the instructions completely. Paco parts are all pictured and labelled, the resistors are neatly mounted on cards for easy identification. And Paco's instruction book doesn't leave you guessing. The fold-out diagrams and drawings are always right beside the instructions, so you're not reading one part of the book and following a diagram in another part. Photographs in Paco's book show how each assembly should actually look. I enjoyed building Paco kits, because I wasn't wasting time or worrying."



"I built a competing Stereo Preamp Amplifier."

Don Taylor, 39 Cross Street, Smithtown, N. Y. "Neither Larry nor I are speed demons because we're very meticulous about wiring and soldering. So I was even more surprised when it took me 50% more time to finish my kit. My problem began when I tried to separate the parts. The resistors were in boxes, but not in any logical way: identical resistors often wound up in different boxes. The instruction book was clumsy to work from. It caused wasteful mistakes. Once I lost 20 to 25 minutes because I misread a tiny key letter that meant not to solder a certain connection. A lot of the fun of kit-building was lost when I had to spend time making up for shortcomings of the packaging and the instruction manual."



THE PACO KITS YOU WANT ARE AT THESE DISTRIBUTORS:

*Hi-Fidelity Equipment Only †Test Equipment Only

ALABAMA

Aniston Southeastern Radio Parts
Birmingham Forbes Distributing Co., Inc.†
Gadsden Southeastern Radio Parts
Mobile Emrich Radio Supply
Montgomery Southeastern Radio Parts
Selma Southeastern Radio Parts

CALIFORNIA

Bellflower Giant Electronics*
Berkeley Electronic Suppliers
Danoga Park Sandy's Electronic Supply†
Culver City Arrow Sales, Inc.†
Hayward Hayward Electronics†
Hollywood Hollywood Radio & Elec., Inc.†
Inglewood Arrow Sales, Inc.†
Long Beach R. C. & L. F. Hall, Inc.
Los Angeles L. A. Electronic Supply
Millbrae T. V. Radio Wholesaler†
Modesto Inland Electronic Suppliers†
Monterey Monterey Electronic Supply†
Mountainview Ray-Tel Industrial Co.
North Hollywood Arrow Sales, Inc.†
Ontario Distributing Co.†
Palo Alto Peninsula Electronics Supply
Zack Electronics

COLORADO

Denver Electronic Parts Company
CONNECTICUT
Bridgeport Hatry Electronic Enterprises
Hartford Del Padre Supply of Hartford
Hatry Electronic Enterprises
Radio Shack Corporation
Signal-Electronic Center
Scell Electronics
New Britain United Electronics
New Haven American Television, Inc.
Hatry Electronic Enterprises
Radio Shack Corporation
Norwich Aikens Electronic Supply Inc.
Stamford Radio Shack Corporation
Waterbury Hatry Electronic Enterprises
Parts Unlimited Stores
See your classified phone directory

FLORIDA

Daytona Beach Hammond Electr., Inc.
Jacksonville Hammond Electronics, Inc.
Kinkade Radio Supply
Peard Electronic Supply Co.†
Lakeland Hammond Electronics, Inc.
Melbourne Electr. Wholesalers, Inc.
Miami Electronic Equipment Co., Inc.
Electronic Wholesalers, Inc.
Herman Electronics
Orlando Hammond Electronics, Inc.
Tampa Hammond Electronics, Inc.
Kinkade Radio Supply
Thurrow Electronics

GEORGIA

Athens Southeastern Radio Parts
Atlanta Southeastern Radio Parts
Gainesville Southeastern Radio Parts
La Grange Southeastern Radio Parts
Rome Southeastern Radio Parts
Savannah Southeastern Radio Parts

HAWAII

Honolulu Precision Radio Ltd.
ILLINOIS
Champaign Electronic Parts Co.
Chicago Arthur Nagel Inc.
Irving Joseph, Inc.
U. S. Radio & T. V. Supplies
Jacksonville Baptist Electronic Supply†
Joliet Mainline Industrial Supply Co.

INDIANA

Bloomington H. A. Williams Co.
Columbus H. A. Williams Co.
Evansville Hutch & Son, Inc.†
Ohio Valley Sound†
Indianapolis Graham Elec. Supply Inc.
Meunier Electronic Supply Co.
Van Sickle Radio Supply Co.
Lafayette Lafayette Radio Supply
Muncie Muncie Electronic Supply
Richmond H. A. Williams Co.

KANSAS

Kansas City Manhattan Radio & Equip.†
KENTUCKY
Lexington Radio Electronic Equip. Co.
Louisville P. I. Burks Co.

LOUISIANA

Baton Rouge Davis Electronic Supply†
Lake Charles Television Radio Supply†
New Orleans Crescent Radio & Sup. Inc.†
Epcot†
Southern Radio Supply†
Shreveport Koelemay Sales Co., Inc.†

MARYLAND

Baltimore Hi-Fi Shops*
Revaco of Maryland†
Hagerstown Zimmerman Wholesalers
Salisbury Standard Electronics Supply†
Towson Baynesville Electronicist
Wheaton Key Electronics

MASSACHUSETTS

Boston Lafayette Radio Electronics
Radio Shack Corporation
Braintree Radio Shack Corporation
Brockton Tee Vee Supply Co.
Brookline Radio Shack Corporation
Chelsea Lektron, Inc.
Holyoke Kathleen Smith Music Shop Inc.
Jamaica Plain Tee Vee Supply Co.
Lynn Land Electronics Supply Inc.†
Milford Tee Vee Supply Co.
Peabody Tee Vee Supply Co.
Springfield Del Padre Music Shop Inc.
Del Padre Supply of Springfield

MICHIGAN

Battle Creek Electronic Supply Corp.
Dearborn Hi-Fi Studios, Inc.*
Detroit Hi Fidelity Workshop*
Hi-Fi Studios, Inc.
Radio Specialties Co.
Grand Rapids Burma Radio Supply
Grosse Pointe Hi Fidelity Workshop*
Kalamazoo Electronic Supply Corp.
Muskegon Western Elec. Supply Co.†
Pontiac Hi Fidelity Workshop*
Wyandotte Hi Fidelity Workshop*
Radio Specialties Co.

MINNESOTA

Minneapolis Ken Craft Hi-Fi*
St. Paul Electronic Market*

MISSOURI

Joplin Four State Radio Supply†
Kansas City McGee Radio Co.
Manhattan Radio & Equipment Inc.†
St. Louis Deltronics Distributing Co.†
Olive Electronic Supply

MONTANA

Billings Electronic Supply Co.†

NEBRASKA

Omaha Omaha Electronics Co.†
Scotts Bluff Tri State Electronics Inc.

NEW HAMPSHIRE

Concord Evans Radio

NEW JERSEY

Bergenfield Arcco T. V. Parts Corp.*
Hackensack Emco Electronics Inc.*
Morris Plains Park Electronic Corp.
Newark Terminal-Hudson
Lafayette Radio Electronics
North Bergen Arcco T. V. Parts Corp.*
Paramus Lafayette Radio Electronics
Passaic Ed's Electronics Inc.
Plainfield Lafayette Radio Electronics
Princeton Sun Radio & Electronics Co.
Springfield Disco Electronics, Inc.
Westwood Arcco T. V. Parts Corp.*
Parts Unlimited Stores
See your classified phone directory

NEW MEXICO

Albuquerque Electronic Parts Co.†
Yucca Wholesaler†
Los Alamos Valley Engineering Co.

NEW YORK

Albany Greylock Electronics†
Selden Sound, Inc.†
Bayside Snyder Electronic Dists. Inc.*
Binghamton Stack Electronics†
Brooklyn Wital Electronics*
Benay Electronic Distributors
Bronx Adamson Electronic Corp.*
Buhalo Radio Equipment Corp.†
Standard Electronics, Inc.†
East Northport Arena Electronics, Inc.†
Elmont Great Eastern Mills Electronics*
Hempstead Newark & Lewis*
Jamaica Harrison Radio Corp.
Lafayette Radio Electronics
Peerless Radio Dist. Inc.
Kingston Greylock Electronics†
Long Island City Electronics Supply Corp.
Middletown Artec Distributors Inc.†
Certified Electronics Inc.†
Mineola Arrow Electronics Inc.
New Hyde Park Dressner Audio Sales Co.*
New York City Adson Electronics
Arrow Electronics
Consolidated Radio Sales Inc.†
Dale Electronics Co.
Grand Central Radio
Harrison Radio Corp.
Hi Fidelity Center*
Lafayette Radio Electronics
Magic Vue Television Corp.*
Magna Electronics Co.
Sun Radio & Electronics Co.
Terminal-Hudson
Wilmar Distributors Corp.*
Zalytron Tube Corp.
Poughkeepsie Greylock Electronics†
Rochester Rochester Radio Supply Co.
Rome Rome Electronics, Inc.†
Schenectady Grimmers Elec. Parts Sup.
Syracuse L. Gordon Dist. Co.†
Syracuse Radio Supply Co.
Utica Grapac Electronic†
Parts Unlimited Stores
See your classified phone directory

NORTH CAROLINA

Concord Mac Victor Electr. Supply Inc.*

(Continued on next page) →

BUILD A HI-FI MUSIC WALL! Don Brann's new book *How to Build a Hi-Fi Music Wall* gives you step-by-step instructions for building a decorator styled cabinet or an entire music wall. Send 50c and your name and address to: PACOTRONICS, INC., Dept. EW-10 70-31 84th Street, Glendale 27, New York.

PACO DISTRIBUTOR LIST (cont'd.)

- OHIO**
Columbus Whitehead Radio Co.*
Cincinnati United Radio, Inc.
Dayton SrePco Inc.
Toledo Lifetime Electronics
Warren Radio Co.
Warren Valley Electronics*
Youngstown Armies Electronics
- OKLAHOMA**
Oklahoma City Dulaney's†
- PENNSYLVANIA**
Allentown A. A. Peters, Inc.
Charleroi Barno Radio Co.
Erie Mace Electronics
Harrisburg Electronic Wholesalers, Inc.
Radio Distributing Co.
McKeesport Barno Radio Co.
New Brighton Television Parts Co., Inc.
Pittsburgh House of Audio*
Marks Parts Co.†
Metropolitan Distributors, Inc.
Opus One*
Reading George D. Barbey Co.
State College Alvo Electronics Dist. Inc.*
Tarentum Huston TV Parts Co.
Wilkes-Barre General Radio & Elec. Co.
- RHODE ISLAND**
Providence Electronic Distributors, Inc.
Radio Shack Corporation
- SOUTH CAROLINA**
Columbia Hi-Fi Sound & Records Co.*
Southeastern Radio Parts
- SOUTH DAKOTA**
Rapid City Dakota Electronics
- TENNESSEE**
Enattanooga Curle Radio Supply
Columbia Randolph & Williams†
Knoxville Smith Electronics Supply Inc.†
Nashville Electra Distributing Co.*
Randolph & Rice†
- TEXAS**
Abilene R & R Electronics Co.
Amarillo R & R Electronics Co.
Austin Modern Electronics Co.
Service Electronic Supply
Bay City R. C. & L. F. Hall, Inc.
Baytown R. C. & L. F. Hall, Inc.
Beaumont R. C. & L. F. Hall, Inc.
Conroe R. C. & L. F. Hall, Inc.
Corpus Christi Modern Electronics Co.
Wicks Radio Equipment Co.†
Dallas All State Distributors, Inc.†
Crawtree's Wholesale Radio & TV
Denison Denison Radio Supply
Freeport R. C. & L. F. Hall, Inc.
Galveston Electrotex
R. C. & L. F. Hall, Inc.
Houston Electrotex
Gilbert Co.
R. C. & L. F. Hall, Inc.
McAllen Rio Radio Supply Co.†
Midland R & R Electronics Co.
Odessa R & R Electronics Co.
Pasadena R. C. & L. F. Hall, Inc.
San Angelo R & R Electronics Co.
San Antonio Modern Electronics Co.
Radio TV Parts Co.†
Sherman Electronics Supply Inc.
Texas City Electrotex
R. C. & L. F. Hall, Inc.
Wichita Falls R & R Electronics Co.
- UTAH**
Salt Lake City Moore Radio Supply†
- VIRGINIA**
Norfolk Southern Television Corp.†
Richmond Banner Electronics, Inc.†
Industrial Electronic Tube Corp.†
Roanoke Dixie Appliance Co.†
- WASHINGTON**
Seattle Empire Electronic Supply Inc.
Northgate Cameras*
Pacific Electronic Sales Co., Inc.
Radio Products Sales Co., Inc.
Spokane E. M. Johnson Co.
Tacoma Branham Hi-Fi*
Sound Center*
- WASHINGTON, D. C.**
Elec. Wholesalers, Inc.
Rucker Electronic Products Inc.
Arlington, Va. Key Electronics
Rucker Electronic Products Inc.
College Park, Md. Rucker Elec. Prod. Inc.
Silver Spring, Md. Kenyon Elec. Corp.†
Rucker Electronic Products Inc.
Silver Spring Electronic Supply
- WISCONSIN**
Milwaukee Acme Radio Supply
West Allis Hi-Fi Salon*
- WEST VIRGINIA**
Beckley Chemcity Electronic Dist. Inc.†
- EXPORT:**
Morhan Exporting Corp., New York, N. Y.
- CANADA:**
Atlas Radio Corp., Toronto, Ontario
*Hi-Fidelity Equipment Only
†Test Equipment Only



For free illustrated PACO catalog write:
Paco Electronics, Dept. EW-10
70-31 84th Street, Glendale 27, N. Y.
A subsidiary of PACOTRONICS, INC.

Within the Industry

W. F. WELLS has been appointed senior vice-president and general manager of



Midwestern Instruments, Inc., joining the firm from *General Electric Company* where he had served as manager of manufacturing engineering in the Phoenix plant since 1957.

In his new post, Mr. Wells will exercise administrative control over the firm's engineering, manufacturing, and marketing functions. He holds a B.S. in mechanical engineering and took graduate work in advanced marketing at Harvard Business School.

RAYTHEON recently dedicated a 116,500-square-foot semiconductor plant in Lewiston, Maine which will eventually employ approximately 1500 persons in the production of high-reliability transistors. . . . **E. F. JOHNSON COMPANY** has opened a new general-office and manufacturing facility at 10th Avenue, Southwest in Waseca, Minnesota. . . . **MOTOROLA's** Semiconductor Products Division has added 315,000 square feet to its manufacturing facilities in Phoenix, Ariz., which more than doubles the size of the present plant. . . . **HEATH COMPANY** is building a 70,000-square-foot addition to its plant on Hilltop Road in St. Joseph, Mich. Completion is scheduled for October 1st. . . . **FILTORS, INC.** has purchased a 22-acre industrial site in Huntington, Long Island and will begin construction of a 61,700-square-foot plant which is scheduled to go into operation early next year.

ROBERT E. LEARNED has been promoted to the new post of production manager for diodes at *Motorola's* Semiconductor Products Division in Phoenix, Arizona.



Previously, he had been chief electrical engineer for diode products manufactured by the company. In his new position he will be responsible for diode and rectifier production and final testing.

Mr. Learned joined the firm in 1957. He is a 1952 engineering graduate of the Colorado School of Mines.

BERNE N. FISHER has been named president of *Gonset Division*, West Coast manufacturer of amateur radio equipment and mobile radio for CB and business applications. He was formerly vice-

president of *Telecomputing, Inc.*

RAY F. SPARROW, executive vice-president of *P. R. Mallory & Co. Inc.*, died recently at the age of 63. He was an early pioneer in the electronics industry, joining *Mallory* in 1929. He was also active in EIA affairs. . . . **FRANK N. KIRBY** has been named engineering manager for the Riverdale, Md. plant of *ACF Electronics Division*. He was formerly with *Raytheon*. . . . **JOHN E. O'HANLON** is the new national sales manager of *Fanon Transistor Corporation*. . . . *Paco Electronics, Inc.* has named **SIDNEY SOLOMON** to the post of sales manager of *Paco Electronics Company, Inc.*, its electronic kit manufacturing subsidiary. . . . **FRANK A. COMERCI** has joined the staff of *CBS Laboratories* as manager of the Magnetics Research Department. He will make his headquarters at the Stamford, Conn. plant. . . . *Triad Transformer Corp.* has appointed **JEANN C. NIELSEN** to the post of sales promotion manager. She joins the firm from the *ITT* Distributor Division where she headed the advertising department.

THOMAS A. BRENDL has been appointed to the new position of manager of electronic development at the Instrument Division of *American Optical Company*.



A native of Green Lane, Pa., Mr. Brendel was graduated in 1942 from Carnegie Institute of Technology. He was an engineer with *Western Electric* from 1943 through 1949 and subsequently served in various engineering posts with *Blaw-Knox*, *Westinghouse*, and *Curtiss-Wright*.

L. BERKLEY DAVIS, vice-president of *General Electric* and general manager of the firm's electronic components division, has been re-elected president of the Electronic Industries Association, Washington, D.C.

He will serve his second one-year term as head of the national association of electronic manufacturers. Serving with Mr. Davis will be Leslie F. Muter, president of *The Muter Co.*, who was re-elected to his 26th term as treasurer; James D. Secrest, re-named executive vice-president for the 12th successive year; and John B. Olverson, re-elected general counsel.

Heading the various divisions within the association are: George W. Keown, vice-president of *Tung-Sol Electric Inc.*; Robert S. Bell, president of *Packard Bell Electronics Corp.*; Sidney R. Curtis,

senior vice-president of *General Dynamics/Electronics*; Ben Adler, president of *Adler Electronics, Inc.*; and W. S. Parsons, president of *Centralab*, Division of *Globe-Union, Inc.*

New directors named were: L. M. Sandwick, vice-president of *Pilot Radio Corp.* and G. B. Mallory, president of *P. R. Mallory & Co., Inc.*

EUGENE DANIEL POWER has been elected president and a director of *Components Corp. of America*, replacing Russell Maguire who has been president since 1939.



The new president began his career as an attorney in New York in 1936 and in 1940 joined *Auto-Ordnance Corp.* as executive vice-president. In 1951 he took over management of *Components Corp. of America*, then known as *Maguire Industries*.

He is a graduate of St. John's University where he received his Bachelor of Laws degree in 1935 and a Master of Laws degree in 1936.

BENDIX CORPORATION has established a separate semiconductor operation with headquarters in a new multi-million-dollar plant at Holmdel, New Jersey . . .

CAMBRIDGE SCIENTIFIC INDUSTRIES, INC. has been established in Cambridge, Maryland to design and manufacture electromechanical devices for the electronic and aircraft industries . . . The formation of **MULTIPLEX CORP.** to develop and produce radios capable of receiving multiplex has been announced. The new corporation, a wholly owned subsidiary of **AUTOMATIC RADIO MFG. CO., INC.**, will have headquarters at 122 Brookline Ave., Boston . . .

SEG ELECTRONICS CO. of Brooklyn has acquired **SOLAR ELECTRONICS CORP.** for an undisclosed sum. Operations of the new subsidiary are being transferred to 12 Hinsdale Street, Brooklyn, headquarters of the parent company . . . **ESTEY ELECTRONICS, INC.**, of Torrance, California has merged with **ORGAN CORPORATION OF AMERICA** of West Hempstead, New York. The surviving corporation will be known as **ESTEY ELECTRONICS, INC.** . . .

CBS ELECTRONICS has announced that it will discontinue its receiving tube operations in Danvers and Newburyport, Mass. **RAYTHEON**, which will purchase part of the remaining tube inventory, plans to offer sales and service of these products to CBS customers . . . **UNITED COMPONENTS, INC. OF NEW ENGLAND** has been organized in Worcester, Mass. to expand the parent firm's line of semiconductors. Corporate headquarters are in Orange, N.J. . . .

MELPAR, INC. has acquired **TELEVISION ASSOCIATES, INC.** and its wholly owned subsidiary, **TELEVISION ASSOCIATES OF INDIANA, INC.**, both located in Michigan City, Ind. . . . **RODNEY D. CHIPP & ASSOCIATES**, a consulting engineering firm with headquarters at 15 Ward Street, Bloomfield, N.J., has been established by Rodney D. Chipp, former engineering executive at **ITT**. ▲



COMMAIRE PT 27... world's first long range portable self-powered, two-way CB radio with AM receiver!

Totally new—and another first from Commaire! Don't confuse the Commaire PT-27 with ordinary-range, "line-of-sight" portable units. Here's an extraordinary, fully professional 4-channel long-range Citizens Band two-way radio, plus an outstanding built-in AM receiver. The entire unit is completely portable—and self-powered! There's never been a unit like it. Commaire PT-27 requires no costly installation. Goes anywhere. Works anywhere.

CHECK THESE EXCITING FEATURES:

Full-range two-way radio on the 11 meter Citizens Band that gives accurate, sensitive performance . . . up to 5 miles with portable antenna . . . still much greater range with full-size antenna.

Built-in AM receiver to keep you in touch with news, weather and entertainment.

Portable—and self-powered. Use anywhere on boats, in cars or business. No installation needed.

18 Transistors plus 2 tubes in transmitter section for greater stability.

Power output: 1/2 watt on transmit.

4 fixed channels—tunable receiver.

Receiver (double conversion super-heterodyne) sensitivity is 0.1 microvolts; selectivity is 40 db down at ± 10 KC.

Built-in battery box, charger, antenna, microphone and crystal for one channel.

Measurements: Only 11" long x 4" wide x 9" high.

10 controls for convenient, simple operation.

Model PT-27—\$250.00 each, list. Write for descriptive brochure.

COMPLETE COMMUNICATIONS SYSTEM

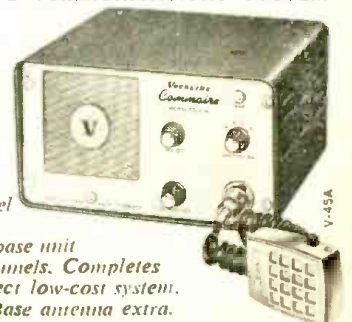

Also Model **ED-27M**, powerful base unit with 4 channels. Completes your perfect low-cost system. \$189.50. Base antenna extra.

VOCALINE COMPANY OF AMERICA, INC. OLD SAYBROOK, CONNECTICUT

EXAMINE ANY OF THESE TESTERS BEFORE YOU BUY!!

Yes, we offer to ship at our risk
one or more of the testers
described on these pages.

SUPERIOR'S NEW MODEL 770-A

VOLT-OHM MILLIAMMETER



FEATURES:

- Compact—measures 3 1/8" x 5 7/8" x 2 1/4".
- Uses "Full View" 2% accurate 850 Microampere D'Arsonval type meter
- Housed in round-cornered, molded case.

SPECIFICATIONS:

- 6 A.C. VOLTAGE RANGES: 0-15/30/150/300/1500/3000 Volts.
- 6 D.C. VOLTAGE RANGES: 0-7.5/15/75/150/750/1500 Volts.
- 2 RESISTANCE RANGES: 0-10,000 Ohms, 0-1 Megohm.
- 3 D.C. CURRENT RANGES: 0-15/150 Ma., 0-1.5 Amps.
- 3 DECIBEL RANGES: -6 db to +18 db, +14 db to +38 db, +34 db to +58 db.

The Model 770-A comes complete with test leads and operating instructions. Price is \$15.85. Terms: \$3.85 after 10 day trial then \$4.00 monthly for 3 months.

SUPERIOR'S NEW MODEL 77

VACUUM TUBE VOLTMETER

WITH NEW 6" FULL VIEW METER

Compare it to any peak-to-peak V.T.V.M. made by any other manufacturer at any price!



SPECIFICATIONS:

- DC VOLTS—0 to 3/15/75/150/300/750/1500 volts at 11 megohms input resistance.
- AC VOLTS (RMS)—0 to 3/15/75/150/300/750/1500 volts.
- AC VOLTS (Peak to Peak)—0 to 8/40/200/400/800/2000 volts.
- ELECTRONIC OHMMETER—0 to 1000 ohms/10,000 ohms/100,000 ohms/1 megohm/10 megohms/100 megohms/1,000 megohms.
- DECIBELS—10 db to +18 db, +10 db to +38 db, +30 db to +58 db. All based on 0 db = .006 watts (6 mw) into a 500 ohm line (1.73v).
- ZERO CENTER METER—For discriminator alignment with full scale range of 0 to 1.5/7.5/37.5/75/150/375/750 volts at 11 megohms input resistance.

Model 77 comes complete with operating instructions, probe and test leads and carrying case. Price is \$42.50. Terms: \$12.50 after 10 day trial then \$6.00 monthly for 5 months.

SUPERIOR'S NEW MODEL 70 UTILITY TESTER

FOR REPAIRING ALL ELECTRICAL APPLIANCES MOTORS * AUTOMOBILES



INCLUDED FREE
64 Page condensed course in electricity. Profusely illustrated. Written in simple, easy-to-understand style.

As an electrical trouble shooter the Model 70:

- Will test: Toasters, Irons, Broilers, Heating Pads, Clocks, Fans, Vacuum Cleaners, Refrigerators, Lamps, Fluorescents, Switches, Thermostats, etc.
- Measures A.C. and D.C. Voltages, A.C. and D.C. Current, Resistances, Leakage, etc.
- Incorporates a sensitive direct-reading resistance range which will measure all resistances commonly used in electrical appliances, motors, etc.
- Leakage detecting circuit will indicate continuity from zero ohms to 5 megohms (5,000,000 ohms).

As an Automotive Tester the Model 70 will test:

- Both 6 Volt and 12 Volt Storage Batteries • Generators • Starters • Distributors • Ignition Coils • Regulators • Relays • Circuit Breakers • Cigarette Lighters • Stop Lights • Condensers • Directional Signal Systems • All Lamps and Bulbs • Fuses • Heating Systems • Horns • Also will locate poor grounds, breaks in wiring, poor connections, etc.

Model 70 comes complete with 64 page book and test leads. Price is \$15.85. Terms: \$3.85 after 10 day trial then \$4.00 monthly for 3 months.

SUPERIOR'S NEW MODEL 79

SUPER-METER

WITH NEW 6" FULL VIEW METER

SPECIFICATIONS:

- D.C. VOLTS: 0 to 7.5/15/75/150/750/1,500.
- A.C. VOLTS: 0 to 15/30/150/300/1,500/3,000.
- D.C. CURRENT: 0 to 1.5/15/150 Ma. 0 to 1.5/15 Amperes.
- RESISTANCE: 0 to 1,000/100,000 Ohms. 0 to 10 Megohms.
- CAPACITY: .001 to 1 Mfd. 1 to 50 Mfd.
- REACTANCE: 50 to 2,500 Ohms, 2,500 Ohms to 2.5 Megohms.
- INDUCTANCE: .15 to 7 Henries. 7 to 7,000 Henries.
- DECIBELS: -6 to +18, +14 to +38, +34 to +58.



The following components are all tested for QUALITY at appropriate test potentials. Two separate BAD-GOOD scales on the meter are used for direct readings.

All Electrolytic Condensers from 1 MPD to 1000 MPD.
All Selenium Rectifiers. All Germanium Diodes.
All Silicon Rectifiers. All Silicon Diodes.

Model 79 comes complete with operating instructions, test leads and carrying case. Price is \$38.50. Terms: \$8.50 after 10 day trial then \$6.00 monthly for 3 months.

SUPERIOR'S NEW MODEL 80

20,000 OHMS PER VOLT ALLMETER

6 INCH FULL-VIEW METER provides large easy-to-read calibrations. No squinting or guessing when you use Model 80.

MIRRORED SCALE permits fine accurate measurements where fractional readings are important.

SPECIFICATIONS:

- 7 D.C. VOLTAGE RANGES: (At a sensitivity of 20,000 Ohms per Volt) 0 to 15/75/150/300/750/1500/7500 Volts.
- 6 A.C. VOLTAGE RANGES: (At a sensitivity of 5,000 Ohms per Volt) 0 to 15/75/150/300/750/1500 Volts.
- 3 RESISTANCE RANGES: 0 to 2,000/200,000 Ohms. 0-20 Megohms.
- 2 CAPACITY RANGES: .00025 Mfd. to 3 Mfd., .05 Mfd. to 30 Mfd.
- D.C. CURRENT RANGES: 0-7.5 Microamperes, 0 to 7.5/75/750 Milli-amperes, 0 to 15 Amperes.
- 3 DECIBEL RANGES: -6 db to +18 db, +14 db to +38 db, +34 db to +58 db.

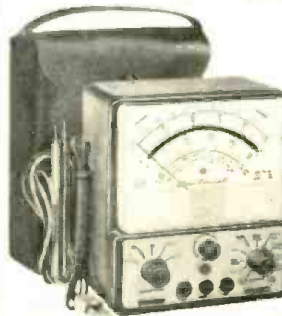

NOTE: The line cord is used only for capacity measurements. Resistance ranges operate on self-contained batteries.

Model 80 Allmeter comes complete with operating instructions, test leads and portable carrying case. Price is \$42.50. Terms: \$12.50 after 10 day trial then \$6.00 monthly for 5 months.

DID YOU EVER?

- ▶ Order merchandise by mail, including deposit or payment in full, then wait and write...wait and write?
- ▶ Purchase anything on time and sign a lengthy complex contract written in small difficult-to-read type?
- ▶ Purchase an item by mail or in a retail store then experience frustrating delay and red tape when you applied for a refund?

Obviously prompt shipment and attention to orders is an essential requirement in our business... We ship at our risk!

SHIPPED ON APPROVAL NO MONEY WITH ORDER - NO C.O.D.

We invite you to try before you buy any of the models described on these pages. If after a 10 day trial you are completely satisfied and decide to keep the Tester, you need send us only the down payment and agree to pay the balance due at the monthly indicated rate.

NO INTEREST OR FINANCE CHARGES ADDED!

If not completely satisfied, you are privileged to return the Tester to us, cancelling any further obligation.

*Send this
Air Mail
Card
Today!*

(NO POSTAGE
NECESSARY)

MOSS ELECTRONIC, INC.
Dept. D-909, 3849 Tenth Ave.
New York 34, N.Y.

Please send me the units checked on approval. If completely satisfied I will pay on the terms specified with no interest or finance charges added. Otherwise, I will return after a 10 day trial positively cancelling all further obligations.

Name _____

Address _____

City _____ Zone _____

State _____

- Model 370-A Total Price \$15.85
\$3.85 within 10 days. Balance
\$4.00 monthly for 3 months.
- Model 39 Total Price \$38.50
\$8.50 within 10 days. Balance
\$6.00 monthly for 5 months.
- Model 77 Total Price \$42.50
\$12.50 within 10 days. Balance
\$6.00 monthly for 5 months.
- Model 80 Total Price \$42.50
\$12.50 within 10 days. Balance
\$6.00 monthly for 5 months.
- Model TW-41 Total Price \$47.50
\$11.50 within 10 days. Balance
\$6.00 monthly for 6 months.
- Model 83-A Total Price \$38.50
\$8.50 within 10 days. Balance
\$6.00 monthly for 5 months.
- Model 78 Total Price \$15.85
\$3.85 within 10 days. Balance
\$4.00 monthly for 3 months.
- Model 82-A Total Price \$36.50
\$6.50 within 10 days. Balance
\$6.00 monthly for 5 months.
- Model 85 Total Price \$52.50
\$12.50 within 10 days. Balance
\$8.00 monthly for 5 months.
- Model TV-50A Total Price \$47.50
\$11.50 within 10 days. Balance
\$6.00 monthly for 6 months.
- Model 88 Total Price \$38.50
\$8.50 within 10 days. Balance
\$6.00 monthly for 5 months.

All prices net. F.O.B., N. Y. C.

SHIPPED ON APPROVAL NO MONEY WITH ORDER — NO C.O.D.

We invite you to try before you buy any of the models described on these pages. If after a 10 day trial you are completely satisfied and decide to keep the Tester, you need send us only the down payment and agree to pay the balance due at the monthly indicated rate.

NO INTEREST OR FINANCE CHARGES ADDED!

If not completely satisfied, you are privileged to return the Tester to us, cancelling any further obligation.

BUSINESS REPLY CARD

No Postage Stamp Necessary if Mailed in the U. S.

POSTAGE WILL BE PAID BY —

MOSS ELECTRONIC, INC.

3849 TENTH AVENUE

NEW YORK 34, N. Y.

FIRST CLASS

Permit No. 61430

New York, N. Y.

VIA AIR MAIL



*Send this
Air Mail
Card
Today!*

(NO POSTAGE
NECESSARY)

NO

**CONTRACT TO SIGN
CO-MAKERS
EMPLOYER
NOTIFICATION**

The simple order authorization included in this offer is *all* you sign. We ask only that you promise to pay for or return the goods we ship in good faith.

**EXAMINE ANY ITEM YOU SELECT
IN THE PRIVACY OF YOUR OWN HOME**

Then if completely satisfied pay on the interest-free terms plainly specified. When we say interest-free we mean not one penny added for "interest" for "finance" for "credit-checking" or for "carrying charges." The net price of each tester is plainly marked in our ads—that is all you pay except for parcel post or other transportation charges we may prepay.

SUPERIOR'S NEW MODEL 82A
MULTI-SOCKET TYPE

TUBE TESTER

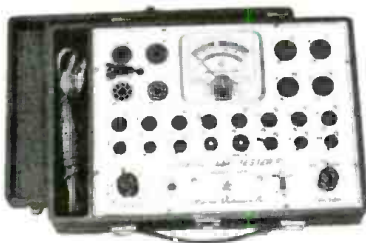

Model 82A comes housed in handsome, portable case. Price is \$36.50. Terms: \$6.50 after 10 day trial then \$6.00 monthly for 5 months.

SPECIFICATIONS:

- Tests over 1000 tube types.
- Tests OZ4 and other gas-filled tubes.
- Employs new 4" meter with sealed air-damping chamber resulting in accurate vibrationless readings.
- Use of 22 sockets permits testing all popular tube types and prevents possible obsolescence.
- Dual Scale meter permits testing of low current tubes.
- 7 and 9 pin straighteners mounted on panel.
- All sections of multi-element tubes tested simultaneously.
- Ultra-sensitive leakage test circuit will indicate leakage up to 5 megohms.

SUPERIOR'S NEW MODEL 83A

C.R.T. TESTER

**Tests and Rejuvenates
ALL PICTURE TUBES**



Model 83-A comes housed in handsome portable Saddle-stitched Texon case—complete with socket for all black and white tubes and all color tubes. Price is \$38.50. Terms: \$8.50 after 10 day trial then \$6.00 monthly for 5 months.

ALL BLACK AND WHITE TUBES
From 50 degree to 110 degree types—
from 8" to 30" types.

ALL COLOR TUBES
Test ALL picture tubes—in the carton
—out of the carton—in the set!

Model 83A provides separate filament operating voltages for the older 6.3 types and the newer 8.4 types.

Model 83A properly tests the red, green and blue sections of color tubes individually—for each section of a color tube contains its own filament, plate, grid and cathode.

Model 83A will detect tubes which are apparently good but require rejuvenation. Such tubes will provide a picture seemingly good but lacking in proper definition, contrast and focus.

Rejuvenation of picture tubes is not simply a matter of applying a high voltage to the filament. Such voltages improperly applied can strip the cathode of the oxide coating essential for proper emission. The Model 83A applies a selective low voltage uniformly to assure increased life with no danger of cathode damage.

SUPERIOR'S NEW MODEL TW-11

STANDARD PROFESSIONAL TUBE TESTER



The Model TW-11 comes housed in a handsome, portable, saddle-stitched Texon case. Price is \$47.50. Terms: \$11.50 after 10 day trial then \$6.00 monthly for 6 months.

- Uses the new self-cleaning Lever Action Switches for individual element testing. Because all elements are numbered according to pin-number in the RMA basic numbering system, the user can instantly identify which element is under test.
- Free-moving built-in roll chart provides complete data for all tubes. All tube listings printed in large-easy-to-read type.
- **NOISE TEST:** Phono-jack on front panel for plugging in either phones or external amplifier will detect microphonic tubes or noise due to faulty elements and loose internal connections.
- **SEPARATE SCALE FOR LOW-CURRENT TUBES**—Previously on emission type tube testers, it has been standard practice to use one scale for all tubes. As a result, the calibration for low-current tubes has been restricted to a small portion of the scale. The extra scale used here greatly simplifies testing of low-current types.

SUPERIOR'S NEW MODEL 85

TRANS-CONDUCTANCE TYPE TUBE TESTER

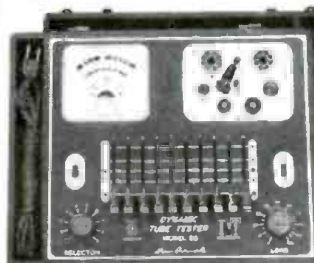

Model 85 comes complete, housed in a handsome portable cabinet with slip-on cover. Price is \$52.50. Terms: \$12.50 after 10 day trial then \$8.00 monthly for 5 months.

- Employs latest improved TRANS-CONDUCTANCE circuit. Test tubes under "dynamic" (simulated) operating conditions. An in-phase signal is impressed on the input section of a tube and the resultant plate current change is measured as a function of tube quality. This provides the most suitable method of simulating the manner in which tubes actually operate in radio, TV receivers, amplifiers and other circuits. Amplification factor, plate resistance and cathode emission are all correlated in one meter reading.

- **SYMBOL REFERENCES:** Model 85 employs time-saving symbols (•, ••, •••, ▲, ■) in place of difficult-to-remember letters previously used. Repeated time-studies proved to us that use of these

scientifically selected symbols speeded up the element switching step. As the tube manufacturers increase the release of new tube types, this time-saving feature becomes necessary and advantageous.

- **"FREE-POINT" LEVER TYPE ELEMENT SWITCH ASSEMBLY** marked according to RETMA basing, permits application of test voltages to any of the elements of a tube.

- **FREE FIVE (5) YEAR CHART DATA SERVICE.** Revised up-to-date subsequent charts will be mailed to all Model 85 purchasers at no charge for a period of five years after date of purchase.

SUPERIOR'S NEW MODEL TV-50A

GENOMETER 7 Signal Generators in One!



The Model TV-50A comes absolutely complete with shielded leads and operating instructions. Price is \$41.50. Terms: \$11.50 after 10 day trial then \$6.00 monthly for 6 months.

- ✓ R.F. Signal Generator for A.M.
- ✓ R.F. Signal Generator for F.M.
- ✓ Audio Frequency Generator
- ✓ Bar Generator
- ✓ Cross Hatch Generator
- ✓ Color Dot Pattern Generator
- ✓ Marker Generator

A versatile all-inclusive GENERATOR which provides ALL the outputs for servicing:

- A.M. Radio • F.M. Radio • Amplifiers
- Black and White TV • Color TV

SUPERIOR'S NEW MODEL 88

TESTS ALL TRANSISTORS AND TRANSISTOR RADIOS



AS A TRANSISTOR TESTER

The Model 88 will test all transistors including NPN and PNP, silicon, germanium and the new gallium arsenide types, without referring to characteristic data sheets. The time-saving advantage of this technique is self-evident. A further benefit of this service is that it will enable you to test new transistors as they are released!

Model 88 comes housed in a handsome portable case. Complete with a set of Clip-on Cables for Transistor Testing; an R.F. Diode Probe for R.F. & I.F. Tracing; an Audio Probe for Amplifier Tracing and a Signal Injector Cable. Complete—nothing else to buy! Price is \$38.50. Terms: \$8.50 after 10 day trial then \$6.00 monthly for 5 months.

AS A TRANSISTOR RADIO TESTER

An R.F. Signal source, modulated by an audio tone is injected into the transistor Receiver from the antenna through the R.F. stage, past the mixer into the I.F. Amplifier and detector stages and on to the audio amplifier. This injected signal is then followed and traced through the receiver by means of a built-in High Gain Transistorized Signal Tracer until the cause of trouble is located and pinpointed.

SEND POSTCARD TODAY

**(NO POSTAGE
NECESSARY)**

Try any of the instruments on this or the facing page for 10 days before you buy. If completely satisfied then send down payment and pay balance as indicated on coupon. No interest or Finance Charges Added! If not completely satisfied return unit to us, no explanation necessary.

MOSS ELECTRONIC, INC., DEPT D-909 3849 TENTH AVENUE, NEW YORK 34, N.Y.



How's Your Frequency

RADIO-TRANSMITTER FREQUENCY, That is ?

A quick check with a tunable receiver in almost any populous area shows lots of activity on the Citizens Band . . . and a surprising proportion of transmitters which are off frequency.

TWO VERY GOOD REASONS FOR HOLDING REQUIRED FREQUENCY TOLERANCE ARE:

1. VOICE QUALITY AND DISTANCE COVERED WILL BE AT MAXIMUM . . . BECAUSE OFF-TUNING DOWNGRADES PERFORMANCE VERY QUICKLY.
2. NO TICKETS FROM THE FCC FOR VIOLATIONS. FCC TOLERANCE FOR CLASS D CITIZENS BAND IS 0.005%.

THE LAMPKIN 105-B FREQUENCY METER IS A NATURAL FOR CITIZENS BAND WORK. ACCURACY IS AMPLE (0.0025%). IT COVERS ALL CHANNELS (CALIBRATIONS FREE WITH NEW METER. ON REQUEST, FOR THE 23 CLASS D CHANNELS) . . . AND WILL OPERATE AS A SIGNAL GENERATOR (FOR ACCURATE RECEIVER ALIGNMENT). THE PRICE IS LOW (\$260.00 NET) AND DELIVERY IS IMMEDIATE! GET ONE YOURSELF—OR HAVE YOUR CB CLUB BUY ONE!

INFORMATIVE BOOKLET ON TWO-WAY RADIO. IT'S FULL OF FACTS AND FIGURES



105-B FREQUENCY METER
Reliable . . . since 1938!

LAMPKIN LABORATORIES, INC.
BRADENTON
FLORIDA

FREE

LAMPKIN LABORATORIES, INC.
MFM Division, Bradenton, Florida

At no obligation to me, please send free booklet and information on Lampkin meters.

Name _____
Address _____
City _____ State _____

BARGAIN HUNTING? **TV SERVICEMEN!**
Write for SENSATIONAL CATALOG
HENSHAW RADIO SUPPLY
3619 TROOST KANSAS CITY, MO.

MAIL ORDER HI-FI
You can now purchase all your HI-FI from one reliable source and be assured of perfect delivery. We deliver most hi-fi components, recorders & tape within 24 hours. SEND US YOUR LIST OF HI-FI REQUIREMENTS FOR OUR WHOLESALE QUOTATION and FREE catalogue. WE WILL NOT BE UNDERSOLD. Write us for proof of this statement.
CARSTON
125-7D E. 88 St. New York 28, N.Y.



MODEL 704 STEREO FM/AM RADIO with Automatic Frequency Control \$49.95* Also available as Model 604 FM Radio \$39.95*

MODEL SC-4 GRANCO FM STEREO COMPANION \$29.95* for use with Models 704 and 604

STEREO FM RADIO

Only Granco brings the magnificent new sound of stereophonic FM radio into your home—today! Fine Granco FM/AM radio with AFC . . . and matching speaker-amplifier Stereo Companion for total listening pleasure never before possible. Hear Granco stereophonic FM radio now—at fine dealers everywhere.

Write for free booklet "THE WONDERFUL WORLD OF STEREO FM"



GRANCO

America's Leading Specialist in Stereophonic FM

DIVISION · DUMONT EMERSON CORPORATION, Dept. E W, 680 FIFTH AVENUE, N.Y. 19

*Suggested list. Prices slightly higher in some areas.

Vertical Antenna Base Insulator

By HOWARD S. PYLE, W7OE

Cheap and effective way to support insulated verticals.

WITH the growing popularity of vertical antennas, 30 to 35 feet high and constructed of 3/4" or 1" water pipe or conduit, a bit of a problem is encountered in providing a satisfactory base insulator at low cost.

The insulator described and illustrated here has been used by the writer for several years and on powers up to 250 watts. There has never been evidence of leakage or mechanical failure. The cost is substantially less than a dollar, the parts were readily procured locally, and the assembly was but a matter of minutes.

The insulator itself is nothing more than a common, glazed porcelain bushing, available from any electrical dealer. The galvanized floor flange and pipe nipple are everyday items in your local hardware or plumbing shop. Fasten the floor flange to the roof or to a stub post set in the ground with wood screws or small lag screws, as you see fit. Screw the pipe nipple into the floor flange, drop the porcelain bushing over the nipple, and set your radiator over the bushing as shown. That does it!

If you are using 3/4" pipe or conduit, get a 3/4" bushing from your electrician. If it's 1/2" or 1" pipe, procure a bushing of appropriate size. Just be sure that the hole in the bushing is of a diameter which will fit the pipe nipple.

Such a base insulator is giving very satisfactory service currently at the writer's station, W7OE, to provide base insulation for a *Gotham V-80* vertical radiator. Such an insulator will, of course, serve just as well on any similar factory-built antenna or a home-made job of similar type. ▲

Here is how an ordinary electrical bushing is utilized as the base insulator for the vertical antenna at the author's ham station. This method has been in use for several years without showing any failure.

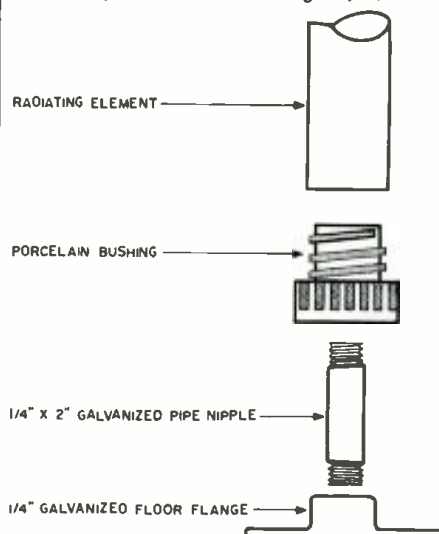

RADIO SHACK Proudly Presents



29 Realistic KITS

GREATEST VALUES IN ELECTRONICS
 Look, perform like factory-wired units at up to 42% less cost
 Exclusive years-ahead designs

Radio Shack's whole new family of audio and test equipment kits employs the most advanced designs and engineering concepts known today! They meet the most exacting requirements in performance and appearance. They're easy and fun to build! Critical areas are pre-wired, factory-aligned. Even a novice can follow the simplified assembly manuals. And they're easy to own on No Money Down credit terms. Every kit backed by a money-back guarantee. We show here six kits newly introduced in our exciting 1962 Catalog.

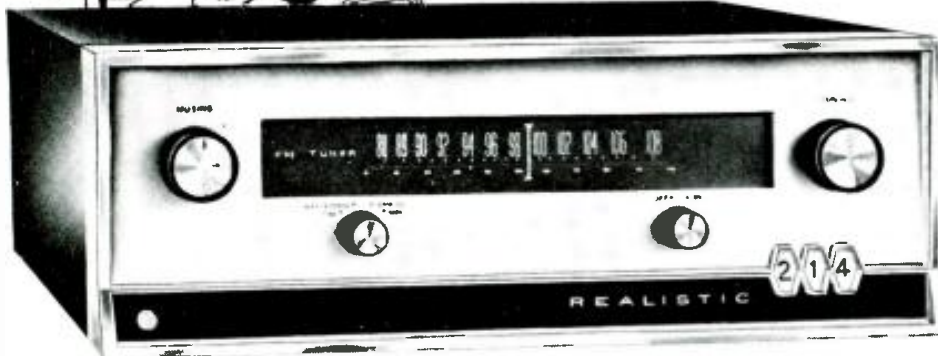

FM Stereo Multiplex Tuner Kit. Highest standards of excellence with deluxe built-in integral multiplex section. It features wide band circuitry for exceptional sensitivity: 2.2 μ V, drift-free selectivity. Frequency response 10-20,000 cps \pm 1 db. 3 I-F stages, 3 limiters. 11 tubes plus rectifier. Muting, tuning, function selector. Tape recorder output. 90LX092—\$149.95

Matching Units—unexcelled anywhere

50-Watt Stereo Amplifier Kit — the powerful, all-transistor HK-208. Unique 18-transistor circuit eliminates hum, noise, output transformers and heat. Absolutely flat -1 db 10-15,000 cps at full power. Truly a breakthrough in semi-conductor stereo design, the only amplifier of its kind in the world! 90LX093 — \$139.95

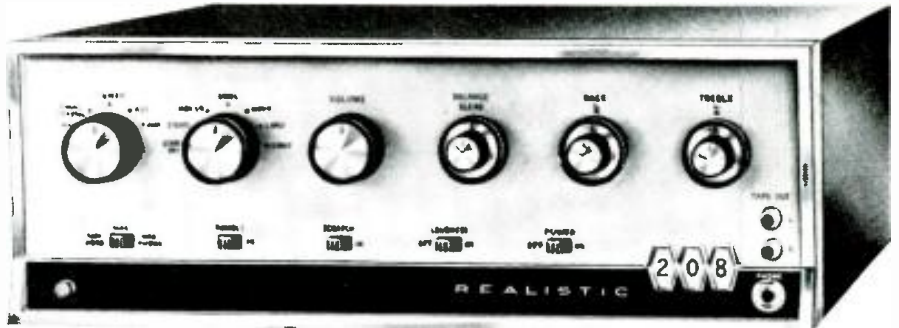

Radio Shack's 1962 Line of Kits Includes All These:

- Stereophonic Preamplifier Kit
- Stereo 140W Basic Amplifier Kit
- 40 Watt Stereo Amplifier Kit
- Complete Stereo System Kits
- Universal Multiplex Adapter Kit
- Hi-Fi 12 Watt Amplifier Kit
- FM Adapter Kit
- Stereo Balance Meter Kit
- Wireless Intercom Kits
- Deluxe Signal Generator Kit
- Deluxe VTVM Kit
- Standard VTVM Kit
- Ultra-Modern Tube Tester Kit
- 500W Variable AC Supply Kit
- VOM Kit with 4 1/2" Meter
- Signal Generator Kit
- AC VTVM Preamplifier Kit
- Electronic Photo Relay Kit
- "Novatherm" Thermometer Kit
- 5-Tube Teakwood Radio Kit
- 2-Transistor Home Radio Kit
- 6-Transistor Portable Radio Kit
- Transistor Experimental Lab Kit

See complete specifications of these fine kits in Free Catalog

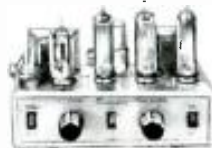

Stereo Amplifier Kit. Terrific value! Converts mono phono to stereo. Easy to build. 90LX079 — \$10.95



The HK204 — Quality FM Tuner Kit. Incredible value! Simple assembly. 90LX070 — \$19.95



Dual Trace Oscilloscope Kit. Flat response from 10 cycles to 3 megacycles. 94LX072 — \$79.95



Tube Tester Kit. Superbly engineered — priced low. For actual, local, 9-7 pin tubes. 94L061 — \$15.95



Send today for **FREE** 1962 Catalog

Gentlemen:

Please send me your giant new 340-page Electronics Catalog of over 100,000 items and every supplement for one year—all FREE and POSTPAID.

Mail coupon to

RADIO SHACK Corp.
 730 Commonwealth Avenue
 Boston 17, Massachusetts

NAME _____
 ADDRESS _____
 CITY _____ ZONE _____
 STATE _____ 61K6D

FAST, DEPENDABLE TUNER REPAIR SERVICE



ALL
MAKES

**ONLY \$8.50 INCLUDING
ALL PARTS and LABOR**
**24-HOUR SERVICE
6-MONTH WARRANTY**
Tuners Repaired on
Approved, Open Accounts

It just makes sense that a manufacturer of tuners should be better-qualified, better-equipped to offer the most dependable tuner repair and overhaul service.

Sarkes Tarzian, Inc., pioneer in the tuner business, maintains a complete, well-equipped Factory Service Dept.—assisted by Engineering personnel—and staffed by specialized technicians who handle ONLY tuner repairs on ALL makes and models.

Tarzian-made tuners received one day will be fixed and shipped out the next. Cost is only \$8.50 and \$15 for UV combinations. That includes ALL parts and labor, and a 6-month guarantee against defective workmanship and parts failure due to normal usage. Replacements available at low cost on tuners beyond practical repair.

Tarzian-made tuners are identified by this stamping. When inquiring about service on other tuners, always give tube complement . . . shaft length . . . filament . . . voltage . . . series or shunt heater . . . IF frequency . . . chassis identification. All tuners repaired on approved, open accounts. Check with your local distributor for Sarkes Tarzian replacement tuners, replacement parts, or repair service.

SERVICE MANAGER • TUNER DIVISION • DEPT. C
SARKES TARZIAN INC.
east hills de dr. • 10005 gr. n. rd ana
ca 92751

TELEPHONE 5 7771
TAPE RECORDER 5 7771

NOW! FAIRCHILD PRESENTS THE NEW

COMPANDER®

FOR THE RECREATION OF ORIGINAL PERFORMANCE DYNAMICS

A new, exciting and completely different development from Fairchild... a product so unusual that we believe every serious audiophile will want to know about the Compander. Briefly, the Compander is an automatic dynamic sensing device that overcomes the controls placed upon both disc and tape recordings and thereby restores the full dynamic range of the original performance. By freeing program material from the usual recording restraints the Compander brings you a giant step closer to the original performance. Accomplished without distortion, the Compander is easily integrated into any monaural or stereo quality component system. The Compander is priced at \$75.00. Write for our fully detailed bulletin.

FAIRCHILD RECORDING EQUIPMENT CORP., 10-40 45th AVE., LONG ISLAND CITY, N.Y.

FREE Catalog of The WORLD'S FINEST GOV'T SURPLUS ELECTRONIC BARGAINS

12—24 Volt CONVERTER

PP-18/AR VIBRATOR POWER SUPPLY—12 Volt DC
Input: 28 Volts DC Output @ 1.5 Amps.

Unit uses a nitrogen-filled vibrator that is hermetically sealed, input and output arc well filtered for hum and hash and ext. interference. Used by Navy and Airforce to operate ARC-5 and Command Receivers, using 24 Volt Dynamos, from 12 volts. Also can be used to operate any 24 Volt device, or Units can be wired in parallel to supply a higher current output. Complete with connecting plugs, spare vibrator and mounting. NEW: \$7.95
Size: 6 1/2 x 5 1/4 x 8 1/2 Wt.: 9 lbs. Price:

SEND FOR CATALOG!

FM EQUIPMENT

BC-603 FM REC.—20—27.9 MC. Re-New: \$18.95
BC-683 FM REC.—27—39.1 MC. Re-New: \$34.95
BC-923 FM REC.—27—39.1 MC. New: \$29.95
BC-604 FM Transmr. 20-27.9 MC. Re-New: \$4.95
BC-684 FM Transmr. 27—39.1 MC. Re-New: \$4.95
Re-New: \$4.95
FT-346 MOUNTING for Receiver only Re-New: \$ 1.95
DM-34 DYN. 12V. 1 BC-603-683-U. Re-New: \$ 1.95
DM-35 DYN. 12V. 1 BC-604-684-U. Re-New: \$ 1.95
AC POWER SUPPLY — F BC-603-683 — Output: 220
VDC 80 MA & 24 VAC 2 Amps. Transformer & Tube
Type. Chassis not hot. Mounts on rear Plug of BC-603-
683. Can be adapted to other Receivers.
KIT: \$10.00 WIRED: \$14.95
BC-620 FM Rec.—Transmr. Re-New: \$14.95
20 to 27.9 MC. Re-New: \$14.95
BC-659 FM Rec.—Transmr. Re-New: \$14.95
27—39.1 MC. Re-New: \$14.95
PE-120 Power Supply for BC-659 or BC-620;
with Vibrator for 12 Volt operation. Re-New: 7.95
BA-41 Bjt. Battery for BC-659-620 New: 3.95
AN-29 Telescoping Antenna F BC-659 New: 2.95
AN-45 Telescoping Antenna F BC-620 New: 1.95

RECEIVERS:

R-23/ARC-5 RECEIVER—100 to 150 MC. U: \$12.95
NAVY ARB/CRV 46151—100 to 150 MC. U: 18.95
R-77/ARC-3 AM REC.—100 to 150 MC. U: 14.95
BC-733 Localizer REC.—100 to 150 MC. U: 4.95
BC-1206 Beacon REC.—200—1000 Kc. R-N: 9.95
BC-652 RECEIVER—2 to 6 MC.—Loss Par. U: 19.95

TRANSMITTERS:

T-17/ARC-5 TRANS.—1 to 2.1 MC. New: \$14.95
T-18/ARC-5 TRANS.—2.1 to 1 MC. New: 8.95
T-19/NAVY TRANS.—3 to 1 MC. Used: 6.95
T-20/ARC-5 TRANS.—4 to 7.1 MC. New: 8.95
T-21/ARC-5 TRANS.—3 to 7 MC. New: 9.95
T-22/ARC-5 TRANS.—7 to 9.1 MC. New: 12.95
T-23/ARC-5 TRANS.—100 to 150 MC. New: 16.95
T-67/ARC-3 TRANS.—100 to 150 MC. Used: 16.95

TELEPHONES, HEADSETS, MIC'S., Etc.:

TS-9 Handset—Used: \$2.95 New: 3.95
TS-13 Handset w/PL-55 & PL-68. U: \$2.95—N: 3.95
T-17 Microphone—New: 6.95
EE-8 Field Telephone—Used: \$12.95 Recond: 14.95
RM-32 Control Unit (Patch Found.) U: \$1.95 N: 2.95
H-16/U Headset—8000 ohm. —New: 3.50

FAIR RADIO SALES

2133 ELIDA RD. • P. O. Box 1105 • LIMA, OHIO

Address Dept. EW • All
Prices F.O.B. Lima, Ohio.
\$5.00 Minimum Order, 25%
Deposit on all C.O.D.'s.

Matching in P.A. Systems

(Continued from page 36)

install as many as 10 lorgnette-type ear-phones for members of the congregation whose hearing is impaired. These ear-phones usually are high-impedance devices—on the order of 2000 ohms. Very little power is required to drive them, approximately 25 milliwatts being sufficient. Considering the case of the church system where a 50-watt amplifier is used to drive four loudspeakers and 10 lorgnette hearing aids, we find that the 2000-ohm impedance of a hearing aid, when connected directly to the 4-ohm output of the amplifier, presents an upward mismatch of 500 to 1. From this it follows that each hearing aid will be driven to 1/500th of the amplifier output—or .1 watt.

As noted previously, this is more than enough to provide a comfortable listening level. Ten such hearing aids, each driven to a .1-watt level, will require a total of only 1 watt from the amplifier. This power is so low that we may disregard it completely in our impedance-matching computations for the four loudspeakers. Adjust the earphone conveniently to the desired level.

Manufacturers of hearing aids also provide a compact box which incorporates a phone jack, potentiometer with knob, and a means for hanging up the hearing aid when not in use. The entire assembly attaches easily to the rear of the pew. The potentiometer (usually 10,000 ohms) permits convenient adjustment of the volume required to suit individual needs.

To simplify installation, all hearing aids should be located in the same section of the church so that a single transmission line may be run from them to the 4-ohm output tap on the amplifier. The transmission line between a suitable amplifier output tap and the several loudspeakers should be routed in any desirable manner; the primary impedance tap values on the line-matching transformers would then be determined without giving any consideration to the fact that the earphones are being used. The wiring diagram for a system of this type is shown in Fig. 15.

Impedance matching by means of transformers and a high-impedance transmission line often entails computations which require some understanding of mathematics. In the concluding article we will review a more widely used technique—the constant-voltage distribution system—which enables even inexperienced sound installers to arrive at a perfect match between amplifier and loudspeaker with speed, accuracy, and confidence—and with recourse only to simple arithmetic.

(Concluded next month)

sound solution

new sound columns reduce acoustic feedback and reverberation to insignificant levels... offer the highest power-handling capacity and widest frequency response in the industry.

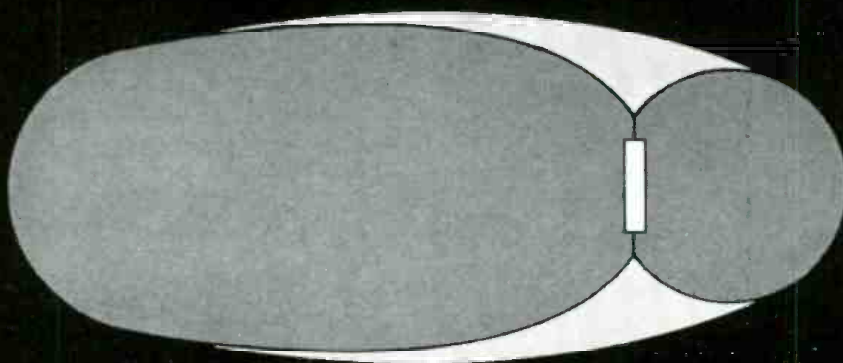

NEW UNIVERSITY UNILINE acoustically-tapered p.a./hi-fi sound columns

BUT FIRST THINGS FIRST. WHAT IS A SOUND COLUMN ?

THEORY: Essentially, a sound column is an in-line radiator using multiple speakers, one above the other, to provide broad horizontal dispersion and narrow vertical dispersion. The shape of the beam is similar to that of a fan held horizontally, its apex representing the source of the sound. As a result of its restricted vertical dispersion pattern, the sound is placed **only where it is needed**, avoiding reflections from the ceiling and floor to reduce acoustic feedback and reverberation.

PRACTICE: Theoretically, all sound columns should perform with equal success—but they don't. What makes the difference? The degree of uniformity of the beam in the upper frequency range. In ordinary sound columns, the higher the frequency, the narrower the beam. Consequently, some means must be provided to reduce excessive high frequency beaming.

Only UNILINE offers acoustic tapering, the most perfect method yet devised for preventing uneven high frequency dispersion! UNILINE reduces acoustic feedback and reverberation to virtual non-existence, thus solving your difficult microphone and speaker placement problems. And only UNILINE offers power-handling capacity up to 150 watts... with frequency response ratings as wide as 35-17,000 cps! (Special voice frequency model available.)

For optimum dispersion at all frequencies, for uniform sound level within the beam, for music and speech, indoors and out... for all high reverberation areas... specifications and performance reveal that there is only one best line of sound columns—it is UNILINE.

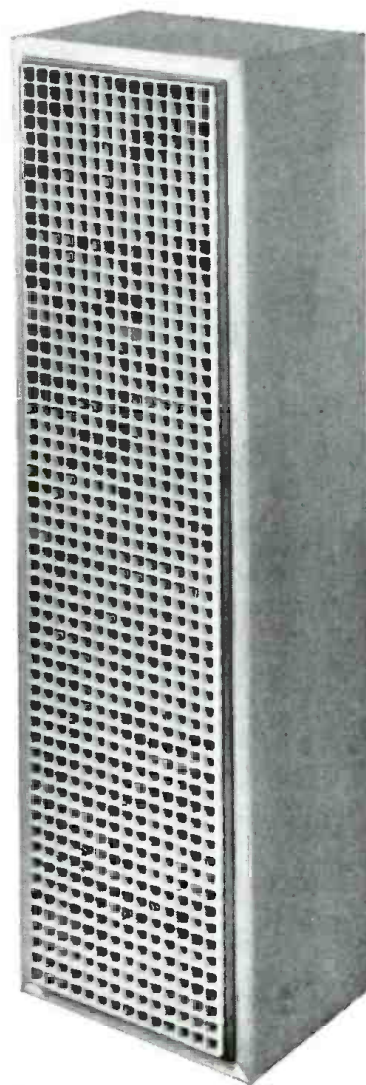

MODEL UCS-6—MUSIC & SPEECH

60" Column
(6 extended-range 8" speakers)
Frequency Range: 35-17,000 cps
Power Capacity: 150 watts IPM
Impedance: 16 ohms
Vertical Angle: 15°
Horizontal Angle: 120°
Dimensions: 58½" x 10" x 7"

MODEL CS0-6

Same as above, but completely weather-proof for outdoor installations.

MODEL CS-4—MUSIC & SPEECH

40" column
(4 extended-range 8" speakers)
Frequency Range: 45-17,000 cps
Power Capacity: 80 watts IPM
Impedance: 8 ohms
Vertical Angle: 22°
Horizontal Angle: 120°
Dimensions: 39¼" x 10" x 7"

MODEL CS-3—SPEECH

40" column
(Special, multi-design speakers for speech applications)
Frequency Range: 150-10,000 cps
Power Capacity: 40 watts
Impedance: 8 ohms
Vertical Angle: 22°
Horizontal Angle: 120°
Dimensions: 39" x 8" x 6"

SLATED FOR AUGUST DELIVERY!

For complete specifications on all four of the new UNILINE Models, contact your UNIVERSITY representative or write:

Desk S-10U
University Loudspeakers, Inc.,
80 S. Kensico Ave.,
White Plains, New York.



A Division of Ling-Temco Electronics, Inc.

BUILD THE FINEST
Professional Quality
 CUSTOMIZED
TV KIT

On Easy "Pay As You Wire" Terms
 Only \$15 for the Starting Package!

The "PROFESSIONAL" Series—designed for the perfectionist seeking the finest in TV performance. Easy to assemble. No technical knowledge required. An ideal "Learning" Kit with a Complete Course of Study is available.



Also available:
WIRED CHASSIS for custom installations with a choice of vertical or horizontal controls and the newest 23", 24" or 27" CRT.



Beautiful Cabinets — designed to enhance sound quality and blend with modern decor. For TV or combination TV and Hi-Fi.

A few of the Professional Quality Features: Choice of push-pull 10-watt audio or output to your Hi-Fi system... D.C. restoration... Ultra-linear sweep circuits... Standard Coil Guided Grid Turret Tuner... Super-sensitivity for fringe areas... Complete line of Accessories for Custom Installations.

Choice of 23", 24" or 27" CRT. Prices range from \$119 to \$199.

U.S. Armed Services and over 4000 schools and colleges have selected Transvision Receivers for educational television.

Interested in Electronics? Learn the basic principles of electronics from the Course available with the Kit.

ASSEMBLY MANUAL—\$2.00

See how easy it is to assemble the Transvision Kit. Cost of Manual refunded on purchase of Kit.

TRANSVISION New Rochelle, N.Y. NE 6-6000

START NOW — MAIL THIS COUPON —
 TRANSVISION Electronics, Inc., New Rochelle, N.Y. Dept. EW
 Send FREE 8-page Catalog... I enclose \$2 for Assembly Manual, refundable on purchase of Kit.
 I enclose \$15 for Starting Pkg. on pay-as-you-wire plan. (Complete Kits range from \$119 to \$199.)

Name _____
 Address _____
 City _____ Zone _____ State _____

EW Lab Tested
 (Continued from page 24)

comment on the principles of operation of this speaker, in the absence of more specific information. The actual performance data is interesting enough.

(EDITOR'S NOTE: The driver used in the system is a single, wide-range 10-inch speaker whose cone is made of molded tripolymer plastic material. A hemispheric dome at the cone apex aids in



high-frequency radiation and dispersion. Applied to the voice-coil form, but insulated from the coil, is a film of magnetic material which has the appearance of oxide coating on magnetic tape. This film, working in conjunction with the speaker's magnet, supplies much of the speaker's restoring force, thereby improving damping and linearity. As a result the voice-coil spider is not relied upon to restore the speaker diaphragm to its normal, resting position. Specially formed pole pieces are used to produce the optimum flux configuration. The enclosure is a completely sealed infinite-baffle type. An unusual arrangement of two types of sound-proofing material is used in the enclosure to completely absorb the speaker's rear wave. The arrangement is such that 70 square feet of sound-absorbing surface is available.)

We measured the frequency response of the speaker in a room approximately

11 feet x 30 feet. The speaker was set up first on a short wall of the room and then on the long wall. In each position frequency-response measurements were made with the *Altec 21BR150* microphone in four different locations in the room. All eight sets of readings were averaged and plotted. Harmonic distortion was measured from the acoustic output at low frequencies, with 1-watt input to the speaker. The transient response was checked by means of tone bursts whose frequency was swept throughout the spectrum. Oscilloscope photos were taken of typical tone-burst responses.

The frequency response curve shows an unusual smoothness in the low and middle frequencies. Unlike most speakers, which drop off appreciably at low frequencies, the *Hartley* maintained nearly full response down to 20 cps. This is mostly true bass response as the distortion curve shows very low distortion down to 40 cps and only moderate distortion at 20 cps. The absence of peaks or holes in the response is also noteworthy. The holes at 4 kc. and 7 kc. are apparently due to a mechanical crossover cancellation in the speaker. The general trend of the high-frequency response, like the low end, is toward a gradual drop-off rather than an abrupt cut-off.

The tone burst photos, taken at 530 cps and 3600 cps, are among the cleanest we have seen. They show practically no hangover or ringing and no spurious frequencies were generated during our tests.

In listening tests, the *Hartley* proved to be as distinctive as its measurements hinted. It is a tight, crisp-sounding speaker, virtually devoid of boom or boxy sound. The highs are very well dispersed, with practically no directional effects being audible. The lows seem to be missing much of the time but this is normal in a speaker whose low bass distortion does not allow false or exaggerated bass response caused by doubling. Unless there are truly low frequencies in the program, the speaker doesn't put out any sound in that region. Like the higher frequencies, the low-frequency reproduction is very tight and has a distinctly different character from the sound of most other speakers.

The *Hartley* "magnetic suspension" speaker is a very easy one to listen to although it does take a while to get used

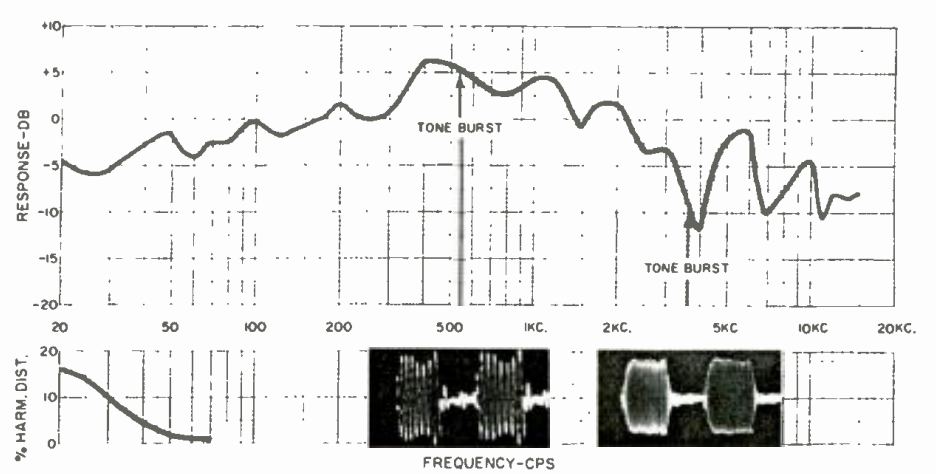



**TO LEARN ABOUT THE 1962 ALL-TRANSISTOR CAR RADIOS
AT THE DELCO RADIO NEW PRODUCT CLINIC**

Very soon now the Delco Radio New Product Clinic will be in your area. It offers you and your employees the opportunity to become familiar with the all-new, all-transistor radios for the 1962 General Motors cars. ■ The Delco Training Course offered includes a wealth of information—transistor fundamentals plus the testing and servicing of 1962 Delco Radio all-transistor circuits. It requires only two hours and is tuition-free. ■ The date this clinic will appear in your area is an important one! Circle it on the list below, and make it a "must"—because this course will mean extra profits for you, especially when servicing the all-transistor radios for the 1962 models. We look forward to seeing you. Contact your Delco electronics parts supplier for further information.

DELCO RADIO ELECTRONICS SCHOOL SCHEDULE

| School Dates | CITY | School Dates | CITY | School Dates | CITY | School Dates | CITY |
|--------------|--|--------------|--|--------------|--|--------------|---|
| Sept. 11 | Indianapolis, Ind. | Oct. 2 | Union, N. J. Toledo, Ohio Birmingham, Ala. Milwaukee, Wis. Los Angeles, Cal. San Antonio, Tex. | Oct. 16 | Portland, Ore. Amarillo, Tex. | Nov. 1 | Rochester, N. Y. Mason City, Iowa |
| Sept. 18 | Harrisburg, Pa. Grand Rapids, Mich. South Bend, Ind. Denver, Colo. Shreveport, La. | | | Oct. 18 | Boston, Mass. Columbus, Ohio Chattanooga, Tenn. Moorhead, Minn. Seattle, Wash. Oklahoma City, Okla. | Nov. 6 | Syracuse, N. Y. Jacksonville, Fla. |
| Sept. 20 | Philadelphia, Pa. Marion, Ind. Nashville, Tenn. Chicago, Ill. Cheyenne, Wyo. Dallas, Tex. | Oct. 4 | Tarrytown, N. Y. Detroit, Mich. Atlanta, Ga. Green Bay, Wis. San Diego, Cal. Corpus Christi, Tex. | Oct. 23 | Youngstown, Ohio Charlotte, N. C. Sioux Falls, S. D. Spokane, Wash. Wichita, Kan. | Nov. 8 | Albany, N. Y. Tampa, Fla. Long Beach, Cal. El Paso, Tex. |
| Sept. 25 | Wilkes-Barre, Pa. Louisville, Ky. Memphis, Tenn. Davenport, Iowa Salt Lake City, Utah Houston, Tex. | Oct. 9 | Hempstead, L. I., N. Y. Fresno, Cal. Midland, Tex. | Oct. 25 | Pittsburgh, Pa. Durham, N. C. Omaha, Neb. Kansas City, Kan. | Nov. 13 | Dayton, O. Miami, Fla. Decatur, Ill. Tucson, Ariz. |
| Sept. 27 | Cincinnati, Ohio Little Rock, Ark. Madison, Wis. Beaumont, Tex. | Oct. 11 | Wallingford, Conn. San Francisco, Cal. Lubbock, Tex. | Oct. 30 | Buffalo, N. Y. Altoona, Pa. Greenville, S. C. Des Moines, Iowa | Nov. 15 | Huntington, W. Va. St. Louis, Mo. Sacramento Cal. Phoenix, Ar z. |
| | | Oct. 16 | Providence, R. I. Cleveland, Ohio Minneapolis, Minn. | | | Nov. 16 | Mobile, Ala. |
| | | | | | | Nov. 20 | New Orleans, La. |
| | | | | | | Nov. 27 | Washington, D. C. |
| | | | | | | Nov. 29 | Richmond, Va. |

Brand new! Delco's electronically filtered power supply



Every car radio service shop needs this new Delco power supply! Plugs into 110-volt outlet, converts power to 6 or 12 volts to facilitate bench servicing without batteries. Features: Output 0-8V DC, 0-16V DC ■ Rating 8a at 6V, 5a at 12V ■ Maximum instantaneous current 20a ■ Maximum ripple .01% ■ No LC filter, instant response ■ Light, portable ■ Rugged—3 Delco power transistors ■ Best for transistor radios ■ Also operates "Wonder Bar" tuners at 12 volts.



*Division of General Motors,
Kokomo, Indiana*

SEE IT DEMONSTRATED AT YOUR LOCAL DELCO SERVICE SCHOOL!

MUSIC BIG AS LIFE

Utah's High-Fidelity CONTINENTAL SPEAKERS



C12RD 12"
WOOFER
2 Lb. Alnico
V Magnet and
2" Voice Coil

YOU GET LIFE-SIZE SOUND in every range, from 20 to 20,000 CPS, with Utah's precision-engineered stereo/high-fidelity speakers. Tweeters and mid-range speakers feature a specially engineered horn formula to enhance "presence". Each speaker has color-coded 4-way terminals.



1124 Franklin St.
Huntington
Indiana

Please mail me prices, specifications and performance details of your Continental speaker line.

NAME _____
ADDRESS _____
CITY _____ STATE _____

to it. It sounds different and may not appeal to everyone, but it deserves serious consideration by anyone trying to achieve natural sound reproduction.

The price of the "Holton" system is \$245 and it is available in walnut, mahogany, and korina. The loudspeaker is also available separately at \$135.00. ▲

Columbian Hydrosonics "Aqua-Probe" Depth Finder

For copy of manufacturer's brochure, circle No. 59 on coupon (page 130).



ALTHOUGH the boating season is coming to a close shortly in our area, we feel that there are many individuals who continue their electronic interest in boating all year round. We have had considerable enjoyment in experimenting and testing a new depth finder that is completely transistorized. It is housed in a non-metallic enclosure which is of extreme importance in salt-water areas. It is compact in design, can be mounted in any position, and all depth pips are easily recognized. Ultrasonic pulses at the rate

of 1440 per minute are used and, although the limit of our test was only to a depth of 80 feet, it can be used in waters exceeding 100 feet. It is designed for use with an external 12-volt battery or, as in our case, connected directly to a 12-volt marine power system. It was used with a Mercury 70-horsepower outboard motor, and we found no need for extra shielding. Since its power requirements are below 1 watt, excessive battery drain was not encountered.

Depth finders, in general, are not only interesting devices to have aboard, but in many areas where you are in shallow, unknown waters, it becomes imperative as a safety measure to have one available aboard ship. It is interesting in a sense that all depth finders, when properly designed, provide one with an identifying signal indicating rocky or muddy bottoms and, when one becomes accustomed to using such a device, one can develop great skill at interpreting readings. In some cases, even the size and type of fish can be determined.

We found the depth indications extremely accurate and we were able to differentiate between muddy and rocky bottoms and, on many occasions, became aware of either fish or floating objects below the boat. Someday we hope to be able to tell the size of these fish or objects. This unit is manufactured by Columbian Hydrosonics, Inc., a subsidiary of Columbian Bronze Corporation. It is available at \$99.50.....E.W.

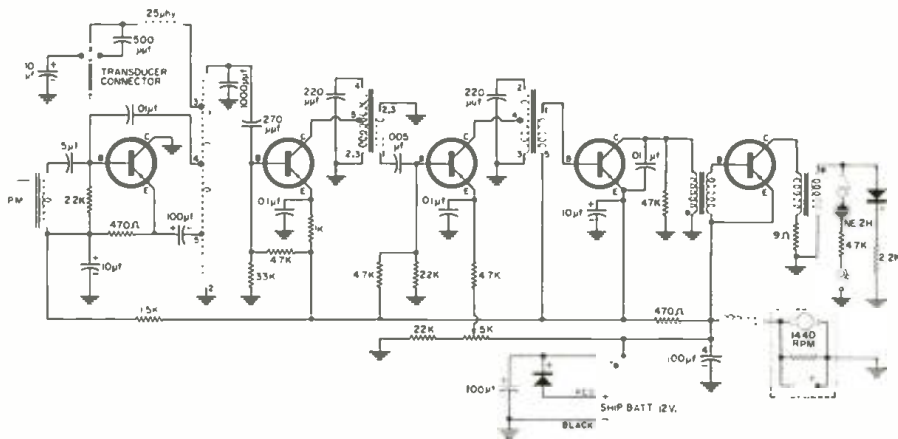

Eico Model 1064 Low-Voltage Power Supply

For copy of manufacturer's brochure, circle No. 60 on coupon (page 130).

A WELL-designed, low-ripple, low d.c. voltage power supply is an absolute necessity in the servicing and testing of transistorized equipment. Not only is such a device important in service shops, but it can be used to great advantage in original laboratory design work. Not only does Eico's Model 1064 fulfill these needs, but this particular unit can be used as a battery charger for either 6- or 12-volt batteries. This design provides two continuously variable ranges: 0-8 volts at 10 amperes continuously or 20 amperes intermittently and 0-16 volts at 6 amperes continuously and 10 amperes intermittently.

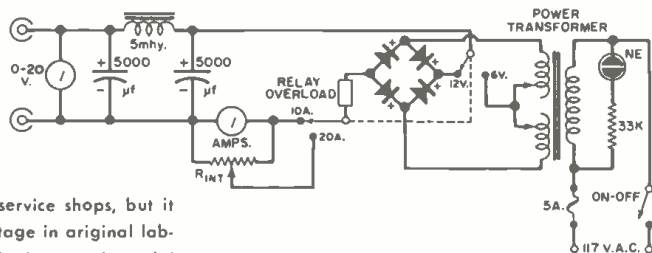



As noted in the schematic diagram, the transformer has two secondary windings, both of which are in parallel for 0-8 volt operation and in series for 0-16 volt operation. An automatic reset overload relay, in the secondary of the transformer, provides the necessary protection against damage due to excessive current drain. The relay opens when the current exceeds 20 amperes and automatically resets itself when the overload is removed.

A pi-type LC filter is used and, as a result, the output has an extremely low ripple content. The accompanying graph shows the results we obtained on our unit. The ripple content is shown for both 6- and 12-volt operation, and the figures are slightly less than those published by the manufacturer.

Another feature which is more than just a convenience to the user is the incorporation of a voltmeter and ammeter connected in the output circuit that allows simultaneous observation of both the output voltage and current without the need of switching. Obviously, these meters have small scales and are not intended to provide readings of calibration accuracy. They should certainly suffice for any kind of service or maintenance applications but, for original design work, it might be advisable to connect, externally, meters of greater accuracy.

This new unit is extremely rugged and designed especially for hard use. It is housed in a grey perforated steel cabinet. Its over-all size is 10½" x 7¾" x 8¾", and the over-all weight is 16 pounds. It is, in all sense of the word, professional in appearance, and is particularly designed in style and shape to match the company's Model 260 o.c.-volt-watt meter, and Model 1078 power-line voltage regulator. This unit is available at \$43.95 in kit form and \$52.95 completely assembled. E.W.

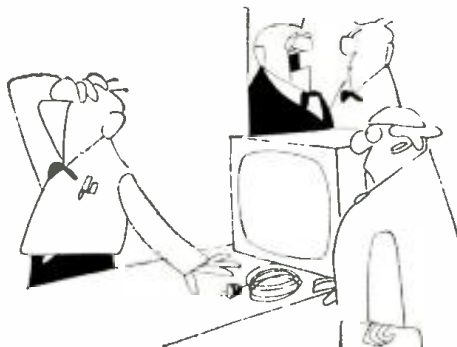
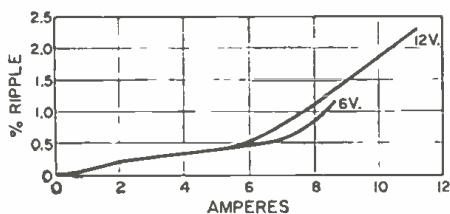

"Farnsworth has a nice technique when they mention the trouble."

October, 1961

For the 1 family in 17 that demands Recording-Studio Quality from their tape recorder...



People actively engaged in the musical arts—amateurs as well as professionals—are finding the Continental '400' the practical solution to the problems of complexity and cost posed by professional recording equipment.

Guild-crafted by Philips of the Netherlands—styled by the Continent's top designers, the Continental '400' is simple to use yet amazingly versatile. The 3-speed, 4-track '400' offers professional quality recording and playback, both stereo and mono, at moderate cost for home use.



the Norelco® CONTINENTAL '400'

world's most advanced, most versatile, portable stereo/mono tape recorder

Completely self-contained with dual recording and playback preamps, dual power amplifiers, stereo-dynamic microphone and two stereo-matched wide-range Norelco loudspeakers.

VERSATILITY: 4-track stereo recording and playback, as well as 4-track monophonic recording and playback, at any of its 3 speeds.

FREQUENCY RESPONSE: at 7½ ips, 50-18,000 cps; at 3¾ ips, 50-14,000 cps; at 1½ ips, 60-7000 cps.

PROFESSIONAL EXTRAS (at no extra cost): mixing, monitoring and sound-on-sound facilities.

SIGNAL-TO-NOISE-RATIO: 48 db or better.

WOW AND FLUTTER: less than .15% at 7½ ips.

CROSSTALK: 55 db. **HEAD GAP:** .00012".

NORTH AMERICAN PHILIPS COMPANY, INC. Hi Fidelity Products Division, 230 Duffy Avenue, Hicksville, L.I., N.Y.



RADIO SHACK Corp.
Boston, Massachusetts

Send for your **FREE** personal copy of **RADIO SHACK'S 336-PAGE 1962 CATALOG**

Nationwide standard of excellence in Electronics, Music, Communications

Also receive all other issues for 1 year!

Our bigger, better catalogs offer the widest line of electronic parts and equipment in the world! Latest in Stereo, Hi-Fi, Ham Radio, Test Equipment, Pre-Recorded Tapes, Tape Recorders, Records, Component Parts—plus 30 pages of new fun-to-build kits. Every item is easy to own on new No Money Down Credit Terms. Every item is guaranteed to satisfy or your money back.

MAIL THIS COUPON TODAY

RADIO SHACK Corp. Dept. 61K6C
730 Commonwealth Ave., Boston 17, Massachusetts
Please send me Radio Shack's new 1962 Electronics Catalog and every new issue for the next 12 months—all FREE and POSTPAID.

Name _____

Address _____

City & Zone _____ State _____

URNS COUNTING DIAL

Duo dial Model RB. Mfg by Hellipot, 100 divisions per turn, will count to 15 turns. Dial suitable for helipot, Var. inductors etc. With mounting hardware. PRICE **\$2.95**

BC 442 ANTENNA BOX (ARC 5)

Contains RF Meter (750 Ma.) Relay, etc. See Catalog. Price **\$1.95**

POWER TRANSFORMER

110V-60 Cy.-Sec 385-0-385 V. @ 200 Ma. Fil E.3V 6 Amps. 5 V. 3 Amps. Ea. **\$3.50**

FILAMENT TRANSFORMER

Input 110-220V, 60 cycle. Secondary 6.3V. @ 10 Amp. Ea. **\$2.25**

Input 110V 60 cy. Output 6.3V @ 5 Amps. 6.3V @ 10 Amps. 5V @ 5 Amps. Ea. **\$2.75**

CARDWELL TRANSMITTING VAR. COND.

Dual Section 211 UUF per section. 5700 Volts AC. Each **\$5.95**

DYNAMOTOR SPECIALS

12 Volts Input-Output 440V. @ 200Ma. 12 Volts Input-Output 225V. @ 100Ma. All in one Dynamotor. BRAND NEW. Ea. **\$5.95**

SILICON RECTIFIERS

| PIV | Current | Price | PIV | Current | Price |
|---|---------|-------|-----|---------|--------|
| 100 | 500 Ma | \$.25 | 200 | 2 Amps | \$.75 |
| 200 | 500 Ma | .30 | 400 | 2 Amps | 1.25 |
| 400 | 500 Ma | .50 | 100 | 15 Amps | 2.50 |
| 750 | 500 Ma | .80 | 200 | 15 Amps | 4.50 |
| 11 items above are Hi-Efficiency Gold Plated! | | | | | |
| 200 | 750 Ma | .50 | 400 | 15 Amps | 8.50 |
| 400 | 750 Ma | .50 | 50 | 50 Amps | 4.95 |
| 100 | 2 Amps | .50 | 100 | 50 Amps | 7.50 |
| | | | 200 | 50 Amps | 9.50 |

POWER TRANSISTORS

PNP GERMANIUM — Similar to following transistors

| | | | |
|--------|-----|-------|------|
| 2N1320 | 70c | 2N155 | 70c |
| 2N1328 | 70c | 2N173 | 2.50 |
| 2N156 | 70c | | |

CHOKE—FULLY CASED

| | |
|-------------------|-------|
| 5 HENRY @ 200 Ma | 1.95 |
| 5 HENRY @ 250 Ma | 2.25 |
| 10 HENRY 300 Mill | 3.00 |
| 4 HENRY 400 Mill | 3.95 |
| 4 HENRY 900 Mill | 8.95 |
| 4 HENRY—1 amp. | 11.95 |

BRAND NEW OIL CONDENSERS

| | | | |
|-----------------|------|----------------|-------|
| 50 MFD 50 VDC | 1.95 | 4 MFD 2000 VDC | 3.50 |
| 50 MFD 200 VDC | 4.50 | 5 MFD 2000 VDC | 4.95 |
| 2 MFD 600 VDC | .50 | 1 MFD 3000 VDC | 1.85 |
| 3 MFD 600 VDC | .60 | 2 MFD 3000 VDC | 3.50 |
| 4 MFD 600 VDC | .75 | 1 MFD 4000 VDC | 6.25 |
| 5 MFD 600 VDC | .80 | 2 MFD 4000 VDC | 6.25 |
| 6 MFD 600 VDC | .85 | 3 MFD 4000 VDC | 8.95 |
| 8 MFD 600 VDC | .95 | 4 MFD 1000 " | 12.95 |
| 10 MFD 600 VDC | 1.15 | 5 MFD 600 VDC | 4.50 |
| 12 MFD 600 VDC | 1.50 | 2 MFD 5000 VDC | 8.50 |
| 15 MFD 600 VDC | 1.70 | 4 MFD 5000 " | 15.95 |
| 1 MFD 1000 VDC | 4.50 | 15 MFD 5000 " | 39.50 |
| 2 MFD 1000 VDC | .70 | 5 MFD 5000 " | 2.95 |
| 4 MFD 1000 VDC | 1.35 | 1 MFD 7500 VDC | 6.95 |
| 8 MFD 1000 VDC | 1.95 | 2 MFD 7500 " | 17.95 |
| 10 MFD 1000 VDC | 2.50 | 9 MFD 10,000 " | 49.50 |
| 12 MFD 1000 VDC | 2.95 | 2 MFD 10,000 " | 29.95 |
| 15 MFD 1000 VDC | 3.50 | 5 MFD 10,000 " | 59.95 |
| 1 MFD 1500 VDC | 1.95 | 1 MFD 12,500 " | 69.95 |
| 2 MFD 1500 VDC | .75 | 1 MFD 15,000 " | 42.50 |
| 2 MFD 1500 VDC | 1.10 | 5 MFD 25,000 " | 34.95 |
| 4 MFD 1500 VDC | 1.95 | 1 MFD 25,000 " | 69.95 |
| 8 MFD 1500 VDC | 2.95 | 10 MFD 300 AC | 1.95 |
| 1 MFD 2000 VDC | .85 | 20 MFD 300 AC | 2.95 |
| 2 MFD 2000 VDC | 1.50 | 50 MFD 350 AC | 5.95 |
| | | 8 MFD 800 AC | 2.95 |

RELAYS

| | |
|---|-------------------|
| WARD LEONARD Heavy duty relay coil 220V 60Cy., 2 phase, 5 HP. | |
| 3 Pole ST, 25 Amp contacts | Ea. \$6.95 |
| 6 Volt DC. H.S. Relay DPDT | .95 |
| 6 Volt DC. H.S. Relay 3 PST N.O. | .65 |
| GUARDIAN 110V AC, 2 Pole Single Throw (1 N.O. & 1 N.C.) Repl. BC-510 | \$2.50 |
| Potter-Brumfield SMSLS 5000 ohm, 4 Ma. Sens. | Ea. \$2.25 |
| 110 Volt AC Relay-DPST 60 cy, 10 Amp. Contacts | Ea. \$1.50 |
| Sens. Relay 11,000 ohm coil, 1 Ma Adj. Cont. Armature Tension SPDT | Ea. \$1.95 |
| 12 Volt DPDT DC Relay | Ea. \$1.35 |
| SGMA type 22RJC 8,000 ohm SPDT, small sealed relay | \$2.49 |
| Sealed Relay, SPDT, 6,000 ohm coil | \$1.95 |
| G.E. Relay Cont. contains 8000 ohm relay, sensitivity 2 mils. 10 for \$9.25 ea. | \$1.10 |

PANEL METERS

| STANDARD BRANDS | | 3" METERS | |
|------------------|------|--------------------------------------|------|
| 1 1/2" METERS | | 0-1 Mill DC | 3.95 |
| 0-100 Micro | 3.95 | 0-10 Mils DC | 3.95 |
| 0-500 Micro | 2.95 | 0-500 Mils DC | 3.95 |
| 2" METERS | | | |
| 0-50 Micro | 4.95 | 0-50 V. DC | 4.50 |
| 100-0-100 Micro | 2.95 | 0-150 V. AC | 4.50 |
| 0-1 Ma | 3.50 | 0-15 Amps RF | 4.50 |
| 0-50 Ma | 2.95 | 0-15 Volts AC | 3.95 |
| 0-200 Ma | 2.95 | 0-1.5 KV | 5.95 |
| 0-500 Ma | 2.95 | 0-2.5 KV | 6.95 |
| 0-10 Amps DC | 2.95 | 0-1 Amp DC | 3.95 |
| 0-20 Volts DC | 2.95 | 4" METERS | |
| 0-40 Volts | 2.95 | 0-150 Amps AC (with current transf.) | 5.95 |
| 18-36 Volts DC | 1.99 | 0-2500 V. DC | 6.95 |
| 0-150 V. AC | 2.95 | 100-0-100 UA | 5.95 |
| 0-5 amps RF | 2.95 | D-200 UA | 6.95 |

All merchandise sold on a 10 day money back guarantee. Min. Order \$3.00—25¢, with Order—F.O.B. New York

PEAK

ELECTRONICS COMPANY
66 W. Broadway, New York 7, N. Y., WO-2-2370

Mac's Service Shop

(Continued from page 52)

difficult to repair. Even though he can make it work by spending enough time on it, he takes no pride or pleasure in the job; and some of his dissatisfaction is very likely to spread to the owner, especially when the technician justifies his service charge by pointing out how difficult it is to locate and repair trouble in the receiver.

"I know it is almost heresy to say this," Mac concluded; "but I still believe there is a very substantial demand for good quality merchandise at a fair price. There is a growing rebellion against the shoddy 'competitive' type of product that many manufacturers seem convinced is what the public wants. I hear this discontent on every side. 'I would rather pay a little more and get something decent,' people tell me; 'but how can I? All too often the expensive model is actually the same thing as the low-cost model with just more gadgets added. I don't want only to pay more! I want to get more—more that really counts.'"

"Say," Barney interrupted as he glanced at the clock, "this is all pretty fascinating, but I wonder if you could come down to earth and help me with a little problem that has been bugging me lately. What am I supposed to do with transistor sets that develop bad on-off switches? I'm running into more of these all the time, and I'm not having much luck fixing them. In the first place, I don't see why they should give trouble. After all, they handle only a few mils of current, while a tube receiver switch usually controls a current of an ampere or so; yet the latter seldom gives trouble unless lightning gets at it."

"Very likely the low current through the transistor switch is partly the cause of the trouble," Mac suggested. "Any relay manufacturer will tell you 'dry' contact points are the hardest to keep operating dependably. By 'dry' I mean contact points handling no appreciable amount of current, such as those transferring a receiver from one antenna to another. In the case of contacts handling relatively heavy current, tiny arcing takes place during making and breaking and burns off insulating oxide and dirt. The voltage necessarily present also helps penetrate any thin insulating film. Where there is no voltage and current, this does not happen. Increased contact pressure and a wiping action of the contacts will usually help in a relay; and so will sealing them off from dirt."

"I think I'm beginning to get the picture," Barney broke in. "Most of these transistor switches are pretty crude affairs right out in the open. Two little brass or bronze tongues are held in contact by their own spring tension until a cam on the volume control rotor pushes one of them away. There is not much pressure, no wiping action, and no protection against dust and lint except that afforded by the receiver case. No won-

Ask By Name For GENUINE

"No Noise" PRODUCTS

your assurance of brand name quality

No-Noise **VOLUME CONTROL** and Contact Restorer
• Cleans • Lubricates • Protects
Not a Carbon Tet Solution
2 Oz. Bottle **\$1.00** 6 Oz. Spray Can **\$2.25**
Net to Servicemen

No-Noise **TUNER-TONIC** with PERMA-FILM
• Cleans, lubricates, restores all tuners, including wiper type
• Non-toxic, non-inflammatory
• For TV, radio and FM use
• Economical—a little does a lot.
6 oz. Aerosol Can **\$3.25**
Net to Servicemen

FREE with each can of ELECTRONIC CHEMICAL products—**5" PLASTIC EXTENDER**
Push Button Assembly For Pin Point Applications—Does Not Cause Shorts

Electronic Chemical new formula **EC-44**
Lubricates, conditions, cleans all electrical contacts. Economical little does a lot!
6 oz. spray can **\$3.50**

ELECTRONIC CHEMICAL CORP.
813 Communipaw Avenue Jersey City 4, N. J.

SAY YOU SAW IT IN ELECTRONICS WORLD

CASH FOR YOU-

REPAIR BUSTED

Electric APPLIANCES

Learn at Home • \$3 to \$5 an Hour
Spare Time, Full Time • Be Your Own Boss

FREE BOOK tells about profitable business you can run—right at home. Repair Electric Appliances, using simple tools. Pays \$3-\$5 an hour! **CASH IN ON THIS BIG 800M 400 MILLION** Appliances are in American homes right now. People need them fixed. You make good money doing it. In your basement, garage, even your kitchen. **QUICK WAY TO GET STARTED** For less than 20c a day

our easy, pictured instruction—backed by 45 years of success in home-training—prepares you for top earnings. Earl Reid of Thompson, Ohio, says: "Made \$510 in one month spare time." At no extra charge you get Appliance Tester, too. Finds trouble-spots, checks your work. Get your **FREE Book** and **FREE Sample Lesson!** Mail coupon below. letter or postcard, now.

NATIONAL RADIO INSTITUTE, Appliance Div.
Dept. EK1, Washington 16, D. C.
Send **Free Book, Free Appliance Repair Course Lesson.** Am interested in:
 Spare Time Earnings My Own Business
 Better Job

Name

Address

City

Zone

State

Accredited Member National Home Study Council

der they give trouble. I've tried contact cleaner on them without much luck. In some cases, this seemed to make things worse."

"I found that out, too," Mac confided. "Most of those cleaners are intended to work on sliding contacts. In the case of transistor switch contacts that simply touch together and pull apart, the cleaner acts more as an insulator in itself and as a binder for dirt to accumulate between the contacts. I've had the best luck using this stuff to clean the contacts first and then wiping them completely dry with a pipe cleaner. After that I carefully bend the contact tongues so they are held together with considerable tension when the receiver is turned on and are not spread very far apart when the receiver is turned off. So far—knock on wood!—every switch I've repaired in this fashion has continued working."

"Thanks for the tip," Barney said as he picked up a set of jeweler's screwdrivers, took the case off a little transistor receiver, and screwed a jeweler's loupe into his eye. "I'll soon let you know if it works for me!" ▲

HOME-BUILT & SURPLUS EQUIPMENT FOR CB

ACCORDING to a recent FCC release, there is no objection to the use of home-designed and home-constructed Citizens Radio equipment provided that such equipment is built to specifications that insure its operation according to the rules. Further, the equipment must have been "checked out" by or under the direct supervision of the holder of a first- or second-class radio operator's license, not an amateur ticket holder. Factory-assembled or certified kits do not require the services of a licensed radio operator.

On the other hand, military surplus equipment is not suitable for use for the following reasons: (1) It is not normally able to maintain the required frequency stability. (2) The equipment usually uses FM rather than the AM required. (3) Power inputs over the 5-watt limit are frequently employed. (4) The equipment, in general, cannot maintain the emission within the authorized 8-ke. bandwidth when used on AM.

In general, it is the experience of the Commission that the expense involved in making such modifications as may be necessary to make military gear conform to the rules—in those cases where such modification is at all possible—renders such practice impracticable. ▲

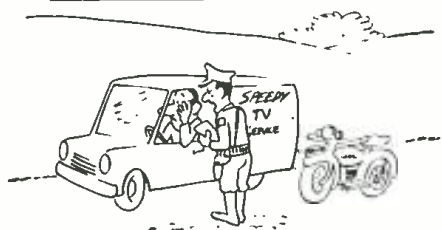

"That's 34 service calls you owe me."

October, 1961

★ EARN MORE MONEY

★ BUILD A BETTER FUTURE

NOW you can learn 2-way radio servicing at home from Motorola

NOW, for the first time, a home study course devoted exclusively to 2-way FM radio servicing.

The MOTOROLA TRAINING INSTITUTE trains you for a professional career with unlimited potential. The booming 2-way radio market should triple in the next 10 years. Qualified servicemen are urgently needed!

The Motorola Training Institute course covers everything in 2-way radio from basic principles to system analysis and troubleshooting the latest transistorized equipment.

Course Includes:

- 38 STUDY LESSONS WITH COMPLETE SECTION ON TRANSISTORS
- 9 UP-TO-DATE TEXTS
- MORE THAN 20 TECHNICAL ARTICLES

HERE'S WHAT STUDENTS SAY ABOUT THE MOTOROLA TRAINING INSTITUTE COURSE

"The section on transistors alone is more than worth the price of the full course." (K. F.—Illinois)

"Although I have an FCC license and some experience as a technician, I did not have a good working knowledge of the squelch circuit. Now, through my Motorola Training Institute training, I am able to do a decent troubleshooting job." (P. C.—Indiana)

"Personally, I think any technician that does not sign up for this course is missing a good opportunity to ease his servicing problems." (N. V.—New Jersey)

Write Today for Complete Information

NO OBLIGATION AND NO SALESMAN WILL CALL



NEW TECHNICIANS: Learn in just a few months what could take years. Course prepared by experienced faculty and highly skilled technicians. Easy-to-grasp lessons—reference library—individualized instruction.



TV-RADIO SERVICE MANAGERS: Here's a great growth opportunity for you and your technicians. The Motorola Training Institute home study course teaches your technicians the right way to do 2-way radio servicing and enables you to expand your range of services.



EXPERIENCED TECHNICIANS: Learn advanced servicing techniques and technological improvements. Get new information and know how on all the new transistorized equipment. An excellent "brush-up" course.

MOTOROLA TRAINING INSTITUTE

4501 Augusta Blvd., Chicago 51, Ill.

Please send me complete information on the MOTOROLA TRAINING INSTITUTE No. A-166.

(please print)

NAME _____

ADDRESS _____

CITY _____ ZONE _____ STATE _____



*lowest cost
master antenna system
ever developed*

**NEW
BLONDER-TONGUE
TRANSISTOR 4-SET
BOOSTER—MODEL IT-3**

All the gain you need from one antenna for 4 TV or FM sets!

This new transistor-operated 4-set booster provides higher gain and lower noise than any comparable vacuum tube unit. There are no tubes to replace, lower power drain and negligible heat — all contributing to lower cost, longer maintenance-free operation than any unit on the market. List price of model IT-3, \$32.50.

SUPERB 1, 2, 3 or 4 SET PERFORMANCE

- **1 SET**—B-T 'straight thru' circuit provides full gain without isolation losses (Gain: 9 to 14 db, TV; 8 to 12 db, FM).
- **2, 3 OR 4 SETS**—splitting circuit provides gain and inter-set isolation necessary to provide top performance on 2, 3 or 4 sets. Gain two sets—each set 4 to 8 db; Gain three sets—each set 3 to 4 db; Gain four sets—each set 2 to 3 db.

*Sold through distributors. For details write: Dept. EW10
engineered and manufactured by*

BLONDER-TONGUE
9 Alling St., Newark, N. J.

Canadian Div.: Benco Television Assoc. Ltd., Toronto, Ont. • Export: Morhan Export Corp., N. Y. 13
home TV accessories • UHF converters • master TV systems • industrial TV systems • FM/AM radios

Ion Generator & Air Filter

(Continued from page 50)

rather easy to keep the area clean.

The actual installation consists simply of sliding the filter, with ionizer frame attached, into its normal place and inserting the high-voltage lead into the banana jack on the ionizer unit. The ground lead should be run from the power-supply chassis to the filter frame. You can now plug the power supply into the receptacle you have provided and the job is completed.

You may notice a faint, sweet smell close to the warm-air registers when the unit is first turned on. This will appear to lessen or go away after a week or so — not because the unit is working less effectively, but because you are becoming accustomed to the smell.

Cleaning

The filter should be cleaned after the first two weeks of operation and then once a month thereafter. To clean, loosen the two screws at the top and bottom center of the ionizer frame and slide it away from the filter. Draw as much dirt as possible with a vacuum cleaner, then wash with warm water and detergent. Rinse with clean water and let dry thoroughly. Run a soft camel hair brush up and down the wire grid to remove any dust that may have accumulated on the wire. Make sure the expanded metal ground plate is clean before installing the ionizer frame in the filter.

Because of the electrostatic action, it will be unnecessary to use oil in the furnace's regular metal filter. This will result in freer movement of air through the filter and an increase in the efficiency of the entire heating system. ▲

HANDY TEST PRODS

By G. F. STILLWELL

If you can use an extra pair of handy electrical prods, you can make them in a minute from discarded ballpoint pen sleeves. The pen sleeves must be of plastic and since many of them are, this is no problem. Remove the pen mechanism then solder the bare end of a length of insulated wire to a sharpened nail. This, of course, will be the prod. Remove the cap from the pen sleeve and insert this prod through cap and sleeve. Fasten the prod in some way (by flattening) to keep it from backing out. Most inexpensive ballpoint pens come in various colors and a red one can be used for the positive prod. Happily cheap pens are better for this purpose than expensive ones.

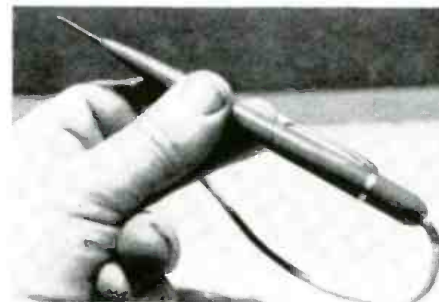

ELECTRONICS WORLD

Electronic Clothes Dryer

(Continued from page 57)

near the revolving drum. A brush on the drum connects the ring with the set of electrodes. The path to the other set of electrodes is completed through the wet clothing, which makes a good conductor and is always in contact with these "fingers" mounted on the baffles inside the rotating drum. The path to dryer ground is completed through the metal of the drum itself.

The current flow, limited by the resistor, is only a few microamperes. While this avoids any hazard, it is enough to prevent the low-current supply from charging capacitor *C*. As the contents of the drum dry however, conduction through the electrodes is reduced. Voltage across the capacitor can now build up. When the latter charge reaches 74 volts, it is up to the firing point of *NE*, a neon glow lamp. The lamp ionizes and glows instantaneously as the capacitor discharges through it. Brief as the glow is, it is enough to activate the photoelectric device, *PC*.

Maytag calls the cell a light-decreasing resistor, which provides the clue to its behavior. Ordinarily it exhibits a very high resistance. Under these conditions, it limits current to the a.c. relay, preventing the latter from being energized. However, when light strikes it, resistance of *PC* drops to a negligible value. This lets the relay pull in, closing

the circuit to the timer motor. The latter then continues drum rotation for a short "cool-down" period. Another set of contacts on the relay, not shown, holds the latter until the completion of the cycle. The role of the built-in timer during this operation is strictly secondary. The length of the over-all drying period is primarily dependent on the moisture content sensed in the clothes.

Actually either of two resistors is used for *R*. When the machine is set to "Regular Fabrics," a 30-megohm resistor is switched into the circuit for maximum drying. In the "Damp Dry" position, used for materials that will be ironed, a 330,000-ohm component permits earlier build-up of the capacitor charge. For wash-and-wear fabrics, instead of using a third resistor to permit termination at still another level of moisture content, the low-value resistor is used and other changes are made during the full cycle. These include the use of higher internal temperatures.

The control system, on which the manufacturer has made extensive patent applications, appears to offer many of the attributes considered desirable in a home appliance. It is simple, using only a few components housed in a box about the size of two packs of cigarettes. It avoids a system of moving parts that may wear out or break down. It is relatively inexpensive. In addition, it is more than a mere gadget: it fills a need felt by the consumer who wants fully automatic operation that is not met in other ways. ▲

QUICKLY CUT HOLES

in metal, plastics,
hard rubber...



GREENLEE CHASSIS PUNCHES

Make smooth, accurate openings in 1½ minutes or less . . . for sockets, plugs, controls, meters, panel lights, etc. Easy to use . . . simply turn with wrench. Many sizes and models. Write for literature.



GREENLEE TOOL CO.
1916 Columbia Ave., Rockford, Illinois



Transistor Manual

An industry classic, now in its 5th edition. 320 fact-filled pages on theory, construction techniques, signal characteristics, hi-fi and radio circuits, transistor radio servicing techniques, feedback and servo amplifiers, switching characteristics, unijunction transistor circuits, complete specs and JEDEC listings, introductions to silicon controlled rectifiers and tunnel diodes. \$1.00.

Tunnel Diode Manual

This is the most comprehensive presentation of theory, circuits, applications and specifications available today for tunnel diodes. Complete ratings and characteristics, tunnel diode specifications, chapters on tunnel diode amplifiers, oscillators, switches, logic circuits and tunnel diode test circuits. Also a bibliography of basic tunnel diode source material. Just \$1.00.

Get your copies today from your Authorized G-E Semiconductor Distributor. Or mail the coupon directly to the factory.



Bring your Semiconductor Library up to date!



Latest G-E Semiconductor Full Line Bulletin — Free. Here are the latest ratings and specifications for every semiconductor device in General Electric's famous line. Transistors, rectifiers, tunnel diodes, silicon controlled rectifiers, rectifier stocks . . . 14 pages, arranged for quick and easy reference. Free.

General Electric Co., Semiconductor Products Department, Section 58J103, Electronics Park, Syracuse, New York.

Please send me the following publications for my reference library:

- G-E Transistor Manual. I enclose \$1.00 (no stamps, please)
 G-E Tunnel Diode Manual. I enclose \$1.00
 1961 G-E Semiconductor Full Line Bulletin. Free.

Name _____
 Address _____
 City _____ Zone _____ State _____

GENERAL  ELECTRIC

With a high enough external resistor, say 300,000 ohms or more, and a source voltage in the vicinity of 10 volts, it would be practical to ignore internal resistance, if the latter is not known, even on the lowest current scale, which is likely to be in the range of 50 micro-amperes. Although this current scale is the one on which meter resistance will be highest, the error it introduces is likely to be less than 1 per-cent. On higher current scales, meter resistance becomes negligible so that one or more lower-value external resistors can be used with assorted voltages to provide check-points. Once more, if meter linearity is already known, only a single check-point on any d.c. current scale is needed to calibrate the entire range.

The calibration of a.c. and ohmmeter scales is another matter altogether, since factors other than inherent linearity of the meter affect accuracy. These will be discussed separately, in other articles. As to calibration for reading of direct current and voltage, the chief problem is the choice of the voltage source you feel you can trust most for your starting point. With one of the more accurate ones listed earlier, or with a choice of more than one to double check, and with care in using them, you should be able to calibrate your instrument so that you can rely on reading within a narrow range of percentage variation anywhere on any d.c. scale. ▲

FM STATIONS PLAN FOR STEREO

ACCORDING to a survey by the NAB among its FM station members, a total of 79 stations will be airing stereo FM programs by the end of this year, and 178 by the end of 1962.

Of the 384 stations replying to the questionnaire, 140 stations have no plans at all for FM stereocasting, 32 stations are undecided, while 21 stations already broadcast AM/FM stereo and have no plans for multiplexing.

As to the proposed number of hours to be devoted to stereo programs, the responses varied from 2 to 130 hours a week. Some of the stations reported delays because of lack of equipment, while others are waiting for wider availability of FM stereo receivers to the general public. ▲

INEXPENSIVE DIODE WITH HIGH BACK RESISTANCE

By JIM KYLE

EXPERIMENTERS and others have need of a crystal diode with extremely high reverse resistance. While such an item is available (at a price almost as high as its reverse resistance), the base-emitter junction of any common transistor, such as the CK722, the 2N108, or the 2N229, has a reverse resistance higher than any easily obtainable diode—at a price of less than a dollar for any of the types mentioned.

To use the transistor in this application, clip off the collector lead and use the base (for a "p-n-p" type) as the diode cathode. Polarity will be reversed with an "n-p-n" unit. ▲

October, 1961

YOURS FREE 1962 CATALOG OF USER-SELECTED* CONAR KITS



GUARANTEE—The CONAR 4-point guarantee is your assurance of complete satisfaction on all purchases. Every item must perform in accordance with stated specifications. Your money will be promptly and cheerfully refunded if for any reason you are not entirely satisfied



A selective grouping of the Electronic test instruments, tools and kits you need

and want the most. Every item has been "user-selected" by men like yourself and kit-engineered for simplified construction, perfect performance. You'll like the reasonable prices and convenient payment plans which make CONAR Kits so easy to own



5-INCH WIDE BAND OSCILLOSCOPE KIT—For black-white, color, AM-FM and electronic applications. High intensity trace. Extremely stable sync. Advanced design. Kit—\$89.50
Assembled—\$139.50

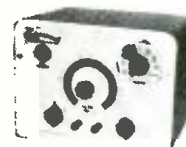

R-C TESTER KIT
C ranges 10 mmf. to 1500 mfd. R ranges one ohm to 150 meg. Eye indicator; bridge circuit. Fully variable DC working V. to 450V. \$21.95

6-TRANSISTOR RADIO KIT—Excellent tone and sensitivity. Nodelicate printed circuits. Attractive, durable case. All U.S. made parts. \$25.50



VACUUM TUBE VOLTMETER KIT (6-INCH METER). RMS and p. to p. scale. Input imped. 12.2 meg. Professional performance and appearance. \$31.95

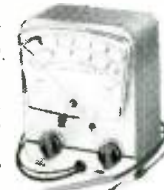

CONAR instruments

division of NATIONAL RADIO INSTITUTE

CONAR INSTRUMENTS

3939 Wisconsin Avenue, N.W.
Washington 16, D.C.

KB

Send me your new 1962 CONAR KIT CATALOG

Name _____
Address _____
City _____ Zone _____ State _____

Performance tested and approved by NRI... the first name in Electronics training for nearly 50 years.

LAFAYETTE is America's Citizens Band Headquarters

Complete Portable Communications for Everyone



HE-29A

**PORTABLE—
POCKET SIZE
Only
6 3/4 x 3 3/4 x 1 1/4"**



Ship to Shore



On the Farm



Construction Work

**NO LICENSES,
TESTS OR
AGE LIMITS**

LAFAYETTE 9 TRANSISTOR CITIZENS BAND "WALKIE TALKIE"

39.95

**2 for 78.88
NO MONEY DOWN**



Complete with Leather Carrying Case, Earphone, Antenna, Batteries, and Crystal

- Completely Wired—Ready to Operate
 - Fully Transistorized—9 Transistors plus 1 Diode
 - Uses Inexpensive Penlight Batteries
 - No License, Tests or Age Limits
 - Comes with Leather Carrying Case, Earphone, Antenna, Batteries and Crystals
- As simple and easy to use as the telephone—and twice as handy. Receives and transmits up to 1.5 miles under average conditions. Weighs only 18-oz. and slips into your pocket. Push-to-talk button operates built-in speaker as sensitive microphone.

LAFAYETTE HE-20A Deluxe CITIZENS BAND TRANSCEIVER

**ONLY
109⁵⁰
NO MONEY DOWN**



Made in U.S.A.

Now With Added Deluxe Features—

- Pi-Network for Greater Power Output
 - Calibrated "S" Meter
 - 14 Tube Performance, 3 Diodes
 - Built-in 12 Volt Power Supply for Mobile Use
 - Complete with Matched Crystals for Channel 9
- A highly efficient 2-way communications system operating over a distance of up to 20 miles or more depending on terrain. Features

4 crystal-controlled transmit positions and 4 crystal-controlled receive positions. Tuneable superhet receiver covers all 23 assigned channels. Other highlights include dependable push-to-talk ceramic mike & relay, adjustable squelch control, automatic series gate noise limiter and illuminated dial.

LAFAYETTE HE-15A

Made in U.S.A.



SUPERHET

CITIZENS BAND TRANSCEIVER

- Completely Wired—Not A Kit
- 5 Crystal-Controlled Transmitting Positions
- Tuneable Receiver Over Full 23 Channels
- High Output Ceramic Microphone
- Complete with Transmitting Crystal for Channel 9

A compact, precision transmitter and receiver covering up to a 20 mile or more radius, depending upon conditions. The HE-15A features an effective full-wave variable noise limiter, planetary vernier tuning, RF and microphone jack, on front panel. 12 tube performance from 4 dual-function tubes, 2 single-function tubes, 2 rectifiers.

| | |
|---------------------------------|-----------|
| HE-19 Telescoping Whip Antenna | Net 3.95 |
| HE-16 Power Supply for 12 Volts | Net 10.95 |
| HE-18 Power Supply for 6 Volts | Net 10.95 |

NOT A KIT

**ONLY
59⁵⁰
NO MONEY DOWN**

LAFAYETTE All-in-One CITIZENS BAND MOBILE ANTENNA

6.95

HE-800WX

- Chrome Swivel Base
- Stainless Steel Spring
- 10 1/2" Stainless Steel Whip for Optimum 11-Meter Performance

Chrome swivel ball mount base designed for mounting on any surface. Stainless steel spring holds rod in properly adjusted position and prevents rod damage from shocks and blows. Stainless steel whip for maximum resiliency and strength.



NEW! LAFAYETTE RADIO FIELD INDICATOR

6.95

- Continuously Indicates Transmitter Output
 - Rugged 200 ua Meter Movement
 - Requires No Electricity, Batteries or Transmitter Connection
- Check the performance of marine, mobile or fixed transmitter. Features a 200 ua meter movement with variable sensitivity control. Earphones can be plugged in for an aural check of output. Antenna extends from 3 1/4" to 10 3/4". Magnet on bottom plate allows easy mounting on car dash or metal surfaces. Size, less antenna, 3 1/8"W, 2 1/4"H, 2"D.



TM-14

LAFAYETTE RADIO

SEND MAIL ORDER TO LAFAYETTE RADIO
111 JERICHO TURNPIKE
SYOSSET, LONG ISLAND, NEW YORK

PLEASE INCLUDE SHIPPING CHARGES WITH ORDER.

OTHER LOCATIONS

NEW YORK, N. Y.
100 6th Avenue

NEWARK, N. J.
24 Central Avenue

PARAMUS, N. J.
182 Route 17

JAMAICA, N. Y.
165-08 Liberty Avenue

BRONX, N. Y.
542 E. Fordham Rd.

BOSTON, MASS.
110 Federal Street

PLAINFIELD, N. J.
139 W. 2nd Street

FREE!

LAFAYETTE

**340 PAGE 1962
ELECTRONICS CATALOG**

*"America's Hi-Fi &
Electronics Shopping Center"*

Yours free for the asking — the biggest, best and most comprehensive catalog in the 41-year history of Lafayette Radio. Audiophile, Experimenter, Hobbyist, Technician, Engineer, Student, Serviceman, Dealer — you'll find what you want in this latest Lafayette catalog.

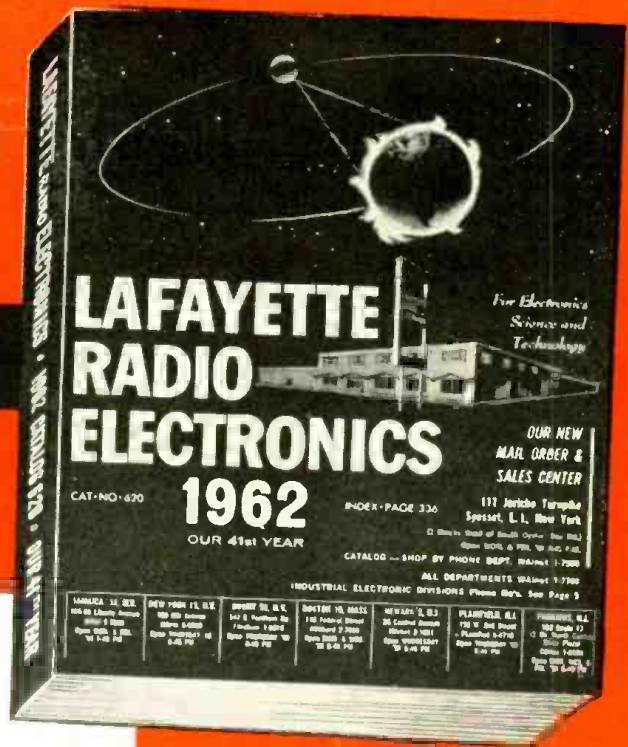

CATALOG # 620

LARGEST STOCK SELECTION. Stereophonic Hi-Fi equipment, Citizens Band, Ham and Amateur equipment, Radio & TV parts, Optics, Industrial Supplies, and much more, including all the favorite name brands.

LAFAYETTE EXCLUSIVES. Featured are the famous Lafayette Kits . . . dollar for dollar the best value for your money today. You'll also see hundreds of Lafayette specials . . . available only from Lafayette. And, as always, **SATISFACTION GUARANTEED OR MONEY REFUNDED.**

LOWEST PRICES. You'll save money too with Lafayette's low, low prices. The lowest prices are always in the Lafayette catalog.

24-HOUR SERVICE. Quick, courteous service is your guarantee at Lafayette. Most orders are fully processed within 24 hours after receipt in the mail Order Division.

NEW EASY-PAY PLAN.
Now, **NO MONEY DOWN . . .**
up to 24 months to pay.



**COMPLETELY WIRED,
FULL SIZE TUBE TESTER
TE-15.....19.95**



**10,000
OHMS-PER-VOLT
MULTITESTER
TE-10.....9.95**

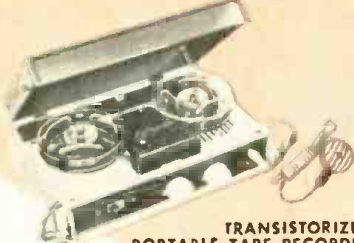

**TRANSISTORIZED
PORTABLE TAPE RECORDER
RK-125.....29.95**

**SUPERHETERODYNE
COMMUNICATIONS RECEIVER
KT-200, Kit64.50
HE-10, Wired79.95**



**FM STEREO
MULTIPLEX TUNER
LT-700129.50**



**9-TRANSISTOR
CITIZENS BAND
"WALKIE TALKIE"
HE-29A each 39.95
2-for 78.88**

LAFAYETTE'S

**NEW MAIL ORDER HEADQUARTERS
111 JERICHO TURNPIKE
(2 Blocks West of South Oyster Bay Rd.)
SYOSSET, LONG ISLAND, NEW YORK**

**Watch for Opening
Fall, 1961**



**LAFAYETTE RADIO, DEPT. RJ1-2
P.O. BOX 10, SYOSSET, L. I., N. Y.**

- Rush my FREE Lafayette 1962 Catalog 620
 Please send me # _____, shipping charges collect.

I am enclosing \$ _____

340 PAGES

Name _____

Address _____

City _____

Zone _____ State _____

COLUMBIA GEMS!

BC-669 TRANSMITTER-RECEIVER
 Freq. 1680-4450 kc. 75 W. AM Transmitter. 6 crystal controlled, pre-set channels on both xmit. and recvr. as well as VFO control, P.B. for marine or ham use. Built-in speaker. Full set of controls on front panel. Power requirements: 12 V. filament, 250 V., 100 MA for Recvr. 550 V., 400 MA for Xmitr. O.R.C. designed by Hal Peck. IICrafters for marine use. Excel. cond. **\$89.50**
 PE-110 Power Supply: for above. **\$49.95**
 110 V. Excel. **\$49.95**
 CD515 Connecting Cable: for above. Excel. **3.50**

MOBILE RADIO-TELEPHONE
 150-170 Mc. single channel, crystal control. FM. 6 V. Input; out, 25 W. Consists of transmitter, receiver, antenna, connecting cable and other accessories. Mfg. West Coast Elect. Good condition. Only **\$24.95**

RA-91 DRY DISC RECHARGER
 This unit is excellent for recharging and general purpose use. 110 V. A.C. 60 CPS input. This unit will deliver a charging rate of from 2 to 12 amperes into a 6 to 48 V. battery (3 to 24 lead acid cells). Unit has input and output circuit breakers, 0-15 ammeter. Fine and coarse voltage adjustment. Heavy duty transformer, filter resistor, and 4 selenium rectifier stacks. Brand new **\$39.95**

RCA NAVY MODEL TOQ 2 METER TRANSMITTER
 This fine unit built by RCA, 50 W. AM. Transmitter with built-in I.D.V. A.C. 60 CPS. Power supply and plate modulator. Uses 829-B in final, and 2-80T mod. Excellent condition **\$95.00**

Columbia's Classified Corner!
BC-610 TRANSMITTER
 Never before at this low price. Excel. **\$495.00**
PP-112 GRC POWER SUPPLY. Excel. **99.50**
ARC-34 TRANSCIEVER. Excel. Get this! **595.00**
ARC-27 TRANSCIEVER. Excel. con. A buy! **295.00**
SPECIAL! BC-348 RECEIVER **\$99.50**
 Excel.

FACSIMILE TRANSMISSION MODULATOR Model MD-168 T.M. Permits transmission of facsimile signals via air or wire. **\$99.50**
 BRAND NEW

RT-82 APX-6 TRANSCIEVER 1215 Mc.
 Less tubes... excellent condition **\$3.95**

WIRE RECORDER
 Manufactured by Air-King Products. This is a complete wire recorder with amplifier for voice and music with a 24V DC 2.5 Amps. input. This unit has 2 carbon microphone inputs and one 600 ohm audio output. 14" long, 8" wide, 8" high. Excel. cond. **\$9.95**

BC-375 100 W. TRANSMITTER
 Ideal for domestic use, as well as export marine and mobile! Freqs 200-13,500 kc. with proper tuning unit. CW or M.W. Excellent cond. Only **\$14.95**
 ABOVE. Unit in good condition. **\$9.95**
PE-73 DYNAMOTOR FOR ABOVE: Input 24 V. Output 1000 V. @ 500 mA. W/Filtering base. Like new. **\$7.95** Excel. cond. **\$4.95**
TUNING UNITS: For BC-375 Each **\$1.95**

| | |
|--|---|
| RA-105 POWER SUPPLY Sell-Out! 115 VAC. 60 cps. Input. Multiple outputs: 2400 V., 344 V., 295 V., 0-1 V. A.C. @ 12 amps. 0-3 VAC @ 10 amps. Uses 3 5U4 tubes, 7-2N20 and 1 6X5. With tubes. Good cond. Only \$9.95 . | HEAVY DUTY 12V BATTERY Thomas A. Edison dry charged 12V. @ 7.5 A.H. Ideal for mobile radio work. A COLUMBIA EXTRA. Spec. brand new \$29.95 |
|--|---|

RT-91/ARC-2 COLLINS TRANSMITTER-RECEIVER
 2.8 Mc. 50 W. Xmitr. and Recvr. Uses Collins PTO oscillator, includes 24 tubes and 100 kc. crystal. Built-in 24 V. dynamotor. Compact, table-top unit. P.B. for marine, amateur, and mobile use. Excellent cond. Features ultra-sensitive Recvr. with 3 I.F. stages, 4 I.F. stages. With schematic. **\$39.95**
 LIKE NEW. Special! Only **\$49.95**

DESK TELEPHONES
 Western Electric & other brands. With dial—excellent cond. **\$3.95**
 Less dial—excellent cond. **\$2.95**

APN-4B MARINE LORAN RECVR & INDICATOR
 Gives exact fix in relation to known stations. Works on 12 or 24 V. If you own a boat, this is the cheapest life insurance you can buy! **\$69.50**
 Like new, and UNEXD. only

WRITE IN for new Bargain Bulletin!
 All orders FOB Los Angeles. 25% deposit required. All items subject to prior sale. **NOTE** MINIMUM ORDER \$3.00. WRITE TO DEPT. R

COLUMBIA ELECTRONICS

4365 WEST PICO BLVD. LOS ANGELES 19, CALIF.

engineering degree in 27 mos.

Become an Electronics Engineer. Share rewards of college degree... more income, rapid advancement. Important firms interview seniors. They like Tri-State graduates. Qualify faster here. *Bachelor of Science Degree in 27 Months in Electrical (Electronics or Power major), Mechanical, Chemical, Aeronautical, Civil Engineering. In 36 Months in Business Administration (General Business, Accounting, Motor Transport Management majors).* For earnest, capable, mature students. Small classes. More professional class hours. Well-equipped labs. Dorms. Campus. Modest costs. Enter Jan., Mar., June, Sept. Founded 1884. Write J. H. McCarthy, Director of Admissions for Catalog and "Your Career" Book.

TRI-STATE COLLEGE
 16101 College Ave., Angola, Ind.

Speaker Testing & Measurement

(Continued from page 44)

radiated from the speaker rather than sound pressure at any particular angle.

Following the same reasoning, peaks and dips caused by diffraction around the cabinet edges—variations in response which do not change the total amount of energy radiated—are of very small significance in a listening room, although they will show up in an anechoic chamber reading.

Interpreting Response Curves

The most important information that a speaker response curve can convey relates to smoothness of response which, in turn, is an accurate index of transient response. Peaks which reflect speaker resonance predict ringing or hangover—the tendency of the speaker cone to continue to vibrate after the signal has stopped. In the bass this makes for boomy sound; in the midrange and treble it makes for harsh, blurred sound, often with a sort of nasal quality. Tone-burst tests are an excellent indication of transient response. They predict the degree of smoothness of frequency response even more accurately than the prediction of transient performance by frequency response curves.

Roughness in a response curve, which is the result of interference or diffraction, is not associated with resonant hangover and is not important. One way of identifying roughness caused by speaker resonance is to find the same peaks and dips in the response curve at various angles from the axis of the speaker.

Harmonic Distortion

Very little is ever said about speaker bass distortion, possibly because it is an embarrassing subject. When bass distortion studies are made and published, the percentage of distortion in the octave below 60 cycles (at moderate sound levels) generally ranges from about 5 to 50% and sometimes higher. Fortunately those speakers whose distortion is at the high end of this range often exhibit severe bass attenuation as well so that there isn't as much distorted bass to contend with, but clean bass is just as significant in speakers as it is in other components.

A loudspeaker may make a loud sound when a 30-cps signal is fed to it, but unless the distortion is reasonably low, the speaker cannot be said to have useful response at 30 cycles. The major part of the sound output may be at 60 and 90 cps, with little of the fundamental energy which gives a deep organ tone its "feel." All speakers have 30-cycle response in the sense that they do something when stimulated at this fre-

STANDARD TRANS VISION, INC.

39 **\$1 YEAR GUARANTEED RADIO-TV TUBES**
\$37 Per 100 TUBES
 EACH

All tubes not necessarily new, but may be electronically perfect factory stock or used. Each clearly marked. STANDARD TRANS VISION will replace FREE any tube that becomes defective in use within 1 year from date of purchase. All tubes individually boxed and marked. Partial listing only—thousands more tubes in stock!

| | | | | | |
|-----|-------|------|-----|-----|------|
| 31A | 5VAC | 6B6G | 6D6 | 7AT | 12X7 |
| 31B | 5V6GT | 6B6G | 6F6 | 7B5 | 12X8 |
| 31C | 5Y6 | 6B6G | 6H6 | 7B5 | 12X8 |
| 31D | 5Y6GT | 6B6G | 6H6 | 7B5 | 12X8 |
| 31E | 6AR5 | 6B6G | 6H6 | 7B5 | 12X8 |
| 31F | 6AR5 | 6B6G | 6H6 | 7B5 | 12X8 |
| 31G | 6AR5 | 6B6G | 6H6 | 7B5 | 12X8 |
| 31H | 6AR5 | 6B6G | 6H6 | 7B5 | 12X8 |
| 31I | 6AR5 | 6B6G | 6H6 | 7B5 | 12X8 |
| 31J | 6AR5 | 6B6G | 6H6 | 7B5 | 12X8 |
| 31K | 6AR5 | 6B6G | 6H6 | 7B5 | 12X8 |
| 31L | 6AR5 | 6B6G | 6H6 | 7B5 | 12X8 |
| 31M | 6AR5 | 6B6G | 6H6 | 7B5 | 12X8 |
| 31N | 6AR5 | 6B6G | 6H6 | 7B5 | 12X8 |
| 31O | 6AR5 | 6B6G | 6H6 | 7B5 | 12X8 |
| 31P | 6AR5 | 6B6G | 6H6 | 7B5 | 12X8 |
| 31Q | 6AR5 | 6B6G | 6H6 | 7B5 | 12X8 |
| 31R | 6AR5 | 6B6G | 6H6 | 7B5 | 12X8 |
| 31S | 6AR5 | 6B6G | 6H6 | 7B5 | 12X8 |
| 31T | 6AR5 | 6B6G | 6H6 | 7B5 | 12X8 |
| 31U | 6AR5 | 6B6G | 6H6 | 7B5 | 12X8 |
| 31V | 6AR5 | 6B6G | 6H6 | 7B5 | 12X8 |
| 31W | 6AR5 | 6B6G | 6H6 | 7B5 | 12X8 |
| 31X | 6AR5 | 6B6G | 6H6 | 7B5 | 12X8 |
| 31Y | 6AR5 | 6B6G | 6H6 | 7B5 | 12X8 |
| 31Z | 6AR5 | 6B6G | 6H6 | 7B5 | 12X8 |
| 32A | 6AR5 | 6B6G | 6H6 | 7B5 | 12X8 |
| 32B | 6AR5 | 6B6G | 6H6 | 7B5 | 12X8 |
| 32C | 6AR5 | 6B6G | 6H6 | 7B5 | 12X8 |
| 32D | 6AR5 | 6B6G | 6H6 | 7B5 | 12X8 |
| 32E | 6AR5 | 6B6G | 6H6 | 7B5 | 12X8 |
| 32F | 6AR5 | 6B6G | 6H6 | 7B5 | 12X8 |
| 32G | 6AR5 | 6B6G | 6H6 | 7B5 | 12X8 |
| 32H | 6AR5 | 6B6G | 6H6 | 7B5 | 12X8 |
| 32I | 6AR5 | 6B6G | 6H6 | 7B5 | 12X8 |
| 32J | 6AR5 | 6B6G | 6H6 | 7B5 | 12X8 |
| 32K | 6AR5 | 6B6G | 6H6 | 7B5 | 12X8 |
| 32L | 6AR5 | 6B6G | 6H6 | 7B5 | 12X8 |
| 32M | 6AR5 | 6B6G | 6H6 | 7B5 | 12X8 |
| 32N | 6AR5 | 6B6G | 6H6 | 7B5 | 12X8 |
| 32O | 6AR5 | 6B6G | 6H6 | 7B5 | 12X8 |
| 32P | 6AR5 | 6B6G | 6H6 | 7B5 | 12X8 |
| 32Q | 6AR5 | 6B6G | 6H6 | 7B5 | 12X8 |
| 32R | 6AR5 | 6B6G | 6H6 | 7B5 | 12X8 |
| 32S | 6AR5 | 6B6G | 6H6 | 7B5 | 12X8 |
| 32T | 6AR5 | 6B6G | 6H6 | 7B5 | 12X8 |
| 32U | 6AR5 | 6B6G | 6H6 | 7B5 | 12X8 |
| 32V | 6AR5 | 6B6G | 6H6 | 7B5 | 12X8 |
| 32W | 6AR5 | 6B6G | 6H6 | 7B5 | 12X8 |
| 32X | 6AR5 | 6B6G | 6H6 | 7B5 | 12X8 |
| 32Y | 6AR5 | 6B6G | 6H6 | 7B5 | 12X8 |
| 32Z | 6AR5 | 6B6G | 6H6 | 7B5 | 12X8 |

ORDER SHIPPED SAME DAY RECEIVED
 SHIPPING INSTRUCTIONS: STANDARD TRANS VISION PAYS YOUR POSTAGE on orders of \$10 or more in U.S.A. and Territories. Send address, postage on Canadian and foreign orders. Any order less than \$10 requires 25c handling charge. Send 25c on C.O.D.'s. ANY RECEIVER TUBE NOT LISTED ALSO AVAILABLE AT 39c EACH!

STANDARD TRANS VISION, INC.
 3750 E. 10th Ct. HIALEAH, FLORIDA
 Phone: OXford 1-5331

VOCATIONAL STUDENTS

It Took Us 2 Years To Design This TV Kit Especially For You

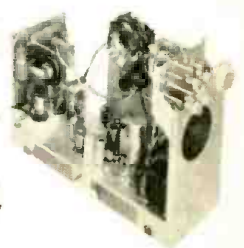

VIDEOLA by Tech-Master

Every Part Custom-Engineered Exclusively For This Chassis

With this kit you build more than a chassis... You build a career in electronics. Tech-Master's VIDEOLA guarantees you the ultimate in training and development. For this is the most up-to-date professional kit available. Every possible improvement in tubes and circuitry is included. Each and every component is absolutely related... engineered precisely for this kit... designed for flawless assembly and maximum performance. There are no printed circuits. You build everything yourself. Step-by-step instructions with easy to follow pictorial and schematic diagrams.

FEATURES: Advanced and improved, super-selective, 12 channel tuner—Full power transformer for safe cold chassis operation—Operates new low-voltage electrostatic focus kinescope (17" to 27" including 19" and 23" sizes)... 110 to 114 degree deflection—18 to 20 KV anode voltage—High efficiency circuit-sensitivity of 9uv at 20V peak-to-peak—High power audio output—Three-stage stagger-tuned IF using high-gain bi-filar coils—Keyst automatic gain control—Adjustable noise cancellation circuit—Bright spot eliminator circuit—Ceramic core horizontal output transformer with beam power amplifier—Chassis constructed so that tuning and related controls are on separate panels. Can be placed away from chassis proper to accommodate custom requirements—Sockets, terminal strips and connectors riveted on chassis. 6x17x1-3/4 chassis size—Weight 21 lbs.

MODEL 1561... PRICE \$99.95

COMPLETE CONSTRUCTION MANUAL \$3.75
 Cost Of Manual Refunded With Kit Purchase

Videola by Tech-Master
 75 Front St., Brooklyn 1, N. Y.

quency; a two-inch portable speaker may respond by having the cone fly out into the air. To be meaningful a frequency response curve must be accompanied, particularly in the bass range, by a distortion curve. An alternative is to have non-fundamental components filtered from the microphone output before the level is recorded.

Meaning of Speaker Measurements

Speakers are very imperfect devices and the state of the art has not achieved the level of transparency of electronic circuitry. There is a large subjective element involved in evaluating loudspeakers, even with the most reliable test results available. This is because one must make a choice among various types of speaker deficiencies—the tendency to shrillness of one speaker, to boominess of another, or to distortion of a third. In all cases one must decide which aberration intrudes itself least into the illusion of musical reality. To one person a particular defect will mar the naturalness of sound more than will another.

Taste is an important element in evaluating a creative musical performance, but it does not help in evaluating the accuracy of re-creation, that is, the degree of fidelity of sound reproducing equipment. Perception and understanding of the degree of similarity to the original sound, rather than likes and dislikes, should be the key in judging loudspeakers.

Objective test results give more information on loudspeakers and, to the experienced person who knows how to interpret such results, the actual sound of the speaker can be predicted before the speaker is ever connected to a hi-fi system. As long as the test conditions for objective measurements are correctly interpreted in relation to what they have to say about musical realism, they are extremely useful to the consumer and indispensable to the designer. They have the advantage, of course, of being unaffected by the tester's musical preferences, his current mood, or what he had for lunch.

REFERENCES

1. If the anechoic chamber is a very large one, such a curve can be interpreted. Each time the solid angle is cut in half the bass range of the response curve is lifted in a predictable manner, by 3 db. See Heranek, Leo L.: "Acoustics", McGraw-Hill Book Company, Inc., New York, 1954, page 320.
2. Correction of the response curve to account for a further reduction of solid angle can be avoided by using a lower amplifier damping factor, which accomplishes the same result. ▲

REDUCING FM BACKGROUND NOISE

By ELWOOD C. THOMPSON

TO REDUCE background noise in FM receivers when no station is tuned in, try adding fixed bias to the limiter tube. Sufficient bias should be used to cut the tube off, plus enough to keep the noise voltage from drawing limiter grid current. ▲

KIT KING ITS

SAVE CASH

YOU GET MORE ITEMS FOR LESS MONEY

PACKED IN THE NEW RE-USABLE BOX FOR EASY SHELF STACKING! OBSOLETE PLASTIC BAGS

- 5 1N34 DIODES, gl. sealed, germanium 5 for 66c
- 15 ALLEN BRADLEY RESIST., 1/2-watt, 15 for 66c
- 5 VOL. CONTR'LS, to 1/2-meg, mini too 5 for 66c
- 25 COILS, r.f. ant. osc., slug-t., i.f.s. 25 for 66c
- 5 ELECTROLYTICS, FPS, tubular, siml. 5 for 66c
- 5 TRANSISTOR SOCKETS, low loss case 5 for 66c
- 15 STANDARD KNOBS, radio-TV, hi-fi 15 for 66c
- 30 CERAMIC CONDENSERS, to .01 mf 30 for 66c
- 2 SYLVANIA TRANSISTORS 2 for 51
- 10 CARBON RESTRS., 1/2, 1, 2W; 1.5% 30 for 66c
- "HOOK-UP" WIRE SPEC., all types 150 ft. 66c
- 20 TUBE SOCKETS, minishield based 20 for 66c
- 30 RESISTOR SPEC., to 1/2-watt every type 30 for 66c
- 30 TUBULAR CONDENSERS, .001-.3mf 30 for 66c
- 5 TRANSISTOR SOCKETS, low loss case 5 for 66c
- 5 TRANSISTOR ELECTROLYTICS 5 for 66c
- 15 MINI. PRECISION resist., 1% 10 for 66c
- 15 CRYSTAL DIODES, germanium 15 for 66c
- 750-MIL TUBULAR RECT., 500V, epoxy 66c
- 500-MIL SILICON RECTIFIER 3 for 66c
- 750-MIL "TOP HAT" RECTIF., silicon, 300V 66c
- 75-ft HOOKUP WIRE, 25-ft rolls, awg. 75 ft. 66c
- 30 TERMINAL STRIPS, lug & screw 30 for 66c
- \$15 RELAY SURPRISE, guaranteed to satisfy 66c
- 5-PR. RCA PHONO PLUG & JACK SETS 5 pr. 66c
- POWER RES., 1/2-watt, 50-750ohms 10 for 66c
- 30-PC. CONDENSER "SPEC." variety 30 for 66c
- 1 365mmf VARIABLE COND., 1 1/2 sq. 66c
- 25 "HI-Q" CONDENSERS incl: 470K 25 for 66c
- 400 PCS HARDW., screws, nuts, etc. 400 for 66c
- 30 MICA CONDENS., incl. "silvers" too 30 for 66c
- 30 CERAMIC CONDENSERS, to .01mf 30 for 66c
- 15 SILVER MICA CONDENSERS, 1% tool 15 for 66c
- 10 MOLDED CONDENS., .003-.25mf 10 for 66c
- 25 SUBMINI DISC., cond., .001 to .05 25 for 66c
- FERRITE LOOPSTICK, 8" mat., 360mmf var 66c
- 1 PHILCO PNP TRANSISTOR, worlds smallest 66c
- 2 SUN CELLS; 55 sq. unmd 2 for 66c
- 3 PNP TRANSISTORS: "golden" value 2 for 66c
- 3 NPN TRANSISTORS: "golden" value 3 for 66c
- TOGGLE TYPE SWITCHES: SPST, DPDT 4 for 66c
- 1 GIANT SUN BATTERY, 1 1/2" dia., unmd 66c
- 15 PRECISION RSTRS., 1% 1/2, 1, 2W 15 for 66c
- TRANSISTOR VOL. CONTRL with switch, 5K 66c
- DUAL 1-meg. VOL. CONTRL, stereo balance 66c
- CARBON MINE TRANSFM, 100 ohms to 120K 66c
- 13 PRNTD CKT PYS., xfr. con. res., etc. 13 for 66c

SAVE \$3-\$25 Per Kit

All Parts Made in U.S.A.

Sold by LEKTRON Only!

All Parts BRAND NEW!

CLIP OUT AND MAIL

HOW TO ORDER: Check (✓) boxes; send check, cash, or m.p. Rated 30 days.

POSTAGE CHART

\$5-\$10 ORDER—ADD 85¢

\$2-\$5 ORDER—ADD 55¢

MINIMUM ORDER—4 KITS

MAIL TO:

LEKTRON KIT KING DIVISION

241-243 EVERETT AVE., CHELSEA 50, MASS.

NOW! . . . IT'S

QUIETROLE

with the

FREE EXTENDER TUBE



Quality QUIETROLE, your first choice "Lubri-Cleaner" in silencing noisy controls and switches on TV, radio and electronic instruments now provides you with a FREE EXTENDER TUBE to easily reach those once "hard-to-get-at" places. You'll like QUIETROLE better than ever now . . . In spray can or bottle.



IN SPRAY CAN or 2, 4, 8 oz. BOTTLES

manufactured by

QUIETROLE

COMPANY

Spartanburg, South Carolina

In Canada: CROSS CANADA ELECTRONICS
12 Laurel Street, Waterloo, Ontario

"Head" gone FLAT?



Call your dealer to replace with Nortronics Magnetic Recording Heads found in most original equipment. See what a difference a Nortronics Replacement Head or 4-Track Stereo Conversion can make.

World's largest manufacturer of laminated heads . . . the heart of your tape recorder.

Send 25¢ for Tape Recording Manual



THE **Nortronics** CO., INC.

"Music sounds best on tape—tape sounds best on Nortronics Heads!"

1023 South Sixth St., Minneapolis 4, Minn.

October, 1961

99

www.americanradiohistory.com

FREE CAREER BOOKLET

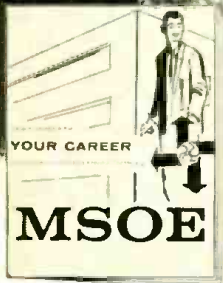

to guide you to a successful future in

ELECTRONICS
RADIO-TV
COMPUTERS
ELECTRICAL ENGINEERING

This interesting pictorial booklet tells you how you can prepare for a dynamic career as an Electrical Engineer or Engineering Technician in many exciting, growing fields:

**MISSILES • RADAR • RESEARCH
ELECTRICAL POWER • ROCKETRY
AUTOMATION • AVIONICS
SALES • DEVELOPMENT**

Get all the facts about job opportunities, length of study, courses offered, degrees you can earn, scholarships, part-time work — as well as pictures of the Milwaukee School of Engineering's educational and recreational facilities. No obligation — it's yours free.

MILWAUKEE SCHOOL OF ENGINEERING

MAIL COUPON TODAY!

MILWAUKEE SCHOOL OF ENGINEERING
Dept. EW-1061, 1025 N Milwaukee St.
Milwaukee, Wisconsin MS-113

Please send FREE "Your Career" booklet
I'm interested in Electronics Radio-TV
 Computers Electrical Engineering
 Mechanical Engineering
(PLEASE PRINT)

Name _____ Age _____

Address _____

City _____ Zone _____ State _____

I'm eligible for veterans education benefits.

Discharge date _____

SERVICE INDUSTRY NEWS

Interest in color grows; more developments noted.

WHETHER CURRENT excitement will be reflected in sales figures, where it counts, won't be known for at least several months, but color TV has surely been responsible for much talk—and activity, too—on the manufacturing end. In recent months, we have noted the introduction of an improved, shadow-mask CRT by *RCA* and the serious entry of both *G-E* and *Zenith* into receiver production, with innovations in circuit design. Other manufacturers have elected to market *RCA*-built chassis in their own cabinets. Since our last report, at least five more "names" have entered the color derby in one way or another.

Motorola, although not about to market a set, created the greatest stir with a successful demonstration of a 90-degree, 23-inch, rectangular tube. The CRT is otherwise a conventional three-gun, shadow-mask type not likely to effect a significant cut in set prices, at least initially. What, then, are its advantages? The manufacturer sees at least two, the first based on the conviction that receiver cost is *not* the chief deterrent to sales. Present round, 70-degree tubes, large and bulky, have necessitated cabinets that are correspondingly ungainly. The squared-off tube not only displays a picture of the same, familiar size and shape as that obtained on monochrome types, but also permits more acceptable housing. *Motorola* made its point by demonstrating an operative receiver in one of the furniture-styled cabinets used for its monochrome line. It feels people will pay for a receiver that meets their requirements.

Motorola has not attempted to alter the basic structure of the triple gun in the re-designed CRT, which is already five inches shorter than the round tube. An additional effort in this direction, it is felt, might result in a "short-necked" type that would reduce depth still more.

Another claimed advantage is that, whereas production of the round CRT requires heavy investment in all-new equipment, the rectangular version may be built with existing black-and-white production facilities, plus a relatively modest investment in add-on equipment. CRT makers other than *RCA*, with no assurance of appreciable demand, have been notably reluctant to

YOU SAVE MONEY!

RUSH US YOUR LIST OF HI-FI COMPONENTS FOR A SPECIAL QUOTATION WRITE FOR FREE AUDIO DISCOUNT CATALOG A-15

New low prices on amplifiers, tuners, tape recorders, speakers, etc.

KEY ELECTRONICS CO.
120 LIBERTY STREET
NEW YORK 6, N.Y.

PREFERRED TUNER CLEANER OF OVER 250,000 SERVICEMEN



Special CADDY SIZE... 98c
includes FREE "SPRAY-AID"

CHEMTRONICS inc.
870 East 52nd Street, Brooklyn 3, New York

TEACH-R-MATIC



Actual Dia. 11 1/4"

NEW!

Automated Teaching Device

BE A RADIO-TV DIAGNOSTICIAN! TEACH-R-MATIC self-teacher with Home Study Course TV-1 enables you to learn faster & easier. Makes home study more effective. Improves memory. Ideal for review. Provides practical home instruction in diagnosing TV and radio troubles.

ILLUSTRATES and gives symptoms of fifty oft-recurrent TV faults PLUS symptoms of fifty common radio faults. Provides 500 TESTS on cards—YOU SELECT ANSWERS. TEACH-R-MATIC tells you automatically and immediately if selection is right or wrong.

Also indicates by code where to look for defects causing troubles & how to remedy them. Score cards check proficiency and progress.

TEACH-R-MATIC can be used to study other subjects. New home study courses will soon be announced.

SPECIAL INTRODUCTORY OFFER!

Place order promptly and you will receive absolutely FREE Cisin's RAPID TV TROUBLE SHOOTING METHOD selling at \$1.00 This offer expires Oct. 31st, 1961.

TEACH-R-MATIC is the invention of Harry G. Cisin, well-known educator, author and inventor. It is FULLY GUARANTEED. Money back in 5 days if not satisfied, if TV-1 is returned in original condition.

Special quantity discounts to correspondence schools, distributors and residence schools.

PRICE \$4.90
(postage 10¢)

Price includes TEACH-R-MATIC device and TV-1 Study Course

RUSH COUPON NOW!

H. G. Cisin, Consulting Engineer
Dept. R-1—Amagansett, N.Y.

Enclosed find \$ —. Rush TEACH-R-MATIC device and HOME STUDY COURSE TV-1. Also include FREE copy of RAPID TV TROUBLE SHOOTING METHOD as per Special Offer.

Name _____
Address _____
City _____ Zone _____ State _____

functioning legislation that still stands today as a model for other areas. We had the privilege of knowing him and seeing him in action. In addition to serving TSA as president for three terms and in other capacities, he was a prominent civic leader and Chamber of Commerce official.

Hoosiers Honor Teskey

It will take a constitutional amendment to do it, but IESA of Indiana is creating a new position on its board of directors for Frank J. Teskey, editor of its official monthly, "The Hoosier Test Probe." The move acknowledges the significant role the publication—and its editor—have played in advancing IESA activities. It also facilitates the close coordination needed to enhance this role in the future. Teskey, whose conviction that national unity is essential figured prominently in bringing his Indianapolis group into the NATESA fold, was also named chairman of the IESA License Steering Committee. Good luck, Frank. We hope your stepped-up activities leave you some time to run your shop!

Also from Indiana comes news that the central part of the state is being swept by the "free" tube-testing gimmick. As has been the case elsewhere, this "wave" will pass after a while, when enough set owners have been taken in to alert the remainder. However, it will leave in its wake not only fleeced customers, but legitimate servicers who have lost income, and a blackened eye for TV service in general.

IESA proposes to resist the racket with facts for its members and their customers. Men making calls for the "free" testers, it states, work on commission only and therefore must build up a bill to make a profit on each job. Customers are "loaded" with as many new tubes, after testing, as possible, needed or not. Then come extras, often over-priced, like cleaning the tuner (no chassis removal), adjusting controls (\$3.50), and rejuvenating the CRT (\$9.95, plus \$4.50 for a brightener). Sets are pulled wherever possible. The lowest shop bill noted in this case was \$44. Often there is no evidence that work has been done. Proof, once more, of the high cost of getting something for nothing.

Stop the CRT Racket

While a rebuilt picture tube, properly made and using a new gun, is *bona fide* merchandise, some shady "rebilders" are peddling substandard goods. "NATESA Scope" claims that at least 60 per-cent of this shoddy merchandise has never been opened up, using the original gun, possibly rejuvenated. On this premise, it suggests how the racket can be stopped cold. Every legitimate technician should apply line voltage to the heater pins of every dud through a cheater cord to burn up the filament. This will not impair the dud's value either to him or to an honest rebuilder, but it will thwart the "junkmen" completely. ▲

EICO new Transistor Stereo/Mono 4-track Tape Deck

Model RP 100W
Completely assembled, wired and tested with 3 heads, and stereo record and stereo playback pre-amplifiers.

Model RP 100K
Semi-Kit includes transport completely assembled and tested with 3 heads and control electronics, stereo record, and stereo playback pre-amplifiers in easy-to-assemble kit form.

Write for full specifications

TAPE STORAGE OR CARRYING CASE

reg. 9.95, now 5.95

(Heavy wood construction, waterproof vinyl covering. Holds up to 24 tapes.)

reg. 2.45, now 1.49

(Pressed cardboard, holds 10 tapes or 60 45 rpm records.) Plus Postage

SAXITONE RECORDING TAPE

*Guaranteed not to rub off or squeak—or money back. Compare ours with other "bargain" tape. You'll find it's more than just "price" when you deal with us. We are original processors in the tape recorder business and our reputation means everything to us.

| | |
|--|------|
| 600' acetate plastic, 5" | .75 |
| 900' MYLAR 5" reel | .95 |
| 900' MYLAR polyester, 5" | 1.18 |
| 1200' MYLAR, 1 1/2 mil, 5" reel | 1.19 |
| 1200' Acetate plastic, 7" | 1.68 |
| 1800' MYLAR, 1 1/2 mil, (strong) | 1.79 |
| 1800' acetate plastic, 7" | 1.99 |
| 2400' MYLAR, intensitized, 7" | 2.69 |
| 2400' MYLAR, tensitized, 7" | 2.99 |

Studios, Large Users Even Lower. PLUS POSTAGE



Save 30% on 4-Track STEREO MUSIC ON TAPE!

Empty 3 in. Plastic Reels 7¢ ea.

BARGAIN PRICES! SEND FOR OUR FREE Tape Recorder/Blank/Pre-recorded Tape Catalog

NORELCO SPEAKER

Famous A13800M, twin cone 8" (75-19,000 cycles) discontinued model, former \$18.00, usual net 9.00 going at 4.95 plus postage, (10 for 39.95). Other Norelco speaker sizes at bargain prices—SEND FOR SPEAKER SPECIFICATION SHEET.



SAXITONE TAPE SALES

(DIV. OF COMMISSIONED ELECTRONICS, INC.)
1776 Columbia Rd., NW, Washington, D.C.

MOVING?

Make sure you notify our subscription department about any change of address. Be sure to include your postal zone number as well as both old and new addresses. Please allow four weeks' time for processing.

ELECTRONICS WORLD

434 South Wabash Avenue
Chicago 5, Illinois

- BC-1306 3800-6500 KC TRANSCEIVER, new, 29.95
- unusual wiring tubes—20 lbs.
- PE-237 6, 12 or 24 VOLT POWER SUPPLY for 17.95
- 1300 new, unusual—w Vibrator—75 lbs.
- MULTITESTER #1-176—checks volts, AC/DC, ohms, 19.95
- to 10 meg, microamps, millamps, 20,000 ohms, vol, 11 x 8 x 3 used, tested, with new batteries
- 2 METER TRANS. #SCR-522, 18 tubes, gal 24.95
- cont. 10 lbs.
- FIELD PHONES—EE-8, w/leather case, 23.95
- gd cont. 10 lbs.
- POWER SUPPLY CHASSIS—11 x 6 x 2, Brand new, 9.95
- 10 lbs., M-304, 5000, 24V 150, 24V 105, 10-0, 1-0817 with all tubes
- LOW VOLTAGE SUPPLY—input 115 VAC, 60 cycle, 8.95
- out 1.4 VDC, 2 amps; key max mar case, br new, 20 lbs
- PARABOLIC DISH—3 CM—10" APD—11" w motor 9.95
- and gears, 24 VDC, brand new, boxed, 15 lbs.
- DYNAMOTOR—CARTER—input 6 VDC output 27.5 VDC, brand new, 4.95
- TRANSMITTER—BC-604-20—27.5 Mc w/all tubes—less dynamotor—brand new—50 8.95
- lbs.
- ANTENNA SYSTEM—AS-50—TNC-22 connector to a 10" alum. mast, comp. w 50' RG 8 U, hdwre, tools, gny canvas carry sacks—10 lbs— 29.95
- boxed
- ART-26 TRANSMITTER—300-100 Mc cavity, CXP 24.95
- triod oscillator, 15 tubes, motor plus pwr supply plus 10' APT-3, brand new, complete.
- 50 lbs.
- COMPLETE LINK TRANSMITTER—receiver system 150.00
- MS-3—contains transmitter, receiver, 20' CFT, 30-42 Mc FM, self powered 115 VAC, 60 cycle or 6 VDC, control box, cables, handset, test-set and test manual—etc, used condition, complete.
- NATIONAL "S" METER—plus 50 ohm over 3.49
- 80—2 mil base, illuminated, new
- ARC-5 MODULATOR—M-7 (plan 3) with all 7.95
- tubes—dynamotor, used cond, 20 lbs
- CO-AXIAL RELAY ASSEMBLY—180 ohm coil, 1.95
- BNC connectors, U.S. Navy, new, 1 lb

REX RADIO SUPPLY CO.

88 Cortlandt St. New York 7, New York CO 7-1617

Marine Radios To Double In 5 Years

Number of licensed radio-telephones may hit 180,000.

THE total number of licensed marine radiotelephones will double to 180,000 over the course of the next five years, according to a prediction by J. Leonard Lovett, marketing manager for *Raytheon* marine products. Lovett also predicted that motor manufacturers will yield to consumer pressure and offer motors that adequately suppress ignition and generator noise radiation.

The addition of alternators on outboard motors and improved noise suppression, coupled with more efficient and less expensive radiotelephones to be introduced by electronic manufacturers, will further tax the available communications channels. Lovett suggested increased use of the Citizens Band to relieve some of this traffic. Citing the inability to call the Coast Guard on 27-mc. equipment, he proposed designation of a single channel in each boating area as a safety and distress channel and urged the Coast Guard to monitor this channel locally. He also proposed the development of an inexpensive radiotelephone alarm system.

Discussing other alternatives to the marine band for all communications, the *Raytheon* executive praised v.h.f. equipment but observed that the general safety and calling frequency of 158.6 mc. is not well guarded because of the limited number of v.h.f. sets in use. A marine v.h.f. 3- or 4-channel radio telephone represents an investment of \$750-\$800 whereas a 4- or 5-channel marine-band unit costs only \$250-\$300. He predicted that the marine band would continue to enjoy at least a two-to-one price advantage over v.h.f. despite new components and manufacturing techniques.

Although many years away from widespread use on small craft, single-sideband equipment will eventually help relieve the congestion. This type of equipment will be particularly attractive to long-range pleasure craft and commercial vessels.

Lovett urged that communications education programs be tied more closely to over-all safe boating programs. "If you analyze the various electronic products sold in quantity to small craft owners, you will find that they offer added attractions besides safety. The depth sounder helps with fishing, the radiotelephone adds the convenience of being able to talk to home or office and adds prestige, and the RDF also plays broadcast frequencies. The gasoline fume detector, however, is not sold in large quantities. It is reliable and not too expensive but it doesn't do anything except protect life and property. If it would play music or something, it would probably sell in quantity and reduce the needless explosions and fires we encounter every season." ▲

news from hallicrafters



CB-3 TRANSCEIVER

Only Hallicrafters offers 8-channel convenience and all these quality performance features.

The transmitter . . . output circuit matches 50 ohm antenna systems. Standardized CR23/U crystals (3rd overtone, series resonant) readily available. Output amplifier adjustable for max. legal input. 100% modulation on positive peaks. Series-tuned 2nd harmonic trap for excellent TV suppression.

The receiver . . . sensitivity less than 1.0 UV for 10 db. signal-to-noise ratio. Electronic squelch works on less than 6 db. signal strength change. 6 kc. selectivity. Image rej. 40 db. min. Audio output over 2 watts. Auto. noise limiter. series and shunt diodes.

\$149.50

citizens band

Before you choose from the countless brands of CB equipment available, consider this fact: Nowhere in the field of communications is a manufacturer's experience, integrity and record of achievement more critical to performance and reliability than in citizen's band. Hallicrafters has built more precision communications equipment than *all other CB manufacturers.*

the new ideas in communications are born at . . .



Chicago 24, Illinois

Export Sales: International Div.,
Raytheon Mfg. Co., Waltham, Mass.

Canada: Gould Sales Co.
Montreal, P.Q.

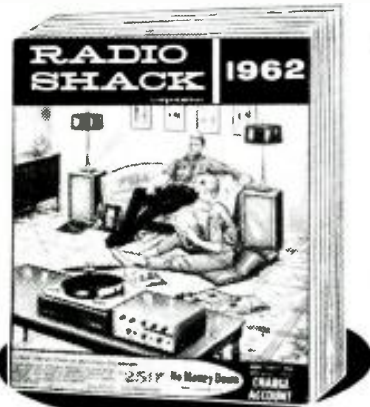

RADIO SHACK Corp.
Boston, Massachusetts

Send for your **FREE** personal copy of
RADIO SHACK'S 336-PAGE 1962 CATALOG
Nationwide standard of excellence in
Electronics, Music, Communications

Also receive all other issues for 1 year!

Our bigger, better catalogs offer the widest line of electronic parts and equipment in the world! Latest in Stereo, Hi-Fi, Ham Radio, Test Equipment, Pre-Recorded Tapes, Tape Recorders, Records, Component Parts—plus 30 pages of new fun-to-build kits. Every item is easy to own on new No Money Down Credit Terms. Every item is guaranteed to satisfy or your money back.

MAIL THIS COUPON TODAY

RADIO SHACK Corp. Dept. 61K6A
730 Commonwealth Ave., Boston 17, Massachusetts
Please send me Radio Shack's new 1962 Electronics Catalog and every new issue for the next 12 months—all FREE and POSTPAID.

Name _____

Address _____

City & Zone _____ State _____

REDUCING FM MULTIPATH DISTORTION

New information on a type of distortion that may affect your FM reception—based on some recent BBC studies. / By PATRICK HALLIDAY

HIGH-FIDELITY reception of FM sound broadcasts suffers more often than is generally realized from multipath distortion. This distortion, due to simultaneous pickup of direct and reflected v.h.f. signals, is the counterpart of the much better known "TV ghosting." It is similarly brought about by signal reflections from hills, towers, buildings, and the like, and occasionally by freak auroral propagation. But, whereas ghost images unmistakably pinpoint this condition on TV, the resulting audio distortion on sound program material is often attributed to equipment shortcomings.

Because multipath distortion, when severe, can sound like an off-center voice coil, complaints are often wrongly directed to loudspeaker manufacturers. Less severe distortion may pass unnoticed for a time but eventually shows up on certain types of program material. Fresh information on this type of distortion has come to light recently as a result of investigations by the *British Broadcasting Corporation*, using delay lines to simulate reflections.

European broadcasting came late to FM, but once the decision to introduce v.h.f. broadcasts had been made, there were no half measures. West Germany, with AM programs severely handicapped by lack of frequency allocations after World War II, established a nationwide FM service in the early fifties. A few years later, despairing of the chaotic and overcrowded conditions on the AM broadcast bands, the *BBC* and other European broadcasting organizations followed suit. In Britain there is now a full three-program FM network in the 87.5-100 mc. band available to 97 per-cent of the population: one home in five has an FM or AM/FM, or combined TV/FM receiver. The primary intention is to provide an interference-free, rather than a high-fidelity, service but the performance specifications for the FM transmitters call for an a.f. response from 60 to 10,000 cps with less than 1 per-cent distortion at the full 75-ke. deviation; and but little worse up to 15,000-20,000 cps and down to 30 cps. In practice, the audio performance is often restricted by the losses in the program lines between studios and transmitters. But for many of the more important musical transmissions special lines are used and the transmitted a.f. range is well calculated to meet the needs of the most discriminating high-fidelity enthusiasts.

But within a short time of the opening of the FM service, reports of poor quality began to trickle in to the *BBC*, and engineers were put on to investigating these unexpected complaints. It was soon discovered that the trouble was caused by multipath reception which, until then, had received com-

paratively little attention and was almost ignored in many standard texts. Set makers were advised to improve AM suppression characteristics and recent receiver designs have proved less susceptible.

Effects & How Produced

Whereas this form of distortion often passes unnoticed on standard broadcast receivers of restricted audio range, it can show up on hi-fi installations in varying degrees from just perceptible to a severe breaking up of the higher audio notes. Difficult to detect on orchestral music, it can be observed on sustained notes and solo instruments, particularly piano pieces. Although most common in fringe areas or in pockets of poor signal strength, distortion may be experienced almost anywhere throughout the service area of an FM transmitter.

Basically, multipath distortion is produced by the mixing of the reflected signal with the direct signal, the combination possessing unwanted amplitude and phase modulation which may prove too much for the degree of limiting provided by a ratio detector even when assisted by the partial limiting found in most FM receivers and tuners. In the *BBC* investigations it has been found that high-fidelity tuners are often only marginally better than standard

tuners in combating multipath effects; possibly because of the phase- or frequency-modulated component. A good capture ratio thus helps but, as we shall see later, is not the whole story.

Improving AM Suppression

A well-designed ratio detector provides considerable AM suppression on good signals, but is vulnerable to downward amplitude modulation of the carrier, a condition which often occurs in multipath conditions. Additional limiting is thus highly desirable, provided the receiver has sufficient reserve of gain to permit this.

Fig. 1 shows the final i.f. stage of a typical FM receiver: the effect of R_1 and C_1 in the grid return converts what would otherwise be a straight amplifier into a saturated limiter provided that the carrier input is sufficient to cause grid current to flow. The time constant, $C_1 \times R_1$, is chosen to be long enough to allow the AM signal variations to develop bias to reduce stage gain but not so long as to make the receiver susceptible to ignition and other impulse forms of interference: typical values would be between 2.5 and 10 μ sec. Low plate and screen voltages improve the limiting effect at the expense of some reduction in stage gain. This type of limiting can be much improved by applying it to two stages with a short time constant in the first stage and a longer one in the second stage; this is usually possible only in the more elegant tuners having a good reserve of gain.

Fig. 1 also shows a popular method of reducing distortion of the i.f. response curve due to positive feedback in the tube. The plate decoupler, C_2 , is connected to screen instead of direct to chassis. The common plate and screen decoupler, C_3 , then forms part of a bridge neutralizing circuit in conjunction with the tube capacitances.

Another method of improving the AM suppression characteristics of an unbalanced ratio detector, incorporated in a number of current European FM and AM/FM receivers, is shown in Fig. 2. A 5000-ohm pre-set AM rejection control can be adjusted at the factory or by a service technician to provide a position of maximum AM suppression. Accurate setting of this control requires the injection into the receiver of an AM signal from a generator entirely free from any appreciable FM component and adjustment of the pre-set control for minimum audio output. Connection of the d.c. potential developed in the ratio detector to the suppressor grid of the first or second i.f. stage provides a.g.c. action to further reduce the effect of signal variations.

However, standard limiter circuits of this type will not eliminate entirely

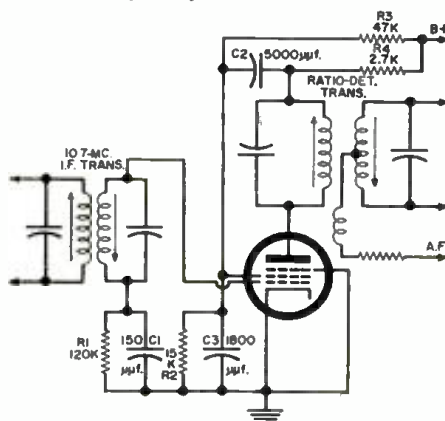
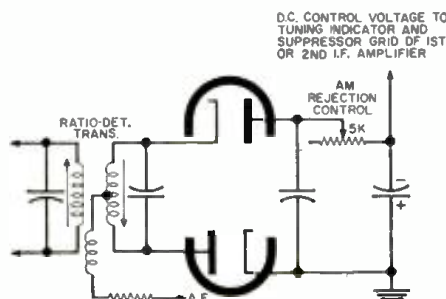

Fig. 1. Final i.f. stage of typical FM receiver showing one method of reducing distortion of the i.f. response curve.

Fig. 2. A method of improving the AM suppression characteristics of ratio detector.



RCA ELECTRONIC INSTRUMENTS

"PREFERRED BY PROFESSIONALS"

METERS and TUBE TESTERS

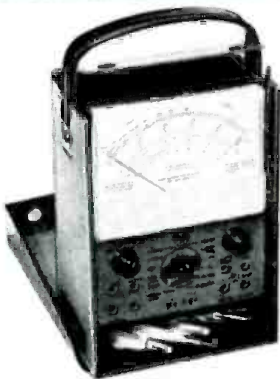

WV-38A VOLT-OHM-MILLIAMMETER THE V-O-M WITH THE EXTRAS!

Compare this superlative RCA V-O-M against the model you may have been thinking of buying. See if it doesn't check out better in these extra features:

- EXTRA! 1.0 volt and 0.25 volt ranges DC!
 - EXTRA! Big easy-to-read 5 1/4" meter!
 - EXTRA! Non-breakable plastic case; no glass to crack or shatter!
 - EXTRA! Smart attractive modern styling—the V-O-M of the future!
 - EXTRA! Red test lead has probe and slip-on alligator clip for added versatility!
 - EXTRA! Orderly location of jacks below switches keeps leads out of the way!
 - EXTRA! Spring clips on handle to hold test leads!
- EXTRA! DB scales clearly marked: no squinting!
- EXTRA! Rugged, scuff-proof, stain-resistant laminated vinyl carrying case, only \$4.95* extra!

Only \$43.95* complete with batteries, instruction book and all probes, clips and cables. (RCA V-O-M Kit only \$29.95*.)



NEW! WV-77E VOLTOHMYST®

Measures AC and DC voltages to 1500 volts; resistance from 0.2 ohm to 1,000 megohms. Separate scales, 1 1/2 volts rms and 4 volts peak-to-peak for low AC measurements.

Only \$43.95* complete with probes, leads, instructions. (RCA VoltOhmyst Kit only \$29.95*.)



NEW! WV-98B SENIOR VOLTOHMYST®

Measures AC and DC voltages (3% accuracy); resistance from 0 to 1,000 megohms. Measures peak-to-peak values of complex waveforms. Rugged cast aluminum case, big 6 1/2" meter. Only \$79.50* with leads, clips, instructions. Also available in economical kit form.

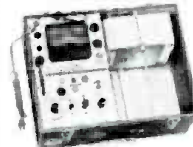

WT-110A AUTOMATIC ELECTRON TUBE TESTER

Especially designed for testing of electron tubes. Uses automatic punched-card selection of correct test conditions on wide variety of tubes. Checks vacuum-tube rectifiers under high-current conditions. \$199.50* complete with 263 punched cards, 24 blank cards, card punch; instruction book.

SCOPES



W0-91A 5-INCH COLOR-TV OSCILLOSCOPE

High-performance, wide-band oscilloscope ideally suited for color-TV, black-and-white TV, and other electronic applications. Dual bandwidth (4.5 Mc, 0.053 volts rms/in. and 1.5 Mc, 0.018 volts rms/in.). Internal calibrating voltage and calibrated graph screen. Includes special direct/low-cap shielded probe and cable.

Only \$239.50* complete with ground cable, insulated clip, instruction book.



NEW! W0-33A SUPER-PORTABLE OSCILLOSCOPE

A low-cost all-purpose scope you can carry anywhere—only 14 pounds—ideal for in-the-home servicing of black-and-white and color-TV, audio and ultrasonic equipment. High gain and wide bandwidth to handle the tough jobs! Rugged and compact—scaled 3" graph screen.

Only \$129.95* complete with low-cap direct input probe, cable, power cord, cord-carrying brackets, instructions. (RCA Super-Portable Oscilloscope Kit, only \$79.95*.)

GENERATORS



NEW! WA-44C AUDIO GENERATOR

Generates sine and square wave signals for testing audio systems. Frequency range: 20 cps to 200 Kc. Used to measure intermodulation distortion, frequency response, input and output impedances, speaker resonance, speed of recording and playback mechanisms, transient response and phase shift. Only \$98.50* with cable and instructions.

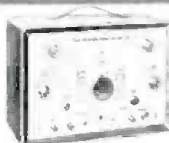

WR-69A TELEVISION/FM SWEEP GENERATOR

For visual alignment and troubleshooting of TV rf/lf/vf circuits and other electronic equipment. IF/video frequency ranges 50 Kc to 50 Mc, TV channels 2 to 13, plus FM range—88-108 Mc. Sweep width continuously adjustable to 12 Mc or more. Only \$295.00* with cables, instruction book.



WR-99A CRYSTAL- CALIBRATED MARKER GENERATOR

To supply a fundamental frequency rf carrier of crystal accuracy for aligning and troubleshooting color-TV, black-and-white TV, FM receivers and other electronic equipment operating in 19 Mc to 260 Mc range. Only \$242.50* complete with output cable, two phone tips, instruction book.



WR-49B SIGNAL GENERATOR

For alignment and signal tracing of AM/FM receivers, low-frequency signal tracing and alignment of TV vf/lf amplifiers. Six ranges—85 Kc to 30 Mc. Internal 400 cps modulation. Low rf signal leakage! Only \$79.50* complete with shielded cable for rf and af output, instruction book.

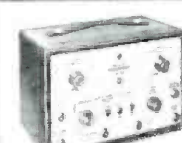

WR-70A RF/IF/VF MARKER ADDER

To be used with WR-69A or similar electronic equipment. Eliminates waveform distortion due to receiver overloading during visual alignment by adding markers after the rf signal is demodulated. Only \$74.50* with cables, instruction book.

There's an RCA test instrument to help you do every job better, and easier—and to save you valuable time. A comprehensive line of test accessories: video multi-markers, TV isotaps and bias supplies, probes and cables. See your Authorized RCA Electronic Instrument Distributor for complete information.

RCA Electron Tube Division, Harrison, N.J.

*User Price (Optional)



The Most Trusted Name in Electronics
RADIO CORPORATION OF AMERICA



- FREE** 10 OLSON STORES Plus MAIL ORDER
- Visit your local Olson Stores at . . .
- FREE** AKRON, OHIO
69 W. State Street
- FREE** BUFFALO, N.Y.
711 Main Street
- FREE** CHICAGO, ILL.
4101 N. Milwaukee Ave.
- FREE** CHICAGO, ILL.
123 N. Western Ave.
- FREE** CLEVELAND, OHIO
2020 Euclid Ave.
- FREE** CLEVELAND, OHIO
6813 Pearl Road
- FREE** COLUMBUS, OHIO
142 N. High Street
- FREE** INGLEWOOD, CALIF.
4642 W. Century Blvd.
- FREE** MILWAUKEE, WISC.
423 W. Michigan
- FREE** PITTSBURGH, PENN.
5918 Penn Avenue

Fill in coupon for a FREE One Year Subscription to OLSON'S Fantastic Bargain Packed Catalog—Unheard of LOW, LOW WHOLESALE PRICES on Brand Name Speakers, Changers, Tubes, Tools, Hi-Fi's, Stereo Amps, Tuners and other Bargains.

MAIL TO: **OLSON ELECTRONICS**
625 S. Forge Street
Akron 8, Ohio

NAME _____
ADDRESS _____
CITY _____ ZONE _____ STATE _____

the effects of multipath conditions. A most important criterion is the difference in the path lengths of the direct and the reflected signals. A tuner which may function perfectly in one location despite the presence of reflected signals can show distortion in another, even though the relative amplitudes of the direct and reflected signals may be the same. The BBC tests show that distortion becomes more serious as the difference in path lengths increases. For instance, the amplitude of reflected signal compared to direct signal needed to produce "slightly disturbing" distortion on solo piano is about 35 percent for a path difference of 5 miles; similar distortion can be produced with a path difference of 18 miles by reflected signal content of only 6 per-cent.

These results point up the very real importance, in locations where natural or man-made obstructions favor the production of long path reflections, of minimizing pickup of the reflected signals. This can best be done by careful orientation of directional antennas. Even the simple dipole can be adjusted to provide relatively low pickup of the reflected signal by change in position and/or slope. The benefits of a well-designed antenna system also include the more efficient functioning of the limiting circuits in weak signal areas. Often an FM antenna which provides quiet background noise levels is considered satisfactory, whereas an improved antenna system would also clear up multipath effects if adjusted for minimum indirect wave pickup.

Accurate orientation of an FM antenna without test equipment can be difficult in areas where the signal is strong enough to provide good limiting even when well off beam. In such conditions an attenuator pad between feeder and receiver antenna socket can be used to bring down the input signal level below the level of limiting action to make it easier to line up the antenna; afterwards the pad should, of course, be removed.

A final tip to help positive identification of multipath distortion as opposed to equipment faults is to check whether reception of all stations is equally affected. Multipath distortion usually shows up in varying degrees on stations operating on different frequencies, even when these are located quite close together. ▲

CLEVELAND HAMFEST
THE 1961 ARRL Great Lakes Division Convention, sponsored by The Cleveland Amateurradio Convention, Inc., will be held October 13 and 14 at The Sheraton-Cleveland Hotel. A SSB dinner will start off the convention at 1900 EDST on October 13, followed by open house and hospitality gatherings at 2000. A "Royal Order of Wouff Hong" initiation will take place at 2359.
Saturday's session will include displays, technical talks, a DX session, Army MARS session, XL forum, etc. The convention will conclude with a banquet in the Grand Ballroom of the hotel.
Requests for tickets should be mailed to Cleveland Amateurradio Convention, P.O. Box 5167, Cleveland 1, Ohio. ▲

SILICON RECTIFIERS Factory Direct  **750 MA TOP HATS** Mfg. Prices

| | | | |
|-------------------------------|--------------------------------|---------------------------------|---------------------------------|
| PIV/RMS 50 35 .15 ea. | PIV/RMS 100 70 .25 ea. | PIV/RMS 200 140 .30 ea. | PIV/RMS 300 210 .40 ea. |
| PIV/RMS 400 280 .45 ea. | PIV/RMS 500 350 .65 ea. | PIV/RMS 600 420 .75 ea. | PIV/RMS 700 490 .90 ea. |
| PIV/RMS 800 560 .95 ea. | PIV/RMS 900 630 1.15 ea. | PIV/RMS 1000 700 1.55 ea. | PIV/RMS 1100 770 1.75 ea. |

General Purpose Special 2 for .75 400PIV at 300MA 25 for \$7.50

LOW PRICES
100 Different prec. res., 1/2 W, 1 W, 2 W of 1/2 % . 1% Tolerance . . . only 1.90/c
General Electric 1N91 Power Junction Diode 10 for \$1.50
Top Hat Silicon Diode 25PIV/17RMS 500MA 20 for \$2.00
Hughes 1N67A Crystal Diode Glass Special 10 for \$1.50
Int. Rect. Selenium PIV440/RMS160 DS Current 10MA 10 for \$2.00

All material guaranteed. \$2.00 min. order. Orders F.O.B. NYC. Include check or money order. SHIP. charges plus. C.O.D. orders 25% down.

WARREN DIST. CO.
NYC 7, NY 87 Chamber St. WD 2-5727

WALKIE-TALKIE RADIOPHONES
Made in U.S.A. From \$24.98 for electronic chassis



Now you can afford the new fully transistorized, portable SPRINGFIELD TR-28 radiophone kit or the new VANGUARD Mark I factory assembled radiophone. Both high quality industrial types with a 5 year service guarantee. Available for license free C.B. and Amateur Bands. Send for free literature Dept. WE-10 Vanguard Electronic Labs, 190-48 99 Ave. Hollis 23, N.Y.

Grommes
ALL NEW!
STEREO-MONAUURAL HI-FIDELITY TUNERS & AMPLIFIERS



High Quality Performance Low in Cost

24L Stereophonic Amplifier . . . Complete 24 watt stereo, pre-amplifier and amplifier in one low cost unit. Net. \$79.95 (Enclosure \$10.00 Extra).

10L Amplifier . . . Low priced stereo and monaural amplifier. Net. \$59.95 (Enclosure \$10.00 Extra).

LJ8 Amplifier . . . 12 watt monaural amplifier with built-in pre-amplifier. Net. \$39.95 (Enclosure \$10.00 Extra).

S01A Receiver . . . AM-FM Tuner, Stereo and Monaural Amplifier. Net. \$149.95 less Multiplex (Enclosure \$10.00 Extra).

Write today for FREE literature on the complete Grommes Line.

GROMMES Div. of Precision Electronics, Inc.
9101-N King Ave., Franklin Park, Illinois
Please rush details on the Grommes Line.

Name _____
Address _____
City _____ Zone _____ State _____

VARIABLE TIME-DELAY RELAY

By C. J. FAUST, Jr.

Simple circuit uses heater warm-up to produce delay.

AT ONE time or another, most of us find the need for a time-delay relay to retard the application of voltage to a circuit, such as plate voltage to rectifier tubes, and for various timing operations.

When such a need arose recently, the unit to be described was built and found to perform the required functions quite satisfactorily. Since other readers might find themselves in a similar situation, the author is passing along the circuit details. The unit is simple and low in cost.

Operation of the unit depends on the fact that the warm-up period of an indirectly heated cathode type tube can be controlled by varying the heater voltage applied to it. Usable delay periods of from 20 seconds to approximately 2 minutes can be obtained from the time heater voltage is applied until the tube begins to conduct sufficient current to close the relay.

The original circuit, shown in Fig. 1, was designed to operate from a supply voltage of 20 volts a.c. as part of an automatic furnace-control system. With a value of 100 ohms for R_1 , and 150 ohms for R_2 , the delay time was adjustable from 30 seconds to a little over 2 minutes with good reliability. These values are suitable with supply voltages between 20 and 30 volts.

The type of relay used will determine the value of R_2 , which is not critical. Pick a value which will pass enough current to allow the relay to pull in at maximum delay settings. The relay used by the author was a 6-volt, 105-ohm surplus unit from a radiosonde trans-

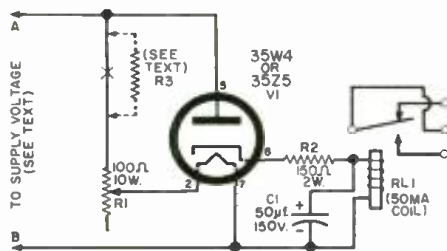

Fig. 1. Circuit for 20 to 30 volts a.c. Pin connections shown are for 35Z5 tube.

mitter. Any relay that will pull in at 50 ma. or less will be satisfactory.

Most likely you will want to operate the unit from the 117-volt power line. In this case, the value of R_1 should be 3000 ohms and R_2 (500 ohms) would be added in series as a current-limiting resistor. For a 50 ma. relay, R_2 should be approximately 2000 ohms. If the relay draws less current or you use different supply voltages, simple Ohm's Law calculations will derive the proper values for R_1 and R_2 . ▲

October, 1961

spend one hour a day with this famous course
and prepare yourself for a rewarding future

BASIC ELECTRONICS

by Van Valkenburgh, Nooger & Neville, Inc.

The civilian version of the extremely successful illustrated training course used by the U. S. Navy

The Navy course turned out naval trained technicians in record time. More than 100,000 naval trainees learned basic electronics this easy "picture-book" way. The modern course we offer also presents BASIC ELECTRONICS in a "picture-book" manner that everyone can grasp, regardless of previous education. Only a knowledge of the basics of electricity is necessary. So successful has the Rider published course proven in industry, that the nation's leading firms use it to teach their personnel. And, now you can master the basics of electronics at home with this same "learn-by-pictures" training course! (This course is available only from John F. Rider Publisher, Inc. or its dealers.)

HERE'S HOW THIS EASY, ILLUSTRATED COURSE WORKS: Every page covers one complete idea. There's at least one carefully selected illustration on that same page to explain it. Then, at the end of every section, you'll find review pages that highlight the important topics you have just covered. You build a thorough step-by-step knowledge at your own pace—as fast as you yourself want to. The illustrations—more than 800 of them and the text are the perfect combination to make the subject of electronics completely understandable.

BASIC ELECTRONICS COURSE NOW AVAILABLE IN TWO WAYS

BASIC ELECTRONICS 5-VOLUME COURSE AVAILABLE AS HERETOFORE. The 5-volume civilian version of the U. S. Navy course covers vacuum tube diodes and power supplies, amplifiers, oscillators, transmitters, and receivers. This is the same as has been available heretofore.

BASIC ELECTRONICS EXPANDED COURSE. The INTEGRATED EXPANDED COURSE consists of 6 volumes, including the 5-volume course, plus a 6th volume which expands into the areas of semiconductors, transistors, and frequency modulation. Transistors and semiconductors are the most modern devices in electronic technology. Everyone interested in the broad subject of electronics now must have a familiarity with transistors and semiconductors. If you are interested in learning the basics of electronics, this 6-volume course is the best that you can buy. If you are among the great many tens of thousands who have completed the 5-volume course, the 6th volume on semiconductors transistors, and FM is a book which you should own. It can be bought separately.

BASIC ELECTRONICS: #170, set of Vols. I to V in soft covers, \$11.25. #170-H, all 5 vols. in single cloth binding, \$12.75.
BASIC ELECTRONICS EXPANDED course, #170-X, sets of Vols. I to VI in soft covers, \$13.85; #170-XH, 6 volumes in single cloth binding, \$14.85.
BASIC ELECTRONICS Vol. 6 only. #170-6 soft cover, \$2.90; #170-6H cloth, \$3.95.

ALSO AVAILABLE — A 5-VOLUME COURSE ON

BASIC ELECTRICITY

For those who wish to master the basics of electricity before they progress in electronics, there is BASIC ELECTRICITY. This is the civilian version of the course on electricity used by the U. S. Navy to turn out trained technicians. (This course is available only from John F. Rider Publisher, Inc. or its dealers.)

More than 900 carefully selected illustrations supported by crystal-clear text make electricity completely understandable. #169, 5 vols. soft covers, \$11.25 per set; #169-H all 5 vols. in single cloth binding, \$12.75.

These and many other Rider titles are available at bookstores, electronic parts distributors, dept. stores or direct. Send for new catalog.

Buy these books today—No matter where you buy these books, we guarantee satisfaction, or your money back within 30 days of purchase.

EW-10



JOHN F. RIDER PUBLISHER, INC., 116 West 14th Street, New York 11, N. Y.

Canada: Chas. W. Pointon, Ltd., 86 Racine Rd., Rexdale, Ont.
Export: Acme Code Company, Inc., 630 9th Ave., N. Y. C.
India: Asia Publishing House, Bombay and other cities



RADIO SHACK Corp.
Boston, Massachusetts

Send for your **FREE** personal copy of
RADIO SHACK'S 336-PAGE 1962 CATALOG
Nationwide standard of excellence in
Electronics, Music, Communications

Also receive all other issues for 1 year!

Our bigger, better catalogs offer the widest line of electronic parts and equipment in the world! Latest in Stereo, Hi-Fi, Ham Radio, Test Equipment, Pre-Recorded Tapes, Tape Recorders, Records, Component Parts—plus 30 pages of new fun-to-build kits. Every item is easy to own on new No Money Down Credit Terms. Every item is guaranteed to satisfy or your money back.

MAIL THIS COUPON TODAY

RADIO SHACK Corp. Dept. 61K6B
730 Commonwealth Ave., Boston 17, Massachusetts
Please send me Radio Shack's new 1962 Electronics Catalog and every new issue for the next 12 months—all FREE and POSTPAID.

Name _____

Address _____

City & Zone _____ State _____

Surprise!
**WALTER ASHE
 TRADES HIGHER**

(he always has since 1922)

You always save money dealing with Walter Ashe Radio . . . because we always offer you more for your used transmitters, receiver or other surplus amateur gear* Find out for yourself . . . tell us what you have to trade and what you want. We guarantee you'll be genuinely surprised by the Walter Ashe deal! Use the coupon below . . . mail it today!



**DO YOU HAVE OUR NEW
 144 PAGE AMATEUR CATALOG?
 ...IT'S FREE**

Check the coupon...get the amateur's most complete catalog of the newest in equipment, parts and supplies... everything you need!
 *Made Since 1945

Phone:
Chestnut 1-1125
WALTER ASHE RADIO CO.
 Dept. R-10-61
 1123 Pine St.
 St. Louis 1, Mo.

WALTER ASHE RADIO COMPANY
 Dept. R-10-61, 1123 Pine Street, St. Louis, Missouri

I am interested in _____

What is the Ashe "Surprise" allowance on _____

Name _____

Address _____

City _____ Zone _____ State _____

Send New Catalog Send Reconditioned Bulletin



NEW **Mobilaire**
Browning Mobile
CB Transceiver

Mobilaire Transceiver
\$159.50

To complete the finest CB radio communications system available, Browning brings you Mobilaire, the mobile transceiver with the same quality components as Browning's base station equipment.

Now you can take Browning quality with you wherever you go . . . car, boat, other vehicles.

ORDER DIRECT FROM BROWNING AND SAVE!



browning

Send for free literature and complete specifications

Browning Laboratories, Inc. 102 Union Ave. Laconia, N.H.

ACOUSTICS ANAGRAM

By **JOHN COMSTOCK**

(Answers on page 126)

ACROSS

1. Audio.
4. Sound energy dissipated without accomplishing any work.
6. Part of familiar term for full-range reproduction.
8. A regularly occurring pulsation of amplitude resulting from the combining of two sounds or tones.
9. Opposite of treble sound frequencies.
12. Device used in a sound system to attenuate a signal or couple two impedances.
13. Term often applied to a coaxially constructed speaker.
14. Electro-acoustic unit of power ratio based on the Napierian base of logarithms.
15. Coil found in speakers (abbr.).
16. Class of audio amplification.
18. Satisfactory in quality.
19. Transducer that picks up sound and converts it into electrical currents (fam.).
20. River in Italy.
22. Unit of loudness.
23. Material removed from surface of phonograph recording disc by the cutting stylus.
24. Undesirable noise in an audio system.
25. Opposite of a "dead" or highly damped room.
27. High frequencies.
29. Unit of stylus pressure.
30. Equipment used to address large gatherings (abbr.).
31. Essential component in a hi-fi system (abbr.).
33. Recording companies' trade association (abbr.).
38. Frequencies above 20,000 cps.

DOWN

1. Unit of sound absorption.
2. Electro-acoustic unit of relative power, voltage, or current (abbr.).
3. The amount that an audio amplifier can increase the amplitude of a signal.
5. Sound in its "third dimension."
7. In acoustics, inductance is the equivalent of _____.
10. Transducer used in every audio system.
11. One circuit of audio amplification.
17. The _____ of audio frequencies extends from 15-20,000 cps.
19. The part of a speaker that receives power from the electrical circuit and converts it into mechanical energy.
21. Pertaining to the ear or sense of hearing.
26. The "receiving" circuit of an audio amplifier.
27. Ordinarily, sound is composed of a number of _____.
28. Organ used for the perception of sound.
29. That portion of a magnetic circuit in which there is no ferromagnetic material.
32. Loud, undesirable sound.
34. Medium through which sound waves travel.
35. Sound ratio.
36. Meter watched by recording engineer (abbr.).
37. "Twin" of "hi."

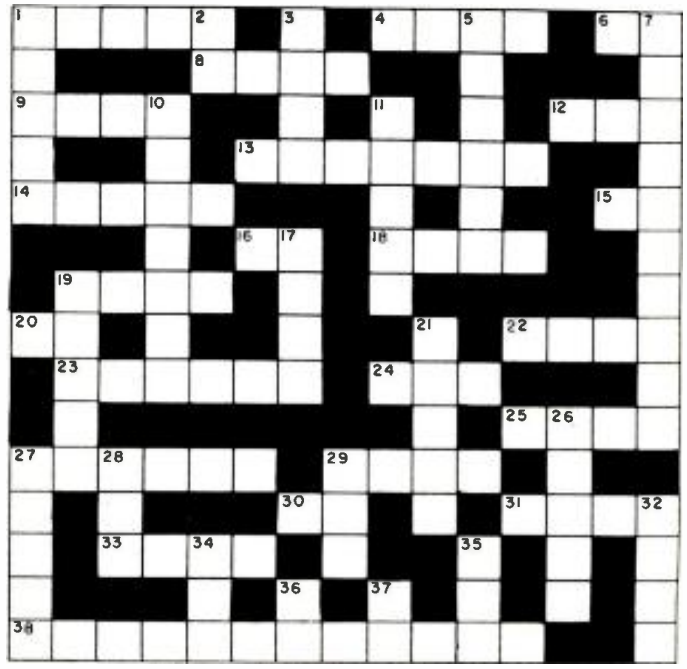

ELECTRONICS WORLD HAS
A BUYER FOR YOUR USED EQUIPMENT OR COMPONENTS!

The 245,000 purchasers of **ELECTRONICS WORLD** are always in the market for good used equipment or components. So if you have something to sell, let **EW** readers know about it through our classified columns. It costs very little: just 60¢ a word, including name and address. Minimum message: 10 words.

For further information write: **Martin Lincoln ELECTRONICS WORLD One Park Avenue New York 16, N. Y.**

| | |
|--|----------------|
| BC-221 FREQUENCY METER. Like New Condition Only | \$69.50 |
| 85kc IF Transformers | 2.25 |
| ARM-12, New | 79c ea. 3 for |
| BC-603 FM Receiver | 14.95 |
| B-603 FM Receiver | 18.95 |
| BC-923 A FM Receiver | 29.95 |
| ART-13 Transmitter | 49.50 |
| BC-604 MF Transmitter | 4.95 |
| Antenna Mast Base | 2.95 |
| BC-191 Transmitter | 14.95 |
| GE Computer Tester | 12.95 |
| Servo Amplifier Assembly | 3.00 |
| B-442 Antenna Relay | 2.95 |
| ARR-2 Receiver | 4.95 |
| ARC-3 AM Receiver | 12.95 |
| ARC-3 AM Transmitter | 14.95 |
| 1-130A Signal Generator | 7.95 |
| 1-95B Field Strength Meter | 7.95 |
| MD-7 Modulator with tubes | 5.95 |
| Swinging Chokes, 9-20 Hertz | 4.95 |

Send Money Order or Check with Order Write for Bulletin No. 33—LOADS OF BARGAINS!
R W ELECTRONICS
 2430 S. Michigan Avenue Dept. EW10
 Phone: CALumet 5-1281 Chicago 16, Ill.

OUT OF SPACE?
 You bet we'd be... if we were to tell you all about AUDION'S "Out of this World Hi Fi Values"
 Write for free Catalog
audion
 25-W Oxford Road
 Massapequa, New York

Marine Electronics
 (Continued from page 62)

not touch the chart. Do not disconnect the motor or motors so as not to disturb the power-consumption balance. Make sure that the full input voltage is applied to the sounder.

After a thorough warm-up, adjust the tuning slugs or trimmers for maximum output, using the minimum possible input from the audio generator.

When the pulse generator is a vacuum-tube oscillator, a slightly different technique is employed. With the transducer to be used with the sounder connected, and with the sounder operating at the correct input voltage, adjust the oscillator transformer's tuning slug to produce the maximum kick on the lowest a.c. scale of a v.o.m. connected across the transducer terminals. Now disable the keying and connect a scope (sweep off) and an audio generator as shown in Fig. 13. Warm up the sounder, scope, and generator.

Using a clip lead or other convenient means, key the sounder slowly, attenuate the scope input signals as required, and adjust the audio-generator frequency until a circular pattern is obtained. The audio generator is now set for the frequency at which the energy transfer between the pulse generator and the transducer is maximum. This setting will be quite close to the rated frequency of the sounder. When adjusting the audio generator, do not allow the pulse generator to run for more than a few seconds at a time.

Remove the scope and, without disturbing the setting of the audio generator, connect the latter across the transducer terminals. Connect the scope or a v.t.v.m. to the amplifier output as before, using the 10,000-ohm load with recorders, and adjust the tuning slugs or trimmers for maximum output with the minimum input.

Small sounders having a single adjustment may be aligned or tuned quite well without instruments if they are in operating order but seem insensitive. Set the gain at a maximum and, if a second echo appears, proceed to water deep enough to cause it to disappear. Then attempt to bring it back by adjusting the tuning control. If this is not possible, the tuning was correct. Return to shallower water and make sure the tuning has been re-set properly. If it is not possible to obtain a second echo in more than about 10 feet of water, the sounder probably requires further work.

Accuracy: The accuracy of flashers and recorders is dependent entirely upon the scanning or stylus-drive motor running at the correct speed. Too high a speed will give depth indications higher than the correct value and *vice versa*.

Check d.c. motors for correct governor setting and, if they cannot be brought up to speed, check for tight bearings, a partially shorted commutator, or faulty windings. Input voltage must, of course, be correct.

The speed of a.c. motors is controlled

TV-RADIO Servicemen or Beginners
SEND FOR
Coyne's
7-Volume Job Training Set
on 7-Day FREE TRIAL
 The First Practical TV-RADIO-ELECTRONICS Shop Library



Answers ALL Servicing Problems QUICKLY . . .

Makes You Worth More On The Job!
 Examine Coyne's all-new 7-Volume TV-RADIO-ELECTRONICS Reference Set for 7 days at our expense! Be convinced it gives you the way to easier TV-Radio repair—time saving, practical working knowledge that helps you get the BIG money! See how to install, service and align ALL radio and TV sets, even color-TV, UHF, FM and transistorized equipment. New photo-instruction method is quick and easy to understand. No complicated math or theory—just practical facts you can put to use immediately right in the shop, or for ready reference at home. Over 3000 pages; 1200 diagrams; 10,000 facts!

| | |
|--|--|
| VOL. 1—EVERYTHING ON TV-RADIO PRINCIPLES! 300 pages of practical explanations; hundreds of illustrations. | VOL. 5—EVERYTHING ON TV TROUBLE-SHOOTING! Covers all types of sets; 437 pages; illustrations, diagrams. |
| VOL. 2—EVERYTHING ON TV-RADIO-FM RECEIVERS! 403 pages; fully illustrated. | VOL. 6—TV CYCLOPEDIA! Quick and concise answers to TV problems in alphabetical order, including UHF, Color TV and Transistors; 868 pages. |
| VOL. 3—EVERYTHING ON TV-RADIO CIRCUITS! 336 pages; hundreds of illustrations, circuit diagrams. | VOL. 7—TRANSISTOR CIRCUIT HANDBOOK! Practical Reference covering Transistor Applications; over 200 Circuit Diagrams; 410 pages. |
| VOL. 4—EVERYTHING ON SERVICING INSTRUMENTS! How they work, how to use them; 368 pages; illustrated. | |

DIAGRAM BOOK FREE!

For prompt action, we'll also send you this big book, "150 Radio-Television Picture Patterns and Diagrams Explained" ABSOLUTELY FREE just for examining Coyne's 7-Volume Shop Library on 7-Day FREE TRIAL! Shows how to cut servicing time by reading picture-patterns, plus schematic diagrams for many TV and radio sets.



SEND NO MONEY

Just mail coupon for 7-Volume TV-Radio Set on 7-Day FREE TRIAL! We'll include the DIAGRAM BOOK FREE! If you keep the set, pay only \$3 in 7 days and \$3 per month until \$27.25 plus postage is paid. Cash price only \$24.95. Or return set at our expense in 7 days and owe nothing. Either way, the FREE BOOK is yours to keep. Offer is limited, so mail the coupon TODAY!

FREE BOOK—FREE TRIAL COUPON

Educational Book Publishing Division
COYNE ELECTRICAL SCHOOL
 1455 W. Congress Parkway, Dept. A1-EW, Chicago 7, Ill.
 Yes! Send me COYNE'S 7-Volume Applied Practical TV-RADIO-ELECTRONICS Set for 7-Days FREE TRIAL per your offer. Include "Patterns & Diagrams" book FREE!
 Name Age
 Address
 City Zone State
 Check here if you want Set sent C.O.D. Coyne pays postage on C.O.D. and cash orders. 7-Day Money-Back Guarantee.

for outstanding value . . .

Build Your Own superb Scott Stereo Components!

Have fun . . . save money . . . get the best! Now you can build your own world-famous Scott components . . . and you can make substantial savings compared to the costs of the nearest equivalent factory assembled units.

H. H. Scott kits feature the same engineering, same high performance, same features and parts as do the factory wired components. Tuners have exclusive Scott Wide-Band design with factory aligned silver-plated front ends. Amplifiers use H. H. Scott's superb conservatively rated transformers.

Scott kits are fun to build, too. The wires are pre-cut to exact length and pre-stripped. Instruction books are in full color to help you see exactly what you're doing. Mechanical parts are factory-riveted to the chassis.

For a genuine H. H. Scott system at a real saving, choose from these fine kits:

LT-110 FM Multiplex Stereo Tuner Pre-wired and aligned front end and multiplex sections; Wide-Band design; 2.2 uv sensitivity (IHFM); \$159.95*

LK-48 48-Watt Stereo Complete Amplifier Kit A truly superior amplifier with power enough to drive even the most inefficient speaker systems. Only \$119.95*

LK-72 72-Watt Stereo Complete Amplifier Kit Fabulous Scott features never before available in a kit: derived center channel controls; tape monitor; \$159.95*

LT-10 FM Tuner Kit Unique Ez-A-Line alignment system. Sensitivity 2.2 uv (IHFM). \$99.95*

LC-21 Stereo Pre-Amplifier Kit Exceptional versatility. 16 front panel controls; frequency response for optional laboratory applications 8 to 50,000 cps! \$99.95*

LK-150 150-Watt Stereo Power Amplifier Kit Conservative design, massive transformers unsurpassed performance. \$169.95*

*slightly higher West of Rockies.

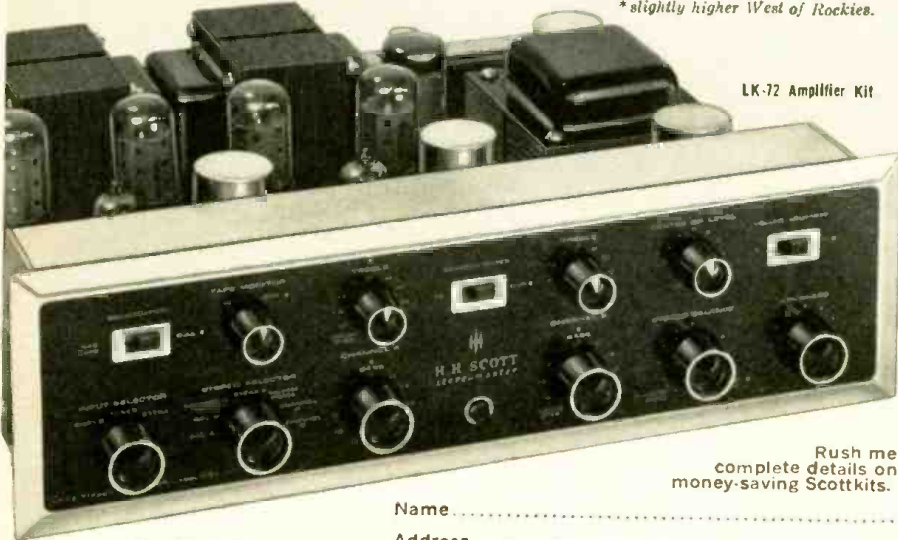

LK-72 Amplifier Kit

Rush me complete details on money-saving Scottkits.

Name
Address
City Zone State

FREE!

Colorful and detailed 20-page "Guide to Custom Stereo" including complete technical information on Scottkits.

H. H. SCOTT

H. H. Scott, Inc., Dept. 160-10
111 Powdermill Rd., Maynard, Mass.

Export: Morhan
Exporting Corp.,
458 Broadway, NYC

LEARN TRANSISTOR, COMPUTER OR RADAR ELECTRONICS AT HOME!

Prepare now for a profitable career in one of these growing fields. Learn theory and practical application of all makes and types with proven home study courses from the Philco Technological Center.

For FREE information write:

PHILCO
TECHNOLOGICAL CENTER
P.O. Box 4730, Dept. W-2, Philadelphia 34, Pa.

CITIZENS BAND EQUIPMENT LIGHTNING PROTECTION

- "BLITZ-BUG" →
 - For any standard coaxial cable
 - Will not effect performance
- See your Local Distributor



\$3.95
Net

CUSHCRAFT

621 HAYWARD ST.
MANCHESTER, N. H.

ENGINEERING DEGREES



E.E. Option Electronics or Power
Civil, Mechanical, Physics.
Also in Liberal Arts

Earned through Home Study
Specify course desired
Pacific International
College of Arts & Sciences
Primarily a Correspondence School
Resident classes also available
5719-R Santa Monica Blvd. Hollywood 38, Calif.

by the supply frequency which, in turn, is dependent upon the power-supply vibrator frequency. Most "off-the-shelf" replacement vibrators are close enough to the rated frequency to hold the accuracy of the sounder within the manufacturer's specifications. However, an occasionally fussy customer will insist on one that is exactly 60 cps. When such selection is necessary, a vibrating-reed frequency meter is a great convenience. Friction and defective motor capacitors will also affect the speed of motors used in sounders.

Inaccuracies in scopes are caused by incorrect sweep speed. Check the RC circuit and, if the capacitor is good, adjust the series resistor as required.

The best way to check for the source of inaccuracy in a meter-type indicator that is electronically timed is to work backwards from the meter movement through the gating and pulse circuits.

Strays: Random flashes around the dial of a flasher or on the screen of a scope, or short, black marks scattered over the chart of a depth recorder, are known as strays. They can be caused by turbulence due to barnacle growth on the transducer or other underwater factors, by vibration, or by electrical pick-up through the transducer or power cables. Remedies include grounding the sounder, connecting a capacitor of several hundred microfarads across the power leads, and separating transducer and power cables, if they run close together. If not already installed, conventional radio noise-suppression capacitors should be connected to the engine generator, the voltage regulator, and also the coil on spark-ignition engines.

If the strays assume a regular pattern, the trouble is probably due to defective filtering or spurious oscillation in the sounder itself. Check plate and bias-supply filtering and bypass and decoupling capacitors.

A completely black chart on recorders can be caused by lack of bias on vacuum-tube pulse generators or on the output tube, or by a defective fix marker switch.

Conclusion

As the technician gains experience with depth sounders, he will soon be able to spot transducer, stylus, and keying troubles quickly. Once these elements are out of the picture, the remainder resolves itself into straightforward electronic troubleshooting. Aside from the electro-mechanical items and transducers, the author has, during the past ten years, found the following to be the most common trouble points: shorted buffers, defective 2D21's, open gain controls (when used to control plate voltage), shorted motor capacitors, leaky coupling capacitors, open windings in iron-core transformers, and open screen resistors.

Nothing has been said about checking for lack of plate voltages, vibrator troubles, or lack of high voltage or sweep on scopes; for it is believed that this would be "old stuff" to the radio, TV, and audio man. ▲

EICO®...UNCOMPROMISING ENGINEERING

BEST BUYS IN SERVICE INSTRUMENTS: everything from Scopes to Probes

DC-5 MC
5" Scope #460
Kit \$79.95
Wired \$129.50

Also Avail.—5" Push-Pull Scope #425
Kit \$44.95 Wired \$79.95



Peak-To-Peak
VTVM #232
& Uni-Probe®
Kit \$29.95
Wired \$49.95
VTVM #221
Kit \$25.95
Wired \$39.95



Pat. #2,790,051

Dynamic Conductance
Tube & Transistor Tester #666
Kit \$69.95 Wired \$109.95
Complete with steel cover & handle



TV-FM Sweep Generator
& Marker #368
Kit \$69.95 Wired \$119.95



BEST BUYS FOR INDUSTRIAL TESTING: everything from Bridges to Supplies

NEW Metered
Variable
Auto-Transformer
AC Bench
Supplies:

#1073 (3 amp.)
Kit \$35.95
Wired \$47.95
#1078 (7½ amp.)
Kit \$42.95
Wired \$54.95



NEW Extra-Low-
Ripple 6 &
12 Volt
Battery
Eliminator
& Charger #1064
Kit \$43.95
Wired \$52.95



NEW AC
Volt-Watt
Meter #260
Kit \$49.95
Wired \$79.95



1350 Combinations!
Series/Parallel R-C
Combination Box #1140
U.S. Pat. No. 2954518
Kit \$13.95 Wired \$19.95



BEST BUYS IN STEREO & MONO HI-FI: everything from Tape Decks to Speakers

TRANSIS-
TORIZED An original, exclusive EICO product
designed and manufactured in the
U.S.A. (Patents Pending)

Stereo/
Mono
4-Track
Tape
Deck
Wired
Model
RP100W
\$399.95
Semi-Kit
Model
RP100K
Electronics in Kit form \$299.95

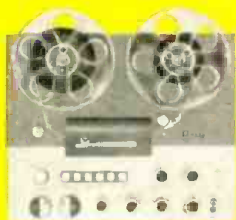

NEW FM-AM Stereo Tuner ST96
Kit \$89.95 Wired \$129.95 Inc. FET



NEW 70-Watt Integrated
Stereo Amplifier ST70
Kit \$94.95 Wired \$149.95



NEW 40-Watt Integrated
Stereo Amplifier ST40
Kit \$79.95 Wired \$129.95



Bookshelf Speaker System HFS1
Kit \$39.95 Wired \$47.95



BEST BUYS IN "HAM" GEAR: from Transmitters to Code Oscillators

NEW 60-Watt CW Transmitter #723
Kit \$49.95 Wired \$79.95



90-Watt CW Transmitter #720
U.S. Pat. No. 0-184776
Kit \$79.95 Wired \$119.95



Universal Modulator Driver #730
Kit \$49.95 Wired \$79.95
Cover E-5 \$4.50



Grid Dip Meter #710
Kit \$29.95 Wired \$49.95



Over 2 MILLION EICO instruments in use. Compare EICO side-by-side critically with products selling for 2 or 3 times more. Buy your EICO right "off the shelf" from 1500 neighborhood dealers coast to coast, most of whom offer budget terms.

BEST BUYS IN CITIZENS TRANSCEIVERS AND TRANSISTOR RADIOS

Over 80 unique
products to
choose from!

*Including Posi-Lock®
Mounting Bracket
(PAT. PEND.)



NEW DeLuxe
Citizens Band Transceivers:
#770:117 VAC—
Kit \$69.95 Wired \$99.95
#771:117 VAC & 6 VDC,*
#772:117 VAC & 12 VDC*—
Kit \$79.95 Wired \$109.95



Citizens Band Transceivers:
#760:117 VAC—
Kit \$59.95 Wired \$89.95
#761:117 VAC & 6 VDC,*
#762:117 VAC & 12 VDC*—
Kit \$69.95 Wired \$99.95



Transistor Portable Radio RA6
Kit \$29.95 Wired \$49.95 Incl. FET

EICO, 3300 N. Blvd., L.I.C. 1, N.Y. EW-10

Send free 32-page catalog & Distributor's name.

Send Free Schematic of Model No. _____

Send new 36-page GUIDEBOOK TO HI-FI for which I enclose 25c for postage & handling.

Name _____

Address _____

City _____ Zone _____ State _____

Listen to the EICO Hour, WABC-FM, N. Y. 95.5 MC, Mon.-Fri., 7:15-8 P.M.

See our other advertisement on page 32

Add 5% in the West

Free

ALLIED

444-PAGE ELECTRONICS CATALOG

WORLD'S BIGGEST • MOST COMPLETE

best buys
for 1962

EVERYTHING IN
ELECTRONICS
including exclusive
products & special
values available
only from
ALLIED

Send
for it
today!

**SAVE
MOST
ON EVERYTHING IN ELECTRONICS**

- New Stereo Hi-Fi Systems—Everything in Hi-Fi Components
- New Multiplex Stereo FM • All-Transistor Stereo Hi-Fi
- Money-Saving Build-Your-Own KNIGHT-KITS® for Every Need
- Best Buys in Tape Recorders, Tape, and Supplies
- Citizens Band 2-Way Radios • Short-Wave Receivers
- Amateur Receivers, Transmitters, and Station Gear
- Latest Public Address Systems, Paging and Intercom Equipment
- TV Tubes, Antennas, Accessories • Batteries, Wire and Cable
- Test and Laboratory Instruments • Tools, Hardware
- Huge Listings of Parts, Tubes, Transistors, Technical Books

NEW Multiplex Stereo FM
All-Transistor Stereo Hi-Fi

exclusive money-saving KNIGHT® products
SAVE MOST on famous KNIGHT Stereo Hi-Fi—comparable to the best in quality, styling and performance, yet priced far lower. Select super-value KNIGHT components or complete systems (including latest Multiplex Stereo and All-Transistor hi-fi) and save most. KNIGHT products are acclaimed by all those who recognize integrity in design and manufacture and who appreciate value.

new

NO MONEY DOWN

on Allied's new Credit Fund Plan

Now—enjoy 50% more buying power—up to 24 months to pay—see our 1962 Catalog for simple details.

SEND FOR 444-PAGE CATALOG TODAY!

Satisfaction Guaranteed or Your Money Back

ALLIED

ELECTRONICS WORLD

Free

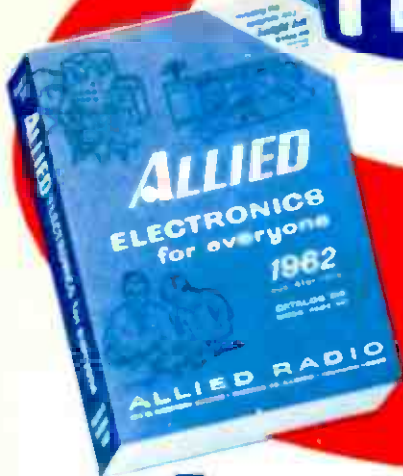

Send for
**MONEY-
SAVING**
1962

ALLIED

ELECTRONICS CATALOG

**444
PAGES**

VALUE-PACKED

*featuring exclusive products
and special values available
only from ALLIED.*

SAVE MOST on everything in Electronics for *everyone!* Enjoy every buying advantage: get fastest service from the world's largest stocks, lowest money-saving prices, expert personal help—satisfaction guaranteed or your money back. Get the world's biggest Electronics Catalog now—**FREE!**

EASY TERMS—NO MONEY DOWN

**ACT
NOW!**

For **FREE** catalog, fill in,
detach, mail card today!

Name _____

PLEASE PRINT

Address _____

City _____ Zone _____

State _____

302



your

1962

ALLIED

ELECTRONICS CATALOG!

**SAVE ON
EVERYTHING:**

- **KNIGHT-KITS®**—Best in Build-Your-Own
- Everything in Stereo Hi-Fi
- **KNIGHT®** Super-Value Stereo HI-FI
- Tape Recorders & Phono Equipment
- Citizens Band Transceivers
- TV Tubes, Antennas, Accessories
- Parts, Tubes, Transistors, Books, Tools
- Amateur Station Equipment
- Public Address & Intercom Systems
- Test & Lab Instruments

TO:
ALLIED RADIO
100 N. WESTERN AVE.
CHICAGO 80, ILL.

PLACE
3¢ STAMP
HERE

Free

Send for the
444-PAGE 1962



ALLIED
ELECTRONICS
CATALOG!

MOST COMPLETE • SAVE ON EVERYTHING

Kit Builders, Experimenters, Hi-Fi fans, Servicemen, Engineers
—SAVE MOST ON:



• Knight-Kits® — Greatest Build-Your-Own Kit Line
• Knight® famous Stereo Hi-Fi • Everything in Stereo Systems & Components • Tape Recorders & Phono Equipment • TV Tubes, Antennas, Accessories • Parts, Tubes, Transistors • Tools & Books • Amateur Station Equipment • Public Address Systems

Satisfaction Guaranteed or Your Money Back!

EASY TERMS—NO MONEY DOWN

ACT NOW!

**FOR FREE ALLIED CATALOG
FILL IN OTHER SIDE OF
THIS CARD—DETACH
AND MAIL IT TODAY!**



BIG PLUS!
in your 1962
ALLIED
CATALOG

includes complete catalog featuring over 90 exciting

knight-kits 
A PRODUCT OF ALLIED RADIO

NEW for '62 and simply great!
available only from **ALLIED**

new
HI-FI KITS

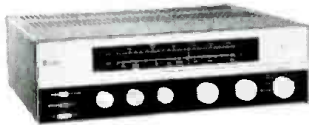

All-In-One FM-AM Tuner-Amplifier Kit with latest built-in MULTIPLEX Stereo FM.....\$129.95



MULTIPLEX Self-Powered Adapter Kit, for Stereo FM reception.....\$19.95



Deluxe Stereo FM-AM Tuner Kit with latest built-in MULTIPLEX Stereo FM.....\$99.95

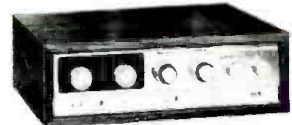

ALL-TRANSISTOR 50-Watt Stereo Amplifier Kit, less case.....\$79.95

new
HOBBYIST KITS



ALL-TRANSISTOR Wireless Intercom System Kit (2 units).....\$45.90



TRANSISTORIZED Electronic Tachometer Kit. \$24.95



Amazing 100-In-1 Electronic Science Lab Kit.....\$29.95



ALL-TRANSISTOR 2-Band AM-Shortwave DX'er Radio Receiver Kit.....\$19.95

building a Knight-Kit is the most satisfying do-it-yourself experience in the world!

5 BIG REASONS WHY:

- **Convenience Designed**—makes you a kit-building expert—even the very first time!
- **Wonderful to Build**—you'll marvel at the sheer ease of assembly with the exclusive "show-how" manual guiding you like a good instructor.
- **You Own the Best**—you'll enjoy with pride a true custom-built product, professional in its engineering and performance.
- **You Save So Much**—because you buy direct from Allied at our money-saving volume prices—and because you do the easy assembly yourself.
- **Easiest to Buy**—NO MONEY DOWN on Allied's new Credit Fund Plan—easiest terms ever!

MONEY BACK GUARANTEE: Buy any Knight-Kit. Build it! Use it! You must be satisfied or you get your money back!

see more than 90 KNIGHT-KITS

- 21 HIGH-FIDELITY KITS
- 25 HOBBYIST KITS
- 31 INSTRUMENT KITS
- 14 AMATEUR & CITIZENS BAND KITS

KNIGHT-KITS are also available in Canada

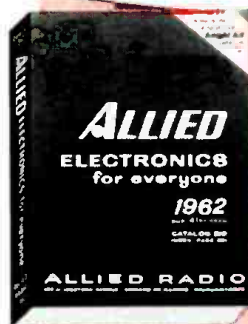

Send for it today!

new

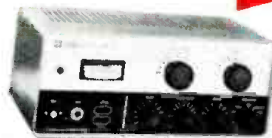

Phone and CW 60-Watt Ham Transmitter Kit.....\$49.95



Mutual Conductance Tube Tester Kit.....\$99.50

- World's Largest Stocks • Lowest Money-Saving Prices
 - Fastest Shipment • Expert Help • Easiest-Pay Terms
 - Satisfaction Guaranteed or Your Money Back
- send for the world's biggest electronics catalog!

Free

ALLIED RADIO, Dept. 199-K1
100 N. Western Ave., Chicago 80, Ill.

Send FREE 1962 ALLIED 444-page Catalog

Name _____
PLEASE PRINT

Address _____

City _____ Zone _____ State _____

RADIO  World's Largest Electronic Supply House

New Products and Literature for Electronics Technicians

Additional information on the items covered in this section is available from the manufacturers. Each item is identified by a code number. To obtain further details, simply fill in the coupon appearing on page 130.

ISOLATION TRANSFORMERS

1 United Transformer Corp. has added a series of ultra-shielded isolation transformers to its HIF series as the HIF-15.

Designed to simulate battery operation, these units can be used for extremely critical circuits requiring the ultimate in isolation for power-line equipment, according to the company. The HIF-15 has a power rating of 150 watts industrial and 120 watts to MIL-T-27A. Effective capacity between primary and secondary windings is less than .1 μf . Input and output terminals are brought out on opposite sides of the special housing for maximum isolation.

PLUG-IN PHASE UNIT

2 Hewlett Packard Company is now in production on a new unit for phase-angle measurement, with accuracy approaching $\pm .1$ degree.

Designed as a plug-in unit for the company's Models 524B/C/D electronic counters, the Model 526D phase unit equips the counter to measure

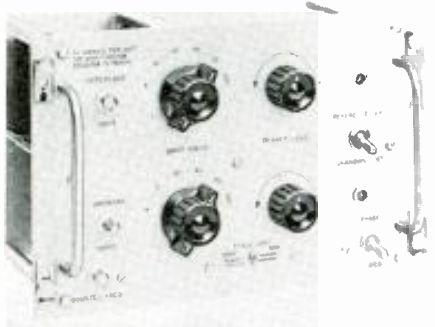

any lead or lag phase angle between two signals in the 1 to 20,000 cps range. For frequencies from 396 to 404 cps, a X3600 frequency multiplier provides readings direct in tenths of a degree. At other frequencies readings are presented in time units, with resolution of 1 μsec . for full frequency range.

ENCAPSULATED RESISTORS

3 Texas Instruments Incorporated has announced the commercial availability of an $\frac{1}{8}$ -watt hermetic precision resistor encapsulated in hard glass. Measuring only $\frac{1}{4}$ " in length, these



new $\frac{1}{8}$ -watt carbon film units are the same size as conventional $\frac{1}{10}$ -watt film resistors.

The Type CG- $\frac{1}{8}$ resistors are now available in values from 10 ohms to 100,000 ohms at a tolerance of $\pm 1\%$.

SWEEP GENERATOR/MARKER

4 Paco Electronics Company, Inc. is now offering the Model G-32 sweep generator and marker adder, designed for versatility and ease of operation.

As the r.f. output is swept in frequency, an electronic voltage regulator keeps the amplitude



constant. Dual attenuators permit close control of output voltage to match circuit conditions. Sweep width is also continuously variable.

Frequency coverage is 3 to 220 mc. in five fundamental sweep-frequency ranges. Sweep width is 0 to over 20 mc. on high-frequency ranges, continuously variable; the marker oscillator is crystal-controlled.

PRINTED-CIRCUIT ADHESIVES

5 Minnesota Mining and Manufacturing Co. has announced the development of four new liquid synthetic resin-base thermosetting adhesives for bonding copper foil to phenolic or epoxy-impregnated base stock, phenolic paper, epoxy paper, and epoxy glass materials in printed circuit manufacture.

The four adhesives, designated as EC-1855, EC-1857, EC-2080, and EC-2130, have been developed to meet each individual manufacturer's requirements.

V.H.F.-U.H.F. POWER OSCILLATORS

6 Microdot Inc. is now offering a new line of v.h.f.-u.h.f. power oscillators featuring compactly designed r.f. cavities with frequency

ranges from 200 to 1050 mc. and power output from 50 mw. to 50 watts.

The new units can be used for antenna evaluation, calibration of power measuring devices, driving amplifiers and solid-state varactors, and other applications requiring more power than milliwatt signal generators can provide.

The oscillators are continuously tunable over 2:1 frequency bands and have a high ratio dial featuring negligible backlash and a logging scale permitting a resettability of .002%.

Model 408 offers a range of 220 to 550 mc. while the Model 410 covers from 500 to 1050 mc. Both operate from 115 volts a.c., measure 8" x 11 $\frac{1}{2}$ " x 19", and weigh 45 pounds.



WAFER CAPACITOR

7 AMP Incorporated is now marketing a new wafer capacitor, molded in silicone rubber, which is ideally suited for encapsulation in epoxy resins, for applications involving heavy shock,

vibration, and temperature and altitude extremes.

The new unit is available in a range of capacitance from 100 μf . to .1 μf . $\pm 10\%$, working voltages of 2 to 12 kv, pulse, 4 to 15 kv, d.c. It is extremely light in weight with minimum size as small as 1 $\frac{1}{8}$ " x 1 $\frac{1}{8}$ " x $\frac{1}{4}$ ".

BUTTON CAPACITOR

8 Sangamo Electric Company has announced a new welded-seal button capacitor which is said to embody the high-frequency characteristics and reliability associated with hermetically sealed units.

The solder-free design completely eliminates the restrictions imposed by relatively low-melting point soft-solder seals and thus permits operation at high ambient temperatures. This also allows high-temperature soldering techniques for easy circuit installation without risk of damage to capacitor seals.

Capacitance values up to 1500 μf . at 500 volts are available, in a wide variety of mounting configurations.

MINIATURE PLUG LINE

9 Cannon Electric Company has added a new series of connectors to its line.

The TM (Twinax Miniature) plugs are de-



signed for subminiature applications involving a common shield over a twisted pair of wires or for requirements involving two power leads, thereby replacing two subminiature plugs. Identical inserts with either male or female contacts are used for both plug and receptacle.

The inserts can be removed for bench soldering and are assembled into the plug shells before the appropriate clamping parts are assembled.

TUBE TESTER

10 Sencore, Inc. has announced the availability of an improved version of its tube tester which is being marketed as the "Mighty Mite II."

The improved tester, Model TC114, is designed to check all the tubes that the earlier model could handle plus the new G-E compactrons, the new Sylvania 10-pin tubes, and RCA univisors and novars.

The cover of the case is mirrored so that it can be set at any angle and used for TV adjustments.



SILICON PLANAR TRANSISTOR

11 Fairchild Semiconductor has developed a new silicon planar transistor which has broken all speed records for fast switching in saturating logic circuits.

The new device, designated the 2N709, is ca-

pable of switching speeds "two to three times faster than any existing germanium or silicon transistor," according to the company.

The transistor is rated at 300 mw. of power. Its high-speed features include: typical charge storage time-constant of 3 nanoseconds; average propagation delay time of only 2.5 nsec. in direct-coupled transistor logic circuits; average propagation delay time of 7.5 nsec. with a rise time of 3.5 nsec. in TDL logic circuits.

H.F. TRANSFER VOLTMETER

12 Ballantine Laboratories, Inc. is now marketing its Model 393 high-frequency transfer voltmeter by means of which an unknown a.c. voltage may be measured in terms of a d.c. voltage. The design is such that the transfer impedance of the probe is uniform from 25 cps to 30 mc.

Primary uses of the new instrument will be in standards laboratories for calibration of r.f. signal sources, r.f. voltmeters, and the frequency response of amplifiers or other devices. Accuracy of transfer is .1% from 25 cps to 10 mc., and .5% from 10 mc. to 30 mc.

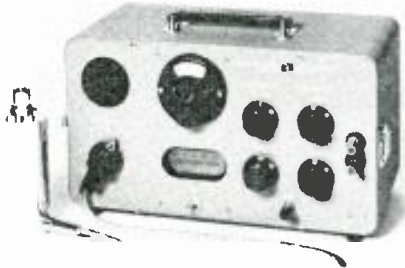

CURRENT-MODULATED TESTERS

13 Modutronics, Inc. is now offering a new line of current-modulated testers designed to eliminate time-consuming breadboarding. The new units are capable of quickly determining the d.c. and/or a.c. characteristics of such d.c.-excited components as zener diodes, matching diodes, rectifiers, chokes, filters, transformers, relay coils, and solenoids, as well as meter movements, power supplies, etc.

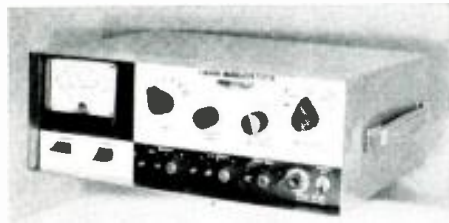

The instruments make use of a 60-cps internal current-modulated circuit, while providing for external modulation of frequencies from 20 to 100,000 cps. Three models (0-80 volts, 0-40 volts, 0-250 volts) are included in the series.

MICROMINIATURE RESISTORS

14 Dale Electronics, Inc. has announced a line of microminiature resistors, utilizing the standard RCA wafer, which can be made to customer specifications. Dimensions of the wafer are .31" x .31" x .010". The wafers have 12 interconnecting notches, three to each side.

Electrical specifications are: resistance range from 100 to 100,000 ohms, $\pm 1\%$; temperature coefficient of 100 ppm-per-degree C; and maximum dissipation of $\frac{1}{2}$ watt per wafer.

MODULE TEST INSTRUMENTS

15 Burr-Brown Research Corporation has added the Model 1800 Series to its line of transistorized laboratory test equipment.

The new series employs standard sub-modules including differential and chopper stabilized operational amplifiers to provide a variety of gain ranges, gain steps, frequency response, and outputs. The typical instrument provides variable gain of 0 to 1000 over 0 to 20,000 cps with an input impedance greater than 1 megohm and an output impedance suitable for driving a 100-ma. galvanometer.

The 1800 Series features a plug-in modular package with up to 8 units accommodated in a $5\frac{1}{4}$ " x 19" standard rack.

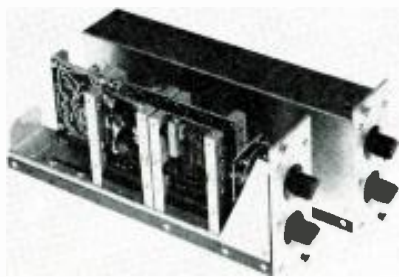

ELECTRO-OPTICAL CONTROLS

16 Raytheon Company's Industrial Components Division is now in production on a relay and potentiometer, both designed for noise-free control of a.c. or d.c. signals over a wide range.

These two electro-optical components incorporate a light bulb and photocell, assembled in a light-proof casing. A variation in the input to the four-terminal devices causes a change in the output resistance. There are no moving parts or electrical connection between the control and signal circuits, eliminating noise and resulting in inherently long operating life.

The Model CK-1111 incorporates a special gas-discharge

ENGINEERING WRITERS

Your 6 answers may put you in line for unusual Project Positions with General Electric

Do you have your BSEE degree together with experience in our product line?

Or, are you an E.C.P.D.-accredited Technical-School graduate with military experience that includes 2 or more years' maintenance or repair experience on either radar systems, computers (fire control or GCI radar) or sonar?

Do you feel you have a high level of technical competence—approaching that of a design engineer?

Do you have three or more years' Engineering Writing experience that may be related to our needs for large-scale, advanced electronic systems?

Could you accept the responsibilities, develop the schedules and meet deadlines in a way that would be expected of you as a professional employee? Could you inspire your technical writer associates to follow your leadership?

Are you interested in continuing your own self-development in Company-sponsored educational programs?

Would you like to continue your career as a professional employee of a diversified, technically oriented Company that is an acknowledged leader in the market areas in which it competes?

If you can answer yes to these questions, you are a long way toward qualifying for openings within General Electric's Heavy Military Electronics Department. You'll be working on some of the most advanced electronic development programs underway today—like HIPAR, designed to triple the Nike-Hercules system capability by tracking smaller, faster targets at greater distances than was previously possible. You'll join a publications organization that has grown 700% in the last eight years with no end in sight. And you'll join an organization where you are treated—and paid—as a professional employee, where the demand for Engineering Writers will continue into the foreseeable future.

Upon receipt of a detailed summary of your experience and background, we'll send information that will help you make an objective comparison. Relocation assistance will be provided. All qualified applicants will receive consideration for employment without regard to race, creed, color, or national origin.

179-02

WRITE IN CONFIDENCE TO

Mr. George B. Callender
Engineering Administration, Section T-11
Heavy Military Electronics Department
Court Street, Syracuse, N. Y.

GENERAL  ELECTRIC

NEW SAMS BOOKS

JUST OUT—THIRD EDITION OF
THE FAMOUS HOWARD W. SAMS

Tube Substitution Handbook

Still Only \$1.50

- ★ Completely Updated and Fully Revised
- ★ Includes Over 800 New Substitutions

Latest edition of the book you'll find useful every day. Contains only DIRECT substitutions. Now includes 5,234 substitutions (808 more than in prior volume). Lists 2,759 substitutions for 1,687 receiving tube types. Shows 224 industrial and 602 European substitutes for American receiving types; 513 American for European receiving types; 465 picture tubes with 1,136 substitutes. Includes useful data on tube substitution. A "must" for every tube caddy and service bench.

96 pages; 5 1/2 x 8 1/4". Only \$1.50

New On Industrial Electronics!

Using The Oscilloscope In Industrial Electronics

by Middleton & Payne

Explains how to use scope to test industrial equipment such as thyatron controls, ignitrons and controls, saturable reactors and magnetic amplifiers, radar equipment, automotive ignition systems, transistorized controls. First 4 chapters cover basics: scope information capability, operating features, characteristics, general use in industrial electronics. Ten other chapters discuss waveform photography, lab applications, scope maintenance and calibration, etc. Includes handy scope specifications charts as well as numerous waveforms showing normal and abnormal operation. 256 pages, 5 1/2 x 8 1/4". Only \$4.95

Explains how to use scope to test industrial equipment such as thyatron controls, ignitrons and controls, saturable reactors and magnetic amplifiers, radar equipment, automotive ignition systems, transistorized controls. First 4 chapters cover basics: scope information capability, operating features, characteristics, general use in industrial electronics. Ten other chapters discuss waveform photography, lab applications, scope maintenance and calibration, etc. Includes handy scope specifications charts as well as numerous waveforms showing normal and abnormal operation. 256 pages, 5 1/2 x 8 1/4". Only \$4.95

Industrial Transistor & Semiconductor Handbook

by Robert B. Tomer

Now available—latest, most complete data on industrial semiconductors, their characteristics, circuit-design procedures, typical applications. First 4 chapters on semiconductor physics, general characteristics, circuit fundamentals, ratings and measurements. Other chapters discuss applications: diodes, industrial control, power converters, communications, unusual devices, thermoelectricity in solar-energy conversion. Special chapter discloses advanced semiconductor manufacturing techniques. Final chapter describes new developments, such as thin-film and integrated circuits, high-density packaging, microelements, etc. Appendix contains transistor parameter symbols and definitions, plus methods for determining thermal stability of transistor circuits. The up-to-the-minute book on semiconductors. 256 pages; 5 1/2 x 8 1/4". Only \$4.95

control, power converters, communications, unusual devices, thermoelectricity in solar-energy conversion. Special chapter discloses advanced semiconductor manufacturing techniques. Final chapter describes new developments, such as thin-film and integrated circuits, high-density packaging, microelements, etc. Appendix contains transistor parameter symbols and definitions, plus methods for determining thermal stability of transistor circuits. The up-to-the-minute book on semiconductors. 256 pages; 5 1/2 x 8 1/4". Only \$4.95

NEW! VOL. 9 SERVICING TRANSISTOR RADIOS!
Just out—covers 47 models produced in 1960.
Complete PHOTOFACT® servicing data. 160 pages; 8 1/2 x 11". Only \$2.95

HOWARD W. SAMS & CO., INC.

Order from your Sams Distributor today, or mail to Howard W. Sams & Co., Inc. Dept. K-11
1720 E. 38th St., Indianapolis 6, Ind.

- Send me the following books:
- Tube Substitution Handbook Vol. 3 (TUB-3)
 - Using the Scope in Industrial Electronics (OSM-1)
 - Indust. Transistor & Semicond. Handbook (ITT-1)
 - Servicing Transistor Radios (TSM-9)
- \$.....enclosed. Send Free Book List

Name _____
Address _____
City _____ Zone _____ State _____
IN CANADA: A. C. Simmonds & Sons, Ltd., Toronto 7
(outside U.S.A. priced slightly higher)

light source while the CK-1112 uses an incandescent light source.

NEW PC LAMINATE

17 Cinema Division of The Cincinnati Milling Machine Co. has introduced a new copper-clad laminate for printed-circuit applications.

Known as "Cinclad," the new product provides the high tensile, flexural, and impact strength of glass-fibre reinforced plastic at a price competitive with paper-base phenolic circuit boards.

The new boards are easy to process and cold punch well at room temperatures. From the flammability standpoint, it is self-extinguishing.

RACK-MOUNTED V.O.M.

18 The Triplett Electrical Instrument Co. has announced the availability of a rack-mounted v.o.m., the Model 630-NA-RM.

Among the features of this new 68-range, mirror-scaled instrument are: meter protection



against overloads, high accuracy on the same scale for a.c. and d.c., frequency compensation from 35 to 20,000 cps, temperature compensation, accuracy within a wide range of ambient temperatures, and d.c. reversing switch.

The etched aluminum panel, 19" x 5 1/4", has two chrome plate handles for easy removal of the tester from the rack.

THIN-CELL SELENIUMS

19 General Electric Company has introduced a new line of thin-cell selenium rectifiers in a new paper base, phenolic cartridge.

Known as "Vac-U-Sels," the cells are of .010-inch thin aluminum stock. They are fitted into the new phenolic housing in stacks with up to 700 cells available per stack. The cells operate at 130 degrees C ambient temperature. A single stack used in a half-wave circuit will accommodate 15,000 volts and will block a peak reverse voltage of 31,500 volts.

COMPACT OSCILLOSCOPE

20 National Union Electric Corp. is currently introducing a self-contained, compact, portable oscilloscope as the "NUscope." According to the company, it provides performance equivalent to many larger and bulkier instruments. The new NU125 cathode-ray tube provides a brilliant, sharp-focused display of ample size to observe electrical phenomena.

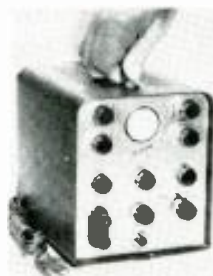

The unit measures only 5 1/8" x 6 1/8" x 7" and weighs just 5 1/2 pounds. It operates from a 117-volt power source. The instrument is housed in a black case with gold finish front panel. The carrying handle permits the unit to be moved about easily.

The vertical amplifier provides nearly flat response from 10 to 225,000 cps and is useful from 10 to over 500,000 cps. Sweep frequencies are controlled between 20 to 30,000 cps.

VOLTAGE CALIBRATOR

21 Electro Scientific Industries has released its Model SC-194 voltage calibrator, a two-dial test instrument for checking the calibration adjustments of accurate d.c. voltmeters.

Output voltages of .05, .1, .5, 1, 5, 10, 50, 100, 500, and 1000 are provided. A calibration certificate supplied with the unit specifies corrections for the left-hand dial to obtain highest accuracy.

(Continued on page 122)

G-R VARIACS

| | | |
|-----------|---------------------------------|---------|
| 1 1/4 Amp | 115 VAC Input, 0-135 VAC Output | 10.95 |
| 2 Amp | 115 VAC Input, 0-135 VAC Output | 22.95 |
| 3 Amp | 115 VAC Input, 0-135 VAC Output | 39.95 |
| 7 1/2 Amp | motor driven powerstat | \$35.00 |

CONS. VOLTAGE FTMRs

| | |
|------------------------------------|-------|
| Input 95-130 VAC, 400 cyc; 115 VAC | 19.95 |
| Input 95-130 VAC, 60 cyc; 115 VAC | 39.50 |
| Out 500 watt | |

VIBRATOR POWER SUPPLIES

| | |
|----------------------------------|-------|
| Output 117 VAC, 60 cyc, 80 watts | 24.95 |
| Input 210-240 VDC | 24.95 |
| Input 32-40 VDC | |

TRANSFORMERS

| | |
|---|--------|
| Primary 115 VAC, 60 cycles | |
| Sec. 460 VCT, 50 MA; 6.3 V, 2.5 A | \$3.25 |
| Sec. 2250 VCT, 200 MA; 2 X 10 VCT | 3.75 |
| 1 A; 3 X 5 VCT, 1.2 A; 5 V, 2 A | 6.95 |
| Sec. 1050 VCT, 200 MA; 6.3 VCT, 3 A; | |
| 6.3 VCT, 4 A; 5 VCT, 3 A | 5.95 |
| Sec. 800 VCT, 200 MA; 6.3 V, 6 A; 5 V, 3 A; | 5.75 |
| Sec. 1100 VCT; 212 MA | 3.95 |
| Sec. 12.6 VCT, 3.5 A; 15.6 V, 1 A | 2.45 |

CHOKES

| | | | |
|--------------|------|--------------|------|
| 10 H, 200 MA | 2.95 | 12 H, 150 MA | 2.45 |
| 11 H, 350 MA | 3.65 | 22 H, 100 MA | 1.95 |

METERS

| | | | |
|---------------------------------|-------------------------------|------------|--------|
| 2" 0-1 MA | | 0-150 MADC | \$3.45 |
| 3" 0-150 VAC | 4.45 | 0-250 MADC | 3.75 |
| 0-75 VDC | 3.85 | 0-1 MADC | 3.75 |
| 4 1/2" 0-50 VDC | 50, 100, 200; 300 volt scales | | 7.95 |
| 9 Read—Freq. meter, 380-420 Cyc | | | 9.95 |

RELAYS

| | | |
|------------------------------------|-----------------|-------|
| Sigma—4F—10K | ohm; SPDT, Adj. | 3.79 |
| 12VDC, DPDT, 10 A, cont. | | 1.35 |
| 28 VDC, DPDT, 10 A, cont. | | 1.95 |
| Stepping Relays | | |
| 3 Deck, 10 Pos. reset type, 12 VDC | | 7.95 |
| 4 Deck, 11 Pos., 48 VDC | | 14.95 |

FASCO MOTORS

| | |
|--|-------------|
| 115 VAC 1550 rpm 4 1/4" x 1 1/4" shaft | \$3.95 |
| 115 VAC Dbl ended shaft 3 1/4" x 1 1/4", 1 1/2" x 1 1/4" slotted two speed motor | each \$4.95 |

Write about other Fasco Motors

Note New Address!!

Advance Electronics

79 Cortlandt Street

New York 7, N.Y. RE 2-0270

!!! NEVER BEFORE AVAILABLE !!!

4 POLE, 100 POSITION Telephone System STEPPING RELAYS

complete with 200 double contacts on 20 two-sided decks, Stepping and Rotating Relays and 5 or more phone type multi-contact stack relays, condensers and wiring ready for installation. Activate with 50 Volt power supply and regular telephone dial! Shipping weight 15 lbs.

Above, nearly new, decks with clean solder contacts \$47.50

Above, in good condition, decks with crimp contacts (can be soldered) & wires clipped from outside circuits \$36.50

Cash, Check or M.O. only, sorry NO C.O.D.'s
LIMITED QUANTITY, subject to prior sales.

Your Name and address will place you on our free mailing list!

U-T-I. RECON Sales

P. O. Box 187,
Tuckahoe, New Jersey

TAPE RECORDERS



HI-FI COMPONENTS SLEEP LEARN KITS

UNUSUAL VALUES
FREE 1961
Catalog
DRESSNER
MERITAPE—Low cost, high quality recording tape, in boxes or cans.

1523RA Jericho Tpke, New Hyde Park, N.Y.



CHANNEL MASTER
PUTS A BRIGHT NEW STAR
IN THE SKIES

*Turn the page and learn why this is
the most powerful TV antenna of all time!*

Because today's fringe area reception problems cannot be solved by yesterday's antennas...

CHANNEL MASTER

Channel Master's world-famous Antenna Development Laboratory has done it again! By using a brand new concept in antenna design... PROPORTIONAL ENERGY ABSORPTION... Channel Master meets the fringe area challenge with the most powerful TV antenna ever produced... the Crossfire!

Proportional Energy Absorption works like this!

Each Crossfire element has a predetermined impedance, at each frequency, which determines its degree of energy absorption. This impedance, governed by the taper and spacing of the dipoles, decreases with the distance from the feed point. Each successive element therefore absorbs a larger percentage of the available energy.

Since the amount of available energy decreases as it progresses along the length of the antenna, each element, by absorbing a *larger* percentage, absorbs approximately the *same amount* of energy as the other elements in the array.

This means that the Crossfire...unlike other antennas...has a large group of driven dipoles actively working to increase gain *on every channel*...on both low and high bands.

More working elements provide more picture power! This is the key to the remarkable performance of the Crossfire.

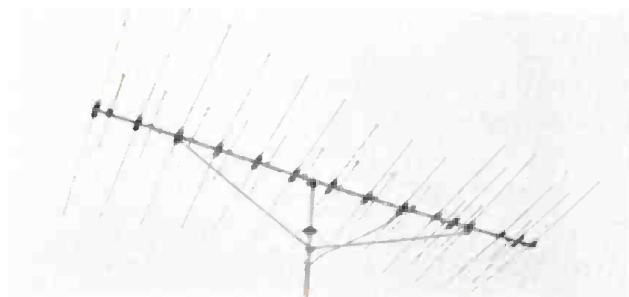

...And the Crossfire is Gold!

The Crossfire's performance is matched only by its beauty. Channel Master's exclusive E*P*C Process gives the antenna a lustrous golden coating that enriches its appearance and protects it for years against corrosion.

Channel Master's E*P*C Process is *not* anodizing! The disadvantage of anodizing is that the anodized film is an electrical insulator, and must be removed by *abrasion* wherever metal-to-metal contact is required. Therefore, anodized antennas have no surface protection on the very parts that need it most! Channel Master's E*P*C Process protects the *entire* antenna. It is the same protective treatment now required on all commercial jet aircraft and on rockets like the Redstone.

**THERE'S
A CROSSFIRE TO MEET
EVERY RECEPTION PROBLEM!**

model 3600
28 elements

model 3601
23 elements

model 3602
19 elements

model 3603
15 elements

model 3604
11 elements

INTRODUCES THE NEW, GOLDEN **Crossfire**

SERIES 3600

Transposed Feed Line Means Cleaner Gain!

Extremely high front-to-back ratios are accomplished by a Transposed Feed Line, from which the Crossfire gets its name. This feed line is transposed between each successive pair of elements. As a result, the radiations from each pair of adjacent elements are self-cancelling because they are 180° out of phase. This carefully engineered system is so efficient that the Crossfire needs no parasitic reflector element.

Because of these high front-to-back ratios, the Crossfire provides *cleaner* gain than any other all-channel antenna. It pulls in the signal you want while rejecting unwanted interference of every type (auto ignition systems, electrical noise, other TV signals, etc.) from both side and rear. See untouched photo of actual horizontal polar pattern.

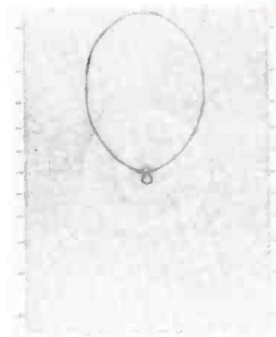
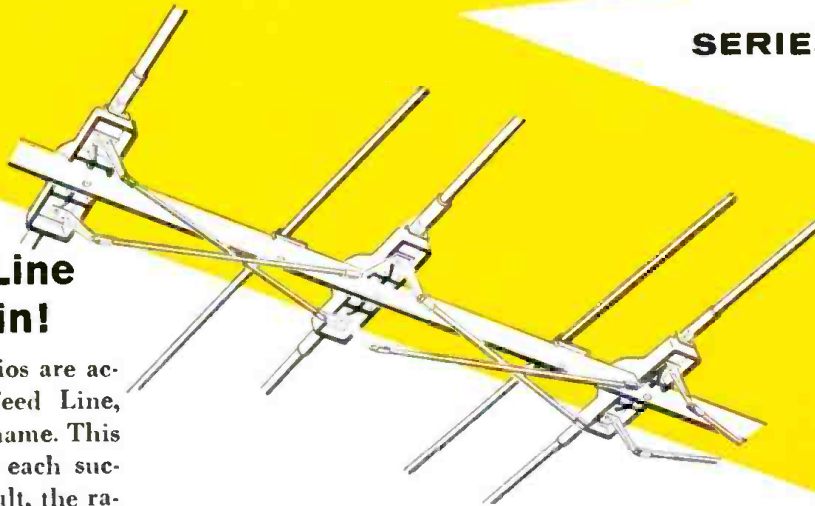

Revolutionary New Dual Dipole System

Each parasite reverses phase of high band current on the adjacent low band dipole, so that it operates as three driven half-wave high band elements.

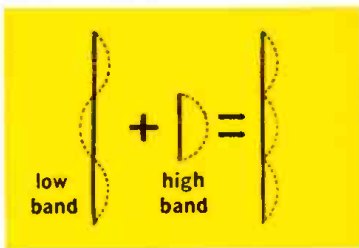

The Crossfire is the only antenna you can sell with full confidence that it will outperform anything your customer is now using!

For still more power... add the new

CHANNEL MASTER JETRON

Antenna-mounted transistorized signal amplifier and set coupler
Most effective...most dependable...lowest noise figure!

model 0020

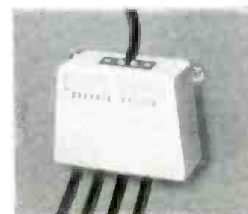

Power supply (with built-in 4-set coupler) is conveniently located in the home. Compact, only 5" x 3 3/4" x 1 3/4".

* Patent Pending

Copyright 1951, Channel Master Corp.

model 3605
7 elements

www.americanradiohistory.com

7-TUBE, 14 WATT STEREO \$29.95

AMPLIFIER WITH 6 SPEAKERS AS SHOWN \$45.95 IDEAL FOR CUSTOM INSTALLATION



PUSH PULL OUTPUT ON EACH CHANNEL

McGee offers \$100,000 worth of stereo amplifiers at a fraction of their original cost. 14 watts (7 watts per channel) 7 tubes. Push Pull output on each channel matches any 8 ohm hi-fidelity speaker. Response 35 to 15000 cps. Full tone control circuits, separate magnet base and treble tone controls, balance control, loudness control, plus input selector switch for any crystal phono cartridge, or radio tuner. Controls are mounted on a 3 1/2" x 15" solid excitation plate. A 30" lead plugs the control system into the amplifier for easy custom installation. Amplifier size 12 1/2" long, 4 1/2" tall and 7 1/2" wide. Operates on 110 volts 60 cycle a. c. Sump. wt. 8 lbs. Shipped complete with instructions. Stock no. M-1400. McGee sale price \$29.95 with tubes, loss speakers. Price with 6 speakers as illustrated \$45.95. The 6 speakers included are 2 10 inch heavy anilco V woofers, 2 matched 6" mid-range and 2 matched 4" anilco V tweeters. Stock No. M-1400-GS. VM-4 speed record changer with Astatic 13TX diamond needle stereo cartridge \$21.95 extra.

DECCA 2-TRACK STEREO TAPE SALE

PETE TOUNTAIN—King of the clarinet recorded in New Orleans. I GOT RHYTHM. J.A.O.A. CHINA BOY. AVALON. SHINE. TIGER RAG. DON'T BE THAT WAY. POOR BUTTERFLY. SOMEDAY SWEETHEART. 'S WONDERFUL. Coral 2 track stereo tape regularly \$9.95. from McGee at \$3.95. Stock No. 57313

WRITE FOR McGEE'S 1962 172 PAGE CATALOG

McGEE RADIO CO.

1901 McGee St., Kansas City 8, Missouri

Calibration data is accurate to better than $\pm .005\%$ at a temperature of 25 degrees C. at the time of measurement.

CAPACITOR STANDARDS

22 Central Scientific Co. is now offering two new precision capacitor standards for use as



laboratory standards or as circuit elements in tuned circuits, measurement circuits, and filter networks.

The Model 83516-1 has a capacitance of .5 μ f, while the Model 83516-2 is rated at 1 μ f. Capacitance tolerance is $\pm .25\%$, capacitance stability is $\pm .1\%$, d.c. working voltage is 300, and power factor at 1 kc. is $\pm .02\%$. Universal binding posts accept all common connectors.

HI-FI—AUDIO PRODUCTS

TRANSISTORIZED RECORDER

23 Craig Panorama, Inc. has available a miniaturized transistor tape recorder which is being offered as the Model TR-403.

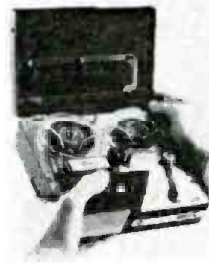

Available accessories include footswitch, telephone

Featuring two-speed operation, the unit can record up to 68 minutes on one tape. A vtu meter provides for checking recording level and battery condition. The recorder is powered by standard penlite batteries.

The unit comes equipped with microphone and case, reel case, and earphones.

pickup, as well as an a.c. adapter for 117-volt operation.

FULL-FIDELITY SPEAKER SYSTEM

24 Advanced Acoustics Corporation has added the "Modulaire" to its line of "Bi-Phonic Coupler" unique full-fidelity loudspeaker systems.



Smaller in both size and depth than previous types, the new unit covers the range from 35 cps to well beyond audibility. It is 13 1/2" wide and 3 1/2" thick, permitting the unit to be hung on a wall like a picture, used as a room divider, or incorporated into any furniture piece or bookshelf. It will also mount between 16" studs of a standard wall for built-in applications.

The unit incorporates an electro-dynamic driving system and can be coupled to the 8-ohm output of any hi-fi amplifier, requiring only 15 watts of clean audio power to produce its full range of output.

LOW-PASS FILTER

25 Phi Research is currently introducing a new low-pass filter which has been developed specifically for the recently adopted stereo multiplex system.



Known as the L.P-15, the filter is designed to be used either at the inputs of stereo exciters and generators or to simplify output measurements of adapters. At-

TRU-VAC FREE

UP TO 100 1-YR. GUARANTEED TRU-VAC TUBES

TO QUANTITY BUYERS!

Now quantity buyers get a FREE assortment of individually-boxed, regular stock TRU-VAC tubes with each order.

PLACE YOUR ORDER TODAY! GET UP TO 100 TUBES FREE!

Here's how this FREE offer works!

- 15 FREE TUBES With Order of \$25
- 25 FREE TUBES With Order of \$50
- 50 FREE TUBES With Order of \$100
- 100 FREE TUBES With Order of \$500

LOOK! 1,000 USED TV'S \$16.95
As Is
Costly famous make portable models with little or no tube replacement adjustment. Permanent for resale, or as test for use. Set your own second set! 17" and 19" screens. Some smaller! Sets shipped. Set, Harrison, N.J.

1-yr. guaranteed Radio & TV Tubes

35¢
\$33 PER EA. 100 TUBES
These Types Not Included In Sale!

Factory Used or Factory Second Tubes! TRU-VAC will replace FREE any tube that becomes defective in use within 1 year from date of purchase!

ALL TUBES INDIVIDUALLY BOXED! CODE DATED & BRANDED "TRU-VAC"

Partial Listing Only . . . Thousands More Tubes in Stock!

| | | | | | | | | | | | | |
|-------|-------|--------|--------|--------|--------|--------|-------|---------|-------|---------|--------|----|
| 0Y4 | 3BC5 | 5T8 | 6A55 | 6RM5 | 6CN7 | 654 | 6X4 | 7E7 | 12AX7 | 12R5 | 35B5 | |
| 0Z4 | 3UN6 | 5U4 | 6AT6 | 6BM7 | 6C6 | 657 | 6X5GT | 7F7 | 12AZ7 | 12SA7 | 35C5 | |
| 1A7GT | 3UZ6 | 5U8 | 6AU6GT | 6BL7GT | 6C56 | 658GT | 6X8 | 7E8 | 12B7 | 12S7 | 35W4 | |
| 1B3GT | 3CR6 | 5V4C | 6AU5GT | 6C16 | 6C57 | 65A7 | 6Y6G | 7G7 | 12BA6 | 125M7 | 35Z5 | |
| 1H5GT | 3Q4 | 5V6GT | 6AU8 | 6B06GT | 6C15 | 65D7GT | 7A4 | 7H7 | 12BA7 | 125N7GT | 36 | |
| 1L4 | 354 | 5X8 | 6AV5GT | 6B07 | 6C16 | 65E5 | 7A5 | 7Q7 | 12BD6 | 125Q7 | 38 | |
| 1L6 | 3V4 | 5Y3 | 6AV6 | 6B08 | 6D6 | 65E7 | 7A6 | 7S7 | 12BE6 | 12V6GT | 39-44 | |
| 1N5GT | 4B07A | 6A6 | 6AW8 | 6B58 | 6D6E | 65C7 | 7A7 | 7X6 | 12BF6 | 12W6GT | 41 | |
| 1S5 | 4B5B | 6AB4 | 6AX4GT | 65Y5G | 6DC6GT | 65H7 | 7A8 | 7X7 | 12BH7 | 12X4 | 42 | |
| 1T4 | 4BZ7 | 6AF4 | 6AX5GT | 6BZ6 | 6DF6 | 65J7 | 7B4 | 7Y4 | 12BQ6 | 14A7 | 12B7 | 43 |
| 1U4 | 4CR6 | 6AM3GT | 6B8 | 6BZ7 | 6E5 | 65K7 | 7B5 | 7Z4 | 12BR7 | 14B6 | 50A5 | |
| 1U5 | 5AM8 | 6BA6 | 6C1 | 6E5 | 65L7 | 7B6 | 7B6 | 12A8 | 12BY7 | 14C7 | 50B5 | |
| 1V2 | 5AN8 | 6AK5 | 6BC5 | 6CAB | 6E6 | 65O7 | 7B7 | 12AB5 | 12CA5 | 19A4GT | 50C5 | |
| 1X2 | 5AT8 | 6AL5 | 6BC8 | 6C06G | 6H6 | 65R7 | 7B8 | 12AQ5 | 12CN5 | 19BG6G | 50L6 | |
| 2AF4 | 5AV8 | 6AM8 | 6BD6 | 6CF6 | 6J4 | 6T4 | 7C4 | 12AT6 | 12E5 | 19J6 | 56 | |
| 2BN4 | 5AZ4 | 6AN8 | 6BE6 | 6C08 | 6J8 | 6T8 | 7C5 | 12AT7 | 12F8 | 19T8 | 80 | |
| 2CY5 | 5BR8 | 6AQ5 | 6BF5 | 6C8H | 6M6GT | 6J5 | 7C6 | 12AU6 | 12K5 | 24A | 84/6Z4 | |
| 3A5 | 5CG8 | 6AQ6 | 6BG6G | 6CL6 | 6M7 | 6U8 | 7C7 | 12AV6 | 12M7 | 25Z6GT | 11/23 | |
| 3A5S | 5U8 | 6AU7 | 6BM6 | 6CM6 | 6M7 | 6V6GT | 7E5 | 12AV7 | 12L6 | 27 | | |
| 3AU6 | 5R4 | 6AR5 | 6B6 | 6CM7 | 6Q7 | 6W6GT | 7E6 | 12AX4GT | 12Q7 | 35A5 | | |

Any Tube Not Listed Also Available at 35¢ Each!
BRAND NEW 1-YEAR GUARANTEED TV PICTURE TUBES

Below Listed prices do not include duty. Add Additional \$3.00 (approx) on tube sizes to 20" or 21" and 21" tubes—\$7.00 extra. Deposit refunded immediately when duty is returned.

Special: Aluminized tubes—\$4.00 extra. Picture tubes shipped only to continental USA and Canada—All tubes F.O.B., Harrison, N.J.

100P4 7.99 16KP4 11.99 17BP4 16.99 20HP4 17.89 21AP4 17.49 21XP4 17.49
12LP4 10.49 16LP4 12.19 17LP4 16.99 21AP4 17.49 21EP4 17.39 21FP4 18.39
13HP4 11.99 16RP4 11.99 17QP4 13.89 21AP4 18.79 21FP4 18.79 21GP4 17.49
16AP4 13.49 17AP4 13.49 18AP4 13.89 21AP4 18.79 21MP4 18.79 21NP4 18.79
16BP4 16.99 17CP4 16.99 17DP4 16.99 21AP4 18.79 21WP4 17.79 21XP4 20.79
17BP4 17.99 17CP4 17.99 17DP4 17.99 21AP4 18.79 21WP4 17.79 21XP4 20.79

ATTENTION QUANTITY USERS! Big Discounts Are Yours! Call or Write For Our 1000 Tube "Private Label" Special Attention Handling Fee! Money cheerfully refunded!

TRU-VAC TO PAY YOUR POSTAGE—on orders of \$3 or more in USA and Territories. Send approximate postage on Canadian and foreign orders. Any order less than \$3 requires 25¢ handling charge. Send 25¢ on C.O.D.'s. All orders subject to prior sale, complying with Federal regulations, the following statement appears in all Tru-Vac advertising: Tubes in this ad may be FACTORY SECONDS or USED tubes and are clearly marked.

TRU-VAC

Harrison Avenue • Box 107 • Harrison, N. J. HUmboldt 4-9770

termination at 19 kc. is at least 60 db yet the pass-band is flat to less than .5 db from 20 to 15,000 cps.

TRANSISTORIZED STEREO AMP

26 Allied Radio Corporation has added an all-transistor, 75-watt stereo amplifier to its "Knight" line of audio equipment.

The new KN-150 features 37½ watts per channel (HF-M music power output); response 20-30,000 cps \pm .5 db at rated power; harmonic distortion of .5% at rated power, and hum and noise 95 (rmer) and \pm 65 db (magnetic phono). The amplifier has five pairs of inputs and two convenience a.c. outlets.



SINGLE-SPEED TURNTABLE

27 Acoustic Research is currently marketing its first product outside the loudspeaker field—a single-speed (33½ rpm) turntable which comes complete with arm, oiled-walnut base, transparent dust cover, cables, and an overhang adjustment device and needle force gauge.

The unit features belt drive, synchronous motor, 3.5-pound machined, individually balanced aluminum platter, plus a manufacturer's guarantee that the turntable meets NAB specifications for broadcast equipment on wow, flutter, rumble, and speed accuracy.

INTEGRATED AMPLIFIER

28 Monarch Electronics International, Inc. is now in production on a 32-watt stereo amplifier, AM-FM-SW tuners, and control facilities built on a single chassis and being offered as the Model 200-A.

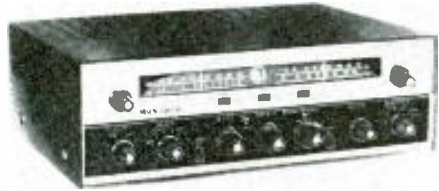

The 15-tube circuit incorporates Foster-Seely discriminator, a.l.c., FM sensitivity of 2 μ v, for 20 db quieting, scratch and rumble filters, plus inputs for magnetic, crystal, and ceramic cartridges, microphone, and multiplex adapter. The preamp, which

is transistorized, offers complete control of function, mode, bass, treble, presence, balance, phasing, loudness, and volume.

PORTABLE TAPE RECORDER

29 International Products Co. is now marketing a miniature tape recorder which features printed circuits and transistor operation. Response is 150-6000 cps and the unit will record over an hour at 178 ips and over 30 minutes at 3½ ips. Features of the recorder include a combination level meter and battery drain indicator, footswitch, remote control microphone, stereo headset, patchcord for direct recordings, telephone pickup, and a.c. adapter.



Powered by six pen-lic cells, the unit measures 7¾" x 5¾" x 2½" and weighs 3.7 pounds including batteries. A leather carrying case with adjustable strap is included with the instrument.

NEW SPEAKER SYSTEM

30 Bogen and Rich, Inc. is bringing out a new type of high-fidelity speaker which features a unique transducer utilizing a completely active plane radiation surface. According to the company, extremely low harmonic distortion, even at bass frequencies, and transient response equivalent to that obtainable only from electrostatic loudspeakers are characteristics of the new unit.

The three-way system is flat from 20 to 20,000 cps.

COLOR-CODED CABLES

31 Zoron, Inc. has announced the availability of a new series of color-coded connector cables for tape, magnetic phono, ceramic phono, tuner, amplifier, microphone, and speaker.

The new cables are coded in five colors for quick and easy lead identification. The cords are supplied in white, green, yellow, red, and blue. One basic color is recommended for each connection from jack to cord to jack while channel or multiple connections may be marked for rapid

sm thest resp nse

the all-new

SHURE Sonodyne II

adjustable frequency response microphone

Life-like, natural reproduction achieved through a smooth response from 60 to 10,000 cps . . . without coloration. *Revolutionary Adjustable Frequency Response* feature permits you to roll off highs or lows, separately or together—provides additional flexibility in a variety of microphone applications. Omni-directional . . . high output dynamic element. Equipped with *reliable* on-off switch and "positive action" 150° swivel that permits you to "aim" the microphone at the source of sound. Model 540S priced at only \$29.97 audio net.



Write for literature:

Shure Brothers, Inc.
222 Hartrey Ave.
Evanston, Illinois
Dept. 13-J

**SEND
ELECTRONICS WORLD
EVERY
MONTH**

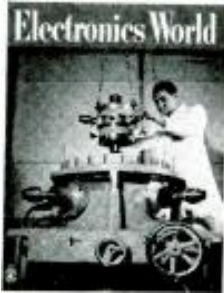

name _____

address _____

city _____ zone _____ state _____

Check one:

- 3 years for \$12 2 years for \$9
 1 year for \$5

In the U. S., its possessions, and Canada

- Payment enclosed Bill me

Foreign rates: Pan American Union countries, add .50 per year; all other foreign countries, add \$1.00 per year.

Mail to: **ELECTRONICS WORLD**
Dept. EW 1061H, 434 S. Wabash Ave.
Chicago 5, Ill.

**PURCHASING
A HI-FI
SYSTEM?**

TIME PAYMENTS AVAILABLE
Up to 2 years to pay!

**Send Us
Your List Of
Components
For A
Package
Quotation**

**YOU CAN BUY
WITH CONFIDENCE
AT AIREX**

All merchandise is
brand new, factory
fresh & guaranteed.

Free Hi-Fi Catalog

**AIREX
RADIO**

CORPORATION
85-R Cortlandt St., N.Y. 7, WO 4-1820

Jim Lansing*
Altec Lansing
Electrovoice
Hartley*
University
Acoustic Research
Janszen • Jensen
Wharfedale
USL Citizen Band
Ganset • Hallicrafter
Texas Crystals
International Crystals
Concertone • Viking
Bell • G.E.
Weathers
Harman-Kardon
Eico • Pilot
Sherwood*
ESL
Frazier
Dual Changer
Bogen • RCA
Dynakit • Fisher
H. H. Scott
Thorens*
TEC. Amps & Tuners
DeWald • National
Superscope
Sony • Roberts
Challenger
Wallensak
Garrard • Norelco
Miracord
Glaser-Steers
Rok-O-Kut
Polytronics
Tandberg*
Fairchild • Conrac
Pickering • Sonar
Audio Tape
Magnecord*
Rockford Cabinets
*Fair Traded

identification by means of available colored marking strips applied to handles or color dots applied to chassis.

INTEGRATED MULTIPLEX TUNER

32 Harman-Kardon, Inc. has recently introduced an integrated multiplex tuner, the Model T300X. The new unit is an AM-FM tuner with built-in multiplex section. The T300X features a wide-band detector and three high-gain i.f. stages. Sensitivity is .95 μ v. for 20 db of quieting and 3.2 μ v. usable sensitivity (IFEM standards). Distortion is less than .1% at 100% modulation while response is 10-35,000 cps \pm 1 db.

The company is also marketing a plug-in multiplex adapter designed to be used with the firm's F500 professional FM tuner.

CB-HAM-COMMUNICATIONS

CB ACCESSORY

33 Martin Development Co. is now in production on an accessory for CB use, the "CB-Beeper." Essentially a tone generator for signaling use with any CB transceiver, the "Beeper" is a compact, transistorized, and self-powered unit. It measures 2" x 3" x 4" and is housed in a black and hammertone gray case.

The instrument generates a 1000-cps tone for signalling. Its installation requires only one simple connection. A less expensive unit, the "Econo-Beeper," is slightly smaller in size but is not self-powered. Its installation requires three connections to the CB transceiver.

MARINE RADIOTELEPHONE

34 Pearce-Simpson, Inc. is now offering a 30-watt marine radiotelephone which has been specifically designed with the small boat owner in mind.

The "Marathon-30" features 5 marine channels plus the broadcast band, hybrid circuitry for premium performance, unbreakable cabinet,



low current drain, simple operation, small size, and light weight.

The units operate from 12 volts d.c., measure 9 1/2" x 13" x 5 3/4", and come complete with a nylon-cased microphone with coiled cord.

POCKET TRANSCEIVER

35 Osborne Electronic Sales Corp. has added a transistorized, portable transceiver to its line of communications equipment.



Known as the "Duo-Com 120," the new unit weighs 28 ounces, is hand-held, and delivers a full watt of output. In addition to noise quieting features, it has a rechargeable battery pack with up to 18 hours of usable life before recharging.

The company also produces the battery charger unit for use with this transceiver.

NEW CB UNIT

36 E.C.I. Electronics Communications, Inc. is now marketing the "Gourier I," a CB transceiver featuring triple-conversion and two i. f. stages.

The unit features 12-channel transmitting, fixed and tunable drift-free reception, built-in



"S" and "RF" meter, electronic switching, built-in noise limiter and squelch circuits, and a front-panel-adjustable r.f. gain control.

The circuit is built in five individual hand-wired segments facilitating service and replacement. All metal parts are cadmium plated for marine applications. AM radio is available as an optional feature at extra cost.

CB TRANSCEIVER

37 The Hallicrafters Co. has introduced a new CB transceiver which features eight-channel potential.

The "Littlelone" Model CB-3 has a self-contained dual power supply, permitting operation on standard 117-volt a.c. or on 12-volt battery.



Switching from a.c. to d.c. is accomplished by changing power plugs, which are included with the unit. A completely electronic squelch device quiets static.

Included with the CB-3 are a mounting accessory kit, a push-to-talk hand microphone, crystals for one channel, and CB license application forms.

NEW TWO-WAY RADIO

38 General Electric Company has developed and is currently marketing a new, extensively transistorized personal portable two-way radio for the 132-174 mc. service.

Known as the "Voice Commander," this FM unit is small, light, and compact. It features a 1-watt transmitter r.f. power output. The transmitter-receiver is housed in a single 9.5" x 5.3" x 1.7" case which contains a built-in microphone and speaker.



NEW CB EQUIPMENT

39 Eico has announced a new series of deluxe CB transceivers which feature multi-channel operation, a choice of crystal or continuous reception, press-to-talk microphone, superhet receiver



with an r.f. stage and a 1750-kc. i.f. strip, and adjustable squelch control and automatic series-gate noise limiter.

Three models are available in the new series. All have transformer-operated silicon-diode doubler power supplies for 117 volt, 60-cps operation. In addition, the Models 771 and 772 are equipped with vibrator power supplies for 6 volts d.c. and 12 volts d.c. battery operation, respectively.

All three units, Models 770, 771, and 772, are being offered in both kit and wired versions.

MANUFACTURERS' LITERATURE

ULTRAMINIATURE WIREWOUNDS

40 Reon Resistor Corp. has issued a technical bulletin (P5 5/61) which describes its line of ultraminiature encapsulated wirewound resistors for microminiature circuits applications in industry and the military.

Complete physical and electrical specifications are given on a wide range of both axial and lug types.

SILICON DIODE DATA

41 Computer Diode Corporation has released a four-page brochure listing the characteristics of 86 conventional glass silicon diodes currently available from the firm.

Catalogue D-100 lists 35 general-purpose types and 51 computer-diode types.

SILICON RECTIFIERS

42 Bradley Semiconductor Corp. has issued a six-page short-form data folder covering its line of JEDEC-type silicon rectifiers.

The material is presented in tabular form for ready reference.

TERMINALS & SPLICES

43 AMP Incorporated has issued an 8-page catalogue which enables users to compute precisely what terminal or splice barrel size must be used to accept any given size of solid, stranded,

rectangular, or square wire (single or in combination) from 226 to 1,000,000 circular mils.

Separate charts define the computations necessary to determine the circular mil area of square or rectangular wire, round solid wire AWG, and stranded wire AWG. Another chart shows how to choose oval-shaped terminal barrels for some combinations of wire or in cases of unusually wide and thin rectangular wire. When circular mil area has been computed, reference is then made to a series of charts which equate circular mil area with terminal or splice size.

MODULAR POWER SUPPLIES

44 Quan-Tech Laboratories, Inc. is now offering a technical flyer which describes three versions of its new Series 170 modular, regulated power supplies.

Complete technical data is given, including dimensional drawings, electrical specifications, weight, and price.

CB-HAM-SW EQUIPMENT

45 Lafayette Radio has issued a two-color brochure listing a complete line of equipment for the Citizens' Band, radio amateur, and SWL. Details on the firm's line for these services are given, with complete specifications and application data. In addition, this publication carries useful information on the CB service, lists CB channels and frequencies, provides a CB call area map, explains CB licensing procedures, how to choose the right antenna, and how to mount fixed antennas for maximum range. A line of CB accessories is briefly described and illustrated.

HEAVY-DUTY CAPACITORS

46 Corson Electric Mfg. Corp. has issued a four-page catalogue which describes a line of heavy-duty capacitors for use in power supplies, voltage-doubling circuits, communication receivers and transmitters, x-ray equipment energy storage, and other electronic applications.

The literature describes how these capacitors



\$200.00

Value

**RCA POWER AMPLIFIER plus
RCA PRE-AMP CONTROL UNIT**

both for only **\$74⁹⁵**
either ONE worth every penny of it!

NOT A KIT • FULLY ASSEMBLED • as illus.

Direct from Importer to You

STEREO-MATE or COMPLETE MONAURAL

New, exclusive electro-acoustic features include:
* 20-watt (40-watt peak) power output maintained to limits of audible frequency spectrum * infinitely variable loudspeaker damping factor * accurate disc record compensation * extensive filtering system * frequency response 0.2 db 20-25,000 c.p.s.

**ORDER NOW—NO MORE EVER
AT THIS PRICE! 2 MONEY-BACK
GUARANTEES—RCA'S AND OURS!**

NEW YORK SALES & SERVICE

Dept. W 911 Broadway, N. Y. 10, N. Y.

Delivery or fleet operation

Your own personal use

Construction or Business

HERE'S THE NEW, 2-WAY HAND-HELD TRANSCIVER THAT
OUTPERFORMS 'EM ALL!

PERSONAL

Messenger

- No license required—may be used at once!
- Meets FCC requirements for use with licensed Citizens' Band stations, too!

This is the new "Personal Messenger"—a superbly engineered 2-way crystal-controlled transceiver so compact it fits in your hand—so flexible it can be used in thousands of applications! 11 transistors and 4 diodes—superheterodyne receiver with exclusive tuned R.F. amplifier gives you twice the sensitivity and more than 40% more range than units with conventional circuitry! Powerful two-stage transmitter delivers more power output than similar units with the same rated input! Unmatched audio intelligibility and razor-sharp voice reproduction—automatic noise limiter—automatic volume control—positive squelch control—elastic hand strap—operates on penlight or rechargeable **\$109⁵⁰** nickel-cadmium batteries.

ILLUSTRATED AT LEFT—The Viking "Messenger"—maximum legal power Citizens' Band crystal-controlled transceiver. Excellent receiver sensitivity and selectivity—highly efficient transmitter punches your signal home! Built-in squelch—AVC—ANL. With tubes, push-to-talk microphone and crystals for 1 channel. FROM **\$134⁹⁵**

FREE
Color Brochure



WRITE TODAY



E. F. JOHNSON COMPANY

911 Tenth Avenue S. W. • Waseca, Minnesota

• Please rush me your full color brochure.

NAME _____

ADDRESS _____

CITY _____

STATE _____

Manufacturers of the world's most widely used personal communications transmitters

LORAN APN/4 OSCILLOSCOPE
Easily converted for use on radio-TV service bench.
LIKE NEW! Supplied with Scope, type 5CP1 only **\$14.50**

BC-711 VHF 10-Tube Aircraft Receiver. 6-channel crystal control. Free 100 to 110 Mc. Dual ether range. Easily converted for tracking Sputniks. 1000 tubes. **\$9.95**

FAMOUS BC-645 TRANSCEIVER
15 Tubes 435 to 500 MC
Can be modified for 2-way communication, voice or code, on ham band 420-450 mc. citizens radio 460-700 mc. fixed and mobile 450-460 mc. television experimental 470-500 mc. 13 tubes. tubes alone worth more than sale price! 1-2FT, 4-717, 1-2E4, 4-6B, 2-6B2 and 1-WK-116A. Now covers 400 to 500 mc. Brand new BC-645 with tubes, less power supply in factory carton. **\$19.50**
Shipping weight 5 lbs. SPECIAL!
PE-101C Dynamotor, 1 1/2 24V input... \$7.95
UMF Antenna Assembly... 2.45
Complete Set of 10 Plugs... 3.80
Control Box... 2.25
SPECIAL "PACKAGE" OFFER:
BC-645 Transceiver, Dynamotor and all accessories above. COMPLETE, BRAND NEW. **\$29.50**
White Stocks Last

SCR-274 COMMAND EQUIPMENT
ALL COMPLETE WITH TUBES
Type Description Used Like
BC-453 Receiver 100-550 KC... \$12.95 \$14.95
BC-474 Receiver 3-6 Mc... 10.45 12.45
BC-155 Receiver 430 Mc... 2.95 3.95
Marine Receiver 1500-3000 KC Brand New... \$16.95

110 Volt AC Power Supply Kit, for all 274-N and ARC-5 Receivers. Complete with metal case, instructions **\$1.95**
Factory wired, tested, ready to operate... \$11.50
SPLINED TUNING KNOB for 274-N and ARC-5 RECEIVERS. Fits BC-453, BC-454 and others. Only **49c**

BC-457 TRANSMITTER-4.5-3 Mc. complete with all tubes and crystal. BRAND NEW **\$9.75**
BC-458 TRANSMITTER-5.3 to 7 Mc. Complete with all tubes and crystal. BRAND NEW **\$9.75**
T19 TRANSMITTER 3/4 mc. complete with all tubes and crystal. Exc. Used **\$9.95**
BC-474 Modulator. Like New. **USD 3.45 NEW 5.95**
MD7 Modulator. Like New. **USD 3.45 NEW 5.95**

APN-1 FM TRANSMITTER-RECEIVER
420 to 480 Mc. Aircraft Radio altimeter equipment. Tubes: 4-1055, 3-125L7, 4-125H7, 2-316E, 1-1V150; Complete with tubes, Exc. Used, Like New! **\$6.95**
APN-1 Brand New **\$8.95**

BC-603 FM RECEIVER
20 TO 27.9 MC. **\$14.95**
Excellent Used **BRAND NEW \$18.95**
10-channel, push-button or continuous tuning. Complete with speaker, squealer, and ten tubes: 3-4V7, 1-6J5, 2-12SG7, 1-4L6, 1-4A6, 2-6X5
EXTRA SET OF 10 TUBES FOR ABOVE brand new in original boxes **\$3.95**
FT-237 MOUNTING BASE for BC-603 Revr and BC-604 Xmitter, Brand New **\$5.95**
12 or 24V Dynamotor for Above Exc. Used **\$4.25** Brand New **\$5.50**
BC-603 FM Receiver, 27 to 28.9 Mc. Complete with all tubes, Like New. **\$33.33**
4-Section Antenna for BC-603, 603 Receivers. Complete with mounting base. BRAND NEW **\$4.95**
BC-604 TRANSMITTER-Companion unit for BC-603 Revr above. With all tubes. BRAND NEW **\$6.95**
4-Section Antenna for BC-604, 604 Transmitters. Complete with mounting base. BRAND NEW **\$4.95**
We carry a complete line of spare parts for above.

SPECIAL! BC-603 FM RCVR CONVERTED FOR ANY FREQ.—30 TO 50 MC.
BRAND NEW! Checked out, perfect working condition, ready for operation. Specify frequency desired (between 30-50 Mc) when ordering. **\$29.50**
AC POWER SUPPLY FOR BC603, 603
Interchangeable. Line 1 amp. 100-0-100 volt. NO BEYER CHANGE NEEDED. Provides 250 VAC @ 80 Ma, 21VAC @ 2 Amps. **\$10.25**
Complete 240-page Technical Manual for BC-603, 604 **\$3.15**

BC-605 INTERPHONE AMPLIFIER for above. BRAND NEW. Each **\$4.95**

BC-638A FREQUENCY METER 100-156 Mc. Xtal controlled. Rack mounting. For 110V AC operation. Less crystals. BRAND NEW **\$29.50**

ARN-5-C AIRBORNE Equipment, to give vertical guidance during landings. 1 tube superhet circuit. Tubes: 2RD7, 2-125R7, 2-125N7, 7-6A55. Crystal Controlled on 6 channels. Exc. Used **\$12.95**

SCR-522 2-METER RIG!
Terrific buy! VHF Transmitter-receiver, 100-156 Mc. 4 channels. Xtal controlled. Amplitude modulated voice. They're going fast. Excellent condition.
SCR-522 Transmitter-Receiver, complete with all 18 tubes, top rack and metal case. **\$29.50**
COMBINATION, Exc. Used

WILLARD 6-VOLT MIDGET STORAGE BATTERY
3 Amp. Hour. BRAND NEW. 3 3/4" x 1-13/16" x 2 3/8". Uses Standard Electrolyte. Only **\$2.95**

SCHEMATIC DIAGRAMS For most equipment on this page, each **65c**
WE HAVE IN STOCK many, many other Wonderful Buys in Surplus Govt. Electronic Equipment, not shown here. Your inquiries are invited. Send Name & Address on Postal Card for our latest FREE BULLETIN!

ARC-3 RECEIVER!
Complete with All Tubes Exc. Used **\$16.95**
Like NEW **\$21.95**
Used **\$15.95**
Crystal-Controlled 17-tube superhet. 4 tubes from 100 to 156 MC., AM., on any 8 pre-selected channels. 28-volt DC power input. Tubes: 1-9002, 6-6A5, 1-125N7, 3-125G7, 1-9001, 1-12H6, 2-125N7, 1-125L7, 1-12A6.

ARC-3 TRANSMITTER
Companion unit for Receiver. 100 to 156 MC on any 8 pre-selected channels. 8 tubes, crystal controlled. Provides tone and voice modulation. 28V DC Power input. Complete with all tubes. Tubes: 3-6A5, 2-6B2, 1-125H7, 1-6D5, 2-6L6, Exc. Used **\$16.95**
Like new condition **\$22.50**
ARC-3 STILL IN CONTROL BOX **\$5.95**

AN/ART-13 100-WATT XMTR
11 CHANNELS
200-1500 Kc
2 to 18.1 Mc
\$58.50
Complete with Tubes
Famous Collins Automatic Aerial Transmitter, AM, CW, MCW. Quick change to any of ten preset channels or manual tuning. Speech amplifier/clipper uses carbon or magnetic mike. Highly stable, highly accurate VFO. Built in Xtal controlled calibrator. PPM's modulate R13 in final up to 100%, class "B" A Real "Hot" Ham buy at our low price! **\$58.50**
0-16 Low Freq. Osc. Coil for ART-13... 7.95
24V Dynamotor for ART-13... 11.95
Same as above less meter... 39.50
We carry a complete line of spare parts for above.

MICROPHONES
Model Description BRAND
T-17... Carbon Hand Mike... \$5.45
RS-38... Navy Type Carbon Hand Mike... 4.75

HEADPHONES Excellent BRAND
Model Description Used NEW
HS-23... High Impedance... \$2.19... \$4.49
HS-33... Low Impedance... 2.69... 4.59
HS-30... Low Imp. (leatherw.)... 2.90... 4.85
H-16 U... High Imp. (2 units)... 3.75... 7.95
TELEPHONICS—600 ohm low Impedance HEADPHONES—NEW, PEU PAIR... \$3.25
CD-307A cords, with PL55 plug and JK26 Jack... .99
Earphone Cushions for above—pair... .50

BC-906 FREQ. METER—SPECIAL
Cavity type, 145 to 235 Mc. BRAND NEW, complete with antenna. Manual and original calibration charts included.
OUR LOW PRICE... **\$10.88**

BC-221 FREQUENCY METER
SPECIAL BUY! This excellent frequency standard is equipped with original calibration charts, and has ranges from 125 Kc to 20,000 Kc with crystal check points in all ranges. Excels Used with original Calibration Book, Crystal, and all tubes—LIKE NEW!
Unmodulated... \$72.50 Modulated... \$99.50
RA-133 original A.C. power supply made for Govt. For use with BC-221. Wired and tested **\$18.95**

SCR-625 MINE DETECTOR
Complete portable outfit in original packaging. With all accessories. Brand New **\$27.50**

DYNAMOTOR ASSEMBLY
Very fine unit, made by Collins Radio. Consists of TWO Dynamotors mounted on filter base.
Dynamotor #1 OUTPUT
12VDC @ 3.8A 220VDC @ 100 Ma.
Dynamotor #2 OUTPUT
12VDC @ 9.9A 400VDC @ 180 Ma.
BRAND NEW, in original packaging, ship wt 29 lbs. **\$9.95**
OUR LOW PRICE

MOBILE-MARINE DYNAMOTOR
Model DM35
Input 12V DC. Output 625 V DC @ 225 Ma. for press-to-talk intermittent operation. SHRP. wt. 14 lbs. **\$8.95**
OUR LOW PRICE. BRAND NEW

OTHER DYNAMOTOR VALUES: Excellent BRAND

| Type | Input | Output | Used | NEW |
|--------|-----------|-------------|------|--------|
| DM-25 | 12V 2.2A | 250V .050A | | \$4.50 |
| DA-1A | 28V 1.6A | 230V .100A | | 3.25 |
| DM-2B | 28V | 224V .07A | 2.75 | 4.75 |
| DM-32A | 28V 1.1A | 250V .05A | 2.45 | 4.45 |
| DM-33A | 28V 5A | 575V .16A | | |
| | 28V 7A | 540V .25A | 1.95 | 3.75 |
| DM-34D | 12V 2A | 220V .080A | 4.15 | 5.50 |
| DM-53A | 28V 1.4A | 220V .080A | 3.75 | 5.45 |
| DM-64A | 12V 5.1A | 275V .150A | | 7.95 |
| PE-73C | 28V 20A | 1000V .350A | 8.95 | 14.95 |
| PE-86 | 28V 1.25A | 250V .050A | 2.75 | 3.85 |

Please include 25c deposit with order—balance C.O.D., or Remittance in Full. 50c Handling Charges on all orders under \$5.00. All shipments F.O.B. Our Warehouse, N.Y.C. All Merchandise subject to Prior Sale and Price Change.

G & G RADIO SUPPLY CO.
Telephone: CO 7-4605
Mail Order Retail Sales
51 Vesey St. 75-77 Leonard St.
New York 7, N. Y. New York 13, N. Y.

may be used for high-voltage filtering for 10,000 hours between -55 and +115 degrees C. Ten different ranges are covered from 10 to 60 kv. d.c.

DYNAMIC HEADPHONES
47 PermoLux Products Company has available a four-page brochure containing complete descriptions and prices of its entire line of binaural and monaural headphones. The models offered range in impedance from 8 ohms to very-high. In addition, the catalogue sheet gives a complete list of adapters which will enable headphones to be used with any type of equipment, together with a list of replacement parts.

FLASHTUBES FOR LASERS
48 General Electric Company's Photo Lamp Department has issued a booklet which describes the Laser effect, how it is produced, and lists the company's flashtubes available for its application. By using standard currently available photographic-type flashtubes certain economic advantages can be achieved.
The text describes the various units suitable to this application and discusses their merits as drivers.

HIGH-VOLTAGE CAPACITORS
49 Corson Electric Mfg. Corp. is offering a new 4-page catalogue which describes a line of high-voltage d.c. Mylar capacitors which far surpass the requirements of MIL-C-25A, characteristic E.

The units are suitable for high voltage power filters, audio coupling, voltage-doubler circuits, receivers and transmitters, energy storage, etc. Complete specifications and operating characteristics are provided on fifteen ranges of capacitors.

PANEL INSTRUMENTS
50 Weston Instruments Division has issued a 6-page bulletin which discusses features, selection, and uses of a line of 2 1/2" and 3 1/2" matched panel instruments which are available in round or square Bakelite cases. The meters include d.c., r.f., and a.c. rectifier types as well as moving-iron a.c. types.
Complete electrical and physical specifications, as well as application data, are included in this publication.

PILOT LIGHT DIGEST
51 Dialight Corp. is offering a digest of condensed technical information on a wide range of pilot lights and the various lamps for which they were designed. The categories described include subminiature indicator lights, pilot lights with built-in resistors for neon lamps, enclosed assemblies for neon and incandescent lamps, oil-tight indicator lights, dimmers, light shields, press-to-test indicator lights, indicator lights for T-2 telephone slide-base lamps, open type assemblies, lens holders for panel mounting, connectors and sockets for small lamps. ▲

Answer to Puzzle
Appearing on page 108

| | | | | | | | | | | | |
|---|---|---|---|---|---|---|---|---|---|---|---|
| S | O | U | N | D | G | L | O | S | S | H | I |
| A | B | E | A | T | T | | | | | | N |
| B | A | S | S | I | S | E | P | A | D | | |
| I | P | U | N | I | T | A | R | Y | | U | |
| N | E | P | E | R | A | E | V | C | | | |
| | A | A | B | G | O | O | D | | T | | |
| | M | I | K | E | A | E | | | A | | |
| P | O | H | E | A | N | A | P | H | O | N | |
| T | H | R | E | A | D | H | U | M | | C | |
| O | | | | | | | | | | L | I |
| T | R | E | B | L | E | G | R | A | M | N | |
| O | A | | | | | | | | | S | P |
| N | R | I | A | A | P | B | U | O | | | |
| E | I | V | F | E | T | A | | | | | |
| S | U | P | E | R | A | U | D | I | B | L | E |
| | | | | | | | | | | | R |

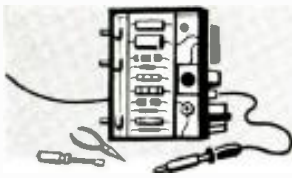

ELECTRONICS MARKET PLACE

RATE: 60¢ per word. Minimum 10 words. December issue closes October 1st. Send order and remittance to: ELECTRONICS WORLD, One Park Ave., N. Y. C. 16, N. Y.

ELECTRONICS ENGINEERING & INSTRUCTION

ENGINEERING Education for the Space Age. Northrop Institute of Technology is a privately endowed, non-profit college of engineering offering a complete Bachelor of Science Degree Program and Two-Year accredited technical institute curricula. Students from 50 states, many foreign countries. Outstandingly successful graduates employed in aeronautics, electronics, and space technology. Write today for catalog—no obligation. Northrop Institute of Technology, 1183 West Arbor Vitae Street, Inglewood 1, California.

ELECTRONICS! Associate degree—29 months. Technicians, field engineers, specialists in communications, missiles, computers, radar, automation. Start September, February. Valparaiso Technical Institute, Dept. N, Valparaiso, Indiana.

USED Correspondence Courses and Books sold and rented. Money back guarantee. Catalog free. (Courses Bought.) Lee Mountain, Pisgah, Alabama.

HIGHLY Effective Home Study Review For FCC Commercial Phone Exams. Free Literature. Wallace Cook, Box 10634, Jackson 9, Mississippi.

MINIATURE Transistor 20 Watt HiFi Amplifier; Wireless FM Mike (Circuit size of your thumb); Transistor Guitar Amplifier; Schematic with Construction info. \$2.00 ea. Brunswick Industries, P.O. Box 639, Hawthorne, Calif.

EARN \$150 Week Mechanical, Electronics Drafting. Send \$2 first Lesson, \$25 Complete Home Study Course. Prior, Inc., Dept. 123, 23-09 169 Street, White-stone 57, New York.

FOR SALE

TV Tuners—Rebuilt or Exchanged \$9.95 complete—all types—fast, guaranteed service. Send tuner with all parts to: L. A. Tuner Exchange, 4611 West Jefferson Blvd., Los Angeles 16, California.

TUBES—TV, Radio, Transmitting And Industrial Types At Sensibly Low Prices. New, Guaranteed. 1st Quality, Top Name Brands Only. Write For Free Catalog or Call Walker 5-7000, Barry Electronics Corp., 512 Broadway, New York 12N, N. Y.

DIAGRAMS for repairing radios \$1.00. Television \$2.00. Give make, model. Diagram Service, Box 672-E, Harford 1, Conn.

GOVERNMENT Surplus Receivers, Transmitters, Snooperscopes, Parabolic Reflectors. Picture Catalog 10¢. Meshna, Malden 48, Mass.

GOVERNMENT Sells Surplus: — Electronics: Oscilloscopes; Transceivers; Test Equipment; Radar; Sonar; Walkie-Talkie; Boats; Jeeps; Aircrafts; Misc.—Send for "U.S. Depot Directory & Procedures"—\$1.00—Brody, Box 425(RT), Nanuet, New York.

PROFESSIONAL Electronic Projects—Organs, Timers, Computers, Industrial, etc.—\$1 up. List Free. Parks, Box 1665 Lake City, Seattle 55, Wash.

BEFORE You Buy Receiving Tubes or Hi-Fi Components send now for your giant Free Zalytron current catalog—featuring nationally known Zalytron First Quality TV-Radio Tubes, Hi-Fi Stereo Systems, Kits, Parts, etc. All priced to Save You Plenty Why Pay More? Zalytron Tube Corp. 220 W. 42nd St., NYC.

"SURPLUS Electronics, Optics. Free Catalog. Thermo-electric Devices, Inc. 302 Massachusetts Ave., Cambridge, Mass.

CITIZEN-Band Crystals—Direct from Manufacturer. Guaranteed .005% Tolerance. Send only \$1.75 for Each Crystal with Equipment Mfg. Name, Model No. and Channel No. to Michigan Crystal Co., Inc., Box 413 (C), Lansing, Michigan.

COMMUNICATIONS Teletype-Unusual Surplus Bargains, Free Flyer, MDC, 923 W. Schiller, Phila., 40.

INFRA-Red!! Snooperscopes, Optics, Lamps, Parts. World's largest stock Infra-red components. Write for Free Infra-red Catalog. McNeal Electric & Equipment, Dept. EW-9, 4736 Olive, St. Louis 8, Mo.

NEW Precision E-310 generator \$140, 960 transistor tester \$65, Heathkit AW-1 wattmeter \$15, RCA WV-84A VTVM-microammeter \$60, Robert Ireland, Pleasant Valley, N.Y.

MILITARY communications receivers, \$10.00 to \$1500.00. Laboratory quality test equipment. Describe your needs for attractive values. Gizmos & Such, Still River, Mass.

ELECTRIC Engraver permanently engraves tools, any metal. \$2.00 postpaid. Relco, Box 10563, Houston 18, Texas.

SUPERSENSITIVE directional microphone picks up a whisper at great distances. Hears through ordinary walls. Used by investigators. Easily built for about \$6.00. Plans \$2.00. Dee Company, Box 7263, Houston 8, Texas.

RADIO & T.V. Tubes Jobber Boxed R.C.A., G.E., Sylvania, Westinghouse, 65% off List Price, 25% Deposit on all orders. Balance C.O.D. F.O.B. N.Y., Sulton Electronics, Box 503, Hicksville, N.Y.

SURPLUS Aircraft Radio Units and Electronic Parts. Instruments, Controls, Power Supplies, Resistors, Capacitors, Many Others. Free List. Echols Electronics, Box 5522, Arlington 5, Virginia.

PRECISION Resistors. Carbon-Deposit. Guaranteed 1% Accuracy. Millions in Stock. 1/2 Watt—8¢, 1 Watt—12¢, 2 Watt—15¢. Leading manufacturers, Rock Distributing Co., 902 Corwin Road, Rochester 10, N.Y.

TV, Radio Tubes, Top Name Brands, Manufacturers boxes, New, First Quality. Guaranteed, No rejects, Terrific discounts on any quantity, Parallel Rebrighteners, 55¢, 500 MA Selenium Rectifiers 85¢, other good buys. Teletube Supply Co., 159 Western Promenade, Cranston, Rhode Island.

TRANSISTORIZED police radar detector kits. Free Diagram and literature. Deekit Co., Box 7263, Houston 8, Texas.

WRITE for stereo component prices, no catalogues. We ship anywhere in the U.S. (We say: "If you can beat our Prices, You're lying.") Masterpiece, 1801 Kings Highway, Brooklyn. In business 16 years—Custom made Cabinets for TV, Stereo, Bars & Hi-Fi.

UNIQUE! New Citizens Band Pocket Receiver. Cigarette package size, extremely sensitive and lightweight. Completely Transistorized, Tunable, Complete with Folding Antenna. Tested, Foolproof, Guaranteed; other frequencies available. Only 19.95. No COD's please. Gratron Industries, Box 654, Huntington Beach, California.

DIAGRAMS—For Fixing Your TV \$2. For Radio \$1. Please state Model and Make of Your TV or Radio. Hielt Diagrams, Box 816, Laredo, Tex.

SERVICEMEN, Schools, Labs, Industrials, get our catalog for fastest moving electronic items. Rock bottom prices. Send stamp please. Valandy Instrument Co., 61-35 166th St., Flushing, New York.

TRANSISTORIZED products dealers catalog \$1. Inter-market, CPO 1717, Tokyo, Japan.

FREE Confidential Bargain Sheets Electronic Components—Lowest Prices Guaranteed—Knapp—3174 1/2 8th Ave. S.W., Largo, Florida.

CITIZENS' Band—New "Noisstop" eliminates ignition interference from nearby vehicles—no suppression needed your car either! Boosts range by hearing weak signals without jamming from trucks, other cars! For all but super-regen types. Complete with instructions for Eico, Elmac, Globe, Gosnet, Hallicrafters, Heathkit, Johnson, Lafayette, Polycrom, Raytheon, Utica, Webster. \$15.95. Business Radio, Box 5652, Minneapolis 17, Minnesota.

WANTED

QUICKSILVER, Platinum, Silver, Gold, Ores Analyzed. Free Circular. Mercury Terminal, Norwood, Massachusetts.

CASH Paid! Sell your surplus electronic tubes. Want unused, Clean radio and TV receiving, transmitting special purpose, Magnetrons, Klystrons, broadcast types. Want military and commercial lab test equipment such as G.R.H.P., AN UPM prefix. Also want commercial Ham Receivers and Transmitters. For a Fair Deal write: Barry Electronics Corp., 512 Broadway, New York 12, N. Y. (Walker 5-7000).

INVENTIONS Wanted for immediate promotion! Patented, unpatented, Outright cash; royalties! Casco, Dept. BB Mills Building, Washington 6, D.C.

TRIGGER—W91VJ We Buy Shortwave Equipment For Cash. 7361 W. North, River Forest, Ill. Phone PR 1-8616. Chicago TU 9-6429.

WANTED: Tubes, Diodes, Transistors, Military, Commercial Lab-Grade Test Equipment, Components, PRC, GRC Equipment, Aircraft Equipment by Collins. Top Prices. Write details. Bob Sanett, W6REX, V&H Radio & Electronics, 2053 Venice Blvd., Los Angeles 6, California.

INVENTIONS, New Products Wanted! Patent Sales Engineers have national contacts with manufacturers, distributors. Send details. Inventors Creative Service, 354 South Spring, Los Angeles 13, California.

WANT to buy good equipment and accessories? Place a low-cost classified ad in this space.

TAPE & RECORDERS

TAPE Recorders, Hi-Fi Components. Sleep Learning Equipment. Tapes. Unusual Values. Free Catalog. Dressner, 1523 EW Jericho Turnpike. New Hyde Park, N.Y.

RENT Stereo Tapes—over 2,000 Different—all major labels—free catalog. Stereo-Parti, 811-G, Centinela Ave., Inglewood 3, California.

DON'T Buy Hi-Fi components, kits, tape, tape recorders until you get our low. low return mail quotes. "We Guarantee Not To Be Undersold." Wholesale catalog free. Easy time payment plan, 10% down—up to 24 mos. to pay. Hi-Fidelity Center, 220NC E. 23 St., New York 10, N. Y.

SELF-Hypnosis. New concept teaches you quickly by tape or LP-record. Free literature. McKinley Publishers, Dept. T6, Box 3038, San Bernardino, California.

AMPEX, Bōzak, Citation, Concertone, Crown, Magnecord, Presto, Norelco, Tandberg, Sherwood, Thorens, Scott, Shure, others... Trades. Boynton Studio, Dept. RT, 10 Pennsylvania Ave., Tuckahoe, New York.

STEREO Playback Tape Deck. Professional Quality Precision Made Telefunken Heads, Dual Speed. Special Price \$59.95. Send For details. Universal Dist. Co., P.O. Box 204, Richmond Hill, N.Y.

HIGH-FIDELITY



SOUNDTASTIC! That's what our customers are saying upon receiving our prices on our latest High Fidelity Stereo and Monaural, amplifiers, tuners, turntables, speakers, tape recorders, kits. All brand new with factory guarantee. Individual quotations only. No catalogues. Audio World, 117-20 14th Road, College Point 56, New York, Dept. HR

PROMPT Delivery, We Will Not Be Undersold. Amplifiers, Tape Recorders, Tuners, Etc. No Catalogs. Air Mail Quotes. Compare. L. M. Brown Sales Corp., Dept. W, 239 E. 24 St., N. Y. 10, N. Y.

DISGUSTED with "Hi" Hi-Fi Prices? Unusual Discounts On your High Fidelity Requirements. Write. Key Electronics, 120 Liberty St., New York 6, N. Y. Cloverdale 8-4288.

COAXIAL Speaker Special—Heavy duty 12" woofer, 3" tweeter, top quality by prime U. S. manufacturer. 12 watt, 8 ohm—\$13.50 each, 2 for \$25.00 postpaid. Order while supply lasts from West Pacific Distributing, 1301 N. W. Glisan, Portland 9, Oregon

RECORDERS, Components. Free wholesale catalogue. Carston 125-R, East 88, N.Y.C. 28.

PRICES? The Best! Factory-sealed Hi-Fi Components? Yes! Send for free catalog. Audion, 25T Oxford Road, Massapequa, N.Y.

REPAIRS and SERVICING

KIT Repairing—Kit trouble send to us for expert repair. We service all makes and models of Kits: Hi-Fi. Test Equipment, Receivers, Transmitters, Etc. Terms: Ship equipment to us prepaid, returned to you C.O.D. plus shipping charges. K. T. Electronic Service, 1401 28th Street, Vienna, West Virginia.

GOVERNMENT SURPLUS

JEeps \$278, Airplanes \$159, Boats \$7.88, generators \$2.68, typewriters \$8.79, are typical government surplus sale prices. Buy 10,001 items wholesale, direct. Full details, 627 locations, procedure, only \$1.00. Surplus, Box 789-C9Z, York, Penna.

PATENTS

PATENT Searches, \$6.00. For free Invention Record, and "Information Inventor's Need." Write: Miss Heyward, 1029 Vermont Avenue, N.W., Washington 5, D.C.

MISCELLANEOUS

CONVERT any television to sensitive, big screen oscilloscope. Only minor changes necessary. Plans \$2.00. Relco, Box 10563, Houston 18, Texas.

SHOPPING GUIDE Classified

A HANDY GUIDE TO PRODUCTS, NOT NECESSARILY ELECTRONIC, BUT OF WIDE GENERAL INTEREST.

PHOTOGRAPHY—FILM, EQUIPMENT, SERVICES

SCIENCE Bargains—Request Free Giant Catalog "CJ"—144 pages—Astronomical Telescopes, Microscopes, Lenses, Binoculars, Kits, Parts. War surplus bargains. Edmund Scientific Co., Barrington, New Jersey.

STAMPS & COINS

GIGANTIC Collection Free! Includes triangles, early United States animals, commemoratives, British Colonies, high value pictorials, etc. Complete collection plus big illustrated magazine all free. Send 5¢ for postage. Gray Stamp Company, Dept. 22, Toronto, Canada.

HELP WANTED

HIGH Paying Jobs in Foreign Lands! Send \$2.00 for complete scoop! Foreign Opportunities, Box 172, Columbus 16, Ohio.

EXPERIENCED electronic technicians to service nuclear instruments. Part time work within 100 mile radius of your home. Please supply resume. Electronics World Box 574, One Park Avenue, New York 16, New York.

EARN Extra money selling advertising book matches. Free Samples furnished. Matchcorp. Dept. MD-91, Chicago 32, Ill.

EDUCATIONAL OPPORTUNITIES

LEARN While Asleep, hypnotize with your recorder, phonograph. Astonishing details, sensational catalog free! Sleep-Learning Association, Box 24-ZD, Olympia, Washington.

BUSINESS OPPORTUNITIES

FREE Book "990 Successful, Little-Known Businesses." Work home! Plymouth-455R, Brooklyn 4, New York.

MAKE \$25-\$50 Week, clipping newspaper items for publishers. Some clippings worth \$5.00 each. Particulars free. National, 81-DG, Knickerbocker Station, New York.

SECOND Income From Oil Can End Your Toil! Free Book and Oilfield Maps! National Petroleum, Pan-American Building—PP, Miami 32, Florida.

I Want A Man who wants a business of his own. I will train you, supply the equipment, help finance you, start you rolling. This is not a risky-get-rich-quick scheme. It is a legitimate business, an exclusive protected franchise, proved successful by hundreds throughout the country. An investment of \$995 is required. Send name and address and phone number. Marion Wade, 2117 North Wayne, Dept. 454M, Chicago, 14, Illinois.

BECOME a telephoneman, experience unnecessary. details free. Occupations Unlimited, 1100 Reeve, Santa Clara, Calif.

MISCELLANEOUS

WRITERS!—Free Sample copy of Pink Sheets listing top-notch USA markets for short stories, articles, books and plays available to you upon request. Write today! Literary Agent Mead, 915 Broadway, New York 10, N.Y.

FOR Lease: "Owner-builder has new, modern, 1-story industrial building just completed. 15,000 sq. ft., 4 offices. Rest rooms for offices and factory. Could have railroad siding. Zones light manufacturing. Location: Santa Ana, California. Phone Pleasant 4-3385. Janesville, Wisconsin."

FIX LOOSE CRT BASES

By HERB BROWN

A PICTURE TUBE often "fails" or becomes intermittent although it is in perfectly good condition, internally speaking. This happens when there is nothing more than poor contact at one or more base pins. The actual failure is of the base-to-glass cement. Repair is a tricky business, but better than scrapping an expensive, otherwise useful component. Try this technique to make the job relatively painless.

First remove the base without breaking the fine leads that protrude from the glass into the base pins, as follows: heat each pin with a soldering iron and work the base to free the wire. After this is done for each pin, the base is drawn off entirely.

Scrape, clean, straighten, and tin each lead on the neck. Then prepare the base as follows: Ream out each pin while heating it with the iron. Make sure each is unobstructed all the way through and use the reamer to open out the rounded pin tips.

Now for the master stroke. Take spaghetti, thin enough to pass through the pins, and cut it into as many lengths, each five or six inches, as you have wires. Thread a spaghetti sleeve on each lead right up to the glass. With the base correctly aligned (see illustration), thread each sleeve through the corresponding base pin and out the other side. Coat the butt of the tube and the inside of the base with a good cement; then draw the base tightly up against the glass.

Now withdraw each length of spaghetti carefully. Each bare wire will be entirely inside its own pin, and perhaps even protrude slightly past the open end. With solder and an iron, you can now make a good bond between each wire and its pin. Clean up each pin and you are done. ▲

Threading leads through base pins, normally tricky, is easier with spaghetti.

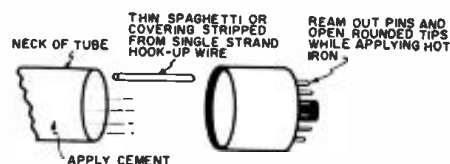

Full Color Giant Fold-Out Charts Still Available!

Here's a complete series of colorful, authoritative fold-out wall-charts (originally appearing in the pages of **ELECTRONICS WORLD**)—yours for only 15¢ each. All in full-color—each suitable for framing.

- Hi-Fi Crossover Network Design Charts:** Tells how to build speaker nets for any crossover frequency. Complete coil-winding data, capacitor values given.
- Color Codes Chart:** Gives you coding for capacitors, resistors, transformers, resistance control tapers—all in easy-to-use form.
- Bass-Reflex Design Charts:** Complete data on building own bass-reflex enclosures for any speaker, including ducted-port enclosures.
- Radio Amateur Great Circle Chart:** For Hams and short-wave listeners—gives complete listing and map of amateur prefixes by calls and countries.

IMPORTANT: ORDER BY NUMBER! OUR SUPPLY OF THESE FOLD-OUT CHARTS LIMITED. OFFERED ONLY ON A FIRST COME, FIRST SERVED BASIS.

Send 15¢ per selection to
ELECTRONICS WORLD

Box 378, Church Street Station

New York 8, New York

PHOTO CREDITS

| Page | Credit |
|-------------------|------------------------------|
| 20 | DuKane Corp. |
| 24 | Stereosonics Inc. |
| 38 (top) | American Optical Co. |
| 38 (center) | Radio Corporation of America |
| 38 (bottom) | Airborne Instruments Lab. |
| 39 (top) | Westinghouse Electric Co. |
| 39 (center left) | Rantec Corp. |
| 39 (center right) | Atomium Corp. |
| 39 (bottom) | ACF Electronics |
| 44 | Acoustic Research, Inc. |
| 46, 47 | CBS Television |
| 49, 50 | Philco Corp. |
| 54 | Bogen-Presto Div. |
| 57 | Maytag Co. |
| 64 | U.S. Sonics Corp. |
| 84 | Hartley Products Company |
| 86 | Columbian Hydrosonics, Inc. |
| 87 | Eico |

FALL ROUNDUP of RAD-TEL Tube Values BUY 10 TUBES OF ANY ONE TYPE GET 1 FREE

You get 11 tubes (same type) . . . pay for only 10
Offer limited to the following types only:
1R5 - 1U5 - 3BC5 - 3BU8 - 5BK7 - 5U8 - 6AQ5 - 6BN6
6BU8 - 6CD6 - 6EA8 - 6U8 - 12CU6 - 12BH7 - 12W6

UP TO **75% OFF**
RAD-TEL'S FIRST QUALITY
BRAND NEW TUBES

500 MA SILICON RECTIFIER Epoxy construction, size of 1-watt resistor
1 reverse at 400 Volts .3 ma
30¢ lots of 20 ea. | 35¢ lots of 10 ea. | 45¢ ea.
Each rectifier "Performance Tested" on an American TV Set

1 YR. GUARANTEE

ONE DAY SERVICE
SERVICEMEN:
Compare Rad-Tel's "Money-Saving" Fall Roundup of Tube Values. Buy 10 Tubes . . . get 1 Free Direct from Rad-Tel . . . FAST, DEPENDABLE SERVICE. Rad-Tel sells only Brand New Tubes.



EACH TUBE INDIVIDUALLY & ATTRACTIVELY BOXED

| Qty. | Type | Price | Qty. | Type | Price | Qty. | Type | Price |
|------|------|-------|--------|------|-------|-------|------|-------|
| 6AU7 | .61 | | 6J6 | .67 | | 12D4 | .69 | |
| 6AU8 | .87 | | 6J7 | .62 | | 12DB5 | .69 | |
| 6AV6 | .41 | | 6K6 | .63 | | 12DE8 | .75 | |
| 6AW8 | .90 | | 6L6 | 1.06 | | 12DL8 | .85 | |
| 6AX4 | .66 | | 6N7 | .98 | | 12DM7 | .67 | |
| 6AX5 | .74 | | 6S4 | .51 | | 12DQ6 | 1.04 | |
| 6AX7 | .64 | | 6S8 | .76 | | 12DS7 | .79 | |
| 6AX8 | .92 | | 6SA7GT | .76 | | 12DT5 | .76 | |
| 6BA6 | .50 | | 6SG7GT | .41 | | 12DT7 | .79 | |
| 6BA7 | .84 | | 6SH7GT | .49 | | 12DT8 | .79 | |
| 6BA8 | .88 | | 6SJ7 | .88 | | 12DW8 | .89 | |
| 6BC5 | .61 | | 6SK7GT | .74 | | 12DZ6 | .56 | |
| 6BC7 | .94 | | 6SL7GT | .80 | | 12EG6 | .54 | |
| 6BC8 | .97 | | 6SN7GT | .65 | | 12EK6 | .56 | |
| 6BD5 | 1.25 | | 6SQ7 | .73 | | 12EL6 | .50 | |
| 6BD6 | .57 | | 6T4 | .99 | | 12EM6 | .79 | |
| 6BE6 | .55 | | 6T8 | .85 | | 12EN6 | .78 | |

| | | | | | |
|------|------|-------|-----|-------|------|
| 6BF5 | .90 | 6U8 | .83 | 12EZ6 | .53 |
| 6BF6 | .44 | 6V6GT | .54 | 12F8 | .66 |
| 6BG6 | 1.66 | 6V8 | .86 | 12FA6 | .79 |
| 6BH6 | .65 | 6W4 | .60 | 12FM6 | .43 |
| 6BH8 | .87 | 6W6 | .71 | 12FR8 | .91 |
| 6BJ6 | .62 | 6X4 | .39 | 12FX8 | .85 |
| 6BJ7 | .79 | 6X5GT | .53 | 12GC6 | 1.06 |
| 6BK7 | .85 | 6X8 | .80 | 12J8 | .84 |
| 6BL7 | 1.00 | 6Y6G | .65 | 12K5 | .65 |
| 6BN4 | .57 | 7A8 | .68 | 12L6 | .58 |
| 6BN6 | .74 | 7AU7 | .61 | 12S8 | .62 |
| 6BQ5 | .65 | 7B6 | .69 | 12SA7 | .92 |
| 6BQ6 | 1.05 | 7EY6 | .73 | 12SF5 | .50 |
| 6BQ7 | 1.00 | 7F8 | .90 | 12SF7 | .69 |
| 6BR8 | .78 | 7Y4 | .69 | 12SH7 | .49 |
| 6BS8 | .90 | 8AU8 | .83 | 12SJ7 | .67 |
| 6BU8 | .70 | 8AW8 | .93 | 12SK7 | .74 |

| | | | | | |
|------|------|-------|-----|-------|------|
| 6BX7 | 1.02 | 8BH8 | .90 | 12SL7 | .80 |
| 6BY5 | 1.15 | 8BN8 | .75 | 12SN7 | .67 |
| 6BY6 | .54 | 8BQ5 | .60 | 12SQ7 | .78 |
| 6BY8 | .66 | 8CG7 | .62 | 12U7 | .62 |
| 6BZ6 | .55 | 8CM7 | .68 | 12V6 | .53 |
| 6BZ7 | 1.01 | 8CN7 | .97 | 12W6 | .69 |
| 6BZ8 | 1.09 | 8CS7 | .74 | 12X4 | .38 |
| 6C4 | .43 | 8CX8 | .93 | 17AX4 | .67 |
| 6C8 | .90 | 8EB8 | .94 | 17BQ6 | 1.09 |
| 6CB6 | .55 | 8SN7 | .66 | 17D4 | .69 |
| 6CD6 | 1.42 | 9CL8 | .79 | 17DQ6 | 1.06 |
| 6CE5 | .57 | 11CY7 | .75 | 17L6 | .58 |
| 6CF6 | .64 | 12A4 | .60 | 17W6 | .70 |
| 6CG7 | .61 | 12AB5 | .55 | 18FW6 | .49 |
| 6CG8 | .77 | 12AC6 | .49 | 18FX6 | .53 |
| 6CK4 | .70 | 12AD6 | .57 | 18FY6 | .50 |
| 6CL8 | .79 | 12AE6 | .43 | 19AU4 | .83 |

| | | | | | |
|------|------|-------|------|-------|------|
| 6CM6 | .64 | 12AE7 | .94 | 19BG6 | 1.39 |
| 6CM7 | .66 | 12AF3 | .73 | 19T8 | .80 |
| 6CM8 | .90 | 12AF6 | .49 | 19V8 | .79 |
| 6CN7 | .65 | 12AJ6 | .46 | 21EX6 | 1.49 |
| 6CQ8 | .84 | 12AL5 | .45 | 25AV5 | .83 |
| 6CR6 | .51 | 12AL8 | .95 | 25AX4 | .70 |
| 6CS6 | .57 | 12AQ5 | .60 | 25BK5 | .91 |
| 6CS7 | .69 | 12AT6 | .43 | 25BQ6 | 1.11 |
| 6CU5 | .58 | 12AT7 | .76 | 25C5 | .53 |
| 6CU6 | 1.08 | 12AU6 | .51 | 25CA5 | .59 |
| 6CY5 | .70 | 12AU7 | .60 | 25CD6 | 1.44 |
| 6CY7 | .71 | 12AV6 | .41 | 25CU6 | 1.11 |
| 6DA4 | .68 | 12AV7 | .75 | 25DN6 | 1.42 |
| 6DB5 | .69 | 12AX4 | .67 | 25EH5 | .55 |
| 6DB6 | .51 | 12AX7 | .63 | 25L6 | .57 |
| 6DE6 | .58 | 12AY7 | 1.44 | 25W4 | .68 |
| 6DG6 | .59 | 12AZ7 | .86 | 25Z6 | .66 |
| 6DK6 | .59 | 12B4 | .63 | 32ET5 | .55 |

| | | | | | |
|-------|------|-------|------|--------|------|
| 6DN6 | 1.55 | 12BA6 | .50 | 32L7 | .90 |
| 6DQ6 | 1.10 | 12BA7 | .84 | 35B5 | .60 |
| 6DT6 | .53 | 12BD6 | .50 | 35C5 | .51 |
| 6DT8 | .79 | 12BE6 | .53 | 35L6 | .57 |
| 6EA8 | .79 | 12BF6 | .44 | 35W4 | .42 |
| 6EB5 | .72 | 12BH7 | .77 | 35Z5 | .60 |
| 6EB8 | .94 | 12BK5 | 1.00 | 36AM3 | .36 |
| 6EM5 | .76 | 12BL6 | .56 | 50B5 | .60 |
| 6EM7 | .82 | 12BQ6 | 1.06 | 50C5 | .53 |
| 6EU8 | .79 | 12BY7 | .77 | 50EH5 | .55 |
| 6EW6 | .57 | 12BZ7 | .75 | 50L6 | .61 |
| 6EY6 | .75 | 12C5 | .56 | 57G3 | 1.00 |
| 6F5GT | .39 | 12CN5 | .56 | 7DL7 | .97 |
| 6F6 | .69 | 12CR6 | .54 | 70Z5 | .69 |
| 6GK6 | .79 | 12CU5 | .58 | 84 6Z4 | .46 |
| 6GN8 | .94 | 12CU6 | 1.06 | 807 | .70 |
| 6HG6 | .58 | 12CX6 | .54 | 117Z3 | .61 |
| 6J5GT | .51 | | | | |

• NOT AFFILIATED WITH ANY OTHER MAIL ORDER TUBE COMPANY •



SEND FOR FREE TROUBLE SHOOTER GUIDE AND NEW TUBE & PARTS CATALOG

RAD-TEL TUBE CO.

EW-1061 55 CHAMBERS STREET, NEWARK 5, N. J.

TERMS: 25% deposit must accompany all orders, balance COD. Orders under \$5: add \$1 handling charge plus postage. Orders over \$5: plus postage. Approx. 8 tubes per 1 lb. Subject to prior sale. Prices subject to change. No COD's outside continental USA.

ADVERTISERS' INDEX OCTOBER, 1961

Advertisers listed below have additional information available on their products in the form of catalogues and bulletins. To obtain more detailed data, simply circle the proper code number in the coupon below and mail it to the address indicated. We will direct your inquiry to the manufacturer for processing.

| CODE NO. | ADVERTISER | PAGE | CODE NO. | ADVERTISER | PAGE | CODE NO. | ADVERTISER | PAGE |
|----------|--|--------------------|----------|--|----------------|----------|-----------------------------------|--------------|
| 100 | A.E.S., Inc | 65 | 141 | Grantham School of Electronics | 5 | | Radio Corporation of America | FOURTH COVER |
| 101 | Acoustic Research, Inc | 66 | 142 | Greenlee Tool Co | 91 | 177 | Radio Shack Corp | 67 |
| 102 | Advance Electronics | 118 | 143 | Grommes Div. Precision Electronics Inc | 106 | 178 | Radio Shack Corp | 81 |
| 103 | Airex Radio Corporation | 124 | 144 | Hallcrafters | 103 | 179 | Radio Shack Corp | 87 |
| 104 | Allied Radio | 112, 113, 114, 115 | 145 | Harmon-Kardon Inc | 16 | 180 | Radio Shack Corp | 103 |
| 105 | Ashe Radio Company, Walter | 108 | 146 | Harmon-Kardon Inc | 23 | 181 | Radio Shack Corp | 107 |
| 106 | Audion | 109 | 147 | Heath Company | 68, 69 | 182 | Reeves Soundcraft Corp | 102 |
| 107 | B & K Manufacturing Co | 11 | 148 | Henshaw Radio Supply | 80 | 183 | Rex Radio Supply Co | 106 |
| 108 | Bell Telephone Laboratories | 30 | 149 | Indiana Technical College | 101 | 184 | Rider Publisher Inc., John F | 107 |
| 109 | Blonder-Tongue | 90 | 150 | Jackson Electrical Instrument Company | 12 | 185 | Sams & Co., Inc., Howard W | 31 |
| 110 | Browning Laboratories, Inc | 108 | 151 | Johnson Company, E. F. | 125 | 186 | Sams & Co., Inc., Howard W | 118 |
| 111 | Burstein-Applebee Co | 67 | 152 | Key Electronics | 100 | 187 | Sarkes Tarzian Inc | 82 |
| 112 | Candee Co., J. J. | 70 | 153 | Lafayette Radio | 94, 95, 96, 97 | 188 | Saxitone Tape Sales | 102 |
| 113 | Capitol Radio Engineering Institute, The | 6, 7 | 154 | Lampkin Laboratories, Inc | 80 | 189 | Scott Inc., H. H. | 110 |
| 114 | Carston | 80 | 155 | Lektron | 99 | 190 | Sencore | 1 |
| 115 | Central Technical Institute | 25 | 156 | McGee Radio Co | 122 | 191 | Shure Brothers, Inc | 123 |
| 116 | Channel Master | 119, 120, 121 | 157 | Mark Mobile, Inc | 8 | 192 | Sonar Electronic Tube Co | 92 |
| 117 | Chemtronics Inc | 100 | 158 | Milwaukee School of Engineering | 100 | 193 | Sonotone Corp | 22 |
| 118 | Cisin, Consulting Engineer, Harry G. | 102 | 159 | Moog Co., R. A. | 8 | 194 | Sprague Electric Co | 63 |
| 119 | Cleveland Institute of Electronics | 17 | 160 | Moss Electronic, Inc | 76, 77, 78, 79 | 195 | Standard Kollsman Industries, Inc | THIRD COVER |
| 120 | Columbia Electronics | 98 | 161 | Motorola Training Institute | 89 | 196 | Standard Trans Vision, Inc | 98 |
| 121 | Conar Instruments | 93 | | National Radio Institute | 13, 14 | 197 | Switchcraft, Inc | 101 |
| 122 | Coyne Electrical School | 109 | 162 | National Radio Institute | 88 | | Sylvania Electric Products Inc | SECOND COVER |
| 123 | Cushcraft | 110 | 163 | National Technical Schools | 21 | 198 | Tech-Master | 98 |
| 124 | Delco Radio | 85 | 164 | New York Sales & Service | 125 | 199 | Texas Crystals | 70 |
| 125 | Dressner | 118 | 165 | North American Philips Company, Inc | 87 | 200 | Transvision Electronic, Inc | 84 |
| 126 | Dukane Corporation | 24 | 166 | Nortronics Co., Inc., The | 99 | 201 | Tri-State College | 98 |
| 127 | E.C.I. Electronics Communications, Inc | 9 | 167 | Olson Electronics | 106 | 202 | Triton Electronics, Inc | 70 |
| 128 | EICO | 32 | 167 | Pacific International College of Arts & Sciences | 110 | 203 | Tru-Vac | 122 |
| 129 | EICO | 111 | 168 | Pacotronics, Inc | 71, 72, 73, 74 | 204 | U. S. Crystals, Inc | 92 |
| 130 | Electro-Voice, Inc | 15, 66 | 169 | Peak Electronics Company | 88 | 205 | U-T. I. Recon Sales | 118 |
| 131 | Electronic Chemical Corp | 88 | 170 | Philco Technological Center | 4 | 206 | University Loudspeakers, Inc | 2 |
| 132 | Fair Radio Sales | 82 | 171 | Philco Technological Center | 110 | 207 | University Loudspeakers, Inc | 83 |
| 133 | Fairchild Recording Equipment Corp | 82 | 172 | Picture Tube Outlet | 101 | 208 | Utah Electronics Corp | 86 |
| 134 | Fanon Electronic Industries, Inc | 10 | 173 | Quietrole Company | 99 | 209 | Valparaiso Technical Institute | 92 |
| 135 | Fisher Radio Corporation | 64 | 174 | RCA Institutes, Inc | 26, 27, 28, 29 | 210 | Vanguard Electronic Labs | 106 |
| 136 | G & G Radio Supply Co | 126 | 175 | R W Electronics | 109 | 211 | Vocaline Company of America, Inc | 75 |
| 137 | General Electric | 91 | 176 | Rad-Tel Tube Co | 129 | 212 | Warren Distributing Co | 106 |
| 138 | General Electric | 117 | | Radio Corporation of America | 105 | 213 | Winegard Antenna Systems | 18, 19 |
| 139 | Goodheart Co., R. E. | 101 | | | | 214 | Wuerth Products Corp | 92 |
| 140 | Granco | 80 | | | | | | |

The coupon below can also be used to obtain additional information on the new product items shown on pages 116 through 126 as well as on the ads as listed above.

| | |
|---|---|
| VOID AFTER OCT. 31, 1961 | NAME _____ |
| | STREET NO. _____ |
| | CITY _____ ZONE _____ STATE _____ |
| ADVERTISED PRODUCTS (SEE INDEX ABOVE) | 100 101 102 103 104 105 106 107 108 109 110 111 112 113 114 115 116 117 118 119 120 121 122 123 124 125 126 127 128 129 130 131 132 133 134 135 136 137 138 139 140 141 142 143 144 145 146 147 148 149 150 151 152 153 154 155 156 157 158 159 160 161 162 163 164 165 166 167 168 169 170 171 172 173 174 175 176 177 178 179 180 181 182 183 184 185 186 187 188 189 190 191 192 193 194 195 196 197 198 199 200 201 202 203 204 205 206 207 208 209 210 211 212 213 214 215 216 217 218 219 220 221 222 223 224 225 226 227 228 229 230 231 232 233 234 235 236 237 238 239 |
| | 1 2 3 4 5 6 7 8 9 10 11 12 13 14 15 16 17 18 19 20 21 22 23 24 25 26 27 28 29 30 31 32 33 34 35 36 37 38 39 40 41 42 43 44 45 46 47 48 49 50 51 52 53 54 55 56 57 58 59 60 |
| | NEW PRODUCTS & LITERATURE |
| | MAIL TO ELECTRONICS WORLD P.O. BOX 212 VILLAGE STATION NEW YORK 14, N.Y. |
| | INDICATE NUMBER OF ITEMS REQUESTED <input type="checkbox"/> |

 Make sure that your name and address are printed clearly.

ELECTRONICS WORLD READER SERVICE COUPON

Standard Made It...

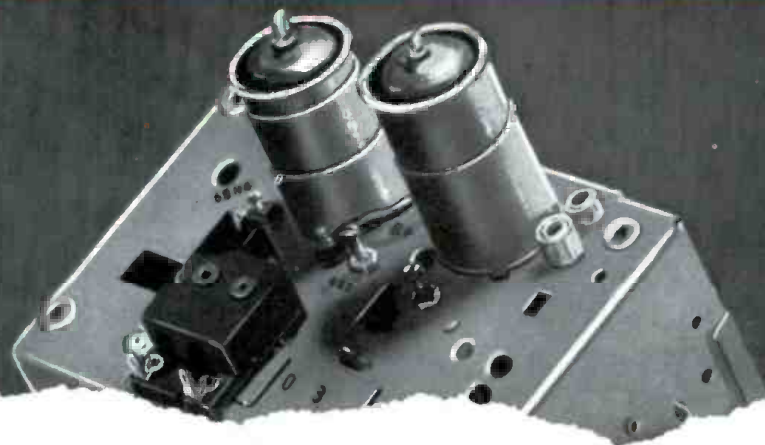

STANDARD CAN FIX IT BEST



\$11⁵⁰ Plus Parts . . . **\$13.50 Maximum Total Cost**

FREE Specially designed shipping cartons to prevent damage in transit

**6 Months
GUARANTEE**

Only BRAND NEW PARTS Used • 48 Hour
Service on All STANDARD Tuners • Latest
Testing Techniques Assure Proper Alignment •
\$3.00 Defective Tuner Trade-in Allowance
Against a New STANDARD Replacement Tuner
Carrying a 12 MONTH GUARANTEE

IN TV IT'S *Standard*

STANDARD has maintained uniform mounting centers for the last 13 years. Over 50% of the TV sets in existence today have STANDARD tuners—in the case of most other tuners one of the 8 STANDARD replacement models can be easily adapted or will fit directly in place of these units. All STANDARD replacement tuners carry a 12 Month Guarantee.

**SEE YOUR AUTHORIZED
STANDARD DISTRIBUTOR**

MORE PROFIT FOR THE SERVICE DEALER • GREATER CUSTOMER SATISFACTION
GUARANTEED BY THE WORLD'S LARGEST TV TUNER MANUFACTURER

standard kollsman INDUSTRIES INC.

FORMERLY STANDARD COIL PRODUCTS CO., INC., MELROSE PARK, ILLINOIS



“BUSINESS END” of a NOVAR tube

You're looking at the base of one of RCA's remarkable new novar tubes... the first in a new family of tubes that will mean better business for you through reduced call backs.

This new base—with 9 widely-spaced, heavy-gauge pins—characterizes novar, RCA's line of large all-glass integral base tubes designed to do the work of conventional tubes with molded bases. Because novars *outperform* these con-



ventional types, they are being selected for use in more and more radio and TV receivers as well as hi-fi equipment. From present indications, novar should become the standard of the industry.

Look for novar, RCA's latest contribution to electron tube design. Your Authorized RCA Electron Tube Distributor now has RCA-7868 novar and will soon have many other types to support your servicing business.

RCA ELECTRON TUBE DIVISION, HARRISON, N.J.



The Most Trusted Name in Electronics