

ELECTRONICS WORLD

JULY, 1960

50 CENTS

PROGRESS REPORT ON HOME TAPE RECORDING
RADIO AIDS TO AIRCRAFT NAVIGATION
BUILD YOUR OWN ELECTRONIC PHOTOFLASH
HOW COMPUTERS "REMEMBER"

**A SINGLE-TUBE
CITIZENS BAND CONVERTER**
(See Page 50)

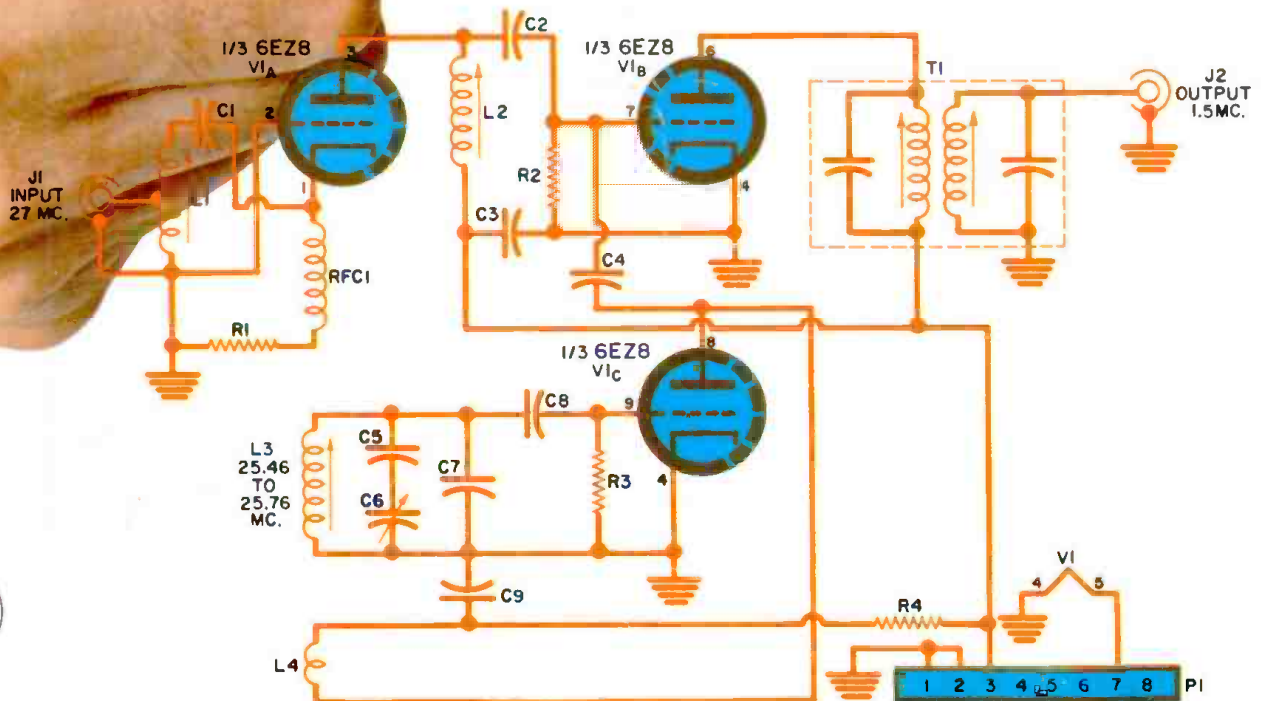

Let SYLVANIA help you improve your business—now!

*New Home Study Course for Radio-TV
Service Dealers Offers 12
Important Money-Making Chapters:*

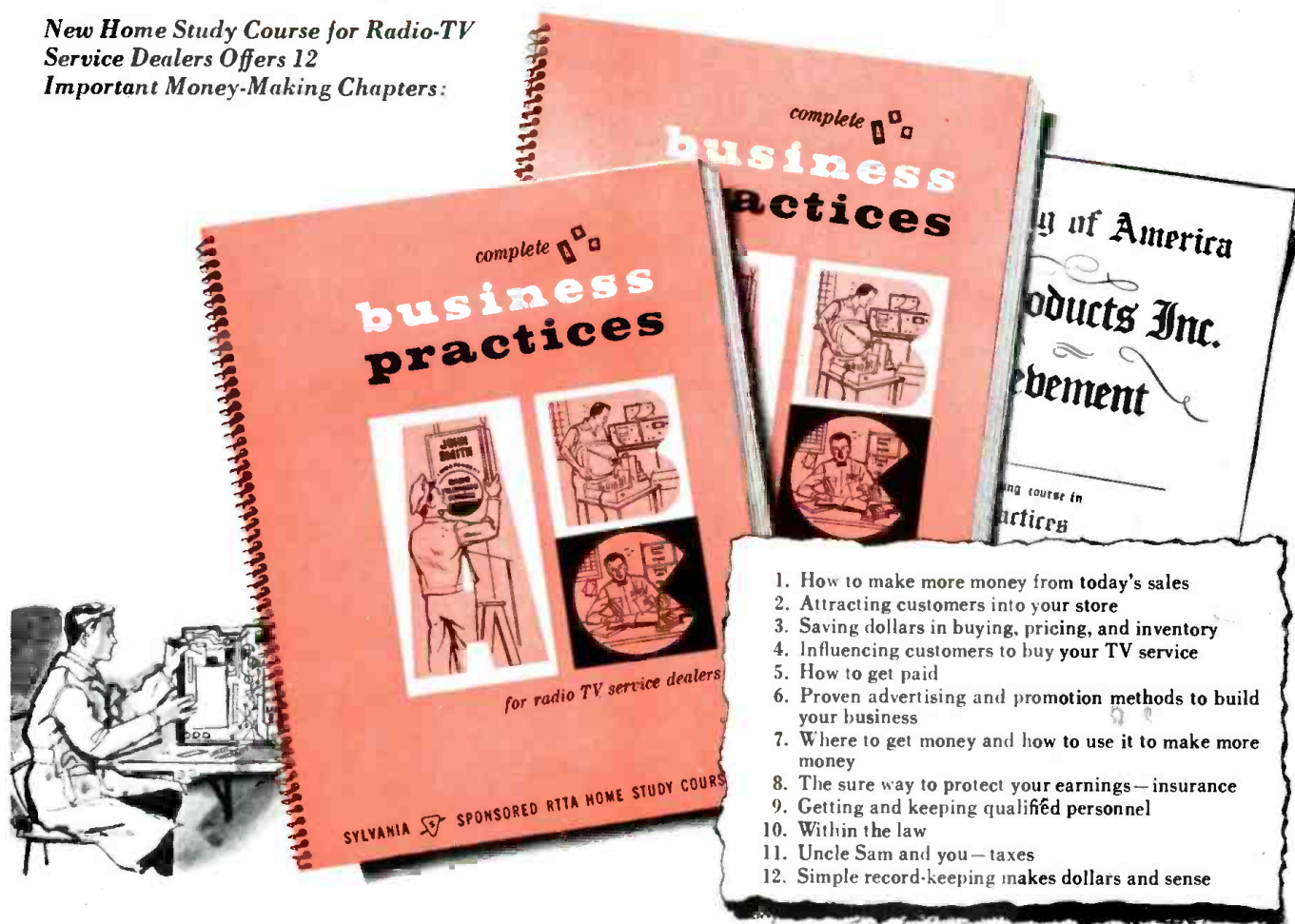

1. How to make more money from today's sales
2. Attracting customers into your store
3. Saving dollars in buying, pricing, and inventory
4. Influencing customers to buy your TV service
5. How to get paid
6. Proven advertising and promotion methods to build your business
7. Where to get money and how to use it to make more money
8. The sure way to protect your earnings—insurance
9. Getting and keeping qualified personnel
10. Within the law
11. Uncle Sam and you—taxes
12. Simple record-keeping makes dollars and sense

As a service dealer you wear two "hats"—(1) you are a technical expert, qualified to repair and maintain electronic equipment, and (2) you are an independent shopowner, a businessman important to the economy of our country.

You can succeed in your profession only if you are thoroughly trained in both service and sales.

SYLVANIA now offers an outstanding, valuable course in "business practices." It's easy to get. Easy to use. Sure to help you build more profits.

A certificate of achievement is awarded on completion of the course. Display it in your shop . . . it tells all your customers that you are a trained serviceman—a trained businessman.

**YOUR AUTHORIZED SYLVANIA TUBE DISTRIBUTOR HAS COMPLETE DETAILS. CALL HIM NOW.
CHECK YOUR TUBE STOCK FIRST. AND ASK HIM FOR SYLVANIA TUBES!**
Electronic Tubes Division, Sylvania Electric Products Inc., 1740 Broadway, New York, N. Y.

SYLVANIA

Subsidiary of **GENERAL TELEPHONE & ELECTRONICS** 

Train at Home for Success in RADIO TELEVISION ELECTRONICS

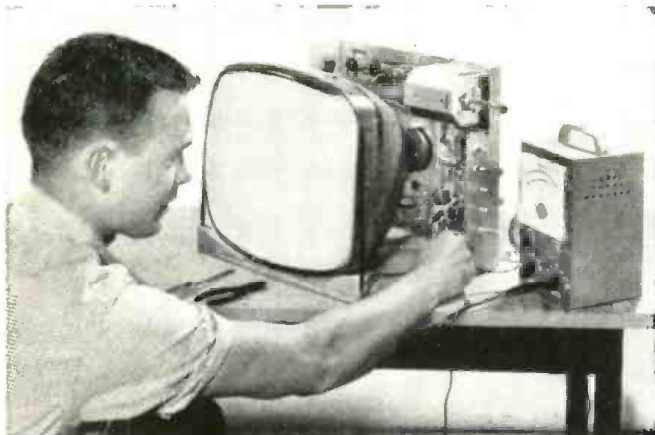

You Learn at Home by Actual Practice

With NRI kits you build actual Radio-Television circuits and testing instrument. Practice locating and fixing Radio-Television troubles. Learn soon to earn extra money.



Good Jobs in Radio-TV Communications

NRI trained men hold good jobs as operators and technicians in Radio and Television broadcasting stations, with Police, Marine and Aviation stations. Interesting work, good pay.

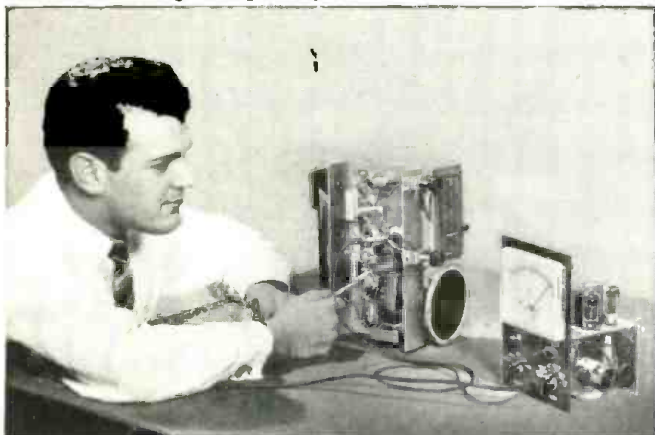

There's Good Pay in Radio-TV Servicing

NRI trained technicians are needed, paid well, to help maintain 150 million home and auto Radios, 38 million TV sets. Color TV adding opportunities. Excellent field for spare time earning.

Join the thousands N.R.I. has trained for Successful Careers in Radio-TV

Get the benefit of NRI's 40 years experience training men for success in this field. Get personal attention of experienced instructors. Also get practice with Radio-TV equipment—learn by *doing*—with kits supplied as part of your course. Courses are easy to learn. Most successful NRI men start without any knowledge of Radio, many without a high school education.



J. E. Smith
Founder

Find Out What Radio-TV Offers You

As trained Radio-TV Technician, you are prepared to supply much needed services. The technician is a respected and appreciated member of his community. Get Sample Lesson FREE. See how practical NRI has made learning at home. Mail the coupon. You also get 64-page Catalog telling about NRI, the lessons, equipment supplied, instruction services.

N. R. I. TRAINED THESE MEN FOR SUCCESS



"I am a police captain and have a good spare time Radio-Television service business. Just opened new shop." C. W. LEWIS, Pensacola, Florida.



"Received my License and worked on ships. Now Chief Engineer Station, W.P.A. Grateful to N.R.I." R. D. ARNOLD, Rumford, Rhode Island.



"Enrolled while meat market manager. Got serviceman job. In a year my pay increased 50%." C. CARTER, San Bernardino, California.



"Have a Radar job. Also do spare time Radio-Television servicing. Have my own amateur Radio Station." F. ZAWAKE, Scranton, Pennsylvania.

Added Income Soon—\$10, \$15 a Week in Your Spare Time

Soon after enrolling, many NRI students earn \$10, \$15 a week extra fixing sets in spare time. Vacuum Tube Voltmeter you build with parts we send helps you locate and fix troubles. Special lessons show you how. Many students use spare time earnings to pay for their training, and provide capital to start their own businesses when they get their National Radio Institute Diploma.

Color TV Making More Jobs

Radio-Television is an industry noted for continued and spectacular growth. Number of trained men employed has increased steadily. Color TV and other late developments are creating need for more technicians. The future is very bright for trained men. Find out how you can get ready at low cost, on easy terms. Send for FREE Sample Lesson and Catalog. Mail coupon today—National Radio Institute, Dept. OGE Washington 16, D. C.

VETERANS—Approved under GI Bills

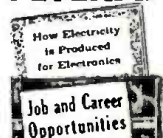

Send for Sample Lesson and Catalog FREE

MAIL COUPON TODAY

NATIONAL RADIO INSTITUTE
Dept. OGE, Washington 16, D. C.

Please send me sample lesson of your Radio-Television Training and catalog FREE. (No salesman will call.)

Name _____ Age _____

Address _____

City _____ Zone _____ State _____

ACCREDITED MEMBER, NATIONAL HOME STUDY COUNCIL

Publisher
OLIVER READ, D. Sc., WIETI

Editor
WM. A. STOCKLIN, B. S.

Technical Editor
MILTON S. SNITZER, W2QYI

Service Editor
SIDNEY C. SILVER

Associate Editor
P. B. HOEFER

Industrial Consultant
WALTER H. BUCHSBAUM

Art Editor
MILTON BERWIN

Art and Drafting Dept.
J. A. GOLANEK
K. W. PAUL, JR.

Advertising Director
JOHN A. RONAN, JR.

Advertising Manager
GEORGE E. MORRISSEY

Midwest Adv. Manager
GILBERT J. JORGENSON

Western Adv. Manager
DON CENA



ZIFF-DAVIS PUBLISHING COMPANY
William Ziff, President; W. Bradford Briggs, Executive Vice-President; Michael Michaelson, Vice-President and Circulation Director; Marshal B. Sarbin, Vice-President; J. L. O'Donnell, Treasurer.

Editorial and Executive Offices
One Park Avenue
New York 16, N. Y. OR. 9-7200



BRANCH OFFICES: Midwestern Office, 434 S. Wabash Ave., Chicago 5, Ill.; Western Office, 9025 Wilshire Blvd., Beverly Hills, Calif.; James R. Pierce, manager.

FOREIGN ADVERTISING REPRESENTATIVES: D. A. Goodall Ltd., London; Albert Milhado & Co., Antwerp and Dusseldorf.

First in radio-television-audio-electronics

CONTENTS

ELECTRONICS—GENERAL

A Century of Signals (Editorial).....	W. A. Stocklin	6
Spot News	Washington Correspondent	20
Radio Aids to Aircraft Navigation (Part 1).....	Francis A. Gicca	29
Electric Power in Automation.....	Walter H. Buchsbaum	42
Recent Developments in Electronics.....		44
Computer Memory Devices (Part 1).....	Ed Bukstein	47
Electronic Crosswords.....	Gordon B. Duncan	93

HIGH-FIDELITY AND AUDIO

Design of a Transistorized Preamp.....	H. F. Starke	34
Tape's Progress—A Status Report.....	Herman Burstein	38
Photocell Control for Phonograph.....	Lawrence W. Dobbins	52
Hi-Fi—Audio Product Review.....		73
Sound on Tape.....	Bert Whyte	98
New Audio Test Report (Norelco "Continental 400", Madison Fielding Model 630, Garrard Model 210)—EW Lab Tested.....		106

TELEVISION-RADIO

Fusing TV Tuners.....	Paul Mitnau	33
Pix Tube as Tuning Eye.....	A. V. J. Martin	46
Newfoundland's Microwave TV Network.....	Hugh G. Jarman	54
Mac's Service Shop.....	John T. Frye	64
19-inch Transistor TV.....		70
Did Popov Invent Radio?.....	Theodore M. Hannah	78
Service Industry News.....		84
Getting Results from Business Letters.....	J. E. Kitchin	115

TEST EQUIPMENT

A Dynamic Capacitor Checker.....	B. E. Wrigley	40
An R-C Substitution Box.....	Frank Damico	60
Voltage Regulation for Transistors.....	Kenneth Bramham	62
Measurement of Meter Resistance.....	John Gerstle	82
New Tube Tester Data.....		96

COMMUNICATIONS

2-Way Mobile—Repair vs. Maintenance.....	Jerry S. Stover	37
Triple-Triode Citizens Band Converter (Cover Story).....	P. E. Hatfield	50

ELECTRONIC CONSTRUCTION

Professional Electronic Photoflash.....	R. L. Winklepleck	56
---	-------------------	----

DEPARTMENTS

Within the Industry.....	8	Technical Books.....	86
Letters from Our Readers.....	22	Manufacturers' Literature.....	100
What's New in Radio.....	116		

Net Paid Circulation 244,070

Radio & TV News • Radio News • Television News Trademarks Reg. U. S. Pat. Off.
Copyright © 1960 by Ziff-Davis Publishing Company. All rights reserved.

SUBSCRIPTION SERVICE: Form 3570 and all subscription correspondence should be addressed to Circulation Department, 434 South Wabash Avenue, Chicago 5, Illinois. Please allow at least four weeks for change of address. Include your old address as well as new—enclosing if possible an address label from a recent issue.

CONTRIBUTIONS: Contributors are advised to retain a copy of their manuscripts and illustrations. Contributions should be mailed to the New York Editorial Office and must be accompanied by return postage. Contributions will be handled with reasonable care, but this magazine assumes no responsibility for their safety. Any copy accepted is subject to whatever adaptations and revisions are necessary to meet the requirements of this publication. Payment covers all author's, contributor's, and contestant's rights, title, and interest in and to the material accepted and will be made at our current rates upon acceptance. All photos and drawings will be considered as part of the material purchased.

Men 17-55

READ THESE AMAZING FACTS ABOUT A MAN WHO COULD BE YOU!

Are **You** One of
the men who could
prepare for a job that
PAYS REAL MONEY in

**TELEVISION
RADIO**

Electronics

ONLY DeVRY OFFERS ALL THESE FEATURES!

Only DeVry Tech provides Training Movies to make the basic principles of Electronics crystal clear! DeVry's explanations and illustrations are a pleasure to follow. Over 300 practical experiments with actual Electronic parts are included to give you on-the-job type know-how. You even build your own test equipment.

EMPLOYMENT SERVICE

The Industry knows the quality of DeVry training. That's why our Employment Service usually has more demands for graduates than we can fill. We can also help you get started in your own shop.

**ARE YOU PASSING UP THE PAYCHECK—THE SOLID FUTURE
—THE REAL BREAK—YOU'VE ALWAYS DREAMED OF?**

You meet them almost every day . . . the men who want to advance out of humdrum, low-pay, or no-future jobs. Some are men who had to quit school too soon; men just out of school with no idea of what to do; or men looking for help in planning a better future. Yet, many of them could—can, if they're 17-55—train at home, in their spare time, for an exciting career with real money and an inspiring future in the field of Electronics. And the tragedy of it is: they don't know it! They think they need an advanced education, or some special experience, or a lot of money, to start—but what they need most is the will to win. Maybe you're a man like that. Well, here's great news! It's not too late! Electronics offers men like you, when trained, dozens of different job opportunities—from guided missile control to running your own radio-television service shop. Get the full story of the jobs you may prepare for . . . **NOW . . . BEFORE** the years and responsibilities close in on you.

Send coupon today
no obligation.

EMPLOYMENT
SERVICE

NOTHING
ELSE
LIKE IT

NO
PREVIOUS
TECHNICAL
EXPERIENCE
NEEDED

NO
ADVANCED
EDUCATION
NEEDED

LEARN
AT HOME
OR . . .

. . . IN OUR
CHICAGO
OR TORONTO
LABORATORIES

2 MODERN TRAINING CENTERS

Large modern training centers in Chicago and Toronto offer DeVry students day and evening classes. The staffs, facilities and experience of these centers stand back of the home training programs. Whether you train at home or in residence, you're a DeVry Tech man. Look into it now!



DON'T DELAY!

Be A Standout in Electronics . Be A DeVry Tech Man!

Accredited Member of National Home Study Council
"One of North America's Foremost Electronics Training Centers"



DeVRY TECHNICAL INSTITUTE

CHICAGO 41, ILLINOIS

MAIL COUPON TODAY

DeVRY TECHNICAL INSTITUTE

4141 Belmont Ave., Chicago 41, Ill., Dept. EW-7-Q

Please give me your FREE booklets, "Pocket Guide to Real Earnings" and "Electronics in Space Travel," and tell me how to prepare to enter one or more branches of Electronics.

NAME _____ AGE _____

STREET _____ PLEASE PRINT _____ APT. _____

CITY _____ ZONE _____ STATE _____

Check here if subject to military training.

Canadian residents address: DeVry Tech of Canada, Ltd.
970 Lawrence Avenue West, Toronto, Ontario

2060

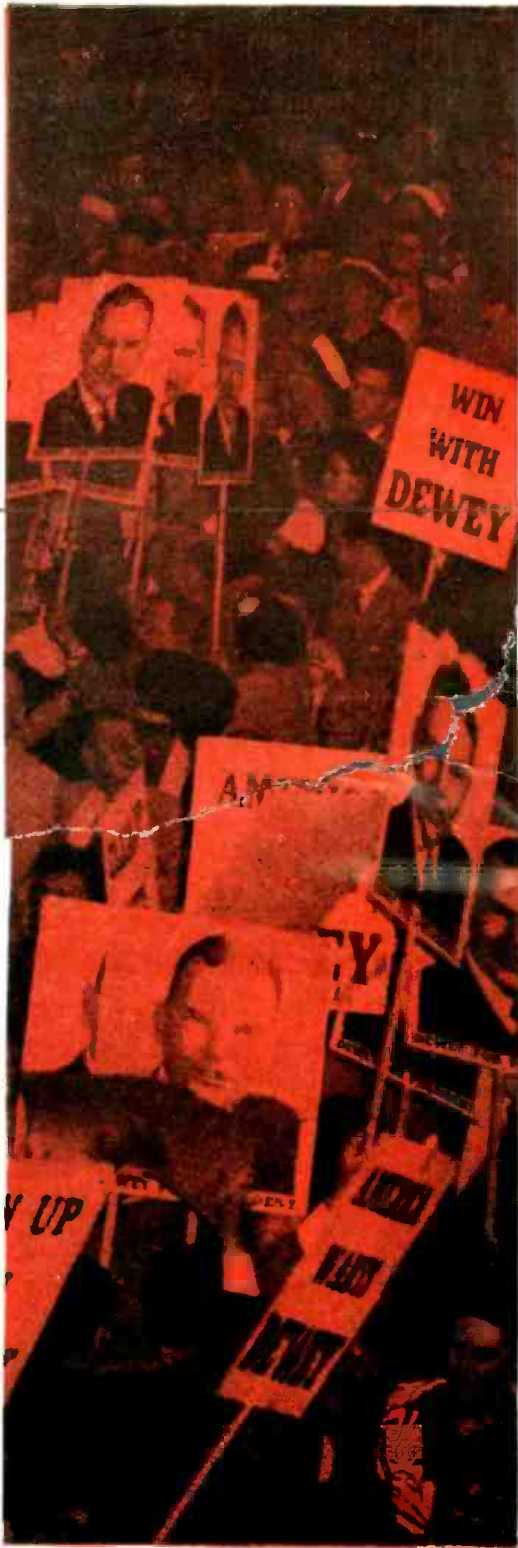

EVERY DAY



DURING BOTH POLITICAL CONVENTIONS



BETTY FURNESS



WILL SELL FOR YOU!

Now "Miss Westinghouse" is going on the air with the biggest, most powerful Westinghouse TV and Radio Tube promotion ever for Service Dealers! Daily during both political conventions—beginning July 9 (Democrat) and July 24 (Republican)—she'll blanket the country over a 204-sta-



tion CBS-Radio network reaching more than 11 million listeners per broadcast. The result will be a tremendous parade of customers looking for their local Service Dealer who sells Westinghouse TV and Radio Tubes. Get ready to cash in on this profit opportunity. Put up the special Westinghouse Tube displays. Tie in with your own advertising. **BUT FIRST**—call your Westinghouse Distributor and place your tube order right away! You're going to need a lot!

YOU CAN BE SURE...IF IT'S **Westinghouse**

Westinghouse Electric Corp., Electronic Tube Division, Elmira, New York
Tune in Westinghouse-CBS TV-Radio Coverage, Presidential Conventions, July 10-29.

SERVICE MASTER... EVERY TOOL YOU NEED 99% OF THE TIME



complete 23-piece kit for radio, TV,
and electronic service calls

2 HANDLES:

shockproof plastic.
Regular 4" length
... 2" Stubby. Inter-
changeable. Patented
spring holds snap-in
tools firmly in place.

9 NUTDRIVERS:

High Nickel chrome
finish, $\frac{3}{16}$ " to $\frac{1}{2}$ "

3 STUBBY

NUTDRIVERS:
 $\frac{1}{4}$ ", $\frac{3}{16}$ ", $\frac{1}{8}$ "

EXTENSION BLADE:

Adds 7". Fits
both handles.

3 SCREWDRIVERS:

Two slotted ...
 $\frac{3}{16}$ ", $\frac{1}{2}$ "
#1 Phillips

2 REAMERS:

$\frac{1}{8}$ "- $\frac{3}{8}$ ", $\frac{1}{4}$ "- $\frac{1}{2}$ "

ADJUSTABLE WRENCH:

6" thin pattern,
1" opening

LONG NOSE PLIER:

"Cushion Grip",
 $2\frac{1}{4}$ " nose

DIAGONAL PLIER:

"Cushion Grip"
hand-honed
cutting edges

ROLL UP KIT:

Durable, plastic-
coated canvas.
Compact, easy-
to-carry.

Ask your distributor to show you kit 99 SM

XCELITE

XCELITE, INC. • ORCHARD PARK, N. Y.
Canada: Charles W. Pointon, Ltd., Toronto, Ont.

...for the Record

By W. A. STOCKLIN
Editor



A CENTURY OF SIGNALS

THE twentieth of June marked a century of service by the U. S. Army Signal Corps to the Army and to the Nation. During its first hundred years, the art of communication has progressed from colored signal flags to a communications satellite relaying voice and teletypewriter messages from outer space!

An Army surgeon, Major Albert J. Myer, is credited with founding the Signal Corps as a separate branch of the services. His interest stemmed from an attempt to help the deaf which, in turn, led to a system of sign language between military outposts. Thus, within a century, signal flags painstakingly spelling out messages have been replaced by electronic computing machines and electric signals which flash information to the ends of the earth and beyond at speeds measured in millions of "bits" of data per second.

This progress is awe-inspiring and we, along with all of our fellow Americans, salute the U. S. Army Signal Corps for a job "well done." We have long nourished a warm spot in our hearts for the Signal Corps which dates back to World War II days.



Major-Gen. Nelson
Chief Signal Officer

Since the growth of our civilian electronics industry has closely paralleled that of the military—in many cases through mutual cooperation—the accomplishments of the Signal Corps today are of continuing interest as a clue to "things to come" in the civilian market. Printed-circuit wiring, modules, and many other miniaturization techniques used in consumer equipment today were developed for, and sometimes by, the Signal Corps for military electronic applications.

The modern-day Signal Corps is a far cry from the infant organization of the Civil War era, although the same pioneering spirit characterizes both establishments. The Corps of the 1800's readily adopted the then-new electric telegraph and the hand-operated magnetos used to power the equipment; they participated in the First Polar Year (1881) just as they played a prominent and important role in the International Geophysical Year.

Phenomenal growth in recent years—accelerated by the missile and space era—has characterized many of the Signal Corps' major efforts. The ad-

vent and rapid development of Army missiles engendered a relatively new and expanding mission area for the Signal Corps—that of combat surveillance and target acquisition.

Automatic data processing, added to the world-wide communication system in 1955, is being directed to tactical communications and militarized equipment for use in the field army is under development. These and other advances in elaborate tactical communications, including a tiny belt-pack or helmet radio carried by an individual soldier, made possible by micro-miniaturization techniques; mobile and air transportable long-range communications central for STRAC-type missions; and satellite communications have revolutionized the art of signaling.

Under its eighteenth Chief Signal Officer, Major-General R. T. Nelson (appointed May 1, 1959), the Army Signal Corps continues to seek improved command control systems of communication, combat surveillance, electronic warfare, and avionics for the Army and to contribute to the electronic science and capability of America's space effort.

Among promising new items and systems under advance development are a mobile radio switching central, carried in an Army vehicle, which will handle up to 48 radio "subscriber sets" in jeeps—much the same as a telephone switchboard handles telephone calls; a push-button telephone to replace the conventional dial type; smaller and lighter miniaturized telephone, teletypewriter, and radio equipment—all geared for combat use; jet surveillance drones and advanced sensors of improved resolution and discrimination; small tactical computer equipment; and a mobile decision-making complex on which visual displays of information and communications means will be centralized.

While some of these units, by their very nature, will remain in the military "arsenal," much of the equipment and many of the techniques will, in time, benefit the civilian population. As has been the case since the founding of the Signal Corps a century ago—as the Corps sows, the civilian reaps. Today's military communications satellites may, within a relatively short space of time, provide us with TV programs, radio broadcasts, and two-way communications from countries overseas—shrinking the globe still another notch.

So for past services and the brilliant future we can confidently predict for the Signal Corps—a big thanks and a sincere Happy Hundredth!

2 Great *knight-kit*® Citizens Band Transceiver Kits

A PRODUCT OF ALLIED RADIO

YOUR CHOICE OF THE FINEST VALUES IN 2-WAY RADIO EQUIPMENT



For Auto-to-Auto
or Auto to
Home or Office



For Farming
Operations



Local Trucking,
Delivery,
Construction Work



Boat-to-Boat,
Ship-to-Shore

YOU BE THE JUDGE OF
knight-kit VALUE!

FREE Examination Privilege

We invite you to take advantage of our exclusive free examination offer. Order a Knight-Kit Transceiver. Examine it on arrival. Inspect the quality of the components, the circuitry, the easy-assembly manual. We're so confident you'll want the kit, we can make this offer: If you're not **COMPLETELY SATISFIED**, just return the kit for full refund!



Ultra-Selective
Super-Sensitive
The Very Finest

Lowest Cost
Quality
2-Way Radio

Citizens Band Superhet Transceiver Kit

Y-712L BEAUTIFUL STYLING... UNEXCELLED PERFORMANCE

\$79⁹⁵

\$5

Have dependable, economical 2-way radio communication with this top-rated, do-it-yourself transceiver. Has two crystal-controlled transmitting positions; operates at maximum FCC legal power input of 5 watts fully modulated. Superhet receiver is continuously tunable over the full 22 channel band; also has two optional crystal-controlled fixed frequency positions. Works just like press-to-talk intercom—speaker also serves as mike.

Ultra-selective, highly sensitive dual-conversion superhet receiver features built-in adjustable squelch and noise limiter. Sensitivity (manual) is better than 1 μ v for 10 db S/N; crystal, 1/2 μ v. Includes built-in AC power supply. Easy to assemble; has dependable printed circuitry and pre-aligned IF transformers. With distinctively styled high-impact case, 5 x 12 x 12". Complete with all parts, wire-type doublet antenna, and one transmitting crystal (available for any channel from 1 to 22—specify preference). FCC application form is included (license is available to any citizen over 18—no exams to take). See below for DC mobile supply, vertical antenna, etc. Wt., 20 lbs.

Model Y-712L. \$5 Down. ONLY **\$79⁹⁵**

- Y-729L. 3 Ft. Vertical Antenna. 2 lbs. NET..... 6.50
- Y-714L. Mobile Mounting Bracket. 4 lbs. NET..... 5.35
- Y-723L. 6-12 V. Mobile Power Supply. 6 lbs. NET..... 10.95
- Y-769L. Optional Receiving Crystal (specify frequency) . . 1.99
- Y-719L. Optional Hand-Held Mike. 1 lb. NET..... 9.50

Top Buy Citizens Band Transceiver Kit

Y-713L

\$39⁹⁵

\$2

Now have your own private 2-way radio system at an amazingly low cost! Consists of easy-to-assemble superregenerative receiver and 5-watt transmitter. Readily fits car, boat or desk. Single, one-switch operation permits talk or listen. Receiver tunes all 22 channels continuously. Built-in AC power supply. Handsomely styled case, 7x10x8". With mike, doublet antenna, and transmitting crystal (specify channel—1 to 22—if you have a preference). See below for antenna, mobile power supply, etc. Shpg. wt., 10 lbs.

Model Y-713L. \$2 Down. ONLY **\$39⁹⁵**

- Y-729L. 3 Ft. Vertical Antenna. 2 lbs. NET..... 6.50
- Y-723L. 6-12 V. Mobile Power Supply. 6 lbs. NET..... 10.95
- Y-724L. Mobile Mounting Bracket. 4 lbs. NET. 5.35

ORDER NOW

ALLIED RADIO CORP., Dept. 72-G
100 N. Western Ave., Chicago 80, Ill.

Please ship: Y-712L Transceiver. Y-713L Transceiver.

- Y-729L Y-723L Y-714L Y-724L
- Y-769L Y-719L \$ enclosed

Send latest catalog describing Knight-Kits.

Name _____

Address _____

City _____ Zone _____ State _____

Manufactured and sold exclusively by **ALLIED RADIO**

a wire-stripping notch

that **REALLY WORKS!**

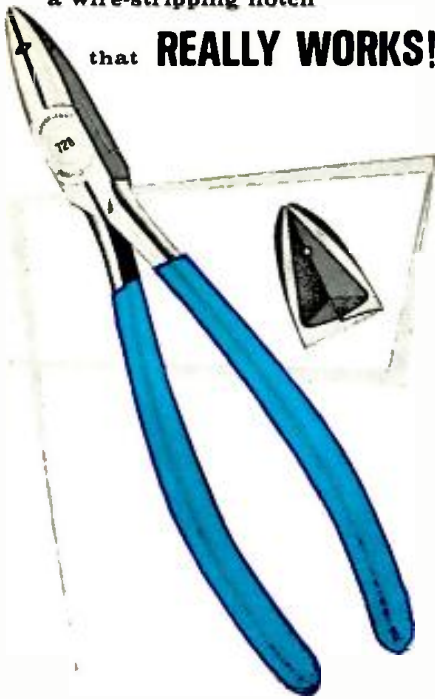

Specially Designed

CHANNEL LOCK

No. 728 Long-reach

Diagonal Cutter

You'll strip off plastic insulation quick as a wink—clean and smooth—with the patented wire-stripping notch of this CHANNELLOCK Diagonal Cutter. And you'll like the handy long reach . . . the precision-matched, hand honed cutting edges, too; A versatile cutter for electrical, radio, TV, Hi-Fi and all other types of electronics work. Comfortable, blue-plastic grips. Top quality, polished forged steel. Ask your tool supplier for a CHANNELLOCK No. 728 Diagonal Cutter. If he's out of them, ask him to order one for you.



Write for Catalog of Complete Line of Pliers



#718 LONG-REACH FLAT-NOSE PLIER



#738 LONG-REACH ROUND-NOSE PLIER



#748 LONG-REACH END CUTTER

Channellock Pliers are made only by

CHAMPION DEARMENT TOOL COMPANY
Meadville, Pennsylvania

Within the Industry

RICHARD E. KRAFVE has been elected president of *Raytheon Co.*, Waltham, Mass., succeeding Charles F. Adams who has been named to the newly created position of chairman of the board. Mr. Krafve, is former vice-president of the *Ford Motor Co.* who joined *Raytheon* in April 1959 as group vice-president and a director last September. A native of Minnesota, he attended the Minnesota College of Law and the University of Minnesota.



During the war, Captain Krafve served as control officer and later director of the Control division, Third Service Command.

SYLVANIA ELECTRONIC SYSTEMS, a division of **SYLVANIA ELECTRIC PRODUCTS INC.** has announced plans for a new Applied Research Laboratory facility and new headquarters building, each totalling approximately 45,000 square feet, on a 55-acre site adjacent to present division facilities in Waltham, Mass. . . . **UHER TAPE RECORDERS** has moved to larger quarters in New York City . . . **CLEVITE TRANSISTOR's** new \$4 million plant in Waltham, Mass. is expected to open July 1 . . . **ATLAS SOUND CORP.**, Brooklyn, N. Y. has announced plans for a new factory annex to adjoin present facilities . . . **DELCO RADIO DIVISION, GENERAL MOTORS**, recently broke ground for a new engineering building in Kokomo, Ind. Featured in the ceremonies was the use of a hand-held portable garage-door opening device that activated a 25-ton bulldozer . . . **TALK-A-PHONE CO.**, Chicago, is in full operation at its new plant, specializing in the manufacture of intercommunications systems . . . **GRANCO PRODUCTS, INC.** has moved offices and production lines to a larger plant in Kew Gardens, Long Island, N. Y. The new location, a 63,000 square foot building, is expected to triple the company's production capacity.

GEORGE E. ALTHOUSE has been selected to fill the newly created position of Customer Service Manager at the *Heath Company*, Benton Harbor, Mich. In his new post, Mr. Althouse will direct the activities of the recently consolidated technical consultants, service repair, adjustments and



service parts sections. A five-year veteran with *Heath*, Mr. Althouse was formerly office manager and before that, supervisor of sales. Before joining the firm, he was assistant to the Postmaster in Benton Harbor where he gained much of his direct mail know-how.

Mr. Althouse is a veteran of the U.S. Navy in World War II and attended Michigan State University.

Moving into the post of office manager vacated by Mr. Althouse is Matthew R. Cutter, who joined the company in 1955.

G. BARRON MALLORY has been elected president of *P. R. Mallory Co., Inc.*, Indianapolis, Ind. . . . **THEODORE LINDENBERG** has been named director of engineering for the *Astatic Corp.*, Conneaut, Ohio . . . **J. W. RINGROSE** has been appointed chief applications engineer of *Semiconductors, Ltd.*, while **J. H. THORP** has been named sales manager of the British firm . . . **ARTHUR L. KOEHLER**, appointed manufacturing manager of *Sorensen & Co.*, South Norwalk, Conn., will take charge of all production in the company's plants there and in New York City . . . **WEBSTER H. WILSON** has been elected president of *Hazeltine Corp.*, Little Neck, N. Y. . . . **GEORGE J. FEDER** has been appointed manager, Somerville Operation Services, for the *RCA Semiconductor and Materials Division*, Somerville, N. J. . . . **ROY N. SUNDBLUM** has been named to the new position of senior project engineer for the Electrical Products Division of *Corning Glass Works*, Corning, N. Y. . . . **I. ROBERT ROSS** has been appointed general manager of *U.S. Transistor Corp.*, Syosset, Long Island, N. Y., where he will be in charge of sales and production administration . . . **ALBERT K. HAWKES** has been promoted to supervisor in electronic research at Armour Research Foundation of the Illinois Institute of Technology . . . **FRANK GENOCHIO** has moved up to vice-president in charge of sales at *Kaar Engineering Corp.*, Palo Alto, Calif. . . . **ROBERT E. DRYDEN** has been appointed vice-president, engineering at *Pearce-Simpson, Inc.*, Miami, Fla. . . . **ANTHONY DILLON** has assumed the post of general sales manager at *Sony Corporation of America*, New York, N. Y. . . . **HOWARD B. SALTZMAN** has been elected executive vice-president of *Alpha Wire Corp.*, New York, N. Y., while Jack Kirschbaum and Philip Freidin have been elected to the offices of vice-president in charge of sales and treasurer respectively . . . **DR. SIDNEY J. STEIN**, who is the director of research and of engineering for *International Resistor*

Introducing a new small-size bi-directional Ribbon Microphone VM-16, Velocity Type.

MODEL VM-16

- Superlative high quality response characteristics.
- Engineered in collaboration with the Technical Research Laboratory of the Japan Broadcasting Corporation (NHK).
- Outstanding results when used for FM broadcasting and high fidelity recording because of its exacting quality of tone reproduction.
- Because of the above superior characteristics, its small size and non reflecting satin-chrome finish, it is ideally suited for TV broadcasting.



MODEL VM-16

SPECIFICATION

Frequency Response: 50-15,000 c/s ± 3 dB
 Output Level: -80 dB (150 ohms/1,000 c/s)
 Impedance: 150 ohms, 250 ohms or 600 ohms
 Directional Characteristic: Bi-directional
 S/N 20 dB or below (in parallel field at 1m gauss)

Directional Characteristic

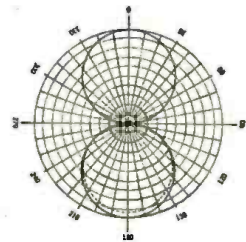

— 500 c/s, 1000 c/s 8000 c/s

AIWA

MODEL DM-20

SPECIFICATION

Frequency Response: 70-10,000 c/s ± 5 dB
 Output Level: -79 dB (150 ohms, 1,000 c/s)
 Impedance: 50 ohms, 150 ohms, 250 ohms, 10K ohms and 50K ohms
 Directional Characteristic: Non-directional

Directional characteristic:

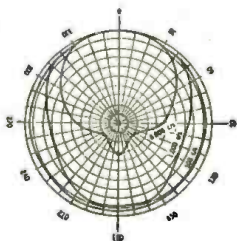

MODEL DM-20

Newly Developed, Economical Dynamic Microphone DM-20

- The DM-20 features a strong diecast body formed after exhaustive acoustical research to achieve reproduction of full audio range.
- Introduces a new plastic diaphragm free from mechanical distortion and physical deterioration.
- An exceptional dynamic microphone for studio broadcasting or recording, resulting in improved, clear and lifelike tone quality.
- Broadens the realism of the tone reproduction in tape recording, well above currently used types of microphone.
- Reasonable price.

AIWA CO., LTD.
 Tokyo, Japan

RESIDENT SCHOOL COURSES IN
LOS ANGELES AND NEW YORK CITY

START YOUR CAREER IN ELECTRONICS NOW AT RCA INSTITUTES...

Choose from this list

	Course	Qualifications	Length of Course
A	Advanced Electronic Technology (T-3)	High School grad, with Algebra, Physics or Science	Day 2¼ yrs. Eve. 6¾ yrs.
B	TV and General Electronics (V-7)	2 yrs. High School, with Algebra, Physics or Science	Day 1½ yrs. Eve. 4½ yrs.
C	Radio & TV Servicing (V-3)	2 yrs. High School	Day 9 mos. Eve. 2¼ yrs.
D	Transistors*	V-3 or equivalent	Eve. 3 mos.
E	Electronic Drafting (V-9)*	2 yrs. High School, with Algebra, Physics or Science	Eve. 3 yrs.
F	Color TV	V-3 or equivalent	Day 3 mos. Eve. 3 mos.
G	Audio-Hi Fidelity*	V-3 or equivalent	Eve. 3 mos.
H	Video Tape*	V-3 or equivalent	Eve. 3 mos.
I	Technical Writing (V-10)	V-3 or equivalent	Eve. 3-18 mos.
J	Radio Telegraph Operating (V-5)*	2 yrs. High School, with Algebra, Physics or Science	Day 9 mos. Eve. 2¼ yrs.
K	Radio Code (V-4)*	8th Grade	Eve. as desired
L	Preparatory Math & Physics (P-0)	1 yr. High School	Day 3 mos.
M	Preparatory Mathematics (P-0A)	1 yr. High School	Eve. 3 mos.

*Courses to be added to Los Angeles Curriculum

RCA Institutes is one of the largest technical institutes in the United States devoted exclusively to electronics. Coeducational Day and Evening classes. Free placement service. Applications now being accepted.



The Most Trusted Name
in Electronics
RADIO CORPORATION OF AMERICA



Send to the school nearest you

RCA Institutes, Inc. Dept. EWR-70
350 West Fourth Street Pacific Electric Building
New York 14, New York 610 S. Main St., L.A. 14, Calif.

Please send me your FREE catalog. I am interested in the courses circled below.

A B C D E F G H I J K L M

Name _____ (please print)

Address _____

City _____ Zone _____ State _____

For Home Study Courses See Ad On Opposite Page

Co., Philadelphia, Pa., has been elected a vice-president. He will implement IRC's new expansion plans.

PETER J. GRANT has been appointed president of *Sylvania Home Electronics Corp.*, marketing subsidiary of *Sylvania Electric Products Inc.*, it was announced recently by Marion E. Pettegrew, senior vice-president. Mr. Grant, who has been vice-president, national sales since April 1959, succeeds Robert L. Shaw who resigned. In his new position, Mr. Grant will be responsible for all marketing operations for the division's home electronic products, which include television sets, radios, and stereo phonographs. Mr. Grant joined *Sylvania* in 1951 as a sales representative for the company's lighting products. Since his transfer in 1952 to Home Electronics, he has served as district sales manager, Eastern regional sales manager, manager of sales management development, manager of marketing services, national sales manager, and vice-president of national sales.



A native of Lakewood, Ohio, he was graduated from Ohio State University in 1948.

ASSOCIATION OF ELECTRONIC PARTS AND EQUIPMENT MANUFACTURERS, INC. has announced the election of new officers. President of the Association is Irving Rossman, executive vice-president of *Pentron Electronics Corp.* Other officers are: first vice-president, Warren Stuart, manager of field sales and sales training, *Belden Mfg. Co.*; second vice-president, Bruce Vinkemulder, assistant general sales manager, *Centralab Division, Globe-Union, Inc.*; treasurer, Kenneth Hathaway, manager, radio and electronic distributor division, *Ward Leonard Electric Co.*; executive secretary, Kenneth C. Prince. The new officers will serve one year.

Named to the board of directors for a three-year term were Wilfred L. Larson, president of *Switchcraft, Inc.*; Robert E. Svoboda, general manager, *Amphenol* distributor division, *Amphenol-Borg Electronics Corp.*; and Richard Crossley, president, *Electro-Products Laboratories.*

STANDARD COIL PRODUCTS announces that construction of its 58,000-square foot plant in Oshkosh, Wis. should be completed about August 1 . . . **LAMBDA ELECTRONICS CORP.** expects to complete its 76,000-square foot plant in Huntington, L. I., N. Y. late this year . . . **AMPEREX ELECTRONICS CORP.**, Hicksville, L. I., N. Y. has acquired a plant in the Woonsocket Industrial Park in Slatersville, R. I., for large scale production of PADT transistors and semiconductor diodes . . . **ELGIN NATIONAL WATCH CO.** will set up a new research and engineering plant for **ELGIN MICRONICS** near Palatine, Ill.

WILLIAM (BILL) ORR, W6SAI, has been appointed Manager of the Amateur Service Department at *Eitel-McCullough, Inc.*, San Carlos, California manufacturer of *Eimac* electron-power tubes, according to O. H. Brown, Director of Marketing. A world-traveled amateur radio authority, Mr. Orr is editor of the "Radio Handbook" in addition to his duties at *Eimac*. He also is the author of the "Beam Antenna Handbook," "VHF Handbook," "Quad Antennas" and other ham publications.



He received his first amateur licence (W2HCE) in 1934 and has been licensed as W6SAI since 1938. He holds WAZ, DXCC (265 countries) and numerous other awards. Prior to joining *Eimac*, Mr. Orr and his family spent 14 months touring Europe and Africa, visiting 23 countries and meeting friends contacted over the air. Amateur operations were conducted in such spots as Finland, Sweden, Vatican City, Monaco, and Andorra, in addition to the islands of St. Pierre and Miquelon.

Born in St. Louis, Missouri, Mr. Orr attended Columbia University, UCLA, and gained his B.S. degree from the University of California.



RCA INSTITUTES



OFFERS YOU THE FINEST OF HOME STUDY TRAINING

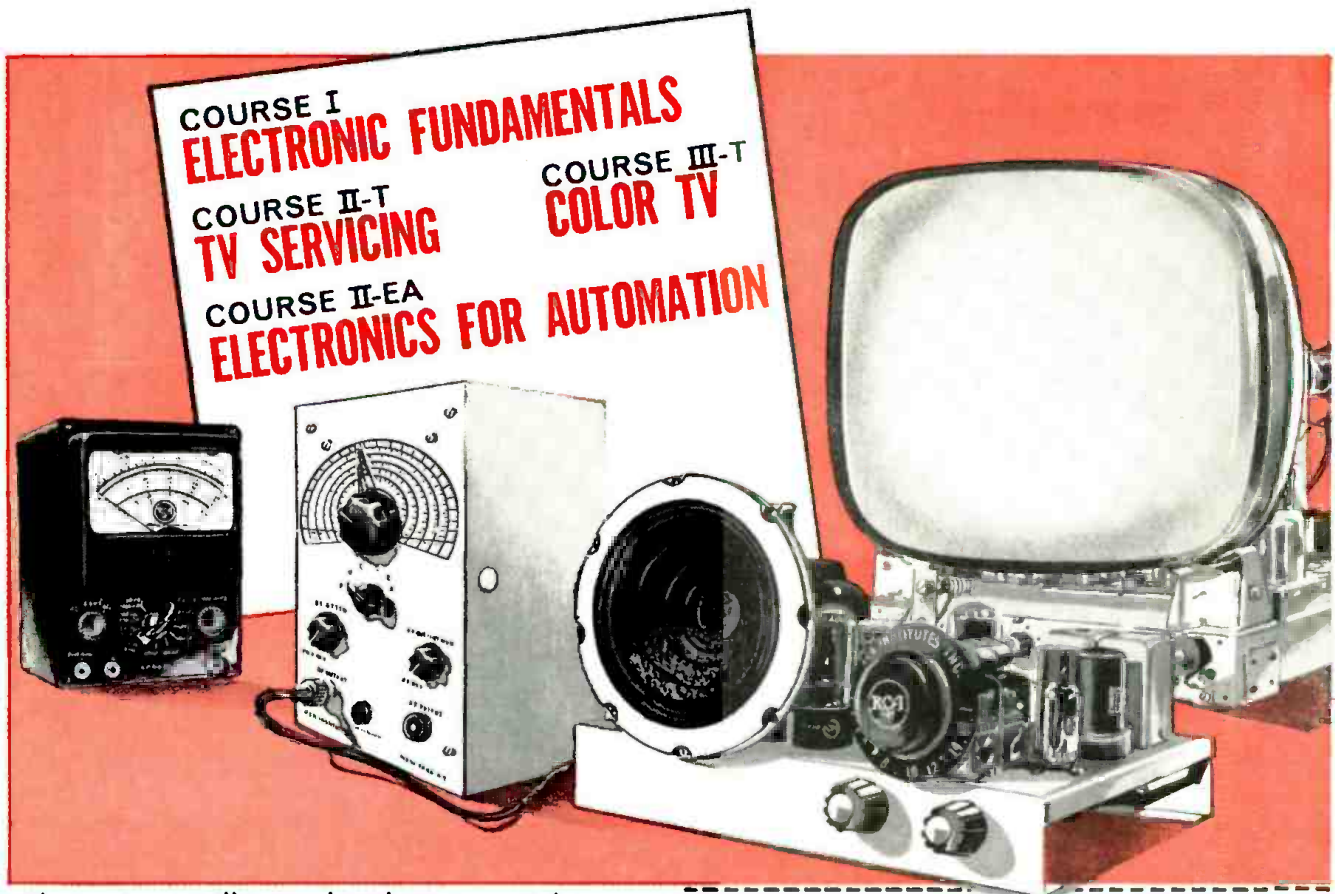

**COURSE I
ELECTRONIC FUNDAMENTALS**

**COURSE II-T
TV SERVICING**

**COURSE II-EA
ELECTRONICS FOR AUTOMATION**

**COURSE III-T
COLOR TV**

The equipment illustrated and text material you get with each course is yours to keep. Practical work with very first lesson. Courses for the beginner and the advanced student. Pay-as-you-learn. You need pay for only one study group at a time.

RCA INSTITUTES, Inc. Home Study School Dept. EW-70

A Service of Radio Corporation of America
350 West Fourth Street, New York 14, N. Y.

Without obligation, send me **FREE 64-page CATALOG** on Home Study Courses. No salesman will call.



**SEND FOR THIS
FREE BOOK NOW** ▶

For Resident School courses see ad on opposite page

Another way RCA serves education through electronics

Name Age
Please print

Address

City Zone State

Korean Vets! Enter discharge date _____

CANADIANS—Take advantage of these same RCA courses at no additional cost. No postage, no customs, no delay. Send coupon to:

RCA VICTOR COMPANY, LTD.
5575 Royalmount Avenue, Montreal 9, Que.

To save time, paste coupon on postcard

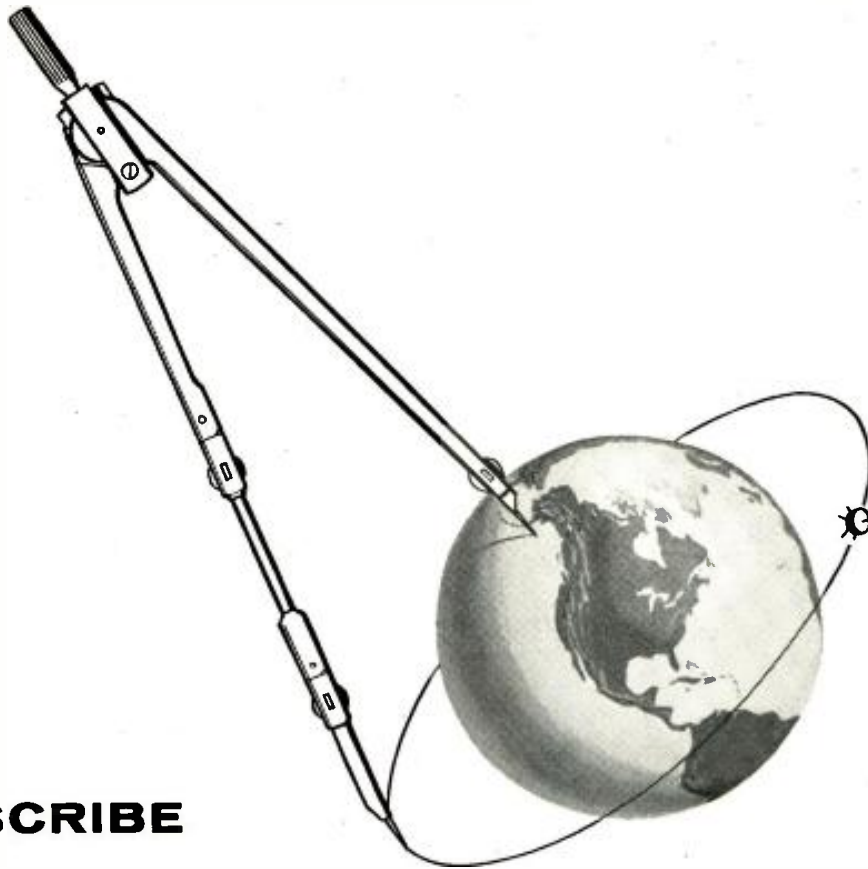

HOW TO SCRIBE A "PERFECT" CIRCLE IN OUTER SPACE

Bell Laboratories guidance system achieves unprecedented accuracy in steering Tiros weather satellite into orbit

Equipped with TV cameras, tape recorders, solar cells and antennas, the world's most advanced weather satellite, the NASA Tiros I, had to be placed in a precisely circular orbit at a specified altitude to do its job well.

The "shot" was a virtual bull's-eye. The mean altitude was within *one mile* of that planned. And

Two Bell Laboratories engineers, T. J. Grieser and D. R. Hagner, look over the second-stage section of the Air Force Thor-Able missile used to launch the NASA Tiros weather satellite.



the deviation from this mean was less than $\frac{1}{2}$ per cent, making it the most-nearly-perfect circular orbit ever achieved with a space vehicle by either the United States or Russia.

The dependability and accuracy of Bell Laboratories' ground-controlled Command Guidance System has been proven before—in the successful test flights of the Air Force Titan intercontinental ballistic missile, and in last year's Air Force Thor-Able re-entry test shots from which the first nose-cone recoveries were made at ICBM distance. Now, with Tiros, the system contributes to a dramatic *non-military* project. Other uses are in the offing.

This achievement in precise guidance again illustrates the versatility of Bell Laboratories' research and development capabilities—directed primarily toward improving your Bell Telephone service.

BELL TELEPHONE LABORATORIES

World center of communications research and development



ELECTRONICS WORLD

Do you WISH you were EMPLOYED in ELECTRONICS?

F.C.C. LICENSE—THE KEY TO BETTER JOBS

An F.C.C. *commercial* (not amateur) license is your ticket to higher pay and more interesting employment. This license is Federal Government evidence of your qualifications in electronics. Employers are eager to hire *licensed* technicians.

WHICH LICENSE FOR WHICH JOB?

The **THIRD CLASS** radiotelephone license is of value primarily in that it qualifies you to take the second class examination. The scope of authority covered by a third class license is extremely limited.

The **SECOND CLASS** radiotelephone license qualifies you to install, maintain and operate most all radiotelephone equipment except commercial broadcast station equipment.

The **FIRST CLASS** radio telephone license qualifies you to install, maintain and operate every type of radiotelephone equipment (except amateur) including all radio and television stations in the United States, its territories and possessions. This is the highest class of radiotelephone license available.

GRANTHAM TRAINING PREPARES YOU

The Grantham course covers the required subject matter completely. Even though it is planned primarily to lead directly to a first class FCC license, it does this by **TEACHING** you electronics. Some of the subjects covered in detail are: Basic Electricity for Beginners. Basic Mathematics. Ohm's and Kirchhoff's Laws. Alternating Current, Frequency and Wavelength. Inductance. Capacitance. Impedance. Resonance. Vacuum Tubes, Transistors. Basic Principles of Amplification. Classes of Amplifiers, Oscillators. Power Supplies, AM Transmitters and Receivers, FM Transmitters and Receivers. Antennas and Transmission Lines. Measuring Instruments, FCC Rules and Regulations, and extensive theory and mathematical calculations associated with all the above subjects explained simply and in detail.

OUR GUARANTEE

If you should fail the F. C. C. exam after finishing our course, we guarantee to give additional training at **NO ADDITIONAL COST**. Read details in our free booklet.

Get Your First Class Commercial F.C.C. LICENSE QUICKLY!

CORRESPONDENCE OR RESIDENCE CLASSES

Grantham School of Electronics *specializes* in F. C. C. license preparation. Correspondence training is conducted from Hollywood, Seattle, Kansas City and Washington; also, resident **DAY** and **EVENING** classes are held in all four cities. Either way, by correspondence or in resident classes, we train you quickly and well.

This booklet **FREE!**

This free booklet gives details of our training and explains what an F. C. C. license can do for your future.

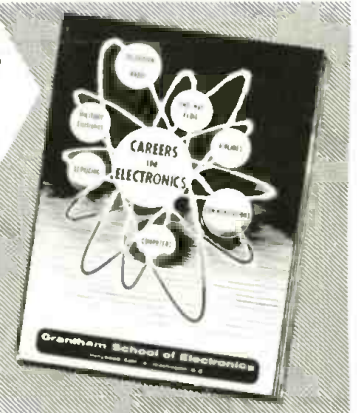

HERE'S PROOF...

that Grantham students prepare for F.C.C. examinations in a minimum of time. Here is a list of a few of our recent graduates, the class of license they got, and how long it took them:

	License	Weeks
Richard M. Wilhoit, 2104 Santa Paula, Las Vegas, Nev.	1st	12
Larry R. Perrine, 7 Normandy Place, Champaign, Ill.	1st	15
Emerson F. Lawson, 111 Excelsior Ave., Union, S. C.	1st	12
Harold W. Johnson, 5070 Hermosa Ave., Los Angeles, Calif.	1st	15
Arthur W. Hardy, 66 Dresser Ave., Great Barrington, Mass.	1st	12
Ralph Frederick Beisner, 2126 Grand, Joplin, Mo.	1st	12
N. B. Mills, II, 110 So. Race St., Statesville, N. C.	1st	12
Dean A. Darling, 403 S. Chase Ave., Columbus 4, Ohio.	1st	12
Paul D. Bernard, 408 First Ave., N.E., Watertown, S. D.	1st	18
Gerald L. Chopp, 518 Audubon Road, Kohler, Wisc.	1st	12

Grantham School of Electronics

Hollywood Division

1505 N. Western Ave.
Hollywood 27, Calif.
(Phone: HO 7-7727)

Seattle Division

408 Marion Street
Seattle 4, Wash.
(Phone: MA 2-7227)

Kansas City Division

3123 Gillham Road
Kansas City 9, Mo.
(Phone: JE 1-6320)

Washington Division

821-19th Street, N. W.
Washington 6, D. C.
(Phone: ST 3-3614)

MAIL COUPON TO SCHOOL NEAREST YOU



(Mail in envelope or paste on postal card)

To: **GRANTHAM SCHOOL OF ELECTRONICS**

1505 N. Western Hollywood • 408 Marion Seattle • 3123 Gillham Rd. Kansas City • 821-19th, NW Washington

Gentlemen:

Please send me your free booklet telling how I can get my commercial F.C.C. license quickly. I understand there is no obligation and no salesman will call.

Name _____ Age _____

Address _____

City _____ State _____

I am interested in: Home Study, Resident Classes 08-K

2 great **SPRAGUE DIFILM** tubulars

are tops in their field . . . take your choice!

For maximum reliability
and performance
under toughest conditions

SPRAGUE DIFILM[®] BLACK BEAUTY[®]



For extremely small
size and exact
original replacement

SPRAGUE DIFILM[®] ORANGE DROP[®]



Sprague Black Beauty tubulars are missile-type capacitors. Actually, they are low cost versions of the famous Sprague capacitors now being used in every modern military missile. Where positive reliability is important, make no mistake, use Black Beauty Difilm Molded Capacitors! You get the most for the least with Black Beauties!

Difilm Black Beauties are engineered to withstand the hottest temperatures to be found in TV or auto radio sets—in the most humid climates. Further, unlike straight polyester film tubulars, these capacitors operate in a 105°C environment—without derating!

Black Beauty tubulars are tough units, too—no fragile shell to break—you can't damage them in soldering. For your convenience, every capacitor is marked twice . . . no need to twist capacitor around to read rating.

The heart of these Sprague Difilm Capacitors can't be beat! It's a dual dielectric combination of Mylar[®] polyester film and special capacitor tissue—resulting in capacitors which are superior to all other comparable tubulars. Sprague's rock-hard solid HCX[®] impregnant fills voids and pin holes in the film. Difilm capacitors have high insulation resistance, low power factor, and excellent capacitance stability and retrace under temperature cycling!

Sprague Difilm "Orange Drops" are a "must" for your service kit where only an exact replacement will fit. They are the perfect replacement for dipped capacitors now used by leading manufacturers in many popular television receivers. And when a dipped tubular is called for, you'll find that Orange Drops outperform all others, safeguarding your work and reputation for quality service.

Orange Drops are specially designed for easiest possible installation. Radial leads are crimped to assure neat mounting parallel to printed wiring boards . . . extremely small size makes them fit handily in tight spots. They'll beat heat and humidity because the solid, rock-hard capacitor section, double-dipped in bright orange epoxy resin, is well protected against moisture. A perfect team-mate for Black Beauty.

±10% CAPACITANCE TOLERANCE IS STANDARD AT NO EXTRA COST

Difilm Black Beauty and Difilm Orange Drops are packaged in sturdy, reusable rigid plastic Klear-Pak[®] boxes. Your distributor is stocked in all the popular ratings. Order some today. You can count on Difilm.

SPRAGUE[®]
THE MARK OF RELIABILITY

IMPORTANT: For the man who wants to make big money in Radio-Television!

ONLY SPRAYBERRY TRAINING IN RADIO and TELEVISION

**OFFERS YOU ALL OF THESE VITAL NEW ADVANTAGES
TO HELP YOU EARN MORE MONEY FROM THE START!**

NEW BUSINESS BUILDERS

...through these practical proven plans and ideas we help you make plenty of extra money in spare time while training.

NEW TRAINING EQUIPMENT

...the famous Sprayberry Training kits have been newly engineered by our staff to offer you the latest in Radio-TV Service Techniques!

NEW TRANSISTOR COURSE

...literally millions of new transistor radios are being used. We show you how to make money fixing them!

NEW HIGH FIDELITY

...there's big money to be made installing and servicing Hi-Fi units. Your Sprayberry training now offers you this valuable and profitable preparation!

TRAIN AT HOME—SPARE TIME

WITH THESE 25 BIG COMPLETE KITS OF PARTS & EQUIPMENT



You learn Radio-TV Servicing the best way...the practical way...testing and assembling these modern kits of equipment.

The new Sprayberry Training Television Receiver, built and tested in 5 sections.

Now offered...this fine modern oscilloscope.

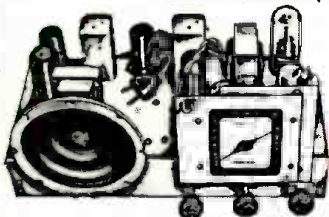

You build this powerful two-band super-heterodyne radio receiver.

You build the new Sprayberry tester—a complete 18-range Volt-Ohm-Milliammeter test meter.

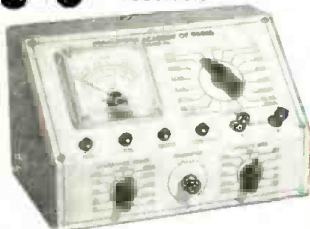

FREE These two big new books are yours free! Find out what Radio-Television offers you...and let us show you how easily you can learn, even without previous experience of any kind. Rush **COUPON** today!

The field of Radio-Television Servicing is such a fast moving industry that the best jobs and biggest incomes always go first to the man with the most modern, complete and up-to-date training. Thanks to constant revision and improvement... Sprayberry Training helps you earn more from the start... and keeps you earning more in the months and years ahead!

Make no mistake! All radio-television training is not alike. The basic purpose behind Sprayberry Training is to prepare you as rapidly and as surely as possible... to make top money servicing Radio and Television sets and equipment. This is where the big money has been for years... and will continue to be in the years ahead.

It's important for you to know that for over 30 years... Sprayberry Training has been preparing ambitious men for success in this interesting and profitable kind of work. Our school has helped hundreds to qualify for the best jobs... or to get started in profitable businesses of their own. Today our student rolls are the largest in our school's history... because the need and demand for Radio-Television Service Technicians has never been more urgent.

Just \$6.00 Starts You

To encourage more men to enter Radio-Television at once... to help fill the great need for trained men... we're making it easier than ever before to start training. Just \$6.00 enrolls you. This liberal offer is naturally limited. Get the facts now

and consider enrollment while these favorable terms are available to you.

KEEP YOUR JOB ... while learning

Under the Sprayberry Plan you train entirely at home in spare time. You combine the most modern lesson training with fascinating and invaluable practical work with 25 big kits of parts and equipment that we supply. You get the equivalent of years of shop practice... and you can train as fast or as slowly as you wish. We help you make excellent spare time money while learning... and everything you receive—lessons, books, manuals, equipment—all yours to keep!

This is the Radio-Television industry's most modern and up-to-the-minute training. Sprayberry is the one school that gives you personalized attention and takes a real interest in your progress. Remember... just \$6 starts you! Mail the coupon today. Let the facts speak for themselves. Let us send you our new catalog and sample lesson... and prove the kind of opportunity that Sprayberry training can open up for you.

SPRAYBERRY ACADEMY OF RADIO-TELEVISION

Dept. 25-N 1512 West Jarvis Ave., Chicago 26, Ill.



MAIL COUPON—No Salesman Will Call

SPRAYBERRY ACADEMY OF RADIO-TELEVISION
DEPT. 25-N 1512 W. JARVIS AVE., CHICAGO 26, ILL.

Please rush all information on your ALL-NEW Radio-Television Training Plan. I understand this does not obligate me and that no salesman will call upon me. Include New Catalog and Sample Lesson FREE.

NAME..... AGE.....
ADDRESS.....
CITY.....ZONE.....STATE.....

**CREI's Extension Division offers Engineering Technicians and Engineers a combination of courses in advanced electronic engineering technology.*

**The program is designed to meet your present and future employment requirements and to increase your professional status and earning power.*

-this CREI College-level Home Study Program in Electronics is Comparable in Technological Content to Advanced Residence Courses!!!!

The CREI home study program is the culmination of 33 years of working closely with leading companies and Government agencies in the critical field of electronics. This accredited program is designed for men already employed in a technical capacity in the electronics industry.

This CREI college-level program is comparable in technological content to advanced residence courses. You may complete the program in 2 to 4 years, depending on the amount of free time you can devote to study, and the courses you choose.

For several years the electronics industry has suffered a serious shortage of technical personnel with

modern advanced education, and there is every indication that this shortage will increase in the years ahead. New jobs are being created daily through the application of electronic developments in missiles, space exploration, automation, instrumentation, computers, telemetering and many other fields. These positions must be filled by men with modern advanced education, which fact is evidenced by the experience of the CREI Placement Bureau, where the demand for graduates and advanced students far exceeds the supply. It is of interest to note that Help Wanted ads frequently specify "CREI education or equivalent."

CREI is recognized by industry and government

Another reason why CREI men are respected and eagerly sought by industry and Government agencies alike is the accreditation and enthusiastic approval accorded the CREI home study program in advanced electronics. We co-founded the National Council of Technical Schools, and we were among the first three technical institutes whose curricula were accredited by the Engineers' Council for Professional Development. Further, the U.S. Office of Education lists CREI as "an institution of higher education."

Of equal importance, we believe, is the appreciation expressed by industry and government for the CREI programs. Dozens of major electronics organizations, ranging from industrial giants to the Government's Voice of America, have agreements with CREI for enrollment of students under company sponsorship. U.S. Navy electronic personnel in the number of 5,240 are enrolled in CREI extension programs. The British Royal Air Force, Army and Navy have approved CREI courses under their tuition assistance plan. The following companies comprise only a partial list of the organizations which not only recommend CREI study but actually, in many cases, pay all or part of the tuition for employees taking CREI courses:

National Broadcasting Company
Jerrold Electronics Corporation
Pan American Airways
Radio Corporation of America
Canadian Aviation and Electronics
Federal Electric Corporation
The Martin Company
Voice of America
Canadian Broadcasting Corporation
Northwest Telephone Company
Commercial Cable, Incorporated
Canadair Limited
Columbia Broadcasting System
All America Cable and Radio
Canadian Marconi
Mackay Radio
United Air Lines
Gates Radio Company
Mohawk Airlines
Florida Power and Light Company

RESIDENCE SCHOOL

... in Washington, D.C., for those who can attend classes. Day and evening classes start at regular intervals. Graduates earn AAS degree in 27 months. Electronics experience is not required for admission.

QUALIFICATIONS FOR CREI ENROLLMENT FACTS ABOUT TUITION, REGISTRATION

If you have a high school diploma or equivalent, basic electronic training and practical experience in electronics, you meet the minimum requirements for enrollment. Tuition is reasonable and may be paid monthly, if you wish. Veterans qualify for this program under the GI bill.

Over 20,500 CREI students find home study convenient and profitable

You can pursue the CREI program while you continue your regular full-time job. You study at home during hours chosen by you. You are not rushed and you have plenty of time to do your best.

The courses are prepared in easy-to-understand format, and the CREI staff of experienced instructors guides your progress all along the way. These instructors stand ready to assist you whenever you need help. You will find our personal assistance and guidance efficient and helpful, because 33 years of experience in home study teaching enables us to anticipate questions in our lesson material.

Many CREI students have learned that they do not have to wait until they have completed the program to realize significant improvement in their status and income. The very fact that you are ambitious enough to pursue this college-level program enhances your opportunities for rapid promotion. Project leaders and supervisors recognize the value of CREI education.

How you benefit from CREI program of home study

CREI students are electronic engineers and technicians engaged in every phase of electronics. They are in research laboratories and manufacturing plants. They work on the design, development and production of the latest computers; on the latest military and civilian aircraft; on the electronic equipment associated with the Nation's missiles and space exploration efforts; on communications equipment of all kinds; they maintain electronic equipment for the air lines, the Government and private corporations. You will find CREI students in all 50 States and in most foreign countries of the free world.

To the serious-minded and ambitious CREI student our home study program offers a series of important benefits:

1. You gain a solid college-level education in advanced electronic engineering technology; you keep abreast of continuous new developments in the field.
2. You can gain higher status and enjoy the increased respect of your associates.
3. You facilitate more rapid professional advancement with corresponding significant increases in pay.
4. You gain the personal satisfaction that comes from working and communicating intelligently with your technical colleagues and superiors.

WRITE FOR DETAILED 44-PAGE BOOK of curricula and other information about CREI, entitled "Insurance for Your Future in the New World of Electronics." USE POSTAGE-PAID CARD ATTACHED, or write to Dept. 1107-G

The Capitol Radio Engineering Institute

ECPD Accredited Technical
Institute Curricula
FOUNDED 1927

3224 16th Street, N.W.
Washington 10, D.C.
Dept. 1107-G



**Latest Information
on the Electronic Industry**

Spot News

By ELECTRONICS WORLD'S
WASHINGTON EDITOR

NEW "TRANSIT" SATELLITE TO CARRY ELECTRONIC MAPPING DEVICE—A six-pound transponder—receiver/transmitter component of SECOR (Sequential Correlation Range) that measures distance by radio—will be placed aboard a Navy "Transit" satellite next fall to assist the Army in obtaining more precise geodetic and mapping information. Four portable stations, movable from one point to another on the earth's surface, will simultaneously send to and receive radio signals from the instrument. This will be possible because signals traveling at the speed of light can be rapidly converted into measurements of the distance from the ground stations to the satellite. Thus, with three stations at widely separated known points on the earth, up to 2000 miles apart, the location of the fourth, or unknown, point can be determined by triangulation computations. Considered part of "Project Betty", which has three "Minitrack Mark II" stations on Pacific Ocean Islands taking observations on the Navy "Vanguard" satellite since 1958, the new technique is said to be better suited than "Minitrack".

NATIONAL SPACE GOALS STRESS ELECTRONIC POTENTIALS—A 12-point space program, with heavy emphasis on the vast possibilities of electronics systems, was outlined recently by Senator Alexander Wiley before the Senate Aeronautical and Space Sciences Committee. In 1961, he said, we should look for not only successful manned space flights, but the establishment of a communications-satellite system including transmission of radio, telephone, teletypewriter, and television; weather satellites; and an adequate national warning-tracking system with radar and sentinel satellites to provide us with a space-guard against surprise attack. And by 1963-64, the Senator added, electronics should play a major role in lunar soft landings carrying television, seismograph, and radiation detection devices to observe and analyze the surface and subsurface of the moon.

ULTRA-SENSITIVE RUBY MASER ELECTRONIC EAR DEVELOPED FOR ARMY—A 25-pound ruby maser electronic ear, considered to be one of the most sensitive listening devices invented and keen enough to pick up faint radio signals from interplanetary rockets, has been developed for the Signal Corps by Hughes Aircraft. The maser (Microwave Amplification by Stimulated Emission of Radiation) is expected to detect radio beeps from space vehicles millions of miles away and enable our defense systems using long-range, high-angle radars to detect intercontinental ballistic missiles far earlier than they can now. In operation, a special 2-carat synthetic ruby inside the maser is cooled to 452 degrees below zero Fahrenheit—about as cold as any object in the universe can become. At this temperature the jewel can detect and amplify almost imperceptible faint radio signals.

AIR-TRAFFIC COMMUNICATIONS TO GET MORE CHANNELS—Effective this July there will be available for air-traffic control five additional megacycles—adding 100 more channels to the communications system. Over 300 of the changes (in the 126.825-128.825 and 132.025-135.0 mc. bands) will become operational on the 7th of this month with an equal number to go into effect within 90 days. Due to the limitations of airborne radios now on aircraft, not all planes will be able to utilize the extra frequencies. This includes equipment which will not tune to frequencies above 127 mc. and where selectivity characteristics require 100-kc. channel separation. The new plan provides, at this time, for the accommodation of limited equipment users through a duplication of some services and the restriction of many other services to channels between 118-127 mc. with a separation of 100 kc.

ROCKET-BORNE RADIOSONDE DEVELOPED—A rocket-borne radiosonde, featuring a transmitter and silver-zinc batteries in an 18-inch fiber glass shell, has been designed and built at the U.S. Army Signal Research and Development Laboratory, Fort Monmouth, N.J. Developed to probe electronically the atmosphere up to a height of 40 miles for weather data, twice the usual ceiling for weather balloons, the device will be extremely valuable for plotting upper atmosphere conditions. Packed into the nose cone of a 77-pound rocket (ARCAS), the radiosonde, after release, floats earthward on a 15-foot parachute. Wind speed and direction are spelled out by an automatic ground tracker, called a "rawin set".

INTRODUCING THE



Today — nearly every American family enjoys television's wide range of entertainment and educational programming. Ten years ago this was not so, for there were problems that had to be overcome in order to provide the nation with top quality TV reception — weak signal areas, interference, areas geographically inaccessible to telecasts; areas where many receivers had to operate from a single antenna; UHF areas with peculiar reception problems. Ten years ago, Blonder-Tongue designed and produced its first product, a TV booster, the model HA-1. Immediately it was accepted for the dramatic improvement it brought to fringe area TV reception.

During the 10 year period in which the TV art achieved the advanced state that exists today, Blonder-Tongue was responsible for 22 important patents that expanded the scope and improved the quality of TV reception. Blonder-Tongue TV signal amplifiers, UHF converters, couplers, CCTV cameras and accessories provide better reception to more than 3 million TV receivers in the home, school, motels, hotels, hospitals and industry. To the nation's TV viewers, we dedicate our 10th Anniversary Line.

IT'S TRANSISTORIZED

to provide a new high in reliability—units can be left in operation indefinitely without damage from overheating. Practically eliminates need for service calls.

IT'S TRANSISTORIZED

to reduce operating costs — low power drain makes operating costs negligible. Also has battery plug for 22 volt DC supply.

IT'S TRANSISTORIZED

to achieve performance previously impossible —new circuitry (pat. pend.) provides maximum gain and minimum noise, high output capabilities with low cross modulation. Can be used with low input signals. Insures top performance for color and black-and-white TV, plus coverage of the FM radio band.

IT'S TRANSISTORIZED BLONDER-TONGUE BT-3

all
transistorized
broadband
tv/fm amplifier

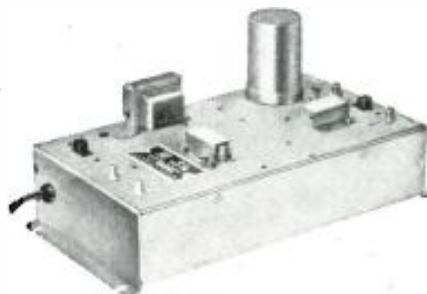

More features to make the BT-3 ideal for master TV systems.....List 99.50

- Separate low band (Channels 2 to 6 and FM) and high band (Channels 7 to 13) inputs permit the use of separate low and high band antennas and insertion of attenuators, if necessary, to equalize signal levels from both bands. Also has provision for single input for combined high and low band signals. • Convenient Output Monitor Jack permits system checking and adjustment without interrupting service. • Solderless 75 ohm coax cable fittings—input and output 75 ohm. • Gain: 18—15 db (channel 2-6); 19 db (7-13); 15—9 db (88-108 mc.). • Maximum output: 0.7 volts max. for 1% cross modulation (total of both bands); 1.25 volts max. for 3% cross modulation (total of both bands).

Available at parts distributors. For further information write Dept. EW-7



BLONDER-TONGUE LABORATORIES, INC. 9 Alling Street, Newark 2, New Jersey
In Canada: Telequipment Mfg. Co., Ltd., London, Ont. Export: Morhan Export Corp., N. Y. 13, N. Y.



DON'T WASTE MONEY
on instruments you don't need!
CUT TEST TIME IN HALF!

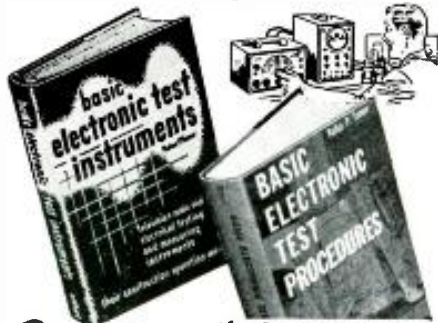

Down-to-earth training in
MODERN TEST INSTRUMENTS
and how to use them
fast and right!

The most important factor in TV-radio or industrial electronic service is a complete working knowledge of instruments—which ones you really ought to have—which ones to use for specific jobs—how to substitute one for another—and how to follow professional time-saving procedures every step of the way. And that's exactly the kind of practical training these two Rinehart manuals bring you! 570 pages and over 360 clear pictures provide above-average instrument training that equips you for better, faster work and higher earnings.

1 A COMPLETE MANUAL OF MODERN INSTRUMENTS
A money-saving guide to every type in common use!

This 254-page BASIC ELECTRONIC TEST INSTRUMENTS is a complete working guide to practically every instrument in common use. Teaches you the advantages and disadvantages of various types; helps you get more for your instrument dollars and avoid those you don't really need; outlines instrument construction and operation; explains instrument features and the particular applications for each; tells how to calibrate and care for them, and how to select the ones most suitable for your particular needs. Price separately \$4.95.

2 New guide to TIME-SAVING TEST PROCEDURES
How to troubleshoot better, faster and more accurately!

BASIC ELECTRONIC TEST PROCEDURES Manual brings the kind of "brass tacks" training that helps you locate troubles in a jiffy. Teaches you exactly what instruments to use and exactly how, where and why to use them; how to substitute one instrument for another and how to develop time- and money-saving test methods all along the line. Subjects include: Current Checks; making measurements of Power, Capacitance, Inductance, Resistance, AF, RF, Phase, Distortion and Modulation; checking Sensitivity, RF Gain, Fidelity, AVC Voltage, Operating Voltages, etc. Covers time-saving visual alignment techniques—even transmitter and industrial electronic test procedures. 316 pages, 190 how-to-do-it pictures and dozens of step-by-step troubleshooting procedures. Price \$6.50 separately.

SAVE \$1.45
on this complete 2 vol. instrument library!

PRACTICE 10-DAYS FREE!

Dept. RN-70, RINEHART & CO., INC.
232 Madison Ave., New York 16, N. Y.

Send books indicated below for 10-day FREE examination. In 10 days I will either remit price shown (plus postage) or return books postpaid and owe you nothing.

- Basic Electronic TEST INSTRUMENTS, \$4.95
- Basic Electronic TEST PROCEDURES, \$6.50
- Check here for **MONEY-SAVING COMBINATION OFFER**. . . . Send both manuals at special price of only \$10.00 for the two (regular price \$11.45 . . . you save \$1.45). . . . Payable at rate of \$4.00 plus postage after 10 days if you decide to keep books and \$3.00 a month for 2 months until \$10.00 has been paid. (EXTRA SAVINGS! Send \$10 with order and Rinehart pays postage. 10-day return privilege with money refunded.)

Name

Address

City, Zone, State

OUTSIDE U. S. A.—\$5.45 for TEST INSTRUMENTS; \$7.00 for TEST PROCEDURES; \$11.00 for both. Cash only. 10-day money-back guarantee.



THE "30" SLUG

To the Editors:

I have been a subscriber to your magazine for a good many years, but I confess there is still one thing that puzzles me. At the end of every article, the number "30" appears. Just what does this number mean anyway?

L. R. EDWARDS
Chicago, Illinois

JOHN JORDAN
Newark, New Jersey

The "30" symbol is a carryover from the old days of hand telegraphy, and it stood for the "end of transmission." When reporters filed their stories via telegraphy, the symbol appeared at the end of their stories. Hence, we use the "30" simply to indicate "end of story."
—Editors.

* * *

CONTACT CLEANERS

To the Editors:

The article "Know Your Electronic Chemicals" in your February 1960 issue is quite interesting. However, if I may, I would like to point out a few disturbing paragraphs along with some suggestions.

You point out that many contact cleaners leave a film behind that serves to lubricate the wearing surfaces and that this film should be conductive. Actually this film should not be conductive, and the switch contacts should make contact of their own accord. The film may serve as a light lubricant, but definitely should not be conductive. If this were so, spraying a tuner, for example, with a chemical cleaner that would deposit a conductive film would prove disastrous, especially to high-frequency circuits.

There are two other chemicals well worth mentioning. One is xyzol and the other is trichloroethylene. Xyzol is highly inflammable, quickly dissolves grease and grime, and does a superb job. Other than that, its properties are not known. On the other hand, trichloroethylene is a fantastic cleaner, swiftly dissolves grease and grime, and supposedly has the reputation of polishing and plating any alloy in one quick operation. I have used both chemicals with excellent results. I also feel that petroleum jelly or white Vaseline is worth mentioning as a suitable lubricant for switch bearings, cams, etc.

The acetone that you mentioned, outlined in Table 1 on page 52, is about the best chemical available for cleaning printed circuits after a soldering job, for example. This quickly removes excess rosin and residue and leaves a sparkling printed circuit board. I've used this chemical for nearly two decades.

The carbon tet that you mention is a

very dangerous chemical and should be used out in the open only. I understand that many government agencies have outlawed carbon tet since it generates poison gas known as phosgene, the type used in World War I. Penetration of carbon tet through the skin may also prove fatal.

Concerning the use of a contact cleaner which leaves a conductive film, we would like to point out that the word "conductive" merely refers to the relative resistance which any material has. Many oil-based lubricants present a very high resistance, such as 2 or 3 ohms per square unit over a thickness of 0.0001 inch. This would show up as contact resistance and result in noisy and intermittent switch operation. A conductive lubricant may present 0.01 ohm at the same thickness. The resistance of such a film covering the insulating material between contacts depends on the path's length and is usually well over several thousand ohms. It is on these terms that we recommend the use of chemicals as contact cleaners.

Xyzol is indeed a very powerful solvent but, unfortunately, it attacks a number of widely used plastics, resistor and capacitor markings, and it is also very volatile and dangerous.—Editors.

QUADRATURE FM DETECTORS

To the Editors:

I would like to bring to your attention an error in the article "Quadrature FM Detectors" by Ken Bramham in the December issue of ELECTRONICS WORLD. Although the narrative portion is quite interesting and accurate, the error actually lies in Fig. 4B.

As Mr. Bramham stated in the discussion, the voltage developed across the LC resonant circuit associated with the quadrature grid (G_2) is 90 degrees out-of-phase (lagging) with the signal introduced on the limiter grid (G_1) provided, of course, that the frequency driving G_1 is equal to the resonant frequency of the quadrature grid tank. If, however, the frequency of the input signal increases, the quadrature grid circuit will change from resistive (where inductive reactance was equal to capacitive reactance and the resistance was that inherent in the circuit) to capacitive, where there will be a further voltage lag angle introduced depending upon how capacitive the circuit becomes, which in turn is a function of the initial frequency increase. Therefore, G_2 voltage will lag G_1 voltage by more than 90 degrees, causing the angle of 6BN6 plate current flow

how to get a Commercial FCC LICENSE

We guarantee
to train you until you receive
Your FCC License
— or your money back

The Master Course in Electronics will provide you with the mental tools of the electronics technician and prepare you for a First Class FCC License (Commercial) with a radar endorsement. When you successfully complete the Master Course, if you fail to pass the FCC examination, you will receive a full refund of all tuition payments.

“License and Good Job . . . Thanks”

“After finishing your Master Course, I passed the FCC exam for the 1st class license. I had my ticket for only one week and I got a job at WOC-TV, AM-FM. Incidentally, WOC is the oldest radio station west of the Mississippi. I sincerely feel that if it weren't for taking your Master Course, I would not have received my 1st class ticket. So I want to take this occasion to again thank you for such a fine preparation for electronics work.”

FRANCIS J. MCMANUS
Davenport, Iowa

Cleveland Institute Training Results in Job Offers Like These . . .

ELECTRONICS TECHNICIANS:

RCA has positions for technicians, field engineers & instructor technicians to install, maintain, and teach military radar, communications, and fire control equipment. Company benefits.

RADIO OPERATORS & TECHNICIANS

American Airlines — Chicago, Detroit, St. Louis, Cincinnati and Cleveland — has openings for radio operators and radio mechanics. Operators must have a 2nd class FCC license and ability to type 40 wpm. Many company benefits.

CLEVELAND INSTITUTE OF ELECTRONICS
Desk RN 43 4900 Euclid Avenue Cleveland 3, Ohio

Mail
Coupon
NOW!



good training
doesn't cost . . .
it pays!

get all three FREE!

We can train you to pass your License Exams if you've had any practical experience — amateur, military, radio servicing, or other. Our proven plan can help put you on the road to success.

- Your FCC ticket will be recognized by employers as proof of your technical ability.

Accredited by the National Home Study Council

Cleveland Institute of Electronics



Desk RN 43, 4900 Euclid Ave., Cleveland 3, Ohio
Please send Free Booklets prepared to help me get ahead in Electronics. I have had training or experience in Electronics as indicated below.

- | | |
|---|---|
| <input type="checkbox"/> Military | <input type="checkbox"/> Broadcasting |
| <input type="checkbox"/> Radio-TV Servicing | <input type="checkbox"/> Home Experimenting |
| <input type="checkbox"/> Manufacturing | <input type="checkbox"/> Telephone Company |
| <input type="checkbox"/> Amateur Radio | <input type="checkbox"/> Other _____ |

In what kind of work are you now engaged?

In what branch of Electronics are you interested?

Name _____ Age _____

Address _____

City _____ Zone _____ State _____

RN43

Citizen's Band Radio Operators!



For improved reception, quality and range, use

Sarkes Tarzian Full Wave Silicon Rectifiers

\$13.00
user's price

S5347—replaces 6BW4 or 12BW4
S5017—replaces OZ4

Tarzian silicon rectifiers are available to replace over 95% of all popular vacuum tube rectifiers

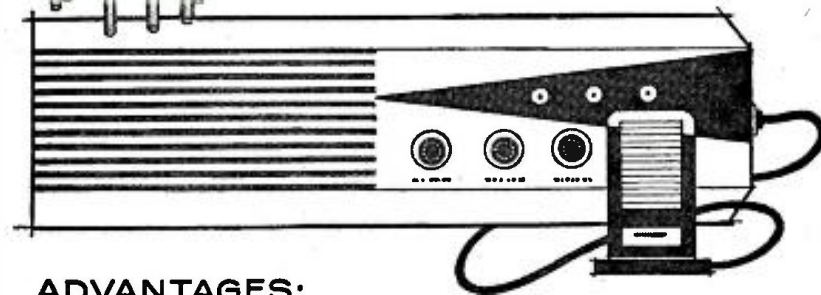

ADVANTAGES:

- Improved performance
- Cooler operation
- More reliability
- Less power drain (batteries last longer)
- Longer life for components
- Better regulation

Sarkes Tarzian's new Full Wave Silicon Rectifiers are ultra-high performance replacement tubes that give you the very maximum in reception, quality and range. Cool operation improves reliability and long life of all components.

Ask your repairman for a Sarkes Tarzian Full Wave Rectifier replacement, or see your nearest Sarkes Tarzian distributor. For additional information about Sarkes Tarzian tube replacement silicon rectifiers, write Section 5102D.



SARKES TARZIAN, INC.

World's Leading Manufacturers of TV and FM Tuners • Closed Circuit TV Systems • Broadcast Equipment • Air Trimmers • FM Radios • Magnetic Recording Tape • Semiconductor Devices

SEMICONDUCTOR DIVISION • BLOOMINGTON, INDIANA
In Canada: 700 Weston Rd., Toronto 9 • Export: Ad Aurlima, Inc., New York

to be reduced and raising the average plate voltage. If, on the other hand the input signal frequency had decreased, the quadrature tank would have appeared inductive, the voltage on the quadrature grid would have lagged the limiter grid by less than 90 degrees, and the average plate voltage on the 6BN6 would have decreased.

Referring to Fig. 4B, Mr. Bramham has illustrated just the opposite effect of plate current and voltage *versus* frequency deviation.

EDWARD L. JAYSON
Port Washington, New York

Thanks to Reader Jayson for pointing out the inconsistency. His analysis appears to be quite correct, and Author Bramham concurs.—Editors.

TRANSISTORIZED FM RECEIVER

To the Editors:

In your article "Portable Transistorized FM Receiver," which appeared in your March, 1960 issue, you say that one 2N224 is equivalent to two 2N225's. According to my *Lafayette* catalogue, one 2N225 is equivalent to a pair of 2N224's. Which is right?

DONALD E. SAVAGE
Rome, New York

The Lafayette catalogue is right on this one. Unfortunately, we got our 2N's transposed in the article and in the diagram.—Editors.

NEW G-E TV CIRCUIT

To the Editors:

Your article entitled "New TV Designs for 1960" in the March issue of *ELECTRONICS WORLD* is very interesting and informative. Naturally, I am gratified to find *General Electric* is included in your coverage, and trust you will continue to follow our developments in the future.

However, I am somewhat concerned that the most important improvement incorporated in the M5 clipper circuit is not completely explained. I refer to the a.g.c. function performed by the circuit, which is the reason for the re-

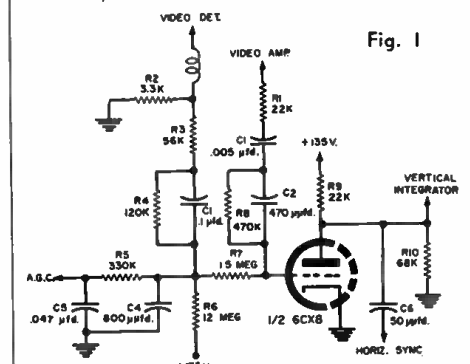

Fig. 1

turn to an opposite signal phase at the detector. Referring to Fig. 2 in your article (reproduced above as Fig. 1), the circuit operation is as follows:

1. Positive going sync pulses from the video amplifier are applied to the clipper grid.
2. Grid current resulting from rectification of these pulses flows through R_7 , R_4 , R_3 , and R_2 to ground.

NOW!
at a price
you can afford!

MAKE MORE MONEY in TELEVISION RADIO-ELECTRONICS

**BETTER...MORE COMPLETE...LOWER COST...
WITH NATIONAL SCHOOLS SHOP-METHOD
HOME TRAINING!**

BETTER... Training that is proved and tested in Resident School shops and laboratories, by a School that is the **OLDEST** and **LARGEST** of its kind in the world.

MORE COMPLETE... You learn **ALL PHASES** of *Television-Radio-Electronics*.

LOWER COST... Other schools make several courses out of the material in our **ONE MASTER COURSE**... and you pay more for less training than you get in *our course* at **ONE LOW TUITION!**



These
two FREE books will
show you how!

You get all information
by mail... You make
your own decision... at
home! **NO SALESMAN
WILL CALL**

TOP PAY... UNLIMITED OPPORTUNITIES LIFETIME SECURITY CAN BE YOURS!

You are needed in the Television, Radio, and Electronics industry! Trained technicians are in growing demand at excellent pay—in **ALL PHASES**, including Servicing, Manufacturing, Broadcasting and Communications, Automation, Radar, Government Missile Projects.

NATIONAL SCHOOLS SHOP-METHOD HOME TRAINING, with newly added lessons and equipment, trains you in your spare time at home, for these unlimited opportunities, including many technical jobs leading to supervisory positions.

YOU LEARN BY BUILDING EQUIPMENT WITH KITS AND PARTS WE SEND YOU. Your National Schools course includes thorough *Practical* training—**YOU LEARN BY DOING!** We send you complete standard equipment of professional quality for building various experimental and test units. You advance step by step, perform more than 100 experiments, and you build a complete TV set from the ground up, that is yours to keep! A big, new TV picture tube is included at no extra charge.

EARN AS YOU LEARN. We'll show you how to earn extra money right from the start. Many of our students pay for their course—and more—while studying. So can you!

RESIDENT TRAINING AT LOS ANGELES

If you wish to take your training in our Resident School at Los Angeles, the world's TV capital, start **NOW** in our big, modern Shops, Labs and Radio-TV Studios. Here you work with latest Electronic equipment - - professionally installed - - finest, most complete facilities offered by any school. Expert, friendly instructors. Personal attention. Graduate Employment Service. Help in finding home near school - - and part time job while you learn. Check box in coupon for full information.

LESSONS AND INSTRUCTION MATERIAL ARE UP-TO-DATE, PRACTICAL, INTERESTING. Every National Schools Shop-Method lesson is made easy to understand by numerous illustrations and diagrams. All instruction material has been developed and tested in our own Resident School Shops, Laboratories and Studios.

SEND FOR INFORMATION TODAY... it can mean the difference between **SUCCESS** and failure for you! Send for your **FREE BOOK** "Your Future in Television-Radio-Electronics" and **FREE Sample Lesson.** Do it **TODAY**, while you are thinking about your future. It doesn't cost you anything to investigate!

GET THE BENEFITS OF OUR OVER 50 YEARS EXPERIENCE

Approved for
GI Training



NATIONAL SCHOOLS

Los Angeles 37, Calif.

YOU GET...

- 19 Big Kits—**YOURS TO KEEP!**
- Friendly Instruction and Guidance
- Job Placement Service
- Unlimited Consultation
- Diploma—Recognized by Industry
- **EVERYTHING YOU NEED FOR SUCCESS!**

SHOP-METHOD HOME TRAINING COVERS ALL PHASES OF INDUSTRY

1. Television, including Color TV
2. Radio AM & FM
3. Electronics for Guided Missiles
4. Sound Recording and Hi-Fidelity
5. FCC License
6. Automation and Computers
7. Radar & Micro-Waves
8. Broadcasting and Communications

NATIONAL TECHNICAL SCHOOLS

WORLD-WIDE TRAINING SINCE 1905

MAIL NOW TO

NATIONAL SCHOOLS, Dept RH-70

4000 S. FIGUEROA ST. LOS ANGELES 37, CALIF.

Rush free TV-Radio "Opportunity" Book and sample lesson. No salesman will call.

NAME _____ AGE _____

ADDRESS _____

CITY _____ ZONE _____ STATE _____

Check if interested **ONLY** in Resident School training at Los Angeles.

VETERANS: Give date of Discharge _____



The "Big Picture"

...informative shop talks

by AL MERRIAM

Sylvania National Service Manager

One tool pulls the whole "works"...

That's the way it is with the new Sylvania TV consoles. When you have to pull the "works"—back cover, chassis, control cluster or even the picture tube—all you need is one ¼" socket wrench...

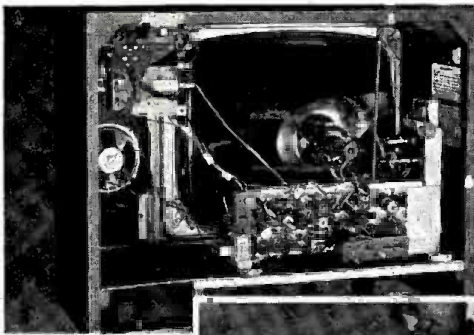
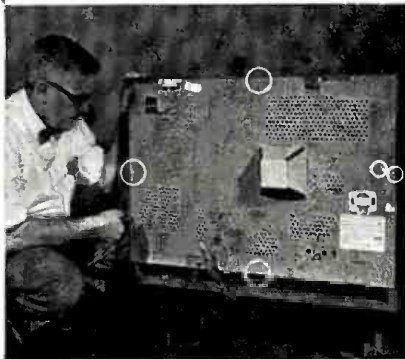

▲ to remove the *five* screws holding the back cover (three less screws than the average cover!).

◀ All the tubes—everything is in plain sight and easy for you to service. If you have to take the chassis to the shop—

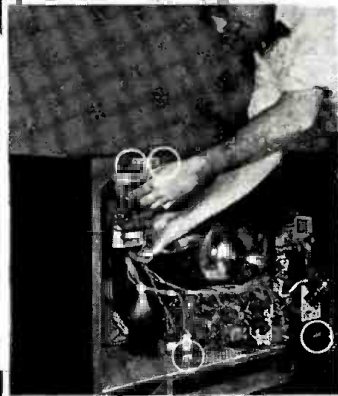

one ¼" socket wrench takes out the *two* screws holding the chassis—and the *two* screws on the control cluster bracket. Just pull the plug-in leads for the speaker, for HaloLight® and for the picture tube.....

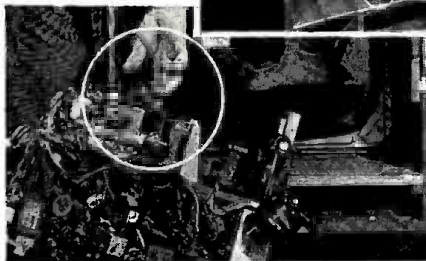

and slide off the yoke connection to the picture tube, and hang it on the special hook on the chassis. Easy as pie, the control cluster unit locks to the chassis, and you're on your way—faster, easier and with no dangling parts to lose or trip over.

The whole job takes an old duffer like me about three minutes. It may take you a few seconds more the first time, but you'll leave me in the dust after that! Here's another tip that pays. Take along some furniture polish to slick up the cabinet—takes just a second, and the folks like those thoughtful "extras." And don't forget about the Sylvania Service Bulletins and Service Clinics! Ask your distributor for the "Big Picture" on the next clinic session in your area, or write me—Al Merriam, Sylvania Home Electronics Corp., Batavia, N. Y.

SYLVANIA

Subsidiary of GENERAL TELEPHONE & ELECTRONICS



3. The proper negative voltage level to apply as a.g.c. is found at the junction of R_2 and R_3 . Unfortunately, there normally is a substantial video modulation present at this point, which is undesirable on an a.g.c. supply.

4. The point on this string of load resistors where the negative sync information from the detector and the positive sync information from the video amplifier just cancel out is the junction of R_1 and R_2 .

5. By the addition of C_1 (.1 μ f.) across R_1 ; this a.c. balance point is transferred to the junction of R_2 and R_3 .

This circuit advantage provides practically ripple-free negative d.c. voltages for the a.g.c. line. Shorter time-constant decoupling filters may be used and thus provide faster a.g.c. control action as needed for airplane flutter or other rapid fading.

R. C. HANNUM

Supervisor-Technical Service
General Electric Co.
Syracuse, New York

The G-E circuit referred to is certainly quite interesting and well worth the analysis given above.—Editors.

"WHITE ALICE" SYSTEM

To the Editors:

After reading your article on tropospheric radio communication in the March issue, we found it very interesting and enlightening, but slightly misleading.

We are currently stationed in Alaska at a remote Air Force site which is served by the "White Alice" system. The site we are on is Tin City Air Force Station, which was incorrectly referred to in your article as Wales. Wales, in reality, is a small Eskimo village approximately five miles from Tin City and is not served by "White Alice." Your article also stated that Wales, correctly called Tin City, is 56 miles from Russia. We are actually 48 miles from the coast of Siberia, but only 26 miles from the Big Diomed Island which is Russian controlled and located west of the International Date Line, separating Russia from the U. S.

The power fluctuations you mentioned are caused at this station by the fact that "White Alice" operates on the same power as the site's radar. Although the only two things on this power are "White Alice" and the radar set, the fluctuations nevertheless exist. This power is generated by several generators in parallel. The radar set draws more power than "White Alice." When the radar transmitter high voltage is turned on or off, there is a tremendous change in power. While the generators are compensating for this sudden drop, or increase, whichever the case may be, there are slight variations in voltage and frequency, which frequently cause difficulties.

BARRY R. BOOLE
Radar Maint. Tech.
RICHARD J. EICHER
Radio Maint. Tech.
Tin City, Alaska

—50—

ELECTRONICS WORLD

The specs prove it...your best buy is



B
**TV-FM SWEEP GENERATOR
 AND MARKER #368**
 KIT \$69.95 WIRED \$119.95

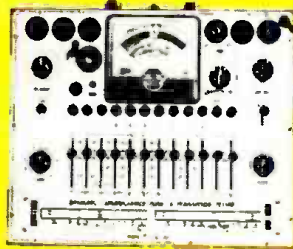

A
**DYNAMIC CONDUCTANCE
 TUBE & TRANSISTOR
 TESTER #666**
 KIT \$69.95 WIRED \$109.95
 Complete with steel cover & handle

RF SIGNAL GENERATOR #324
 KIT \$26.95 WIRED \$39.95



D
**PEAK-TO-PEAK
 VTVM #232 &
 UNIPROBE**
 KIT \$29.95
 WIRED \$49.95



E
**COLOR & MONOCHROME
 DC TO 5 MC LAB & TV
 5" OSCILLOSCOPE #460**
 KIT \$79.95 WIRED \$129.50
**5" PUSH-PULL
 Oscilloscope #425:**
 Kit \$44.95 WIRED \$79.95



A Tests all receiving tubes (picture tubes with adapter), n-p-n and p-n-p transistors. Composite indication of Gm, Gp & peak emission. Simultaneous selection of any one of 4 combinations of 3 plate voltages, 3 screen voltages, 3 ranges of continuously variable grid voltage (with 5% accurate pot.). Sensitive 200 ua meter. 10 six-position lever switches: freepoint connection of each tube pin. 10 pushbuttons: rapid insert of any tube element in leakage test circuit. Direct reading of inter-element leakage in ohms. New gear-driven rollchart. CRA Adapter \$4.50.

B Entirely electronic sweep circuit with accurately-biased inductor for excellent linearity. Extremely flat RF output. Exceptional tuning accuracy. Hum and leakage eliminated. 5 fund. sweep ranges: 3-216 mc. Variable marker range: 2-75 mc

in 3 fund. bands, 60-225 mc on harmonic band. 4.5 xtal marker osc., xtal supplied. Ext. marker provision. Attenuators: Marker Size, RF Fine, RF Coarse (4-step decade). Narrow range phasing control for accurate alignment.

C 150 kc to 435 mc with ONE generator in 6 fund. bands and 1 harmonic band! $\pm 1.5\%$ freq. accuracy. Colpitts RF osc. directly plate-modulated by K-follower for improved mod. Variable depth of int. mod. 0-50% by 400 cps Colpitts osc. Variable gain ext. mod. amplifier: only 3.0 v needed for 30% mod. Turret-mounted, slug-tuned coils for max. accuracy. Fine and Coarse (3-step) RF attenuators. RF output 100,000 uv, AF output to 10 v.

D Uni-Probe - exclusive with EICO - only 1 probe performs all functions: half-turn of probe tip selects DC or AC-Ohms. Calibration without re-

moving from cabinet. Measure directly p-p voltage of complex & sine waves: 0-4, 14, 42, 140, 420, 1400, 4200. DC/RMS sine volts: 0-1.5, 5, 15, 50, 150, 500, 1500 (up to 30,000 v. with HVP probe, & 250 mc with PRF probe). Ohms: 0.2 ohms to 1000 megs. $4\frac{1}{2}$ " meter, can't-burn-out circuit. 7 non-skp ranges on every function. Zero center.

E Features DC amplifiers! Flat from DC to 4.5 mc, usable to 10 mc. Vert. Sens.: 25 mv/in.; input Z 3 megs; direct-coupled & push-pull throughout. 4-step freq.-compensated attenuator up to 1000:1. Sweep: perfectly linear 10 cps - 100 kc (ext. cap. for range to 1 cps). Pre-set TV V & H positions. Auto sync. lim. & ampl. Direct or cap. coupling; bal. or unbal. inputs; edge-lit engraved lucite screen with dimmer control; plus many more outstanding features.

FREE CATALOG shows you HOW TO SAVE 50% on 65 models of top quality professional test equipment. MAIL COUPON NOW!

SEE OUR OTHER ADVERTISEMENT ON PAGE 93



**New Transistor
 Portable Radio RA-6**
 KIT \$29.95
 WIRED \$49.95
 Incl. F.E.T.; less 9V batt.
 Prealigned RF, IF
 xfms; push-pull
 audio; 6" spkr.

*PAT. PEND.



**NEW Power & Bias
 Supply for
 Transistorized
 Eqpt. #1020 ***
 KIT \$19.95
 WIRED \$27.95



**NEW Tube &
 CRT Fil.
 Tester #612**
 KIT \$3.95
 WIRED \$5.95
 Fast-checks
 radio/TV tubes,
 pilot lamps, etc.



**Series/Parallel
 R-C Combination
 Box #1140**
 KIT \$13.95
 WIRED \$19.95



Tube Tester #625
 KIT \$34.95
 WIRED \$49.95
 • tests 600 mil
 series string type
 tubes
 • illuminated
 roll-chart
 Pix Tube Test
 Adapter.....\$4.50



**6V & 12V Battery
 Eliminator
 & Charger #1050**
 KIT \$29.95
 WIRED \$38.95
 Extra-filtered for
 transistor equipmt.
 #1060 KIT \$38.95
 WIRED \$47.95

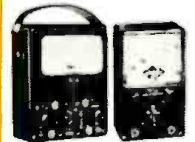

**20,000 Ohms/Volt
 V-O-M #565**
 KIT \$24.95
 WIRED \$29.95
**1000 Ohms/Volt
 V-O-M #536**
 KIT \$12.90
 WIRED \$14.90



33-00 Northern Blvd. L. I. C. 1, N. Y.

Add 5% in the West. © 1959

TURN PAGE FOR MORE EICO VALUES



**R-C Bridge & R-C-L
 Comparator #950B**
 KIT \$19.95
 WIRED \$29.95
 Reads 0.5 ohms-
 500 megs,
 10 mmfd-5000 mfd,
 power factor



VTVM Probes

Peak-to-Peak	Kit \$4.95	Wired \$6.95
RF	\$3.75	\$4.95
High Voltage Probe-1	\$6.95	
High Voltage Probe-2	\$4.95	
Scope Probes		
Demodulator	\$3.75	\$5.75
Direct	\$2.75	\$3.95
Low Capacity	\$3.75	\$5.75

EICO
 33-00 Northern Blvd.
 L. I. C. 1, N. Y.

EW-7

Show me HOW TO SAVE 50% on Test Instruments
 Hi-Fi Ham Gear. Send free Stereo Hi-Fi
 Guide. Send FREE Short Course for Novice License.
 Send me FREE Catalog, name of neighborhood dealer.

Name

Address

City Zone State

EICO KITS

IF YOU LOVE TO CREATE... BUILD

In **STEREO** and

**Mono HI-FI...
the experts say
your Best Buy
is EICO**

Over 2 MILLION EICO instruments in use throughout the world. Add 5% in the West.



Stereo Amplifier-Preamplifier HF81t



Stereo Preamplifier HF85tt



FM Tuner HFT90tt
AM Tuner HFT94tt
FM/AM Tuner HFT92tt



100W Stereo Power Amplifier HF89
70W Stereo Power Amplifier HF87
28W Stereo Power Amplifier HF86



Stereo Integrated Amplifier AF4tt



3-Way Speaker System HFS3
2-Way Bookshelf Speaker Systems
HFS5 and HFS1



Stereo Automatic Changer/
Player 1007



- Exclusive advanced systematized engineering
 - Latest and finest quality parts
 - Exclusive "Beginner-Tested" easy step-by-step instructions
 - Exclusive TRIPLE quality control
 - Exclusive LIFETIME guarantee at nominal cost
- IN STOCK — Compare, then take home any EICO equipment — right "off the shelf" — from 1500 neighborhood EICO dealers throughout the U. S. and Canada.

HF81 Stereo Amplifier-Preamplifier selects, amplifies, controls any stereo source & feeds it thru self-contained dual 14W amplifiers to a pair of speakers. Provides 28W monophonically. Ganged level controls, separate balance control, independent bass and treble controls for each channel. Identical Williamson-type, push-pull EL84 power amplifiers. "Excellent" — SATURDAY REVIEW. "Outstanding... extremely versatile." — ELECTRONICS WORLD. Kit \$69.95. Wired \$109.95. Incl. cover.

HF85 Stereo Preamplifier: Complete master stereo preamplifier-control unit, self-powered. Distortion borders on unmeasurable. Level, bass, & treble controls independent for each channel or ganged for both channels. Inputs for phono, tape head, mike, AM, FM, & FM-multiplex. One each auxiliary A & B input in each channel. "Extreme flexibility... a bargain." — HI-FI REVIEW. Kit \$39.95. Wired \$64.95. Incl. cover.

New HF89 100-Watt Stereo Power Amplifier: Dual 50W highest quality power amplifiers. 200W peak power output. Uses superlative ultra-linear connected output transformers for undistorted response across the entire audio range at full power, assuring utmost clarity on full orchestra & organ. 60 db channel separation. IM distortion 0.5% at 100W; harmonic distortion less than 1% from 20-20,000 cps within 1 db of 100W. Kit \$99.50. Wired \$139.50.

HF87 70-Watt Stereo Power Amplifier. Dual 35W power amplifiers identical circuit-wise to the superb HF89, differing only in rating of the output transformers. IM distortion 1% at 70W; harmonic distortion less than 1% from 20-20,000 cps within 1 db of 70W. Kit \$74.95. Wired \$114.95.

HF86 28-Watt Stereo Power Amp. Flawless reproduction at modest price. Kit \$43.95. Wired \$74.95.

FM Tuner HFT90: Prewired, prealigned, temperature-compensated "front end" is drift-free. Prewired exclusive precision eye-tronic® traveling tuning indicator. Sensitivity: 1.5 uv for 20 db quieting; 2.5 uv for 30 db quieting, full limiting from 25 uv. IF bandwidth 260 kc at 6 db points. Both cathode follower & FM-multiplex stereo outputs, prevent obsolescence. Very low distortion. "One of the best buys in high fidelity kits." — AUDIOCRRAFT. Kit \$39.95*. Wired \$65.95*. Cover \$3.95. *Less cover, F.E.T. incl.

AM Tuner HFT94: Matches HFT 90. Selects "hi-fi" wide (20-9000 cps @ -3 db) or weak-station narrow (20-5000 cps @ -3 db) bandpass. Tuned RF stage for high selectivity & sensitivity. Precision eye-tronic® tuning. "One of the best available." — HI-FI SYSTEMS. Kit \$39.95. Wired \$65.95. Incl. cover & F.E.T.

New FM/AM Tuner HFT92 combines renowned EICO HFT90 FM Tuner with excellent AM tuning facilities. Kit \$59.95. Wired \$94.95. Incl. cover & F.E.T.

New AF-4 Economy Stereo Integrated Amplifier provides clean 4W per channel or 8W total output. Kit \$38.95. Wired \$64.95. Incl. cover & F.E.T.

HF12 Mono Integrated Amplifier (not illus.): Complete "front end" facilities & true hi-fi performance. 12W continuous, 25W peak. Kit \$34.95. Wired \$75.95. Incl. cover.

New HFS3 3-Way Speaker System Semi-Kit complete with factory-built 3/4" veneered plywood (4 sides) cabinet. Bellows-suspension, full-inch excursion 12" woofer (22 cps res.) 8" mid-range speaker with high internal damping cone for smooth response, 3 1/2" cone tweeter. 2 1/4 cu. ft. ducted-port enclosure. System Q of 1/2 for smoothest frequency & best transient response. 32-14,000 cps clean, useful response. 16 ohms impedance. HWD: 26 1/2", 13 3/8", 14 3/8". Unfinished birch. Kit \$72.50. Wired \$84.50. Walnut or mahogany. Kit \$87.50. Wired \$99.50.

New HFS5 2-Way Speaker System Semi-Kit complete with factory-built 3/4" veneered plywood (4 sides) cabinet. Bellows-suspension, 5/8" excursion, 8" woofer (45 cps. res.), & 3 1/2" cone tweeter. 1 1/2 cu. ft. ducted-port enclosure. System Q of 1/2 for smoothest freq. & best transient resp. 45-14,000 cps clean, useful resp. 16 ohms,

HWD: 24", 12 1/2", 10 1/2". Unfinished birch. Kit \$47.50. Wired \$56.50. Walnut or mahogany. Kit \$59.50. Wired \$69.50.

HFS1 Bookshelf Speaker System complete with factory-built cabinet. Jensen 8" woofer, matching Jensen compression-driver exponential horn tweeter. Smooth clean bass; crisp extended highs; 70-12,000 cps range, 8 ohms. HWD: 23" x 11" x 9". Kit \$39.95. Wired \$47.95.

HFS2 Omni-Directional Speaker System (not illus.) HWD: 36", 15 1/4", 11 1/2". "Fine for stereo" — MODERN HI-FI. Completely factory-built. Mahogany or walnut \$139.95. Blond \$144.95.

New Stereo Automatic Changer/Player: Jam-proof 4-speed, all record sizes, automatic changer and auto/manual player. New extremely smooth, low distortion moisture-proof stereo crystal cartridge designed integrally with tonearm to eliminate mid-range resonances. Constant 4 1/2 grams stylus force is optimum to prevent groove flutter distortion. No hum, turntable attractions, acoustic feedback, center-hole enlargement. Only 10 3/4" x 13". Model 1007D: 0.7 mil diamond, 3 mil sapphire dual styli, \$59.75. 1007S: 0.7 mil, 3 mil sapphire, \$49.75. Incl. FET.

†Shown in optional Furniture Wood Cabinet WE71: Unfinished Birch, \$9.95; Walnut or Mahogany, \$13.95.

††Shown in optional Furniture Wood Cabinet WE70: Unfinished Birch, \$8.95; Walnut or Mahogany, \$12.50.

EICO, 33-00 N. Blvd., L.I.C. 1, N. Y. EW-7
Show me how to SAVE 50% on easy-to-build top-quality Hi-Fi. Send FREE catalog, Stereo Hi-Fi Guide plus name of neighborhood EICO dealer.

Name.....
Address.....
City..... Zone..... State.....

Listen to the EICO Hour, WABC-FM, N. Y., 95.5 MC, Mon. to Fri. 7:15-8 P.M., Sat. 11-12 P.M. Ask dealer about EICO's Stereo Records Bonus.
© 1960 by EICO, 33-00 N. Blvd., L. I. C. 1, N. Y.

ELECTRONICS WORLD

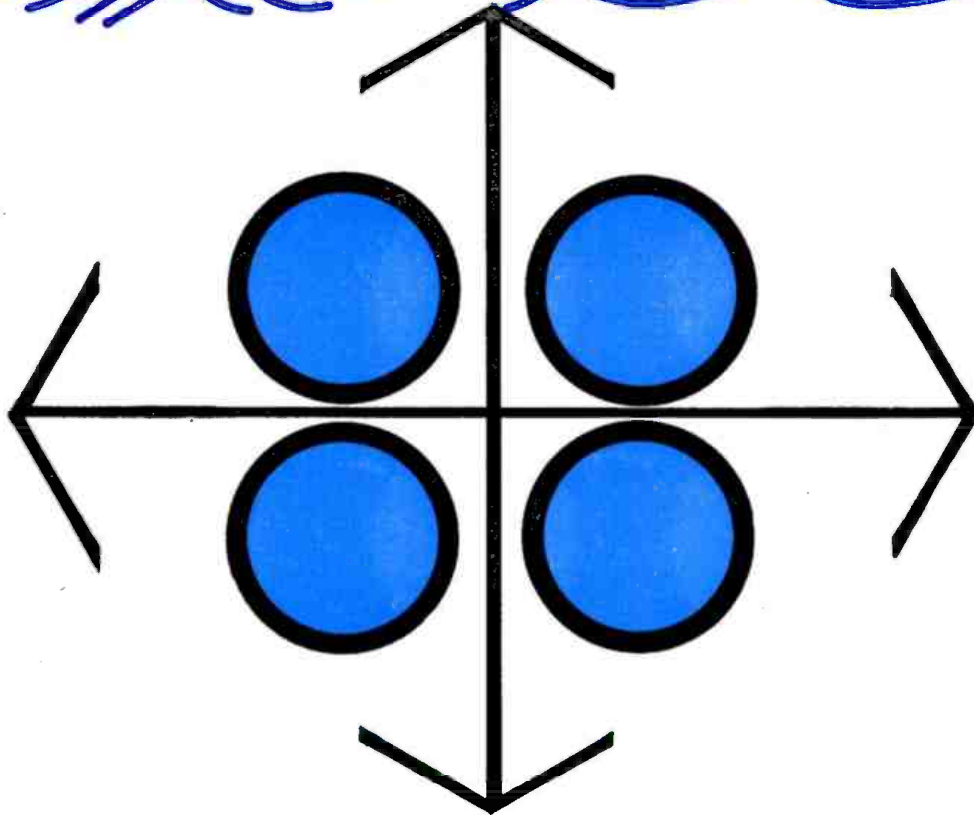
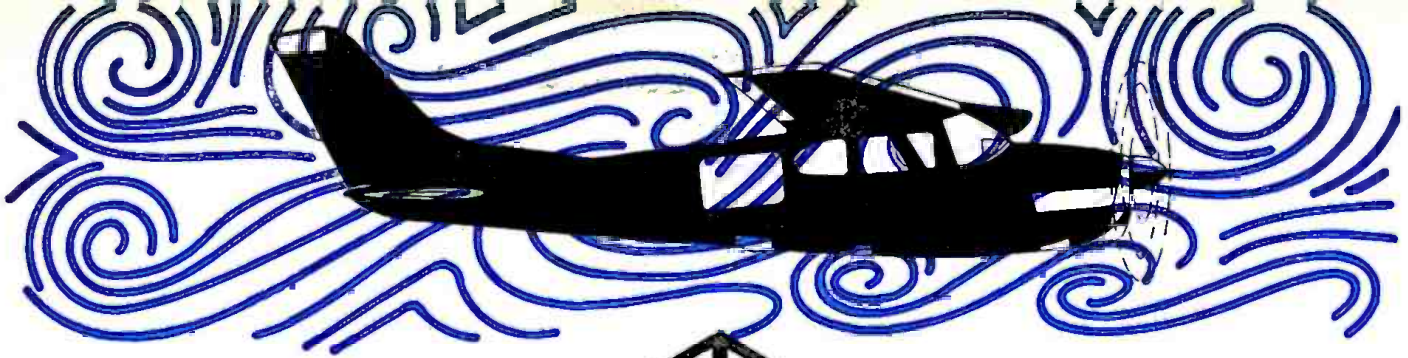

Radio Aids to Aircraft Navigation

Part 1. Low-Frequency Ranges & Direction Finding

By **FRANCIS A. GICCA**
Senior Engineer, Raytheon Co.

Operation and use of important electronic aids that make flying safe—with emphasis on private-plane applications.

OUR AUTHOR is well-qualified to write on this important subject. His professional work is directly concerned with the development of navigational and guidance systems. Also, he possesses a Private Pilot's License and is personally acquainted with the operation and use of all the systems described in this series of three articles. Finally, he has assembled several complete navigation systems for a flying club and has had to service all of this equipment.

THE success of any transportation system depends greatly upon its ability to maintain safe, scheduled operation. Since World War II the airplane as a means of dependable transportation has grown to the point where most long-distance travel is done by air. This tremendous growth of air transportation is due, to a large extent, to the development of radio aids for aviation which allow modern aircraft to

operate under all weather conditions. Radio today provides aviation with communications, traffic-control and, perhaps most important, navigation. For, without radio navigation, it would be impossible for airplanes to fly from city to city and land safely under any but the most favorable weather conditions.

Recently, the United States system of traffic-control and navigation has been under criticism as being unable to cope with the problems of high-density, high-speed air traffic. In many cases, these criticisms are valid. It must also be noted on the positive side, however, that the United States maintains the most complex and efficient system of traffic-control and federal radio aids to navigation in the world.

Nevertheless, the Federal Aviation Agency is currently spending thousands of dollars for the improvement and safety of civil aviation. In the months ahead, words like ADF, VOR, and ILS will appear often in the press as the FAA makes its recommendations for some modernization of the airways system.

This three-part article will explore the operation of America's complex network of radio aids to aircraft navigation. Radio navigation is a fascinating field and, with the current national interest in aircraft control, it is certainly worthwhile to understand the operation of the present navigational systems. Aircraft navigation can be broadly classified into two categories. The first concerns all long-range sys-



Four-course low-frequency radio-range station showing the five antenna towers.

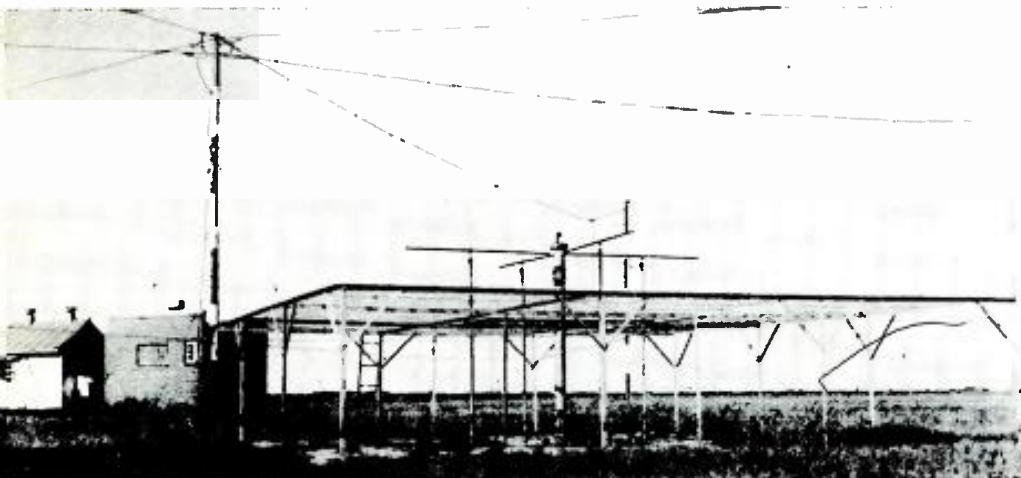

This four-course low-frequency radio-range station is of the loop type (as are about one-third of FAA's low-frequency ranges; the balance are 5-tower Adcock types). The long-wire antennas in the background are the two loops which are at 90 degrees to each other and are used to form the actual low-frequency range courses. The antenna structure in the foreground is a marker antenna array. This projects a 75-mc. signal directly upward in order to provide a positive "fix" over the station itself.

tems which allow a pilot to fly his plane between two distant cities. The second group may be termed "terminal navigation" and includes all systems which guide the pilot to his terminal airport and allow him to perform a safe instrument landing.

This first article will describe the op-

eration of the two oldest schemes of long-range navigation which are in widespread use today. The second part will describe VOR, the modern system of long-range navigation. The final article in this series will describe all currently used systems for terminal navigation of aircraft.

Nearly all long-range air travel today is conducted along civil airways, ten-mile-wide highways in the sky which interconnect all major and minor cities in the country. It is the primary task of all long-range navigational systems to lead aircraft along these routes. In all cases, this end result is achieved by having the airplane follow a radio beam oriented along the center-line of the civil airway. However, the methods used to create this beam and the equipment needed for reception vary widely.

Low-Frequency Radio Range

The low-frequency radio-range scheme of airborne navigation was the first system generally adopted in the United States. The first station began broadcasting in 1931 and there are about four hundred range stations in operation today. Because of the inherent simplicity of the range system of navigation, it is still the most widely used method of radio navigation, although it has several serious limitations.

Radio-range stations broadcast in the low-frequency band of 200 to 415 kilocycles. Each station transmits four "on the beam" courses, nominally 90 degrees apart, by interlocking two figure-eight antenna radiation patterns. These individual quadrantal courses are identified by a 1020-cycle code modulation. In two diagonally opposite quadrants the letter *A* is transmitted in international Morse code (·—), and in the remaining pair of quadrants the letter *N* (—·) is transmitted. Each quadrant slightly overlaps the neighboring quadrants and in the narrow wedge formed by the overlap the two signals are heard with equal intensity. The dots and dashes interlock in this narrow region to produce a continuous "on the beam" signal, or monotone. Thus, a pilot with a simple, inexpensive low-frequency receiver can easily navigate. He will hear

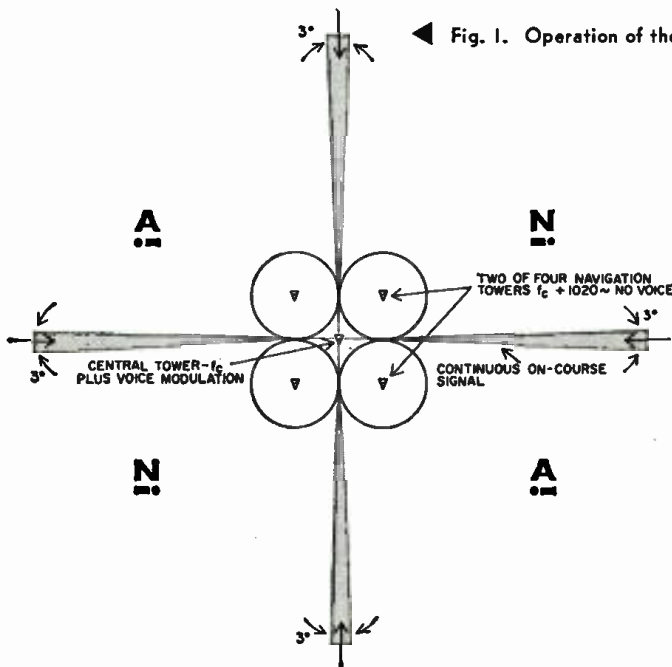
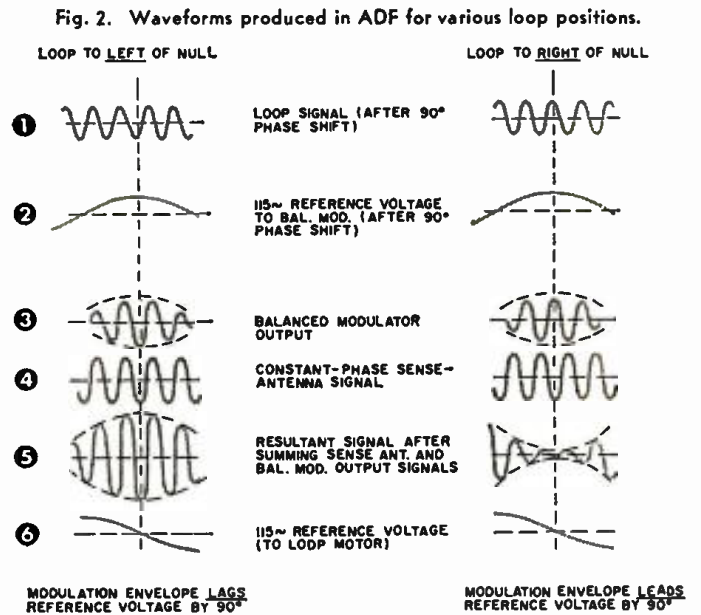

Fig. 1. Operation of the low-frequency radio-range station.



a continuous tone when he is on course, but if he drifts to either side of the beam he will hear either the *A* or *N* begin to predominate and must re-adjust his heading to stay on course.

The simplest radio-range station, shown in Fig. 1, consists of two pairs of vertical transmitting antennas about 130 feet high set at opposite corners of a square. The field radiation pattern of each of these pairs is a figure-eight, with the pattern of one pair displaced 90 degrees from the other. A transmitter is switched from one pair of antennas to the other to transmit the *A* on one pair and the *N* on the other. These signals are overlapped in time so that along the bisector of the two figure-eight patterns, where the intensity of the signal received from both pairs will be equal, the continuous "on the beam" signal is heard over a region with a width of about 3 degrees. The on-course legs of the beam need not be at right angles to each other. By appropriate tuning of the antennas, the beam may be directed at various angles in order to lie along civil airways. The signals transmitted by the four corner antennas are continuous and contain no modulation. Midway between the two pairs of towers just described is a fifth tower which transmits continuously a signal differing in frequency by 1020 cycles from the transmission of the corner antennas and radiating equally in all directions. It is the 1020-cycle beat between the center antenna and the four corner antennas which causes the code modulation which is heard in the receiver.

The central transmitter is voice-modulated for station identification and for transmission of weather and traffic control information. The federal radio-range installations shown in the photographs on the facing page are typical of the antenna installations that are employed.

The chief virtue of the low-frequency radio-range system is its simplicity since only a low-frequency receiver is required for navigation. However, there are many limitations, some of them serious. First, the low-frequency radio band is inherently noisy and highly susceptible to static. The static during a local thunderstorm may make it im-

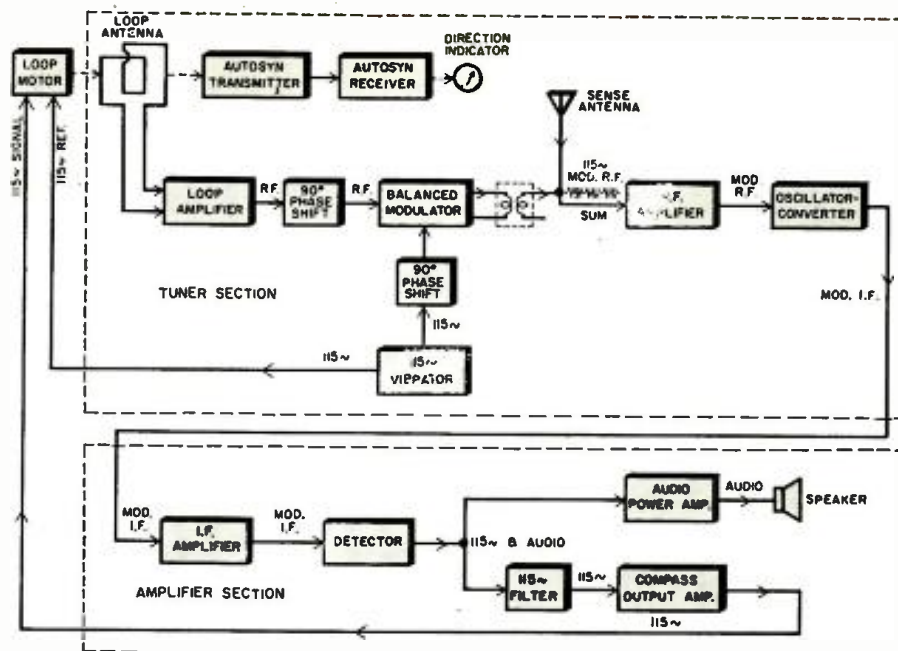

Fig. 3. Functional block diagram of a typical aircraft automatic direction finder.

possible for a pilot to aurally follow the on-course signal when he may need it most. Second, a pilot has no choice in direction of flight since he can only fly one of the four on-course radials from the station. Furthermore, all courses are ambiguous. That is, it is impossible to determine in which direction along an on-course radial a pilot is flying without special maneuvers. Third, and most important, low-frequency signals tend to bend under certain atmospheric conditions creating deadly "ghost" on-course signals. This is particularly true near mountain areas.

Radio Direction Finding

Several direction-finding schemes have been devised which allow a pilot to either "home" on a ground transmitting station or determine his azimuthal direction from the station. "RDF" (*Radio Direction Finding*) generally refers to all types of manual direction finders while "ADF" (*Automatic Direction Finding*) refers to direction finders which automatically determine the direction of the trans-

mitting station. Recently, the term "Radio Compass" has come to mean an automatic direction finder, and that is the term we will use.

Perhaps the greatest advantage of radio direction finding as a navigational aid is the fact that this system does not require a special ground transmitting station for its operation. Theoretically, any station on the ground can be used for RDF orientation. In practice, however, only standard AM broadcasting stations, the low-frequency range stations, and special low-frequency beacons are used in order to avoid the necessity of carrying a large number of receivers covering all frequency bands.

All RDF systems require a directional receiving antenna, a receiver, and a bearing indicator. Antenna systems used with RDF equipment vary radically in design. The latest and most sophisticated is *Lear's "Gonio Loop,"* a flat-wound ferrite core that is electronically, rather than mechanically, rotated. More familiar is the circular loop about one foot in diameter which is manually rotated. Such a loop has a

The ADF receiver unit described in the accompanying text.

Two-band i.f. unit. 200-415 kc. is for low-frequency ranges.



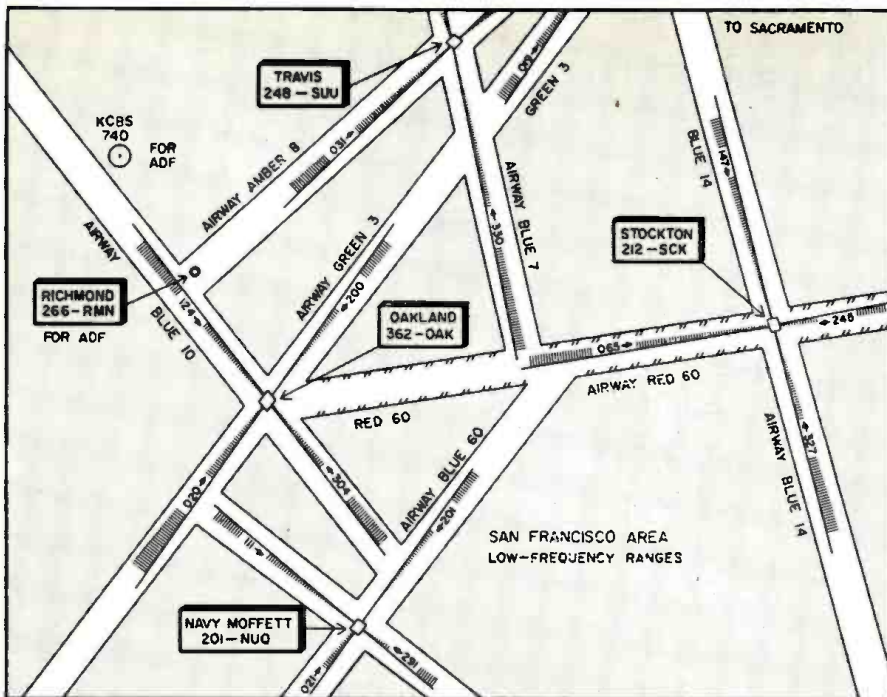

Fig. 4. Simplified navigational chart showing low-frequency radio aids.

figure-eight receiving pattern perpendicular to the plane of the loop. When the plane of the loop points at the transmitting station, signals are received with maximum volume. When the plane of the loop is at right angles to the direct line to the station, signals are received with minimum volume. This minimum volume point, or "aural null" is used by all direction finders for orientation rather than the aural maximum point since the null can be determined more accurately. Note that since the loop plane has two sides, there will be two aural nulls, one on each side of the loop. For this reason, the simple manual loop is ambiguous since it is impossible to determine whether the station lies in front or behind the plane of the loop. This makes it impossible for a pilot to home on a station without special orientation flying to determine whether he is flying towards or away from the station.

The mainstay of the single-engine lightplane flyer is a simple two-band receiver covering the low-frequency

radio range and standard broadcast bands and including a manually rotatable loop for RDF use. With such a receiver, the private flyer can inexpensively navigate through the use of the radio ranges and RDF, as well as maintain radio contact with ground traffic-control and weather stations. Most of this equipment is purchased by the small plane owner as used equipment since simple RDF equipment is no longer being manufactured.

ADF systems have almost universally replaced the simple manual loop RDF. ADF receivers are unambiguous, that is, they always point at the station and do so automatically. Unlike the manual loop, modern ADF loop antennas use a small horizontal ferrite core upon which symmetrical turns of wire are wound. Like manual loops, these ferrite loops also have a figure-eight receiving pattern and are inherently ambiguous. Unambiguous reception is due not to the antenna pattern, therefore, but rather to the method in which the loop is used in the ADF.

A typical ADF receiver, the Lear ADF-12E, is shown on page 31. In this ADF receiver the aural null property of the directional ferrite loop and its phase characteristics are used. As the loop crosses the null point from left of station to right of station, the output of the loop shifts 180 degrees in phase. This effect is utilized in the receiver to give "left of null, right of null" sense to the system. A second antenna is used in the ADF-12E receiver. This second antenna is a long-wire, non-directional "sense" antenna. Since it is non-directional, its phase is constant irrespective of the location of the transmitting station and is used to provide a fixed phase reference against which the loop's phase output can be compared in order to rotate the loop to a null. When the loop is left of true null its output leads the sense antenna output by 90 degrees, and when the loop is right of true null its output lags the sense output by 90 degrees.

Referring to Fig. 3, the amplified r.f. output voltage from the loop is first phase shifted by 90 degrees in the phase shifter. This 90-degree shift is introduced as a delay in phase. The result is that if the loop originally led the sense antenna by 90 degrees, it is now in-phase with the sense antenna as a result of being delayed in phase. Likewise, if the loop originally lagged the sense antenna by 90 degrees, it now lags the sense antenna by 180 degrees. These waveforms are shown at (1) in Fig. 2, which shows important waveforms in the ADF-12E receiver.

This phase-shifted loop signal is now applied to a balanced modulator where it is AM-modulated at 115 cycles which is produced by a synchronous vibrator from the aircraft's d.c. supply. Before application to the balanced modulator, the 115-cycle signal is first phase-shifted by 90 degrees, waveform (2) in Fig. 2. The balanced modulator simply AM modulates the loop signal carrier close to 100% at a 115-cycle rate. The balanced modulator output waveform is shown at (3) in Fig. 2.

After being modulated in the balanced modulator, the loop signal is now mixed with the constant-phase sense antenna signal. The net output pro-

(Continued on page 104)

Another typical ADF receiver unit.



Direction indicator employed with ADF. ▶

▼ Rotating ferrite-loop ADF antenna.

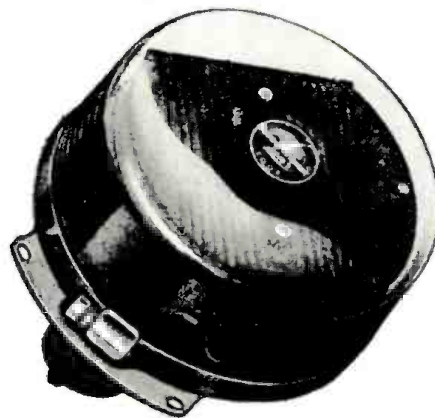

Fusing TV Tuners



By PAUL MITNAUL

A familiar repair headache in the front end can be avoided, making happier technicians and customers.

AS IS THE case with other parts of the TV receiver, tuner design has undergone quite a few changes since the early 30-tube sets began to find favor with the public. From the outset, the front end was a particularly tricky circuit for the service technician to work on, with replacement often following trouble instead of repair. What with progressive design changes over the years, many technicians have had difficulty keeping up with troubleshooting technique for the tuner, and still avoid repairs in this portion of the set as though it were a nest of rattlesnakes.

One way of avoiding trouble is to prevent it. Fortunately one of the most frequent troubles with one of the most popular tuner designs in use today can be avoided in a relatively simple way. The design in question is the cascode circuit, which uses a twin-triode r.f. amplifier like the 6BQ7, 6BS8, 6BZ7, or some similar type. The problem lies in the pattern of failure.

When a cascode front end acts up, the first suspicion is that the twin-triode needs replacement. This is generally true. Furthermore, the tube fault is likely to be an interelectrode short (or high leakage) since, to obtain high gain, elements in these tubes are quite close to each other. When shorting occurs, current through the tube is considerable, and any resistors or other components in series with the triodes can break down or change in value. In the tuner circuit of Fig. 1, for example, resistors R_8 and R_{11} , shown in broken-line circles, are in danger. Replacing them or other affected parts involves a touchy repair.

Preventing such difficulties can be achieved simply by fusing the tuner. Generally neglected by the set manufacturer, this precautionary feature can be added easily by the technician without the need to get inside the front end itself. A cartridge fuse in series with the "B+" line for the entire tuner

will generally do the job. Then, when a tube shorts, it is only necessary to replace the tube and the inexpensive fuse. Further checking for component damage—or the risk of a callback—is virtually eliminated. This removes much strain from the consumer-technician-manufacturer relationship, especially if the set was involved in such difficulty in the recent past.

Choosing the right fuse is relatively simple. To demonstrate, an RCA cascode tuner (type KRK 22-R) will be used. In addition to the 6BQ7 r.f. tube (Fig. 1), it uses a 6X8 as oscillator-mixer. The tube manual indicates that the 6X8 is likely to draw about 19 ma. for both sections; and the 6BQ7, with both plates in series, draws about 10 ma. Thus the entire tuner takes about 29 ma. from "B+." However, actual tuner current was metered. It varied from a low of 18 ma. when a strong signal was tuned in to a high of 28 ma. with no signal input. Accordingly a 250-volt fuse rated at $\frac{1}{32}$ ampere (about 31 ma.) was chosen.

Although this seemed to allow little margin, remember that any fuse can carry an overload of about 10 per-cent indefinitely. A slow-blow type will stand up against short-term excesses.

With the particular RCA tuner, it was simple to solder the fuse holder directly to terminal No. 4 ("B+" at the rear of the tuner, as shown in Fig. 2). A similar arrangement is possible in most cases. Where it is not convenient, the "B+" lead for the tuner only can be opened anywhere along its length to accommodate the addition.

To make certain of the right fuse value, total tuner current should always be monitored during greatest drain (off channel) although a tube-manual check is helpful. If it seems that the $\frac{1}{32}$ -amp. unit is too small, a $\frac{1}{16}$ -amp. fuse (about 62 ma.) may permit the power rating of endangered resistors to be exceeded. This can be checked. If necessary, separate fusing

of "B+" to the twin-triode might be considered. As a rule, such measures are not needed.

It has been easy to sell this addition, at a small added charge, whenever repair work is being done on a set that could benefit from it. This has been the author's practice for quite some time, and everyone is satisfied with the results.

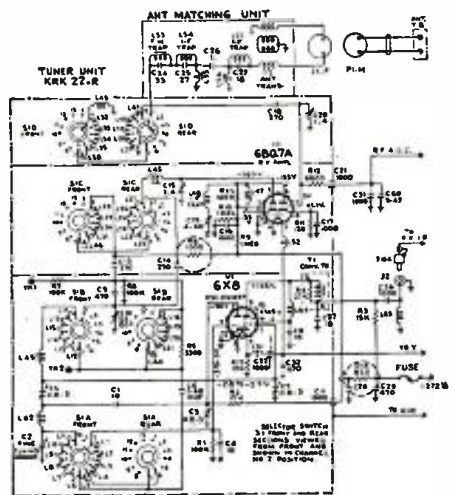
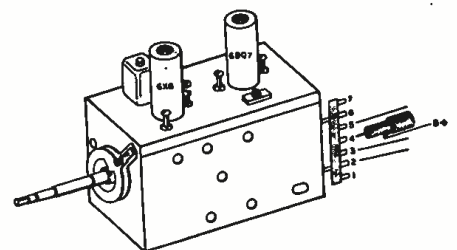
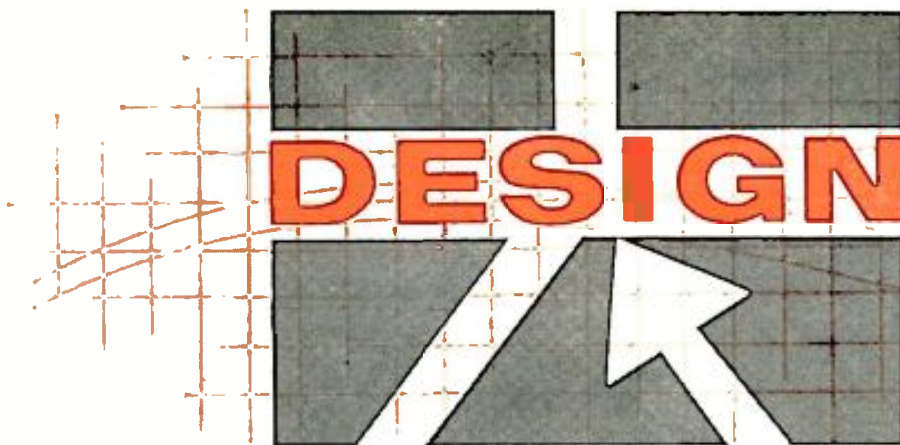

Fig. 1. This cascode circuit shows components (circled) that are likely to burn up when the r.f. tube shorts.

Fig. 2. Where the fuse and fuse holder can be added to a typical RCA cascode front end. Similar placement can be worked out with most other tuners.





of a Transistorized Phono Preamp

By H. F. STARKE / Applications Engineering, Raytheon Co.

Practical design hints along with useful circuits for both magnetic and ceramic high-fidelity phonograph pickups.

THIS article deals with the design and construction of several practical transistorized preamps for phono pickups. Such preamps would be useful under one of the following conditions:

(1) The user already has a complete system, containing whatever compensation seems appropriate for the pickup in use, and would like to interpose a preamp mainly for the purpose of improving the signal-to-noise ratio. Because of the more favorable source impedance, this is usually more readily accomplished with the inductive type of pickup than with the ceramic. The general requirements for this preamplifier are: low distortion, best signal-to-noise ratio, and relatively low gain.

(2) The user has a flat power amplifier of acceptable performance and wishes to build a transistor preamp incorporating RIAA equalization to be used with an inductive pickup. He requires only that the gain be substantially equal to that of its vacuum-tube counterpart and that its signal-to-noise ratio be considerably better.

(3) In this case, the equipment on hand includes a ceramic pickup loaded with the resistance value recommended by the manufacturer. The user has purchased a test record and taken a frequency response curve. He is not overjoyed with the results and wonders why some improvement could not be effected through the use of a preamp having somewhat better equalization.

Pickup Characteristics

The majority of modern phonograph pickups fall into two general classifications with important differences as to impedance and response characteristics. The inductive device is character-

ized by a voltage in series with an inductance plus a small amount of resistance. Whether the core is moved, its reluctance varied, or the coil moved, the response is, in general, the same and all may be referred to as "magnetic."

Like its predecessor, the crystal pickup, the ceramic element is a capacitive device and since its capacitance is fairly low it must be regarded as a high-impedance source. Although the older crystal element usually showed a capacitance not too far from 500 $\mu\text{f.}$, its modern equivalent often has considerably less than this. Information as to the value for some specific unit is frequently unavailable and the user must either measure it himself or rely upon the manufacturer's statement as to the best "matching" resistor.

Since the voltage available from the magnetic unit depends on the rate of flux cutting, the device is said to be responsive to *velocity* which, of course, rises with frequency with the usual 6 db-per-octave slope. The capacitive unit, on the other hand, depends on the piezo-electric properties of its element, which is insensitive to rate and responds only to pressure. Because the latter varies directly with the amplitude of the motion of the stylus, the capacitive pickup is described as *amplitude* responsive.

The difference between these response types must be considered in relation to the industry recording and playback characteristics. The standard (AES, RIAA, and NAB) is expressed in terms of the correct system frequency response when using an inductive pickup. This is shown as "A" in Fig. 1, using the asymptotes for clarity and

simplicity; the smooth cornerless curve is readily synthesized by using a point 3 db from the crossover and points 1 db from the asymptote at one-half and twice the crossover frequency.

Curve "B" of Fig. 1 is complementary to "A" and is the velocity response of the recording characteristic. In other words, it is the relative response of an inductive pickup working into a resistive load having a value considerably higher than the reactance of the pickup at any frequency of interest. Curve "C" (Fig. 1) is derived from "B" and is the amplitude response of the recording characteristic. Again, it should be noted that this is an open-circuit voltage obtained only by operating into a load resistor of considerably higher value than the reactance of the element at any frequency in the band. All curves have a common reference level of 0 db at 1 kc. and "D" in Fig. 1 has been drawn through this point with a slope of 20 db per logarithmic cycle. The latter represents the open-circuit output of an inductive element from a hypothetical recording of constant level without reference to the pre-emphasis and de-emphasis recording standards adopted by the industry.

Since "D" also represents the output developed by a capacitive element across a load approaching a short circuit (from the same constant level recording), it follows that if "D" is added to "C" the result is "B" again. In brief, if a ceramic cartridge is operated into a resistor giving a crossover of 60 kc. or higher, the ceramic is said to have "velocity response" and to require the same equalization as an inductive cartridge. This technique, while of somewhat questionable value for a

vacuum-tube system, becomes quite useful in relation to the design of a transistorized preamp for the ceramic cartridge.

In the standard, the crossovers are defined in terms of the time constants of equivalent RC networks: 3180, 318, and 75 microseconds. The latter works out to 2120 cycles but since most designers prefer to simplify this value to 2 kc. (an even two octaves from the next crossover at 500 cycles), one wonders why the corresponding time constant was not made 80 microseconds in the first place. It is somewhat inconsistent to split hairs between 2120 and 2000 cycles in one sentence and allow a ± 2 db tolerance in another.

Flat Amplifier for Magnetics

The amplifier shown in Fig. 2 is flat ± 0.2 db from 30 to 20,000 cps. Gain is 26 db and at 2 volts output the total distortion is less than 1%. If both emitter bypasses are reduced to 20 μ f., response is down 1.1 db at 30 cps and if the smaller bypass (0.004 μ f.) is omitted at the second stage emitter, response is down 1.5 db at 20,000 cps.

Since this unit is intended to operate from an inductive source with equalization at other points in the system, its input impedance should be considerably higher than the source reactance at

For various practical reasons, it may be decided to incorporate the necessary equalization in the preamp itself. With respect to the treble roll-off with crossover at 2000 cps (Fig. 1A), the designer must choose between the following two approaches: (1) The input impedance (resistive) may be adjusted to equal the reactance of the cartridge at 2000 cps or (2) the input impedance may be made relatively high with treble roll-off being obtained from a simple parallel network elsewhere in the amplifier.

The first of these requires considerable stabilization because the desired impedance will change quite rapidly with changes in operating current. Furthermore, if the cartridge should be replaced by another unit having a different value of inductance, it may be necessary to make extensive re-adjustments of the first-stage operating point.

The amplifier shown in Fig. 3 is, accordingly, based on the second approach. The input impedance of this amplifier is considerably higher than the 20,000-cps reactance of any magnetic pickup commonly available and the treble roll-off is obtained by an RC network in the collector circuit of the first stage, as previously noted. The double arrows indicate the break points for the purpose of building the first stage into the tone arm and, if this is

crossover relatively undisturbed for volume changes. Devices for obtaining low boost (500 cps) and bass flattening (50 cycles) appear in the third stage.

Gain is 30 to 35 db and with a 22-volt supply distortion is very low for inputs up to 100 millivolts. Response should be within one-half db of the RIAA curve from 30 to 15,000 cps. If it should be found to require trimming, the following procedure is recommended: (1) Remove the .0018- μ f. collector bypass in the first stage, (2) increase the inter-stage capacitor value from .25 μ f. to 10 μ f., and (3) disconnect the series RC feedback circuit in the third stage.

The amplifier should now be reasonably flat over the entire range and the three crossovers with the required slopes are readily investigated one at a time. In place of the pickup, a small transformer may be used with metered and attenuated secondary voltage. If the 20,000-cps response is down more than 1 db (before applying the 6 db-per-octave treble cut) it may be lifted with a small bypass (2200 μ f.) across the second stage series feedback resistor (2700 ohms).

For the benefit of those who aren't happy unless the curve is within ± 0.2 db of the standards over the entire range, it may be noted that the AES-RIAA-NAB standard specifies: "Tolerance—The maximum deviation of the system from this characteristic shall not exceed plus or minus 2 db."

Since the source impedances here are of levels resulting in the lowest available noise figures, the signal-to-noise ratio (for thermal noise only) is 5 to 10 db better than a vacuum tube operated at a point resulting in an equivalent noise input resistance of 3000 ohms. In addition: (1) the transistor has a better spectral characteristic than the tube in the important region below 1000 cps where the amplifier gain rises; (2) the transistor is non-microphonic; and (3) in the event that hum is picked up at the input circuit, it is more readily phased out with transistors, later in the system, than with tubes.

The last named point has nothing to do with the pickup; the reduction of hum in this element is the problem of the manufacturer. We are referring

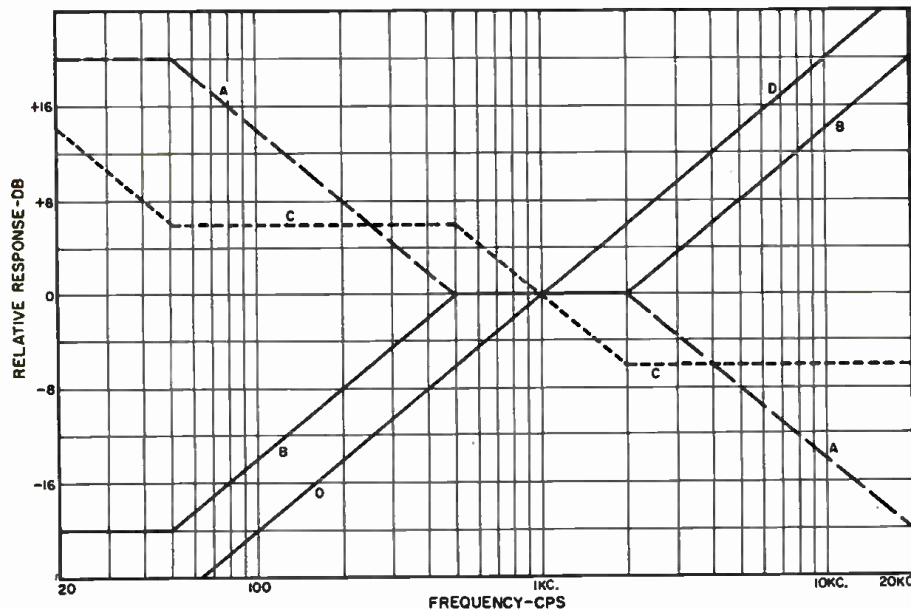

Fig. 1. (A) Standard playback curve using the asymptotes for clarity and simplicity rather than the smooth cornerless curve usually shown. (B) Velocity response of the recording characteristic and complement to curve "A". (C) Amplitude response of the recording characteristic. (D) 20 db per logarithmic cycle response curve.

20,000 cps. If the transistors have current gains of 100 or more, this condition is met for cartridges up to 500 mhy. The trend in recent years has been in the direction of lower inductance in magnetic units.

Transistor noise will be less of a problem than hum pickup at the cartridge. If the use of a magnetically shielded pickup having rather low output is contemplated, it may be worthwhile to use a low-noise type transistor (2N422) in the first stage.

done, it should be noted that the capacitance of the output cable parallels the .0018 μ f. for roll-off. (The exact value here will depend somewhat on transistor characteristics because the resistive component of the network is paralleled by the output impedance of the transistor, although the effect of the latter is considerably reduced by the series feedback in the emitter.) The network between the first and second stages is designed to keep d.c. out of the volume control and to leave the treble

Fig. 2. Flat preamp for magnetic pickup.

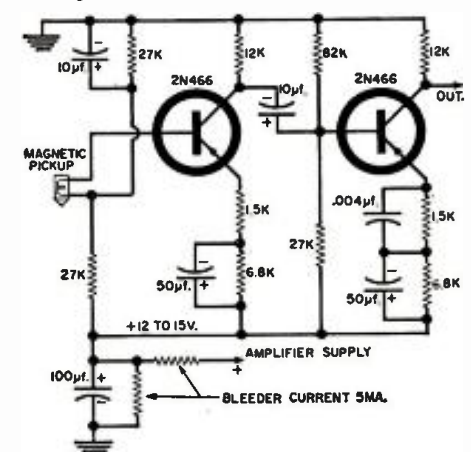

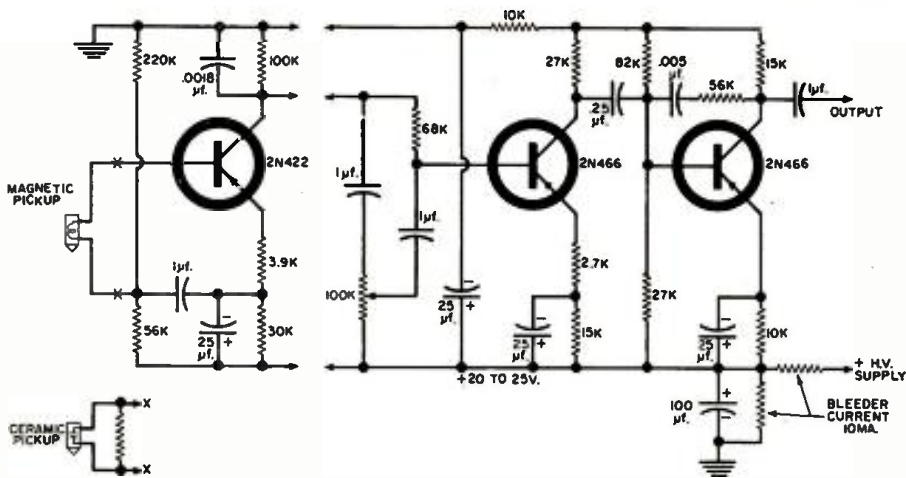

Fig. 3. Equalized preamp for magnetic and ceramic cartridges. Treble equalization is accomplished in first stage, while bass equalization is accomplished in the third stage. The second stage may be considered to be the volume-control stage of preamp.

more particularly to the fact that the transistor input stage has but one hum-sensitive element, the input base, while the tube has several hum-producing mechanisms including: (1) stray emission from heater to cathode; (2) stray emission from cathode to heater; (3) thermally sensitive emission from the cathode extremities; (4) heater-cathode leakage; and (5) direct field effect.

As a consequence, the hum picked up by the transistor base has but one phase, with principal components at the fundamental line frequency and its third harmonic, while the hum appearing in the vacuum-tube plate circuit is of pseudo-polyphase waveform and it is usually impracticable to buck out more than one component. Furthermore, the relative strength of the various components can change considerably with line voltage changes.

Equalized Preamps for Ceramics

Published material on ceramic units usually includes a column giving the load resistor for best match. This appears to be based on the supposition that the amplifier has a bass boost control to supplement the choice of load giving a 2000 cps crossover. If such a control is not available, the over-all response is shown in Fig. 4 which is the result of applying the amplitude response curve of Fig. 1C to an equivalent RC network with crossovers as indicated. However, response will be quite flat if the bass control is available and, as is often the case, has a crossover at 500 cps.

The foregoing technique is more suitable for vacuum tubes than for transistors. Even if the capacitance of the element is as high as 1000 μf., the transistor input must be 80,000 ohms which is not a particularly favorable value as far as the noise figure is concerned; in general, pickup capacitances are considerably less than this.

In the case of the transistorized preamp for the ceramic unit, the signal-to-noise ratio will be better with the velocity response arrangement with a high crossover because the noise factor of the transistor increases appreciably

for generator impedance much in excess of 5 or 10 kilohms. With this method of operation, the signal-to-noise ratio of a transistorized preamp will be poorer than the tube version by approximately the noise factor of the transistor at the predetermined generator impedance and operating point. If this sounds alarming, we hasten to add that this does not take into account these additional factors: (1) the transistor has a considerable advantage in relation to the hum problem; (2) the transistor is non-microphonic; and (3) the noise power spectrum of a low-noise transistor is superior to that of the average vacuum tube in the important range below 1000 cps. At the higher gains required by RIAA equalization at these frequencies, this factor tends to reduce the difference in signal-to-noise ratio due to the transistor noise figure.

Returning to Fig. 3, it will be noted that the alternative connection shows the loading resistor at the element so that the input impedance of the transistor may be made high enough to also accommodate an inductive unit having an inductance of 0.5 hy. or more. As noted previously, the resistor should not be more than 10,000 ohms even though this will place the crossover for a 200 μf. element at 80,000 cps. The operating current of the input

stage has been selected to give a low-noise figure and it may be noted, at this point, that this current is considerably lower than the 1 ma. value commonly found on data sheets for general-purpose a.f. types since the latter represents a more or less standard test condition rather than the best point for low-noise operation.

Ceramic vs Magnetic

A comparison of the two basic systems as to performance and mechanical parameters is obviously out of place here. Unfortunately, the recent design trend, particularly with the advent of stereo, has been in the direction of poorer signal-to-noise ratios although such degradation is more rapid for the capacitive than for the inductive element. This is true whether the input system uses vacuum tubes or transistors and if the use of a capacitive element is contemplated, the electrical parameters of the device should not be overlooked.

As described in the comments on pickup characteristics, the amplitude response of the capacitive element may be converted to the equivalent of a velocity responsive system by loading it with a resistor giving a crossover of 60,000 cps or higher. This technique is quite advantageous when applied to transistor inputs but before such a system is described it will be informative to see how it affects the signal-to-noise ratio in a typical design using tubes.

Let us assume that the cartridge has a capacitance of 500 μf. and an open-circuit output of 500 mv. at 1000 cps. One method of operation is to choose a grid leak of such a value that the input is down 3 db at 50 cycles so that bass flattening is not required elsewhere in the amplifier. In this event, the combination of a 6-megohm leak and the necessity for increasing the amplifier gain by some 12 db from 2000 cps to the top of the band results in a signal-to-noise ratio somewhat poorer than the method described earlier involving placing the input crossover at 2000 cps and raising gain from 500 cps down.

For the 160,000-ohm leak which would be required in the latter type of operation, the resistor noise is 7.15 μv.

(Continued on page 118)

Fig. 4. Response obtained when the curve of Fig. 1C (amplitude response of the recording system) is applied to RC networks having crossover frequencies shown.

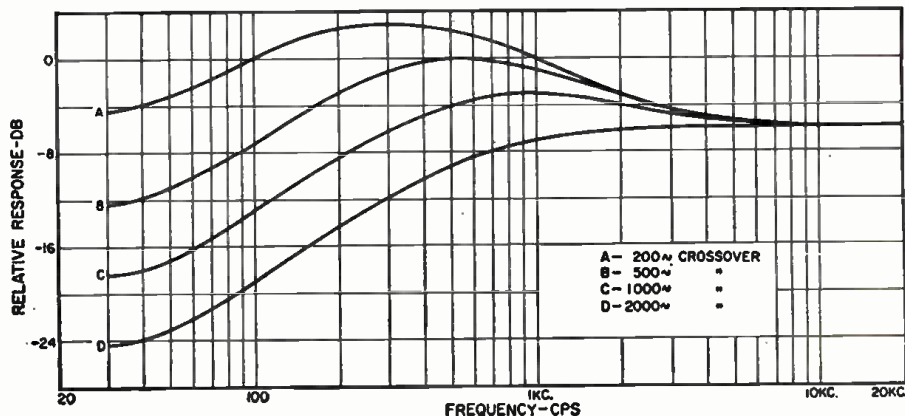

EDITOR'S NOTE: It is often said that, for two-way communications, systematic maintenance programs are superior to hit-or-miss service procedures in which the technician goes into action only after trouble crops up. We are seldom told why this is so. The author, affiliated with a good-sized organization that specializes in this field, gives his reasons. He can cite figures and give examples to show that both the equipment user and the servicing agency benefit in many ways.

INDUSTRIAL maintenance programs have been in use for hundreds of years. Even the early users of Watts' steam engine learned that a policy of "wait until it quits" resulted in higher over-all costs and reduced the dependability and ultimate life of the engine. Probably the best examples of modern day maintenance programs are those of large auto and truck fleet operators. They have learned through experience that operating costs are reduced and equipment utilization is improved by proper over-all servicing procedures.

The same is true of other equipment used in industry, whether they be turbines, bulldozers, or drill presses. Be-

unit may be performing, it has no value until it becomes an integral part of a communications system which includes other vehicles and stations. Thus, radio maintenance must be treated on a *system* basis rather than on the basis of individual repair jobs.

Therefore, instead of a "fix it when it quits" service policy, most firms with important industrial operations select a comprehensive maintenance program which includes system engineering, radio procedures, interference reduction, and necessary FCC measurements.

The program can be provided either by the user's own radio department or by contracting with companies versed in radio-system maintenance. Unless the user has a large number of mobile units concentrated in one area, it is usually more economical to contract for the service. One company maintenance man trying to cover a wide-spread system loses so much time in travel that his effectiveness is reduced while costs begin to increase sharply.

Under flat-rate contracts, several hundred two-way radio users, representing a total of approximately 1000 base stations and 5000 mobile units. Although our services are not billed on a "per call" basis, we do prepare separate job tickets which are transferred to IBM punch cards. These are sorted and computed to provide us with cost accounting breakdown by area, customer, technician, and equipment.

A recent analysis, covering some 15,000 service jobs on mobile units, showed that only 70% of our service costs involved repair to the equipment. The remaining 30% included such non-repair items as engineering problems, noise and interference, FCC measurements, and preventive-maintenance inspections. The complete breakdown of our findings with respect to mobile-unit maintenance costs is as follows:

Non-repair items	30%
Tube replacement	30%
Component replacement	8%
Vibrator replacement	7%

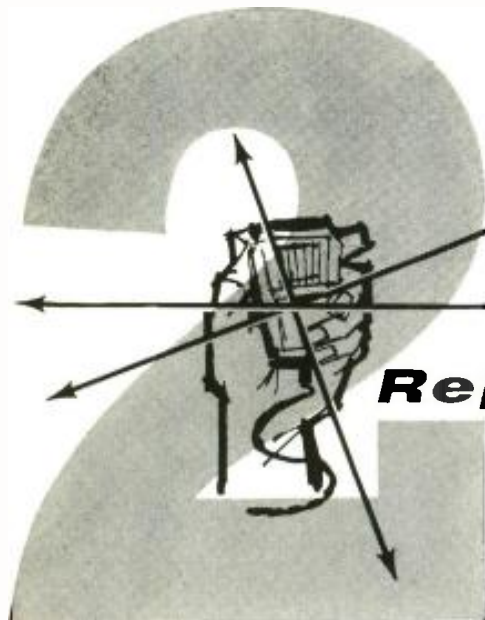

-Way Mobile

Repair vs. Maintenance

By **JERRY S. STOVER**
Communications Engineering Co.

A successful specialist in this field not only picks the better program, but offers evidence.

cause two-way radio is used in the minute-to-minute direction of expensive personnel and equipment, it is one "tool" where the utmost in reliability and performance must be achieved.

Once an organization becomes geared to the use of radio, the failure to receive an important message quickly and accurately can have a more detrimental effect than if the radio had never been installed. The value of radio lies in its ability to handle messages speedily and accurately. When it begins to perform poorly, with reduced coverage, reduced clarity, or reduced reliability, this value drops rapidly. Therefore, the selection of a maintenance program warrants careful study.

Two-way radio maintenance differs from the usual mechanical maintenance in one very significant respect. A car or truck can be repaired and sent out to do a productive job independent of other vehicles in the fleet. This is not true of a mobile radio unit. No matter how well the individual radio

In the past it has been the practice of some companies to justify the cost of a radio man on the payroll by assigning additional duties, such as dispatching or instrument repair. Where the radio system is limited, this arrangement may work satisfactorily but, if many radios are involved, duty conflicts arise which compromise efficiency of several operations. More important, this can cause the radio man to lose sight of his primary mission—maintenance of communication—and he becomes only a "repair man," with consequent decrease in system efficiency. Also, administrative costs involving training, travel expense, vacation and sick relief, test equipment, and spare parts tend to increase the cost of self-maintenance.

Because the *maintenance* of communication involves so much more than mere *repair*, it can best be performed under a flat-rate contract when using outside agencies.

The company the author represents

Fuse replacement	5%
Re-tuning	5%
All others	15%
	<hr/>
	100%

It is service performed in the non-repair category that insures that a system maintained under a flat-rate service policy will perform better and more reliably than a system using a repair-only type of service. Comparison of the two types of service cannot be based on assumptions, but must be borne out by broad-based analysis of cost and quality of service.

We recently completed a frequency change involving nearly 3000 mobiles and 200 base stations. This entailed a check of all the equipment and necessary maintenance to bring it up to full factory specifications. The labor and materials required (over and above the change-over materials) are a good indication as to the general condition of the equipment prior to change-over.

(Continued on page 88)

TAPE'S PROGRESS

By HERMAN BURSTEIN

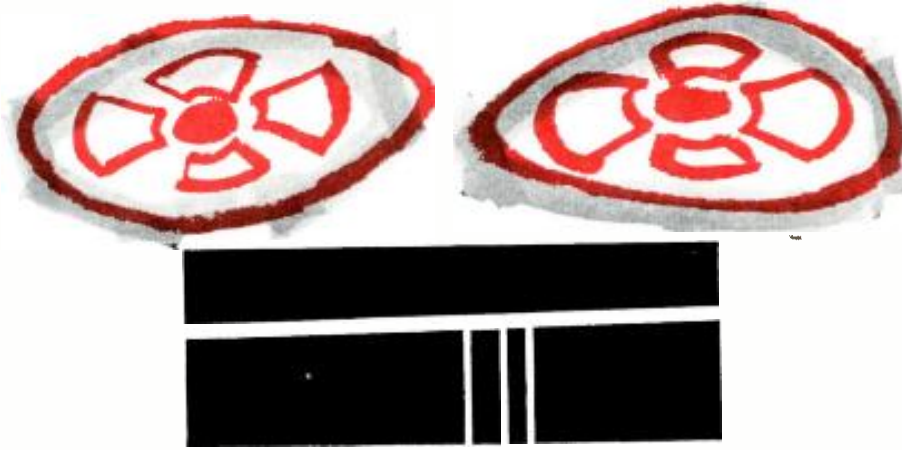

There is much activity in the hi-fi tape field today. Here is a summary of where tape stands now and where it's going.

IN 1958 and 1959 tape was the sick man of the high-fidelity industry. The single-groove stereo disc had made a dramatic entrance and usurped attention to the virtual exclusion of tape. Besides, stereo tape was a good deal more expensive than the stereo disc, and the technology of reproduction *via* tape was undergoing several changes at once. Thus a good deal was to be resolved before many persons would be willing to invest in tape machines and pre-recorded tape for high-fidelity purposes.

Today, in contrast, tape is probably the liveliest topic in audio. It is not that the stereo disc has lost ground, but that tape is emerging from the shadow of the former. Questions as to tape speed, equalization, type of head, number of recorded tracks, role of the tape cartridge, etc. have either been resolved or appear well on the way to settlement. In addition, various mechanical features that make the tape machine simpler and more convenient to use have become commonplace. Hence it appears that tape is destined for a resurgence that will lift it to a position far more prominent than heretofore.

Tape Speed

Less than five years ago it wouldn't have been at all difficult to find someone who would argue that high fidelity was impossible at a tape speed of 7½ ips. That was the era when professional studios still operated at 30 ips, and 15 ips was considered the minimum speed for high fidelity—more so for the home than the studio. Even within the past two years questions have been raised whether the best commercial

pre-recorded tapes at 7½ ips were as good as their best disc counterparts.

Improvements in tapes, transports, tape amplifiers, heads, and techniques have made it clear that high fidelity is attainable at lower speeds than before. Almost all professionals have standardized on 15 ips, and 7½ ips is conceded to be entirely adequate for home use. This means that at 7½ ips one can have not only treble response virtually flat to 15 kc., *but also low distortion and a high signal-to-noise ratio.* (Too many make the mistake of thinking that extended treble response is the only or chief criterion whether a given tape speed is adequate.)

The once scoffed-at speed of 3¾ ips has risen in esteem. Response to 15,000 cps is now feasible at this speed, rivalling 7½ ips in this respect although noise and distortion are not as low as at 7½ ips. Over-all, 3¾ ips can provide "good fidelity," consistent with the quality of many moderate-price audio systems and satisfying the requirements of the many listeners who do not demand the ultimate in sound reproduction.

A Status Report

A serious role has developed for the 1½-ips speed. It is proving suitable not only for speech but also for music where "relaxed" standards of reproduction apply, for example, background music or dance music for a party, where the circumstances of ambient noise and listener preoccupation with other matters do not warrant high-fidelity reproduction.

In sum, it appears that in home use 7½ ips is the speed for true high fidelity; 3¾ ips for good fidelity; and 1½ ips for utilitarian purposes.

The slower speeds, coupled with other developments that have taken place in the past few years, offer fascinating possibilities in the economy of recording, that is, in the amount of program material that can be put on a single 7-inch reel of tape. At 3¾ ips, using double-play tape (2400 feet on a 7-inch reel) and 4-track mono recording, 8 hours and 32 minutes can be recorded on one reel. At 1½ ips, the total time goes up to 17 hours and 4 minutes; one can record for 4 hours and 16 minutes before the reels need be reversed.

Cost of Pre-recorded Tape

Until quite recently pre-recorded stereo tape generally cost at least twice as much and often three times as much as the same material on a stereo disc. The relatively smaller scale of pre-recorded tape production accounted for only part of this differential. Also a key factor was the cost of the tape itself, compared with the few cents worth of vinylite that goes into a disc. Moreover, stereo tape was recorded at 7½ ips and was of the 2-track variety,

meaning that the tape was recorded only in one direction; hence, in relative terms, a good deal of tape was needed.

With the advent of 4-track stereo recording—utilizing the tape in both directions—and with the achievement of good results at 3¾ ips, the amount of tape required has been cut by 75%, substantially reducing the cost of pre-recorded tape. In addition, techniques of tape duplication have improved, with resultant economies. Altogether, it is now economic to offer pre-recorded stereo tape—4-track, 3¾ ips—at nearly the same price as stereo discs. Even at 7½ ips, the difference between tape and disc has been brought down to the range of a dollar or two in many or most instances.

Head & Track Arrangements

In the days of mono reproduction, things were quite settled for a long time as far as track arrangements for home recording were concerned. Half-track recording was the accepted method. As shown in Fig. 1, about 40% of the width of the standard ¼-inch tape was recorded in one direction and, after reel reversal, 40% in the other direction, with a safety island between tracks to prevent crosstalk.

When stereo came along, essentially

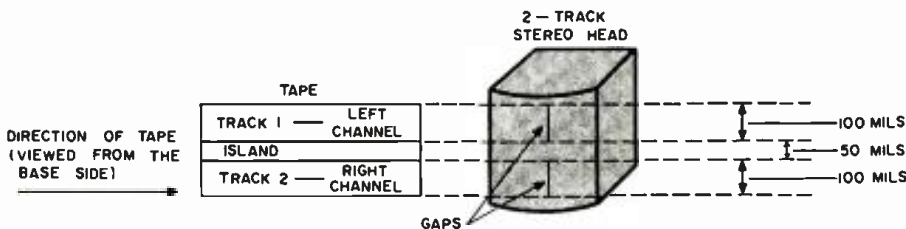
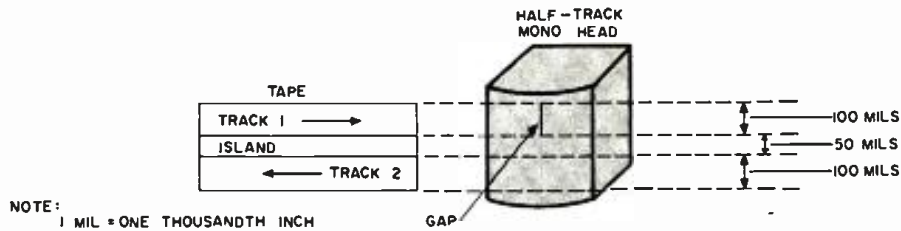

Fig. 2. With a two-track (half-track) stereo tape, this is the arrangement.

the same track arrangement was used, except that one track was for the left channel and the other for the right channel. Initially, staggered heads were employed, namely two conventional mono heads, spaced about 1¼" apart, with the gap of one spanning the upper track and the gap of the other spanning the lower track.

This state of things did not continue very long. Changes came left and right (pun intended). The in-line head, consisting of two heads in the same housing, one above the other and with co-linear gaps, displaced the staggered head arrangement, although not without difficulty. Fig. 2 represents the in-line head. Staggered heads had the advantages of lower cost because of the technical difficulties of manufacturing in-line heads, no crosstalk between head sections, and no problem of getting both gaps in exact azimuth alignment. On the other hand, they were space-consuming. Eventually the problems associated with the in-line head were resolved and the staggered head arrangement became obsolete. So did the tapes that had been recorded with staggered heads.

Advent of the stereo disc put into sharp focus a serious problem of stereo tape: it was recorded only in one direction. This was a problem not merely of



NOTE: 1 MIL = ONE THOUSANDTH INCH
Fig. 1. Tape head and tape-track arrangement employed for half-track mono.

tape cost, but also of convenience. It was necessary to rewind the tape before putting it away, instead of being able to play it back in the opposite direction (after reversing the reels of course) as with mono half-track recordings.

Four-track tapes and heads, illustrated in Fig. 3, solved the problem. Tracks 1 and 3 are used in one direction, and tracks 2 and 4 in the other. Today, virtually every tape machine made for home use permits playing 4-track as well as 2-track stereo tapes. As far as pre-recorded tapes are concerned, the trend is strong toward 4-track recordings, with the 2-track version becoming obsolete. In light of previous comments on tape speed, the combination for high fidelity appears to be 4-track recordings at 7½ ips.

Compared with 2-track stereo tape,

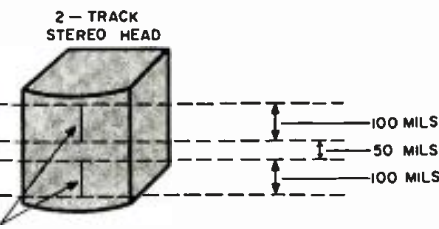

Fig. 3. Four-track (quarter-track) stereo tape utilizes this arrangement.

4-track tape has a basic disadvantage because the narrower track produces a lower signal-to-noise ratio in playback. But 4-track tape also has two distinct advantages (1) azimuth alignment becomes less critical as the track width decreases. (2) the wider spacing between the sections of a 4-track head—compare Figs. 2 and 3—results in less crosstalk.

Most home machines use the same head for recording as well as playback. Therefore such machines permit 4-track stereo recording. But the situation is less clear in machines that use separate heads for recording and playback. While they all permit 4-track playback, some of them employ 2-track record heads. Others, however, employ 4-track record heads. On the whole, it appears that eventually all home machines will provide for 4-track recording as well as 4-track playback.

The introduction of 4-track heads has brought with it a very interesting development, namely 4-track mono recording. Referring to Fig. 3, the recording sequence is tracks 1, 4, 3, and 2. Through proper switching facilities, including the shut-off of bias-erase current to the record and erase heads on one channel, many or most home machines enable the operator to record and play back twice in one direction and twice in the other, thereby doubling the playing time of a reel of tape. Since the extra switching is relatively simple and inexpensive, it can be expected that eventually all home machines will permit 4-track mono operation.

Cartridge vs Open Reel

It has long been the goal of a section of the tape industry to make it as simple to play a pre-recorded tape as a phonograph disc. Toward this end, certain convenience features have become commonplace, such as in-line loading (merely dropping the tape through a slot instead of laboriously threading it among various guides), footage counters (to facilitate location of a desired section of the tape), and automatic stop mechanisms that operate when the tape breaks and/or runs out.

However, the tape cartridge offers the most effective way of putting tape on a par with discs for simplicity of operation. One merely places the cartridge in position, pushes a button, and the tape machine takes over. The operator does not even have to touch the tape itself.

For quite a while, development of a mechanically satisfactory tape cartridge and cartridge player appeared problematical. But mechanical success is now assured. Equally important, it appears that the cost of a cartridge player, originally rather forbidding, can be pared down to an attractive figure. Moreover, there has recently been an announcement that a cartridge changer (analogous to a record changer) is in the process of development using ½-inch tape operating at a speed of 1⅞ ips. Engineering samples of these units have been heard and their performance is quite good. As regular models are not

(Continued on page 102)

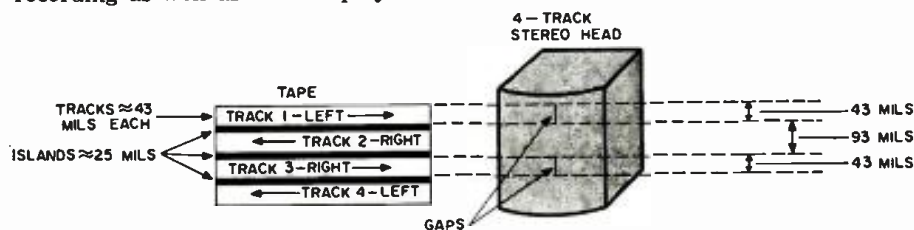
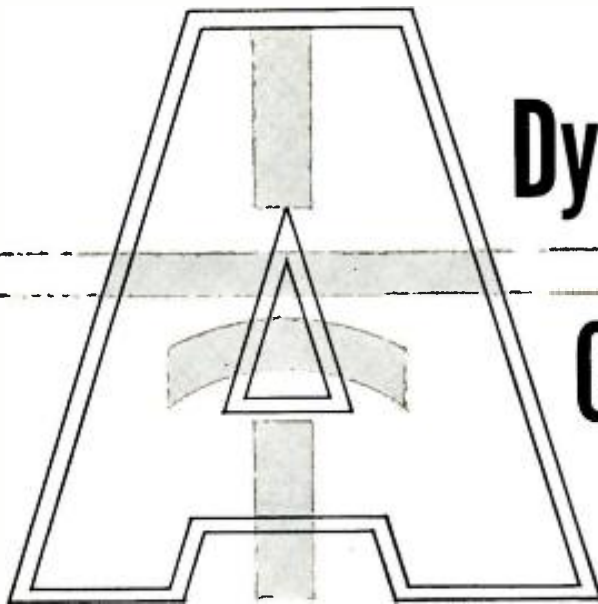

Fig. 3. Four-track (quarter-track) stereo tape utilizes this arrangement.



Dynamic

Capacitor Checker

By B. E. WRIGLEY

Multiple unit checks value and leakage; indicates open or shorted capacitors.

CAPACITOR checkers vary from expensive instruments with laboratory precision to the simplest of neon indicators. The average service technician or experimenter needs a unit somewhere between. The one to be described offers an accuracy of measurement and positiveness of test well within the needs of most out-of-laboratory workers.

This unit (Fig. 1) performs three basic functions: It will measure capacitance; it will measure (where leakage is a factor) the amount of leakage current under working conditions; and it will give positive indication of shorted and open capacitors. Despite its versatility, it is not an expensive instrument to build. Priced new, with careful shopping, all components would total less than \$20.00. It actually cost the writer only \$3.75 in new parts—the rest came from the junk box.

Circuit Analysis

The circuit is functionally divided

into two portions, although the "Meter and Function" switch (S_1) in Fig. 2 is common to both. The first section, a Wheatstone bridge adapted to capacitor measurement, follows the plan shown in Fig. 3. It covers measurement of capacitance by meter null from 10 $\mu\text{f.}$ to 1000 $\mu\text{f.}$ An internal source of a.c. taken from the 5-volt winding of the power transformer operates the bridge. Each side of the bridge becomes a voltage divider when an a.c. voltage is applied as indicated. There will then be a point on potentiometer R_2 which will match, in opposing phase, the voltage at the junction of one arm of the capacitive divider against the voltage of the other. This is the null point, which can be calibrated on the pot dial with various values of known capacitors used in the position normally taken by the unknown unit. Thereafter, of course, the pot dial is simply rotated to the point at which the meter nulls and a reading is taken of the unknown.

S_2 (see Fig. 2) provides the means for introducing an external a.c. source, such as the output of an audio generator, through J_1 and J_2 . The external signal is to be preferred with low-value capacitors, which present a high impedance to the 60-cycle signal of the internal voltage, passing very little current. This results in a smaller meter deflection and more difficulty in reading the null point. Use of varying high-frequency audio signals (say 10 to 50 kc.) results in greater meter deflection in the low-capacitance range and, in addition, offers an approximate check of a capacitor's frequency sensitivity.

Measurement of most electrolytics is possible since the low value of applied a.c. can only damage such units with very low voltage ratings. Null reading of electrolytics leaves something to be desired because of the slow reaction of the meter, necessitating a rocking of the null control to gain an accurate reading. However, since the bridge measurement can be augmented by a dynamic leakage test, the true condition of an electrolytic can be determined.

Accuracy of reading depends largely on the accuracy of the standards (C_1 through C_4 on S_2). Units of 1 per-cent tolerance were used. Both accuracy of reading and adequacy of ranges were beyond ordinary needs.

The second section of the circuit provides for measurement of leakage and shorting. Simplified circuit functions are shown in Fig. 4. With the function switch in its B position, the proper operational voltage is selected by R_1 and applied to the capacitor under test, which is connected between J_3 and J_4 . Here M_1 acts as voltmeter with a nominal range of 0-500 volts. Actually a lower voltage range is provided in this metering position on section B of switch S_3 , which shunts resistor R_2 with R_3 to permit readings from 0-50 volts. Values of these two resistors, although not particularly critical, are based on

Fig. 1. Front-panel layout of author's version, designed for rack mounting.

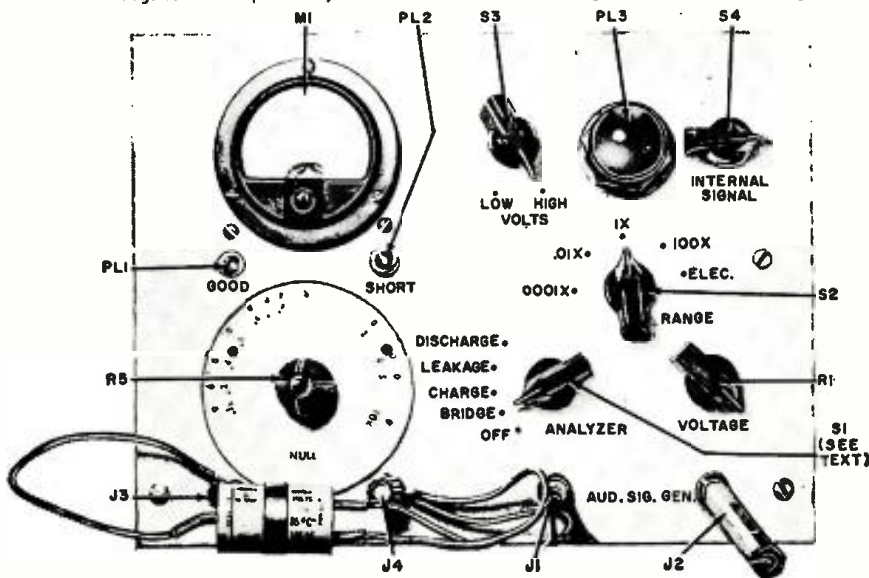

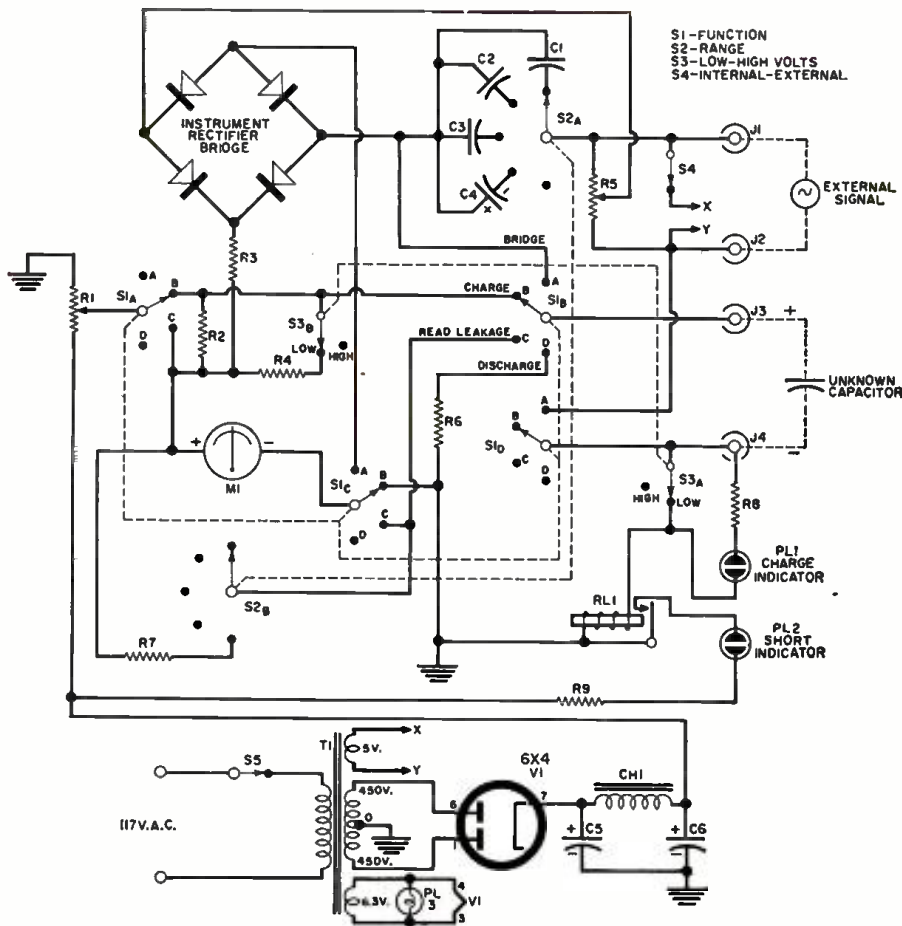

- R1—50,000 ohm, 20 w. wirewound pot.
- R2—1 megohm, 1/2 w. res.
- R3—18,000 ohm, 1/2 w. res.
- R4, R5—100,000 ohm, 1/2 w. res.
- R6—500 ohm, 2 w. wirewound pot.
- R7—200 ohm, 10 w. res.
- R8—400 ohm, 1/2 w. res. (Meter shunt. Value depends on value of meter and should equal the meter resistance)
- R9—10,000 ohm, 1/2 w. res. (see text)
- C1—100 μ f., 100 v. capacitor \pm 1%
- C2—0.1 μ f., 100 v. capacitor \pm 1%
- C3—1 μ f., 100 v. capacitor (close tolerance, see text)
- C4—100 μ f., 25 v. elec. capacitor (see text)
- C5, C6—40/10 μ f., 450 v. elec. capacitor
- S1—4-pole, 4-pos. non-shorting rotary switch

- (with auxiliary power switch, see text)
- S2—D.p. 5-pos. non-shorting rotary switch
- S3—D.p.d.t. switch
- S4—S.p.s.t. switch (see text)
- S5—S.p.s.t. switch
- RL1—Any sensitive plate-current-type relay, preferably over 6000 ohms, to close on approx. 1 ma. (Sigma 4F, 10,000-ohm coil or equiv.)
- PL1, PL2—NE-51 neon pilot light
- PL3—6.3 volt pilot light
- T1—Power trans. 450-0-450 v. @ 100 ma. (min.); 5 v. @ 1 amp.; 6.3 v. @ 1 amp.
- CH1—4 hy., 50 ma. filter choke (Stancor C-1706 or equiv.)
- M1—500 μ a meter (see text)
- Bridge—Copper oxide bridge rectifier (Conant Series 160, 10 ma. or equiv.)
- V1—6X4 tube

Fig. 2. Circuit includes capacitance bridge and leakage-current metering.

a meter resistance of 400 ohms. A word of caution here. Since S_2 does not limit the voltage available to the capacitor under test, control R_1 should always be set to its minimum position before S_2 is closed. This switch also provides short-circuit protection on its A section, as we shall see later.

S_1 , after the bridge or capacitance-measurement test, is rotated to its B position to charge the test capacitor, and this should cause PL_1 to light temporarily. Good mica, ceramic, or paper units will cause a flash. Light intensity will decrease with good electrolytics. Leaky capacitors will produce intermittent flashing. A steady glow indicates a short; complete failure to flash signals an open unit. The basic circuit involved is shown in Fig. 4A.

This short indication is direct as long as the voltage applied is above the firing point of the neon lamp (about 80 volts, d.c.). However, shorting or heavy leakage will not show up here when low-voltage capacitors are being put to

the test. This creates a problem since, if the user goes on to the next step (reading leakage, by rotating S_1 to its C position), the meter is in series with "B+" and the shorted capacitor (Fig. 4B). Meter damage is then a definite risk. To provide adequate warning, a sensitive relay that will close on approximately 1 ma. is inserted in series with the capacitor and meter movement (Fig. 4C) and, in the low-voltage position of S_1 , PL_1 is shorted out completely. Since RL_1 is not critical, there are many inexpensive units available at surplus that will serve. Closing of the relay contacts activates PL_2 and the user is warned to progress no further on tests.

This added indicating circuit extends protection down to the use of about 15 volts applied to the unknown capacitor. Below this point, leakage may be read on the meter, without fear of damage, even with a direct short.

In the leakage test (third position, C, of S_1) the meter measures leakage

current directly (Fig. 4B). To measure heavy leakage on high-value, high-voltage units, a fifth position on section B of range switch S_2 inserts a current-halving shunt (R_7 , which will always be equal to the internal resistance of the meter, although shown as 400 ohms in this case). Meter current readings are doubled when this shunt is in place.

Leakage measurement need not be precise for most purposes. A rule of thumb is to allow an average of .02 microampere per microfarad per volt. For most applications, a leakage as high as .05 μ a./ μ f./volt is tolerable. Sensitivity of this test, by the way, is primarily limited by the purse of the builder. A 500- μ a. meter, like the one shown, will give adequate readings for all but capacitors of very low value. This range could be extended by using a more sensitive meter and switching in more shunts.

Position D on S_1 , which discharges the component under test, is simply to protect the user, particularly on electrolytics.

Construction

Layout is non-critical, but Fig. 1 can serve as a guide. All components other than the power supply and high-value capacitors of the bridge were panel mounted. The entire unit was designed to be slipped into a test-bench panel, but a utility box will serve ideally for the purpose. A minimum of 8 by 5 inches of panel space will probably be needed.

R_1 , the charging-voltage control, is a 20-watt, 50,000-ohm wirewound potentiometer. A more inexpensive pot could be used—but power dissipation must be kept in mind. Moreover, use of a higher resistance (thus lower wattage) will slow the charging action. This is not necessarily a drawback to the patient user.

The power supply is straightforward, offering 450 volts d.c. adequately filtered for dynamic testing. Here again compromise with expense was kept in mind. A power supply which would reach the peak voltages required to test extra-high-level capacitors (e.g., 1000 volts or more) was more expensive than the benefits it offered. T_1 was pirated from an old radio. Actually, any transformer that provides from 250 volts and beyond will suffice, although the higher voltage is to be preferred.

NE-51 bulbs were used as PL_1 and PL_2 . Any neon will suffice, but other bulbs may require adjustment of the
(Continued on page 110)

Fig. 3. A basic capacitance bridge.

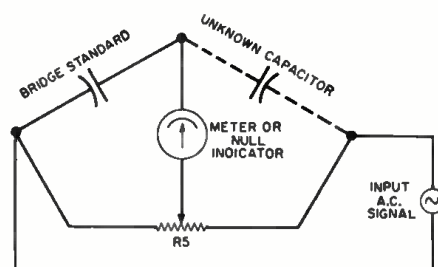

Electric POWER in Automation

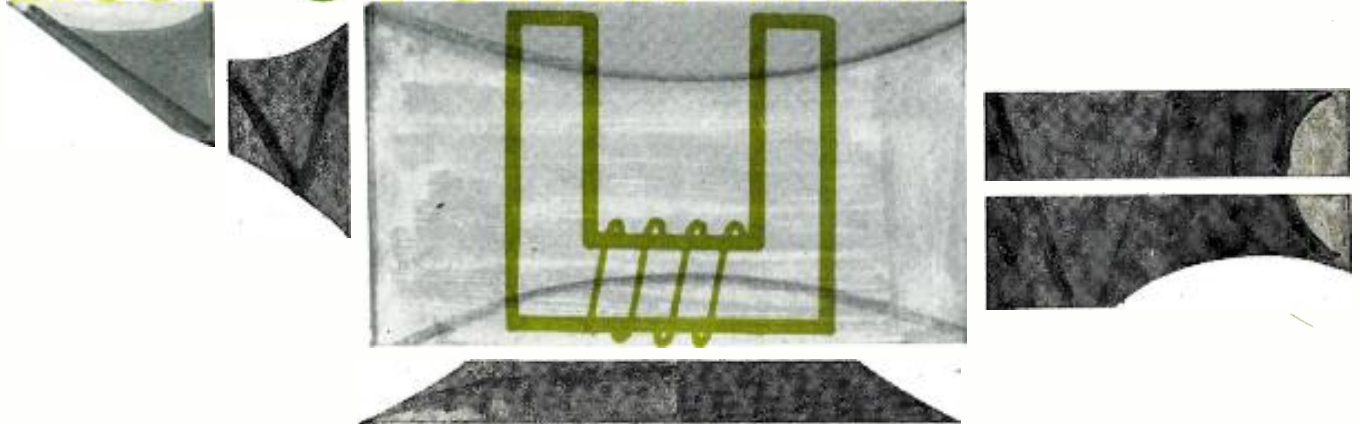

By **WALTER H. BUCHSBAUM**
Industrial Consultant, **ELECTRONICS WORLD**

Solenoids and motors are frequently used to carry out the functions dictated by a control system.

AT FIRST glance, the title may indicate the treatment of a rather superfluous subject. Electrical power is obviously used in automation. However, we are not concerned here with electricity as it is used to activate electronic sensing and control circuitry and associated devices. Aside from the existence of these circuits, every automatic system has "muscles" that carry out the decisions made by the rest of the system. Electrical power is often the necessary muscle power.

After the sensing circuits and the electronic "brains" (or decision-making circuits) have had their say, how are the decisions executed? How is the output of a control system translated into the physical force that moves, hammers, bends, pulls, or otherwise shapes a work piece?

Many types of actuators are used to provide the final muscle power. Hydraulic or pneumatic principles are used in many of these actuators. Many others are electrical machines—like the electric motor. Such devices are much older than the field of electronics as we know it today. Yet, partly because of the needs of electronics, there has been such development in the field of electrical power machinery that today's motors bear as little resemblance to their forebears as do today's automobiles to those of 1913 vintage.

There is a wide variety of motors and solenoids in current use, and many of them have been influenced in their design by the electronic circuits that regulate or control them. Although the

electronic technician who must maintain industrial systems is not ordinarily expected to work directly on the power machinery, he must know something about the nature and function of such equipment and understand how it fits into the over-all system. Often such an understanding is essential to determine whether a system failure is or is not in his portion of the combination. To be able to read prints and follow other basic maintenance literature, he must be able to recognize basic symbols

for devices that are non-electronic.

Conversion into Motion

Practically all of the electrical machines in existence do not convert electrical energy *directly* into a motion or pressure, but do so by first setting up a magnetic field and then using the magnetic force between two iron pieces. A simple example is the solenoid shown in Fig. 1. When current flows in the coil, a magnetic field is set up in the iron core and this attracts the T-shaped ram which, in turn, is put into motion.

Basically there are only two types of motion possible with electrical machines, linear or rotary. The first is usually obtained by solenoids and the second—the largest application of electricity in automation—is the action of an electric motor. In the latter, the attraction and repulsion between the stationary pole pieces and the rotating member generate the rotation and the torque.

Solenoids

In many automation systems, solenoids are used to perform quick, short strokes that do not require too much force and are not part of a continuous process. For example, a solenoid can be used to open the latch of a door or push a "reject" stamp against a defective unit in an automatic inspection line. Only rarely is one used in riveting, making eyelets, punching, or other less simple operations. The reason for this lies in the basic mechanics of solenoid action.

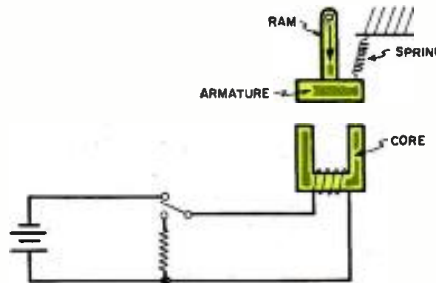
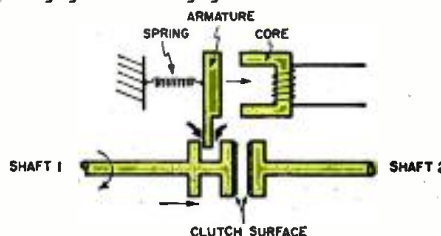

Fig. 1. Electromagnetic field of activated solenoid's core pulls in armature.

Fig. 2. A solenoid may be used to engage or disengage a friction clutch.



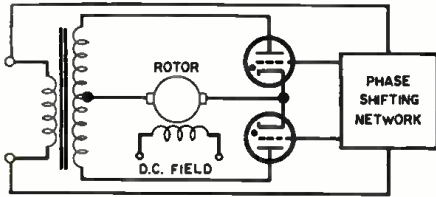

Fig. 3. This arrangement for speed control is used with large d.c. motors.

As shown in Fig. 1, a spring keeps the armature or moving section separated from the main core so that the former remains in this position until power is applied to the coil. Fundamental electricity teaches us that current through the coil builds up as a function of time and inductance, and this means that it takes a little time until full current flows through the coil. The magnetic force is strictly proportional to the current flowing through the coil, and it therefore does not reach its peak until the current is maximum.

Magnetic attraction is a function of the square of the distance between the two elements. This means that the force applied to the armature is smallest at the start and increases as the armature moves closer to the core. In other words, the armature starts moving slowly and gathers force until it smacks against the core. This feature alone presents a mechanical problem that limits the use of solenoids to intermittent-duty applications.

When the actuating switch is opened, the energy stored in the coil must be dissipated and, since arcing would quickly wreck the switch contacts, arc suppressors or dummy loads (like the resistor shown) must be used.

Solenoids are always used together with some mechanical linkage and, if the linkage sticks, the solenoid will often fail to operate, since the starting force is usually small. In many instances, a solenoid is part of some other control mechanism, such as the clutch shown in Fig. 2. Actually the entire assembly of clutch, armature, and plunger usually is a single, integrated unit, but the action of the solenoid can be understood better by separating them in the drawing.

Shaft 1 rotates and, when the solenoid pushes the clutch surfaces together, shaft 2 is connected to shaft 1. In this arrangement, there are two major sources of friction, shown by the heavy arrows in Fig. 2, which must be overcome by the holding power of the solenoid. When this friction becomes too great—due to lack of lubrication, for example—the clutch will fail, even though the solenoid may still be in good condition. Solenoids are often used to control valves in hydraulic or pneumatic systems. The same servicing problems apply there, and it is always wise to make sure that solenoid failure is *not* due to mechanical trouble in the related mechanism.

Electric Motors

There is probably no home in the U. S. today that does not have at least

several electric motors of one kind or another. Because most homes use a.c. power, these motors will tend to be of the induction type; but in industry d.c. motors are also used widely. There are motors that fit into a wrist watch and run a year from a battery the size of a dime; and then there are motors having over 1000-horsepower output that require a room full of electronic gear for starting and speed control. In between these extremes are a series of standard motor types in wide use for specific industrial applications. Some of these types are not involved too frequently as parts of an automation system. Others, like the servo motor, are particularly useful in positioning and

other operations that are automated.

To understand the relationship to the over-all system of any motors used, the electronic technician should know something about the characteristics of the various types. He should also be able to recognize them as they are symbolically represented on the prints he will use in tracing and troubleshooting. The most commonly used types are represented in Fig. 4, and Table 1, which is coordinated with this illustration, provides information about the units that can be helpful.

In addition to the windings shown here, the reader should understand that other starting, compensating, and con-

(Continued on page 120)

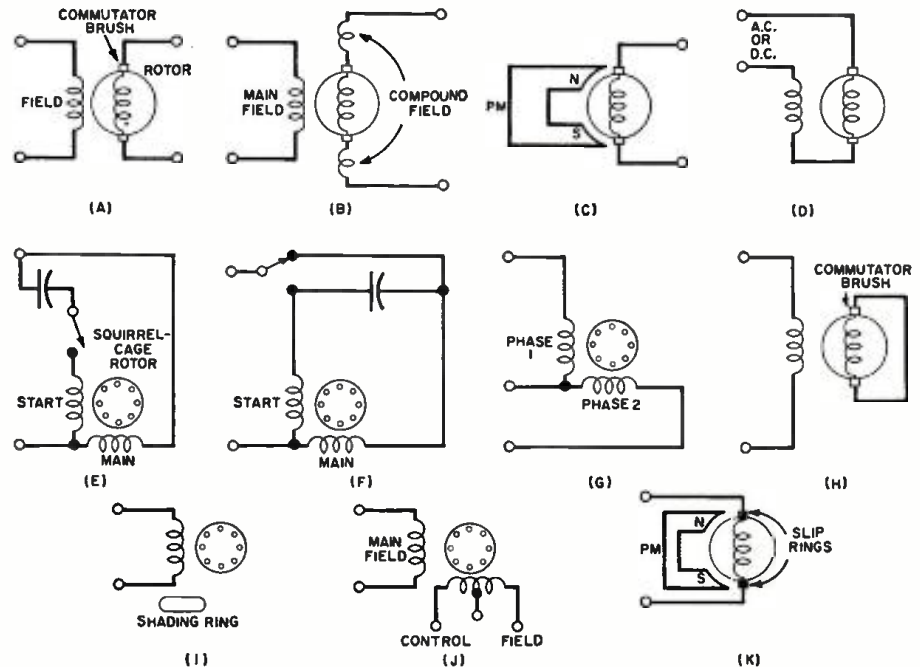

Fig. 4. Symbols for motor types that may be encountered in automated systems.

Table 1. Useful information concerning the common motor types shown in Fig. 4.

TYPE & FIG. 4 REFERENCE	STARTING TORQUE	SPEED CONTROL	OPERATING FEATURES	TYPICAL APPLICATIONS
D.c. shunt (A)	Medium	Thyatron or voltage control	Adjustable speed; constant torque or constant power	Pumps, conveyors, wire and paper winding
D.c. compound (B)	High	Usually not used	Speed adjustable over small range; high but varying torque	Flywheel drive, shears, punch presses, hoists
D.c.-PM field (C)	Low	Power tubes or transistors		Fans, blowers, battery-operated devices
Universal series d.c. or a.c. (D)	Very high	Thyatron, saturable reactor, series resistor	High speed; high efficiency	Hoists, cranes, vehicles, hand tools, appliances, general utility
Capacitor start a.c. (E)	Very high	Saturable reactor	Limited range of speed control as torque drops with voltage	Compressors, pumps, blowers
Capacitor running (reversible) (F)	Low	Usually not used	Speed varies greatly with load	Fans, blowers, centrifugal pumps
Squirrel-cage induction (poly-phase) (G)	Depends on type used	Saturable reactor, resistors	Available in six classes of performance characteristics	General-purpose industrial motor used as main power source for heavy machinery
Repulsion-start, induction-run (H)	Very high	Usually not used	High starting-current surge	Pumps, compressors, conveyors
Shaded pole (I)	Very low	Usually not used	Relatively inefficient, but low in cost	Fans, blowers, heaters, phonographs
Servo (J)	High	Power amplifier, saturable reactor	Accurate control through special control winding	Positioning systems, computers
Synchronous (K)	Low	None	Constant speed depends on number of poles and line frequency	Clocks, timers, blowers, fans, compressors



Longest Army Closed-Circuit TV Link

◀ The longest CCTV circuit in Army history linked West Point and Redstone Arsenal, Ala. for the transmission of a one-hour orientation course in missiles. Some 17 cameras and 3 mobile TV units provided a panoramic view of activities at the Arsenal, located some 1100 miles to the south of West Point, where about 1200 cadets watched the showing. Cooperating with the Army were *RCA*, whose electronics gear was used, and *Teleprompter Corp.*, the producer.

The "Shape Recognizer"

An early experimental step toward machines that read is demonstrated by a *Bell Laboratories* scientist. The machine displays a lighted square, showing that it has "recognized" a drawing of a square. The device also identifies triangles, pentagons, hexagons, and circles.



Recent Developments in Electronics

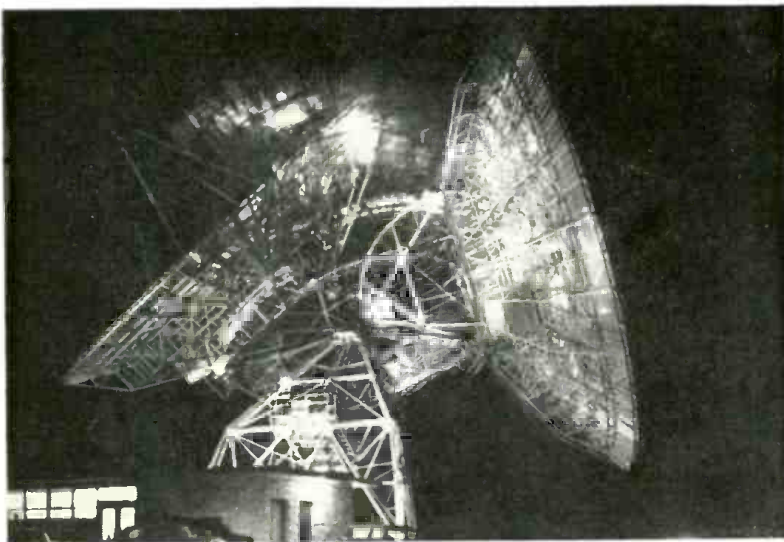

Rotating Radio Telescope

◀ A time exposure provided this dramatic illustration of an 85-foot diameter radio telescope in use at the National Radio Astronomy Observatory in Green Bank, W. Va. Tracking celestial objects with this unit, designed and built by *Blaw-Knox Co.*, is simplified because of equatorial mounting. The telescope's axis is parallel to the earth's axis and it turns at a constant rate of speed—one revolution per day—to follow discrete radio noise sources.

Airborne TV Ice Watch

A TV-equipped helicopter is being used by the Navy as an advanced eye to help ships ply the perilous waters of the Antarctic. The USS "Glacier," an icebreaker, recently charted a course through heavy floes there, with the assistance of the copter which flew ahead of the ship. A TV camera aboard the copter transmitted a picture of ice conditions back to a monitor aboard the "Glacier" enabling the ship to pick a path of least resistance. The helicopter used was the Navy version of *Bell's* commercial "Ranger" series.



Tubes Sealed by Optical Lapping

A sealing technique adapted from optical manufacturing processes, which substantially increases electron-tube reliability and life, was demonstrated by *Chatham Electronics* (division of *Tung-Sol*) and the U. S. Army Signal Supply Agency. In the usual production, a tube's glass-button base is sealed to the glass bulb by means of high-temperature gas flames. This method may contaminate the tube's cathode and subject the elements to stress which may result in failure or reduced life. With the new method the glass surfaces are carefully lapped so that a tight fit occurs and a vacuum may be produced without heat. Final sealing, but at a low relative temperature, is accomplished by induction heating. Engineer at right is studying interference rings, or fringe patterns, at the mating surfaces of the tube bulb and button stem. Monochromatic helium light is used to make these rings visible. The new technique, known as polyoptic sealing, has been the subject of a preliminary evaluation program and is based on a similar sealing process pioneered by the French electronic company *Compagnie Generale de Telegraphie Sans Fil*.



Electronic Brain Pilots Cross-Country Flight

An Air Force all-weather interceptor recently flew itself non-stop across the continent from California to Florida. The 2500-mile flight, made without refueling, was under the control of a *Hughes Aircraft Co.* electronic system (part of which is shown at the left) which took over the controls shortly after take-off.

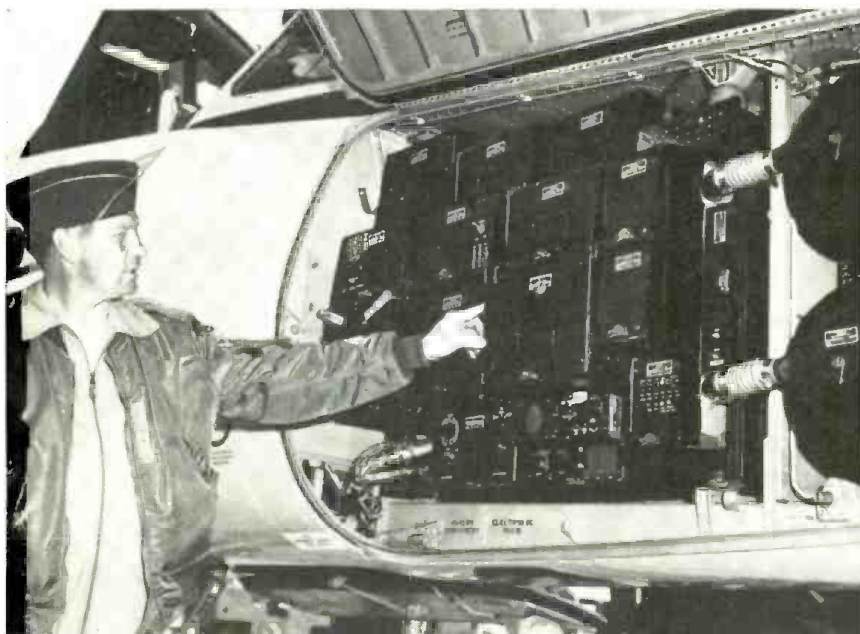

Radio-Controlled Concrete Bucket

The large 8 cubic yard concrete bucket shown below is the first radio-controlled unit scheduled for construction operations. The bucket is one of three similar units being used in the construction of Greers Ferry Dam in Arkansas. The self-powered hydraulic units are equipped with an automatic latch for engaging a cableway sling, and for manual operation.

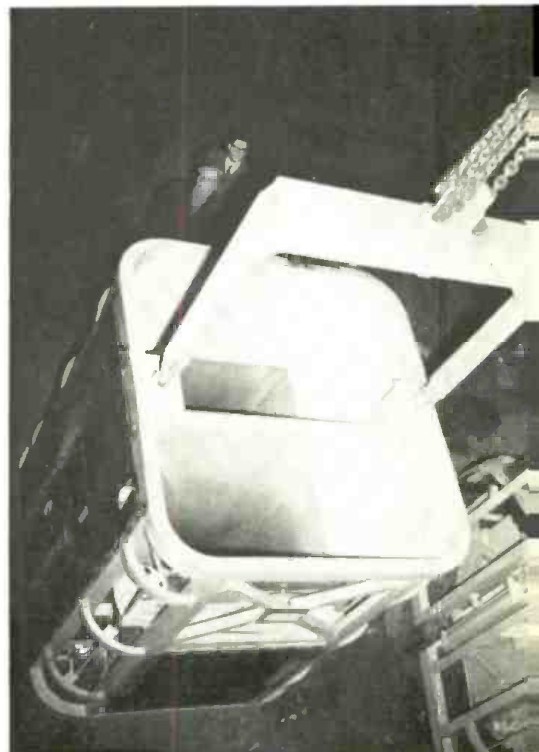

Swedish Integrated Speaker System

The *Elektron Lund* speaker system, four of which are shown below, includes woofer, mid-range speaker, and tweeters, along with two separate power amplifiers (one for treble, the other for bass), all built into a striking enclosure. The system is now being marketed in this country. The amplifiers, whose response complements that of the speakers, are each 10-12 watt units employing output-transformerless circuits.

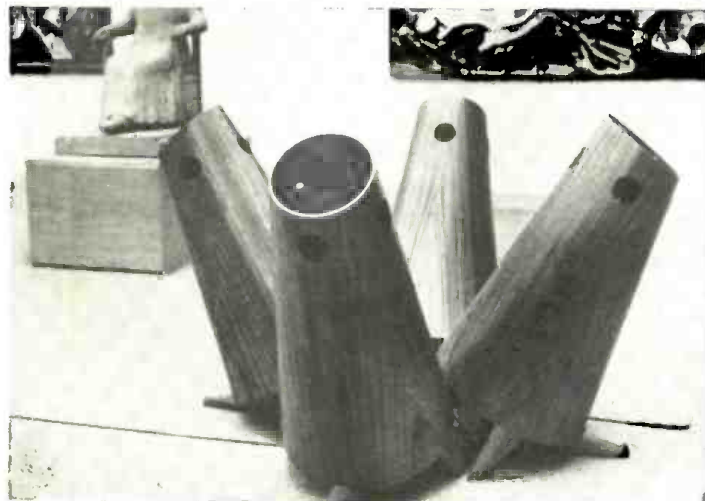

Computer Memory Devices

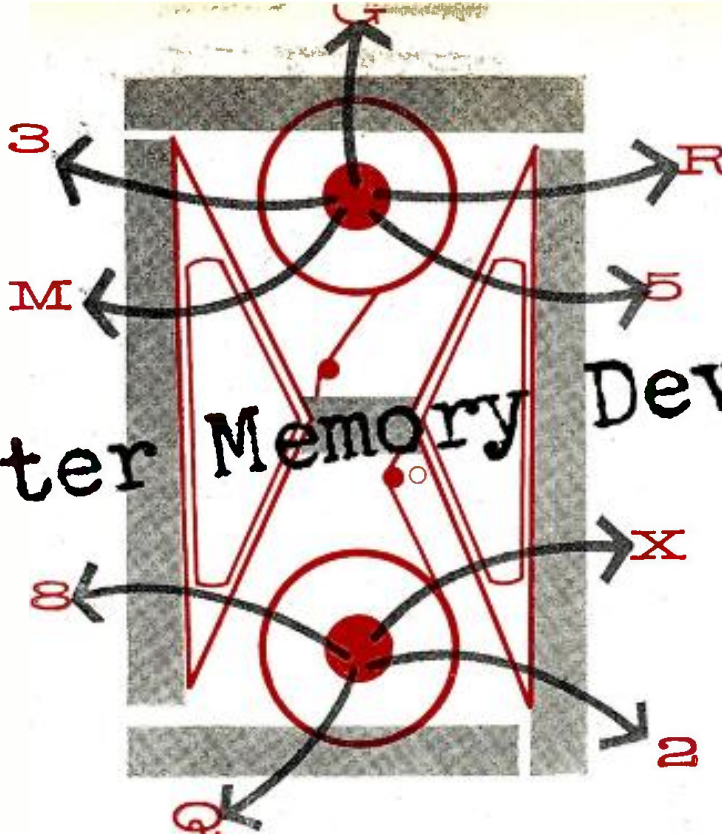

By ED BUKSTEIN
Northwestern TV & Electronic Inst.

For speed and automation, storing information is important. Magnetic tapes and drums are used.

PART 1

AS COMPARED to mechanical calculators such as the ordinary adding machine, the electronic computer has two important advantages: *high speed* and *automatic operation*. Both of these advantages result from the use of memory or storage devices. The numbers to be used in calculation and the instructions which specify the types of operations to be performed (addition, subtraction, etc.) are stored in the memory device before the calculation begins. The computer then extracts this information as it is needed during the course of the computation. As a result, the computer is able to perform a lengthy series of calculations without the intervention of a human operator.

In this sense, the computer is automatic. By contrast, the operator of an office-type adding machine must punch in new information (through the keyboard) before each individual step of the calculation. Since the machine is "idle" during the time the operator is entering new information into the keyboard, the calculation progresses at a relatively slow rate. A full day's work might therefore be required to complete a calculation which an electronic computer could perform in a matter of seconds.

The memory section of a computer is also used to store partial answers, obtained in early steps of a calculation,

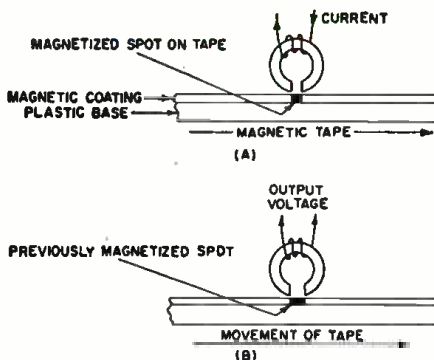
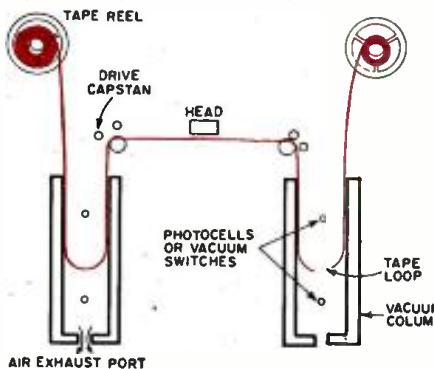

Fig. 1. As with sound, electromagnetic heads (A) record and (B) play back data.

Fig. 2. Tape-tensioning vacuum columns permit rapid, harmless stops and starts.



which may be required in a later step. Final answers are also stored in the memory and, at some convenient time, can be transferred to a print-out device, such as an electric typewriter. Many computers are so designed that the print-out function can be performed while the computer is simultaneously working on another problem.

Magnetic Tape Storage

The magnetic tape recorders used for data storage in digital computers differ in physical detail, but not in basic principle, from those used for audio recording. This basic principle is illustrated in Fig. 1. As shown, the tape consists of a plastic base coated with a thin layer of magnetic oxide. This tape is moved through the machine by a motor-driven transport mechanism. The path of the tape is such that the magnetic coating passes adjacent to the air gap in the *write* head (Fig. 1A).

If a pulse of current is passed through the coil of the write head, magnetic lines of force will be established in the core. These lines of force bridge the air gap by flowing through the magnetic coating of the tape. The section of tape under the air gap therefore becomes magnetized as a consequence of the current flow through the write coil.

Playback, known as *reading* in computer terminology, is accomplished by

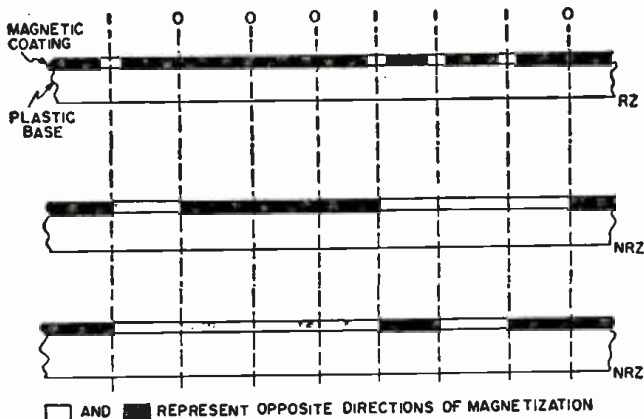

(A) Fig. 3. In return-to-zero recording (A), binary 1 is represented by tape magnetization in one direction and binary 0 by magnetization in the opposite direction. In non-return-to-zero recording, direction of magnetization is changed (B) only when switching from one digit to the other or (C) only when 1 is recorded.

moving the tape adjacent to the air gap of a read head (Fig. 1B). As the magnetized tape passes the gap, a magnetic field is established in the core and the lines of force cut across the coil. The voltage induced in the coil constitutes the output.

In computer practice, the same head is used for both writing and reading. This is permissible because the two operations do not occur simultaneously. Information is recorded in a number of parallel tracks across the width of the tape and a separate head is provided for each track. Binary-coded decimal, excess-3 code, and 7-bit code are frequently used for storing data on magnetized tape (see "Numbers Systems and Codes," *ELECTRONICS WORLD*, November 1959).

Recording is interrupted at periodic intervals so that the information is recorded in blocks. Typically, each block of information occupies about an inch of tape length, and the blocks are separated by about a quarter inch of blank tape. Such grouping of the recorded material is an aid in locating and selecting desired data for read-out. Counting circuits that respond to the passing blocks of information activate the reading circuits when the desired block passes under the reading heads.

In audio recording, the degree of magnetization of the tape is an important factor and varies with the audio signal being recorded. In computer applications, however, the direction of magnetization is the important factor and the degree of magnetization conveys no intelligence. For improved signal-to-noise ratio, the write currents are made sufficient in amplitude to magnetize the tape completely to saturation. The recorded tape is therefore fully magnetized in one direction or the other.

Since data is recorded in binary form, one direction of magnetization represents binary 1 and the opposite direction of magnetization represents binary 0. This technique, known as RZ (return-to-zero) recording, is illustrated in Fig. 3A. In the method known as NRZ (non-return-to-zero) recording (Fig. 3B), the direction of magnetization of the tape changes only when the data changes from 0 to 1, or from 1 to 0. In another variation of NRZ recording, the direction of magnetization changes only when a 1 is to be re-

corded. As shown in Fig. 3C, each change in the direction of magnetization represents a 1, and the 0 is recorded by maintaining the magnetization in the same direction it had during the previous bit. As compared to RZ recording, the NRZ techniques are characterized by less frequent changes in the direction of magnetization. This is an important advantage because it permits more bits of information to be recorded on a given length of tape.

The mechanical requirements of a tape machine designed for computer work are somewhat more demanding than those of a machine designed for audio applications. This is so because the computer tape must be frequently started, stopped, and reversed in direction. To prevent tape breakage and to permit rapid acceleration and deceleration, the tape is allowed to hang in a loose loop on each side of the head, as shown in Fig. 2. The loops hang down into vacuum columns, so that the atmospheric pressure on top of the tape maintains a slight tension on the loops.

This arrangement permits the tape to be started and brought up to speed in a very short time because the motor need accelerate only the tape in the loop. The other reel and the remaining tape "catch up" a short time later.

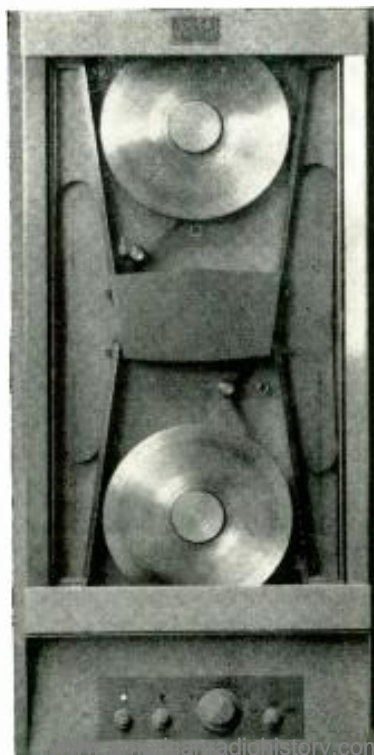

Start and stop times of five milliseconds are typical. Each reel has its own motor, and a servomechanism control prevents the loops from becoming too short or too long. The servomechanism responds to signals supplied by either pressure switches or photocells located in the vacuum columns.

The Ampex FR-300 digital tape handler, shown in Fig. 4, has a standard speed of 150 inches per second forward or reverse, and a fast speed of 225 inches per second. Start and stop times are 1.5 milliseconds. The tape-tensioning air columns of this machine are constructed as shown in Fig. 5. Air drawn from the exhaust ports maintains tension on the loops, and the loops contract or expand as the tape accelerates or decelerates. To minimize wear, the FR-300 drives on the tape backing rather than on the oxide side. This machine handles either half-inch or one-inch tape widths, providing 8 or 16 recording tracks.

Magnetic tape, as a storage medium, offers the advantage of very great capacity. At a packing density of 200 bits per inch, a half-inch tape 1200 feet in length can store literally millions of bits of information. Tape lengths of 2400 and 3600 feet are also commonly used and provide even greater storage capacities. Furthermore, a single computer may have at its command a large number of tape machines.

One disadvantage of tape storage, however, is its relatively long access time. Since the information required at some particular instant may be out at the far end of the tape, several minutes may be required to bring it under the reading heads. For this reason, computers utilize magnetic tape for reserve storage, but use a medium having a shorter access time for the main memory. The magnetic drum is often used for this purpose.

The Magnetic Drum

The magnetic drum consists of a motor-driven, aluminum cylinder

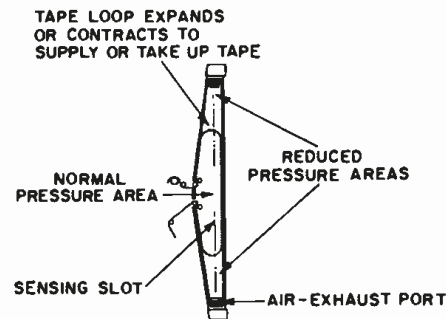

Fig. 4 (Left). Upper portion of rack-mounted Ampex FR-300 digital tape handler with standard speed of 150 inches per second and a fast speed of 225 ips.

Fig. 5 (Above). Detail of one of the vertical vacuum columns used in the handler of Fig. 4. Compare this arrangement with the one highlighted in Fig. 2.

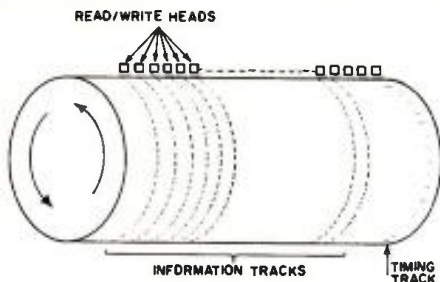

Fig. 6. Access time of a magnetic drum is shorter than that for a reel of tape.

coated with a thin layer of magnetic oxide. Writing and reading are accomplished in a manner similar to that used with magnetic tape. In a sense, the drum surface is like a short, wide tape with the ends joined to form a continuous loop. As shown in Fig. 6, many parallel tracks can be recorded on the drum. A twelve-inch drum, for example, may hold 200 tracks of information. The number of bits that can be stored in each track is, of course, determined by the diameter of the drum. Drum diameters from five to ten inches are common, but smaller and larger sizes are sometimes used.

Magnetic drums are normally provided with separate heads for each track. It is possible, of course, to use fewer heads so mounted that they can be moved from one track to another. This arrangement however, results in an increase of mechanical complexity as well as an increase of access time.

The heads of a magnetic drum may be connected in parallel (through diodes) as shown in Fig. 7. Since the diodes are biased in the non-conducting direction, the heads are effectively isolated from each other. Any given track can then be selected for writing or reading by making the associated diodes conductive. If, for example, a positive control signal is applied to the grid of V_1 in Fig. 7, this tube will become conductive and the voltage at point X will rise from a negative to a positive value. Since diodes D_1 and D_2 are now forward biased, the head for track 1 is connected to the read and write amplifiers.

Drum storage is *cyclic*, because each revolution of the drum brings the same information under the reading heads. The access time of the drum is therefore determined by the rate of revolution. Since it may happen that the desired information has just passed the reading heads at the time it is needed, the *maximum* access time is the time required for the drum to complete one revolution. It may happen, however, that the desired information is just approaching the reading position at the time this information is required. In such a case, the actual access time will be much shorter than the maximum access time. For this reason, access time is often specified as an *average* value, equal to the time required for the drum to make one half revolution.

A common value of drum speed is 3600 rpm, but rates in excess of 12,000 rpm have been used. At 3600 rpm, the maximum access time would be 16.7 milliseconds and the average access

time would be approximately 8.3 milliseconds.

The magnetic drum used in Royal McBee Corporation's LGP-30 computer is shown in Fig. 8. Data on this drum is divided into groups known as *words*, each of which contains 32 bits including the sign bit (plus or minus) and the spacer bit. The drum holds 4096 such words. The drum surface can be seen in Fig. 8 between the rows of heads.

Many computers are designed to handle numbers that are 10 to 12 digits in length. Since each of these decimal digits can be represented in coded decimal notation by four binary bits, 40 to 48 bits are required to represent each decimal number. In addition, another four-bit combination is used to indicate whether the number is positive or negative, bringing the total to 44 to 52 bits. This amount of information is known as a *word*, and many such words may be recorded in each track of a magnetic drum.

To read a particular word from one of the drum tracks, it is necessary to activate the reading circuits just before the first bit of the desired word reaches the head, and to de-activate

the circuits as soon as the last bit of the desired word has been read. For this purpose, a timing track is recorded on the drum as shown in Fig. 6. On this track, a series of pulses is recorded in positions such that each pulse passes under the reading head at a time when the first bit of a word is approaching the reading heads on the other tracks.

The pulses from the timing track are fed into a word counter, as shown in Fig. 9. This binary counter therefore advances its count each time a new word moves into the reading position. A comparator circuit (coincidence detector) produces an output when the number in the word counter is equal to a number previously stored in the *address selector* flip-flops.

If the fifth word on the track is to be read, for example, the address selector must first be set to 101 (decimal 5). This is done automatically by the *control* section of the computer. As the drum revolves and the word counter advances, the comparator produces an output signal when the word counter reaches 101 (first and third stages in the *one* condition and second stage in the *zero* condition).

(Continued on page 118)

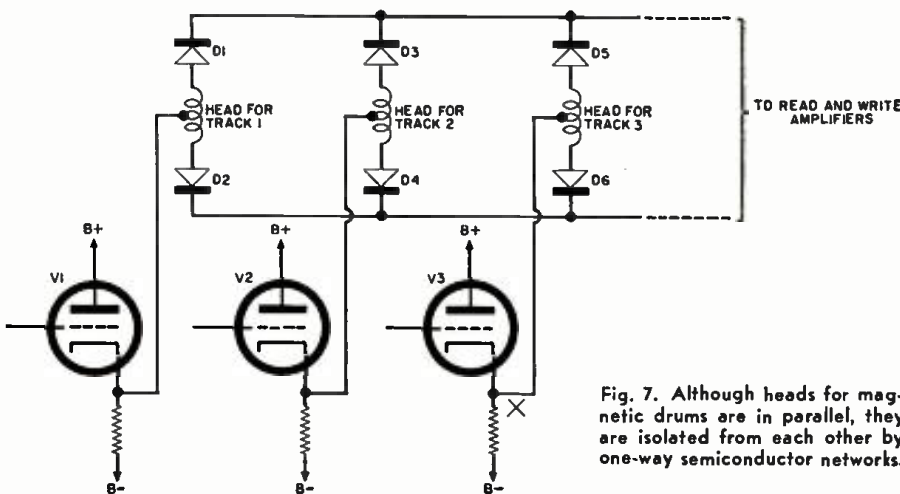
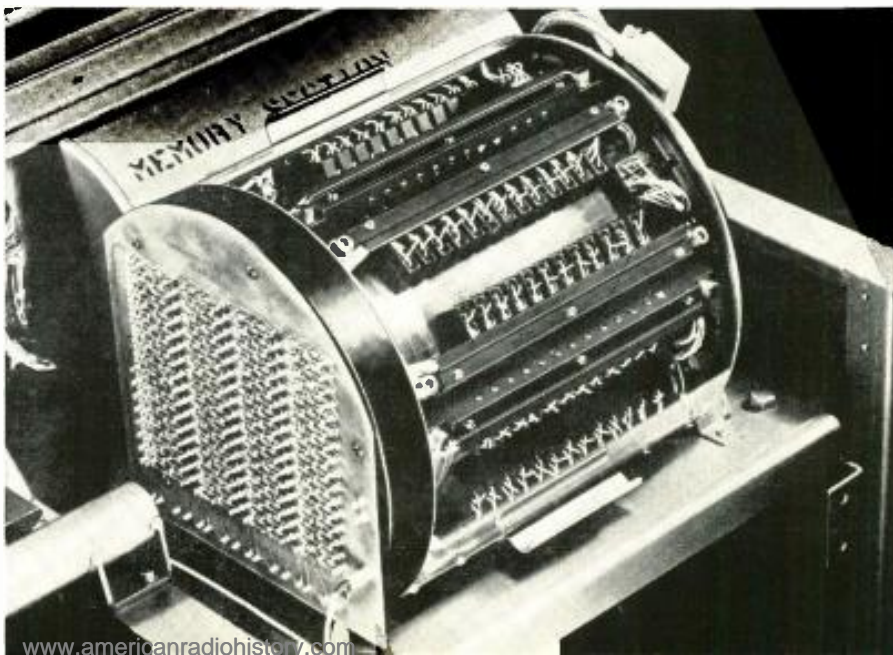

Fig. 7. Although heads for magnetic drums are in parallel, they are isolated from each other by one-way semiconductor networks.

Fig. 8. The magnetic drum of this Royal McBee LGP computer, which can be seen passing under the heads, stores 4096 words.



Cover Story

Triple-Triode Citizens Band Converter

By P. E. HATFIELD/Receiving Tube Dept., General Electric Co.

Construction of a well-designed tunable converter for broadcast receiver. Costs about \$10 to build and uses new triple-triode tube. Can also cover 10-meter band.

MUCH of the equipment suggested for use in the Citizens Band has employed the time-tested superregenerative receiver in the interests of simplicity. This has allowed rapid occupancy of the band and has gotten the service off to a good start.

However, the increase in Citizens Band activity has demonstrated the well-known shortcomings of the superregenerative circuit especially when no r.f. amplification is used: lack of selectivity and moderate sensitivity, plus radiation of a strong signal.

The superheterodyne circuit has distinct advantages, but construction of a complete receiver of this type is both costly and moderately difficult. Use of a converter ahead of a reasonably good receiver allows this receiver to supply much of the required gain and selectivity.

A converter can, of course, consist of nothing more than an oscillator-mixer, feeding a following receiver. Superior performance may be obtained if an r.f. amplifier is used ahead of the mixer. This would normally dictate a minimum of two tubes. A recently announced *General Electric* tube, the 6EZ8, contains three triodes in one envelope and allows the construction of a small three-stage converter with one tube.

The converter to be described was designed to be used in connection with any broadcast receiver capable of being tuned to 1500 kc. It may serve as the main Citizens Band receiver or make it possible to have auxiliary or monitoring receivers available at low cost. The cost of the converter is approximately ten dollars and will be even less if junk-box parts are available. The sensitivity, selectivity, and frequency stability are good, although these qualities are all governed, in part, by the receiver used as an i.f. amplifier. A bonus to the constructor who is also a ham is the easy adaptability of the converter to the ten-meter amateur band, a result of the wide tuning range of the slug-tuned coils used. The basic circuit is shown in Fig. 1.

Circuit

One section of the triple-triode is used as a grounded-grid input stage. This contributes useful gain as well as providing isolation between the antenna and mixer stage. This isolation decreases oscillator radiation, which sometimes reaches serious proportions

with a superregenerative detector or a simple mixer-oscillator coupled to an antenna. A broadband input circuit is used so that no tuning is required.

A second section of the tube is used as a mixer with a broadband grid circuit. Use of broadband circuits in both the r.f. amplifier and mixer simplifies construction of the converter; only the oscillator need be tuned, and this eliminates the problems of ganging and tracking.

The oscillator employs a high-"C" tickler-feedback circuit which operates on the low-frequency side of the incoming signal. The circuit constants are selected to provide adequate bandspread of the Citizens Band. Simple modifications required to give complete ten-meter bandspread will be described later.

Construction

The converter is constructed in a $2\frac{1}{2}'' \times 2\frac{1}{4}'' \times 5''$ chassis box. An inexpensive vernier dial is used to operate the oscillator tuning capacitor, the only control on the converter. Input and output connections are made through phono-type connectors and power is fed in through an octal plug, arranged to mate with an octal socket on the matching power supply. If de-

sired, a cable could be substituted for the power plug.

Parts layout is not especially critical. Since only one tube is used, the parts may be grouped around the socket with as short leads as practical, following the layout shown clearly in the photographs.

An old TV booster or u.h.f. converter might be used to supply the cabinet, chassis, dial, and power supply at a considerable saving in parts cost.

If power is to be taken from the receiver to be used as an i.f. amplifier, detector, and audio amplifier, the separate power supply can be omitted. (Of course, this cannot be easily accomplished with an a.c.-d.c. receiver, but nearly any transformer-operated receiver will stand the small additional power drain of the converter.) If a power supply is constructed, it will be required to provide 6.3 volts at 450 ma. and approximately 100 volts at 10 ma. This is well within the capabilities of the smallest booster or converter transformers.

The power supply is built in the same size box as the converter and has an octal socket mounted on one end to match the plug on the converter. A booster transformer is used for power. A selenium rectifier, simple RC filter,

Top view of the converter. A slug-tuned i.f. transformer is used for T₁ in this model, but a capacitor-tuned transformer is equally suitable. One slug screw on T₁ projects out of the bottom of the shield can and is adjusted through opening.

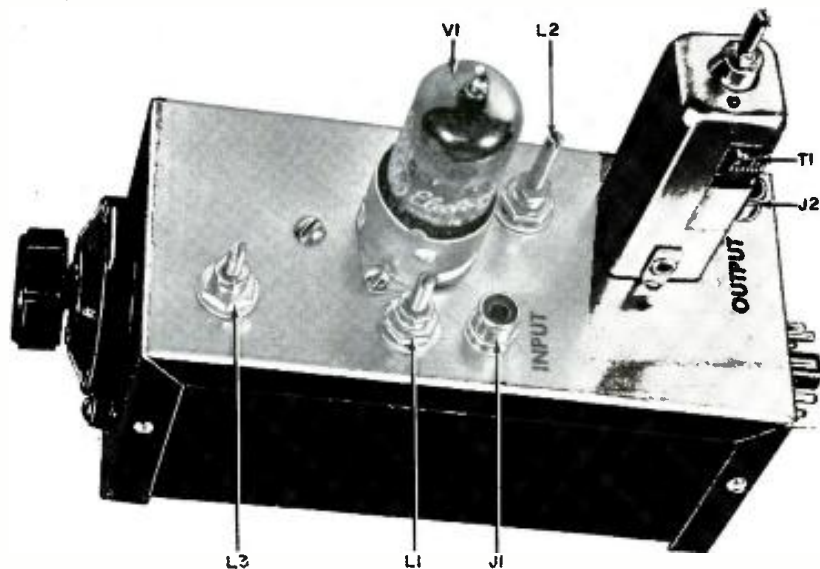

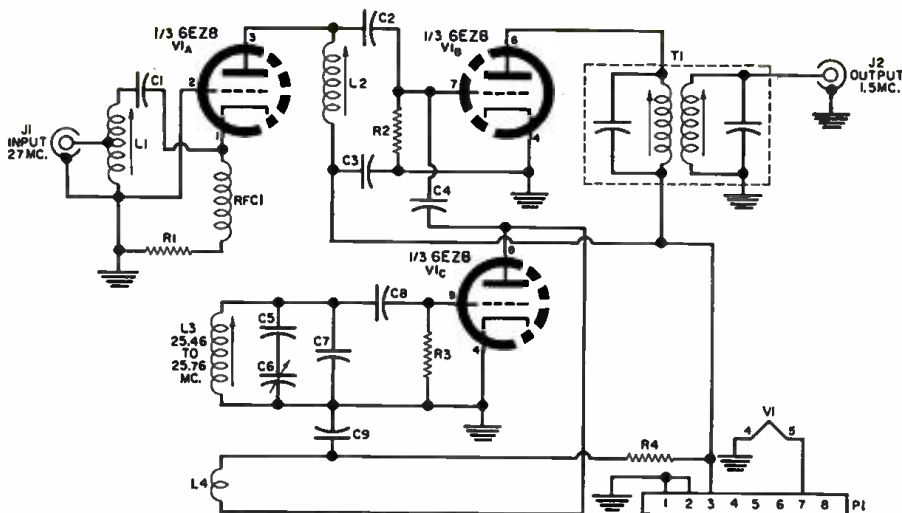

- R₁—270 ohm, 1/2 w. res.
- R₂—1 megohm, 1/2 w. res.
- R₃—10,000 ohm, 1/2 w. res.
- R₄—2700 ohm, 1/2 w. res.
- C₁—470 μf. ceramic capacitor
- C₂, C₈—100 μf. mica capacitor ±10%
- C₃, C₉—0.01 μf. ceramic capacitor
- C₄—1 μf. ceramic capacitor
- C₅—10 μf. silver mica capacitor (see text)
- C₆—2.8-17.5 μf. var. capacitor (Hammarlund Type HF-15). For 10-meter operation a 3.5-27 μf. var. may be substituted (Johnson Type 25L15, see text)
- C₇—150 μf. silver mica capacitor

- J₁, J₂—Coax or phono jack
- RFC₁—750 μhy. r.f. choke
- L₁—20 t. #26 en. closewound, tapped 6 t. from gnd. end (CTC Type LS3, 3/8" form, 20063-B slug)
- L₂—18 t. #26 en. closewound (CTC Type LS3 form, 20063-B slug)
- L₃—4 t. #24 en. spaced to 1/4" (CTC Type LS3 form, 20063-B slug)
- L₄—10 1/2 t. #28 en. closewound at distance of 1/4" from gnd. end of L₃.
- T₁—1400-1600 kc. i.f. output trans. (Miller Type 12-W2)
- V₁—6EZ8 tube (G-E)
- P₁—Octal plug

Fig. 1. Separate sections of the 6EZ8 are used as r.f., mixer, and oscillator stages.

and line switch complete this assembly. The suggested circuit is shown in Fig. 2. The use of a regulator tube is not mandatory but it does improve stability. If the OB2 is not used, remove R₇ and increase the value to R₆ to 4700 ohms at 2 watts. Output voltage will then be about +100 volts.

Connecting the Converter

If the receiver to be used with the converter is transformer-operated and does not use a loop antenna for its input coil, connection of the converter is relatively simple. A piece of 50- or 75-

ohm coaxial cable not more than 2 feet long (up to 6 feet of low-capacity auto radio lead-in cable may be used) should be employed to connect the converter output to the antenna and ground binding posts of the receiver.

Use of an a.c.-d.c. receiver will require blocking capacitors in both leads from the converter in order to keep the converter chassis from being "hot." These capacitors may be any value from 0.01 to 0.1 μf.

A receiver with a loop antenna may give trouble with pickup of broadcast stations which will ride in with the sig-

nals from the converter. The best solution to this problem is to remove the loop and substitute a shielded antenna coil. If the slug-tuned variety is used, no difficulty should be encountered in obtaining tracking of the receiver in the broadcast band.

Alignment for Citizens Band

The converter may be aligned with a signal generator or by using on-the-air signals. If an on-the-air signal is used, it will be necessary to know the channel frequency, as the oscillator dial must be set to place the signal in its proper position on the dial.

After the converter is hooked up to the receiver and power supply, turn it on and allow approximately ten min-

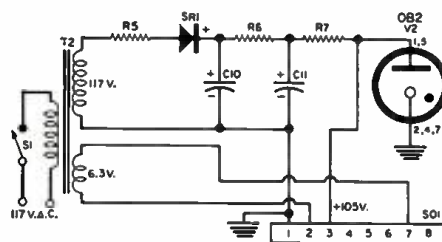

- R₆—47 ohm, 1/2 w. res.
- R₇—680 ohm, 2 w. res.
- C₁₀-C₁₁—40/40 μf., 150 v. elec. capacitor
- S₁—5-p.s.t. toggle switch
- SO—Octal socket
- SR₁—35 ma., 130 volt selenium rectifier (Torian Model 35 or equiv.)
- T₁—Power trans., 117 v. @ 20 ma.; 6.3 v. @ 1 amp.
- V₂—OB2 tube (see text)

Fig. 2. Suggested circuit for 105-volt d.c. power supply. The OB2 regulator is helpful in stabilizing oscillator plate voltage and thus eliminating frequency shifts that may be caused by power-line voltage variations.

utes' warm-up time before starting alignment. Tune the broadcast receiver to a relatively clear channel near 1500 kc. and feed in a signal of known frequency in the Citizens Band, either from a signal generator directly connected or from an antenna and a local station. Set the dial at a position which will place the signal at the proper part of the dial and adjust the slug in L₃ until the signal is heard. Now adjust the slugs in L₁, L₂, and tune T₁ for maximum signal, keeping the signal tuned in with C₆.

10-Meter-Band Alignment

The converter may be aligned to cover any 400-kc. portion of the ten-meter band without changing the capacitors in the oscillator circuit. If the 10-μf. capacitor (C₆) is removed from the oscillator circuit and the stator of the tuning capacitor connected directly to the top end of L₃, more of the band may be covered. If full ten-meter-band coverage is desired, omit the 10-μf. capacitor and substitute a 3.5 to 27-μf. capacitor in place of the 2.8 to 17.5-μf. unit specified.

To align, tune the broadcast receiver to 1500 kc. and feed a 28.8-mc. signal into the converter. Set the converter
(Continued on page 109)

Bottom view with shielding cover removed. The oscillator tuning capacitor, C₆, is fastened to the top of the box with a small angle bracket. Some capacitors already have this bracket attached. Tie points were used to anchor small parts in two places.

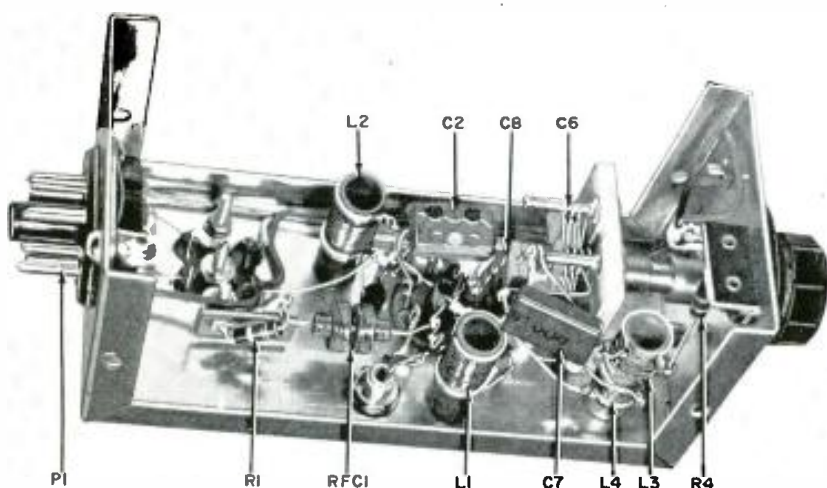

SERIOUS music lovers and hi-fi fans who want to listen to their records without the distracting rumble and wow often associated with record changers are obliged to buy a good turntable and a separate tone arm and then mount these components on a base. Superb record reproduction can result from such a "do-it-yourself" phonograph, but the record player is, in many cases, completely manual. Once a record is started on the turntable someone must be present to turn off the instrument when the disc is finished. Even the serious listener (who normally sits beside the turntable in rapt attention) occasionally gets called to the phone or otherwise interrupted by family activities after the record is started. When these interruptions occur, a device which will automatically turn the phonograph off is certainly convenient and, in addition, can prevent unnecessary wear on the stylus.

An interrupted beam of light was chosen as the actuating mechanism for the phono shut-off because it is simple, reliable, and requires no energy from the record groove for operation. Other phono shut-offs have been described

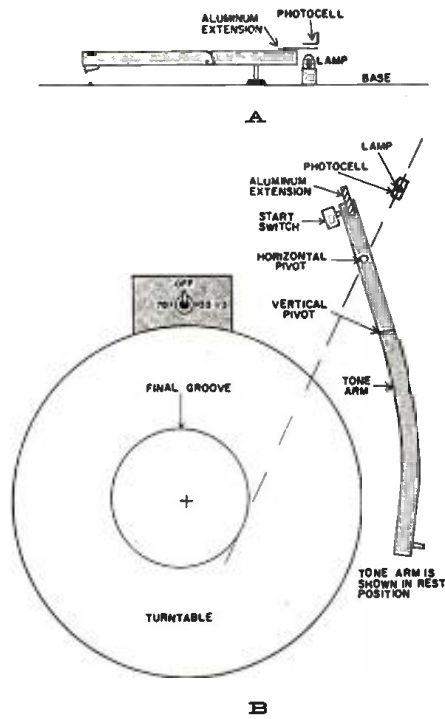

Fig. 1. Side and top views of phonograph.

The turntable is started by actuating a start switch which simultaneously applies power to the turntable motor and the power supply for the transistor-relay amplifier. After being started, the motor will continue to run until the beam of light shining on the photocell is interrupted. The photocell generates about 0.3 volt when illuminated by a #46 pilot light placed one-half inch away. This small voltage will not operate an inexpensive relay directly therefore this voltage is used to forward-bias the base-emitter junction of a transistor which causes current to flow in the collector circuit and operate a relay. R_2 causes a back bias to appear between the base-emitter junction when the photocell is not illuminated, thereby stopping the flow of current in the collector circuit. The transistor is thus used as a switch—when it is conducting, only 0.2 volt is dropped across it and when turned off the current is reduced to a few microamperes.

The "start" switch, S_1 , is connected in parallel with the normally open contacts of the relay. When the start switch is closed momentarily, power is applied to the turntable motor and the



Photocell Control For Phonograph

By LAWRENCE W. DOBBINS

Build this simple, low-cost, dependable circuit to turn off phonograph turntable at the end of a record.

where the absence of a signal on the record for a period of 30 seconds or so would cause the turntable to stop. These devices are somewhat unreliable because the turntable may be stopped in the middle of a low-volume passage or may not operate because of a noisy oscillating groove at the end of the record. The photocell is used as a position-sensing device—the tone arm interrupts a beam of light when the stylus reaches the end of the record, thereby turning the turntable motor off. This control is relatively inexpensive—the total cost is under \$10 using a surplus relay.

Operation

The control circuit consists of a selenium photocell, a transistor-operated relay, and a power supply.

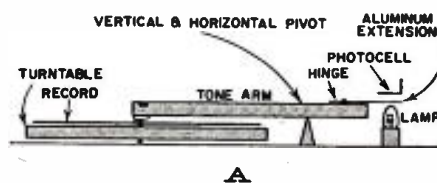
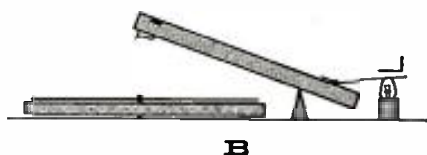

Fig. 2A. Use of photocell control unit in conjunction with a one-piece tone arm.

Fig. 2B. The hinged aluminum extension remains horizontal when the arm is raised.



transistor power supply. If the photocell is illuminated, current begins to flow in the relay coil causing the contacts to close, maintaining the flow of current to the phono motor and the transistor power supply. The phono motor will then be stopped at the end of the record when the tone arm interrupts the beam of light.

The "start" switch, S_1 , is connected in parallel with the normally open contact since the power supply for the transistor is turned off with the motor. The oscillating final groove on modern records could cause the turntable motor to turn on again as the turntable coasted to a stop if the transistor power supply were energized continuously.

On the author's phonograph, the start switch is mechanically operated when the tone arm is moved beyond the

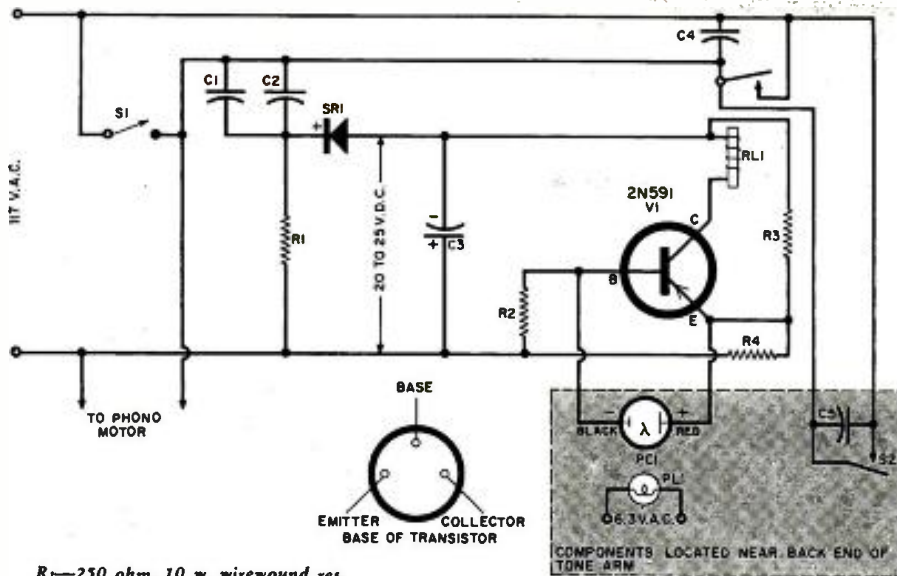

- R₁*—250 ohm, 10 w. wirewound res.
R₂—82,000 ohm, 1/2 w. res.
R₃—4700 ohm, 1/2 w. res.
R₄—150 ohm, 1/2 w. res.
C₁, *C₂*—1 μf., 600 v. paper capacitor
C₃—25 μf., 50 v. elec. capacitor
C₄, *C₅*—0.1 μf., 600 v. paper capacitor
SR₁—Crystal diode (1N538, 1N539, 1N602, 1N1763, or 1N1764)

- RL₁*—S.p. a.c.-d.c. relay, 5000 ohms @ 3 ma. (Sigma 41F-5000-S-511 or equiv.)
S₁—S.p.s.t. toggle switch ("Manual-Auto")
S₂—Momentary contact switch ("Start")
PC—Photocell (International Rectifier B-2-M or equiv.)
PL₁—#46 pilot light
V₁—"p-n-p" transistor (RCA 2N591)

Fig. 3. Complete circuit diagram and parts listing for photocell control unit.

edge of a 12-inch record. At the end of a record-playing session, it is important that turntables driven with a rubber idler wheel be placed in "neutral" to prevent flat spots from developing on the idler. As the tone arm is placed in the rest position, the turntable starts, acting as a reminder to disengage the idler wheel at the end of a record-playing session. The author's turntable is equipped with a single control which turns the motor on and engages the idler wheel. This control is now used only at the beginning and end of a record-playing session. Thus the automatic turntable control operates without adding more switches to the control panel.

The 20-volt power supply for the transistor is unusual in that the 117-volt a.c. input is reduced in an RC voltage divider. A capacitor was used to reduce the power dissipated in the voltage divider. The voltage rating of these capacitors should be 600 volts due to the large applied a.c. voltage. *R₁* dissipates about four watts which is almost the entire power dissipated in this device. A transformer was not used for the voltage reduction because of its high cost and because of the undesirable amount of heat generated by a transformer. The isolation afforded by a transformer is not required since all parts of this control circuit can be insulated from the hi-fi amplifier. Both the relay contacts and the start switch are bypassed with 0.1-μf. capacitors to prevent clicks and pops in the amplifier and to reduce arcing at the contacts. *S₁* allows the phonograph control to be bypassed quickly, if desired.

Construction

The power supply, transistor, and relay are mounted in the aluminum

"Minibox" shown in Fig. 4. The "Minibox" measures 5 1/4" x 3" x 2 1/8". This layout is not obligatory, however, since the circuit is not critical. The transistor must be protected from the heat of the soldering iron by firmly gripping each lead with a pair of pliers between the transistor body and the connection being soldered. The transistor can be mounted in a socket, if desired, to avoid any soldering problem. The positive lead of the photocell is connected to the

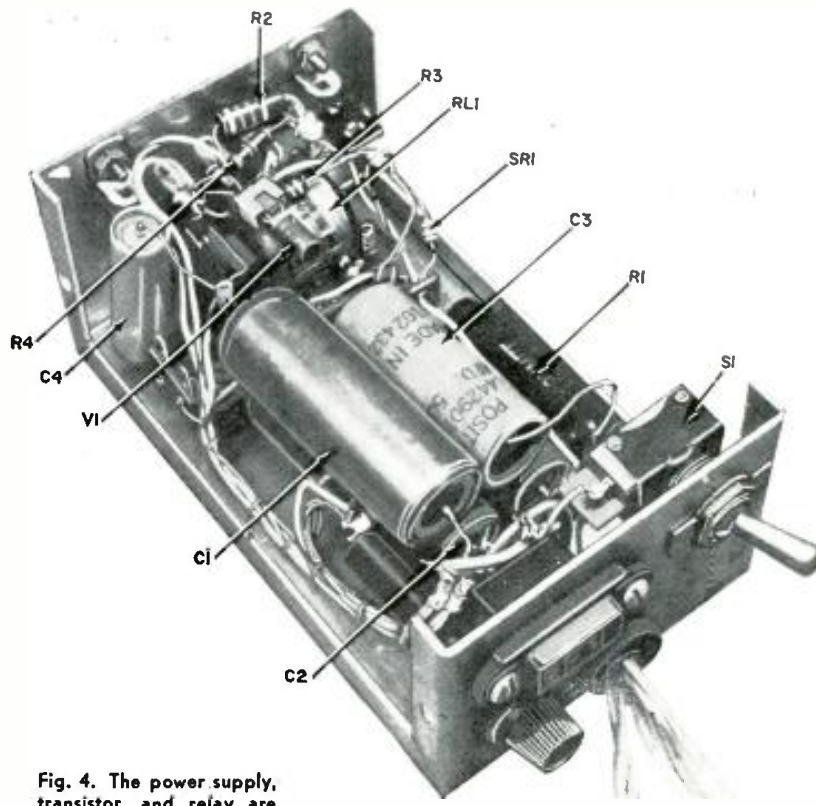

Fig. 4. The power supply, transistor, and relay are in this small chassis box.

emitter of the RCA 2N591 transistor.

Installation of the photocell and the light source will pose individual problems, depending on the type of phono arm and the arrangement of components within the cabinet. The beam of light is interrupted by a small piece of aluminum which extends from the back end of the phono arm. A Fairchild tone arm was used in the author's phonograph, as shown in Fig. 1. The back end of the Fairchild arm does not move up and down, allowing close spacing between the vertically mounted pilot light and the photocell directly above it. This circuit will permit the gap between the photocell and lamp to be as large as 3/8 inch. The photocell is mounted so that the turntable motor is turned off when the stylus approaches within 2 1/4 inches of the record center.

In cases where the back end of the tone arm moves up and down, the beam of light can be interrupted with a piece of aluminum mounted on a hinge, as shown in Fig. 2. The hinge will allow the arm to be raised at the end of a record when the aluminum extension is located between the photocell and the lamp.

A piece of vinyl tape was placed over the relay pole piece to minimize the difference between pull-in and drop-out current.

Conclusion

This photocell-operated phono turn-off has worked successfully with a collection of 150 records and has virtually eliminated the need for a mad dash to the phonograph to save the stylus before being ground to dust in the final record grooves.

Newfoundland's Microwave TV Network

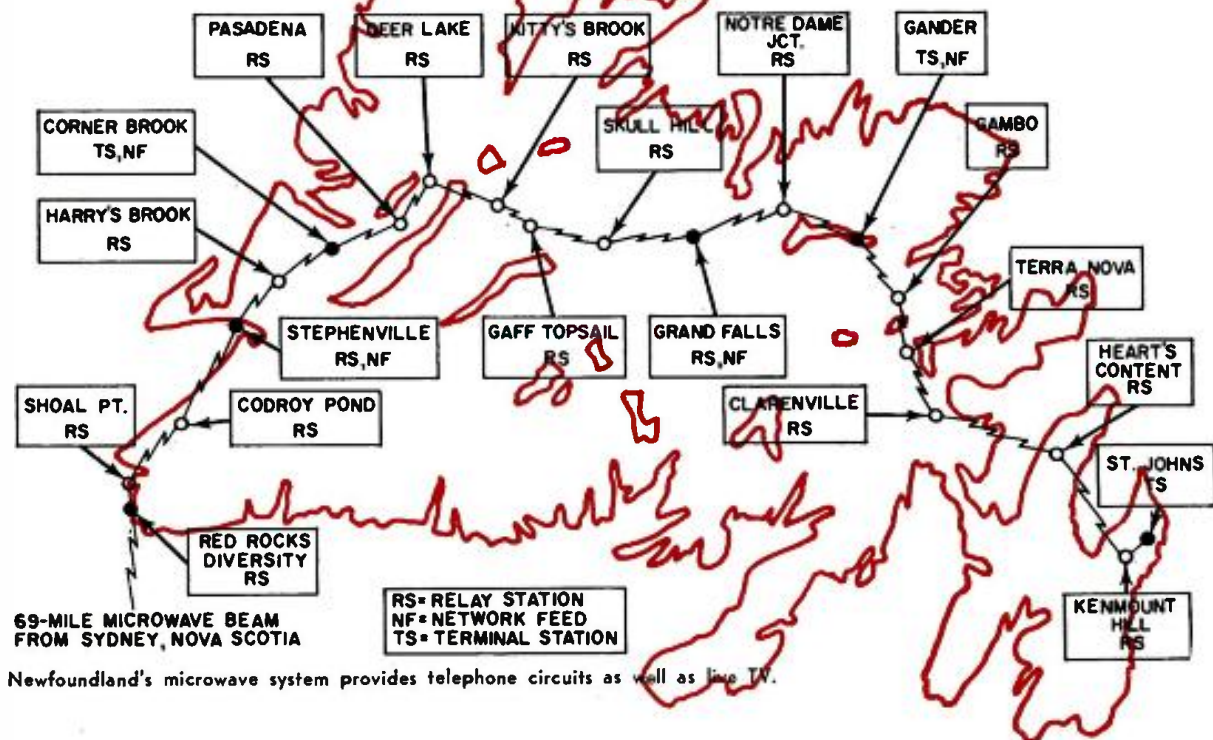

By HUGH G. JARMAN

Canadian Broadcasting Company's coast-to-coast TV network is now complete with the full operation of a \$9-million microwave system spanning Newfoundland.

ONE day last summer a select group of television viewers—a group barely large enough to fill an average living room—gathered to watch a program which 10,000,000 of their fellow Canadians didn't see.

This was not a case of the *Canadian Broadcasting Corp.* catering to a chosen few but a group of *Canadian National Telegraph* engineers and the "show" they were seeing was one of their own devising—the final testing of the new microwave television network linking Newfoundland with the rest of Canada and completing *CBC's* coast-to-coast system.

This key link was completed under a "crash" program and was actually ready ahead of schedule, enabling the *CBC* to cover the arrival of the Queen and Prince Philip in Canada on June 18, 1959. The original plans envisioned TV transmissions into Newfoundland by June but no one thought programs could be originated and transmitted to

the rest of the country by that date.

The whole program had its origins back in 1955 when the *CBC* asked *Canadian National Telegraph* to submit a proposal, on a competitive-bid basis, for extending their network from Sydney, Nova Scotia to St. Johns, Newfoundland.

CNT was awarded the contract and immediately authorized its chief engineer to proceed with plans for the largest construction job in the organization's history. As many as 54 *CNT* engineers, as well as drafting and clerical employees, were directly involved in the project at one time or another.

The reader examining the route map accompanying this article might object that the engineers "took the long way around" in setting up the network and that they would have been better advised to cut straight across southern Newfoundland. Actually the final route was dictated by *CBC's* specialized needs as well as by *CNT's* own

particular commercial requirements.

The string of repeater stations roughly parallels the *Canadian National Railway's* main line—an extremely important factor when it came to access for construction and maintenance. In addition, *CNT* has been able to provide 85 new telephone circuits using the same facilities on the microwave system as the TV network. This pre-planning makes provision for more than 800 telephone circuits which may be added as required.

Newfoundland, with its relatively few miles of highway and with its hundreds of communities relying mainly on coastal steamers for transportation, is in critical need of more telephone, telegraph, and radio facilities than any other Canadian province.

The rugged Newfoundland terrain posed tough engineering problems all along the route. The first step was to have physical surveys and radio tests made by firms specializing in that type

of work. Under the direction of *CNT* engineers, they plotted the best locations for each of the repeater stations—19 of them on the island proper and 2 on Cape Breton.

With the surveys completed, *CNT* started awarding contracts for the towers and buildings to house the repeater equipment and power generating machinery. It had been originally planned to make the construction a "summer project" but it developed into a "year-around" proposition right through what turned out to be one of the worst Canadian winters in 35 years.

With 35-foot snowdrifts and winds that howled at 135 miles an hour, the men worked under almost impossible handicaps. It was often necessary to chip the wind-blown ice off the towers before work could continue.

The distance between the microwave repeater stations varies from 3 miles to 40 miles overland with one hop cov-

This hill-top installation at Deer Lake is typical of Newfoundland's repeater stations.



July, 1960



These reflectors face a similar pair located some 69 miles across the open sea.

ering 69 miles. The 69-mile link is the "water hop" over Cabot Strait, from Red Rocks, Newfoundland to Cape North, Nova Scotia—what is claimed to be the longest line-of-sight microwave link in the world. This "hop" is a source of special pride to the *CNT* engineers. Its successful operation was made possible by new techniques developed by *Standard Telephone and Cables Ltd.*, the supplier of the microwave equipment, using "space diversity" reception with phasing control.

There are longer over-the-water hops in existence but they are spanned by the "scatter" technique which requires vastly more power than the line-of-sight system used by *CNT* and *CBC* in this installation. At each repeater station, parabolic reflectors, 14 feet in diameter and referred to as "dishes," pick up the weak (1 microwatt) incoming signal. Amplifiers then boost the signal to 5 watts and re-transmit it to the next station.

Since "line-of-sight" implies that the antennas on one tower are aimed directly at those of the next tower in the line, "panning the dishes" is a precise and tricky technique which must be followed in setting up the microwave link. The engineers had to first install the dishes on their respective towers, adjust them so that they faced each other, tilt and swing them as required by the test readings obtained, and finally lock the antennas into position.

During these adjustments, the engineers at each end kept in contact by means of two-way radio. When thought is given to the tight limits of tolerance that these adjustments required, the job of lining up the dishes over 69 miles of open sea must be regarded as a major engineering achievement. It is much as if you and a friend took dinner plates, stood seven miles apart with a lake between you, and got the plates to face each other exactly—all this while standing in the propeller wash of a

Super Constellation while ice water was being sprayed on you.

The towers that support the dishes are designed to provide maximum rigidity as the quality of the transmitted signal would be seriously affected if there were any sway or vibration. Accomplishing this with a steel tower as much as 200 feet high is no minor-league engineering feat. These towers have been constructed to withstand winds of hurricane force and to resist rapid ice formation during severe winter storms.

The power generating equipment at the repeater stations is of various types depending on the accessibility or otherwise of commercial power. In each case, however, there is an elaborate standby installation to take over in the event that normal power fails.

Obviously there must be no interruption of power irrespective of circumstances and, in addition, the voltage must be maintained within $\pm 1\%$ of its normal value. In some instances where there is no commercial power available diesel-powered alternators are used.

Much of the generating machinery and control equipment used in the installation was designed and built by *CNT's* engineering department. They have devised a scheme whereby the standby diesel engine is linked by a clutch and installed on the same shaft that connects the motor to the alternator. If power fails, the load is automatically picked up by the diesel.

Where commercial power is not available, the repeater station houses two complete diesel-driven generators—each one working week-in and week-out to supply current to the motor that runs the alternator. An electric clock automatically switches from one diesel set to the other every seven days. The idle set then serves as the standby unit.

In some cases it proved impossible to

(Continued on page 110)

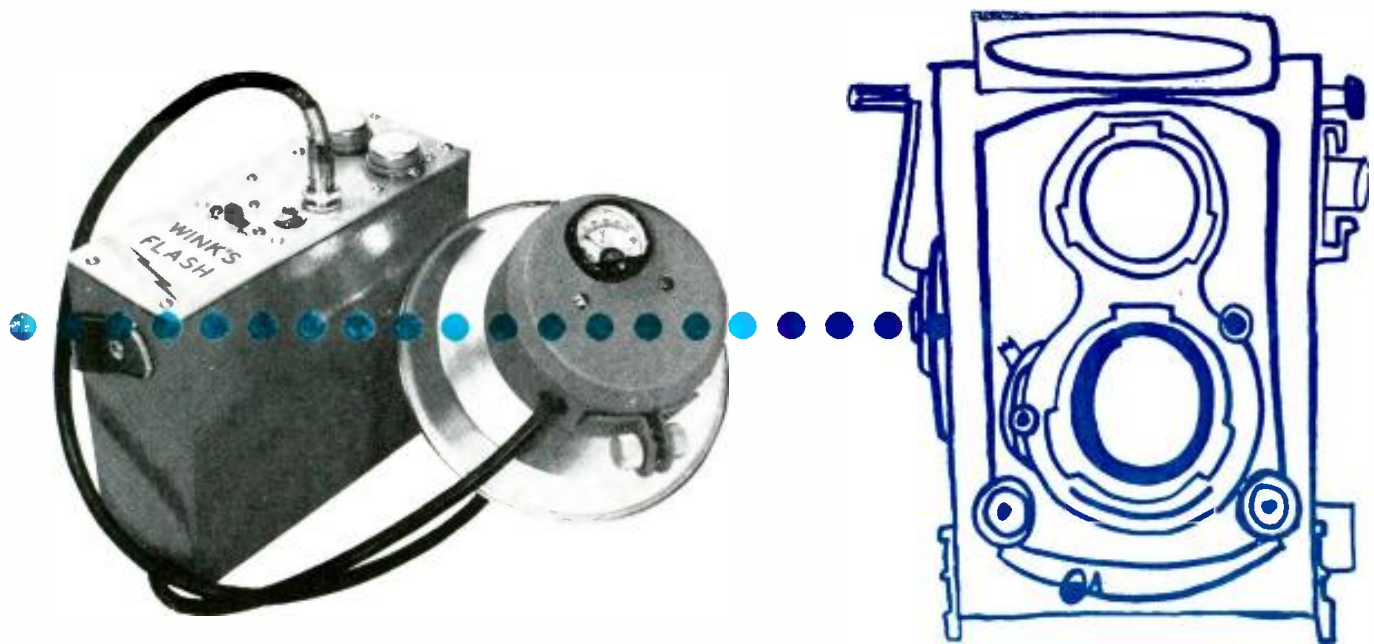

Professional Electronic Photoflash

By R. L. WINKLEPLECK / Complete construction details on a well designed unit that is not cheap to build but is economical to operate.

ELECTRONIC photoflash has increased in popularity by leaps and bounds during the past few years. Many casual amateur photographers have their own outfits or are actively looking over the field and virtually every professional lights his pictures electronically.

There are several good reasons why this whirlwind-change is taking place. Operating cost of an electronic unit is low—with no bulbs to buy. The flashtube itself enjoys an almost unlimited life and the only operating cost is for batteries. The burst of light from ionization of gas in the flashtube is so

brief that all action is frozen and there's little reason to worry about either camera or subject movement. The light itself has some interesting characteristics. It closely approximates daylight, which is of decided interest to the color photographer, and it has a peculiar soft quality which is especially attractive in portraiture. Further, it seems to have a greater depth of effective illumination in that less frequently than with bulbs is the foreground burned out and the background left dark.

These features are so compelling that seldom does a photographer go

back to bulbs after once using electronic flash. But there's another side to the coin. Electronic flash units are expensive to purchase—just how expensive depends upon several factors. They use a lot of current since the electricity actually produces the light instead of merely starting the fire as is the case with flashbulbs. The electronic flash unit is both heavy and bulky when compared with a flashbulb unit but this is partially offset by the fact that there's no supply of bulbs to carry and dispose of in some dark corner when no one's looking.

If you use a case or two of bulbs a year electronic flash is definitely a good investment. The big question is the type of electronic unit to get and this is a really big question since there is a wide choice. There are actually hundreds of different commercial units on the market and they vary in many respects. The smaller, lighter, and cheaper units have limited light output. Some operate only from house current and these are usually less costly than those of similar output operating from batteries. The line cord restricts operations, however. Some units use high-voltage batteries and these are usually in the lower price range but they're heavy and the batteries alone may cost fifteen dollars. For dollar economy it's necessary to take a lot of pictures before old age overtakes them and makes replacement necessary.

Some electronic flash units are designed for the ultimate in compactness but this usually runs up the price.

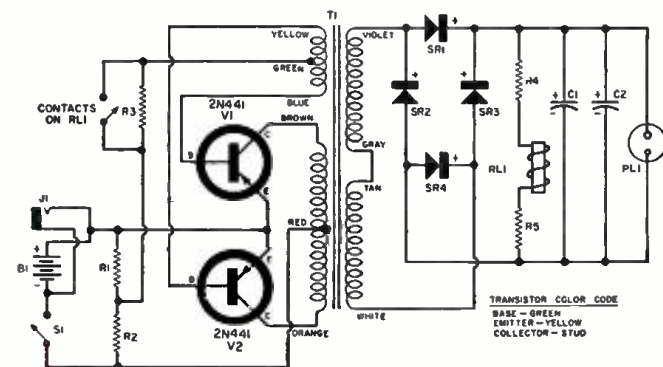

Fig. 1. Power supply circuit diagram for the photoflash unit. This highly efficient circuit charges the two 500- μ f. capacitors to 450 volts in less than about fifteen seconds.

- R₁—470 ohm, 1 w. res.
- R₂—30 ohm, 10 w. res.
- R₃—430 ohm, 1 w. res.
- R₄—100,000 ohm, 1/2 w. res.
- R₅—39,000 ohm, 1/2 w. res.
- C₁, C₂—500 μ f., 450 v. low-leakage elcc. capacitor (Sangamo DCM or equiv.)
- RL—5000 ohm d.c. relay (Potter & Brumfield RSSD)
- PL—2-connector polarized female mike plug

- S—S.p.s.t. slide switch
- B₁—Four 1.2-volt nickel cadmium batteries (available from Esse Radio, 42 W. South St., Indianapolis 25, Ind., see text)
- J₁—Phone jack
- T₁—Toroid trans. (Sunair Electronics, Inc. Type 4-500-05. Available from manufacturer at Ft. Lauderdale, Fla., see text)
- SR₁, SR₂, SR₃, SR₄—High-voltage silicon rectifier (International Rectifier 1N1706)
- V₁, V₂—Power transistor (Delco 2N441)

Further, high light output and real compactness do not go hand-in-hand. Some of the battery units use rechargeable batteries; others use four to six conventional "D" cells. Some secure the necessary high voltage from low-voltage batteries with a vibrator and transformer and some of the newer ones use the more efficient transistor-voltage amplifier. Some units require a long time to recycle or recharge the capacitors for the next flash and some use a monitor or cut-off system to hold the unit in stand-by readiness without exhausting the batteries unduly. The more of the desirable features in a unit the more it costs but, very roughly, the retail price averages about one dollar a watt-second. A watt-second, incidentally, is a measure of the stored electrical energy and an approximate indication of the light output. The rating of any unit may be calculated from the formula $W-S = CV^2/2$ where C is the capacitance in microfarads and V is the voltage in kilovolts.

This thoroughly confusing introduction, which only touches on the problems associated with acquiring an electronic flash outfit, should make it clear that there can be no one unit which will best serve the needs of all photographers. Each person must decide what he wants most in an electronic flash and what he's willing to sacrifice to get it. Are you willing to carry more bulk and weight to get more light? Will you stand hitched to an electrical outlet to secure low first cost and economical operation? Will you put some effort of your own into a build-it-yourself electronic flash to have an outfit with all the characteristics you want at reasonable cost?

Circuit Features

If your answer to the last question is "yes" then this electronic flash outfit may be what you've been looking for. It's *not* cheap. You can buy any number of commercial units for less money. But it's a bargain if you want the many extras it provides.

Before going into details, here's a quick sketch of what's offered. An over-the-shoulder case about the size of a large binocular case contains the batteries, power supply, and energy storage capacitors. The lightweight flashtube, reflector, and firing circuit fasten to the camera. Lifetime rechargeable nickel-cadmium batteries supply the energy. The freshly charged batteries will operate the unit for over 150 flashes. They may then be recharged overnight with the charger. Operating cost is thus practically nil.

A highly efficient, heavy-duty transistorized power supply charges two 500- μ f. capacitors to 450 volts in less than fifteen seconds. This is a whopping 101 watt-seconds. A relay in the power supply switches the current to standby when full charge is reached. This reduces the battery drain from 6-7 amperes while charging to 1 ampere or less. It eliminates the need to keep switching the supply on and off to conserve the batteries while waiting for a

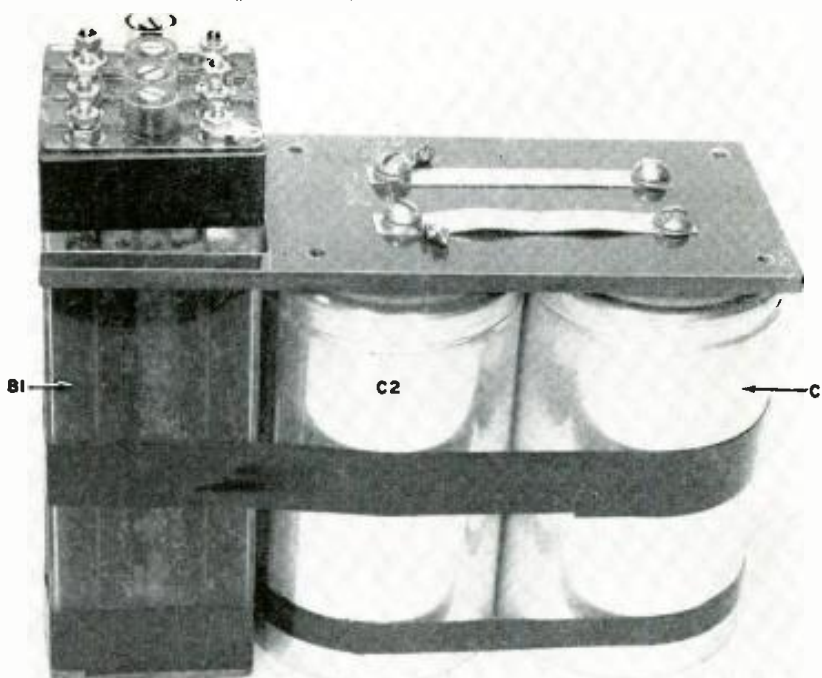

The two storage capacitors, C_1 and C_2 , are mounted to a plastic panel by their studs. The four battery cells fit in a cut-out of panel and are taped in place.

picture. All this is compactly arranged in the power unit.

Now, in the flash unit, a miniature voltmeter replaces the conventional ready-light. In most electronic flash outfits the ready-light goes on when the charge in the storage capacitor reaches about 375 volts. In some units it starts flashing slowly at this voltage and speeds up as the voltage increases. In others it goes on and stays on. It's extremely difficult to determine the exact charge from these neon lights and the voltage difference is important. For instance, in a unit rated at 100 W-S at 450 volts, the actual rating at 400 volts is only about 90 W-S, a reduction in light output which requires correction in color photography and makes an observable difference in black-and-white negative density. With the meter this possibility of error is eliminated.

In the flash head is a thyatron gas tube firing circuit. Conventionally, the

flash tube is fired by discharging a capacitor through the camera flash contacts into the ignition transformer. The flow of current is not great but the shutter's sync contacts are small and they frequently fail after a comparatively short life. The thyatron reduces this current flow almost to zero. Some trigger tube firing circuits in the past have been somewhat erratic.

The tube used in this unit incorporates a second grid which makes possible a "keep alive" current and firing is very consistent. The tube offers two extra dividends. It eliminates the possibility of the slight but annoying shock received when touching the sync leads of the direct-fired circuit and it makes "slave" operation possible. Simply by inserting a phototube in the sync socket in place of the camera sync cord, the unit becomes a slave which operates in response to the flash from any other light source and offers all

Underside of aluminum top panel showing parts placement. The toroid transformer is mounted between plastic sheets and rectifiers are soldered to terminal strip.

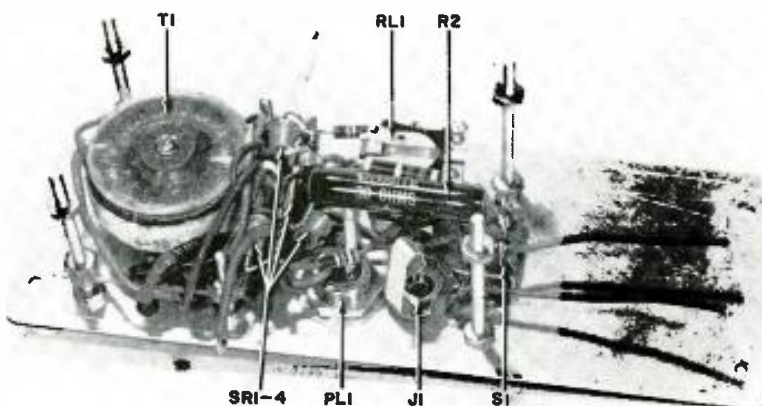

the advantages of multiple lighting without interconnecting cords.

The reflector is a 6½-inch stepped, polished type which makes maximum use of the light from the flash tube. Smaller reflectors may be used but the correct reflector may easily double the effective light as compared with a small, poorly designed one. It doesn't make sense to go to so much trouble and expense to secure high light output only to have the wrong reflector waste it. Some commercial units would produce more useable light if their reflectors were larger.

Which brings us to the subject of performance claims for commercial units. Some statements are completely factual and may be substantiated by actual trial. There are unfortunately, however, no standardized testing methods among manufacturers and some of the claims can be charitably classified as gross exaggeration. Some of the claimed exposure times can only be duplicated with the fastest films, greatly overdeveloped. Recycling times reported are frequently achieved only with fresh batteries and they are generally computed only to the 375-volt level at which the ready-light goes on. Please, compare the performance of this unit with the actual performance of others and, if you decide to buy rather than build, test the commercial unit thoroughly. There are many good ones—and many others.

Construction Details

Construction of this electronic flash unit is not especially complicated. The

pack. The transistors are comparatively new, heavy-duty *Delco* units rated at 13 amperes collector current. Smaller ones could be used but this would require changing the values of R_1 and R_2 and lengthening the recycling time. These transistors have the mounting stud collector leads common with the cases. They must be electrically insulated from the mounting panel with either mica or anodized aluminum washers so the considerable heat they generate can be easily dissipated. If you are unable to locate these *Delco* units the *Bendix* 2N677 or 2N677A transistor will be satisfactory.

The transformer is a special small toroid type made for this specific ap-

tors R_1 and R_2 are selected to pass sufficient current to cause the relay to pull in when the capacitor charge reaches 450 volts. Resistor R_2 across the normally closed contacts of the relay serves to reduce the transistor base current when the relay is actuated to an amount which will just maintain the 450-volt charge.

The four battery cells are surplus nickel cadmium units using a potassium hydroxide electrolyte which does not give off corrosive fumes on either charge or discharge. They are rated at 10 ampere-hours and their low internal resistance provides good voltage maintenance even at high discharge rates. They may be recharged at least

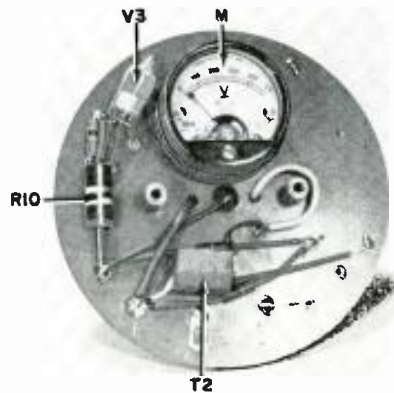

One side of the mounting board in flash-head assembly with parts in place. It fastens to the back cover with two machine screws threaded into the spacer posts.

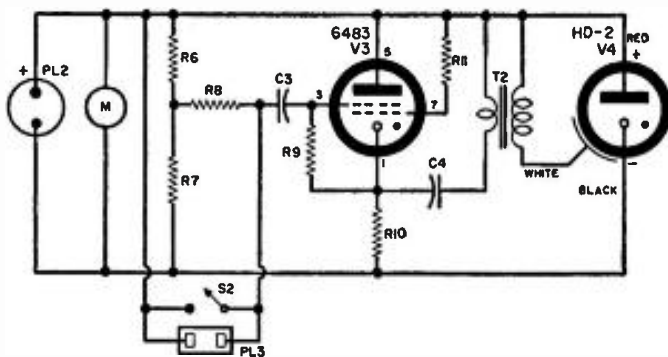

Fig. 2. Flash-head assembly circuit diagram for the photo-flash unit. The rating of this professional-type unit is about 100 watt-seconds.

- R_6, R_8, R_9 —5.1 megohm, ½ w. res.
- R_7 —2.7 megohm, ½ w. res.
- R_{10} —100,000 ohm, 2 w. res.
- R_{11} —10 megohm, ½ w. res.
- C_3 —.01 μ f., 200 v. tubular capacitor
- C_1 —.1 μ f., 600 v. tubular capacitor
- M —1½", 500 v. d.c. meter

- S_2 —S.p.s.t. miniature push-button switch ("open flash")
- PL_1 —2-connector polarized male mike plug
- PL_2 —2-prong electrical outlet ("sync connection")
- T_2 —Ignition coil (*Anglo* ST-25)
- V_3 —Thyatron tube (*Sylvania* 6483)
- V_4 —Flash tube (*Anglo* Type HD-2, see text)

real work is more mechanical than electrical in order to achieve convenience and compactness. The photographs show clearly the general layout. This may be changed as desired, keeping in mind only that the heavy current-carrying leads from the storage capacitors, C_1 and C_2 , to the flashtube, V_4 (Fig. 2), must be relatively large. Number 18 stranded wire is satisfactory. The cord connecting the power supply with the flash head is ordinary #18 stranded, 600-volt rubber insulated electrical cord.

Fig. 1 is the schematic of the power

plication. It can be small because of the 1000-2000 cps frequency of the circuit. It is available directly from *Sun-air* for \$16.00. It is designed for an output of 500 volts with a 4-volt input. The full-wave bridge rectifier uses four efficient high-voltage silicon rectifiers. These are conveniently mounted on a tie-strip and, because of crowding, have been dipped in Glyptol, an insulating varnish. The two energy storage tanks, capacitors C_1 and C_2 , are low-leakage units and any other make designed especially for photoflash use would be satisfactory. Dropping resis-

5000 times without capacity decrease. These batteries are available for \$1.95 used or \$2.95 new per cell and the new ones are probably the better buy.

The arrangement of these components is shown in the illustrations. A ¼-inch plastic panel supports the storage capacitors by their studs and is cut out to accept the four storage batteries which are taped in place. All the other components in the power supply are attached to the top panel of aluminum. The toroid coil is mounted in a small plastic sandwich just below the transistors. After these parts are all wired the aluminum panel is mounted across the tops of the batteries and 1½ inches above the plastic panel to which it is attached with four 2-inch machine screws. The completed unit then slips into a wood and Masonite open top box with outside measurements of 3" x 7¾" x 6¼". An over-the-shoulder leather carrying strap attaches to the box.

The power cord attaches to the power pack with a standard two-connector microphone plug so the flash head may be removed if desired. If you expect to always use these two units together and see no reason to separate them, this connector plug may be omitted.

You're working in close quarters when wiring the flash head assembly according to the Fig. 2 schematic but the *Anglo* flash tube, reflector, back

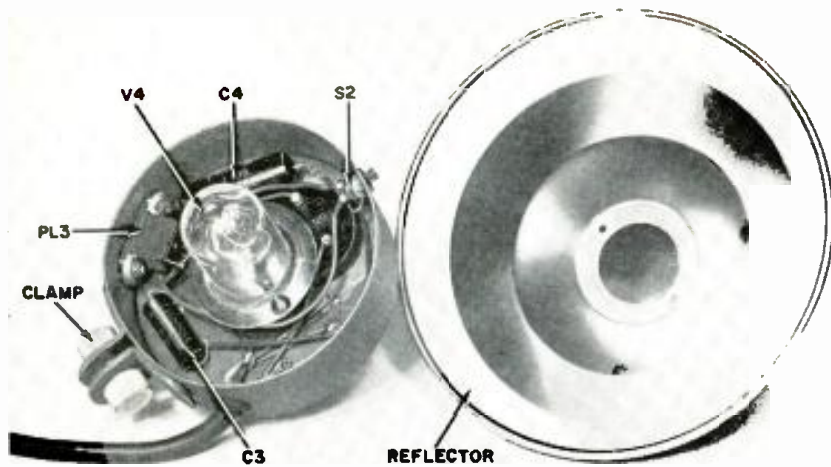

Mounting board in place in the back cover with cord, sync socket, and switch installed. Two screws holding the flash tube are removed to attach the reflector.

cover, and mounting board make possible a neat, compact unit. The reflector is identified as *Amglo* part AR-365 and the back cover and mounting board is R-65C. The 1½-inch meter has a plastic mounting flange which is filed off. Holes are cut in the aluminum housing and in the composition mounting board just the size of the meter and it is then cemented to the board which is completely wired before placement in the back cover. The various components are mounted on both sides of the board through holes drilled in it. Eyelets may be set in these holes and the components soldered to the eyelets. Holes are cut in the housing for the sync plug (an ordinary electrical outlet) and for the cord from the power unit (protected by a rubber grommet) and for the open-flash switch. These are not installed, however, until the completely wired panel is fastened in position. They are then put in place, wired into the circuit, and the reflector is attached.

As is especially important with any portable equipment, construction must be strong and all components firmly attached so they'll neither move around nor work loose. Keep in mind that you are working with comparatively high voltage and high amperage. Insulate the wiring and keep exposed connections as well separated as possible. Above all, handle this voltage with great respect. When a charged storage capacitor must be discharged it should be shorted with a power resis-

tor of several hundred ohms. Shorting the terminals with a screwdriver will produce a rifle-like blast and a flash of fire as the tip of the screwdriver is vaporized. Accidental contact is always unpleasant and could be fatal. Please be careful.

Checking the Operation

When construction is completed recheck the wiring carefully. Are the soldered joints strong? Are there any places where high-voltage breakdown can take place? Are the polarities of batteries, transistors, capacitors, meter, and flashtube correct? Have you observed the toroid transformer color coding? If all is well turn the unit on and watch the voltmeter. Almost immediately the voltage should start climbing. This will be slow as the electrolyte in the big storage capacitors reforms and it may take a couple of minutes to reach 450 volts. At about this point the relay should be activated, placing R_1 in the transistor base circuit and slowing the charging rate and flow of battery current. If the rate of charge stops much before reaching 450 volts (and the batteries are fully charged) either R_1 or R_2 should be slightly larger and if the voltage continues to climb steadily without actuating the relay, the value of either of these resistors should be reduced slightly to increase current flow through the relay. After the relay operates the voltage should hold steady. If it drops slowly R_2 should

be smaller. If it continues to climb increase the value of R_1 .

With the unit charged, close the sync contacts either by connecting a sync cord to the camera shutter and operating the shutter or by pushing the open-flash button, S_2 , on the top of the back cover. The gas in the flash tube should ionize with a burst of bluish white light of approximately one millisecond duration.

The reflector assembly may be mounted on the camera with a mounting bracket also available from *Amglo* (which permits tilting the reflector for bounce light) or with any suitable mounting bracket or shoe assembly. Standard sync cords are available at any photo shop. Remember this is synced for zero or "X" delay.

The exact exposure will depend on a number of variables and can best be determined by trial. To establish a flash number set up a picture representing average conditions—possibly a family group in the living room. Place camera and mounted flash a fixed distance from the subject and make a series of exposures varying only the camera aperture. Develop the film and print all negatives which show any image. The aperture at which the best picture was taken multiplied by the camera-to-subject distance is the flash number for this combination of camera, film, and flash unit. For instance, suppose the camera-to-subject distance chosen is ten feet and the print taken at f.11 is best. Your flash number is 10 x 11 or 110. Whenever you're taking flash shots just divide the distance into 110 to determine the correct lens aperture. Incidentally, if you do your own dark-room work, don't judge the quality of electronic flash negatives by usual standards. They may look thin and flat but they will usually print beautifully.

The manufacturer of the thyatron trigger tube recommends this firing circuit and advises that it may be used for "slave" operation simply by attaching a type 929 phototube to the sync outlet. The phototube should be mounted in a housing which directs the light to the sensitive area of the tube and a simple adapter may be made to permit plugging the tube into the sync outlet. Both plug and outlet should be marked so the anode of the tube is connected to the positive side of the outlet. For dependable slave

(Continued on page 77)

Fig. 3. Schematic diagram and parts listing for the simple battery charger.

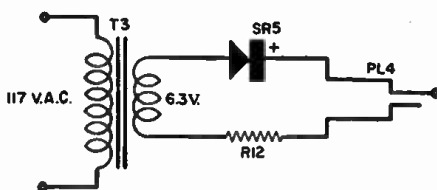

R_{12} —5 ohm, 5 w. res.
 SR5—200 ma. silicon rectifier
 PL4—Phone plug (see text)
 T3—Fil. trans., 6.3 v. @ 1.2 amp. (Stancor P-6134 or equiv.)

Internal view of the charger showing component placement. The center-tap of the filament winding is unused. The phone plug fits the socket on panel of power unit.

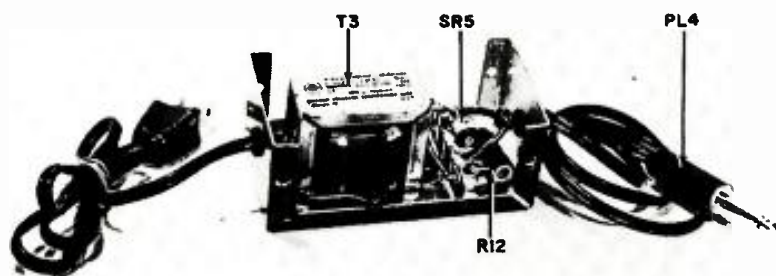



an

R-C

substitution box

By FRANK DAMICO

A wide range of resistor and capacitor values is obtainable with simple construction and switching.

MANY VERSIONS of resistor or capacitor substitution boxes have appeared through the years, ranging from simple units employing a single-deck rotary switch with a dozen or so positions to cover the most popular component values, to those which use multiple switches for greater flexibility. Some units, in an effort to get the most value from the least amount of parts, employ numerous toggle switches in complicated circuits to supply a good many more component values than the basic number used in the unit. These, however, become rather involved. Construction cost, together with the difficulty of operation, often detract from their value.

The author's version of "the most for the least" (Fig. 2) was inspired by the need for a wide-range unit that was to be used, for the most part, in audio experimentation. Every effort was made to supply a wide variety of resistor and capacitor values for the least number of parts, with the switches an important part of the consideration. Complicated switch tossing was also minimized.

The unit employs twelve pairs of resistors, five pairs of tubular capacitors, and two pairs of electrolytics for a total of thirty-eight components. By using a multiplier switch (S_2 in Fig. 1) to connect these basic pairs in series, in parallel, or make them available as single units, a total of fifty-seven resistor and capacitor values is obtained, which is 50 per-cent more than the number of units involved.

Each basic pair provides three values. For example, the pair of 10-ohm resistors, R_1 and R_2 , affords 5 ohms, in parallel; 10 ohms, using one of these alone; and 20 ohms, in series. The pairs were chosen carefully to meet two requirements. To begin with, there is no duplication of values. In addition, "even" values were chosen for the original components so that the values obtained through series or parallel connections would be immediately obvious without resort to calculations. The overlap is such that the total of available resistances and capacitances is

spread out well over a wide range. Thirty-six resistance values are spread out from 5 ohms to 20 megohms. Twenty-one capacitor values range from 50 $\mu\text{f.}$ to 100 $\mu\text{f.}$

A two-gang, 20-position switch that will handle 19 positions plus one "off" position (S_1) selects basic pairs of components. S_2 determines the manner in which the selected pair is used. Fig. 3 indicates how this is done for each of the three possibilities. Capacitors have been used here to illustrate an important point. Where polarity is important, as with electrolytics, the capacitors are always connected to each other and to the output jacks in such a way that no problems arise. J_2 is always the positive end of the capacitor or pair of capacitors, and J_1 is always the negative end of any combination.

Due to the differences indicated in Ohm's Law between connecting a pair of resistors in parallel (or in series) and connecting a pair of capacitors in parallel (or in series), the user must remember that two positions of S_2 will work one way with one type of com-

ponent and another way with the other type. In the series position, resistor pairs are added up, but the value of a pair of capacitors is half that of one taken alone. In parallel, capacitor pairs provide the value of both units added together while resistor pairs become half the value of one unit. To avoid confusion, it would be possible to mark three concentric circles of values around the external knob for S_1 , one circle for each position of S_2 . However, the user is not likely to find this necessary.

Construction

Putting the unit together is fairly simple, with most of the builder's time being devoted to wiring selector S_1 . The placement of parts is shown in Fig. 4. The unit was built into a Bud "Minibox," 8 inches by 6 inches by 3 1/2 inches. The big switch, of course, is wired first. All resistors and the smaller capacitors (C_1 through C_6) have one end connected directly to switch terminals. Of these, all even-numbered components ($R_2, R_4, \text{etc.}$) each have one lead wired

Fig. 1. The main switch, about which the unit is planned, is special but not highly expensive. An added multiplier switch increases the range of values.

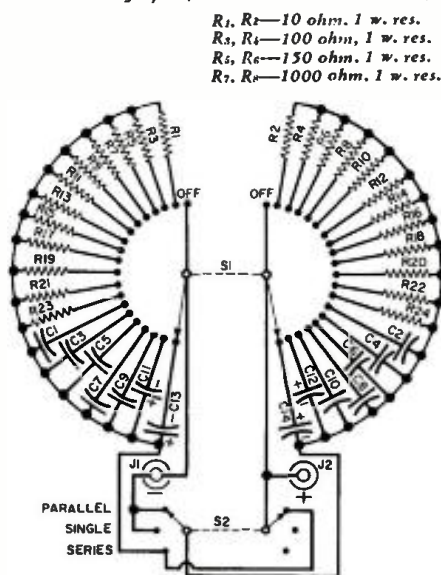

R_1, R_2 —10 ohm, 1 w. res.
 R_3, R_4 —100 ohm, 1 w. res.
 R_5, R_6 —150 ohm, 1 w. res.
 R_7, R_8 —1000 ohm, 1 w. res.

R_9, R_{10} —1500 ohm, 1 w. res.
 R_{11}, R_{12} —10,000 ohm, 1 w. res.
 R_{13}, R_{14} —15,000 ohm, 1 w. res.
 R_{15}, R_{16} —100,000 ohm, 1 w. res.
 R_{17}, R_{18} —150,000 ohm, 1 w. res.
 R_{19}, R_{20} —1 megohm, 1 w. res.
 R_{21}, R_{22} —1.5 megohm, 1 w. res.
 R_{23}, R_{24} —10 megohm, 1 w. res.

Note: All resistors to be $\pm 5\%$ or $\pm 10\%$.

C_1, C_2 —0.001 $\mu\text{f.}$, 600 v. capacitor
 C_3, C_4 —0.01 $\mu\text{f.}$, 600 v. capacitor
 C_5, C_6 —0.1 $\mu\text{f.}$, 600 v. capacitor
 C_7, C_8 —1 $\mu\text{f.}$, 600 v. capacitor
 C_9, C_{10} —5 $\mu\text{f.}$, 400 v. capacitor
 C_{11}, C_{12} —20 $\mu\text{f.}$, 450 v. elec. capacitor
 C_{13}, C_{14} —50 $\mu\text{f.}$, 450 v. elec. capacitor

S_1 —Two-gang, 20-pos.-per-pole, non-shorting rotary switch including "Off" position (JBT MS-20-2)

S_2 —D.p. 3-pos. single-gang, non-shorting rotary switch (Mallory 3223J or equiv.)

J_1, J_2 —Phone tip, banana, or all-purpose jack (1 red, 1 black)

I—Dial plate (optional, marked "Off" through 19, JBT EP-19)

1—Terminal board (for C_7, C_8, C_9, C_{10})

1—Insulating board (for C_{11}, C_{12}, C_{13} , and C_{14} if twist-prong electrolytics are used)

1—8" x 6" x 3 1/2" "Minibox" (Bud CU-2109)

to a terminal on the rear deck (the one nearest the viewer in Fig. 4), and all odd-numbered components each have one lead connected to a terminal on the front deck.

Wire the rear deck first, making the connected component leads as short as possible, with the uncut free leads pointing straight back toward the rear wall of the box. The free ends are then soldered around a "ring," formed from a length of bus bar or heavy copper wire, after trimming these ends as neatly as possible. The front deck is then wired in the same manner, except that it will be necessary to space the bodies of these units away from those on the rear deck.

This should be done by forming a right angle with the lead of each component connected to the front deck. This lead, trimmed to about 1 1/4 inch, is first soldered with the component pointing out from the switch. The lead is then bent at about 3/4 inch from the connection so that the body now points toward the rear wall, parallel to the matching component on the rear deck. These free ends are also trimmed and soldered around a ring, as was done with the rear-deck units on the inner ring.

The rings can be formed by bending the bus bar or heavy wire around a glass jar or round can of suitable diameter. The ring for the rear-deck units is 3 inches in diameter, and the outer front-deck ring is 3 1/4 inches. The free ends of these rings can be joined to complete the circles by forming a spring or spiral made up of #20 solid wire. Simply slip the spring over the

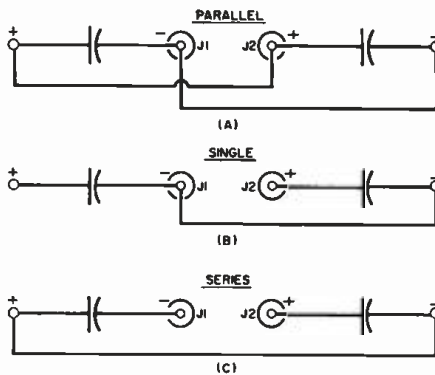

Fig. 3. How component pairs are used in each of three multiplier-switch positions. Polarity of electrolytics is considered.

free ends and solder. The two spirals can be seen above C_{11} and C_{13} (Fig. 4).

C_7 , C_8 , C_9 , and C_{10} are mounted on the terminal board seen above S_1 . C_{11} , C_{12} , C_{13} , and C_{14} are mounted below S_1 on an insulating board. Twist-prong electrolytics were used without insulating wafers, and so this type of mounting was dictated. If tubular electrolytics are to be used, the board can be dispensed with and the capacitors can be strapped to the bottom of the box.

A study of the schematic will show that the box cannot be used as a common negative for the electrolytics. The output jacks (J_1 , J_2) should not only be color coded or otherwise marked to indicate polarity, but should also be insulated from the box. All wiring involving the capacitors mounted on the two boards is completed on the boards before the latter are mounted in their respective positions. Flexible leads

brought out from the boards are connected to appropriate points on S_1 , S_2 , or the rings. The polarity of the electrolytics and the larger tubulars must be observed.

The resistors used were one-watt units of 5 per-cent or 10 per-cent tolerance, but should be reasonably matched on an ohmmeter or bridge. The electrolytics are 450-volt units, and the .5- μ f. capacitors have a 400-volt rating. All the others are 600-volt units. The .0001- μ f. units may be mica or tubular (the author used micas).

If all new construction is attempted, it would be wise to purchase the smallest capacitors available, such as Sprague "Midgets" for the electrolytics and Cornell-Dubilier "Cubs" for the others. Ohmite "Little Devils" are a good choice for the resistors. The use of small-sized components will make construction easier if the recommended box is used—or could result in a more compact unit if desired.

The method of calibrating S_1 used in the author's version (Fig. 1) need not be followed. White bristol paper cemented on a round plate could be employed with the values marked in ink. Or else, a dial plate is available for use with this switch, marked "Off" through "19," and a small chart could be cemented somewhere on the box showing the basic value at each rotation of the switch.

As noted earlier, this substitution box was originally planned with audio work in mind. However, its broad and comprehensive coverage has made it just as valuable in every other application to which it has been put. —30—

Fig. 2. A pair of connector jacks and only two controls, for choosing any of 57 values, keep the box functionally simple.

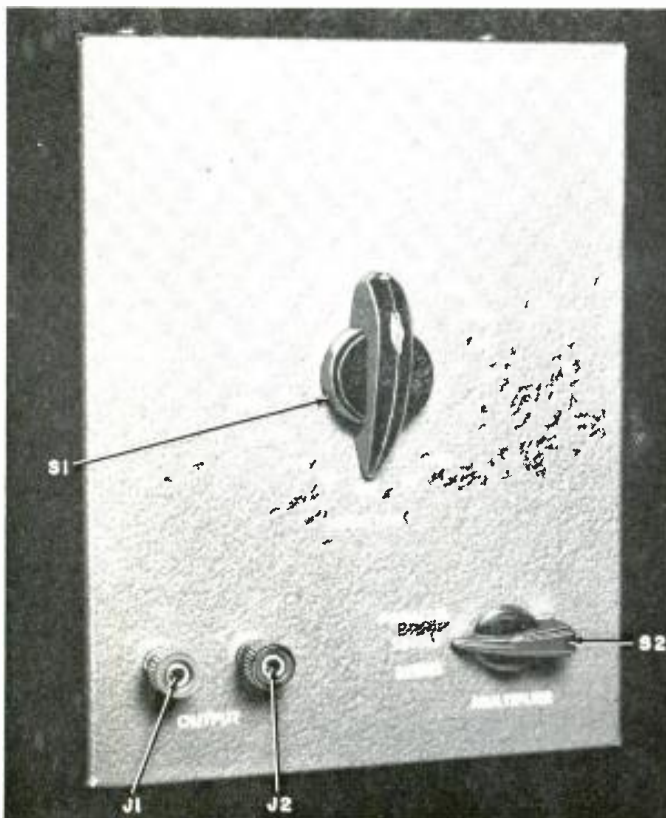
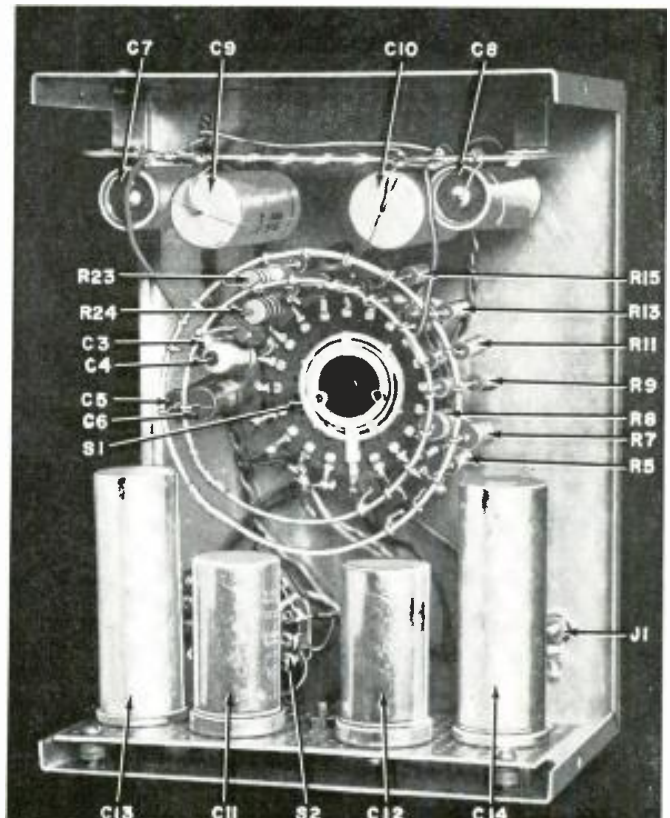

Fig. 4. Rear view shows relationship between component pairs on both switch decks and two "rings" for common connections.





Voltage Regulation for Transistors

By KENNETH BRAMHAM

**Especially useful with supplies for transistorized gear,
inexpensive semiconductor diodes may be used for
close stabilization of other low-voltage sources.**

THE ABILITY to design a simple voltage regulator circuit is often useful to the service technician when he is working on transistorized communications or industrial equipment. Service problems tracked down to a varying supply voltage, or to battery-operated equipment to be converted for power-line operation, are both instances where the ability to add voltage regulation is useful. For the technician building his own transistorized test equipment or the ham turning to transistorized gear, a few basic voltage-regulator circuits are essential. The type to be described fills a need for low-cost regulators in the .3- to 3-volt range, which includes the bias voltage of many transistor circuits.

Why this special need for regulation with transistor circuits? The transistor is a current-drawing device operating at relatively low voltages. Wide variations of current drain often occur in normal operation, and cause widely varying voltage drops across the internal resistance of the supply. These voltage changes are particularly bothersome in the case of circuits using a fixed bias supply, where the relation of bias to "B" voltage must be maintained within narrow limits if the circuit is to work as intended.

A voltage-reference component is, of course, the first requirement of any regulator circuit. For our low-voltage regulator, the silicon junction diode

will be used as a reference element, and a brief review of its characteristics is in order. The junction diodes so familiar to the service technician as power rectifiers have the characteristics of low resistance in the forward direction and a very high resistance when the polarity of the applied voltage is reversed. Each diode type has certain limitations as to the maximum current in the forward direction and maximum voltage in the reverse direction. If the forward-current rating is exceeded, the diode junction overheats and is destroyed; if the inverse voltage

rating is exceeded, the normally very small reverse current, due to secondary emission in the junction, starts to increase and creates an "avalanche" of increasing current which, in turn, overheats and destroys the junction. The "perfect" diode would have infinite resistance in the inverse direction and no resistance in the forward direction. In short, it would therefore have no limitations as to current and voltage.

A voltage-current curve for a typical silicon rectifier is shown in Fig. 1. Here we see that a change in current through the diode from almost zero to 100 milliamperes results in a change in the voltage drop across the diode from .6 to .8 volt, but that this change in voltage is not linear. (The linear voltage change across a pure resistance would be a straight line.) It is possible, however, to use a small part of the voltage-current curve to give a reasonably small voltage change for a current change of, say, 20 or 30 ma. This suggests the use of a semiconductor diode as a voltage-reference element of sufficient accuracy for our purpose, although not of the accuracy expected with a higher-cost zener diode manufactured specifically for voltage-regulator service.

And now, another brief review—the basic principles of voltage regulation. Voltage variations across a load originate in two ways; through changes in voltage of the source (which may be

Fig. 1. For a given range of current variation, voltage across a silicon diode, for the most part, changes little.

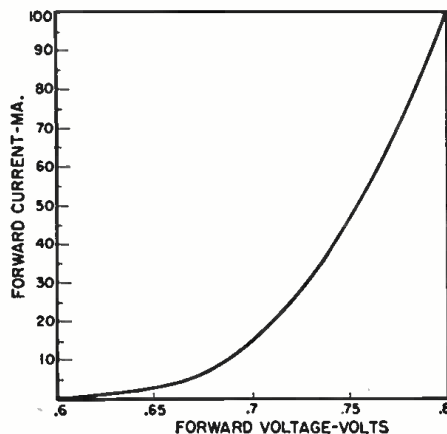

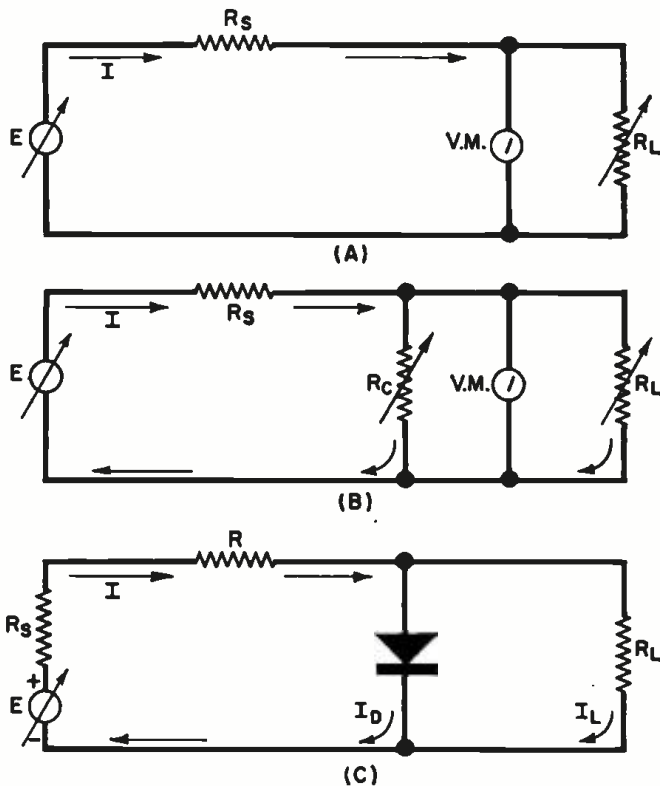

Fig. 2. Variations in the output voltage of a power supply (A) can arise either because of changes in source voltage E or in the load R_L , producing changes in the drop across the internal resistance of the supply, R_s . It is possible to adjust for such changes (B) by inserting a potentiometer, R_c , and resetting it manually. For automatic, quick-acting regulation (C), resistor R is put in series with the load and a regulating diode is put across the load. Fig. 1 shows the voltage-current characteristic of the diode making this possible.

either a rectified a.c. supply or a battery), and through changes in the resistance of the load (causing a change in voltage drop across the internal resistance of the source). A simplified, equivalent circuit of a typical power supply and load is given in Fig. 2A where the voltage source, E , is shown variable, representing either an a.c. power line subject to fluctuations or a battery that deteriorates with use. The resistor, R_s , represents the power-supply components in the case of an a.c. supply, or the internal resistance of a battery. The load resistor, R_L , represents the circuit being supplied, and is shown variable to account for changes in current drain. If either of the two variable components is changed, a change in voltage across the load will result.

Our equivalent circuit is shown modified in Fig. 2B to include a variable resistor, R_c , across the load. It is now possible to compensate for changes in source voltage and load resistance by adjusting R_c , thus regulating the current through R , and the voltage drop across it, to maintain a constant voltage across the load. A manual compensation circuit of this type would hardly be practical for actual use, as it would require constant attendance and would depend upon the voltmeter's efficiency and operator's reaction time for its operating speed. Obviously, we need some form of *automatic* compensating resistance to replace both meter and operator. The silicon junction diode is the component we will use.

A very simple voltage regulator circuit is shown in Fig. 2C consisting of a regulating resistor R (which is much greater than the source resistance) placed in series with the supply, and a silicon rectifier diode across the load.

Variations in current through the diode, caused either by supply-voltage changes or by the effective resistance of the load (in parallel with the diode), will produce voltage variations in accordance with the voltage-current curve of Fig. 1. By limiting the diode current to a range from, say, 10 to 20 ma., we are able to limit the voltage range from .69 to .71 volt, or .7 volt \pm 1.43 per-cent. This tolerance is more than adequate for the majority of applications encountered by the technician. (In theory, we have one other variable besides current and voltage; this is the temperature of the silicon junction, which can be ignored in most service jobs.)

Now let us apply this regulator circuit to an actual case. A regulated supply is needed to provide 1.4 volts to a transistor circuit from a 117-volt a.c. supply, replacing a zinc-carbon (1.5-volt) or mercury (1.34-volt) dry cell. The load current is known to vary from 5 to 10 ma., while the a.c. supply is known to vary from 95 to 120 volts. A 6.3-volt filament transformer is a stock component, as are silicon rectifier diodes. One diode and a resistance-capacitor filter along with the transformer can be used to make a half-wave rectifier with a d.c. output of 3.5 to 4.5 volts when connected to our 95- to 120-volt supply. From Fig. 1 we see

that a diode conducting 15 ma. will have .7 volt across it; Two diodes in series will therefore give the required 1.4 volts. The completed circuit is shown in Fig. 3; all that remains is to calculate the value of R , from the following formula:

$$R = \frac{V - V_o}{I_L + I_d}$$

where, V = mean rectified supply voltage; V_o = desired output voltage; I_d = diode current; and I_L = mean output current.

Thus,

$$R = \frac{4 - 1.4}{.0075 + .015} = 116 \text{ ohms.}$$

The closest standard value likely to be in stock would be 100 ohms, and this is the value we choose for R .

Now the worst possible conditions of voltage and current will be 4.5-volts d.c. with a load of 5 ma., and 3.5-volts d.c. with a load of 10 ma. In the first case, the drop across R is measured as 3.1 volts. Thus, by Ohm's Law, current through this 100-ohm resistor is 31 ma. Since I_d has been given as 5 ma., this leaves 26 ma. as current through the diode. Fig. 1 shows that, with this current through it, the drop across one diode will be about .74 volt—or 1.44 volts through two of them.

With 3.5 volts from the supply and 10 ma. drawn by the load (the other extreme), 2.1 volts are measured across R , indicating 21 ma. total current. Thus I_d is 11 ma., the drop across one diode (Fig. 1) is .69 volt and, across two, 1.38 volts.

This type of circuit is not limited to silicon diodes. The germanium junction diode may be used, and with much greater accuracy than the silicon diode, but the voltage across a germanium junction is in the region of .3 volt and circuit values must be calculated around this level. The combination of a silicon and a germanium diode in series can be convenient when a 1-volt reference is needed. In fact, various combinations permit flexibility in establishing different regulated voltages.

However, it is not practical to apply this circuit, using semiconductor diodes, where output voltage requirements are so high as to need more than three or four diodes. The reason is that the cost then exceeds that of a regular zener diode manufactured specifically for voltage regulation. The technique can, however, be used with good results in such low-voltage applications as the transistor bias supply and other transistor circuits.

Fig. 3. Silicon (or germanium) diodes can be used in series to obtain a stable output at a desired voltage from a relatively unstable source, such as the power supply shown in broken lines.

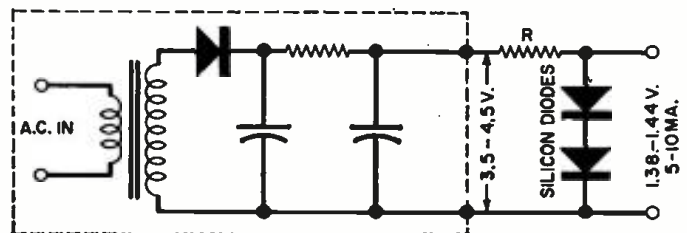

By JOHN T. FRYE



Oscillating Canine

BARNEY stopped short in the door of the service department as he heard a droning voice, mixed in with slow-speed code, emanating from a three-way portable sitting on the end of the service bench.

"What station's that?" he demanded of Mac, his employer, who was looking down at the receiver with a smile of satisfaction.

"It's the aviation range station at Center City operating on a frequency of 266 kilocycles," Mac explained. "This station puts out a continuous weather report for planes in this general area. The reports are on tapes that are changed at frequent intervals. That 'dit-dah, dit-dah, dit-dah' in the background shows we're not in the center of the beam."

"Just a minute, just a doggoned minute!" Barney interrupted. "That's a broadcast receiver, pure and simple. How come it's pulling in that low-frequency station—and why is it?"

"The receiver belongs to Mr. Smith, owner of the Bon Ton Department Store. He is a flying enthusiast with his own plane. As such, he likes to keep an eye on the weather, even when he is down at the office. When conditions are particularly good, he can sneak off for an hour or so of flying. With this in mind, he asked me if I could convert one of the many broadcast receivers he had lying around the house so that it would pick up this weather report.

"At first I shied away from the idea. I was thinking in terms of trying to make the broadcast receiver tune the whole low-frequency band from 200 to 550 kilocycles; and you know what a complete re-doing of the front end that would take; then, too, I was concerned with the idea an aviation weather receiver should be very, very dependable because the flier's life might depend on it. But Mr. Smith explained he only wanted to receive just this one station and that the receiver would be used only in his office or at his home. His plane was fully equipped with all sorts of standard aviation radio equipment. This put a different light on the project, and I agreed to see what I could do.

"Actually the solution turned out to be ridiculously simple. After putting the receiver into good operating condition—it needed new filter capacitors—I had only to pad the oscillator and antenna circuits down to where the 266 kc. station could be picked up with the receiver dial sitting on 600 kc. I picked this dial setting so as to have a little tuning leeway and yet be able to use most of the capacity in the receiver's tuning capacitor.

"For padders I used the double compression trimmers out of a discarded i.f. transformer. These had a measured maximum capacity of about 200 μf . each; and one was more than enough to lower the oscillator frequency from 1056, where it sat to tune in 600 kc., down to 722 kc., where it had to be to produce a 456 difference beat with 266 kc. However, since you have to quadruple the capacity of a parallel tuned circuit to halve the resonant frequency, I knew I'd have to use considerably more extra capacity than the 200 μf . available in the other trimmer to lower the frequency of the antenna circuit from 600 to 266 kc. A little cut-and-try procedure, using the grid-dip oscillator to keep track of resonance, revealed that a .001- μf . silver mica in parallel with the 200- μf . trimmer and the set's tuning capacitor did the job in fine shape."

"Having to listen to that program very long would drive me nuts," Barney said as the taped voice, punctuated with the slow code, droned on and on. "It would be easy, though, to use a d.p.s.t. switch to cut out the extra capacities and restore ordinary broadcast reception."

"Yes, and I mentioned that to Mr. Smith; but he said it wasn't worth the trouble to him. He already had lots of broadcast receivers," Mac answered.

"Well," Barney said with a deep sigh, "you've solved your problem, but I've still got mine."

"You mean you're still working on that little transistor set you started on this time yesterday?"

"Yes, and at the rate I'm going, I'll be still working on it a week from now,

That little monster is a real live dog."

"The only trouble is that it oscillates, isn't it?"

"Oh yes, that's the *only* trouble," Barney answered sarcastically; "but I've got news for you: running down oscillation in a printed circuit transistor receiver is a lot different than hunting the same difficulty in a tube receiver."

"From what I've heard, it's an r.f. or i.f. rather than an audio oscillation."

"True. You get a heterodyne whistle on every station."

"I suppose you started by changing the battery."

"Right. I'm hep to the fact that some of the cheaper receivers depend on the low resistance of a good battery to tie signal-carrying return circuits down to ground. When the battery is partially exhausted, its internal resistance goes up and permits coupling between some of the return circuits that can cause oscillation. A new battery made no difference."

"Then I suppose you paralleled all the decoupling capacitors, one at a time, with a unit you knew to be good."

"Yes, and since this is a well-designed receiver, there were several of those capacitors. I had to remove the speaker to get at some of them, but I never missed a one. I'll stake my reputation as a hot-shot electronic technician that there are no open capacitors."

"At the moment you wouldn't be putting up much," Mac said with a wry grin. "About next, I imagine you checked the alignment."

"Your crystal ball is clear today! I went over the alignment two or three times, and there is nothing wrong in that department."

"How about the possibility that the printed circuit board was cracked so as to produce a break in the grounding lead? That would leave part of the grounded circuit floating."

"I thought of that, too," Barney said triumphantly, "and I jumped across various portions of the ground bus. It's OK."

"H-m-m-m-m, how did a careful voltage check turn out? Maybe some of the bias resistors have changed value and altered stage gain."

"All voltages are right on the button, but I did not stop there. I pulled all the transistors from their sockets and did a complete resistance check. The resistances at all check points provided in the service data are well within five per-cent of values specified."

"This is getting interesting," Mac said as he reached over and picked up the circuit diagram. "Looking at this, I can see one very nasty possibility: the i.f. stages are neutralized, and if one of those neutralizing capacitors opened up, or if this resistor in series with a neutralizing capacitor opened up, the stage would oscillate quite merrily."

"You've got to do better than that," Barney gloated. "I used a little variable trimmer capacitor in place of each of those little ceramic neutralizing capacitors and varied it back and forth

(Continued on page 92)



Vertical Non-Linearity



Horizontal Non-Linearity



Smeared Picture



Loss of Vertical Sync



Heater-Cathode Leakage

PINPOINT TV TROUBLES



Video I.F. Overload



60-Cycle Hum in Picture



Loss of Horizontal Sync



Loss of Vertical Sweep

IN 1/2 THE TIME

B&K TELEVISION ANALYST

**By Easy Point-to-Point Signal Injection,
You See the Trouble on the TV Screen and
Correct it—Faster and More Profitably!**

Most useful instrument in TV servicing today!
Enables you to inject your own TV signal at any point and watch the resulting test pattern on the picture tube itself. Makes it quick and easy to isolate, pinpoint, and correct TV trouble in any stage throughout the video, audio, r.f., i.f., sync, and sweep sections of black & white and color television sets—including intermittents. Makes external scope or wave-form interpretation unnecessary. Enables any serviceman to cut servicing time in half, service more TV sets in less time, really satisfy more customers, and make more money. Color generator provides both rainbow pattern and color bars. Net \$279⁹⁵



Solve Rough Sweep Output Problems with **DYNA-SWEEP CIRCUIT ANALYZER**

Saves many hours of service work. Provides vertical and horizontal sync and driving pulses that enable you more easily and quickly to check out every stage in the sync and sweep sections of a television receiver. Tracks down troubles in the horizontal and vertical output circuit including defective output transformer and yoke; checks for shorted turns, leakage, opens, short circuits, and continuity. Includes unique high-voltage indication. Eliminates trial and error replacements.

Model A107 Dyna-Sweep. Companion unit for use only with B&K Model 1075 Television Analyst for driving source. Net, \$54.95

Model 1070 Dyna-Sweep. Same as Model A107 but has its own horizontal and vertical driving pulse, and is used independently of the Model 1075 Television Analyst, for separate testing. Net, \$74.95

MODEL 1075 TELEVISION ANALYST
Makes Money for Thousands of Service Technicians



See Your B&K Distributor
or Write for Bulletin ST25-N

B & K MANUFACTURING CO.

1801 W. BELLE PLAINE AVE • CHICAGO 13, ILL.

Canada: Atlas Radio Corp., 50 Wingold, Toronto 10, Ont.
Export: Empire Exporters, 277 Broadway, New York 7, U.S.A.

HEATH
PRESENTS
18
NEW
ITEMS for
your
summertime
enjoyment

a subsidiary of
DAYSTROM, INCORPORATED



"ECONOMY" STEREO AM/FM TUNER KIT (AJ-10)

Full fidelity AM and FM reception, plus up-to-the-minute design features are yours at minimum cost with this new Heathkit stereo tuner. Features include: 2.5uv sensitivity for 20 db quieting; individual flywheel tuning; separate magic-eye tuning indicators for AM and FM; AM bandwidth switch; 3-position (off-half-full) automatic frequency control (AFC); FM multiplex adapter output. 14 lbs.

AJ-10 \$59⁹⁵

\$6.00 dn., \$6.00 mo.

HI-FI RATED 25/25 WATT STEREO AMPLIFIER (AA-50)

In one handsome package, you get both stereo power and control, with a host of deluxe features. Hi-fi rated at 25 watts per stereo channel (50 watts mono), this new Heathkit design includes channel separation control; new mixed center speaker output; stereo reverse and balance controls; separate tone controls for each channel with ganged volume controls; five switch-selected inputs for each channel (stereo "mag. phono," tape head, 3 hi-level). Extra input for mono "mag. phono." Special outputs for tape recording. Ease of assembly assured by two circuit boards. 30 lbs.

AA-50 \$79⁹⁵

\$8.00 dn., \$8.00 mo.

**MIXED LOWS
STEREO CROSSOVER KIT (AN-10)**

Permits using one bass woofer and more economical "wing" speakers for stereo. Delivers non-directional bass of both channels below 250 cps to one woofer; passes higher frequencies to wing speaker. Takes 25 watts per channel; 8, 16 ohm woofers; 8 ohm high freq. speakers. 10 lbs.

AN-10 \$19⁹⁵

**Player Kit by Heath—
Mechanism by Garrard**

**MANUAL
STEREO RECORD PLAYER KIT (AD-10)**

Rubber matted heavy turntable is shock mounted, and idler wheels retract to prevent flat spots. 4-pole motor; 16, 33½, 45 and 78 RPM; Sonatone 8TA 4-SD ceramic stereo turnover cartridge with diamond and sapphire styli; preassembled mechanism and base. 10 lbs.

AD-10 \$33⁹⁵



Quality Stereo at Minimum Cost

ECONOMY STEREO PREAMPLIFIER KIT (AA-20)

A low-cost, versatile stereo preamp-control center. Four inputs each channel accept magnetic cartridge, crystal or ceramic cartridge, and tuner, tape, TV, etc. Six position function switch gives flexible stereo or monophonic use. Features cathode follower outputs plus hi-level outputs for tape recorder drive, calibrated Baxandall-type tone controls for each channel, clutch-type volume controls, filament balance controls, and accessory AC sockets. Self-powered. Styled in black and gold. 8 lbs.

AA-20 **\$34.95**

PROFESSIONAL RATED 35/35 WATT BASIC AMPLIFIER KIT (AA-40)

Doubles as a superb dual 35 watt stereo amplifier or a full-fledged 70 watt monophonic amplifier. Features a mixed-channels center speaker output for fill-in sound, and individual level controls for stereo. "Stereo-Mono" switch ties both amplifiers to one level control for monophonic use. Dual outputs for 4, 8, 16, and 32 ohm speakers. Paralleling outputs for 70 watt monophonic use matches 2, 4, 8, and 16 ohm speakers. 41 lbs.

AA-40 **\$79.95**
\$8.00 dn., \$8.00 mo.

HI-FI RATED 14/14 WATT BASIC STEREO AMPLIFIER KIT (AA-30) (not illustrated)

14 watts per channel, separate level controls, local/remote power switch, circuit board. Styled like AA-40 above. 21 lbs.

AA-30 **\$45.95**

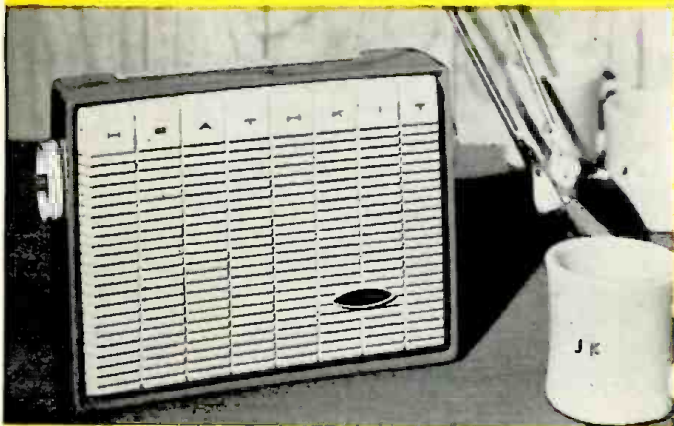

Perfect for Summer Sun and Fun!

6-TRANSISTOR PORTABLE RADIO KITS (XR-2 Series)

Assembled in only a few hours, both of these models incorporate superior design features that will give you portable-listening enjoyment day after day. Vernier tuning control gives smooth, easily-separated station tuning. Large 4" x 6" PM speaker with heavy magnet provides "big set" richness of tone. Operates on standard size "D" flashlight batteries. Six Texas Instrument transistors.

XR-2P (plastic) 6 lbs. **\$29.95**
XR-2L (simulated leather) 7 lbs. **\$34.95**

MOBILE PA SOUND EQUIPMENT

Perfect for political campaigns, advertising, sporting events... hundreds of PA applications. The 10 watt amplifier operates from any 12 to 15 volt battery. Features an all-transistor circuit for rugged, dependable performance and long life. No warm-up time required. Mounts easily under auto dash. Inputs for microphone and music source. Two channel mixing circuit "fades" auxiliary input when used with microphone supplied... lets you override music with voice without changing control settings. Outputs for 8 and 16 ohm speakers.

MOBILE PA AMPLIFIER KIT (AA-80) 7 lbs. \$39.95

COMMERCIAL SOUND SYSTEM (CSS-1) consists of AA-80 Amplifier; microphone; car-top carrier; one 16 ohm, 15 watt outdoor speaker. 19 lbs. **\$84.95**

COMMERCIAL SOUND SYSTEM (CSS-2) same as above except with 2 speakers. 25 lbs. **\$99.95**

EXTRA HORN SPEAKERS (401-38): \$19.95
As described above. 6 lbs.

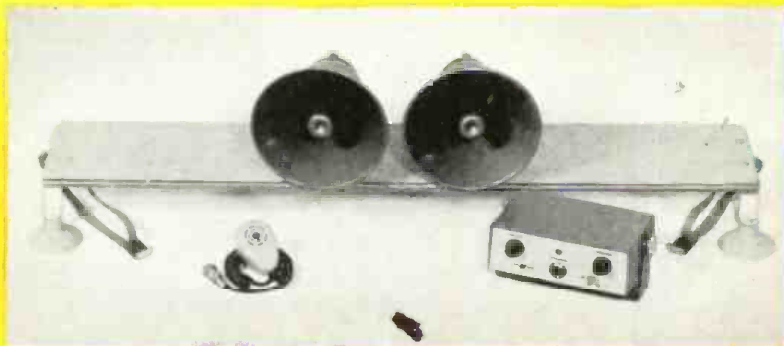

FREE CATALOG

Send for your free Heathkit catalog today... describes over 150 hi-fi, ham, test, marine, and general kits.

NEW! Citizens Band Transceiver...

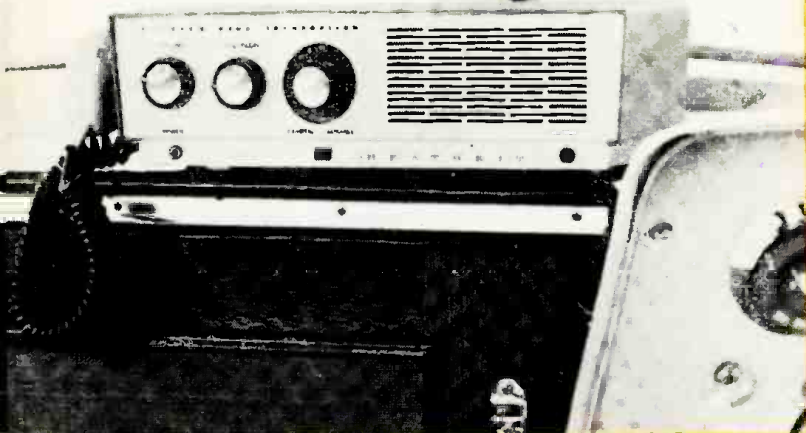

CITIZENS BAND TRANSCEIVER KIT (GW-10)

Now, from Heath, a new 2-way Citizens Band Transceiver with every modern improvement for clear, noise-free operation. The superheterodyne receiver section may be either crystal controlled on any one predetermined channel, or all 23 channels may be continuously tuned by the front panel tuning knob; a front panel switch selects either crystal or variable control. An automatic "series gate" noise limiter minimizes impulse-type noises (ignition interference, etc.). Adjustable squelch control silences the receiver during "stand-by." Press-to-talk microphone features a coil-cord connection to the transceiver. Transmitter is crystal controlled on any one of 23 assigned channel frequencies chosen. Order model GW-10A for 117v AC operation; order GW-10D for 6 and 12v DC operation, both with self-contained power supply. 11 lbs.

GW-10A or GW-10D **\$62⁹⁵** each

\$6.30 dn., \$6.00 mo.



3 band "Mariner" TRANSISTOR DIRECTION FINDER KIT (DF-3)

Features nine-transistor circuit, flashlight battery power supply, pre-assembled, pre-aligned tuning section, three bands (beacon-aeronautical, broadcast and marine-telephone), and a new "sense" antenna system that eliminates 180° ambiguity in bearings. Splash resistant. 13 lbs.

DF-3 **\$99⁹⁵**

\$10.00 dn., \$9.00 mo.



For Boating, Fishing, Skindiving

TRANSISTOR DEPTH SOUNDER KIT (DS-1)

Completely transistorized. Indicates depth, type of bottom, and submerged objects, from 0 to 100 feet. Powered by 6 flashlight batteries for complete portability. Transducer included may be mounted through hull, or temporarily outboard. Rugged, splash-resistant cabinet. Adjustable mounting bracket. 10 lbs.

DS-1 **\$69⁹⁵**

\$7.00 dn., \$7.00 mo.



Ten-transistor "Mohican"

GENERAL COVERAGE RECEIVER KIT (GC-1)

First kit of its kind to use ceramic IF "Transfilters." Covers 550 to 30 mc on 5 bands, with 5 separately calibrated bands to cover amateur frequencies (including 11 meter citizens band). Powered by 8 flashlight batteries. Built-in 54" whip antenna, tuning meter, headphone jack. 20 lbs.

GC-1 **\$109⁹⁵**

(Less Batteries)

\$11.00 dn., \$10.00 mo.

First of a Series

EDUCATIONAL KIT (EK-1)

Teaches, as you build, the basic "yardsticks" of electronics... opens up fascinating areas of study for youngsters and adults alike. The combination kit and text-workbook gives you a practical demonstration of the principles of voltage, current and resistance, the theory and construction of direct current series and parallel circuits, voltmeter, ammeter and ohmmeter circuits and the application of ohms law to these circuits. The completed meter is used to verify ohms law and the maximum power transfer theorem, one of the most important theorems in electronics. The finished kit, a practical volt-ohm-milliammeter, may be used in a variety of applications. Procedures for checking home appliances and automobile circuits included with the kit. The EK-1 will serve as a prerequisite to following Heathkit Educational kits; get started NOW in this "learn-by-doing" series. 4 lbs.

EK-1 **\$19⁹⁵**



Outstanding Professional Quality...

**MUTUAL CONDUCTANCE
TUBE TESTER KIT (TT-1)**

An impressive list of electronic and mechanical features make this tube tester one of the finest values in the electronics industry. Test Gm (amplifiers) from 0 to 24,000 micromhos. Emission. Leakage. Grid Current (1/4 microampere sensitivity), Voltage Regulators (built-in variable DC power supply), low power Thyatron and Eye tubes. Features 300, 450 and 600 ma constant current heater supplies. Life test, Hybrid tube test, built-in switch-operated calibration circuit. Large, easy-to-read meter. Constant tension, free rolling illuminated chart. Kit includes 7 wiring harnesses. Assembly skill of technician or higher recommended; assembly time, 40 hours average. Black leatherette case with white trim, nylon feet, removable top. A specialized tool of unusual value that will pay for itself many times over. 27 lbs.

TT-1 **\$134⁹⁵**
\$13.50 dn., \$12.00 mo.



**New Improved Design
TRANSISTOR MOBILE
POWER SUPPLY (HP-10)**

All transistor circuit! Operates from 11 to 15VDC input; at 12VDC provides 600 VDC @ 200ma, or 600VDC @ 150ma & 300VDC @ 100ma simultaneously, at 120 watts. Negative 125V @ 30 ma also provided. Max. ambient temp. 150° @ 120 watts ICAS. Input required: 2 amps idling; 13 amps full output. Includes heavy filtering, remote relay primary control, silicon rectifiers, aluminum heat sinks. 10 lbs.

HP-10 **\$44⁹⁵**

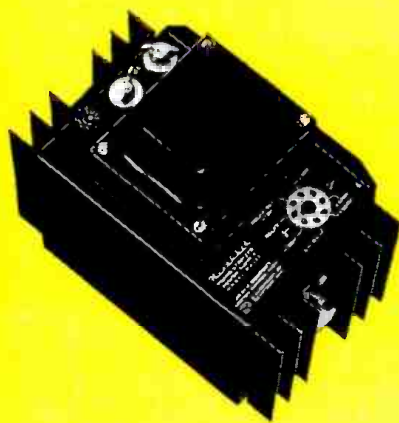

**NEW Six and Ten Meter
TRANSCEIVER KITS
(HW-19 and HW-29)**

Combination crystal controlled transmitters and variable tuned receivers operating fixed or mobile on the 6 and 10 meter amateur bands (50-54 mc for HW-29 and 28-29.7 mc for HW-19). Superregenerative receiver pulls in signals of 1 microvolt; transmitter input approximately 5 watts. Built-in 117 VAC power supply, metering jack, press-to-talk switch. 10 lbs.

HW-19 (10 meters) **\$39⁹⁵**
HW-29 (6 meters) **\$39⁹⁵** ea.
Less crystal



send today for Your
FREE HEATHKIT® CATALOG

Over 150 items of hi-fi,
marine, amateur, test and general
equipment are illustrated
and described in the complete
Heathkit catalog.



**Heathkit® gives you more
in these 10 ways**

1. BUILDING A HEATHKIT IS EASY—Check-by-step instruction manuals make it virtually impossible for you to fail.
2. BUILDING A HEATHKIT IS QUICK—No complicated, technical jargon for you to decipher; at most, a Heathkit takes only a few evenings to assemble.
3. BUILDING A HEATHKIT IS ECONOMICAL—Mass production and purchasing economies are passed directly along to you, our customers.
4. BUILDING A HEATHKIT IS EDUCATIONAL—As you build, you learn . . . more about electronics, more about the component units and when and where to add them.
5. BUILDING A HEATHKIT IS FUN—Nothing quite equals the sense of achievement you receive when you successfully complete a Heathkit unit and "tune-in" for the first time.
6. YOUR HEATHKIT IS GUARANTEED—Every Heathkit unit is guaranteed to meet advertised performance specifications . . . or your money will be cheerfully refunded.
7. YOUR HEATHKIT IS AVAILABLE ON CONVENIENT CREDIT—Our time payment plan makes it possible for you to order now . . . pay later.
8. YOUR HEATHKIT IS TOPS IN QUALITY—The very finest in electronic equipment comes to you in kit form from the Heath Company.
9. HEATHKIT DEALERS CAN SERVE YOU LOCALLY—Carefully selected Heathkit representatives are available in many localities. The convenience of local Heathkit sales and service costs but a few dollars more.
10. HEATHKIT SERVICE IS CUSTOMER SERVICE—Our staff of technical experts is always ready to answer your questions or help you if you have any difficulty.

A



ORDERING INSTRUCTIONS

Fill out the order blank below. Include charges for parcel post according to weights shown. Express orders shipped delivery charges collect. All prices F.O.B. Benton Harbor, Mich. A 20% deposit is required on all C.O.D. orders. Prices subject to change without notice.

DAYSTROM, INCORPORATED

HEATH COMPANY, Benton Harbor 15, Michigan

Please send the following HEATHKITS:

ITEM	MODEL NO.	PRICE

Ship via () Parcel Post () Express () COD () Best Way

() SEND MY FREE COPY OF YOUR COMPLETE CATALOG

Name _____

Address _____

City _____ Zone _____ State _____

Dealer and export prices slightly higher.

WHO NEEDS MILES OF WIRE?

GET
HOME ELECTRICITY
ANYWHERE
WITH A

terado CONVERTER

Change 6 or 12 volt D.C. to
110 volt, 60 cycle A.C.

No Installation—Just plug into
cigarette lighter of car, truck,
or boat, and it's ready to go!

Operate lights, elec-
tric shavers, dictation
machines, record
players, small electric
tools, portable TV, and
testing equipment.

Models from 15
to 200 watts,
priced as low as **\$1295**



See Your Electronic Parts Dealer or Jobber
terado COMPANY
DESIGNERS & MFRS OF ELECTRONIC EQUIPMENT SINCE 1927
1058 RAYMOND AVE., ST. PAUL 14, MINNESOTA
In Canada: ATLAS RADIO CORP. LTD.—Toronto, Ont.

Ask By Name For
GENUINE
your assurance
of brand name
quality

"NO NOISE" PRODUCTS



NO-NOISE VOLUME CONTROL and CONTACT RESTORER

- Lubricates
- Cleans
- Not a Carbon Tet Solution
- 2 Oz. Bottle
- Protects
- 6 Oz. Spray Can

\$100 \$225

Net to Servicemen

NO-NOISE TUNER-TONIC With PERMA-FILM

- Cleans, lubricates, restores all tuners, including water type.
- Non-toxic, non-inflammable.
- For TV, radio and FM use.
- Economical — a little does a lot.

6 Oz. Aerosol Can
\$325

Net to Servicemen



FREE At Your Jobbers 5" PLASTIC EXTENDER

- Push Button Assembly
- For Pin-Point Applications
- Does Not Cause Shorts

ELECTRONIC CHEMICAL CORP.

813 Communipaw Avenue Jersey City 4, N. J.

P.S. Be Sure to Ask for
NO-NOISE RUBBER COAT 6 Oz. Spray Can **\$325**



Fig. 1. Using a 19-in. (diagonal measurement) CRT, set width is only 18 in.

19-inch Transistor TV

Motorola is now producing this self-contained,
battery receiver that also works from a.c. line.

A SPECIALLY designed battery, a new transistor tuner, and a redesigned CRT have helped make possible Motorola's first commercial, portable TV with a large screen. The set (Fig. 1) weighs in at 40 pounds including the battery and features a telescoping antenna for completely independent operation.

Its 19AEP4, 114° CRT is a 19XP4 whose gun structure has been modified to give sharp focus with only 100 volts on the screen (G_2). Also the filament has been designed for 12.6 volts at 150 ma.

The sensitive front end is a *Standard Coil* turret tuner using three transistors—r.f. amplifier, oscillator, and mixer—to which strips for u.h.f. reception can be added. The noise figure is 10 db, and a 15-microvolt signal will produce the 20-volt peak-to-peak output from the video amplifier needed to drive the CRT. The tuner can be seen on the hand-wired vertical chassis in the upper, left-hand corner of Fig. 2.

The 5-pound, rechargeable, silver-cadmium battery (20-22 volts) maintains its output well for the playing cycle of five to six hours. Guaranteed for a full year, it can be recharged at least 500 times. Charge begins when a detachable line cord is plugged into an a.c. outlet while the receiver is in the "off" condition, and is automatically interrupted by a relay when full charge is reached. If the receiver is turned on while the line cord is connected, the battery is disconnected and the built-in charger becomes the power supply for the receiver circuits. Available separately at \$88, this power pack is estimated to provide viewing at the cost of two cents per hour.

Using 23 transistors and 12 diodes, the circuit includes a three-stage i.f. amplifier; a two-stage video amplifier; and a two-stage, amplified, keyed a.g.c. circuit in conjunction with a three-position sensitivity switch. The push-pull audio output delivers $\frac{3}{4}$ watt at 10% distortion.

A regulated, 15-kv. flyback supply provides high voltage. Regulation permits the same brightness and sharpness obtained with supplies rated at 18-20 kv., which actually fall off drastically under normal loading. This circuit also provides "B+" for the video amplifier to obtain sufficient drive for the CRT.

Dubbed the "Astronaut," the luggage-styled set features a carrying handle and detachable front cover to protect the CRT in transit. Its price is \$275 excluding the battery pack. —50—

Fig. 2. Wrap-around chassis takes little room. CRT determines over-all size.

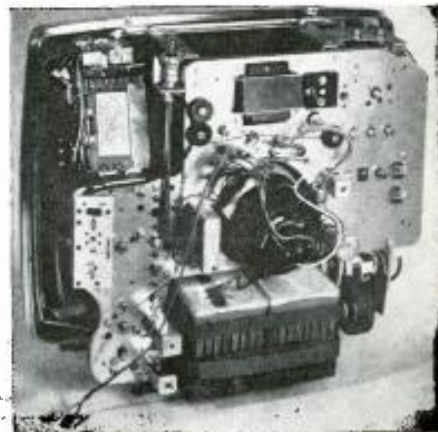

NEW

LAFAYETTE HE-15 CITIZENS BAND 11 METER 2-WAY SUPERHETERODYNE TRANSCEIVER

MADE IN U.S.A.



**COMPLETELY WIRED
NOT A KIT!**

64.50

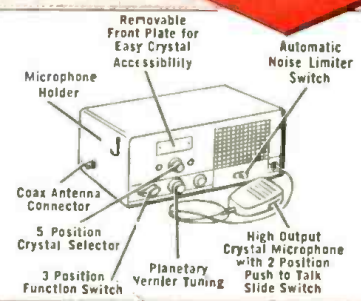

ONLY 5.00 DOWN

Not Superregenerative but **SUPERHET!**



The Lafayette HE-15 meets all FCC requirements and operates in much the same manner as police and other short wave communications systems. The Transceiver features 5 crystal controlled transmitting channels operating at a maximum legal power input of 5 watts fully modulated. RF stage in both transmitter and receiver. Any one of 5 transmitting frequencies may be instantly selected by the 5 position crystal selector on the front panel. These 5 crystals are readily accessible by means of a removable front plate and this may be easily interchanged with any 5 crystals of the remaining 22 allocated citizens band frequencies.

The Superheterodyne receiver is tuneable over the full 22 channel band with 3 watts audio output. Controls include a 3 position function switch (transmit, receive, and transmit with spring return), planetary vernier tuning plus squelch noise limiter control switch. All coils are ferrite tuned. Output impedance matches 52 and 72 ohm antenna with Amphenol type coax connector for operating into dipole, ground plane or rod antenna. Has large 4" PM speaker; input jack for crystal or ceramic microphone; power receptacle in rear for AC line and 6 or 12 volt external power supply. Transceiver is supplied with single transmitting crystal for channel 9. Complete high output with crystal microphone, and brackets for easy mounting of unit in auto, boat, etc. Operated on 115 volts AC. Addition of 6 or 12 volt power supply (separately supplied) adapts transceiver for mobile operation. Size 5 1/2" H x 6 3/8" D. Shpg wt., 11 lbs.

HE-15 Factory Wired and Tested (Less antenna). 5.00 Down.....	Net 64.50
HE-19 Whip Antenna.....	Net 3.95
HE-16 Power Supply For 12 Volts.....	Net 11.95
HE-18 Power Supply For 6 Volts.....	Net 11.95

- 5 CRYSTAL CONTROLLED TRANSMITTING POSITIONS
- SUPERHETERODYNE TUNEABLE RECEIVER OVER FULL 22 CHANNEL BAND
- 4 DUAL FUNCTION TUBES, PLUS 2 SINGLE FUNCTION TUBES, PLUS 2 RECTIFIERS FOR 12 TUBE PERFORMANCE
- PLANETARY VERNIER TUNING
- COMPLETE WITH TRANSMITTING CRYSTAL FOR 27.065MC
- MEETS ALL FCC REGULATIONS
- REMOVABLE FRONT PLATE FOR EASY ACCESSIBILITY OF CRYSTALS
- UNEXCELLED RECEPTION ON LAND AND SEA... COMPARES WITH UNITS COSTING 3 TIMES AS MUCH

NEW! LAFAYETTE TELESCOPIC CITIZENS BAND WHIP ANTENNA

- Chrome Plated
- Telescopes From 16 1/2" to 40"
- Mounts Vertically or Right Angle

3.95

An outstanding antenna value. This high quality three section telescoping antenna is designed for attachment directly to your citizens band transceiver. Ideal for point to point service over short distances. Molded base loading coil has a threaded stud with a PL-259 plug—connector for vertical or right angle mounting. Shpg. wt.; 1 lb.



NEW! LAFAYETTE RADIO FIELD INDICATOR

A Must For Ham & Citizens Band Operators

- Provides a Continuous Indication of Transmitter Output • Rugged 200 ua Meter Movement
- Completely Portable — Requires no Electricity, Batteries or Transmitter Connection.

With this rugged, new radio field indicator you can check performance of your marine, mobile or fixed transmitter... actually measures the RF field generated by any transmitter between 100KC and 250MC regardless of power. Features a 200 ua meter movement with a variable sensitivity control. Phone jack at rear of indicator accepts earphones thus providing an aural check of transmitter output. Antenna extends from 3 1/4" to 10 3/4". Powerful magnet on bottom plate allows easy mounting on car dashboard or metal surfaces. Use anywhere... requires no electricity or batteries. Dimensions: (less antenna) 3 1/8" W x 2 1/4" H x 2" D.

7.95

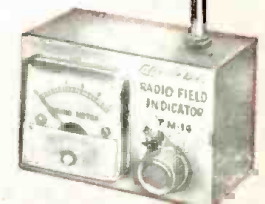

NEW! LAFAYETTE "Tiny"

6 Transistor Radio

SENSATIONAL PERFORMANCE
In a Small Package!

- 6 Transistor Plus a Germanium Diode
- Superheterodyne Circuit • Vest Pocket Size
- Built in Earphone Jack For Private Listening
- Trouble-Free Printed Circuit

Engineered and constructed with the jewel like precision of a fine watch... true superhet circuit, with push-pull audio output powers either the built-in dynamic speaker or the personal-type earphone. Extremely sensitive... built in ferrite—rod antenna brings in distant stations like locals. Employs standard 9 volt battery for economical service. Housed in smart black and gold rugged plastic case. Measures only 4" x 2 1/2" x 1 1/4" and weighs a mere 10 ounces. Complete with battery, carrying case and earphone. Shpg. wt., 2 lbs.



19.95

PLEASE RUSH ITEMS CHECKED!

- HE-15 CITIZENS BAND TRANSCEIVER
- TM-14 RADIO FIELD INDICATOR
- FS-206 "TINY" 6 TRANSISTOR RADIO
- HE-19 WHIP ANTENNA
- FREE 308 PAGE CATALOG 600

Enclosed Find \$.....(Please include postage to cover shipping)

FREE 308 Giant Size Pages!



Everything in Hi-Fi and Electronics

Name.....
Address.....
City..... Zone..... State.....

LAFAYETTE RADIO,
P. O. BOX 222, JAMAICA 33, N.Y. Dept.

RG-6

"BEST OF ALL CONTACT SPRAYS"

AS REPORTED BY INDEPENDENT PRODUCT-TESTING LABORATORY

	Shield	A	B	C	D	E	F	G	H	I
Lubrication After Rubbing For 90 Sec.	GOOD	Fair	Very Poor	Poor	Good	Poor	Very Poor	Good	Poor	Fair
Cleaning After Rubbing For 90 Sec.	GOOD	Good	Good	Good	Good	Fair	Poor	Good	Fair	Poor
Protection After 30 Sec. Exposure to H ₂ S Gas	GOOD	Fair	Fair	Good	Good	Fair	Very Poor	Good	Very Poor	Good
Protection After 2 Hours Exposure to H ₂ S Gas	BEST	—*	—*	2nd Best	5th Best	—*	—*	3rd Best	—*	4th Best
Flash Characteristics	None at 200°F.	—*	—*	Greatest tendency	Boils at 70°F. Tendency to ignite	—*	—*	Tendency to ignite	—*	Slight tendency to ignite
Attack On Plastic Material	NO	—*	—*	Yes**	Yes**	—*	—*	Yes**	—*	Yes**

*Not tested further following sub-standard performance in 30-second exposure test.

**Presence of solvents and chlorinated hydrocarbons.

Channel Master introduces the first triple-action spray!

Channel Master set out to provide a superior cleaner, lubricant, and protector for electrical contacts. Contact Shield was the result.

To verify our own estimates of the product's effectiveness, Contact Shield was submitted to a nationally known independent testing laboratory.

This famous testing organization made a thorough study of Contact Shield, as well as of nine similar products on the market. The above findings demonstrate conclusively that this new Channel Master product is the most reliable contact spray you can buy!



Here's why **Contact Shield** is best:

- provides the most long-lasting protection
- eliminates background and resistance noises
- is safer. Will not ignite, flash, or cause short circuits... propellant is actually a fire extinguisher
- contains no solvents to attack plastics
- performs at temperatures from -95°F. to +320°F.

CHANNEL MASTER works wonders in sight and sound
Ellenville, New York



VU METERS

PACE Electrical Instruments Co., Inc., 70-31 84th St., Glendale, Long Island, N. Y. has added a full line of standard vu meters to its existing line of panel meters.

The new vu indicators are available with A or B scale plates and in sizes of 2½", 3½", and 4½", round or rectangular, and in either acrylic or phenolic cases.

The meters are designed for service in monitoring panels, tape recorders, sound level indicators, p.a. systems, and other audio applications. They employ double bridge d'Arsonval movements with wide-band, full-bridge rectifiers. For further information, write to the manufacturer.

TINY TRANSISTOR AMPLIFIER

Centralab, Division of Globe-Union, Inc., 900 East Keefe Ave., Milwaukee 1, Wis. announces that its model TA-12, said to be the smallest 4-stage transistor amplifier ever built, is now generally available through electronics parts distributors. Heretofore, the TA-12 was sold only to the original equipment market.



The TA-12 is a 73-db gain audio amplifier with a diameter of 0.531 inch, and height of 0.228 inch. It has an input impedance of 2500 ohms nominal, power output up to .5 mw, and frequency characteristic of ±5 db, 300 cps to 20 kc. The single unit integrates, by means of packaged circuitry, 12 resistors, 5 capacitors, and 4 transistors. Its component density is 357 per cubic inch. For further information, write to the manufacturer.

"INVERTED" SPEAKER

Utah Radio & Electronic Corp., 1124 E. Franklin St., Huntington, Ind., has introduced an "inverted" loudspeaker in which the pot and magnet assembly is placed inside the cone instead of behind it.

Called "Magni-Magic," the speaker is produced in both the 8-inch and 6 x 9-inch oval sizes. The manufacturer states that the new design permits full reproduction plus power handling ability within a compact package and a minimum of space.

For additional information, write to the manufacturer.

DYNAMIC MICROPHONE

Electronic Applications, Inc., Stamford, Conn. is offering a dynamic cardioid microphone said to cover the full audio spectrum. Sensitivity is listed as 2.5 mv. per millibar at 1000 cps. The cardioid pattern (-15 db at 180°) tends to eliminate unwanted background noise and room resonances or reverberation. A bass-attenuation switch for voice cuts 8 db at 200 cps when needed.



Designated as Model AKG D 11 N, the microphone comes in a polystyrol case with built-in folding table stand, a receptacle for a standard miniature 3-pin plug, and 4-foot shielded cable. The AKG D 11 N is a product of *Akustische und Kino-Geräte GmbH*, Vienna, and is imported and serviced in the U.S.A. by the Stamford organization.

HEATHKIT STEREO AMP

Heath Company, Benton Harbor, Mich. has announced a new dual 35-watt power amplifier in kit form. The unit may be used as a dual-channel basic amplifier, 35 watts per channel, or as a 70-watt monophonic amplifier. Response is said to be 20 to 20,000 cps ±1 db, with less than 1 per-cent distortion at full rated output.

Listed as "Heathkit" AA-40, the new unit is equipped with a "stereo-mono" switch as well as individual channel level controls and a mixed channel output for a center-channel speaker. Full details are available from the manufacturer.

NEW RECORD CHANGER

Arkay International, 88-06 Van Wyck Expressway, Jamaica, N. Y. has announced its new "Human Brain" record changer. According to the manufacturer, the changer will play



all size records, mixed or the same diameter, and guarantee perfect alignment with the starting groove of each record.

The changer is available in kit or factory-wired form. For further information, contact the manufacturer.

UHER TAPE RECORDERS

Uher Sales & Service, 346 West 44th St., New York 36, N. Y. has introduced a new line of tape decks and recorders, including a voice-operated stereo record/stereo playback machine as well as a transistorized, battery-operated unit.

Known as the Stereo Record III, the voice-operated model also features automatic slide projector synchronization, permits playback on one track while recording on the other, and claims a frequency response of 40 to 20,000 cps. The machine can handle both quarter-track mono and stereo tapes.

These tape recorders are made in

West Germany. For additional information contact the N. Y. organization.

DUAL-CHANNEL SPEAKERS

Radio Frequency Laboratories, Inc., Boonton, N. J. has announced a line of dual-channel, single-cabinet speaker systems for stereo or monophonic high-

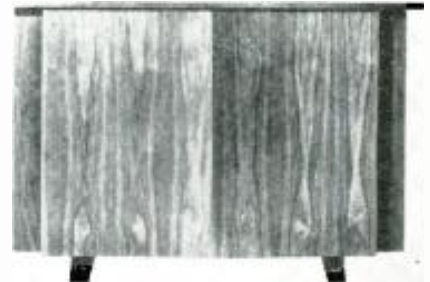

fidelity applications. Called "Spatial Fidelity," the new speaker systems are available in a variety of sizes, shapes, and furniture styles.

According to the manufacturer, the single-cabinet system provides full dimensional stereo no matter where the listener is in the room. The new systems are said to utilize the walls, ceiling, and furnishings of a room to achieve a sense of spaciousness and dimension. This is accomplished through the design and geometry of the enclosures as well as by the positioning of the speakers within them.

For full details, write to the manufacturer.

GELOSO MICROPHONES

American Geloso Electronics, Inc., 251 Park Ave., South, New York 10, N. Y. is offering two series of dynamic non-directional microphones. Both series are available in high- and low-impedance models.

The "Gold Line" series M60 and M61 microphones are said to offer a flat frequency response of 60 to 14,000 cps. The "Slim Jim" series M62 and M63 microphones have the same specifications but are adapted for special services requiring a light, easy-to-handle unit.

The microphones are produced by *Geloso S.p.A.*, Milan, Italy. For additional information, contact the American representative.

NEW STEREO CARTRIDGE

Dyna Empire, Inc., 1075 Stewart Ave., Garden City, N. Y. has announced a new "Audio Empire" stereo cartridge. Listed as the Empire 108, the new pickup uses a moving magnet structure and is suited for playing both stereo and mono records.

Frequency response is stated as 15

500 ELECTRONIC KITS

WHAT THEY ARE!
WHAT THEY COST!
WHAT THEY DO!

Yours in the brand new 1960



Here it is — the only complete, comprehensive directory covering the exciting world of electronic kits! It's yours in the 1960 ELECTRONIC KITS DIRECTORY — over 160 pages — listing over 500 kits of all kinds. Each listing gives you manufacturers, specifications, prices, everything you need to know about kits!

You'll find such informative features as:

• GIANT KIT BUILDERS GUIDE

Gives you the latest improvements, and innovations in kits...helps you select the right kit...identifies parts for you, too!

• COMPLETE SURVEY AND DIRECTORY OF:

Kits for HI-FI — make your own amplifiers, preamps, speakers, turntables, stereo control units, and tone arms.

Kits for COMMUNICATIONS — Rundowns on kits for oscilloscopes, tube testers, power supplies, transmitters, receivers, transceivers.

Kits for EDUCATION — Coverage of radio kits and many other special projects.

NOW ON SALE
AT YOUR
FAVORITE
NEWSSTAND OR
ELECTRONIC
PARTS
STORE



ONLY
\$1.00

Don't miss 1960 ELECTRONIC KITS DIRECTORY
Now on sale at newsstands, electronic parts stores and hi-fi salons! Buy your copy today, or order by using the handy coupon below.

Only \$1.00.

Ziff-Davis Publishing Company
Department EW-76
434 S. Wabash Ave., Chicago 5, Illinois

Please send me a copy of the 1960 ELECTRONIC KITS DIRECTORY. I enclose \$1.00 plus 10¢ to cover mailing and handling charges. (Canada and Foreign \$1.25 plus 10¢ postage).

Name _____

Address _____

City _____ Zone _____ State _____

cps to 20 kc. ± 2 db; channel separation, more than 25 db; output voltage, 8 mv. per channel balanced to within ± 1 db; compliance, 6×10^{-9} cm./dyne; recommended tracking force, 1.5 to 5 grams.

The model 108 is a four-terminal cartridge. Additional information is available from the manufacturer.

LAFAYETTE TAPE DECK

Lafayette Radio, 165-08 Liberty Ave., Jamaica 33, N. Y. has introduced a new "precision" tape deck said to offer performance and features for-

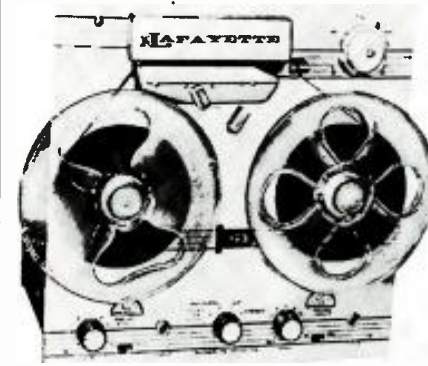

merly found only in costly professional equipment.

Listed as Model RK-107, the new tape deck features a separate recording preamplifier with individual vu meters integrated with the tape mechanism. The deck may be used for playing half-track or quarter-track tapes and for recording quarter-track monophonically or stereophonically. Frequency response is stated as 30 cps to 17 kc. at $7\frac{1}{2}$ -ips speed; 40 cps to 15 kc. at $3\frac{3}{4}$ -ips speed.

Two separate motors are used; one is for tape drive, the other for fast forward and rewind. Among the controls is a "cue" position that permits manual positioning of the reels to select a desired spot on the tape.

SPEAKER SWITCHES

Mosley Electronics, Inc., 4610 N. Lindbergh Blvd., Bridgeton, Mo. has announced a flush wall plate switch, Model FAS-6, which facilitates push-button selection of any combination up to six remote speakers.

Each FAS-6 switch kit includes the switches, face plate, and mounting brackets. The push-buttons are numbered "1" through "6." For full details, write to the manufacturer.

STEREO PREAMP KIT

Allied Radio Corporation, 100 N. Western Ave., Chicago 80, Ill. has released a new "Knight-Kit" stereo preamplifier. Featuring printed-circuit construction, the unit may be used as the control center for a stereo or monophonic high-fidelity system. Provision is made for channel reversal as well as combining channels for monophonic use. Dual-concentric clutch-type controls permit adjustment of volume, treble, and bass of each channel separately or simultaneously. Five positions of record equalization are provided.

The input stage uses 12AY7 tubes.

All tube filaments are heated with d.c. to minimize hum. Other features include scratch and rumble filters, cathode-follower outputs, and separate tape recorder outputs. The kit is supplied with all parts, tubes, case, solder, wire, and step-by-step instructions.

PHONO BASES

Audiotex Mfg. Co., a division of GC-Textron Electronics, 400 So. Wyman St., Rockford, Ill. has announced a new line of "customized" phono bases to match the size and color of seven popular record changers.

For further information on the new "Meta-Lux" line, contact the manufacturer.

NEW "SUPER TWEETER"

University Loudspeakers, Inc., 80 So. Kensico Ave., White Plains, N. Y. has brought out a new high-frequency speaker with a claimed response to 40,000 cps.

Designed to cover the range upward from 3000 cps, the "Spheron" Model T-202 uses a domed phenolic diaphragm acoustically loaded by a conoidal ring for smooth response. The tweeter, for which a 120-degree dispersion pattern is claimed, has a built-in crossover network as well as a level control attached to a 36-inch long cable. Efficiency is high, power capacity is 30 watts, nominal impedance is 8 ohms. According to the manufacturer, the "Spheron" T-202 can be matched perfectly to any speaker system without sacrificing bass efficiency.



CEILING SPEAKER Baffles

Utah Radio & Electronic Corp., Huntington, Ind. has announced a full line of ceiling baffles for flush-mounting of speakers in diameters of $3\frac{1}{2}$ to 12 inches. Models are offered in both steel and aluminum construction. A large demand is anticipated for an all-aluminum model designed for an 8-inch speaker that is louvered for 360-degree sound dispersion.

Speaker and baffle mounting hardware is furnished with each model. Plaster rings and baffle housings (speaker enclosures) also are available for use with the new ceiling baffles.

"KNIGHT" STEREO CARTRIDGE

Allied Radio Corp., 100 N. Western Ave., Chicago 80, Ill. announces its new "Knight" KN-500X stereo magnetic cartridge. Featuring a 4-coil moving-magnet design, the KN-500X uses a .0005-inch diamond stylus and is designed to track at pressures of 1 to 4 grams.

Frequency response is said to be 20 to 20,000 cps, ± 2 db. Channels are balanced to within ± 1 db. Stated compliance is 5.5×10^{-9} cm./dyne; channel isolation, more than 20 db. The new

cartridge is listed as Stock No. 89 RC 225.

2-SPEED TAPE RECORDER

Radio Shack Corp., 730 Commonwealth Ave., Boston 17, Mass. has introduced a new low-cost, dual-track tape recorder. Bearing the "Realistic" label, the unit operates at either 3.75 or 7.5-ips speed; performs the functions of record, erase, playback, and rewind; has external jacks for microphone, radio-phono, and external speaker; and includes a microphone, radio patch cord, and 5-inch blank reel. It is furnished with carrying case. For full details, write to the company.

TAPE DECK AND PARTS

Telectrosonic Corp., 35-18 37th St., Long Island City 1, N. Y. is offering a new line of magnetic tape recorder equipment which permits the user to start modestly and, through a "building block" program, expand the basic tape system.

Included in the new line are five different tape decks and six preampli-

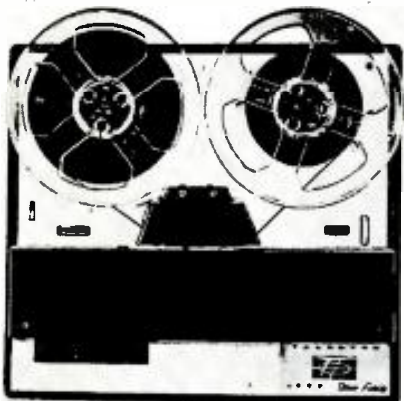

fiers. The combinations provide for different systems of play and record in monophonic and stereo. For details, write to the manufacturer.

AUDIO CATALOGUES

UTAH SPEAKERS

Utah Radio & Electronic Corp., 1124 E. Franklin St., Huntington, Ind. is offering a new catalogue describing its line of speakers for various applications. Included in the catalogue are crossover networks and a listing of new ceiling baffles.

STYLUS BOOKLET

Duotone Co., Keyport, N. J. is distributing a new booklet which discusses diamond styli.

Written for consumers, the booklet covers needle wear and offers advice on how and when to replace a stylus. It is available through dealers.

STEREO DISC STANDARDS

American Standards Association, Dept. PR 135, 10 E. 40 St., N. Y. 16, N. Y. has announced IEC (International Electrochemical Commission) Publications 98 and 98-1, which deal with the cutting of records. No. 98 is titled "Recommendations for Lateral-Cut Commercial and Transcription Disk Recordings." No. 98-1, a supple-



introducing the
world's smallest
cardioid dynamic
microphone

UNIDYNE III
by
SHURE



EVERYTHING YOU WANT IN A
QUALITY CARDIOID MICROPHONE
. . . AND THEN SOME!

Compact size . . . modern design . . . wide response . . . superior feedback suppression . . . uniform cardioid pattern . . . ruggedness . . . reliability; you name it, SHURE has designed it into the dramatic new Unidyne III.

50% SMALLER — Less than 6" x 1 1/4", 0.6 lb.!

PERFECTION IN PERFORMANCE — moving coil design with truly uniform cardioid pick-up pattern. Response: 50 to 15,000 cps. Up to 75% greater distances from sound source. Impressive feedback suppression.

MAXIMUM VERSATILITY — unobtrusive size, dual impedance, light weight, instant change from stand to hand, and wide-range response make it ideal for faithful reproduction of voice or music, indoors or out, for P.A., tape recording . . . anywhere fine quality is required.

RUGGED AND RELIABLE — Famous SHURE quality. Takes 6-foot drops and still performs according to specifications!

Literature available:

SHURE BROTHERS, INC.
222 Hartrey Ave., Evanston, Ill.

\$5000

Professional Net

SEND
ELECTRONICS WORLD
EVERY
MONTH

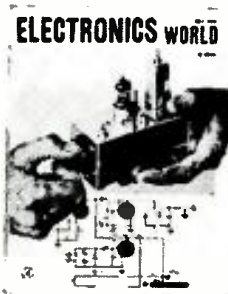

name _____

address _____

city _____ zone _____ state _____

Check one:

- 3 years for \$12
- 2 years for \$9
- 1 year for \$5

In the U. S., its possessions, and Canada

- Payment enclosed
- Bill me

Foreign rates: Pan American Union countries, add .50 per year; all other foreign countries, add \$1.00 per year.

Mail to: **ELECTRONICS WORLD**, Dept. EW 76, 434 S. Wabash Ave., Chicago 5, Ill.

GOODHEART'S GUARANTEED GOODIES

... super values, too!

3 NEW ARRIVALS FOR LASS, TECHNICIANS:

(See also June p. 82, May p. 95, Apr. p. 90, etc.)
0.1% STABLE LINE VOLTAGE (adjustable 110-120 v) despite line changes 95-120 v or load changes 0-5000 VA. Sorensen #5000S. 1 ph 50/60 cy. Recovery time 0.15 sec. Max. harmonics 3%. Cabinet model, normally \$595.00 less spares. BRAND NEW, WITH SPARES. 285± fob Utica, N. Y. \$349.50
0.1% DC WHEATSTONE BRIDGE. 4 dials 1-10,110 ohms, and Ratio dial X.001 to X100 in decade steps. Built-in galvanometer. Same spec. as L&W #34 D, I-49, ZM-4(1/2). Checked and guaranteed, fob Los Angeles. (Our choice of mfrs.) \$129.00
1% ACCURACY MICROVOLTER, G. R. #605-B w/pwr supply. Sig. 9000 AM to 1000 cy. 0.9% mod. RF 930 to 30,000 kc. FOB Los Angeles. \$295.00
 Same specs: Navy "LP," adds 30-50 mc to the range, w/pwr supply, fob Los Angeles **\$179.50**



\$850 TEST OSCILLOSCOPE FOR ONLY \$39.50

TS-34/AP. Why modify radar scopes? This is ready to plug into 103 1/2-126 1/2 v, 50-2500 cy, and use. Checked and OK'd before shipping. In portable carrying case. Less cords (which are easy to match with reprint of the most important 16 pages of the tech manual). Uses a small pic tube but you look into the hood and thru a magnifying lens that gives the equivalent of a 5 in pic tube and the hood shields external light so you see fast rises. 0-40 db attenuators in 2 db steps are so accurate that you get instructions to use as a VTVM. Video is flat 40-2,500,000 cy. Sweep is contin. variable 10-50,000 cy. BEST OF ALL, there is a "Start-Stop" switch position in which pulses to be viewed each trigger their own sweep, with sweep durations of 5, 50, or 250 microseconds so accurate and linear that you can measure pulse width. INVALUABLE FOR TV PULSE VIEWING! Pulses may be periodic or random, pos. or neg., as low as 0.1 volt, and may vary in width from a line pip to 200 u-sec. AT THIS LOW PRICE, ONE NEED DO WITHOUT THIS WONDERFUL SCOPE!
 50 lbs, fob Los Angeles. **\$39.50**

SAME, but BRAND NEW, with all cords and complete tech manual, fob Los Angeles. **\$69.50**

TS-34A/AP. No cords or carrying case. Checked and certified equal to new. Same as TS-34/AP except that the triggered sweeps can be varied 4 1/2-2, 20-50, and 120-280 microseconds. **\$39.50**

JULY SPECIAL! DUMONT 5" SCOPE \$59.50!



#241 as illustrated, with line cord, guar. ready to use. Don't be fooled by scopes which are radar calibrators! #241 is a standard test scope you can use and be proud of. Has Z-axis mg. for markers and X-axis ampli. for ext. sweeps or to zeroed frequencies. Internal sweep 15-30,000 cy. Video response flat 20 cy to 2 mc. Direct-plate terminals and all controls on front panel 10 1/2" wd x 13" h. With reprint of the Dumont Instruction Book. Checked out, certified, 75 lbs.
F.O.B., Los Angeles, JULY ONLY! ... \$59.50

IMPROVE YOUR RECEIVER 53%!
 SEND ADDRESSED ENVELOPE FOR FREE INFORMATION

A TERRIFIC BUY IN XMTR POWER SUPPLY & VOLUME-COMPRESSING AUDIO AMPLIFIER

You get a plug-in module 30 W speech amp. that holds output to -55% for input blast of -85% above the 90-95% modulation level. 6-tube chassis includes keyed tone os. and sidetone. Carbon or dyn. mike. PF 807's, 6 K ohms out. You also get a plug-in module HV power supply, puts out filtered DC's of 600 v, 445 ma, 300 v, 175 ma, and 47 v bias. Uses 4 3C23's. You also get two FW selenium supplies w/aging taps, and 1 1/2 v 60 cy blower, to furnish filtered DC's of 12 v, 1 A and -115 v, 1/2 A. Input 115 v, 60 cy. W/schematic, parts characteristics, and complete instructions. 175 lbs fob Los Angeles, but shipped as Transformers at very low rate. With tubes, only \$29.50. Less tubes, you steal it for only. **\$14.95**

VHF MICROVOLTER SIGNAL GENERATOR

LAF-2, 90-600 mc, accuracy 1%. For FCC VHF Mobile and Aircraft service work, can be set within 1/4% by peaking crystal-controlled xmtr of receiver being serviced. Accurate bolometer-bridge circuit meters output 1-100,000 microvolts. Checked and certified by Standards Lab. With calibration charts, schematic instructions. ONLY. **\$89.50**

SCHEMATICS/CONVERSIONS, SURPLUS GEAR

List G. NEW! Send long stamped addressed envelope. Includes many Tech Manuals. Add 25¢ for chart explaining AN Nomenclature. Example of new listings: 20-page book on 1-177, with diagram of MX-949/U socket adapter, tube data compiled to March 1947, \$5.00. RT-18/ARC-1 schem. & tune-up instr. \$2.00. MAR, 22 pages & 5 large pulout schematics, \$9.00.

Calif. buyers please add 4% when remitting.

R. E. GOODHEART CO.

P. O. Box 1220-A Beverly Hills, Calif.

ment to 98, is titled "Recommendations for Stereophonic Commercial Disk Records," IEC Publications 98 and 98-1 are available at \$4.00 and \$1.60 respectively, from the ASA.

HI-FI KITS BOOKLET

Lafayette Electronics Mfg. Corp., 104-46 Dunkirk St., Jamaica 12, New York has released a 20-page catalogue describing its line of kits for building hi-fi and stereo components.

The two-color booklet contains general and technical descriptions and is lavishly illustrated. For your copy, write the company direct.

ALTEC HI-FI DATA

Altec Lansing Corporation, 1515 S. Manchester Ave., Anaheim, Calif. is now offering a two-color catalogue which gives details on its hi-fi equipment as well as illustrating custom monophonic and stereo installations.

Described in detail are tuners, preamps, amplifiers, speakers, speaker components, speaker systems, enclosures, and microphones. A special feature is a section which diagrams the proper placement of speakers and other components in a room.

For a copy of the booklet, "Altec, the True Sound of Music," contact your local dealer or write the company for a copy of Publication No. AL 1302.

TAPE-HEAD REFERENCE GUIDE

Robins Industries Corp., Flushing 54, N. Y. has published a 16-page "Tape Recording Head Reference Guide." Listing more than 25 different brands of tape recorders, the Guide contains cross-reference data, specifications, and illustrations of record/playback and erase heads, heads for 2- and 4-track stereo, and heads for 2-track monophonic. According to the company, the Guide should prove a valuable aid to service technicians and dealers who repair, upgrade, or convert existing recorders to stereo.

The book is priced at 50 cents, but is being offered at no charge under certain conditions to distributors and their service dealers. Form number of the volume is RMM-2. Write the company for details.

SCOTT TECHNICAL DATA

H. H. Scott, Inc., 111 Powdermill Road, Maynard, Mass. has announced publication of two technical bulletins of interest to audiophiles.

One bulletin covers the firm's new 272 72-watt complete stereo amplifier while the second publication is concerned with the 314 AM-FM tuner.

Complete specifications and technical information are included in the publications. For a copy of either or both of these bulletins, write Dept. D of the company. Request Booklets 272 and 314.

STEREO/MONO UNITS

Harman-Kardon, Inc., 520 Main St., Westbury, Long Island, New York is currently offering copies of its free catalogue which illustrates and describes a complete line of stereo and monophonic high-fidelity instruments in all price brackets.

The new publication provides information on AM-FM tuners, all-in-one compact stereo receivers, amplifiers, and preamplifiers.

The line offers a variety of styles to fit any interior as well as a series designed for built-in and custom installations. The bulletin offers a unique selection of finishes on instrument panels, as well as optional enclosures.

PHONO ACCESSORIES

Duotone Company, Keyport, N. J. has a 40-page phonograph and accessories catalogue available which is being offered to dealers of audio gear.

Complete information on needle replacements for every type of phono unit is given along with a selection of various record accessories. -50-

Allied Radio Corporation, Chicago, has just completed the installation of a new stereo "Auditioner" console for the demonstration of high-fidelity stereo systems. Designed and built for the company, the console permits the quick and easy selection of countless system combinations consisting of famous-name tuners, preamps, basic amplifiers, tape recorders, turntables, and record changers. The performance of any combination of these components can be demonstrated through any two of the 64 speakers in the studio. The unit also features remote controls which permit the prospective purchaser to control volume and balance of the various speaker systems.



ELECTRONICS WORLD

Professional Photoflash
(Continued from page 59)

operation it may be necessary to replace C, with a .25- μ f. capacitor and the T₂ trigger coil with a larger, more efficient unit such as the Amglo MT-55. These are both larger than the ones specified and it may be difficult to find room for them in the back cover.

Battery Charger

The separate battery charging unit (Fig. 3) consists of a filament transformer, a current limiting resistor and a silicon rectifier. They may be conveniently mounted in a Bud CU-2115, 4" x 2" x 2 3/4" "Minibox." The 2 3/4" dimension of the one illustrated was cut down to the height of the transformer for compactness. A phone plug on the charger and a phone jack on the power pack permit quick coupling with no danger of accidentally reversing the polarity. The charging rate is over 200 ma. when the batteries are discharged and it slows as they approach full charge. Overnight charging will usually bring them back to full charge even after extensive use. While the batteries are spillproof and may be operated in any position, they should be upright while charging as they generate some gas during the latter part of the charging period.

This flash outfit is good for at least 150 flashes between charging without unduly prolonging the recycling period. In one test it was fired 100 times over a period of one hour. Battery voltage had dropped from 4.8 volts to 4.4 volts *under load*. Recycling time at the end of the test was 16 seconds—only two seconds longer than at the beginning. And remember, this is the recycling time to 450 volts.

Circuit Modifications

Obviously, many modifications are possible. Any other components of equivalent performance may be substituted for those specified. The power-supply circuit may be incorporated in an existing flash outfit. The thyatron trigger circuit may likewise be added to an existing unit. Possibly a less elaborate and less expensive outfit is desired and the trigger tube and meter may be eliminated or one storage capacitor may be used to provide only 50 W-S of energy. Proceed cautiously in modifying the power supply, however. This combination is excellent but many transistor power supplies fail when fed into 1000 μ f. of capacitance which acts almost like a short circuit. If other batteries are used remember that current drain while charging the capacitors reaches a 6 to 7 ampere peak. Ordinary flashlight batteries won't take it.

This is a professional electronic flash unit with real professional performance. It's not cheap to build but it sure is economical to operate. At a net saving of over ten cents per flash as compared with bulbs, it's a bargain. —[50]

with **DYNAKIT**

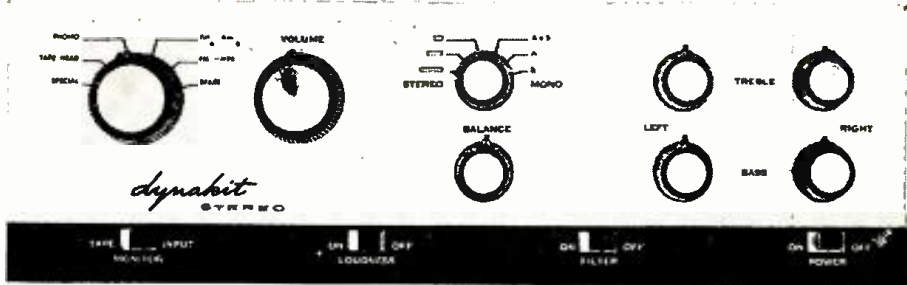

PAS-2 \$59.95 kit, \$99.95 assembled

you know
you have the **BEST!**

The new Dynakit Stereophonic Preamplifier has *all* the quality features which you require for the finest high fidelity reproduction. This handsomely styled control unit is a model of classical quality and contemporary simplicity.

BEST IN EVERY WAY

In either kit or wired form, the new Dynakit Stereo Preamp represents both the finest quality and the finest value available. It utilizes the basic circuitry of the famous Dynakit monophonic preamplifier without compromise of quality. This circuit has the lowest possible distortion, an absolute minimum of hum and noise, superior transient response, and every other attribute which can contribute to natural, satisfying sound quality.

Dynakit's basic philosophy of simplicity of layout and control action, along with impeccable performance, is well exemplified in the design. Every useful function is incorporated, but the operation of the unit is not complex since the controls are arranged and identified in a functional manner. Operation of controls and switches is smooth, noise-free, and non-interacting. The unit is a pleasure to assemble, a pleasure to operate, and a pleasure to hear.

It is not necessary to spend a lot of money to have the best sound available. Dynakit equipment has no compromises in quality. It is designed to be the finest and to be used by those who are not satisfied with less than the best. We suggest that you listen to it at your Hi Fi dealer, or write for our brochure which gives complete specifications on all Dynakit high fidelity components.

★ **Best Performance**

Frequency response within 1 db 10 cps to 40 kc. Distortion (either IM or harmonic) less than .05%. Response and distortion unaffected by settings of volume control. Undistorted square wave performance demonstrates outstandingly fine transient performance. Noise and hum inaudible at normal listening levels. High gain permits operation with lowest level cartridges. (1 millivolt input gives 1 volt output on RIAA input.)

★ **Finest Quality Components**

1% tolerance components used in critical equalization-determining circuits. Tone control components matched to provide **absolutely flat response** at center settings. Highest quality plastic molded capacitors, low noise resistors, conservatively operated electrolytics, plated chassis and hardware, all lead to long life with unchanging specifications. One year guarantee on all parts.

★ **Greater Flexibility**

7 stereo inputs (or 14 monophonic ones) provide for all present and future sources. "Special" input provides option for special equalization characteristics. Provision for tape head, tape playback amplifier, and monitoring tape recordings. **Independent** tone controls for each channel. Exclusive Dyna "Blend" switch to control stereo separation. Unique feedback scratch filter takes out the hash and leaves in the music. Rear panel ac outlets enable switching other components with preamp on-off switch. Self-powered (with dc heater supply) permits use with any amplifiers.

★ **Outstanding Appearance**

Choice of bone white or charcoal brown textured finish cover. Solid brass, etched front panel. Designed by Raoul Iorguen, prominent industrial stylist. Requires only 13" by 3 3/4" panel space and can be readily mounted on any thickness of panel with convenient PM-3 auxiliary mounting kit.

★ **Easiest Assembly**

About 8 hour average assembly time—from one-third to one-fourth that of other kits. Assembly speeded by use of pre-assembled printed circuit boards plus ultra-simple and accessible layout of parts. Complete pictorial diagrams included plus step-by-step instructions so that no technical skill is required. Also available fully wired and individually tested.

DYNACO, INC., 3916 POWELTON AVENUE, PHILA. 4, PA.
CABLE ADDRESS: DYNACO, PHILA.

DID POPOV INVENT RADIO?



Aleksandr Popov (1859-1906)

By THEODORE M. HANNAH

We call Marconi "father of radio;" Russians give Popov credit. Who is correct and exactly what did Popov do?

ASK an American who invented radio and he will probably say "Marconi;" ask a Russian and he will very likely say "Popov." Who is right? Can either Marconi or Popov be considered the inventor of radio? For that matter, who is Popov?

Throughout the communist world Aleksandr Stepanovich Popov is recognized as the sole inventor of radio. A cursory examination of any recent Russian electronics journal makes this abundantly clear, for 1959 was the centennial of Popov's birth (he was born March 16, 1859, in what is now the Sverdlovsk oblast). To commemorate the anniversary, a number of special events were held during 1959: scientific meetings in Moscow and elsewhere; dedication of a statue of Popov in Leningrad; the Russian amateur radio organization held an international radio contest on Popov's birthday and then offered a special award to any amateur who contacted 100 Russian amateur stations during 1959; special postage stamps have been issued, etc. Popov is memorialized in other ways too. The Russian equivalent of the IRE is known as the Popov Society; scientists—both Russian and foreign—who make outstanding contributions to the radio art receive Popov gold medals; the first page or so of every Soviet book on radio-electronics is ritualistically devoted to a tribute to A. S. Popov, "the inventor of radio."

The Russian claim of priority in the invention of radio is based on an event of May 7, 1895 (since 1945 this day has been celebrated as Radio Day in the Soviet Union). At a meeting of the Physics Branch of the Russian Physical-Chemical Society in Petersburg, Popov, then an instructor at the Kronstadt naval school, reported on and

demonstrated his invention, a "radio receiver." The device was actually designed only to receive and record lightning discharges; the term "radio receiver" (usually prefaced with "the world's first") became commonly applied to Popov's device only after the advent to power of the Communists in Russia. This may be not so much willful distortion as it is a problem of definition. Popov's device *did* detect and record electromagnetic radiation (if only static crashes), and in that sense it *was* a radio receiver; yet, because there were no transmitting stations at that time, can his invention really be called a radio receiver? In a way this is the reverse of the old question: "If a tree falls in the forest but there is no one there to hear it, is there any sound?" In 1895 there *was* someone to hear, but there was no *tree*, at least not near Petersburg.

While an instructor at Kronstadt, Popov had access to a well-equipped laboratory and a library well stocked

Drawing illustrating Popov's first receiver (1895) which detected lightning discharges.

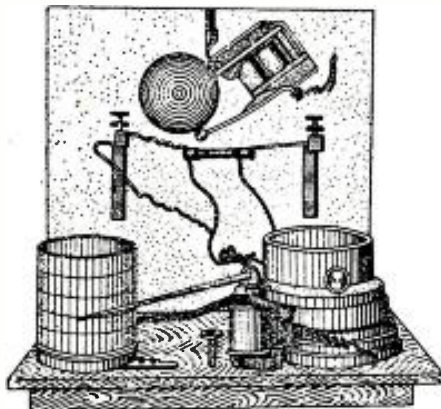

with foreign periodicals and books. Popov was particularly interested in the work of Heinrich Hertz and he repeated many of the German's experiments in electromagnetic waves. The experiments and writings of Sir Oliver Lodge, Edouard Branly, Augusto Righi, and others also influenced his thinking. The detector which Popov demonstrated before the Physical-Chemical Society meeting was basically Branly's coherer (a metal-filing type) to which Popov added an arrangement for automatically tapping back the filings to a sensitive condition after they had cohered upon the reception of oscillations. Each static discharge caused a bell to ring or a mark to be made on a paper tape. The implication conveyed in some descriptions of Popov's receiver is that the tapping device was original with Popov.³ Actually, an automatic tapper was a part of the receiver which Lodge demonstrated at a meeting of the British Association for the Advancement of Science in 1894.⁴ What may have been original with Popov was the addition of choke coils to protect the coherer from the effects of local sparking at the relay contacts.⁵

Contemporary Soviet accounts of Popov's invention attach considerable importance to the antenna which he used with his receiver. Described as a long vertical wire, insulated at the upper end and connected through the coherer to ground at the lower end, it is claimed to have been the final element needed for the reception of radio signals. The literature is not conclusive on this point; Hertz had been using a loop antenna for his experiments, but whether Popov was the first to employ an antenna and ground system remains an unanswered question. There is evidence that Marconi had been using

such a system in his experiments conducted at or before this time.⁴

It should be pointed out that Popov foresaw that his invention might be used for purposes of communication. During his demonstration of May 7, 1895 he is reported to have said:

"With further improvement, my device can be adapted to the distant reception of signals by means of rapid electric oscillations, as soon as a sufficiently powerful source of such oscillations is found."⁵

Perhaps unknown to Popov, a source of such oscillations had already been found. During the summer of 1894, at Pontecchio, near Bologna, Italy, a young man named Guglielmo Marconi succeeded in receiving and sending wireless signals over a distance of about three-quarters of a mile. Similar experiments had also been made by Lodge and Sir Henry Jackson. From then on, progress was swift. Marconi moved to England, and by the beginning of 1896 was receiving Morse code messages over a distance of nearly two miles. On June 2, 1896 Marconi applied for the first patent ever granted for a system of wireless telegraphy based on the use of electric waves.⁶ During 1896-97, transmitting distance was increased to four miles over land, then nine miles across the Bristol Channel. In 1899 wireless signals spanned the English Channel, the first instance of international radio communication. In the same year British warships, using Marconi equipment, exchanged messages at distances of 75 miles. Only two years later, on December 12, 1901, with Marconi at the receiving station in Newfoundland, the letter "S" was transmitted across the Atlantic. World-wide radio communication was now within reach.

What was Popov doing during this time? In January, 1896 a report of his demonstration of the previous May was published in the *Journal of the Russian Physical-Chemical Society* under the title "A Device for Detecting and Recording Electric Oscillations." On March 24, 1896 Popov sent his first message by wireless. Transmitted over a distance of about 600 feet, the message consisted of two words: "Heinrich Hertz." Early the following year he was communicating with ships over short distances.⁷ His equipment was employed in what was probably the first use of radio in the saving of human lives. In February, 1900 a message was flashed from Petersburg to the ice-breaker "Ermak" instructing it to rescue some fishermen stranded on floating ice in the Gulf of Finland. In 1901, the year Marconi sent signals 2000 miles across the Atlantic, Popov established communication between ships on the Black Sea; the distance was 80 miles.

How then can the Russians claim that Popov invented radio? Two arguments are used: (1) that Popov's demonstration of 1895 predated Marconi's patent of 1896, and (2) that, in any case, Marconi's invention was a direct copy of Popov's.

Popov is said to have refused to take out a patent on his invention, contending that the discovery should benefit the scientific world at large.⁸ This may be true (university professors are traditionally uninterested in patenting their discoveries), or it may be a convenient means of explaining how Marconi, rather than Popov, came to be almost universally recognized as the father of wireless communication.

With respect to the second argument, it is certainly true that no one inventor or invention was responsible for radio. And there was considerable similarity between the inventions of Marconi and Popov, just as Popov's was similar to and based upon Lodge's. Lodge's upon Hertz's, etc. But this is really not the point. The thing that the Russians seem to overlook is that neither Popov, nor Lodge, nor Branly, nor Hertz recognized the fact that radiation was the real key to wireless. And, as the courts later held, none of these scientists ever fully realized the practical possibilities of wireless as a means of communication. Marconi grasped both of these ideas. If not a creative inventor, Marconi was blessed with a genius for perfecting the crude laboratory-type apparatus of his predecessors and for promoting wireless telegraphy as a practical instrument of communication. He was, in short, the midwife of radio.

Without admitting that he was responsible for practical wireless telegraphy, Soviet sources, particularly the earlier ones, give at least some credit to Marconi for his contributions to the development of radio. A Soviet encyclopedia begins its article on Marconi by saying: "Marconi (1874-1937), Italian engineer and radio technician, the inventor, after Professor A. S. Popov, of the radiotelegraph."⁹ This early source is kinder in its treatment of Marconi than one published in 1954. The latter dismisses Marconi as an opportunist who, taking advantage of the fact that Popov had not patented his invention, went ahead and obtained a patent on his device, which was, after all, only a copy of Popov's.¹⁰

The contributions of the men who pioneered in the study of electricity and electromagnetic waves—Galvani, Volta, Morse, Bell, Faraday, Henry, Thompson, Branly, and Lodge—are freely acknowledged in the Soviet literature, but in a condescending sort of way. The Russians take the attitude that what these men did was but prelude to Popov's "invention" of radio.

An interesting feature of Soviet accounts of Popov is that, of all the inventions claimed to have been made by Russians, radio seems to be the one first claimed. The argument that Popov was the real inventor of radio was put forth at least as early as 1925;¹¹ other Russian inventions (including baseball and the hula hoop) were announced considerably later.¹²

There is no denying the fact that Popov's considerable talents were little appreciated by the tsarist government. It must have been particularly galling

to Popov to see, in 1902, his rival Marconi decorated by the Tsar with the Order of St. Anne. There is no record that Popov ever received similar recognition from his government.¹³

Popov's last few years were spent in Petersburg as a professor, then director, of the Electrotechnical Institute. He died on January 13, 1906 at the age of 47. The brain hemorrhage which caused his death was due, according to one recent Soviet source, to heated arguments between Popov and the tsarist minister to whom he was subordinate.¹⁴

Returning to our original question, did Aleksandr Popov invent radio? No, and neither did Marconi. The latter made wireless practical, but without the pioneering work of scientists like Popov. Marconi's achievements would have been impossible.¹⁵

An American scientist who recently visited the Soviet Union brings back an interesting anecdote. In a discussion of Russian claims that Popov invented radio, a Soviet electronics engineer is quoted as saying: "Well, Marconi did something too, and what difference does it make? We now have radio and that's good!" And it is too.

¹ All dates are New Style.

² Dictionary definition of radio: "The transmission and reception of signals by means of electric waves without a connecting wire . . ."

³ See, for example, *Bol'shaya Sovetskaya Entsiklopediya (Large Soviet Encyclopedia)*, First Edition, Vol. 46, columns 422-23, and *Encyclopaedia Britannica*, 1956, Vol. 18, pp. 230-31.

⁴ W. H. Eccles, *Wireless*, London, Oxford University Press, 1933, pp. 53-54. Quoted in W. Rupert Maclaurin, *Invention and Innovation in the Radio Industry*, New York, Macmillan, 1949, p. 18.

⁵ *Ibid.*, p. 20.

⁶ Orrin E. Dunlap, Jr., *Radio's 100 Men of Science*, New York, Harper, 1944, p. 172, and *Encyclopaedia Britannica*, Vol. 14, p. 869.

⁷ *Bol'shaya Sovetskaya Entsiklopediya*, loc. cit.

⁸ This was British patent No. 12,039. The equivalent American patent, No. 586,193, was granted him on July 13, 1897.

⁹ A description of Marconi's wireless system was not published until June, 1897.

¹⁰ Dunlap, *op. cit.*, p. 127.

¹¹ *Bol'shaya Sovetskaya Entsiklopediya*, First Edition, Vol. 38, column 155.

¹² *Bol'shaya Sovetskaya Entsiklopediya*, Second Edition, Vol. 26, p. 299.

¹³ Postage stamps honoring Popov as the inventor of radio were issued that year.

¹⁴ Popov is also credited with discovering the principles of radar and radio direction finding.

¹⁵ His contributions to the sciences were recognized by the Fourth International Electrotechnical Congress, held in Paris in 1900. There he received an honorary degree and a gold medal. *Bol'shaya Sovetskaya Entsiklopediya*, Second Edition, Vol. 34, p. 159.

¹⁶ N. M. Izyumov, *Kurs Radiotekhniki (A Course in Radiotechnology)*, Moscow, 1958, n. 6.

¹⁷ While acknowledging the contributions of some of his predecessors and contemporaries, Marconi appears never to have been aware of Popov's existence.

BIBLIOGRAPHY

Sources in English

Dunlap, Orrin E., Jr.; *Radio's 100 Men of Science*, Harper and Bros., 1944.

Maclaurin, W. Rupert; *Invention and Innovation in the Radio Industry*, Macmillan Co., New York, 1949.

Marconi, Guglielmo; "Thirty-Seven Years of Radio Progress," *RADIO NEWS*, January, 1932, pp. 53-54, ff.

"Encyclopaedia Britannica," Chicago, 1956.

"Who Was Who," Vol. III (1929-1940), Adam and Charles Black, London, 1941.

Sources in Russian

Izyumov, N. M.; "Kurs Radiotekhniki" (A Course in Radiotechnology), Moscow, 1958.

Levinzon-Aleksandrov, F. L., et al.; "Radiotekhnika" (Radiotechnology), Moscow, 1957.

"60 Let Radio" (60 Years of Radio), Ed. by A. D. Fortushenko, Moscow, 1955.

Veitkov, Fedor; "Rasskaz o Tvoitsakh Telegrafa" (The Story of the Creators of the Telegraph), Moscow, 1950.

"Bol'shaya Sovetskaya Entsiklopediya" (The Large Soviet Encyclopedia), First and Second Editions, Moscow, 1938-57. —30—

SUPERIOR'S
NEW MODEL 77

VACUUM TUBE VOLTMETER

WITH NEW 6" FULL-VIEW METER



Model 77—VACUUM TUBE VOLTMETER
... Total Price \$42.50—Terms: \$12.50 after
10 day trial, then \$6.00 monthly for 5
months if satisfactory. Otherwise return,
no explanation necessary!

Compare it to any peak-to-peak V. T. V. M. made by any other manufacturer at any price

- ✓ Model 77 completely wired and calibrated with accessories (including Probe, test leads and portable carrying case) sells for only \$42.50.
- ✓ Model 77 employs a sensitive six inch meter. Extra large meter scale enables us to print all calibrations in large easy-to-read type.
- ✓ Model 77 uses new improved SICO printed circuitry.
- ✓ Model 77 employs a 12AU7 as D.C. amplifier and two 9006's as peak-to-peak voltage rectifiers to assure maximum stability.

AS A DC VOLTMETER: The Model 77 is indispensable in Hi-Fi Amplifier servicing and a must for Black and White and color TV Receiver servicing where circuit loading cannot be tolerated.

AS AN AC VOLTMETER: Measures RMS values of sine wave, and peak-to-peak value of complex wave. Pedestal voltages that determine the "black" level in TV receivers are easily read.

AS AN ELECTRONIC OHMMETER: Because of its wide range of measurement leaky capacitors show up glaringly. Because of its sensitivity and low loading, interments are easily found, isolated and repaired.

Model 77 comes complete with operating instructions, probe and test leads. Use it on the bench—use it on calls. A streamlined carrying case, included at no extra charge, accommodates the tester, instruction book, probe and leads. Operates on 110-120 volt 60 cycle. Only.....

- ✓ Model 77 uses a selenium-rectified power supply resulting in less heat and thus reducing possibility of damage or value changes of delicate components.
- ✓ Model 77 meter is virtually burn-out proof. The sensitive 400 microampere meter is isolated from the measuring circuit by a balanced push-pull amplifier.
- ✓ Model 77 uses selected 1% zero temperature coefficient resistors as multipliers. This assures unchanging accurate readings on all ranges.

SPECIFICATIONS

• DC VOLTS—0 to 3/15/75/150/300/750/1,500 volts at 11 megohms input resistance. • AC VOLTS (RMS)—0 to 3/15/75/150/300/750/1,500 volts. • AC VOLTS (Peak to Peak)—0 to 8/40/200/400/800/1,000 volts. • ELECTRONIC OHMMETER—0 to 1,000 ohms/10,000 ohms/100,000 ohms/1 megohm/10 megohms/100 megohms/1,000 megohms • DECIBELS—10 db to + 18 db, + 10 db to + 38 db + 30 db to + 58 db. All based on 0 db = .006 watts (6 mw) into a 500 ohm line (1.73v). • ZERO CENTER METER—For discriminator alignment with full scale ranges of 0 to 1.5/7.5/37.5/75/150/375/750 volts at 11 megohms input resistance.

\$42.50
NET

SUPERIOR'S
NEW MODEL 80

20,000 OHMS PER VOLT ALLMETER

THE ONLY 20,000 OHMS PER VOLT V.O.M. SELLING FOR LESS THAN \$50 WHICH PROVIDES ALL THE FOLLOWING FEATURES:



Model 80 — ALLMETER ... Total Price \$42.50—Terms: \$12.50 after 10 day trial, then \$6.00 monthly for 5 months if satisfactory. Otherwise return, no explanation necessary!

- ✓ 6 INCH FULL-VIEW METER provides large easy-to-read calibrations. No squinting or guessing when you use Model 80.
- ✓ MIRRORED SCALE permits fine accurate measurements where fractional readings are important.
- ✓ CAPACITY RANGES permit you to accurately measure all condensers from .00025 MFD to 30 MFD in addition to the standard volt, current, resistance and decibel ranges.
- ✓ HANDSOME SADDLE-STITCHED CARRYING CASE included with Model 80 Allmeter at no extra charge enables you to use this fine instrument on outside calls as well as on the bench in your shop.

NOTE: The line cord is used only for capacity measurements. Resistance ranges operate on self-contained batteries.

- A built-in Isolation Transformer automatically isolates the Model 80 from the power line when capacity service is in use.
- Selected, 1% zero temperature coefficient metalized resistors are used as multipliers to assure unchanging accurate readings on all ranges.

SPECIFICATIONS:

7 D.C. VOLTAGE RANGES: 0 to 15/75/150/300/750/1500/7500 Volts.
0 to 15/75/150/300/750/1500/7500 Volts.
6 A.C. VOLTAGE RANGES: (At a sensitivity of 5,000 Ohms per Volt) 0 to 15/75/150/300/750/1500 Volts
3 RESISTANCE RANGES: 0 to 2,000/200,000 Ohms. 0-20 Megohms.
2 CAPACITY RANGES: .00025 Mfd. to .3 Mfd., .05 Mfd. to 30 Mfd.
5 D.C. CURRENT RANGES: 0 to 7.5/75/750 Milliamperes, 0 to 15 Amperes.
3 DECIBEL RANGES: - 6 db to + 18 db + 14 db to + 38 db

Model 80 Allmeter comes complete with operating instructions, test leads and portable carrying case. Only.....

\$42.50
NET



Model TV-50A—Genometer
Total Price\$47.50
Terms: \$11.50 after 10 day trial, then \$6.00 monthly for 6 months if satisfactory. Otherwise return, no explanation necessary.

GENOMETER

7 Signal Generators in One!

- ✓ R.F. Signal Generator for A.M. ✓ Bar Generator
- ✓ R.F. Signal Generator for F.M. ✓ Cross Hatch Generator
- ✓ Audio Frequency Generator ✓ Color Dot Pattern Generator
- ✓ Marker Generator

A versatile all-inclusive GENERATOR which provides ALL the outputs for servicing:

A.M. Radio • F.M. Radio • Amplifiers • Black and White TV • Color TV

R. F. SIGNAL GENERATOR: The Model TV-50A Genometer provides complete coverage for A.M. and F.M. alignment. Generates Radio Frequencies from 100 Kilocycles to 60 Megacycles on fundamentals and from 60 Megacycles to 180 Megacycles on powerful harmonics.

VARIABLE AUDIO FREQUENCY GENERATOR: In addition to a fixed 400 cycle sine-wave audio, the Model TV-50A Genometer provides a variable 300 cycle to 20,000 cycle peak wave audio signal.

BAR GENERATOR: The Model TV-50A projects an actual Bar Pattern on any TV Receiver Screen. Pattern will consist of 4 to 16 horizontal bars or 7 to 20 vertical bars.

THE MODEL TV-50A comes absolutely complete with shielded leads and operating instructions.

CROSS HATCH GENERATOR: The Model TV-50A Genometer will project a cross-hatch pattern on any TV picture tube. The pattern will consist of non-shifting, horizontal and vertical lines interlaced to provide a stable cross-hatch effect.

DOT PATTERN GENERATOR (FOR COLOR TV): Although you will be able to use most of your regular standard equipment for servicing Color TV, the one addition which is a "must" is a Dot Pattern Generator. The Dot Pattern projected on any color TV Receiver tube by the Model TV-50A will enable you to adjust for proper color convergence.

MARKER GENERATOR: The Model TV-50A includes all the most frequently needed marker points. The following markers are provided: 189 Kc., 282.5 Kc., 456 Kc., 600 Kc., 1000 Kc., 1400 Kc., 1800 Kc., 2000 Kc., 2500 Kc., 3579 Kc., 4.5 Mc., 5 Mc., 10.7 Mc., (3579 Kc. is the color burst frequency)

\$47.50
NET

EXAMINE BEFORE YOU BUY!
USE APPROVAL FORM ON NEXT PAGE



SUPERIOR'S NEW MODEL TW-11

STANDARD PROFESSIONAL

TUBE TESTER

★ Tests all tubes, including 4, 5, 6, 7, Octal, Lock-in, Hearing Aid, Thyatron, Miniatures, Sub-miniatures, Novals, Subminars, Proximity fuse types, etc.

★ Uses the new self-cleaning Lever Action Switches for individual element testing. Because all elements are numbered according to pin-number in the RMA base numbering system, the user can instantly identify which element is under test. Tubes having tapped filaments and tubes with filaments terminating in more than one pin are truly tested with the Model TW-11 as any of the pins may be placed in the neutral position when necessary.

★ The Model TW-11 does not use any combination type sockets. Instead individual sockets are used for each type of tube. Thus it is impossible to damage a tube by inserting it in the wrong socket.

NOISE TEST: Phono-jack on front panel for plugging in either phones or external amplifier will detect microphonic tubes or noise due to faulty elements and loose internal connections.

EXTRAORDINARY FEATURE

SEPARATE SCALE FOR LOW-CURRENT TUBES: Previously, on emission-type tube testers, it has been standard practice to use one scale for all tubes. As a result, the calibration for low-current types has been restricted to a small portion of the scale. The extra scale used here greatly simplifies testing of low-current types.

Model TW-11—Tube Tester
Total Price \$47.50
Terms: \$11.50 after 10 day trial, then \$6.00 monthly for 6 months if satisfactory. Otherwise return, no explanation necessary.

The Model TW-11 operates on 105-130 Volt 60 Cycles A.C. Comes housed in a handsome, portable Saddle-Stitched Texon Case. Only **\$47⁵⁰**

SUPERIOR'S NEW MODEL 82A

Multi-Socket Type

TUBE TESTER



TEST ANY TUBE IN 10 SECONDS FLAT!

- 1 Turn the filament selector switch to position specified.
- 2 Insert tube into a numbered socket as designated on our chart (over 600 types included).
- 3 Press down the quality button—

THAT'S ALL! Read emission quality direct on bad-good meter scale.

- SPECIFICATIONS**
- Tests over 600 tube types
 - Tests OZ4 and other gas-filled tubes
 - Employs new 4" meter with sealed air-damping chamber resulting in accurate vibrationless readings
 - Use of 22 sockets permits testing all popular tube types and prevents possible obsolescence
 - Dual Scale meter permits testing of low current tubes
 - 7 and 9 pin straighteners mounted on panel
 - All sections of multi-element tubes tested simultaneously
 - Ultra-sensitive leakage test circuit will indicate leakage up to 5 megohms

Production of this Model was delayed a full year pending careful study by Superior's engineering staff of this new method of testing tubes. Don't let the low price mislead you! We claim Model 82A will outperform similar looking units which sell for much more — and as proof, we offer to ship it on our examine before you buy policy.

To test any tube, you simply insert it into a numbered socket as designated, turn the filament switch and press down the quality switch — THAT'S ALL! Read quality on meter. Inter-element leakage if any indicates automatically.

Model 82A—Tube Tester
Total Price \$36.50
Terms: \$6.50 after 10 day trial, then \$6.00 monthly for 5 months if satisfactory. Otherwise return, no explanation necessary.

Model 82A comes housed in handsome, portable Saddle-Stitched Texon case. Only **\$36⁵⁰**

SUPERIOR'S NEW MODEL 83

C.R.T. TESTER

TESTS AND REJUVENATES ALL PICTURE TUBES

ALL BLACK AND WHITE TUBES

From 50 degree to 110 degree types — from 8" to 30" types.

ALL COLOR TUBES

Test ALL picture tubes—in the carton—out of the carton—in the set!



Model 83—C.R.T. Tube Tester
Total Price \$38.50
Terms: \$8.50 after 10 day trial, then \$6.00 monthly for 5 months if satisfactory. Otherwise return, no explanation necessary.

• Model 83 is not simply a rehashed black and white C.R.T. Tester with a color adapter added. Model 83 employs a new improved circuit designed specifically to test the older type black and white tubes, the newer type black and white tubes and all color picture tubes.

• Model 83 provides separate filament operating voltages for the older 6.3 types and the newer 8.4 types.

• Model 83 employs a 4" air-damped meter with quality and calibrated scales.

• Model 83 properly tests the red, green and blue sections of color tubes individually for each section of a color tube contains its own filament, plate, grid and cathode.

• Model 83 will detect tubes which are apparently good but require rejuvenation. Such tubes will provide a picture seemingly good but lacking in proper definition, contrast and focus. To test for such malfunction, you simply press the rej. switch of Model 83. If the tube is weakening, the meter reading will indicate the condition.

• Rejuvenation of picture tubes is not simply a matter of applying a high voltage to the filament. Such voltages improperly applied can strip the cathode of the oxide coating essential for proper emission. The Model 83 applies a selective low voltage uniformly to assure increased life with no danger of cathode damage.

Model 83 comes housed in handsome portable Saddle-Stitched Texon case—complete with sockets for all black and white tubes and all color tubes. Only **\$38⁵⁰**

SHIPPED ON APPROVAL NO MONEY WITH ORDER — NO C.O.D.

Try any of the instruments on this or the facing page for 10 days before you buy. If completely satisfied then send down payment and pay balance as indicated on coupon. No Interest or Finance Charges Added! If not completely satisfied return unit to us, no explanation necessary.

MOSS ELECTRONIC, INC.

Dept. D-780 3849 Tenth Ave., New York 34, N. Y.

Please send me the units checked on approval. If completely satisfied I will pay on the terms specified with no interest or finance charges added. Otherwise, I will return after a 10 day trial positively cancelling all further obligations.

- | | |
|---|--|
| <input type="checkbox"/> Model 77..... Total Price \$42.50
\$12.50 within 10 days. Balance \$6.00
monthly for 5 months. | <input type="checkbox"/> Model TW-11..... Total Price \$47.50
\$11.50 within 10 days. Balance \$6.00
monthly for 6 months. |
| <input type="checkbox"/> Model 80..... Total Price \$42.50
\$12.50 within 10 days. Balance \$6.00
monthly for 5 months. | <input type="checkbox"/> Model 82A..... Total Price \$36.50
\$6.50 within 10 days. Balance \$6.00
monthly for 5 months. |
| <input type="checkbox"/> Model TV-50A..... Total Price \$47.50
\$11.50 within 10 days. Balance \$6.00
monthly for 6 months. | <input type="checkbox"/> Model 83..... Total Price \$38.50
\$8.50 within 10 days. Balance \$6.00
monthly for 5 months. |

Name

Address

City Zone..... State.....

All prices net. F.O.B. N. Y. C.
Export Division: Rocke International Corp.
13 East 40th Street, New York 16, N. Y.

Coaxial Cable FOR LESS THAN 3c Per Foot! RG-54 A/U CABLE—

Designed for long life and constant attenuation with polyethylene jacket. 58 ohms .250 OD—

370 FOOT ROLL: **\$10.95**
70 FOOT ROLL: **\$1.95**

RG-8/U—8 Ft. w/PL-259 ea. end..... .95
L-101 COAXIAL ATTENUATOR—52 ohm impedance matching cable and sliding adjustment\$1.95
ID-98/APN—OUTPUT INDICATOR\$1.50
ALL of the above items are part of the TS-10B/APN ALTIMETER TEST SET shown below:



TS-10B/APN TEST SET

• Used for checking sensitivity, tuning, antenna systems, calibration and limit calibrations of Altimeters. Consists of 370 Ft. & 70 Ft. of RG-54 A/U Coaxial Cable delay lines, L-101 Attenuator, ID-98 Indicator, two 8 Ft. 1/20" & 1/12" Cables of RG-8/U with PL-259 connectors each end. Also four SD-239 connectors. Complete in carrying case, size: 19 x 15 x 17". Wt.: 36 lbs. (As shown to left)—used—

ALL FOR **\$15.00**

BC-221 FREQUENCY METER



Frequency 125 to 20,000 KC Crystal Calibration in all ranges. Can be used as a signal generator and VFO. Complete with original crystal & calibration book. Voltage required 6 VDC @ .9 amp. & 135 VDC 20 MA. Price—Used—less Modulation\$79.50

TS-175 FREQUENCY METER

Same as BC-221 only covers the range of 85 to 1000 MC. With Modulation \$99.50
—Price—Used, Excellent.....
Metal Cases Only—No Canvas Covers!

BC-603 — \$14.95 — RE-NEW

BC-603 FM RECEIVER—20 to 27.9 MC. Re-New: \$14.95
BC-604 FM TRANSMITTER—20 to 27.9 MC
Used.....\$4.95 Re-New.....\$ 7.95
BC-684 FM TRNSMTR—27-89.1 MC.....Used:\$7.95
FT-287 MOUNTING for Rec. Trans.....Re-New: \$ 7.95
FT-346 MOUNTING for Receiver only.....Re-New: \$ 4.95
DM-34 DYN. 12V. f/BC-603-683—U: \$2.95—R-N: \$ 4.95
DM-85 DYN. 12V. f/BC-604-684—U: \$6.95—R-N: \$ 9.95

AC POWER SUPPLY



F/BC-603-683—Output: 220 VDC 80MA & 24VAC 2Amps. Tube Rectification: mounts on rear Plus of BC-603-683. Can be adapted to other Receivers. KIT: \$10.00—WIRED: \$14.95

ARC-3 RECEIVER—100-156 MC: \$24.95
VHF Crystal Control 8 channel, electric band change, 17 Tubes: 9001, 9002, 12A6, 12H6, 12SH7, 12SL7, 2/12SN7, 3/12SG7, & 6/6AK5. Voltage required 210 VDC 125 MA and 24 VDC. Used \$24.95

TCK-7 TRANSMITTER: Navy Type, 2 to 18 MC. Complete w/Tubes, Manual, Mic.....New: \$150.00

FREE CATALOG New—write—ask for your Free copy today!

Address Dept. EW • All Prices F.O.B., Lima, Ohio. Minimum Order \$5.00, & 25% Deposit on all C.O.D.'s

Fair Radio Sales
3133 FLIDA ROAD
P. O. BOX 1105 LIMA, OHIO

Measurement of Meter Resistance



By JOHN GERSTLE

*Simple method gives a high degree of accuracy.
Does not require elaborate laboratory equipment.*

IT IS common practice to measure meter resistance using the circuit of Fig. 1, where R_m = the meter resistance; R_s = a variable shunt resistance; I_m = the current through the meter; R_p = the variable resistance to limit the current through the unshunted meter to full-scale value; and E = the voltage source.

Using this method, the procedure is to vary R_p until the meter reads full-scale value. The shunting resistor, R_s , is then inserted and varied until the meter reads half-scale value. The value of R_s at half-scale is then measured to give the meter resistance.

This method is entirely suitable for the well-equipped laboratory where the R_s value for the half-scale reading can be accurately measured on a precision instrument, such as a bridge.

For the ordinary experimenter or service technician to whom such laboratory equipment is not available, the following method can be used with a high degree of accuracy.

The circuit for making this measurement is exactly the same as that shown in Fig. 1 except that the meter can be shunted with any accurate fixed resistor of a value somewhere near that of the meter resistance. Such a resistor is much more likely to be available or obtainable than an accurate bridge.

Actually, it is unnecessary for the shunted meter to be set initially to full-scale value but doing this will give a more accurate result.

The equation for meter resistance in terms of shunt resistance R_s , unshunted meter current I_m , shunted meter current I_s , and meter resistance R_m , is:

$$R_m = R_s \left(\frac{I_m}{I_s} - 1 \right)$$

This equation can be used to calculate the meter resistance even though the shunt resistance is not equal to the meter resistance. As an example, suppose it is desired to measure the resistance of a 1 ma. meter that is known to have a resistance of approximately 30 ohms and, say, only a 25-ohm shunt resistance is available.

If measurement shows the shunted meter current to be .45 ma. when the

25-ohm resistor is used, then: $R_s = 25$ ohms; $I_m = 1$ ma.; and $I_s = .45$ ma. Substituting these values into the original equation, we have:

$$R_m = 25 \left(\frac{1}{.45} - 1 \right) = 25 (1.22)$$

or, $R_m = 30.5$ ohms (the value of meter resistance).

If, in this example, the usual method of measuring meter resistance had been followed, then: $R_s = 30.5$ ohms; $I_m = 1$ ma.; and $I_s = .5$ ma. or the current when the meter is shunted. Substituting these values in the original equation, then:

$$R_m = 30.5 \left(\frac{1}{.5} - 1 \right) = 30.5 (1)$$

or, $R_m = 30.5$ ohms. This shows that either method gives exactly the same result.

In measuring meter resistance it is not advisable to use a switch to cut in the shunt resistor as most switches, in time, develop enough resistance to introduce inaccuracy when measuring a low-value meter resistance. The switch shown in Fig. 1 was inserted merely to show that the shunt resistor is not always in the circuit.

In selecting the fixed shunt resistor, a preliminary check with common resistors should be made to determine the approximate value of the meter resistance should this value be unknown.

For high accuracy, the fixed shunt resistor should reduce the meter reading to between .4 and .6 of its full-scale value. However, any meter reading will give an approximation of the meter resistance.

Fig. 1. Circuit employed to measure the resistance of a meter. See the text above for a complete explanation.

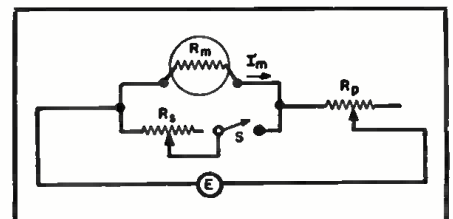

NEW ILLUMINATED DEALER SIGNS!

pick

the one for your store!



14" x 50" with clock and changeable copy panel

14" x 37" with changeable copy panel



ALL THREE SIGNS IN BRILLIANT BLUE AND RED ON A WHITE BACKGROUND.



Double-faced 3' x 6'
Deluxe outdoor sign



Copyright 1940 Channel Master Corp.

Channel Master's big, bright spectaculars increase your sales. Day and night, they:

- IDENTIFY YOU IMMEDIATELY AS A CHANNEL MASTER DEALER
- STIMULATE STORE TRAFFIC
- HELP YOU CAPITALIZE ON CONSUMER PREFERENCE FOR CHANNEL MASTER PRODUCTS
- ADD TO THE APPEARANCE OF YOUR STORE

Call your Channel Master distributor today

4 GREAT NEW SAMS BOOKS

"Tube Substitution Handbook"

Compiled by the engineering staff of Howard W. Sams & Co., Inc. Lists over 1500 American receiving tubes, including more than 300 which can be replaced by European receiving tube types. Also lists 400 picture tubes; 179 European types that can be replaced by American tubes, and 78 receiving tubes replaceable by industrial types. Includes helpful facts on tube substitution. Invaluable reference for technicians. Handy 5 1/2 x 8 1/2" size. Only.....



\$150

"Practical Transistor Servicing"

by William C. Caldwell

The latest word on how transistors and transistor circuits operate—shows how to signal-trace and diagnose portable and auto-radio troubles. Tried and tested procedures are based on the premise that "time saved is money earned." Concentrates on the practical in 8 fact-filled chapters; tells clearly how transistors work; describes circuit components and their functions; shows how to isolate troubles; indicates normal transistor voltages and explains meanings of defective voltages; tells how to test transistors; shows how to troubleshoot auto radios; gives actual case histories. Profusely illustrated; 5 1/2 x 8 1/2" \$295 Only.....



\$295

"Rapid Printed Circuit Repair"

by G. Warren Heath

Printed circuit boards, now being used in more and more electronic devices, can be a headache to the technician unless he understands their function and how to repair them. This practical book avoids complicated theory; it clearly describes and illustrates the fundamentals of printed circuitry and the components used by various manufacturers. Servicing and repair techniques and the various types of defects likely to be encountered are listed in alphabetical order for easy reference. 5 1/2 x 8 1/2". Only.....



\$195

"Electronic Tips and Timesavers"

by John Comstock

Includes over 300 ingenious time- and money-saving tips—solving just about any problem the technician, engineer, builder or experimenter might face. Simply written and supported by illustrations, these bench-tested hints will save you much effort and frustration. You'll want to keep this book handy for constant reference use. Eight sections include tips on bench and field servicing, shop and truck equipment, soldering, tools, test equipment, construction and experimentation. 5 1/2 x 8 1/2". Only.....



\$150

HOWARD W. SAMS & CO., INC.

Order from your Sams Distributor today, or mail to Howard W. Sams & Co., Inc., Dept. G-10 1720 E. 38th St., Indianapolis 6, Ind.

Send me the following books:

- "Tube Substitution Handbook" (TUB-1)
- "Practical Transistor Servicing" (PTC-1)
- "Rapid Printed Circuit Repair" (PC-2)
- "Electronic Tips and Timesavers" (TSC-1)

\$.....enclosed. Send Free Book List

Name.....

Address.....

City..... Zone..... State.....

(outside U.S.A. priced slightly higher)



YOU WILL never stir up much of an argument by repeating the old truism, "You can't please everybody." Few recognize the truth of that well-worn phrase more than do editors who try to make each of their hundreds of thousands of readers happy with everything they choose for publication. Witness the letter we got from L. B. H., an independent service operator from Palmerton, Penna., who also happens to be the author of a number of successful articles, over the years, in this and other publications.

He believes that, with "Service in 1959" (April 1960 issue), we have "thrown one of the worst below-the-belt punches at the service industry" he has seen. Particularly, Mr. H. is disturbed over what he calls our "favorable comment on licensing." As a matter of fact, as we will note shortly, we think this correspondent has failed to understand our actual position. However, let's first give him the chance to make a few more points.

"If you are so conscientiously concerned about abuses in the industry," he adds, "why not delve into the manufacturer's practice of peddling \$100 sets for \$400 that usually conk out about the second day after arriving from the 'printers'? The public, however, has been so overwhelmingly impressed . . . that the service man who can't fix it with a flick of the wrist must surely be a shady character . . . Now, you are all for hanging a 'license' tag on him.

"These 'licensed' service men will, of course, all be Phi Beta Kappa, honor-bound not to try to sell tubes or accessories and—oh, yes—their numbers must be in bold yellow across their

backs . . . Would you like a bit of constructive criticism? 'Thou shalt not sell that which thou canst not service in its entirety.'"

That's quite a bit off one writer's chest. For our part, we have never taken a stand either for or against licensing. If Mr. H. will check our past issues, he will find he is not the first "anti" whose viewpoint was run in this space. In fact, the April article to which he objects acknowledges (third paragraph) that many service dealers and associations are opposed to licensing. We used this issue, however, to illustrate the point that the maturing service industry is now getting things done where, not so many years ago, it was relatively ineffectual.

All right, then; why did we have to pick on licensing? Simply because the service industry itself has made it the foremost issue before it and because most members of the industry do favor it. These are facts, not opinions. We have done everything in our power to sample the service associations throughout the nation—more than 200 of them—on this (and other) issues. We receive an impressive volume of mail from service dealers and technicians, in and out of associations, on this (and other) matters. We implement this with every other sampling technique we know. We doubt that many people are in a better position to know what industry feeling is on this matter.

We believe it would be morally wrong for us to cheat the industry of its obligation to make up its own mind on this important issue, and we will not do so. However, we must also report the cold fact that, for better or

Half a dozen service-industry leaders from Florida: the newly elected officers of the Television & Electronic Service Association of Miami. From left to right, in the back row: Charles D. Pierce, 2nd vice-president; Roger Misleh, 1st vice-president; James J. Ross, corresponding secretary; and Sam Kessler, recording secretary. Front row: C. W. Minter, treasurer, and A. Edward Stevens, president.



worse, an impressive majority is in favor of licensing. Stating as much is not exactly what Mr. H. charges us with doing. As for this writer's other comments, we are not inclined to argue with him. We have had our say on poor layout for serviceability, printed-wiring problems, quality control, and other matters.

We cannot resist a footnote before dropping this subject. Under "Must Reading," the April issue of the "TSA Newsletter" (Northeastern New York) says "every upstanding technician" should take the time to read "a very enlightening article, 'Service in 1959.' Don't miss this discussion," says the editor. As we started out to say, "You can't please everybody."

Beginner's Dilemma

Another recent letter, by contrast, comes from a relative newcomer. "The course that I studied TV repairing in taught us not to speak against any other repairmen," writes H. C. W. of San Bernardino, Calif., "but many of your readers who seem to be very capable repairmen appear as though they were running around like hungry wolves seeking any beginners that they might devour . . . Some of your readers would make it impossible to get repair experience in the manner that the course has recommended; that is, by fixing TV sets for your friends and neighbors.

"I would like to ask you or any of your readers what I should do—and what you did—to get this experience! Let the man that is innocent among you cast the first stone."

Mr. W. has something of a point. If lack of experience is a crime, then all of us have been guilty at one time or another. However, there are many different ways of getting experience. Many of us, no matter how well grounded we were in theory at the outset, at no time presumed to take chances on other people's sets by plunging right in on our own. We managed to tie in with established, reliable shops, where we could work under the surveillance of more knowledgeable men who could protect us (and the customers) from our inevitable, early blunders. We didn't always land a job on the first try but, when we did, it was by representing ourselves honestly—as eager, well-informed, but inexperienced men who were essentially looking for apprenticeship.

Today Mr. W. is in a much better position to use that approach than was possible up to a few years ago. Many forward-looking service associations, aware of his particular problem, have begun to experiment with apprenticeship programs, conditional membership for newcomers, and other such "door openers." As it happens, a good deal of this activity is going on in Mr. W's home state. We have taken the liberty of referring him to a local group.

We cannot dictate a "one right way." However, learning to walk before one learns to run can surely do no harm and may do much good. —30—

"PHOTOFACTS...most complete..."

"I have found PHOTOFACTS to be the most complete service information available on all makes and models of radios and television."

—Aaron F. Triplett
Flint, Michigan

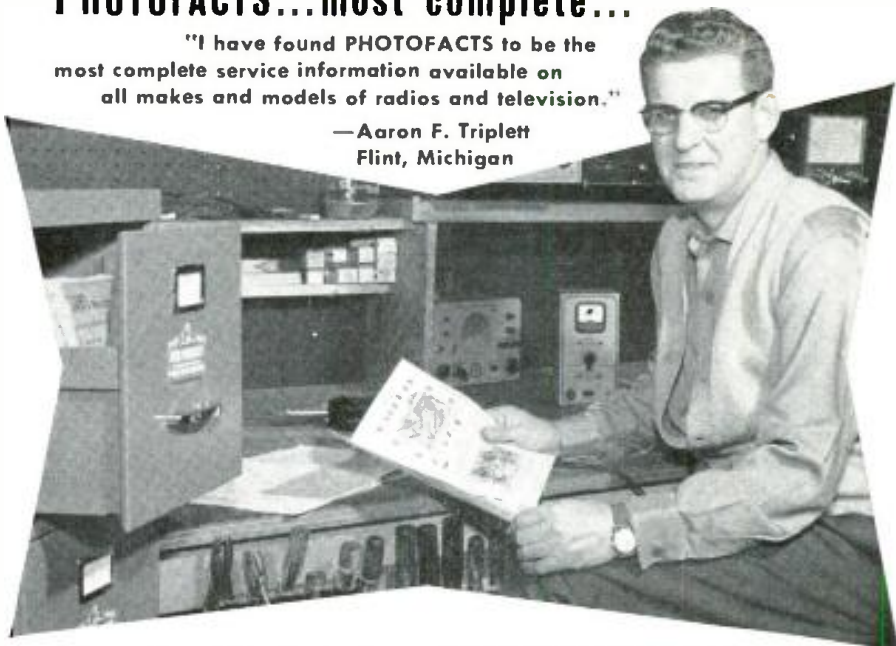

Service Technicians! YOU EARN MORE... YOU RATE with the public when you own the PHOTOFACT® service data library!

You enjoy maximum earnings as the owner of a complete PHOTOFACT Service Data Library! It's inevitable, because no matter how expert you are, you can always *save more time on any job, get more jobs done daily*—**EARN MORE, DAY IN AND DAY OUT...**

What's more—as the owner of a complete PHOTOFACT Library, you know your customers' sets *best*. You can actually show each customer you have the PHOTOFACT Folder covering his very own set. Result: You command public respect and acceptance which paves the way to more business and earnings for you.

HOW TO STAY AHEAD...

Yes, the truly successful Service Technicians are those who own the complete PHOTOFACT Library, who can meet and solve any repair problem—faster and more profitably. And these men *keep ahead* because they're on a Standing Order Subscription with their Distributors to receive all new PHOTOFACTS as they are released monthly. (They're eligible for the benefits of membership in PEET, too—see below!)

ONLY \$10 DOWN puts the complete PHOTOFACT Library in your shop—and you have up to 30 months to pay. See your Sams Distributor today, or write to Howard W. Sams

NOW IS THE TIME TO JOIN

"PEET"

THE POWERFUL NEW PROGRAM FOR QUALIFIED TECHNICIANS

If you now own a PHOTOFACT Library or plan to own one, you can apply for membership in "PEET." It's the first industry program really designed to build powerful public acceptance for the Service Technician who qualifies. Builds enviable prestige and business for its members. Benefits cost you absolutely nothing if you qualify. Ask your Sams Distributor for the "PEET" details, or mail coupon today.

HOWARD W. SAMS & CO., INC.
1724 E. 38th St., Indianapolis 6, Ind.

- Send me full details on the new "PEET" Program.
- Send full information on the Easy-Buy Plan and Free File Cabinet deal.
- I'm interested in a Standing Order Subscription.
- I'm a Service Technician full-time; part-time

My distributor is _____

Shop Name _____

Attn: _____

Address _____

City _____ Zone _____ State _____

DYNAMOTOR SPECIAL

2 Inputs 12 Volts—2 Outputs (440 V. @ 200 Ma., 225 V. @ 100 Ma.)
Cont. Duty. BRAND NEW. Ea. **\$7.95**

BRAND NEW CARTER DYNAMOTOR
INPUT 5.9 VOLTS, OUTPUT 405 V. @ 270 MA. SMALL SIZE.....Ea. **\$4.95**

COAX CABLE

RG8U—52 Ohm Impedance—Fresh Stock—500 feet on sealed wooden spools **\$32.50**
Each
Smaller quantities 7½¢ per ft. Minimum order 25 ft.

NEW VACUUM CAPACITORS

EIMAC VC 12 MMF-32KV.....Ea. \$6.95
EIMAC VC 25 MMF-32KV.....Ea. 7.95
EIMAC VC 50 MMF-32KV.....Ea. 8.95
JENNINGS JVC-150 MMF-20KV.....Ea. 24.95
JENNINGS 100 MMF-20KV.....Ea. 12.95
50 MMF-5KV.....Ea. .95
25 MMF-10KV.....Ea. 2.25

POWER TRANSFORMER

Primary 110V. 60 cy., Sec 445-0-445V. @ 150 Ma. 6.3V. @ 6 Amps, 5V. @ 3 Amps.
Fully shielded.....Ea. **\$3.95**
Write for quantity prices

FILAMENT TRANSFORMERS

Primary 110 volts 60 cycle, Secondary 2½ V. 10 Amps, 10,000 V. Insulation.
Primary 110V. Sec. 6-3V. @ 60 Amps.....Ea. **\$8.95**

CHOKE—FULLY CASED

5 HENRY @ 200 Ma.....Ea. 1.95
5 HENRY @ 250 Ma.....Ea. 2.25
4 HENRY 400 Ma.....Ea. 3.95
12 HENRY 500 Ma.....Ea. 12.95
4 HENRY 600 Ma.....Ea. 12.95
6 HENRY 600 Ma.....Ea. 8.95

BRAND NEW OIL CONDENSERS

3 MFD 600 VDC .80	8 MFD 2000 VDC 4.95
4 MFD 600 VDC .80	4 MFD 2000 VDC 8.95
5 MFD 600 VDC .80	2 MFD 2500 VDC 2.50
6 MFD 600 VDC .85	1 MFD 3000 VDC 1.85
8 MFD 600 VDC 1.05	2 MFD 3000 VDC 3.50
10 MFD 600 VDC 1.19	1 MFD 4000 VDC 3.25
12 MFD 600 VDC 1.30	2 MFD 4000 VDC 6.25
15 MFD 600 VDC 1.70	2 MFD 4000 VDC 6.95
3x8 (24 MFD) 600 VDC 2.80	4 MFD 4000 12.95
1 MFD 1000 VDC .60	15 MFD 5000 39.50
2 MFD 1000 VDC .85	5 MFD 7500 VDC 2.95
4 MFD 1000 VDC 1.35	1 MFD 7500 VDC 6.95
8 MFD 1000 VDC 2.05	2 MFD 7500 17.95
10 MFD 1000 VDC 2.50	1 MFD 10,000 19.95
12 MFD 1000 VDC 2.95	2 MFD 12,500 34.50
15 MFD 1000 VDC 3.70	5 MFD 10,000 29.95
1 MFD 1200 VDC .45	5 MFD 25,000 34.95
1 MFD 1500 VDC .75	1 MFD 25,000 69.95
2 MFD 1500 VDC 1.10	50 MFD 10,000 AC 3.50
4 MFD 1500 VDC 1.99	10 MFD 150 AC 1.95
8 MFD 1500 VDC 2.95	20 MFD 330 AC 2.95
1 MFD 2000 VDC 1.50	5 MFD 10,000 AC 2.95
2 MFD 2000 VDC 1.95	8 MFD 660 AC 2.95
4 MFD 2000 VDC 3.50	2 MFD 600 VDC .50

SIGMA 5F RELAY

16,000 ohm in dual 8,000 ohm coils. SPDT adjustable silver contacts and armature tension. Operates on 500 Microamperes or less.....Ea. **\$3.95**
Write for quantity prices

RELAYS

GUARDIAN 110V AC, 2 Pole Single Throw (1 N.O. & 1 N.C.) Repl. BC-610..... **\$2.50**
24V. AC 4PDT.....Ea. **\$1.85**
ALLIED 110V. AC 4PDT.....Ea. **\$2.75**
Potter-Brumfield SMSLS 5000 ohm, 4 Ma. Sens.....Ea. **\$2.25**
Allied Relay 110 V. AC. DPST.....Ea. **\$1.35**
Hermetically Sealed Relay Coil 110V AC 60 cy SPDT Contacts 5 Amps.....Ea. **\$1.50**
6 Volt DC DPDT H.S.....Ea. **99c**
12 Volt DPDT DC Relay.....Ea. **\$1.35**
SIGMA type 22RJC 8,000 ohm.....Ea. **\$2.49**
SPDT, small sealed relay.....Ea. **\$1.95**
Sealed Relay, SPDT, 6,000 ohm coil.....Ea. **\$1.95**
G.E. Relay control, contains 8000 ohm relay, sensitivity 10 for \$9.25. Ea. **\$1.10**
LEACH ANT. RELAY 110V. AC DPDT Ceramic Ins.....Ea. **\$2.95**

PANEL METERS

STANDARD BRANDS 1½" METERS	3" METERS
0-1 Mil.....2.95	100-0-100 Micro Amps DC.....3.95
0-100 Micro.....3.95	0-1 Mil DC.....3.95
	0-10 Mills DC.....3.95
	0-50 Mills DC.....3.95
	0-100 Mills DC.....3.95
	0-150 Mills DC.....3.95
	0-250 Mills DC.....3.95
	0-500 V. DC.....3.95
	0-1 Amp RF.....4.50
	0-15 Amps RF.....4.50
	0-12 Volts AC.....3.95
	0-15 Volts AC.....3.95

MISCELLANEOUS SPECIALS

CARDWELL Var. Cond. 1000MMF 1700V **\$2.50**
SPERT Vacuum Switch used in ART13 ea. \$1.50
36 OHM 50 Watt Globar Non-Ind. Res. 2 for \$1.00
3-12 MMF Erie Ceramic Trimmers.....21c
NESI NEON BULBS.....**\$1.00**
Box of 10 MAGNETIC PICK-UP TOOL gets Nuts, Bolts, Tacks, etc out of difficult places. **79c**
Each CUTLER-HAMMER TOGGLE SWITCH.....**29c**
SPDT (ST42D) 4 for \$1.00.....Ea. **29c**
WILLARD STORAGE CELL—2V. 28 Amp hrs. Clear plastic case. Shipped dry. Ea. **\$2.50**
Write for quantity prices on all special items

All merchandise sold on a 10 day money back guarantee
Min. Order \$3.00—25% with Order—F.O.B. New York

PEAK

ELECTRONICS COMPANY
66 W. Broadway, New York 7, N. Y., WO-2-2370



THIS month we continue to bring you capsule reviews of outstanding new technical books. In this way, we are able to provide pertinent information on the many excellent publications received here, with the hope that you will follow up with a more leisurely examination of these books at your bookseller or distributor.

AUDIO AND HI-FI

"HI-FI MADE EASY" by Norman H. Crowhurst. Published by *Gernsback Library, Inc.*, New York. 224 pages. Price \$2.90, soft cover; \$5.00, hard cover.

The author—an audio consultant, engineer, and prolific writer in this area—here tackles some of the basic concepts and techniques of high-fidelity sound for the average, non-technical reader. The book is illustrated, not with diagrams or photographs, but with saucy little cartoons that make a technical point by analogy. Although primarily aimed at the beginner, this book might appeal to some advanced audiophiles as well.

"A GUIDE TO STEREO SOUND" by David Tardy. Published by *Popular Mechanics Press*, Chicago. 192 pages. Price \$4.95.

This book examines, in simple language and with abundant illustrations, the fundamental concepts involved in stereophonic sound for the home, explains how many of the approaches used differ from each other, and how home stereo differs from movie stereo. Included are discussions of the relation of stereo to hi-fi, multiple channel setups, sound and location, microphone techniques as they relate to playback, stereo amplifiers, broadcasts, tapes, and discs.

THEORY AND FUNDAMENTALS

"LOW FREQUENCY AMPLIFIERS" edited by Alexander Schure. Published by *John F. Rider, Inc.*, New York. 88 pages. Price \$1.80. Soft cover.

This book deals with the audio band from 20 to 16,000 cycles, clarifying the application of vacuum tubes and transistors to audio-frequency amplifiers. Special emphasis is given to the design of systems, showing and solving specific design problems.

"LOW FREQUENCY AMPLIFIER SYSTEMS" edited by Alexander Schure. Published by *John F. Rider Publisher, Inc.*, New York. 80 pages. Price \$1.80. Soft cover.

A companion volume to the book described above, this work deals with low-frequency amplifying systems with special emphasis on coupling methods

suitable for this frequency band, as well as such topics as phase inversion, inverse feedback, and circuit design.

"PHOTOTUBES" edited by Alexander Schure. Published by *John F. Rider Publisher, Inc.*, New York. 96 pages. Price \$1.80. Soft cover.

This book deals with the principles underlying the operation of the different types of phototubes that have become vital elements in many applications of industrial electronics and other fields. Theory, structure, and types of phototubes are covered, as well as the essentials of phototube amplifiers.

"MAGNETIC AND ELECTRICAL FUNDAMENTALS" by Alexander Efron. Published by *John F. Rider Publisher, Inc.*, New York. 132 pages. Price \$2.50. Soft cover.

An accurate and readable explanation of the subject is provided in this book, with the emphasis on the physics viewpoint. The material should interest students as well as technicians who want to expand their personal store of basic information.

"FUNDAMENTALS OF ELECTRONICS" by Matthew Mandl. Published by *Prentice-Hall Inc.*, Englewood Cliffs, N. J. 574 pages. Price \$10.60.

This volume covers basic theory as well as the practical aspects of electronics, and provides a solid foundation for more advanced or specialized studies. It is aimed at the serious reader who wants a thorough grounding in this area. Subjects covered include: electron theory, circuit elements, series and parallel circuits, power sources and measuring devices, magnetism, a.c. theory, inductance and capacitance, resonance, vacuum tubes, transistors, amplifiers, oscillators, modulation, receiver principles, transmission lines and antennas, miscellaneous circuits, and test equipment.

"MAGNETISM AND ELECTROMAGNETISM" edited by Alexander Schure. Published by *John F. Rider Publisher, Inc.*, New York. 78 pages. Price \$1.80. Soft cover.

This book deals with those aspects of magnetism and electromagnetism that underlie the operation of communication and industrial electronic devices. Its intent is to explain the major theoretical considerations of its subject matter at the intermediate level.

"ADVANCED MAGNETISM AND ELECTROMAGNETISM" edited by Alexander Schure. Published by *John F. Rider Publisher, Inc.*, New York. 104 pages. Price \$2.25. Soft cover.

This is a companion volume to the book described above. Advanced concepts are explained, and the author penetrates more deeply into the subject, covering such topics as Biot's Law, the Curie-Weiss Law, the domain theory of magnetism, the cyclotron, the mass spectrophotograph, and terrestrial magnetism.

"R-F AMPLIFIERS" edited by Alexander Schure. Published by *John F. Rider Publisher, Inc.*, New York. 104 pages. Price \$2.40. Soft cover.

An excellent discussion of low- and high-powered r.f. amplifiers is given in this book. Design and theory are covered, with special emphasis placed on resonant circuits. Practical examples of design are included in this useful volume.

"TELEMETERING SYSTEMS" by Perry A. Borden and W. J. Mayo-Wells. Published by *Reinhold Publishing Corp.*, New York. 349 pages. Price \$8.50.

Full details on the practical aspects and possibilities of stationary and mobile telemetering are explained in this book. The various systems of telemetering are thoroughly discussed, as are such topics as telemetering pickups, links and channels, remote reading, reliability and testing, and others. Diagrams, photos of equipment, and extensive lists of reference works enhance this book's usefulness for the advanced technician who is interested in this field.

"FUNDAMENTALS OF ELECTRONICS" by E. Norman Lurch. Published by *John Wiley & Sons, Inc.*, New York. 631 pages. Price \$8.25.

This book, with the same title as the volume described before, inevitably invites comparison with it. Actually, Lurch's work is on a somewhat more advanced level technically and presumes a previous knowledge of d.c. and a.c. circuits. This book goes more deeply into certain aspects of basic electronics, and relies more heavily on mathematics and more complex circuit diagrams to help explain various points. All in all, a book for the non-engineer who is advanced beyond the beginning stages of technical development.

"FUNDAMENTALS OF ELECTRICITY" by Kennard C. Graham. Published by *American Technical Society*, Chicago. 342 pages. Price \$4.75.

This is the fourth edition of a work that has long been a popular and efficient guide to electrical fundamentals. Subjects covered include: the nature of electricity, electrical quantities, Ohm's law, magnetism and electro-magnetism, generators, motors, power and heating effects, transformers and rectifiers, measuring devices, waves, and automation devices. The book is liberally illustrated and includes a glossary of terms.

"WHAT IS CYBERNETICS?" by G. T. Guilbaud. Translated by Valerie MacKay. Published by *Criterion Books, Inc.*,

New York, N. Y. 126 pages. Price \$3.50.

Written by an eminent French authority on cybernetics, this book is a popular introduction to "the study of systems of control and communications in animals and in electrically operated devices such as calculating machines." It explains, in non-technical language, the fundamentals of control systems, signals and messages, feedback, information theory and related pertinent subjects.

"DIGITAL COUNTERS AND COMPUTERS" by Ed Bukstein. Published by *Rinehart & Co., Inc.*, N. Y. 248 pages. Price \$7.00.

Partially based on a series of articles by the author for this publication, this work approaches the subject of computers from two ways. First, the author explains the electronic circuitry that is involved. Then, the book goes into such topics as the number theories and counting systems by means of which computers do their work.

"DIRECT CURRENT ELECTRICITY" by Alexander Efron. Published by *John F. Rider Publisher, Inc.*, New York. 100 pages. Price \$2.25. Soft cover.

The text covers d.c. fundamentals from the viewpoint of the student of physics as well as the beginner in electrical engineering. The book moves logically from electrochemistry through circuit analysis and on to measuring instruments and magnetic laws.

(To be continued)

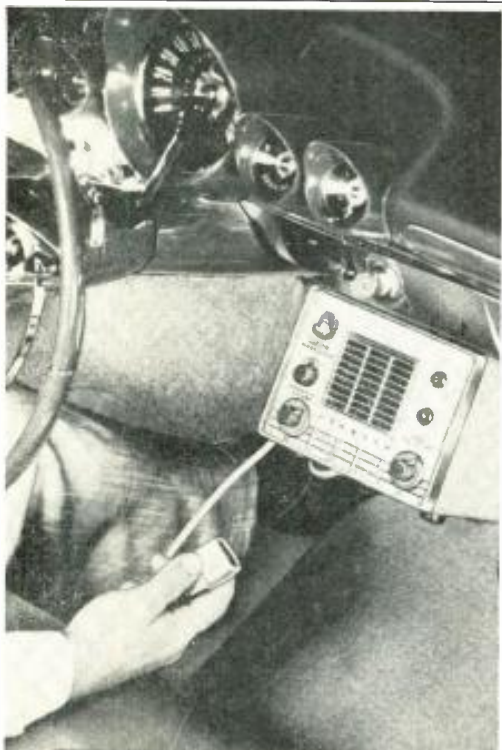

"More than Citizens' Radio" ...

a complete, fully engineered "industrial-type" transceiver!

VIKING *Messenger*

Anyone can operate—license issued by the FCC on request

from **\$129⁷⁵**

- Complete 23 channel Citizens' Band coverage—choose 1 of any 5 channels by the flip of a switch.
- Maximum legal power—excellent range—meets all FCC requirements.
- Excellent receiver sensitivity and selectivity—full fidelity voice reproduction.

"More than just 2-way Citizens' Radio equipment"—the Viking "Messenger" will deliver the finest performance of any equipment available in the field. Designed throughout for 10 watt power level—limited to 5 watts for Citizens' Radio. Easy to install anywhere in your home, business location, car, truck or boat . . . offers many unique features found only on more expensive communications systems. Built-in Squelch, Automatic Volume Control, and Automatic Noise Limiter. Compact, modern styling—only 5 3/8" high, 7" wide, and 1 1/4" deep. Complete with tubes, push-to-talk microphone, and crystals for one channel.

 Available from authorized Johnson Electronic or Marine Distributors. Installation and service coast-to-coast at all General Electric Communications Service Stations.



E. F. JOHNSON COMPANY

103 Second Ave. S. W. • Waseca, Minnesota
• Please rush me your full color brochure describing the Viking "Messenger" Citizens' Transceiver.

NAME _____
ADDRESS _____
CITY _____ STATE _____

Manufacturers of the world's most widely used personal communications transmitters

DOES YOUR BUSINESS SLUMP AS TEMPERATURES SOAR?

DIVERSIFY WITH 2-WAY MOBILE-RADIO MAINTENANCE!

Hundreds of progressive radio servicemen are filling the summer slump in entertainment radio—by adding mobile-radio maintenance! Actually, mobile-radio service is business 12 months out of the year—often on contract basis—paid for by going organizations. So rise above competition—and end that summer slump—send coupon below for "How to Make Money in Mobile-Radio Maintenance". It's free!

THIS BOOKLET IS BASED UPON A CAREFUL SURVEY OF THE ACTUAL OPERATING PRACTICES OF SUCCESSFUL MOBILE-RADIO ENGINEERS. IT SHOWS TYPICAL CONTRACT PROVISIONS . . . MONTHLY FEES . . . INSTALLATION CHARGES . . . LABOR RATES . . . ETC.

Lampkin instruments are the most popular mobile-maintenance meters.

MAIL COUPON TODAY ➔

LAMPKIN LABORATORIES, INC.
BRADENTON, FLA.

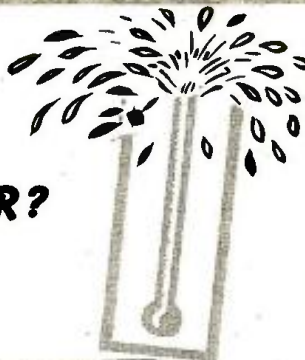

LAMPKIN 105-B
FREQUENCY METER
RANGE 0.1 TO 175 MC AND UP
PRICE \$260.00 NET



LAMPKIN 205-A
FM MODULATION METER
RANGE 25 TO 500 MC
PRICE \$270.00 NET

LAMPKIN LABORATORIES, INC.
MFM Division, Bradenton, Florida
At no obligation to me, please send
 Free booklet Data on Lampkin meters
Name _____
Address _____
City _____ State _____

Two-Way Mobile Maintenance

(Continued from page 37)

In all areas the units that had been maintained under a service policy were in much better condition than those that had been maintained under a "call when it quits" basis. Since both types of maintenance were rendered by essentially the same personnel, the reasons for the differences in condition cannot be attributed to differences in competence of personnel. Although our program of routine inspections, particularly on stations, accounts in large measure for the superior condition of "service policy units," we believe that equal reasons for the improvement are as follows:

1. Under a one-price service policy, drivers and dispatchers never hesitate to call for service at the least sign of trouble, since it costs nothing extra to have the equipment checked. There is no tendency to "get by" with inferior performance only to have equipment fail at what may be a critical and costly time for the user.

2. A radio service organization whose profits and growth depend on the system staying in operation can afford to be more thorough than an individual whose profits depend on how many hours he spends on a disabled unit of the system. Callbacks, always a source of irritation (even when the customer does not pay for them), are considerably reduced.

3. Any organized maintenance program, whether it concerns radios, automobiles, or elevators, is more efficient than a non-organized program.

In addition to providing better performance and reliability for the radio investment, we believe a service policy is more economical and provides an accurate means of determining the true radio operating costs.

The preparation of individual invoices covering radio repair is costly for the servicing company. Verification by the user can be even more costly, since personnel doing this work are not familiar with the radio terms and materials.

For example, one invoice may list a discriminator transformer at \$3.85 and another may list a plate transformer at \$87.00. Not only must the user determine if the pricing on the particular transformer is correct, but he wants to know whether the replacement transformer was necessary. It is also difficult to keep records of, and establish charges for, special engineering required in certain stubborn cases of system trouble, diagnosis, and other operational problems.

All of these problems are eliminated under a flat-rate service policy where a single monthly invoice is rendered, covering the number of units and stations in service. This is not to say that detailed cost accounting and radio maintenance is not necessary but, instead, it is done by the radio contracting firm. This enables the contractor to control costs and maintain



SIGNAL TRACER

Checks all stages from Antenna to Speaker or Picture Tube. Tests microphones, appliances, pickups, transformers, speakers, resistors, condensers, etc.

Model 202 (with AF Probe) . . . Net \$37.50
Model A Probe
(RF Demodulator) Net 4.50
Model B Probe (RF Demodulator,
Amplifier) Net 7.50



VTVM KIT

Easily assembled! Solves numerous problems. Sensitive voltage measurements with negligible circuit loading. Accurate AC voltage ranges for checking line voltages, amplifier power output, frequency response. Positive and negative DC voltage ranges. Checks resistance. Radio, TV servicing; maintenance of electronic equipment; many other uses. Net \$27.95.

PRECISION ELECTRONICS, INC.
9101-Q King Ave., Franklin Park, Illinois

SAY YOU SAW IT IN ELECTRONICS WORLD

SURPLUS



SILICON RECTIFIERS

1N1551	1 amp. 100 volts	.80
1N1552	1 amp. 200 volts	.95
1N1553	1 amp. 300 volts	1.10
1N1554	1 amp. 400 volts	1.25
1N05K7	25 amp. 50 volts	2.50
1N1454	25 amp. 100 volts	3.00
1N1455	25 amp. 200 volts	3.50
1N1456	25 amp. 300 volts	4.00
1N1457	25 amp. 400 volts	4.50
1N1458	35 amp. 100 volts	3.50
1N05R7	75 amp. 50 volts	9.00
1N1466	75 amp. 100 volts	10.00
1N1467	75 amp. 200 volts	11.00
1N1468	75 amp. 300 volts	12.50
1N1469	75 amp. 400 volts	14.00

NO C.O.D.'S. REMIT FULL AMOUNT WITH ORDER.

C & H SALES CO.

2176 E. Colorado St. - Pasadena 8, Calif.

LORAN R-65/APN-9 RECEIVER & INDICATOR

Used in ships and aircraft. Determines position by radio signals from known transmitters. Accurate to within 1% of distance. Complete with tubes and crystal. Exc. used. Value \$4200.00. **Our Price \$79.50**

Used, less tubes, crystal and visor, but with 3BP1 CR tube. \$29.50
 12 Volt Inverter Power Supply for above. BRAND NEW. \$32.50
 28 Volt Inverter Power Supply, exc. cond. \$49.50
 Circuit diagram and connecting plugs available.

TS-100AP 'SCOPE
 (WORTH \$750) **\$2950**
OUR LOW PRICE

Can be used with linear sweep or general purpose test scope. Includes 12" screen. Also used with circular sweep as precision range calibrator. Self-contained in 8" x 12" x 10" deep. For 110 V 50 to 1200 cycles AC. Excellent used, like new, with all tubes including crystals and C. R. Tube.

GOLD PLATED SPECIAL! TS-1/ARR-1 TEST OSCILLATOR
 Portable, complete with two 935 tubes, cavity and antenna. BRAND NEW, in metal housing 9 3/4" x 6 1/2" x 7" high. **OUR LOW PRICE, each \$3.45**

BENDIX DIRECTION FINDERS
 For commercial navigation on boats.
 MN28V 150-325 Kc; 325-605 Kc; 3-4.7 Mc. Complete with tubes, exc. used. **BRAND NEW \$26.95**
 MN28V Receiver Control Box. \$2.95
 MN28G Receiver 150-325 Kc. continuous tuning with 12 tubes and dynamotor. Used. \$18.95
 MN28G Receiver as above. BRAND NEW. \$27.50
 MN20E Rotatable Loop for above. \$4.25
 MN52 Azimuth Control Box. \$2.95
 Flexible Mechanical Cable for Above. \$3.95
 MN28C Receiver Control Box. \$4.95
 Other Accessories available from stock.

NAVY AIRCRAFT RADIO RECEIVER
 ARP/CRV 46151-150 to 9050 Kc in 4 bands. 6 Tube Superhet communications receiver, with local and remote tuning, band change. Sharp and broad tuning. AVC, CW, Illuminated dial. Complete with tubes and dynamotor. BRAND NEW. \$34.50
 Like New. \$26.50
 Power Supply 110 V. AC. Wired. \$8.50

MICROPHONES

Model	Description	Excellent Used	BRAND NEW
T-17	Carbon Handset	\$2.45	\$5.45
T-30	Carbon Throat Mike	\$3.34	\$7.45
T-45	Army and Navy Lip Mike	1.25	2.85
T-9	Handset	1.25	2.85
TS-11	Handset	3.95	8.95
TS-13	Handset	4.25	9.95
RS-38	Hand Type	4.75	10.95

HEADPHONES

Model	Description	Excellent Used	BRAND NEW
HS-23	High Impedance	\$2.19	\$4.50
HS-33	Low Impedance	2.69	4.65
HS-30	Low Imp. (featherweight)	.90	1.65
HS-16 H	High Imp. (2 unit)	3.75	7.95

TELEPHONES-600 ohm Low Impedance HEADSETS- BRAND NEW, PER PAIR \$3.25
 CD-307A Cords, with PL5 Plug and JK26 Jack
 Earphone Cushions for above-pair. .50

NAVY DYNAMIC HEADSET, H-Fl 40 to 14000 cycles, no distortion, complete with cushions, checked out. Exc. used. \$7.95

LORAN APN-4 FINE QUALITY NAVIGATIONAL EQUIPMENT

Determine exact geographic position of your boat or plane. Indicator and receiver complete with all tubes and crystal.

INDICATOR ID-68/APN-4, and RECEIVER R-98/APN-4, complete with tubes. Exc. used \$49.50
Receiver-Indicator as above, BRAND NEW \$79.50

12 V. Inverter Power Supply for above. BRAND NEW. \$32.50
 28 V. Inverter Power Supply for above exc. cond. \$49.50

RADIO RECEIVER NAVY TYPE RAY-3
 Model AN-PR6N is for 14V DC operation.
 These receivers are supplied complete with built-in dynamotor, 11 tubes, Weston output meter on front panel, as well as coax antenna and output connection, phone jack, on-off switch. For 14V or 24V, please specify.
 Like New Condition. **Our Price \$14.95**

BC-906 FREQ. METER-SPECIAL
 Cavity type, 145 to 235 Mc. BRAND NEW, complete with antenna. Manual included. **OUR LOW PRICE \$10.88**

WILLARD 6-VOLT MIDGET STORAGE BATTERY
 3 Amp. Hour. BRAND NEW. 3 3/4" x 1-13/16" x 2 3/4". Uses Standard Electrolyte. **Only \$2.95**

2 VOLT BATTERY "PACKAGE"
 1-2V. 20 Amp. Hr. Willard Storage Battery, Model #20-2. 3" x 4 1/2" x 2 3/4" high. **\$2.79**
 1-2V. 7 prong Synchronous Plug-in Vibrator. **1.49**
 1-Quart. Bottle Electrolyte (for 2 cells) **1.45**
ALL BRAND NEW! \$5.45
 Combination Price

SCHEMATIC DIAGRAMS For any equipment on this page, each. **65c**

BC-603 FM RECEIVER
 20 TO 27.9 Mc. **\$1495**
Excellent Used \$1495
BRAND NEW \$16.95

10 Channel, pushbutton tuning or continuous tuning. Complete with speaker, tubes, switch.

12 or 24V Dynamotor for Above. Exc. Used \$4.25. BRAND NEW \$5.50

BC-604 TRANSMITTER-Companion unit for BC-603 Rcvr above. With all tubes. BRAND NEW \$10.95
 With Tubes. Used \$4.95

SPECIAL! BC-603 FM RCVR CONVERTED FOR ANY FREQUENCY FROM 30 TO 50 MEGACYCLES!

BRAND NEW! Checked out, perfect working condition, ready for operation. Specify Frequency desired (between 30-50 Mc) when ordering. \$2750

AC POWER SUPPLY FOR BC603, 683
 Interchangeable, replaces dynamotor. Has On-Off Switch, NO RECVR. CHANGES NEEDED. Provides 220 VDC @ 80 Ma. 24VAC @ 2 Amps. \$10.49
 Complete 240-page Technical Manual for BC-603, 604. \$2.95

BC-929 3-INCH SCOPE

Low cost station monitor and/or bench scope. Has Horiz., focus, sweep, intensity controls. Tubes: 2-6X5, 2-6H6, 1-6X4, 1-6GG6, 1-2X2, 3BP1 CR Tube. Voltage req. 115V 400 cyc. and 24VDC. Complete with tubes, exc. used. **\$9.95**

BRAND NEW \$12.95
 Conversion instructions for 110V 60 cyc AC \$5c

TERRIFIC BUY! FAMOUS SCR-510 COMPLETE SET
 Consisting of: **BC-620 FM TRANSCIEVER, 20-28 Mc., with Power Supply for 6 or 12 Volt DC operation, including all components: Antenna, Mast Base and Sections, Hamset, Technical Manual and all other accessories, ready for operation. BRAND NEW, in original packing. \$59.50**
OUR LOW PRICE, While They Last! \$59.50

BC-221 FREQUENCY METER

SPECIAL BUY! This excellent frequency standard is equipped with original calibration charts, and has ranges from 125 Kc to 20,000 Kc with crystal check points in all ranges. A true smashing low price. It's FIRST COME FIRST SERVED! Hurry, quantity is limited. Excel. Complete with original Calibration Book, Crystal, and all. **\$59.50**

TG-34A CODE KEYS

Self-contained automatic unit, reproduces code practice signals recorded on paper tape. By use of built-in speaker, provides code-practice signals to one or more listening persons at speeds from 5 to 25 WPM. **BRAND NEW \$22.50**

Checked out, exc. used. \$18.95
 Single Reels of Tape, Each \$1.85

MOBILE-MARINE DYNAMOTOR

Model DM35
 Input 12V DC. Output: 625 V DC @ 225 Ma. for pres-talk intermittent operation.
 3 1/2 lbs. wt. **OUR LOW PRICE. BRAND NEW \$8.45**

OTHER DYNAMOTOR VALUES: Excellent BRAND

Type	Input	Output	Used	NEW
DM-25	12V 2.2A	250V .050A	\$4.50	
DA-1A	28V 1.6A	230V .100A	3.25	
DM-28	28V	224V .07A	2.75	4.75
DM-32A	28V 1.1A	250V .05A	2.45	4.45
DM-33A	28V 5A	575V .16A		
DM-34	28V 7A	540V .25A	1.95	3.75
DM-34D	12V 2A	220V .080A	4.15	5.50
DM-53A	28V 1.4A	220V .080A	3.75	5.45
DM-64A	12V 5.1A	275V .150A		7.95
PE-73C	28V 20A	1000V .350A	7.95	10.50
PE-86	28V 1.25A	250V .050A	2.75	3.85

BD-77 DYNAMOTOR Input 14V @ 30A. Output 1000V @ .350 A, with starting solenoid, Filter Box and Mounting Base. Like New \$11.95

STANDARD TUBES

REMOVED FROM BRAND NEW GOV'T EQUIPMENT	RECEIVING	RECEIVING	RECEIVING
6AG5	.35	12567	.75
12AT7	.45	6J5	.65
6AK5	.40	6S7	.85
6CA4	.30	12AG6	.45
6AL5	.48		
6AC7	.55	SPECIAL PURP.	
6AV6	.65	2C29	.50
		3E29	.25
		1P25A	7.95

Please include 25% deposit with order—Balance C.O.D., or Remittance in Full. 50c Handling Charges on all orders under \$5.00. All shipments F.O.B. Our Warehouse, N.Y.C. All Merchandise subject to Prior Sale and Price Change.

G & G Radio Supply Co.
 Telephone: CO 7-4605
 51 Vesey St., New York 7, N. Y.

AN/ART-13 100-WATT XMTR
11 CHANNELS
 200-1500 Kc
 2 to 18.1 Mc
\$4850

Complete with Tubes
 Famous Collins Autotune Aircraft Transmitter. AM, CW, MCW. Quick change to any of ten preset channels or manual tuning. Speech amplifier/clipper uses carbon or magnetic mike. Highly stable, highly accurate VFO. Built in Xtal controlled calibrator. IFR1 is modulate 813 in final up to 90% class "B". A Real "HOT" Ham buy at our low price! **\$48.50**
 Orig. cost \$1800. Exc. Used \$7.95
 0-15 Low Freq. Osc. Coit for ART-13 7.95
 24V Dynamotor for ART-13 11.95
 Same as above less meter. 39.50

BC-652A RECEIVER-110t Special! 2000 to 6000 Kc AM Receiver, 2-band, complete with all tubes, 200 Kc Xtal Calibrators, and 12 V Dynamotor. Fine for 50-meter Ham band, Marine, etc. Provides for CW, MFC, AVC, Speaker Jack and two Headphone Jacks. SHPE. Wt. 50 lbs. Like new, only \$22.50

POWER SUPPLY FOR BC-620, 659, available for 6, 12 or 24 Volts DC. Specify \$8.95

BC-659 TRANSMITTER & RECEIVER
 27 to 28.0 Mc. F.M. Two protective channels crystal controlled. 5 watts. Complete with speaker, tubes. Used \$10.95
 Less tubes, used \$5.95
 Antenna for BC-659. Telescoping 20" to 8-Ft. \$2.95

FM TRANSMITTER-RECEIVER
 APN-1. 420 to 460 Mc Air-craft Radio altimeter equipment. Tubes: 4-955, 12SJ7, 4-12SH7, 2-12H6, 1-VK150. Complete with all tubes. For 27 V DC. **BRAND NEW \$8.95**

**BC-733 VHF 10-TUBE AIRCRAFT RECEIVER. 6-channel xtal control. Freq. 108.3 to 110.3 Mc. Dual filter range. Easily converted for tracking Sputniks! Brand New complete with tubes. \$8.95
 Dynamotor for above 24 V. New \$5.95**

BC1206-C BEACON RECEIVER
 195 to 420 Kc. made by Satchel - Carlson. Works on 24-28 volts DC. 135 Kc. IF. Complete with 5 tubes. Size 4 7/8" x 4 7/8" x 1 3/4". Wt. 4 lbs. BRAND NEW. \$9.99
 BRAND NEW, less tubes. \$5.95
 USED, with tubes. \$5.95
 USED, less tubes. 2.95

ARC-5/R28 RECEIVER
 2-meter Superhet. 100 to 150 Mc in 4 crystal channels. Complete with 10 Tubes. BRAND NEW \$24.45
 110V AC Power Supp. Kit for above \$9.75

ARC-5/T-23 TRANSMITTER
 100-150 Mc Includes 2-832A, 2-1625 Tubes. BRAND NEW \$21.50
SPECIAL! Limited quantity ARC-5/T23 xmtrrs. Excellent Used, less tubes \$5.95
MD-7 MODULATOR for T-23, complete with 4 tubes. LIKE NEW \$9.95

ARC-5 MARINE RECEIVER-TRANSMITTER
 Navy Type Comm. Receiver 1.5 to 3 Mc BRAND NEW with 8 tubes. **\$16.95**
 Navy Type Comm. Transmitter 2.1-3 Mc BRAND NEW with 4 tubes and Xtal MODULATOR for above, new with tubes \$12.45
 MODULATOR for above, new with tubes \$5.95

SCR-274 COMMAND EQUIPMENT ALL COMPLETE WITH TUBES

Type	Description	Used	Like NEW
BC-453	Receiver 100-550 KC.	\$12.95	\$14.95
BC-434	Receiver 3-8 Mc.	9.45	12.45
BC-455	Receiver 6-9 Mc.	11.50	13.95
BC-450	3-Receiver Control Box.	1.29	1.75

110 Volt AC Power Supply Kit for all 274-N and ARC-5 Receivers. Complete with metal case, instructions. Used, less tubes \$7.95
 Factory wired, tested, ready to operate. \$11.50
SPLINED TUNING KNOB for 274-N and ARC-5 RECEIVERS. Fits BC-453, BC-454 and others. Only 49c

BC-457 TRANSMITTER-4-5.3 Mc. complete with all tubes and crystal. BRAND NEW \$7.85
BC-458 TRANSMITTER-5.3 to 7 Mc. Complete with all tubes and crystal. BRAND NEW \$9.75
BC-459 TRANSMITTER-7-9.1 Mc. complete with all tubes and crystal. BRAND NEW \$13.95

BC-450 Modulator. Used 3.45. NEW 5.95
 BC-451 Exciter Cond. Box. Used 1.25. NEW 5.95
ALL ACCESSORIES AVAILABLE FOR COMMAND EQUIPMENT.

234-258 MC RECEIVER AN/ARR-2
 BRAND NEW 11-tube UHF Tunable Receiver with schematic. Only a few at this low price! **Complete with tubes \$8.88**

Send Name, Address on Post Card for FREE CATALOG of Wonderful Surplus Buys!

1,000,000 RADIO-TV PARTS BOUGHT FOR LEKTRON'S EXCLUSIVE POLY PAKS®

FREE!

\$50.00 WORTH OF RADIO-TV PARTS
 Add 25¢ for Handling (over 150 pcs.)

PLUS \$1 POLY PAK® OF YOUR CHOICE ANY LISTED BELOW

BOTH FREE with Every \$10.00 Order
 Sale ends Aug. 15, 1960

- 8 SILICON—XTAL DIODES
 - 1N21, 1N34, etc. \$1
 - Some worth \$10.
- 4 1N34 DIODES
 - Or equal glass. \$1
 - sealed New mini types.
- 40 DISC CONDENSERS
 - Ass't. .0001 to .01 to 1000v. Worth \$10. \$1
- 4 OUTPUT TRANSFORMERS
 - 50L6, etc. Open frame types. Worth \$8. \$1
- 6 115VAC SWITCHES
 - Panel toggle type, SPST, DPDT, etc. A shop \$1
 - must.
- 2 SAPPHIRE NEEDLES
 - 4 speed, for gen'l purp. cartridges. 10,000 \$1
 - plays. Worth \$5.
- 70 INSULATED RES'TRS
 - IRC, Allen Bradley, Stackpole makers. 1/2, 1W, 100 ohms to 1 meg. 1W, 1/2, 5% loss. Worth \$10. \$1
 - 1/2, 5% loss.
- 10 PANEL SWITCHES
 - Microm, power, rotary types. Exc. varie- ty. Worth \$10. \$1
- 30 PANEL PILOT LITES
 - Mini bay & screw types. Worth \$1. \$1
- 65 RESISTOR SPECIAL
 - Carbons, precision, hi-Q, W.W., carbon films. 1/2, 1W, 1/2, 100, Worth \$10. \$1
- 10 VOLUME CONTROLS
 - Ass't. to 1 meg. Some with switch. Worth \$1. \$1
- 3 HOBBY TRANSISTORS
 - PNP's, etc. Similar to CK-722. Worth \$1. \$1
- 125 RESISTORS
 - 30 values, incl 1/2 too, carbon! To 1 meg. 1W. Worth \$10. \$1
- 15 "POLY" BOXES
 - Snap-top covers: sizes to 4". For parts & radio buses. Worth \$1. \$1
- 4 I.F. TRANSFORMERS
 - 45B ken. Only 1/2" sq. Exc. for trans. \$1
 - circs. Worth \$3.
- 60 PLUGS & REC'PTS
 - Incl: power, audio, battery, etc. Worth \$8. \$1
- 125 CERAMIC CONDENSERS
 - Incl: discs too! Wide variety of sizes & values. Worth \$10. \$1
- 12 GERMANIUM DIODES
 - Glass-sealed, similar to 1N48. \$1
- 13 IN 1 PAK
 - Diodes: carbon, W.W., precision, hi-Q resistors: disc, ceramic, molded, oil-paper, mica condensers: socket: coils. Worth \$8. \$1
- NEEDLE-STAMP CHECKER
 - Battery-operated. Checks needles, stamps, etc. Worth \$3. \$1
- 10 RCA PLUG-IN JACK
 - Sets for amps, tuners, rears, etc. Worth \$2. \$1
- 40 SILVER MICAS
 - 1 & 5% loss values. Finest mica made. \$1
 - Worth \$8.
- 300-FT. HOOKUP WIRE
 - Ass't. colors, insulation, sizes. Worth \$5. \$1
- 40 2-WATT RESISTORS
 - Incl. 1/2 too. Ass't \$1
 - values.
- 3 AC-DC RECTIFIERS
 - SELENIUM, 110V! 65 & 100 ma; half wave. Worth \$3. \$1
- 40 TUBE SOCKETS
 - 4 to 12 prongs, some ceramic & mica filled & milled. Worth \$5. \$1
- 7 SILICON DIODES
 - 1N21, 1N22, 1N23, etc. Same worth \$1. \$1
- 4 AC & DC HOKES
 - Power & radio types; to 300 mills. Open frame type. Worth \$1. \$1
- 2 TRANS. TRANSFORMERS
 - For citizens band & transistor circuits. 100 ohm in. 600s. imp. \$1
 - Worth \$10.
- \$30 RELAY SURPRISE
 - Popular shop & lab. \$1
 - 38K.
- 50-FT. 'ZIP' CORD
 - For speaker extensions. AC/DC, 2-wire, un- shielded. Worth \$3. \$1
- 60 TERMINAL STRIPS
 - in every type of 1/2" hole. Worth \$5. \$1
- 70 COILS & CHOKES
 - Hi-F, ant. exc. single-tuned, I.F. Wonderful shop \$1
 - asst. Worth \$10.
- 70 1-WATT RESISTORS
 - Incl: carbon, W.W., carbon films. 1 & 5% loss. Worth \$20. \$1
- 65 CONDENSER SPECIAL
 - Incl: discs, ceramics, molded, mica, papers, oils, etc. Worth \$12. \$1
- 15 ROTARY SWITCHES
 - Ass't banks, contacts; for power & circuit changing. Worth \$3. \$1
- VEEDER ROOT COUNTER
 - Counts 000 to 999. Exc. for tape recorders & cot. makers. Worth \$3. \$1
- 100 1/2-WATT RESISTORS
 - Pop. ass't vnls. Some 1/2 to 1000 ohms. Worth \$1. \$1
- 10 3-SEC. TIMERS
 - Precision geared. \$1
 - Worth \$5 ea.
- 10 INSTRUMENT KNOBS
 - Point-er types, black, brass ins't. sets. \$1
- 8-PC. NUTDRIVER SET
 - Plastic handle. 3/16 thru 7/16 nutdrivers \$1
 - in hand case. Worth \$3.
- 35 POWER RESISTORS
 - Ass't. 5 to 10,000 ohms. Vitreous types too. Worth \$12. \$1
- 70 MICA CONDENSERS
 - Incl: silver leaf, .00025 to .01 to 600V. \$1
 - Worth \$20.
- 10 ELECTROLYTICS
 - Incl: can & paper types. Duals too! To 1000 mfd to 450V. Worth \$12. \$1
- 80 TUBULAR COND'NRS
 - Papers, moldeds, oils, ceramic! .0001 to 1 mf to 600V. Worth \$16. \$1
- 60 RADIO 'N TV KNOBS
 - Ass't. colors, sizes, shapes; some worth \$1 ea. \$1
- 1500 PCS. HARDWARE
 - Nuts, bolts, etc. wide variety. Handy \$1 shop asst. \$1
- 30 MOLDED COND'NRS
 - Pop. values, black beu- tiful, oils, etc. Lasts for life! Worth \$8. \$1



Portable test instruments are desirable, as they permit routine checking without removing units from vehicles.

service rates that are both reasonable and realistic.

Another benefit to the customer is improvement in reliability of the equipment, from a viewpoint other than those already mentioned. As an example, we determined that it would be economical for us to install, at our own expense, special premium tubes in certain equipment located in remote areas where the cost of tube replacement was much higher than normal. In some instances, these more expensive tubes were "paid out" within a year due to reduced service calls. At the same time, of course, the customer benefited due to reduced "outages" of the equipment.

In the past year we have all heard a great deal about transistors and the manner in which they are being applied to two-way radio equipment. Already they are being widely used in the power-supply portions of two-way equipment and are now being introduced into the receiver and some stages of the transmitter with marked reduc-

tions in battery drain. As indicated earlier, tube replacement is the largest single cost of repair so that the use of more reliable transistors should improve system reliability and reduce repair cost. However, it must be noted that tube replacement still represents only 30% of total radio maintenance costs. Thus, even if a large number of the tubes are replaced by transistors, it is unlikely that maintenance costs will be "slashed" as claimed by some of the more enthusiastic proponents of transistors.

In summary, the radio maintenance engineer should provide complete communications service and not limit his horizons to tube replacement, discriminator readings, and plate current measurement. Instead, he must constantly observe the operation of the entire system to determine if changes in the equipment, antenna directivity, or other operational features can be made that will further improve the value of radio to the user. He should keep in mind that present-day industrial operations are not static. A two-way radio system properly designed by a sales engineer to meet a user's operating requirement several years ago may not meet current requirements due to shifts in areas, change in operations, or expansions.

An alert maintenance organization is usually the first to notice the need for system modification. For example, it may note that there are an increasing number of service calls for a particular area which, upon investigation, will show that the user is now operating in areas beyond the original range planned for that station. The service organization must then work closely with the operating department to determine the nature of the trend and whether changes in the coverage might be warranted either through antenna directivity or relocation of the station.

Only in this way can the mobile radio expert properly carry out his mission of providing communications instead of mere repair service.

Quality work calls for precision equipment. This includes battery eliminator, microvolter, frequency-deviation measuring units, including secondary standard.



BONUS BUCK CLUB
 A membership card is given with every order. Accumulate your purchases—when \$10 is reached choose any \$1 item free.
 Write for Bargain Flyer

\$5 ORDERS
 WE WILL GIVE YOU
\$5 worth of radio parts **FREE**

MINIMUM ORDER \$2.00—Avg. wt. 1 lb. per pak

HOW TO ORDER Check items. Return ad w/check or M.O. including sufficient postage; excess returned. C.O.D. orders 25% down; rated, net 30 days. Print name, address WITH POSTAL ZONE in margin.

LEKTRON 133 Everett Ave. CHELSEA 50, MASS.

CONVERT YOUR CAR RADIO FOR SHORT WAVE RECEPTION WITH ...

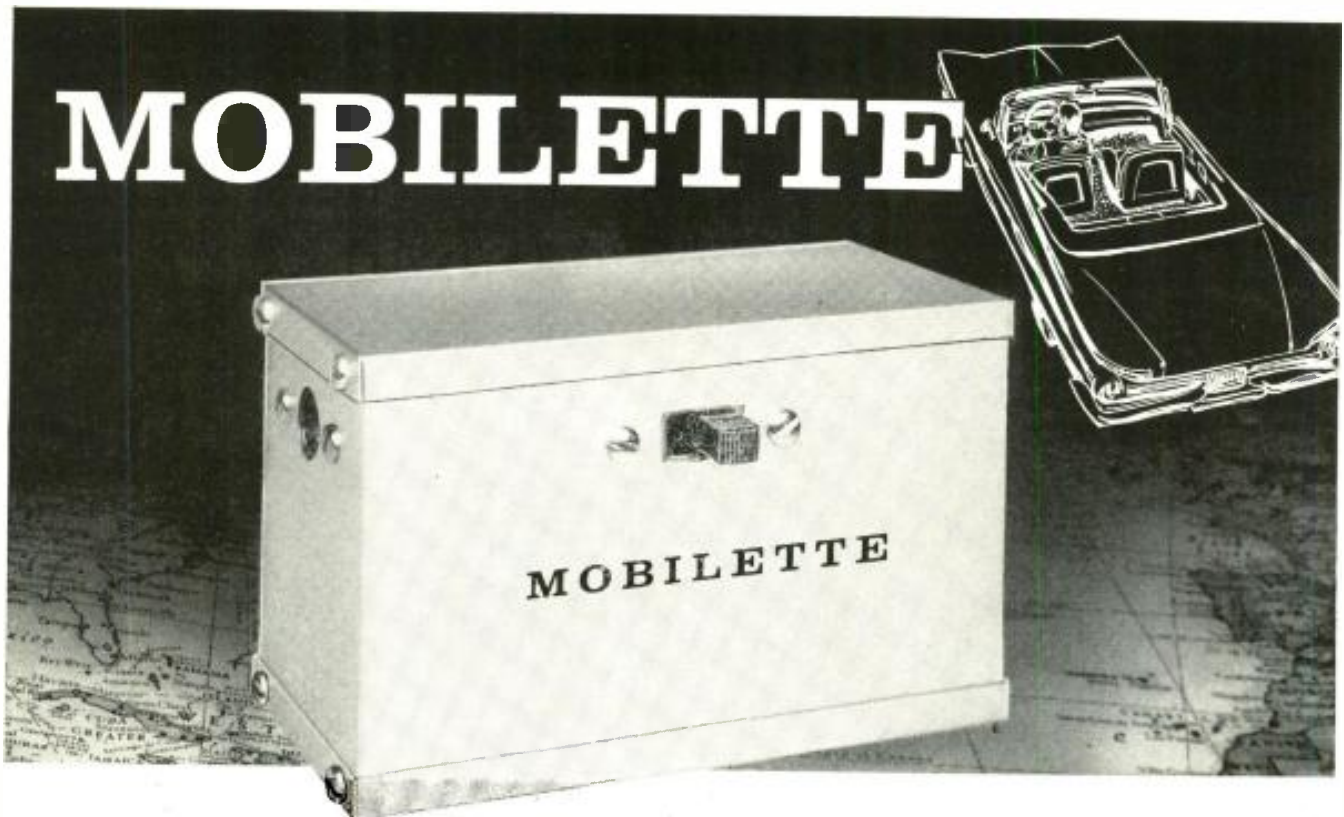

INTERNATIONAL'S ALL TRANSISTOR, CRYSTAL CONTROLLED CONVERTER

Now, in a matter of minutes, your standard broadcast car radio becomes a short wave receiver . . . bringing in stations from coast-to-coast as well as the four corners of the globe.

Designed by International for AMATEURS, CITIZEN LICENSEES, SHORT WAVE LISTENERS, HOBBYIST.

Available in SEVEN frequency ranges covering the Amateur bands, 75 through 10 meters, the Citizens band, and WWV National Bureau of Standards Time Broadcasts.

Three simple steps to install. (1) Remove antenna lead from car radio and plug into input of Mobilette. (2) Plug jumper wire from Mobilette into antenna connection of car radio. (3) Plug power connector into cigarette lighter socket. It's that easy!

Works on either 6 or 12 volts without change. Miniature size.

International Mobilettes cover these short wave bands.

Catalog No.	Frequency
630 — 105	75 meters (Amateur)
630 — 104	40 meters (Amateur)
630 — 106	10 MC (WWV Time Broadcasts)
630 — 103	20 meters (Amateur)
630 — 102	15 meters (Amateur)
630 — 101	11 meters (Citizens)
630 — 100	10 meters (Amateur)
	28.5 — 29.5 MC

Available soon for 6 and 2 meters at slightly higher price.



Complete, ready to plug in and operate . . . only **\$19.95**

Order direct from International. Terms F. O. B. Okla. City. Include postage. Shipping Weight 2 lbs.



18 NORTH LEE — OKLA. CITY, OKLA.

INTERNATIONAL CRYSTAL MFG. CO., INC., 18 NO. LEE
OKLAHOMA CITY, OKLAHOMA

GENTLEMEN: PLEASE SHIP THE FOLLOWING MOBILETTES @ \$19.95 EACH.

CATALOG NO.	FREQ.	QUANTITY
_____	_____	_____

SHIP TO — NAME _____
AMOUNT _____
ENCLOSED ADDRESS _____

INCLUDE POSTAGE WITH ORDER.

A.... Always
B.... Buy
C.... Columbia

ALL PURPOSE ARB COMMUNICATION RECEIVER
 195-9,000 kc. 4 bands. Built-in, directly calibrated tuning control. Ideal for home, mobile or marine. Excellent cond. **\$17.50**
CONTROL BOX & PLUGS: For above. Only **\$4.95**

LM FREQUENCY METER
 Heterodyne type 125-20,000 kc. Built-in 1,000 kc. crystal. Excellent condition. Com. **\$49.50**
 Price with original calibration book!

ARC-5 VHF & UHF EQUIPMENT SPECIALS!
R-26/ARC-5 RECEIVER: 100-150 Mc. 4 channels. Crystal controlled. Excel. cond. Only **\$22.50**
T-23/ARC-5 TRANSMITTER: Companion to above. Same freq., 4-chann. crystal controlled. **12.95**
R-23/ARC-5 RECEIVER: 100-550 kc. Excellent **9.95**
R-25/ARC-5 RECEIVER: 1.5-3 Mc. Excellent **14.95**
R-26/ARC-5 RECEIVER: 3-6 Mc. Excellent **7.95**
R-27/ARC-5 RECEIVER: 6-9 Mc. Excellent **7.95**
T-18/ARC-5 TRANSMITTER: 2.1-3 Mc. Excellent **4.95**
T-19/ARC-5 TRANSMITTER: 3-4 Mc. Excellent **7.95**
T-20/ARC-5 TRANSMITTER: 4-5.3 Mc. Excellent **4.95**
T-21/ARC-5 TRANSMITTER: 5.3-7 Mc. Excellent **4.95**
T-22/ARC-5 TRANSMITTER: 7-9 Mc. Excellent **7.95**
MD-7/ARC-5 MODULATOR: For all of the above Transmitters. Excellent. Bargain @ only **6.95**

CITIZENS' BAND SPECIALS
BC-603 RECEIVER, Excel. cond. **\$14.95**
SC-620 TRANSFORMER: 20-27 Mc. With spare tubes. Govt. recommissioned as new. For above **\$14.95**
POWER SUPPLY: for above. 6 & 12 V **4.95**
12 V. DYNAMOTOR: for above BC-603 **3.95**
115 VAC POWER PACK: wired. Only **9.95**
BC-604 MATCHING TRANSMITTER: Excellent **7.95**
12 V DYNAMOTOR: for BC-604. Excellent **7.95**

CY-139/CPS-1 RANGE AND AZIMUTH INDICATOR
 This is an orbear special! B Scan 7" diam. Calibrated vertical and horizontal lines. Rugged metal cabinet, enclosed treasurehouse of tubes: 4-607, 7-6N7GT, 5-6AC7, 4-6Y6, 3-5U4G, 3-VR150, 1-VR10, 1-6SJ7. Lots of other extras. With regulated AC supply. Wt. 300 lbs. Used, Road. 4 ft. h. approx. 19" wide **\$34.95**

SCR-625 MINE DETECTOR BARGAIN
 Locate that hidden pipe, metal, treasure! **\$22.50**
 Use for parts! With case. Excellent

DM-25 DYNAMOTOR: Input 12 V.; output: 625 V. @ 225 MA. Like new. You can stock up at this price! **\$7.95**

APR-1 RECEIVER SPECIALS!
 30 Mc. IF. 115 V. 60 cps. Like new cond. **\$24.50**
 Plug-in. For above
TN-1: 30-90 Mc. **\$14.95** **COMBO DEAL!**
TN-2: 90-300 Mc. **14.95** **Apr-1 Receiver, PLUS**
TN-3: 300-1000 Mc. **19.95** **TN-1, TN-2, TN-3** **\$62.50**

APR-4 TUNERS—WILL WORK WITH ABOVE REC'R
TN-15: 30-90 Mc. **\$14.95** **COMBO DEAL!**
TN-17: 90-300 Mc. **14.95** **TN-16, TN-17, TN-18,**
TN-18: 300-1000 Mc. **19.95** **TN-19** **\$95.00**
TN-19: 1000-3300 Mc. **49.95**

TS-34 OSCILLOSCOPE: 10-50,000 cycles. Sweeps at 5, 50 or 250 microseconds. Good cond. **\$34.95**
TS-34/AP: Same as above but sweeps can be varied @ 1/2-8, 20-50, 120-250 microseconds. **\$39.50**

SC-638 2-METER FREQUENCY METER: **\$8.95**
 110-150 Mc. AM. Excellent condition

GENERAL RADIO VARIAC: 30 V. 400 Cycles. 5 amp. BRAND NEW. Reduced to **\$1.95**

APT-1 TRANSMITTER: 100-200 Mc. 10 TUBES in all including 832A driver, 829B final and 931 mod. tube. New cond **\$12.95**

ART-13 XMT'R: Model T-47. Excellent cond. Only **\$34.50**

VHF SPECIALS!
R-19/TRC RECEIVER
 70-100 Mc. Crystal controlled. Dual conversion. FM. Built-in speaker and 110 VAC 60 cps. power supply. Self-contained table-top model which may be rack mounted. Companion to T-14/TRC Transmitter below. **\$24.50**
 Excel. cond.

T-14/TRC TRANSMITTER
JUST REDUCED! For action this month!
 70-100 Mc. 50 W input power on phone. Single channel. Built-in 110 V 60 cps power supply. Table top size. Easily converted to 6 meters. Complete. Good condition, excellent buy! **\$19.95**
COMBO DEAL! Both units for only **\$39.50**

All orders FOB Los Angeles. 25% deposit required. All items subject to prior sale. NOTE MINIMUM ORDER \$3.00. WRITE TO DEPT. W.

ELECTRONICS WORLD
 2251 W. WASHINGTON BLVD.
 LOS ANGELES, 18, CALIF.

MOVING?
 Make sure you notify our subscription department about any change of address. Be sure to include your postal zone number as well as both old and new addresses. Please allow four weeks' time for processing.
ELECTRONICS WORLD
 434 South Wabash Avenue Chicago 5, Illinois

Mac's Service Shop
 (Continued from page 64)

without helping the oscillation a bit. And there's nothing wrong with that resistor, either. Unsoldering those neutralizing capacitors and soldering them back is quite a tedious job, I might mention."

"I can imagine," Mac muttered as he continued studying the diagram. "Of course we could be up against a defective transistor, but I doubt it."

"The transistor checker doubts it, too," Barney said. "They all check good with normal gain and no excessive leakage."

"Is there any way you can stop oscillation and still get reception?"

"Yes, if I put my finger on the collector or base of the mixer stage the oscillation stops and the local station can be heard."

Mac was silent for several minutes as he scrutinized the diagram. Then he put it down and picked up the little chassis and looked it over closely. "Hand me a 2.2k resistor," he finally said to Barney.

Carefully he shaped the resistor leads until he could bridge the resistor across a couple of points on the printed circuit board; then, holding the resistor in place, he turned on the receiver. It played perfectly, without a sign of oscillation, until he removed the resistor. When he did that, the oscillation returned.

"Well I'll be!" Barney exclaimed with a mixture of relief and disgust in his voice. "I was so sure those resistance checks were all correct."

"They probably were; but this open resistor—if it is open—would not show on those checks," Mac answered as he plugged in the pencil soldering iron.

"Take a look at the diagram. The set has an r.f. stage ahead of the mixer, but only the antenna circuit and the oscillator circuit are tuned with the tuning capacitor. The collector of the

r.f. stage is coupled to the base of the mixer through a capacitor. Now notice this parallel-tuned circuit in the collector lead of the r.f. stage. See the coil resistance is given as 19 ohms. But notice, too, that this 2.2k resistor is actually connected directly across the tuned circuit. It 'loads' the circuit, lowers the 'Q,' and broadbands the response. With the resistor in place, the r.f. stage is probably designed to deliver uniform response across the whole broadcast band; but when the resistor opens, the 'Q' of the tuned circuit and the impedance at the input of the mixer stage shoots up sharply while the frequency response narrows—which makes things dandy for the mixer stage to oscillate at the i.f. frequency." As he finished speaking, Mac lifted the unsoldered resistor from the printed circuit board and placed the ohmmeter test leads across it. The meter pointer did not even flicker. "It's wide open all right," he said as he started soldering the new resistor in place.

"An open 2.2k resistor would never show across 19 ohms," Barney mused; "but what ever made you suspect that resistor might be open?"

"Your excellent, methodical procedure had just about eliminated everything else; and when you said you could kill the oscillation by putting your finger on the base or collector of the mixer, I started looking for something that would normally load a portion of the circuit as the presence of your finger did. That line of reasoning pointed squarely at the quarter-watt resistor. Incidentally, I've noticed quarter-watt resistors are more prone to open-circuiting than are half-watt units, even when they carry no current."

"Well, I wish I'd found the trouble myself, but I'm happy it's been found," Barney announced. "Ain't it a great feeling when a problem that's been deviling you for a long time is finally whipped? I feel exactly like a cork that's been held under water for a long time and has finally been released so it can pop to the surface." **-30-**

BOOSTING AUDIO IN COMMAND SETS

By HARTLAND B. SMITH, W8YVD

ON the ham band one often hears complaints regarding the low audio level produced by surplus Command Receivers such as the BC-455 and the R-26/ARC-5. Many who have hooked 6-ohm speakers to these sets blame the lack of sufficient volume level on the fact that there is no driver for the 12A6 output stage. Apparently they feel that since there is no audio amplifier between the detector and the output tube, a Command Receiver just won't furnish enough power to operate a loudspeaker.

Actually, the reason for low volume is a mismatch between the 12A6 and the speaker. The output transformer of a Command Receiver has a turns ratio of 8:1. The recommended load for a 12A6, according to the tube charts, is 7500 ohms. Since the impedance ratio of a transformer is equivalent to the square of its turns ratio, the Command Receiver output transformer has an impedance conversion ratio of 64:1. Thus, it will step down the 7500-ohm load on the

plate of the 12A6 to a value of approximately 117 ohms (7500/64). A 6-ohm speaker connected across the 117-ohm terminals of the output transformer will develop very little acoustic power because of the exceptionally poor impedance match.

The cure for the low audio is not, therefore, added amplification, but a better impedance match. This may be effected in two ways. You can put a step-down transformer (125 ohms to voice coil will be OK) between the Command Receiver and the speaker, or, if you don't mind digging into the receiver itself, you can remove the 8:1 transformer and replace it with a small universal type plate-to-voice-coil transformer. In either case, after you've made the change, you will be surprised at how much volume is produced by the Command Receiver.

Hooked to a good antenna, the ham band sigs will come through so loud you definitely will want to keep the gain control below maximum setting. **-30-**

Electronic Crosswords

By **GORDON B. DUNCAN**

HOW'S your knowledge of electronic terminology and are you "up" on some of the little-known words to be found in any standard dictionary? Here is a chance for you to test yourself. If you get stuck, the answer is on page 120.

ACROSS

1. Resistor striped brown-black-green (colloq.).
2. Book of Bible (abbr.).
8. Word common to cps, rpm, and mph.
11. Feminine pronoun.
12. Animals who enjoy vegetables with their meat.
15. Source of power for home lighting in ancient Greece.
17. Unit in Morse Code.
18. Pitcher's dream (abbr.).
19. Old game revived for electronic brains.
20. Power ratio unit.
21. Wire size (slang).
22. Try to persuade.
24. Positive particles in atom.
26. Excessively.
27. Adjust meter readings (abbr.).
28. Main artery.
30. Prerequisite for some electronic jobs (abbr.).
31. Supplied with signal.
32. Past time.
33. "Either's" twin.
34. Scornful expression.
36. Raw metal.
37. Method of shipping (abbr.).
38. Obsolete sewing machine part.
40. Low audio frequency.
41. Compensation for signal variations (abbr.).
42. Wet soil.
43. Liable to cause misadjustment of ion trap.
44. Henry's times volts (abbr.).
45. American soldiers (slang).
46. Usually can't have built-in hi-fi.
49. Causing current to lag voltage.
52. Female deer.
53. Male progeny.
54. Time of orbital cycle.
55. Hobbyist who tunes in overseas broadcasts (abbr.).

DOWN

1. Transconductance of 200 6AU6's parallel.
2. Fish equipped with 600-volt "batteries."
3. Foreigner in Mexico (esp. Yankee).
4. Rhythmic utterance.
5. The d.c. equivalent of a.c.
6. Closed position of s.p.s.t. switch.
7. AM portion of TV wave.
8. Resistor with variable tap (colloq.).
9. One side of Ohm's Law equation.
10. Most numerous components in any kit.
13. Electromotive force.
14. Basic source of energy (colloq.).
16. Compete.
20. An Army Ordnance Research Group (abbr.).
21. Swank suburban apartment (phone-book abbr.).
22. Shoshonian Indian.
23. X-ray units.
24. Speaker volume control.
25. Result of too much registration.
27. Type of capacitor.
31. Charge for professional services.
32. Plural of "am."
35. Voltage drop across wave-shaping network (symbol).
36. Not the latest.
37. Units of capacitance.
39. Condition of many dim picture tubes.
40. Taboo.
41. Storybook user of R/C cave opener (first name).
43. Taunt.
45. Core of CRT.
46. Government agency producing electric power.
47. At present.
48. Wired communication (abbr.).
50. Auxillary verb.
51. Equal conductance (symbol).

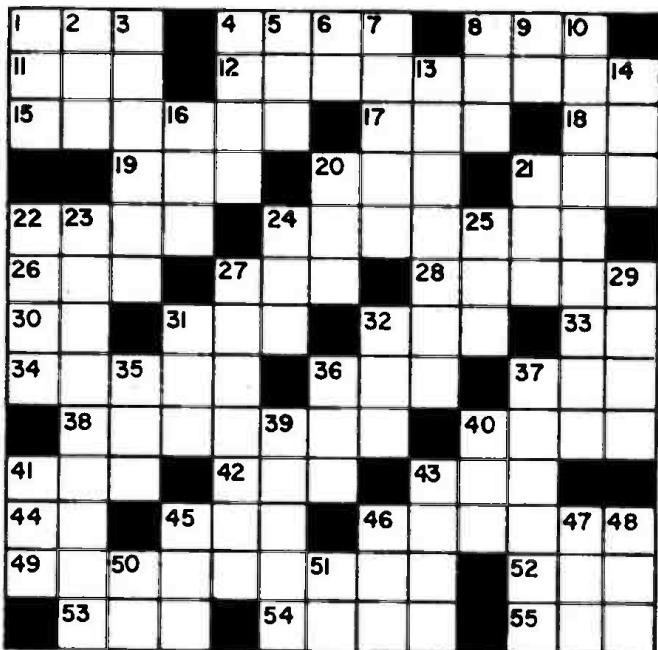

Build the BEST BUY in CITIZENS BAND TRANSCEIVERS...



#760 (117 VAC) less bracket:
Kit \$59.95. Wired \$89.95.

#761 (117 VAC & 6 VDC): Kit \$69.95. Wired \$99.95.

#762 (117 VAC & 12 VDC): Kit \$69.95. Wired \$99.95.

A thoroughly useful and reliable citizens band transceiver of exemplary electronic, mechanical, & industrial design. Consists of a powerful 5-watt (as defined by FCC), crystal-controlled transmitter & extremely sensitive, highly selective superheterodyne receiver with RF stage & noise limiter. Includes built-in speaker & detachable ceramic microphone. Features pre-set & sealed crystal oscillator circuit elements. Broad tuning permits shifting from any of the 23 citizen band channels to any other simply by changing crystals—no adjustments needed. Built-in variable "pi" network matches most popular antennas. Directly attached base-loaded portable whip, & ground plane (roof) antennas available. The quality & precision of this transceiver is very necessary for consistently dependable operation—increasingly so in the future when citizens band is put to greater use. No exams or special skill needed—any citizen 18 years or older may obtain station license by submitting FCC form, supplied by EICO.

Build the Best 6-TRANSISTOR RADIO RA-6

Kit \$29.95 Wired \$49.95

Includes FET, less 9V battery

American-made with finest quality parts. High sensitivity and selectivity. New plug-in type transistors easily removable for checking. Big-set volume and tone with 4" x 6" PM speaker & 250 mw push-pull audio output stage. Built-in Ferrite rod antenna. Pre-aligned RF & IF transformers. Planetary vernier tuning (7:1 reduction) for easy station selection & tuning. High-impedance earphone jack for private listening. Attractive tan leatherette case, retractable handle. Compact: 8 1/2" w, 4 1/2" h, 2 1/2" d. Only 3 lbs.



Build the Best HAM GEAR

New Code Practice Oscillator #706

Kit \$8.95 Wired \$12.95

Rugged battery-operated transistor oscillator circuit with built-in 3" speaker. Front panel (deep-etched satin aluminum) has flashing light, phone jack, pitch control (500-2000 cps), external key terminals, "temporary" key. Panel switch selects Tone, Light, or both Tone & Light. 6 1/2" h, 3 3/4" w, 2 3/4" d.



90-WATT CW TRANSMITTER* #720

Kit \$79.95 Wired \$119.95

*U.S. Pat. No. D-184,776

"Top quality" — ELECTRONIC KITS GUIDE. Ideal for veteran or novice. 90W CW, 65W external plate modulation. 80 through 10 meters.

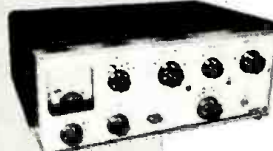

HIGH LEVEL UNIVERSAL MODULATOR-DRIVER #730

Kit \$49.95 Wired \$79.95

Cover E-5 \$4.50

Delivers 50W undistorted audio. Modulates transmitters having RF inputs up to 100W. Unique over-modulation indicator.



GRID DIP METER #710

Kit \$29.95 Wired \$49.95

Includes complete set of coils for full band coverage. Continuous coverage 400 kc to 250 mc. 500 ua meter.



Compare — judge for yourself — at your neighborhood EICO dealer. For FREE catalog on over 70 models of easy-to-build professional test instruments, hi-fi and ham gear, fill out coupon on Page 27.

Add 5% in the West. © 1960



3300 N. Blvd., L.I.C. 1, N.Y.

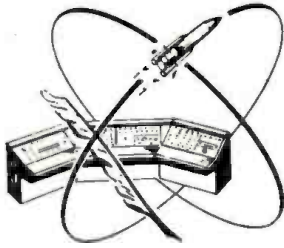

TECH WRITING

a professional career

at

Burroughs

MILITARY FIELD SERVICE DIVISION

You can enter this new and important field which is emerging today as a dynamic and indispensable part of our expanding long range programs.

If you want to realize your full technical potential in terms of advancement and recognition for your talents, here are some specifics you will want to consider:

- Burroughs MFSD Tech Manuals Department consists of a highly skilled Technical Publications team made up of 5 sections: 1) Tech Writing, 2) Editing, 3) Publications Preparation, 4) Technical Art, 5) Reproduction.
- Burroughs Tech Manuals Department's increased business has recently made it necessary to acquire additional operating space within our modern building in an attractive Philadelphia suburb. This Department now totals over 150 employees.

If you are a graduate of an electronics school, with a good background in theory (writing experience is not necessary) ... and would like to discuss these growth positions carrying top salaries and benefits, write today to Mr. G. E. Rogers, Dept. 2889, Military Field Service Division, Burroughs Drive, Radnor, Pa.



Burroughs Corporation

"NEW DIMENSIONS/in computation for military systems"

Pix Tube as Tuning Eye

(Continued from page 46)

provides a steady but gradual change in bias, from one horizontal scanning line to the next during each raster frame, in addition to the bias established by the output of D_3 . Thus there is a slight, progressive difference in the width of the pulse from one scanning line to the next, enough to produce a triangle, as shown at B in the insert of Fig. 1. For a portion of the vertical scan, the vertical pulses manage to cut off the clipper (and consequently the square pulses) entirely, so that the top of the triangle is kept visible.

At correct tuning, triangle height is maximum. When the receiver is detuned 100 kc. on a reasonably strong signal, triangle height is reduced about 20 per-cent, a very noticeable difference. Thus greater accuracy than within 100 kc. is possible, although even this degree of detuning is difficult to recognize in the picture, what with the wide-band reception and detection involved. A 5-megohm potentiometer, in the cathode of V_1 , acts as a sensitivity control to adjust for differences from one transmission to another. With this, average triangle height is set so that it is adequate to indicate tuning variations clearly but not so large as to drive triangle tips off-screen.

When the indicating circuitry is not in use, turning it off, as indicated by the switches shown in the schematic, keeps it in a stand-by condition, ready for use when desired. Plate voltage for the three stages is reduced by a 30,000-ohm dropping resistor. Output pulses from the doubler, required to activate the circuit, are switched to ground so that there is no effect on the picture being viewed.

-50-

PROTECT METER MOVEMENT

By ROBERT HERTZBERG

IF YOU have occasion to carry a multi-meter in a car, protect the needle against excessive movement and possible damage by connecting a dynamic brake to the plus and minus jacks. This "brake" is nothing more than a shorting link of wire, the ends of which are stiffened with solder. Set the meter to its lowest current scale.

A swinging needle makes the meter act as a small generator. The load imposed by the shorting link tends to slow it down. A few high-grade meters have a "transit" position for the range switch which accomplishes the same job.

30-

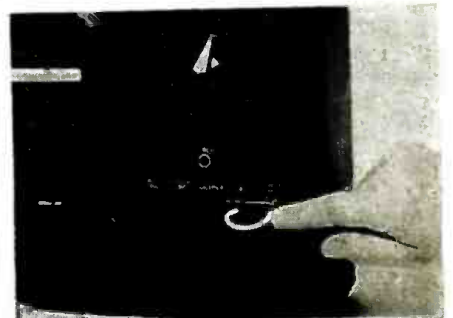

ELECTRONICS WORLD

**ENGINEERING DEGREE IN
SCIENCE 27 or 36 MOS.
MATH**



Accelerated year-round program prepares for early employment in fields of Science and Engineering. Regular 4-year program for B.S. Degree completed in 36 months, special engineering degree program in 27. Classes start quarterly—September, January, March, June. Quality education. Graduates employed from coast to coast. Government approved for veteran training. Students from 30 states, 40 countries. 20 buildings; dorms, gym, Campus. Save time and money. Earn board while studying. Write for catalog and complete information.

970 E. Washington Blvd., Fort Wayne 2, Indiana

INDIANA TECHNICAL COLLEGE



OUT OF SPACE?

You bet we'd be... if we were to tell you all about AUDION'S "Out of this World Hi Fi Values."

Write for
free
Catalog

audion
25-W Oxford Road
Massapequa, New York



**BARGAIN
HUNTING?**

**TV
SERVICEMEN!**

Write for SENSATIONAL CATALOG
HENSHAW RADIO SUPPLY
3619 TROOST KANSAS CITY, MO.



This man is a service technician...



He's an audiophile...



Electronics is his profession...

There's something for all of them in August **ELECTRONICS WORLD**

Don't miss August feature articles on:

• JAPANESE TRANSISTOR CONVERSION CHART

Here's a perfect guide for the service technician working with the ever-growing number of Japanese transistor radios. This complete conversion chart gives you corresponding American transistor equivalents for Japanese numbers.

• CONSTRUCTING THE 40-60 WATT HI-FI AMPLIFIER

Tells you how to build your own ultra-stable power audio amplifier. You can have your choice of either a 40 or 60 watt design.

• ELECTRONICS IN CRIME DETECTION

Though secrecy shrouds much of present day crime detection techniques—August **ELECTRONICS WORLD** will give you a comprehensive look into police labs—show you how phone taps, bugging equipment, drunk testers, lie detectors, electron microscopes, and other electronic equipment is being used to fight and detect crime.

Whether electronics is your hobby or business—you can't afford to miss articles like these—samples of the wealth of information that is yours in the authoritative August issue of **ELECTRONICS WORLD**.





MID-SUMMER SURPLUS SPECIALS

24 HOUR—8 DAY CLOCK



Mfg. by Waltham Watch Co.
Aircraft Instrument Panel Clock. U. S. Navy. Ideal for Radio Ham Operators.
8 Day 24 Hour, 2 3/4" Dial. Indicated Civil Date, Short Knob lower left, Continuously running Sweep-Second Hand. Glowing, Luminous painted Numbers and Hands. Excellent Condition.

\$17.50 Ea.



WATER PROOF SPEAKERS
U. S. Navy. Horn Type, Heavy Duty. All New Outdoor Permanent Magnet Speakers, with Universal Output Transformer. Voice Imp. 6 Watts; 11.40 Ohms. 10 3/4" Dia. 3/16 Deep. Weight, in original Cases—23 lbs.

Our Low Price.....Ea.

12.95

TELESCOPIC AND ANTENNA MASTS



For Citizen Band, Amateur and FM Radio; Television, etc. Made of Heavy Duty Aluminum in 4 Foot, 10 Inch Sections, Diam.—2 inches. Weight of each section is appr. 3 lbs. Make the Mast as high as you wish as each section inter-fits the other.

All New.....Per Section **1.50**



FIELD PHONES

Type EE-8. Magneto Ringer Phones. Use 2 Flashlite Batts. for Power. Operate over wire. Approx. 2 Miles. Excellent Condition.

\$29.95

RECORDING BLANKS

10" Recording Blanks. Make your own Recordings. Aluminum base. Lacquered both sides. Professional quality. All New Stock.....Ea. **50c**
Package of 10.....**\$3.00**
Package of 100.....**\$27.50**

DIAL TELEPHONES

French type phone made by Conn. Tel. & Tel. Can be used for standard extension phone. With Dial, Excellent Cond. Wgt. 7 lbs. Ea. **\$4.95**

RESET COUNTERS



Unit Counter, changes by one digit. Reset: 000 to 999. Ideal for counting turns when winding Coils, Transmitters and General Counting Work. Size is small, 1 1/4" x 3/4" x 1".....Ea. **\$1.95**

LOW VOLTAGE TRANSFORMER

This Transformer produces 0, 7, or 8 Volts. AC 20 Amps. Input 115 Volt, 60 Cycles. All New, Weight 11 Lbs.....Each **\$2.95**
Wgt. 11 lbs. Ea. 4 for.....**\$10.00**

REVERSIBLE MOTOR



1/40 H. P. Ball-bearing 3430 RPM in Blast-proof case. Needs only a capacitor for starting. All Brand New. 110 V. 60 Cy. Special Low Price. Ea. **\$2.95**

Sterling Capacitor.....\$0.48 Ea.
WGT. Approx. 8 Lbs.

TELEPHONE DIALS



Standard Dials. Ideal for Multi Channel Selection or Remote Control Work. Exc. Cond.....Ea. **\$1.50**

See our previous ad for Special Surplus Items. All prices F.O.B. S. F. Calif. Calif. orders add 3% Tax. No COD's. Remit Full Amount with All Orders.

STANDARD SURPLUS

1230 Market St., San Francisco 3, Calif.
Telephone Hemlock 1-3106

SAY YOU SAW IT IN
ELECTRONICS WORLD

PACKAGE HI FI or SINGLE COMPONENTS

You'll find our prices low and service fast.

Write for our quotation.

CENTER ELECTRONICS Co., Inc.
74-L Cortlandt Street, New York 7, N. Y.

New Tube Tester Data

Hole locations for new types for RCA testers and corrections. First part of list appeared in June.

RCA AUTOMATIC TESTER, WT-110A

TUBE TYPE	HOLE LOCATIONS TO BE PUNCHED	NOTES
5DB5	A2, B8, F4, G6, K1, L5, L6, L10, M4, M10, N2, N9	Test P1 and P2. Reject if below 4.
10DR7 Triode #1	A4, B5, C8, D7, G6, J1, K6, L1, M5, M10, N5, N9	For gas test, see instructions;
10DR7 Triode #2	A4, B5, C9, D2, G1, J7, K6, L1, L6, L7, M5, M10, N5, N9	
11C5	A3, B4, C1, D2, E6, G7, I9, I10, J1, K5, L1, L6, L7, M1, M10, N2, N9	
12AE7 Triode #1	A4, B5, C8, D7 G6, J1, K7, L2, L6, L7, M2, M10, N3, N9	For gas test, see instructions.
12AE7 Triode #2	A4, B5, C3, D2, G1, I7, I9, J1, K5, L2, L6, L7, M2, M10, N3, N9	
12BD5	A2, B7, C3, D1, E8, G5, I6, I10, J8, K7, L1, L6, L7, M2, M10, N3, N9	
12DT6	A3, B4, C2, D1, D7, E6, G5, I6, I10, J4, K7, L1, M2, M10, N4, N9	Reject if below 3. For gas test, see instructions.
12DU7 Tetrode	A4, B5, C2, D1, E3, G6, I7, I10, J1, K4, L2, L6, L7, M2, M10, N3, N9	
12DU7 Diode	A4, B5, C2, F9, G7, K6, L4, M2, M10, N3, N9	Reject if below 4. Test P1 and P2.
12FR8 Triode	A4, B5, C2, D1, G9, J2, K9, K10, L2, M2, M10, N3, N9	For gas test, see instructions.
12FR8 Pentode	A4, B5, D3, E6, G7, J2, K3, L2, M2, M10, N3, N9	For gas test, see instructions.
12FR8 Diode	A4, B5, C2, G8, I6, I10, K10, L3, M2, M10, N3, N9	Reject if below 2.
12FT6 Triode	A3, B4, C2, D1, G7, I6, I10, J1, K10, L2, M2, M10, N3, N9	
12FT6 Diode	A3, B4, C2, F5, G6, I6, I10, K10, L3, M2, M10, N3, N9	Test P1 and P2. Reject if below 2.
12FX8 Triode	A4, B5, D6, G8, J2, K8, L2, M2, M10, N3, N9	For gas test, see instructions.
12FX8 Heptode	A4, B5, C7, D2, D9, E1, G3, I6, I10, J2, K9, K10, L2, M2, M10, N3, N9	For gas test, see instructions.
14A4	A1, B8, C7, D6, G2, I6, I10, J2, K7, L1, L6, L7, M2, M10, N3, N9	
14V7	A1, B5, B8, C4, C7, D6, E3, G2, I8, I10, J1, K5, L1, L6, L7, M2, M10, N3, N9	
17CA5	A3, B4, C1, D2, D5, E6, G7, I6, I10, J5, K1, L1, L6, L7, M4, M9, N2, N8	
17EW8	A4, B5, B9, C3, C8, D2, D7, F1, G6, I7, I8, J1, K9, L1, L6, L8, M3, M9, N2, N8	Test P1 and P2.
17R5	A3, B4, C1, D2, E6, G7, I6, I10, J9, K10, L1, L6, L9, M4, M9, N2, N8	
19CL8 Tetrode	A4, B5, C8, D9, E7, G6, I6, I10, J2, K3, L1, L6, L7, M4, M9, N3, N8	
19CL8 Triode	A4, B5, C3, D1, G2, I6, I10, J2, K1, L1, L6, L7, M4, M9, N3, N8	
19EA8 Triode	A4, B5, C8, D9, G1, I6, I9, J1, K1, L1, L6, L7, M4, M9, N3, N8	
19EA8 Pentode	A4, B5, C7; D2, E3, G6, I6, I10, J2, K3, L1, L6, L7, M4, M9, N3, N8	
25AU4	A7, B8, C3, G5, I6, I10, K4, L4, L6, L10, M1, M9, N5, N8	Reject if below 4.
25FY8 Triode	A4, B5, C8, D1, G9, J2, K5, L1, M1, M9, N5, N8	
25FY8 Pentode	A4, B5, C2, D3, E7, G6, I8, I10, J1, K2, L1, L6, L7, M1, M9, N5, N8	
32A8 Triode	A4, B5, C8, D1, G9, J2, K7, L1, M3, M10, N2, N8	For gas test, see instructions.
32A8 Pentode	A4, B5, C2, D3, E7, G6, I6, I7, J1, K4, L1, L6, L7, M3, M10, N2, N8	
35EH5	A3, B4, C1, D2, E6, G7, I7, I10, J1, K6, L1, L6, L8, M5, M10, N1, N8	
60E3	A3, B4, C7, G5, I6, I10, K5, L4, L6, L10, M5, M9, N5, N7	Reject if below 4.
1203A (Same as 7C4)	A1, B8, C7, G4, K6, L3, M5, M10, N2, N9	Reject if below 4.

OTHER CORRECTIONS

1. Remove first data on 6CZ5.
2. Remove first data on 6DQ5.
3. Remove second data on 12AU7.
4. Correct 25GD6 data to read 25CD6.
5. Remove double reference to 6V6.

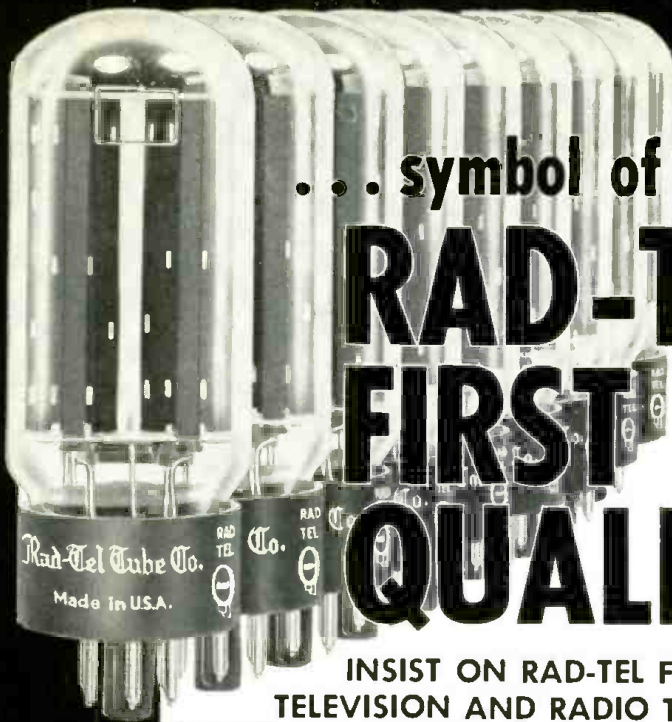

... symbol of
RAD-TEL
FIRST
QUALITY

INSIST ON RAD-TEL FOR EVERY TELEVISION AND RADIO TUBE NEED

Super-Special!

KIT OF 100

Bi-Pass CONDENSERS

Over 50% Are 600V

at
LESS THAN \$3.95
 4¢ each

Goodall
 Semi-Molded
 Paper and
MYLAR

Made up of approx.
 16-200V, 20-400V and
 64-600V.
 Values .001 to 1 mf

70% OFF on BRAND NEW TUBES

GUARANTEED ONE FULL YEAR!

You Can Rely On Rad-Tel's Speedy One Day Service!

Not Used — Not Pulled Out Of Old Sets • Each Tube Individually and Attractively Boxed!

Qty.	Type	Price	Qty.	Type	Price	Qty.	Type	Price	Qty.	Type	Price	Qty.	Type	Price	Qty.	Type	Price	Qty.	Type	Price						
—	0Z4M	.79	—	30T6	.50	—	6AB4	.46	—	6B16	.62	—	6E08	.79	—	12A4	.60	—	12BD6	.50	—	12EG6	.54	—	198G6	1.39
—	1AX2	.62	—	30S	.80	—	6AC7	.96	—	6B17	.85	—	6EA8	.79	—	12AB5	.55	—	12BE6	.53	—	12E26	.53	—	19T8	.80
—	1B3GT	.79	—	354	.61	—	6AF3	.73	—	6BL7	1.00	—	6H6GT	.58	—	12AC6	.49	—	12BF6	.44	—	12F5	.66	—	21EX6	1.49
—	10N5	.55	—	3V4	.58	—	6AF4	.97	—	6BN4	.57	—	6J5GT	.51	—	12AD6	.57	—	12BM7	.73	—	12F8	.66	—	25B06	1.11
—	1G3	.73	—	4BC5	.56	—	6AG5	.65	—	6BN6	.74	—	6J6	.67	—	12AE6	.43	—	12BL6	.56	—	12FM6	.45	—	25C5	.53
—	1J3	.73	—	4BC8	.96	—	6AM6	.99	—	6B05	.65	—	6K6	.79	—	12AF3	.73	—	12B06	1.06	—	12K5	.65	—	25CA5	.59
—	1K3	.73	—	4BN6	.75	—	6AK5	.95	—	6B06GT	1.05	—	6SA	.48	—	12AF6	.49	—	12B7	.74	—	12SA7M	.86	—	25C06	1.44
—	1L6	1.05	—	4B07	.96	—	6AL5	.47	—	6B07	.95	—	6SA7GT	.76	—	12AJ6	.46	—	12B77	.75	—	12SK7GT	.74	—	25C06	1.11
—	1LN5	.59	—	4BS8	.98	—	6AM8	.78	—	6BR8	.78	—	6SK7GT	.74	—	12AL5	.45	—	12C5	.56	—	12SN7	.67	—	25C06	1.42
—	1R5	.62	—	4BU8	.71	—	6AN4	.95	—	6BU8	.70	—	6SL7	.80	—	12AL8	.95	—	12CA5	.59	—	12SQ7M	.73	—	25EM5	.55
—	1S5	.51	—	4BZ6	.58	—	6AN8	.85	—	6BY6	.54	—	6SN7	.65	—	12A05	.52	—	12CN5	.56	—	12U7	.62	—	25L6	.57
—	1T4	.58	—	4BZ7	.96	—	6AQ5	.50	—	6BZ6	.54	—	6SQ7	.73	—	12AT6	.43	—	12CR6	.54	—	12V6GT	.53	—	25W4	.68
—	1U4	.57	—	4CS6	.61	—	6AR5	.55	—	6BZ7	.97	—	6T4	.99	—	12AT7	.76	—	12CU5	.58	—	12W6	.69	—	25Z6	.66
—	1U5	.50	—	4DE6	.62	—	6AS5	.60	—	6C4	.43	—	6U8	.78	—	12AU6	.50	—	12C06	1.06	—	12X4	.38	—	35C5	.51
—	1X2B	.82	—	4DK6	.60	—	6AT6	.43	—	6CB6	.54	—	6V6GT	.54	—	12AU7	.60	—	12CX6	.54	—	17AX4	.67	—	35L6	.57
—	2AF4	.96	—	4OT6	.55	—	6AT8	.79	—	6CD6	1.42	—	6W4	.75	—	12AV5	.97	—	12DB5	.69	—	17B06	1.09	—	35N4	.52
—	2CY5	.71	—	5AM8	.79	—	6AU4	.82	—	6CF6	.64	—	6W6	.69	—	12AV6	.41	—	12DB8	.75	—	17C5	.58	—	35Z5GT	.60
—	3AL5	.42	—	5AN8	.86	—	6AU6	.50	—	6CG7	.60	—	6X4	.39	—	12AV7	.75	—	12DL8	.85	—	17CA5	.62	—	50S5	.60
—	3AU6	.51	—	5AQ5	.52	—	6AU7	.61	—	6CG8	.77	—	6X5GT	.53	—	12AX4	.67	—	12DM7	.67	—	17D4	.69	—	50Z5	.53
—	3AV6	.41	—	5AT8	.80	—	6AU8	.87	—	6CM7	.66	—	6X8	.77	—	12AX7	.63	—	12DQ6	1.04	—	17Q06	1.06	—	50DC4	.37
—	3BA6	.51	—	5BK7A	.82	—	6AV6	.40	—	6CN7	.65	—	7AU7	.61	—	12AZ7	.86	—	12DS7	.79	—	17L6	.58	—	50EH5	.55
—	3BC5	.54	—	5BQ7	.97	—	6AW8	.89	—	6CR6	.51	—	7A8	.68	—	12B4	.63	—	12DZ6	.56	—	17W6	.70	—	50L6	.61
—	3BE6	.52	—	5BR8	.79	—	6AX4	.65	—	6CS6	.57	—	7B6	.69	—	12BA6	.50	—	12EL6	.50	—	19AU4	.83	—	117Z3	.61
—	3BN6	.76	—	5CG8	.76	—	6AX7	.64	—	6CU5	.58	—	7Y4	.69	—											
—	3BU8	.78	—	5CL8	.76	—	6BA6	.49	—	6CU6	1.08	—	8AU8	.83	—											
—	3BY6	.55	—	5EA8	.80	—	6BC5	.54	—	6CY5	.70	—	8AW8	.93	—											
—	3BZ6	.55	—	5EU8	.80	—	6BC7	.94	—	6CY7	.71	—	8B05	.60	—											
—	3CB6	.54	—	5J6	.68	—	6BC8	.97	—	6DA4	.68	—	8CG7	.62	—											
—	3CF6	.60	—	5T8	.81	—	6BD6	.51	—	6DB5	.69	—	8CM7	.68	—											
—	3CS6	.52	—	5U4	.60	—	6BE6	.55	—	6DE	.58	—	8CN7	.97	—											
—	3CY5	.71	—	5U8	.81	—	6BF6	.44	—	6DG6	.59	—	8CX8	.93	—											
—	3DK6	.60	—	5V6	.56	—	6BG6	1.66	—	6DQ6	1.10	—	8E88	.94	—											
			—	5X8	.78	—	6BH6	.65	—	6DT5	.76	—	1DDA7	.71	—											
			—	5Y3	.46	—	6BH8	.87	—	6DT6	.53	—	11CY7	.75	—											

TRANSISTORS

ICBO = 6V IEO = 3V hfe ckt A
 10 pa max. 10 pa max. 25 min.

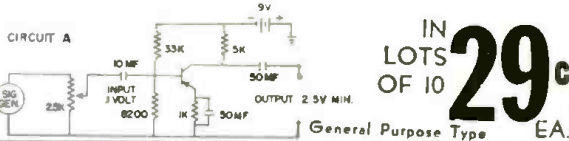

IN
 LOTS
 OF 10
29¢
 EA.

SEND FOR FREE TROUBLE SHOOTER GUIDE AND NEW TUBE & PARTS CATALOG.

NOT AFFILIATED WITH ANY OTHER MAIL ORDER TUBE COMPANY.

RAD-TEL TUBE CO.

55 Chambers St
 Newark 5, N. J.

TERMS: 25% deposit must accompany all orders — balance C. O. D.
 \$1 HANDLING CHARGE FOR ORDERS UNDER \$5. Subject to prior sale.
 Please add postage. No C. O. D.'s outside continental U. S. A.

EW 760

PURCHASING A HI-FI SYSTEM?

NOW YOU CAN CHARGE IT!

If you are an International credit card holder.
Up to 10 months to pay. No down payment necessary.

Send Us
Your
List Of
Components
For A
Package
Quotation

WE WON'T BE
UNDERSOLD!

All merchandise is
brand new, factory
fresh & guaranteed.

AIREX RADIO

CORPORATION

64-R Cortlandt St., N. Y. 7, CO 7-2137

Altec Lansing
Electrovoice
Jensen
Hartley • Stephens
University
Acoustic Research
Janszen
Wharfedale
Karlson Cabinets
Viking
Concertone
Bell • G.E.
Weathers
Harman-Kardon
Eico • Pilot
Sherwood (Fair Trade)
Acrosound
Quad Ampl & Spkrs
Dual Changer
Bogen • Leak
Dynakit • Fisher
H. H. Scott
Uher Recorder
Thorens (Fair Trade)
Pentron • Revere
Amplex • DeWald
Sony • Roberts
Challenger
Wollensak
Garrard
Miracord
Glaser-Steers
Rek-O-Kut
Components
Norelco
Fairchild
Pickering • Gray
Audio Tape
Magnecord
Full Line of
Wellcor Cabinets

RADIO PARTS STORES & HI-FI SALONS!

Hundreds of dealers across the nation profit by selling **ELECTRONICS WORLD** each month to their customers. Are you one of them? **ELECTRONICS WORLD** helps build store traffic . . . keeps customers coming back month after month for the merchandise you sell—and, best of all, you earn a neat profit on each copy sold—No Risk INVOLVED.

So get details on selling **ELECTRONICS WORLD**, the world's largest selling technical electronics magazine. Or, order your copies now. Just use the handy coupon.

Direct Sales Department
Electronics World
One Park Avenue
New York 16, New York

Att: Jerry Schnelder

Send me copies of **ELECTRONICS WORLD** for resale in my store each month. No risk involved on my part.

Send me details on selling **ELECTRONICS WORLD** in my store.

STORE NAME _____

ADDRESS _____

CITY _____ ZONE _____ STATE _____

SIGNATURE _____

EW 760

Sound on Tape

By BERT WHYTE

AFTER the initial furor caused by all the slow-speed tape cartridges which were demonstrated at the IRE Show in New York, the tape world is rather quiet. Of course much of this can be attributed to the seasonal lulls, but it is also due to the fact that, for the most part, the public reacted with interest, but also with a rather "let's wait and see" attitude regarding the proposed new systems.

The consensus seems to be that since the final curtain was almost rung down on tape a few years ago, the present four-track system has enough to offer and is a relatively stable situation. Better to have this despite its limitations than to chase some ephemeral will-o-the-wisp cartridge deal which might result in drying up the available tape supply, such as happened when the stereo disc came along.

This is not to say that anyone wants a static situation but rather, because of the hard knocks the tape fan has received, he looks at things in a very realistic light and displays a much more sophisticated attitude than of yore. And this attitude seems to be reflected in the slow, evolutionary changes that are taking place in the tape business.

For instance, despite denials in some quarters, it has been the sales pattern that two-track stereo tapes were either equal or, in some cases, above the sale of four-track stereo tapes. This was only logical to expect since many owners of two-track machines were literally starved for material, caused by the long drought during the initial stereo disc days.

Now, as many new four-track machines have reached the market and many owners of two-track machines have converted to four-track, there has at last been a gradual lessening of demand for the two-track product. Not that this is now an insubstantial market! Most companies involved intend to supply the two-track market as long as there is sufficient demand to maintain production and make a profit. But the handwriting is on the wall and the encroachment of four-track is greater every day.

Most qualified observers feel the dam will really break at the onset of the Fall market, and that the four-track stereo tape will rule the roost! Impetus for this is furnished by the addition of the huge *London* catalogue and the upswing in activity on the part of pro-

ducers already marketing four-track tapes.

There is a strong rumor that *RCA*, who has for some time maintained a solid front against reel-to-reel, four-track stereo tape will soon capitulate and issue much new four-track material. And a late flash of good news . . . *Capitol Records* which gave us so many fine tapes in the heyday of the two-track format and which stopped production with the onset of the stereo disc, has announced its intention to produce four-track stereo tapes. This will be domestically produced material and will also afford enthusiasts their first taste of *Angel-EMI* tapes. A very few of these were released in the old format and then cut off with the disc-induced cessation of production, so that few people have had a chance to hear some of these fine tapes.

With all this activity, tape is really "back in the act," and my one major gripe with four-track tape . . . a dearth of classical material . . . will be soon satisfied with the *Capitol* and probable *RCA* issues. It is to be hoped that this will stimulate other producers to step up their classical releases.

As it stands now, one must look to the *Everest*, *London*, and *Vanguard* catalogues for the bulk of four-track classical releases. Let's hope these other outfits get the message and surprise us with some classical goodies.

DEBUSSY

LA MER

THE AFTERNOON OF A FAUN

RAVEL

RAPSODIE ESPAGNOLE

L'Orchestre de la Suisse Romande conducted by Ernest Ansermet. London four-track stereo LCL80013. Price \$7.95.

This is one of the new *London* tapes and, as with any Debussy-Ravel music conducted by Ansermet, I was eager to have a listen. To this music Ansermet has addressed himself countless times and with his long association with the composers and with the Diaghilev Ballet, his readings have been accepted as near-definitive.

Perhaps he has gone to the well once too often, but here I find his interpretations less of an exciting musical experience than in former recordings. His tempi seem overly slow and deliberate, he appears to use odd accents and phrasings, and the dynamic expression seems constrained. Maybe this is the way Ansermet feels the music should

ELECTRONICS WORLD

be played these days . . . as for me I'll take his earlier readings.

Perhaps these mannerisms are more exaggerated by the sound which didn't meet expectation. For one thing, the recorded level on the tape is comparatively low and the dynamic range seems severely limited . . . this from a company like *London* whose wide dynamics are virtually a trademark! The sonic texture is "flabby" and the whole sound rather lifeless. It is really an oddball for, in general, the sound is clean and balances well preserved and reverb has been expertly utilized for depth effects.

What is more puzzling is that if one tries to pin the blame for these faults on a disparity between the British CCIR equalization and our own NAB equalization, it is not always the case as witness the reported tape below.

As usual, I'll be in London in late summer and just for my own satisfaction I'm going to play some of these rebellious tapes on English tape machines with the CCIR equalization and hope to find some answers. I suspect that I will find that with these tapes which don't measure up to the usual *London* quality a new recording technique is being used which does not have the appeal for American ears, or has not been as perfected as the original techniques, rather than have the blame lie with any processing error.

RIMSKY-KORSAKOV
CAPRICCIO ESPAGNOL
GRANADOS
ANDALUSIA
CHABRIER
ESPAÑA
MOSKOWSKI
SPANISH DANCES

London Symphony Orchestra conducted by Ataulfo Argenta. London four-track stereo LCL80014. Price \$7.95.

This is the very antithesis of the previous tape as regards to sound. This is high level, big, bold, and brassy, with some huge percussion very cleanly recorded, and nice bright string and wind tone.

The late Argenta was one of our most promising talents as a listen to this tape will prove. If he was not always perfection in a steady metrical beat, he still had an uncanny knack of pacing a performance so that it blazed with life. His dynamic expression was particularly varied and plastic and gave his readings an unmistakable stamp.

The stereo effects here are all that one could desire . . . good directionality without excessive spread . . . clever handling of reverb for good front-to-back depth effects, and great ease of aural positioning. Instrumental definition was of very high order and frequency range was impressively wide.

Tape hiss level was barely apparent when the tape was played at a good, room-filling level. When *forte* and *piano* sections of the opposite tracks were juxtaposed, there was some cross-channel leakage, but it was well down in level and would not be a problem except with the very biggest, top quality tape systems.

—30—

2

for the money

circuit by

tubes by

harman kardon

Amperex*

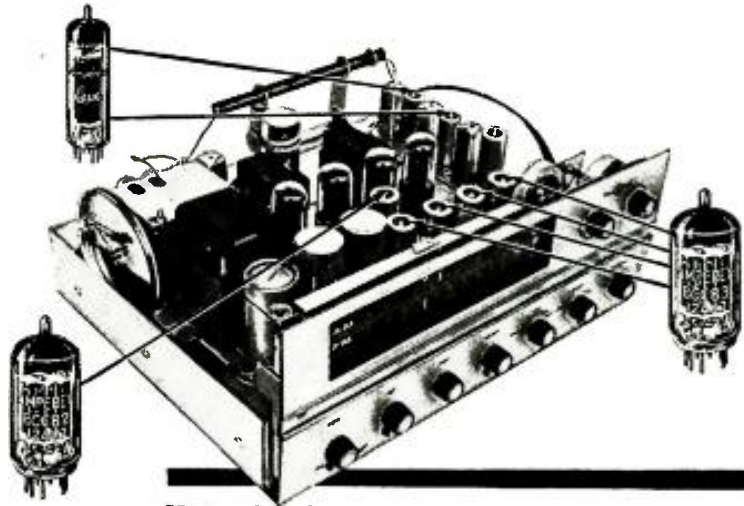

High gain...low noise...absence of microphonics...low distortion...reliability — these are the primary qualities circuit designers look for in electron tubes. Once again, Harman-Kardon engineers have found these qualities best exemplified in Amperex tubes. Small wonder, then, that the tube complement of the new Harman-Kardon "Stereo Recital" Model TA224 Integrated Stereophonic Receiver includes four Amperex 12AX7/ECC83's, one 12AU7/ECC82, and two 6AU6's.

These and many other Amperex 'preferred' tube types have proven their reliability and unique design advantages in the world's finest audio components.

Applications engineering assistance and detailed data are always available to equipment manufacturers. Write: Amperex Electronic Corp., Special Purpose Tube Division, 230 Duffy Avenue, Hicksville, L. I., New York.



about hi-fi tubes
 for hi-fi circuitry

OTHER AMPEREX TUBES FOR QUALITY HIGH-FIDELITY AUDIO APPLICATIONS

POWER AMPLIFIERS

6CA7/EL34: 60 w. distributed load
 71B9: 20 w., push-pull
 6BQ5/EL84: 17 w., push-pull
 6CW5/EL86: 25 w., high current, low voltage
 6BM6/ECL82: Triode-pentode, 8 w., push-pull

VOLTAGE AMPLIFIERS

6267/EF86: Pentode for pre-amps
 12AT7/ECC81: Twin triodes, low hum, noise and microphonics
 12AX7/ECC82: }
 12AX7/ECC83: } microphonics
 6BL6/ECF80: High gain, triode-pentode, low hum, noise and microphonics

RF AMPLIFIERS

6ES8: Frame grid twin triode
 6ER5: Frame grid shielded triode
 6EW7/EF183: Frame grid pentode for IF, remote cut-off
 6EJ7/EF184: Frame grid pentode for IF, sharp cut-off
 6AQ6/ECC85: Dual triode for FM tuners
 6OC6/EBF89: Duo-diode pentode

RECTIFIERS

6V4/EZ80: Indirectly heated, 90 mA
 6CA4/EZ81: Indirectly heated, 150 mA
 5AR4/GZ34: Indirectly heated, 250 mA

INDICATORS

6FG6/EM84: Bar pattern
 1M3/OM70: Subminiature "exclamation" pattern

SEMICONDUCTORS

2N1517: RF transistor, 70 mc
 2N1516: RF transistor, 70 mc
 2N1515: RF transistor, 70 mc

IN542: Matched pair discriminator diodes

IN87A: AM detector diode, subminiature

LEADER TEST INSTRUMENTS

Lag-55 Audio Generator Sine Square

A multi-purpose generator for measurements on audio equipment—amplifiers, speakers, networks. Three waveforms: sine, square and complex for all types of measurements including response, distortion, transient and I-M distortion checks. Full range is from 20 to 200,000 cps, output 5 volts with minimum amplitude variation throughout whole range.

new "LEADER" test instrument



OHMATSU ELECTRIC CO. LTD.

2596, 5-Chome, Kamimeguro, Meguro-Ku
 Tokyo, Japan
 Cable Address "OHMATSULEC" TOKYO

FREE CAREER BOOKLET

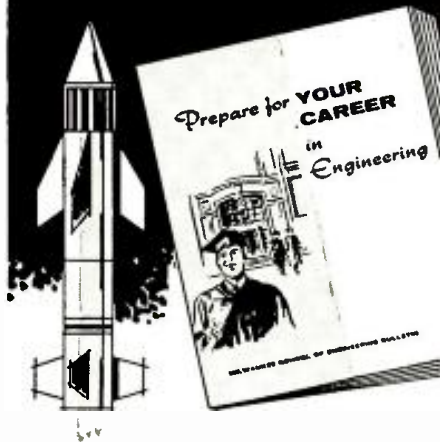

to guide you
to a
successful future
in

ELECTRONICS RADIO-TV COMPUTERS ELECTRICAL ENGINEERING

This interesting pictorial booklet tells you how you can prepare for a dynamic career as an Electrical Engineer or Engineering Technician in many exciting, growing fields:

**MISSILES • RADAR • RESEARCH
ELECTRICAL POWER • ROCKETRY
AUTOMATION • AVIONICS
SALES • DEVELOPMENT**

Get all the facts about job opportunities, length of study, courses offered, degrees you can earn, scholarships, part-time work — as well as pictures of the Milwaukee School of Engineering's educational and recreational facilities. No obligation — it's yours free.

MILWAUKEE SCHOOL OF ENGINEERING

MAIL COUPON TODAY!

MILWAUKEE SCHOOL OF ENGINEERING
Dept. EW-760, 1025 N. Milwaukee St.
Milwaukee, Wisconsin MS-113

Please send FREE "Your Career" booklet
I'm interested in Electronics Radio-TV
 Computers Electrical Engineering
 Mechanical Engineering
(PLEASE PRINT)

Name.....Age.....

Address.....

City.....Zone.....State.....

I'm eligible for veterans education benefits.

Discharge date.....



Manufacturers' Literature

INDUSTRIAL TV CATALOGUE

Radio Corporation of America, ITV-Dep't. 759, Building 15-1, Camden 2, N. J. has announced a 112-page catalogue of closed-circuit television equipment for industry. Described as the first complete listing of its kind, the catalogue is intended as an aid in planning TV systems for a number of industrial applications.

Equipment listed includes cameras, housings, lenses, monitors, switchers, microwave gear, and the new *RCA* Television Tape Recorder. The catalogue should be requested on your company letterhead.

PANEL-MOUNTING METERS

Metronix, Inc., Chesterfield, Ohio is offering a new folder of data sheets describing its line of panel-mounting electronic voltmeters ("PMEV's"). These instruments are designed expressly for continuous monitoring of critical parameters in systems and consoles.

The folder, which discusses the reason for the development of PMEV's, includes descriptions and specifications on single and multiple range meters, both commercial and military types.

POWER SUPPLY CATALOGUE

Sorensen & Company, South Norwalk, Conn. will send on request a new 32-page handbook and catalogue describing more than 400 power supply models. Data is furnished on regulated d.c. supplies, frequency changers (variable frequency power sources), high-voltage power supplies (to 600 kv.) and other high voltage products, miniature transistorized inverters and converters, and a.c. line-voltage regulators.

A section of the catalogue provides technical data on the selection and use of these products.

NEW SWITCH CATALOGUE

Cinema Engineering Division, Aero-vox Corporation, Sales Service Department, 1100 Chestnut St., Burbank, Calif. has made available a new catalogue describing the line of *Cinema* switches. Included in the 28-page illustrated booklet is general information on various types of switches, as well as terminal board reference charts, mechanical dimensions, engineering data, and product descriptions.

DIGEST OF PILOT LIGHTS

Dialight Corp., 60 Stewart Ave., Brooklyn 37, N. Y. is offering a new 24-page Digest of condensed technical data on "Dialco" pilot light assemblies and the lamps for which they were designed. Described as a quick reference

source to aid in the selection of pilot lamps, the Digest also includes information on lens holders, cable connectors, and bracket-mounted sockets for small lamps. Illustrations, charts, and circuit diagrams are provided. Request your copy by writing to Mr. R. E. Greene at the company address, asking for Form L-161B.

GERMANIUM TRANSISTORS

Electronic Transistors Corp., 9226 Hudson Blvd., North Bergen, N. J. announces a 4-page catalogue covering 412 germanium transistor types that are in stock or in production by the company.

According to the manufacturer, the catalogue covers virtually every known type for applications in computers, aircraft, missiles, military, marine, entertainment, and general industry. All are produced to registered EIA specifications.

RADIO SHACK SUPPLEMENT

Radio Shack Corp., 730 Commonwealth Ave., Boston 17, Mass. has issued a new 48-page supplement to its regular catalogue. Available free to the general public, the new publication lists and describes high fidelity and ham equipment, industrial and general type merchandise, records and tape, as well as sale items such as special purchases and closeouts.

INVENTORY HANDBOOK

The Business Publications Division of *Dun & Bradstreet, Inc., P.O. Box 803, Church Street Station, New York 8, N. Y.* has issued a booklet "Inventories and Business Health." Written by a *Dun & Bradstreet* vice-president, Roy A. Foulke, the 61-page volume discusses the causes and effects of inventory losses in small businesses. The author also suggests certain "guides which can lead the business man to a fuller comprehension of inventories and their control" to improve business. Cost of the book is \$1.00.

PLASTIC BOXES

Bradley Industries, 1650 North Damen Ave., Chicago 47, Ill. has issued a 16-page catalogue describing this company's line of small clear plastic boxes in a variety of shapes and styles. Primarily aimed at the industry, this catalogue points to the use of these boxes in terms of sales, packaging, product care, and handling costs.

MECHANICAL FILTERS

Collins Radio Co., Western Division, 2700 West Olive Ave., Burbank, Calif. has issued a specification sheet listing all of its mechanical filters in easy-

reference tabular form. More than 90 different filters are covered. For a copy, write to the company and request Bulletin CR-WD-1005.

BRITISH TUBE LISTINGS

English Electric Valve Co., Ltd., Chelmsford, Essex, England has published a 36-page, spiral-bound book that supplies abridged data for all of this company's tubes (called "valves" in Britain).

Titled "Abridged Valve Data," the booklet describes various tube types including thyatrons, magnetrons, and TV camera tubes. A replacement index is also included. To receive a copy, write to the Technical Publications Dept. at the company address.

HIGH-TEMPERATURE CAPACITORS

Airborne Accessories Corp., 1414 Chcstnut Ave., Hillside 5, N. J. is offering a 4-page product bulletin PS-6A describing new high-temperature mica and mylar motor-starting capacitors. These units have working ranges from -65°F to +700°F and -75°F to +400°F respectively.

To receive a copy of the bulletin, write to S. Banaski, Marketing Dept., at the manufacturer.

SEMICONDUCTOR MANUAL

Sylvania Electric Products Inc., P.O. Box 37, Buffalo 9, N. Y. has announced a semiconductor replacement guide, by equipment brand and model number.

The new manual provides replacement information and mechanical specifications for transistors, diodes, and rectifiers used in TV sets, radios, phonographs, tape recorders, and other home and hobby gear. The manual is available at 50 cents a copy from authorized *Sylvania* dealers or from the manufacturer direct.

EIA ENGINEERING REPORT

The Electronics Industries Association (formerly RETMA), 11 West 42 Street, New York 36, N. Y. has made available an engineering report that includes a bulletin of JEDEC type registrations for components. A list of other new EIA standards, as well as recent news of committee meetings, is included.

TV SERVICE BULLETIN

Chicago Standard Transformer Corp., 3501 W. Addison St., Chicago 18, Ill. is offering a 4-page folder entitled "Servicing the Vertical Sweep System."

Practical hints on locating defects as well as techniques for determining suitable replacements for blocking oscillators and vertical output transformers are given. The publication is available free from *Stancor* distributors or by writing direct to the company.

SUBMINIATURE CAPACITORS

Mucon Corp., Dept. K, 9 St. Francis St., Newark 5, N. J. announces a 4-page bulletin K-1, describing its com-

plete line of subminiature ceramic capacitors. Information included in the bulletin covers properties, ranges, terminal arrangements, and transistor circuit applications.

TEST EQUIPMENT

Precision Apparatus Co., Inc., 70-31 84th St., Glendale 27, L. I., N. Y. has released a 20-page catalogue that lists its lines of "Precision" test equipment and "Face" panel meters.

The booklet, amply illustrated, contains general and technical descriptions, recommended uses, and prices. Accessories, such as probes and carrying cases, are included.

TV SERVICE BULLETIN

Supreme Publications, 1760 Balsam Rd., Highland Park, Ill. is offering a bulletin that describes in detail this publisher's recent "1960 Television Servicing Manual" as well as other *Supreme* publications.

WIRE CATALOGUE

Columbia Wire and Supply Co., 2850 W. Irving Park Rd., Chicago 18, Ill. has issued Supplement 108A to augment its regular and complete catalogue No. 108.

The supplement includes items not shown in the regular catalogue, including "Permaline" package TV transmission line, Citizens Band antenna kits, heavy duty extension cord, and others.

REMARKABLE TUBE VALUES AT 1950 PRICES

ALL TUBES INDIVIDUALLY BOXED, CODE DATED AND BRANDED "TRU-VAC"

Typical TRU-VAC® Bargains!

THIS IS A PARTIAL LIST
Thousands More Always In Stock

6SN7GT ALWAYS 30c
6W4GT ALWAYS 30c

OY4	2CY5	516	6AR5	6BK5	6C0B	657	7A4/XXL 7N7	12BA7	12W6GT	38	
OZ4	3A4	5R4	6A55	6BK7	6CR6	658GT	7A5	12B06	12X4	39/44	
1A7GT	3A5	5U4	6AT6	6B17GT	6CS6	65A7	7A6	757	12B66	14A7/12B 41	
1B3GT	3A15	5U8	6AU4GT	6BN6	6CU5	65D7GT	7A7	7X6	12Bf6	14B6	42
1C6	3AU6	5V4G	6AU5GT	6B06GT	6CU6	65F5	7A8	7X7	12Bh7	14O7	43
1C7	3BC5	5V6GT	6AU6	6B07	6D6	65F7	7B4	7Y4	12BQ6	19	45
1F4	3BN6	5X8	6AU8	6BR8	6DE6	65G7	7B5	7Z4	12BR7	19AU4GT	50A5
1F5	3BZ6	5Y3	6AV5GT	6B58	6DG6GT	65H7	7B6	12AB	12B77	19B66G	50B5
1G4	3CB6	6A6	6AV6	6BY5G	6DO6	65J7	7B7	12A65	12CA5	19J6	50C5
1HSGT	3Q4	6AB4	6AW8	6BZ6	6F5	65K7	7B8	12AQ5	12CN5	19T8	50I6
1L4	354	6AC7	6AX4GT	6BZ7	6F6	65L7	7C4	12AT6	12D4	24A	54
1L6	3V4	6AF4	6AX5GT	6C4	6H6	65O7	7C5	12AT7	12F5	25Z6GT	57
1NSGT	4E07A	6AG5	6B8	6C86	6J4	65R7	7C6	12AU6	12K7	26	58
1R5	4B58	6AH4GT	6BA6	6CD6G	6J5	6T4	7C7	12AU7	12L6	27	71A
1S5	4BZ7	6AH6	6BC5	6CF6	6J6	6U8	7E5	12AV6	12O7	35	75
1T4	4CB6	6AK5	6BC8	6CG7	6J7	6V6GT	7E6	12AV7	12S47	35A5	76
1U4	5AM8	6AL5	6BD6	6CH8	6K6GT	6W6GT	7E7	12AX4GT	12SJ7	35B5	77
1U5	5AN8	6AMB	6BE6	6C16	6K7	6X4	7F7	12AX7	12SK7	35C5	78
1V2	5AT8	6AN8	6BF5	6CM6	6N7	6X5GT	7F8	12AZ7	12SN7GT	35W4	80
1X2	5AV8	6AOS	6BG6G	6CM7	6O7	6X8	7G7	12B4	12S07	35Z5	84/6Z4
2AF4	5AZ4	6AO6	6BH6	6CN7	654	6Y6G	7H7	12BA6	12V6GT	36	117Z3
2BN4	5BR8	6AO7	6BJ6								

1 YEAR GUARANTEED PICTURE TUBES

Brand New* Allied A-1 Tubes Brand New
Below listed prices do not include dud. Add Additional \$5.00 Deposit on tube sizes to 20"; on 21" and 24" tubes - \$7.50. Deposit refunded immediately when dud is returned prepaid. Aluminized tubes - \$4.00 extra.

Picture tubes shipped only to continental USA and Canada - All tubes F.O.B. Harrison, N. J.

10BP4	7.99	16BP4	12.19	17CP4	16.99	19AP4	18.39	21AP4	18.79	21PP4	18.39	21VP4	18.39
12BP4	10.99	16BP4	11.99	17CP4	17.99	20CP4	15.99	21AP4	17.99	21PP4	18.39	21VP4	17.99
14CP4	11.99	16BP4	12.19	17CP4	16.99	20CP4	15.99	21AP4	18.79	21PP4	22.39	24BP4	26.99
16BP4	16.99	16BP4	11.99	17CP4	16.99	20CP4	17.99	21AP4	18.79	21PP4	18.39	24CP4	27.99
16DP4	12.19	17AP4	15.99	17CP4	15.99	21AP4	21.49	21AP4	17.49	21PP4	17.49	24CP4	26.99
16DP4	16.99	17BP4	12.49	17CP4	16.99	21AP4	18.79	21PP4	17.49	21VP4	17.49		

ATTENTION QUANTITY USERS!

Big Discounts Are Yours - Call or Write For Our 1000 Tube "Private Label" Special Attention Branding Dept. MGR.

MONEY CHEERFULLY REFUNDED WITHIN FIVE (5) DAYS, IF NOT COMPLETELY SATISFIED! TRU-VAC® PAYS YOUR POSTAGE on orders of \$5 or more in U.S.A. and Territories. Send approximate postage on Canadian and foreign orders. Any order less than \$5 requires 25c handling charge. Send 25¢ on C.O.D.'s. All orders subject to prior sale.

Complying with Federal regulations, the following statement appears in all Tru-Vac advertising: Tubes appearing in this ad may be FACTORY SECONDS or USED tubes and are clearly marked.

Your best buy . . .

TRU-VAC

35¢

For any used or factory second tube!

USED TV CONSOLES

GUARANTEED To Work When You Receive Them

10" & 12"	\$29
14" & 16"	\$37
17"	\$45
19"	\$59
20" & 21"	\$70

All sets shipped in two cartons to avoid breakage. Sets shipped express to continental U.S.A. and Canada only. F.O.B. Harrison, New Jersey.

FREE BONUS

RABBIT EARS
\$7.95 Value
FREE with each set purchased

GUARANTEE

Only TRU-VAC guarantees to replace free any tube which becomes defective in use within one year of date of purchase.

FREE FUSE CLIP

Sent With Any Order Of \$5 Or More

TRU-VAC Electric Company

Visit Our Huge Testing Dept. In The Heart Of Harrison, N. J.'s Electronics Industry

Harrison Avenue Box 107 Harrison, New Jersey Humboldt 4-9770

YOUR COPIES OF

**ELECTRONICS
WORLD**

ARE VALUABLE!

**Keep them neat . . .
clean . . . ready for
instant reference!**

Now you can keep a year's copies of **ELECTRONICS WORLD** in a rich-looking leatherette file that makes it easy to locate any issue for ready reference.

Specially designed for **ELECTRONICS WORLD**, this handy file—with its distinctive, washable Klvar cover and 16-carat Roid leaf lettering—not only looks good but keeps every issue neat, clean and orderly.

So don't risk tearing and soiling your copies of **ELECTRONICS WORLD**—always a ready source of valuable information. Order several of these **ELECTRONICS WORLD** volume files today. They are \$2.50 each, postpaid—3 for \$7.00, or 6 for \$13.00. Satisfaction guaranteed, or your money back.

(Be sure to specify whether you want lettering to be **Electronics World** or its former title, **Radio & TV News**.)

Order direct from:

JESSE JONES BOX CORP.

Dept. EW

(Established 1843)

Box 5120, Philadelphia 41, Pa.

ENGINEERING HOME STUDY COURSES

Courses written by world authorities in all branches of engineering and science and proved successful by thousands of our graduates. One hour each day in your spare time will start you off to higher pay, security and prestige. Personalized instruction methods ensure rapid progress. Fill in the coupon and indicate the course of interest. We will send you a complete outline of the course and a booklet describing the Institute and our advanced teaching methods.

RADIO
ELECTRONICS
TELEVISION
CIRCUIT
MATHEMATICS
ELECTRICAL ENG.
TELEPHONY
CIVIL ENG.
SURVEYING
ARCHITECTURE
FORESTRY
MINING
STRUCTURAL
MECHANICAL ENG.
INDUSTRIAL ENG.
& MANAGEMENT
REFRIGERATION
DRAFTING
PLASTICS
AERONAUTICAL
ENG.
HIGH SCHOOL
CHEMICAL
MATHEMATICS
JOURNALISM
ACCOUNTING

MAIL THIS COUPON TODAY

CANADIAN INSTITUTE OF SCIENCE & TECHNOLOGY LIMITED
749 Century Bldg., 412, 5th St. N.W., Wash., D.C.

NAME.....

ADDRESS.....

CITY.....STATE.....

COURSE OF INTEREST.....

Canadians: Send to C.I.S.T., 749 Garden Bldg.,
263 Adelaide St. West, Toronto, Ontario.

C. I. S. T.

Tape's Progress

(Continued from page 39)

expected to reach the market until 1961, we will just have to wait and see what effect these machines have on the over-all situation. (Editor's Note: For complete details on this newly proposed system, see our article "1½-ips Stereo Tape System" in the June issue.)

All told, it can be expected that pre-recorded tapes in cartridge form will appear in volume in the near future. Cartridges are presently intended for operation at 3¾ ips, although it is contemplated that in a year or less it may be feasible to provide good quality at lower speeds.

On the other hand, many tape enthusiasts will still prefer the open reel, particularly if pre-recorded tape is offered at no higher speed than 3¾ ips in cartridges. For the recordist, the open reel permits easier physical access to the tape, facilitating such procedures as editing and splicing.

Whatever form pre-recorded tape may take—cartridge or open reel—the rest of the audio system is ready for it. For some time, nearly every preamplifier or integrated amplifier made has incorporated an input specifically intended for the output of a tape head and supplying the necessary amplification and equalization. Therefore the individual having no desire to record tape but only to play it can purchase a transport mechanism and plug the output of the head into the audio system's preamplifier.

Standard Equalization

One of the most nebulous aspects of the tape situation has been playback equalization. Whereas the disc industry decided for once and for all upon a standard playback characteristic (RI-AA curve) as far back as 1954, the issue is still unsettled in the case of tape.

The closest the tape industry has come to adoption of a standard has been the proclamation by manufacturers of tape recorders and preamplifiers that at 7½ ips they adhere to NAB (formerly NARTB) equalization, which is an official standard only at 15 ips. NAB playback equalization consists of bass boost commencing (3 db up) at 3180 cps, rising 6 db per octave with declining frequency, and tapering off (3 db below maximum) at 50 cps.

While a number of manufacturers have faithfully conformed to the 3180 cps turnover frequency, others have been less exact. Often a "modified" NAB curve has been used, having a turnover around 1600 cps; the result, when playing pre-recorded tapes conforming to NAB equalization, as most tapes do, is a significant deficiency of bass. This gives the non-conforming manufacturers an edge with respect to signal-to-noise ratio, because hum in playback is usually the chief deterrent to a high signal-to-noise ratio; de-emphasizing the bass lowers the hum.

However, it appears that adherence to NAB equalization at 7½ ips has grown to majority proportions and is continuing to increase. It is to be expected that all will conform in the near future, unless the MRIA (Magnetic Recording Industry Association), now at work on tape standards, decides upon a new equalization curve for 7½ ips.

The matter of equalization has been even less clear at 3¾ ips, but is also coming out of the dark. In the recent past, not even an unofficial standard was proclaimed. At least three different playback curves have been employed at this speed, having a bass turnover frequency of 795, 1326, or 1590 cps. It now seems that a playback curve with a turnover of 1326 cps has a good chance of becoming the standard.

The problem of choosing a playback equalization curve for a given tape speed is that of achieving the optimum combination of good treble response, low distortion, and high signal-to-noise ratio. At a given speed, it is possible to use, within limits, various playback curves, each of which is complemented by appropriate record equalization to provide flat record-playback response. Without going into the intricacies of tape equalization and the relationship of such equalization to treble response, distortion, and signal-to-noise ratio, let it simply be said here that there is just one optimum playback equalization for each tape speed.

Recording Level

As with equalization, there has been considerable lack of unanimity as to the maximum permissible recording level consistent with high fidelity. Tape machines have been variously rated at 1%, 2%, 3%, or 5% harmonic distortion, meaning that their record level indicators have been set to indicate maximum permissible recording level when harmonic distortion reaches one of these amounts. The difference between 1% and 5% harmonic distortion may at first seem fairly innocuous, but not when one realizes that the corresponding IM distortion may be 5% to 10% in the first case and far in excess of 30% in the second case.

Each increase of 1% in harmonic distortion in the range of 1% to 5% corresponds roughly to a 3 db rise in recording level. Therefore a machine rated at 3% harmonic distortion can quote a signal-to-noise ratio about 6 db higher than one rated at 1%. And the machine rated at 5% can quote a signal-to-noise ratio 6 db higher still.

A recording level that allows harmonic distortion to reach 5% seems excessive for high-fidelity requirements and perhaps for other uses as well. On the other hand, a recording level that stops at 1% distortion often tends to make an unnecessary sacrifice in signal-to-noise ratio. As a consequence, more and more machines, including the high-price ones, have been converging upon 3% harmonic distortion as the maximum permissible amount. It is to be hoped and expected that through MRIA or other means, unanimity will

be reached on maximum recording level.

Mention has been made of the fact that a large number of home machines include such operating conveniences as in-line loading, footage counters, and automatic stops. Another tendency is toward better record level indicators; some machines that formerly employed neon lamps now use magic-eye tubes, while some that employed magic-eyes either are using newer types of magic-eyes which are easier to read or else have graduated to meters.

But in one vital respect there is yet no sign of ground being broken, namely provision for measuring and adjusting speed. In the case of record players, a good deal of attention has been given to speed-adjusting devices and to built-in stroboscopes for checking speed accuracy. Not so, as yet, in the case of tape recorders.

Since accurate speed and thereby accurate pitch are just as important in high-fidelity reproduction *via* tape as *via* disc, there is every reason to expect that one of the imminent developments in the tape field is the appearance of devices to insure accuracy of tape speed.

In conclusion it would seem then that the tape industry is active and healthy and raring to go to still greater heights of accomplishment and consumer acceptance.

SHOCK MOUNTING WITH CABLE STRAPS

By WILLARD WEISS

A CONVENIENT way of shock mounting a subchassis on a larger chassis is to use nylon cable straps or clamps as supports. Sensitive and microphonic electronic circuits can be isolated in this manner.

The nylon clamps provide a very soft and springy support which is superior in some ways to rubber shock mounts. In addition they are more readily available than the rubber type of mount. They come in various sizes and stiffness. Normally one support is used at each corner of the sub-chassis but for heavier units as many as are required may be used around the edge.

The clamps the author has found most suitable are those made by Burndy Electrical Co. These units have mounting tongues spaced at the optimum distance. The spacing can be adjusted by heating the clamps if necessary. See diagram below.

An inexpensive method of shock-mounting.

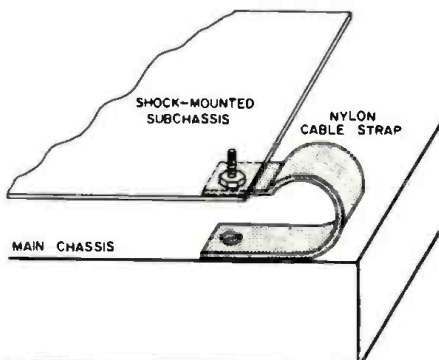

1 Model T-61
New "Speed Check"
Tube Tester Kit
Kit Net Price \$49.95
Factory-wired Net Price ... \$69.95



2 Model C-25
New "In Circuit"
Capacitor Tester Kit
Kit Net Price \$19.95
Factory-wired Net Price ... \$29.95



3 Model T-5
New Rapid Filament
Tester Kit
Kit Net Price \$4.50
Factory-wired Net Price \$6.50

...and now **PRECISION**
adds **10** more
value-packed kits
to the **PACO** Line



5 Model CD-3
New Decade
Condenser Kit
Kit Net Price \$19.95
Factory-wired Net Price ... \$24.95



6 Model SR-2
New Resistance
Substitution Box Kit
Kit Net Price \$8.95
Factory-wired Net Price ... \$11.95



7 Model RD-5
New Decade
Resistor/Divider Kit
Kit Net Price \$23.95
Factory-wired Net Price ... \$29.95



8 Model ST-45
New AM-FM
Stereo Tuner Kit
Kit Net Price \$84.95
Semi-kit Net Price \$99.95
Factory-wired Net Price ... \$134.95



9 Model ST-35
New FM Tuner Kit
Kit Net Price \$59.95
Semi-kit Net Price \$69.95
Factory-wired Net Price ... \$89.95



10 Model L2-U
New Wide-Range
Two-Way Speaker
System Semi-Kit
Semi-kit, unfinished
Net Price \$59.95
Semi-kit, walnut finish
Net Price \$69.95



PACO Test Equipment and Hi Fi Kits are produced under the auspices of **PRECISION Apparatus Company, Inc.**, world-famous manufacturer of industrial electronic test instruments and stereo hi-fi components for over a quarter of a century. Write to Dept. P for new complete 1960 PACO Catalog, just off the press. You'll keep it for permanent reference.

PACO ELECTRONICS CO., INC.

70-31 84th STREET, GLENDALE 27, L. I., N. Y.
Kit Division of **PRECISION Apparatus Co., Inc.**

SEE THESE KITS
ON DISPLAY
AT ANY LEADING
ELECTRONIC PARTS
DISTRIBUTOR

MAIL ORDER HI-FI
You can now purchase all your Hi-Fi from one reliable source and be assured of perfect delivery. Carston makes delivery from NY stock on most Hi-Fi Recorders and Tape within 24 hours. SEND US A LIST OF YOUR HI-FI REQUIREMENTS FOR OUR WHOLESALE QUOTATION and our FREE wholesale catalogue.
CARSTON STUDIOS
125-TD East 88 St. New York 28, N. Y.



LOOK
NO FURTHER . . . IF YOU'RE UNHAPPY WITH "HI" HI-FI PRICES. WRITE FOR OUR UNUSUAL AUDIO CATALOG.
KEY ELECTRONICS CO.
120-C Liberty St., N. Y. 6.
Phone CLOverdale 8-4288

engineering degree in 27 mos.

Become an Electronics Engineer. Share rewards awaiting college men . . . higher income, rapid advancement. Important firms visit Tri-State to interview seniors. *Bachelor of Science Degree in 27 months* in Electrical (Electronics or Power major), Mechanical, Civil, Aeronautical, Chemical Engineering. *In 36 months* a B.S. in Business Administration (General Business, Accounting, Motor Transport Management majors). For earnest, capable students. Small classes. More professional class hours. Well-equipped labs. Dorms. Campus. *Modest costs.* Year-round operation. Enter Sept., Jan., Mar., July. Founded 1884. Write **J. H. McCarthy, Director of Admissions**, for Catalog and "Your Career" Book.



CITIZEN BAND

CLASS "D"

CRYSTALS

All 22 Frequencies in Stock



3rd overtone. .005% tolerance—to meet all FCC requirements. Hermetically sealed HC6/U holders. 1/2" pin spacing—.050 pins. (.093 pins available, add 15c per crystal.) Add 5c per crystal for postage and handling.

\$2.95

Each
We can supply matched sets for Globe, Gonset, Citizen and Hollicrafters units at \$5.90 per set. Specify transmitting frequency and make of equipment.

The following frequencies in stock (frequencies listed in megacycles): 26.965, 26.975, 26.985, 27.005, 27.015, 27.025, 27.035, 27.055, 27.065, 27.075, 27.085, 27.105, 27.115, 27.125, 27.135, 27.155, 27.165, 27.175, 27.185, 27.205, 27.215, 27.225.

RADIO CONTROL CRYSTALS in HC6/U holders in stock for immediate delivery—all channels. Pin diameter .050. \$2.95 ea. .093 pin spacing, add 15c. **SEALED OVERTONE CRYSTALS** Supplied in metal HC6/U holders.

Pin spacing .486, diameter .050
15 to 30 MC .005 tolerance \$3.85 ea.
30 to 45 MC .005 tolerance \$4.10 ea.
45 to 60 MC .005 tolerance \$4.50 ea.

QUARTZ CRYSTALS

for every service

All crystals made from Grade "A" imported quartz—ground and etched to exact frequencies. Unconditionally guaranteed! Supplied in:

FT-243 holders MC-7 holder; an .093" pin spacing 1/2" pin spacing 1/2" an diameter .093 mm diameter .125
DC-34 holders FT-171 holders an spacing 1/2" pin spacing 1/2" pin diameter .156 banana pins



MADE TO ORDER CRYSTALS

1001 KC to 2600 KC:

.01% tolerance \$2.00 ea. .005% tolerance \$2.75 ea.
2601 KC to 9000 KC: .005% tolerance \$2.50 ea.
9001 KC to 11,000 KC: .005% tol. \$3.00 ea.

Specify holder wanted

ANY AMATEUR, NOVICE, TECHNICIAN BAND CRYSTALS

80 meters 3701-3749 KC 01% tolerance
40 meters 7152-7198 KC
15 meters 7034-7082 KC
6 meters 8335-8650 KC (within 1 KC)

1.50 ea.

MARINE FREQUENCY CRYSTALS—All marine frequencies from 2000-3200 KC .005 tolerance \$2.50 ea. (supplied in either FT-243, MC-7 or FT-171 holders)

STOCK CRYSTALS in FT-243 holders from 5675 KC to 8650 KC in 25 KC steps 75c each or 3 for \$2.00. FT-241 Lattice Crystals in all frequencies from 370 KC to 540 KC (all except 455 KC and 500 KC) 50c ea. Pin spacing 1/2" Pin diameter .093

Matched pairs — 15 cycles \$2.50 per pair
200 KC Crystals \$2.00 ea.
455 KC Crystals \$1.50 ea.
500 KC Crystals \$1.50 ea.
100 KC Frequency Standard Crystals in HC6/U holders \$4.50 ea.

Socket for FT-243 crystal 15c ea.
Dual socket for FT-243 crystals 15c ea.
Sockets for MC-7 and FT-171 crystals 25c ea.
Ceramic socket for HC6/U crystals 20c ea.

FREE! Write for new Catalog #860 with oscillator circuits

ASK YOUR PARTS DEALER FOR TEXAS CRYSTALS
See his red display... if he doesn't stock them, send us his name and order direct from our factory.

ORDER FROM OUR NEW FLORIDA PLANT
Shipment by 1st Class Mail—Enclose Coupon

TEXAS CRYSTALS

Dept. R-70, 1000 Crystal Drive, Fort Myers, Fla.
For Fastest Service, Phone WE 6-2100

FILL OUT AND ATTACH THIS COUPON TO YOUR ORDER FOR SHIPMENT VIA 1ST CLASS MAIL AT NO EXTRA COST!

NAME.....

ADDRESS.....

CITY.....ZONE.....STATE.....

TERMS: All items subject to prior sale and change of price without notice. All crystal orders must be accompanied by check, cash or M. O. with PAYMENT IN FULL. NO COD's. Add 5c per crystal for postage and handling charge. Dept. R-70

Radio Aids to Navigation

(Continued from page 32)

duced when these two signals are mixed depends upon the relative phase between them which, in turn, depends upon the loop position from true null. If the loop and sense signals are in-phase (that is, the loop is left of null) the two signals will tend to add together. When loop AM modulation is at maximum, the net output will also be at a maximum. However, if the loop and sense signals are 180 degrees out-of-phase (that is, the loop is right of null) the two signals will tend to subtract and cancel each other. Therefore, when loop AM modulation is at maximum, maximum cancellation occurs and the net output will be at a minimum. The result is that the 115-cycle modulation envelope of the mixed signal either leads or lags the 115-cycle reference produced by the synchronous vibrator by 90 degrees depending upon the relative position of the loop. The waveforms produced are shown at (5) in Fig. 2.

The combined r.f. signal now proceeds through a conventional superheterodyne receiver. At the output of the detector, the detected 115-cycle modulation is separated from communication voice frequencies by a filter. The filtered 115-cycle signal is then amplified in a push-pull compass output power amplifier and is then used to power the control winding of a two-phase loop motor. The reference winding of the loop motor is powered by the 115-cycle vibrator supply.

The two-phase loop motor has two important characteristics. First, it develops maximum rotation torque when its two windings are fed 90 degrees out-of-phase with each other. Second, the direction of shaft rotation depends upon whether the signal winding voltage leads or lags the reference winding by 90 degrees. As was pointed out earlier, the 115-cycle modulation either leads or lags the 115-cycle reference voltage by 90 degrees depending upon whether the loop is to the left or right of a true null. The loop motor is connected so that it will rotate the loop which is attached to its shaft in a direction which moves the loop towards a null. When the null is reached, there is no output from the loop antenna since it is at the aural null, hence no

signal is delivered to the signal winding of the loop motor and it stops. In this manner, the ADF-12E receiver automatically rotates the loop to a true, unambiguous null. A synchro transmitter connected to the loop relays the position of the transmitting station from the aircraft to a direction indicator on the cockpit control panel.

Several companies manufacture ADF equipment similar to the ADF-12E. Many lightplane owners, however, cannot afford this equipment which is expensive due to the high cost of the synchro transmitter and receiver and precision two-phase loop motor used. Since many pilots are interested in using ADF merely for homing to a station, the rotating loop antenna can be replaced by a fixed loop whose aural null is straight ahead. *Aero Signal Labs* produces the inexpensive RDF-2 "Bird Dog" direction finder with circuitry similar to the ADF-12E. However, the loop is fixed for homing and the loop control signal is used to move a meter pointer rather than rotate the loop. This meter then indicates the airplane's homing heading error. If the pilot keeps the meter centered by altering his heading in accordance with the deflections of the meter, he will fly direct to the transmitting station.

Direction finders suffer from the same limitations that radio ranges suffer from and these limitations are due mainly to the poor propagation characteristics of the low and medium frequencies used. In a thunderstorm an ADF direction indicator will aimlessly rotate, pointing at the direction of lightning flashes and discharge static. Unlike the radio-range system, however, planes using ADF receivers can fly along any radial to or from a station and are not limited to flying but four courses as they are with ranges. Furthermore, ADF can be used to obtain running fixes from several stations in order to establish actual position above the ground. This is obviously not possible with radio ranges.

Navigating

Fig. 4 is a simplified radio navigation chart for the San Francisco area showing low-frequency navigation aids. Four low-frequency radio ranges are shown; Travis Range (identified by the letters "SUU" on 248 kc.), Oakland Range (OAK on 362 kc.), Stockton Range (SCK on 212 kc.) and Navy Moffet Range (NUQ on 201 kc.). The

A low-frequency aircraft radio direction finder is shown in this photo along with its indicator.



shaded areas represent the four on-course radials broadcast by the stations. Notice that nearly all of these radials have been oriented to lie along civil airways.

Also shown are two stations intended for ADF use. Commercial station KCBS (740 kc.) lies almost along airway BLUE 10. A federal low-frequency beacon, Richmond Beacon (RMN on 266 kc.), is located along airway AMBER 8 to aid in ADF navigation along this airway.

Suppose an airplane wishes to fly from the east along airway RED 60 to Oakland Range. Using a low-frequency radio-range receiver, the pilot can tune in Stockton Range at 212 kc. and fly the east-west on-course signal until he flies over Oakland Range. With an ADF receiver he can home-in on Oakland Range itself at 362 kc. However, the fact that he homes-in on Oakland does not guarantee that he is on airway RED 60 since any radial from the Oakland Range can be flown with ADF. In order to stay on the airway, the pilot must also use his compass to keep his heading along the airway.

In order to fly from Stockton Range to Travis Range along airways RED 60 and BLUE 7, an aircraft should have two range receivers, one tuned to Stockton Range (212 kc.) and the second tuned to Travis Range (248 kc.). The pilot can then fly along the east-west Stockton on-course signal until the off-course code signal from Travis Range becomes a continuous tone at the intersection of airways RED 60 and BLUE 7. The pilot can then turn towards Travis and follow this range signal to the station.

Flying from Travis to Oakland via airways AMBER 8 and BLUE 10 can be easily accomplished by an aircraft with a range and ADF receiver. Using ADF the plane can home-in on Richmond Beacon (266 kc.) and monitor Oakland Range (362 kc.) on the second receiver until the off-course signal becomes on-course. The pilot can then head towards Oakland Range along airway BLUE 10.

From these "paper flights" it is obvious that navigation can be made easier for the pilot if his aircraft is equipped with more than one type of navigation receiver. For this reason, as well as safety, most commercial airliners carry several receivers, and installations of dual-ADF's and low-frequency range receivers are common. Furthermore, this allows the pilot to tune in the weather forecasts which are broadcast by range stations twice each hour without disturbing the navigational receiver.

Commercial carriers also generally equip their aircraft with dual installations of VOR, the v.h.f. system of navigation. VOR incorporates all the advantages of ADF without many of its disadvantages. Next month we shall discuss this modern system of airborne navigation which is rapidly replacing the ranges and ADF in popularity for long-range navigation.

(To be continued)

July, 1960

IN 1492 CHRISTOPHER COLUMBUS

DISCOVERED AMERICA

... if he'd made the trip today you can bet he would be out to discover—

WALTER ASHE'S BIGGER "SURPRISE" TRADE-IN ALLOWANCE

Chris would have made a good "ham" . . . the kind of fellow who is always looking for new worlds to conquer! Old Columbus proved himself a tight man with a dollar (or was it Spanish doubloons?) when he went to see Queen Isabella. That means he'd want to cash in on the extra big savings of a Walter Ashe "Surprise"

Trade-In Allowance! Follow old Chris Columbus' example . . . and see how much Walter Ashe will allow you towards your new transmitter or receiver!



NEW 1960 CATALOG NOW READY!

The Only Radio Catalog Compiled and Designed Entirely With The Needs of The Amateur in Mind!

If you're an amateur, experimenter or a newcomer "coming up" . . . you're invited to ask for a copy of our brand new 1960 Walter Ashe catalog . . . just off the press. It's packed from cover to cover with everything that's new and needed . . . in mobile or fixed station equipment, parts and supplies, transmitters, receivers, test equipment and Citizen Band units. Incidentally, Walter Ashe is one of America's leading suppliers of High Fidelity equipment . . . and mail the coupon below . . . we'll rush your copy to you!



You Can Be Sure . . .

that every piece of used equipment Walter Ashe takes in trade . . . and later sells . . . is checked thoroughly and guaranteed to work the same as new. Whether you're trading up to new or in the market for used equipment . . . you'll always be money and satisfaction ahead at Walter Ashe!

Walter Ashe
RADIO CO.

Dept. R-7-60, 1125 Pine Street, St. Louis 1, Mo.

TIME PAYMENT TERMS AVAILABLE ON ALL EQUIPMENT

"SURPRISE TRADE IN" COUPON

Walter Ashe Radio Co. - In Our 38th Year
Your One-Stop Supermarket
Dept. R-7-60, St. Louis 1, Mo.

- Rush New Catalog
- Send lists of guaranteed Used Equipment
- Rush "Surprise Trade-in" offer on My _____

For _____
(Show make and model of equipment desired)

Name _____

Address _____

City _____ Zone _____ State _____

METER—3"-0-5 Ma. 270° indication.
By-Pass Shunt and add scale.
Excellent condition. \$1.29
5 for 5.00

Send M.O. or check with order.
Write for Bulletins

R W Electronics 2430 S. Michigan Ave. Dept. N
Chicago 16, Ill. Phone CALumet 5-1281

* **KEEP CANDEE HANDEE!** *
* **FREE!** *Bargain-filled* *
* **Summer Flyer!** *
* Get your copy today! *
* **J. J. CANDEE CO.** *
* 509 N. Victory Blvd. Burbank Calif. *

GET INTO ELECTRONICS

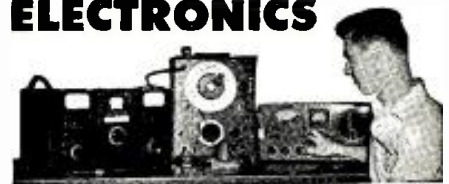

V.T.I. training leads to success as technicians, field engineers, specialists in communications, guided missiles, computers, radar and automation. Basic and advanced courses in theory and laboratory. Associate degree in electronics in 20 months. B.S. in electronic engineering obtainable. ECPD accredited. G.I. approved. Graduates in all branches of electronics with major companies. Start September, February, Dorms, campus. High school graduate or equivalent. Catalog.

VALPARAISO TECHNICAL INSTITUTE
Dept. RD Valparaiso, Indiana

New Audio Test Report



Norelco Stereo "Continental 400" Tape Recorder
Madison Fielding Model 630 FM Tuner
Garrard Model 210 Record Changer



Norelco Tape Recorder

VERSATILITY of operation and an excellent tape-deck mechanism are the two outstanding features of the Norelco Stereo "Continental 400" tape recorder, which we have just checked. The recorder is a four-track machine that will both record and play back stereophonically as well as monophonically at tape speeds of $7\frac{1}{2}$, $3\frac{3}{4}$, or $1\frac{1}{8}$ ips. Built into the unit are two playback power amplifiers, one of which drives the built-in speaker and the other drives the outboard speaker in the removable lid. Provisions are also included for mixing from the stereo microphone (supplied with the recorder) and the radio-phono input, for dub-

bing a signal onto a previously recorded track without erasing, and for stereo headphone monitoring. A built-in 4-digit counter and a magic-eye (EM84) recording indicator are included. Inputs are provided for microphone and two radio-phono circuits, and outputs are provided for use with external amplifiers or external speakers.

We were quite pleased with the performance of the recorder both on record and playback. The stereo microphone, consisting of crossed dynamic elements with built-in transformers all in a single housing, was convenient to use and we were able to produce some

very acceptable live stereo recordings with it. Admittedly the mike is not quite broadcast-quality, but it is far better than a good many of the inexpensive ceramic or magnetic mikes often supplied with recorders.

When we tried out the unit on the playback of some pre-recorded tapes, our audience was very much impressed with the quality and the separation produced. This was true even though the built-in playback amplifiers use just a single-ended EL84 for each channel and the built-in speaker is only a 4 x 6-inch oval for one channel with a 6-inch outboard speaker for the other. Naturally, in order to fully appreciate the high quality of most stereo tapes, we would suggest the use of external amplifiers and speakers; the built-in amplifiers and speakers may then be used for monitoring.

While examining the unit, we found a rather interesting construction used for the outboard speaker. When we removed the back panel of the recorder's lid, we could see the cone and voice-coil connections of the 6-inch speaker but no magnet was in sight. Upon removing the speaker, we found that it has an "inside-out" construction, with the magnet and supporting basket in front of the cone rather than behind it. This makes the entire speaker very shallow and permits the use of a medium-sized unit in the lid of the recorder. We also noticed in the recorder itself a rather flat dry-rectifier assembly mounted on the chassis. This rectifier, a full-wave bridge, supplies "B+" to the recorder's circuits.

During all our playback tests, we were pleased with the silence of the tape deck and the complete absence of audible wow or flutter, even at the slowest speed of operation where these problems are usually most severe. We played a selection including sustained piano chords, and we could detect no waver or irregularity in the long-lasting tones.

Test Results

After using the recorder for several days, we subjected it to a number of tests, the results of which are discussed below. Most of our measurements were taken at the output jacks which supply signal to external amplifiers, hence the characteristics of the recorder's playback power amplifiers are not included in our response curves. We did this since these are the outputs that most of our readers would probably use. Also, we found that the recorder's tone controls (one clutch-type control for each channel) did not provide bass boost in the maximum counterclockwise position, flat response at mid-position, and treble boost in the maximum clockwise position as described in the instruction booklet. A check of the circuit shows that these appear to be conventional treble-cut controls, with maximum cut fully counterclockwise and the flat position fully clockwise. Hence, all our measurements were taken with the controls fully clockwise.

Playback response: This was measured with a special $7\frac{1}{2}$ -ips test tape

(A) Playback response at $7\frac{1}{2}$ ips using a test tape that had been recorded with the standard NAB equalization. (B) Over-all record-playback response at various speeds.

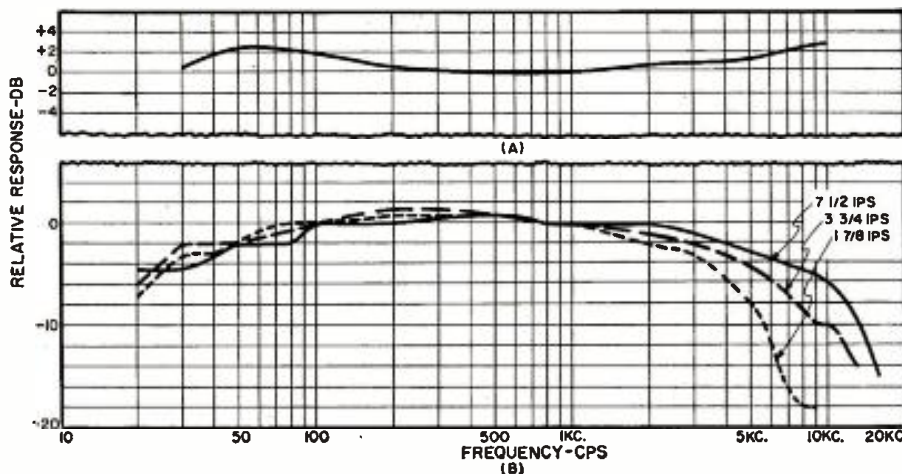

(Audiotex 30-208) which has a frequency run from 30 to 10,000 cps recorded with the standard NAB equalization. The output response is within +3 db and -0 db over the entire range of the tape (see Fig. 1A).

Over-all record-playback response: This was checked by recording via the radio-phono input the output of a low-Z audio oscillator between the frequencies of 20 and 20,000 cps. The output of the oscillator was first set for a 1-volt signal and the level control on the tape recorder was set for maximum record level. Then the output of the oscillator was reduced to 20 db below this level. Under these conditions, the results shown in Fig. 1B were obtained. Recordings were made at all three speeds. Note that the average output is down about 3 db at 35 cps and down about 6 db at 20 cps at the low-frequency end for all speeds. At the high-frequency end, the superiority of the highest speed is evident from the curves even though much more treble boost equalization is used at the lower speeds. At 7½ ips, response is -3 db at 5 kc. and -6 db at 10 kc., with some level still on the tape out to about 18 kc. At 3¾ ips, response is -3 db at 4 kc. and -6 db at 6 kc., with some level still measurable out to about 14 kc. At 1½ ips, response is -3 db at 3 kc. and -6 db at 4 kc., with some level still measurable out to about 8.5 kc.

Sensitivity on record: At maximum gain a signal of 125 mv. into the radio-phono input is required for maximum recording level. With a 1-volt input, the gain control is set to the 1 o'clock position for maximum record level.

Maximum power output: The highest power delivered by the built-in playback amplifiers is 4 watts per channel

at 1000 cps before distortion becomes evident in the output waveform. With maximum recording level applied and with maximum playback gain setting, an output power of 5.1 watts per channel at 1000 cps was produced, but the waveform was clipped.

Signal-to-noise ratio and channel separation: Because of residual tape hiss both on the desired and opposite channels, it was difficult to measure signal-to-noise and separation. However, we used a scope to approximate the amplitude of the hiss and crosstalk at maximum gain. Using this method, the maximum signal-to-noise and stereo crosstalk (separation) is better than 40 db. Residual hum with the tape stationary but with the motor running is about -65 db referred to maximum output.

Speed accuracy: Using a tape-strobe disc, tape speed was found to be 1.3% fast on 7½ ips, and .5% fast on 3¾ ips. The former figure is fairly good for home machines, while the latter figure may be considered to be of semi-professional rank. (See "Measuring Tape Speed" in our June issue.) In addition, this speed error was fairly constant at the beginning, middle, and end of a reel of tape. As a result, when a pre-recorded tape is played back, the sound heard would be pitched high by the above amounts. The slight increase in pitch would be audible only upon a direct A-B comparison with the original recording, however.

In summary then, the Norelco "Continental 400," particularly when used with external amplifiers and speakers, is a worthy addition to any hi-fi system. The complete tape recorder, including the stereo microphone, is priced at \$399.50.

-30-

not readily accessible for alignment. The r.f. tracking was found to be excellent at 100 mc. with only a slight drop-off at 90 and 106 mc.

Performance tests, in accordance with the IHFM (Institute of High Fidelity Manufacturers) standards, yielded the following results:

Volume sensitivity: 90 mc., 1.8 microvolts; 98 mc., 1.2 microvolts; 106 mc., 1.6 microvolts.

Usable sensitivity for 20-db quieting: 90 mc., 1.8 microvolts; 98 mc., 1.8 microvolts; 106 mc., 1.8 microvolts.

Usable sensitivity for 30-db quieting: 90 mc., 3.5 microvolts; 98 mc., 3.0 microvolts; 106 mc., 2.5 microvolts.

Since the manufacturer's data includes sensitivity for full limiting, this test was also performed and full limiting was obtained with 1.4, 1.2, and 1.0 microvolts input at 90, 98, and 106 mc. respectively.

I.F. Bandwidth: 350 kc.

Detector peak separation: 800 kc.

Detector linear region: 410 kc.

A.F.C. range at 98 mc.: +700 kc. -550 kc. (max. a.f.c.).

A.F.C. stability: no discernible drift over one hour.

Audio output: 1.8 volts peak-to-peak, undistorted.

Audio response: within ±1 db from 50 cps to 15,000 cps of the standard de-emphasis curve.

From this data it is apparent that this is one of the better performing tuners and both tube complement and components show this as well. All tubes are foreign, but equivalent and interchangeable with such standard types as 6AQ8, 6BX6, 6DA6, and 12AU7. Printed wiring is used with all parts mounted on the top deck and all wiring at the bottom. The only disappointing part in this area is the relative inaccessibility of one test point which connects to the limiter grid and is used for r.f. and i.f. alignment. The other test point, the output of the detector, is available at a special audio output jack which is ahead of the de-emphasis network and is intended for use with a stereo multiplex adapter. In this respect the manufacturer offers advice on how to build a stereo adapter within the confines of the tuner chassis.

One of the pleasant surprises which the user can look forward to is the inclusion of a twin-lead FM antenna and a complete audio cable in the shipping carton. The cabinet is plastic-covered metal with fairly conventional chassis and bottom cover arrangements. The unit retails for \$84.95.

-30-



Madison Fielding FM Tuner

A TUNER with a stationary pointer and a moving dial has recently been placed on the market by Crosby Electronics, Inc. under the name of the Madison Fielding Model 630. In addition to the unusual dial arrangement, this tuner has another uncommon feature in that the a.f.c. action can be adjusted by a front-panel control. This latter arrangement permits the listener to set the tuner either for very light a.f.c. action or for maximum locking-in, depending on local conditions and whether one is just searching through the band or wants to pull in a particular station. The stationary pointer,

which doubles as tuning indicator, is the glowing portion of a type EM84 tuning-eye tube that is visible as a vertical line from the front.

Performance tests on one unit which we checked indicated a tuning range from 87.5 mc. to 108 mc. with very close correspondence between the dial reading and a crystal-calibrated signal generator. Alignment of the entire tuner was carefully checked and only one side of the detector transformer was found to need touch-up. The r.f. portion of the FM tuner consists of a separate subchassis which appears to be of foreign manufacture and which is

Garrard Record Changer

FOR those of our readers whose first concern when playing their records is operating convenience, a record changer is a "must." An intermix changer provides even more convenience, since no adjustment is required for different record sizes. The Model 210 is Garrard's deluxe version of an intermix record changer, which has been designed and wired for stereo operation. The changer will play auto-

We'd like to send you these important new books for a 7-day free trial examination

Class D CITIZENS RADIO by Leo G. Sands

Here is the first complete book on Citizens Radio Operation. Ever since the initial use of 2-way radiotelephone by police departments, this field has been growing in importance and application. Now, with more than a million vehicles equipped for its use, Citizens Radio is a major phase of the electronics field. This important new volume covers every aspect of the field—its history, rules, and everything about how it works—in seven big chapters with one hundred major sections. You'll learn exactly what Citizens Radio is, its applications, what equipment you need, the full story on receiver circuits and transmitters, antennas, installation, and maintenance, full FCC rulings, how to apply for licenses, etc. Many illustrations. **\$4.95**

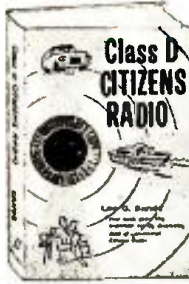

COMPUTERS AND HOW THEY WORK by James D. Fahnestock

Here is a fact-filled exciting guidebook to the wonderworld of electronic computers, with more than 110 illustrations and easy-to-follow tables in 10 big chapters. Step by step, you'll see and understand the workings of many types of computing machines. This important new book illustrates the basic principles of computers in methods that require no knowledge of electronics. You'll learn all about computer memories, flip-flops and the binary counting system. You'll learn the mathematical language of computers where $1 + 1 = 10$. Other chapters show you how computers use tubes and transistors to make complex logical decisions in thousandths of a second. **COMPUTERS AND HOW THEY WORK** is must reading for career minded students and for electronics pros who want a more complete knowledge of this field. **\$4.95**

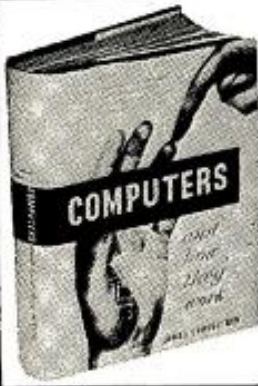

THE ELECTRONIC EXPERIMENTER'S MANUAL by David A. Findlay

With a few dollars worth of basic tools, and this book to guide you, you can explore the magic of electronics experimentation more completely than ever before. In a few short hours, you'll start your first project. You'll learn about every component used in experimentation, every tool, its function and why it is used. There are 8 big sections, each covering a specific phase of construction. There is a giant section of projects you can build, test equipment you'll construct and use in your future work. **THE ELECTRONIC EXPERIMENTER'S MANUAL** will give you the professional know-how you must have no matter what phase of electronics is your specialty. **\$4.95**



7-DAY FREE EXAMINATION

When your books arrive, read and enjoy their diversity of contents, their thoroughness of coverage. Then after seven days examination, if you decide that they are not everything you want, send them back and receive a complete refund of the purchase price.

USE THIS CERTIFICATE FOR 7-DAY FREE EXAMINATION

ELECTRONICS BOOK SERVICE

434 South Wabash Avenue, Chicago 5, Ill.

Please send me _____ copies of **CITIZENS RADIO** and bill me at only \$4.95 a copy plus a few cents postage.

Please send me _____ copies of **COMPUTERS AND HOW THEY WORK**, and bill me at only \$4.95 a copy plus a few cents postage.

Please send me _____ copies of **THE ELECTRONIC EXPERIMENTER'S MANUAL** and bill me at only \$4.95 a copy plus a few cents postage.

If I don't agree that this is one of the best electronics investments I've ever made, I may return the book(s) within seven days and get a full refund.

\$ _____ enclosed. (SAVE MONEY! Enclose payment with your order and we'll pay the postage.)

Name _____
 Address _____
 City _____ Zone _____ State _____



ZEW70

matically or manually up to eight 7-, 10-, or 12-inch records at 16 $\frac{2}{3}$, 33 $\frac{1}{3}$, 45, or 78 rpm. The two larger sizes may be intermixed in any order. The changer may also be stopped and restarted while playing a record without the record changer's cycle going into operation.

The turntable is driven by a four-pole induction motor *via* an idler puck running between a stepped motor drive and the table rim. The turntable is fairly heavy and is covered with an attached rubber pad to prevent record slippage. A convenient stylus-pressure control is provided which allows an adjustment to be made with the arm in the normal playing position. This is an improvement over having to tilt the arm upward and set a hard-to-reach stud or adjusting screw. In this case simply turning a knurled ring near the tone-arm pivot does the job accurately. The tone-arm also has a small locking tab beneath it to hold the arm in a fixed position when the unit is not in use. When the changer is started, the arm is unlocked from its rest position automatically.

When we checked one of these changers, we found that it went

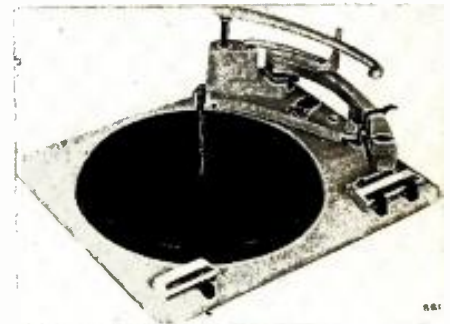

through all its operations properly. A measurement of speed accuracy of the unit showed that the turntable was running very slightly fast (by about .3 per-cent) on all speeds. This variation is within standard speed tolerances and should cause no difficulty. We were able to hear the 100-cps tone recorded on our test record (**ELECTRONICS WORLD Stereo-Mono Test Record #1**) at a level of -40 db with respect to standard reference level. This indicates satisfactory rumble performance. When we first tried out this test, we permitted the changer to rest on the three support brackets riveted to the base plate. Under these conditions, rumble was objectionably high, but as soon as the changer was lifted from our workbench, rumble dropped way down. Under normal operating conditions the changer is suspended from three shock-mount springs and, of course, does not rest on the support brackets mentioned above. Although the wow and flutter are not as low as that obtained with a professional-type turntable, performance is, in general, quite adequate for high-fidelity applications.

The changer is attractively finished in ivory with black and chrome trim. It sells for \$49.50 complete with plug-in shell and mounting hardware for a phono cartridge.

50

C.E.I. CITIZEN'S BAND

Two-Way Transceiver Kits Complete—
New Low Price

No examination required for use of this equipment. Made from parts of finest quality. Meets F.C.C. Requirements.

Kits are complete, including Cabinet, Pre-punched Chassis, Power Transformer, all components, Mike, Crystal, Easy to follow instructions and schematic. F.C.C. form 505 furnished with each order.

SPECIFICATIONS

Superheterodyne Receiver with the 1000 DK has RF Stage. One micro volt sensitivity, over two watts Audio Transmitter 5 Watts of RF, 100% AM Modulated, 40 to 80 Ohms Antenna Output. Power Transformer operates on 6VDC, 12VDC and 117VAC. All units can be operated as base or mobile.



Special One Time Offer at this Price

MODEL 1000 DK

Has Tuneable Receiver. Receives all 22 channels and 10 meter band. Has fixed squelch and noise limiter.

45.95

In Kit.....

This model can be easily converted to 6 Meter operation by changing coil winding and crystal. This new price offer is limited. Order now.

All units complete. 15% deposit required with all C.O.D. orders or send cash and take 2% discount. F.O.B. Chickasha. Prompt shipment.

CHICKASHA ELECTRONICS, Inc.
Chickasha, Oklahoma

FREE

Full Year's Subscription to
RADIO SHACK'S
Sensational
ELECTRONICS CATALOGS



Send coupon today! See world's largest and best line of electronic equipment! Invaluable to pros, exciting for hobbyists. Over 100,000 items—stereo, hi-fi, hom radio, tapes — at money-saving prices. 15-day home trial on any item. Satisfaction Guaranteed.

TYPICAL RADIO SHACK VALUE!

"Realistic" 2-speed
Tape Recorder \$49.95

Radio Shack dual-track portable! Wt. only 17 lbs. Has separate record, playback, erase heads. Mike, 5" reel.



MAIL COUPON NOW

Radio Shack Corp., 730 Commonwealth Ave.
Boston 17, Mass. Dept. 6096

Without further request, send latest catalog plus every issue for year—all FREE.

Name _____
Address _____
Post Office _____
or City _____ Zone _____ State _____

Dynamic Capacitor Checker

(Continued from page 41)

series resistance in the PL_1 circuit to allow proper pull-in of the relay. The resistor R_2 was chosen to allow the relay to activate on the high-voltage range at 100 volts. This, with the low-voltage range switching, provides short protection from 15 volts and beyond. Each relay will require individual test and adjustment of this series resistor. The author used a 50,000-ohm pot in this position and, with R_1 at 100 volts (as read on the meter in position B), the test potentiometer was adjusted to pull in the relay. An ohmmeter then indicated the proper amount of fixed resistance needed for R_2 .

The wiring of the function switch is the most difficult part of the job, but should cause very little trouble if the schematic is followed closely. There is a discrepancy between the pictured unit and schematic involving this switch, S_1 . The unit pictured used a hybrid switch which covered all necessary switch positions plus an auxiliary "on-off" switch. Since standard switches are not available in 5 poles and 5 positions without exceptional expense, S_1 is shown on the schematic and in the parts list as a 4-pole, 4-position switch, and S_2 is added for power control. S_2 , of course, does not show up on Fig. 1.

S_2 is a 2-pole, 5-position switch, chosen because it was available. Since the bridge itself requires only a single-pole, 4-position switch, availability and expense might dictate the use of a separate switch for the meter shunt, which shows up as position 5 of S_2 (marked as "ELEC" in Fig. 1).

Non-shorting switches should be used throughout to prevent meter damage. No arcing will be noticed, and the current requirements are sufficiently low so that almost any type of switch will suffice if it furnishes the necessary circuits and positions.

Calibration of the bridge is accom-

plished by using a group of close-tolerance capacitors of such values that, by paralleling them, step markings from .1 to 10 are obtained. Since the standards are 100 $\mu\text{f.}$, .01 $\mu\text{f.}$, 1 $\mu\text{f.}$, and 100 $\mu\text{f.}$, the ranges are comprehensive from 10 $\mu\text{f.}$, (.1 x 100 $\mu\text{f.}$) to 1000 $\mu\text{f.}$ (10 x 100 $\mu\text{f.}$). The unit here was calibrated with precision units of the values .001, .002, .003, .004, .02, .03, and .04 $\mu\text{f.}$ On the second range (position 2 of S_2 , from .001 to .1), the dial was marked in single steps throughout its range. Other ranges were checked with close-tolerance units to insure concentric reading. If the standards are accurate, and the calibrating units are accurate, calibration of one range will suffice for all ranges. If the calibrating pot is linear, it will be possible to interpolate calibration points provided the extreme points on R_2 (.1 and 10) are accurately placed.

Newfoundland's TV Network

(Continued from page 55)

house the power generating equipment at the transmitter towers, usually because of the terrain. In such cases the twin-diesel generator sets are placed in buildings near access roads or rail lines and the power fed to the repeater station by cable. At the actual location, however, there is a small standby unit in case there is an interruption between the hilltop and the base site.

Some of the communications devices are very sensitive to power interruptions. A break of a second or less will trip the relay and set up a chain reaction which causes a general foul up. The CNT engineers have resorted to a simple but ingenious device to insure that there will be no interruptions in the current supply to the microwave equipment.

On each microwave generating set they have installed a huge flywheel—some of which weigh up to two tons. This flywheel is mounted on the drive shaft between the motor and alternator and if a breakdown should occur, cutting power to the motor, the flywheel keeps the alternator spinning steadily until the automatic switches have time to cut in the standby unit.

An elaborate remote-control system permits the repeater stations to be operated automatically and unattended. The diesel-powered alternators run 24-hours a day, without local supervision other than the regular monthly maintenance inspection. If trouble develops, the maintenance engineers at the control points can, by reading the remote control signalling devices, tell what is wrong and take the necessary remedial steps.

The buildings of the repeater stations are warmed by the exhaust from the diesel-generating sets and each station is equipped with an automatic burglar alarm system.

Today this \$9,000,000 project is finished and is in full operation, giving Canada its first coast-to-coast live TV hook-up—thanks to CNT.

Fig. 4. Simplified circuits highlight (A) charge function, (B) leakage-reading function, and (C) short indicator.

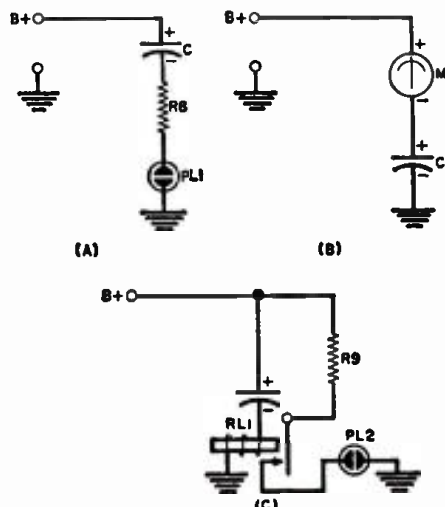

ELECTRONICS WORLD ANNOUNCES A
**SPECIAL SUMMER
 SALE OF 57
 ELECTRONICS
 BOOKS**

The publishers of ELECTRONICS WORLD invite you to choose any of these wonderfully informative electronics books, on a 7-day free trial basis. Here are important books for radio and TV servicemen, electronics professionals, students and hobbyists—books on exciting electronic construction, communications, theory, hi-fi and tape—plus many more subjects that will show you how to save money and get more profit and satisfaction from electronics.

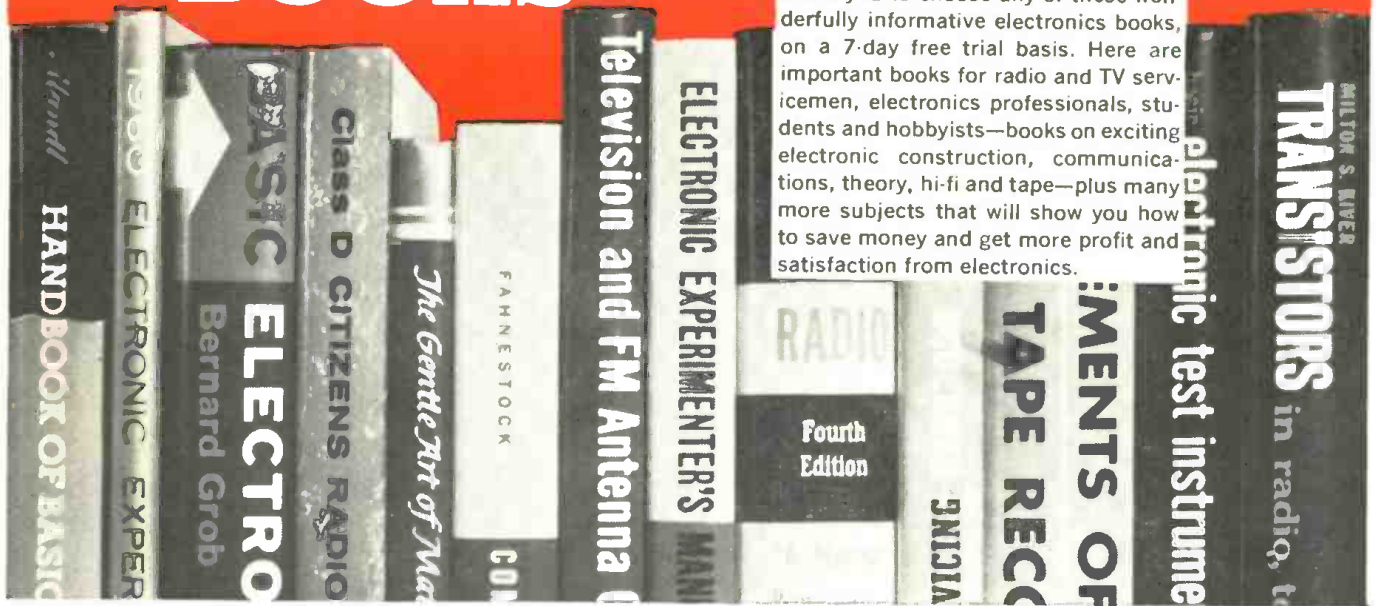

THEORY AND INSTRUCTION

Get started in radio, TV, communications, by using these simple basic guides to electronic principles, functions, and operations!



2500. BASIC ELECTRONICS, Grob
 An introductory text on the fundamentals of electricity and electronics for technicians in radio, television and industrial electronics. \$9.25



2521. BASIC ELECTRONICS, Daly and Greenfield
 Here in twelve chapters is a complete general introduction to electronics for technicians who make use of complex electronic equipment in modern laboratories. \$9.00

2501. ELEMENTS OF ELECTRONICS, Hikey and Villines
 This basic electronics text offers an excellent course for training radio and electronics technicians and for students in television, radar and sonar. \$6.95



2511. UNDERSTANDING RADIO, Watson, Welch and Eby
 For those with little or no technical knowledge who wish to know the fundamentals of radio theory and servicing. \$7.95

2412. TELEVISION AND FM ANTENNA GUIDE, Noll & Mandl
 Two antenna experts tell you their secrets of antenna choice and installation for best reception in any area. Loaded with useful tips on improving reception in fringe and difficult areas. \$5.25



2519. HANDBOOK OF BASIC CIRCUITS, Mandl
 A basic guide to circuitry combining comprehensive coverage of major circuits with detailed information on circuits used in TV, FM and AM. Simply written and easy-to-understand. \$7.95

2522. ELEMENTS OF RADIO, Hellman
 A thorough grounding in all basic principles of radio, radio communication, with a review of electricity and magnetism. Also includes chapter on transistors. \$5.50



2502. ELEMENTS OF RADIO, Marcus & Marcus
 Now in its 4th edition. More than a million copies sold! Follows proved method of exposition, proceeds from the simple to the complex. \$7.00

HI-FI AND TAPE

Special references for the sound enthusiast to help him select, build, and improve his hi-fi and stereo recording system.



2000/60. STEREO-HI-FI GUIDE,
Ziff-Davis Publishing
Company

Just published! 1960 edition features 60-page exclusive by Joseph Marshall on components and how they work. \$1.00

2757. RIBBONS OF SOUND, Barleben

A perfect introduction to tape recording principles and practices. Paper. \$2.50; 2757C Cloth. \$3.50

2760. HI-FI STEREO FOR YOUR HOME, Whitman

Tells what stereo is, how it works, affects home listening habits, and how to install and maintain it. \$3.50



2750. ELEMENTS OF MAGNETIC TAPE RECORDING, Haynes

All aspects of this recording medium are described in easy-to-understand detail. 416 pages, \$7.95

2004/60. HI-FI ANNUAL & AUDIO HANDBOOK,
Ziff-Davis Publishing Company

1960 edition. Prepared by the editors of Electronics World. An excellent advanced guide to theory, construction and circuitry. \$1.00



42. REVERE TAPE RECORDER GUIDE,
Tydings

The first non-technical book to provide useful information on the Revere Tape Recorder. Also a basic guide to the entire field of tape. Will show you new uses and add to your enjoyment of tape recording. \$1.95

2005/60. HI-FI DIRECTORY & BUYERS' GUIDE,
Ziff-Davis Publishing Company

1960 edition. World's only complete listing of all hi-fi and stereo equipment, components and accessories. Five big sections. Over 1,000 illustrations. \$1.00



2753. LOW-COST HI-FI, Hoefler

Hundreds of hints for budget hi-fi will be found in these fourteen chapters with over 300 detailed photographs, drawings and diagrams. \$2.50

49. TAPE RECORDING GUIDE, Marshall

Designed to help you get the most out of your tape recorder, whether for business, pleasure or professional use. A handy guide to have around, no matter what type of equipment you own or plan to purchase. \$1.95



2752. HIGH QUALITY SOUND REPRODUCTION, Moir

A perfect manual for both the professional engineer and the serious amateur in high fidelity. Complete coverage of sound reproduction in 591 pages. \$15.00

Save time and labor in radio and TV maintenance by referring to professional handbooks!

RADIO AND TV SERVICING



2415. MANDL'S TELEVISION SERVICING, Mandl

This standard text book in the T.V. servicing field provides clear descriptions of the fundamentals of T.V., and practical instruction on the diagnosis and correction of typical troubles. \$6.95

2429. TELEVISION RECEIVER SERVICING, Kiver

New (fourth) edition is a carefully written complete handbook for the television serviceman. New chapter discusses color T.V.—operation and servicing. \$5.95



2442. BASIC ELECTRONIC TEST INSTRUMENTS, Turner

Over 60 instruments described, their uses fully explained, and valuable work-saving short-cuts outlined. \$4.95

2416. LABORATORY MANUAL FOR BASIC TELEVISION AND TELEVISION RECEIVER SERVICING,
Zbar and Schildkraut

55 experiments covering fundamental skills in T.V. receivers and T.V. receiver servicing. \$4.50

2422. HANDBOOK OF TV REPAIR, Hertzberg

A basic guide to do-it-yourself T.V. repairs for the amateur. \$2.50

2400. PROFITABLE RADIO TROUBLESHOOTING, Marcus and Levy

Explains in easy-to-understand manner the use of simple and advanced test instruments, opening a radio servicing business, pitfalls, and successful procedures for a full-grown business. \$5.95

2408. ESSENTIALS OF ELECTRICITY FOR RADIO AND TELEVISION,
Slurzberg and Osterheld

Provides necessary background of principles for understanding T.V., FM and radio circuits. \$8.00



2425. ELEMENTS OF TELEVISION SERVICING FOR BENCH AND FIELD, Marcus and Gendler

Up to date discussion of installation, servicing and repair of T.V. receivers, designed for the practicing serviceman. \$8.15

2407. HOW TO GET AHEAD IN THE TELEVISION AND RADIO SERVICING BUSINESS, Marcus

Shows the easy way to get started as a TV-Radio repairman, how to earn while you learn, how to get and keep customers. \$3.50



2404. FM RADIO SERVICING HANDBOOK, King

A practical guide to FM V.H.F. receivers, their design, construction, alignment and repair. \$5.00

ELECTRICITY AND APPLIANCES

Brush up on electrical theory, repair any electrical appliance by using these simple manuals!



2651. MAJOR APPLIANCE SERVICING, Brockwell

Gives essential, over-all information for a career in major-appliance servicing, explaining methods of repairing appliances, organizing and managing a service business. \$5.95

2653. PRACTICAL ELECTRICITY, Croft

What electricity is, how it is generated and how it is used. Simply written with many graphic examples. \$8.50

2667. ELECTRIC MOTOR REPAIR, Rosenberg

All details of modern motor repair work. Actual demonstrations of what to do and why. Designed for bench use with a duo-spiral binding that lies flat. \$6.95

2660. BEGINNING ELECTRICITY, Eaton

Principles, construction and operation of basic electrical devices and appliances. A thorough foundation of electricity. \$6.00

2652. HOW TO REPAIR HOME APPLIANCES, Campbell

For the do-it-yourselfer, a handy, easy-to-read reference book. \$2.50

Be eligible for the higher paying jobs by mastering math needed in electronics — quickly and easily.

MATHEMATICS

2802. MATHEMATICS FOR ELECTRICIANS, Kuehn

A review of the fundamental processes of arithmetic, logarithms, and alternating current work. Includes chapter on the concept of work and horsepower. Material is arranged to provide a logical teaching sequence. \$6.75



2807. THE GENTLE ART OF MATHEMATICS, Pedoe

A fresh slant on things mathematical, a stimulating glimpse into the fascinating world of numbers. You will read and enjoy this diverting as well as instructive book. \$3.95

2803. BASIC MATHEMATICS FOR ELECTRICITY, RADIO AND TELEVISION, Singer

Here, mathematical principles are presented as dynamic tools for solving electrical problems. A practical course for students as well as an excellent refresher course for skilled technicians. \$8.25

TRANSISTORS AND TUBES

Keep abreast of the latest designs and concepts in both transistors and tubes by using the charts, diagrams, and photographs in these practical books!



2600. TRANSISTORS, Gillie

Describes and analyzes semi-conductors and transistors and how they behave. 300 pages, illustrated. \$7.95

2604. BASIC ELECTRON TUBES, Geppert

A text for a first course in electronics. It covers the tubes themselves, not the circuit applications. Basic principles governing operation of specialized tubes are explained. \$7.50

2605. FUNDAMENTALS OF VACUUM TUBES, Eastman

A text midway between the purely descriptive and the purely mathematical. Discusses the principal types of vacuum tubes. \$10.50

2602. TRANSISTOR AUDIO AMPLIFIERS, Shea

Fundamental considerations, transistor parameters, basic amplifier design, coupled stages, preamps, Class A and Class B power amplifiers, examples of practical design and much more. \$7.00

2607. TRANSISTORS, Coblenz & Owens

Treats theory, practical applications and manufacture of transistors in a way useful to technicians, engineers and advanced workers. Silicon and germanium transistors—how they are made, used, how they work. \$6.50

2606. ELECTRON-TUBE CIRCUITS, Seely

A clear analytical method in the study of electron-tube circuits. Provides a broad background in preparing for work in radio and electronic engineering. \$10.50

2603. VACUUM-TUBE AND SEMICONDUCTOR ELECTRONICS, Millman

The first book to integrate vacuum tubes and transistors. Teaches electronic circuit theory to provide an intimate understanding of the vacuum-tube and semiconductor device as a circuit element. \$10.00

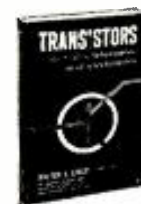

2601. TRANSISTORS IN RADIO, TELEVISION AND ELECTRONICS, Kiver

A descriptive, non-mathematical text for radio, television, electronics technicians and for those who need to gain a working knowledge of transistors and transistor circuits. \$7.95

Construction and Experimentation

Wonderful "how-to" books to help you build and enjoy practical electronic devices simply and easily.



2006. ELECTRONIC EXPERIMENTER'S MANUAL, Findlay

With a few dollars worth of basic tools and this book to guide you, you can explore electronics experimentation more completely than ever before. 10 big sections. \$4.95

2002/60. ELECTRONIC KITS DIRECTORY, Ziff-Davis Publishing Company

New 1960 edition lists over 750 kits, latest models, prices and features for hi-fi, ham radio, SWL, shop improvement, Citizen's Band, fun and education. \$1.00

2351. RADIO PROJECTS, Marcus

10 easy to construct radios described in this book cover the field thoroughly and completely, progressing in difficulty from the simple crystal detector to the super-heterodyne receiver. \$3.85

2001/60. ELECTRONIC EXPERIMENTER'S HANDBOOK, Ziff-Davis Publishing Company

40 projects for home and shop, 20 of which are transistorized. Special section on understanding transistor circuits. \$1.00; 2001C, cloth \$1.95

Communications and Broadcasting

Here are books which simplify basic and advanced theory — and open new horizons to you in the field of communications!

2901. HAM RADIO, Hertzberg

Tells exactly how to become a "ham" — how to obtain a ham "ticket", how to learn code, how to select receivers and transmitters — everything you need to know is between the covers of this handy guidebook. \$2.50

2900. BROADCASTING TELEVISION AND RADIO, Kingson, Cowgill, Levy

A simple, practical introduction to broadcasting, dealing with performance before the microphone and camera. \$8.65



2008. CLASS D CITIZENS RADIO, Sands

First complete book on Citizens Radio operation. Covers Class D history, rules, applications, how it works. Many illustrations. \$4.95

2907. RADIO OPERATING QUESTIONS AND ANSWERS, Hornung & McKenzie

Presents specific information on radio law, operating practices and theory for those studying to pass the FCC commercial radio operator exams of the various license grades. \$6.00

Special Topics

Choose any of these practical books—to take advantage of the growing opportunities in the exciting field of electronics!



2007. COMPUTERS AND HOW THEY WORK, Fahnestock

A fact-filled guidebook to electronic computers. Explains the workings of every major computer system. Must reading for all who want a more complete knowledge of this important field. \$4.95

2003/60. YOUR CAREER IN ELECTRONICS, Ziff-Davis Publishing Company

Tells where you fit in, how to program your future, test your electronics aptitude, advance in your job or career. \$1.00

2301. ELECTRONICS DICTIONARY, Cooke & Markus

An authoritative dictionary containing accurate, understandable definitions of nearly 6500 terms used in radio, television, industrial electronics, facsimile, sound recording, etc. \$6.50

2914. THE RADAR POCKET BOOK, Boulding

A clear and concise handbook of information on basic electrical principles and formulae applicable to radar, together with data on the various parts of a radar installation. \$3.85

*See Your
Parts Jobber
Or Use This
Coupon Today!*

Leading radio and electronics parts jobbers, hi-fi dealers and salons are making their stores headquarters for books on every electronics subject. You can take this list to your favorite dealer for immediate purchase.

If your local parts jobber or dealer does not carry books, use the coupon for prompt delivery from ELECTRONICS BOOK SERVICE, on a 7-day free trial basis.

ELECTRONICS BOOK SERVICE

434 South Wabash Avenue, Chicago 5, Illinois

Please send me the book(s) I have listed below for a FREE 7-day Trial Examination. I understand that if I am not completely satisfied, I may return my selection(s) and I'll owe you nothing. Otherwise, I will send you payment for the book(s) of my choice, plus postage and handling.

NUMBER	TITLE	PRICE
*TOTAL		

*New York City Residents, please add 3% sales tax.

(If you need more space to list additional titles, attach a sheet of paper with additional list.)

SAVE MONEY! Enclose payment in full for the book(s) of your choice and we will pay shipping charges. Same return privileges and prompt refund guaranteed. ZW760

Please send me FREE CATALOG, when published.

NAME _____ PLEASE PRINT CLEARLY

ADDRESS _____

CITY _____ ZONE _____ STATE _____

Getting Results from Business Letters

By J. E. KITCHIN

Some excellent advice for service dealers in writing inquiries to equipment manufacturers.

THE so-called "art of letter writing" is not going to be discussed here, but, rather, why a letter of inquiry to a manufacturer does not produce the desired results. Owners of small businesses often wonder why such letters are either not answered at all or result in a statement to the effect that the manufacturer would prefer to have his equipment serviced through "approved channels."

It is not uncommon to receive some electronic equipment for servicing in the shop only to discover that no data is available. The next step, if the equipment is complicated, is to write the manufacturer for technical information on the model concerned. No answer comes, so the technician makes out as best he can, mentally condemning the manufacturer for his lack of attention and also running the risk, perhaps, of not quite satisfying the customer on the repair job.

But let's examine the situation. Was the letter of inquiry written on a page torn from Junior's school exercise book? Or was it a picture postcard of the city hall? Neither of these would make a good impression. The first rule is: Get a letterhead printed and, if finances don't permit the printing of a bill form as well, have a small form printed with your name, address, and business at the top and use this for both letters and billing. If printing is entirely out of the question, at least use good white bond paper.

Second, how's your handwriting? Maybe Aunt Susie can read it (or is that the reason even *she* doesn't answer your letters?) but can you reasonably expect a business concern to take time out to decipher an illegible scrawl? Write clearly! If possible acquire a typewriter, even a second-hand one is better than nothing at all and the impression it creates in the mind of the reader will be well worth the cost.

Now, what about the facts? The only way a business man can judge whether or not it will pay him to expend time and literature on you is by what you put in the envelope, namely, the type of paper and what you put on it. Specify make and type number if available, year, serial numbers, size, and any other data which will assist in identifying the particular item.

Assuming this is all taken care of, what is the next step? Grammar and composition of all things! Sounds terrible, but really it is not too difficult because both grammar and composition

follow very simple rules which anyone can learn. Take a look in any library or book store and you will find many volumes dedicated to the art of better letter writing. Don't forget, too, that a good dictionary can be of help—if you are not absolutely sure of the spelling—look it up.

Are you too busy in the shop or have a natural aversion to "paper work"? Then why not farm out your correspondence to some stenographer who has a typewriter at home? Most secretarial schools offer courses in business letter writing so you could merely draft a note covering what you want to say and let your "secretary" phrase and write the actual letter. If you don't know such a "free-lance steno," contact your local business school. Such stenographers-in-training are usually glad to do the work a little more cheaply than a "pro" since it provides both experience and a little extra money for them.

Finally, how did you sign the letter? Was it so that your name could be deciphered or must the recipient hire a handwriting expert? It is always better to type your name below your signature or, if the letter is hand written, print your name and address in block letters. And, speaking of those which are written by hand, use pen and ink and not a blunt pencil. Be sure your complete and correct address appears on the letter *itself* since many large companies have departments to open the mail and the envelopes are discarded. If this happens to your letter with just a return address on the envelope, you will become another "File—Insufficient Address" request.

If the letter remains unanswered after a reasonable time, write again and enclose a copy in case your first letter was lost or mislaid. This saves the manufacturer time and trouble in searching for the first letter or, perhaps to your disadvantage, not looking for it at all.

A little attention to these seemingly unimportant details should produce the desired results and will, most certainly, show that you are *in business*. —30—

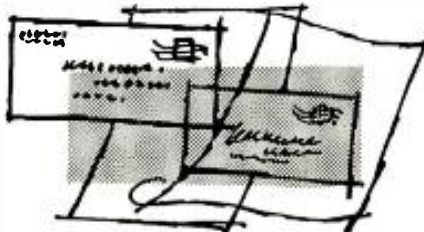

Television
RADIO-ELECTRONICS
Electricity
ELECTRONICS
IN NEW SHOP-LABS OF
COYNE

TRAIN QUICKLY! OLDEST, BEST EQUIPPED SCHOOL of ITS KIND in U.S.

Get practical training in New Shop-Labs of Coyne. Prepare for a better job and a successful future in a top opportunity field. Advanced education or previous experience not needed. Employment service to graduates.

Enroll NOW—Pay Later

Finance Plan and Easy Payment Plan. Also Part Time Employment help for students.

FREE BOOK Clip coupon or write to address below for Free Illustrated Book, "Guide to Careers"—Describes all training offered. No obligation and No Salesman Will Call. Act NOW.

B. W. Cooke, Jr., President

CHARTERED
NOT FOR PROFIT
Established 1899
1501 W. Congress Pkwy.
Chicago, Dept. 80-6C

COYNE
ELECTRICAL SCHOOL

COYNE Electrical School
1501 W. Congress Pkwy., Chicago 7, Ill.
Dept. 80-6C

Send FREE book "Guide to Careers" and details of all training you offer. However, I am especially interested in:

ELECTRICITY TELEVISION BOTH FIELDS

NAME

ADDRESS

CITY STATE

**NEVER FAIL—
ZONE YOUR MAIL**

The Post Office has divided 106 cities into postal delivery zones to speed mail delivery. Be sure to include zone number when writing to these cities; be sure to include your zone number in your return address—after the city, before the state.

TV PICTURE TUBES
At Lowest Prices

10BP4 \$ 7.95	17BP4 \$ 9.95	21AMP4\$15.75
12LP4 8.50	17CP4 17.00	21ATP4 15.75
14B/CP4 9.95	17GP4 17.60	21AUP4 15.75
16DP4 12.00	17HP4 12.50	21EP4 13.50
16EP4 12.75	17LP4 11.50	21FP4 14.50
16GP4 14.50	17QP4 9.95	21WP4 14.00
16KP4 9.95	17TP4 17.00	21YP4 14.50
16LP4 10.95	19AP4 16.00	21ZP4 13.50
16RP4 9.95	20CP4 13.50	24CP4 23.50
16WP4 12.00	20HP4 14.50	24DP4 24.50
16PT4 9.95	21AP4 22.10	27P4 39.95
17AVP4 12.50	21ALP4 15.75	27RP4 39.95

1 Year Warranty
Aluminized tubes \$3.00 for 21"; \$5.00 for 24" and 27" additional. Prices include the return of an acceptable similar tube under vacuum. These tubes are manufactured from reproducible used glass bulbs. All parts and materials including the electron gun are brand new.

ALL PRICES FOR CHICAGO, ILLINOIS. Deposit required, when old tube is not returned, refundable at time of return. 25% deposit required on COD shipments. Old tubes must be returned prepaid. Tubes shipped Rail Express. Shipped only to Continental U. S. and Canada.

WRITE FOR COMPLETE LIST.

PICTURE TUBE OUTLET
2922 NORTH MILWAUKEE AVENUE
CHICAGO 18, ILLINOIS
Dickens 2-2048

What's



New in Radio

SENCORE SERVICE AIDS

Service Instruments Co., 171 Official Rd., Addison, Ill., producer of "Sen-core" products, has announced a "Substitution Service Lab" to facilitate troubleshooting.

The package contains a model H-36 for substitution of capacitors and resistors, the ES102 for electrolytic capacitor substitution, and the RS106 which substitutes for selenium and silicon rectifiers. The three units come in a display-carrying case. The company points out that the RS106, like other models in the firm's line, is also available separately in its own case.

CB TRANSCEIVER KIT

Heath Company, Benton Harbor, Mich. has announced its Model GW-10 2-way Citizens Band transceiver in kit form. The superheterodyne receiver section may be either crystal-controlled on any predetermined channel or con-



tinuously tuned by a variable tuner through 23 channels. The transmitter is crystal-controlled on any one of the 23 assigned frequencies chosen. A press-to-talk microphone has coil-cord connection to the instrument.

The GW-10 is available in a.c. or d.c. models. All necessary hardware for "underdash" mounting for mobile operation is supplied, as well as FCC license application forms and information. For more details, write to the manufacturer.

ANTENNA KITS

Columbia Wire and Supply Company, 2850 W. Irving Park Road, Chicago 18, Ill. has announced two new Citizens Band antenna kits. One is an extended co-linear array with an over-all length of 44 feet and a claimed gain of 3 db. The other, a standard half-wave dipole, assembles to an over-all length of about 17 feet. For further information, write to the manufacturer.

4-WAY POCKET TOOL

Xcelite, Inc., Orchard Park, N. Y. has introduced a new 4-way pocket tool. Designated as Model 600, the new tool is readily adaptable for use as a 1/4-inch nut driver, a 3/16-inch slotted screwdriver, a No. 1 Phillips screwdriver, and a 3/16-inch nut driver.

According to the manufacturer, the tool is especially useful for removing the back of a TV set, or installing an antenna. A spring inside the tool's handle holds the blades in place. The handle is fitted with a pocket clip.

FREQUENCY STANDARD

Haddam Manufacturing Co., Inc., Rt. 9, Haddam, Conn. has recently introduced a portable secondary frequency standard. Known as the Bailey "Zero-beat," the instrument is claimed to be highly stable and particularly useful in the "netting in" of mobile FM communication systems, where all of the mobile and base stations must be maintained to the exact frequency assigned by the FCC.

Simplified design makes it possible to check and correct the frequency of both receiver and transmitter of a given station in a matter of seconds. In addition to these FM applications, the "Zero-beat" will function in the manner of any secondary frequency standard and may be used as such. Additional information may be obtained from the manufacturer.

CBS INSTRUMENT TUBES

CBS Electronics, Division of Columbia Broadcasting System, Inc., Danvers, Mass. has introduced a line of electron tubes produced specifically for instrument manufacturers.

Said to be the first of its kind, the line features new versions of tube types 7728, 7729, 7730, 7731, 7732 and 7733. The first five types replace the 12AT7, 12AX7, 12AU7, 6USA, and 6CB6 respectively. The 7733 is the instrument counterpart of a 6-volt version of type 12BY7A. The tubes feature coil heaters throughout, 48-hour stabilization of electrical characteristics, 100-hour



early life assurance test, special 1000-hour life test, and 5000-hour informational life test.

According to the company, undesirable characteristics such as microphonics, hiss noise, and leakage currents are minimized in the new tubes. Satisfactory operation at low and high line

voltages is assured by controlled cathode activity. Complete technical data can be obtained by writing to CBS Electronics Information Services and asking for Bulletin E-3777.

PORTABLE TUBE TESTER

Lafayette Radio, 165-08 Liberty Ave., Jamaica 33, N. Y. has announced a new portable tube tester designed for field use by the serviceman, experimenter, and technician.

Designated as Model TE-15, the instrument measures 8 1/8" x 9 3/4" x 2 3/8"



and weighs only six pounds, yet is equipped to test most of the tube types commonly employed. Sockets are provided for 7-pin miniature, 9-pin miniature, octal base, loctal base, noval, and subminiature types. An alligator clip lead is furnished for testing tubes with top caps.

The meter is calibrated from 0-100 and has a red-green "replace-good" scale, plus a special scale for checking diodes. Tube charts with test settings are inserted in a slide-out metal tray. For more information, contact company direct.

PHOTOCONDUCTIVE CELLS

Clairnex Corp., 19 West 26 St., New York, N. Y. has made available its new "500 line" of one-half-inch diameter power cells of the photoconductive type. These units are said to combine relatively high dissipation ratings with a small, hermetically sealed package. A specially designed bracket, which serves as a mounting device for any position, is supplied with each cell.

Two standard types are available. Type 504 is a cadmium selenide unit; Type 505, cadmium sulphide. Average continuous power rating for the cells is stated to be .5 and .25 watt with the bracket mounted on a heat sink and without, respectively.

Illustrated bulletins and engineering data on these cells may be obtained by writing the firm.

MICROMINIATURE AMPLIFIER

Viennatone Co., Vienna, Austria announces a new microminiature, three-transistor, RC-coupled, printed-circuit amplifier module. The tiny amplifier (38 of them will fit into one cubic inch) is designed primarily for use in hearing aids. It has a gain of 76 db with a flat response within 3 db from 200 cps

to 10 kc., and a power output of .6 milliwatt into a 600-ohm inductive load at over-all distortion of 10% maximum.

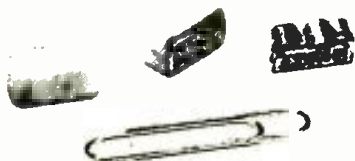

The amplifier operates on a single 1.3 v. mercury cell. According to its U. S. sales representative, *Caine Electronic Sales Co.*, 4120 W. Lawrence Ave., Chicago 30, Ill., the new module, type N-E1, has applications in pocket-size electronic devices such as meters, mike preamps, recorders, dictating machines, stethoscopes, and wrist radios. For additional information, contact the U. S. representative.

GENERAL PURPOSE SCOPE

Precision Apparatus Co., Inc., 70-31 84th St., Glendale, Long Island, N. Y. has announced its new model ES-525 oscilloscope, a general purpose instrument for industrial testing; laboratory applications; radio, TV, and hi-fi servicing; and communications and electronics education.

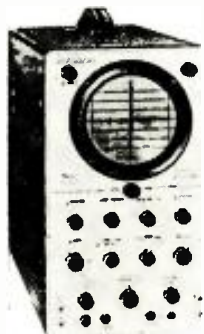

The unit, which measures 8 1/4" x 14 1/2" x 18 1/2", is said to provide excellent square-wave response from 20 cps to 50 kc. It uses nine tubes, including a type 5CP1/A cathode-ray tube. A direct reading built-in peak-to-peak voltage calibrator facilitates the use of the scope as a high-impedance v.t.v.m. Audible monitoring is possible with the use of tip jacks provided.

CIRCULAR SLIDE RULE

General Industrial Co., 1788J Montrose Ave., Chicago 13, Ill. is offering a circular slide rule suitable for simple calculations. Instructions for use are included.

The slide rule will be sent by the manufacturer without charge to engineers and business executives who request it on their letterheads. For all others there is a charge of 50 cents.

PRINTED CIRCUIT BOARDS

Dynex, Inc., 324 Langton Ave., Los Altos, Calif. has announced a new line of printed circuit boards.

Termed "Circuit," the new line comprises ten basic boards that cover all circuit functions for analogue and digital circuitry and is intended for use in the construction of prototype or bread-board models. Additional information and complete specifications may be obtained from the manufacturer.

Full Color Giant Fold-Out Charts Still Available!

Here's a complete series of colorful, authoritative fold-out wall-charts (originally appearing in the pages of *ELECTRONICS WORLD*)—yours for only 15¢ each. All in full-color—each suitable for framing.

- V.H.F. TV Spectrum and Interference Chart:** Servicing aid for TV technicians and hams—saves hours by tracking down interference.
- Hi-Fi Crossover Network Design Charts:** Tells how to build speaker nets for any crossover frequency. Complete coil-winding data, capacitor values given.
- Color Codes Chart:** Gives you coding for capacitors, resistors, transformers, resistance control tapers—all in easy-to-use form.
- Bass-Reflex Design Charts:** Complete data on building own bass-reflex enclosures for any speaker, including ducted-port enclosures.
- Radio Amateur Great Circle Chart:** For Hams and short-wave listeners—gives complete listing and map of amateur prefixes by calls and countries.
- Sound:** Fundamental data on all phases of Sound: frequency ranges, sound levels, equal loudness curves. A must for all audiophiles.

ALSO AVAILABLE:

Reprints of:

- "Build a Citizens Band Transceiver"**—complete details on building an 11-meter transceiver for Citizens Band service.
- "Electrical Shock: Fact and Fiction"**—must reading for everyone whose work or hobby involves electricity. Ideal for utility companies . . . service associations.

IMPORTANT: ORDER BY NUMBER! OUR SUPPLY OF ALL GATEFOLDS AND REPRINTS IS LIMITED. OFFERED ONLY ON A FIRST COME, FIRST SERVED BASIS.

Send 15¢ per selection to

ELECTRONICS WORLD, Dept. N 760

Box 378, Church Street Station

New York 8, New York

JULY SPECIALS

RG8A/U Coaxial Cable. Fresh stock. Latest non-contaminating type of 10GS/U—84¢ per ft.
 UG88/U Connectors modern type BNC connector. (Reg. price \$1.09) .60¢
 Hubbell Polarized Plugs. Rated 20 A. @ 250 V. Order Hubbell "Twist-Lock" .45¢ each Stock # B-207
 Ceramic crystal sockets for modern miniature CR type crystals. 15¢ stk. #15-205
 Silver Plated Buss Strips for UHF wiring and plate connections. 4 1/2" Length. Width: 3/8". In 4 1/2" Length Stock # B-212 @ 13¢ each. In 7 1/2" Length Stock # B-213 @ 25¢ each.
 TS497/U Military Equivalent of Model 80 Sig. Generator. 2 to 400 Mcs in 6 Bands. \$350.00.
 SP-600 Hammarlund Super-Pro. .54 to 54 Mcs. in 6 Bands. Lab certified O.K. Reg. \$1200.00 Special \$34.00.
 Just received new lot of transistorized power supplies. H. P. Digital VTVM's Model 405AR. Megacycle pulse generators. New. Write for details.
 Oil Capacitor Special. 2Mfd @ 2,000 VDC \$2.00 (Barrkett's .20¢ for a pair).
 Westinghouse Glass-Enclosed Overload Relay. Adjustable from 500 Ma. to 2 Amps. Coil: 115 VAC @ 60 CPS. Type SC-1. \$4.95 each.
 Mobile Transmitter. Uses 5618 crystal oscillator into C18 5516 amplifier. Modern design. Only 7 lbs. net wt., including built-in 6 V. vibrator Dvr supply. w/8 silicon rectifiers. Comp. enclosed in aluminum cabinet. Furnished w/crystal that doubles near 10 meter band. Requires slight & easy modification for 10 meter operation. Unuscd. w/tubes. \$13.95.
 Raised Relief Map 28 1/2" x 18 1/2" Beautiful colors in lifetime plastic. Specify USA or World Map @ \$9.95 each (ready for hanging—self frame).
 Ling Model 2050 TV Meter (Demonstrator) 420 to 450 Mc. Write for details.
 Aero 9 Reed Freq. Meter. Range: 58 to 62 Cy. 100-140 V. AC 3" Rd. \$11.00.
 Cramer 15 Second Adjustable Timer. Oper. on 7.5 VAC 60 CPS. Supplied w/suitable xfmr for 117 VAC use. SPDT contacts 10 Amps. Mounts in 3 1/4" Dia. h/c. \$8.95.
 Selen. Rectifier 137 V. RMS 300 Ma. .50¢ RG59/U Coax cable .04" ft. Minimum order \$5.00. .50¢ service charge for orders under \$5.00.
JUST OUT! NEW SUMMER 1960 GREEN SHEET CATALOG. WRITE FOR YOUR COPY TODAY!

BARRY ELECTRONICS CORPORATION

512 Broadway, N.Y.C. 12, N.Y., Dept. EW-7



Fill in coupon for a FREE One Year Subscription to OLSON RADIO'S Fantastic Bargain Packed Catalog—Unheard of LOW, LOW, WHOLESALe PRICES on Brand Name Speakers, Changers, Tubes, Tools, Hi-Fi's, Stereo Amps, Tuners and thousands of other Electronic Bargains.

NAME _____
 ADDRESS _____
 CITY _____ ZONE _____ STATE _____

If you have a friend interested in electronics send his name and address for a FREE subscription also.

OLSON RADIO CORPORATION

609 S. Forge St. Akron 8, Ohio

CRYSTAL CONTROLLED CONVERTERS

POLICE • FIRE • COMMERCIAL
• CITIZENS' BAND •



For use with
12 V. transistor type
car radios
26-50 MC
\$24.95

Complete with crystal and tubes. Requires no high voltage supply. Operates on 12 volts DC. Can be self installed in seconds. Other models for 108-162 MC available.

A practical converter for emergency use with powered home or auto sets. Tunable over 12 MC 26-54 MC or 108-174 MC
\$13.95

Also available crystal controlled up to 54 MC.....\$19.95



Full line of converters & receivers for every application.

ORDER TODAY or WRITE for LITERATURE

KUHN ELECTRONICS

20 GLENWOOD CINCINNATI 17, OHIO

ELECTRONICS WORLD HAS

A BUYER FOR YOUR USED EQUIPMENT OR COMPONENTS!

The 245,000 purchasers of ELECTRONICS WORLD are always in the market for good used equipment or components. So if you have something to sell, let EW readers know about it through our classified columns. It costs very little: just 60c a word, including name and address. Minimum message: 10 words.

For further information write:

Martin Lincoln
ELECTRONICS WORLD
One Park Avenue
New York 16, N. Y.

ELECTRONICS

**PREPARE FOR A GOOD JOB!
BROADCAST ENGINEER
RADIO SERVICING AUTOMATION**

TELEVISION SERVICING
BLACK & WHITE—COLOR

APPROVED FOR VETERANS AND SURVIVORS OF VETERANS
BUILDING AIR CONDITIONED
SEND FOR FREE LITERATURE
BALTIMORE TECHNICAL INSTITUTE
1425 EUTAW PLACE, BALTIMORE 17, MD.

TAPE RECORDERS



**HI-FI COMPONENTS
SLEEP LEARN KITS**

MERITAPE Low cost, high quality recording tape, in boxes or cans.
UNUSUAL VALUES FREE 1960 Catalog
DRESSNER, 69-02 RA 174 St., Flushing 65, N. Y.

A NOTE TO THE HI-FI BUYER

AIR MAIL us your requirements for an IMMEDIATE LOWEST PRICE QUOTATION
Components, Tapes and Recorders
SHIPPED PROMPTLY AT LOWEST PRICES

WRITE TODAY FOR FREE CATALOG

**AUDIO
UNLIMITED**

714-W Lexington Ave.
New York 22, N. Y.

Computer Memory Devices

(Continued from page 49)

The output of the comparator is used to activate the reading head of the track containing the desired word. After the last bit of this word has been read, a pulse from the timing track advances the word counter to 110 (decimal 6). Since the number in the word counter is no longer equal to the number in the address selector, the comparator ceases to produce an output and reading ceases.

It is obvious, from the arrangement of components shown in Fig. 9, that the word counter must be reset to 000 after each complete revolution of the drum. This can be accomplished by means of a single pulse recorded on a separate track of the drum. This pulse marks the starting or home position of the drum and is used to reset the word counter.

For simplicity, only three stages are shown in the word counter and the address selector in Fig. 9. In actual practice, a greater number of stages are required, as determined by the total number of words contained in each track.

One or more tracks of a drum may be set aside for quick-access use, as shown in Fig. 10. Each such track requires two heads, so that, as each bit is read, it is rewritten farther back on the drum surface. In this manner, the same word (or several selected words)

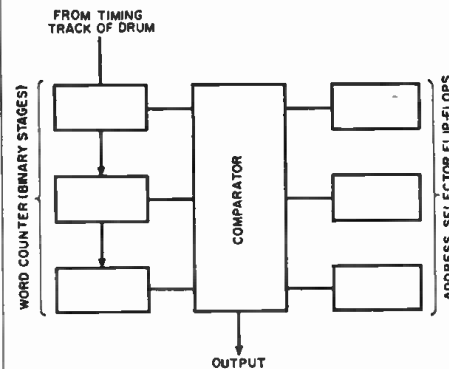
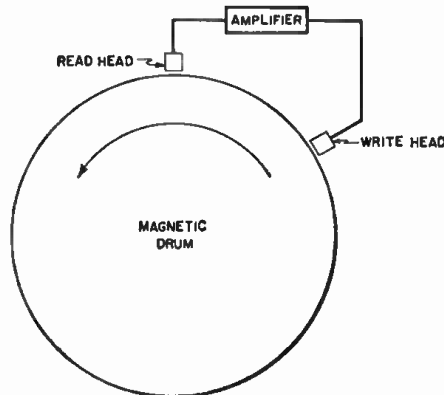

Fig. 9. To select specific stored data, comparator produces output only when right number is fed from timing track.

Fig. 10. A quick-access loop makes data available in less than one revolution by constantly repeating this data.



are continually read and rewritten. Since a given word appears many times around the circumference of the drum, the access time is much shorter than that for words written on the other tracks of the drum. The arrangement shown in Fig. 10 is known as a quick-access loop, a two-headed loop, a recirculating register, or a revolver.

The IBM RAMAC computer uses magnetic discs rather than a drum. These discs, each of which resembles an over-size phonograph record, are coated with a magnetic substance and information is recorded in circular tracks on each side of the disc. The discs are stacked vertically, with sufficient space between for the read/write head to move freely. When a given disc is selected for reading or writing, the head moves into position vertically to the desired disc, and then moves inward toward the center of the disc to the desired track.

Summary

Actually magnetic tape and the magnetic drum complement each other—one providing the greater storage capacity and the other offering shorter access time. Thus many computers use the two in combination, with the drum serving as the main memory and the tape providing back-up storage of information.

In this way, blocks of information can be transferred from the tape to the drum at some time prior to the need for this data in the computer. After the computer has used the data, other blocks of information are transferred to the drum.

In some applications, however, even shorter access time is required than can be provided by a drum. In these cases, there is still another type of device available. These units, magnetic cores, and their application will be covered in the concluding installment of this article.

(Concluded next month)

Design of Phono Preamps

(Continued from page 36)

In this case, the entire band must be used for the noise computation—furthermore, the effective value of the noise voltage must be doubled because of the 6 db needed to bring the output back to the 1-kc. reference level and the final signal-to-noise ratio is approximately 91 db for the 500-mv. signal. The equivalent noise resistance of the tube (Schottky noise) is very much less and may be disregarded.

For velocity response, the lowest crossover frequency, in practical terms, is 50,000 cps only because (a) for a 40,000 cps crossover, the input will be down 1 db at 20,000 cps and (b) the final signal-to-noise ratio is not unduly sensitive to moderate changes in this crossover point.

For 50,000 cps and 500 $\mu\text{f.}$, the leak will be 6400 ohms with a noise voltage of approximately 0.5 $\mu\text{v.}$ In this case,

Now available at electronics parts stores, hi-fi salons, and record shops!



Stereo-Monophonic
Test Record

Specially packaged
at only

\$1.59

(\$1.98 In Canada)

As a man who is seriously interested in hi-fi, you will certainly want to take advantage of this new and important test record, now on sale at electronics parts stores, hi-fi salons, and record shops. It will enable you to know your system inside-out. As a result, your listening enjoyment will be even greater than ever before.

This Stereo-Monophonic Test Record is the most complete test record of its kind—containing the widest range of essential check-points ever incorporated into one test disc! And, best of all, you need no expensive test equipment when you use this record! Just listen and get the thorough results you want—all checks can be made by ear!

This special test record brings you an extraordinary 2-way value. First, it guides you in evaluating the quality of reproduction your equipment now produces. Second, it specifies the adjustments necessary to get the best recorded sound you have ever heard! This is easily the best value of the year for everyone who owns a hi-fi system—either monophonic or stereo!

NOW ON SALE EXCLUSIVELY AT ELECTRONICS PARTS STORES, HI-FI SALONS AND RECORD SHOPS!

You can be sure this Stereo-Monophonic test record comes as close to perfection as is humanly possible, because the editors of *ELECTRONICS WORLD*—leading technical magazine in the field of electronics—have poured their accumulated know-how into this record. Purchase your record today! (If you find your dealer does not yet have a supply available, ask him to order them for you.)

SPECIAL NOTE TO DEALERS: for information on ordering your supply of records, contact Ziff-Davis Publishing Company, Direct Sales Division, One Park Avenue, New York 16, N. Y.

Here are some of the questions this record will answer for you!

- ✓ How good is my stylus? Is it worn? Will it damage my records?
- ✓ What about my stereo cartridge? Does it have enough vertical compliance so that it won't ruin my expensive stereo records?
- ✓ Is my turntable running at the right speed? Is it free of rumble, wow, and flutter?
- ✓ What sort of standing waves do I get in my listening room?
- ✓ Are my speakers hooked up correctly? Are they phased properly, and is the correct speaker connected to the right stereo channel?
- ✓ How perfectly is my system equalized?
- ✓ What about separation? Is it adequate?

INVITATION TO AUTHORS

Just as a reminder, the Editors of *ELECTRONICS WORLD* are always interested in obtaining outstanding manuscripts, for publication in this magazine, covering the fields of audio and high-fidelity and radio-TV-industrial servicing. Articles in manuscript form may be submitted for immediate decision and projected articles can be outlined in a letter in which case the writer will be advised promptly as to the suitability of the topic. We can also use short "filler" items outlining worthwhile shortcuts that have made your servicing chores easier. This magazine pays for articles on acceptance. Send all manuscripts or your letters of suggestion to the Editor, *ELECTRONICS WORLD*, One Park Avenue, New York City 16, New York.

PHOTO CREDITS

Page	Credit
6	U. S. Army Photo
30	Federal Aviation Agency
31 (left), 32 (center & right)	Lear, Incorporated
31 (right)	National Aeronautical Company
32 (left)	Collins Radio Company
44 (top)	Radio Corporation of America
44 (center)	Bell Telephone Laboratories
44 (lower left), 45 (bottom right)	Blaw-Knox
44 (lower right)	Bell Helicopter Corp.
45 (top) C	Chatham Electronics
45 (center)	Hughes Aircraft Corp.
45 (bottom left)	Electron-Lund A. B.
48	Amplex Corporation
49	Royal McBee
50, 51	General Electric Co.
55	Canadian National Railways
70	Motorola Inc.
76	Allied Radio Corporation
78	Levinzon-Aleksandrov
84	Television & Electronic Service Assn. of Miami
90	Communications Engineering Co.
104	Aero Signal Labs
106	North American Philips Co., Inc.
107	Crosby Electronics
108	Garrard Sales Corporation

Answer to Puzzle Appearing on page 93



the noise band is substantially that of the RIAA response characteristic and may be taken as 2500 cycles. At the reference frequency, the signal voltage at the resistor will be approximately 10 mv. with a corresponding signal-to-noise ratio of 86 db. Although the grid leak is much smaller than before, the Schottky noise is still relatively unimportant provided the tube is operated at a plate current giving normal transconductance.

Thus, the signal-to-noise ratio has deteriorated only 5 db in return for the advantage of being able to operate into the same amplifier equalization that must be used for the magnetic unit so that comparisons may be made between pickups without obscuring the issue because of the differences in overall frequency response. —30—

Electric Power (Continued from page 43)

trolling windings are used in some special-purpose variations. The number of poles, number of phases, and the coil design all can vary considerably among the types to produce a still greater variety.

For example, a simple, squirrel-cage motor can operate on two, three, or any number of phases, depending on the field windings. The torque, starting and running, as well as the efficiency, speed regulation characteristic, and other factors can be varied by the skewing of the copper bars in the rotor, by the depth and shape of the slots in which the copper bars are mounted and, naturally, by the field winding itself.

Further study of a particular motor is much simpler when one knows at least what type it is. A brief look at the diagram of Fig. 4 shows that the d.c. motors, including the "universal" series type, use brushes and a commutator. Of the a.c. motors, only the repulsion-start type has brushes, and they merely serve to short-circuit that part of the rotor which is located at a 90-degree angle to the field. The synchronous a.c. motor has a rotor winding, and this is connected to the outside by slip rings and brushes. Some synchronous motors have a multi-phase field winding and a permanent-magnet rotor, while still others use a d.c. field winding with an a.c. rotor. Most a.c. motors have squirrel-cage rotors, and therefore need no brushes, commuta-

Fig. 5. Two-phase induction motor with saturable reactor used to control speed.

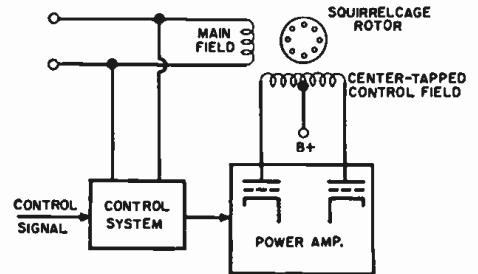
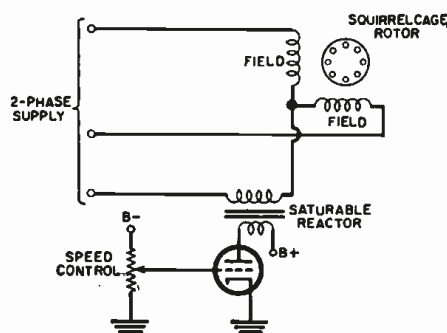

Fig. 6. Simplified servo motor system with power amplifier to regulate speed.

tors or slip rings, which are usually sources of motor troubles.

The connections of the control system can be understood better if we know how it controls the motor; for this reason, we have shown some typical, basic control circuits in Figs. 3, 5, and 6. The first of these is used in the speed control of relatively large d.c. motors, such as the kind used to drive the take-up reel in a paper processing plant. The motor (Fig. 3) is a d.c. shunt type and its speed is varied by adjusting the current through the rotor. Two push-pull thyatron rectifiers are controlled by the phase-shifted signals on their grids. If the motor were really large, ignitrons would take the place of the thyatron tubes.

Fig. 5 shows a typical a.c. induction-motor, speed-control system. Only two phases are shown, but the same saturable-reactor scheme is often used with as many as twelve phases. Here the speed is reduced by reducing the supply voltage, and this is done by varying the d.c. bias, which controls the impedance of the saturable reactor. As more plate current is drawn, more d.c. bias is generated in the reactor, and the inductance drops, allowing the motor to get more supply voltage.

In Fig. 6, a simple servo motor control is shown, without the feedback loop that is frequently used for remote positioning. This loop and its explanation are the subject for a separate article. Nevertheless, the motor-control circuit should be understood in connection with typical power amplifiers. Here one motor winding is connected to the power line while another winding, which controls the motor speed, receives its power from the push-pull output amplifier.

Conclusion

Electric power is converted into mechanical motion either by solenoids or by motors. Solenoids generate linear motion but, since this is not very efficient, they are not used for higher power applications. Rotary motion is generated by electric motors, of which a wide variety is used in automated systems. Different types of motors exhibit different torque and speed characteristics. Control circuits for these motors are generally limited to regulating the supply voltage or current and thereby the speed. Although three typical, basic motor-control schemes were shown here, a host of variations of these circuits actually will be encountered in the field. —30—

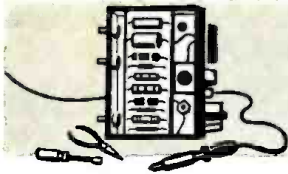

ELECTRONICS MARKET PLACE

RATE: 60¢ per word. Minimum 10 words. September issue closes July 11th. Send order and remittance to ELECTRONICS WORLD, One Park Ave., N. Y. C. 16, N. Y.

RADIO ENGINEERING & INSTRUCTION

ELECTRONICS! Associate degree—29 months. Technicians, field engineers, specialists in communications, missiles, computers, radar, automation. Start September, February. Valparaiso Technical Institute, Dept. N, Valparaiso, Indiana.

ENGINEERING and Art Degrees earned through home study. Electronics, Electrical, Mechanical, Civil, Physics, Business Administration, Accounting, Liberal Arts. When writing, specify course desired. Pacific International College of Arts & Sciences, primarily a correspondence school. Resident classes also carried. 5719-C Santa Monica Boulevard, Hollywood 38, California.

USED Correspondence Courses and Books sold and rented. Money back guarantee. Catalog Free. (Courses Bought). Lee Mountain, Pisgah, Alabama.

FOR SALE

ORGAN blocking osc transformers; \$1.25 ea. Audio chokes dual 300mh & 320 mh; \$1.25 ea., application schem. supplied. R. H. Shaw, 5527 13th St., N.W., Wash. 11, D. C.

SOMETHING for sale? Place a classified ad in this section. Low-cost, fast results. It's easy.

GOVERNMENT sells: Surplus Electronics; Test Equipment; Oscilloscopes; Transceivers; Jeeps; Boats; Aircrafts; Misc.—Send for U. S. Depot Directory & Procedure \$1.00—"Government Surplus Sales," Box 425—RT, Nanuet, N. Y.

AUTO Radio Distributor Selling Servicing Becker Blaupunkt, FM-AM, other European, American Sets. Save 30% + Square Electronics, 150-60 Northern Blvd., Flushing, N. Y.

GOVERNMENT Surplus Receivers, Transmitters, Snooperscopes, Parabolic Reflectors, Picture Catalog 10¢. Meshna, Malden 48, Mass.

TUBES—TV, Radio, Transmitting and Industrial Types at Sensibly Low Prices. New Guaranteed, 1st Quality, Top Name Brands Only. Write for Free Catalog or Call Walker 5-7000, Barry Electronics Corp., 512 Broadway, New York 12N, N. Y.

RADIO & TV Tubes at Manufacturer's prices! 100% Guaranteed! Brand New! No re-brands or pulls! United Radio, Box 1000W, Newark, N. J.

DIAGRAMS for repairing radios \$1.00. Television \$2.00. Give make, model. Diagram Service, Box 672-RN, Hartford 1, Conn.

RADIO and Television Tubes—Brand New, 1st Quality, Top Name Brands in original boxes, 60% off list, Free Bonus with orders, Prompt Deliveries; U T C—Box 306, Syosset, N. Y.

TUBES—TV and Radio tubes, Guaranteed—Save up to 80%—Write: Emkay Electronics, P. O. Box 142, Blythebourne Station, Brooklyn 19, N. Y.

TREMENDOUS savings! Sherwood, Dual AR, all others! Immediate reply to your correspondence. Sound Room, 1509 Bedford Avenue, Brooklyn, N. Y.

RADIO and television tubes, brand new, 1st quality, original boxed name brands only. Discounts up to 66 2/3% off list. Positively no seconds. Send for free price schedule. Edison Tube Co., Menlo Park, N. J.

WANTED

CASH for used Short-Wave Ham Receivers, Transmitters and Accessories. Tregor, W91VJ, 2023 N. Harlem Ave., Chicago 35C, Tuxedo 9-6429.

WANTED: Military and Commercial laboratory test instruments, communications and broadcast equipment, tubes, etc. Electronicraft, Mt. Kisco, N. Y.

WANT 2A5 Tubes, New Only. Advise Price and Quantity. Crossco, Box 9236, Houston, Tex.

CYLINDER and old disc phonographs. Edison Conqueror, Idelia, and Oratorio models. Berliner Gramophones and Zono-o-phones, Columbia cylinder Graphophones, and coin-operated cylinder phonos. Want old catalogues and literature on early phonos prior to 1919. Will pay cash or trade late hi-fi components. Classified, Box 50, Electronics World, 1 Park Ave., New York 16.

WANT to buy good equipment and accessories? Place a low-cost classified ad in this space.

WANTED: Cash Paid! Sell your surplus electronic tubes. Want unused, Clean radio and TV receiving, transmitting special purpose, Magnetrons, Klystrons, broadcast types. Want military and commercial lab/ test equipment such as G.R.H.P., AN/UPM prefix. Also want commercial Ham Receivers and Transmitters. For a Fair Deal write: Barry Electronics Corp., 512 Broadway, New York 12, N. Y. (Walker 5-7000.)

WANTED: Surplus Measurement model 78 or 80 signal generators. Also Federal 804 or used Motorola two-way equipment. State quantity, price, and condition. Communications Service, Inc., 3209 Canton Street, Dallas, Texas.

HIGH-FIDELITY



INDUCTORS for Crossover Networks. 118 types in stock. Send for brochure. C & M Coils, 3016 Holmes Ave., N.W., Huntsville, Ala.

RECORDERS, Components. Free Wholesale Catalogue. Carston, 125-R East 88, N.Y.C. 28.

PRICES? The Best! Factory-sealed Hi-Fi Components? Yes! Send for free catalog. Audion, 25T Oxford Road, Massapequa, N. Y.

DISGUSTED with "Hi" Hi-Fi Prices? Unusual Discounts On Your High Fidelity Requirements. Write. Key Electronics, 120 Liberty St., New York 6, N. Y. Cloverdale 8-4288.

LID supports, counterbalanced, for Hi-Fi cabinets. C B Distributors, Box 72, Stoughton, Wisconsin.

TAPE & RECORDERS

LOW Quotes on everything HiFi & Stereo Tapes. Bargain Lists. HiFi, Dept. E2, Roslyn, Pa.

RENT Stereo Tapes—over 1,500 different—all major labels—free catalog. Stereo-Parti, 811-L, Centinela Ave., Inglewood 3, California.

OVER 245,000 buyers and sellers will read your ad when placed in this space. It costs only 60¢ per word; minimum of 10 words including your name and address.

AMPEX, Concertone, Magnecord, Prestok, Bogen, Tandberg, Pentron, Sherwood, Rek-O-Kut Scott, Shure, Dynakit, others, Trades. Boynton Studio, Dept. RT, 10 Pennsylvania Ave., Tuckahoe, N. Y.

TAPE Recorders, HI-Fi Components. Sleep Learning Kits, Tapes. Unusual Values. Free Catalog. Dressner, 69-02R 174 St., Flushing 65, N. Y.

SHOPPING GUIDE Classified

A HANDY GUIDE TO PRODUCTS, NOT NECESSARILY ELECTRONIC, BUT OF WIDE GENERAL INTEREST.

HELP WANTED

JOBS on Ships \$100. weekly. Beginners write Flagship, Box 111W, Brooklyn 17, N. Y.

HIGH Pay Overseas, Domestic Jobs. Men, Women. Generous Benefits. Companies Pay Transportation. For info, write: World Wide, Dept. E, 149 N. Franklin St., Hempstead, N. Y.

OVERSEAS Employment. American Firms and United States Government. Comprehensive job information \$2.00. Foreign Opportunities, Box 172, Columbus 16, Ohio.

EARN Extra money selling advertising book matches. Free Samples furnished. Matchcorp, Dept. MD-70, Chicago 32, Ill.

BUSINESS OPPORTUNITIES

RADIO Parts Stores & Hi-Fi Salons! Someone "borrowing" your personal copy of Electronics World each month? You ought to be taking advantage of Electronics World convenient re-sale plan. Sell copies in your store . . . perform a good service for your customers . . . with no risk involved. For details, write: Direct Sales Department, Electronics World, One Park Avenue, New York 16, New York.

MAKE \$25-\$50 Week, clipping newspaper items for publishers. Some clippings worth \$5.00 each. Particulars free. National, 81-DG, Knickerbocker Station, New York.

PHOTOGRAPHY—FILM, EQUIPMENT, SERVICES

WHATEVER your needs, Electronics World classified can solve them. Simply place an ad in these columns and watch your results pour in.

OPTICAL—Science—Math Bargains—Request Free Giant Catalog "CJ"—128 pages—Astronomical Telescopes, Microscopes, Lenses, Binoculars, Kits, Parts. Amazing war surplus bargains. Edmund Scientific Co., Barrington, New Jersey.

PHOTOSTATS By Mail. Save by ordering direct. Fast, Reliable. We serve anyone, anywhere. Complete Information. Modern Photostats, 5407 Cullom Avenue, Chicago 41, Illinois.

MUSIC

POEMS Wanted for musical setting and recording. Send poems. Free examination. Crown Music, 49-TM West 32, New York 1.

MISCELLANEOUS

"WINEMAKING," "Beer, Ale Brewing," "Cider," Methods, Illustrated, \$3.00. Eaton Books, Box 1242-X, Santa Rosa, California.

KEY Chains, personalized ashtrays, smoke sets. Useful novelties for home, office and gifts. Inexpensive items. Send 10¢ for illustrated brochure. House of Brand, Dept. EW-3, 3458 Fish Avenue, New York 69, N. Y.

BUSINESS Cards \$3.75 Thousand. Postpaid. Free Samples. Imagination, Box 761, Hollywood 28, Calif.

HIGHLY Effective Home-Study Review for FCC Commercial Phone Exams. Free Literature. Wallace Cook, EW7, Box 10634, Jackson 9, Miss.

GOLF Clubs Wholesale Free Price List. Crystal Golf Sales. Crystal, Mich.

OVER
60 PAGES
OF
COLOR
PHOTOGRAPHS
YOURS IN—

COLOR
PHOTOGRAPHY

1960



NOW ON SALE

AT NEWSSTANDS AND CAMERA STORES
OR ORDER BY COUPON TODAY.

The world's only publication devoted exclusively to color photography! It features the most exciting and comprehensive treasury of color shots ever published — compiled by the editors of POPULAR PHOTOGRAPHY.

YOU'LL ENJOY FEATURES LIKE:

- BERT STERN'S LITTLE GIRLS
- HALSMAN'S WOMEN
- HAUNTED VIEW OF NEW YORK
- SAUL LEITER'S DREAM WORLD
- THE NUDE—IN COLOR OR NOT?
- THE NATURE OF COLOR PHOTOGRAPHY

Be Sure To Get Your Copy Of This
Handsome Annual Today!

Only \$1.25

Ziff-Davis Publishing Company
Department EW-760
434 S. Wabash Avenue
Chicago 5, Illinois

Please send me a copy of COLOR PHOTOGRAPHY 1960. I enclose \$1.25, the cost of COLOR PHOTOGRAPHY, plus 10¢ to cover mailing and handling charges.

NAME _____

ADDRESS _____

CITY _____ ZONE _____ STATE _____

INDEX
OF

Advertisers

JULY
1960

ADVERTISER	PAGE NO.	ADVERTISER	PAGE NO.
Airex Radio Corporation	98	Key Electronics Co.	103
Aiwa Co., Ltd.	9	Kuhn Electronics	118
Allied Radio Corp.	7	Lafayette Radio	71
Amperex Electronic Corp.	99	Lampkin Laboratories, Inc.	88
Ashe Radio Co., Walter	105	Lektron	90
Audio Unlimited	118	Milwaukee School of Engineering	100
Audion	94	Moss Electronic, Inc.	80, 81
B & K Manufacturing Co.	65	National Radio Institute	1
Baltimore Technical Institute	118	National Schools	25
Barry Electronics Corporation	117	Ohmatsu Electric Co. Ltd.	99
Bell Telephone Laboratories	12	Olson Radio Corporation	117
Blonder-Tongue Laboratories, Inc.	21	Paco Electronics Co., Inc.	103
Burroughs Corporation	94	Peak Electronics Company	86
C & H Sales Co.	88	Picture Tube Outlet	115
Canadian Institute of Science & Technology Limited	102	Precision Electronics, Inc.	88
Candee Co., J. J.	105	RCA Institutes, Inc.	10, 11
Capitol Radio Engineering Institute, The	16, 17, 18, 19	R W Electronics	105
Carston Studios	103	Rad-Tel Tube Co.	97
Center Electronics Co., Inc.	96	Radio Corporation of America	4th Cover
Champion DeArment Tool Company	8	Radio Shack Corp.	110
Channel Master	72, 83	Rinehart & Co., Inc.	22
Chicakasha Electronics, Inc.	110	Sams & Co., Inc., Howard W.	84, 85
Cleveland Institute of Electronics	23	Sarkes Tarzian, Inc.	24
Columbia Electronics	92	Shure Brothers, Inc.	75
Coyne Electrical School	115	Sprague	14
DeVry Technical Institute	3	Sprayberry Academy of Radio-Television	15
Dressner	118	Standard Surplus	96
Dynaco, Inc.	77	Sylvania Electric Products Inc.	26, 2nd Cover
EICO	27, 28, 93	Teltron Electric Co.	109
Electronic Chemical Corp.	70	Terado Company	70
Electronics Book Service	108, 111, 112, 113, 114	Texas Crystals	104
Fair Radio Sales	82	Tri-State College	103
G & G Radio Supply Co.	89	Triplett Electrical Instrument Company	3rd Cover
Goodheart Co., R. E.	76	Tru-Vac Electric Company	101
Grantham School of Electronics	13	Valparaiso Technical Institute	105
Heath Company	66, 67, 68, 69	Westinghouse Electric Corp.	4, 5
Henshaw Radio Supply	94	Xcelite, Inc.	6
Indiana Technical College	94		
International Crystal Mfg. Co., Inc.	91		
Johnson Company, E. F.	87		

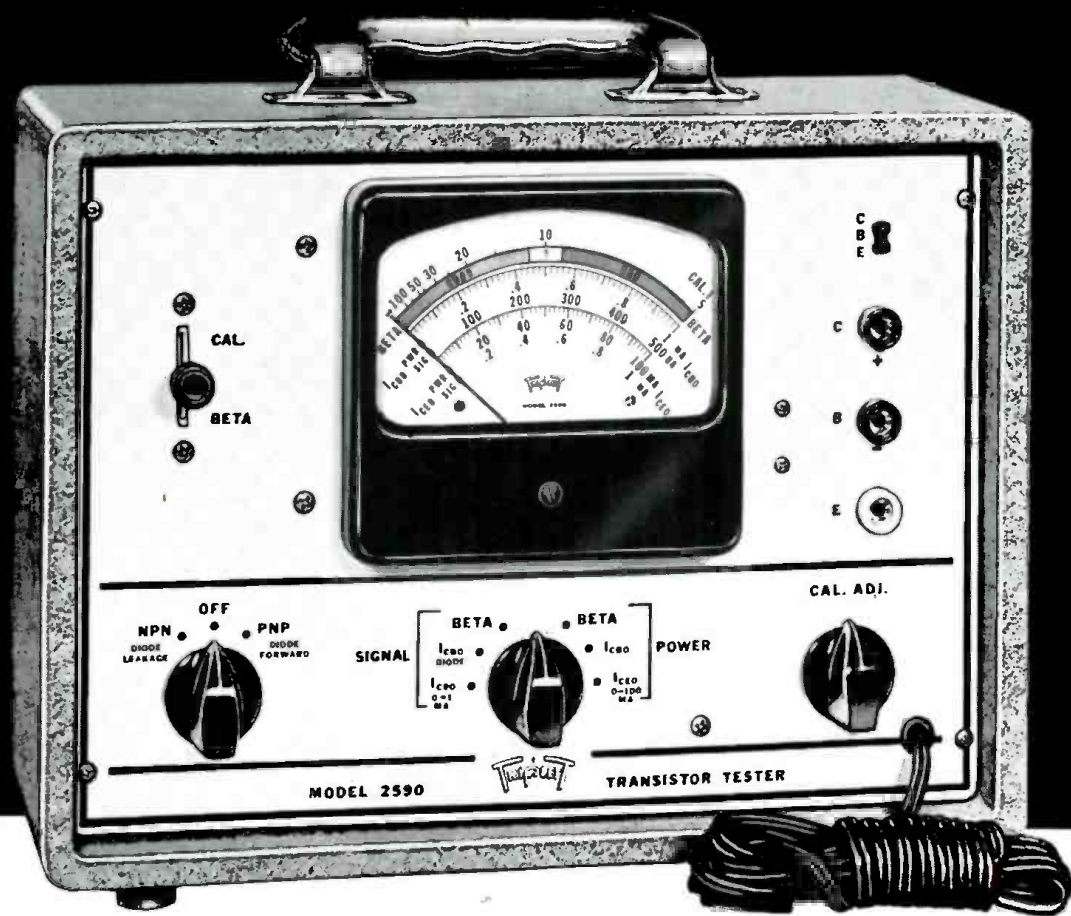

Now you can test transistors under simulated operating conditions . . .
With the NEW Triplet Model 2590 Transistor Tester
Simple to Operate—Versatile—Always Up-to-Date

Simple to Operate—The new Triplet Model 2590 Transistor Tester quickly, easily and accurately tests all power and signal transistors under simulated operating conditions. Only 3 switches and 1 control knob.

Versatile—Has provisions for testing I_{CEO} (at 9.5V), I_{CBO} (at 9.5V) and Beta Amplification (at 3V) on both NPN and PNP transistors. Also checks leakage and forward current of diodes.

Always Up-to-Date—No roll chart, specifications, or special data necessary. All you need know is the transistor type (NPN or PNP and Signal or Power type).

Transistor Socket and External Leads—Allows use with any type basing arrangement.

Accuracy—The Model 2590 is accurate to within $\pm 2\%$ of full scale reading on 0-100 D. C. Ua.

Selector Switch—Provides selection of NPN, OFF or PNP positions.

Function Switch—Provides selection of I_{CBO} Leakage, I_{CEO} Leakage and Beta Gain position for both power and signal transistors.

Beta Switch—Is in the calibrate position normally and is in the Beta test position when pulled down.

Calibrate Adjustment Control—Adjusts for full scale calibration after transistor has been inserted.

Power—115 volts, 50-60 cycle, A.C.

Scales—There are 5 scales on the meter: 0-1 ma. for signal transistor I_{CEO} ; 0-100 ma. for power transistor I_{CEO} ; 0-500 ua. for signal transistor I_{CBO} , also diode leakage and forward current; 0-1 ma. for power I_{CBO} ; 5-100 Beta range also shown as the "GOOD ? BAD" scale.

Case—Handsome gray leatherette case, $11\frac{1}{8}'' \times 8\frac{3}{8}'' \times 5\frac{1}{8}''$; has recessed panel.

MODEL 2590 TRANSISTOR TESTER.
 U.S.A. Dealer Net Price \$49.50

MODEL 690-A PORTABLE TRANSISTOR TESTER



Triplet Model 690-A Transistor Tester is a rugged, small, easily portable unit. Battery operated.

It provides Leakage and Gain tests for all low and medium power PNP and NPN type transistors. Also checks diodes for forward and leakage current.

A single switch is provided for simplicity in selecting transistor type settings. The OFF position prevents drain on the batteries in case of accidentally shorting the leads. Another operating feature is the use of separate "Calibrate" and "Gain" buttons to eliminate errors.

A transistor socket and a set of external leads are provided for use with any basing arrangement.

MODEL 690-A PORTABLE TRANSISTOR TESTER-U.S.A. Dealer Net Price. . . . \$29.50

All Triplet instruments are available nationally through authorized Triplet distributors. A list of the Triplet distributors in your area is available upon request. Write to:



TRIPLET ELECTRICAL INSTRUMENT COMPANY, BLUFFTON, OHIO

Manufacturers of Panel and Portable Instruments, Electrical and Electronic Test Equipment

www.americanradiohistory.com

How do your customers rate you?



Your reputation is based largely on what happens *after* you leave the scene of each service call. For this reason the name on the tubes you install makes a world of difference. RCA tubes are designed and manufactured to assure customer confidence in you as well as in RCA.

RCA tube quality is your best insurance against call-backs due to premature tube failure.

RCA tube performance puts your workmanship in the best light and protects it through rigid quality control.

RCA's trademark symbolizes a name and reputation customers have respected for decades.

Your customers know that those red-white-and-black RCA tube cartons in your tube caddy represent the most trusted name in electronics. Remember, customer confidence is the cornerstone of your business.

To protect your service reputation before, during and after every service call, make sure your next tube order specifies... **RCA TUBES.**

RCA ELECTRON TUBE DIVISION, HARRISON, N. J.



SIGN OF A SERVICE JOB WELL DONE



The Most Trusted Name in Electronics
RADIO CORPORATION OF AMERICA