

Audio Special: Build a Wow & Flutter Meter!

Electronics ILLUSTRATED

CONSISTENTLY THE BEST IN HOBBY ELECTRONICS

JULY 1972

By the Publishers of
MECHANIX ILLUSTRATED

50c

06125

Troubleshooting Color TV With a Scope
Low-Cost Temp-Humidity Meter You Can Build
Build a Cardio-Tach... It Reads Your Pulse!

Big Hi-Fi Contest! Win a Cash Prize!

Details on Page 45

Simple Speed Indicator for the Workshop
Sidestacked TV Antennas for a Super Signal!
The Wild World of 2 Meters

**Easy-to-Build
Override
Monitor
for
Citizens Band
Channel 9**

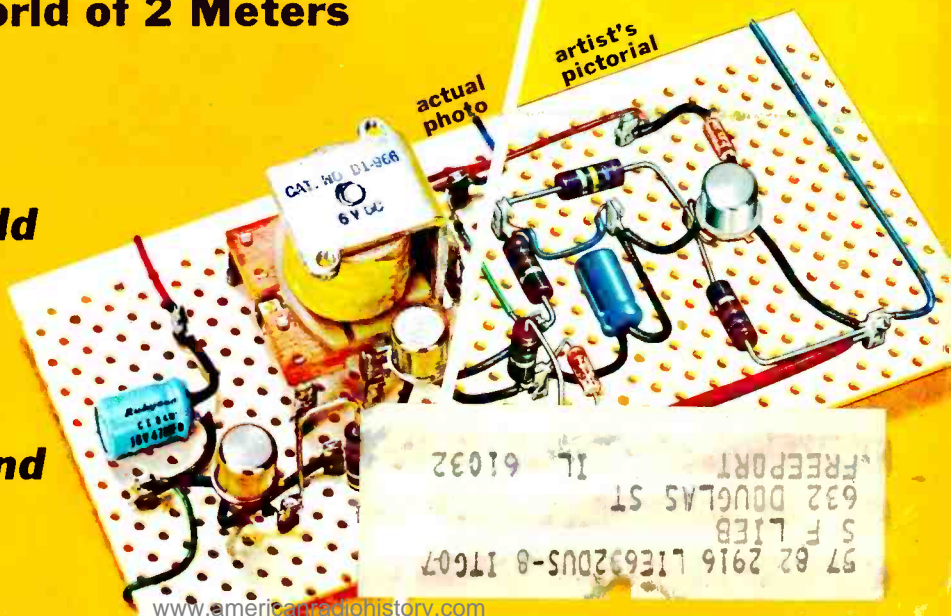

**Let ICS mail
you a FREE
demonstration
lesson without
obligation...
to prove that
you can learn
TV Servicing
at home.**

Credit towards a Certified Electronic Technician (C.E.T.) rating will be granted by the National Electronics Association to ICS students upon completion of the ICS Career Program in TV Service/Repair.



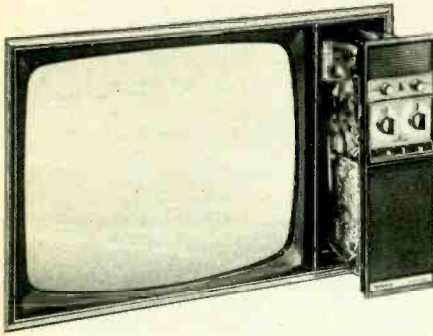

**Practice on a new 25"
MOTOROLA QUASAR II® chassis.**

TV Servicing is a satisfying career . . . and the pay is great. Qualified men are needed now to maintain the 93 million sets in U.S. homes. And prospects for the future are even brighter.

Now . . . here's an opportunity for you to prove to yourself that you can learn TV Servicing . . . at home, in your spare time. ICS, the world's most experienced home-study school, will send you a *FREE* Demonstration Lesson (complete with sample questions) if you will merely fill out the coupon below and mail it to us.

In addition to your free demonstration lesson, we'll send you . . . also *FREE* . . . a brochure that describes the 25" (diagonally measured screen) MOTOROLA QUASAR II® Color TV chassis that we include in our TV Service Training Program.

This chassis with automatic fine tuning control is ideal for training purposes because it combines solid state devices with vacuum tubes to give you both kinds of practical experience. All parts carry Motorola's two year replacement guarantee!

The QUASAR II chassis comes to you in three basic sub-assemblies . . . NOT AS A KIT . . . because we want you to learn how to *repair* TV sets, not build them.

Our free literature also describes the fully assembled test equipment you receive such as the Deluxe 5" Solid State Oscilloscope, the tools and the learn-by-doing kits, all of the finest quality.

And we're going to tell you about eight other career opportunities in Electronics and the ICS Career Programs that can help prepare you for them. All you've got to do is mail the coupon.

SEND IT TODAY!

ICS

Since 1890
**School of Electronics
Scranton, Pa. 18515**

Canadian residents use above address for service from ICS Canadian, Ltd. in Hawaii use Post Office Box 418, Honolulu

Approved for veterans under the new GI bill/approved for federally insured loans/ Accredited by the Accrediting Commission of the National Home Study Council

**ICS School of Electronics
Scranton, Pa. 18515**

Dept. AA203X

YES, I want you to mail to me without obligation, the *FREE* DEMONSTRATION LESSON and complete literature on the career program checked below. (Please check one.)

- | | |
|---|--|
| <input type="checkbox"/> Color TV Servicing | <input type="checkbox"/> FCC License |
| <input type="checkbox"/> Computer Maintenance | <input type="checkbox"/> Communications/
Broadcasting |
| <input type="checkbox"/> CATV Installation | <input type="checkbox"/> Hi-Fi Sound Systems |
| <input type="checkbox"/> Telephony | <input type="checkbox"/> Industrial Electronics |

Name _____ Age _____

Address _____

City _____

State _____ Zip _____

Electronics ILLUSTRATED

A Fawcett Publication

July 1972

Vol. 15 No. 4

Member Institute of High Fidelity, Inc.
COVER: Ektachrome by Mike Bonvino
Illustration by Eugene J. Thompson

COMING NEXT ISSUE

Six Great Projects for Beginners

24-hour Shortwave Schedule

Grid-Dip Meter for VHF/UHF Hams

Guide to Basic Transistor Circuits

AMATEUR RADIO

- 2 Meters—Where the Action Is! Wayne Green, W2NSD/1 63
The Ham Shack Wayne Green 94

CITIZENS BAND

- Channel 9 Override Monitor Herb Friedman, KB19457 31
CB Corner Len Buckwalter, KQA5012 35

AUDIO & HI-FI

- The Thin Look Comes to Records Robert Angus 42
Direct-Reading Wow & Flutter Meter, Part I Harry Kolbe 46
Hi-Fi Today Robert Angus 68

SHORTWAVE LISTENING

- DXing NASA and Its Neighbors Alex Bower 40
The Listener C. M. Stanbury II 95

SERVICE

- Service Tips Art Margolis 24
Troubleshooting Color TV with a Scope Art Margolis 50

ENTERTAINMENT ELECTRONICS

- RCA Says 'Right On' to Home Video Recording 69

THEORY AND PRACTICE

- Sidestacked TV Antennas for a Super Signal! Art Margolis 80

ELECTRONICS IN THE HOME

- Low-Cost Speed Indicator Charles Green 76
Build Your Own Temperature-Humidity Meter Ronald M. Benrey 86

MEDICAL ELECTRONICS

- Build a Cardio-Tach Herb Cohen 59

EI'S NEW HI-FI CONTEST

45

KIT REPORTS

- Digital Multimeter and General-Purpose VOM 84

NEW PRODUCTS

- Electronic Marketplace 14
Electronics in the News 70

HOBBY & BUSINESS OPPORTUNITIES

- Classified Ads 105

REGULAR DEPARTMENTS

- Uncle Tom's Corner Tom Kneitel, K2AES/KQD4552 8
Feedback 12
Product Information Service 15
The EI Ticker 58

Build

RCA

IC Project Kit

Digital Display

KC4011

Learn or extend your knowledge of digital integrated circuits — build practical counting circuits, games, clocks and more — using this building-block kit. Kit features an incandescent readout device of high brightness and clarity providing a display of the numbers 0 through 9.

RCA



RCA

IC Project Kit

Digital Counter

KC4012

Get into digital integrated circuits with this building-block kit. Build frequency-divider chain circuits — power-line or crystal controlled. The crystal-controlled circuit, which provides a wide range of fixed output frequencies, can also be used for calibration of electronic equipment.

RCA



Go digital with RCA KC4011 and KC4012 display and counter kits... newest in a series of RCA project kits designed to provide an introduction to practical applications of Integrated Circuits.

With KC4011 and KC4012, individually or in combination, you can build many functional projects such as binary counter, photoelectric counter, dice game, 12- or 24-hour clock, power-line-divider chain, and frequency-divider chain. Easy-to-follow instructions, too, of course.

For experimenters and profession-

als interested in learning more about IC's, these kits offer an innovative approach to solid-state know-how. At the same time, you can build projects for use on the workbench, in the shop, or around the home.

Your RCA Distributor has KC4011 and KC4012 along with dozens of other RCA Project Kits, Variety Packs, Add-on Kits, Hardware, and Accessories, plus the RCA Solid-State Hobby Circuits Manual, HM-91. See him about the solid-state circuit you have in mind. Ask him, too, for your copy of 1L1350A, a brochure detail-

ing all RCA IC Kits, Experimenter's Kits, and support information. Or, write RCA, Commercial Engineering, Section 72G, Harrison, N.J. 07029. Do it today.

RCA
Electronic Components

versatile new 14-Piece, 1/4" Sq. Drive socket wrench set

drives fasteners
7 different ways



REVERSIBLE RATCHET — Precision made, long life, fully enclosed mechanism. Short handle swing for close quarter work

UNIQUE SPINNER/EXTENSION — 5-3/4" over-all. Plastic (UL) handle with 1/4" sq. drive socket insert for ratchet. Use also as regular nutdriver.

2" DRIVE EXTENSION — Fits on ratchet or either end of spinner/extension.

RUGGED, HEAT TREATED, ALLOY STEEL SOCKETS — Nine for hex sizes 3/16" thru 1/2". Two dual purpose for hex and square sizes 1/4" and 5/16".

FREE STICK-ON INITIALS personalize the sturdy plastic case and help prevent loss or mix-up.

REQUEST
BULLETIN N770

No. 1001 SET



Made in U.S.A.

nationwide availability
through local distributors

XCELITE

XCELITE INC. • 16 BANK ST., ORCHARD PARK, N. Y. 14127
Send Bulletin N770 on 1/4" Square Drive Socket Wrench Set.

name _____
address _____
city _____ state & zone _____

CIRCLE NUMBER 13 ON PAGE 15

Electronics ILLUSTRATED

By the Publishers of MECHANIX ILLUSTRATED

editor **ROBERT G. BEASON**
managing editor **Clifford L. Forbes**
technical editor **Robert Wollins**
art editor **Lou Rubsamen**
associate editor **Jean E. Lee**
consulting editor **Robert D. Freed**
production editor **Priscilla Moody**
adv. director **John F. Webster**
national adv. mgr. **Stanley Tessler**
publisher **George H. Allen**

CONTRIBUTING EDITORS

amateur radio **Wayne Green, W2NSD/1**
citizens band **Len Buckwalter, KQA5012**
swl-dx **C. M. Stanbury II**
special projects **Herb Friedman**
W2ZLF/KB19457
service **Art Margolis**
audio **Harry Kolbe**
audio **Robert Angus**

EXECUTIVE STAFF

president **Roger Fawcett**
secretary-treasurer **Gordon Fawcett**
circulation director **Roscoe K. Fawcett**
vp., magazine div. **George H. Allen**
exec. vp., book div. **Ralph Daigh**
vp., asst. to pres. **Frederick A. Klein**
vp., comptroller **F. Paul Simmering**
vp., dir. admin. services **Joseph Cunningham**
vp., circ. mgr., mag. div. **Luther Bugbee**
subscription manager **Ted Sloat**
vp., circ. mgr., book div. **Edmund Pendergast**
production director **Thomas R. Marvel**
production manager **Judy Schaefer**
art director **Ralph Mattison**

ELECTRONICS ILLUSTRATED is published bi-monthly by Fawcett Publications, Inc., Fawcett Bldg., Greenwich, Conn. 06830. Second-class postage paid at Greenwich, Conn., and at additional mailing offices.

EDITORIAL OFFICES: 1515 Broadway, New York, N.Y. 10036 (phone 212-869-3000). Contributions must be accompanied by sufficient postage and will be handled with care, though the publishers assume no responsibility for return thereof.

ADVERTISING OFFICES: 1515 Broadway, New York, N.Y. 10036 (phone 212-869-3000); Midwestern Representatives, King-will Co., 5528 N. Elston Ave., Chicago, Ill. 60630 (phone 312-774-9680); 211 W. Fort St., Suite 1010, Detroit, Mich. 48226 (phone 313-962-4860); 3807 Wilshire Blvd., Los Angeles, Calif. 90010 (phone 213-287-8258); 681 Market St., San Francisco, Calif. 94105 (phone 415-EX 7-3441); 1422 W. Peachtree St., N.W., Atlanta, Ga. 30309 (phone 404-TR 5-0373).

SUBSCRIPTIONS: \$3 per year (6 issues) in U.S. and possessions and Canada. All other countries \$4 for 6 issues. All subscription correspondence, including changes of address (Form 3579), should be addressed to ELECTRONICS ILLUSTRATED, Subscription Dept., Fawcett Bldg., Greenwich, Conn. 06830. Foreign subscriptions and sales should be remitted by International Money Order in U.S. funds payable at Greenwich, Conn.

COPYRIGHT © 1972 by Fawcett Publications, Inc. The title ELECTRONICS ILLUSTRATED is registered in the U.S. Patent Office. Reproduction in whole or in part is forbidden without written permission of the publishers; however, permission is hereby granted to quote from this issue of this magazine on radio or television, provided a total of not more than 1,000 words is quoted and credit is given to the title of this magazine and issue, as well as the statement, copyright 1972, by Fawcett Publications, Inc. Member ABC, MPA.

PRINTED IN U.S.A. BY FAWCETT PRINTING CORP., LOUISVILLE, KY. 40201. Microfilm copies of current and back issues are available from University Microfilms, 313 N. First St., Ann Arbor, Mich. 48103.

Electronics Illustrated

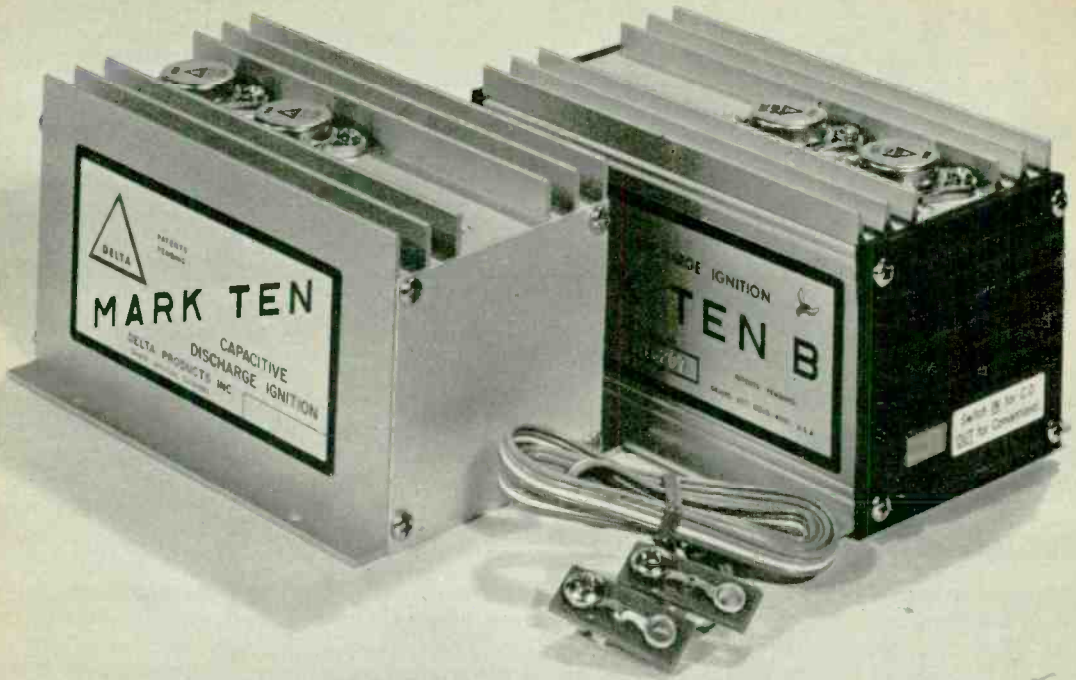

Save money and improve car performance at the same time.

Maintenance costs go down and performance increases when you put a Delta Mark Ten Capacitive Discharge Ignition System on your car.

For eight years we've been telling you about the tremendous advantages of CDI systems. We've promised and delivered better performance for cars, boats and trucks. Hundreds of thousands of satisfied customers testify to that fact. However during these eight years, we've been asked over and over again, "If CDI systems are so great, why doesn't Detroit adopt them?" It's taken a long time, but finally Detroit has recognized the value of the CDI system. Chrysler, long noted for excellence in engineering, is now installing electronic ignitions in new cars. Have you seen their ads? Heard their commercials? They're repeating what we've said for eight years. *Electronic ignition systems not only improve performance, but eliminate the need for most tune-ups.* If you're not buying a new car, but want new car performance, put a Mark Ten or Mark Ten B on your present automobile. If you're purchasing a new car with no CDI system, install a Mark Ten or Mark Ten B and enjoy the benefits of low maintenance and increased performance.

HERE'S WHAT A MARK TEN WILL DO FOR YOU:

Mark Ten and Mark Ten B—up to 20% increase in gasoline mileage Eliminates 3 out of 4 tune-ups Installs in only 10 minutes Spark plugs last 3 to 10 times longer Dramatic increase in performance Promotes more complete combustion Instant starts in all weather.

Mark Ten B—Improves combustion, reducing contaminants Handy switch with redundant contacts for instant return to standard ignition Applicable to ANY 12 volt negative ground engine Eliminates starting and idle problems Longer spark duration during cranking and idling.

Superior Products at Sensible Prices

Mark Ten (Assembled) \$44.95 ppd

Mark Ten (Deltakit) \$29.95 ppd

Kit available in 12 volt only, positive or negative ground

Mark Ten B \$59.95 ppd
(12 volt negative ground only)

Order today!



Dept. EI
DELTA PRODUCTS, INC.

P.O. Box 1147 / Grand Junction, Colo. 81501
(303) 242-9000

Please send me literature immediately:

Enclosed is \$_____ Ship ppd. Ship C.O.D.

Please send:

___Mark Ten B @ \$59.95

___Standard Mark Ten (Assembled) @ \$44.95

___6 Volt: Neg. Ground Only ___Positive Ground

___12 Volt: Specify ___Negative Ground

___Standard Mark Ten (Deltakit) @ \$29.95
(12 Volt Positive Or Negative Ground Only)

Car Year _____ Make _____

Name _____

Address _____

City/State _____ Zip _____



Uncle Tom's Corner

By Tom Kneitel, K2AES/KQD4552

Uncle Tom answers his most interesting letters in this column.
Write him at Electronics Illustrated, 1515 Broadway, New York, N.Y. 10036.

★ *I understand that a team of American Indians was put to use by the U.S. Army Signal Corps in World War II to outwit code-breaking teams of the enemy. Is this true?*

*Quint Harter
Tucson, Ariz.*

Yup, we had American Indians do this chore in both world wars. Seems that nobody but another Indian can savvy their lingo so we just arranged to have Indians talk on unscrambled telephone and radio communications. The Choctaws were the primary tribe that did this in 1918. By World War II the code-talkers were Navajos.

★ *I built an SCA (background music) adaptor for my FM receiver and have noticed now that the music dies out for a brief time every 15 or 20 minutes. Is this a common construction goof when people build these or am I unique?*

*Herb Kriss
San Pedro, Calif.*

Chances are that you built the thing just fine. It's a way of life for some background-music broadcasters. They run a two-minute silent period after about 13 minutes of music. Muzak seems to lead the field in this stunt, saying that it improves the effect of the music.

★ *Despite the fact that I prepare highly detailed reception reports, I find that I get a small percentage of QSL cards back from*

foreign ham operators. For every ten reports sent out, if I get two QSLs back I consider myself lucky. Some guys seem to get an 80 percent return. A secret perhaps?

*Ted Snyder
Paw Paw, Mich.*

I'd be willing to bet you aren't enclosing return postage with your reception reports. Foreign hams are swamped with more American SWL reports than they really want. Those not accompanied by an International Reply Coupon (available at most post offices) generally hit the round file as soon as they are received. An IRC with your report at least gives you a fighting chance for a reply.

★ *How do independent broadcast stations obtain live news broadcasts from other cities—such as coverage of presidential speeches? Obviously they don't get them from competing independents or from the networks.*

*Richard Santoro
Lewes, Del.*

They get them from news services for a fee. I once worked for a ramshackle little station which barely had the funds to pay the electric bill for the transmitter. They figured out a sneaky stunt to get speeches free by simply feeding another station's off-the-air signals into the transmitter. I recall the time the President was talking and our engineer had wandered off to have a cup of coffee with the receptionist. After a while the

[Continued on page 22]

ATTENTION, ALL MAGAZINE RETAILERS

Fawcett Publications, Inc., is pleased to announce a Retail Display Plan available to all retailers interested in earning a display allowance on ELECTRONICS ILLUSTRATED. To obtain details and a copy of the formal contract, please write to Marketing Division, Fawcett Publications, Inc.,

Fawcett Pl., Greenwich, Conn. 06830. Under the Retail Display Plan, in consideration of your acceptance and fulfillment of the terms of the formal contract to be sent to you upon your request, you will receive a display allowance of 10 percent of the cover

price per copy sold by you. This plan will become effective with all issues of Electronics Illustrated delivered to you subsequent to the date your written acceptance of the formal FAWCETT PUBLICATIONS, INC. RETAIL AGREEMENT is received and accepted by our company.

BUILD YOUR OWN RADIO

and Electronics Circuits

Reg. U.S.
Pat. Off.



Training Electronics Technicians Since 1946

PROGRESSIVE HOME RADIO-T.V. COURSE

Now Includes

- ★ 12 RECEIVERS
- ★ 3 TRANSMITTERS
- ★ SQ. WAVE GENERATOR
- ★ SIGNAL TRACER
- ★ AMPLIFIER
- ★ SIGNAL INJECTOR
- ★ CODE OSCILLATOR
- ★ TRANSISTOR (Solid State) CIRCUITS
- ★ VACUUM TUBE CIRCUITS
- ★ PRINTED CIRCUITS
- ★ HAND WIRED CIRCUITS

YOU DON'T HAVE TO SPEND HUNDREDS OF DOLLARS FOR A RADIO COURSE

The "Edu-Kit" offers you an outstanding PRACTICAL HOME RADIO COURSE at a rock-bottom price. Our Kit is designed to train Radio & Electronics Technicians, making use of the most modern methods of home training. You will learn radio theory, construction practice and servicing. THIS IS A COMPLETE RADIO COURSE IN EVERY DETAIL. You will learn how to build radios, using regular schematics; how to wire and solder in a professional manner; how to service radios. You will work with the standard type of punched metal chassis as well as the latest development of Printed Circuit chassis. You will learn the basic principles of radio. You will construct, study and work with RF and AF amplifiers and oscillators, detectors, rectifiers, test equipment. You will learn and practice code, using the Progressive Code Oscillator. You will learn and practice trouble-shooting, using the Progressive Signal Tracer, Progressive Signal Injector, Progressive Dynamic Radio & Electronics Tester, Square Wave Generator and the accompanying instructional material.

You will receive training for the Novice, Technician and General Classes of F.C.C. Radio Amateur Licenses. You will build Receiver, Transmitter, Square Wave Generator, Code Oscillator, Signal Tracer and Signal Injector circuits, and learn how to operate them. You will receive an excellent background for television, Hi-Fi, and Electronics.

Absolutely no previous knowledge of radio or science is required. The "Edu-Kit" is the product of many years of teaching and engineering experience. The "Edu-Kit" will provide you with an excellent background for television, Hi-Fi, and Electronics. Absolutely no previous knowledge of radio or science is required. The "Edu-Kit" will provide you with an excellent background for television, Hi-Fi, and Electronics.

THE KIT FOR EVERYONE

You do not need the slightest background in radio or science. Whether you are interested in Radio & Electronics because you want an interesting hobby, a well paying business or a job with a future, you will find the "Edu-Kit" a worth-while investment. Many thousands of individuals of all

ages and backgrounds have successfully used the "Edu-Kit" in more than 79 countries of the world. The "Edu-Kit" has been carefully designed, step by step, so that you cannot make a mistake. The "Edu-Kit" allows you to teach yourself at your own rate. No instructor is necessary.

PROGRESSIVE TEACHING METHOD

The Progressive Radio "Edu-Kit" is the foremost educational radio kit in the world, and is universally accepted as the standard in the field of electronics training. The "Edu-Kit" uses the modern educational principle of "Learn by Doing." Therefore you construct, learn schematics, study theory, practice trouble-shooting—all in a closely integrated program designed to provide an easily-learned, thorough and interesting background in radio.

You begin by examining the various radio parts of the "Edu-Kit." You then learn the function, theory and wiring of these parts. Then you build a simple radio. With this first set you will enjoy listening to regular broadcast stations, learn theory, practice testing and trouble-shooting. Then you build a more advanced radio, learn more advanced theory and techniques. Gradually, in a progressive manner, and at your own rate, you will find yourself constructing more advanced multi-tube radio circuits, and doing work like a professional Radio Technician.

Included in the "Edu-Kit" course are Receiver, Transmitter, Code Oscillator, Signal Tracer, Square Wave Generator and Signal Injector Circuits. These are not unprofessional "breadboard" experiments, but genuine radio circuits, constructed by means of professional wiring and soldering on metal chassis, plus the new method of radio construction known as "Printed Circuitry." These circuits operate on your regular AC or DC house current.

THE "EDU-KIT" IS COMPLETE

You will receive all parts and instructions necessary to build twenty different radio and electronics circuits, each guaranteed to operate. Our Kits contain tubes, tube sockets, variable, electrolytic, mica, ceramic and paper dielectric condensers, resistors, tie strips, hardware, tubing, punched metal chassis, Instruction Manuals, hook-up wire, solder, selenium rectifiers, coils, volume controls and switches, solid state materials.

In addition, you receive Printed Circuit materials, including Printed Circuits chassis, special tube sockets, hardware and instructions. You also receive a useful set of tools, a professional electric soldering iron, and a self-powered Dynamic Radio and Electronics Tester. The "Edu-Kit" also includes Code Instructions and the Progressive Code Oscillator, in addition to F.C.C. Radio Amateur License training. You will also receive lessons for servicing the Progressive Signal Tracer and the Progressive Signal Injector, a High Fidelity Guide and a Quiz Book. You receive Membership in Radio-TV Club, Free Consultation Service, Certificate of Merit and Discount Privileges. You receive all parts, tools, instructions, etc. Everything is yours to keep.

Progressive "Edu-Kit" Inc., 1189 Broadway, Dept. 627AE, Hewlett, N.Y. 11557

PRINTED CIRCUITRY

At no increase in price, the "Edu-Kit" now includes Printed Circuitry. You build a Printed Circuit Signal Injector, a unique servicing instrument that can detect many Radio and TV troubles. This revolutionary new technique of radio construction is now becoming popular in commercial radio and TV sets.

A Printed Circuit is a special insulated chassis on which has been deposited a conducting material which takes the place of wiring. The various parts are merely plugged in and soldered to terminals.

Printed Circuitry is the basis of modern Automation Electronics. A knowledge of this subject is a necessity today for anyone interested in Electronics.

UNCONDITIONAL MONEY-BACK GUARANTEE

Please rush my Expanded Radio-TV Course with "Edu-Kit"® to me.

- Send Course with Edu-Kits postpaid. I enclose full payment of \$34.95
- I enclose \$5.00 deposit. Send Course with Edu-Kits C.O.D. for balance of \$29.95 plus postage.
- Send me FREE additional information describing Course with Edu-Kits.

NAME
ADDRESS
CITY & STATE ZIP

PROGRESSIVE "EDU-KITS" INC.

1189 Broadway, Dept. 627AE, Hewlett, N.Y. 11557

CIRCLE NUMBER 10 ON PAGE 15

FOR INVENTIVE PEOPLE ONLY

If you're the kind of guy who likes to devise his own equipment or the kind who appreciates clever mechanical design, then Mallory do-your-thing products are for you.

They'll let you invent, create, modify, so things work your way. And of course, you'll get famous Mallory quality and performance you can count on too. Get them at your nearby Mallory Distributor.

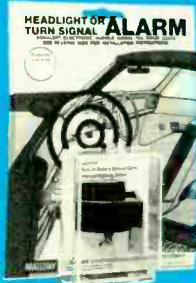

AUTOMOBILE REMINDER ALARM

Ever leave your lights on? Never again...with solid-state Sonalert®. Its shrill sound warns you, prevents battery drain. Use on turn signals, reverse gear...or any electrical component on your car, truck, boat, tractor. For 6 and 12 volt.

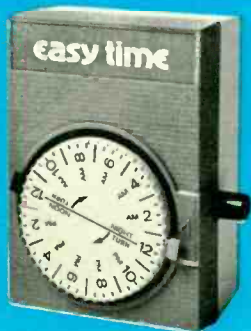

CONTROL YOUR TIME

Use "Easy Time" 24-hour timer. Turns anything you plug into it on and off. Appliances, lights, pumps, motors, humidifiers... you name it. Tough enough to handle 12 amps, 1500 watts.



HIGH INTENSITY NOISE

Compact, purse-size, big-sound Handy Blast... your personal alarm. Use it for anything... boat horn, emergencies, scare muggers, signals, call kids, scouting, bicycling... even cheer your team.



ON-THE-GO GROOMING

Free yourself from conventional, bulky shaving gear. Handy Shaver... it's about the size of a cigarette pack. Hi-speed, quiet, 3-volt motor for fast, no-pull shaving. Comes with Duracell® batteries, mirror cap and tough carrying case. Also available in new sideburn trimmer model.

SILENT PROTECTION

Crime Alert®... uses invisible, silent ultrasonic sound-waves. Anything that moves triggers its piercing alarm. Use anywhere... battery or plug in. Accessories to make it total security system.



CIRCLE NUMBER 23 ON PAGE 15

SOUND WHERE YOU WANT IT



The most popular, portable recorder/ player around. Batteries or plug in. Push-button operation. pop-up ejection, automatic shut off. With sensitive dynamic mike, earphone, Duratape[®] cassette, Duracell[®] alkaline batteries. Ask for the MCR 1211.



FOR GOOD LISTENING

Don't be restricted to one tape for every kind of sound... Duratape[®] is the answer. It's high performance tape with its own built-in head cleaner. Low noise, moderate price. 30, 60, 90 and 120 minutes.

Professional Duratape[®] — For discriminating listeners. High density cobalt-energized, extended frequency. For 4-track stereo. 30, 60, 90 minutes.

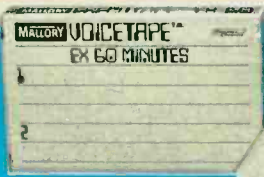

VOICETAPE™

Created especially for voice... dictation, lectures, conferences, rehearsals. In 12-cassette file pak or single box. 60 minutes.



FLIPTAPE™

The bright, colorful tape. Captures the highs and lows of today's music. For general use too. Economical 3-paks... 60, 90 minutes.

POWER WHEN YOU NEED IT

Alkaline Duracells[®]... with the extra power. Perfect for high drain uses... photoflash, cameras, radios, instruments, recorders. Up to 10 times longer life than zinc-carbon batteries.



MALLORY

MALLORY DISTRIBUTOR PRODUCTS COMPANY
a division of P. R. MALLORY & CO. INC.
Box 1284, Indianapolis, Indiana 46206; Telephone: 317-636-5353

CIRCLE NUMBER 23 ON PAGE 15

Feedback from Our Readers

Write to: Letters Editor, Electronics Illustrated, 1515 Broadway, New York, N.Y. 10036

● E—AS IN SCREAM!

With regard to the letter from James Simpson in the January '72 FEEDBACK, I can't understand why this chap—and others—fails to see why the ham fraternity is opposed to Class E CB. He answered his own question by ending with the words, power to the people. The Class E band (220 mc) will never clean up the mess on 27 mc because what CBer in his right mind is going to switch to skip-free frequencies?

Warren Phillips
Kailua, Hawaii

More on this subject appears in this month's Ham Shack. Our DX maven, Wayne Green, seems upset, too.

● MIXING IT UP

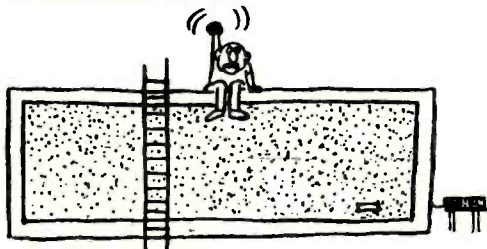

Your article on the PERSUADERS COME TO STEREO (May '72 EI) was too much. Market researchers are giving us—the public—just what we want and we don't need snobs like you telling us that our speakers are over-size, our amplifiers too heavy, our tape recorders decked out with useless accessories and our dreams of being recording engineers unfulfilled. Hell, if we want to play at being a sound engineer, so what. Unhappy people don't buy audio gear—or magazines!

Charles Parker
New Orleans, La.

Now there, Charley, let's not get so upset. There are both snobs and fools in this world and we aren't going to argue with you about who's what. You're right. You can buy anything you want. We just feel that when a manufacturer claims something, our readers have a right to know what his motivation is. . . And some of that four-channel gear coming down the pike nowadays isn't all that good.

● CALCULATING PERSON



I tried to talk my wife into letting me buy a low-cost electronic calculator like the one you showed on your May cover. No dice. I'm not sure whether she's worried about my arithmetic or her shopping list.

Vern Patterson
Boca Raton, Fla.

● AUTOMATIC AMATEUR

I find Wayne Green's ham of the future appalling. No code test, programmed theory, a crystal-controlled FM transceiver that works through a repeater. Sounds like CB on 3000 channels instead of 23. Remember when a ham license was a challenge and having one was proof of your ability?

Carl Menne
Aurora, Ind.

● DROPPING DECIBELS

In a story entitled DOLBY ON A CHIP (March '72 EI) you mention a Dolby noise-reduction system for cassette decks. I would like some information about where I might obtain this kind of cassette player.

Richard Venable
New Tazewell, Tenn.

Rich, any hi-fi store should have a Dolby deck, or you can look in the catalogs of Allied Radio and Lafayette Radio. All cassette decks incorporating the Dolby system have the Dolby name imprinted somewhere on the front panel. Companies licensed by Dolby Labs include Advent, Concord, Fisher, Harman-Kardon, Hitachi, Kenwood, Panasonic, Pioneer, RCA, Revox, Sansui, Teac, Toshiba and Wollensak, among others.

SONY[®] achieves true integration

In all too many transistor integrated amplifiers, the preamp stage does not quite live up to the performance of the amplifier section.

Not in Sony's new TA-1130. Thanks to an FET front end, this integrated package has a preamp stage that really does full justice to its output section.

Why FET's

For the same reason that we use them in our tuners and receivers, and in our studio professional condenser microphones; because FET's have a far wider dynamic range than ordinary transistor types.

And the preamplifier needs that range. Because it has to be sensitive enough to handle the lowest-output, moving-coil cartridges, yet still accept the highest output cartridges without overloading. (The power amp has it easier; you keep its input level fairly constant with your volume control.)

Power to Spare

But if the power amplifier doesn't need that range, it does need power. The output section of TA-1130 has it: 230 IHF watts (into 4 ohms), with continuous power rated at 65+65 watts into 8 ohms. (With all that power, we made sure that both transistor and speaker protection circuits were included.)

Nothing Stands Between You and the Sound

Both sections are powered by balanced positive and negative supply voltages (not just positive and ground), so there need be no coupling capacitors or interstage transformers between you and the sound.

Without them, the TA-1130 can extend its power band width down to 7 Hertz, and actually exceed its rated damping factor of 100 all the way down to 5 Hz.

An Abundance of Audiophile Conveniences

Of course, the TA-1130 has all the control facilities that you could ask for: low and high filters, tape monitor, a speaker selector, and even an Auxiliary input jack on the front panel. The selector switch is

Sony's instant-access knob-and-lever system.

There's even provision to use the TA-1130's power amp and preamp sections separately, to add equalizers, electronic cross-overs, or 4-channel adaptors to your system.

In fact, you can even get the power output section separately, as the model TA-3130 basic amp. It makes a great match for our TA-2000F preamp, too.

Your Sony dealer has both models available, and at down-to-earth prices for the performance they offer. Sony Corporation of America, 47-47 Van Dam Street, Long Island City, New York 11101



SONY FET Amplifier

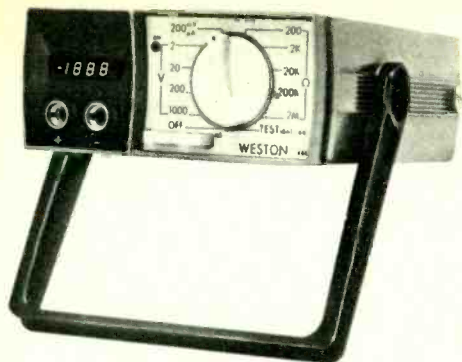

MIGHTY LIGHTWEIGHT. Seventeen ranges, 3½-digit resolution in less than 2½ lbs. are some of the features of the Model 4440 Digital Multimeter, 200 mv to 1,000 V AC/DC, 200 ohms to 2 megs, AC/DC current. \$285. Weston Instruments, 614 Frelinghuysen Ave., Newark, N.J. 07114.



SSB/CW Via SS. Solid-state Argonaut transceiver covers five ham bands, operates on lantern battery for portable or mobile. It weighs just 6 lbs., uses plug-in circuit boards, includes S-meter and SWR bridge. \$288. Ten-Tec, Inc., Highway 411 East, Sevierville, Tenn. 37862.

Electronic Marketplace



Fancy Cat. Puma 23 Citizens Band transceiver has S/Rf meter that glows amber when you're receiving, red when on transmit and flashes red to indicate modulation. The receiver boasts 0.5- μ V sensitivity, noise-cancelling mike. \$114.95. Pearce-Simpson, Box 800, Biscayne Annex, Miami, Fla. 33152.



Treys Wild. The Dyna-Com 3B is a 3-channel crystal-controlled 3-watt walkie-talkie for the Citizens Band. Has provisions for external mike offers variable squelch, comes with Channel 10 crystals. \$59.80. Lafayette Radio Electronics, 111 Jericho Turnpike, Syosset, N.Y. 11791.

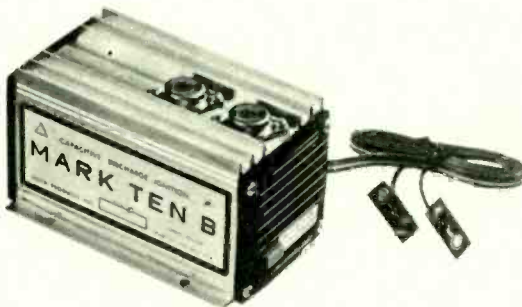

Pep Pill. The Mark 10B capacitive-discharge ignition system gives extended spark during start and idle and thus, the manufacturer claims, can restore pep lost due to emission control. Installs in 10 minutes. \$59.95. Delta Products, Grand Junction, Colo. 81501.

[Continued on page 26]



Product Information Service



If you want more information about one or more of the products advertised in **ELECTRONICS ILLUSTRATED**, this service is for your convenience. The product information you request will be sent to you promptly free of charge.

Just complete the name and address portion of one of the handy coupons below and circle the **PRODUCT INFORMATION SERVICE** number or numbers you find beneath the advertisements in this issue.

Mail a completed coupon to **ELECTRONICS ILLUSTRATED** at the address shown—We'll take care of the rest.

ELECTRONICS ILLUSTRATED P. O. Box 7474, Philadelphia, Pa. 19109										ELECTRONICS ILLUSTRATED P. O. Box 7474, Philadelphia, Pa. 19109									
1	2	3	4	5	6	7	8	9	10	1	2	3	4	5	6	7	8	9	10
11	12	13	14	15	16	17	18	19	20	11	12	13	14	15	16	17	18	19	20
21	22	23	24	25	26	27	28	29	30	21	22	23	24	25	26	27	28	29	30
31	32	33	34	35	36	37	38	39	40	31	32	33	34	35	36	37	38	39	40
41	42	43	44	45	46	47	48	49	50	41	42	43	44	45	46	47	48	49	50
Please Print										Please Print									
NAME _____										NAME _____									
ADDRESS _____										ADDRESS _____									
CITY _____										CITY _____									
STATE _____					ZIP _____					STATE _____					ZIP _____				
<small>7/72</small>										<small>7/72</small>									

A super 25V Color TV—new electronic calculator



NEW Heathkit "Computer Tuner" — we've brought new digital technology to FM stereo for the man who knows his music

NEW TO CONSUMER ELECTRONICS — pure digital design philosophy brings you one of the most fascinating and satisfying kits you'll ever build. Plus, a piece of precision audio gear that's already the talk of the stereo world. With the Heathkit AJ-1510 "Computer Tuner" you "keyboard" your FM station frequency and, if the broadcast is receivable, you hear it instantly. Numerical display tubes show your location on the FM spectrum. And the "Computer Tuner" automatically center-tunes for optimum reception! Gone are the knob, slide-rule frequency scale and tuning meter. A digital frequency synthesizer, employing phase-lock-loop techniques, does the tuning — with channel frequency accuracy better than 0.005%. The preassembled varactor FM RF tuning unit (front end) uses field-effect transistors to provide high sensitivity (less than 1.8 μ V) and low cross modulation with no overload on strong signal local stations. The familiar mechanically-ganged variable capacitor has been replaced by varicaps (voltage variable capacitance diodes) to provide complete electronic tunability. An inductorless digital frequency discriminator of the pulse counting (averaging) type follows two fixed-tuned five-pole LC IF filters thus eliminating all IF and discriminator adjustments while achieving distortion levels of 0.1%.

THREE TOTALLY DISTINCT PROGRAMMING MODES. Besides the exclusive keyboard tuning, you can select your FM with a sweep/scan mode. Push a button and the synthesizer counts down through the band, stopping at each station of listenable quality, or just stereo stations if you prefer. Or, you can pre-program your favorite frequencies on the computer-type punch cards included with the kit. Up to three cards can be inserted simultaneously behind the hinged front panel with instant access to these stations via A, B, C pushbuttons.

AUDIBLY SUPERIOR PERFORMANCE SPECS. Selectivity and IF rejection are better than 95 dB. Image and spurious rejection are better than 90 dB. Signal-to-noise ratio better than 65 dB, separation better than 40 dB. The 55 ICs, 50 transistors and 50 signal diodes mount on 10 modules with seven plugging into a master board for maximum computer modularity. And that makes assembly even easier. Order your "Computer Tuner" and start enjoying the FM sound that only true digital technology can bring.

Kit AJ-1510, "Computer Tuner" less cabinet, 23 lbs. 539.95*
AJA-1510-1, optional pecan cabinet, 6 lbs. 24.95*



The Heathkit AA-2004 Integrated Amplifier — 200 versatile watts for discrete or matrixed 4-Channel sound, and stereo or mono

AA-2004 puts you right in the middle of the 4-channel excitement — without obsoleting all the stereo gear you already own. It serves up a block-busting 200 watts through four channels, with control versatility that lets you put the power into any format — mono, stereo, matrixed 4-channel, discrete 4-channel.

IMPROVES WHAT YOU ALREADY OWN. Thanks to built-in matrix circuitry that decodes matrixed 4-channel recordings and 4-channel broadcasts, the AA-2004 lets you use your present turntable, tape equipment or tuner. Also, the decoder enhances your present stereo record & tape library, and conventional 2-channel FM broadcasts by feeding the "hidden presence" to rear speaker for an extremely satisfying 4-channel effect.

PUTS YOU AHEAD OF TOMORROW'S DEVELOPMENTS. As discrete 4-channel media becomes more prevalent, the AA-2004 is ready. Four conservatively rated and fully protected amplifiers produce 260 watts into 4 ohms (4x65), 200 watts into 8 ohms (4x50), 120 watts into 16 ohms (4x30). Controls are provided for every source, mode and installation. Amplifier sections are

controlled in pairs with one complete stereo system for left & right front speakers and another for left & right rear — so your AA-2004 can be used to power two separate stereo systems if desired. With outputs for both main and remote speaker systems, it can be used to power two 4-channel systems (up to 8 speakers).

PERFORMANCE SPECS YOU'D EXPECT FROM HEATH. Make your own comparison of the AA-2004's impressive specifications: Full power bandwidth on all channels from less than 5 Hz to more than 45 kHz for 0.25% total harmonic distortion. IM distortion less than 0.2%. Damping factor greater than 100. Hum and noise — 65 dB for phono, —75 dB for tape and aux.

GOES TOGETHER WITH TRADITIONAL HEATHKIT SIMPLICITY. Plug-in circuit boards and preassembled wiring harnesses reduce point-to-point wiring — make the AA-2004 as much fun to build as it is to use. Get with the 4-channel revolution now. Order your Heathkit AA-2004.

Kit AA-2004, 39 lbs., less cabinet 349.95*
AA-2004-1, pecan cabinet, 7 lbs. 24.95*

CIRCLE NUMBER 3 ON PAGE 15

—“Computer Tuner”—4-channel amp

And 350 other exciting projects in the FREE Heathkit Catalog

If you're not already into a Heathkit hobby, what's holding you back? Ask around and you'll find a Heathkit builder—who can show you the rewards. You'll pay yourself back for your kitbuilding time with better products. Better in terms of price, value, performance specifications, and self-service features. And the Heathkit line-up is bigger and better than ever. Including color TV, stereo/hi-fi, electronic organs, home appliances, engine tune-up tools, radio control, shortwave, marine gear, instruments, hundreds more. They are all in the free '72 Heathkit Catalog. Send for yours now.

NEW Heathkit Electronic Desk-Top Calculator — full-function, 8-digit readout for a low, low kit price

Approximately eight enjoyable hours of your time can give you that calculator you've been wanting for home or office—at a price substantially below any assembled unit with comparable features. The new Heathkit 2008 Electronic Calculator handles addition, subtraction, multiplication and division with up to eight-figure totals displayed on extra-bright 1/2" seven-segment readout tubes. The 2008 accepts both positive and negative numbers. Solves problems in either constant or chain operations. Simply push the K (constant) key and multiply or divide by one preselected number, release the key and you can work a series of multiple-operation problems with the Calculator automatically displaying running sub-totals with each step.

FOOLPROOF CREDIT BALANCER. The IC-2008 automatically displays a minus result to make credit balancing as easy as keying in the credit and debit columns in any sequence. Touch the total key and you have the result with no need to manually sub-total. You can balance the family checkbook in minutes! A thumbwheel sets the decimal in any one of seven fixed positions, or you can select the floating mode for decimal totals carried out to completion. A ninth readout tube at the left of the display indicates plus or minus overflow, as well as a minus sign for negative results. A partial



clearing key allows you to remove the last entry from the circuitry while preserving the rest of the problem.

DEPENDABLE AMERICAN-MADE LARGE SCALE INTEGRATED CIRCUIT is the "brain" of the Heathkit IC-2008 Calculator. Components mount on two roomy circuit boards for quick, neat construction. And you can wire your IC-2008 for either 120 or 240 VAC operation. Figure it out for yourself—the Heathkit IC-2008 is a great kit-form value. Take advantage of it today.
Kit IC-2008, 11 lbs. 129.95*

NEW Heathkit GR-900 25 V Color TV — the most technically advanced set we've ever offered

13 SUB-KITS SIMPLIFY ASSEMBLY—and take you from the first circuit board through final alignment. The result is the largest color picture you can buy anywhere, with a complement of convenience controls found only on the world's most expensive receivers. A soldering iron and a few conventional hand tools are all you need to get your GR-900 together. We supply everything else.

UHF/VHF DETENT POWER TUNING—heads up the impressive list of GR-900 features. Push a button and you scan either UHF or VHF channels, in either direction, with detent action locking in on the 12 VHF and any 12 preselected UHF channels.

NEW VOLTAGE-CONTROLLED VARACTOR UHF TUNER and a newly designed VHF tuner with MOS field effect transistor contribute to better fringe-area reception and increased sensitivity. A new angular tint control for "normal" or "wide angle" color demodulation minimizes tint and flesh tone change when you switch channels or when programs change. And check this list of deluxe features: "Instant on" with override; automatic fine tuning; adjustable tone control; stereo/hi-fi audio output; automatic chroma control; adjustable video peaking; adjustable noise limiting; gated AGC; illuminated channel identification. For total armchair control, there's even an optional wireless remote control.

EXCLUSIVE HEATH MTX-5 ULTRA-RECTANGULAR BRIGHT TUBE measures a full 25 inch diagonal, 315 sq. in. viewing area—has a specially etched face plate to cut glare, with each color dot projected against solid black background for extra crispness.

STATE-OF-THE-ART RELIABILITY. The modular solid-state design utilizes 46 plug-in transistors, 57 diodes, and four ICs, with the majority of the circuitry on plug-in boards. The built-in dot generator and tilt-out convergence panel are periodic adjustment aids you'll find only on Heathkit sets. And further, a built-in volt-ohm meter and simplified troubleshooting section in the manual permit self-servicing should the need ever arise. The '72

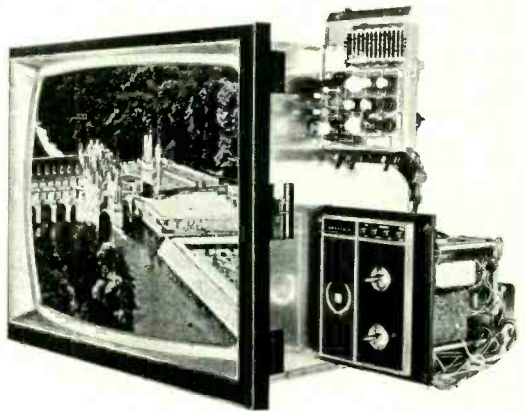

Catalog lists four beautiful cabinets for the GR-900, plus the exciting new Custom Wall Mount that allows you to build the set into a wall. Brighten your life with Heathkit solid-state color entertainment. Order your GR-900 now and know the pride of building and owning the best.

Kit GR-900, TV less cabinet, 125 lbs. 599.95*
Kit GR-900-6, wireless remote control, 6 lbs. 79.95*

See them all at your Heathkit Electronic Center... or fill out the coupon below

HEATHKIT ELECTRONIC CENTERS — ARIZ: Phoenix, 2727 W. Indian School Rd.; CALIF: Anaheim, 330 E. Ball Rd.; El Cerrito, 6000 Potrero Ave.; Los Angeles, 2309 S. Flower St.; Pomona, 1555 Orange Grove Av. N.; Redwood City, 2001 Middlefield Rd.; San Diego (La Mesa), 8363 Center Dr.; Woodland Hills, 22504 Ventura Blvd.; COLO.: Denver, 5940 W. 38th Ave.; FLA.: Miami (Watsah), 4705 W. 16th Ave.; GA.: Atlanta, 5285 Roswell Rd.; ILL.: Chicago, 3462-66 W. Devon Ave.; Downers Grove, 224 Ogden Ave.; KANSAS: Kansas City (Mission), 5960 Lamar Ave.; MD.: Rockville, 5542 Nicholson Lane; MASS.: Boston (Wellesley), 165 Worcester St.; MICH.: Detroit, 18645 P. Eight Mile Rd. & 18149 E. Eight Mile Rd.; MINN.: Minneapolis (Hopkins), 101 Shady Oak Rd.; MO.: St. Louis, 9296 Gravois Ave.; N.J.: Fair Lawn, 35-07 Broadway (Rte. 4); N.Y.: Buffalo (Amherst), 3476 Sheridan Dr.; New York, 35 W. 45th St.; Jericho, L.I., 15 Jericho Turnpike; Rochester, Long Ridge Plaza; OHIO: Cincinnati (Woodlawn), 10133 Springfield Pike; Cleveland, 5444 Pearl Rd.; PA.: Philadelphia, 6318 Roosevelt Blvd.; Pittsburgh, 3482 Wm. Penn Hwy.; TEXAS: Dallas, 2715 Ross Ave.; Houston, 3075 Westheimer; WASH.: Seattle, 2221 Third Ave.; WIS.: Milwaukee, 5215 Fond du Lac.

HEATHKIT	
Schlumberger	
HEATH COMPANY, Dept. 39-7 Benton Harbor, Michigan 49022	
<input type="checkbox"/> Please send FREE Heathkit Catalog.	
<input type="checkbox"/> Enclosed is \$ _____, plus shipping.	
Please send model(s) _____	
Name _____	
City _____ State _____ Zip _____	
Prices & specifications subject to change without notice. *Mail order prices; F.O.B. factory.	
CL-433R	

CIRCLE NUMBER 3 ON PAGE 15

Kit for kit, text for text, dollar for dollar, your best home training buy is NRI

NRI "hands on" method gives you as much as 2 years of on-the-job experience. Pick your field and enroll now!

After over 55 years of training men for Electronics in their homes, NRI knows that theory alone is not enough. That's why NRI concentrates so heavily in the development of special training equipment. Your hands must be trained as well as your head, and NRI gives you both kinds of training in a manner no other school can match.

You get your hands on professional parts and demonstrate theory you read in NRI's unique "bite-size" texts. You build designed-for-learning Electronic circuits and complete, operating equipment. You use what you build to prove out what you read. Electronics comes alive in the most valuable, practical manner. You experiment with the same kinds of solid-state and transistorized and tube circuits you'll find on the job—not hardware or breadboard hobby kits.

NRI prepares you for your choice of careers in Color TV Servicing, Communications, Industrial Electronics and the growing field of Computer Electronics. Many NRI graduates start earning \$5 to \$7 an hour extra soon after they enroll, fixing home Electronic equipment for friends and neighbors in spare time. NRI's remarkable teaching method simplifies, organ-

izes, dramatizes subject matter so that any ambitious man, regardless of his education, can effectively learn and profit from the Electronics course of his choice—and NRI gives you 15 training plans to choose from.

Over three-quarters of a million men have enrolled with NRI since 1914. Proof of the value and experience you get when you choose NRI for your Electronics training . . . proof of why NRI continues to be the country's largest Electronics home-study school. Discover for yourself how easy it is to move into Electronics and move up in a rewarding career. Mail the postage-free card for the new NRI Catalog. There is no obligation. No salesman will call on you because NRI does not employ salesmen. NATIONAL RADIO INSTITUTE, Washington, D.C. 20016.



If postage-free card is missing, write to:
NATIONAL RADIO INSTITUTE
Washington, D.C. 20016

GET FACTS ABOUT GI BILL

If you have served since January 31, 1955, or are in service now, check GI line on postage-free card.



...first and only school to include training equipment designed from chassis up for your education

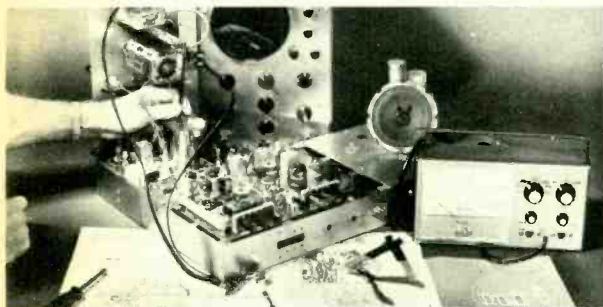

Earn \$5 to \$7 an hour spare or full time in COLOR TV SERVICING

It's easy to learn as you build, stage-by-stage, the only custom designed Color TV receiver engineered specifically for training purposes. You grasp a professional understanding of all color circuits through logical demonstrations never before presented. The end product is a superb Color TV set that will give you and your family years of viewing pleasure. NRI gives you the option of selecting either Color or black-and-white training equipment.

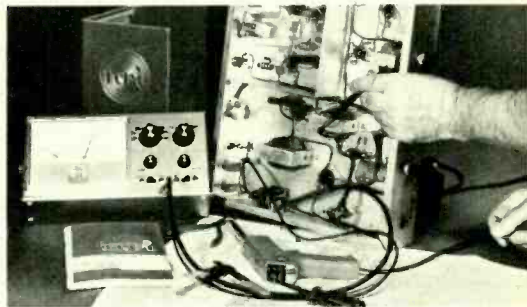

There's glamour, success awaiting Technicians in COMMUNICATIONS

NRI gives you the experience you need to qualify for jobs in TV broadcasting stations, or operating and servicing mobile, marine, aviation communications equipment. You build and use a solid-state voltohmmeter; perform experiments on transmission lines and antenna systems, even build your own 25-watt, phone-cw amateur transmitter band. In all NRI Communications courses, *you must pass your FCC exams—or you get your money back.*



Fill technical jobs without a degree in INDUSTRIAL ELECTRONICS

NRI's Electronics Technology course gives you completely specialized training kits engineered for business, industrial and military Electronics fields. On completing this training, competent technical ability can be instantly demonstrated by you. As you learn, you actually build and use your own training center in solid-state motor control and analog computer servo-mechanisms. Telemetering circuits, solid-state multi-vibrators, even the latest integrated circuits are included in your home training program.



Prepare quickly for a high pay career in COMPUTER ELECTRONICS

This may well be the most unique and exciting educational aid ever developed for home training—a digital computer *with memory* you build and use to learn organization, trouble shooting, operation and programming. It performs the same functions as commercial computers you encounter on the job. Lessons stress computer repair. You perform a hundred experiments, build hundreds of circuits. Your own solid-state voltohmmeter is included among the ten training kits you receive.

OVER 50 YEARS OF LEADERSHIP IN ELECTRONICS TRAINING

LIVE IN THE WORLD OF TOMORROW . . . TODAY!

UNUSUAL BARGAINS

NEW PRODUCTS • NEW MATERIALS • NEW IDEAS

TAPE-SLIDE SYNCHRONIZER



Coordinate tape recordings with slide series. Hook up stereo recorder to remote control projector and TSS—then record what you wish for each slide. Playback and TSS AUTOMATICALLY changes slides in synch w/tape. Your presentation "sings itself." Perfect for sales meetings, lectures, & "talking albums" of child's growth—add new dimension to vacations, parties . . . anywhere.

Stock No. 41,222EB \$21.95 Ppd.
6-FT. CONNECTOR CORDS \$4.50 Ppd. each
Kodak Proj. (#60,804EB) Airquipt (#60,805EB)

\$8.95 ELECTRIC STROBE!



Hand-sized solid state electronic strobe light at fantastically low price. Produces bright psychedelic effects like larger, far more expensive Xenon strobes, yet it's just 2 3/4" x 4" x 1 3/8" thick. Adjustable flash rate, approximately 3-10 flashes per second. Make stop motion effects, posters come alive. Great to take with you to parties, dances, outings, etc. Requires 2 9v transistor batt. (not incl.). Instructions.

Stock No. 41,443EB \$8.95 Ppd.
4 REPLACEMENT LAMPS . . . P-41,444EB \$1.00 Ppd.

SEE FEATURE ARTICLE MARCH ISSUE! ENCAPSULATED LIQUID CRYSTALS



Amazing new development—appear like liquids but have orderly molecular structures similar to solids. Solutions contained in tiny (20-30 microns) capsules coated onto sides of six 6" x 12" Mylar sheets with 6 diff temp. ranges. Surface changes color according to temp.—cover 66° to 120°F (19°-49°C). Use for precise measurements, find hot spots, structural defects, study radiation, test conductivity, etc.

No mess. No contamination. Easy to handle. Use indefinitely. Instruct. color temp. curves.
Stock No. 71,143EB \$10.00 Ppd.
EXPERIMENTERS KIT—same but 4" x 6" sheets
Stock No. 60,756EB \$4.00 Ppd.

TURN BOTTLES INTO TREASURES



Be ecological and artistic . . . with this low-cost Bottle Cutter Kit. Easiest-to-use one we've found. Make salable, attractive glasses, dishes, candleholders, vases . . . from ordinary no-return smooth-surface bottles, jars. Cut any bottle safely, easily in less than 5 minutes for fun, profit, home decorations with just a lee cube and this superior kit. Includes cutter (3 3/4 x 7 1/4 x 2 1/4"), candle, 2-oz. grinding powder, smoothing cloth. Complete instructions.

Stock No. 71,475EB \$10.95 Ppd.

NEW! ELECTRONIC DIGITAL COMPUTER KIT!

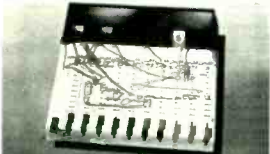

Solve problems, play games, predict weather with this actual working model of giant electronic brains. Amazing new fun way to learn all about computer programming . . . logic, decimal, binary systems, Laws of Sets—even do your own programming after completing simplified 116 page instructive booklet. Includes step-by-step assembly diagrams. Circuits easily changed. Readout from illuminated control panel. Req. 2 "D" batt. (not incl.).

Best model we've seen—for home, school, industry. . . \$31.50 Ppd.
No. 71,434EB . . . (11"x12 1/2"x4")

MAIL COUPON FOR GIANT FREE CATALOG!

148 PAGES • MORE THAN
4,000 UNUSUAL BARGAINS

Completely new 1972 edition. New items, categories, illustrations. Dozens of electrical and electromagnetic parts, accessories. Enormous selection of Astronomical Telescopes, Unique Lighting and ecological items. Microscopes, Binoculars, Magnifiers, Magnets, Lenses, Prisms. Many surplus items.

EDMUND SCIENTIFIC CO., Barrington, N.J. 08007

Please rush Free Giant Catalog "EB"

Name _____
Address _____
City _____ State _____ Zip _____

EDMUND SCIENTIFIC CO. 300 EDSCARP BLDG. BARRINGTON, NEW JERSEY 08007
ORDER BY STOCK NUMBER • SEND CHECK OR MONEY ORDER • MONEY-BACK GUARANTEE

CIRCLE NUMBER 16 ON PAGE 15

Uncle Tom's Corner

manager of the station whose signals we were pirating called to notify us that the President had finished rapping about 20 minutes earlier and that we were now about 15 minutes into simulcasting one of his DJ shows. . . Well, it sounded like a good trick at the time.

★ *You mentioned recently that you were a trout fisherman. If it's not straying too far from electronics, I'd like to ask—a fellow flycaster, where do you do your fishing and how did you get bitten by the ol' bug?*

Ed McIntosh
Byron, Minn.

I like to head for the lakes and rivers of New Hampshire and Vermont for these babies. Sunapee Lake, N.H., is a favorite. Got hooked on trout fishing by the late Nick (The ol' Rebel) Adams a lot of years back and have never been able to kick the habit.

Inside Hint Dept. If you happen to be one of several hundred guys and gals using an illegal ID on single-sideband CB your days of bootlegging probably are few indeed. Somehow or other the FCC has obtained rosters of scads of pirate SSB-CB stations and they are quietly but firmly silencing them in a most painful (and expensive) manner. Maybe you'll be next. Or maybe you'd better take up golf.

★ *While listening on CB's emergency channel 9, I heard a loud signal from a station identifying itself as KRUT in Munich, Germany. I was amazed at the strength of the signal. KRUT announced that it was testing but I doubt if any American CBer had enough power to answer the station. Anyway, nobody tried to answer him. What's the scoop on this station?*

Gene Sawyer, Jr.
Burbank, Ill.

Sounds like one of your neighbors trying to pull the sauerkraut over your eyes.

★ *I recently moved into an apartment. I guess you know the old no-antennas-allowed story. I'm on the 5th floor of a metal-frame building and my HQ-180 receiver is gathering dust.*

Electronics Illustrated

Please help!

George W. Cady
Chicago, Ill.

Frankly (as you've already guessed), you've got a problem. I was once able to string up a beautiful, invisible vertical antenna from a ground-floor apartment to the roof. You might try my trick. I used some very thin wire which I unwound from an old transformer—just run it along the edges of windows.

★ About two years ago you wrote a really wild Ouija Board story in EI called Long Nights of Uncle Tom. I've fooled around with one of these boards from time to time but never recorded the results. Have you made any new contacts recently? Did the story get much mail?

Michael V. Pishioneri
Ellwood City, Pa.

From time to time I still have a go at it. It's a fascinating gadget which still baffles and intrigues me. I wish that somebody would devote some serious research to the Ouija

Board. Yes, the mail was enormous. It was divided basically into two classifications—one group wanted a follow-up story; but there were a few readers who felt that I would get a QSL card from Satan.

How come you've got all the answers?
Red Reitman
Harlan, Ky.

Some of us are just naturally lucky, I guess.

★ I give up. My local fuzz have suddenly vanished from the communications scene. For years they provided good listening on 39.82 and 39.86 mc, and then one day—poof! I checked my receiver out and it seems to be working. I've even tuned across the entire band. The fuzz have simply slipped off into the twilight zone. Any suggestions?

Arthur Callahan
Idaho Falls, Idaho

They, along with many other PDs, have quietly fled to the UHF band. You'll have to get a new receiver. Try 460.325 mc.

**the tape that
turned the
cassette into
a high-fidelity
medium**



TDK SUPER DYNAMIC (SD) TAPE

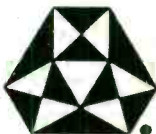

TDK

Until TDK developed gamma ferric oxide, cassette recorders were fine for taping lectures, conferences, verbal memos and family fun—but not for serious high fidelity.

TDK CASSETTE C-120SD

Today you can choose among high-quality stereo cassette decks.

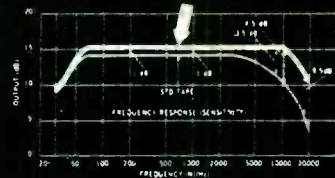

The new magnetic oxide used in TDK Super Dynamic tape distinctively differs from standard formulations in such important properties as coercive force, hysteresis-loop squareness, average particle length (only 0.4 micron!) and particle width/length ratio. These add up to meaningful performance differences: response capability from 30 to 20,000 Hz, drastically reduced background hiss, higher output level, decreased distortion and expanded dynamic range. In response alone, there's about 4 to 10 db more output in the region above 10,000 Hz—and this is immediately evident on any cassette recorder, including older types not designed for high performance. There's a difference in clarity and crispness you can hear.

Available in C30SD, C60SD, C90SD and C120SE length.

TDK ELECTRONICS CORP.
LONG ISLAND CITY, NEW YORK 11103

CIRCLE NUMBER 25 ON PAGE 15



Service Tips

By Art Margolis

GOING to purchase a used oscilloscope? Test it before plunking down the cash. Connect a square wave generator to the scope's vertical amplifier input. The scope should reproduce a clean waveform from 30 to 15,000 cycles per second. If it does, the second-hand scope has adequate frequency response.

When you replace a thermistor, do not use ordinary solder. The thermistor's leads are silver coated and a special silver solder should be used. The recommended type is rosin cored and has a 70 percent lead, 27 percent tin and three percent silver composition.

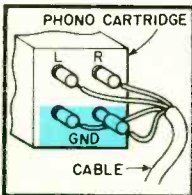

If your phonograph plays with loud hum, look for an open ground. In particular, check the ground wire on the cartridge. Make sure the phono plug from the cartridge is completely seated in the amplifier jack and is not partially sticking out.

Testing transistors with an ohmmeter for reverse and forward bias is easy, but follow this simple precaution. Make sure that you're on the Rx100 or Rx10K scale. If you accidentally touch the transistor leads with your meter on its Rx1 scale, you could be supplying the semiconductor with as much as 100 ma. This amount of current could ruin the transistor.

On rare occasion you'll run across a trimmer capacitor having a defective, or leaky, insulator. Chances are, the trimmer's exact replacement will be hard to come by. Fortunately, you can repair this kind of variable capacitor most of the time. The fault is caused by cracks in the mica insulator. Loosen the adjusting screw, remove the cracked mica and install a new piece. It's a permanent repair.

The *ready* light on your 40-cup percolator is nothing more than a neon lamp attached across the percolator's thermostat. When the coffee is fully brewed the bimetallic elements open. Current now flows through the neon lamp. If the ready light stops working, you can usually trace the trouble to a faulty thermostat and not the lamp.

Changing fuses in solid state devices is not the simple job it appears to be. Always replace fuses with their exact replacement. Some power amplifiers depend upon the fuse's fraction-of-an-ohm internal resistance to develop bias for the protected transistor. Overfusing transistors can create incorrect bias. Besides, overfusing creates problems further confusing troubles if they occur



FREE!

Colorful New Brochures . . . Midland CB, Monitors, Meters

Get the advance facts on Midland's fantastic new 1972 CB and test meter lines. Two colorful brochures packed with information on the latest in CB, scanning monitors, multimeters . . . over 65 products in all! Fully illustrated and **absolutely free**. Send for yours today!

CB/Monitor Brochure

(Circle No. 26 on EI "Reader Service" Card)

Meter Brochure

(Circle No. 27 on EI "Reader Service" Card)

Write Today!

MIDLAND

ELECTRONICS COMPANY®

Post Office Box 19032
Kansas City, Missouri 64141

HAMILTON HOUSE Now Gives You Opportunity To Decide **WHO WAS THE "GREATEST"** **HEAVYWEIGHT CHAMPION OF ALL TIME?** **NOW AN 8mm FIRST!**

Jack Johnson — Jim Flynn 1912

Joe Louis — Tony Galento 1939

Joe Frazier — Muhammad Ali 1971

Jack Dempsey — Jess Willard 1919

Rocky Marciano — Rex Layne 1951

Muhammad Ali — Jimmy Ellis 1971

YOU WATCH! YOU SCORE! YOU DECIDE!

SEE each of the six most brilliant heavyweight champions described by boxing writers, and boxing authorities, as "THE GREATEST OF ALL TIME":

SEE "L'il Artha", Jack Johnson, greatest defensive fighter of all time laughing at the futility of Flynn to land a punch.

SEE the "Brown Bomber", Joe Louis, throwing the hardest four-punch combination in all heavyweight annals.

SEE Muhammad Ali, Cassius Clay, fastest heavyweight champion in boxing history showing his unbelievable speed and effortless grace.

SEE the "Manassa Mauler", Jack Dempsey, throwing the most devastating left hook of all time. It leaps off the screen at you!!!

SEE the "Brockton Blockbuster", Rocky Marciano, smothering his opponent with the most ferocious attack of the boxing decade.

SEE "Smoking Joe's", Joe Frazier, relentless pursuit and pressure making him the scourge of the heavy-weight division.

Six truly extraordinary 8mm fight films. Each a must for every collector and boxing fan. You'll play these films over and over for yourself and your friends, who will be hard pressed to decide "who really was the greatest heavyweight champion of all time?"

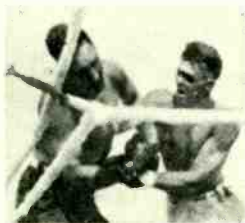

Hamilton House,
 Dept. 629L-7
 Cos Cob, Conn. 06807

Enclosed please find \$ _____
 Please send films checked:

We pay shipping. No C.O.D.'s/
 Send Check or Money Order.
 Conn. Residents — Add appropriate Sales Tax
 (Films supplied on 200' reels—each approx. 10 min. running time.)

Jack Johnson vs. Jim Flynn Jack Dempsey vs. Jess Willard
 1912 1919

Joe Louis vs. Tony Galento Rocky Marciano vs. Rex Layne
 1939 1951

SPECIFY — 8mm or Super 8mm @ \$8.50
 Available in Black & White only

Joe Frazier, featured in three Issues of True Magazine,
 in his most dynamic performance:

Joe Frazier vs. Muhammad Ali
 1971

8mm or Super 8mm

Black & White @ \$9.95 Color @ \$19.95

(Please check 2 boxes above)

Muhammad Ali vs. Jimmy Ellis
 1971

8mm or Super 8mm

Black & White @ \$8.50 Color @ \$16.95

(Please check 2 boxes above)

I am Enclosing \$ _____ Make Check Payable to: Hamilton House
 Charge to: Master Charge American Express

Name _____

Address _____

City _____

State _____ Zip _____

TOM McCAHILL TESTS 3 MINI PICKUPS...



AND TALKS ABOUT THE BOOM IN TINY TRUCKS

It's all in the June issue of MECHANIX ILLUSTRATED. Plus Do It Yourself features that are smart . . . easy . . . and thrifty!

- Basic furniture repairs
- Great gifts for dads and grads
- How to choose an electric drill
- Thrifty man's guide to college
- Build a family fun center
- 12 new moneysaving tips for the family . . . and more!

The June issue of MECHANIX ILLUSTRATED is jam-packed with articles, photos, tips and ideas. Pick up a copy of MECHANIX ILLUSTRATED anywhere magazines are sold. Look for the June issue with Tom McCahill and the mini pickups on the cover.

Mechanix ILLUSTRATED

STILL ONLY **35¢**
AT ALL NEWSSTANDS

Electronic Marketplace

Two Different Personalities. Radio Shack has something for everyone and has just brought out two communications receivers to prove it. Both models are identical, offering all-solid-state circuitry, 11-band coverage, dual regulated power supplies and 50-75 ohm antenna impedance, but the AX-190 covers the ham bands



and the SX-190 is for general-purpose shortwave listening. Both units are said to provide sensitivity of $0.5 \mu\text{V}$ on SSB/CW and $1.0 \mu\text{V}$ on AM for signal-to-noise ratio of 10db. Built-in Q-multiplier gives better than 60db image rejection, 25- and 100-kc crystal calibrators provide accuracy of $\pm 200\text{kc}$ and stability of better than 500 cps per hour is claimed. Both rigs use dual conversion circuitry. AX-190, SX-190: \$249.95. Radio Shack Div. of Tandy Corp.

Scanning the Water Waves. After much success in developing monitor/scanning receivers for police-fire broadcasts, Citizens Band and the 2-meter ham band, Regency has moved quickly into the VHF-FM marine market with a new transceiver called Transcan. In one compact package there's an automatic, signal-seeking 7-channel receiver plus a 6-channel transmitter that puts out from 15 to 25 watts. This radio-telephone will be available at marine product



distributors at a price of \$349. Features include sensitivity of $0.35 \mu\text{V}$ for 20db quieting, scan rate of 15 channels per second and channel activation via pushbuttons. Unit comes equipped with crystals for channels 6 and 16, plus crystal for weather channel. Regency Electronics, Indianapolis, Indiana 46226.

Electronic Marketplace

Spaced Out of Sight. Heath's new AR-1500 AM/FM stereo receiver, a top-of-the-line audiophile's dream which replaces the company's famous AR-15, boasts some specs that would raise the hair of any hi-fi bear. Output is 120 watts per channel into 4 ohms and 90 watts per channel into 8 ohms, with IM distortion claimed at less than 0.2 percent and THD pegged at less than 0.25 percent. Four ICs and two

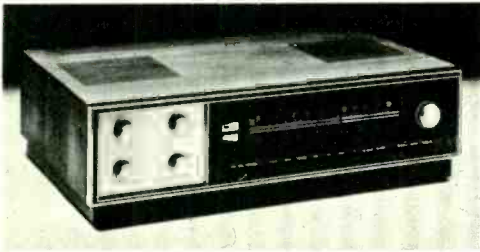

5-pole filters provide FM selectivity better than 90db, 1.5db capture ratio, 1.8 μ V sensitivity and image rejection of 100db. AM specs are just as impressive. Lots of kit building experience isn't required, according to the manufacturer. \$349.95. Heath Co., Benton Harbor, Mich. 49022.

Four Every Which Way. Four-channel decoder, Model SQ-M, is designed to bring flexibility into your living room. By hooking the SQ-M up to an extra stereo amplifier and two additional speakers—which work with your existing hi-fi rig—you can enjoy 4-channel sound from a number of sources: Columbia's SQ quadrasonic



recordings, records using the older Electro-Voice system and, under certain conditions, ordinary stereo programs can be enhanced. Existing phase differences in ordinary stereo programs are detected by the SQ-M's circuits and a surround-sound effect is achieved. Master gain control is provided for adjustment of all active circuits and extra input is available for magnetic phono pickup. All connecting cables included. Unit measures 6 x 2 $\frac{1}{2}$ x 7 $\frac{1}{4}$ in. \$44.95. Lafayette Radio Electronics, Syosset, N.Y. 11791.

[Continued on page 28]

NEW RUBBER STAMP BUSINESS PAYS BEGINNERS UP TO \$16.50 AN HR.

**START AT HOME
IN SPARE TIME**
with Table Top Machine!

We Help Finance You
... at less than bank rates!

The multi-million dollar Rubber Stamp business—once controlled by a few big companies—is now being taken over by small operators—one in each community throughout the United States. Men and Women who have this inexpensive machine can turn out huge quantities of Rubber Stamps with special wording that buyers once were forced to buy from big cities. Material costing only 27c makes a stamp that sells for \$2.75. The machine that does the work is simple and easy to operate and it turns out as many as six Rubber Stamps at a time, each with different wording such as names, addresses, notices, stock numbers, prices and other "copy" needed by offices, factories and individuals. Working full capacity, it can earn as much as \$33.00 an hour for the operator! Now you can get into the big-pay business yourself, with your own home as headquarters. You don't need experience. We supply everything, including complete instructions and eight ways to get business coming in fast. **We even help finance your start.** Start making up to \$16.50 an hour from the very beginning. Cash in on the profitable Rubber Stamp business in your community, right away. We'll mail full particulars FREE and no salesman will call. Be first in your locality. Rush coupon today or send your name on postcard to:

RUBBER STAMP DIV., Dept. R-120-BF
1512 JARVIS AVENUE • CHICAGO, ILL. 60626



RUBBER STAMP DIV.
1512 Jarvis Ave., Dept. R-120-BF
Chicago, Illinois 60626

FREE!

Please rush full particulars about your financing plan and the little machine that can get me started in the profitable Rubber Stamp business at home in spare time. Everything you send me is FREE and no salesman will call.

NAME

ADDRESS

CITY STATE Zip Code

Johnson put it all together.

□ low band and high band channels in any combination □ base and mobile operation with built-in power supply □ auto-scan with push-button "lock out" plus manual "lock in"

new
Duo-Scan™
\$169.95

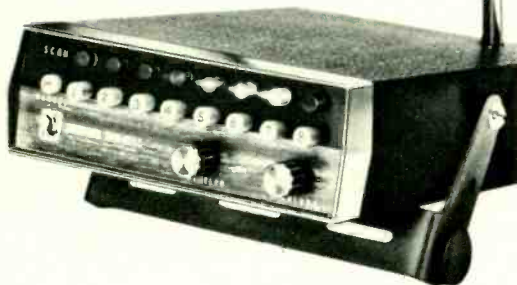

Eight VHF FM channels, in any combination of high and/or low band, keep you on top of all the action. Operates mobile or base with performance features previously found only in professional public safety radio equipment. Two ceramic filters give unsurpassed adjacent channel rejection. Integrated circuit symmetrical limiting makes it really quiet. 0.4 μ V sensitivity lets you hear what others miss. Powerful transistor audio produces clear, undistorted sound. The new Duo-Scan puts it all together, for just \$169.95 (less crystals).



E. F. JOHNSON COMPANY

WASECA, MINNESOTA 56093

©CIRCLE NUMBER 15 ON PAGE 15 1214

Electronic Marketplace

Mixing it all Down. Shure Model M688 stereo microphone mixer is designed for the serious audiophile or professional sound engineer. The mixer accepts four high- or low-impedance microphones, plus an auxiliary stereo high-level input. Each of these has its own volume control and three microphone inputs have front-panel switches for left- or right-channel output. The fourth microphone input has a pan control which



allows the signal to be directed to either the left or right channel—to any degree. A master gain control simultaneously adjusts the level of all inputs. Unit can be paralleled with other Shure mixers. Has stereo high-level, Hi-Z output plus a left and right mono output. \$114. Shure Brothers, Inc., Evanston, Ill. 60204.

Monitor Receiver scans Fuzz and things. Bearcat III scanning receiver monitors high and low public-safety bands and UHF business band. Interchangeable plug-in RF modules will cover any two of the three bands (or a single band) at one time. During two-band operation up to eight channels may be monitored. Placement of eight crystals in unique crystal socket determines the band of operation for each channel. Features include crystal IF filters, LED's to indicate active channels, built-in speaker.



squench control, solid-state circuitry, jack for external speaker and manual/scan/select switch. \$139.95 to \$159.95, depending on bands selected. RF modules, \$20 each. Electra Corp., Cumberland, Indiana 46229

Electronic Marketplace

Super Generator with Super Signal. Designed not only for the servicing of consumer-type color TVs, but also CATV, MATV and CCTV systems, RCA's Model WR-515A Chro-Bar color bar generator provides test signals needed to adjust convergence, color-phasing, gray-



scale tracking, purity and linearity of color receivers. Patterns available include color bars, dots, crosshatch, horizontal and vertical lines, blank raster, and a new feature developed by RCA called Superpulse. This pattern is a white rectangle that's horizontally centered on the screen. Since test signals are at both RF and IF frequencies, unit can be used for stage-by-stage

troubleshooting. \$179. RCA Electronic Components, Harrison, N.J. 07029.

Mike with a bit More Boost. What is said to be the first dynamic microphone ever designed specifically for use with single-sideband rigs, the Sidekick 100, now is available from Turner. Mike has an integrated-circuit amplifier built into its base to provide just the right impedance match with any SSB or solid-state rig. Adjustable volume control is said to provide gain of



up to 40db; frequency response is from 300 to 3500 cps. Unit is adaptable to either relay or electronic switching. Power comes from standard 9-volt battery. Turner Div. of Conrac Corp., Cedar Rapids, Iowa 52402.

Great Business Opportunity

Run a Radio Shack Store Under Our "PARTNERS IN PROFIT" PLAN



Apply Now for a Radio Shack Store! We're Willing to Bet On Your Future...If You Are!

As our partner, you're backed by the training programs of a 50-year-old company and the best in creative marketing and advertising.

Do your own hiring and control your own local costs and profits! A Security Deposit of \$12-20,000 gets you started. We pay all fixed costs—rent, real estate taxes, depreciation.

So, here you have it—a business where you call most of the shots. You sell stereo, radios, walkie-talkies, hobby kits, test instruments, antennas, tools, batteries, wire, recorders and much more—Realistic, Science Fair, Archer, Micronta—all our exclusive, registered brands.

You'll have the know-how of a thriving 1350-store firm to back you up—and you'll enjoy the added prestige and security of our parent company, the Tandy Corporation, an NYSE-listed, recognized leader among firms in retailing. Act NOW!

Capitalize on your ability, share in the profit, enjoy big income—by going into business with us! Radio Shack needs 300 more stores nationwide to meet the growing demand for its products, and maybe YOU can take over a "Partners In Profit" store—perhaps right in your own community!

CALL COLLECT OR WRITE: A. A. Bernabei, V.P. Radio Shack
2617 W. 7th St., Ft. Worth, Tex. 76107
PHONE: (817) 335-3711

radio shack

Dept. E1B-2

Rush "Partners in Profit" Details to:

Please Print

Name _____ Phone _____
Street _____ Apt. # _____
City _____ State _____ Zip _____

if you go for four channel...



you don't have to go for broke

Buy yourself a miracle for as little as \$214.95. That's all it takes to get your conventional two-channel stereo to do anything any total four-channel receiver and control center can do, now or in the future.

The Sansui QS500 and QS100 converters are complete Four-Channel Synthesizer-Decoder-Rear-Amplifier-and-Control-Center combinations that transform standard two-channel stereo totally. The only other equipment you need is another pair of speakers.

You can decode any compatibly matrixed four-channel broadcasts or recordings and reproduce them in four authentic channels. You can detect the ambient signals present in most two-channel recordings or broadcasts and propagate them through the rear channels. In Sansui matrixing, the exclusive phase-shift technique prevents the cancellation of some signals and the change in location of others that occur in many matrixing systems. And the exclusive phase modulators restore the effect of the live sound field.

You can plug in a four-channel reel-to-reel or cartridge deck or any other discrete source. In the future — if you should have to — you can add any adaptor, decoder or what-have-you for any four-channel system for disc or broadcast that anyone's even hinted at. And a full complement of streamlined controls lets you select any function or make any adjustment quickly and positively.

The QS500 features three balance controls for front-rear and left-right, separate positions for decoding and synthesizing, two-channel and four-channel tape monitors, electrical rotation of speaker output, alternate-pair speaker selection, and four VU meters. Total IHF power for the rear speakers is 120 watts (continuous power per channel is 40 watts at 4 ohms, 33 watts at 8 ohms), with TH or IM distortion below 0.5% over a power bandwidth of 20 to 40,000 Hz. In its own walnut cabinet, the QS500 sells for \$289.95.

An alternate four-channel miracle-maker is the modest but well-endowed QS100, with total IHF music power of 50 watts (continuous power per channel of 18 watts at 4 ohms and 15 watts at 8 ohms). In a walnut cabinet, it sells for \$214.95.

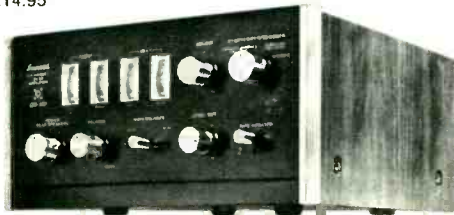

SANSUI ELECTRONICS CORP.

Woodside, New York 11377 • Gardena, California 90274
ELECTRONIC DISTRIBUTORS (Canada), Vancouver 9, B.C.
SANSUI ELECTRIC CO., LTD., Tokyo, Japan • Sansui Audio Europe S. A., Antwerp, Belgium

CIRCLE NUMBER 18 ON PAGE 15

Channel 9 Override Monitor

Catch the emergencies on 9, no matter which CB channel you're working.

By HERB FRIEDMAN, KB19457

READY to spring for a rig having built-in Channel 9 monitor capability? Even if you can't break the bank for one of these latest-generation transceivers, you can still ride the distress calls with our automatic-signalling Channel 9 Override Monitor.

Our monitor comes to life with just about any length of wire connected to its antenna terminal. And, unlike normal rigs, our mini monitor can turn on a light, signalling the presence of a call. Or you can listen to Channel 9 calls via a built-in speaker when there is modulation present. And our monitor can be wired to mute your regular transceiver's speaker and feed Channel 9 messages to it.

This AC-powered Channel 9 rig consists primarily of an inexpensive ready-to-run walkie-talkie. Connected to its output is a combination lamp and relay amplifier which is built on a strip of perfboard. The amplifier responds to the walkie-talkie's speaker output.

When no signal is on Channel 9, the amplifier mutes the walkie-talkie's speaker. Depending on the mode chosen by switch S1, a modulated received signal will either light lamp L1 or operate speaker relay RY1. In the event you want full-time speaker monitoring of Channel 9 the speaker can be manually turned on with switch

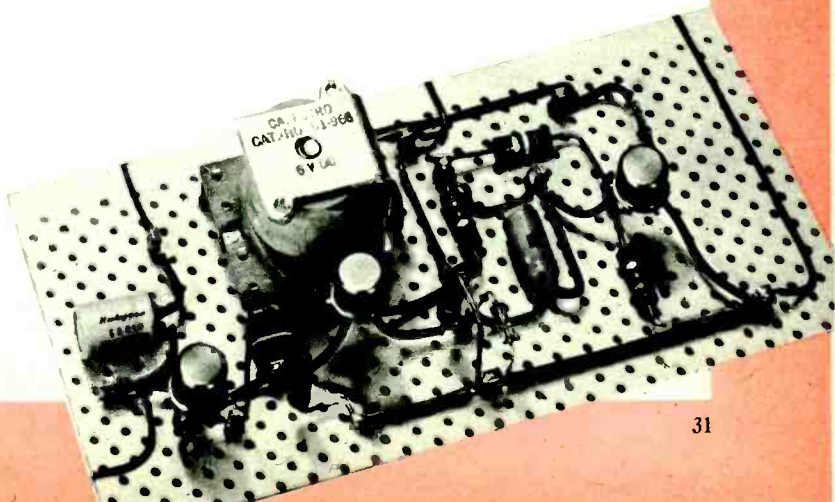

Channel 9 Override Monitor

Fig. 1—Top view of chassis showing perfboard-mounted components. Lamp L1 is above perfboard, shown to left. Layout isn't critical but do not reverse the polarity of electrolytic capacitors or diodes on the board. Capacitor C3 can be mounted off the perfboard if it is physically too large.

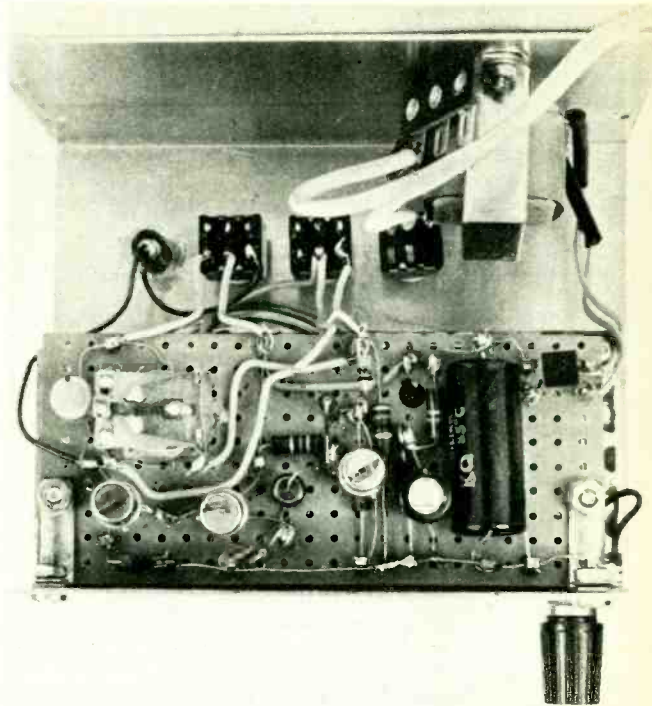

Fig. 2—Pictorial of perfboard wiring shown below. Observe polarity of all transistors, especially Q4. Wire leading away from BP1, labelled D in the pictorial, attaches to RF input transformer on walkie-talkie. See Fig. 3.

CONNECTIONS TO TRANSCEIVER

- (A) OUTPUT TRANSFORMER
- (B) +9V
- (C) - GND
- (D) ANTENNA TERMINAL

Q1,Q2,Q3
BOTTOM



Q4
BOTTOM



BR1
TOP

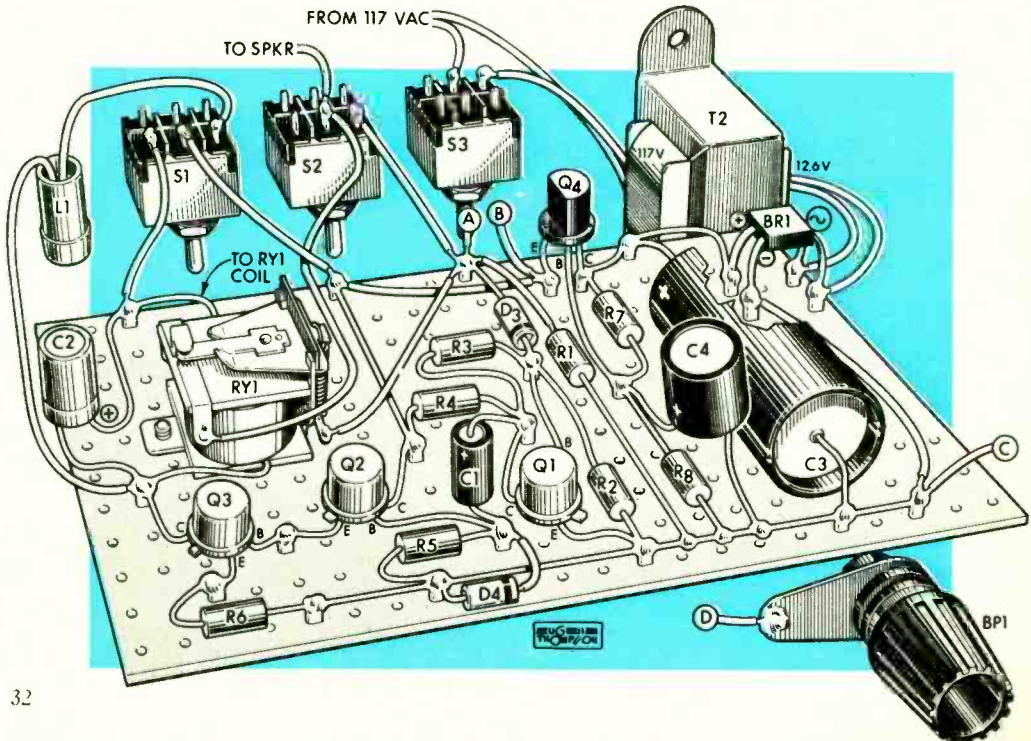
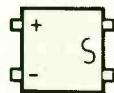

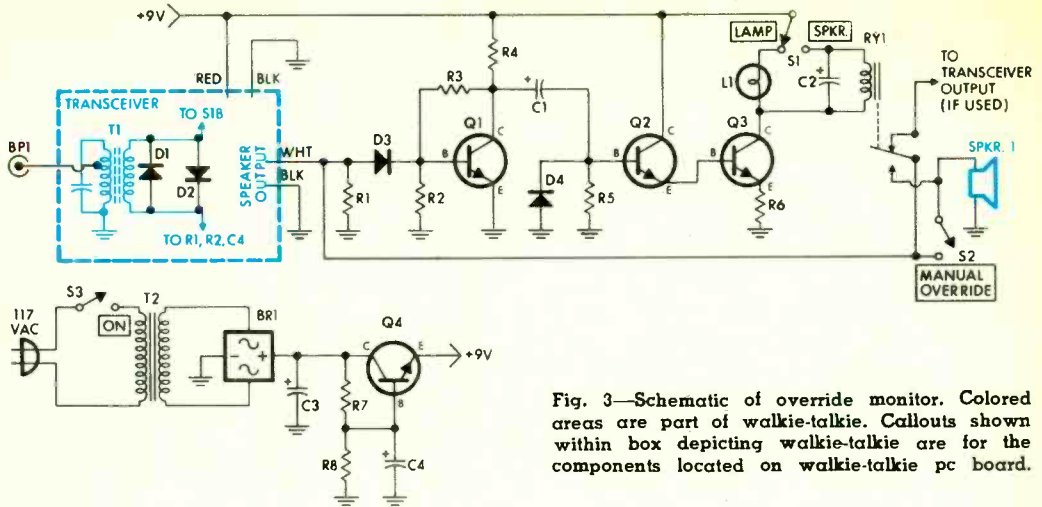

Fig. 3—Schematic of override monitor. Colored areas are part of walkie-talkie. Callouts shown within box depicting walkie-talkie are for the components located on walkie-talkie pc board.

PARTS LIST

BP1—Insulated five-way binding post
 BR1—Bridge rectifier; minimum ratings: 50 PIV @ 1 A (Motorola HEP-175 or equiv.)
 D1-D4—Germanium diode, 1N60 or equiv. (see text)
Capacitors: all 12-V electrolytic unless otherwise noted
 C1—5 μ f C2—50 μ f
 C3—250 μ f, 25-V electrolytic (see text)
 C4—100 μ f
 L1—Subminiature lamp; 12 VDC @ 30 ma.
 Q1-Q3—Npn transistor (see text)
 Q4—2N3393 transistor
Resistors: all $\frac{1}{2}$ watt, 10% unless otherwise indicated
 R1—47 ohms R2,R4—27,000 ohms

R3—270,000 ohms R5—1,000,000 ohms
 R6—33 ohms
 R7—10,000 ohms
 R8—15,000 ohms
 RY1—SPDT relay (P & B type RS5D-6 or equiv.)
 S1—SPDT switch
 S2,S3—SPST switch
 T1—RF transformer (part of walkie-talkie)
 SPK1—Speaker (part of walkie-talkie)
 T2—Power transformer; secondary: 12.6 V @ .1 A (Callectro D1-750 or equiv.)
 1—Walkie-talkie (Lafayette 99R 31452L)
 1—Channel 9 receive crystal (Lafayette 46R10, specify Channel 9)
 Misc.—4 x 5 x 6-in. aluminum cabinet, perboard, push-in terminals.

S2, labelled *Manual Override* in the schematic.

Diode D3 provides coupling between the walkie-talkie and the amplifier. Advantage is taken of D3's normal 0.3V breakover voltage. This provides low level noise limiting so the amplifier is not activated by impulse noise.

The lamp/relay amplifier has been specifically designed to use low-cost components. There is no need to spend money for high-quality components since there is no detectable change in the monitor's performance. The only critical component is transistor Q4. Since this transistor, a 2N3393, sells for pennies, we suggest no substitution be made.

Components Values. Transistors Q1, Q2 and Q3 can be any silicon NPN transistor housed in a TO-5 case. They should have a Beta, or gain, in the range of 80 to 150. Diodes D1, D2, D3 and D4 can be any germanium small-signal type of the 1N34 or 1N60 variety. Almost anything will work

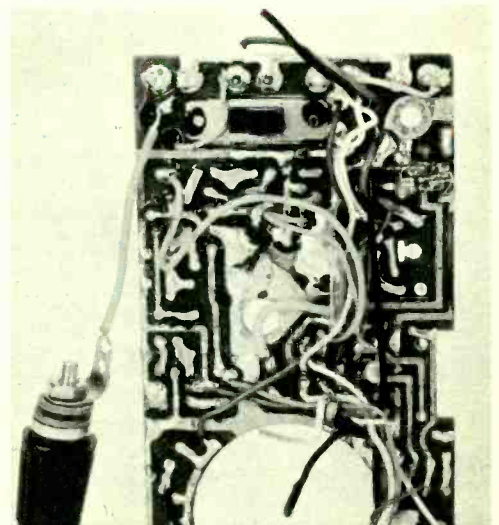

Fig. 4—Walkie-talkie printed-circuit board. Binding post BP1 is shown to the left, with wire leading to RF transformer. D1, D2 are at right.

Channel 9 Override Monitor

if it's the general-purpose type.

Relay RY1 is rated at 6 VDC with a coil resistance in the 500- to 600-ohm range. Transformer T2 is a 12 VAC filament type rated at 100 ma. or higher. Miniature power transformers are available from most electronic mail-order houses. See our Parts List.

Construction. First step is to modify the walkie-talkie. Remove the back of the case and cut the wire between the base of the telescopic antenna and the printed-circuit board.

Next, remove the three screws that hold the pc board to the case. Gently ease the board aside so you can get at the speaker. Remove all screws holding the speaker down to the cabinet. Then lift out the pc board and speaker as a single unit. As you lift out the pc board, the external power socket will also lift out.

Trace out the black wire from the walkie-talkie external power socket. It connects to



Fig. 6—Order Channel 9 receive crystal, at lower right edge of board, since walkie-talkie may not come with one. To order, see our Parts List.

the pc board. Clip the wire off at the board, making certain that no wire strands are sticking out from the board.

Trace out both red leads from the external power socket. You will find that one goes to the battery connector and one to the pc board. Unsolder the red lead going to the battery connector. Unsolder the other red wire at the pc board. And solder the red lead from the battery connector in its place.

Locate the tone beeper switch on the edge of the pc board. It is a SPDT type with a green wire, a black wire and a small capacitor connected to its terminals. Cut off the small capacitor. Then cut the green and black wires and remove the single screw that holds the switch to the pc board.

The green wire connects to one speaker terminal while the white wire connects to the other speaker terminal. Unsolder the green wire at the speaker and discard it. The black wire that formerly connected to the tone beeper switch becomes the new speaker lead, along with the white wire connected to the speaker.

Using diagonal cutters, clip off the shaft of the receive/transmit push switch and remove the transmit crystal from its socket.

The walkie-talkie is further modified by soldering diodes D1 and D2 across the RF input transformer. These diodes protect the walkie-talkie input from excessive RF voltage whenever your regular CB rig is in the trans-

[Continued on page 99]

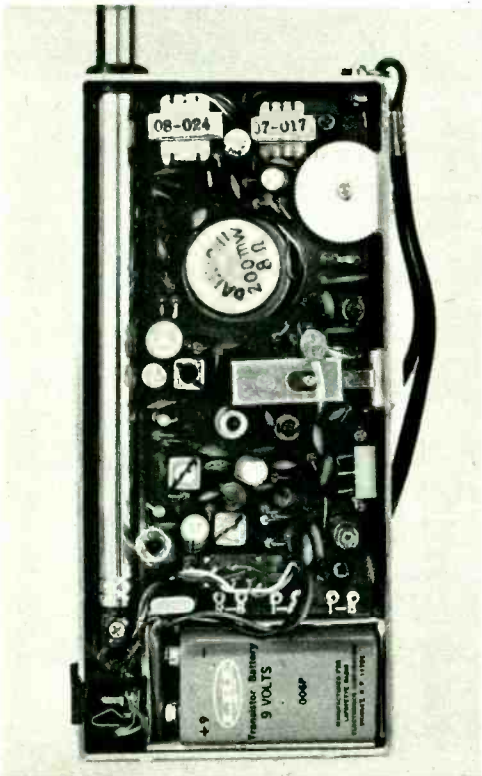

Fig. 5—This is what store-bought Lafayette model HA-73B walkie-talkie looks like before it's modified.

CB Corner

By Len Buckwalter,
KQA5012



Let's Hear it
for REACT!

ONE top cop in Ohio recently told police chiefs based around the country what he thought of CBers. A surprise—his report is a glowing tribute. Col. Robert Chiaramonte, Superintendent of the Ohio State Highway Patrol, told what happened when gendarmes and willing CBers sat down at the peace table to plot a strategy for aiding motorists in trouble. Highlights of what the Colonel said offer an interesting glimpse into what the other side may be thinking.

Eighty REACT teams (some 52,000 CBers) across Ohio agreed to monitor Channel 9 round-the-clock for emergency calls. When a motorist shouted for help, the CBer monitoring at home would relay the information by telephone to the proper authority (police, fire, ambulance, etc.). The CBer would then tell the motorist that help is on the way. All details would be logged on a standard report form which would ultimately reach a computer at General Motors Research Labs.

If the plan succeeded, Ohio troopers hoped to achieve a lot more than quicker reaction time. This saves lives, of course; but it also keeps highway traffic moving faster and cuts down on the hazardous pedestrian traffic of stranded motorists. It would also serve as a model for the rest of the country of what can be accomplished when police and CBers, finally, work together. (Some observers believe that many law enforcement people don't want free help from CBers because this might cut into their budget appropriations.)

During the first year, Ohio motorists did their thing and ran into accidents, fire, a tornado, fog, ice and other highway perils. They flooded the experimental network with 10,000 calls for help. After digesting the mass of data, GM's computers spat out some not-so-surprising results.

About 30 percent of the reports were roadway accidents, followed by stalled vehicles (22.2 percent). Accidents were almost equally distributed on interstate highways and city streets. In most cases (53.3 percent), monitoring CBers relayed reports directly to local police and also made calls to the state highway patrol.

More interesting were the details of computer data about who made the original calls on Channel 9 to trigger the network into operation. It was neither REACT teams nor other stations inside the organization. Most of the 10,000 streetside SOS's were transmitted by a CBer who unexpectedly encountered motorists in distress. Their alarms on Channel 9 alerted the monitors into action.

So the picture that emerges from the computer data is a communications colossus shrouding the state in three layers: a multitude of civilian CBers with mobile rigs going about their daily business, trained REACT teams keeping an ear on the emergency channel, and follow-through by professional, public-safety authorities.

It's not all roses, though. The number of calls reported by various REACT teams is variable. This could mean some groups are better organized or more motivated than others. Certain regions reported few calls, which suggests that all CBers don't automatically switch to Channel 9 when they encounter an emergency. Also, some monitors complained it was difficult to receive messages on Channel 9 because illegal interference blocked the frequency. All these points bear further investigation. But there is increasing agreement that Channel 9 is becoming a cleaner frequency.

Although the Ohio experiment is not yet complete, Col. Chiaramonte is already suggesting that law enforcement agencies everywhere can benefit by cooperating with CBers. He points out that these experiments have shown that a network of this type can get police and other rescuers on the scene an average of 17 minutes earlier than before.

He also cautions fellow professionals that success isn't easy to achieve. All concerned parties—police and CB representatives—must sit down to determine how to carve up an area and assign responsibility. Colonel Chiaramonte strongly believes that control over the program must be firmly held by the law enforcement people or CB volunteers will risk losing official recognition. He reveals

[Continued on page 103]



Cleveland Institute of Electronics

MONEY-BACK WARRANTY

**of success in obtaining a
Government FCC License**

The Cleveland Institute of Electronics hereby warrants that upon completion of the Electronics Technology (with or without Lab), Broadcast Engineering, or First Class FCC License course, you will be able to pass the FCC examination for a First Class Commercial Radiotelephone License (with Radar Endorsement);

OR upon completion of the Electronic Communications course you will be able to pass the FCC examination for a Second Class Commercial Radiotelephone License;

AND if you are unable to pass the FCC test for the course selected, you will be entitled to a FULL REFUND of all tuition payments.

This famous warranty is valid during the entire completion period established for the course you are enrolled in.

G. O. Allen

Dr. G. O. Allen
President

You can earn more money if you get an FCC License

...and here's our famous CIE warranty that you will get your license if you study with us at home... or your money back!

NOT satisfied with your present income? The most practical thing you can do about it is "bone up" on your Electronics, pass the FCC exam, and get your Government License.

The demand for licensed men is great and still growing. Ten years ago there were more than 100,000 licensed communications stations, including those for police and fire departments, airlines, the merchant marine, pipelines, telephone companies, taxicabs, railroads, trucking firms, delivery services, and so on.

Today, there are nearly two million such stations on the air, and the number is growing constantly. And according to Federal law, no one is permitted to operate or service such equipment without a Commercial FCC License or without being under the direct supervision of a licensed operator.

This has resulted in a gold mine of new business for licensed service technicians. A typical mobile radio service contract pays an average of about \$100 a month. It's possible for one trained technician to maintain eight to ten such mobile systems. Some men cover as many as fifteen systems, each with perhaps a dozen units.

Growth of UHF and CATV

To the 500 or so commercial VHF television stations now in operation and nearly 200 commercial UHF stations, add 200 more educational TV stations. And at the start of the Seventies more than 2,500 cable television stations are serving 4,000 communities.

Opportunities in Industry

And there are other exciting opportunities in aerospace industries, electronics manufacturers, telephone companies, and plants operated by electronic automation. Inside industrial plants like these, it's the licensed technician who is usually considered first for promotion and in-plant training programs. The reason is simple. Passing the Federal Government's FCC exam and getting your license is widely accepted proof that you know the fundamentals of Electronics.

So why doesn't everybody who "tinkers" with electronic components get an FCC License?

The answer: it's not that simple. The Government licensing exam is tough. There is one way, however, of getting the kind of preparation that will help you pass the FCC exam. And that is to take one of the FCC license-preparation courses offered by Cleveland Institute of Electronics.

Our training is so effective that better than 9 out of 10 CIE graduates pass the FCC exams. That's why we can offer this famous Money-Back Warranty: when you complete any CIE course which provides FCC License preparation, you'll get your FCC License or a full refund of all tuition paid. This warranty is valid during the entire completion period established for the course selected. You get your FCC License — or your money back.

There's a reason for this remarkable record. From the beginning, CIE has specialized in electronics courses designed for home study. We have developed techniques that make learning at home easier... even if you've had trouble studying before.

In a Class by Yourself

The CIE Instruction Department gives immediate attention to the lessons and questions you send in. It's like being the only student in the "class." Instructors not only grade your work, they also analyze it. Even your correct answers can reveal misunderstandings that the instructors can help you clear up. The corrections and comments are mailed back to you the same day your assignment is received. You can read the notations while everything is still fresh in your mind.

It Really Works

Our files contain hundreds of success stories of men whose CIE training has gained them their FCC "tickets" and admission to a higher income bracket.

David Ferreira of San Diego, California, boosted his earnings and got a promotion after getting his FCC License. He says, "Even before I finished the course, I passed my First Class FCC License test. Since then I've been able to buy a home, get a camper and travel with my family."

CIE graduate, Rondlay Holmes, broadcast engineer for WKBF-TV, Cleveland, Ohio, passed his First Class FCC License exam on the first try. "Now I'm earning three times what I did before my CIE training," writes Holmes.

Mail Card for Two Free Books

Want to know more? The postpaid reply card will bring you free copies of our school catalog describing opportunities in Electronics, our teaching methods, and our courses, together with our special booklet, "How to Get a Commercial FCC License." If card has been removed, just mail the coupon at right.

CIE HAS CAREER COURSES TO FIT YOUR BACKGROUND

ELECTRONICS TECHNOLOGY with LABORATORY... teaches you the fundamentals. With a 161-piece laboratory you apply the principles you learn by analyzing and trouble-shooting electronics equipment.

ELECTRONICS ENGINEERING... A college-level course for men already working in Electronics. Covers steady-state and transient network theory, solid-state physics and circuitry, pulse techniques, computer logic and mathematics through calculus.

THESE CIE MEN PASSED THE FCC LICENSE EXAM... NOW THEY ARE EARNING MORE MONEY

From Tugboat to Television

"When I started my CIE electronics training, I was working in the engine room of a tugboat. Before finishing, I passed my First Class FCC License exam and landed a job as a Broadcast Engineer at KDFM-TV in Beaumont. I was able to work, complete my CIE course and get two raises... all in the first year of my new career in broadcasting. The course was interesting and well written."—Richard L. Kihn, Anahuac, Texas.



New Job with 40% More Pay

"CIE has taken me from a dull low-pay job with little chance for advancement to one with challenge and a good future. I'm now an Engineering Specialist with National Radio Company, Inc. testing prototype equipment. CIE training gave me the electronics technology I needed to pass the exam for First Class FCC License. I'm already earning 40% more than I could without my CIE training."—Joseph E. Perry, Cambridge, Mass.



APPROVED UNDER NEW G.I. BILL: All CIE career courses are approved for full tuition refund under new G.I. Bill. If you served on active duty since January 31, 1955, OR are in service now, check box on reply card or coupon for G.I. Bill information.

Cleveland Institute of Electronics

1776 E. 17th St., Cleveland, Ohio 44114

Please send me without cost or obligation:

1. Your illustrated book, "Succeed in Electronics."
2. Your book on, "How to Get a Commercial FCC License."

I am especially interested in:

- | | |
|--|---|
| <input type="checkbox"/> Electronics Technology | <input type="checkbox"/> Electronic Communications |
| <input type="checkbox"/> Broadcast Engineering | <input type="checkbox"/> Industrial Electronics |
| <input type="checkbox"/> First Class FCC License | <input type="checkbox"/> Electronics Engineering |
| | <input type="checkbox"/> Electronics Technology with Laboratory |

Name _____ (PLEASE PRINT)

Address _____

City _____

State _____ Zip _____ Age _____

Veterans & Servicemen: check here for latest G.I. Bill information. E1-05

CIE Cleveland Institute of Electronics
1776 East 17th Street, Cleveland, Ohio 44114

Accredited Member
National Home Study Council

DXing NASA and its Neighbors

Listening to NASA broadcasts isn't easy —fact is, it's almost impossible — but you can DX radio stations that are neighbors of NASA affiliates and which are located all over the globe. Our DX expert tells how.

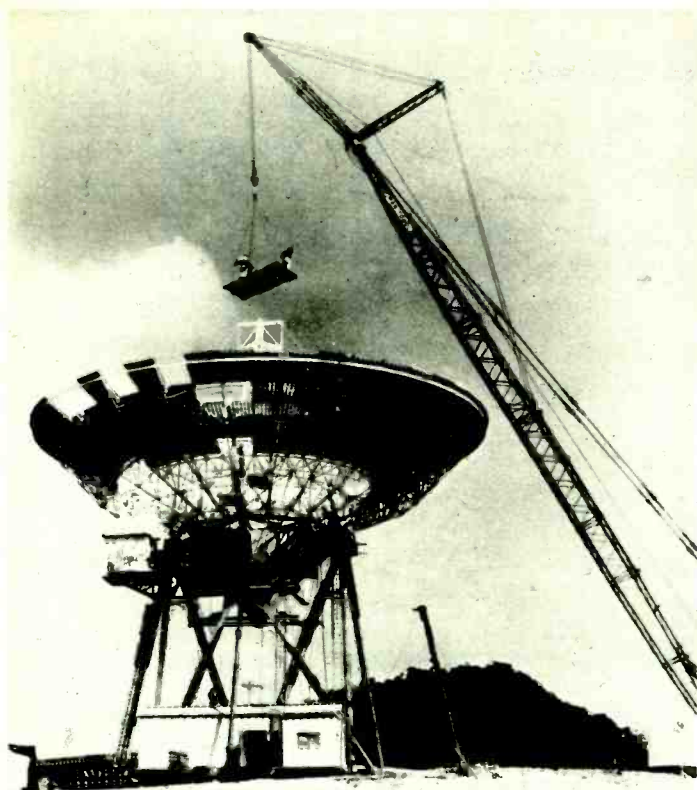

By ALEX BOWER YES, things are coming down to the wire. Apollo XVI is scheduled to blast off as this is being written and Apollo XVII—the last of the series—is scheduled for a December launch. For quite some time DXers have wanted to log the exciting conversations that take place between Houston and Cape Kennedy, between Ground Control and the spacecraft, between Command Module and Lunar Module.

Only trouble is, most of us don't have the fancy equipment that goes along with these transmissions. As you can see from NASA's frequencies, few involve voice communications—most being advanced forms of telemetry that make use of pulse-code, frequency and phase modulation techniques.

What rag-chewing there is takes place up at rarefied frequencies lying between 200 and 300 mc. Other more-informal talk sessions enjoy a bigger spread—some taking place near the FM broadcast band, others popping a cork up in the microwave region around 2000 mc.

So what's an average DXer to do? Well,

don't walk away. Aside from the ultra-sophisticated DXer who works 2 meters via moonbounce or engages in other RF gymnastics at even higher frequencies (who manages to listen in on these private transmissions, but rarely gets QSLs) there is still some DX activity left for those SWLs who work the standard bands.

While Cape Kennedy now only contacts space vehicles directly when they're orbiting the Earth—all deep-space contacts are handled by five communications facilities scattered around the world that work super DX on frequencies such as 2106.4 and 2101.8 mc—the Cape still maintains shortwave communications for such chores as recovery of the space capsule. DXers have a good chance of logging these messages on frequencies such as 17979, 11205 and 9006 kc, especially during launch and splash-down. These transmissions are all via single sideband.

Other NASA IDs which can be bagged on these same frequencies include the islands of San Salvador, Grand Bahama, Ascension and Lajas (Canary Islands). Your reports should be addressed to the technician in charge,

Guide to DXing NASA's Neighbors			
Freq. (kc)	Station	Location	Time
590	KFXM	San Bernardino	0400
683	R. Nacional de Espana	Madrid	evenings
730	5CL	Adelaide, Australia	0500
860	WKKO	Cocoa, Fla.	sunrise/sunset
6090	VLI6	Sydney, Australia	before sunrise
6140	R. Nacional de Espana	Madrid	evenings
9006	Cape Kennedy And Atlantic Recovery Net		(see text)
9360	R. Nacional de Espana	Madrid	evenings
9560	Radio RSA	Johannesburg, S. Africa	evenings
9695	Radio RSA	Johannesburg	evenings
11205	Cape Kennedy And Atlantic Recovery Net		(see text)
17979	Cape Kennedy And Atlantic Recovery Net		(see text)

Chart above shows stations that are close to NASA communications facilities and which count as valid contacts. Chart at right lists many of the frequencies which will be used on final Apollo missions. Most are for data transmission and radar tracking. The contents are private and not to be divulged.

Radio Unit — (ID of station), Patrick Air Force Base, Fla.

Remember that technicians who verify a report are doing it for their own amusement and for the sake of the hobby. NASA officials do not recognize such reports—they feel that their messages are private communications whose revelation can only confuse the public about the nature of a specific mission—and it's practically impossible to get a formal reply from the space agency.

Since Cape Kennedy is probably too close to home for any technician who wants to verify even the simplest DX report, you'll be better off shooting for one of the BCB stations in the area of Cocoa Beach. Not easy logging, to be sure, but WKKO on 860 kc might be possible at either sunrise or sunset (Florida time). A lot will depend on your local QRM.

The major deep-space communications facility in the U.S. is at Goldstone Lake, Calif., located between Death Valley and the Mojave Desert on the Camp Irwin Military Reservation. Shortwave facilities are nil so you'll have to settle for more mundane stations located in San Bernardino County. Sta-

Guide to Spaceflight Frequencies for Apollo Missions			
Freq. (mc)	Mode	Power	Function
232.9	FM TEL	20 W	Launch Vehicle, XVII
234.0	FM TEL	20 W	Launch Vehicle, XVI
240.2	FM TEL	20 W	Launch Vehicle, XVII
241.5	FM TEL	20 W	Launch Vehicle, XVI
243.0	beacon	3 W	Spacecraft Recovery
244.3	PCM TEL	20 W	Launch Vehicle
245.3	PCM TEL	15 W	Spacecraft
248.6	PCM TEL	20 W	Launch Vehicle
250.7	FM TEL	20 W	Spacecraft
256.2	FM TEL	20 W	Launch Vehicle
258.5	PCM TEL	15 W	Launch Vehicle
259.7	VC	10 W	Spacecraft to Earth, Lunar Surface
279.0	VC/TEL	10 W	Space Suit
296.8	VC	10 W	Space to Earth
296.8	VC	100W	Earth to Spacecraft
450.0	TC	10kW	Earth to Launch Vehicle
2101.8	USB DL	10kW	Earth to Spacecraft
2106.4	USB DL	10kW	Earth to Spacecraft
2265.5	USB DL	8 W	Lunar Surface to Earth
2272.5	USB TEL	20 W	Spacecraft
2282.5	USB DL	20 W	Spacecraft
2287.5	USB DL	20 W	Spacecraft
5690.0	radar	3MW	Tracking Radar Interrogation
5765.0	radar	4.5kW	Spacecraft Radar Transponder
9580.0	radar	0.5 W	Spacecraft Landing Altimeter
9792.0	radar	1.7kW	Spacecraft Rendezvous Radar
9832.8	radar	1.7kW	Spacecraft Rendezvous Radar
10510.0	radar	0.5 W	Spacecraft Landing Velocity

TEL—Telemetry, DL—Data Link, VC—Voice Communications, TC—Telecommand, PCM—Pulse Code Modulation, USB—Upper Sideband

tion KFXM on 590 kc is probably your best bet. If you live west of the Mississippi you shouldn't have too much difficulty on Monday mornings at 0100 PST.

Ironically, both the European and African deep-space communications sites are more easily logged by DXers. NASA's link in Madrid is only a few miles away from Radio Nacional de Espana's shortwave station, while NASA's deep-space facility near Johannesburg is not far from the powerful transmitters of Radio RSA.

Radio Nacional de Espana beams English-language broadcasts to the Americas every evening on 6140 kc and Spanish programs on 9360 kc. If you want a bit more of a challenge, try RNE's medium-wave broadcasts on 683 kc, heard from time to time in North America.

The Johannesburg facility, unlike the stations in Madrid and at Goldstone Lake, isn't owned by the U.S. It belongs to the South African government. Radio RSA programs often make much of the fact that Johannesburg has played a vital role in America's con-

[Continued on page 103]

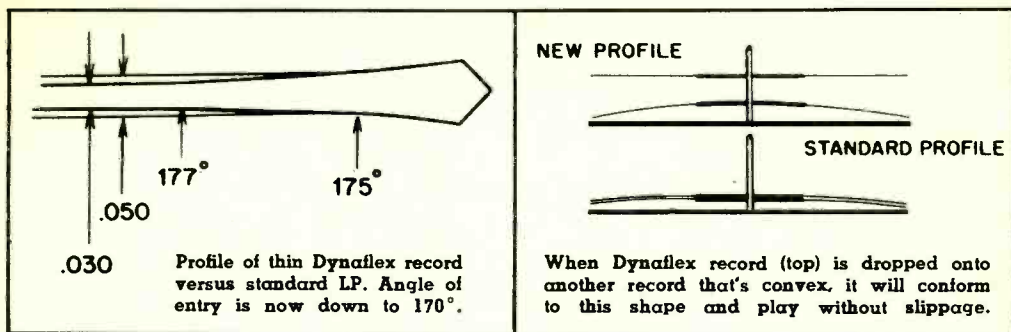

The Thin Look Comes to Records

Watch it! The next LP record you buy may have a thin profile. Companies want to save on materials and still improve quality.

By **ROBERT ANGUS**

IF you've been buying records lately, maybe you've noticed that they're thinner than they used to be. If one of your recent purchases was an RCA release, chances are you can almost bend it double with one hand. If so, when you release it, the record springs back to original form. Fact is, since January 1971, RCA has produced more than 18 million thin records on its own labels and for other record companies whose discs it presses. Even new record releases with labels like Decca and Pickwick are thinner than they used to be.

Right there's the trouble, say some engineers. Thin records are too light to work properly on a record changer. Also, they droop on certain types of spindles. Because of their thinness, say these mavens, they're subject to warpage, which interferes with player performance.

Engineers of one manufacturer estimate that 6½ million record changers sold in the U.S. last year can't handle thin records properly. The largest changer manufacturer of them all, BSR, has considered packing a warning in with its equipment saying that it isn't guaranteed to work with thin records.

Has RCA dug up a rotten fish? Or are changer manufacturers excited over nothing? To understand the controversy, it helps to know that for more than two decades, the 12-in. LP record has been a vinyl biscuit weighing about 135 grams and measuring approximately 50 thousandths of an inch

thick. It has had its faults. LP records warp on occasion and once bent they're virtually impossible to straighten again. Surface noise is not as unobtrusive as engineers would like; also, as records age tiny bubbles of gas trapped within the record work their way to the surface and break, causing still more surface noise.

The Record Industry Association of America (RIAA) established standards for record manufacture some time ago. It decreed that when it comes to records, a foot actually measures 11-7/8 in., with a variation of no more than 1/32 in. Also, the angle of entry of the stylus (the angle formed by the record's surface and the protective bead on the rim) should be a minimum of 175°. Finally, weight would be 135 grams ±10 grams. This was done so that record-changer manufacturers could design equipment around a uniform product.

After the RIAA stepped in, complaints by users that record changers were dropping two discs at once—or worse, not dropping them at all—ceased almost overnight. Failure rates on record changers dropped well below the ratio of one change in 100.

Enter **Dynaflex**, a record weighing only 90 grams, having a thickness (in its playing area) of 30 mils and an angle of entry of 177°. It was developed at RCA's engineering facility in Indianapolis, under the leadership of chief engineer Warren Rex Isom.

The new disc has several virtues. When

bent, it springs back readily. Because of the thickness of the disc, molding procedures avoid the air bubbles which have plagued older LP records so its surfaces are quieter. For the accountants at RCA the new profile represents a tremendous savings in materials like carbon black and vinyl.

According to Isom, RCA tested the new discs on 22 record-changer models selected at random. These included such standard brands as Admiral, BSR, Garrard and Dual. In hundreds of cycles, the records produced an average of two failures per 100 changes, which the company regards as normal. One changer failed an average of four times per 100 changes. When RCA's thin records passed that test the company proceeded to send some 5 million of them to record stores . . . unmarked.

"There were a few hundred letters of complaint," Isom said later, "but the vast majority of these were in the realm of aesthetics. Sometimes the phrase paper-thin was used. Perhaps a third of these respondents were sure that they had been robbed of vinyl to the enrichment of the manufacturer. (RCA denies this.) Relatively few complained of genuine faults."

Initial reaction to the new record profile from audio critics and record reviewers generally confirmed Isom's opinion that the surfaces were quieter. However, at retail outlets, customers were complaining that their record changers wouldn't drop the thin discs. In fact, while RCA was talking about unusually low numbers of complaints, dealers were telling complaining customers that the fault lay with their own equipment. However, it wasn't until audio engineers erupted at a meeting in Los Angeles that these charges took specific form. Finally, Isom and RCA responded.

The engineers said that RCA hadn't conducted enough tests, that the new records tend to drop in pairs because of their thinness (or not drop at all, or that a second disc would drop on top of the tone arm after it had swung back into position to play the first—because of some kind of attraction between pairs). Warpage was a more serious problem than RCA would admit, they said.

When BSR purchased some Dynaflex records in the New York City area for testing, one weighed in at 56 grams instead of the proper 90. Others were 10 to 20 grams light, well outside manufacturing tolerances established by RCA. (Since the introduction of

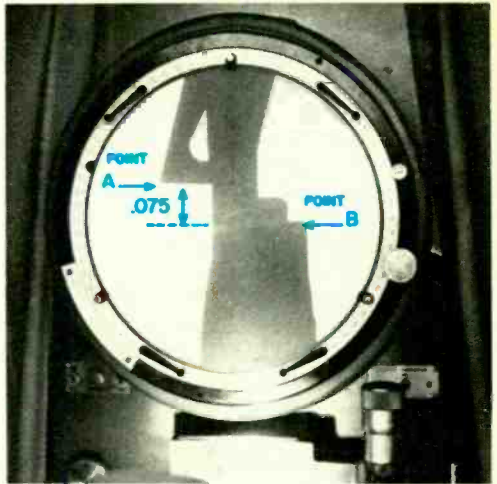

Magnified view of feed-lever mechanism in record-changer spindle. Distance of 0.075 mills (between A and B) should be wide enough for one disc.

Dynaflex, RCA has tightened up its quality control and has instructed record press operators in new handling procedures.) BSR went on to test 100 thin discs on a variety of its own changers and those of its competitors. It discovered that while some complaints had validity others were baseless.

During its testing BSR found that double dropping occurs less frequently than originally believed—and then only when particular pairs of records are played in sequence.



Because record's center of gravity is critical for proper operation of changer, RCA tests its Dynaflex discs for thickness at several different points.

The Thin Look Comes to Records

"It seems that certain pairs of Dynaflex records develop a vacuum between them," says a representative from BSR. "We'd find the same pair of records giving trouble on changer after changer." To test the vacuum theory, BSR people drilled three holes through the labels of each pair. The problem disappeared almost immediately.

At its laboratories in Birmingham, England, BSR placed a Dynaflex record on the 7-in. platter of a BSR Minichanger. A technician left the stylus—tracking at a weight of eight grams—on the outside groove of the record for a weekend, while the temperature of the testing room was increased to 90°F.

By Monday morning the stylus had sunk $\frac{1}{4}$ in. below the surface of the record. When the stylus was removed, there was a permanent deformation of $\frac{1}{8}$ in.

"But that's not a standard playing condition," Isom later protested. "Nobody leaves the stylus in the outer groove of a record for a weekend." BSR engineers pointed out that under the best of circumstances, the stylus had to climb approximately $\frac{1}{8}$ in. as it moved from the outer groove to the inside of a 12-in. record played on such a small turntable.

Basically, the average record changer works on one of two principles: A feed lever holds a stack of records on a spindle until the changer begins its cycle. Then the lever

moves up enough to admit one record—a distance of roughly 0.075 mils. Or, with an umbrella type spindle (which consists of three or four umbrella supports that hold up the record stack), as the changer cycles, the supports fold in and metal leaves come out to hold all but the bottom record. Then the record drops.

Critics have said that both methods spell disaster for Dynaflex. If a feed lever moves a distance of 0.075 mils but a Dynaflex disc measures only 0.059 mils thick at the center hole, then possibly two may slip through when the lever moves up. With the umbrella spindle, according to critics, if the Dynaflex record should droop, causing friction against the sides of the spindle, then proper dropping of the record would be prevented.

"The changer manufacturers introduced the umbrella spindle without a word to the record industry several years ago," according to W. Rex Isom. "Umbrella spindles work on the assumption that the center of gravity of each record is within a circle only about $\frac{5}{16}$ in. in diameter. Until two years ago, there was no such specification and the center of gravity varied greatly. A slight excess of vinyl on one side of the disc, a pull on the center hole as the operator removes the record from a molding machine while the vinyl is still hot, a slight deformation on the outer edge if she grabs it with one hand instead of two—these were enough to cause trouble even when the damage could barely be detected with the naked eye. Now the RIAA has a standard—that the center of gravity fall within 0.315 in. of the center of the record—and manufacturers meet it most of the time."

RCA's vice president in charge of manufacturing, Bill Dearborn, told EI that balance problems can occur when two Dynaflex records both have gravity centers near the outside limit and when both discs are lined up with their heaviest areas on the same side of the spindle. "It also happens with older records and nobody complains about it," he says.

Dearborn says that in RCA's tests, both feed-lever and umbrella changer mechanisms produced about the same number of failures with ordinary LPs as with RCA's thin disc. "In fact," he says, "it's possible to guarantee a failure every time by loading a feed-lever changer so that the feed lever is pushed up out of position."

[Continued on page 104]

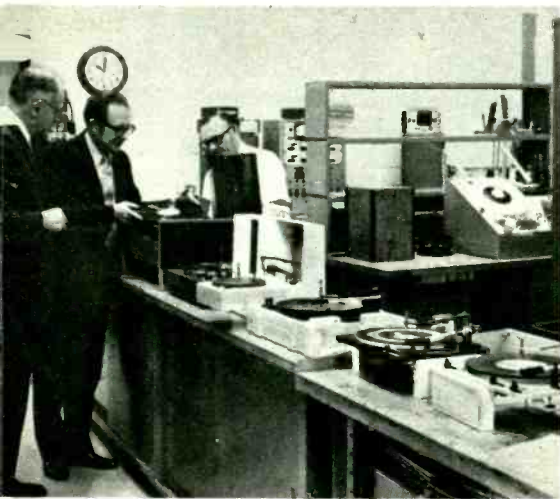

RCA engineering chief W. Rex Isom (left), manufacturing vice president Bill Dearborn (center) and technician test Dynaflex LP on a changer.

Enter EI's Big Hi-Fi Contest and Win a Cash Prize!

In the next issue EI will begin publishing photographs and descriptions of outstanding home hi-fi installations. In each issue we'll select what we consider to be the best installation among those entered and will award the owner a \$200 cash prize. Second prize will be worth \$100, third prize \$50 and fourth prize \$25. We'll publish pictures of all four, of course. General design and ingenuity will be among the judging criteria. Cost and actual amount of equipment will not be considered. EI's Editors will be the judges. To enter your installation in our contest, whether it be monaural, stereo or four-channel, simple or complex, send us one or more good black-and-white photographs (8x10s preferred), a list of your equipment and a description of what you've done. Pack the pictures well to avoid damage. We will return all unused photos. Mail your entry to:

EI's Hi-Fi Contest
1515 Broadway
New York, N.Y. 10036

WIN \$200...\$100...\$50...\$25!

Build a Direct-Reading

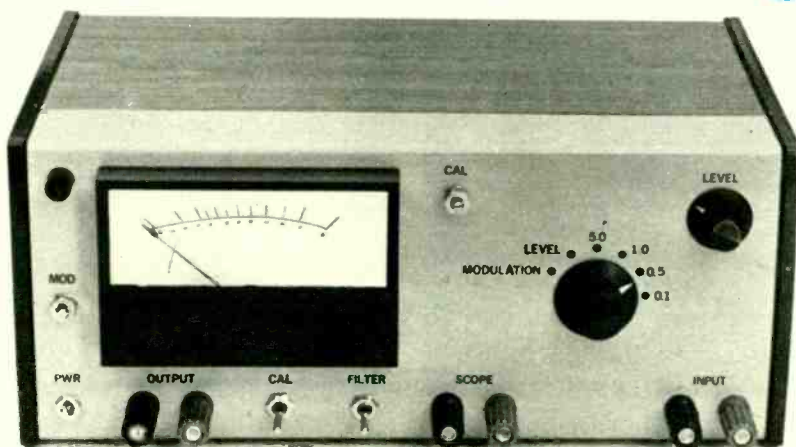

Wow & Flutter Meter

By HARRY KOLBE

EVERYBODY who leans toward the serious side of audiophilia talks about wow and flutter. But almost nobody does anything about it—or them—depending on how many different bad guys you find amongst the three words. In fact not too many hi-fi fans know how one goes about making meaningful measurements of wow and flutter.

But most of us can talk intelligently about wow and flutter because we've heard these culprits at work. Wow and flutter are the retchings of music from record or tape when subjected to periodic and queasily regular variations in the speed of turntable or tape deck. If these draws and swells go slowly (under 6 cps) they're called *wow*; if more quickly (up to 250 cps) they're called *flutter*. So they're a little different, one from the other, while remaining close cousins under the skin.

Our Wow & Flutter Meter almost for the first time enables a non-pro, outside-the-lab hobbyist to substantiate what he believes he's hearing. Our meter also helps to determine exactly how much wow and flutter he has to deal with in terms of percentage of speed variation. And it's an instrument any experienced hobbyist can build and calibrate successfully.

Though wow and flutter could be the re-

sult of either a positive speed variation (with record or tape going faster than spec and then back to spec) or a negative swing (slower than and then back to spec), the direction of swing means little. It's the swing or variation itself that causes the trouble and typically may be due to an out-of-round rotating component.

Essentially, speed variations frequency-modulate program material. You can hear the problem best on a sustained musical tone, such as a long organ note. As turntable or transport speed increases, tone frequency increases proportionally. As speed decreases, frequency dips.

Many years ago researchers came up with a numerical way of specifying degree of speed variation. The unit of measurement is RMS percentage of speed variations. RMS stands for Root-Mean Square, a term often used in AC voltage measurements. The RMS concept is a convenient way to transform a periodically-changing quantity into an equivalent steady (non-changing) quantity.

Let's relate RMS percentage to wow and flutter. We'll take a turntable with a particularly bad case of wow at a frequency of 4 cps. This means the turntable speeds up or slows down significantly four times each second. If you draw the pattern of speed variation

Fig. 1—Majority of components are mounted on pc board, shown almost half-size at right. IC mounting sockets could be utilized on your board if you don't like soldering directly to IC leads. Tolerance of components is not critical but best overall meter accuracy is assured with values and tolerances called for in Parts List. Be sure to use shielded cable where called for on schematic. Solder shield wire only at points designated in schematic.

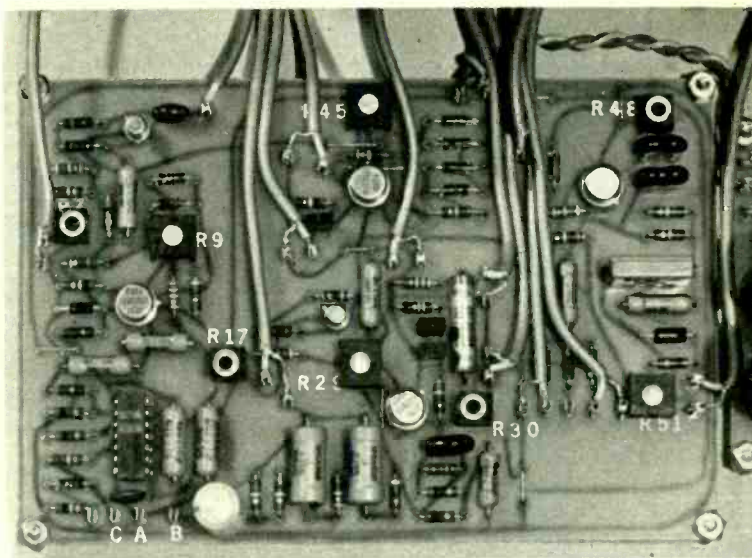

on a piece of graph paper you end up with a curve shaped like a sine wave.

The RMS reading of this periodically-changing function (speed vs time) is a convenient average value that makes it easy to compare turntable specs and, in general, to talk about flutter and wow. You use standard AC calculation formulas to compute RMS percentage—only now, instead of working with peak and peak-to-peak voltages, you use *peak-to-peak percentage speed error*.

Thus, a faulty turntable might display $\pm 5\%$ peak speed variations, running both faster and slower than spec. The peak-to-peak

percentage variation would be 10% so the RMS percentage would work out this way:
 $0.707 \times \text{Peak Variation} = 0.707 \times 5\% = 3.54\% \text{ RMS.}$

In this issue we're presenting Part I, which tells how our Wow & Flutter Meter operates, how you can use it, the functions of the various components and circuits found in the schematic and a Parts List. In our next issue we'll present detailed construction information, data on calibration, more advice on the use of the instrument and, lastly, some tips on how to cure what our Wow & Flutter Meter has diagnosed.

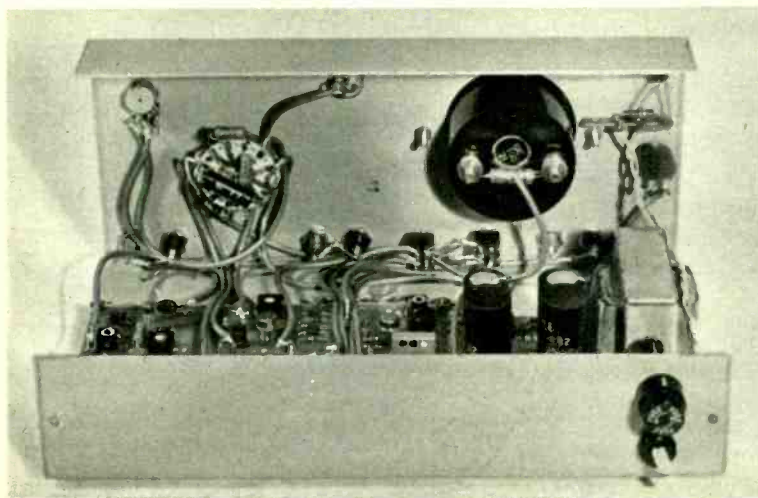

Fig. 2—Power supply is mounted on separate pc board, shown to right of main board. M1 is shown on front panel with C17 connected across its terminals. M1 and C17 are wired to remainder of circuit via shielded cable but two unshielded wires twisted together work as well. Range switch S4 is to left of M1. Between S4 and M1 is pot R41 (Cal). To the left of S4 is pot R1 (Level), while to the right of M1 is pot R56 (Modulation).

Build a Direct-Reading Wow & Flutter Meter

How it Works

The output from your tape deck or pre-amplifier is fed to pot R1 (*Level*) via binding posts BP1 and BP2. The signal is coupled to the gate of transistor Q1, connected as a source follower. Since Q1 only slightly loads pot R1, the input impedance of the Wow & Flutter Meter is effectively 500,000 ohms—a value sufficiently high to work from any source.

The signal from Q1 is injected into IC1, a device which directly converts incoming sine waves of varying amplitude to square waves having equal amplitude. Normally, IC1 is in a non-conducting state. There is no output signal from IC1 at this time.

When a signal is fed into it, IC1 switches into its conducting state. Ordinarily, there is no output signal from IC1. But when a signal reaches IC1, it switches into a conducting state. The IC conducts as long as a signal is present at the input terminal.

The output of IC1 is a square wave having a pulse width equalling the frequency of the input waveform. If the input is not a pure sine wave, the duty cycle of the square waves from the output of IC1 will vary from waveform to waveform. This unequal duty cycle is the result of the wow and flutter signal component modulating the otherwise-pure 3-kc test signal. It is the parameter we are looking at as the meter needle swings up and down the scale.

Potentiometer R9 provides a DC voltage to IC1, forcing it to conduct only when the input signal reaches a particular level. This method of biasing the integrated circuit insures that it doesn't respond to noise and other spurious signals appearing at the input terminals.

The square-wave output signal is coupled via components C3, R14 and R15 to the input of integrated circuit IC2. This IC is a phase-locked loop device and contains an oscillator, amplifier and detector built into the chip.

The IC's oscillator is initially adjusted via pot R17 to 3,000 cps. The frequency of this oscillator and the input frequency is compared in IC2's detector. After the two frequencies are sampled by the detector, a DC output signal emerges from the detector.

[Continued on page 97]

PARTS LIST

- BR1—Motorola HEP-175 or equiv.
 BP1-BP6—Insulated five-way binding post
 Capacitors: 200 V unless otherwise noted
 C1—150 μ f silver mica C4,6—.022 μ f
 C2,3,15,21,22,27—.01 μ f C5—.001 μ f
 C7—100 μ f, 15 V electrolytic C8,9—.1 μ f
 C10—.0039 μ f C11—330 μ f silver mica
 C12,13,16—10 μ f, 10 V tantalum electrolytic
 C14—1 μ f, 35 V tantalum electrolytic
 C17—10 μ f, 25 V electrolytic
 C18,19—1000 μ f silver mica
 C20—1800 μ f silver mica
 C23,24—1000 μ f, 15 V electrolytic
 C25,26—1000 μ f, 25 V electrolytic
 D1-D8—1N458 or equiv.
 *D9—Motorola MV-1666 (Varicap)
 D10,11—Zener diode; 12 Volts @ 1 watt
 (Motorola HEP-105 or equiv.)
 D12—Zener diode; 6.2 Volts @ 1 watt
 (Motorola HEP-103 or equiv.)
 F1— $\frac{1}{4}$ -A fuse
 IC1—Integrated circuit (Fairchild U5B7710393)
 IC2—Integrated circuit (Signetics NE 565)
 See note below.
 IC3-5—Integrated circuit (Fairchild U9T7741393)
 M1—VU meter (Simpson 543 or equiv.)
 NL1—Neon lamp (NE-2 or equiv.)
 Q1,2—2N4220A transistor
 Resistors: all $\frac{1}{4}$ -watt, 5% unless otherwise noted
 R1—1,000,000-ohm, audio-taper pot.
 R2,54—5,600,000 ohms R3—1,200 ohms
 R4,36,47—47,000 ohms
 R5,15,16—1,000 ohms
 R6,11,21,53—10,000 ohms
 R7,17—5,000-ohm, single-turn pot.
 R8—2,700 ohms
 R9,59—1,000-ohm, single-turn pot.
 R10—4,700 ohms R12—33,000 ohms
 R13—510 ohms R14—6,200 ohms
 R18—62,000 ohms
 R19,26,27,52—1,000,000 ohms
 R20,22,49,50,55—51,000 ohms
 R23,44—15,000 ohms R24—12,000 ohms
 R25—9,100 ohms R28—1,800,000 ohms
 R29,45,51—10,000-ohm, single-turn pot.
 R30,48—50,000-ohm, single-turn pot.
 R31—1,300 ohms R32—13,000 ohms
 R33—330,000 ohms R34—3,300,000 ohms
 R35—1,500 ohms R37—5,000 ohms, 1%
 R38—620 ohms, 1% R39—500 ohms, 1%
 R40—120 ohms, 1%
 R41—250-ohm, linear-taper pot.
 R42,43,46—100,000 ohms
 R56—10,000-ohm, linear-taper pot.
 R57,58—68 ohms, $\frac{1}{2}$ watt
 R60—82,000 ohms S1—DPDT switch
 S2—SPDT switch S3—SPST switch
 S4—2-pole, 6-position shorting, rotary ceramic
 (Centralab PA-2002)
 T1—Power transformer; secondary: 25 V @ 0.5 A (Calectro D1-752)
 1—10 $\frac{1}{2}$ x 4 $\frac{1}{2}$ x 6 $\frac{1}{4}$ -in. cabinet. Ten-Tec MW-10 (Available from Ten-Tec, Inc., Industrial Park, Sevierville, Tenn. \$11 plus postage)
 Misc.—dry-transfer lettering, fuseholder, neon lamp assembly, printed circuit board and supplies, shielded audio cable.
 *Available from Newark Electronics, 500 N. Pulaski Rd., Chicago, Ill. 60624 \$3.60 plus postage. Minimum order \$10.
 Note: IC2 available from Circuit Specialists Co., P.O. Box 3047, Scottsdale, Ariz. 85257 \$9 postpaid.

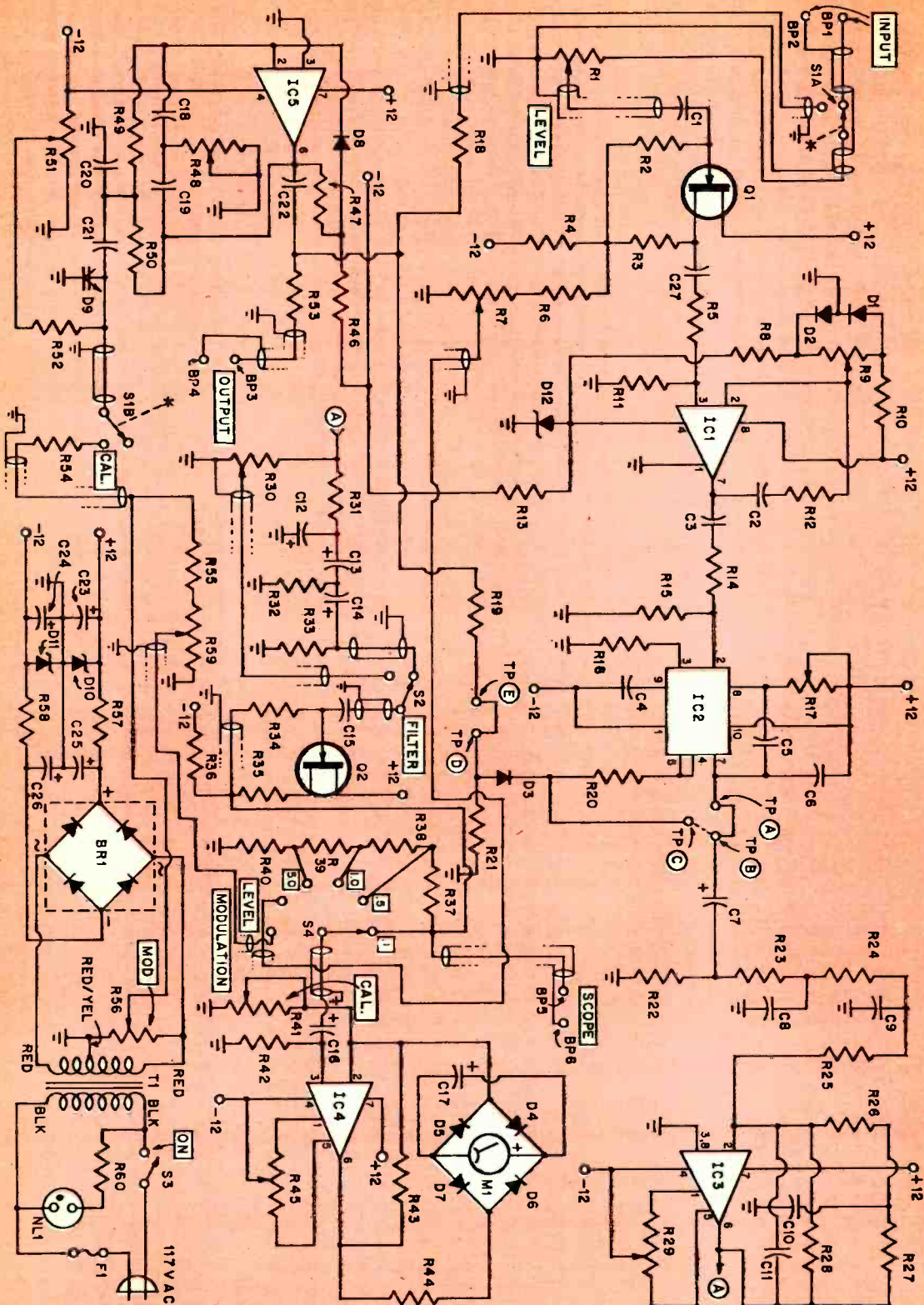

Fig. 3—Solder cable ground leads only at points designated on schematic. Switch S1 is DPDT as shown by asterisk at each switch gang. Test points TP A-E are referred to in the calibration instructions given in the concluding article. Part II will also include both full-size pc board templates referred to in Fig. 2

Troubleshooting Color TV with a Scope

A picture may be worth 1,000 words but when you signal trace a color set with this instrument you'll probably save 1,000 hours in just a few months.

By ART MARGOLIS

GENERAL-PURPOSE oscilloscopes can do two things for you. They can display the shape of electrical waveforms, including phase shift, and they can provide a peak-to-peak voltage indication just like a VTVM. No TV troubleshooting procedure worth its salt will work without a scope. The waveforms that manufacturers include in their schematics (you can see some in this article) can be produced only on an oscilloscope, and for color TV—where phase relationships are fundamental for recovery of blue, green and red signals—these visual clues are the quickest way to clear up TV troubles.

There are many professional scopes on the market but a moderately priced wideband, general-purpose scope having a bandwidth of 5 to 10 mc will do fine. Even a narrowband job fitted out with a high-impedance probe can do much to bring life back to an ailing TV. Not only will you draw a bead on faulty circuits, but you'll be able to pinpoint faulty components in these circuits.

A scope can be used to trace signals in video circuits, sync, AGC, vertical and horizontal sweep sections and through all color circuits. This is about 50 percent of the average black-and-white or color TV (you troubleshoot the tuner, IF strip, audio, high-voltage and low-voltage supplies and convergence circuits using other methods). If you service solid-state TVs a scope is a must.

Scopes are used to check the progress of TV signals once they're detected and to observe the performance of most oscillator circuits—vertical, horizontal and color. Distorted waveforms or incorrect peak-to-peak voltage readings mean something is wrong and indicate the place to zero in on. Service manuals obtained from manufacturers are sure to include both test voltages and wave-shapes for numerous points in the schematic—all you have to do is compare values. Usually, at each test point you'll find the picture of a waveform, its frequency and a peak-to-peak voltage.

It's easy to set up your scope to get a

peak-to-peak voltage display. Most expensive models have built-in calibrators, and you can build your own calibrator into less expensive types (see **LOW-COST SCOPE CALIBRATOR**, May '72 EI). There are other ways, too.

Simply stick your high-impedance probe into an outlet delivering something like 118 VAC. You'll see a 60-cps sine wave appear on the scope's CRT. Its peak-to-peak value ($2.82 \times$ rms value) will be something in the neighborhood of 335 volts. Mark the height of this trace on the scope's graticule. You then calculate peak-to-peak TV-signal voltages by comparing their traces with your marks for AC line voltage. (Most of these will average between zero and 220 volts, though some will climb into the 600- or 700-volt range.)

Another way to check peak-to-peak values of TV waveforms is to use the peak-to-peak scale of a VTVM. However, remember that the higher the frequency of an AC signal, the less accurate your reading will be. A VTVM provides good information—and you'll be using one to troubleshoot other TV circuits—but a built-in calibrator will go a lot further.

Keep in mind that monochrome waveforms are best when controls are set for normal viewing and the set is receiving a good local station. Color waveforms are best when a color-bar generator is attached to the antenna terminals and normal signal level is applied. With this in mind, let's examine some case histories.

Case of a Perfect Waveshape. One day a shapely young lady with dark hair came into the store. She approached slowly and said, "I have a color TV in my station wagon, can you bring it in for me?" I complied, gave her a claim check and began examining the set. It was a 19-in. Magnavox table model. When the picture came on it was scrunched up badly on both sides. Brightness and focus were off slightly, otherwise the TV performed normally. Faulty brightness and focus were due to the shrinking condition and weren't

the primary symptoms.

A faulty horizontal-output stage was indicated by the shrinking. After routine tube substitution tests I grabbed my VTVM and began taking DC voltage readings. First test point was the screen grid of the output tube. The schematic called for +150 volts and that's exactly what it had. Next point was the control grid. The schematic called for -44 volts but instead there was only a value of -15 V. With low bias on the control grid, some of the horizontal oscillator's sawtooth output was being lost. Since the sawtooth controls the horizontal spread of the picture this was the reason for the shrink.

Analysis of the control grid circuit showed two inputs that developed the -44 volts. The oscillator's sawtooth output flowing across the bias resistor and a DC input from the high-voltage regulator circuit also located in the control-grid leg.

Here's where a scope was needed to decide which input was defective. I touched down with the high-impedance probe on the control grid. According to the schematic, a sawtooth having a frequency of 15,750 cps and a peak-to-peak value of 250 volts should be present. It was exactly as indicated. This exonerated the oscillator's output and pinpointed the trouble at the DC input from the high-voltage regulator.

The rest was routine. The voltage in the regulator circuit originated at a 280-volt source and passed through a resistor (rated at 33K, 1 watt) and a zener diode. The zener was rated at 190 volts and clamped the voltage source at its rated value. When the diode is operating normally anything over 190 V passes through the zener to the chassis in voltage divider fashion. A DC reading at the top of the zener showed 280 V instead of the prescribed 190 V.

The zener wasn't working. I measured it and found it was open. A new diode reduced the 280 V to the prescribed value. This drop of 90 V was reflected on the control grid by a restoration of the correct bias level. The picture spread out normally and exhibited normal brightness and focus. All I had to do now was wait for that station wagon.

Symptom of No Red. The set owner was a short, bearded college instructor. He said with a little smile, "My TV only has blue and green colored people."

I answered, "That's a common trouble," and turned on the TV—an RCA 21-in. console. The picture came on and the colors

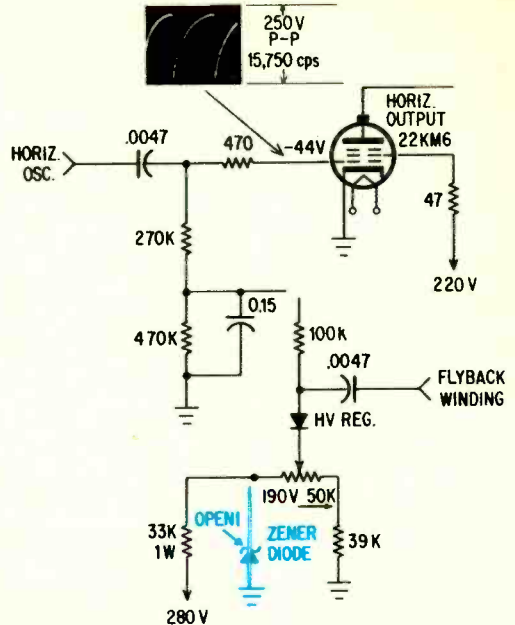

Shrinking raster of Magnavox TV indicated trouble in the horizontal-output stage. Scope helped decide whether low bias was caused by faulty AC or DC input. Here, diode passed too high a DC to tube.

looked almost normal, but it was apparent that no red information was being displayed. I turned down the color intensity control. A good black-and-white picture appeared. This meant the three primary colors, red, blue and green, were being produced by the three electron guns in the CRT. Otherwise the display would appear tinted instead of just black and white. Loss of red was being caused by a defect in the red-signal channel, not in the black-and-white setup of the CRT.

The red signal transmitted by the TV station is amplified, along with blue and green information, in the set's bandpass amplifier. The red information is then extracted from the bandpass-amplifier output in the X-demodulator stage. The blue information is extracted in the Z-demodulator stage. (There's no reason why you can't call them red and blue demodulators.)

In the X-demodulator all the colors are injected into the control grid. A CW signal from the 3.58-mc color oscillator is injected into the suppressor grid. (The same thing happens in the Z-demodulator except the CW signal comes from a phase shifting network and has a different phase relationship for processing blue information.) The oscillator's output combines with the color infor-

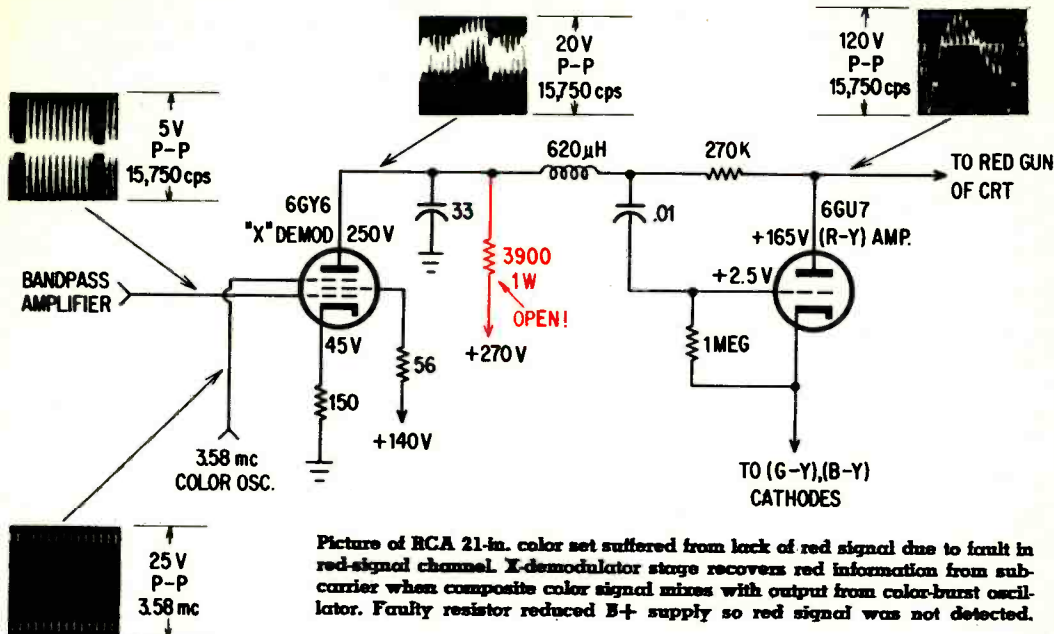

Picture of RCA 21-in. color set suffered from lack of red signal due to fault in red-signal channel. X-demodulator stage recovers red information from sub-carrier when composite color signal mixes with output from color-burst oscillator. Faulty resistor reduced B+ supply so red signal was not detected.

Troubleshooting Color TV with a Scope

mation in the electron stream of the X-demodulator tube and they reconstruct the red information as it was sent from the studio.

As the modulation envelope leaves the plate of the tube it encounters a 33-picofarad capacitor in shunt to chassis ground. This capacitance detects the red information and shunts the CW output (3.58 mc) to ground. Pure red information is then fed to the red (R-Y) amplifier.

Since this fellow's red was missing it was possible that the trouble was in the X-demodulator stage or the R-Y amplifier. The best way to approach these circuits is to trace the various signals. I brought my scope in from the truck and began to probe for revealing pictures.

First I looked at the input of the X-demodulator. It was supposed to have all the color information there at a peak-to-peak value of 5 volts. It was okay. Next I took a look at the suppressor input. There was supposed to be a CW input having a peak-to-peak value of 25 volts. It was there, too.

Next, I touched down on the plate of the X-demodulator. A red information display complete with a modulation envelope was called for. Nothing was there! This meant the stage wasn't conducting.

I brought out my VTVM and began taking

DC voltage readings. The plate read only about 20 volts instead of the 250 V called for. All the other voltages were correct. Working back in the plate circuit, good B+ voltage was indicated on the other side of a 3900 resistor. The resistor had increased in value—it had split and now measured about 750K. A new resistor restored all.

Mystery of Smearly Colors. I walked into the apartment on a service call; the living room wall was covered with watercolors. The TV, a 21-in. Zenith color set, was in the

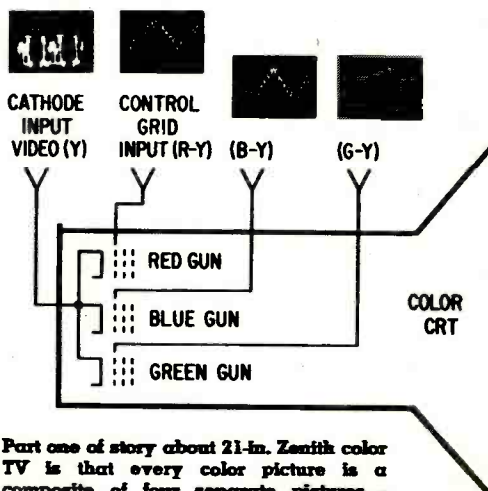

Part one of story about 21-in. Zenith color TV is that every color picture is a composite of four separate pictures—red, blue, green and black-and-white.

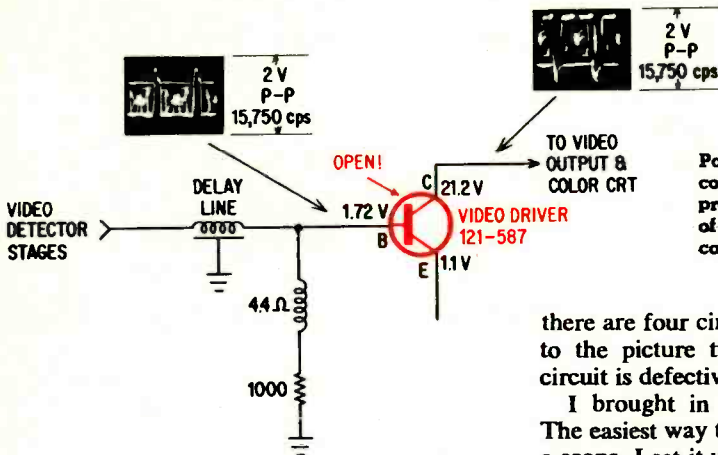

Part two of story about Zenith color set relates to customer's problem with smeary colors. Lack of contrast (b&w signal) was caused by video-driver transistor.

corner. I admired the paintings, then the set owner, a middle aged gentleman, announced, "I did every one myself."

I turned on the TV. Sound and brightness appeared and then some color. There was no real picture, just a smeary three-color display that resembled a picture. The fellow said, "Looks like one of the colors is missing."

I answered, "Sorry to be contrary, but all three colors are present. The black-and-white picture is missing. You know, the contrast." I turned the contrast control all the way up and the color intensity control all the way down. The colors disappeared and no contrast was displayed.

"In every color TV there are actually four pictures on the screen, one on top of another. These are the red, blue, green and black-and-white components of the total picture. So

there are four circuits in the TV that feed into the picture tube. Your black-and-white circuit is defective."

I brought in my scope from the truck. The easiest way to trace video circuits is with a scope. I set it up and began touching down on test points. First I checked the output of the video detector. There was good video there. Then I began touching down on every test point following the video feed. I arrived at the video driver, an npn transistor. Good video was displayed at the input, its base. At the collector there was no video to be seen.

I took the transistor out of the circuit and measured it. The base-to-collector junction was open. I installed a new transistor. The video returned at the collector. Then I checked the TV screen—the contrast was back. I turned up the color intensity control a bit and a beautiful color picture appeared. My customer looked happy.

I turned around and said, "Actually, the color in your TV is more of an overlay than an actual picture. The real picture is the black-and-white component and you fill the [Continued on page 99]

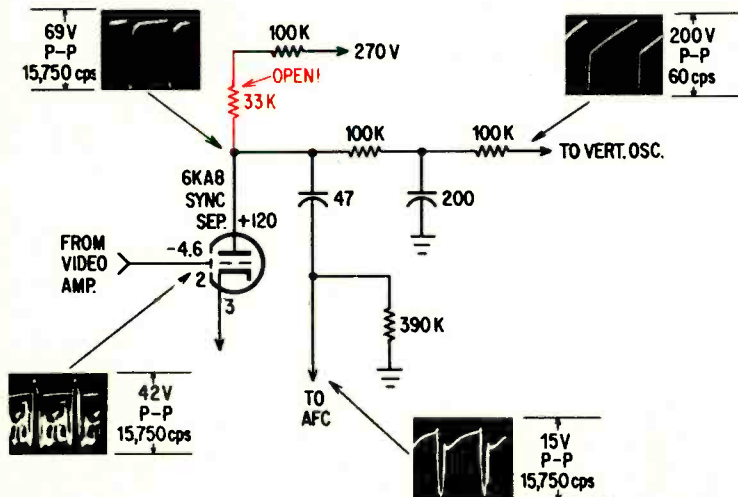

Problem with Philco portable was loss of sync separation. Basic sync-separator circuit uses tube having high negative control bias and low B+ plate supply, so that tube is cut off in presence of video, conducting only upon application of sync pulse. Here, open resistor in plate leg reduced supply voltage.

USE IT ALL AT HOME AS YOU GET READY FOR A NEW CAREER:

\$1,500.00 worth of two-way radio electronic communications equipment

Bell & Howell Schools announces a new learn-at-home program that gives you "hands on" experience with commercial-grade equipment—as you prepare for a business of your own in two-way radio electronic communications servicing.

You need "hands on" experience with a real, commercial-band FM transceiver and actual commercial-grade test equipment—to take full advantage of growing opportunities in electronic communications.

Two-way radio communications is a healthy growth area in electronics. And it's lucrative. Almost two million commercial two-way radio systems now serve as vital communications links for trucks, planes, boats and taxis. And the FCC requires each system to have its equipment serviced regularly by a licensed technician. That's where *you* come in. But you need career-oriented training—plus your FCC license.

Knowing how to put an amateur radio kit together won't help when you're "on the job"—servicing two-way radio systems for aircraft or advising trucking companies about their land-mobile communications system. For that, you need "hands on" experience with the real thing. This unique new Bell & Howell Schools learn-at-home program gives you just that.

Find out more about this exciting new Bell & Howell Schools program. There's no obligation.



For free facts, mail attached card today!

Let Bell & Howell Schools help you get ready for an exciting career or business of your own in two-way radio electronic communications!

Bell & Howell Schools has helped many thousands of people prepare for careers—and businesses of their own—in electronics. You can have absolute confidence in the training you get.

Expert instructors at Bell & Howell Schools plan each program to answer a single question: "What qualifications will you need to take advantage of *actual career opportunities* in electronics?" They then build each program to give you those exact qualifications.

To get ready for a business of your own in two-way radio, you need: 1) career-oriented training; 2) FCC License; 3) "hands on" experience with commercial-grade equipment. Bell & Howell Schools now offers this new at-home training program that gives you all three. (See FCC License Guarantee on attached card.)

JUST LOOK AT ALL THE EQUIPMENT YOU'LL WORK WITH—RIGHT AT HOME—DURING YOUR TRAINING PROGRAM WITH BELL & HOWELL SCHOOLS!

Commercial-Band FM Transceiver . . . exactly the kind of two-way radio you'll service throughout your career.

FCC REGULATIONS GIVE YOU THE OPPORTUNITY TO START YOUR OWN BUSINESS!

The Federal Communications Commission requires that all commercial two-way communications systems be checked and serviced by a licensed technician at regular intervals.

As a Bell & Howell Schools graduate, you'll have the technical know-how you need. With your FCC license, you can go out and eventually build your own business—signing contracts with companies that use two-way radio. FCC regulations could mean security and regular income for you!

BELL & HOWELL SCHOOLS OFFERS YOU THESE SPECIAL ADVANTAGES:

Help Sessions Scheduled regularly every few Saturdays at the Bell & Howell Schools and in many other cities throughout the U.S. and Canada. Top instructors give you personal help and guidance.

Transfer Privileges After completion, you can transfer to any of the resident schools for more advanced study, if you wish.

Lifetime National Placement Service Helps you locate a job any time after you complete your program.

Veterans' Benefits We are approved by the state approval agency for Veterans' Benefits.

Student Financial Aid We are an eligible institution under the Federally Insured Student Loan Program.

EXCLUSIVE ELECTRO-LAB®—YOURS TO KEEP!

To make sure you get practical experience with instruments used daily by professionals, we've integrated into your program three precision instrument kits you assemble yourself and keep:

Design Console Use this to rapidly "breadboard" circuits without soldering.

Oscilloscope Offers bright, sharp screen images, 3-way jacks for leads, plugs.

Transistorized Meter Registers current, voltage and resistance.

FOR FULL INFORMATION, MAIL THE ATTACHED CARD TODAY! OR WRITE:

DEVRY INSTITUTE OF TECHNOLOGY

ONE OF THE

BELL & HOWELL SCHOOLS

4141 Belmont Avenue, Chicago, Illinois 60641

400

Deviation Meter

. . . model favored by many working technicians to check modulation of transmitted signal.

Frequency Meter

. . . highly sensitive instrument used to check signal frequency within precise tolerances established by government standards.

Power Output Meter

. . . meter used almost universally by trained and licensed technicians to check power output—or wattage—of signal.

Alignment Generator

. . . a custom-designed unit you use to generate test signals for transceiver alignment.



The El Ticker

MANAGEMENT at Ampex Corp., long a leading supplier of professional recording gear, announced that it will phase out its consumer line of cassette and reel-to-reel recorders as soon as possible. Reason: the company suffered more than a \$80 million loss in its fiscal year which ended April 30. Ampex will continue to sell professional audio and video recorders, computer equipment and its line of stereo tapes.

★ ★ ★

The freeze in cable TV—which has caused the industry to stagnate for two years and has delayed much needed capital spending in CATV—has finally ended. A compromise solution was worked out between the FCC and the Office of Telecommunications Policy (which acted under direct pressure from the White House). The new rules—which went into effect March 31—permit expansion of cable operations in major metropolitan markets, and require that cable operators develop their own programming and provide adequate channels for public-service TV broadcasting.

★ ★ ★

Another aspect of FCC's recent decision on CATV is greater emphasis on development of non-broadcast services such as two-way communications between homes and banks, shopping centers, utilities, etc., plus transmission of newspaper information by cable. This would supplant services such as weather reports and stock tickers.

★ ★ ★

The White House, through the Office of Telecommunications Policy (OTP), has called for a \$67 million study of pollution of

the electromagnetic environment. This study, which will take several years to complete and involve several government agencies, will examine use of the entire spectrum by all communications interests, including business, military and government.

★ ★ ★

According to the Electronic Industries Association (EIA), consumer electronics sales for 1971 topped \$5 billion at the manufacturing level (including imports), and about \$8 billion at the retail level. Television had a record year—more than 40 percent of all American homes now have a color set while 95 percent have black & white. Consumer electronics during 1971 saw one of the lowest Consumer Price Indexes of any U.S. commodity.

★ ★ ★

Federal Trade Commission has exempted manufacturers of hi-fi amplifiers having power output of 2 watts or less from its proposed rule requiring disclosure of continuous rms power for each channel. Feeling is that these devices are used mostly as toys. Uniform listing of power ratings is designed to protect consumer.

★ ★ ★

Texas Instruments, Inc., has entered into an agreement with the Tandy Corp. of Fort Worth, Texas, to make a number of its small-signal and power transistors available to hobbyists at Tandy's chain of Radio Shack stores under the Archer label. This marks the first time TI has ever offered semiconductors to hobbyists and experimenters through a consumer electronics outlet. At the moment, replacement semiconductors are available from Motorola, General Electric and RCA.



Build a Cardio-Tach

Don't feel your wrist. Lay a finger on the block and our cardio-tachometer instantly reads your pulse.

By HERB COHEN



EVERYONE has taken his own pulse at one time or another. Gently grasping the wrist until the throb of an artery is caught is one of the most basic of all medical tests. That strong, steady pulse can be an indication of a healthy heart, lungs and circulatory system.

Most non-medical people, however, have trouble locating a pulse point. But now it's no longer necessary to fumble with your wrist while you count the seconds with a watch. Place a finger over the pickup block on our Cardio-Tach. You'll be able to read your pulse directly—and in a few seconds.

A light-emitting diode shows you the duration of each pulse. Besides, it gives you a visual indication that your finger is correctly seated on the pickup block.

A lamp and photo transistor built into the pickup are the key to our Cardio-Tach. When your finger is placed on the block, some of the light is conducted through the fingertip flesh. As blood is pumped through the capillaries, light conductivity of the flesh changes. The photo transistor sees these changes as variations of light level and produces a small voltage pulse.

The lamp in the block is a miniature six-V bulb. It's powered by a regulated current source which insures constant light output as the bulb ages. The regulated source also reduces the chance of AC hum voltages leak-

ing into the phototransistor from the lamp filament.

How It Works. Photo transistor Q1 picks up variations in light level caused by the blood pulsations. This signal is fed into transistor Q2, connected as an emitter follower. Some of the high-frequency components are removed by capacitor C2. The signal is further amplified by transistors Q3 and Q4.

Note that transistor Q4 has no external bias and conducts only when Q3 passes a pulse. Capacitor C5 also bypasses high frequencies to ground, making the Cardio-Tach fairly immune to AC-induced hum.

The amplifier voltage pulse is coupled to transistor Q5 via resistor R6. Both transistors Q5 and Q6 are coupled together as a bistable multivibrator. This circuit changes the shape of the pulse by converting it to one having a constant amplitude and sharp rise time.

Whenever transistor Q6 changes its conduction state, it drives transistor Q7 on. The LED, labelled D9 in the schematic, glows red for the brief time that Q6 conducts.

As soon as Q6 switches into its on state, capacitor C6 starts to charge through resistor R12. When the voltage across C6 rises above the gate voltage necessary to fire transistor Q12, it conducts. Transistor Q8 is driven on at the same time. Once it has fired, transistor Q12 will conduct as long as Q6 is also being driven.

Build a Cardio-Tach

Transistor Q8 responds to two different voltage sources. If Q5 is conducting, transistor Q8 is turned on via current passing through diode D3.

The second voltage source presented to Q8 is transistor Q12. When it has fired, Q12's cathode current latches transistor Q8 into its *on* state. The only time Q8 is in its *off* state is the 50 milliseconds it takes capacitor C6 to charge.

The function of transistor Q8 is to short the output of Q10, a 10 ma. constant-current generator. Every time a pulse appears at the base of Q8, it turns off for 50 milliseconds. This gives Q10 time to charge up capacitor C7.

Since C7 is charged from a constant-current source for 50 milliseconds every pulse, its stored voltage level will increase linearly in fixed steps. Components Q11 and R19 (*Calibrate*) supply C7 with a constant current discharge path. Capacitor C7 converts linear pulses to specific voltage levels during each 50 millisecond period. Transistor Q11 also serves as an emitter follower for the meter circuit.

Transistor Q9 is the current source for light bulb L1. Both sources (Q9 and Q10) use zener D10 as their current reference.

Building the Cardio-Tach. The circuit was built on a piece of 2 x 6½-in. perf. board. Mount the perf board assembly via ¼-in. stand-offs to the base of the box. Lead dress and length is not critical.

Next step is to change the meter face. The specified meter has a plastic snap-on cover. Pry it off and cement the new meter face over the original one. As an alternate method, you can cut an adhesive-backed mailing label to cover only the numbers on the original dial scale. Leave the scale division lines visible. The full-scale marking is labelled 150, while

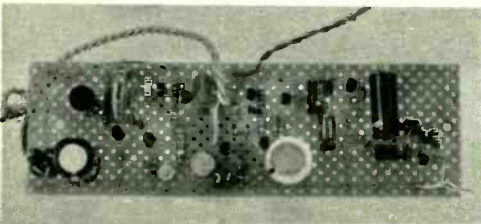

Fig. 1—Prototype's perfboard layout is spacious. Layout can be compressed for more compact unit.

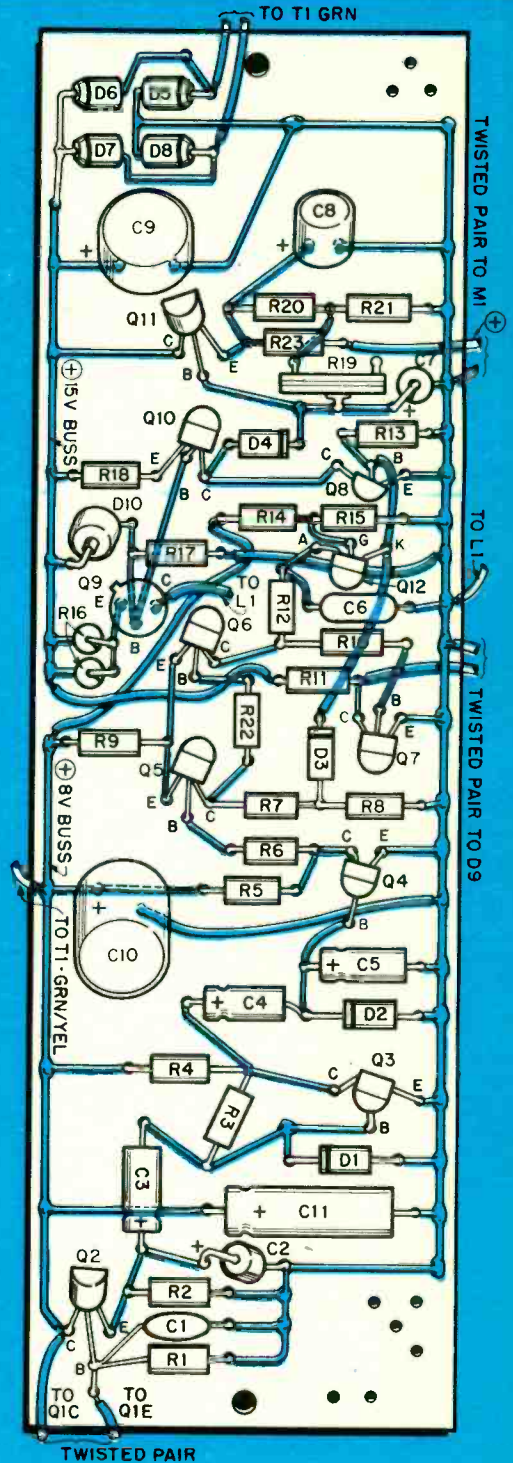

Fig. 2—Layout of cardio-tach. Leads shown in color are beneath perfboard. Clear plastic tubing was used to insulate crossed wires under board.

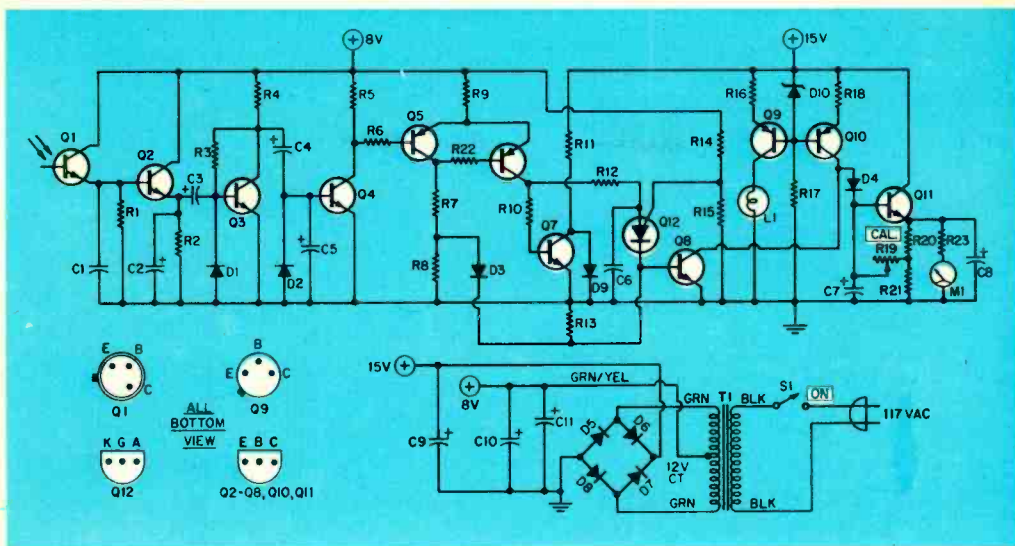

Fig. 3—Schematic of cardio-tach. Be sure to observe proper electrolytic capacitor polarity. Make no substitution for tantalum capacitor C7.

the five remaining segments are marked to read 0, 30, 60, 90 and 120.

Light source L1 and photo transistor Q1 were mounted in a plastic block measuring $1\frac{1}{8} \times \frac{3}{4} \times \frac{1}{2}$ -in. Drill two $\frac{1}{4}$ -in. holes into the block. Hole centers for L1 and Q1 should be spaced $\frac{3}{8}$ -in. apart. See our pictorial.

Since the photo transistor has a lip on the bottom, we slipped a $\frac{1}{8}$ -in. piece of plastic tubing over Q1. This shims Q1 snugly in its mounting hole. Place Q1 into the plastic block so that its lens is slightly raised. When you place your finger on the block, the lens is gently embedded into the flesh. Coat the outer surface of the tubing with epoxy before finally slipping it into the block.

Bulb L1 does not require a socket. Wires are soldered to L1's flange and center terminal. Push the bulb into the hole so that its top surface is flush with the top of the block. A drop of epoxy holds the bulb in place. The block is finally mounted to the front panel with a No. 6 screw or epoxy.

Calibration. The easiest way to calibrate M1 is to measure your pulse rate over a one minute time span. Then place your finger on the plastic block and adjust R19 until M1 reads your pulse rate.

A more accurate calibration method can be made with a phono turntable. Solder a pair of extension wires to Q1 and L1. Place an old LP on your turntable and stick a piece of white masking tape on the outer edge of

PARTS LIST

Capacitors: 15 V electrolytic unless otherwise noted

C1—.01 μ f, 50 V disc ceramic capacitor

C2-C5—10 μ f

C6—.1 μ f, 50 V disc ceramic capacitor

C7—3.9 μ f, 35 V tantalum capacitor (Allied Industrial Electronics No. 926-0335 \$1.15)

C8—50 μ f C9—500 μ f

C10—1100 μ f, 12 V electrolytic

C11—200 μ f, 10 V electrolytic

D1-D3—1N2069 diode

D4—Silicon general-purpose rectifier: 1,000 PIV @ 2.5 A (Motorola HEP-170 or equiv.)

D5-D8—Motorola HEP-156

D9—Light emitting diode (Motorola HEP-P2000 or equiv.)

D10—1N1519 zener diode

L1—6 V @ .04 A lamp (Chicago Miniature 345 or equiv.)

M1—0.50 μ A DC microammeter (Calectro D1-910 or equiv.)

Q1—Photo transistor (Motorola HEP-P0001 or equiv.)

Q2-4, Q11—Npn transistor (Motorola MPS 3694)

Q5,Q6—Pnp transistor (Motorola MPS 3702)

Q7,Q8—Npn transistor (Motorola 2N4401)

Q9—Pnp transistor (RCA 40406)

Q10—Pnp transistor (2N4403 or equiv.)

Resistors: $\frac{1}{4}$ watt, 10% unless otherwise noted

R1—560,000 ohms

R2,R13—4,700 ohms R3—680,000 ohms

R4—15,000 ohms, 5% R5—39,000 ohms

R6,R10—12,000 ohms R7,R8—6,800 ohms

R9—1,000 ohms R11—1,500 ohms

R12—8,200 ohms R14,R15—82,000 ohms

R16—75 ohms, 1 watt (2 x 150 ohms, $\frac{1}{2}$ -watt)

R17—1,200 ohms, $\frac{1}{2}$ watt

R18—390 ohms

R19—1,000,000-ohms, linear-taper pot.

R20—10,000 ohms R21—47,000 ohms

R22—68,000 ohms R23—150,000 ohms

S1—SPST switch

T1—Power transformer; secondary: 12.6 V CT @ 0.1 A (Calectro D1-750 or equiv.)

Misc.—Perforated board, AC line cord.

Note: Cabinet available from Selex Corp., 61 Grove St., New York, N.Y. 10014. Order part No. 30408-P \$3.40 plus postage.



Fig. 4—Photo of plastic block, above. Note how lens of Q1 just clears top surface. Dimensions of block at right. Block material is black opaque plastic. Base lead of Q1 is cut off at case.

Build a Cardio-Tach

the phonograph record.

Cover about 2-in. of the outer rim. Give the record a half-turn and stick another 2-in. piece of tape on the opposite edge of the record. The two pieces of tape are opposite each other.

Switch on the turntable and set the speed for $33\frac{1}{3}$ rpm. Turn the pulse counter on and place the pickup block over the record about $\frac{1}{2}$ -in. above the record's surface and just past its edge. Position the photo pickup so that it can see the masking tape as it goes by. Light emitting diode D9 should start to blink every time a piece of tape goes by.

Adjust R 19 until the meter reads 67 Pulses Per Minute. A drop of cement holds R19's calibration in place.

When placing your finger on the pickup block, lay your finger flat on it so that the fleshy pad completely covers both Q1's lens and L1. Do *not* press down hard since this will cut off blood circulation in the area.

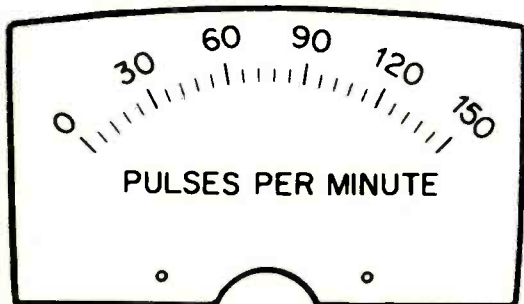
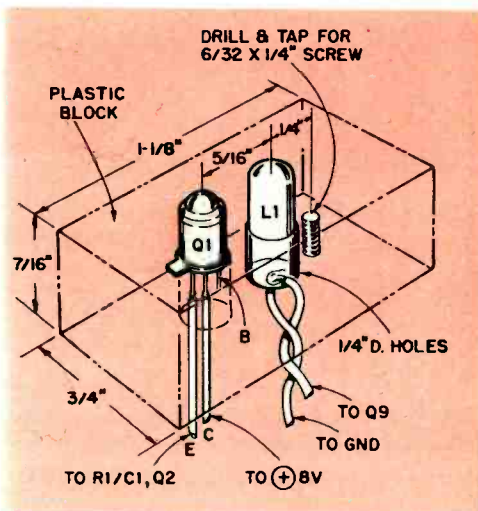

Fig. 5—Cut out or trace dial onto M1. See text.



What does heart rate mean?

A normal heart rate may be anywhere from 60 to 90 beats per minute at rest. Generally, a lower heart rate means that a person is in better than average condition. A stronger heart can pump a larger volume of blood in one stroke, allowing the heart to work at a lower rate.

If you think of your body as a bio-electronic mechanism, the heart is part of a servo loop whose function is to use the blood to carry oxygen from the lungs to body tissues. As stroke volume increases, heart beats-per-minute decrease in order to keep the rate of blood flow constant.

Recently, a great deal of interest has developed around the scientific study of physical fitness. It has been found that if the heart rate can be brought up to 140 beats per minute for several minutes a day, your heart, lungs, and overall muscle tone will start to improve. The best exercises to accomplish this are running, jogging and swimming.

For a man in poor physical condition, any mild exertion may raise his pulse rate from 90 p.p.m. at rest to 140 p.p.m. If he exercises on a regular basis, it will take more strenuous exercise to raise his heart rate to this higher level.

Some athletes have heart rates as low as 40 beats per minute at rest.

Point is, if you can bring your heart rate up to 140 beats per minute, you're doing the right amount of exercise. But too much exercise will force your heart rate to continue to rise. Don't let it exceed 160 p.p.m. for any length of time, unless you're in excellent condition or a trained athlete. In any case, an exercise program should be under the supervision of your family doctor.

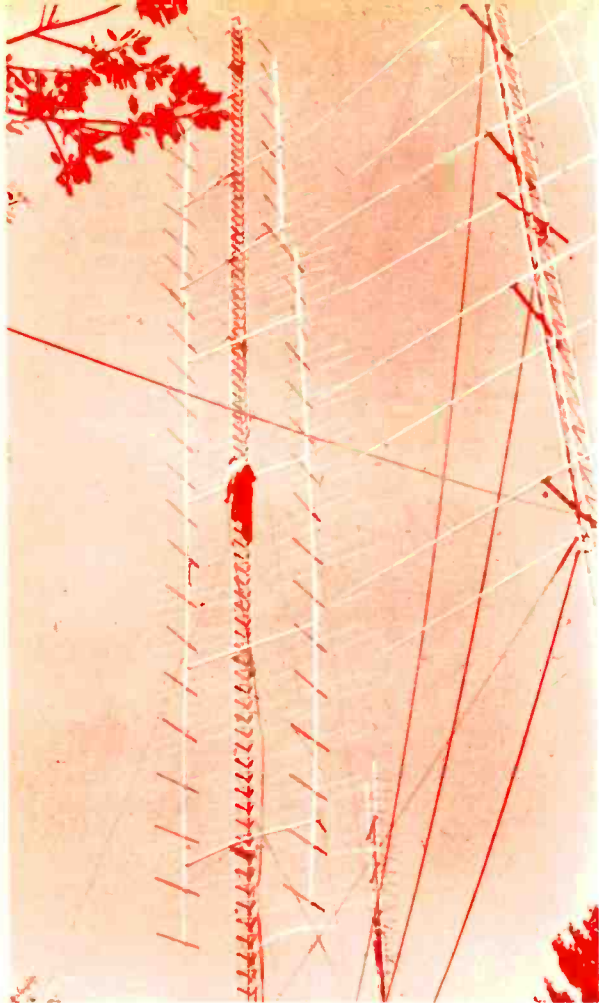

2 Meters —Where the Action Is!

The rarefied atmosphere of this VHF ham band is fast coming down to earth. FM-ers are socking signals over mountains, while DXers are bouncing them around the globe and off meteors, temperature inversions and the moon. There's AM and SSB, too, for plenty of thrills.

By WAYNE GREEN, W2NSD/1

FASTEST growing aspect of amateur radio today is 2-meter FM (frequency modulation), or the Fun Mode as many hams are calling it. FM operation is somewhat like Citizens Band, but highly perfected. There's little interference, you have extended range and complete legality.

FM has grown so rapidly that—a rarity just four years ago—it now rivals all other modes in use on 2 meters. Experienced ham operators count on making just as many FM contacts as with AM and CW during a VHF contest.

Just three years ago most FM equipment used on the amateur 2-meter band was surplus business-band equipment made obsolete by new narrow-band commercial restrictions. It's cheaper to sell customers a whole new transceiver rather than modify it to meet FCC rules. So tens of thousands of these rigs hit the surplus market and found their ways into amateur car trunks and ham shacks.

There probably are more things going on in the amateur 2-meter band than on any other band. Hardy groups of experimenters are working each other around the world by moonbounce. Other hams are bouncing their signals from meteor trails, from the aurora borealis, from temperature inversions and from anything else that will return a fraction of a microvolt well over the horizon.

Sideband, AM and CW are holding their own on the band, while the moonbouncers and meteor bouncers are growing slowly. The incredible growth in the FM part of the band is largely due to Technicians moving up from 6 meters and old timers coming up from the rat race down on 20 meters and other low bands. A growing population of older callsigns is appearing on FM repeaters and even a substantial number of two-letter callsigns that represent a minimum of 25 years in the hobby.

Before we take a closer look at the exciting world of 2-meter FM, let's review the

2 Meters—Where the Action Is!

activities of hams who still work via traditional methods such as AM, CW and single sideband (SSB).

AM Activity. The big action on 2 meters is still AM. There are tens of thousands of Gonset Communicators (called Goonie Boxes) perking away on the band. Most of them are used by younger fellows to talk with friends over a range of perhaps two or three mi. Usually they're hooked up to small antennas which limit their range even more. Large antennas are expensive and a lot of trouble to make (and to turn), so beginners stick to vertical ground planes and such.

The Heathkit Twoers (called Benton Harbor Lunchboxes) are also seen everywhere. While the Gonset sets put out about five to ten watts, the Twoers usually put out only two watts into the antenna. The Twoer receiver is the last word in cheap but it works well as long as rock-stable operation isn't expected and no transmitters are operating close by. Sometimes it's handy not to have too many signals on the band—one loud one will capture the Lunchbox and drown out anything weaker. Still, they're inexpensive and can be a lot of fun. I've worked Twoers over 500 mi. under good conditions.

Most emergency nets (Civil Defense, etc.) are set up on 2 meters and many use Gon-

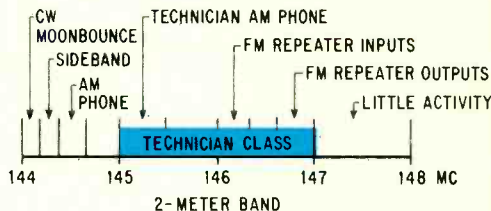

Fig. 1—Spectrum chart of 2-meter band shows ham activity at various frequencies. Technician Class licensees aren't permitted to operate above 147 mc.

sets bought with CD funds (they're painted yellow). You'll hear these nets conducting their drills around urban areas every week. Just outside of the two-meter band, above and below, you can hear the Civil Air Patrol units. These operations have nothing to do with amateur radio, but you may run into them and wonder what it's all about. CAPers have Gonsets, too—in their planes, cars, at airports and in their homes. They use them for coordinating hunts for missing planes and such.

You can also hear Army, Navy and Air Force MARS nets above and below 2 Meters. These nets hold weekly drills, too. Most MARS operators are amateurs who plug in a special MARS crystal to check into the nets.

The AM rag chewers on 2 meters are divided into two groups. Technician licensees

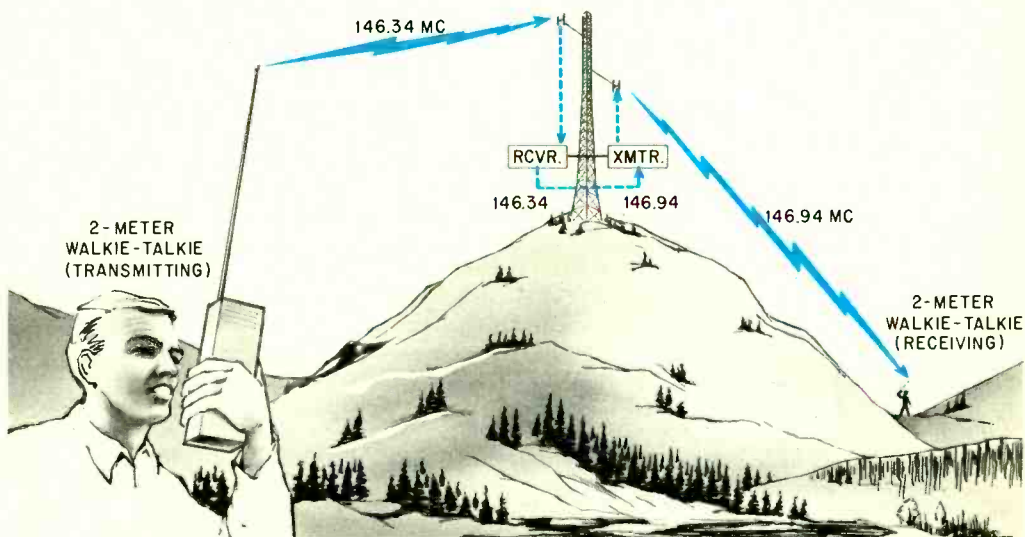

Fig. 2—Two mobile FMers working via an FM repeater. Combination of 146.34-mc. input and 146.94 output is standard, though you may run into a 76 output in certain areas. Repeaters are on high ground.



Above, author Wayne Green, W2NSD/1 and chief mentor of 73 Magazine—a ham journal, talks to a friend via his Motorola HT-220 handie-talkie transceiver. At right, Wayne's FM repeater located on Pack Monadnock Mountain in New Hampshire. Wayne says he gets 200-mi. coverage in all directions. He'd better. He's long been in the forefront of 2-meter FMing.



must stay between 145 and 147 mc. The AM Techs usually cluster around the low end of 145 mc (see Fig. 1). The General, Advanced and Extra Class amateurs can use the entire 144-148 mc band, but they tend to congregate well below 145 mc and many make it plain that they never even listen above 145. Such is our world.

DX Activity. The low end of the two-meter band, from 144.0 to 144.1 mc, is used for CW only (see Fig. 1) and it's here that most DX contacts are made. Of course, DXing can be relative—while Ohio may be exciting to a 2-meter operator from New York it could be a bore to a 20-meter ham who gets his jollies working a ship wrecked blond sitting on a wet rock (in a bikini) at low tide somewhere in the Indian Ocean.

While the 2-meter DXer doesn't require the 40-acre monster used for moonbounce DX contacts, he does have to put up as big an antenna as he can manage. The yardstick for this was established several years ago by Sam Harris, W1FZJ, when he stated that he

felt his antenna wasn't big enough if it stayed up all winter. This doesn't hold for him anymore since he chickened out and moved to Puerto Rico and was last seen down there setting up a 100-ft. dish for moonbounce DX in his backyard.

Hot, muggy summer nights often result in a temperature inversion. This means signals may come pouring in from hundreds of miles away. The scramble to make as many DX contacts as possible during these inversions is exciting and not soon forgotten.

With the fall season come aurora displays and more DX. By pointing a big two-meter beam at the aurora it's possible to bounce signals 500 to 1000 mi. The returning signal sounds very strange. You are used to hearing CW signals as whistles . . . well, aurora CW comes back like a rushing noise.

2 Meters—Where the Action Is!



At left, Regency's new Transcan 2-meter FM transceiver, available as base station (Model HR-2S, \$349) or mobile station (Model HR-2MS, \$319). These eight-channel rigs search out signals and then lock in on transmissions. At right, Regency's popular Model HR-2 transceiver, now updated by Model HR-2A (\$229).

The two-meter signals bounce around so much in the aurora that they are changed in frequency by the Doppler effect and a whole new group of frequencies are reflected back. Sideband signals also can be sent over an aurora path and they come back sounding like someone whispering to you.

Sideband Activity. There is a small but determined band of sideband operators on 2 meters. Manufacturers like Clegg and Gonset put out some two-meter sideband equipment and there once were a couple of converters for the band made by Collins and Hallicrafters. Add to these a handful of homemade sideband rigs and converters and you have the story. The sidebanders get much better range than AM operators, but their equipment has to be much more stable and the circuitry is far more complex.

What About Moonbounce? If you have enough power and a gigantic antenna that's pointed directly at the moon it's possible to send a two-meter radio signal to the moon and have it bounce back with barely enough strength to be heard on a very sensitive receiver. This is definitely not a project for the Sunday afternoon hobbyist.

Perhaps the most enthusiastic 2 meter moonbouncer in the world is a chap from Birchip, Australia—Ray Naughton, VK3-ATN. Ray has a giant diamond-shaped antenna (spread out over quite a few acres) that hangs from four large telephone poles. This rhombic antenna is three layers high. It concentrates the signal sufficiently to get it to the moon and back.

Since the antenna cannot be turned, Ray has to wait for two special days a month when the earth points his antenna at the moon. Then he has to get on the air quickly

and try to get through during the few minutes that his window is open to the other side of the world. Despite technical difficulties and long waits, Ray has made contact via the moon with a number of stations around the U.S.—this includes shacks even all the way up to New Jersey on the East Coast.

FM and FM Repeaters. The one great drawback of VHF operation is the very limited distance covered by the average mobile rig. In most areas of the country, a 10-watt mobile transmitter (typically FM) will cover perhaps 10 mi. or so. Since there are



Under tape deck is Standard's Model 826 transceiver, a 12-channel FM rig. On seat is remote dialing unit for phone calls through local repeater.

not many parts of the country where a significant number of amateurs live within a ten-mile radius, mobile to mobile via VHF has never caught on.

A relay station on top of a nearby mountain or high building can extend the range of mobile stations to 50 mi. or more, enabling many mobiles running low power to talk with each other with simple whip antennas. Some relay stations (called repeaters) have a range of over 100 mi., thereby linking amateurs together over a very wide area. The use of *special* radio channels makes it possible for anyone wanting to use a repeater to simply tune their receiver to that specific channel.

Repeater stations can be expensive, so who is putting them up? In most instances a group of local amateurs get together and pool their resources to put up a repeater. They usually form a club, divide the costs among the members, and collectively get to work setting it up. Some repeaters are put up by amateurs who are in the two-way radio service business. The club then falls heir to low-cost commercial equipment which can be adapted to repeater operation.

There are two basic types of repeaters: open and closed. Open repeaters are available to anyone who wants to use them. Closed repeaters can be used only by members of the club that set up the repeater. These hams feel that since they spent the money and effort to set up the facility they should be the only ones to benefit. FM repeaters have spread quickly and today there are well over 1000 operating in the U.S.

How come all this activity is on FM instead of AM? FMers will tell you that it's logical because FM is so much better than AM, particularly for mobile operation. That is true, but the primary reason for the widespread use of FM is that the two-meter system of single-frequency operation evolved from the use of surplus FM equipment which turned up in great quantities a few years back. This gear encouraged amateurs to form large nets operating on crystal-controlled channels. Amateur two-meter FM got its start this way and then repeaters came along to extend the range of these FM nets.

FM is excellent for this application. The *capture effect* of FM communications results in far less interference between stations than would be the case using AM. Since much two-meter rag chewing is via mobile units FM delivers far more for the dollar.

As soon as the demand for two-meter equipment outstripped the supply of surplus commercial gear, it wasn't long before manufacturers stepped in to fill the need. First units were crude by today's standards but many are still in use. Three years ago there were about three amateur rigs available, now there are at least 15 different companies supplying equipment for two-meter FM.

How wide a coverage do the repeaters provide? There are few places in the country that are out of the range of FM repeaters. There are now two active repeaters in Maine, five in New Hampshire, four in Vermont, fourteen in Massachusetts, nine in Connecticut and even two in Rhode Island. The rest of the country has a similar repeater blanket.

FM Frequencies. All this FM repeater activity on 2 meters has developed around 146-147 mc (see Fig. 1). The standard format is for the *input* and *output* of the repeaters to be 600 kc apart and for individual FM channels to be 30 kc apart.

The most popular receiving channel is 146.94 mc and this is the standard repeater-output frequency in most regions of the country. In a few areas, the basic output channel is 146.76 mc. FMers usually speak in terms of the last two digits only—they would call these frequencies 94 or 76. Other popular channels for receiving are 73, 82 and 88. Repeater input channels are not quite as standardized, but 22, 25, 28, 31, 34 and 37 are the most popular. A 34 input teams with a 94 output most of the time.

As more and more repeaters are set up in an area their coverage overlaps so it becomes important to move them onto unused channels. One of my problems at home (in southern New Hampshire) is that when I operate via 34/94, my rig turns on several repeaters at once. Often I can hear four different repeaters dropping out when I stand by. I'm sure it must be annoying for my signals to be coming out of Concord, New Hampshire, Holyoke, Massachusetts, Mt. Killington, Vermont and Troy, New York, every time I make contact on one of those repeaters.

One way of preventing signals from being repeated unnecessarily is to require a short *tone burst* of a specific frequency at the beginning of each transmission. This turns on the repeater. While most repeaters turn on automatically when a carrier is received, tone-burst entry is better and is gaining rapid

[Continued on page 96]

Hi-Fi Today

By Robert Angus



Hi-Fi from Hungary?

WOULD you believe hi-fi from Hungary? It seems the Magyars are planning to become the first Iron Curtain country to get into the international high-fidelity business. They're going to market a line of loudspeakers that should be available in some American stores by the time you read this. The speakers range in size from the miniscule Model D-131 (9½ x 7½ x 6-in.) to a full-size Ultra I reflective sound system (23¾ x 12¾ x 11½ -in.). Prices will range from \$35 to around \$200.

The sound from the mini-speaker—when demonstrated for me recently in Budapest—was truly amazing for such a small rig. The reflective model provided wide dispersion throughout the listening room.

The Hungarians believe that they have the know-how to make a really good-sounding speaker and the economic advantages to sell it at a reasonable price. Somebody obviously has been talking to them about appearances, too. The small speaker, sold in Hungary only in high-gloss blonde, will be available here in tangerine Formica or oiled walnut.

If they can get the speakers launched successfully, Budapest's audio engineers would like to follow with such products as a 50-watt-per-channel, four-channel amplifier, a cassette deck and some professional broad-

cast and commercial sound equipment.

The surprising thing, to me at least, is the technical preparation which seems to have gone into their product planning. BEAG, the state-owned corporation responsible for designing and manufacturing audio, commercial sound and broadcast equipment, maintains a highly sophisticated acoustic laboratory in its Budapest headquarters. It's staffed by recognized acoustic engineers. Yet BEAG sells few of its products in Hungary.

Not so many years ago, all you demanded of a good stereo receiver was that it should pull in your favorite FM stereocast with a minimum of distortion—or reproduce your prized records and tapes with a minimum of fuss. Nowadays, however, there are receivers that do a great deal more than this.

For example, take the Kenwood KR-6170. It has its own built-in rhythm generator, a timer, a reverb circuit and front-panel electric guitar and mike inputs—features of particular interest to the amateur or professional rock musician. If you're too lazy to get up and change FM stations, both Fisher and Pioneer (as well as Kenwood) will sell you a receiver with electronic tuning. You can tune the rigs automatically from your listening chair. In the Fisher version, you tune in either direction on the dial, skipping merrily from one stereo station to the next.

New four-channel receivers let you pour music into virtually every room in your house via a single control center—in most cases, including a choice of program and volume setting. It works like this. You can use the tuner section of your receiver with the front pair of speakers to pipe two-channel stereo into, say, the living room and bedroom. You use the other two channels of amplification to play stereo records in the den and rec room. It's not only possible to feed two different programs into a quadriphonic control center, but you can adjust sound levels separately. More advanced models even permit you to set main- and remote-speaker levels individually, making sound possible not only in four different rooms, but at the appropriate volume level. ●



Girl shapes cone of mini-speaker at Video-Tone factory in Kecsemet, Hungary. Hungarian audio gear soon will be available here in the United States.



RCA Says 'Right On' to Home Video Recording

RCA is aiming for late 1973 to introduce a home video player it hopes will be a significant breakthrough in videocassettes for consumers.

CONTRARY to general opinion, RCA's SelectaVision System (video playback via laser-made holograms) isn't dead. It's alive and well in a different hardware format—a SelectaVision MagTape system for color video recording and playback to be available in late 1973, and a SelectaVision HoloTape system for video playback only to be available sometime in the near future.

RCA's MagTape color video player for the home works with any TV set and permits playback of prerecorded tapes, recording of programs off-the-air and showing of home movies taken with a black-and-white TV camera (a color camera will be made available later on).

Bell & Howell plans to manufacture the tape transport mechanism and both Bell & Howell and Magnavox will market products based on the MagTape system, with RCA licensing the electronics. RCA's player unit will cost nearly \$700 to start but volume production can be expected to bring the price down. A blank cartridge should cost \$30.

Features of this home TV player-recorder include in-cartridge scanning which simplifies the design of the transport mechanism and provides enhanced performance due to better tape control, a built-in timer which allows you to record a program even though you may not be at home, built-in VHF and UHF tuners for off-the-air recording that allows you to use your own color TV to monitor the program or even to watch something else, a provision for stereo sound should TV broadcasters ever take to giving you hi-fi, attachment to any TV via the set's antenna

terminals and simplified electronics packaged in module form for better reliability and more convenient servicing.

RCA feels that 25 percent of all American households are ready for some form of video player and that a player which has both a record and playback capability will be best for initial sales. However, RCA's plans for software (programming in the form of pre-recorded tapes) are uncertain as of now.



Ray Warren of RCA's Consumer Electronics Division in Indianapolis looks at transport mechanism of MagTape video player that he helped design.

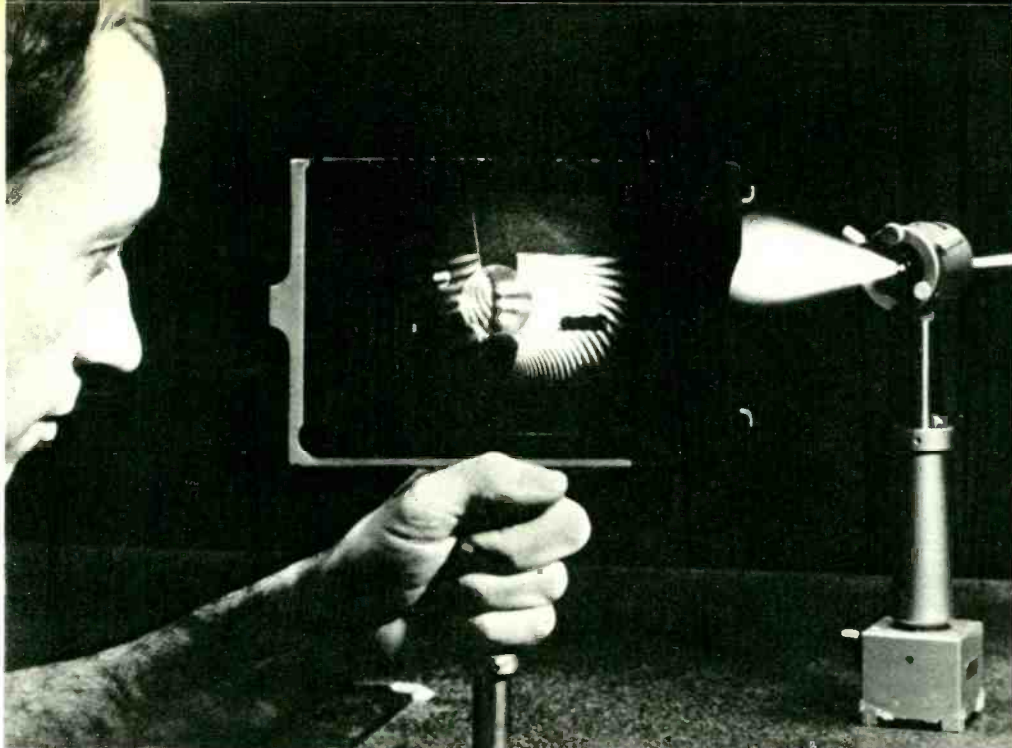

ONE, TWO, ZAP—TESTING. Engineers and scientists at IBM's General Systems Division in Rochester are putting computer parts to the test with three-dimensional holography, also known as 3D laser photography. Quickie checks are made of each part by taking two exposures on the same photographic plate—before and after stress is applied. Photo shows scientist examining fingerprint-like interference pattern that reveals areas of stress. A truly refined form of non-destructive testing!

Electronics in the News

Will Success Spoil Satellite? President Nixon's recent trip to China proved the value of satellite communications, something engineers at Hughes Aircraft Co. don't need to be told. You see them looking at a second Intelsat IV satellite (the first was launched in January 1971) before it was shipped off to Cape Kennedy prior to its launch into synchronous orbit over the Atlantic. Administered by Comsat Corp., the rotund vehicle can carry 6000 two-way telephone calls or 12 simultaneous color TV channels. Its dish antennas aim signals anywhere they're needed.

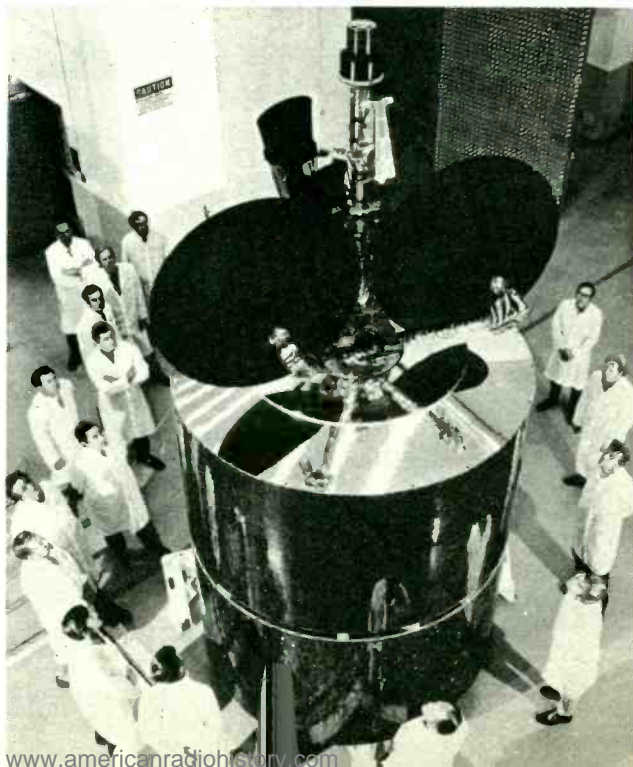

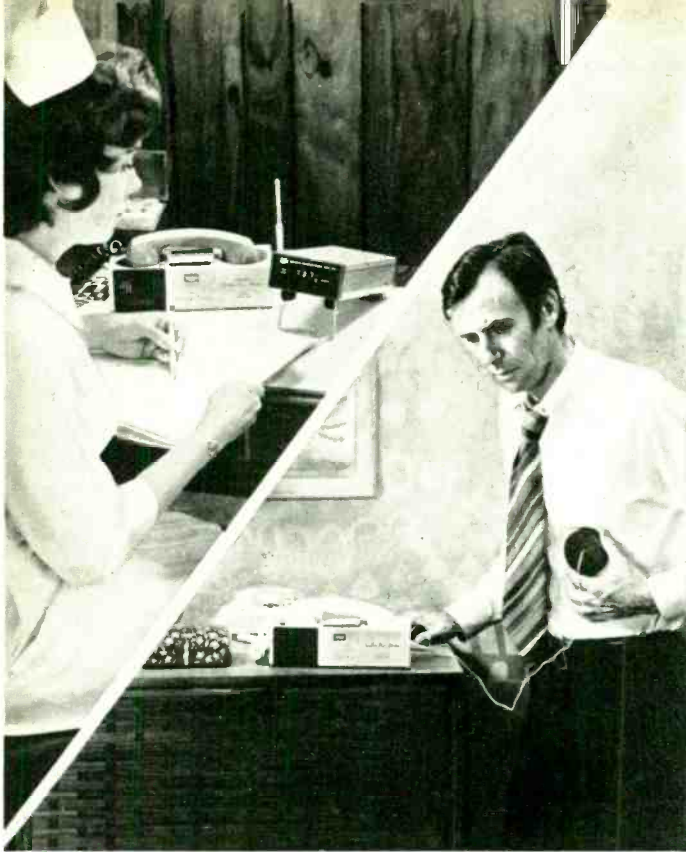

Long-Distance Tachometer. You've heard of the pacemaker, a tiny device surgeons implant near the heart to stimulate an irregular heart-beat. Well, Monsanto's Commercial Products Co. and Concept, Inc. have teamed up to produce an electronic counter and transmitter/receiver that permits physicians to check performance of a pacemaker over the telephone. The busy doctor doesn't need to leave his office. Patient simply calls doctor's office and nurse takes a reading and compares it to previous measurement. Let's see Marcus Welby top this!

Their Finest Crystal. Think the telephone company is falling down on the job? Actually, it's working hard to improve service. The crystal filter shown at right is one example of new methods being implemented to boost Ma Bell's performance. The monolithic crystal filter is a high-frequency bandpass type which will be used in circuits that stack telephone calls in long-distance communications. It took five years to manufacture one having the required tolerances.

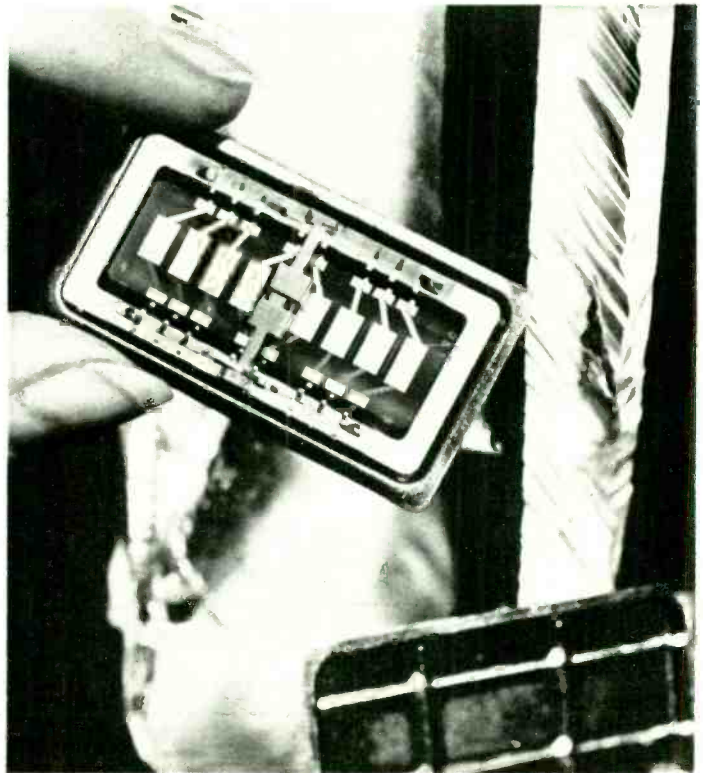

10 Reasons why RCA Home Training is your best investment for a rewarding career in electronics:

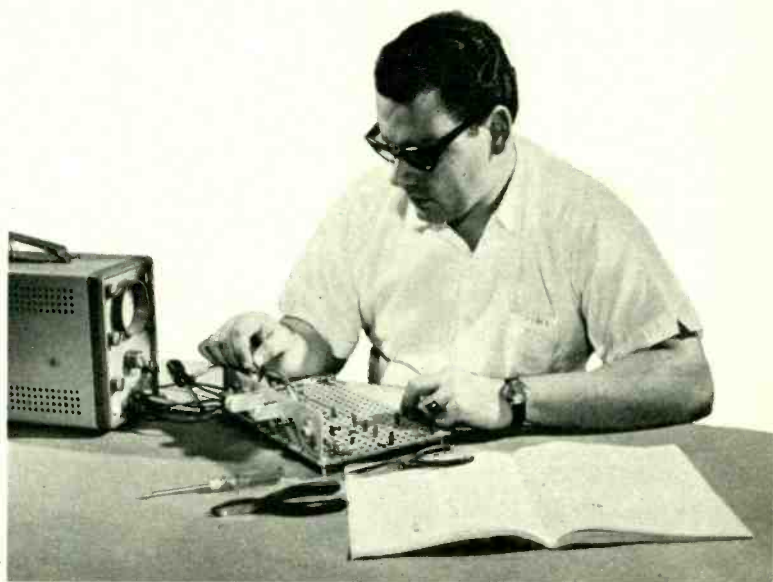

Performing transistor experiments
on programmed breadboard — using
oscilloscope

1 LEADER IN ELECTRONICS TRAINING

When you think of electronics, you immediately think of RCA... a name that stands for dependability, integrity, and pioneering scientific advances. For over half a century, RCA Institutes, Inc., a subsidiary of RCA, has been a leader in technical training.

2 RCA AUTOTEXT TEACHES ELECTRONICS FASTER, EASIER, ALMOST AUTOMATICALLY

Beginner or refresher, AUTOTEXT, RCA Institutes' own method of programmed Home Training will help you learn electronics more quickly and with less effort, even if you've had trouble with conventional learning methods in the past.

3 WELL PAID JOBS ARE OPEN TO MEN SKILLED IN ELECTRONICS

RCA Institutes is doing something positive to help men with an interest in electronics to qualify for rewarding jobs in this fascinating field. There are challenging new fields that need electronics technicians... new careers such as computers, automation, television, space electronics where the work is interesting and earnings are greater.

4 WIDE CHOICE OF CAREER PROGRAMS

Start today on the electronics career of your choice. On the attached card is a list of "Career Programs", each of which starts with the amazing AUTOTEXT method of programmed instruction. Look the list over, pick the one best suited to you and check it off on the card.

5 SPECIALIZED ADVANCED TRAINING

For those already working in electronics or with previous training, RCA Institutes offers advanced courses. You can start on a higher level without wasting time on work you already know.

6 PERSONAL SUPERVISION THROUGHOUT

All during your program of home study, your training is supervised by RCA Institutes experts who become personally involved in your efforts and help you over any "rough spots" that may develop.

7 HANDS-ON TRAINING

To give practical application to your studies, a variety of valuable RCA Institutes engineered kits are included in many programs. Each kit is complete in itself. You never have to take apart one piece to build another. They're yours to keep and use on the job.

8 FCC LICENSE TRAINING—MONEY BACK AGREEMENT

Take RCA's Communications Career program—or enter with advanced standing and prepare immediately for your 1st, 2nd, or 3rd class FCC Radio Telephone License examinations. RCA Institutes money-back agreement assures you of your money back if you fail to pass the FCC examination taken within 6 months after completing the course.

9 CONVENIENT PAYMENT PLANS

You get a selection of low-cost tuition plans. And, we are an eligible insti-

tution under the Federally Insured Student Loan Program.

10 RCA INSTITUTES IS FULLY ACCREDITED

RCA Institutes is an accredited member of the National Home Study Council. Licensed by N. Y. State—courses of study and instructional facilities are approved by the State Education Department.

**VETERANS: TRAIN
UNDER NEW GI BILL**

SEND ATTACHED POSTAGE PAID CARD TODAY! FREE DESCRIPTIVE BOOK YOURS WITHOUT OBLIGATION!

If reply card is detached, send this coupon today.

RCA INSTITUTES, INC.
DEPT. 234-207-0
320 W. 31 ST.
NEW YORK, N.Y. 10001

Please send me FREE illustrated career catalog. I understand that I am under no obligation.

Name _____

Address _____

City _____

State _____ ZIP _____

Age _____

Veterans: Check here

Construction of Multimeter.

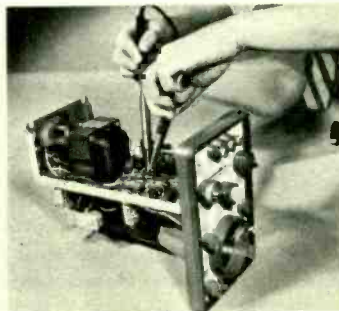
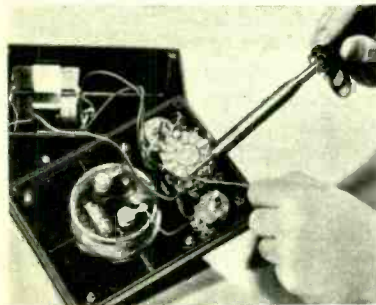

Construction of Oscilloscope.

Temperature experiment with transistors.

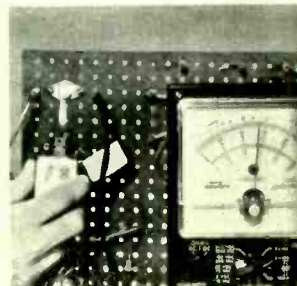



Low-Cost Speed Indicator

By CHARLES GREEN

MANY home craftsmen have discovered that working with the latest generation of infinitely-variable, speed-controlled tools is a frustrating experience. The tools have the capacity to work at full, half, or any speed down to zero. Problem is, few if any of these tools give you the shaft or blade speed for a given trigger setting.

A few years ago, the solid-state speed controller was introduced to the handyman. Plug that old-fashion, single-speed tool into this gadget and variable speed is yours for the dialing. But just like their more recent shop-mates, the add-on speed controller cannot give you any inkling of tool RPM.

It's easy to determine the speed of any power tool, especially those driven via electronic speed control, with our Low-Cost Speed Indicator. This indicator works with a hand drill, lathe, drill press or any rotating workshop instrument. And with practice you can learn to gauge the speed of a saber saw

or any other reciprocating tool.

Our indicator works on the persistence of vision effect. A blinking light is aimed at a moving target. When the number of light bursts at a given moment almost equals the target's speed, the device appears to move slowly. If the light bursts accurately coincide with the moving object, it appears to stand still.

The speed indicator utilizes a neon timing light. The lamp is driven by a solid-state timing circuit. And the dial is calibrated to read speed directly from 125 to 3,000 rpm.

How it Works. Unijunction transistor Q1 and associated components are connected as a sawtooth oscillator. When power is applied to the circuit, current flows through resistor R2 and pot R1 (*rpm*). Capacitor C1 charges up to a voltage of sufficient value to force transistor Q1 to conduct.

When Q1 conducts, a sawtooth-shape current pulse flows through Base 1 and Base 2

of the transistor. This pulse is coupled via resistor R4 to the base of transistor Q2.

Transistor Q2 helps to turn the sawtooth signal into a somewhat squarewave-shape voltage. The waveform is processed to give output autotransformer T1 adequate time to build up energy in the windings.

Transistor Q3 completes the voltage-shap-

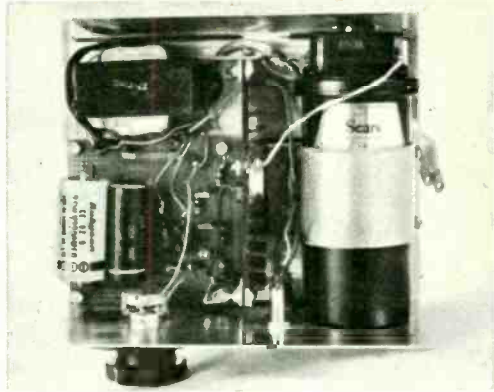
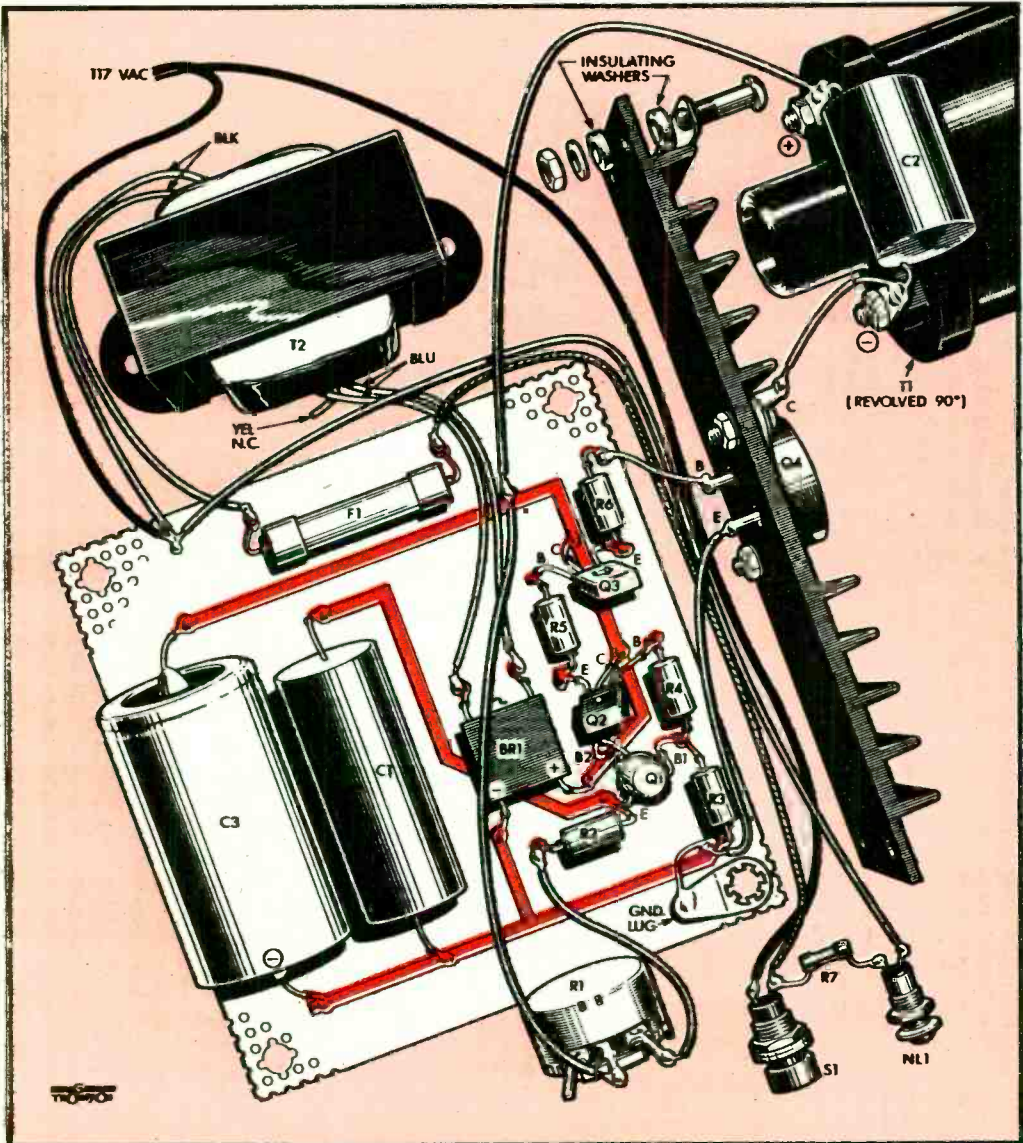
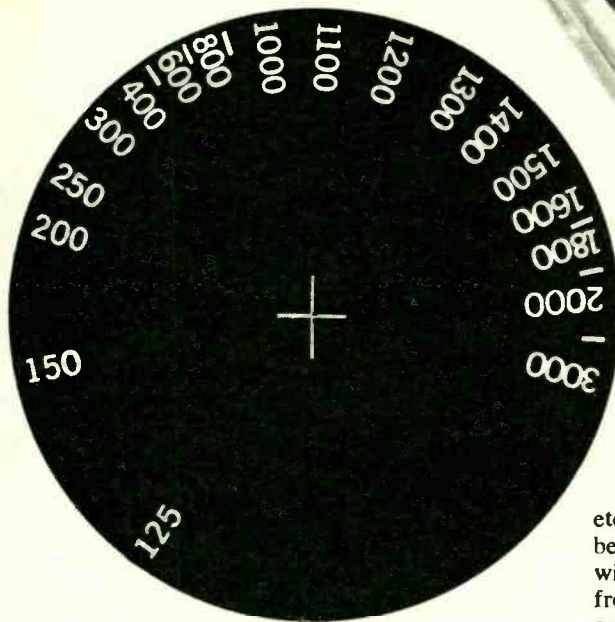

Fig. 1—For clarity, autotransformer T1 was revolved 90° to show its terminal post wiring detail. Heatsink holding Q4 must be electrically insulated from chassis as seen below in pictorial.



Low-Cost Speed Indicator

Fig. 2—Cement dial to piece of plastic. Mount dial to R1 with its shaft in maximum CW position so that 125 RPM reading is at vertical, or 12 o'clock, setting.



ing process. The output of Q3 is fed via resistor R6 to the base of transistor Q4. This semiconductor couples the signal to transformer T1. The secondary winding of T1 steps up the induced waveform to a voltage high enough to fire timing lamp NL2.

When Q1 conducts, it discharges capacitor C1 and the process is repeated. The firing rate of Q1 is determined by the setting of pot R1. The lower the pot's overall resistance, the higher the output frequency of the sawtooth. The neon lamp flashes at a frequency which equals the highest speed measured by the indicator. As the potentiometer resistance is increased, the frequency of the sawtooth decreases, slowing the flash rate of NL2.

Transformer T2, bridge rectifier BR1 and electrolytic capacitor C3 form the indicator's

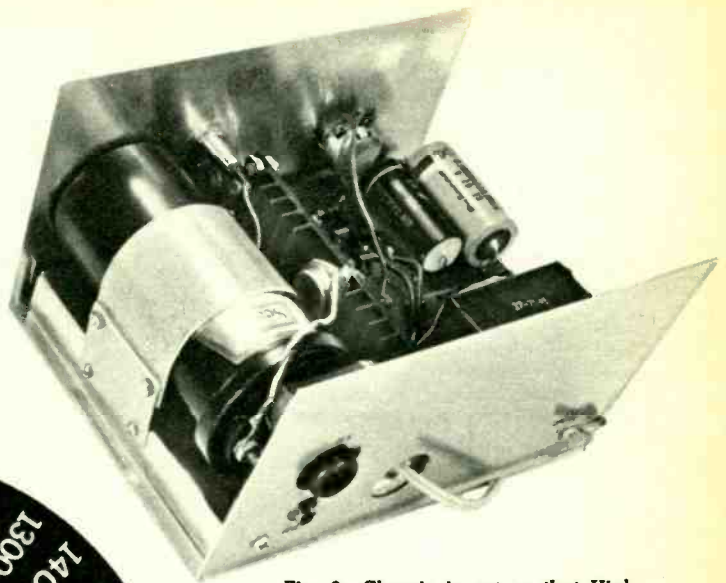

Fig. 3—Chassis is cut so that High Voltage tower of T1 protrudes slightly. Below T1 is ground terminal. Note aluminum strap clamping T1 with masonite holding strap to chassis.

power supply. About 12 VDC is supplied to Q1-Q4.

Building the Speed Indicator. The circuit is housed in a 6 x 8 x 4½-in. aluminum cabinet. Most of the components are mounted on a 3¾-in. square perfboard. Connections are made with pressure-sensitive, pre-etched copper patterns. Components also can be mounted with push-in clips and connected with wire. Since the circuit operates at low frequencies, component placement is not critical.

Two of the components, autotransformer T1 and neon timing light NL2, can be bought at automotive-parts stores. Transformer T1 is a standard ignition coil for any auto using an *external* ignition ballast resistor. Component NL2 is a neon automotive timing light. If you buy a timing light with a remote starting switch, disregard this switch. See the Parts List.

Start construction by cutting out a 3¾-in.-square piece of perfboard. Mount components to the adhesive-backed copper pattern as shown in our pictorial. Wires leading away from the perfboard are terminated with push-in clips soldered to the copper pattern.

Once perfboard wiring is completed, mount it to a corner of the chassis. Use ½-in. spacers at each board corner.

Fasten Q4 to the heatsink and mount the

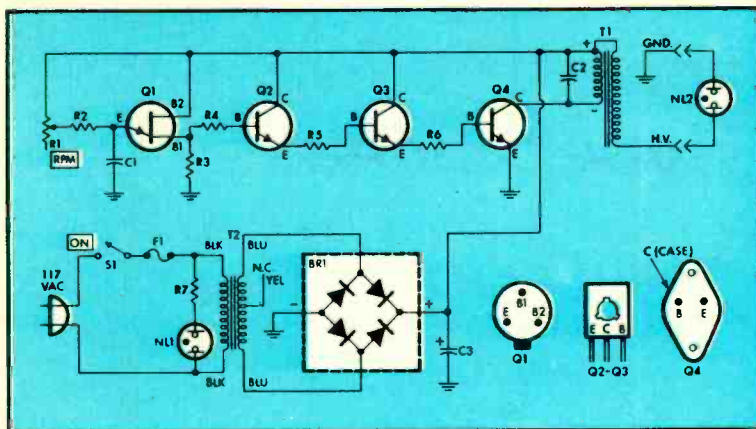

Fig. 4—For proper operation of neon timing lamp NL2, wire autotransformer T1 polarity as shown in schematic. If on/off indicator lamp has built-in current-limiting resistor, omit R7.

PARTS LIST

- C1—1 μ f, 25V capacitor
 C2—0.5 μ f, 100V capacitor
 C3—2200 μ f, 25V electrolytic capacitor
 BR1—Bridge rectifier; minimum ratings:
 50 PIV @ 1.5A (International Rectifier
 18DB6A-6 or equiv.)
 F1—1.5A fuse
 NL1—Neon pilot lamp assembly (includes R7)
 NL2—Automotive timing lamp (Sears,
 Roebuck & Co. 28AR2159 or equiv.)
 Q1—Unijunction transistor (Motorola HEP-310)
 Q2, Q3—Npn transistor (Motorola HEP-245)
 Q3—Npn transistor (Motorola HEP-247)
 Resistors: $\frac{1}{2}$ -watt, 10% unless otherwise
 noted
 R1—500,000 ohms, audio-taper pot.
 (Calectro B1-688 or equiv.)
 R2—10,000 ohms
 R3—1,000 ohms
 R4, R5, R6—47 ohms
 S1—SPST switch (Calectro 34-098 or equiv.)
 T1—12V automotive ignition coil, external res-
 istor type (Sears, Roebuck & Co. 28AR8245
 or equiv.)
 T2—Power transformer; secondary:
 12.6V @ 1.5A (Triad F-25X or equiv.)
 1—Heatsink (International Rectifier IR132-C
 or equiv.)
 Misc.—6 x 8 x 4 $\frac{1}{2}$ -in. aluminum cabinet (LMB
 CB-2), perforated board, $\frac{1}{2}$ -in. aluminum
 spacers, AC line cord, sheet aluminum for
 bracket, adhesive-backed, copper circuit
 patterns.

heatsink with insulating washers and angle brackets to the chassis. The heatsink must be electrically insulated from chassis and bracket. Both angle brackets are cut from sheet aluminum to 5/16-in. wide by 1 $\frac{3}{4}$ -in. high. The bracket foot is about $\frac{1}{2}$ -in. long.

Autotransformer T1 is mounted to the chassis with a J-shaped sheet aluminum section wrapped around T1. A piece of Masonite is slipped between T1 and the chassis, allow-

ing the lip of the ignition coil to clear the chassis. T1's high-voltage terminal protrudes out of a hole cut in the rear of chassis. Position T1 on the chassis as shown in the photo.

Mount T2 to the chassis with No. 6 hardware. Finally, install NL1, S1 and pot R1 on the front panel. Interconnect all switch components: Remember to keep the leads away from the heatsink. A bent ignition wire terminal serves as the chassis ground connection for NL2 but a large fahnestock clip works as well.

Calibrating the Speed Indicator. Connect one lead of the neon timing lamp to T1's HV terminal. The remaining lead is attached to the chassis. If an external ground is handy, run a separate ground lead to the chassis. This minimizes any chance of an electrical shock hazard, especially if your shop floor is damp. Remember, do not touch the ignition coil HV terminal while it's operating.

Plug in the AC line cord and turn S1 on. Rotate R1 from minimum to maximum resistance setting and check the timing-lamp flashes. The frequency of the flashes should have a long dwell period at R1's maximum setting. As R1 is rotated toward minimum resistance, the flashes should increase.

The pot's dial can be accurately calibrated after it is mounted. Connect a triggered time base oscilloscope to the collector of Q4 and directly measure off pulse frequency.

Or, place a silicon photo cell connected to a scope in front of the neon timing lamp. This method was used to calibrate our indicator.

Measure the pulse rate per second (frequency) with the scope. Then multiply this reading by 60 to obtain rpm. For example,
 [Continued on page 101]



Sidestacked TV Antennas for a Super Signal!

If you're in such a poor signal area that even Marcus Welby isn't getting through, the answer may not be a bigger antenna but a group of antennas.

By ART MARGOLIS

WHILE you may have a good TV set and a good broadband antenna, if you're in a poor signal area it means you're getting poor reception. Even if you use a complex log-periodic antenna plus a solid-state pre-amp, high mast and a rotator, there are limits as to how much signal you can pull in with a single skyhook.

But have you ever thought about starting your own antenna farm? You've probably seen fancy government installations from time to time—thousands of antenna elements shaped in wild configurations strewn about over acres of government-owned land.

While you don't have to go into the aerospace business to get a good TV signal, a simple antenna farm—we call 'em side-stacked antennas—can be built which requires only a few hundred feet of yard space. It's really a simple form of a multiple-antenna installation that will work with all types of TV antennas—from a simple dipole to a gigantic deep-fringe monster.

Your antenna farm will consist of a few of these antennas—typically, two, three or four, depending on how much you want to spend and how desperate you are—separated a certain distance along the ground. The gain from each antenna is added together (by a single feed to your TV) to boost signal strength. The more antennas you add to your farm, the greater the chance of your getting a passable TV picture.

With all this theory in my head, I decided to pack up my family and some gear and set off for a remote part of Florida (where I live)—heading toward the southernmost part of Dade County—to see if I could get my antenna farm idea to work. Items included my wife, two daughters, a small TV monitor, a field-strength meter, three all-channel an-

tennas and lots of 300-ohm lead.

In southern Dade County, Channels 5 and 12 (which originate in Palm Beach) normally are not received. I first hooked up one antenna to see just what kind of signal was managing to filter into the area. Generally speaking, a 100-microvolt signal (as measured with a field-strength meter) is not viewable, a 500-microvolt signal is passable, while a 1,000-microvolt signal produces a decent picture.

Channel 5, 125 mi. away in Palm Beach, was delivering 200 microvolts and Channel 12, also in Palm Beach, was producing merely 100 microvolts. Bad news. We went to work and hooked up two antennas in a horizontal array (details on how to do this follow), using a tunable stub at the TV to get rid of ghosts. The TV picture brightened considerably and once both antennas were carefully aligned, we got a 600-microvolt signal on Channel 5 and a 300-microvolt signal on Channel 12.

Pleased but not impressed, we next completed an antenna farm made up of three antennas. It took us about an hour to get all three aligned and humming on the two channels we wanted, but finally—after trimming transmissions lines and tuning the stub—we got viewable pictures. Signals of 1,000 microvolts on 5 and of a passable 500 microvolts on 12.

How do you go about stacking antennas sideways on your own farm? Well, first let's make a distinction between *stacking* antennas and *separating* them. Aside from our informal talk about side-stacking, stacking actually is a technical term used only for antennas that are electromagnetically coupled (their metal elements work together as if there were just one antenna). Antennas can be vertically or horizontally stacked and you've probably

TV CHANNELS: FREQUENCY VS. WAVELENGTH			
Channel	Freq. Band (mc)	Wavelength (inches)	
2	54-60	202.0	L
3	60-66	182.8	O
4	66-72	166.8	W
5	76-82	145.6	V
6	82-88	135.6	H
7	174-180	64.8	H
8	180-186	62.8	I
9	186-192	60.8	G
10	192-198	58.8	H
11	198-204	57.2	V
12	204-210	55.6	H
13	210-216	54.0	F
14	470-476	25.0	H
29	560-566	21.0	F
48	674-680	17.5	B
64	770-776	15.3	A
75	836-842	14.1	N
83	884-890	13.3	D

seen vertically-stacked antennas often—they're usually the more expensive multiple-element, all-band types. Fig. 1 shows a diagram of a horizontally stacked rig that's a brainchild of the Channel Master Corp. (Interesting, but difficult to set up and maintain.)

By horizontally or vertically separated antennas, we mean an installation (i.e., antenna farm) where a number of individual antennas—which can be simple dipoles or stacked all-band models—are set up a certain distance apart. A horizontal array is more practical than a vertical one because it's easier to place antennas side by side (see Fig. 2) than to try to arrange them on top of one another via a super-tall mast.

Whereas coupled antennas are only inches apart and can pick up only one station (to which they are precisely tuned), horizontally separated antennas can be anywhere from 50 ft. to 1 ft. apart (depending on the wavelength of the TV station's signal), and can pick up several different signals, depending

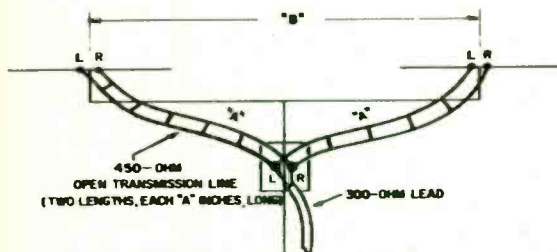

Fig. 1—Horizontally stacked antenna design from Channel Master. Big disadvantage is 450-ohm open-wire leads that match antennas to 300-ohm twinlead. Antennas are single-channel yagis.

on the types of antennas you use, how carefully you set them up, and on how spread-out the TV stations are.

While you needn't worry about coupling, separating, etc., if you are located 125 mi. or so from the station you want to receive, you must select high-gain (thus, expensive) antennas for your farm. An old truism in the antennas business says that the only way to increase signal strength is by antenna geometry. This means you make the rig as large as possible—the more metal you have in the air, including dipoles, reflectors and directors, the greater the signal voltage induced into it. You can't rely on electronic circuits, such as preamps, to get the job done.

So if you install two antennas where there was only one before or three where there were only two you can keep on collecting more and more signal until you get a satisfactory TV picture. That is, until transmission lines get so long that signal losses equal whatever extra gain is being squeezed out of the system. Now let's tackle the tricky details of actually building one.

Rules of the Game. You must choose your antennas carefully. Just planting three or four assorted TV antennas won't do. Decide how much you want to spend, how many signals you wish to capture and how many elements you need (how much gain). For instance, if you only want to pull in Channel 6, then purchase some yagis cut for this channel or build them yourself. To pull in more than one channel, your best bet is a multiple-channel antenna.

If antennas aren't separated they interfere

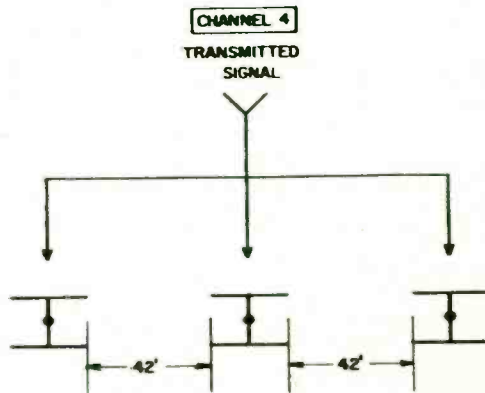

Fig. 2—Antenna farm of three horizontally separated dipoles. Antennas must be spaced three wavelengths apart to avoid interference. Bays are 42 ft. apart—3 times Channel 4's wavelength.

Sidestacked TV Antennas for a Super Signal!

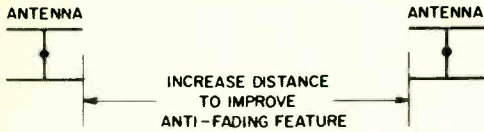

Fig. 3—TV signals often are subject to fading and airplane flutter. Increasing distance between antennas (beyond three-wavelength figure) may help improve reception if fading actually is a problem.

with each other. Rule of thumb here is that your skyhooks must be at least three wavelengths apart. If you're going for more than one station, the one having the lowest frequency is your guide. For instance, suppose you are trying to get Channels 4, 7 and 10. Check the chart of TV frequencies. Channel 4 (66 mc) is lowest. Its wavelength is about 170 in. Therefore, tip-to-tip separation between antennas should be three times 170 in., or approximately 42 ft.

The separation produces a fringe benefit. One problem with long-distance TV reception is signal fade and airplane flutter. The farther you separate your antennas, the more you reduce these factors (see Fig. 3).

Everyone knows that the higher a TV antenna, the better the reception. But few know why this is so. It's because the earth—or ground—acts like a mirror to a transmitted signal. When you put up an antenna a mirror image of the antenna appears in the earth. You can't see it, but the mirror image, electromagnetically speaking, is just as capable of collecting a signal as the real antenna. However, the image is upside down and opposite in polarity (see Fig. 4) and there's no twin lead going to the TV set. It's simply a pest.

So that this image won't interfere, it should be at least three wavelengths away from your antenna, too. For instance, on Channel 4, a 25-ft. high mast will do since active elements will be 25 ft. above and below ground, adding up to a 50-ft. separation. On higher channels having shorter wavelengths, the required height is less. Always consider antenna height above earth, not above a building. The undesired image is in the earth.

It goes without saying that your antennas must be pointed bull's-eye at the transmitters (assuming they're sending from the same

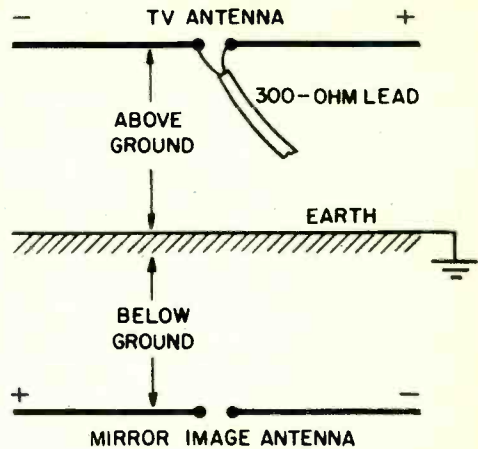

Fig. 4—Tail mast for each antenna is a must. Earth forms a mirror image of any antenna placed above it. Distance between real antenna and image below ground should be three wavelengths.

direction). You should line them up with the elements broadside to the station (see Fig. 5) so that as you look down the line they present a common front.

When the first antenna is erected care must be taken that it's at the point where the TV signal is strongest—somewhere in the space loop. As the TV signal passes through the air (see Fig. 6) each wavelength has a position where it induces maximum voltage. When

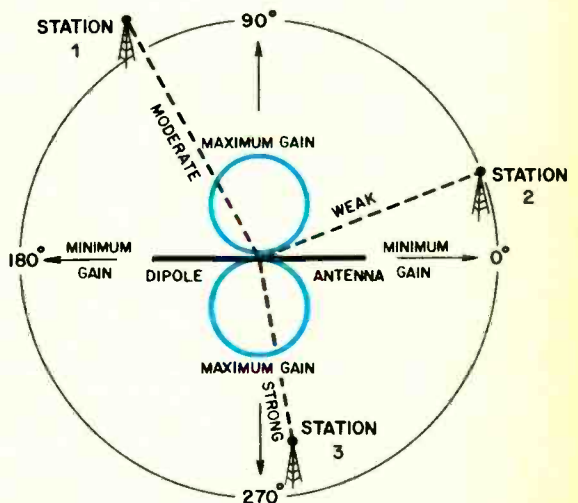

Fig. 5—In general, antenna elements go broadside to incoming signal for maximum gain. Diagram shows pickup pattern for dipole. The more area that signal covers, the stronger it will be.

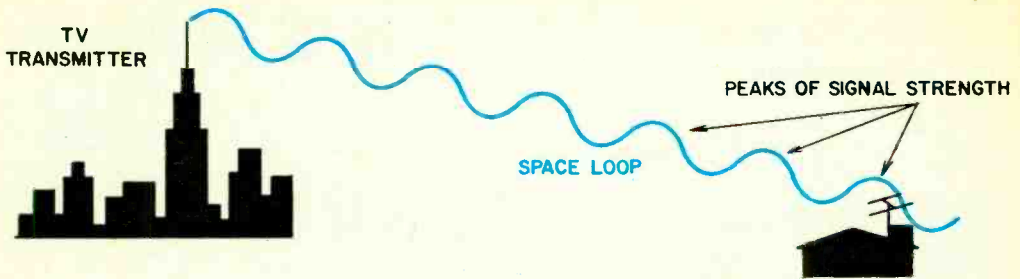

Fig. 6—No matter how far TV station is located from your TV set, there is one position for your antenna where induced signal voltage will be maximum. In space loop point occurs at peak amplitude of wave.

you're aiming for a single TV station, the first antenna should be hooked up to the TV and moved back and forth until a good picture is attained. When several different channels are desired, the best compensated position should be found.

Once you've taken aim at the station (or stations) and have found the best spot in the space loop, try for the best tilt. You tilt the antenna forward and backward until you get a maximum signal. An ordinary roof mount that goes on the bottom of the mast will do. It swivels to compensate for tilted roofs. Once the best position is found fix the mast there. Finally, install the other antennas in a broad-side line on either side of the first antenna, observing position, separation and height.

Once all the antennas are correctly positioned and collecting a signal, the induced voltages have to be funneled to the TV. This chore is performed by the transmission line.

While this lead may look like plain wire, it's actually a tuned circuit—just like the antenna—and requires special care. Typical flat twinlead has an impedance of 300 ohms. At TV frequencies this wire is equivalent to a number of coils, capacitors and resistors. The TV signal passes through all these distributed components at its particular design-

ated wavelength (see Fig. 7).

If you cut the twinlead to exact multiples of this wavelength it will pass all of the signal as if it were a one-to-one transformer. For instance, if you're trying to get Channel 4 and you install a twinlead whose length is any multiple of 170 in. (170, 340, 510, 680, etc.), you'll have tuned the wire perfectly and a maximum signal will be passed. Simply attach all such leads directly to your TV and the signals will be added together. This is shown in Fig. 8.

While it's great to adjust twinleads exactly, it's not so easy. If one or more leads are not cut correctly, an impedance mismatch occurs. Mismatching in strong signal areas is inconsequential but in weak signal areas it's serious. Up to 75 percent of the signal can be lost. A mismatch occurring between antenna and twinlead, or between twinlead and TV causes the signal to be re-

[Continued on page 98]

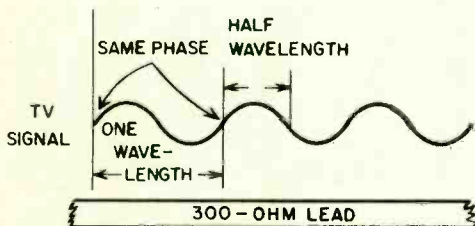

Fig. 7—Transmission line acts like tuned element to feed signal from antenna to TV. Signal travels through lead like undulating rope. It should pass into set at point where no reflection can occur.

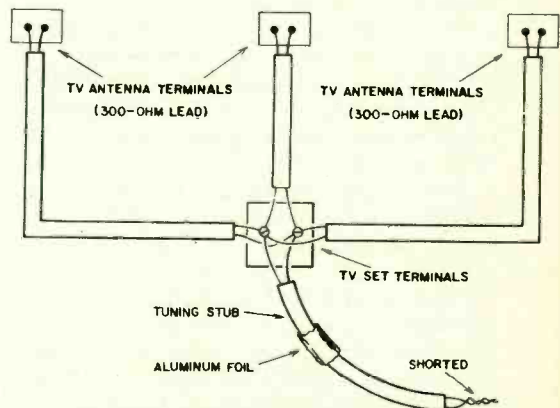
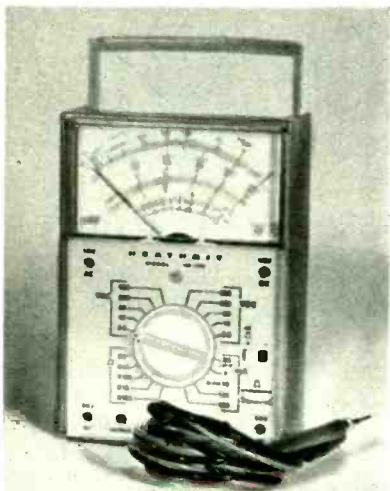

Fig. 8—TV signals from all antennas should arrive at antenna terminals in phase. This is achieved by cutting leads to exact lengths to avoid a mismatch and by using the aluminum-foil stub.

A New Digital Multimeter and a General-Purpose VOM



Heathkit IM-105

IF we took a poll to find the most-popular piece of test gear we're sure the general-purpose multimeter would catch first-place honors.

Though counters, solid-state voltmeters and triggered scopes are the glamor boys of the electronics industry, the multimeter still remains the old, reliable workhorse of the average experimenter and service shop. But while the counter crowd has been fighting the trigger-scope gang for attention in the lime-light, everyman's plain-vanilla multimeter (or Volt Ohm Meter as it is more commonly called) has quietly taken some tremendous technological strides on its own.

The Heath Co. recently began to offer a couple of multimeters in kit form which reflect the growing sophistication of the VOM. One of the kits, model IM-105, retains the outward appearance of being that jack-of-all-trades multimeter found on every workbench.

But don't let appearances fool you. If you accidentally drop a late-model VOM off the bench, chances are you're going to drop a piece of change for a new multimeter. Not so, though, with the IM-105. This \$54.95 kit can survive even a 5-ft. plunge to the floor. Pick it up, dust off your pride and continue to work as if nothing had happened. (Though the instrument is ruggedized, Heath plays it cool and makes no drop-test claims at all.)

The Heathkit IM-102, on the other hand, doesn't even have a meter needle to bend.

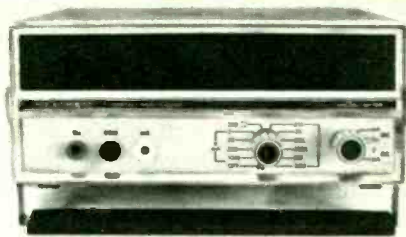

Heathkit IM-102

This is a digital instrument and relies on cold-cathode readout tubes to tell its user what it is reading. Until Heath made the digital multimeter available in kit form, this device's sole domain was the lab. The IM-102 represents the first instrument of its kind available to the hobbyist.

While the kit seems expensive at \$229.95, neither hobbyist nor lab engineer can outgrow the usefulness of this piece of gear. In terms of overall measurement accuracy, the digital

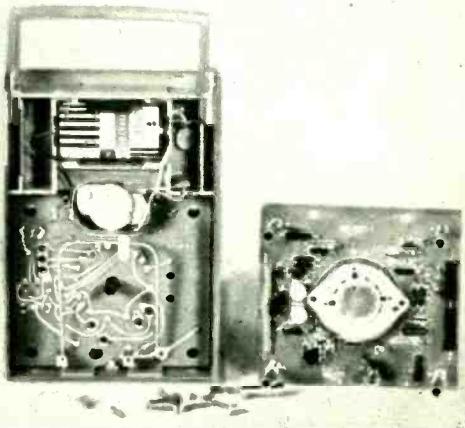

Fig. 1—Rear printed-circuit board on Heathkit IM-105 plugs into front board via jacks and mating plugs. Most connections are made this way.

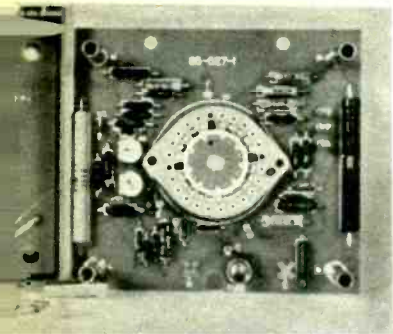

Fig. 2—Function switch is soldered to both front and rear pc boards, then connected via shaft.

multimeter cannot be approached by the more conventional analog-type VOM. Furthermore, the IM-102 costs less than half the amount charged for off-the-shelf digital multimeters having equivalent performance.

As expected, the IM-102 is more challenging to build than its analog sister, the IM-105. After soldering components to the IM-102's printed-circuit board, we discovered that there are several unfilled holes in the board. We don't know why there were empty holes. But the kit works well even with this seeming oversight on the part of Heath.

The Heathkit IM-105 can be built in a couple of hours. Although the Heathkit IM-105 is a state-of-the-art analog meter, it is meant to be constructed by the beginner. There are no surprises for the hobbyist in this kit.

The IM-105 is a ruggedized instrument, using a taut-band meter movement and precision resistors. The movement is protected

by a pair of diodes across the terminals. The entire circuit is protected via an in-line fuse accessible from the front panel.

Just about every part and component mounts on a printed-circuit board. Even the range switch is designed to be soldered via lugs directly to the pc board. The assembly basically consists of two boards sandwiched together. Connections between both boards are made via jacks on the front board, with plugs on the rear. After soldering all board components in place, push the two boards together, and nearly all connections are made automatically.

Sensitivity on the DC range of the Heathkit IM-105 is 20,000 ohms-per-volt. Accuracy is 3 percent of full-scale deflection. On the AC ranges, the sensitivity is 5,000 ohms-per-volt at 4 percent full-scale deflection.

Both DC and AC voltage ranges are 0-2.5, 10, 50, 250, 500, 1,000 and 5,000 volts. Also, a special range enabling you to measure 0-0.25 VDC is available via front-panel jacks.

A DC-blocking output capacitor permits measurements of AC voltages superimposed on DC. A dB scale is provided for measuring audio voltages.

The IM-105 has a total of six DC current ranges and five resistance ranges, with 20 ohms being the center-scale value.

Except for the 1,000- and 5,000-volt scales and the 10-A range, all measurements can be made via two jacks. The range switch selects the proper function so there is no need to worry about plugging the test leads into the

[Continued on page 100]

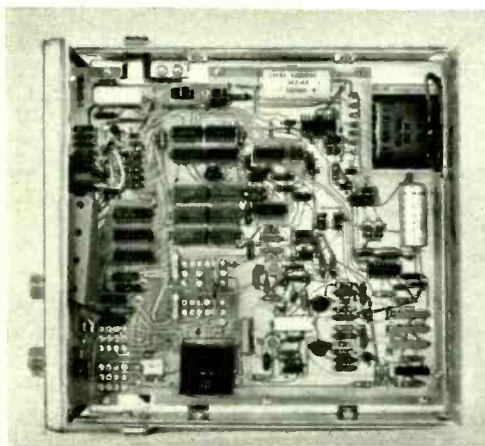

Fig. 3—Top view of IM-102 shows majority of components are mounted to printed-circuit. Note in lower left corner empty holes on board.

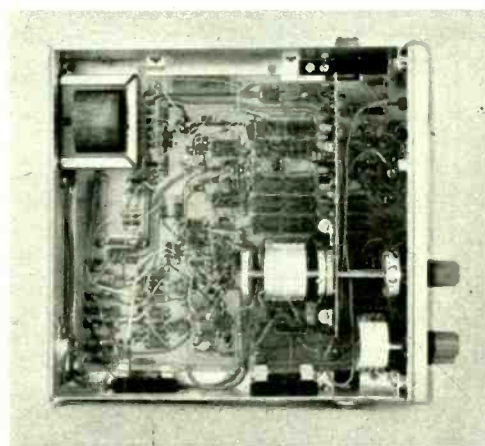

Fig. 4—Bottom view of IM-102 pc board showing range, mode switch, plus AC converter board vertically mounted to 11-deck rotary range switch.

Our comfort meter lets you know when to relax.



Build Your Own Temperature-Humidity Meter

By **RONALD M. BENREY** IT'S not the heat, it's the humidity.

The next time you sweat out a sultry summer day, keep in mind that old bromide. Whether you agree or not, it does contain an element of truth. Most people do feel a lot more uncomfortable when both temperature and humidity are high.

Atmospheric humidity plays a major role in your personal comfort. Your body is able to withstand a lot more heat when the humidity is low. Reason is that sweat evaporating on the skin surface is one of the ways your body regulates internal temperature. When the humidity soars, most people feel limp because their bodies cannot lose moisture fast enough.

Tests have shown that 10 percent of us begin to itch when the THI reaches 70. As the THI nudges 75, half of the population starts to complain. And almost everybody is hot and bothered when the THI sweeps over the 80 mark.

The U.S. Weather Service defines the Temperature-Humidity Index according to the following equation:

$$THI = .4 (T_w + T_d) + 15$$

The quantity T_d is the dry bulb temperature, while T_w is the temperature of the wet bulb. At the Weather Bureau, these temperatures are measured on two identical thermom-

eters. One thermometer is equipped with a water-dampened wick hanging from its bulb.

Temperature readings of the wet-bulb thermometer usually are different from that of the dry bulb. As moisture evaporates, it lowers the bulb's temperature. The overall reading of both thermometers is correspondingly lowered. The difference between wet and dry bulb temperatures can be used to determine humidity.

Our temperature-humidity meter won't make you feel any cooler. It will measure the THI in and around your home. Once you know how uncomfortable you are, it's a simple matter adjusting an air conditioner or dehumidifier for best room comfort.

Our meter, circuitwise, is a simple wheatstone bridge. One arm of this bridge contains two thermistors arranged to sample both heat and humidity according to the Weather Service's definition.

In our THI meter, wet and dry thermometers are replaced with thermistors. The thermistors (whose full name is thermal resistor) is the ideal device for the job. As the temperature rises, the thermistor's electrical resistance decreases. This inverse operating characteristic can be made linear over the thermistor's operating range.

Both thermistors are mounted on a probe which is fastened to the end of a fiber or

plastic rod. One of the thermistors is made to measure wet bulb temperature by adding a small square of plastic foam dampened with water. The water must be at room temperature, otherwise the equation for THI is no longer valid.

To take a THI reading, vigorously wave the rod-mounted probe for a few seconds.

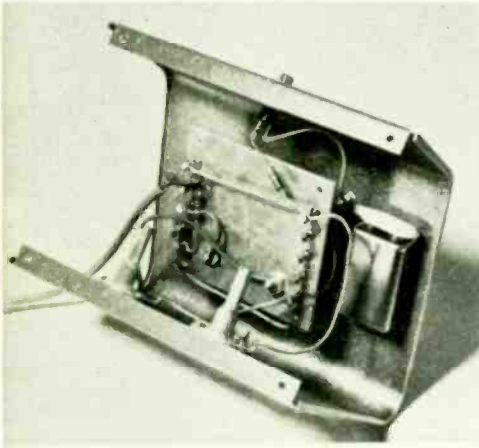

Fig. 1—Except for pots R3, R4 and battery, entire circuit is built on an eight-lug terminal board. Unused lugs are not shown in pictorial for clarity. Terminal board mounts to meter lugs as shown below. B1 is mercury cell.

This gives the water a chance to start evaporating. The wet thermistor's temperature will drop below the dry thermistor's.

Potentiometer R3, labelled *High Adjust* in the schematic, determines the meter's final scale reading by multiplying the scale value by 0.4. Similarly, pot R4, labelled *Zero Adjust*, adds 15 points to the scale value. Again, this is done to satisfy the Weather Bureau's THI equation.

Building the THI Meter. The probe body holding both thermistors is made from the plastic barrels of two discarded ballpoint pens. These barrels are held together with a dab of epoxy. Both barrels will later be joined to the plastic rod with a length of heat-shrinkable tubing.

Begin construction by prying the used ink cartridges out of the barrels. Cut an inch or so off one of the barrels. The inside diameter of the barrels will accept plastic-cased, two-conductor cable without squeezing.

Connect the thermistor leads to the ends of two short lengths of cable. Place a piece of spaghetti over one lead of each thermistor to prevent short circuits. Feed the cable through the barrels.

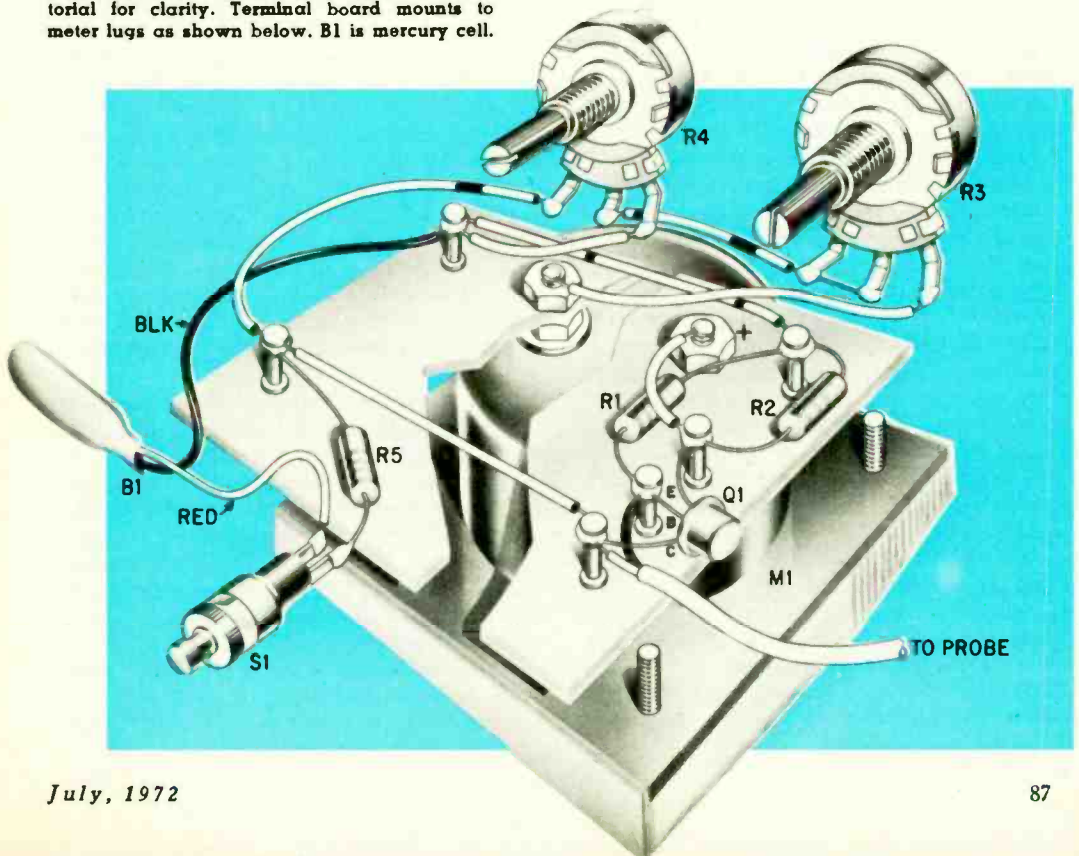

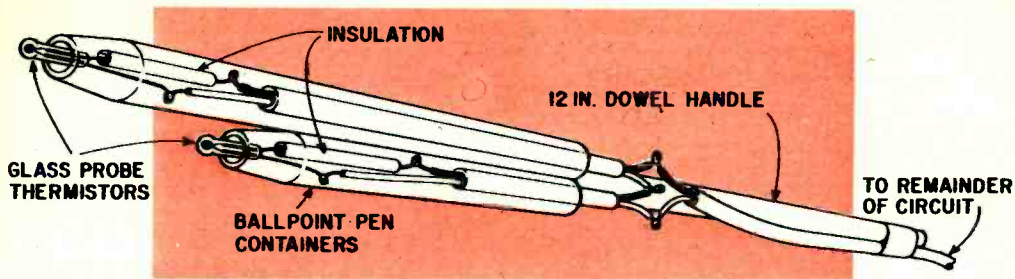

Fig. 2—Tip of thermistor protrudes slightly out of pen container. After thermistors are wired, epoxy them into container. Keep epoxy off tip.

Build Your Own Temperature-Humidity Meter

Cement the thermistors into the tips of the barrels with epoxy. Allow the dark spots within the thermistors to protrude $\frac{1}{4}$ -in. beyond the tip end.

After the thermistors are soldered to their respective lengths of cable, series-connect the two cables together at the base of the barrels. Attach the two remaining leads to a five foot length of two-conductor cable.

Tape one end of a $\frac{1}{4}$ -in. dia. plastic rod to both pen barrels. Then slip a three inch length of $\frac{3}{8}$ -in. dia. shrink-fit tubing over the barrel assembly and rod. Heat the tubing until it shrinks to a form-fit over both barrels and rod.

After you build the probe, drill and file a couple of holes in the meter case for S1. (*Press to Read*), and a grommet large enough to pass the two-conductor cable through it. After the meter is fastened to the case, remove its plastic front panel.

Cut out (or copy on a piece of card stock) the new meter face and glue it to the existing face. Snap the plastic front panel back into place, making sure that the zero adjust pin on the front panel makes contact with the pointer assembly.

Both pots were glued to the meter case with epoxy. We suggest you do likewise.

Part values are not critical in our THI meter. All of the resistors are soldered to an eight-lug terminal board. The board is fastened to the meter by drilling two holes in the board and bolting it down via the meter lug nuts. See the pictorial for layout.

Wire the circuit by following the pictorial. Battery B1 was also epoxied to the meter

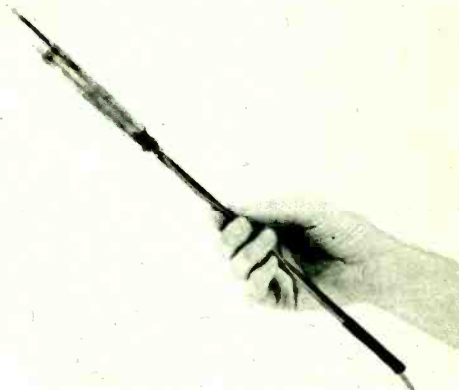

Fig. 3—Entire probe assembly after heat-shrinkable tubing is set in place. Thermistor tip in longer container has sponge placed on it. See text.

case, but we suggest that you buy a battery holder and fasten this to the case. Since the voltage delivered by B1 affects the calibration of the battery circuit, it should be a constant-voltage cell. A mercury battery is best. See the Parts List for the recommended type.

Calibrating the meter. To calibrate the meter, you'll need two water baths. This consists of two glasses of water at two different temperatures. Buy an inexpensive darkroom thermometer at your local photo shop, and set the first water bath at 44°F . The other water bath is set to 100°F .

Make the colder bath by mixing together tap water and ice cubes. Mix the hot bath by heating water on the kitchen stove.

After the water bath temperatures have stabilized, place the probe assembly in the cold bath. Both thermistors must be covered by the liquid. Set R3 to mid rotation. Wait at least 20 seconds for probe temperatures to stabilize, and then press S1. Adjust R4 for a zero reading on M1.

Next, place the probe in the hot bath. Again, both thermistors must be covered. Wait 20 seconds, and press S1 again. Adjust R3 for

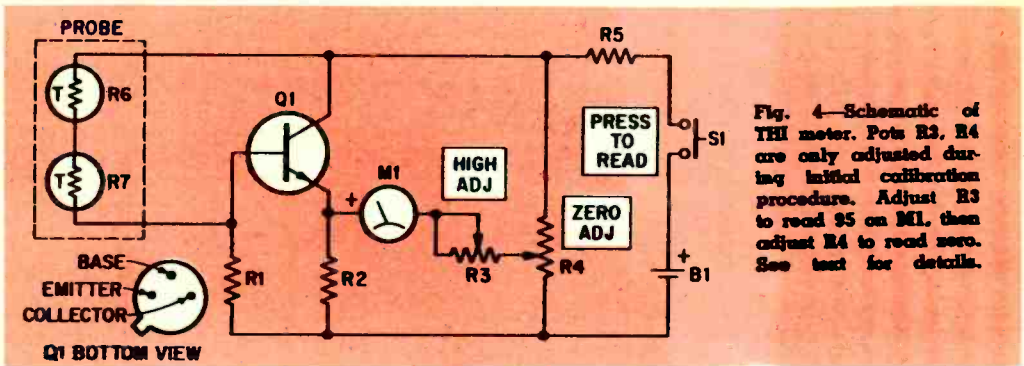

Fig. 4—Schematic of THI meter. Pots R3, R4 are only adjusted during initial calibration procedure. Adjust R3 to read 95 on M1, then adjust R4 to read zero. See text for details.

PARTS LIST

- B1—8.4-V mercury battery (Mallory TR146-X or equiv.)
- M1—0.1 ma. DC milliammeter (see note below)
- Q1—Npn transistor (Motorola HEP-50 or equiv.)
- Resistors: 1/2-watt, 10% unless otherwise indicated
- R1—4,700 ohms
- R2—270 ohms
- R3—5,000-ohm pot.
- R4—500-ohm pot.
- R5—330 ohms

- R6,R7—Glass-probe thermistor, 4,000 ohms @ 25 C (Fenwal GB34P2)
- S1—SPST push-button switch
- 1—4 1/4 x 4 x 4-in. aluminum sloping panel meter case (Bud CMA1936 or equiv.)
- 1—terminal board
- Misc.—two-conductor cable, epoxy cement, contact cement, fiber or plastic rod (see text), 1/8-in. shrink-fit tubing.
- Note: M1 available from Allied Industrial Electronics, 2400 W. Washington Blvd., Chicago, Ill. 60612. Part number 701-0020 \$17.40 plus postage.

a meter reading of 95.

Before using the THI meter, make sure that thermistor elements R6 and R7 are at the same temperature. The sponge pad should be dry before it is dampened for best instrument accuracy.

As mentioned earlier, our THI meter alone can't make you more comfortable. That job is up to your air conditioner or dehumidifier. If the air conditioner is working properly, room THI should drop whenever it's operating.

Some people don't like the effect of air conditioning and rely upon dehumidification instead. Again, adjust the dehumidifier until the THI meter registers a steady 60-65 reading.

Room comfort is not only affected by the size and efficiency of an air conditioner or dehumidifier but also the number of windows, outside temperature and room insulation. A room facing north in a temperate climate will probably be cooler than one having windows facing south. Thus, a room's total heat load fluctuates constantly.

To use the temperature-humidity index meter, dampen a foam pad with water and slip it over the thermistor cemented to the longer of the two pen barrels. Wave the probe assembly vigorously for about 30 seconds. Press S1, and take your reading.

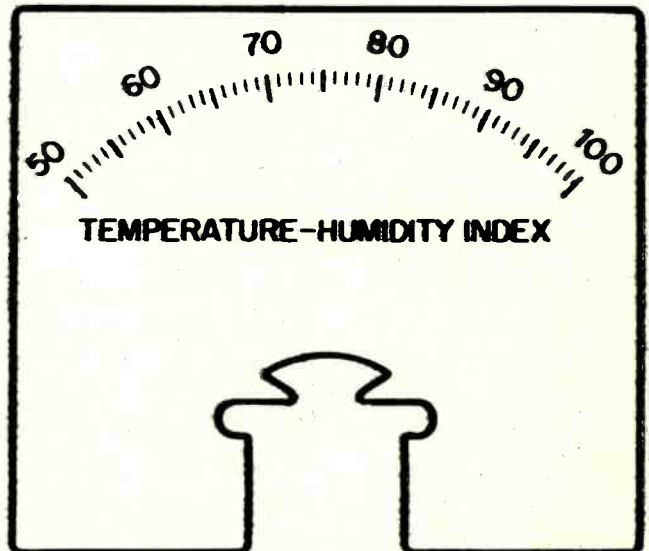

Fig. 5—Cut out meter face and paste it over original dial.

“At ComSonics we encourage all our technicians and engineers to enroll with CREI. Know why?”

WARREN BRAUN, *President, ComSonics Inc., Virginia Engineer Of The Year, ASE International Award Winner, CREI Graduate*



Photographed at ComSonics, Inc., Harrisonburg, Va.



"As a CREI graduate myself, I know the advantages of their home-study programs. CREI education has proven an excellent tool of continuing education for our employees and for me. And I strongly believe in CREI's ability to teach a man to learn independently and to use reference materials on his own.

"As President of ComSonics, I see changes taking place in our Electronics business every day. We're in closed circuit TV and acoustical engineering...and pioneered in Cable TV. CREI gives my men the knowledge they need to work in new areas...CREI's new course in Cable TV is an example. The CATV industry is expected to grow 250% in the next three years. I know the opportunities in Cable TV. I designed one of the first CATV systems in 1950. But technical advances are constantly changing the field. And since CREI's experts know most of what's going on in all areas of Electronics, I know that CREI can give my men some of the important, specialized training they'll need to maintain our position in Cable TV and our reputation in Electronics.

"We've interviewed many technicians and engineers for jobs in the past year and had to reject them because their knowledge is archaic and out-of-date. A man is of no value to us if he doesn't keep up-to-date."

Some of the biggest names in electronics buy CREI courses for their own employees. CREI students and graduates prove themselves on the job. They move ahead of the pack by earning promotions and salary increases.

The Future Belongs To You

You've been in Electronics long enough to know that the field is changing more rapidly than ever. New industries, like Cable TV, are born almost overnight. But surveys show that three out of four men now working in Electronics aren't technically qualified to work in these new areas. Clearly, the future will belong to the man who gets the right education now.

Start Learning At Home

But what you learn depends on which school you choose. Here's why CREI is among the best.

With the CREI program you study at home. At your own pace. There are no classes to miss, no work to make up. Each lesson is explained in clear, easy-to-read language. That's why many men do far better in home study than they ever did in school...even if they've been out of school for years. And the study habits they learn from CREI are sustained through life.

As a CREI student, you'll be assigned to an experienced instructor who will grade your assignments and offer constructive comments and criticism. If there's a special problem, the instructor will work with you until you understand it fully. You'll receive personal attention from your instructor because he deals with each student individually—as a class of one.

What Will I Learn?

You'll be learning the latest in advanced technology, geared to specific industry programs. Both theory and practical material are presented to meet all phases of job-related training needs.

CREI courses are written for the man who knows basic Electronics, but whose advancement depends on keeping his technical know-how current. You choose what you want to learn. You study subjects which help you grow and advance

in your present job and which relate to your career objectives. CREI offers you the opportunity to continue your education throughout your working life.

Constantly Up-Dated Courses

Because of rapid changes in Electronics, CREI courses are constantly being revised and up-dated by professionals who work in Electronics every day. New developments are included as quickly as they occur. Right now, CREI students are getting the latest up-to-the-minute information on such things as Cable TV, LSI chips, microminiaturization, lasers and masers, telemetry systems, servomechanisms, and data links. If it's new in electronics, CREI—and you—will know about it!

Developed By Top Scientists And Engineers

CREI maintains a full-time advisory faculty of some of the top names in Electronics. Each is a specialist in his own field, an expert who plans and develops CREI lesson material. After each expert submits his course plan, it is carefully reviewed and written by the CREI educational staff. Then each course is broken down into individual lessons. And they make certain each lesson is clear and self-explanatory. Just the right length for easy understanding and effective study.

How Can I Qualify?

If you've read this far, your interest in getting ahead in Electronics is evident. Send for our famous book on how to prepare for tomorrow's jobs in Electronics—the book that has helped thousands of men just like you get ahead. For your free copy, simply mail postpaid card today.



Founded 1927
Accredited Member
of the National
Home Study Council

Free book tells you all about CREI programs. For your copy, mail coupon, post-paid card or write: CREI, Dept. E1707C, 3939 Wisconsin Avenue, Washington, D.C. 20016

CREI, A Division of the McGraw-Hill Continuing Education Company
Dept. E1707C, 3939 Wisconsin Ave., Washington, D.C. 20016

Please mail me free book describing CREI Programs.

I am interested in: College Credits for CREI Study
 Space Electronics Electronic Engineering Technology
 Computers Industrial Electronics Nuclear Engineering Technology
 Electronics Systems Engineering Nontechnical Course in Computer Programming
 CATV Engineering

Name _____ Age _____
Address _____
City _____ State _____ Zip Code _____
Employed by _____
Type of Present Work _____ G. I. Bill _____

APPROVED FOR TRAINING UNDER NEW G.I. BILL



The Ham Shack

By Wayne Green
W2NSD/1



The Battle for 220 Begins

WILL hams save 220 mc for themselves or will the band become a tool of Class E CBers? The battle for the long-dormant 220-mc amateur band is beginning to shape up. A lack of commercial or surplus equipment to convert for use at frequencies of 220-225 mc has kept the band relatively inactive while VHFers have vented their enthusiasm on the 144- and 420-mc bands.

Two meters (144-148 mc) got its start with several thousand tons of World War II surplus equipment, all easily converted. Amateurs with long memories will recall the halcyon days of 144-mc amplitude modulation when SCR-522s were on by the thousands. This was 1948-58. These were joined later by government gear such as the ARC-1, 2, 3, 4 and 5s, plus dozens of other models.

In the mid-'50s, the Gonset Communicator arrived and swept the 2-meter market, pushing ARCs and SCRs off the operating table and into the attic. Heathkit Lunchboxes finished the retirement of military surplus. But still nothing for 220.

The '60s brought surplus commercial FM equipment and the rush to 146-mc FM was on. The '70s will provide equipment made specially for 146-mc FM . . . but still nothing for 220.

The situation came to a head in 1971 when the Electronics Industries Association (EIA) petitioned the FCC for the formation of a new Class E Citizens Band on the lower part of the 220 amateur band. This was countered by my own petition for a hobby-class amateur license for use in this band. Both petitions initially were met with apathy by amateurs.

The EIA just might sneak this one through. Manufacturers stand to gain millions on new CB equipment. Their lobby in Washington is effective and it's unopposed by any form of amateur lobby, giving the EIA almost carte blanche.

When the EIA's PR mills began to grind, amateurs read the electronics press in disbelief. "FCC officials said amateur-radio users are not greatly opposed to losing the frequencies because they are not used very much." So said a story which appeared in

Electronic News—only to be denied later by the FCC.

The effect of these stories was the opposite of that desired. When amateurs finally got wind of this turn of events they suddenly became concerned and decided that it was time to call a halt to this nonsense.

At a meeting which gathered 50 New England FM repeater groups together, standards for 220-mc repeaters were agreed upon; a frequency-coordinating committee was established to facilitate orderly growth of the band. Every 146-mc repeater group attending, without exception, agreed to set up a 220-mc repeater function as soon as possible. The first of these was actually on the air one week after the agreement was completed.

A few days after the repeater groups met, the Clegg division of IAS announced it would go ahead immediately with production of a 220-mc transceiver, plus a converter and repeater package. Tempo also agreed to rush its coming 220-mc transceiver into production to help amateurs move into the band.

How come the panic rush to populate 220? FM repeater groups realize all too well the importance of the 220-mc band for the growth of FM. Available channels on 146 are completely filled in some areas of the country and well on the way towards being filled in others . . . without 220 mc, a serious curtailment of FM would be inevitable.

The crowding on 146 mc is so serious in the New York City area that every channel has been taken and new repeaters are beginning to fill in the cracks between regular channels. The result is chaos. By moving repeater operations to 220 mc, another 66 channels would open up, thus providing growth for at least another year or two. By then, satellite repeaters may have come along and we can move up to 420 mc.

If repeater groups throughout the country respond to this emergency as enthusiastically as the New England groups did, we may well have over 1000 stations using the 220-mc band before the end of 1972! It doesn't seem likely that the FCC would torpedo the whole

[Continued on page 102]

The Listener

By C. M. Stanbury II



DXing the Lost States

DURING the past 20 years some eight different states in the continental U.S. have boasted SWBC transmitter sites. Excluding pirate operations, they've included California, Ohio, Pennsylvania, North Carolina, Massachusetts, Arizona, New Jersey and New York. Transmitters in the last three states are now defunct and thus present an intriguing historical challenge to the novice DXer.

If your rig is equipped to receive single sideband, then New Jersey is best logged via American Telephone & Telegraph's station WOO (Box 538, Beach Ave., Manahawkin, N.J. 08050). Weather broadcasts are aired at 0830 and 2030 EST on a number of frequencies, including 4403, 8757.6 and 13175.5 kc.

The state of New York can be logged by SWLs via the FAA's New York Aeradio. It has extensive weather broadcasts on 3001 kc (with an occasionally strong harmonic on 6002 kc in the 49-meter band), 5656, 8868 and 13272 kc.

But things do get tough when you tackle Arizona. You'll have to switch to a medium-wave frequency for this one. KTUF, a daytimer on 1580 kc, has been heard occasionally from coast to coast at sunset (PST). Be careful you don't get fooled by a Mexican station on this channel, XEDM (Hermosillo, Sonora) which at night announces a Nogales, Arizona mailing address.

Mix-up in Toronto. Sometime within the next few months Canada will embark upon its first jamming exercise. Of course, the Canadian government isn't describing it as such. Officially, the Canadian Broadcasting Corporation's TV station, CBLT, will move to Channel 5 so that Channel 6 can be opened up to new stations operating in other parts of Ontario. With UHF frequencies wide open in Canada, this puny gain hardly justifies the adjacent channel interference CBLT will cause to Channel 4 (WBEN-TV in Buffalo) throughout the most populous metropolitan area in Ontario. Fact is, all three VHF stations in Buffalo (2, 4 and 7) are more popular with people in Toronto than the

CBC, and this is Ottawa's way of trying to recapture some of its turf.

In 1970, under somewhat similar circumstances (when the BBC and British Post Office jammed Radio Northsea International), a myriad of bootleg rigs appeared in retaliation on the BBC's most popular medium-wave frequency. London attempted to play down the effectiveness of this reaction, at the same time quietly issuing orders for all transmitter sites to maintain full power at all times (peak radiated powers in England normally are reduced during daylight hours). Unfortunately, this Canadian move is far more subtle than the BBC's was. CBLT will be both a legitimate program outlet as well as a jammer.

It might be good idea to keep an eye on 740 kc (CBC's medium-wave frequency), as well as Channel 5. U.S. and Canadian TV DXers still have a chance to log CBLT on Channel 6. As you read this, ionospheric conditions will be near the peak of the sporadic E-Layer skip season. When CBLT switches to Channel 5 it will be subject to even more skip.

Ionosphere takes its Lumps. As if there wasn't enough shortwave interference already, a recent issue of the publication *Aviation Week and Space Technology* reported that both Washington and Moscow are busy developing high-frequency radar systems. The United States has been experimenting with three different types of over-the-horizon radars for the past few years and at least one of these will be fully operational in the near future. When you log one of these megawatt monsters it will probably produce a blip sound as its transmitter sweeps across the frequency you're tuned to.

A bit earlier, the U.S. Dept. of Commerce's weekly, *Commerce Today*, carried an article on the Department's experimental, super-power shortwave beam located near Platteville, Colorado. The test facility is said to detect the effects which will be produced in the upper atmosphere by future high-power transmitters. The initial results clearly show that high-energy RF is harmful to reception

[Continued on page 104]

2 Meters—Where the Action Is!

Continued from page 67

acceptance. At least three companies now are selling accessories for this purpose and it won't be long before most transceivers have this capability built in. Standard tones are now 1500, 1650, 1800, 1950, 2100 and 2250 cps.

Using FM Repeaters. If you have a Technician Class amateur-radio license (or better) you have a passport to inexpensive fun . . . a whole lot of fun. The only equipment needed are a simple transceiver having at least a one-watt output, a simple vertical antenna and crystals for your local repeater. The transceivers run from about \$200 up, a few cost over \$350. Your antenna can be anything from a coat hanger to a commercial 5/8 wavelength mobile whip mounted on a magnetic base. Few amateurs live far enough from repeaters to make it worth putting up big antennas and most live within walkie-talkie range.

Let's say you live near a 34/94 repeater (see Fig. 2), which is where most of us live. This means your transmitter will be set up on 146.34 mc and your receiver on 146.94 mc. Most commercial transceivers come with this pair of crystals installed since the frequencies are so common.

You set up your transceiver in your car or at home using a 12-V power supply, hook on a vertical antenna and push the transmit button located on the microphone. As you raise your finger off the button you should hear a slight hum or rush in your receiver followed by the squelch shutting off the sound.

This is the *squelch tail* of the repeater coming back. Your transmitter has turned on the repeater and you have heard the one-to-three-second delay built into the repeater which lets you know that your message has been rebroadcast. If you don't hear a squelch tail you have a pretty good idea that you are not making it through the repeater.

You should keep in mind that most repeater groups have a considerable investment tied up in the equipment that's up there on the mountain and that if you want to share in the fun you should share in some of their costs. Ask about this early in the game and be prepared to hold up your end either with money or work. Talent at putting up new antennas is usually as welcome

as a checkbook.

If there aren't many repeaters in your area you should keep this in mind and not get involved in long-winded conversations which tie up the repeater for long periods of time. Also be sure that you allow plenty of time between transmissions for any would-be talker to get a word in edgewise. Many repeaters have a timer which will turn the whole rig off if you don't let the squelch tail drop out every three minutes. This device is a nuisance but it does thwart operators who would otherwise never give someone else a chance.

Traveling with 2M. You can be sure I take my little hand unit with me wherever I go. This transceiver has a built-in Nicad battery and puts out two watts. The receiver is tuned to 94; the transmitter can be switched to 34 or 94 so I can operate either through a repeater or direct (called simplex) into 94 receivers. However, this arrangement can be troublesome when I am in regions of the country where 94 is not a standard frequency.

On a recent trip to the state of Washington I called out plaintively for several minutes on 34 looking for an answer. I was amazed at how dead the band was. Then someone figured out what was wrong and tuned in on 94 to explain to me that I was getting into the repeater just fine (on 34) but that everyone was calling me on its 76 output. He then told some of the chaps who had 94 crystals about my receive frequency and several came up to 94 to talk.

Those amateurs who have invested in the few hand units available have been having so much fun that this aspect of the hobby is sure to spread rapidly. Motorola's HT-220s cost about \$1000, but a few have been turning up lately that are available from one or two sources in small quantities for about \$300.

This price matches the new Standard hand unit, the Sonar and even some reconditioned Hallicrafters units, which are all in the same general price range. The Drake TR-22 is just a bit large for hand-holding, but it does come with a shoulder strap and it's the next best thing (at \$200).

Future of the Band. As the repeaters fill up the 146-147 mc portion of the band, I expect they will expand into the 147-148 segment and down into 145.5-146 mc. This should take care of future growth. With repeater channels spaced every 30 kc it's pos-

Continued from page 48

sible to get about 14 of them into a 1-mc band using the present standard of 600-kc spacing between transmit and receive. Crowding is still a long way off, though few repeaters remain unused during the peak hours of from 6 to 10 pm.

There is a petition before the FCC to open the entire two-meter band to Technicians. This would simplify many growth problems by permitting repeater inputs to be above 147 mc—territory which is presently forbidden to the Techs. At present, Techs are not permitted to transmit above 147 mc so they are unable to use the few repeaters whose inputs are above this frequency . . . and there are a few.

The only difference between the Technician Class and General Class license is that the latter requires a 13-wpm Morse Code exam while the Technician license demands only 5 wpm. There is one other basic difference. The Tech exam is given by your friendly local radio amateur, and the General exam by a steely eyed FCC examiner down at FCC HQ. Let's hope the FCC will simplify the expansion of repeaters by extending the Tech band to 148 mc. Since this would not include any band restricted to CW there should be no serious arguments against such a move.

New Equipment. The lack of growth in AM and SSB has kept manufacturers from spending money on new technological developments. The two-meter FM scene has been the most progressive, as you might expect. Starting with simple three-channel FM rigs just a couple of years ago now we are seeing eight- and ten-channel transceivers, and even a receiver that has a scanner built in to check various repeater and direct (simplex) channels. With the coming of toneburst entry, rigs are coming out with tone oscillators designed to turn on specific repeaters. This will be helpful if there are two or more repeaters which can be triggered by the same frequency in your area.

Mobile antenna design has been evolving. Some of these antennas can extend the range of a mobile station considerably. Many hams report gains of 50 percent in their range. Several companies now have amplifiers on the market which extend range considerably, too. Of course, a 100-watt amplifier, while entirely solid-state, does draw quite a bit of juice from your car's electrical system. Extended use demands that you consider where those extra amperes are coming from.

The DC output voltage is generated by the detector after it responds to the difference of the two frequencies. For instance, if the square wave coming from IC1 was 3 kc, then the output of IC2's detector would be a DC voltage corresponding to zero cps. Wow and flutter components, however, change the frequency of the incoming test signal, producing a proportional DC voltage.

The frequency-mixing and detecting process within IC2 forces the PLL to follow input frequency variations. As the input signal's duty cycle changes, the detector's output varies correspondingly.

The output of IC2's detector is amplified and appears at pin 7. It is coupled via capacitor C7 to a low-pass filter.

Resistors R22 through R25 and capacitors C8 and C9 form a 200-cps low-pass filter. Any remaining 3,000-cps component is attenuated by this filter, and further reduced in amplitude by integrated circuit IC3. The bandwidth of the signal arriving at point A in the schematic consists mainly of frequencies from 200 cps down to 4 cps.

Wow and flutter frequencies arriving at the junction of components R30 and R31 normally are sent through the weighting network consisting of components C12-C14 and R31-R33. This network shapes the signal to comply with the latest psychoacoustic weighting standards which apply to wow and flutter test procedures.

The signal also can be bypassed around the weighting network via pot R30.

After the signal has been weighted, it is fed to transistor Q2, connected as a source follower. This stage couples the signal to attenuator switch S4. Transistor Q2 also feeds the signal to binding posts BP5 and BP6.

The last integrated circuit in the amplifier chain is IC4. Meter M1 is driven by it. Note that M1 and associate components are in the feedback loop. Meter linearity is assured at low input signal levels.

Meter M1 is a modified VU meter. Since only the ballistics of the movement are required for our purposes, the meter's internal rectifier assembly and matching resistor network are removed before the meter is mounted to the cabinet.

Electrolytic capacitor C17 connects across

the terminals of meter M1 to assist the meter's own damping action, which makes a meaningful reading possible.

Calibration is a simple procedure with integrated circuit IC5 connected as a 60-cps modulated test oscillator. Voltage-variable capacitance diode D9 is connected in parallel across one of the frequency-determining capacitors. Our Wow & Flutter Meter is calibrated to its full-scale (5%) reading by modulating the oscillator with 60-cps line frequency via D9. Without the line frequency modulating this 3,000-cps oscillator, the output of IC5 is available to make record and playback measurements.

Our Wow & Flutter Meter's power supply is a conventional bipolar affair. Zener diodes D10 and D11 stabilize the output of each leg of the supply. These diodes also provide a low-impedance path to ground for AC voltages appearing across C23 and C24.

Though our Wow & Flutter Meter is meant to be an instrument that both measures and provides a visual readout of what it finds, scope readings also are possible through use of part of its circuitry. A scope connected to terminals BP5 and BP6 will display essentially the same information as M1 except in pattern form.

Our meter will most often be used with a test tape or record made specifically for the purpose of measuring wow and flutter. Suitable test tapes are available for reel-to-reel machines from Ampex. CBS Laboratories has a test record, BTR-150, available for the purpose of making wow and flutter measurements on a turntable.

Connect the output of your tape deck or preamp-connected turntable to BP1 and BP2 (*Input*). Place the test tape or record on the machine and set it in motion.

Turn range switch S4 to the *Level* position. Then adjust pot R1 (*Level*) for a half-scale reading.

Switch S1 (*Calibrate*) is in its off setting. Switch S2 (*Filter*) is in its on or off position, according to the measurement mode (RMS or peak-to-peak) desired.

Set the range switch to the position giving best meter deflection. The needle may oscillate slowly about a reading. If this occurs, choose the highest point of needle travel as your reading.

If you want to make your own test tape, set the tape recorder in its *Record* mode and connect the machine to binding posts BP3 and BP4 (*Output*). Adjust for optimum level

of the recorded signal using only virgin tape. Rewind the reel and set the machine in its *Playback* mode.

Although all test tapes should be played through the deck from end to end, it is permissible to make wow and flutter measurements by running off a section at the beginning of the reel, another at reel midpoint, and a third at the end of the reel.

Complete instructions for building the Wow & Flutter Meter, plus other information, will be presented in Part II in our next issue.

Sidestacked TV Antenna

Continued from page 83

flected back and forth in the transmission line. This causes standing-wave energy losses. With more than one lead attached to the TV's antenna terminals a severe mismatch is likely to occur. What can be done?

The answer is quite simple. At the antenna terminals, on top of all other twinleads, you attach a piece of twinlead about 5 ft. long. It's called a *stub*. You then take a piece of aluminum foil, about 5 x 10 in., and wrap it around the stub. The aluminum is pressed just tight enough so that it can slide down the stub but still remain in one position.

This wire-foil combination forms a variable transmission-line tuner. By sliding the foil up and down you vary the stub's impedance. This way you can tune out a lot of mismatch as you change TV channels (see Fig. 8).

When you work with small amounts of signal in fringe areas, the more attention you pay to details, the more signal you'll receive. Remember that even a small mismatch can drain more than 50 percent of your signal.

Using your TV set as a monitor, carefully recheck the position, orientation and tilt of each antenna. You may find each one requires a slight adjustment to produce a bit more signal strength. Place the aluminum foil in the best position on the stub for the highest channel you're going to receive. Next, squeeze each transmission line about 6 in. away from the connection at the antenna terminals. If the squeeze causes a drastic picture loss, cut small pieces off that particular twinlead until the loss is minimized. Re-adjust the foil every time you snip off a piece. Lastly, try different stub lengths—both open-ended and shorted. Use the stub that provides the best TV pictures.

Troubleshooting Color TV

Continued from page 53

colors in like one of these hobby paintings of yours, where you fill in numbers."

The customer laughed, "I couldn't fool you, could I? You recognized my paintings as those number jobs right off. But you're the first one."

Question of Separation. I was working at the bench in the shop when one of the young fellows we have holding down the front counter came into the back. He said with a sly smile, "There's a customer out front I'd like you to handle."

I went out front and found a fellow in his early thirties. He had a Philco portable. Both of the picture's syncs, horizontal and vertical, were running. The customer said, "I'm going on vacation this afternoon and I'd like to take the TV with me." It seemed strange to take a vacation on a blustery Wednesday but who am I to argue.

I saw that my counter man had changed the sync separator tube. I brought my scope over. Troubleshooting the sync separator is easiest if you take a look at the signal. The basic sync-separator circuit has a high negative control-grid bias and a low B+ plate supply. That way the tube is cut off most of the time.

The composite TV signal is fed to the control grid. The tube stays at cutoff during the time the video is applied. The tube conducts only when a high-amplitude sync pulse arrives at the grid. That way only the sync pulse is amplified; it then appears at the plate. This separation process can be observed with a scope. At the sync separator's control grid you should see video, at the plate, only a sync tip.

When I probed this TV the video was appearing at the grid, but nothing was on the plate. I took some DC readings and found only five volts on the plate instead of the 30 V called for. A 33K load resistor in the plate circuit was open. I changed it and the sync returned. 

Channel 9 Override Monitor

Continued from page 34

mit mode. If you won't be using a CB transceiver in the same building, there is no need to install the diodes.

Place D1 and D2 side by side with the cathode of one connected to the anode of the other. Twist their wires together. Locate the walkie-talkie's RF input coil, labelled T1 in the instructions supplied with the unit. Transformer T1 is located on the edge of the pc board on the same side as volume control.

Using the shortest possible leads, solder diodes D1 and D2 across T1's secondary terminals. These are the terminals facing the volume control. The primary terminals of T1 face the bottom of the pc board.

This completes the walkie-talkie modifications. Set the assembly aside until later and wire the lamp/relay amplifier.

Cabinet Assembly. In our prototype, the walkie-talkie pc board and the amplifier mount on the left side of the specified aluminum cabinet. Temporarily position the pc board next to the side of the cabinet. Mark the speaker position on the front of cabinet.

Cut an opening for the speaker and prepare a speaker grill from spare perfboard. Finally, snap the three speaker mounting lugs off the speaker frame in the walkie-talkie and secure the speaker to the cabinet panel.

Position the pc board over the speaker. Mark the front panel under the two pc board mounting holes closest to the edge of the board. Remove the speaker, drill all necessary front panel holes, and then re-install the speaker with its grill.

Using the two holes in the walkie-talkie's pc board, install the board directly over the speaker via 1-in. standoffs. Make certain that the walkie-talkie's volume control, which passes through a slot in the side of the cabinet, does not bind when the board is mounted.

Connect the walkie-talkie antenna wire to binding post BP1. If the wire doesn't reach, splice a short length to it. Unless you have experience with working on fine printed circuit wiring, we do not suggest you try to solder a longer antenna wire to the pc board.

Install the amplifier assembly directly over the pc board, using two L-shaped brackets as shown. Do not leave excessive clearance between the boards. Provide only enough room so the push-in terminals extending through the amplifier perfboard do not short against the pc board.

Install power transformer T2 and complete the power supply wiring. Cut off the walkie-talkie battery connector and connect the black wire to ground. The red wire from the walkie-talkie runs to the emitter lead of transistor Q4. *[Continued overleaf]*

POLY-PLANAR IS BUILT-IN SOUND ON A BUDGET.

Walls, ceilings, doors, floors, closets—any surface at all—become hi-fi speaker systems with Poly-Planar. Send for detailed specifications and installation ideas.

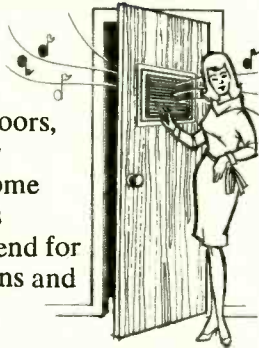

THE SPEAKER YOU DON'T HAVE TO SEE TO HEAR.

The Magitran Company

311 East Park Street • Moonachie, New Jersey 07074

CIRCLE NUMBER 5 ON PAGE 15

WANT A JOB? PART TIME— FULL TIME?

No Boss! No Experience!

No Capital! Your Own Hours!

WHAT A JOB ! ! ! !

And yet selling subscriptions to **ELECTRONICS ILLUSTRATED** and other leading publications is just like being in business for yourself. But no business requires less capital, stock and space. The time you devote and the money you make is up to you. You need no experience to earn steady profits and you keep a cash commission on every sale. You operate in your own community by phone or personal calls. You will be authorized to sell new and renewal subscriptions along with special offers made by the publishers. You'll be amazed at the number of people wanting to take advantage of the convenience, service and savings you can offer them. To get started immediately—send us your name (on a postal card) requesting free supplies and selling materials.

Write to: Subscription Dept. DE
ELECTRONICS ILLUSTRATED
Fawcett Bldg., Greenwich, Conn. 06830

Transceiver over-ride modification. If desired, you can connect the wires from your transceiver's speaker to relay RY1. Now the monitor's output will be fed through the transceiver's speaker. Connect the hot lead from the transceiver speaker to RY1's wiper contact. Connect the hot lead from the transceiver's output transformer to RY1's upper contact. Last step is to connect the monitor's output lead to RY1's lower contact.

With no signal in the monitor, RY1 will connect the transceiver's speaker in the normal manner. When a signal is received, RY1 will pull in, connecting the transceiver speaker to the monitor.

Kit Report

Continued from page 85

wrong jacks. If you connect the test leads into a DC circuit with reversed polarity, just flip polarity-reversing switch on front panel.

Before beginning construction of the IM-102, the builder will need a high-quality miniature 25-watt pencil soldering iron. A magnifier of some kind will help reduce eye strain. In many areas of the printed-circuit board, the foil area surrounding the holes is exceedingly small. Great care must be exercised to prevent solder bridging adjacent areas of foil.

Sort out and identify all kit components before starting the IM-102. For example, a given value resistor may be present in as many as four styles. It is important that the correct type of component as well as the correct value be selected. If inspection for solder bridges, cold joints and excess rosin between foil areas is maintained at each stage of assembly you will end up with a properly functioning digital multimeter.

In any DC measurement mode, an automatic polarity indicator displays the polarity of the signal being measured. Also, all measurement modes can activate an overrange display. This automatically lets you know when the quantity under measurement exceeds any given full scale range. All voltage and current modes are protected against overload.

The input impedance of the IM-102's two lowest DC voltage ranges (200 mv and 2 V) exceeds 100 megohms and 1,000 megohms, respectively. The input impedance of the 20-, 200- and 1,000-volt DC ranges is 10 megohms. Input impedance on all AC ranges measures 1 megohm.

The IM-102 has six resistance ranges. The

lowest starts with 200 ohms full-scale and can resolve as little as 0.1 ohm. The highest resistance the IM-102 can measure is 20 meg-ohms full-scale.

The most difficult problem for those who assemble test equipment kits capable of a high degree of accuracy is the calibration procedure. Test gear on par with the IM-102 is designed to be exceptionally accurate. But this kind of instrument can only be as precise as its calibration source. Furthermore, high-accuracy calibration sources are very expensive and are usually found only in the hands of professionals.

Heath has solved this calibration problem. Included with the IM-102 is a wired, factory adjusted calibrator. It consists of a mercury cell and precision voltage divider adjusted at the factory to provide exactly 200 millivolts DC. We checked the accuracy of the calibrator supplied with our kit against a standard cell. It measured within 0.1 percent of 200 mv. After the multimeter has been calibrated in the DC mode, an internal AC calibrator can be adjusted to provide a highly accurate AC source.

The IM-102 spec sheet gives two sets of figures which indicate the final accuracy to be expected from the calibrated instrument. One set of figures lists the accuracy obtained when laboratory standards are used as the calibration source. The second set of figures refer to the results obtained when the 200 mv calibrator is used. After calibrating the multimeter, we found that the accuracy provided by the 200 mv calibrator exceeded the specifications claimed by Heath. Accuracy with the supplied calibration source was as good as that obtained with lab-grade standards.

Low-Cost Speed Indicator

Continued from page 79

if you read 10 pulses per second on the scope multiply by 60 for a 600-rpm reading.

The speed indicator can be calibrated against an automotive tachometer by aiming NL2 at an engine flywheel timing mark.

Close calibration can be made by tracing the dial on a piece of cardboard. Our dial is 3½-in. in diameter and is cut from a sheet of plastic. Position the dial so that the 125-rpm marking coincides with the dial index when the pot is rotated to maximum resistance point.

Operating the Indicator. If the speed of

FREE!

LAFAYETTE 1972 Catalog

468 Pages

Our 51st Year

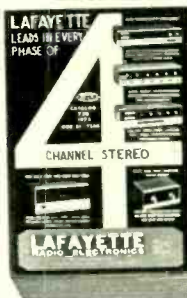

Stereo Hi-Fi ■ Citizens Band
 ■ Ham Gear ■ Tape Recorders
 ■ Test Equipment ■ TV and Radio Tubes and Parts
 ■ Cameras ■ Auto Accessories
 ■ Musical Instruments
 ■ Tools ■ Books

Your Complete Buying Guide
 to Everything in Electronics

Lafayette Radio Electronics
 Dept 29072, P.O. Box 10
 Syosset, L.I., N.Y. 11791

Send me my FREE Catalog 29072

Name

Address

City

State Zip

CIRCLE NUMBER 8 ON PAGE 15

Have your own Radio Station!

Learn AMATEUR RADIO



AT HOME IN YOUR SPARE TIME

Get your Amateur Radio license and "go on the air." NRI, leader in Electronics home training for more than 50 years, offers a choice of training plans leading to required FCC licenses, ranging from Basic Amateur Radio for the beginner to Advanced Amateur Radio for the ham who already has a license and wants to move up.

HAM RADIO EQUIPMENT INCLUDED

NRI's beginner's course includes your own Novice Class 25-watt transmitter, 3-band receiver and transistorized code practice oscillator with code key and headset. You learn code using special LP records. Choose from 3 Amateur Radio courses. Low tuition. Monthly payment plans. Get all the facts. Mail coupon. No salesman will call. NATIONAL RADIO INSTITUTE, Washington, D.C. 20016.



.....MAIL COUPON TODAY.....

• NATIONAL RADIO INSTITUTE 53-072

• Washington, D.C. 20016

• Please send me information on Amateur Radio training.

• Name Age

• Address

• City State Zip

• ACCREDITED MEMBER NATIONAL HOME STUDY COUNCIL

AT LAST! PROFESSIONAL HOME PROTECTION EVERYONE CAN INSTALL AND AFFORD.

Model FC-100
59⁹⁵
WIRED



- Start your custom Burglar/Hold-up/Fire Alarm System with the FC-100. Add on Sensors, Alarms and Accessories to suit your own needs.
- "Do-it-Yourself" Installers Handbook included. No technical knowledge needed — No soldering.
- 100% Professional in Design, Reliability, Performance.



'Fail Safe'-SYSTEM BY EICO

A New Concept in "Do-it-Yourself" Home Protection

FREE 32 PAGE EICO CATALOG

For latest catalog on EICO Test Instruments, Stereo, EICOCRAFT Projects, Environmental Lighting, Burglar/Fire Alarm Systems, and name of nearest EICO Distributor, check Reader Service Card or send 25c for First Class mail service.

EICO, 283 Malta Street, Brooklyn, N.Y. 11207



CIRCLE NUMBER 6 ON PAGE 15

BRAND-NEW SAM DURELL ADVENTURE

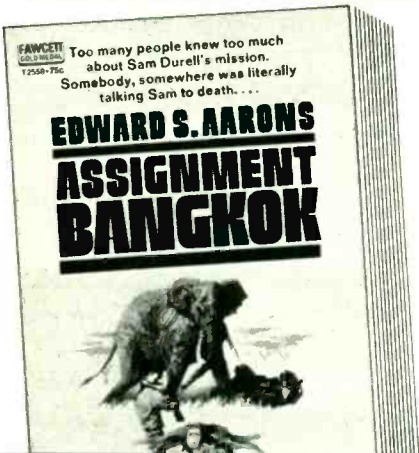

T2559-75c

Buy this Gold Medal Book from your paperback book-seller. If he is sold out, send only price of book plus 15c for postage and handling to Gold Medal Books, Fawcett World Library, Greenwich, Connecticut 06830. Please order by number and title. Orders accepted only for the United States and Possessions.

the object and the light pulse repetition rate are matched exactly, a mark on the object will appear as a stationary reference mark.

The single-image stroboscopic effect will also occur when NL2's pulse frequency is a sub-multiple (half, third, quarter, etc.) of the rotating object. Multiple images occur when the light pulse frequency is a multiple of the rotating object frequency. Reason is, the rotating object is illuminated more than once each cycle.

To measure the rpm of a rotating object, set the dial to the 3,000-rpm mark. The rotating object should be marked with chalk, a pasted-on marked paper tab or engraved line. Lower the dial slowly until the first single image appears.

The Ham Shack

Continued from page 94

repeater structure by deciding one hundred percent for the EIA proposal.

A good deal has been written about the EIA's CB petition already so I won't go into it in detail. The restrictions requested by the EIA are very similar to those already existing on the Class D Citizens Band (27 mc) and logic seems to tell us that if the FCC follows the wishes of the EIA, they will be in for a *second* gigantic headache.

Many people who have looked at the situation closely have come to the conclusion that one basic reason Class D CB is such a mess is that hamming is not permitted. Add an almost complete lack of policing to the situation and you have a full-blown bunch of 23-channel 1000-watt (or higher) stations, all pirates, hamming away 24 hours a day. Give the EIA its way and we may have 80 more fascinating channels to tune.

The FM repeater approach to populating the 220-mc band in a hurry is quite simple. Each repeater group will first set up a 220 transmitter in parallel with its 146-mc transmitter. The next step is to put in a 220 receiver with an input that has priority when used. (If someone is working 220, anyone working 2 meters will have to wait.) This should encourage amateurs to install 220 transceivers in their cars and get into their local repeater via 220 instead of 146. Once enough operators are using the 220 repeater it can be made separate from the 146 repeater, or tied in with it by means of a tone system (or any other system desired).

DXing NASA

Continued from page 41

quest of space. Radio RSA's North American service is one of the more powerful voices of discontent to reach these shores and it's a cinch to log during evening hours (EST) on a variety of frequencies. These include 9560 and 9695 kc.

Australia, unfortunately, is a different matter. Things get tough when you start out on the track of the deep-space communications facilities operated by the Australian government for NASA. One, located at Canberra, is in the Capitol Territory, a tiny enclave surrounded by the state of New South Wales. The nearest shortwave station is located less than 100 miles away in Sydney and is operated by the Australian Broadcasting Commission. This station, VLI6, is heard occasionally in North America on 6090 kc around 0400 EST.

The second deep-space site—located at Woomera—is hairy, indeed. Station 5CL, located at Adelaide, South Australia, which broadcasts on a medium-wave frequency (730 kc), is the closest the author has come to DXing Woomera. With today's QRM, however, even logging 5CL on the West Coast is quite a feat. It's only due to a fluke in the ionosphere that low-power stations in the South Pacific can be heard.

CB Corner

Continued from page 35

that early pow-wows also bring warring CB tribes into closer cooperation.

The biggest pay-off could be to the suffering U.S. taxpayer. Authorities say the problem of highway safety can no longer be left to a handkerchief tied to an auto antenna, or the chance passing of a police car. Experts are proposing a half-dozen sophisticated systems to detect and assist stranded motorists and the cost could be staggering. They include roadside call boxes, sensors embedded in the pavement and electronic vehicle locator systems. None of these systems can touch two-way radio's versatility, a resource that's already rolling in great numbers over the highways—as Citizens Band radio. The Ohio experiment has shown that countless manhours from CB volunteers are there for the asking.

July, 1972

TYMETER®

"Time At A Glance"

DIGITAL CLOCKS



MADE IN U.S.A.

\$16.50

Plus
\$1.00
Postage



DIGITAL CLOCK MOVEMENTS

#130..12 HOUR #131..24 HOUR

DIGITS RESETTABLE INDIVIDUALLY

Available in 50, 60 cy., all voltages, AC. UL approved motor, cord. One Year Guarantee.

Complete Line of Count-Up and
Count-Down Digital Computers

CATALOG ON REQUEST

PENNWOOD NUMECHRON CO.

TYMETER ELECTRONICS

7249 FRANKTOWN AVE. PITTSBURGH, PA. 15208

CIRCLE NUMBER 22 ON PAGE 15

A monitor receiver
without a professional
monitor antenna is
like a kite without
a tail:

way
down

Mobile or base

Want the high performance you paid for? Choose a professional A/S monitor antenna. Over 20 models, one for your exact need. Let us send our catalog.

**the antenna
specialists co.**



Stripes of Quality

Div. of allen Electric & Equipment Co.
12435 Euclid Avenue • Cleveland, Ohio 44106

CIRCLE NUMBER 21 ON PAGE 15

103

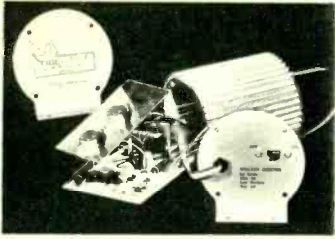

FROM KIT TO CAR IN 80 MINUTES

Electronic ignition is "in". Update your car with the TOPS in power, efficiency and reliability — the TIGER SST capacitive discharge ignition (CD).

The TIGER delivers everything other CD's promise — and more: quicker starting, more power, more gas mileage, tune-ups eliminated, lifetime plugs and points, reduced repairs and pollution.

The TIGER can be built and installed in your car in 80 minutes. The TIGER is unique! Errors in construction or incorrect installation will not harm the TIGER or the engine. The TIGER will not operate under either condition.

The TIGER comes with a switch for TIGER or standard ignition for 12V negative ground only.

SATISFACTION GUARANTEED
or Money Back.

Simpli-Kit \$29.95 Assembled \$39.95

Send check or money order with order to:

Tri-Star Corporation

DEPT. E., P. O. Box 1946
Grand Junction, Colorado 81501
DEALER INQUIRIES INVITED
CIRCLE NUMBER 20 ON PAGE 15

ANOTHER SUPERB VALUE

from **Olson**

Electronics
ONLY

\$10⁹⁸

**DELUXE
BATTERY TESTER**

Compact precision tester checks all types of batteries from radio to industrial. 12 position switch selects most popular ranges from 1.5 volts to 240 volts. 1.5v to 15v ranges are tested under load. Complete with test leads and instructions.

Olson Electronics, Dept. D7 260 S. Forge St.,
Akron, Ohio 44308

- I enclose \$10.98 plus \$1 for postage and handling. Send me the TE-237 Battery Tester.
- Send me the next seven issues of the Olson Catalog, without cost or obligation. **FREE**

Name _____
Address _____
City _____
State _____ Zip _____

CIRCLE NUMBER 9 ON PAGE 15

The Listener

Continued from page 95

of shortwave DX.

Shortwave radar transmitters clearly fall into a super-high-power category. At one radar site recently completed in England (Oxford Ness, Fylingdales, Yorkshire) fishermen have been warned that they could receive electric shocks if they sail within three mi. of the station during transmission periods. A touch of irony creeps in when one realizes that OTH radars are possible only because of exhaustive research into DX modes of ionospheric propagation.

Propagation Forecast. Summer conditions continue and round-the-clock DX is possible in the 19-meter band. During daylight hours, this band will provide good DX to all parts of the world. At night, circuits from the south—particularly from Latin America—will be good, and reception from the west will be good until several hours after local sunset.

In general, DX will be possible during daylight hours in bands ranging from 10 to 19 meters; the higher frequencies will be much less reliable than 16 or 19 meters.

At night, DX will be good anywhere from 19 to 49 meters, depending on the direction of the station. Medium-wave DX will still be poor due to long hours of daylight and high noise levels in this hemisphere.

Thin Look Comes To Records

Continued from page 44

One criticism that Isom of RCA does acknowledge is the entry angle. "They said the angle of entry to the playing area was too great, that the stylus would slide down the side of the bead into the playing area. We agreed—after an initial run of Dynaflex discs—and we changed the angle of entry from 177 to 170 degrees. Less than that on conventional records."

RCA's competitors, perhaps caught up in the same profit squeeze, also have looked into thin records. One of the first to adopt Dynaflex specifications was Keel Manufacturing, an independent producer which presses discs for Pickwick/33, among others. Columbia and the MCA group (Decca, Kapp, and Uni) have compromised on a 110-gram disc, while other independents also are beginning to press thin records.

Classified Ads

ELECTRONICS ILLUSTRATED

Your advertisement can reach this mail-buying audience for only 50¢ per word . . . payable in advance (Check or M.O. please) . . . minimum 10 words. Closing dates are the 20th of 4th preceding month i.e. copy for the November issue must be in our office by July 20th. Mail to ELECTRONICS ILLUSTRATED, 1515 Broadway, New York, N. Y. 10036. Word count: Zipcode number free. Figure one word: Name of state (New Jersey), name of city (New York); sets of characters as in key (14-O); also abbreviations as 35MM, Bx10, A.C.

SAVE MONEY • ORDER BY MAIL

• • • FOR SALE

CONSTRUCTION PLANS: Laser \$2.00. Investigation Aids—2 FM Telephone Transmitters . . . \$1.00 FM Telephone Transmitter . . . \$2.00. Sound Telescope . . . \$2.00. Space Monitor—Missile Tracker . . . \$2.00. Free equipment and Kit Catalog. Howard 20174 Ward, Detroit, Michigan 48235.

FREE! GIANT Electronics Catalog. McCord Electronics, Box 41-E, Sylvania, Ohio 43560.

TREASURE FINDER locates buried gold, silver, coins, treasures, 5 powerful models. \$19.95 up. Free Catalog. Relco A-192, Box 10839, Houston, Texas 77018.

POWER SUPPLIES: input 117vac transformer isolated. 2.5 watts output. Model 104A ± 25 vdc at 50 ma. Model 104B 25 vdc. at 100ma. Ripple less than 5%. \$15.00 plus postage. MANCHESTER ELECTRONICS, 20 Meadow St., Manchester, N.H. 03103.

HOW TO Break Into Radio, Television Broadcasting Book \$2.00. I.Q. Engineering, Box 374, Canoga Park, California 91305.

PHOTOFASH CAPACITORS 490MFD at 500VDC 5/8 x 1/2" \$1.50 each, postpaid. Electronic Surplus, 1224 Prospect, Cleveland, Ohio 44115.

MAGNETS. ALL types. Specials: 20 disc magnets, or 2 stick magnets, or 10 small bar magnets, or B assorted magnets, \$1.00. Maryland Magnet Company, Box 192-F, Randallstown, Maryland 21133.

TREASURE HUNTERS! Prospectors! Rock-hounds! Hobbyist! Find gold, silver, relics with world famous Detectors! Metal Detectors. Free information. Delivery immediate. Detectors, Dept. 7-EI, Box 243, San Gabriel, California 91778.

INVESTIGATORS, LATEST Electronic Aids. Free Literature. Clifton, 11500-X NW 7th Ave., Miami, Florida 33168.

POLICE/FIRE RADIO Dispatcher directories! Exclusive listings. "confidential" frequencies, call signs. All areas. Send \$6 stamp for catalogs. Communications, Box 56-EX, Commack, N.Y. 11725.

CONVERT ANY television to sensitive, big-screen oscilloscope. Only minor changes required. No electronic experience necessary. Illustrated plans, \$2.00. Relco. A-19, Box 10563, Houston, Texas 77018.

CANADIANS: FREE bargain packed electronics catalog. ETCO, 464 McGill, Montreal, Canada.

ANTI GRAVITY. EXPERIMENT and theory; Rushed—\$2.00. Intertech 4A2, Box 5373, Station F, Ottawa, Canada.

NEW AMAZING telephone recorder. Automatically records every word each time your telephone is used. Only \$24.95. Amplicom, 4334 Tujunga Avenue, North Hollywood, Calif. 91604.

ELECTRONIC IGNITION \$7.95. Write for information. EMP Company, Box 1047, Livermore, Calif. 94550.

SKILL-RATED construction plans. Free catalog. Systems-Mart, Dept. 315, Box 25280, Portland, Oregon 97225.

SEMICONDUCTOR ASSORTMENT, includes I.C.'s, diodes, transistors and assemblies, marked and manufactured by top U.S. manufacturers. Contains 100 pieces only \$4.95 prepaid anywhere in the U.S. Money back guarantee. Unitron Kits, P.O. Box 2584, Santa Fe Springs, Calif. 90670.

ELECTRONIC ORGAN Keyboards, oscillator coils, printed circuits, and other components for organ circuitry, 25¢ for catalog. Devtronix Organ Products, 5872 Amapola Drive, San Jose, Calif. 95129.

WHOLESALE BURGLAR alarm supplies. Catalog \$1.00 (refundable). Ellin, 161-E Bonad, Chestnut Hill, Mass. 02167.

TOOL KIT, (9 pc.) For Bench or Mobile. Sat. guar. \$2.98 Ppd. Renco (EI), P.O. Box 4411, Hayward, Calif. 94544.

VHF TRANSCEIVERS, amplifiers, spares, test and bench equipment, complete schematic files from marine and mobile shop. List from Box 429, Cape May, N.J. 08204.

MAGNETIC-PICKUP CD ignition plans. Write SES Enterprises, Box 607, Ferndale, Wash. 98248.

• • • GOVERNMENT SURPLUS

JEEPS TYPICALLY From \$53.90 . . . Trucks From \$78.40 . . . Boats, Typewriters, Airplanes, Multimeters, Oscilloscopes, Transceivers, Electronics Equipment, Wide Variety, Condition, 100,000 Bid Bargains Direct From Government Nationwide. Complete Sales Directory and Surplus Categories Catalog \$1.00 (Deductible First \$10.00 Order From Our Separate Included Catalog.) Surplus Service, Box 820-T, Holland, Michigan 49423.

GOVERNMENT SURPLUS, How and Where to buy in Your Area. Send \$1.00, Surplus Information, Headquarters Bldg., Box 30177-EI, Washington, D. C. 20014.

• • • BUSINESS OPPORTUNITIES

MAKE \$1.00 PER Sale selling engraved metal Social Security plates. Free Sales Kit. Engravaplates, Box 10460-81, Jacksonville, Florida 32207.

EASY-TO-START rubber stamp business at home in spare time. Make up to \$16.50 an hour without experience. Facts free! Write to: Roberts, Room RC-120-BF, 1512 Jarvis, Chicago, Ill. 60626.

VENDING MACHINES. No selling. Routes earn amazing profits. Big catalogue free. Parkway Corporation, 715E1 Ensor Street, Baltimore, Maryland 21202.

311 FAST, EASY ways to make money! Free! Rush name, address, zip. Perry, 13263V Ventura Blvd., Studio City, Calif. 91604.

INSTALL BURGLAR alarms. Exclusive schematics, \$2.00. System acts before entry. Millers, Box 145, Cleveland, Ohio 44121.

MAILORDER-CARRY no stock. Companies will pack, ship under your label. One-man operation capable of \$10,000-\$20,000 year. Details free! Distributors, Box 9J, East Rockaway, N.Y. 11518.

\$200.00 DAILY In Your Mailbox! Your Opportunity To Make Money Like Mail-order Experts. Free Details. Associates, Box 136-El, Holland, Michigan 49423.

JAPAN HONG Kong Directory. World products information. \$1.00 today. Sekai Shogyo Annai, Hillyard, Washington 99207.

START SMALL, highly profitable electronic production in your basement. Investment, knowledge unnecessary. Post-card brings facts. Barta-Elmon, Box 248, Walnut Creek, California 94597.

• • • EMPLOYMENT INFORMATION

PRINTING—ADVERTISING Salesmen. Excellent moneymaking sideline selling Decalcomania Name Plates. Advertising Specialties. Sign Letters, Automobile Initials. Free Samples. Relco EI, Box L, Boston, Mass. 02119.

AUSTRALIA WANTS You—Latest information describing government assisted passage, passport-visa, employment, business, teaching, etc., plus forms \$1.00. Employment Directories: U.S. businesses there \$1.50. Australian businesses \$1.50. All three \$2.00. Australian Services, Box 1032PC, Fairborn, Ohio 45324

EXCITING OVERSEAS jobs. Directory \$1.00. Research Associates, Box 889-FW, Belmont, California 94002.

EUROPEAN-FOREIGN (Employment). Listing of currently available technical positions. Europe, Australia, Africa. \$3.00. Eurojob Report, Box 52634-Y, Lafayette, Louisiana, 70501.

• • • EDUCATION AND INSTRUCTION

AVIATION ELECTRONICS Technician— Prepare for exciting career in new field of "Avionics." Train at nation's largest aeronautical school. Indicate if eligible for G.I. Benefits. Spartan Airschool, International Airport, Dept. MKW, Tulsa, Oklahoma 74151.

HIGHLY EFFECTIVE home study courses in Electronics Engineering Technology and Electronics Engineering Mathematics. Earn your Degree. Write for Free Descriptive Literature. Cook's Institute of Electronics Engineering (Dept. 14), P.O. Box 10634, Jackson, Miss. 39209. (Established 1945.)

LEARN CARTOONING At Home. Free booklet: "Key to Cartoon Career." Approved for G. I. Bill. Write: Cartooning, Box 7069X, Colorado Springs, Colorado 80907.

HOME STUDY courses in watchmaking, engraving, diamond setting and clock repair. Learn while you earn for a more secure future. For complete information write: Kansas City School of Watchmaking, Dept. E-1, 101 W. 11th St., Kansas City, Mo. 64105.

FREE INFORMATION. Get FCC license new, easy way. Academy of Communications Technology, El-1, Box 389, Roswell, New Mexico 88201.

YOU CAN learn TRIGONOMETRY in one day at home with 100% accuracy. (Guaranteed) No algebra, geometry, or square root required. *Valuable for Electronics.* For FREE brochure, write RYBOG-90 Trig System, Dept. 8, 15380 Wedgewood Station, Seattle, Wash. 98115.

ELECTRO-OPTICS. The new technology. Free brochure. Epi, Education Dept., Box 413 Mountain View, Calif. 94040.

• • • **BUILD-IT-YOURSELF (OR DO-IT-YOURSELF)**

LOUDSPEAKERS KITS, complete or cabinet only. Great savings factory direct. Catalog 25¢. R.C.S. Co., P.O. Box 30312, Santa Barbara, Calif. 93105.

LINEAR AMPLIFIERS: Build your own 250 Watt 10-15 Meters Linear. Plans \$1.00. Roberts, Box 8791, Ft. Lauderdale, Florida 33310.

NEW LOCATOR indicates difference in metals detected. Plans \$4.00. Taylor Electronics, P.O. Box 253, Cape May, New Jersey 08204.

AUTOMATIC ACTIVATED phone patch for recording those important calls on your cassette recorder, kit \$12.95, plans \$3.50. 115DB solidstate alarm sander, 3 to 24 volts at low current, less speaker, \$9.95. Burglar alarms, remote control tone Encoders and Decoders, Receiver speech scrambler decoders, other kits, plans, and components. Catalog 25¢. Krystal Kits, Box 4232, Dept. E1, Little Rock, Arkansas 72204.

FISHWORMS AT your fingertips. Easy illustrated instructions, \$1.00. It's a, P.O. Box 135, Martinsville, Indiana 46151.

BUILD YOUR own treasure finder. Build a \$129.00 treasure finder for under \$20.00. Easy to follow plans. Parts list \$2.00. Century Radio, P.O. Box 1712, Sanford, Fla. 32771.

COLOR ORGANS, amplifiers, synchronizers, strobes, Workshop, Box 393E, Bethpage, New York 11714.

INTEGRATED CIRCUIT kits Free catalog. Frazer & Associates, 3809 Surfwood Road, Malibu, California 90265.

• • • **HI-FI, STEREO**

GUARANTEED LOWEST Prices: All Stereo Equip., TV's, etc. Request Quotes: Newport Audio Mart, 50 Newport Drive, Hewlett, New York 11557.

STEREO COMPONENTS at lowest prices. Send for free catalog. Carston, Box 10948, Danbury, Conn. 06810.

BUY IRISH tape open reel and cassettes and 8-track blanks at discount prices. Write: Direct Mail Cassette Corp., Box 71, Plainview, N.Y. 11803.

DISCOUNTS—STEREO components & Systems. Lowest possible prices on quality brands. For fastest service, lowest cost—get our quote! Redwood Stereo Co., P.O. Box 2794, San Rafael, Calif. 94902. (415) 472-2255.

• • • **TAPE RECORDERS**

LEARN WHILE Asleep with your recorder, phonograph or amazing new "Electronic Educator"—endless tape recorder. Details free. Sleep-Learning Research Association, Box 24-E1, Olympia, Washington 98501.

RADIO SHOWS. Stamp For Free Catalog. Box 724-E1, Redmond, Wash. 98052.

OLD RADIO programs catalog 50¢. Randall Dunford, 10126 Ferndale, Dallas, Texas 75238.

RENT 4-TRACK open reel tapes—all major labels—3,000 different—free brochure. Stereo-Parli, 55 St. James Drive, Santa Rosa, Calif. 95401.

• • • **RADIO & TV**

TV TUNERS rebuilt and aligned per manufacturers specification. Only \$9.50. Any make UHF or VHF. We ship COD. Ninety day written guarantee. Ship complete with tubes or write for free mailing kit and dealer brochure. JW Electronics, Box 51K, Bloomington, Indiana 47401.

FREE! BARGAIN Catalog. Fiber optics, LED's, transistors, diodes, rectifiers, SCR's triacs, parts. Poly Paks, Box 942, Lynnfield, Mass. 01940.

RADIO & TV Tubes—34¢. Free List. Cornell, 4213-15 University, San Diego, Calif. 92105.

"DISTANCE CRYSTAL Set Construction" Handbook—50¢. "20 Crystal Plans"—50¢. Catalog. Laboratories, 745-K Cordone, Reno, Nevada 89502.

REPAIR TV Tuners—High Earnings. Details of Complete Course, 12 Repair Tricks, Many Plans, Two Lessons, all for \$1. Refundable. Frank Boccek, 3236 Enterprise Branch, Redding, Calif. 96001.

TELEVISION HIGH Voltage Test Probe Only \$2. No meter or electronic experience needed. Schek Television Company, 8101 Schrider Street, Silver Spring, Maryland 20910.

OLD RADIO programs. Catalog \$1.00 (Refundable). Radio Vault, Box 9032, Wyoming, Michigan 49509.

FREE CATALOG! Tremendous electronics bargains. Compukits, Box 4192T, Mountain View, California 94040.

• • • **INVENTIONS & INVENTORS**

MANUFACTURERS NEED New Products. Your ideas and inventions developed for commercial appeal and cash/royalty sales. Free "Invention Record" and "Product Marketing" brochure. Raymond Lee Organization, 230-X Park Avenue, New York City 10017.

INVENTORS! SELL your invention for cash or royalties! Our client manufacturers eagerly seek new items. Patented. Unpatented. Financial assistance if needed. 25 years proven performance. For free information, write Dept. 27, Gilbert Adams, Invention Broker, 80 Wall St., New York, N.Y. 10005.

PATENT SEARCHES including maximum speed, full airmail report and closest patent copies \$4.00. Quality searches expertly administered with complete secrecy guaranteed. Free Invention Protection forms and "Patent Information." Write Washington Patent Search Bureau, Dept. 20, Benjamin Franklin Substation, P.O. Box 7167, Washington, D.C. 20044.

• • • **ELECTRONICS SUPPLIES & EQUIPMENT**

SUPREME TWENTY different radio-television volumes, \$50 value, only \$19.95, postpaid. Supreme Publications, 1760 Balsam, Highland Park, Illinois 60035.

KITS AND EQUIPMENT FM Wireless microphone transmitters, FM Telephone transmitters, Infinity transmitters. Security Electronics, P.O. Box 245, Huntington, W. Va. 25707.

TRANSISTORS—SAVE up to 60%. 10MA NPN Amplifiers 5 for \$1.00. 100MA NPN or PNP Amplifiers 4 for \$1.00. Data sheet supplies with each order. Send cash or money order to: J. C. Electronics, 21921 Ackmar, Carson, Calif. 90745.

FRONT—PANELS, Professionalize your homemade equipment with custom-built front panels. Free detailed information. PANELS, Box-5, Gallitzin, Penna. 16641.

FREE CATALOG—Loads of Bargains. R.W. Electronics, 4405 West Belmont, Chicago, Illinois 60641.

INTEGRATED CIRCUITS linear and digital. SN7400N series, from 30¢. Stamp for catalog. Digitek, Box 658, Thief River Falls, Minn. 56701.

WHOLESALE C.B. transceivers, multi-band receivers. Lowest prices. Dealers welcome. List 25¢. G-Enterprises, Box 14E, O'Fallon, Ill. 62269.

FREE OVER 50 electronic catalogs just for the asking. Send \$1 for list. Otek Communications, Inc., Box 1691, New Haven, Conn. 06507.

FREE ILLUSTRATED catalog!! covering wide range of low-cost stock business forms from 2-Way Radio to TV Service. Write today. Free catalog; samples, too. Oelrich Publications, 4040 N. Nashville East, Chicago, Illinois 60634.

• • • **MUSIC**

SONGS, POEMS Wanted! For publishing, recording at our expense! Talent, 17-E1 Longwood Road, Quincy, Mass. 02169.

SONGPOEMS NEEDED, all types, Country, Western, Popular, Romantic, Folk, Rock, Religious, etc. Possible Recording/Publishing—Rush to Betty's Music Makers, 1417 Park Bldg., Dept. H, Pittsburgh, Penna. 15222.

SHOW ALBUMS—Rare Out-of-Print LP's. Large list 12¢. Broadway/Hollywood Recordings, Georgetown, Connecticut 06829.

SONGWRITERS! POETS! Spiritual and religious poems, songs wanted for recording by Chapel Symphony Orchestra and Choir. We pay all recording costs! Chapel Recording, P.O. Box 162-E1, Wollaston, Mass. 02170.

BIG BAND SOUNDS of the 20's, 30's and 40's—swing and dixieland jazz. 5,000 performances from original recordings and broadcasts available reel to reel or cassette. Ed Jones, 5127 Bauman Ave., Omaha, Nebr. 68152.

• • • **PERSONAL**

VACATIONING? RETIRING? Read "Bargain Parades of the World"; or "Off the Beaten Path." (America). Either book \$2.50. Both only \$4.75. Calif. residents add 5% tax. Spectrum Enterprises, 7650 Isabel Drive, Cotati, Calif. 94928.

HIGHER INCOME security and power. 256 page book "Thinking Big" reveals secrets that make men rich. Send \$2.00 plus tax. Jan's Fashionable Gifts, 3670 W. Imperial, Space 54, Inglewood, Calif. 90303.

LIFETIME SOCIAL Security plate and ID card. Encased name and Social Security number engraved \$2.00. R. Manzi, S-D, 2307 Morris Ave., Bronx, New York 10468.

• • • **MISCELLANEOUS**

NOW! ENJOY the great outdoors in comfort with your pocket size electronic Skeeter Skat mosquito repeller. \$9.95 postpaid, U.S.A. Satisfaction guaranteed. Detectron, Dept. C-7, P.O. Box 243, San Gabriel, California 91778.

YOUR OWN Electronic Business. Easy—lucrative. Details Free. Barta-ELAS, Box 248, Walnut Creek, California 94597.

FASCINATING "HOW to make Delicious wine and champagne at home." Recipes, step by step instructions. Make superb inexpensive wines and champagnes using ordinary kitchen utensils. Guaranteed. \$3.98. Nu-View Publishing Company, P.O. Box 701-E1, Aurora, Colo. 80010.

"CAUTION—ALARM Sounds When Window is Opened"—Four stickers and police whistle—\$1.00. Regis Game Co., 91-03F 172nd Street, Jamaica, New York 11432.

He made it with his own two hands.

There's a name for a place that employs men and women with serious physical and mental handicaps. It's called a "sheltered workshop."

As you might expect, "sheltered workshops" are an unusual kind of business.

But as you might or might not expect, they do an unusual kind of work. Excellent.

In fact, sheltered workshops consistently turn out work every bit as

good as more usual kinds of businesses. And priced just as low.

If your company farms out any of its work, we'd like to invite you to give a sheltered workshop a chance to bid on it—without obligation, of course.

(For more information, write to Workshop, c/o HURRAH, Box 1200, Washington, D.C. 20013.)

If you like their bid, you may decide to give them a chance to do

some of your work.

In which case, you'll be helping a lot more people "make it" with their own two hands.

And, if you like good work, helping yourself in the bargain.

The State-Federal Program of Vocational Rehabilitation.

Help Us Reach & Rehabilitate
America's Handicapped

HURRAH

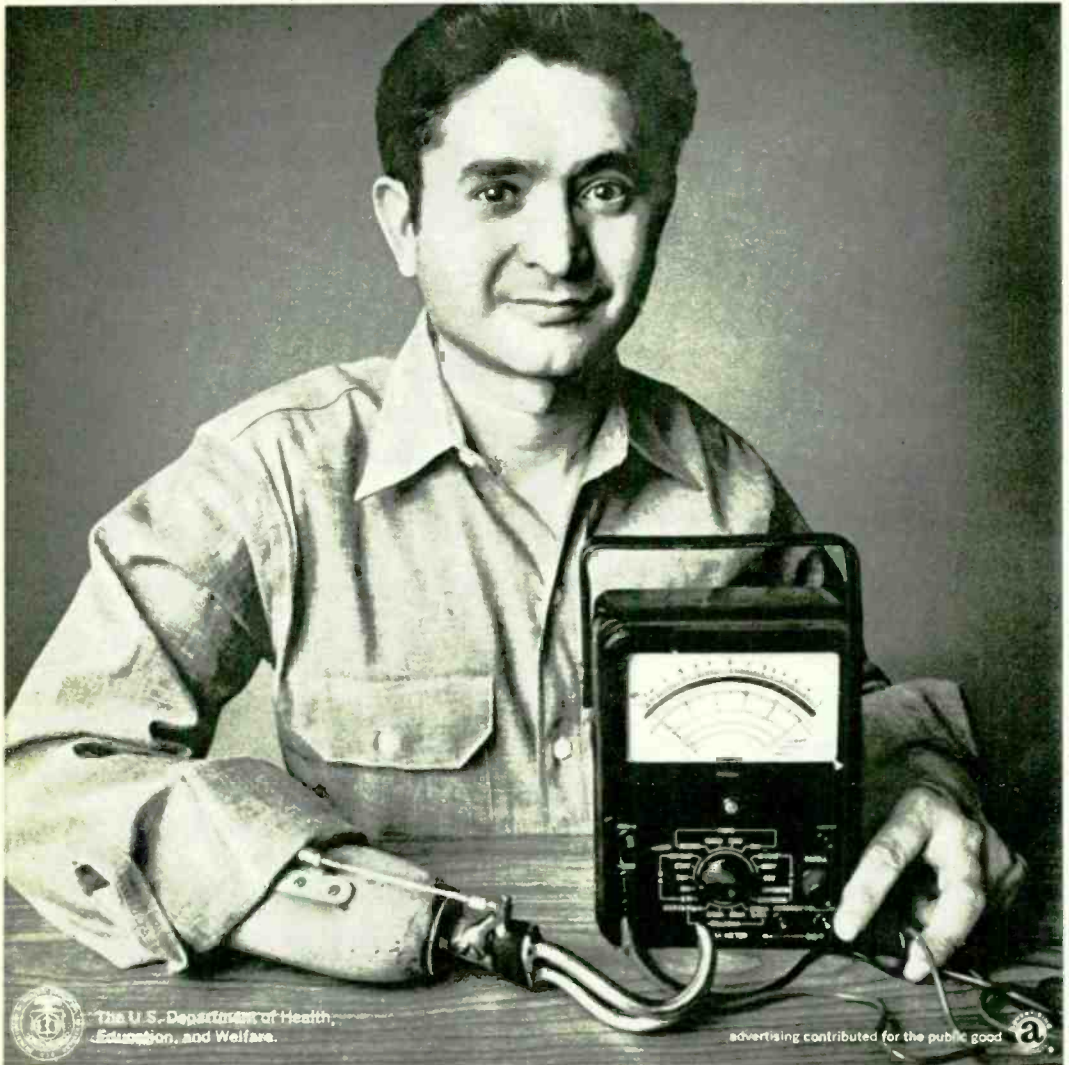

The U.S. Department of Health,
Education, and Welfare.

Advertising contributed for the public good



Great careers

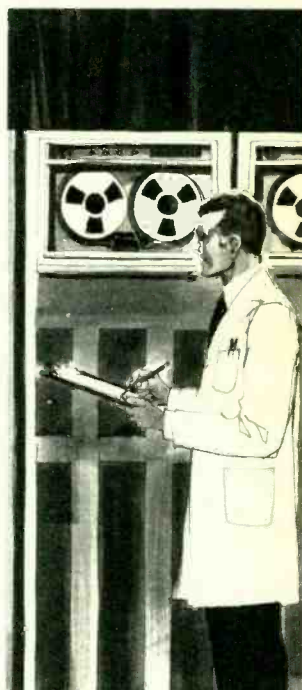
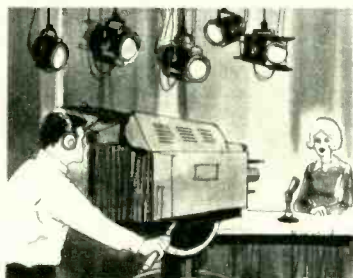

Join the high-paid electronics technicians who got their start through NTS Home Training.

Your home can become your own private classroom-workshop. NTS sends you everything you need to learn valuable technical skills in electronics. You get easy-to-grasp lessons, comprehensive kit manuals, large fold-out charts, and more. Plus the finest professional equipment available today. It's all included in your tuition, yours to keep.

Your equipment is sent to you in kit form, matched to lesson material. With the NTS Project Method, you start with simple projects, then move from basics to more complex concepts. You discover how electronic principles work by performing practical, fascinating experiments. Learn at your own pace.

You quickly become expert in the actual equipment and meth-

ods you'll use on the job. And soon you're ready to cash in on the tremendous opportunities in the expanding, exciting world of electronics!

If your field is television, you might decide to join a first-class TV repair center. Or start a shop of your own. Or specialize in industrial applications of television. Once you master an area of electronics, the direction you take is really up to you. And you'll be able to use the test instruments you built yourself!

It all begins at home, with NTS Project Method Training. Find out how fast and easy it is to learn skills that pay off. Check card or coupon today for your *free* full-color NTS Catalog and complete details. No obligation. No salesman will call.

NTS COLOR AND B&W TV SERVICING

Build the largest, most advanced color TV made! Over-all solid-state design, 315 sq. in. ultra-rectangular screen, matrix picture tube, built-in self-servicing features, "Instant On," A.F.T., solid-state VHF tuner, and much more! Also build and keep AM-SW Radio, Solid-State Radio, FET Volt-Ohmmeter, and Electronic Tube Tester. Learn trouble-shooting, hi-fi, stereo, multiplex systems, radio, color and B&W TV servicing.

**Solid-state
B&W TV**
74 sq. in.
picture
(cabinet
included)



Learn sophisticated solid-state circuitry as you build this B&W TV receiver. Course covers the full range of home entertainment electronics.

Electronics Illustrated

begin at home.



New solid-state
315 sq. in. color TV



The exclusive
NTS Compu-Trainer

NTS COMPUTER ELECTRONICS

Build and operate the exclusive NTS Compu-Trainer! Loaded with integrated circuits, it teaches you the how, what, and why of computers faster, more thoroughly. You perform all wiring and patch-cording. No short-cuts. No pre-wired circuit boards. Also receive an FET Volt-Ohmmeter and a 5" wide-band Oscilloscope.

NTS ELECTRONIC COMMUNICATIONS

Gain the prestige and earning power of owning an FCC First Class Radio Telephone License! Two exciting courses in the fields of transmitting and receiving. Experiment with an amateur phone 6-meter VHF transmitter, NTS' exclusive 6-transistor solid-state radio, and a fully transistorized volt-ohmmeter.

5-watt AM
transmitter/
receiver.

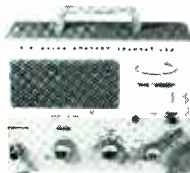

NTS AUTOMATION/ INDUSTRIAL ELECTRONICS

Systems automation is the future of industry — and you can play an important role! Enter the age of electronic controls by training on the NTS Electro-Lab — a complete workshop. Also receive a 5" wide-band professionally rated Oscilloscope. Build five industrial controls to regulate motor speed, temperatures, pressure, liquid level and much more.

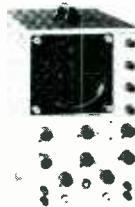

5" Oscilloscope

CLASSROOM TRAINING AT LOS ANGELES

You can take classroom training at Los Angeles in sunny Southern California. NTS occupies a city block with over a million dollars in facilities devoted exclusively to technical training. Check box in coupon.

APPROVED FOR VETERANS

Accredited Member: National Association of Trade and Technical Schools: National Home Study Council.

NATIONAL TECHNICAL SCHOOLS

WORLD-WIDE TRAINING SINCE 1905

4000 S. Figueroa St., Los Angeles, CA 90037

Please rush Free Color Catalog and Sample Lesson, plus information on course checked below. No obligation. No salesman will call.

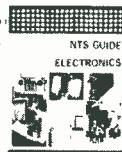

National Technical Schools

4000 S. Figueroa St., Los Angeles, CA 90037

- Master Course in Color TV Servicing
- Color TV Servicing (For Advanced Technicians)
- Master Course in B&W TV & Radio Servicing
- Master Course in Electronic Communications
- Practical Radio Servicing
- FCC License Course
- Master Course in Electronics Technology
- Automation & Industrial Electronics
- Computer Electronics
- Basic Electronics
- Stereo, Hi-Fi & Sound Systems
- High School at Home Dept 213-062

Name _____ Age _____

Address _____

City _____ State _____ Zip _____

- Check if interested in Veteran Training under new G.I. bill
- Check if interested ONLY in Classroom Training at Los Angeles

The 30 second glue:

The secret is hot glue.

It sets by cooling—instead of drying—in about 20 seconds. With a strong, complete bond in just 30 seconds. No waiting. No clamping. Just draw a bead of hot glue, press together and in 30 seconds the job's done.



Any gluing job is easier with the Weller Glue Gun. It loads simply and feeds automatically. It's lightweight and easy to handle. There's even a light that comes on automatically to tell you when the glue's hot. It also illuminates your work.



At the work bench, the Weller Glue Gun lets you glue as you work. The exclusive positive cut-off tip eliminates drips. You glue more cleanly, more precisely than ever before. (It's practically like using a ballpoint pen.) And

Weller Glue Sticks bond wood, glass, porcelain, pottery, ivory, linoleum, fiber-glass, even concrete.

And since the adhesive is both flexible and waterproof you can even mend



a handbag. Or a slicker. Just repair and wear. Great for plastic, rubber, leather and cloth.

At \$10.95 the Glue Gun Kit makes a great gift. Especially for the man who has everything and half of it's broken. It comes in a sturdy case with a portable bench stand, seven free glue sticks and seven free caulk sticks.

With a Weller Glue Gun you'll fix things you never thought possible. Just

The
30 second
Glue
Weller
Automatic
Glue Gun Kit



drop in Weller Caulk Sticks and you can caulk boats, bathtubs, gutters, leaders—you name it.

Our Soldering Gun revolutionized soldering. Our Glue Gun is a whole new way to glue. Once you try it, you'll stick with it. See it now where fine tools are sold.



The
Cooper
Group

CRESCENT · LUFKIN · WELLER