

Contest Winners Announced in This Issue!

Electronics ILLUSTRATED

CONSISTENTLY THE BEST IN HOBBY ELECTRONICS

MARCH 1972

50c

By the Publishers of

MECHANIX ILLUSTRATED

06125

Build a Hi-Performance Converter for 2 Meters
Service: What to Do about Color TV Herringbones
DXing the India-Pakistan Powderkeg
Build a Telephone Message Repeater
The Truth about Careers in Aerospace Electronics!

Build This ALL-PUR
for Your Test Bench!

57 02 2916 LIE62205-0 17G09
S F LIEB
632 DOUGLAS ST
FREEPORT
IL 61032

You get more for your money from NRI—

America's oldest and largest Electronic, Radio-Television home-study school

Compare. You'll find—as have so many thousands of others—NRI training can't be beat. From the delivery of your first lessons in the remarkable, new Achievement Kit, to "bite size," easily-read texts and carefully designed training equipment . . . NRI gives you more value.

Shown below is a dramatic, pictorial example of training materials in *just one* NRI Course. Everything you see below is included in low-cost NRI training. Other major NRI courses are equally complete. Text for text, kit for kit, dollar for dollar—your best home-study buy is NRI.

All this is yours—from Achievement Kit to the only Color TV specifically designed for training—when you enroll for NRI's TV-Radio Servicing course. Other courses are equally complete. But NRI training is more than kits and "bite-size" texts. It's also personal services which have made NRI a 50 year leader in the home-study field. Mail the postage-free card today.

Approved under GI BILL

If you served since Jan. 31, 1955, or are in service, check GI line in postage-free card.



GET A FASTER START WITH NRI'S NEW EXCLUSIVE ACHIEVEMENT KIT

The day your enrollment is received your Achievement Kit will be on its way to you. It contains everything you need to make an easy, fast start in the Electronics training of your choice. This attractive, new starter kit is an outstanding, logical way to introduce you to home-study the way NRI teaches it . . . backed by a dedicated staff and the personal attention you should expect of a home-study school. It is your first special training aid . . . designed to make your adventure into Electronics absorbing, meaningful. Your Achievement Kit contains your first group of lesson texts; rich vinyl desk folder to hold study material; the industry's most complete Radio-TV Electronics Dictionary; valuable reference texts; lesson answer sheets; envelopes; pencils, pen; engineer's ruler—even postage. No other school has anything like it.

OVER 50 YEARS OF LEADERSHIP



LEARNING BECOMES AN ABSORBING ADVENTURE WITH NRI TRAINING KITS

What better way to learn than by doing? NRI pioneered and perfected the "home lab" technique of learning at home in your spare time. You get your hands on actual parts and use them to build, experiment, explore, discover. Electronics come alive! NRI invites comparison with training equipment offered by any other school. Begin NOW this exciting, practical program. It's the best way to understand the skills of the finest technicians—and make their techniques your own. Whatever your reason for wanting to increase your knowledge of Electronics . . . whatever your field of interest . . . whatever your education . . . there's an NRI instruction plan for you, at low tuition rates to fit your budget. Get all the facts about NRI training plans, NRI training equipment. Fill in and mail the attached postage-free card today.

NATIONAL RADIO INSTITUTE, Wash-
ington, D.C. 20016.

IN ELECTRONICS TRAINING

Accredited by the Accrediting Commission of the National Home Study Council

NEW COLOR TV

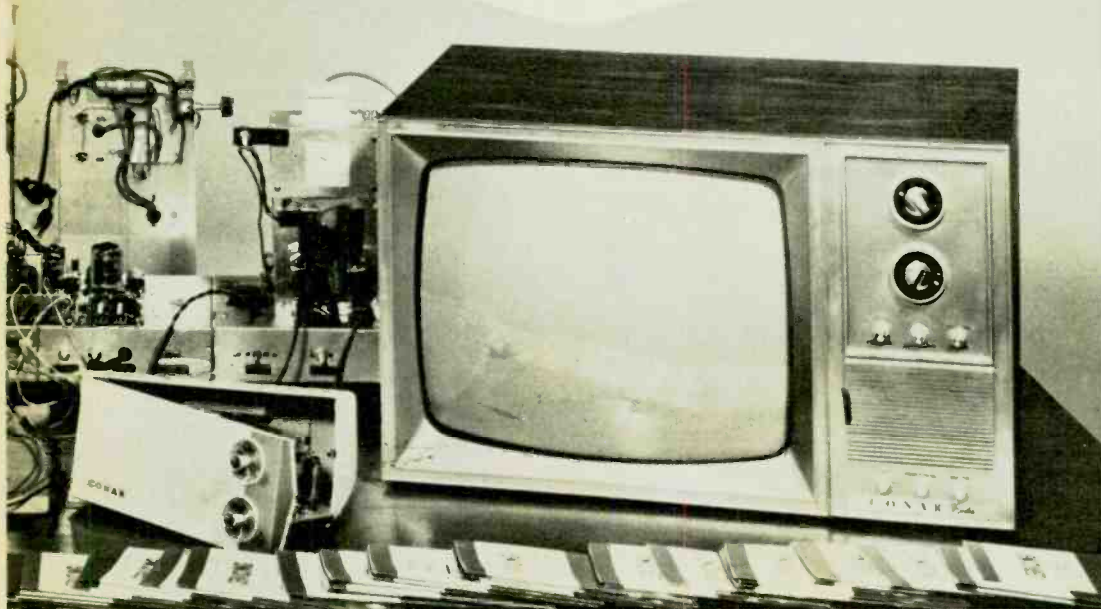

Electronics ILLUSTRATED

A Fawcett Publication

March 1972

Vol. 15 No. 2

Member Institute of High Fidelity, Inc.
COVER: Ektachrome by Bruce Pendleton
Schematic by Eugene J. Thompson

COMING NEXT ISSUE

Oscilloscope Calibrator

How to use Your Color Bar Generator

Special Shortwave Preselector

Four-Channel FM Broadcasting

AMATEUR RADIO

- Hi-Performance Converter for 2 Meters..... Jim White, W5LET 76
The Ham Shack Wayne Green, W2NSD/1 94

CITIZENS BAND

- CB Corner Len Buckwalter, KQA5012 83

AUDIO & HI-FI

- Hi-Fi Today Robert Angus 31
Dolby on a Chip 52

SHORTWAVE LISTENING

- DXing the India-Pakistan Powderkeg Alex Bower 32
The Listener C. M. Stanbury II 89

SERVICE

- Service Tips Art Margolis 10
How To Defeat Color Beats & Herringbones Art Margolis 80

SOLID-STATE ELECTRONICS

- Lab-Grade Power Supply for Test Bench Harry Kolbe 23
The Latest on Liquid Crystals Jorma Hyypia and Clifford L. Forbes 64
Putting Liquid Crystals to Work..... John P. Shields and Jorma Hyypia 68

ENTERTAINMENT ELECTRONICS

- That Yen for Japanese TV Sets Forest H. Belt 44
How Sony's One-Gun Color TV Works..... Len Buckwalter 48

YOUR CAREER

- An Exciting Career in Aerospace Electronics? Forest H. Belt 61

ELECTRONICS IN THE HOME

- Automatic Message Repeater for Your Phone Leslie Powell 40
Light-Sensitive Light Controller Ronald M. Benrey 58

KIT REPORT

- AR-3a Speaker in Kit Form 86

EP's WIN-THE-WORLD CONTEST

84

NEW PRODUCTS

- Electronic Marketplace 13
Electronics in the News 70

YOUR LIBRARY

- Good Reading 88

HOBBY & BUSINESS OPPORTUNITIES

- Classified Ads 105

REGULAR DEPARTMENTS

- Uncle Tom's Corner Tom Kneitel, K2AES/KBG4303 8
Feedback 11
Product Information Service 15
The EI Ticker 35
Tips 95

Prepare now for a successful future!

266 ICS COURSES



Earn more money, enjoy greater security and faster promotion—and gain all the satisfaction of doing a job well that you like to do. Check the list of 266 ICS career opportunities for a better future. You receive individual

instruction, success-proved training you can apply immediately. And you earn the famous ICS diploma. Don't waste time! Send the coupon today for FREE information on a brighter career the ICS way!



LEADERS IN THE ICS SUCCESS PARADE...
 Automobile Engine Tune-Up
 Introduction to System/360 Computer Business Administration
 Accounting
 Civil Engineering
 Practical Electrician
 TV-Radio Servicing

ACCOUNTING
 Accounting (U.S.A.)
 Accounting (Canadian)
 Accounting for Business Programmers
 Auditing
 Business Law (U.S.A.)
 Cost Accounting
 CPA Review (U.S.A.)
 General Accounting
 Federal Tax (U.S.A.)
 General Business Accounting
 Junior Accounting
 Office Accounting
 Practical Accounting
 Public Accounting
 Small Business Accounting (U.S.A.)
 Starting and Managing a Small Accounting Service (U.S.A.)

ARCHITECTURE AND BUILDING
 Architectural Drafting and Designing
 Architecture
 Building Contractor
 Building Estimator
 Building Inspector
 Building Maintenance
 Carpenter-BUILDER
 Carpentry and Millwork
 House Planning and Interior Design
 Mason
 Painting Contractor
 Reading Architects Blueprints

ART
 Amateur Artist
 Commercial Art
 Cartooning
 Illustrating
 —Advertising Layout
 Interior Decorating and Design
 Oil Painting
 Show Card and Sign Painting and Designing

Show Card Writing
 Sign Painting and Designing
 Sketching and Painting
AUTOMOTIVE
 Automatic Transmission Specialist
 Automobile Air Conditioning Specialist
 Automobile Body Rebuilding & Refinishing
 Automobile Engine Tune-Up
 Automotive Mechanic
 Automobile Master Mechanic
 Automotive Diesel-Gas Mechanic

BUSINESS
 Advertising Acct. Exec.
 Advertising Media
 Advertising Copywriting
 Advertising Production
 Business Administration
 Business Law
 Canadian Business Course
 Industrial Psychology
 Basic Inventory Control
 Managing a Small Store
 Marketing Management
 Marketing Research Management
 Exec. Management
 Office Management
 Production Management
 Purchasing Agent
 Retail Bus. Management
 Retail Buyer
 Systems and Procedures Analysis

BUSINESS: SALES
 Real Estate Agent
 Modern Salesman
 Sales Manager
BUSINESS: SUPERVISION
 Advanced Management
 Basic Management

Industrial Foremanship
 Management
 Industrial Supervision
 Sales Management
 Personnel—Labor Relations (U.S.A.)
 General Supervision

CHEMICAL
 Chemical Analyst
 Chemical Engineering
 Chemical Laboratory Technician
 Chemical Process Op.
 Elements of Nuclear Energy
 General Chemistry
 Instrumental Laboratory Analysis

CIVIL ENGINEERING
 Civil Engineering
 Construction Eng'g Technician
 Highway Eng'g Tech.
 Principles of Surveying
 Reading Highway Blueprints
 Reading Structural Blueprints
 Sanitary Engineering Technology
 Sewage—Plant Operator
 Structural Eng'g Tech.
 Surveying and Mapping
 Water-Works Operator

COMPUTERS
 Fundamentals of Computer Programming
 COBOL Programming
 Fortran IV Programming
 Introduction to Digital Computer Programming
 Programming the IBM 1401 Computer
 Introduction to System 360 Computer

DRAFTING
 Aircraft Drafting
 Architectural Drafting
 Design Drafting
 Drafting Technology
 Electrical Drafting
 Electronic Drafting
 Introductory Mech. Drafting
 Mechanical Drafting
 Pressure-Vessel and Tank Print Reading
 Sheet Metal Layout
 Structural Drafting

ELECTRICAL
 Electrical Engineering—Electronics Option.
 —Power Option
 Electrical Appliance Ser.
 Electrical Contractor
 Electrical Eng'g Tech.
 Electrical Home Maint.
 Electrical Instrumentation Tech.
 Electric Motor Repairman
 Industrial Elec. Tech.
 Industrial Electrician
 Industrial Maintenance Electrician
 Power-Line Design and Construction
 Power Plant Operator—Hydro Option
 —Steam Option
 Practical Electrician
 Utility Lineman
 Reading Elec. Blueprints

ENGLISH AND WRITING
 Better Business Writing
 English for Spanish (U.S.A.)
 Free Lance Writing for Fun and Profit
 Modern Letter Writing
 Practical English
 Reading Improvement
 Short Story Writing

HIGH SCHOOL
 High School Business
 High School (Canadian)
 High School General
 High School Math.
 High School Secretarial
 High School Vocational
 High School College Preparatory—Arts
 High School College Prep—Engineering and Science
 Preparatory Course for High School Equivalency Exam.

MACHINE SHOP PRACTICE
 Industrial Metallurgy
 Mach. Shop Inspection
 Mach. Shop Practice
 Metallurgical Tech.
 Reading Shop Blueprints
 Tool & Die Maker
 Tool and Die Foreman
 Welding Foreman

MATHEMATICS
 Math and Mechanics for Engineers

Math and Physics for Engineers

MECHANICAL
 Mechanical Engineering
 Aircraft and Power Plant Mechanic
 Principles of Hydraulic and Pneumatic Power
 Industrial Engineering
 Industrial Eng'g Tech.
 Industrial Instrumentation
 Machine Design
 Quality Control
 Safety Eng'g Tech.
 Tool Design
 Vibration Analysis and Control

PETROLEUM
 Natural Gas Production and Transmission
 Oil Well Servicing
 Petroleum Production Operator
 Petroleum Production Field Tech.
 Petroleum Refinery Op.

PLASTICS
 Plastics Technician

PLUMBING, HEATING AND AIR CONDITIONING
 Air Conditioning Estimator
 Air Conditioning Maint.
 Domestic Heating with Gas and Oil
 Heating & Air Conditioning with Drawing
 Industrial Air Cond.
 Pipe Fitting Plumbing
 Plumbing and Heating
 Plumbing and Heating Est.
 Practical Plumbing
 Domestic-Commercial Refrigeration and Air Conditioning Serv.

PULP AND PAPER
 Paper Machine Operator
 Paper Making
 Pulp Making
 Pulp & Paper Tech.

SECRETARIAL
 Clerk-Typist
 Secretary, Private Sec'y, Legal
 Secretary, Executive

Shorthand/Stenographic Typewriting

STEAM AND DIESEL POWER
 Boiler Inspector
 Building Eng's
 Power Plant Engineering
 Stationary Diesel Eng's (operation and maintenance)
 Stationary Fireman
 Stationary Steam Eng'g

TEXTILES
 Carding and Spinning
 Dyeing and Finishing
 Loom Fixing
 Textile Designing
 Textile Mill Superintendent
 Textile Mill Supervisor

TRAFFIC
 Motor Traffic Man'g'm't
 Traffic Management

TV-RADIO-ELECTRONICS
 Cable TV Installer
 Commercial Radio Telephone License

1st Class
 2nd Class
 3rd Class
Electronics Service Technician
 Principles of Electronic Computers
 General Electronics
 Hi-Fi Stereo and Sound System Servicing
 Industrial Electronics
 Numerical Control
 Maintenance and Troubleshooting
 TV and Radio Servicing
 Solid State Electronics
 Telephony

APPROVED FOR VETERANS FOR TUITION REFUND
 (G.I.'s quality after 180 days active service)
 Accredited member, National Home Study Council.
 Easy pay-as-you-learn plan.
 Special rates to members.
 U.S. Armed Forces.

ICS
 International Correspondence Schools
 Division of Intext
 ICS, Scranton, Pa. 18515
 Canadian residents: Send coupon to Scranton. Our affiliate in Canada will reply.
 In Honolulu: Use P.O. Box 418, Honolulu.

TAKE YOUR FIRST STEP... MAIL THIS COUPON TODAY—ICS, SCRANTON, PA. 18515 **7K312A**

I'm interested in a program of independent study. Send me, without cost, your booklet on the principles of success, sample text demonstrating famous ICS method, and your catalog for _____ (Print name of course. See list.)

Miss _____ Age _____
 Mrs. _____ Age _____
 Mr. _____ Age _____

Address _____ Apt. _____
 City _____ State _____ Zip Code _____

Occupation _____ Employed by _____ Working Hours _____ A.M. to _____ P.M.

Johnson put it all together.

□ low band and high band channels in any combination □ base and mobile operation with built-in power supply □ auto-scan with push-button "lock out" plus manual "lock in"

new
Duo-Scan™
\$169⁹⁵



Eight VHF FM channels, in any combination of high and/or low band, keep you on top of all the action. Operates mobile or base with performance features previously found only in professional public safety radio equipment. Two ceramic filters give unsurpassed adjacent channel rejection. Integrated circuit symmetrical limiting makes it really quiet. 0.4 μ V sensitivity lets you hear what others miss. Powerful transistor audio produces clear, undistorted sound. The new Duo-Scan puts it all together, for just \$169.95 (less crystals).



E. F. JOHNSON COMPANY

WASECA, MINNESOTA 56093

© CIRCLE NUMBER 15 ON PAGE 15 1214

Electronics ILLUSTRATED

By the Publishers of MECHANIX ILLUSTRATED

editor **ROBERT G. BEASON**
managing editor **Clifford L. Forbes**
technical editor **Robert Wollins**
art editor **Lou Rubsamen**
associate editor **Jean E. Lee**
consulting editor **Robert D. Freed**
production editor **Priscilla Moody**
adv. director **John F. Webster**
national adv. mgr. **Stanley Tessler**

publisher **George H. Allen**

CONTRIBUTING EDITORS

amateur radio **Wayne Green, W2NSD/1**
citizens band **Len Buckwalter, KQA5012**
swl-dx **C. M. Stanbury II**
special projects **Herb Friedman**
W2ZLF/KB19457
service **Art Margolis**
audio **Harry Kolbe**
audio **John Milder**

EXECUTIVE STAFF

president **Roger Fawcett**
secretary-treasurer **Gordon Fawcett**
circulation director **Roscoe K. Fawcett**
vp., magazine div. **George H. Allen**
exec. vp., book div. **Ralph Daigh**
vp., asst. to pres. **Frederick A. Klein**
vp., comptroller **F. Paul Simmering**
vp., dir. admin. services **Joseph Cunningham**
vp., circ. mgr., mag. div. **Luther Bugbee**
subscription manager **Ted Sloat**
vp., circ. mgr., book div. **Edmund Pendergast**
production director **Thomas R. Marvel**
production manager **Judy Schaefer**
art director **Ralph Mattison**

ELECTRONICS ILLUSTRATED is published bi-monthly by Fawcett Publications, Inc., Fawcett Bldg., Greenwich, Conn. 06830. Second-class postage paid at Greenwich, Conn., and at additional mailing offices.

EDITORIAL OFFICES: 1515 Broadway, New York, N.Y. 10036 (phone 212-869-3000). Contributions must be accompanied by sufficient postage and will be handled with care, though the publishers assume no responsibility for return thereof.

ADVERTISING OFFICES: 1515 Broadway, New York, N.Y. 10036 (phone 212-869-3000); Midwestern Representatives, King will Co., 5526 N. Elston Ave., Chicago, Ill. 60630 (phone 312-774-9660); 211 W. Fort St., Suite 1010, Detroit, Mich. 48226 (phone 313-962-4860); 3307 Wilshire Blvd., Los Angeles, Calif. 90010 (phone 213-287-8258); 681 Market St., San Francisco, Calif. 94105 (phone 415-EX 7-3441); 1422 W. Peachtree St., N.W., Atlanta, Ga. 30309 (phone 404-TR 5-9373).

SUBSCRIPTIONS: \$3 per year (6 issues) in U.S. and possessions and Canada. All other countries \$4 for 6 issues. All subscription correspondence, including changes of address (Form 3579), should be addressed to **ELECTRONICS ILLUSTRATED**, Subscription Dept., Fawcett Bldg., Greenwich, Conn. 06830. Foreign subscriptions and sales should be remitted by International Money Order in U.S. funds payable at Greenwich, Conn.

COPYRIGHT © 1972 by Fawcett Publications, Inc. The title **ELECTRONICS ILLUSTRATED** is registered in the U.S. Patent Office. Reproduction in whole or in part is forbidden without written permission of the publishers; however, permission is hereby granted to quote from this issue of this magazine on radio or television, provided a total of not more than 1,000 words is quoted and credit is given to the title of this magazine and issue, as well as the statement, copyright 1972, by Fawcett Publications, Inc. Member ABC, MPA.

PRINTED IN U.S.A. BY FAWCETT PRINTING CORP., LOUISVILLE, KY. 40201. Microfilm copies of current and back issues are available from University Microfilms, 313 N. First St., Ann Arbor, Mich. 48103.

KEEP PACE WITH SPACE AGE! SEE MOON SHOTS—LANDINGS, SPACE FLIGHTS, CLOSE-UP!

AMAZING SCIENCE TOYS

for FUN, STUDY or PROFIT



See moon shots,
orbits, stars,
craters!

NEW 3" REFLECTOR TELESCOPE

Deluxe Features at economy price 60 to 180X

Amazingly priced Apollo Space Explorer brings the wonders of the universe up close. 3" aluminum & overcoated f/10 mirror. Reaches theoretical limits of resolution & definition. 60X standard size 1 1/4" O.D. eyepiece 1/2" F.L. 3X adjustable Barlow (X) finder telescope; high impact plastic tube; metal fork mount w/ positive locking. 36" hardwood tripod. Included FREE: 272 p. Handbook, Star Chart. Instructions. Best value ever!

- Stock No. 80,162EB \$9.50 Ppd.
- REG. 3" REFLECTOR TELESCOPE
- Stock No. 85,050EB \$34.50 Ppd.
- 4 1/4" ASTRONOMICAL REFLECTOR TELESCOPE
- Stock No. 85,105EB \$94.50 F.O.B.
- 6" ASTRONOMICAL REFLECTOR TELESCOPE
- Stock No. 85,086EB \$239.50 F.O.B.

ALMOST-INVISIBLE ELEC. WIRE



Eliminate ugly cord! Pressure sensitive, low voltage wire-tape is paper thin, makes a permanent bond to any surface. Easily covered w/ paint, practically invisible. Hook up stereo extension speakers, connect model railroads, phones, doorbells, clocks, etc. Go around doorways, windows, cabinets under carpet, over woodwork. On car windshield, it's better than wire antenna kit. 10-ft. wire-tape

(3/8"W), spcl. connectors, straight-angle splices, instrs. Stock No. 41, 627EB \$5.00 Ppd.

INFRA RED SENSOR ALARM KIT



Make a sensor alarm w/ new low cost experimental kit. When infra red hits solid state sensor LASCR (Light Activated Silicon Controlled Rectifier) it actuates the integrated circ. tone generator. Oscillations then amplified into loud speaker. Incls. 18 ohm 2 1/2" dia. spike perf. hd. batt. clip & holder; 24" .020 dia. plastic fiberoptics light gd. w/ infra red filter; wires; resistors; capacitor; transistor NPN. Req. 4 AA cells, not incl.

Instrs. w/ exps. & apps. Stock No. 41, 995EB \$6.95 Ppd.

SEE QUALITY OPAQUE UNDER \$200

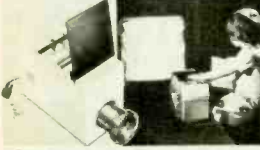

Terrific Buyl Top Quality! Projects brilliant sharp 4 1/2 ft. sq. image from 8' using up to 5"x5" color, b&w, illustrations. Retains all original colors, proportions. Enlarges drawings, coins, maps, etc. Revolutionary peanut-size quartz Halogen lamp (50 hr. life), 200mm anastigmatic lens (F3.5, 8' F.L.), unique internal reflecting system give maximum brightness, entire field focus. Can be used upside down. Turbo-cooled. 5 1/2 ft. cord.

Stock No. 71, 272EB .. (Wt. 11 1/2 lbs) \$98.75 Ppd.

AMAZING NEW Wankel Engine KIT

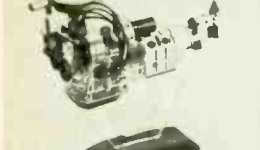

Thrill to the fun of building your own see-through motorized model of revolutionary piston-less type engine, rights for which GM recently paid \$50 million! Only engine experts think economically modifiable to meet new pollution standards. Replaces piston, cylinder, crank assemblies with rotating discs (sections removed for firing chambers). Smaller than conventional; fewer parts, greater reliability, same speed w/ less horsepower. Feat: flashing plugs, rubber fan belt, stick-shift, off of switch. Req. 2-1.5V batt. (not incl.).

Stock No. 71, 424EB .. (4 1/2"x5"x9") \$6.75 Ppd.

MAIL COUPON FOR GIANT FREE CATALOG

148 PAGES!—1000's OF BARGAINS

EDMUND SCIENTIFIC CO., 300 EDSCORP BUILDING, BARRINGTON, NEW JERSEY 08007

Completely new edition. Dozens of electrical and electromagnetics parts, accessories. Enormous selection of unique lighting and ecological items. Astronomical Telescopes, Microscopes, Binoculars, Magnifiers, Magnets, Lenses, Prisms. Many hard-to-find surplus items for hobbyists, experimenters, workshop, factory.

WRITE FOR CATALOG "EB."

Hand-sized solid state electronic strobe light at fantastically low price. Produces bright psychedelic effects, like larger, far more expensive Xenon strobes, yet it's just 2 1/4" x 4 x 1 3/8" thick. Adjustable flash rate, approximately 3-10 flashes per second. Make stop motion effects, posters come alive. Great to take with you to parties, dances, outings, etc. Requires 2 9v transistor batt. (not incl.). Instructions.



Stock No. 41, 443EB \$8.95 Ppd.
4 REPLACEMENT LAMPS P-41, 444EB 1.00 Ppd.

NEW! ELECTRONIC DIGITAL COMPUTER KIT

Solve problems, play games, predict weather with actual working model of giant electronic brains. Amazing new fun way to learn all about computer programming logic, decimal binary systems, Laws of Sets—even do your own programming after completing simplified 118 page instruction booklet. Includes step-by-step assembly diagrams. Circuits easily changed. Readout from illuminated control panel. Req. 2 "D" batt. (not incl.). Best model we've seen—for home, school, industry.



Stock No. 71, 434EB \$31.50 Ppd. (11"x12 1/2"x4")

18" FLEXIBLE FIBERSCOPE

Hi-resolution image-transmitter lets you see into remote, inaccessible illuminated areas; through pipes, tubes or any 3/8" opening no matter how intricate. Provides clear, wide sighting. 7X magnifying eyepiece focuses from less than 1/8" from subject to infinity. Ideal for monitoring hazardous processes, surveillance instrument, demonstrate fiber optics. Over 4,000 colored glass fibers (.002"), 3/8" dia. semi-rigid goose-neck sheathing.



Stock No. 60, 857EB \$40.00 Ppd.

POWER HORN BLASTS A MILE

Frighten prowlers, muggers, vicious dogs with 118 decibels. Just press and this Freon powered pocket-sized metal horn can be heard a mile away to signal for help or fun. Great for boating (it floats), hiking, camping, hunting, seashore, rooting for your team. Can be heard over traffic and constr. noises to sound fire drill, lunch break or emergency. Weighs only 3 oz. but contains up to 100 mile-piercing blasts. A real bargain.



Stock No. 41, 424EB \$3.25 Ppd.
2 Refill Cartrs. (P-41, 424EB) \$2.75 Ppd.

BLACK-LIGHT MIGHTY MITES

Relatively small (12") fixtures give surprisingly bright black-light. Mirror-finished reflector makes instant starting 8-watt, high-intensity bulb look like 40-watter. Up to 5,000 hours of safe, long-wave (3600A) black-light to really turn-on parties, light & theatrical shows, psychedelic decor, holiday decorations. Shockproof end-caps remove for safe, easy replacement of bulb and starter. Stands upright or horizontal. Aluminum case.

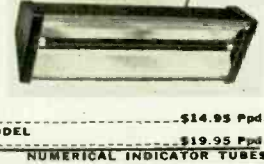

Stock No. 71, 274EB \$14.95 Ppd.
DELUXE OUTDOOR/INDOOR MODEL
Stock No. 71, 299EB \$19.95 Ppd.

Designed as direct line, side-view readout devices for basic control and computer circuits. Gas filled cold-cathode numerical readout tubes use common anode 10 cathodes in shapes of numerals 0-9. Also give usual digital display of volts, cycles, etc. High reliability, long life; wide-angle viewing with brightness and stability.



TUBE W/O DECIMAL: No. 41, 993EB \$5.95 Ppd.
Socket for above: No. 41, 816EB80 Ppd.
TUBE W/ DECIMAL: No. 41, 818EB \$5.95 Ppd.
Socket for above: No. 41, 617EB80 Ppd.

TAPE-SLIDE SYNCHRONIZER

Automatically coordinates tape recordings with a series of slides. Just hook up recorder and slide projector to the TSS—then record what you wish for each slide. On playback, the TSS will automatically change slide in conjunction with that slide's recording. Makes 1 man show into no-man show. Your presentation "gives itself." Perfect for presentations, sales meetings, lectures. Make "talking album" of child's growth, add new dimension to vacations, slides, pictures from zoo, party, ballpark... anywhere.



Stock No. 41, 222EB \$21.95 Ppd.

EDMUND SCIENTIFIC CO. ORDER BY STOCK NUMBER · SEND CHECK OR MONEY ORDER · MONEY-BACK GUARANTEE

300 EDSCORP BLDG. BARRINGTON, NEW JERSEY 08007



Uncle Tom's Corner

By Tom Kneitel, K2AES/KBG4303

Uncle Tom answers his most interesting letters in this column.
Write him at Electronics Illustrated, 1515 Broadway, New York, N.Y. 10036.

★ *High fidelity went from one track to two, then to four, but TV just keeps rolling along. After they developed color TV they seemed to come to a dead end as far as sales gimmicks go. What's next, 3D TV?*

Tim Fitzpatrick
Crawfordsville, Ind.

My crystal ball says first a flat picture tube that will be hung on the wall like a picture in a frame, followed by stereo sound.

★ *I happened to be poking around inside my CB rig and noticed that the transmit crystal for CB channel 1 was marked 26.965 mc but the receive rock plainly read 26.510 mc. That's not even within the band limits, what gives?*

Greg D. Lorenzo
Rupert, Iowa

The receiver crystal is cut 455 kc lower than the transmit frequency because that's the way a superhet receiver with a 455-kc IF circuit is designed. Don't worry, the set still pulls in CB channel 1 despite the misleading markings. An old-time CB trick was to get your own private bootleg channel outside the crowded CB channels by reversing these two crystals and really transmitting on 26.510, outside of the band. The FCC put a stop to this with stepped-up monitoring of homebrew non-channels.

★ *Several issues back you said that you could spot an experimental station by the fact that it had a callsign consisting of the letter K followed by another letter, then 2X and two more letters. What about a station WW2XAE which I hear on about 4.1 mc? It has some elements of your magic formula but seems different.*

Mark Fredericks
Cape May, N. J.

There's one in every crowd. Apparently you've stumbled upon one of the few exceptions to my formula. I've heard this station, too. It's on 4141 kc and appears to be aboard a research ship operated by the Lamont Geophysical Lab of Columbia University. It's the only WW experimental call I've ever heard.

★ *Is it possible to use a piece of military surplus gear called the APS-13 on the 420-mc ham band? There seems to be no commercially made gear for this band and I can get an APS-1 on a quickie swap with a buddy of mine.*

Harlan Quackenbush
Toledo, Ohio

The APS-13 was a World War II radar unit used in the tail of bombers to pick up approaching enemy aircraft. In fact, it was called Tail End Charlie. It's an outdated jungle of 6J6s which easily can be converted to ham use but it's not effective for this purpose. Your best bet is to pick up some second-hand UHF business-band gear. Some of it comes pretty cheap if you shop around.

★ *My husband is a ham operator—one of the mobile breed. He panics me with his annoying habit of driving around with one hand on the steering wheel while he goes on tuning the band, adjusting the volume and pressing the mike button with the other. He reads your column so perhaps you can clue this big clod in before he scatters his precious Collins rig (and me) all over the highway.*

Mrs. E.P.
Rolling Hills, Calif.

I recall the old *Ode To A Mobile Ham* which goes: "He went barrelling down the highway, one hand held mike and switch.

[Continued on page 12]

RADIO SHACK ISSUES A NEW AND DIFFERENT CATALOG!

**FREE
NEW 1972
EDITION**

**ELECTRONICS
FROM A to Z**

- ANTENNAS • BATTERIES
- CAPACITORS • DIODES
- EDUCATIONAL KITS
- FIBER OPTICS
- GRILLE CLOTH
- HI-FI SPEAKERS • IC'S
- JACKS • KNOBS • L-PADS
- MIKES • NEEDLES
- OSCILLATORS • P-BOXES
- QUADRACS • RESISTORS
- SEMICONDUCTORS
- TELEPHONES
- ULTRASONIC ALARMS
- VHF ANTENNAS • WIRE
- XENON STROBE LIGHT
- "Y" ADAPTERS
- ZENER DIODES
- AND MUCH MORE!

1000's of
Products!

100's of
Exclusives!

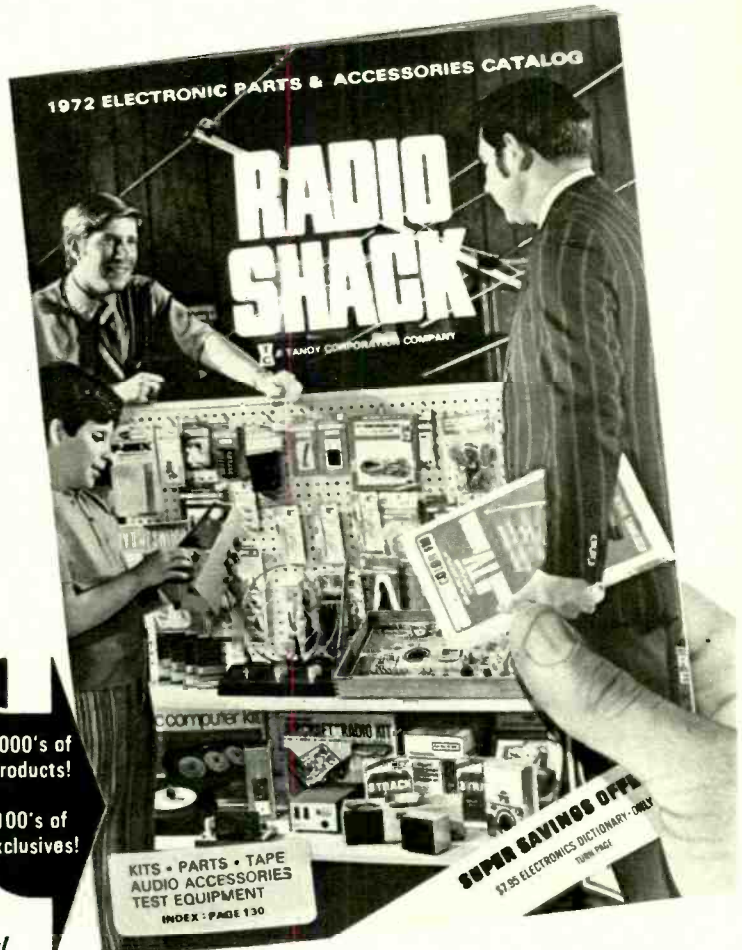

**Get a Copy At Your Nearby
Store or Mail Coupon Today!**

THE buying guide for kit builders, Hams, CB'ers, installers, experimenters, fix-it men, hobbyists, electricians, anyone in electronics in any way. It lists 1000's of things most stores don't stock. Things that keep equipment working, or make it work even better or do even more. Features our complete Science Fair and Knight-Kit lines of electronics and hobby kits, too. Use this catalog to find what you need, then go to our store near you and get it. Or you may order by mail.

Over 1100 Stores in 49 States

ALLIED RADIO SHACK Dept. E1-9
A TANDY CORPORATION/KIT COMPANY

2725 W. 7th St. Fort Worth, Texas 76107

Send me your FREE 1972 Catalog #215

Please PRINT Clearly

Name _____ Apt. # _____

Street or Rte. & Box _____

City _____

State _____ Zip



Service Tips

By Art Margolis

THE giant-size high-voltage anode suction cups found in recent-vintage color TVs have a tendency to harden and lose their ability to maintain suction. When there is no suction, the high voltage crackles out to the chassis. A new suction cup is needed and it's best to replace those old large ones with a new small dia. type. The small ones are better at containing the high voltage.

Bothered by poor purity around the perimeter of your color TV picture? The trouble could be due

to your set's picture tube and its holder becoming magnetized. If you do not have a demagnetizer (or degausser, as it's called) you can use your soldering gun to do the job. Its transformer radiates a strong magnetic field. Move it around the picture tube and the impurity splotches should disappear.

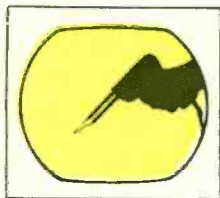

Common misconception on the gray-scale setup on a color TV concerns both the drive and the screen controls. Most set-up procedures are begun by turning the drive controls all the way up (clockwise) and the screen controls all the way down (counterclockwise).

When installed in trouble lamps or an outdoor socket, light bulbs have a tendency to corrode and rust tight in the socket making replacement quite difficult. This can be avoided by rubbing a thin layer of ordinary Vaseline on the metal parts of the bulb before installation.

Does your house get cold during the time an appliance, such as a washer, dryer or TV set, is operating? If so, check the location of the furnace thermostat in relation to the appliance. Chances are some heat from the appliance is getting to the thermostat and shutting it off.

If you have an appliance motor that seems to be running too slow, odds are good that lubrication will speed it up. A word of caution, however. Don't use any of those handy little household oils you get in a hardware store. Your best bet are those special auto friction-proofing oils such as STP. Other oils gum up when heated.

Don't let wires shortchange you when building a kit. It's a nuisance during final assembly to find a previously soldered wire won't reach its other destination. Add another half inch or so the first time. There should be extra wire, but if you do run out, there's more in the junk box.

*the tape that
turned the
cassette into
a high-fidelity
medium*



TDK SUPER DYNAMIC (SD) TAPE

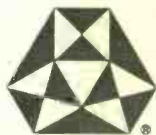

TDK

Until TDK developed *gamma ferric oxide*, cassette recorders were fine for taping lectures, conferences, verbal memos and family fun—but not for serious high fidelity.

TDK CASSETTE C-60SD

Today you can choose among high-quality stereo cassette decks.

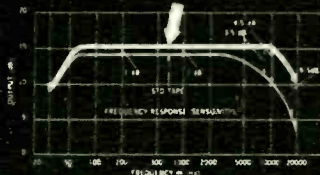

The new magnetic oxide used in TDK Super Dynamic tape distinctively differs from standard formulations in such important properties as coercive force, hysteresis-loop squareness, average particle length (only 0.4 micron!) and particle width/length ratio. These add up to meaningful performance differences: response capability from 30 to 20,000 Hz, drastically reduced background hiss, higher output level, decreased distortion and expanded dynamic range. In response alone, there's about 4 to 10 db more output in the region above 10,000 Hz—and this is immediately evident on any cassette recorder, including older types not designed for high performance. There's a difference in clarity and crispness you can hear.

Available in C60SD and C90SD lengths.

TDK ELECTRONICS CORP.
LONG ISLAND CITY, NEW YORK 11103

CIRCLE NUMBER 25 ON PAGE 15

Feedback from Our Readers

Write to: Letters Editor, Electronics Illustrated, 1515 Broadway, New York, N.Y. 10036

● POISON GAS?

I was appalled to read in Art Margolis' Service Tips column (Nov. '71 EI) that he advocates the use of a carbon tetrachloride fire extinguisher for electrical fires. Carbon tetrachloride fire extinguishers shouldn't be used under any circumstances. The chemical is extremely toxic and when it burns, phosgene gas—used as a poison gas during World War I—can be produced. Fire-fighting experts agree that these extinguishers should be done away with entirely.

Timothy A. Manzone
Haverford, Pa.

Sorry about that, Tim. Maybe we concentrated too much on getting the spelling right.

● MORE TIPS

I enjoy your magazine but your Tips on page 103 in the November EI were too much. I don't understand how people with only two hands are supposed to do that soldering trick. I tried it with my foot but almost burned off a toe.

Mike Hill
San Antonio, Tex.

● SHOCK TACTICS

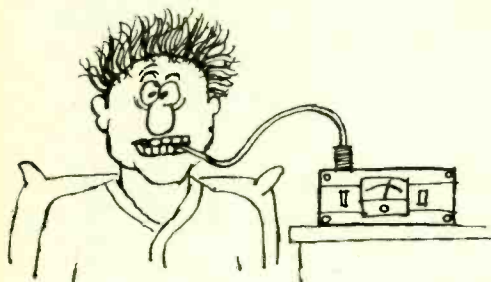

Your electronic thermometer project (LOW-COST ELECTRONIC MEDICAL THERMOMETER, Jan. '72 EI) seems to be an excellent circuit and I'm sure it works okay. But how do you convince people they won't get a shock when the probe goes under the tongue?

Peter Richards
Bismarck, N.D.

● A INSTEAD OF E

Once a CBer, I had to give it up 'cause I couldn't make contact with my mobile station due to skip and chit-chat. I can see the need for a skip-free CB band. But why not use CB's Class A band instead of wresting 220 mc from the hams? Class A is dying anyway because businesses are moving to VHF channels. Range on A's 465 mc would be the same as 220 mc.

Charles Milazzo, WB2OZA
Bronx, N.Y.

● TAPE MEASURE

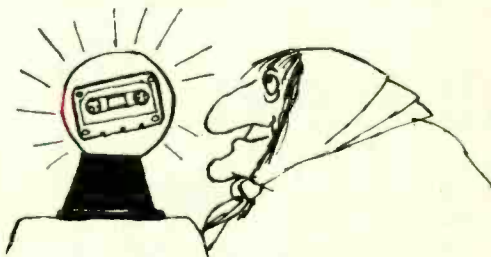

I was disturbed by Bob Angus' evaluation report on audio cassettes published in the November issue of EI. The Memorex C-60 cassette is reported to be lacking in sound quality and such parts as rollers and head shields and subject to occasional fadeouts and loss of sound. But the Memorex chromium-dioxide cassette is given a good review.

Fact is, our ferric-oxide and chromium-dioxide C-60 cassettes are of identical construction. All of our cassettes not only contain rollers but a shield that wraps around the head to give added protection from hum pickup. The pad is part of the head assembly.

I can only conclude that by some mischance, Mr. Angus obtained a sample of a Memorex C-60 cassette which left the factory in the state he describes. It seems inconceivable that a cassette could leave our plant in such a condition. If, however, this were the case, I would be both embarrassed and apologetic. I'd be glad if you could arrange to have a test rerun on a properly assembled Memorex ferric-oxide cassette.

Eric D. Daniel
Memorex Corp.
Santa Clara, Calif.



another great
new idea

reversible ratchet handles

for Xcelite "99" tools



These two unique plastic (UL) handles extend the usefulness of all Xcelite Series "99" tools, make welcome additions to any "99" set.

Both regular (99-1R) and Tee (99-4R) types accept more than 60 individually available nut-driver, screwdriver, and special purpose snap-in blades to speed and simplify assembly and service work.

Fully enclosed ratchet mechanism is built to highest socket wrench quality standards. Recessed reversing shift operates at the flick of a thumb. Patented spring chuck holds blades firmly.

nationwide availability through local distributors

REQUEST BULLETIN N670

Made in U.S.A.

XCELITE

XCELITE INC. • 16 BANK ST., ORCHARD PARK, N. Y. 14127
Send Bulletin N670 on Series "99" Reversible Ratchet
Handles.

name _____

address _____

city _____

state & zone _____

In Canada contact Charles W. Pointon, Ltd.

CIRCLE NUMBER 13 ON PAGE 15

Uncle Tom's Corner

Continued from page 8

A truck pulled out in front of him; he didn't even twitch."

★ *Is it possible to obtain the operating frequency of the NIMBUS weather satellite? Can I monitor this satellite on a regular communications receiver?*

Mel Hildebrand
Arnold, Md.

NIMBUS operates on 136.5, 136.95 and 466.0 mc, which is within the range of most VHF and UHF monitor receivers. However, the transmitter operates only on a command from a ground station. The transmissions are coded, of rather brief duration and the weak signals would require a healthy antenna system. There must be an easier way to get a weather forecast, Mel.

★ *While delving into reference material at our university library for a term paper (it's a paper on famous women in literature), I came across an interesting thing. In the book, Rebecca West, Artist and Thinker by Prof. Peter Wolfe of the University of Missouri, the author offers thanks to several folks who made major contributions to the book. One of those thanked was a Guido Kneitel. It was such an unusual name I had to write and ask if Guido Kneitel is a long-lost relative of yours whose star shines in the marble halls of education or literature.*

Willard Van Cook
Lafayette, Ind.

I wish it were true but it isn't. The author of that book is a boyhood chum who, professor or not, can't resist the temptation to work one of his pet nicknames for me into his epics. I've appeared, under various nicknames, in many of his books and I get about three letters a month asking the same question you asked.

★ *Like, I'm working at my first job and the boss places this big copying machine on my desk. Before it can be used each time, they put a lead shield over the thing. I'm sure it's giving off some rays and I'm wondering if*

[Continued on page 14]

COMPACT COLOR. Nine-inch portable color set measures $10\frac{1}{4} \times 15\frac{7}{8} \times 14\frac{1}{5}$ in. and weighs approximately 25 pounds. Low-profile, built-in antenna and carrying handle make this set suitable for people on the go. Additional features include solid-state, instant-on circuits, AFT and removable sunshield. \$300. Sears, Roebuck & Co., Chicago, Illinois 60611.

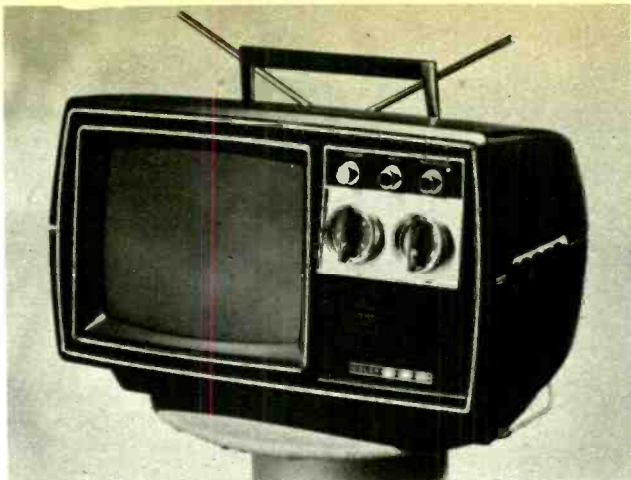

Electronic Marketplace



Emergency CB. Cobra 28 mobile CB transceiver uses an FET, ICs and dual-conversion circuitry to provide sensitivity of $0.5 \mu\text{V}$ for 10dB S/N ratio, selectivity of 6dB at 4 kc and image rejection of 40dB. Features Channel 9 Scan-Alert—emergency call on 9 will override other 22 channels. \$169.95. Dynascan Corp., Chicago, Ill. 60613.

Better than two heads. Model SE-L20 stereo headphones weigh eight ounces, have ear pads designed for optimum comfort. Frequency response is 20 cps to 20,000 kc. \$29.95. U.S. Pioneer Electronics Corp., Carlstadt, N.J. 07072.



Four off the Floor. Sony's Model 277-4 four-channel reel-to-reel tape recorder offers complete facilities for four-channel/two-channel recording. Included are independent level controls, four illuminated VU meters, equalization switch, four-digit counter and pause control. \$299.95. Super-scope, Inc., Sun Valley, Calif. 91352

Uncle Tom's Corner

Continued from page 12

you have any thoughts on my problem.

*Aaron Weiss
Miami Beach, Fla.*

Any rays at all in a new job is hard to come by—don't complain.

★ *Basically, your answers are pretty good, but every now and then you seem to take an unwarranted nasty crack at some poor reader who doesn't deserve your ire. I want very much to like you but you aren't making it easy.*

*Lester Hirsh
Palmdale, Calif.*

Les, if I wanted to be loved I would have joined the Peace Corps.

Petty Dept. Don't look now but the SWL clubs are gearing up for their annual bickering festival. Nothing seems quite so

pathetic to me as to see the continual name-calling and needling going on between what are otherwise fine DX groups. The past few months have brought the always-simmering pot to a high boil, the next few months promise new heights in two-bit intrigue. Wish these clubs would cool it once and for all.

★ *About ten years back there was a lot of hullabaloo about a little gizmo that you placed on your desk. It generated negative ions into the atmosphere and was supposed to make you happier and healthier. What ever became of the device? Where can I buy one?*

*R. S. Toolan, Sr.
Crivitz, Wis.*

Somebody in Washington felt that the manufacturer of the gadget was getting wealthier but the buyer wasn't getting healthier. They were pulled off the market.

★ *How do you keep your fame from going to your head?*

*Harry Merkin
Oswego, N.Y.*

I don't. 

NEW RUBBER STAMP BUSINESS PAYS BEGINNERS UP TO \$16.50 AN HR.

**START AT HOME
IN SPARE TIME**
with Table Top Machine!

We Help Finance You
... at less than bank rates!

The multi-million dollar Rubber Stamp business—once controlled by a few big companies—is now being taken over by small operators—one in each community throughout the United States. Men and Women who have this inexpensive machine can turn out huge quantities of Rubber Stamps with special wording that buyers once were forced to buy from big cities. Material costing only 27c makes a stamp that sells for \$2.75. The machine that does the work is simple and easy to operate and it turns out as many as six Rubber Stamps at a time, each with different wording such as names, addresses, notices, stock numbers, prices and other "copy" needed by offices, factories and individuals. Working full capacity, it can earn as much as \$33.00 an hour for the operator! Now you can get into the big-pay business yourself, with your own home as headquarters. You don't need experience. We supply everything, including complete instructions and eight ways to get business coming in fast. **We even help finance your start.** Start making up to \$16.50 an hour from the very beginning. Cash in on the profitable Rubber Stamp business in your community, right away. We'll mail full particulars FREE and no salesman will call. Be first in your locality. Rush coupon today or send your name on postcard to:

RUBBER STAMP DIV., Dept. R-120-BB
1512 JARVIS AVENUE • CHICAGO, ILL. 60626



RUBBER STAMP DIV.
1512 Jarvis Ave., Dept. R-120-BB
Chicago, Illinois 60626

FREE!

Please rush full particulars about your financing plan and the little machine that can get me started in the profitable Rubber Stamp business at home in spare time. Everything you send me is FREE and no salesman will call.

NAME

ADDRESS

CITY STATE Zip Code



Product Information Service



If you want more information about one or more of the products advertised in **ELECTRONICS ILLUSTRATED**, this service is for your convenience. The product information you request will be sent to you promptly free of charge.

Just complete the name and address portion of one of the handy coupons below and circle the **PRODUCT INFORMATION SERVICE** number or numbers you find beneath the advertisements in this issue.

Mail a completed coupon to **ELECTRONICS ILLUSTRATED**
at the address shown — We'll take care of the rest.

ELECTRONICS ILLUSTRATED P.O. Box 645, Princeton, N.J. 08540										ELECTRONICS ILLUSTRATED P.O. Box 645, Princeton, N.J. 08540									
1	2	3	4	5	6	7	8	9	10	1	2	3	4	5	6	7	8	9	10
11	12	13	14	15	16	17	18	19	20	11	12	13	14	15	16	17	18	19	20
21	22	23	24	25	26	27	28	29	30	21	22	23	24	25	26	27	28	29	30
31	32	33	34	35	36	37	38	39	40	31	32	33	34	35	36	37	38	39	40
41	42	43	44	45	46	47	48	49	50	41	42	43	44	45	46	47	48	49	50
Please Print										Please Print									
NAME _____										NAME _____									
ADDRESS _____										ADDRESS _____									
CITY _____										CITY _____									
STATE _____					ZIP _____					STATE _____					ZIP _____				
<small>3/72</small>										<small>3/72</small>									

ADMIT 1 ADULT MALE

to 12 months of reading TRUE, For Today's Adventurous Man. \$7.00 for 12 exciting issues.

TRUE, For Today's Adventurous Man
Fawcett Building
Greenwich, Conn. 06830

name _____

address _____

city _____

state _____

zip _____

I enclose \$7.00

Bill me later

Here's your 12 trip ticket to adventure!

Enjoy 12 issues of TRUE for \$7.00

If you can't go where men are making things happen, doing the things you like to do, you can still be there with TRUE! Just put your John Henry on the coupon above and drop it in the mail and I'll send you 12 months of TRUE, For Today's Adventurous Man, for \$7.00.

TRUE tells you what other men are up to in the world of sports, cars, the great outdoors, money management, health, clothes, entertainment and wherever the lure of adventure leads them. If you wear a man's shoes, why not read the man's magazine?

Just fill out and mail the coupon and I'll see that you get the next 12 issues of TRUE—to tell it like it is and to make it all more enjoyable each month.



Ted Sloat

TRUE For Today's
Adventurous Man

Electronic Marketplace

Seeing it is tuning it. A Marantz tuner, Model 120, features built-in oscilloscope that displays signal strength, FM center-channel tuning, FM multipath distortion and multipath and audio



from external source. Other features include: pushbutton controls, Gyro-Touch tuning, illuminated dial pointer, lighted function indicator, 300- and 75-ohm antenna connection, four-channel output jack, muting threshold control and FM antenna attenuator. Sensitivity is 1.9 μ V, capture ratio, 1.6dB; stereo separation is 26dB at 10 kc and image rejection is 93dB. \$395. Superscope, Inc., Sun Valley, Calif. 91352

Trip around the World. Hallicrafters' Star-Quest II, also called Model S-125, is a combination AM and general-coverage shortwave radio suited for the beginning DXer. Coverage includes standard broadcast band (550-1600 kc) and three shortwave bands (2-5 mc, 4.8-11.5 mc and 11-30



mc). Circuitry is solid-state throughout and includes beat frequency oscillator (BFO) for reception of code and automatic gain control (AGC). Other features include: headphone jack, logging scale, bandspread, 4-in. speaker and power jack which enables the Star Quest to be operated from a battery power source as well as the 117-VAC line voltage. \$59.95. Hallicrafters Co., Rolling Meadows, Ill. 60008.

HAWK *the mini-rocket* is ready to take off!

- ready to fly
- reaches heights of 300 feet or more
- safe, clean propellant is easy to replace
- costs just pennies to fly

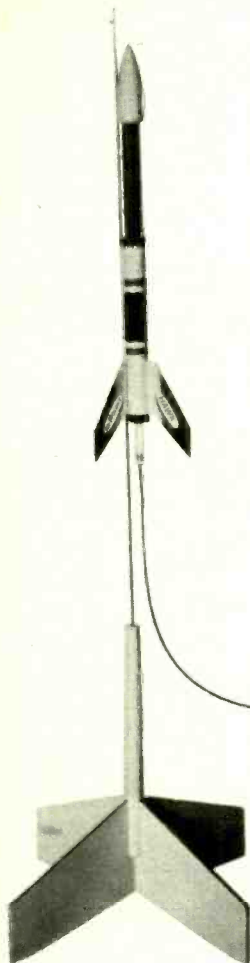

Enjoy the excitement of space flight as you blast off into the atmosphere with HAWK, the new space-age toy. Powered by Zoom Propellant... a safe, clean, cool liquid gas that lets your Hawk mini-rocket soar to heights of 300 feet or more.

(Extra propellant is available... costs just pennies to fly). Rocket comes ready-to-fly, with launching pad, propellant, filler tube and easy-to-follow instructions for rapid launchings.

Money-back guarantee.

\$4.98
plus 65¢
postage and handling.



HAMILTON HOUSE

Cos Cob, Conn. 06807

Hamilton House, Dept. 62-L3
Cos Cob, Conn. 06807

Enclosed please find \$_____. Please send me _____ Hawk, the Mini-Rocket(s) at \$4.98 plus 65¢ postage and handling. I understand that if I am not completely satisfied, I may return it for a full refund.

Name _____

Address _____

City _____

State _____ Zip _____



New Heathkit AR-1500 stereo receiver



... the critics
say it all:

"The AR-1500 is the most powerful and sensitive receiver we have ever measured..."

—JULIAN HIRSCH, *Stereo Review*

"... a stereo receiver easily worth twice the cost (or perhaps even more)..."

—*Audio Magazine*

"Great new solid-state stereo receiver kit matches the demands of the most golden of golden ears."

—*Radio Electronics*

Mr. Hirsch goes on to say: "The FM tuner section of the AR-1500 was outstandingly sensitive. We measured the IHF sensitivity at 1.4 microvolts, and the limiting curve was the steepest we have ever measured... The FM frequency response was literally perfectly flat from 30 to 15,000 Hz. ...Image rejection was over 100 dB (our measurement limit)..."

"The AM tuner was a pleasant surprise... It sounded very much like the FM tuner, with distinct sibilants and a quiet background, and was easily the best-sounding AM tuner we have had the pleasure of using..."

"... all input levels can be matched and set for the most effective use of the loudness compensation. This valuable feature is rarely found on high fidelity receivers and amplifiers..."

"The phono equalization was perfectly accurate (within our measuring tolerance)... The magnetic phono-input sensitivity was adjustable from 0.62 millivolt to about 4.5 millivolts, with a noise level of -66 dB, which is very low... When properly set up, it would be impossible to overload the phono inputs of the AR-1500 with any magnetic cartridge..."

"... it significantly bettered Heath's conservative specifications. Into 8-ohm loads, with both channels driven, the continuous power at clipping level was 81.5 watts per channel. Into 4 ohms it was 133 watts per channel, and even with 16-ohm loads the receiver delivered 46.5 watts per channel. Needless to say, the AR-1500 can drive any speaker we know of and with power to spare..."

"At 1,000 Hz, harmonic distortion was well under 0.05 per cent from 1 to 75 watts per channel... The IM distortion was under 0.05 per cent at a level of a couple of watts or less, and gradually increased from 0.09 per cent at 10 watts to 0.16 per cent at 75 watts... The heavy power transformer is evidence that there was no skimping in the power supply of the AR-1500, and its performance at the low-frequency extremes clearly sets it apart from most receivers..."

"Virtually all the circuit boards plug into sockets, which are hinged so that boards can be swung out for testing or servicing without shutting off the receiver. An 'extender' cable permits any part of the receiver to be operated 'in the clear' — even the entire power-transistor and heat-sink assembly! The 245-page manual has extensive tests charts that show all voltage and resistance measurements in key circuits as they should appear on the receiver's built-in test meter..."

"With their well-known thoroughness, Heath has left little to the builder's imagination, and has assumed no electronic training or knowledge on his part. The separate packaging of all parts for each circuit board assembly is a major boon..."

"In sound quality and ease of operation, and in overall suitability for its intended use, one could not expect more from any high-fidelity component..."

From the pages of *Audio Magazine*: "... the AR-1500 outperforms the near-perfect AR-15 in almost every important specification..."

"The FM front end features six tuned circuits and utilizes three FETs, while the AM RF section has two dual-gate MOSFETs (for RF and mixer

stages) and an FET oscillator stage. The AM IF section features a 12-pole LC filter and a broad band detector. The FM IF section is worthy of special comment. Three IC stages are used and there are two 5-pole LC filters..."

"... IHF FM sensitivity... turned out to be 1.5 uV as opposed to the 1.8 uV claimed. Furthermore, it was identical at 90 MHz and 106 MHz (the IHF spec requires a statement only for IHF sensitivity at 98 MHz but we always measure this important spec at three points on the dial). Notice that at just over 2 microvolts of input signal S/N has already reached 50 dB. Ultimate S/N measured was 66 dB and consisted of small hum components rather than any residual noise. THD in Mono measured 0.25%, exactly twice as good as claimed! Stereo THD was identical, at 0.25% which is quite a feat..."

"... the separation of the multiplex section of the AR-1500 reaches about 45 dB at mid-band and is still 32 dB at 50 Hz and 25 dB at 10 kHz (Can your phono cartridge do as well?)..."

"The real surprise came when we spent some time listening to AM... This new AM design is superb. We still have one classical music station that has some simultaneous broadcasting on its AM and FM outlets and that gave us a good opportunity to A-B between the AM and FM performance of the AR-1500. There was some high-frequency roll-off to be sure, but BOTH signals were virtually noise-free and we were hard pressed to detect more THD from the AM than from the FM equivalent. Given AM circuits like this (and a bit of care on the part of broadcasters), AM may not be as dead as FM advocates would have us believe!..."

"As for the amplifiers and preamplifier sections, we just couldn't hear them — and that's a commendation. All we heard was program material (plus some speaker coloration, regrettably) unencumbered by audible distortion, noise, hum or any other of the multitude of afflictions which beset some high fidelity stereo installations."

"Rated distortion [0.24%] is reached at a [continuous] power output of 77.5 watts per channel with 8 ohm loads (both channels driven). At rated output (60 watts per channel) THD was a mere 0.1% and at lower power levels there was never a tendency for the THD to 'creep up' again, which indicates the virtually complete absence of any 'crossover distortion' components. No so-called 'transistor sound' from this receiver, you can be sure. We tried to measure IM distortion but kept getting readings of 0.05% no matter what we did. Since that happens to be the 'limit' of our test equipment and since the rated IM stated by Heath is 'less than 0.1% at all power levels up to rated power output' there isn't much more we can say except that, again, the unit is better than the specification — we just don't know how much better..."

"As always, construction instructions are lucid enough for the inexperienced kit-builder and there is enough technical and theoretical information to satisfy even the most knowledgeable audio/RF engineer..."

Kit AR-1500, less cabinet, 53 lbs. 349.95*

ARA-1500-1, walnut cabinet, 8 lbs. 24.95*

CIRCLE NUMBER 3 ON PAGE 15

and two precedent-setting oscilloscopes

New Heathkit dual trace DC-15 MHz solid-state scope sets a low-price precedent in high performance



Heathkit 5" 10-102 brings you solid-state scope performance on a budget

The new Heathkit 10-105 brings you a high performance scope designed for a wide range of measurements in instrumentation courses, engineering, R&D and electronics... at a fraction of the cost of comparable scopes. The big 5" (8x10 cm flatface) CRT provides separate signal display in channel 1 or channel 2 modes, direct comparison display in alternate and chopped modes, x-y mode for presentation of signals as a function of each other. Has triggered time base with 18 calibrated rates, 0.2 us/cm - 100 ms/cm in 1,2,5 sequence, $\pm 3\%$; x5 sweep magnification. Compare the price, compare the specs... then order your 10-105 today.

Kit 10-105, 40 lbs., available 399.95*

10-105 SPECIFICATIONS - VERTICAL - Accuracy: $\pm 3\%$. **Input impedance:** 1 megohm shunted by 35 pF. **Maximum input voltage:** 600 VDC. **Sensitivity:** AC or DC, 0.05 V/cm. **Frequency response:** DC to 15 MHz, 3 dB with 4 cm deflection. **Vertical windows:** 2 minimum. **Rise time:** 24 ns. **Overhoot:** Less than 10%. **Attenuator:** 9 positions in a 1, 2, 5 sequence. 0.05 V/cm to 20 V/cm, $\pm 3\%$. **Variable gain (uncalibrated)** thru entire range. **Vertical display in sweep mode:** Channel 1, Channel 2, Channel 1 & 2 alternately; or Channel 1 & Channel 2 chopped (50 kHz). **HORIZONTAL - Time base:** Triggered with 18 calibrated rates, 0.2 us/cm to 100 ms/cm in a 1, 2, 5 sequence, $\pm 3\%$. **Continuously variable (uncalibrated)** within the same range. **Sweep magnifier:** x5 (time base accuracy is $\pm 5\%$ when the magnifier is being used). **External horizontal input:** 750 millivolts/cm (uncalibrated & not adjustable). 100 K ohm minimum input impedance, DC to 100 kHz. **X-Y MODE - Sensitivity:** 0.05 V/cm to 20 V/cm, $\pm 3\%$. **Frequency response:** -3 dB @ 100 kHz (Channel 2). **Phase shift between channels:** $\pm 5^\circ$ or less from DC to 50 kHz within graticule limits. **TRIGGERING - Delay:** Approx. 600 ns. **Auto:** Zero crossing $\pm 1/2$ cm of zero crossing. **Norm:** Within viewing area. **Source:** Channel 1, Channel 2, or Channels 1 & 2. **Polarity:** + or - slope. **Coupling:** AC or DC. **Sensitivity:** Internal, 1/2 cm; external, 100 mV minimum, 7 V max. **GENERAL - Blanking in:** TTL compatible (Logic 0-blank). **Gate out:** 3.5 volts minimum. **Input connections:** Vertical, coaxial & BNC, horizontal, binding post; external trigger, binding post on 3/4" center with ground. **CRT accelerating potential:** 2200 VDC regulated. **CRT type:** 8x10 cm, rectangular, Hal-face, D14-107GA. **Retrace suppression:** DC coupled unblanking of the CRT. **Graticule:** 8 cm x 10 cm grid, edge lighted. **Power requirements:** 105-125 or 210-250 VAC, 50/60 Hz, 60 watts. **Warm-up time:** CRT heating time, approx. 30 seconds; for full calibration, approx. 15 minutes. **Overall dimensions:** 12 3/4"

H x 10 1/2" W x 15" D. Note: Specifications measured at 25° C with 120 VAC line voltage.

The Heathkit 10-102 general purpose scope combines the virtues of top performance, maximum convenience and low cost. All solid-state design is your assurance of long-term reliability under sometimes rough shop conditions. Wide 5 MHz bandwidth, 30 mV/cm sensitivity and 80 nanosecond rise time add up to truly unusual value at this low price. Switch-selected AC or DC coupling adds extra convenience and versatility. Frequency-compensated 3-position attenuator accommodates varying input levels. A separate switch position grounds the input to provide a zero reference line. One megohm FET input minimizes circuit loading. The recurrent, automatic sync type sweep generator provides continuous sweep from 10 Hz to 500 kHz. Front panel external horizontal and sync inputs. One volt P-P output included. The 5" flat-face 5DEP1 CRT gives a brilliant, highly visible trace, even in high light levels. 6x10 cm ruled graticule makes amplitude easy to determine. All supplies are zener-regulated to give the 10-102 excellent display stability. 120/240 VAC wiring options. Put this top value scope to work for you now.

Kit 10-102, 31 lbs. 119.95*

Assembled 10W-102, 29 lbs. 179.95*

10-102 SPECIFICATIONS - VERTICAL CHANNEL - Sensitivity: 30 mV/cm, uncalibrated. **Frequency Response:** DC to 5 MHz, ± 3 dB. **Rise Time:** 80 nanoseconds. **Input Impedance:** 1 megohm shunted by 35 pF. **Attenuator:** 3-position, frequency compensated; x1, x10, x100. **HORIZONTAL CHANNEL - Sensitivity:** 0.1 V/cm. **Frequency Response:** 1 MHz ± 3 dB. **Input Impedance:** 1 megohm shunted by 50 pF. **Sweep Generator-Type:** Recurrent, automatic sync. **Range:** 10 Hz to 500 kHz in five switch-selected steps, continuously variable between steps. **GENERAL - Cathode Ray Tube:** Type, 5DEP1, green medium persistence phosphor. **Viewing area,** 6x10 cm. **Power Supplies:** All solid-state rectifiers. All amplifier supplies regulated. **Power Requirements:** 120/240 VAC, 50-60 Hz, 35 watts. **Overall Dimensions:** 12 3/4" H x 9 1/4" W x 16 1/4" L, including knobs, handle, feet, etc.

See these kits at your local Heathkit Electronic Center... or fill out the coupon at right.

ARIZ.: Phoenix, 2727 W. Indian School Rd.; CALIF.: Anaheim, 330 E. Ball Rd.; El Cerrito, 6000 Potrero Ave.; Los Angeles, 2309 S. Flower St.; Redwood City, 2001 Middlefield Rd.; San Diego (La Mesa), 8363 Center Dr.; Woodland Hills, 22504 Ventura Blvd.; COLO.: Denver, 5940 W. 38th Ave.; FLA.: Miami (Midleah), 4705 W. 16th Ave.; GA.: Atlanta, 5285 Roswell Rd.; ILL.: Chicago, 3462-66 W. Devon Ave.; Downers Grove, 224 Ogden Ave.; KANSAS: Kansas City (Mission), 5960 Lamar Ave.; MD.: Rockville, 5542 Nicholson Lane; MASS.: Boston (Wellesley), 165 Worcester St.; MICH.: Detroit, 18645 W. Eight Mile Rd. & 18149 E. Eight Mile Rd.; MINN.: Minneapolis (Hopkins), 101 Shady Oak Rd.; MO.: St. Louis, 9296 Gravois Ave.; N.J.: Fair Lawn, 35-07 Broadway (Rte. 4); N.Y.: Buffalo (Amherst), 3476 Sheridan Dr.; New York, 35 W. 45th St.; Jericho, L.I., 15 Jericho Turnpike; Rochester, Long Ridge Plaza, OHIO: Cincinnati (Woodlawn), 10133 Springfield Pike; Cleveland, 5444 Pearl Rd.; PA.: Philadelphia, 6318 Roosevelt Blvd.; Pittsburgh, 3482 Wm. Penn Hwy.; TEXAS: Dallas, 2715 Ross Ave.; Houston, 3705 Westheimer; WASH.: Seattle, 2221 Third Ave.; WIS.: Milwaukee, 5215 Fond du Lac.

HEATHKIT
Schlumberger

HEATH COMPANY, Dept. 39-3
Benton Harbor, Michigan 49022

Please rush my FREE Heathkit Catalog.

Enclosed is \$ _____, plus shipping.

Please send model(s) _____

Name _____

Address _____

City _____ State _____ Zip _____

Prices & specifications subject to change without notice.
* Mail order prices: F.O.B. factory. CL-425

CIRCLE NUMBER 3 ON PAGE 15

One third of America's best students never get past high school.

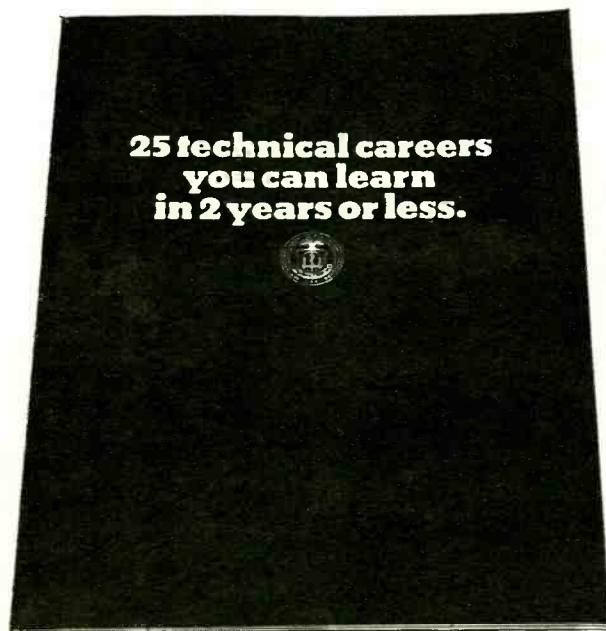

You can help end the waste with this guide.

A lot of talented young people simply can't afford four years of college.

But many could afford a year or two of technical education.

The problem is, they simply don't know that such programs exist. Or that men and women with technical educations are needed badly—and can easily make themselves fine careers.

This guide from the U. S. Office of Education tells the story.

It lists 25 technical careers. Describes one- and two-year technical programs on the post-secondary level. Gives information on financial assistance.

To get information on quantity reprints for your students, write: Technicians, P.O. Box 313, Radio City Station, New York, N. Y. 10019.



Advertising contributed for the public good.

Electronics Illustrated

MENTION the words *power supply* to the experimenter and two images immediately flash into his mind. Banks of batteries hooked together are the first idea. His second thought consists of an isolation transformer connected to a rectifier and brute-force filtering.

Years ago, when vacuum-tube projects were occupying the hobbyist's bench, either power supply could have done an adequate job. But today's high-gain, low-impedance IC projects demand much more from a bench power supply.

ICs, in particular, have the notorious habit of expiring in nanoseconds if a wrong lead is connected to the source of power. And while discrete solid-state components fare a notch better if electrically manhandled, neither IC nor transistor can withstand the punishment meted out by an improperly set voltage- or current-limiting control on a power supply. Especially one having only crude current- or voltage-limiting provisions—or none at all.



A Lab-Grade Power Supply for your Test Bench

By HARRY KILBE

A Lab-Grade Power Supply for your Test Bench

Even if you weren't concerned with the safety of your power source or of the project to which it's connected, the inability to reset power source output voltage or current to a precise value each time you use it hobbles the accuracy of most supplies. Conventional supplies require the experimenter to turn a knob until the desired voltage level is reached on a voltmeter. If the hobbyist is trying to limit current to a predetermined value, he's also got to monitor yet another meter—all the while keeping tabs on voltage and current flow within the project under test. Needless to say, both voltage and current output are only as accurate as the meters employed to measure these quantities.

Only one kind of power supply has the ability to limit both output parameters to a preset value. Called the *programmable* power supply, it can keep tabs on either current or voltage delivered to the load. A programmable power source can act as either a constant-current supply by limiting the voltage supplied to the load. Or, it delivers a constant voltage, limiting the current flowing into the device under test.

With this type of power supply, you've got to make an effort in order to burn out an IC or transistorized project. Once you set the voltage- and current-limit controls on a programmable supply, it takes over all monitoring and limiting functions. Once you've freed your voltage and current measuring test instruments from the power supply, you can use them at the device under test.

In order to better understand the programmable power supply, first let's discuss its electronic predecessor—the voltage-regulated power supply. Some of the components found in the programmable supply also are in the voltage-regulated power source. Refer to the schematic on page 29. Both supply types have an isolating power transformer (T1 in the schematic), a rectifier labeled BR1, and electrolytic filter capacitor C1. Both power supplies also contain some means of regulating the output voltage.

A transistor performs the voltage-regulating function. This stage includes components Q1 and Q2 in the schematic. Another part of the voltage-regulator circuit monitors the supply output by tapping off a portion of the

PARTS LIST

- BP1-BP2, BP3-BP4—Dual binding posts (H. H. Smith type 269RB or equiv.)
 - BR1—Bridge rectifier; minimum ratings: 3.75 A, 200 PIV (IR type 50FB2L)
 - BR2—Bridge rectifier; minimum ratings: 1 A, 50 PIV (Motorola HEP 175)
 - C1—6,500 μ f, 75-V electrolytic capacitor (see text)
 - C2—3,500 μ f, 75-V electrolytic capacitor (see text)
 - C3,C4—220 μ f, 35-V electrolytic capacitor
 - C5,C6—500 μ f, 35-V electrolytic capacitor
 - C7—1,000 μ f, 16-V electrolytic capacitor
 - C8,C10—47 μ f, 1,000-V ceramic disc capacitor
 - C9,C11—.01 μ f, 50-V ceramic disc capacitor
 - D1,D2—Zener diode; 15 V, 1 watt (Motorola HEP 607)
 - D3,D4—Silicon diode (1N459 or equiv.)
 - D5,D6—Zener diode; 6.8 V, 400 mw (1N754 or equiv.)
 - F1—3 A, 250-V 3AG fuse
 - IC1,IC2—IC (Motorola MC1709L or MC1741L)
 - L1,L2—Pilot lamp; 6V @ .2A
 - M1—0-1 ma DC milliammeter (see text)
 - Q1,Q2—2N3055 transistor (RCA)
 - Q3,Q6,Q7—40311 transistor (RCA)
 - Q4,Q5—2N4037 transistor (RCA)
 - Resistors: 1/2 watt, 10% unless otherwise indicated
 - R1—5 ohm, 25 watt wirewound (Memcor/Ohmite type 270-25 or equiv.)
 - R2—9,530 ohms, 1%
 - R3,R4—0.27 ohms, 2 watts
 - R5—90 ohms, 1% R6—10 ohms, 1%
 - R7—7.5 ohms, 5% R8-R10—1 ohm, 1 watt
 - R11,R12—1 ohm, 2 watt, 1%
 - R13,R14—82 ohms, 2 watts
 - R15—2,700 ohms R16,R39,R40—1,000 ohms
 - R17,R25,R28—1,500 ohms R18—220 ohms
 - R19—25,000-ohm linear-taper pot (CTS U-201R253B or equiv.)
 - R20,R42,R43—100 ohms
 - R21—1,000-ohm, 2-watt wirewound pot (Ohmite CU-1021)
 - R22,R31—560 ohms
 - R23,R30—5,000-ohm linear-taper pot (Mallory MLC53L)
 - R24,R29—6,800 ohms, 5%
 - R26,R27—10,000 ohms, 5%
 - R32—10,000-ohm, 10-turn wirewound pot (Duncan model 3253) See note below.
 - R33-R37—10,000 ohms, 1%
 - R38,R41—2,700 ohms S1—SPST switch
 - S2—Three-pole, six-position shorting-type rotary switch (Centralab type PA2008)
 - S3—Two-pole, six-position shorting-type rotary switch (Centralab type PA2002)
 - S4—SPDT switch
 - T1—Power transformer; primary: 117 VAC, secondaries: 0-14-28-42-56 V @ 2 A Barry Electronics Model 56-2. (Barry Electronics, 512 Broadway, N.Y., N.Y. \$9.79 plus postage.)
 - T2—Power transformer; primary: 117 V, secondaries: 10/20 V CT, 40 V CT @ 0.3 A (Triad F91-X or equiv.)
 - Misc.
 - 1—Case (LMB C0-2 or equiv.)
 - 2—Heat sinks (Thermalloy type 6421B-2)
 - 2—IC holders (H. H. Smith type 6252 or equiv.)
 - 1—Ten-turn dial (Duncan model 81 or equiv. Allied 530-1081. \$5.75 plus postage.)
 - 1—Thermal joint compound (Thermalloy type 249)
- Note: R32 available from Allied Industrial Electronics, 2400 W. Washington Blvd., Chicago, Ill. 60612. Part No. 530-4040. \$5.35, plus postage.

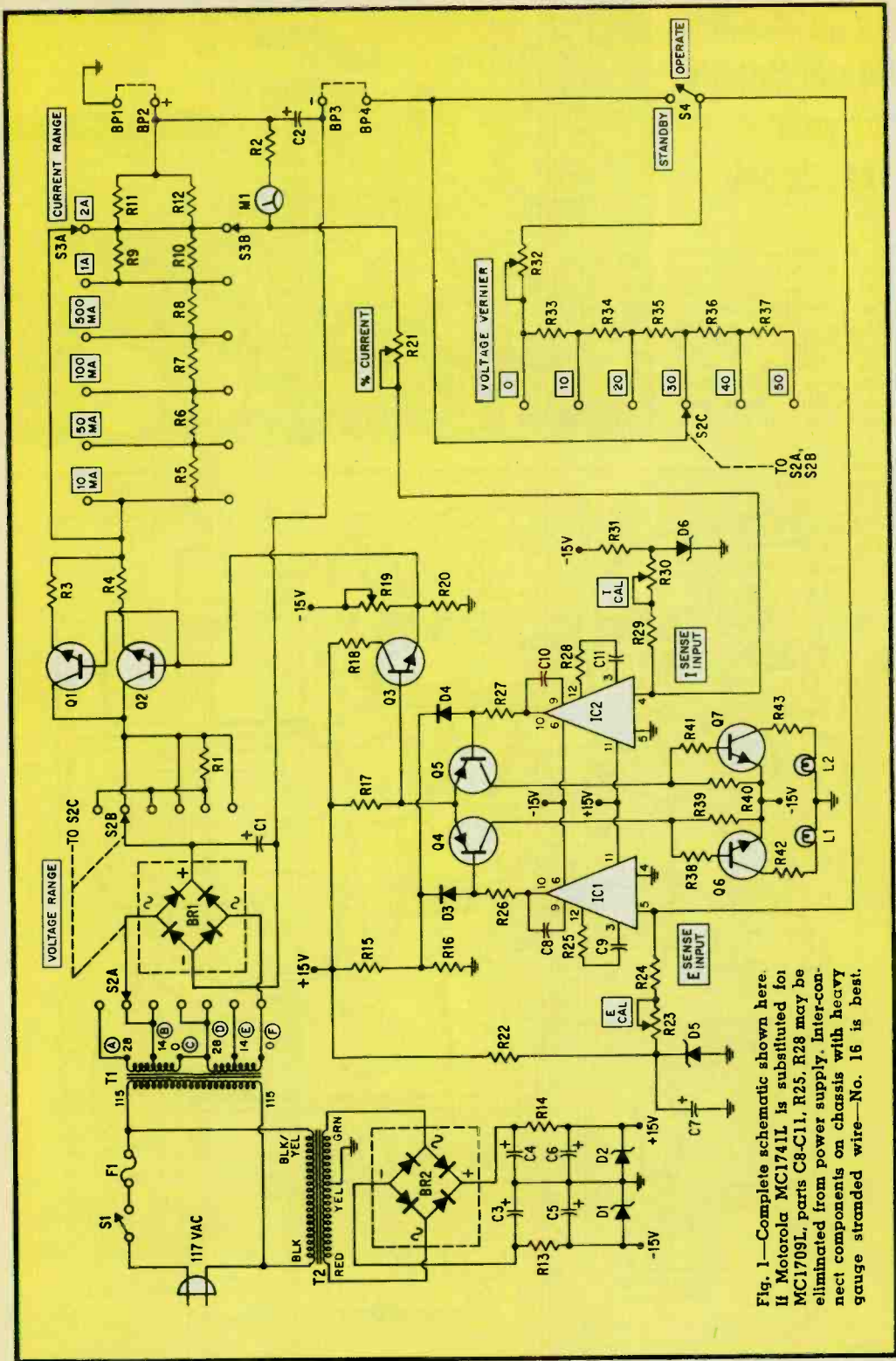
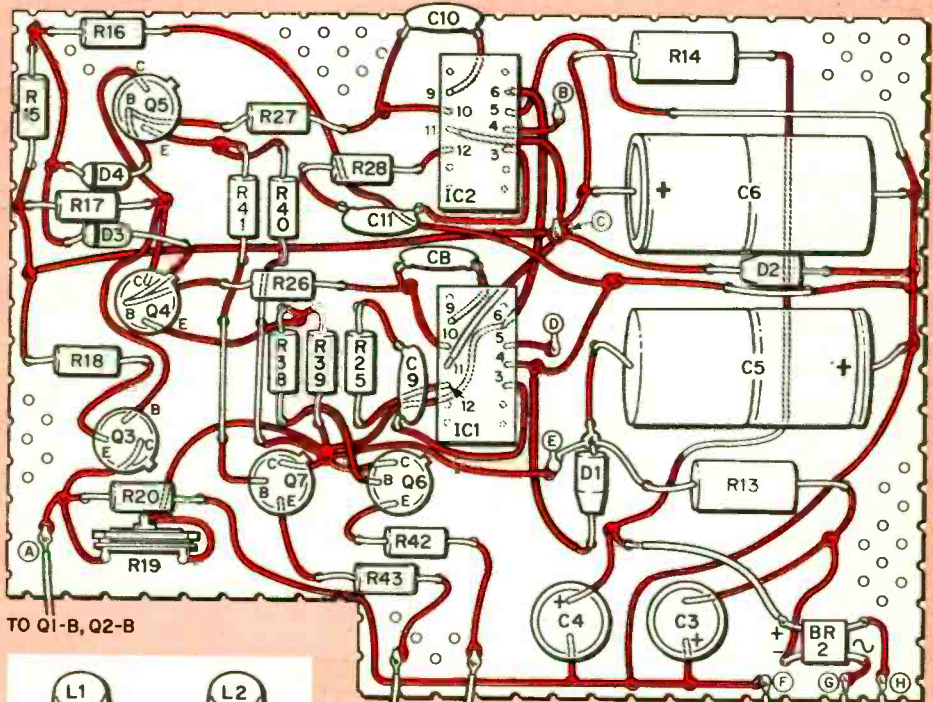
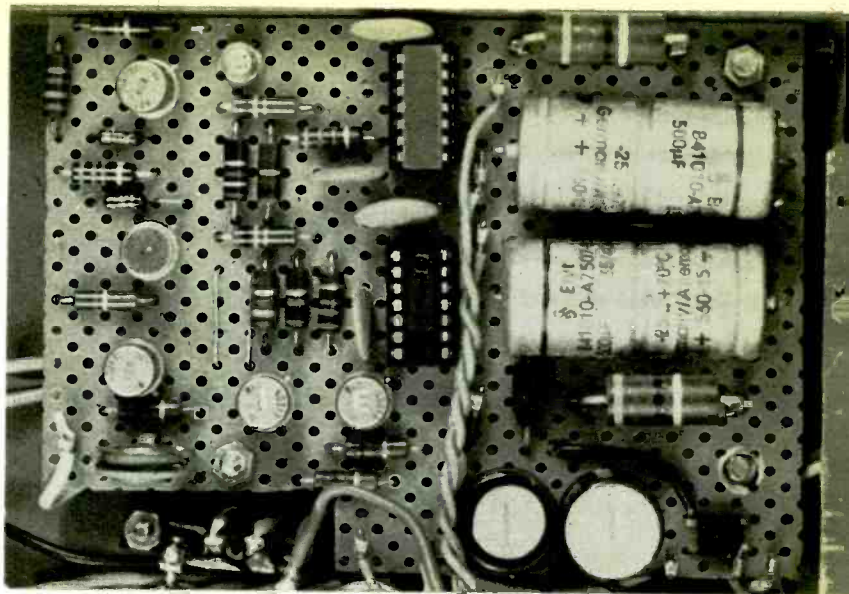

Fig. 1—Complete schematic shown here. If Motorola MC1741L is substituted for MC1709L, parts C8-C11, R25, R28 may be eliminated from power supply. Interconnect components on chassis with heavy gauge stranded wire—No. 16 is best.

A Lab-Grade Power Supply for your Test Bench

Fig. 2—Perfboard is shown almost full-size at the right. Most of the control circuitry is on board. Note that R14, R13 are mounted by their leads well above perfboard—they dissipate a lot of heat. After wiring circuit and testing, mount perfboard with 3/4-in. standoffs.



TO Q1-B, Q2-B

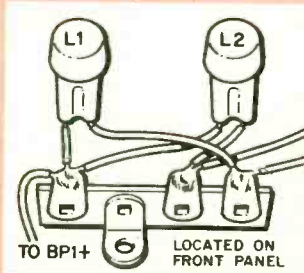

B — TO TS3-D
 D — TO TS3-A
 C — TO TS3-C
 E — TO TS3-F
 TO TS3-B
 TO TS2-B
 TO TS2-A

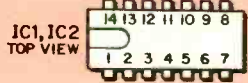

voltage delivered to the output terminals. After sensing this voltage, feedback is applied to the regulator allowing it to adjust itself to either increase or decrease its output.

Current delivered to the load is completely dependent upon the resistance of the load and voltage delivered to it. This, of course, assumes that the current capability of the regulator transistor isn't exceeded.

What happens if the load suddenly demands more current? A drop in voltage is sensed at the output terminals of the power supply. The regulator automatically compensates for this drop by automatically restoring the output voltage back to the original level.

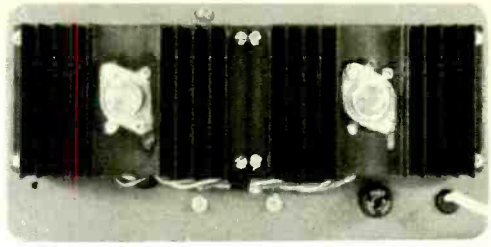

Fig. 3—Power supply rear panel showing heat-sink-mounted output transistors, location of fuse-holder. Pots R23, R30 are below sinks, to left of F1.

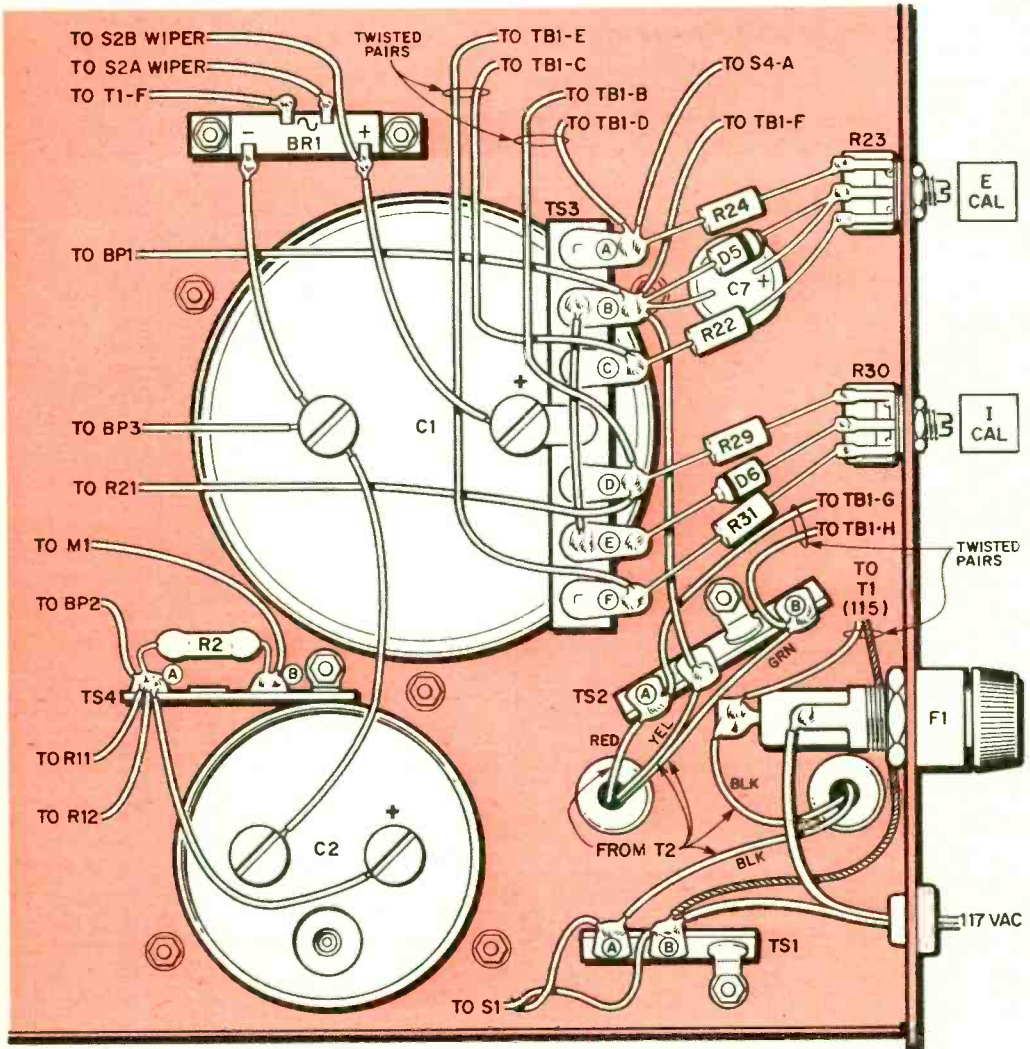

Fig. 4—For safety's sake, mount TS3 to chassis if overall length of C1 prohibits you from mounting it to C1's positive terminal. Position of BR1 shown is at approximate location on power supply. Substitute silicon rectifiers if desired.

A Lab-Grade Power Supply for your Test Bench

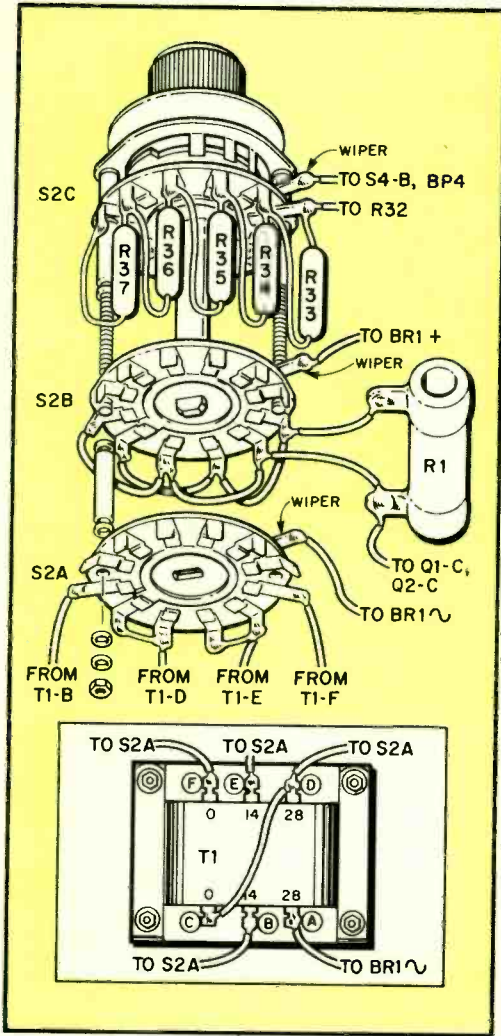

Fig. 5—Exploded view of Voltage range switch S2. Be sure to buy shorting type as called for in Parts List—severe contact arcing and burning could result otherwise. Wire-wound resistor R1 is mounted on rear panel—see Fig. 8 on pg. 34. Wire secondary terminals of T1 as shown.

Fig. 6—Heat-sink subassemblies also indicating mounting hardware used to fasten Q1, Q2 to heat sinks. When mounting heat-sink subassemblies to rear panel, make sure that R3, R4 have room to dissipate heat.

Depending upon how well your project can withstand an overcurrent or overvoltage surge, the power supply proceeds to attempt to burn it out.

Some of the more popular priced voltage-regulated power supplies that you can buy have provisions for cutting the output voltage to the load—only if the current rises above a preset level. But two big drawbacks exist under this setup.

First, the current delivered to the load is not regulated—it is simply interrupted. This on-off type of circuit cannot cope with fluctuating current demands made by most ICs. Nor is it fast enough to respond to genuine current overload conditions—a mechanical relay generally opens the power supply circuit leading to the output binding posts.

Even with its relatively simple circuitry, the voltage-regulated power supply does have a place on your test bench. It comes in handy when testing projects having *known* input current demands. The voltage-regulated power supply also is great for powering slot cars around the track. But for all other assignments, the programmable supply takes first choice on the hobbyist's workbench.

Until now, programmable power supplies were considered to be fairly exotic in both function and price. Found mainly in test labs, the supply costs several hundred dollars in commercial dress. Our programmable Lab-Grade Power Supply limits current and voltage just like its laboratory counterpart. And its output—zero to 60 VDC—can be reset to any voltage within .001 V of the desired value. All this without the need to monitor a voltmeter. Furthermore, our power supply can be built for a fraction of what the commercial versions cost—about \$60 if you carefully shop for parts.

How It Works. The components which

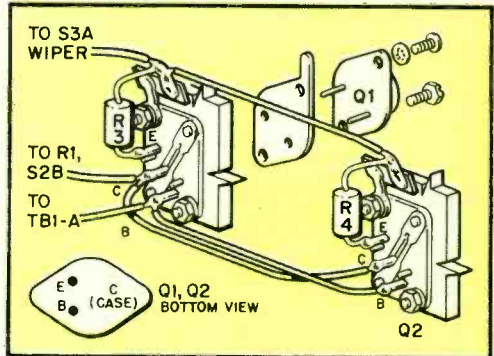

were previously used to describe the voltage-regulated power supply (T1, BR1, C1 and Q1/Q2) perform identical functions in our supply. Note that besides those previously mentioned parts, the supply also has a low-voltage power supply feeding control circuits, and five bipolar transistors acting mainly as switching devices. Also note a couple of ICs working as DC-coupled feedback amplifiers, and two resistor networks labeled *current range* and *voltage range* (switch S2C). Let's take a look at these sub-circuits.

The bipolar 15-V low-voltage source powers all discrete semiconductors (except Q1 and Q2) both ICs, and precision current sources formed by zener diodes D5 and D6.

Transistor Q3 is connected as an emitter follower. It supplies drive current to both transistors Q1 and Q2. As more current flows through Q3's base circuit, collector-emitter current increases, driving more current through Q1/Q2 into the load. Transistor Q3 is, in turn, controlled by Q4 (voltage limit), and Q5 (current limit). Both of these semiconductors are biased so very little current flows through them under normal conditions—that is, when the power supply is not connected to a load.

Ordinarily, under normal operating conditions with a load connected to the output terminals, more current passes through Q4 than Q5, and it assumes control of Q3. But if a greater than desired output current flows into the load, a DC signal fed back to Q4 and Q5 via the ICs switches the control mode from voltage to current. Transistor Q5 immediately assumes control of Q3. Our circuit is designed so either Q4 or Q5 determine which control function regulates Q3—never both transistors at the same time. Transistors Q6 and Q7 drive mode indicating lamps L1 (voltage) and L2 (current).

Integrated circuits IC1 and IC2 form the heart of our programmable power supply. Note the terminals labeled *E Sense Input* and *I Sense Input* on IC1 and IC2, respectively. Current flowing into the inputs of these DC-coupled amplifiers produces an output from each device which is proportional to the input. The input to either IC forms part of a negative feedback circuit around each respective IC. Also connected to these input terminals are current sources providing exactly 1 ma to each IC. These are labeled *E Cal* and *I Cal* for IC1 and IC2, respectively.

Let's assume there's a load connected

across the output terminals, and S4 is in the *Operate* position. Current flows through BP3/BP4, voltage vernier pot and resistor network forming the voltage-range switch into pin 5 of IC1. Since the function of this IC is to maintain a steady voltage at the load, any

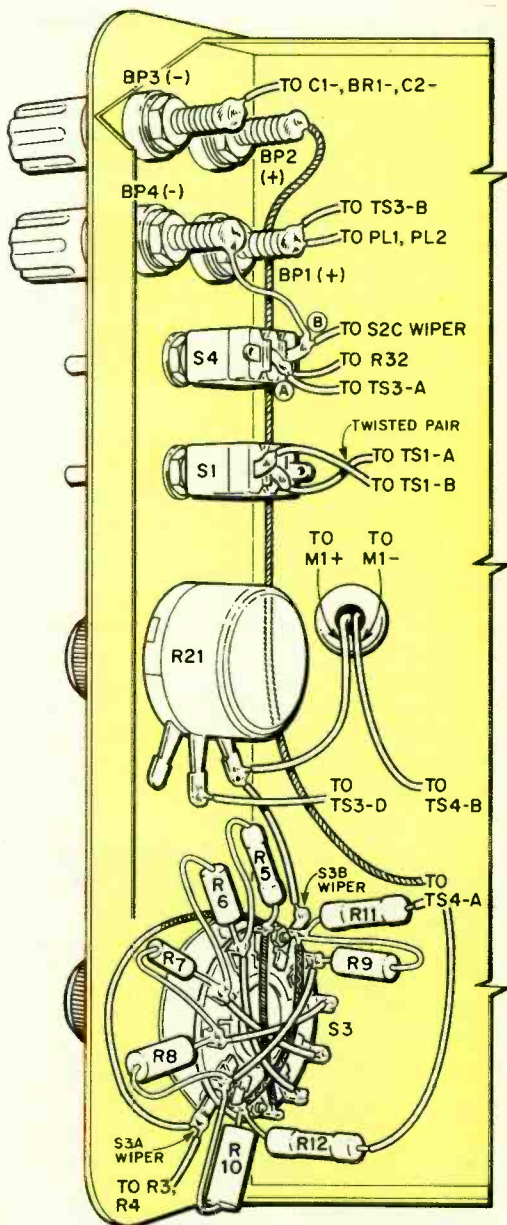

Fig. 7—Bottom of front panel. Pre-wire S3 before mounting it to panel—follow pictorial as shown.

A Lab-Grade Power Supply for your Test Bench

input current less than 1 ma. flowing into pin 5 causes IC1 to increase its output. Transistors Q1 and Q2 receive more base current, and pass more voltage into the load. If the input current is greater than 1 ma., the effect will be just the opposite—Q1/Q2 will pass less voltage to the load.

Integrated circuit IC2 works the same way. The biggest difference is that input current greater than 1 ma. result in a diminishing output from IC2. If a very heavy current is suddenly demanded by the load, a very large current is passed into pin 4 of IC2. The IC automatically takes over the regulating function, and limits current passing into the load until 1 ma. begins to flow into IC2. The experimenter sees the Voltage lamp go off as the Current lamp lights up.

While IC2 brings its input current down to 1 ma., output voltage across the load drops. Now IC1 tries to assume the regulating function. In effect, under shortcircuit conditions (or when the current capability of the power supply is exceeded), the job of regulating the output is alternately switched between IC1 and IC2 as they both try to reach their respective 1 ma. input current levels.

Although both Current and Voltage range switches merely appear to be two sets of switchable resistive dividers, their tolerances largely help to determine the resettability of output voltage or current. Our Parts List calls

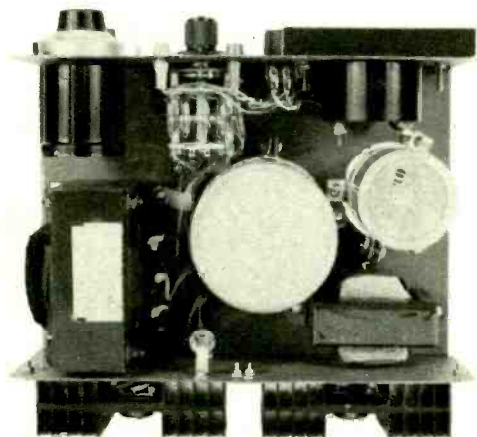

Fig. 8—Top view of power supply. Transformer T2 is in lower right corner, with resistor R1 between it and T1 in lower left. R32 is at upper left.



Fig. 9—Front panel indicating how various controls are labeled. Note jumpers connecting Sensing to Output binding posts—both are solid wire.

for 1- and 5-percent tolerance resistors in both networks. If 10 percent resistors are used instead, voltage or current reset accuracy of the power supply will be slightly downgraded.

Construction. Begin by building the perfboard control circuitry. Layout and a photo of the perfboard appear on page 30. We suggest that you follow our layout as shown. First, assemble and wire the low-voltage power supply. Observe proper polarity of diodes D1 and D2. After you've wired this portion of the circuit, temporarily connect power transformer T2 to perfboard terminals F, G and H.

Connect the primary of T2 to 117 VAC and measure voltages between terminals C and F, and E and F. You should measure about +15 VDC at terminal C. You should read -15 VDC at terminal E. If both voltages are equal and opposite in polarity, disconnect the transformer and proceed to wire the remainder of the perfboard components.

Prepare the chassis for capacitors C1 and C2 by cutting appropriate holes for these components. If you are not able to buy the capacitors specified in the Parts List, purchase any electrolytic capacitor with an identical voltage rating and having a capacitance as close to specified value as you can get. For instance, a 7,700- μ f 75V capacitor can be substituted for C1. Substitute a 3,750- μ f 75-V electrolytic for C2 if you can't find the specified unit. Incidentally, both substitutions are available from Barry Electronics, the supplier of transformer T1.

Prepare the chassis for the remainder of the chassis-mounted components. The pictorials on pages 31-35 serves as a layout guide for parts placement. Note that a Simpson Model 523 0-1 DC milliammeter was used for M1 in our model. But any 1-ma.

[Continued on page 96]

Hi-Fi Today

By Robert Angus



Goodbye to 78/16?

THE long-playing record was introduced nearly 25 years ago. Some 15 years ago, the Record Industry Association of America (RIAA) stopped keeping track of sales of 78 rpm records because they had become such an insignificant part of the business. Yet, last year, manufacturers of automatic turntables sold some 6.5 million new units designed to play a speed that was obsolete in 1960. What is even more incomprehensible, the same 6.5 million changers were designed to play records cut at 16½ rpm, a speed used only for talking books (of which perhaps only a dozen records have ever been released commercially—way back in 1957).

These artifacts of record changer design have plagued audio purists for years. Though audiophiles never use them, many marketing types feel they belong on a piece of audio

models having only two speeds—45 rpm and 33⅓ rpm. The Garrard Model Zero 100 and BSR Model 810 are designed to appeal to the audiophile and are premium-priced.

Of course, neither company is committing itself to drop the other speeds from its models overnight. But unless consumer resistance to the new models appears, it's a safe bet that other new changers from the two British firms will have two speeds rather than four. Miracord already has some two-speed models and Dual can be expected to follow suit.

My basic objection to the 78/16 speeds is that they add unnecessarily (if only very slightly) to the cost of the changer and to the complexity of the design. They're achieved by creating steps on a motor shaft. The shaft, in turn, drives the turntable platter by pressing against an idler wheel or belt. It's possible for the idler wheel to get trapped between the steps, making for uneven wear and erratic speeds.

At the same time, a mechanism that provides rapid changes from one LP (or 45 rpm) side to the next must still be gentle enough to accommodate a 78 rpm platter. And the whole mechanism has to accept the weight of four or five 12-in. 78 rpm discs at a time.

Yes, there are good reasons for dumping 78/16. It seems inconceivable that the old speeds could have hung on for so long.

Actually, the two-speed player isn't entirely new. Sherwood and V-M have had one for several years, and Dual jettisoned the 16½ rpm speed some time ago. Acoustic Research has a manual turntable which has sold very well—only two speeds are offered.

Of course, it's true that certain collectors still have some prized 78 rpm discs. But collectors also have hill-and-dale records and Edison cylinders and nobody seriously suggests that today's audio gear should be capable of playing them.

I can't say I'm particularly sorry to see 78 rpm go. If you're one of those with a hoard of Caruso or Bunny Berrigan shellacs, now may be the time to trot them down out of the attic, put them on last year's record player and transcribe them on tape. —



Garrard Zero 100 automatic turntable costs \$189.50, offers two speeds, synchronous motor and tone arm that works like cutting lathe in recording studio.

gear and some manufacturers have found it difficult to sell record changers (and even manual turntables) that didn't have these obsolete speeds.

Now it seems the two speeds may be on the way out for good. Both Garrard and BSR, the two largest suppliers of automatic turntables in the U.S., have introduced new

DXing the India-Pakistan Powderkeg



UPI Photo

By ALEX BOWER IF there ever was a panorama of human tragedy to be seen, it is on the continent of India. Along the eastern and western borders which separate India from East and West Pakistan recent events (plus a small-scale war) have heightened the ferment that exists between peoples, religions, and nations.

The Free Bengal uprising in East Pakistan and the subsequent repression of the Bengali populace by the West Pakistani army has added an aura of disbelief to the extent of human suffering endured in this part of the world. In less than a year, over 9 million Pakistani refugees have crossed the border, leaving East Pakistan for the safety of refugee camps set up in neighboring India.

However, tragedy does bring excitement—plus propaganda—so the India-Pakistan scene has much to offer the avid DXer. Not that DXing the Indian continent is an easy chore. QRM from stations in other areas settles over these weak signals like a fog over

water. Still, it can be done—if you like to chase your quarry.

In strife-torn East Pakistan the official government station, Radio Pakistan, operates a facility at Dacca (see map). According to unsubstantiated press reports, this site was severely damaged in the early fighting. However, this station now is definitely back on the air and—when conditions are right—it can be heard early evenings (EST) near 15520 kc (the signal drifts considerably). Another regularly used channel is 11650 kc.

During the period when DXers lost contact with Dacca's signal—around the beginning of the civil war—a clandestine station calling itself Radio Bengla Desh, or Radio Free Bengal, appeared on 690 kc (MW), 11620 kc, as well as on Dacca's channel, 11650 kc. According to the British Diplomatic Wireless Service (in a report aired over the BBC), this station operated aboard a ship anchored in the Hooghly river near Calcutta.

This BBC report also claimed that the

East Pakistan (on far right) has long been neglected and exploited by the West Pakistani government. Economic development has been concentrated in the neighborhood of West Pakistan. The populace of East Pakistan numbers some 78 million and the majority of civilians are Moslem. Thus, the Hindu minority (approx. 10 million people), which includes the Bengalis, still will have to find a way to coexist once the latest hostilities are ended.

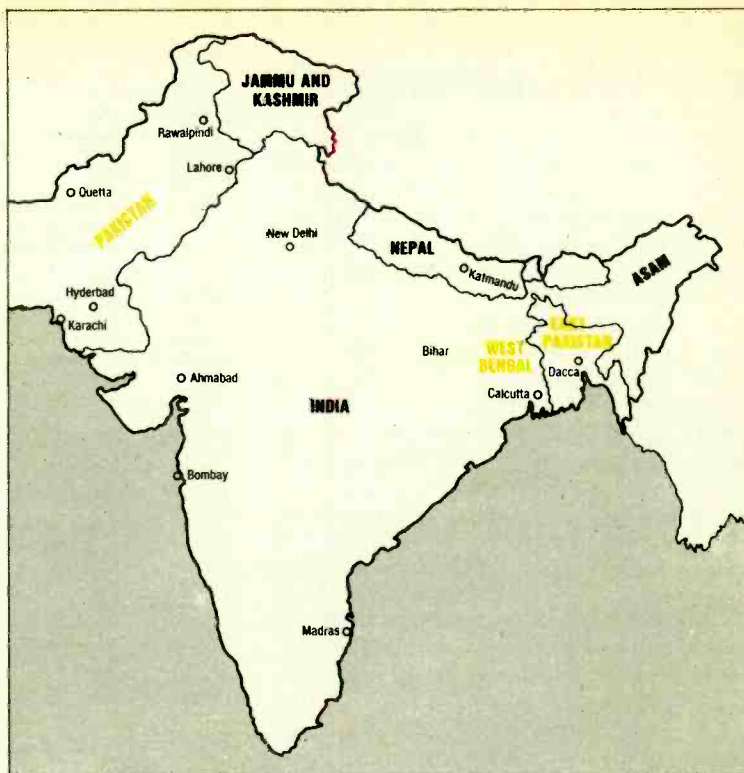

rebel station couldn't be heard outside the Indian state of West Bengal. However, we do know that reception was reported by a well-known DXer based on the island of Ceylon. No shortwave transmissions have been heard from Radio Bengla Desh since April. If the station should return to the air, the frequencies mentioned above are the channels you should monitor.

Radio Pakistan's most powerful transmitter is located at Karachi. The station's antennas are used for both foreign and domestic broadcast services. In North America the most readily heard frequencies are 11672 kc and 17935 kc (subject to drift). You can log either frequency at various times of the day and night.

The foreign service of All India Radio is most commonly heard east of the Mississippi around 1700 EST on 9912 kc, though the 9525-kc channel occasionally makes it through the QRM, too. AIR is heard in western North America on 11775 kc at 0200 PST. Transmissions also can be heard on another channel formerly usurped by the Bengla Desh, 11620 kc, during early afternoons and mid-evenings (EST).

Most AIR foreign-service broadcasts orig-

inate at an old transmitter site at Delhi and at a new site at Aligarh some 75 miles to the southeast. A Wisconsin DXer, Gerry Dexter, has monitored an Aligarh announcement on 17705 kc at 2230 EST (sign-on). Most of the time, however, you'll have to wait for AIR's QSL card to find out which location you have logged. The Aligarh and Delhi sites probably will be used interchangeably.

Reports of all AIR transmissions should go to Delhi, no matter which site is heard. All Radio Pakistan reports should go to Rawalpindi—the probable site of the Pakistani government's own clandestine operation, Azad Kashmir Radio, sometimes heard on 4750 kc.

The best time to monitor Indian and Pakistani stations operating on frequencies in and below the 41-meter band is at sunrise (listener's time) and occasionally around 0200 EST. Of course, reception below 41 Meters is never easy. In fact, some of the 60- and 90-meter SW stations listed in the chart may never have been logged in North America.

One important signal that has made it into North America comes from the disputed territory of Kashmir. India's Radio Kashmir

DXing the India-Pakistan Powderkeg

broadcasts on 3277 kc from Sringer.

Yet another intriguing AIR transmitter site is the one located at Calcutta. (After R. Bengla Desh returned to the air last June—on a medium-wave channel only—a British newspaper correspondent in Calcutta claimed that RDF measurements of the Bengla Desh station pointed to the Indian government's own Calcutta station.) While no one in North America will hear Calcutta on a medium-wave channel these days (due to QRM), regular AIR programs from that location can be logged with considerable effort on 4820 kc.

Some of the less important Pakistani and Indian sites also broadcast on the upper SW bands. Regular Radio Pakistan programs apparently can be heard from Rawalpindi on 15130 kc around 0200 EST, while the Islamabad transmitter site sometimes is audible at the same time on 11705 kc and again at 2100 EST on 15380 kc.

The AIR station at Madras has been logged on 9510 kc at 0500, while the Bombay site occasionally is used to augment Delhi's foreign service. Whether this schedule will be continued once the new Aligarh facility attains full capacity remains to be seen. At the moment, the Bombay station beams news programs in English to Africa

DX GUIDE TO INDIA & PAKISTAN		
Freq. (kc)	Station	Location
3204	All India Radio	Lucknow, India
3223	AIR	Simla, India
3235	AIR	Guahati, India
3277	R. Kashmir	Sringer, Kashmir
3315	AIR	Bhopal, India
3355	AIR	Kurseong, India
3375	AIR	Guahati, India
3915	R. Pakistan	Quetta, W. Pakistan
3945	R. Pakistan	Peshawar, W. Pakistan
4750	Azad Kashmir R.	Rawalpindi, W. Pakistan
(approx.)		
4800	AIR	Hyderabad, India
4820	AIR	Calcutta, India
4915	R. Pakistan	Quetta, W. Pakistan
4920	AIR	Madras, India
4945	R. Pakistan	Peshawar, W. Pakistan
4969	AIR	Bhopal, India
6085	AIR	Madras, India
7240	AIR	Bombay, India
9510	AIR	Madras, India
9525	AIR	Delhi, India
9530	AIR	Calcutta, India
9912	AIR	Delhi, India
11620	AIR	Delhi, India
11650	R. Pakistan	Dacca, E. Pakistan
11670	R. Pakistan	Karachi, W. Pakistan
11705	R. Pakistan	Islamabad, W. Pakistan
11775	AIR	Delhi, India
15080	AIR	Bombay, India
15130	R. Pakistan	Rawalpindi, W. Pakistan
15380	R. Pakistan	Islamabad, W. Pakistan
15520	R. Pakistan	Dacca, E. Pakistan
(approx.)		
17705	AIR	Aligarh, India
17935	R. Pakistan	Karachi, W. Pakistan
(approx.)		

on 15080 kc at 1300 EST.

Foreign broadcasts from All India Radio—whether via Aligarh, Bombay or Delhi—should remain prize catches for some time to come.

In the city of Jessore, East Pakistan, Bengal liberation fighters—the Mukti Bahini—practice taking up defensive positions. The East Pakistani rebels are part of a guerrilla army numbering about 60,000 men. The photo at right shows they are armed with Enfield rifles of World War I vintage. West Pakistani troops are armed with the latest military equipment—all of it contributed by Pakistan's western allies.



UPI Photo

The El Ticker

THE manufacturers of TV sets have been ordered to back advertising claims—or else. In its first action against the TV industry's advertising, the Federal Trade Commission told makers to prove such claims as "Instantatic Tuning helps tune the picture even when you switch channels....," or, "Color Magic purifies color...tinted glass adds contrast...push-pull volume control prevents sudden blare." Several companies, including Admiral, GE, Magnavox, Matsushita, Montgomery-Ward, Motorola, Ford, RCA, Sears, Sony and Zenith, have been ordered to furnish proof of advertising claims.

★ ★ ★

Public Law 92-140 has been enacted by Congress and signed by the President. Under its terms, a sound recording (such as an LP record) may be subject to statutory copyright protection provided: the sounds constituting the recording—as published—were fixed on or after February 15, 1972, and the recording is first published on or after February 15, 1972, with copyright notice as specified by the law.

★ ★ ★

Color TV sales continue to boom. Sales to dealers during the first nine months of 1971 were up more than 25 percent over the previous year. Monochrome TV, automobile-radio, home-radio and phonograph sales also topped the previous year's figures by a considerable margin.

★ ★ ★

The FCC has initiated a study concerning use of digital modulation techniques in microwave radio systems. The report will seek to project digital communi-

cation methods, usage and operating modes over next 20 years. Data communications via microwave relay, according to equipment manufacturers and users, will have tremendous growth in next decade.

★ ★ ★

The FCC has issued a revised standard covering radiation from devices such as videocassette players, video recorders and TV cameras that are used in homes, schools and industrial applications. The proposed radiation limit is 15 microvolts per meter at a distance of 157 ft. divided by the frequency (in megacycles) or at a distance of one meter, whichever is the larger distance. Motorola asked for rules to govern use of its Electronic Video Recorder (EVR), developed jointly with CBS and now in production at CBS' new plant located at Rockleigh, N.J.

★ ★ ★

Department of Health, Education & Welfare says viewers need no longer fear radiation leakage from television sets. According to HEW, there is no significant health hazard resulting from TV X radiation at any distance from the screen where quality would be satisfactory to viewers. Also, HEW's Bureau of Radiological Health reports there is no evidence that a TV receiver's X rays have ever resulted in injury to humans. So much for that old chestnut.

★ ★ ★

The FCC has approved a second pay-TV system. Called No. 4745 and developed by Blonder-Tongue Laboratories, it becomes the second in the list of systems—along with Zenith's Phonovision—awaiting some pay-TV programming.

**“He’s a good worker.
I’d promote him
right now if he had
more education
in electronics.”**

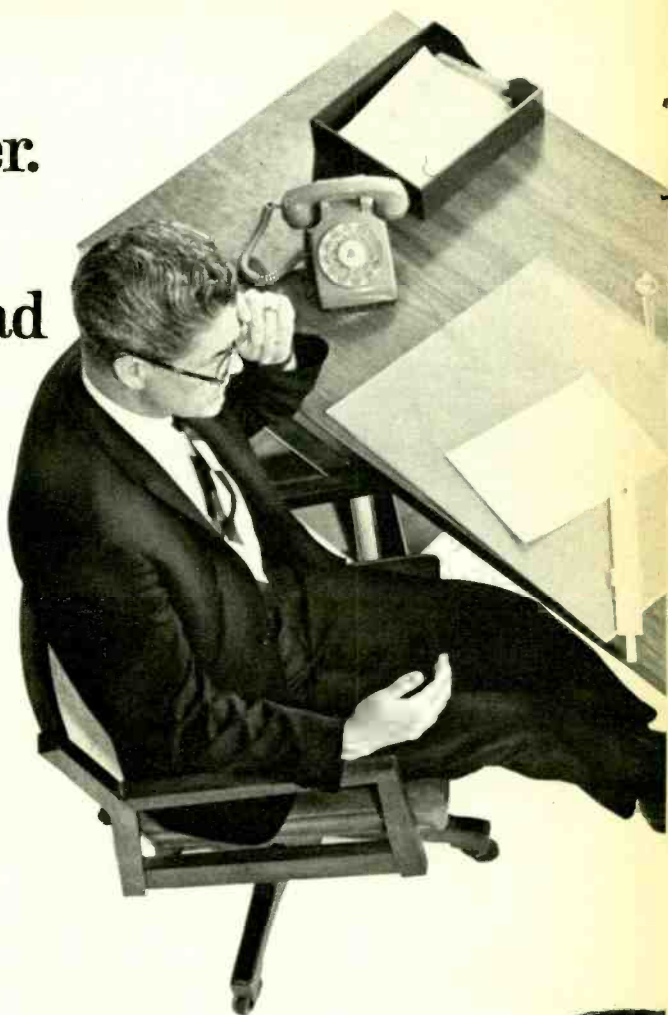

Could they be talking about you?

You'll miss a lot of opportunities if you try to get along in the electronics industry without an advanced education. Many doors will be closed to you, and no amount of hard work will open them.

But you can build a rewarding career if you supplement your experience with specialized knowledge of one of the key areas of electronics. As a specialist, you will enjoy security, excellent pay, and the kind of future you want for yourself and your family.

Going back to school isn't easy for a man with a

full-time job and family obligations. But CREI Home Study Programs make it possible for you to get the additional education you need without attending classes. You study at home, at your own pace, on your own schedule. You study with the assurance that what you learn can be applied to the job immediately.

CREI Programs[®] cover all important areas of electronics including communications, radar and sonar, even cable TV engineering. You're sure to find a program that fits your career objectives.



You're eligible for a CREI Program if you work in electronics and have a high school education. Our FREE book gives complete information. Mail postpaid card for your copy. If card is detached, use coupon at right or write: CREI, Dept. E1703C, Wisconsin Ave. & Tilden St., Washington, D.C. 20016.

Founded 1927

CREI

Accredited Member of the
National Home Study Council



**CREI, A Division of the McGraw-Hill
Continuing Education Company
Dept. E1703C, Wisconsin Ave. & Tilden St.,
Washington, D.C. 20016**

Please send me FREE book describing CREI Programs. I am employed in electronics and have a high school education.

NAME _____ AGE _____

ADDRESS _____

CITY _____ STATE _____ ZIP CODE _____

EMPLOYED BY _____

TYPE OF PRESENT WORK _____ G.I. BILL

- I am Interested in:
- Space Electronics
 - Electronic Engineering Technology Computers
 - Industrial Electronics Nuclear Engineering Technology
 - Electronics Systems Engineering
 - Non-technical course in computer programming
 - CATV Engineering

APPROVED FOR TRAINING UNDER NEW G.I. BILL

Build an Automatic Message Repeater for your Phone

Unglue yourself from the telephone with our automatic repeater. It answers the call, delivers the message then hangs up



By **LESLIE POWELL** It's a waste of time sitting around waiting for calls from people asking the same question, requiring the same answer. Like, where will the game be played? What time does the church social or PTA meeting start and what should we bring?

Do what big business, your movie theater and even the phone company do to solve the problem of continuously conveying the same information . . . use a message repeater.

Connect a message repeater to your phone line and you'll only have to record the message once. Each time someone calls the repeater automatically answers the phone and plays the message. Since messages can be changed easily you can use the repeater for everything from telling the gang where to meet you to club announcements to the information that you're out and will be back at 6.

Commercial repeaters start at about \$100 but you can build ours for less than \$25; less than \$10 if you've got a well-stocked junkbox.

The repeater is built around a continuous-tape-loop mechanism available for \$3.95 from Burstein-Applebee. The mechanism is a complete system, consisting of a tape trans-

port, record/play amplifier and wired function switch. It's supplied ready-to-use, and you need add only control circuits and a power supply.

The repeater will record up to a 30-second message at the touch of a button. Flip switch S2 to *line*, and at the first ring of the phone the repeater answers, plays your message, stops, disconnects from the line and is ready to answer the next call.

Save Your Money. The repeater has been designed to be built with junkbox parts. It will not work any better with new parts which could easily double or triple total cost. Use surplus relays, diodes, capacitors and an imported power transformer. We provide all necessary operating parameters for these components so you can save money.

Construction. The description of the continuous-tape-loop mechanism supplied by Burstein-Applebee is incorrect. The permanent tone recorded on the tape loop can be erased, so don't worry about having a beep in the middle of your message. As supplied, the mechanism is powered by 1.5-V D cell (for the amplifier); the battery is retained here for the motor. The amplifier will be powered by the repeater's relay power supply (T1 and associated components). It is im-

portant to keep in mind that the loop mechanism uses a *positive ground* for both the motor and battery. Make certain the positive output of the power supply is grounded. Double-check the polarity of capacitor C1 and diodes D1 through D4 before soldering them into the circuit. It is a good idea to check out the power supply with a voltmeter before connecting it to the amplifier.

Before proceeding with construction you must make a minor modification to the tape-loop mechanism. On the underside of its chassis there's a leaf switch that is controlled by a cam which is driven by the capstan drive. This switch normally turns on a tone generator that records a beep tone at the end of the tape loop. Unsolder the wires at each switch terminal and cut the ends of the wires so strands don't short to ground. Then solder a 10-in. insulated wire to each terminal so the switch can be used to power motor-control relay RY3.

The repeater is built in the main section of an 8 x 6 x 3½-in. Minibox. This size allows enough room to avoid a parts jam and also provides a base for a desk telephone. However, as long as transformer T1 is kept far away from the tape mechanism's record/playback head, the layout isn't critical and

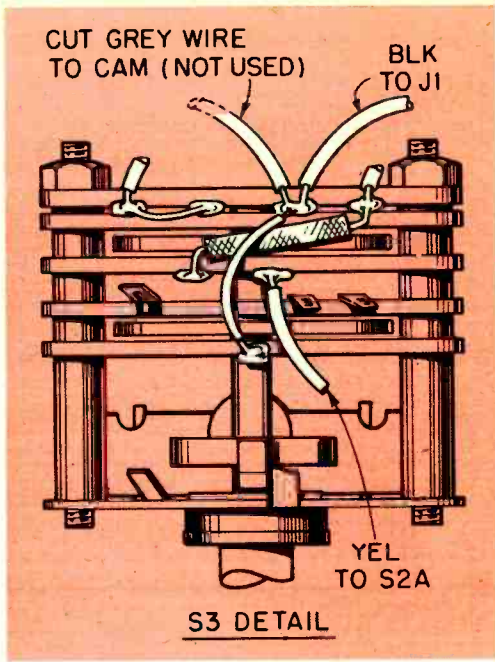

Fig. 1—Pictorial of S3 (supplied with continuous-tape-loop mechanism) shows connections to be made to it. Before attaching the wires, position index tabs (just above the shaft) as shown.

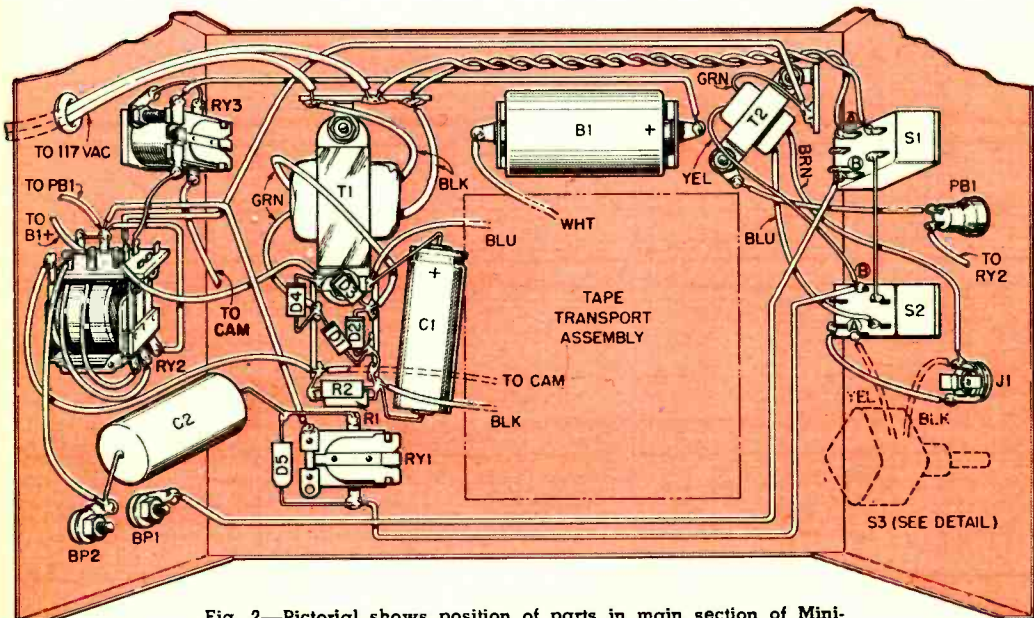

Fig. 2—Pictorial shows position of parts in main section of Mini-box. Drill all holes and remove burrs before installing transport.

Build an Automatic Message Repeater for your Phone

you can change it.

First step is to drill the front panel holes for S1, S2 and record/play switch S3. Temporarily install all switches and push the tape mechanism as close to the switches as possible and make marks for its mounting holes. Leave the tape mechanism in position and mark the mounting holes for the relays and transformers.

Remove the tape mechanism from the cabinet and drill all mounting holes. Do not attempt to drill the chassis with the tape mechanism in position as the chips will surely cause trouble.

Next, install and wire all the front-panel switches and jacks, except switch S3. Install T1 and T2 at this point, and make as many of their connections as you can. Then install all other components including B1's holder and complete as much wiring as is possible. Finally, install and wire the tape mechanism.

Transformer T1 is an imported 6.3-V filament type. In this circuit the power supply will deliver 9 to 10 VDC under full load. Diodes D1 through D4 are the absolute cheapest silicon rectifiers rated higher than 20 PIV at a current rating greater than 150 ma. Diode D5 is also the cheapest silicon rectifier rated higher than 75 PIV at any current.

Capacitor C1 can be any size rated higher than 10 V at 1,000 to 2,000 μ f. Transformer T2 is 500 ohms to 500 ohms. If it is supplied with center-tap leads cut them off.

Relay RY1 is a 2,500-ohm DC type such

PARTS LIST

B1—1½-V D cell
 BP1, BP2—Insulated binding posts
 C1—1,000 to 2,000 μ f 10-V electrolytic capacitor (see text)
 C2—2 μ f, 100-V non-polarized capacitor (see text)
 D1, D2, D3, D4—Silicon rectifier: 25 PIV or higher (see text)
 D5—Silicon rectifier: 100 PIV or higher
 J1—Miniature phone jack
 PB1—Normally-open pushbutton switch
 R1, R2—31 to 39-ohm, ½ watt, 10% resistor
 RY1—SPDT relay, Potter & Brumfield RS5D-2500
 RY2—3PDT relay, Magnecraft W88X-10

RY3—SPDT relay, Potter & Brumfield RS5D
 S1—DPST switch
 S2—DPDT switch
 S3—Supplied with tape-loop mechanism
 T1—Filament transformer; secondary: 6.3 V @ 1 A (Lafayette 33 R 37029 or equiv.)
 T2—Transistor transformer; primary: 500 ohms, secondary: 500 ohms (Lafayette 33 R 85531 or equiv.)
 Misc.—Tape-loop mechanism (Burstin Applebee, 3199 Mercier St., Kansas City, Mo. 64144, \$3.95 plus postage, stock No. 18A1509), battery holder, 8 x 6 x 3½-in. Minibox, terminal strips.

Fig. 3—Schematic. Switches and relays are shown in off mode. When S1 is closed, repeater goes in standby mode and relay contacts remain in same position. Mike, for recording message, is plugged in J1. BP1, BP2 are connected to phone lines. PB1 starts tape transport mechanism.

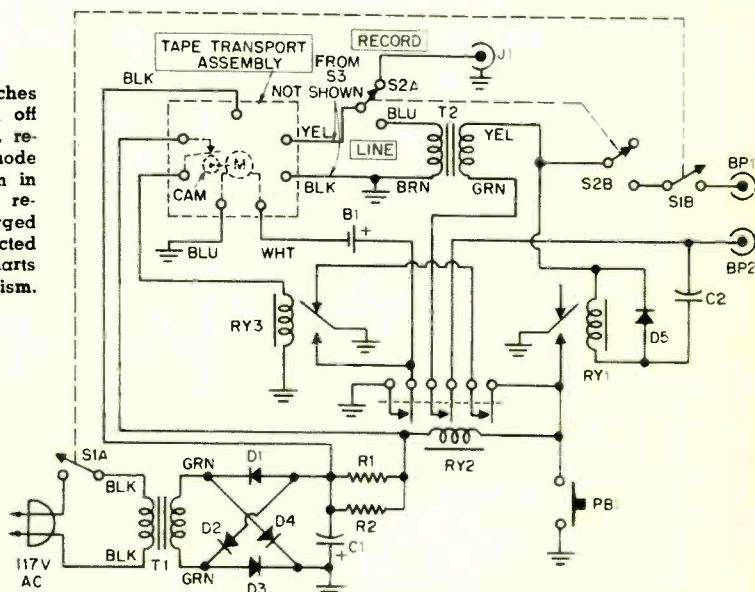

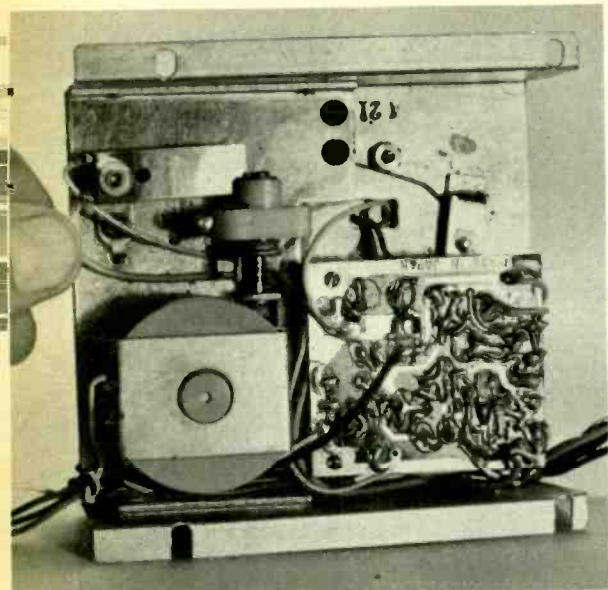

Fig. 4—Unsolder the two wires that are connected to the cam-driven leaf switch. In our circuit, the leaf switch is used to control relay RY3.

as a Potter & Brumfield RS5D-2500, rated at 5 ma pull-in (60 mw). Relay RY3 is a 6-VDC, 335-ohm (110 mw) type such as the Potter & Brumfield RS5D-6. Note that the wiper contacts on RS relays are connected to the mounting frame; they will automatic-

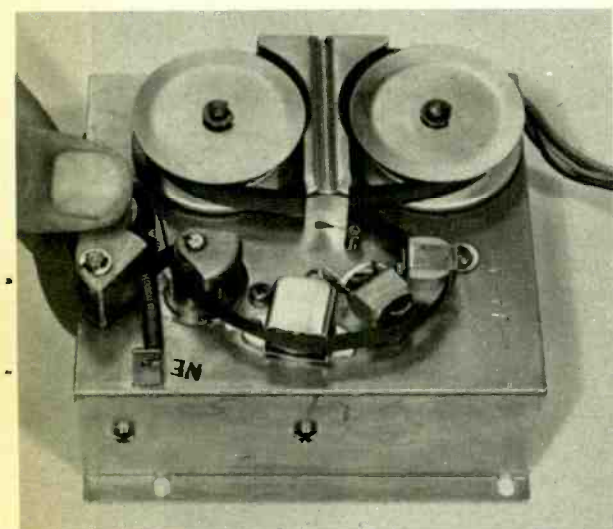

Fig. 5—To release tape tension so tape can be fed through by hand, press thumb down on capstan idler wheel and pull it away from capstan.

ally connect to ground when the relay is installed. You can substitute any other relay of similar ratings.

Relay RY2 is 3PDT, though it is used as a 3PST. The specified Magnecraft W88X-10 rated at 6 VDC, 30 ohms is recommended, though any 6-VDC relay with a coil resistance of 30 to 45 ohms can be used. Do not substitute for RY2 a relay with a coil resistance of less than 30 ohms.

Capacitor C2 is a 2- μ f, 100-V non-polarized type. You cannot substitute an electrolytic. To obtain the 2 μ f value parallel-connect two 1 μ f capacitors.

Don't Modify the Circuit. You will probably discover that the tape mechanism has a transformer output, so the question might arise as to why it's necessary to use T2. The tape mechanism's output transformer has one lead grounded, and this will induce severe hum into the phone lines. Therefore T2 must be used to provide isolation from ground. Do not eliminate T2 under any circumstances.

Set-up and Checkout. The tape mechanism is supplied with a small speaker that is supposed to be used as a microphone. Forget it; it delivers pure distortion. Use a low-impedance dynamic mike like those supplied with the cheapest cassette recorders.

Apply power by closing switch S1—nothing should happen. Next, press switch PB1. Relay RY2 should close making the tape mechanism start. After about 30 seconds (maybe less), the contacts on the underside of the tape mechanism will *click* once and relay RY3 will pull in and relay RY2 will drop out. In another second there will be a second click and RY3 will drop out, causing the tape mechanism to stop. If this sequence does not occur check for a wiring error in RY2's and RY3's circuits.

Plug a microphone in Jack J1, set S2 to *record* and set S3 full counterclockwise (*record*). Then press PB1. Allow about a second for the tape mechanism to come up to speed and then record some words for about 25 seconds. (There is no microphone gain control, so hold the mike about 6 in. from your mouth and speak in a moderate volume.) In a few seconds the tape will stop. Set S3 full clockwise (*play*) but leave S2 in the *record* position. Press PB1; the tape will start and you will hear the message played back through the mike. It will sound distorted because the mike is not a great play-

[Continued on page 100]

That Yen for Japanese TV Sets

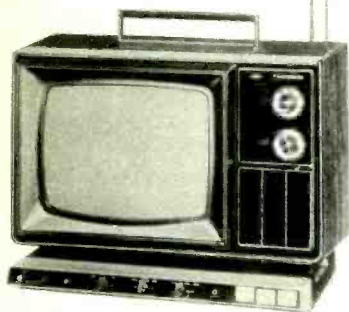

Panasonic's Rossville, Model CT-27, features swivel base, 12-in. screen and Self-Set color.

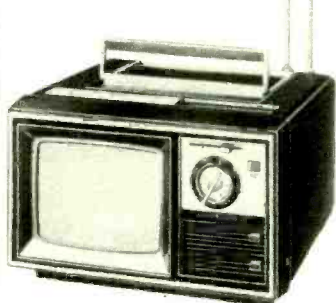

Pana-Port Seven, Model CT-771, from Panasonic has 7-in. screen, works from AC line or battery.

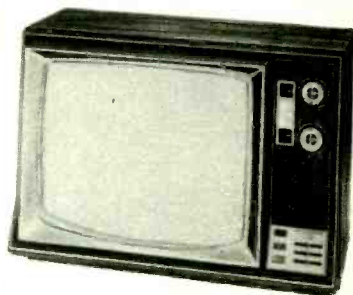

Panasonic's Lynwood, Model CT-210, has 21-in. screen, Self-Set color plus AFT feature.

ONCE upon a time you may have had a yen for a Japanese color TV. Perhaps you still do. There are many reasons why sets from the Land of the Rising Sun have come on strong during the last two years. And strong is how they've come on.

According to the Japanese Finance Ministry, Japan exported 94,260 color TV sets worth \$14,792,000 to the U.S. in August 1970 but 155,680 color sets worth \$25,399,000 were sent to the U.S. in August of 1971—an increase of almost 72 percent.

For the first eight months of 1971, imports of color TV sets from Japan were up 81 percent over the same period a year earlier. That's a total of 881,330 sets. People are saying that price, quality and reliability are the reasons why they buy Nippon products.

Last August was a critical month because that's when President Nixon announced his new economic policy aimed particularly at the Japanese invasion. Until then, most people thought (and they were generally right) that Japanese color sets were cheaper than American models. The fact that the Japanese have gone the small-screen route has much to do with this.

Now the whole picture is uncertain. Japan has been battling inflation as much as we have and costs of labor and materials over there have never been higher.

But with two new blows landing at Japan's midsection—upward revaluation of the yen

(making Japanese products more expensive) and a 10 percent surcharge on all imported goods—prices of items imported by the U.S., including color TV sets, have become higher. It's safe to say that much Japanese merchandise now enjoys no price advantage.

The second factor, quality, is a trickier topic. When people go shopping at a department store they may find dozens of sets operating simultaneously in one large room. Most of the sets are color models and many are adjusted incorrectly. Time and time again, a Japanese set's picture appears to be clearer and sharper than the rest.

One reason is its smaller picture tube. When you compare a Japanese 12- or 16-in. screen to an American 21- or 23-in. model there are bound to be differences in the quality of the picture. (When you consider the differences in the horizontal deflection voltages used in these sets this point has more punch.) Often the consumer is comparing American TV sets in one class with Japanese sets from another class. He gets a false image, in our opinion, when he does this.

Another reason why Japanese color sets seem to have the edge is due to the Sony Corp. Most large department stores carry the Sony line of color TVs (though Panasonic is there, too) and many of these sets use Sony's patented Trinitron color picture tube. This picture tube is unique (and made only by Sony).

The Trinitron tube has only one electron gun—which produces all three electron

—And What to do About It

By FOREST H. BELT

beams—and with electrostatic focusing it paints colors in stripes rather than illuminating colored phosphor dots as do all other American and Japanese picture tubes. There's no doubt that the Trinitron system does make a difference. The picture is bright, convergence and purity are optimum, the raster (scanning lines which appear on the screen) is remarkably sharp. The Trinitron system makes for simplification and good quality at what seems a reasonable price.

The only problem is that, until now, the Trinitron has been available only as a small-screen item—via 9- and 12-in. models. Now, the long-awaited 17-in. model KV-1710 (long since in use in Japan) has arrived on our shores and this receiver has caused quite a stir. It will certainly help the Japanese TV industry's image.

However, while the Japanese now are weighing in with 17-in. and 18-in. color sets (Panasonic has introduced a 21-in. model), these still are small-screen TVs when compared to larger American color sets. And people *do* confuse small-screen Japanese sets—especially the Trinitron—with Japanese quality overall. They seem to associate all Japanese color TV manufacturing with either Sony's Trinitron tube or with light and lively small-screen sets, which are particularly impressive when incorporated into closed-circuit TV systems where no broadcasting is involved.

What other quality features are offered by the competition? Many people like the gadgetry that makes a set easier to operate or more enjoyable to watch. Not the Japanese. They don't go in much for gadgets.



Sony's 9-in. Trinitron color TV has solid-state circuits. Note VHF channel selector at front. UHF selector is on side panel (KV-9000U).



Model KV-1220U. Sony's 12-in. Trinitron color set, has solid-state circuitry (like all Sony TVs), and front-panel tuning controls.



Newest Trinitron color TV from Sony. Model KV-1710. features 17-in. screen. Set has illuminated VHF and UHF channel selectors.

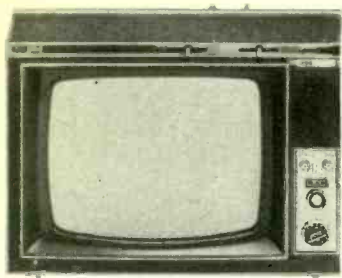

Toshiba's Model C-501S has 15-in. screen, AFC and slide controls for tint and color.

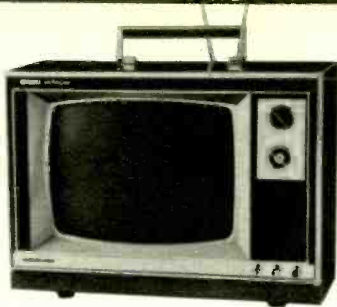

Hitachi's Model CFA-450 is solid-state portable color TV. Set has APS feature and 14-in. screen.

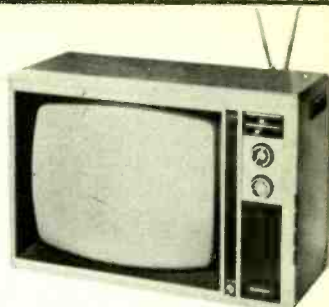

Sanyo's Model 81C25 has 18-in. screen, slide controls, APS, solid-state chroma circuits.

That Yen for Japanese TV Sets —And What to do About It

Don't look for automatic tint control (ATC) on a Japanese color set. There isn't any. Many American models have this convenience. It helps keep faces from turning green or blue when programs change. Some advertisements seem to imply that certain Japanese sets have ATC. Not so. What they do have is a switch called an Automatic Picture Setting (APS). It hooks up to an extra set of tint and color controls inside the set. When the switch is on *automatic*, a technician can adjust these controls for best flesh colors during the programs you watch most. If colors change unduly when you're viewing other programs, you flip the switch off. Then you use the front-panel tint and color controls to make the flesh tones right.

The Japanese tradition of handcrafting seems to have enhanced the image of Japanese electronic manufacturers. Thus, reliability often is mentioned as a reason for buying a color TV imported from Japan. While the Japanese do have a deserved reputation for doing excellent work, experience proves that imported TV sets (coming from any nation) are no more nor any less reliable than American models—they break down just as frequently.

Both Japanese and American engineers exploit the benefits of solid-state technology. No one country has a jump on implementing integrated circuits—it's just a matter of dollars and profit margins. While the Japanese were first on the market with a solid-state

black-and-white TV, it was Motorola—with its popular Quasar model—which first had an all-transistor color set for sale in late 1967.

American manufacturers also have gone full speed ahead with modules, replacement PC boards, plus ICs. The Works in a Drawer design introduced by Motorola has proved popular. Now RCA, Sylvania and Zenith also sell solid-state color receivers and they're beginning to use modular techniques, RCA, for instance, recently opened a manufacturing facility that will produce ceramic modules for its line of television receivers. The company hopes to use these circuits in 80 percent of its wares in about five years. Of course, the Japanese have transistor color TV, too. All Hitachi and Sony models are solid-state, as are many Panasonic sets.

Many good service technicians won't touch



Scene inside RCA's new manufacturing facility for ceramic modules in Indianapolis. All RCA XL-100 color sets use these circuits.

a foreign set because the circuits are different and they're not used to the construction techniques. Service information often is difficult to come by.

The importers deny this, yet in the same breath they admit that service data is furnished only to appointed service centers. Without this data a technician can't troubleshoot a set efficiently or even know what parts he should order.

TV shop owners—some of whom run appointed service centers—tell us that parts for imported sets often are not available. Spot checks prove this to be the case. Many important parts are temporarily out of stock. Some technicians say that "temporary" may mean months of waiting—all the while customers are upset and TVless.

One technician we know bought the service manual for a Japanese set to please a good customer. It took three weeks to get the manual. The technician diagnosed the bad part and ordered a replacement—by number.

Three weeks later he received a form letter asking for payment in advance. He wrote a check and four weeks later he got the part. It didn't fit. Six weeks later, after three more letters, the company sent the right part. It turned out that this particular part was listed in a later edition of the service manual and he had been sent an out-of-date copy. Due to the four-month wait he lost his customer. Now the technician swears he'll never work on another imported TV.

Stories like this are common. Of course, the same headaches and frustrations happen with U.S. brands, too. Special parts are sometimes out of stock. But we're told that manufacturers are trying to improve the situation—even though fifteen years have passed since the introduction of color TV and the public suffers on.

Repairs for American-made TV receivers are seldom restricted to a select group of dealers or repair shops. Usually you can pick your own technician. He can buy the data and parts for your set from a nearby distributor. Distributors specializing in new sets sometimes have a repair specialist to help technicians if they run up against problems.

A much more serious development is that many good service shops are refusing to be service centers for imported models or American-made sets. They are losing money and shop owners don't want unprofitable work.

Several technician/owners gave us these



Vikona, Model GQ-867R, is top-of-line color console from RCA. Set has varactor-diode remote tuning, AccuColor, 25-in. screen.

reasons: Warranty work loses money for the shop, parts are slow to arrive and often are out of stock, service data is incomplete and inaccurate, and there is too much red tape associated with *authorized service* business.

Most people, including importers and U.S. manufacturers and distributors, admit that they have a service problem—"Good service people are hard to find," they say. Whether you feel safer on home ground or not—when you do buy your color TV, chances are that if you do have a yen for an imported model you'll go ahead and satisfy it no matter what. Our advice is simply that you should look at all the models. When it comes to price, quality and reliability, the color TV race is a toss-up.



Zenith's Avante, Model C4730X, is deluxe 25-in. color console that features Titan 101 solid-state chassis; Dura-Modules and ICs.

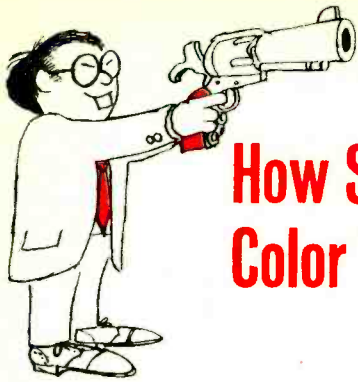

How Sony's One-Gun Color TV Works

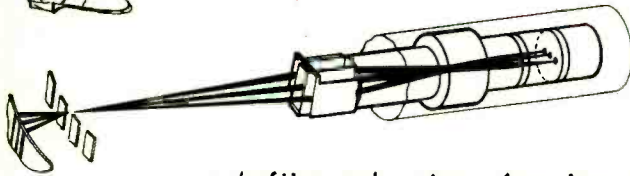

Japanese electronics takes a heftier poke at an American stronghold—color television.

By **LEN BUCKWALTER** NO MATTER what kind of color TV you own, you are watching an RCA set. Don't get up to check the label because it will only tell you what you already believe. It's on the inside that RCA comes to the fore, for it's here that most of the circuitry is of RCA design, especially the picture tube. This grasp on worldwide color picture tubes has gone unchallenged for two decades—until recently.

The first color tube to depart from RCA's design, a three-gun shadowmask method, is a commercial reality. It's called the Trinitron and is produced in Japan by Sony and imported to the U.S. in 9-, 12- and 17-in. portables. Success of the Trinitron has been so great, Sony now is planning to build a plant in San Diego, Calif., to produce them.

The stakes are high for any new color tube, especially if it sidesteps RCA licensing fees. Sony is out to do just that. In 1968 it demonstrated Trinitron to American TV makers in a mission intended to capture \$5 million in U.S. manufacturing rights. Back in Japan, Sony was already using the new tube to eat into a \$4 million royalty being paid by the Japanese for the license to build a bit of RCA into their own sets.

So that's the motivation behind Trinitron. New designs have been tried before—resulting in tubes with strangled necks that poke sideways from the screen and primitive electro-luminescent panels that are to TV what the cactus needle is to the phonograph. Sony's Trinitron is the first to succeed and has a tube that could be good enough to touch off a battle of the manufacturers, at

least in small to moderate screen sizes.

View the Trinitron screen next to a conventional set and you'll see why. Like many an electronic engineer before you, you'll probably ooh and ah. Color rendition and hue brightness are nothing short of surprising. Color holds up well under extremely strong light, a distinct asset for a portable TV. Inside, the Trinitron needs fewer parts, consumes less power and virtually does away with convergence. Once the technician's most ticklish task, convergence is a series of adjustments to pull color beams into registration on the screen. A conventional set has more than a dozen—Trinitron has two. American manufacturers, however, are a bit cautious about any changeover to the Trinitron. The reasons should become apparent after we look at how it operates.

A novelty in any color tube is how it achieves color separation. (Trinitron is shown in Fig. 1 and the RCA is in Fig. 2.)

As you may recall, a black-and-white tube creates a picture with an electron gun that flings a beam of electrons toward the screen. The image appears because the screen phosphor emits light under the impact of electrons. To convert that process to color is easy in theory. Use three electron guns and coat the screen with phosphors which glow red, blue and green. This arrangement keeps primary hues apart until the final moment, when they mix in the eye to produce up to 40,000-odd colors in the original scene.

RCA's tricolor tube exploits that basic idea, and handily packages it inside a single glass envelope. There are three separate

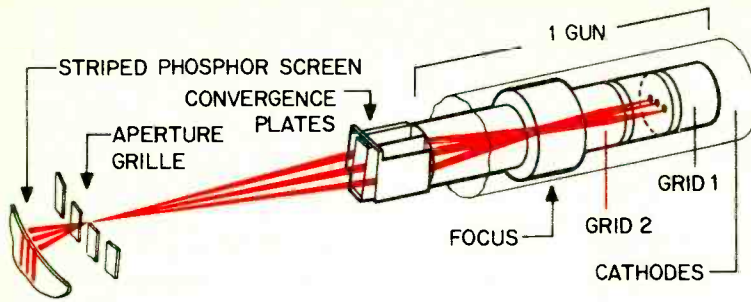

Fig. 1—This diagram shows how the Sony Trinitron system produces color with only one gun. It has three cathodes, one for each color. Three beams from cathodes are attracted to phosphor by two common grids. Note focus assembly is also common to three beams. It's small enough to fit in neck of tube.

electron guns, as shown in Fig. 2. Instead of individual color screens, the tube has separate color dots, about a million of them, in tiny trios of red, blue and green phosphors. Each gun is aimed at its corresponding dot so a blue gun, for example, illuminates only blue dots.

The color tube has achieved the first step in color separation: three beams, three sets of color dots. But push the beams across the screen to scan a whole picture and there'd be a muddy mess. A red beam, for example, would race over blue and green dots in colorful confusion. This state of affairs is prevented by the shadowmask—a steel plate suspended just behind the phosphor screen. It's perforated with one tiny hole for each trio of color dots and forms a window through which the beams must pass. As the illustration shows, the beams look through the hole at slightly different angles and thus can land only on their assigned dots. Now as the beams move across the screen they're blocked by the shadowmask and won't "see" the next hole until they're in correct position to hit the next trio of dots.

The Trinitron scraps both shadowmask and three guns to achieve its color separation. Instead, it uses an aperture grille as shown in Fig. 1. The color phosphors are laid down in vertical stripes, not dots. At any point in the scanning procedure, the beams will

be striking three points in a horizontal line, rather than three points of a triangle. Despite this radical difference, the operating principle doesn't change much. There are still three beams that strike their assigned phosphor stripes. As they sweep, they're blocked by the aperture grille until the landing angles are correct for the proper color stripes to be illuminated. A more detailed view of how the screen portion of the Trinitron operates is shown in Fig. 4.

The grille has one great benefit—its spacious, open structure presents a bigger window to the electron beams, compared to the tiny holes in a shadowmask. That works in favor of a brighter color picture. Besides high brightness, a second advantage of the grille arrangement is resistance to the earth's magnetic field. If the beams are pulled by natural magnetism, they still remain on their assigned color, at least in the vertical direction.

The next major difference between Trinitron and a conventional color tube is in the electron gun. Recall that an RCA tube has three guns. They are identical units mounted in the neck in a triangular (or delta) array.

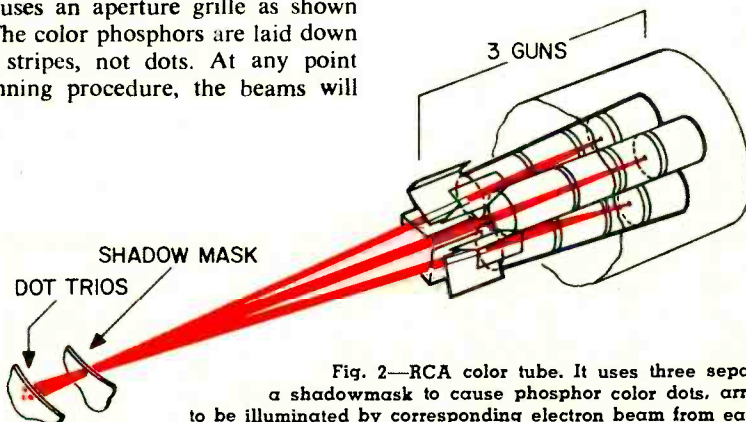
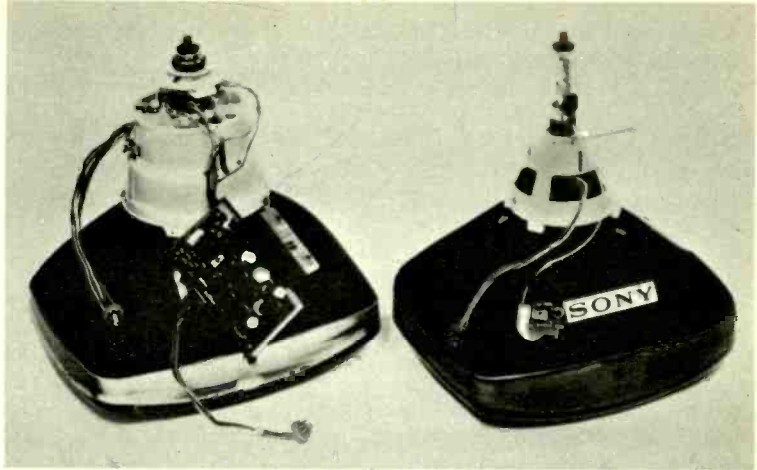

Fig. 2—RCA color tube. It uses three separate guns and a shadowmask to cause phosphor color dots, arranged in trios, to be illuminated by corresponding electron beam from each of the guns.

How Sony's One-Gun Color TV Works

Fig. 3—Here, a Sony Trinitron picture tube (right) is shown next to conventional CRT. Note amazing differences in neck assemblies and convergence boards. Sony has two convergence controls.



Trinitron has one gun, from which three electron beams emanate (see Fig. 5). This is at the core of Sony's ability to toss out a lot of the convergence circuits. It takes fewer components and coils to deflect three beams emitted from a single gun.

The beams begin at three cathodes which boil electrons toward control grid 1. (Three cathodes are needed so red, blue and green beams can be independently modulated by color signals.) Here's where the Trinitron radically differs from the RCA tube: the three beams pass through three holes in common grid 1, then are accelerated by second common grid 2, which again emits the beams through three holes. In the RCA tube, such control and acceleration are handled by three physically separate guns. Further, a Trinitron passes all three beams through one focusing assembly located in the neck.

Yet another major departure is in those convergence plates shown in Fig. 5. They assure that when the beams finally reach the screen, they'll cross over exactly at the

opening in the aperture grille, then spread slightly to land on the correct color stripes. In the conventional tube, this is done by electromagnetic coils in the yoke around the tube neck. These coils need a considerable number of adjustments to keep the three beams converged over the complete picture (especially at the screen edge). In the Trinitron, there's a simple arrangement of internal electrostatic plates charged with high voltage to converge the beams. The job is easier because a Trinitron gun emits its three beams in an in-line, or flattened-out, pattern. The beams lie in one plane so convergence is simpler than for the triangular firing pattern of conventional guns. With this arrangement, only two basic convergence adjustments (moving the outside beams horizontally) are needed to keep colors in good registration over the whole screen.

Another of Sony's unique features arises with the focus assembly. Since it's common to all three beams (RCA has three smaller equivalents), the focus assembly can be rela-

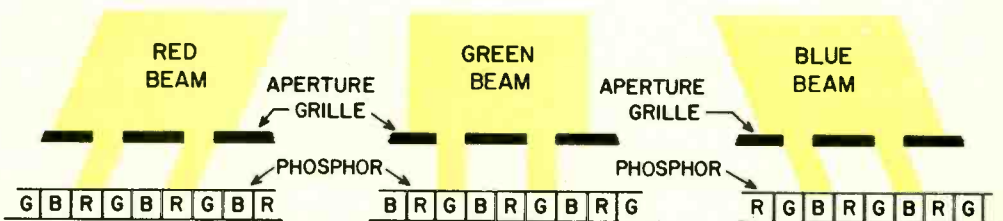

Fig. 4—This is an illustration of how the Trinitron aperture grille is employed to direct the three color beams to their appropriate phosphors. The angle of the beam, in combination with the grille slit, make it impossible for a particular color beam to strike another color's vertical phosphor stripe.

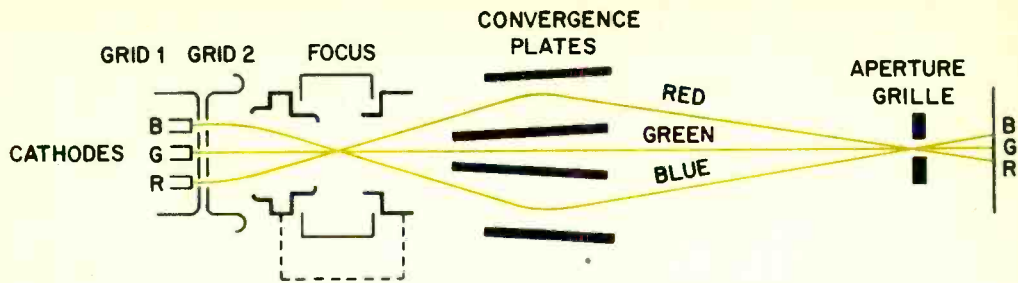

Fig. 5—Schematic representation of the Trinitron system. Three cathodes modulate three color beams which are accelerated by common grids at different angles when focused by two convergence plates.

tively large and still fit inside the neck of the tube. A large focus assembly imparts the same effect on electron beams as a small F-stop does on light through a camera lens—it improves the depth of field area which remains in focus.

For example, at small lens openings, everything may be in focus, while at a large lens openings only the object which you have focused on will be clear and that in front or to the rear will be blurred. In a picture tube there are many differences in the distance that the beam must travel. To reach screen center the beam must travel only a short distance, but to reach the edges, the beam must be longer. The focus assembly insures that the area of focus or the area in which each beam is distinct, will be great enough so that the picture will be clear at all places on the screen. Viewing tests of a Trinitron support the claim of uniform focus throughout, with virtually no color fringing around the picture elements.

Sony has advanced the state of the art with the Trinitron, but it isn't a revolutionary idea. The company took a laboratory oddity—the Chromatron—and spent much effort and money to convert it to an impressive performer. To evade the three-gun shadowmask and Chromatron, the company filed more than a hundred new patents.

Invented more than 20 years ago by Dr. E. O. Lawrence (also famous for the cyclotron), the Chromatron was a true, one-gun tube that fired a single beam at a screen which remotely resembles Trinitron's vertical stripes. Color separation, however, was done by fine wire grids that wiggled the tip of the beam to select various phosphors. This writer saw a demonstration of a Chromatron in the mid-60's and was astounded by its brilliant color. But it was technically too

foreboding for anyone to try to sell.

Some observers of the picture-tube scene believe there could be room for both RCA's dotted and Sony's striped screens. Trinitron could flourish in smaller sizes, leaving the consoles to the dots.

Now that a 17-in. Trinitron is available—plans for larger models are still uncertain at this time—Sony's future producing color TVs in the U.S. looks bright. Sony's new plant in San Diego (to open early in 1972) is just the answer to dock strikes, import surcharges, etc. So color the Trinitron a winner—until something new in picture tubes comes along to dazzle the eye.

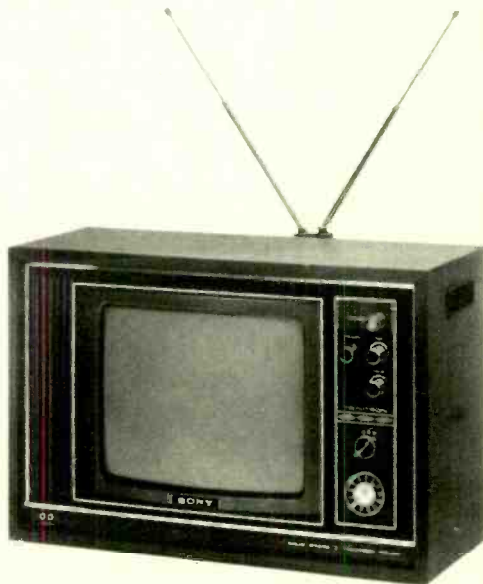

Trinitron color set imported to the U.S. Sony now makes 9-, 12- and 17-in. versions but plans for larger portable models could be in the offing.

Ray Dolby holds latest version of his famous noise-reduction system. Designed for FM broadcast stations and home receivers, it effectively increases transmitter power by factor of 10.

Dolby on a Chip

*Cassettes may crawl at a lowly
1 7/8 ips but Dolby Labs plans to
eliminate noise from all of them.*



WHEN EI last reported on Ray Dolby and his unique audio noise-suppression system (MR. DOLBY'S WONDERFUL SYSTEM and RAPPING WITH RAY DOLBY, May '71 EI) everything was coming up Dolby. Now used by most of the major recording companies to process master tapes and integrated into numerous reel-to-reel tape recorders and cassette machines, the Dolby system has become a standard feature in high-quality sound systems.

Recently, Dolby Laboratories, Inc.—headed by Dr. Dolby and based in London, England—introduced Type A (professional) and Type B (consumer) noise-reduction equipment for FM broadcasters and home listeners, claiming that implementation of Dolby FM gear could effectively increase the power of an FM transmitter tenfold.

While compatibility (that is, FCC approval) may prove a stumbling block for the FM version of the Dolby system, there can be little doubt that Dolby circuits—matched with such advances as chromium-dioxide (Crolyn) tape—will revolutionize the cassette industry and make cassettes a viable alternative to open-reel tapes and LP records. Up to now, the only problem has been cost. Even that appears to be solved at last.

Signetics, a major West Coast semi-

conductor manufacturer of digital and linear integrated circuits, in collaboration with Dolby Labs in London, is coming out with an IC version of the Dolby Type B consumer noise-reduction system. The device—whose price should start at about \$3, possibly winding up at \$1 in large quantities—should go into production this March and be available to Dolby licensees shortly thereafter. Signetics will retain exclusive rights to the Dolby IC for a short period, then it will be made available to the entire industry.

This means that cassette and reel-to-reel tape-recorder manufacturers who are licensed by Dolby Labs to use the Type B system can do so at far less cost to the consumer. Since it's generally agreed that Dolby processing is the only way high-quality, noise-free cassettes can be obtained, the availability of Dolby on an inexpensive chip should mean that cassette equipment manufacturers will be signing up for licenses in droves.

This turn of events is based on the happy circumstance that the Dolby Type B circuitry, though not as complex as the professional Type A system, accomplishes the very same thing in a smaller package. You may remember that the Dolby system processes audio signals by boosting the low-level passages where signal-to-noise ratios are at their

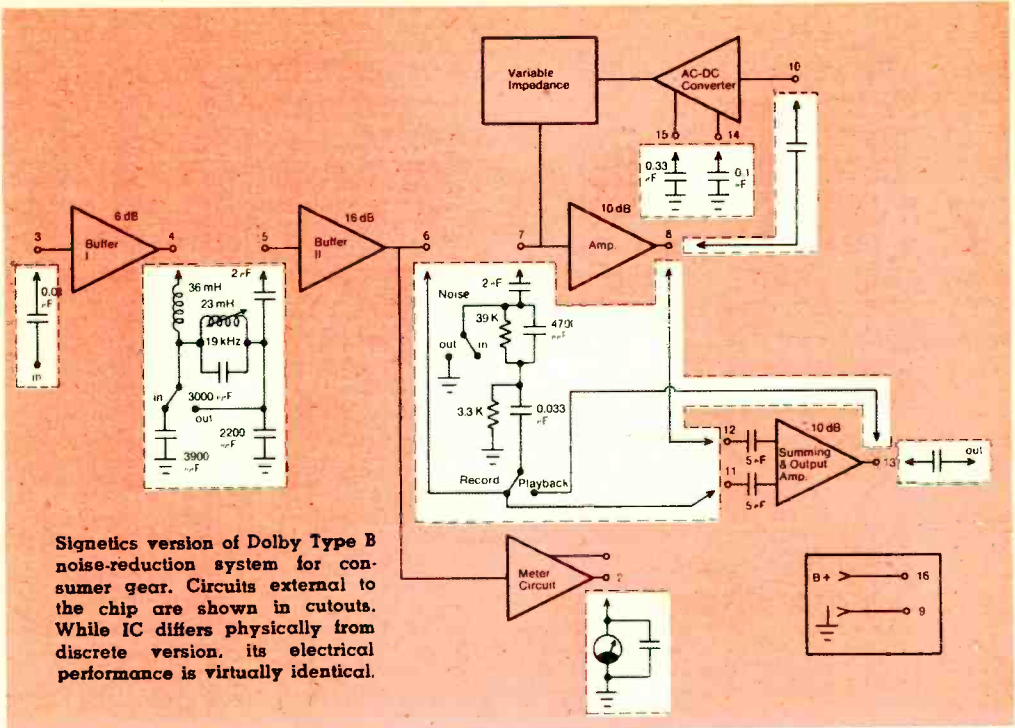

worst due to tape hiss, hum, etc

The Dolby circuits attack audio information in terms of both signal level and frequency. The Type A system has—aside from audio compressors for recording and expanders for playback—four filters which split the audio spectrum up into four bands.

High-level signals, i.e. loud passages, at most frequencies bypass the Dolby circuits. Low-level signals, especially those occurring at high frequencies, are boosted so that during playback Dolby consumer gear can return these signals to their original level, at the same time reducing tape hiss, rumble, hum, crosstalk and assorted clicks by 10db.

The trick to the Dolby B system for consumer gear is that the circuits divide the audio spectrum much more simply—they attack signals having frequencies of 1200 cps or higher. Strong signals pass the system by, while soft passages are boosted and then returned (later) to their original loudness level. The fact remains that unwanted noise drops down the db scale as these low-level signals return from whence they came.

Ray Dolby and his associates can be rightly proud of their achievement. The development of a Dolby IC is the frosting on the cake.

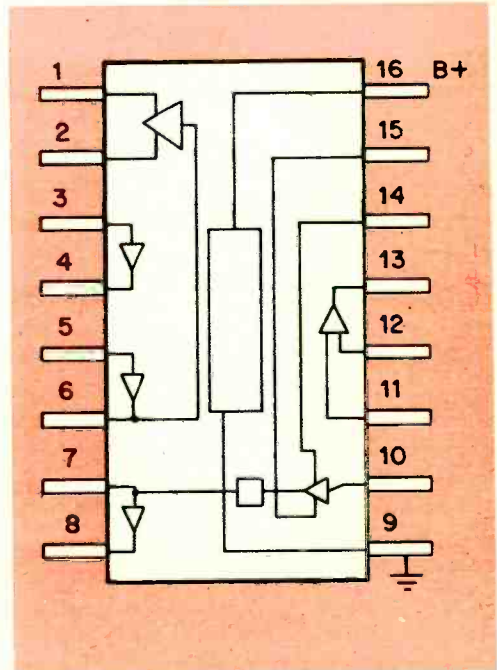

Preliminary pin configuration for Signetics Dolby IC shown above in detail. Final version may have 24 pins and include adjustable gain control.

BELL & HOWELL TECHNICAL REPORT

Subject: New Home Entertainment Electronics Systems Program

Competitive Advantages:

- Features first Solid-State Color TV (315-square inch, rectangular screen) Kit for at-home training to build, keep.
- Helps prepare recipient for Color TV Service Business of his own. Covers solid-state circuitry in depth--also other Home Entertainment equipment. Fully updated.
- Provides three additional professional quality kits to assemble, keep, use.

COMPONENTS:

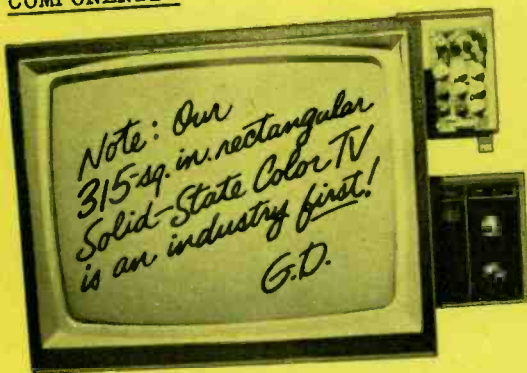

Specifications:

New 25" diagonal, ultra rectangular screen. 315-sq. inch viewing area. 25,000 volt, solid-state design, w/ 45 transistors, 55 diodes, 2 silicon rectifiers. 4 advanced IC's w/ 46 transistors, 21 diodes. 2 tubes: picture and high voltage rectifier. Solid-State VHF and UHF tuners. 3-stage solid-state IF. AFT standard. VHF power tuning. Also: "Instant On" circuit, automatic color control, noise limiter.

Descriptive analysis:

Modular plug-in circuit board design provides for more than 100 advanced solid-state devices. Insures premium color, sound control, exceptional reliability, easy access. Includes Hi-Fi amplifier for sound output, built-in dot generator, tilt-out convergence panel. Handy Volt-Ohm meter permits initial set-up and adjustment plus detailed trouble-shooting. 315-sq. inch picture tube face transmits entire image. Push button channel advance. AFT module brings in perfect picture, sound

automatically. Easier to service than older, non solid-state sets. Quality components throughout.

Electro-Lab-at-Home Components included:

The Electro-Lab® consists of three units, arriving in 16 shipments which recipient assembles, keeps. All components are professional quality. The circuit DESIGN CONSOLE contains built-in power supply, test light, speaker. Patented Modular Connectors permit plug-in to console to rapidly "bread-board" many different circuits. No soldering or messy un-soldering necessary.

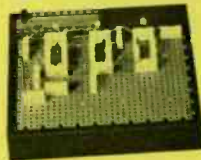

The portable 5-inch, wide-band OSCILLOSCOPE is calibrated for peak-to-peak voltage and time measurements... offers 3-way jacks to handle test leads, wires, plugs. Images on screen are bright, sharp.



The lightweight TRANSISTORIZED METER combines most desired features of a vacuum-tube voltmeter and a high-quality multimeter. Features a highly sensitive, 4-inch, jewel-bearing d'Arsonval meter movement. Registers slightest power surge or lag on large, easily read dial. CONSENSUS: first class gear.



Program is designed to give:

- Understanding of electronic circuits in most home entertainment electronic systems
- Ability to analyze and troubleshoot a wide variety of advanced solid-state and other TV circuits
- Capability to understand and use test equipment and procedures with special emphasis on TV testing
- Ability to assemble, test and adjust the solid-state TV kit included with the program

MAIL CARD TODAY FOR ALL THE FACTS
No Postage Needed →

Color TV is going Solid-State—here's how to help yourself get ready for it:

There's nothing else like this exciting new program that offers the *first* 315-sq. inch Solid-State Color TV available for at-home training.

As you follow the simple, step-by-step assembly and testing procedures, you will soon become thoroughly familiar with the most advanced solid-state TV circuitry. And you'll help prepare yourself for a profitable Color TV service business of your own—either full or part time.

Why Color TV pays better.

Today, Color TV is the big seller. And tomorrow, when it goes all solid-state, the man who has mastered this circuitry, will be in demand. This, of course, is where the money is going to be made.

But, this new Bell & Howell Schools program will also give you the in-depth knowledge of the basics as well as TV circuit analysis. You'll get the theory and practical experience you need to handle radios, Hi-Fi's, stereos, tape recorders, B & W television as well as most other home entertainment electronic devices.

Build, keep your own 25" diagonal Solid-State Color TV Set

Whether you are a beginner, an experienced hobbyist, or a pro working in the field, you are going to be delighted with the performance you get from this new solid-state kit. So proud, you'll want to show it off to your relatives and friends.

The "specs" at left give a few of the facts. But there are many, many features besides these which you will not find in any set on the market today. Send for all the facts and this is the one you'll want.

You're ready for many kinds of Home Entertainment Equipment

This is a thorough-going program, put together by professionals, with completely up-dated components and materials. When you have completed it, you'll have a new kind of confidence in your ability to tackle almost anything related to electronics in the home. And I can assure that these devices are definitely on the increase!

In addition, you'll have the kind of sound technical background you need for either a career as a technician in the Electronics industry or a business of your own—either full or part time.

Note: TV picture is simulated.



CONSIDER THESE ADVANTAGES:

Bell & Howell Schools' Electro-Lab-at-Home Plan gives you the most thorough background possible in solid-state Color TV. Everything comes to you by mail. No traveling. You go at your own speed and never miss a paycheck!

When you've completed your program, our Lifetime National Employment Service will help you locate in an area that interests you. This service is available at any time—now or in the future.

Approved for G.I. Benefits.

Our programs are approved for Veterans' Benefits. If you're a Vet, check the space in the card for full details.

Student Loans Available.

If you're a non-veteran and need financial assistance, you may qualify for a student loan. This may enable you to *learn now... repay later.*

Special Help Sessions.

These are scheduled regularly (Saturdays) at seven Bell & Howell Schools and in many other cities. Here you can get expert guidance by top instructors to help you over any rough spots.

Bell & Howell Schools offer you even more. Once you have finished your program at home, you may decide you want more advanced preparation. In this case, you can **earn transfer credits** to any one of our seven schools which are located all across the country.

Mail the postage-free card today for all the facts. There is no cost or obligation of any kind.



BELL & HOWELL SCHOOLS

4141 Belmont, Chicago, Illinois 60641



FREE! MAIL CARD TODAY FOR ALL THE FACTS
No Postage Needed

322

57



Light-Sensitive Light Controller

This dimmer gradually changes a lamp's brightness at sunrise or sunset.

By **RONALD M. BENREY** WINTER is here, the time when sunlight has a trick of disappearing mighty fast as late afternoon approaches. Now you can enjoy those picturesque winter sunsets and not get caught in the dark while you're doing it.

Our Light-Sensitive Light Controller makes sure you can have light anywhere, just when you need it. No if's, and's or black-outs. This dimmer responds to darkness by gradually increasing the light level just as the daylight surrounding you starts to wane. And you can adjust the dimmer to turn on or off any kind of lighting load up to 1,000 watts—indoors or out. Conversely, in the morning the Controller can turn lights off as daylight returns.

Besides setting the dimmer to trigger at a certain level of ambient light, you also can set it to gradually energize the lamps over a period of time once the circuit is triggered. The lights can come on dimly, then grow brighter and finally reach their peak intensity. Or, you can simply have them turn on to full brightness at a particular level of

outdoor ambient light level.

How it Works. Heart of the Controller's circuit is a triac. Labeled Q1 in the schematic, it's a semiconductor which acts like an on-off toggle switch. Note how Q1's anodes, A1 and A2, are wired in series between the AC power cord and load outlet SO1.

Normally, Q1 is in a non-conducting state—to the circuit under control it looks like an open switch. Consequently, almost no current passes through it. But whenever a pulse of sufficient amplitude and duration is applied to Q1's gate electrode (G) during each half-cycle of AC

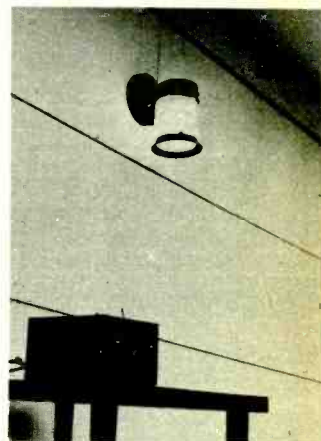
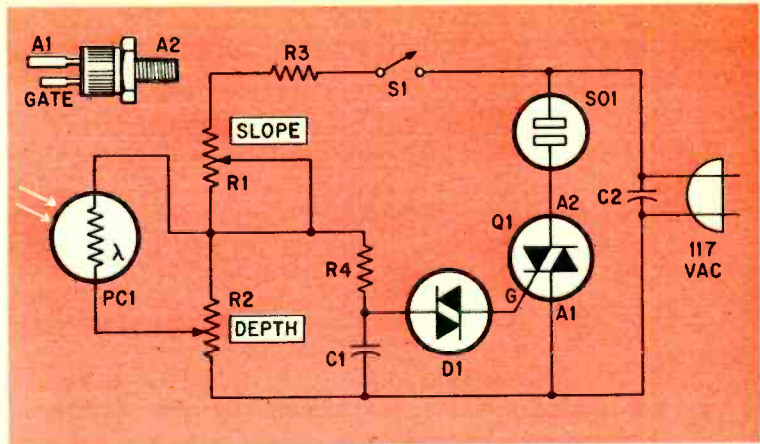

Fig. 1—Always point photocell away from artificial light sources under control of the dimmer.

Fig. 2—Pay attention to size of Q1's solder terminals. The smaller one is gate (G) connector. Pot R2 controls sensitivity of dimmer, i.e., photocell's response to strength of sun's rays.



line current, current will flow.

Power will be delivered to the lamp plugged into SO1 only so long as this trigger pulse is present. Without it, Q1 automatically reverts back to its non-conducting state. This switching action allows the triac to control large AC currents with a low-power trigger pulse.

But there's a catch to harnessing Q1. Not only must you deliver a pulse of correct amplitude, you've got to shoot it to Q1 at the exact time. Voltage and time are important elements which determine a triac's correct operation.

The element of time is the most important basic principle behind all triac AC power controls. The triac compares the time delay, or *phase shift*, of the trigger pulse against instantaneous values of AC line voltage at every moment. The greater the amount of phase shift (the greater the time delay) between control pulse and the AC line voltage reference, the longer it takes the control pulse to switch the triac into its conducting state.

Suppose the trigger pulse is applied to Q1 late during each half cycle. Only a small amount of current will flow through Q1's load. If this is a lamp, it glows dimly. On the other hand, if the trigger pulse is applied to Q1's gate earlier during each half cycle, Q1 conducts over a much longer period of time. A larger current flows into the lamp making it glow brightly.

In our Controller, the gate timing is set by a variable time-delay circuit that includes a light-sensitive cadmium-sulfide photocell. To the rest of the controller's circuit, resistance R1-R4 and photocell PC1, look as

PARTS LIST

- C1—.1 μ f, 600-V capacitor
- C2—.05 μ f, 600-V capacitor
- D1—1N5411 bilateral trigger diode (RCA)
- PC1—Cadmium-sulfide photocell, GE-X6 (Lafayette 19 R 27094)
- Q1—2N5569 triac (RCA)
- Resistors: $\frac{1}{2}$ watt, 10% unless otherwise indicated
- R1, R2—100,000-ohm pot. screwdriver-adjust shaft
- R3—4,700 ohms
- R4—33,000 ohms
- S1—SPST switch
- SO1—Panel-mounted AC receptacle
- Misc.—3 x 4 x 5-in. aluminum minibox, 2 x $3\frac{1}{2}$ x $\frac{5}{8}$ -in. finned, aluminum heat sink, terminal strips, AC line cord (10-A rating).

if they're lumped together electrically. They appear to capacitor C1 as a single equivalent resistance enabling it to charge up from the AC line voltage.

When C1 charges up to about 32 V, bilateral trigger diode D1 suddenly conducts. The voltage stored by capacitor C1 now discharges through D1 into Q1's gate, allowing line current to flow through Q1 and, ultimately, through the load plugged into SO1.

The length of time required to charge C1—in other words, the phase shift of the trigger pulse—depends upon settings of potentiometers R1 and R2 and on PC1's resistance. As with all cadmium-sulfide photocells, the brighter the light striking it, the lower the cell's resistance.

Photocell PC1's contribution to the total timing resistance available to charge C1 is controlled by the *depth* pot setting. After R2 is adjusted to bring PC1 into the circuit, a changing light level on the cell will

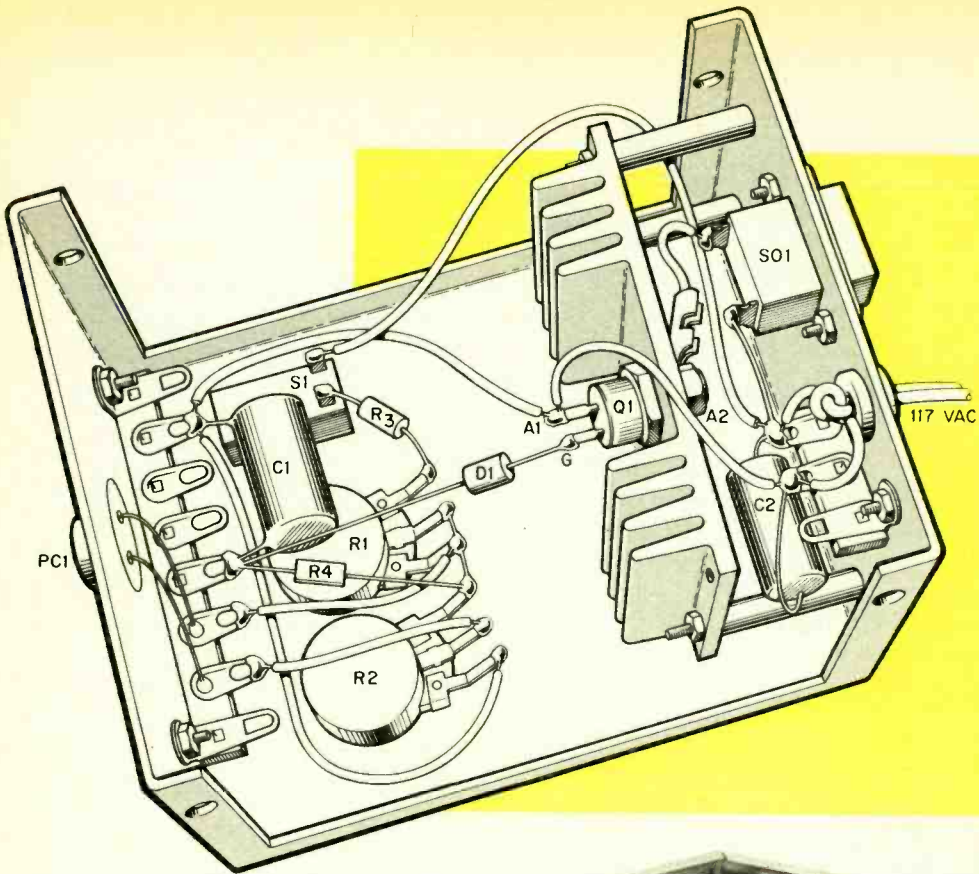

Fig. 3—While pictorial above doesn't show it, photo at right indicates how triac must be insulated from heat sink with mica washers.

Light-Sensitive Light Controller

vary the timing of the trigger pulse. Full counterclockwise adjustment of this pot effectively takes PC1 out of the circuit. By setting R2 fully clockwise you can produce the maximum effect from PC1. No matter how you've set R2, the lower the ambient light level, the earlier each timing pulse is delivered to Q1.

Potentiometer R1 is labeled *slope* because it determines the speed with which the circuit responds to changing light levels. It also partially fixes the total load current delivered by Q1 when PC1 is completely darkened.

Capacitor C2 is wired across the power line. It bypasses RF interference generated by Q1 as it switches on and off.

Building It. Start construction by mounting Q1 on its heat sink. Use the mica insulating washers and nylon stud spacer supplied with Q1. The triac's body (anode No.

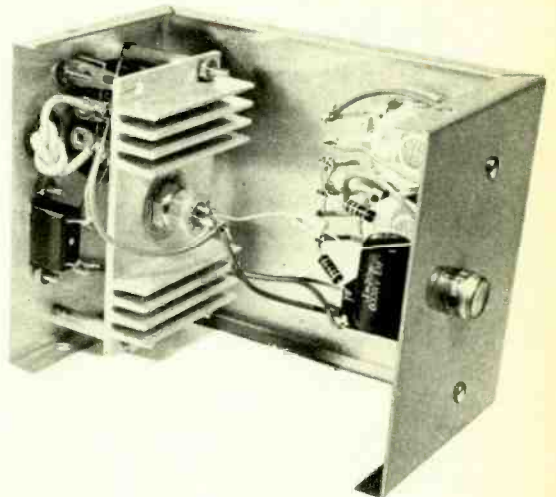

2) must be electrically insulated from the heat sink when it is mounted. Be sure to coat both sides of each mica washer with a thin film of silicone grease. This helps insure good heat transfer between Q1 and the heat sink.

The complete dimmer circuit is housed in a 3 x 4 x 5-in. aluminum Minibox. Mount both potentiometers, AC socket SO1, the

[Continued on page 102]

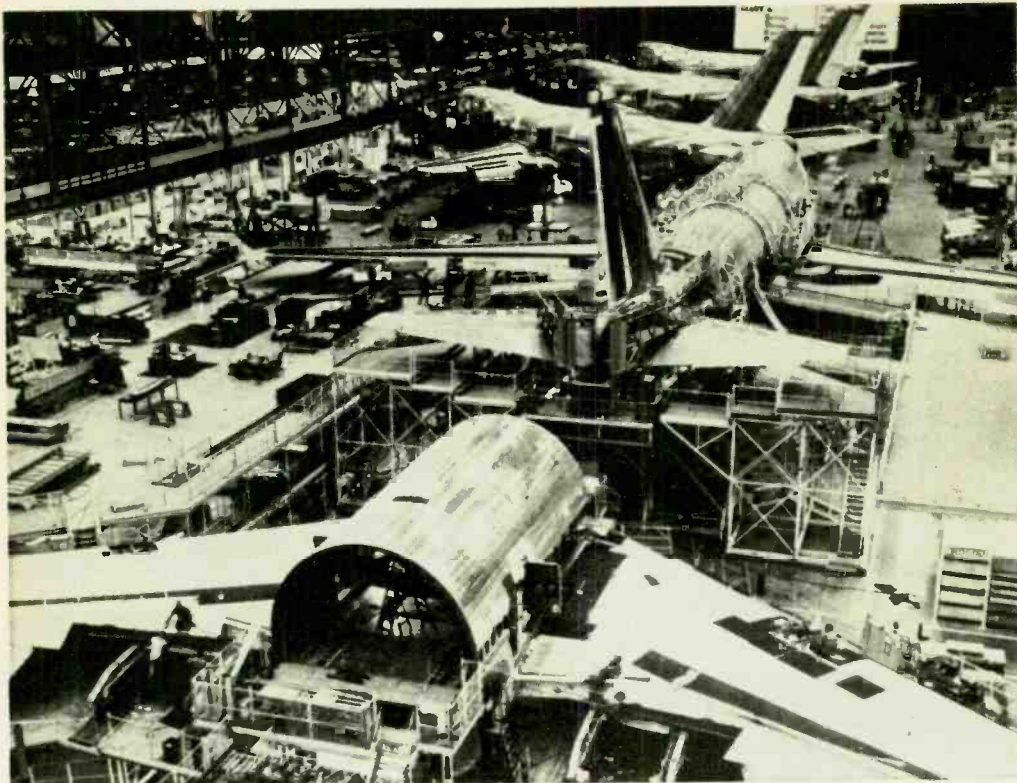

Final assembly line at Boeing's gigantic 747 manufacturing plant located at Everett, Washington.

An Exciting Career in Aerospace Electronics?

By **FOREST H. BELT** YES, Virginia, there is an aerospace industry—still! In spite of the C5A cost overruns and resulting Congressional hassles, in spite of the cancellation of the SST and cutbacks in our space program (NASA's budget, folks), people are going about their daily tasks as usual—building prop and jet aircraft, jumbo jets, space vehicles and electronically guided missiles.

True, the industry is in the doldrums and many people are unemployed. In fact, more aerospace engineers and scientists—some 200,000—are unemployed than you would care to shake a stick at (many having PhDs). But there are some bright spots.

Lockheed will get the funds it needs to build the TriStar and the competition's DC-10 is now flying.

If President Nixon's economic policy has the effect it was supposed to have, the aircraft industry—as well as commercial airlines—should benefit almost immediately from increased capital spending. So, even though space programs are planned to last well into the 1980s, in the near future, avionics looks better than aerospace so far as jobs are concerned because after Apollo XVII the NASA wheels evidently are going to turn quite slowly.

But the situation we're talking about is a couple of years hence. If you've just com-

pleted some kind of training and are looking for an avionics or aerospace job you already know the situation (which is not good). But we're talking about a job that might come after a couple of years of study and training, and the view over this longer haul does look somewhat more promising.

Whatever the exact niche that interests you, keep in mind the fact that you must be selective when planning your career. Don't just jump in without examining the field, the many types of electronic specialities there are and the opportunities that exist for advancement.

Remember that engineers and technicians working in the avionics and aerospace fields get involved in guidance, telemetry, voice and data communications, television, radio-astronomy, computers, biomedicine, instrumentation, geology, electro-optics, cryogenics and infrared technology, to name just a few. Non-destructive testing and reliability control are of extreme importance in any program.

While you may start out in avionics or

aerospace, there is always a possibility that you may switch to another field—or even have to change, whether you like it or not. A key factor in your success story will be just how broad your electronics training is.

Are your courses sufficiently comprehensive so that you can apply your knowledge of electronics in several areas? Those who manage to obtain a degree in electrical engineering may be better off if they choose courses so as to cover a wide area (although, as we said, there are plenty of men with degrees out of work).

People who plan to be technicians may have a somewhat easier time—at least as far as job security goes—though they won't command the salaries that an engineer does (when he's working). Best bet for those going to technical schools is to write for all the information they can get (good information about schools is available from the National Home Study Council, 1601 18th St., N.W., Washington, D.C. 20009) and then compare courses. The course that provides a

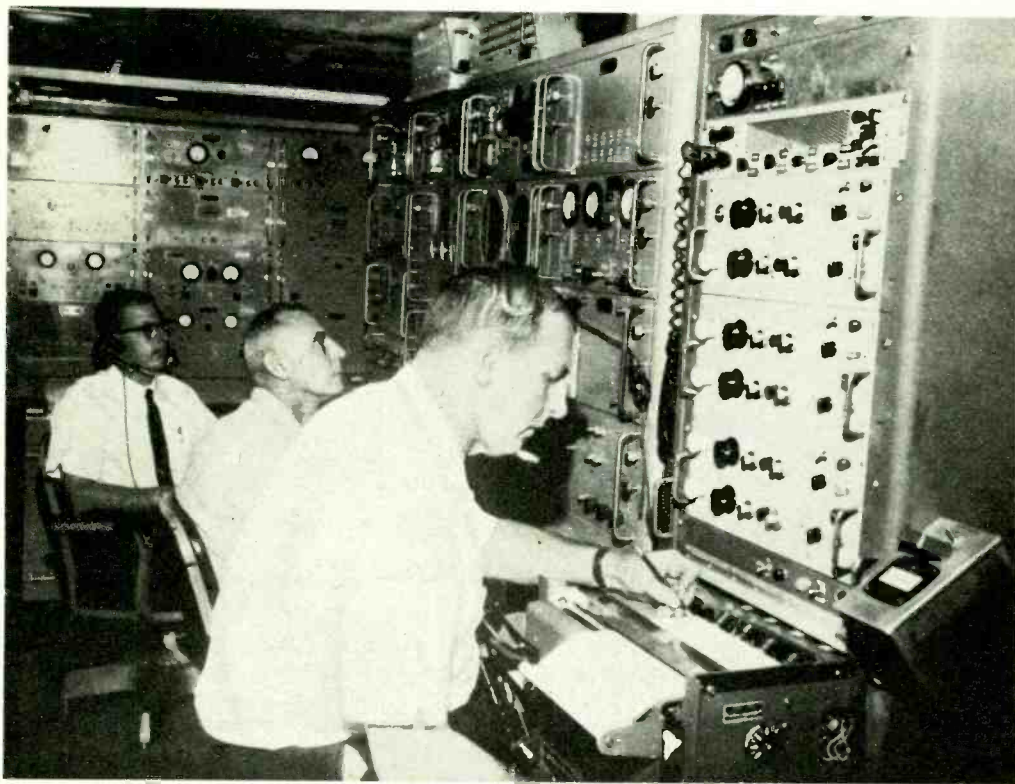

Engineers working with communications equipment that is part of Space Tracking and Data Acquisition Network (STADAN). Network includes both electronic and optical gear and is used to track flights.

An Exciting Career in Aerospace Electronics?

wide background—e.g., semiconductors, vacuum-tube technology (especially power), communications, computers and instrumentation—will be the best ticket for a long ride upward.

Almost a million people still are employed by the aerospace industry and nearly half of them have some training in electronics. NASA employs a small fraction of the work force. Most engineers and technicians have jobs with large companies such as Boeing, Grumman, General Dynamics or McDonnell-Douglas or with contractors and subcontractors who usually do specific work for the firm (or firms) that have won major government contracts.

Regardless of whether they're working in a space program or designing better planes, weapons and missile systems, engineers and technicians often are involved in exciting and important tasks. Many of these tasks are important for the future of life on this planet.

Much of the interest in environment and ecology stems from information gathered during the evolution of our space programs. Because of this, geology, biology, meteorology and oceanography are as important today as the study of orbital paths of vehicles carrying the instruments and experiments.

Just what kind of work can you expect to do? As a technician or engineer you may develop new ways to do something (such as designing a braking system for short-takeoff-and-landing aircraft—STOL), or test an idea that someone else has developed. You could invent new uses for old gear or design new gear to do an old job. Aside from building and testing new gadgets, you might devise or put together systems from those gadgets and make sure they work the way they're supposed to.

Also important is the repair and maintenance of instruments and equipment used aboard aircraft and space vehicles. In many cases, you actually may have a life in your hands. The amount of electronics being stuffed into the latest commercial and military aircraft is incredible.

What can you expect to earn when you're on the job? Typically, an engineer with a BSEE degree can expect to start out making around \$9,000 a year. This assumes he has no experience in aerospace electronics. After he

has some extra schooling in his specialty he might begin in the \$9,000 to \$11,000 bracket.

Once he is settled and doing a good job, an engineer's salary starts an upward climb from a level around \$12,000. By the time he has earned a PhD, his talent and experience can lead to an income of \$18,000 or more.

Technicians can do extremely well once they have experience. While their strong technical training may not have the status of a degree, technicians who become experts sometimes are indispensable to the project leader. In some programs they have been the last to go.

Salaries for electronic technicians in avionics or aerospace can sometimes be as low as \$6,000 for beginners. However, any technician worth his salt—once he has gained some experience—easily can make somewhere between \$9,000 and \$12,000 a year. Those men with take-charge ability earn upwards of \$15,000.

[Continued on page 101]

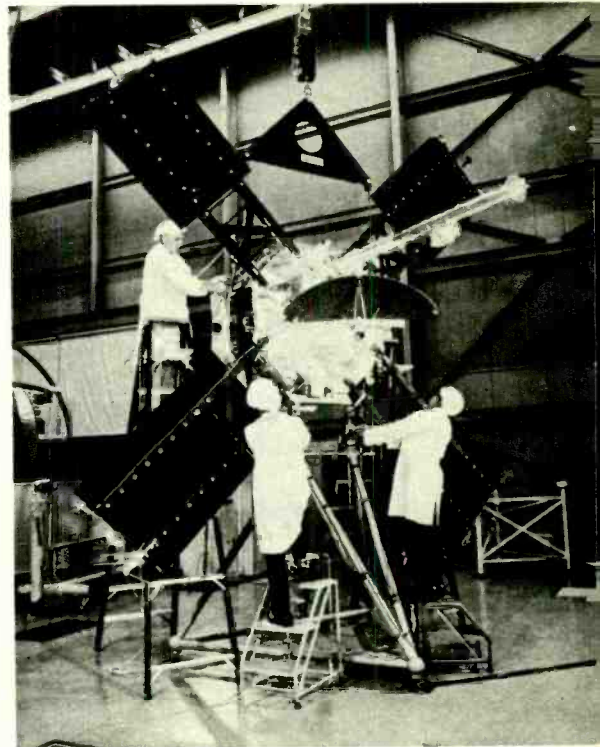

Mariner space vehicle being readied for trip to Venus. Panels of solar cells furnish most of the power needed by TV cameras and instruments.

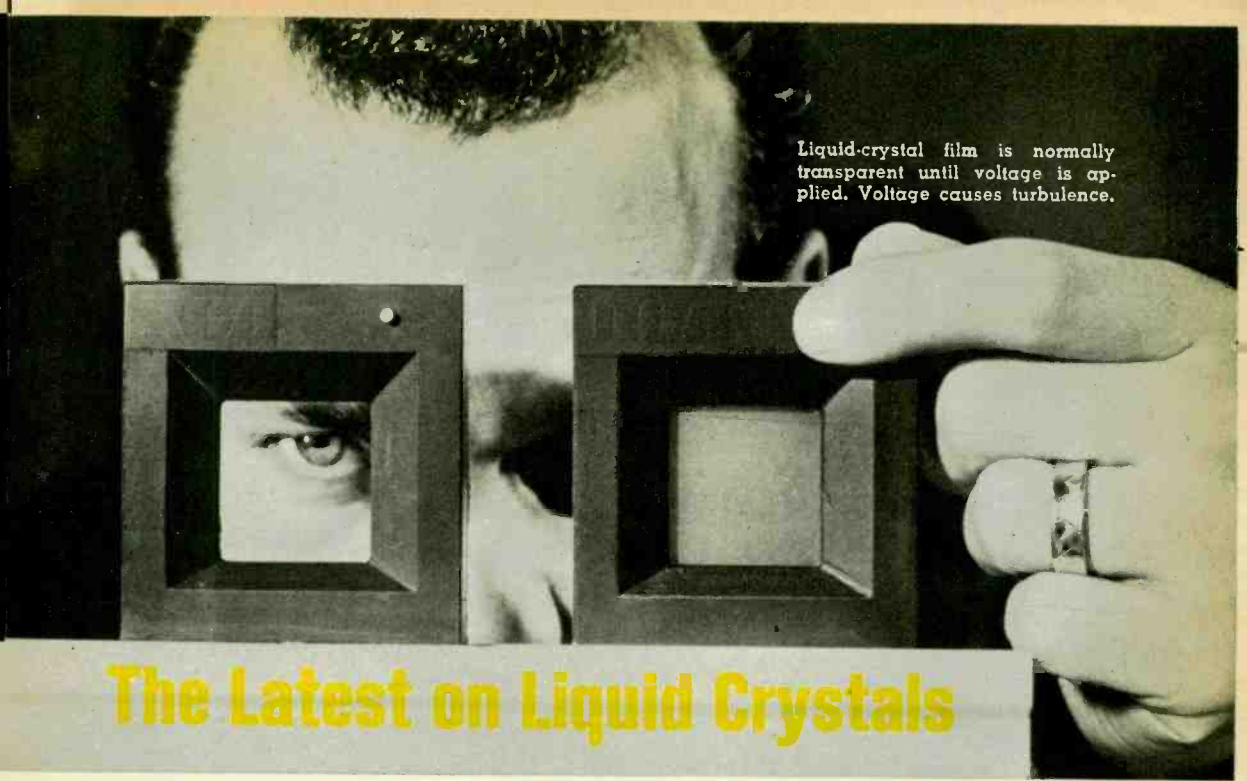

Liquid-crystal film is normally transparent until voltage is applied. Voltage causes turbulence.

The Latest on Liquid Crystals

First there were Nixie tubes, then light-emitting diodes, and now, liquid crystals that scatter incident light. They'll go in calculators and flat-screen TVs.

By JORMA HYYPIA and CLIFFORD L. FORBES

EVERYONE knows that there are two ways to measure electrical information—the analog method and the digital method. In an analog system, a voltage is obtained which is directly proportional to the parameter being measured. The voltage—or the equivalent current flow—is read from a meter.

In a digital system, switching circuits count the number of pulses (over a specific time period) that are equivalent to a voltage or current level. The total number represents the parameter being measured and is displayed via digital (numerical) readout—no meter is required.

For a long time, the cold-cathode (Nixie) tube has been used for numerical displays. Anyone who has ever used a Xerox machine has seen Nixie tubes counting off the copies. These tubes are fairly expensive, they consume a good deal of power (especially when used in computer circuits), and due to their overlapping grids—for the digits 0 to 9—sometimes the numerals are difficult to read.

First cure to come along was the light-emitting diode (LED), a semiconductor de-

vice that emits light (visible or infrared) when its p-n junction is forward biased. LEDs were introduced in 1963 and marketed full-scale around 1968. Some major advantages of LEDs include long lifetimes (up to 100 years), resistance to shock and vibration, low power consumption, fast switching speeds and compatibility with low-level logic circuits. Reliability made LEDs an instant space-age success.

However, LEDs have some drawbacks. Their output (brightness) is limited, as is the area of the light-emitting surface, and they can be expensive when grouped in large arrays. They seem best suited as indicator lamps or, when grouped in arrays, as numerals.

On the other hand, liquid crystals—until recently a laboratory curiosity—have some unique properties which are just now being exploited.

Whereas LEDs are sources of light, liquid crystals reflect or scatter ambient light. This means liquid-crystal displays aren't subject to some of the limitations of LEDs. They can be made up in sheets (as a film) or en-



ISOTROPIC LIQUID

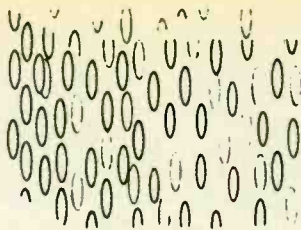

NEMATIC

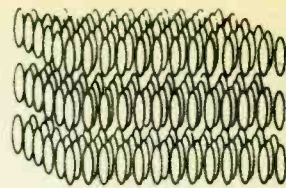

SMECTIC

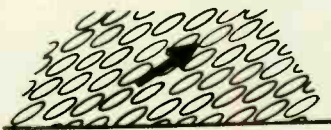
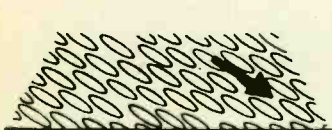

CHOLESTERIC

At top left, isotropic liquid is ordinary liquid (like water) having random molecular structure. At top center, nematic liquid crystal has molecules aligned in common direction, while smectic type (top right) has molecules stacked in parallel layers. Cholesteric type (at bottom) has molecules arranged in a spiral.

capsulated in any kind of package, so they don't have a limited surface area for light transmission or a restricted size and shape.

LEDs and liquid crystals usually are arranged in segments or bars, typically seven, to form the numerals 0 to 9. When these numerals are grouped into an array they form multidigit readouts. However, since liquid crystals can come in any kind of package they'll soon be seen in other configurations. (They're not limited to the area of a semiconductor chip, a filament, cathode or grid.)

Liquid crystals also consume very little power (at most, a milliwatt per square inch). They're inexpensive, too. One other advantage, unwanted bright light simply makes a liquid-crystal display brighter, whereas it can wash out LED or Nixie-tube readouts.

The notion that a crystal can be a liquid

may seem implausible. After all, we know that the molecules in a crystal lattice are locked tightly in an orderly pattern, while in ordinary liquids loosely bound molecules roam about in random fashion. Still, it's a fact that some substances can flow—and thus, be poured like an ordinary liquid—but they retain a crystal-like molecular structure.

Liquid crystals were discovered in 1888 and it has been estimated since that one out of every 200 organic chemical compounds can exist in a liquid-crystal phase. RCA, in 1968, was one of the first companies to announce progress in its R&D efforts to manufacture liquid-crystal displays commercially.

There are three distinct types of liquid crystal. All exist as homogeneous liquids—they are not a suspension of solid crystals in a liquid solution. In a *nematic* (thread-like)

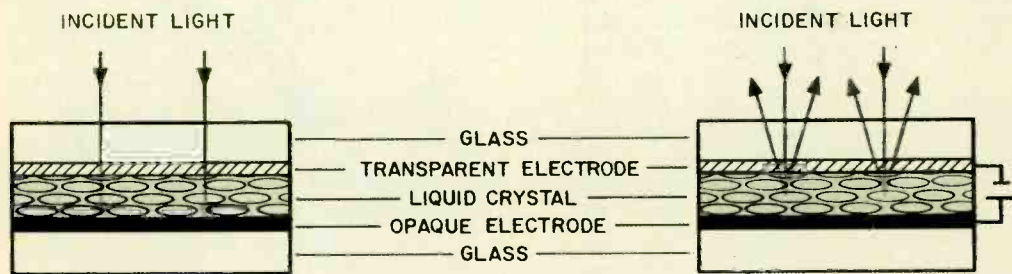

Typical liquid-crystal display consists of liquid-crystal film sandwiched between two sheets of glass. Each glass sheet has a film-like electrode that can be transmissive (transparent) or reflective (opaque). The film electrode makes direct contact with the liquid-crystal material. Applied voltage can be AC or DC.

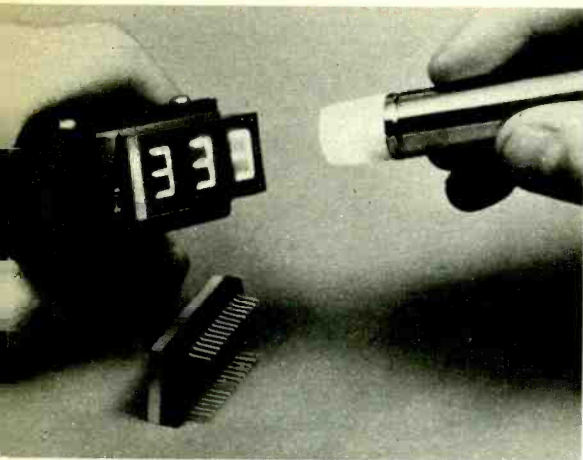

Model 1003 liquid-crystal display from Optel Corp. comes in 28-pin package, works from 15-60 V, consumes 40 microwatts per segment at 20 V.

The Latest on Liquid Crystals

liquid crystal, the molecules align themselves in a single direction so that they are able to slide past each other. In a *smectic* (soap-like) liquid crystal, the molecules are stacked in parallel layers so that they cannot slide past one another.

In the third type of liquid crystal, the *cholesteric* (so called because the majority of these crystals are chemical derivatives of cholesterol—an organic compound), the molecular structure somewhat resembles that of nematic liquid crystals except that a spiral orientation separates the molecular layers into distinct planes. A cholesteric liquid crystal is a bit more three-dimensional than the nematic type.

At low temperatures all these materials are solids. However, as the temperature is raised, they quickly enter a liquid-crystal phase. At still higher temperatures, they become ordinary *isotropic* liquids (like water) which have a random molecular orientation. Therefore, each liquid crystal has its own specific temperature range. Outside this range it exists as a solid or a liquid.

Nematic liquid crystals seem to respond best to electric fields and, so far, are the most important for electronic research. When a normally transparent nematic crystal is exposed to an electric field it becomes milky white (or cloudy). When the field is removed it becomes transparent again.

Apparently the electric field creates ions that travel through the crystal to produce a turbulence that scatters ambient light, thus producing the milky appearance. The amount of light scattered depends on the applied voltage, which typically can range from six volts to upwards of 60 V, DC or pulsed. More recent research indicates that low- and high-frequency alternating currents can make a liquid crystal appear frosty or transparent, too. Typical applied frequencies might be 60 cps and 1 kc (in the same voltage range).

If a liquid-crystal film is placed over a black background, a complete scale of grey tones—from black to white—is achieved by varying the applied voltage. The total power required can range from one milliwatt per square inch down to 300 microwatts per square inch, depending on voltage, whether it's AC or DC, frequency, etc.

Actually, nematic liquid-crystal displays work something like parallel-plate capacitors. The liquid-crystal substance serves as a dielectric (insulator) that is placed between the electrodes which apply the electric field.

A liquid-crystal display is constructed by placing a thin film (about one-thousandth of an inch thick) of liquid-crystal material between two sheets of glass. Each sheet of glass has an electrode film that makes contact with the liquid-crystal film. One of the electrodes



RCA's TA8040-8043 liquid-crystal readouts have four 7-segment digits, will operate from 15 VAC at frequency of 60 cps. Readouts cost \$75 each.



Liquid-crystal display developed by Research and Development Center at General Electric uses low- and high-frequency pulses to activate segments of 8-character readout. Circuitry is reduced 75%.

—usually tin oxide—must be transparent. If the second electrode can be opaque (it usually is so that it will reflect light), it's made of evaporated nickel or aluminum. Thus, a liquid-crystal display either can be reflective or transmissive—the inner surface of the back plate either is opaque (for contrast) or transparent (for back lighting).

Ordinarily, when the applied voltage is removed, a nematic liquid-crystal display ceases to be turbulent (cloudy or milky) and once again becomes transparent. A liquid-crystal readout that stays on after the voltage is removed would be helpful in certain applications.

One approach is to mix nematic and cholesteric liquid crystals together. The cholesteric molecules apparently form clumps that prevent the nematic-crystal molecules from realigning themselves to their former orientation when the charge is removed. An AC voltage (in the audio-frequency range) then can be used to untangle the clumped chole-

steric molecules and turn the display off. Progress in this area, however, is slow and most displays being readied for commercial ventures require a continuously applied voltage.

Commercial applications for nematic liquid-crystal displays could include—aside from numerical readouts for calculators, computers, test equipment, etc.—electronic clocks and watches, automobile dashboard displays, scoreboards, stock-tickers, panel displays to replace cathode-ray tubes and flat-screen TV sets.

The idea of a flat-screen TV starts most people daydreaming, even though this product still is some time off in the future. However, liquid crystals could eventually make it a reality. Remember that liquid crystals reflect ambient light (an electroluminescent CRT generates its own), so image brightness improves as room lighting is increased. A portable TV set having a screen made up of nematic liquid crystals would perform best out in broad daylight.

While a liquid-crystal, flat-screen TV would make good use of current IC technology and operate on low voltages, there are technical hurdles that will take time to overcome. For one, a conductive coating must be laid down as a fine mosaic whose individual elements are charged sequentially by a scanning video signal. Such a mosaic would require perhaps 525 row electrodes and about 700 column electrodes—or at least 367,500 electrical connections.

A second problem is that liquid crystals (unlike LEDs) do not respond quickly enough to the addressing signal. They have slow switching speeds. In a TV mosaic, the elements would not turn on fast enough. Thus it's likely that line-at-a-time addressing would be used.

Instead of sending video information directly to the liquid-crystal matrix, a line's worth of video information would be accumulated in a storage register and then transferred to the mosaic en-masse.

Recent work in nematic liquid-crystal displays centers around commercially feasible numerical readouts. Since each liquid-crystal digit consists of (at least) seven bars or segments, the problem of hooking up a multi-digit display becomes critical—though not as impossible as a TV-screen matrix. For example, a numerical display consisting of eight seven-segment liquid-crystal digits

[Continued on page 103]

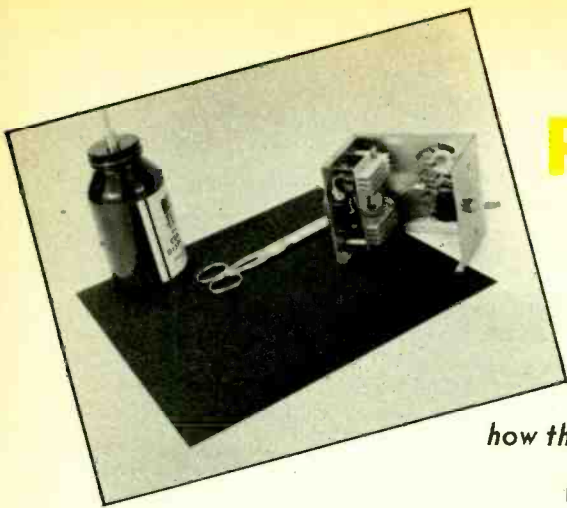

Putting Liquid Crystals to Work

Let's take a look at the practical side of liquid crystals by seeing how they change color when exposed to heat.

By JOHN POTTER SHIELDS and JORMA HYYPIA

WE HAVE seen that there are three types of liquid crystals—nematic, smectic and cholesteric—and that nematic liquid crystals make display systems upon application of an electric field. The crystals become turbulent, taking on a frosty appearance when they reflect incident light. Thus, a nematic liquid-crystal display turns on by reflecting light in patterns (numerals, letters, etc.).

However, liquid crystals can be used in *detection* systems as well as display systems. Turbulence in the crystals caused by electrical, magnetic or thermal (heat) energy is revealed when the crystals change *color*. In this article, we'll concentrate on using liquid crystals to detect heat (power dissipation) in semiconductors.

Cholesteric liquid crystals are best for this purpose because they exhibit colors that can be related to specific temperatures. Some of the cholesteric liquid crystals are sensitive enough to produce a minute color shift for one degree of temperature change (as the temperature rises, these liquid crystals change color from red to orange to yellow to green to blue).

Liquid crystals can be painted onto objects, but it's more convenient to use liquid crystals that are encapsulated in microscopic bubbles attached to sheets of plastic. The crystals don't become contaminated and thus last longer. These sheets can be pressed against (or glued to) the object being tested. The heat-induced color patterns that result—they resemble iridescent oil films—indicate the temperature of the device.

The color changes enable temperature variations in an electronic component to be detected and related to power dissipation.

For example, the breakdown point of a semiconductor rectifier's p-n junction can be pinpointed because abnormal heat produced by a high current creates a revealing color pattern. The procedure is simple. You just match the temperature range of your liquid crystals with the critical temperature of the rectifier (which should be provided in the manufacturer's spec sheet) and you're in business.

Luckily, home experimenters can use liquid crystals available from Edmund Scien-

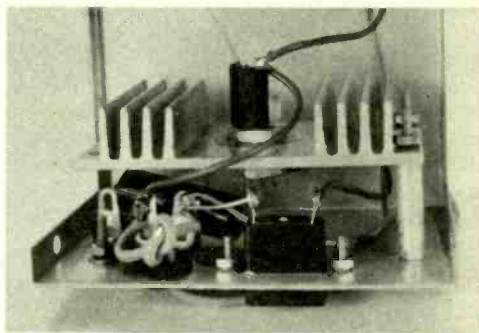

Photograph shows small piece of liquid-crystal sheet attached to triac. Mylar film encapsulating liquid-crystal substance may resist bending, so care must be exercised when you try to attach it.

tific Co., Barrington, N.J. 08007, (609) 547-3488, to study the effects of heat on electronic gear. These liquid crystals are available encapsulated on a substrate of Mylar film. (See page 142 of Edmund Scientific's Catalog No. 721).

There are six Mylar sheets in every kit which are sensitive to a specific temperature

range (66.2-77°F., 84.2-91.4°F., 86-96.8°F., 91.4-98.6°F., 95-96.8°F. and 113-120.2°F.). An experimenter's kit using 4 x 6-in. sheets costs \$4. A larger kit which has 6 x 12-in. sheets costs \$10. Graphs (see illustration) are included which relate these temperatures to specific colors. (A paint-on liquid-crystal set is also available for \$19.50. This is useful for objects having irregular surfaces, or where the surface area on a component is limited. Remember, however, that the liquid-crystal substance will deteriorate rather quickly since there is no encapsulation.)

The temperature range offered by Edmund Scientific that's most useful to check the power dissipation of electronic components—for instance, power transistors, SCRs, triacs, silicon rectifiers, zener diodes, ICs etc.—is 113 to 120°F. (45-49°C.). This sheet is included in every kit. (It's also available as a single 12 x 12-in. sheet from Edmund Scientific for \$2.75.)

Whatever size sheet you order, you can cut it up into smaller pieces to suit your experiment (e.g. to the size of the device). Note, however, that the Mylar-film encapsulation is stiff material and this sometimes makes it difficult to wrap the liquid-crystal sheets around components. Also remember that the colors result because the liquid crystals reflect incident light. Thus, the more they are illuminated, say, with a bright lamp, the more intense the colors will be.

Now let's get down to the business of using these liquid crystals to measure component temperatures. Our illustration shows a small strip of liquid-crystal sheet wrapped around a triac that's mounted on a heat sink (a dab of rubber cement will do the job fine).

Since a triac or SCR is designed to control a wide range of currents, large and small, it's helpful that the color changes for these components (which should be correlated with the color-temperature curves provided with the liquid-crystal sheet) can give an indication of when the devices are drawing too much current—or perhaps not enough for a specific application, such as a solid-state blender or light dimmer. If, for instance, the triac's critical temperature is in the blue portion of the curve, any change from green to blue will mean a burnout is imminent.

If you are working with output transistors (in pairs) any unbalance in these transistors' collector currents should become evident by a change in color of the attached liquid-

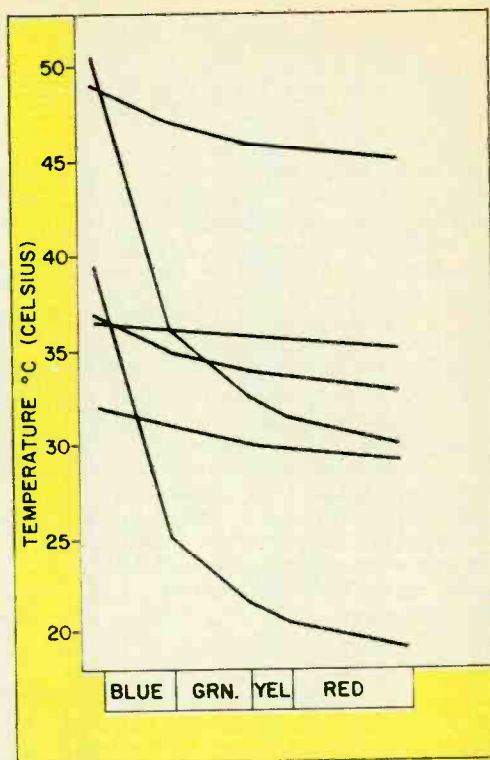

Graph of color-temperature curves is supplied by Edmund Scientific Co. with its kits of encapsulated liquid crystals. Sensitive crystals which show all colors within a few degrees have flat curves. Less sensitive crystals have steeper curves because greater changes in temperature are required to produce all colors. Curve for liquid-crystal sheet used in electronic experiments (range is 45-49°C.) is shown at top. Color change is from red to blue.

crystal sheets. If you do a lot of experimenting in the audio field, this is a quick and dirty—but effective—way of saving expensive power transistors.

Also, don't forget critical components such as resistors, rectifiers and transformer windings which may be crowded in some remote part of a chassis. If these should become too hot, a color change may be a quicker indication of trouble than the traditional technique of taking a whiff of burning insulation.

Burn, baby, burn is an outmoded form of troubleshooting, as well as a costly one (power transistors can run \$8 or more). Liquid crystals could be the answer you've been looking for.

VICTORY AT LAST! Dr. Peter C. Goldmark, a pioneer in the field of home-entertainment electronics who has retired from his position as head of CBS Laboratories, looks at a child whose birth was delayed some 30 years. It's the compact color TV camera made by RCA which was used by the Astronauts on the Apollo XV mission to send back magnificent color pictures from the moon's surface. The camera uses a field-sequential technique—where first red, then blue and finally green images are transmitted in a sequence—which was developed by Dr. Goldmark back in 1940. This is the only method which permits telecasting at the low light levels of the lunar atmosphere.



Electronics in the News



Pen name or photo credit? Editors at United Press International, a major news service headquartered in New York, are getting ready to create stories via a computer. A computer system to be installed at UPI by mid-1972 will permit an editor to display a news story on a video terminal so that he can prepare the copy for distribution to subscribers. First, stories filed by UPI correspondents are fed into the computer, then the computer prepares an abstract of the story suitable for visual display. The editor makes his changes via a keyboard and then feeds the story back to the computer for distribution on the newswire.

Bird's eye view of sun. Engineers at Hughes Aircraft Co. examine a scale model of what will be a new generation of Orbiting Solar Observatories. OSOs will be launched by NASA in 1973, 1975 and 1976—they'll provide the most detailed picture of X-ray and ultraviolet activity on the sun ever. One basic question NASA scientists hope will be answered is how the sun—a relatively cool body having a temperature of 10,000° F. at its surface—heats its 10,000-mile corona to a temperature of 4 million degrees.

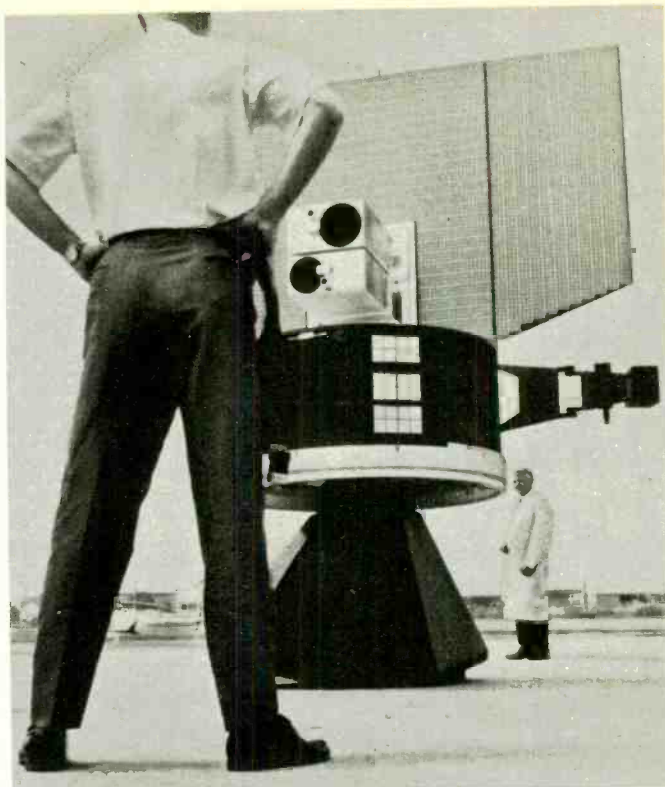

Is she programmed? No, the lovely lady is not listening to four-channel stereo. Believe it or not, she's closer to electronic warfare than high-fidelity sound. Teamed up with a Sony video tape recorder is EMI's (they're a major British electronics company) new radar signal recorder. The signal processor (at right) is filled with circuit modules so the device will adapt to all types of radar systems. It permits both primary and secondary radar signals to be recorded on magnetic tape.

10 Reasons why RCA Home Training is your best investment for a rewarding career in electronics:

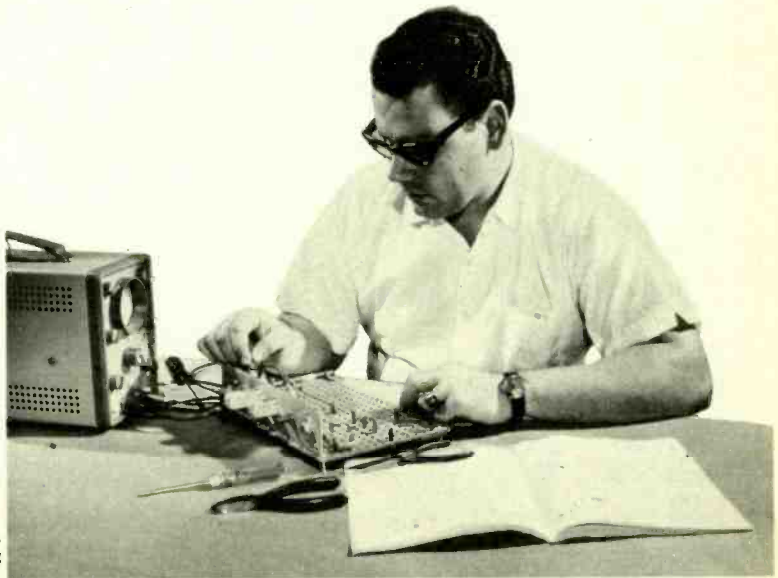

Performing transistor experiments on programmed breadboard — using oscilloscope

1 LEADER IN ELECTRONICS TRAINING

When you think of electronics, you immediately think of RCA... a name that stands for dependability, integrity, and pioneering scientific advances. For over half a century, RCA Institutes, Inc., a subsidiary of RCA, has been a leader in technical training.

2 RCA AUTOTEXT TEACHES ELECTRONICS FASTER, EASIER, ALMOST AUTOMATICALLY

Beginner or refresher, AUTOTEXT, RCA Institutes' own method of programmed Home Training will help you learn electronics more quickly and with less effort, even if you've had trouble with conventional learning methods in the past.

3 WELL PAID JOBS ARE OPEN TO MEN SKILLED IN ELECTRONICS

RCA Institutes is doing something positive to help men with an interest in electronics to qualify for rewarding jobs in this fascinating field. There are challenging new fields that need electronics technicians... new careers such as computers, automation, television, space electronics where the work is interesting and earnings are greater.

4 WIDE CHOICE OF CAREER PROGRAMS

Start today on the electronics career of your choice. On the attached card is a list of "Career Programs", each of which starts with the amazing AUTOTEXT method of programmed instruction. Look the list over, pick the one best suited to you and check it off on the card.

5 SPECIALIZED ADVANCED TRAINING

For those already working in electronics or with previous training, RCA Institutes offers advanced courses. You can start on a higher level without wasting time on work you already know.

6 PERSONAL SUPERVISION THROUGHOUT

All during your program of home study, your training is supervised by RCA Institutes experts who become personally involved in your efforts and help you over any "rough spots" that may develop.

7 HANDS-ON TRAINING

To give practical application to your studies, a variety of valuable RCA Institutes engineered kits are included in your program. You get over 250 projects and experiments and as many as 22 kits in some programs. Each kit is complete in itself. You never have to take apart one piece to build another. They're yours to keep and use on the job.

8 FCC LICENSE TRAINING—MONEY BACK AGREEMENT

Take RCA's Communications Career program—or enter with advanced standing and prepare immediately for your 1st, 2nd, or 3rd class FCC Radio Telephone License examinations. RCA Institutes money-back agreement assures you of your money back if you fail to pass the FCC examination taken within 6 months after completing the course.

9 CONVENIENT PAYMENT PLANS

You get a selection of low-cost tuition plans. And, we are an eligible insti-

tution under the Federally Insured Student Loan Program.

10 RCA INSTITUTES IS FULLY ACCREDITED

RCA Institutes is an accredited member of the National Home Study Council. Licensed by N. Y. State—courses of study and instructional facilities are approved by the State Education Department.

**VETERANS: TRAIN
UNDER NEW GI BILL**

SEND ATTACHED POSTAGE PAID CARD TODAY! FREE DESCRIPTIVE BOOK YOURS WITHOUT OBLIGATION!

If reply card is detached, send this coupon today.

RCA INSTITUTES, INC.
DEPT. T. 234-203-0
320 W. 31 ST.
NEW YORK, N. Y. 10001

Please send me FREE illustrated career catalog. I understand that I am under no obligation.

Name _____

Address _____

City _____

State _____ ZIP _____

Age _____

Veterans: Check here

Construction of Multimeter.

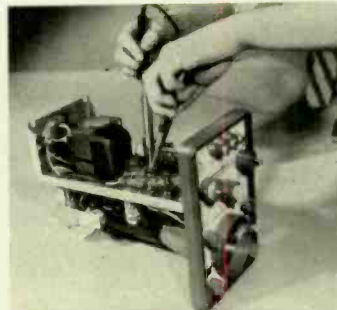

Construction of Oscilloscope.

Temperature experiment with transistors.

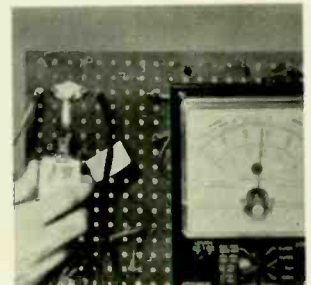

Hi-Performance Converter for 2 Meters

Stepping up to 2 meters? Our low-cost 2-meter converter features good selectivity and sensitivity—and it works with your present rig.

By JIM WHITE, W5LET

THE 2-meter band can be lots of fun. What other band lets you call other hams over 50 to 60 mi. away with just a few watts? And on what other band can you call via repeater to a mobile far beyond the normal capabilities of your equipment? Two meters has a lot of advantages over the lower bands. There are some disadvantages but, fortunately, these can be overcome.

One of the problems encountered by most newcomers stepping up to VHF is lack of a good receiver. Most hams can't afford the luxury of a separate 2-meter rig. Figuring that a converter is the answer, they buy one, hoping it will mate with the communications rig they already own. The fledgling VHFer is almost immediately discouraged by his newly purchased cheap-and-simple converter.

For consistent reception on 2 meters, a high-performance converter is a must. Our Hi-Performance Converter was designed and built with two basic objectives in mind: sensitivity and selectivity at low cost.

How It Works. Our performance-proven converter uses the latest semiconductors throughout. Two RF amplifiers (Q1 and Q2) boost the input signal. The antenna is coupled to Q1, a dual-gate field-effect transistor. This transistor provides excellent sensitivity and superior immunity to cross modulation. The first RF amplifier is followed by Q2, a junction-type FET. Both input and output of the RF amplifiers are tuned to 2 meters.

The second RF amplifier is followed by Q3, another FET. It operates as a mixer. The output of this stage is tuned to 16 mc.

The local-oscillator portion of our converter is crystal controlled. Consisting of bipolar transistor Q4, its output is tuned to 43.33 mc. The other transistor, Q5, is an FET. It's tuned to Q4's third harmonic—or 130 mc. The circuit shown assures sufficient oscillator injection to the mixer.

Included on the same mounting plate with the RF portion of the converter is a power supply that provides about 13 VDC. A 12-VAC low-voltage transformer (T1) bridge rectifier assembly (SR1-SR4)

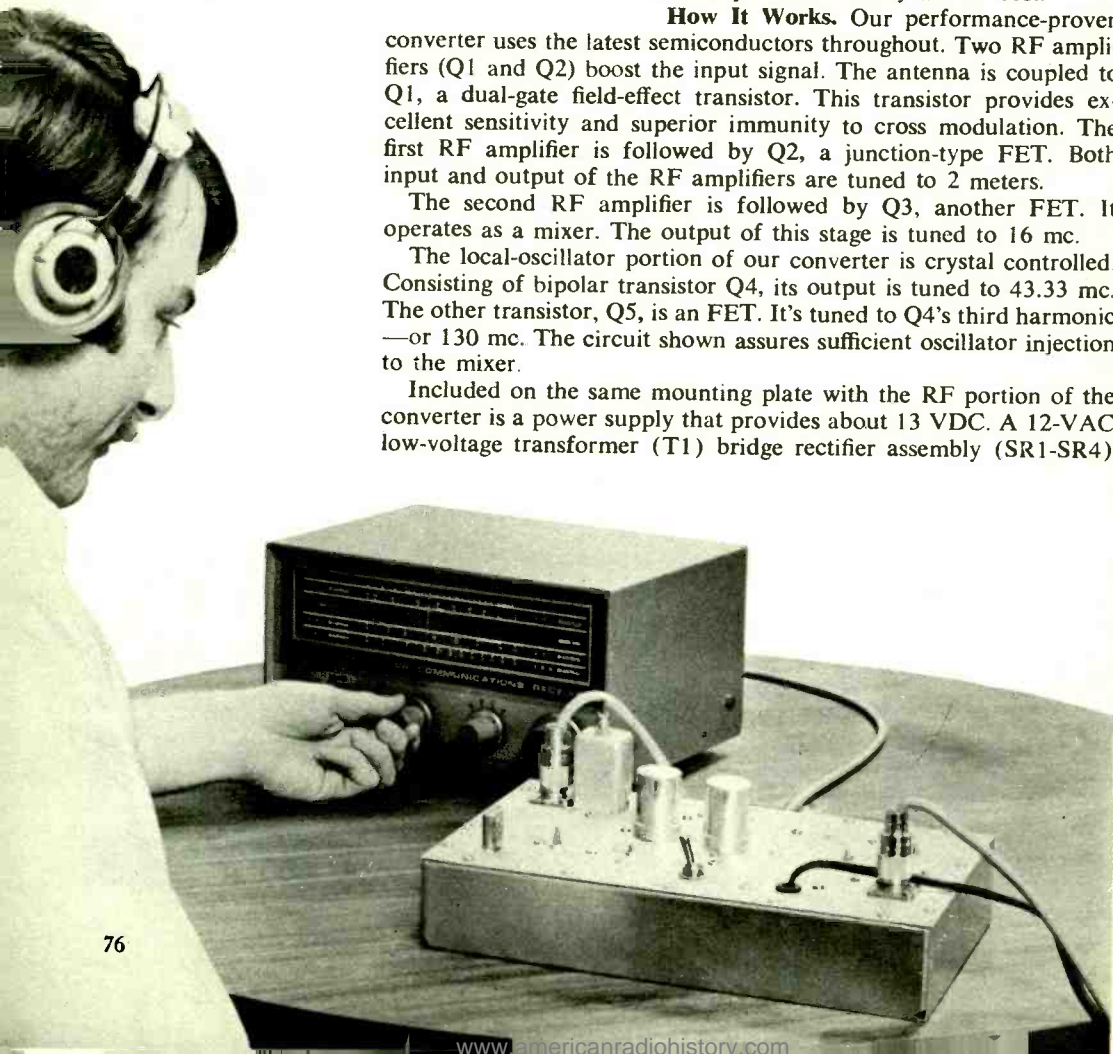

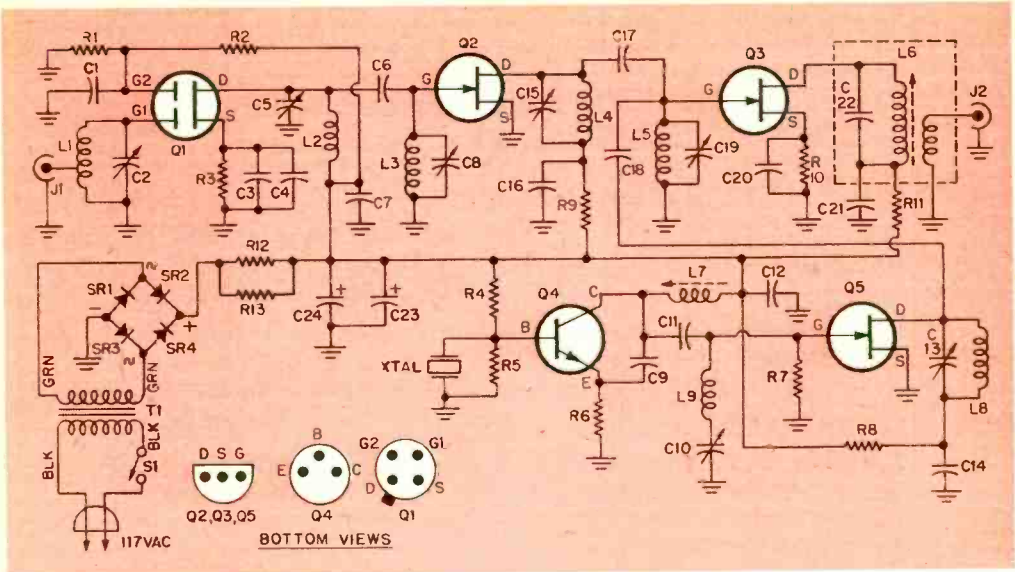

Fig. 1—Complete schematic of 2-meter converter shown here. Capacitor C18 consists of two lengths of No. 20 insulated hookup wire twisted together. Keep all lead lengths short in first two RF amplifier stages.

PARTS LIST

C1,C3,C7,C14,C16—.001 μ f button type capacitor
 C2,C5—2 to 6 μ f ceramic trimmer capacitor
 C4,C12,C14,C21—.01 μ f 50 VDC ceramic disc capacitor
 C6—12 μ f silver mica capacitor
 C8,C13,C15,C19—1 to 7 μ f compression type trimmer capacitor
 C9—6.8 μ f silver mica capacitor
 C11—15 μ f silver mica capacitor
 C17—5 μ f silver mica capacitor
 C20—.002 μ f 50 VDC ceramic disc capacitor
 C22—22 μ f silver mica capacitor
 C23,C24—1,000 μ f @ 15 electrolytic capacitor
 Q1—Dual gate FET RCA type 40600
 Q2,Q3,Q5—Junction FET Motorola type MPF102
 Q4—2N706A
 Resistors: All resistors $\frac{1}{2}$ watt, 10% unless otherwise indicated
 R1—47,000 ohms
 R2—100,000 ohms
 R3—120 ohms

R4,R10—10,000 ohms
 R5—3,300 ohms
 R6,R8—100 ohms
 R7—1 megohm
 R9—1,000 ohms
 R11—470 ohms
 R12,R13—47 ohms, 1 watt
 SR1-SR4—Bridge rectifier unit: minimum rating 200 PIV @ 1 A.
 T1—Low voltage transformer; primary: 117 VAC, secondary: 12.6 V AC @ 1A.
 XTAL—43.333 mc. third overtone type crystal
 1—7 x 11 x 2-in. aluminum chassis
 1—Bottom chassis cover 7 x 11 in.
 2—Chassis type coax connectors
 1—Crystal socket
 1—Slug-tuned coil form $\frac{1}{4}$ in. dia.
 2—Slug-tuned coil form $\frac{3}{8}$ in. dia.
 Misc.—3 ground lugs, 8 3-lug terminal strips, 3 1-lug terminal strips, 1 4-lug terminal strip, 1 5-lug terminal strip, No. 20 solid No. 22 stranded wire, 5-32 hardware, line cord, etc.

and two filter capacitors (C23 and C24) make up this part of the circuit.

Our converter is constructed in an unorthodox manner. An aluminum chassis measuring 7 x 11 x 2 in. serves as the base for the converter. There are two advantages to this type of construction: easier building and good shielding. The converter is built on an aluminum plate and is attached to the chassis with sheet-metal screws.

Building the Converter. Before you actually begin construction, take a look at the pictorial. It is absolutely necessary that you follow the layout for the RF portion of the converter just as shown.

Begin by building the oscillator stage. Note

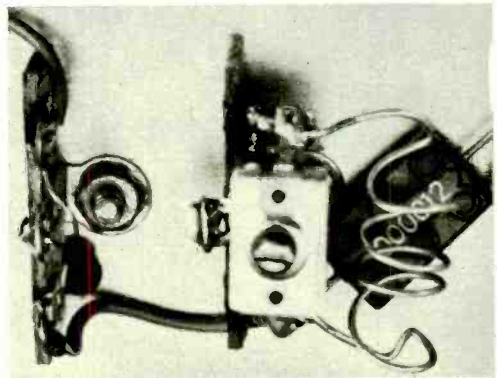
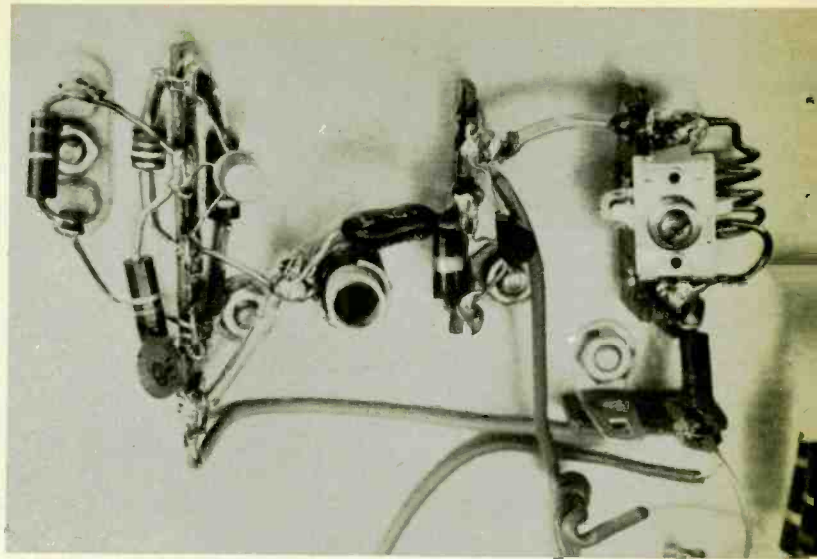

Fig. 2—Coil L3 on top of C6. To left is transistor Q2, second RF amplifier stage. Spread L3 as shown.

Hi-Performance Converter for 2 Meters

Fig. 3—Oscillator stage Q3 is shown to the left while tripler output stage Q5 and components are at the right. Capacitor C18 is twisted piece of wire.



that this stage, as well as others, makes liberal use of terminal strips. Build the tripler stage next. When you have completed both stages, you can check your work. Insert a 43.333 mc crystal in the socket. Now connect the positive terminal of a 9-V battery to the junction of components L7 and C12.

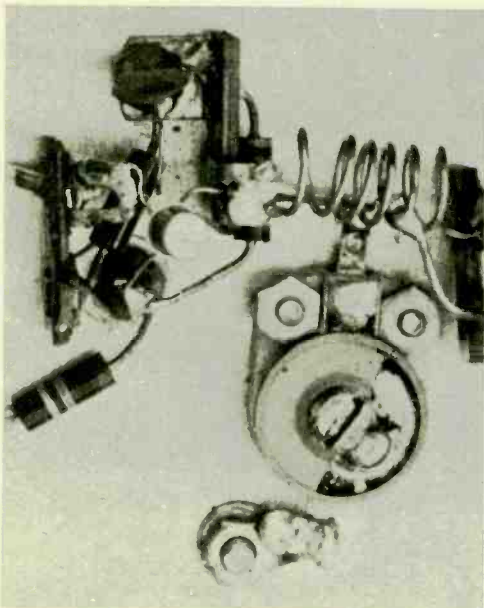

Fig. 4—Short leads are the rule for the first RF amplifier stage, shown above. You might want to experiment with the location of the input tap on L1 in order to get optimum converter performance.

Attach the negative battery terminal to the mounting plate. Connect a VTVM to the gate of Q1 and turn L7's slug until a negative voltage is indicated on the meter. Your reading should fall between 6 and 15 VDC.

The tripler stage is checked by connecting a VTVM through an RF probe to Q5's drain via a 5- μ f capacitor. Peak coil L8 by turning C13's adjusting screw with an insulated screwdriver. If both oscillator and tripler stages check out, proceed to build the mixer.

Mixer stage (Q31) is built in a straightforward manner. Output transformer L6 is constructed separately and later installed on the chassis. Both primary and secondary coils are wound on a $\frac{3}{8}$ -in. slug-tuned form. The primary consists of 22 turns of No. 28 enamelled wire closewound. The secondary winding consists of four turns of No. 22 solid hookup wire wound over the primary. Solder C22 across the primary. Install L6 in a square shield can cannibalized from an old IF transformer.

Capacitor C18 is made by twisting two lengths of No. 20 insulated hookup wire together. Eight or nine turns, about an inch long, is sufficient. See the pictorial for details.

Components L5 and C19 as well as Q3 are terminal-strip-mounted. Coil L5 is self-supporting and is made of No. 20 hare hookup wire.

The two RF amplifiers are constructed in the same manner as the mixer. No special precautions need be observed except when

[Continued on page 98]

How To Defeat Color TV Beat



By ART MARGOLIS

Getting rid of herringbones, wiggly lines and swirling colors is a lot easier than you may think. A screwdriver, diddlestick and quick thinking will do it.

EVERYBODY at one time or another is bothered by herringbones, lightning bolts and other gremlins that quickly turn a color TV into a mod version of a barber's pole. Fortunately, such havoc is easy to get rid of. All it takes is a little thought and no tools other than a screwdriver and a plastic hex-head diddlestick.

Two questions to think about are: One, is the beat caused by an external signal or does it originate inside the TV? Two, what is the name and frequency of the beat signal?

Now that you know what questions to ask and what kind of tools to use, four typical case histories should help you clean up the screen.

Outside Interference. The voice on the phone sounded irritated. "Ever since you installed this new antenna system, channel three has been a zero." I recognized the voice immediately. It was Jack Wilson, the owner of Wilson Chemical Co., a small plant at the edge of town. I said, "Be right over."

At setside I switched to channel three. A beautiful color picture appeared. I looked at Wilson quizzically. He snapped, "It doesn't happen all the time." Then it zonked us. A herringbone pattern appeared on the screen. At first it whirled round and round, then it became stationary.

Wilson said, "Now watch this!" He took a small screwdriver, disconnected the antenna lead from the terminals and put his finger there instead. The beat pattern dissolved and a sickly version of channel three appeared. When he reattached the antenna lead, a strong channel three reappeared—complete with the beat pattern overlay.

I nodded. Then he said, "No doubt it's the fault of your antenna." I smiled. I reached over to the control box of his antenna rotor, noted the heading NE and gave it a new heading due north. The box clattered. I could picture the large antenna head lumbering around to the new heading.

Wilson said rather startled, "It's gone."

I said, "Yes, but your channel three is not as good either." I continued, "You're picking up some kind of TV interference. It looks like a transmitter operating in the 30 to 50 megacycle Special Services band. Evidently the transmitter is northeast from here. Channel three is probably northeast from here, too. When you aim your new directional antenna to get channel three you're also aiming at the source of the TVI. Let's see if we can pinpoint it."

I picked up the phone and called the shop. My son Denny answered. I said, "Den, rotate our big antenna and see if you can pick up

some herringbone on channel three. Get me the exact direction."

While he was doing that I went out to the truck and rummaged around for a high-pass filter that cuts off at 52 mc and a map of our town.

Back in the house, I attached the wavetraps to the antenna terminals and reset his antenna to northeast. The beat pattern all but disappeared. He beamed.

Then the phone rang. I picked it up. "Yeah. Den."

He said, "I get some beat on channel three when I point our antenna due east." I thanked my son for the prompt call and reached into my pocket for the map.

I laid out the map and marked the locations of Wilson's house, our shop and channel three. Sure enough, channel three's transmitter was directly northeast. Then I drew two lines on the map. One ran from Wilson's house northeast and the other ran due east from our shop. The lines intersected near the corner of 68th Avenue and North First Street.

Jack Wilson was watching me. He said, "Why that's exactly where my plant is."

I asked, "Do you have any electronic gear there?"

He said quietly, "Why no, we are a chemical company." Then he mused, "Wait a minute, we did have to get some kind of permit for a new kind of heater. Works on RF energy or something."

I charged him for a service call and the

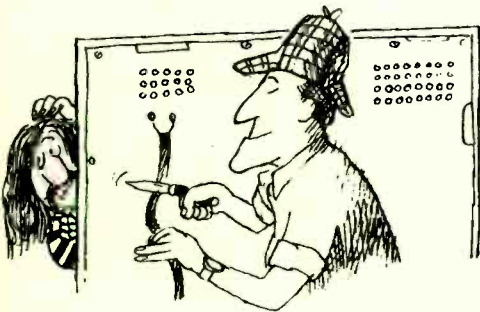

high-pass filter. "Better get it adjusted before somebody else complains to the FCC." I advised. As I drove away he waved with a bewildered look on his face.

Dancing With A Silent Partner. On a rainy day I got a call from a guy whose color set was on the fritz. I paused in the doorway of his den and watched a boy and girl—both

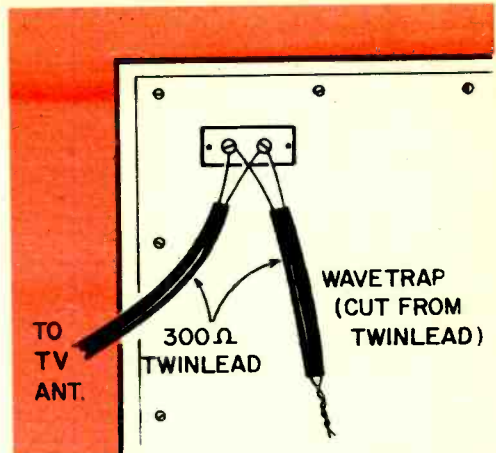

Quick and dirty wavetraps can be cut from 300-ohm twinlead to remove FM radio interference. FM signal beats with carriers of channels 7 thru 13.

about sixteen—dancing some kind of rock. But there wasn't a sound in the room, not a note of music.

They spotted me and stopped. The girl's father shooed them out and then took me over to the TV. It was on, but the sound was turned down.

The father looked at me, shrugged and turned the sound up. The TV sounded fine. He said, "Art, the set is working okay except for channel seven. Watch!"

He tuned in a color picture. Just at the point where the color should have been perfect an undulating herringbone pattern appeared. I thought to myself, it's not a fixed frequency otherwise the pattern would be steady. It's being modulated by some sort of signal.

A nearby FM station can do this by throwing a beat signal into one of the high-band (7-13) channels. I reached into my tube caddy and took out a tunable trap. I attached it to the antenna lead-in and tuned it from one end of the FM band to the other (from 88 to 108 mc). At about 102 mc the herringbone disappeared.

The owner smiled. Meanwhile the young couple drifted back in. I removed the trap and got a piece of 300-ohm lead from the truck.

My FM trap is an expensive item—since it covers the entire FM band—and I use it strictly for testing. A simple wavetraps for a single frequency can be made with a length of 300-ohm lead.

I attached one end of the lead-in wire

How To Defeat Color TV Beat

to the antenna terminals. While watching the TV screen, with the aid of my pocket knife I began a trial-and-error shorting procedure. I pushed the blade of the knife through the insulation of the ribbon

lead until the steel blade shorted one wire to the other. At different points along the wire the short eliminated the beat signal to a greater or lesser extent. Then I hit the spot where the FM beat disappeared altogether.

I cut the wire an inch further down along the ribbon, stripped it back an inch and shorted the two exposed ends together. That was it. The beat was gone.

The father smiled, but the younger fellow frowned. "Sir," he asked. I looked up. He continued, "Is there any way I can get that beat pattern back?"

I nodded, "Sure, just take off the trap. However, this gentleman is going to pay me for attaching it."

He interrupted, "Oh, I'll put it back on later. It's just that we were dancing a new dance. Instead of dancing to a sound beat we've been dancing to the picture beat."

The Moving Windshield Wiper. A bass voice on the phone said, "This is John Barclay of Barclay and Baird. I wonder if you could give me some advice?" I recognized the firm as a well known law partnership located in the county seat about thirty miles away.

He continued, "Ah, what is your normal service charge for color TV sets?"



I said, "In your area we charge \$9.95."

He went on, "Well, you won't need to come out here, just give me some advice."

I sighed, "Yes sir, what is it?"

"Well, we just had cable TV installed in our home—two outlets, one in the living room and the other in the bedroom. Now, in the bedroom there is a black and white portable and in the living room there is a 23-in. color set."

I let out an "Uh-huh."

"Well, on both TV's I get some interference on channel ten that looks like a moving windshield wiper. With the portable I can use the fine tuner to get it out. But on the color TV, if I get it out with the fine tuner I also lose color. Then, when I try to tune the color back in, the windshield wiper starts up again."

I interjected, "That windshield wiper is called adjacent channel interference. It is actually the picture signal of channel eleven slopping over into channel ten."

He said, "That's very interesting, but how
[Continued on page 97]

TV interference which remains stable during tuning usually results from external signals. Tunable TVI is caused by TV receiver's circuits. One common problem, 920-kc beat, is caused by color subcarrier beating with a sound carrier that shouldn't be present in third video IF stage. Sound carrier is removed via two traps—the sound reject pot and a 41.25-mc trap. Adjust sound reject first, then the 41.25-mc trap if necessary.

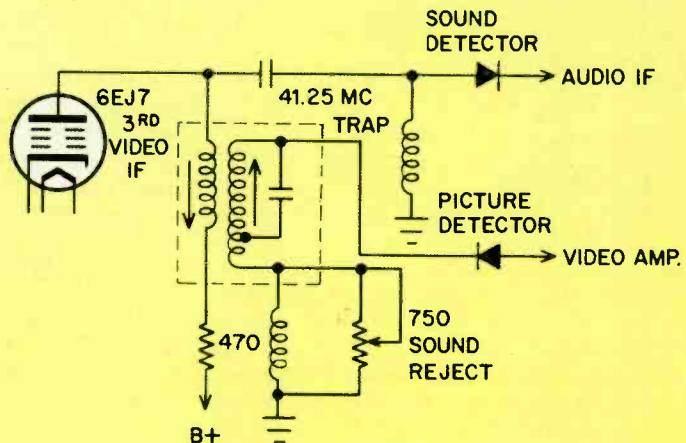

CB Corner

By Len Buckwalter,
KQA5012



Latest Figures on CB

THE LATEST FCC figures are out and a few of the statistics are revealing. This agency now regulates about 50 different types of mobile radio—from police cars to pizza wagons—and two-way radio is the largest group it controls.

Guess who's the biggest group in the land? CB is the winner, with 886,951 licenses issued. That's about three times more fans than the closest competitor has—ham radio with 275,451 tickets. Third down the line are ships, with about 201,000 tickets.

Besides figures, we have an exciting regulation from the 1510 people who make up the FCC. Channel 9 has been set aside for emergency communications. Another notable happening, a new schedule of whopping license fees has gone into effect. Before the fee increase, the FCC collected about \$4.6 million on CB applications. This now should puff up to about \$24.9 million. This last figure is a twit above the amount appropriated by Congress (\$24.5 million) to keep the FCC in application forms and direction-finding gear. It means that the 36-year-old FCC should be self-supporting.

The fearless detectives of the FCC's Field Engineering Bureau cracked down on enough CB outlaws in one 12-month period to begin 300 hearings to revoke licenses. Surprisingly, the number was down slightly from the previous 12 months (335 cases), but there probably has been less CB activity because of the recession rather than any outbreak of honest operating.

One startling figure buried in these raw statistics may stop some of the wild talk about CB law-breakers. Maybe they're not such a dastardly lot, after all. During these 12 months FCC inspectors swooped down on nearly 2000 commercial broadcast-radio stations—the men who bring us Marcus Welby and Doris Day! In more than half of these investigations, broadcasters were found to be violating one or more FCC rules.

Throttling RF Gain. Few CBers ever complain that incoming signals are too strong but overpowering RF from a nearby neighbor or mobile station can cause trouble. The usual

symptom is front-end overload, which transforms audio into a blather. This even can happen when a powerful station on a different channel sneaks into the receiver and blocks one you're working. Yet another malady is cross-modulation, where potent interference embraces the signal you're hearing and modulates it.

That's why almost all ham and communications receivers have a front-panel control marked RF Gain. This pot lets the operator throttle back the RF amplifier stage, where most overload troubles occur.

Since the RF stage often operates over a million-to-one range, it needs some manual assistance. Some CB receivers get by without the control by relying on an automatic gain control (AGC). A few manufacturers, though, add the RF gain control to CB sets. This raises the question of whether it's essential or just nice to have.

If your set is single-sideband, then RF gain is as important as a standard volume control. Sideband (SSB) confuses AGC circuits and it's better to adjust a radio-frequency amplifier manually for each incoming sideband signal.

When your rig is operating in conventional fashion you can get along nicely without this accessory. It just might be a good idea, though, if you're plagued by neighbors who fill your receiver with false responses or people who run up power with illegal linears. An RF gain control affords a slight tuning advantage in the rare case of too much rather than too little.

Trunking CB Channels. In my last column I discussed a study, done by Advanced Technology Systems, Inc., for the FCC, which was based on a sampling of 9,296 CBers selected at random by the U.S. Census Bureau. One suggestion brought forth by ATS in its report seems especially commendable. It's borrowed from the trunking system used by telephone companies. Here's how it works.

The study discovered that many CBers own multichannel rigs but typically operate on only one, two or three channels. To contact

[Continued on page 104]



We Search for the Winners of EI's Win-the-World Contest!

OUR Win-the-World Contest draws to a close . . . but slowly, and the end has not quite been reached at this writing.

EI here again presents the list of 100 great prizes and at the right is the list of finalists. The winners are all in that group. But not everybody in the group is a winner.

And, as you will soon note, the names are shown in alphabetical order rather than by ranking. The ranking process—determining who gets what prize—is still going on as

this is being written.

The contest has not been decided quite as soon as we had planned because of the complications brought about by the necessity of verifying a huge number of QSL cards and letters. The verification process has turned out to be a longer-lasting job than we at EI had anticipated.

To repeat what we've just said: at this writing we have not arrived at a ranking of the winners. But material that appears in

PRIZE	DESCRIPTION	PRIZE	DESCRIPTION
GRAND	A trip to your favorite country anywhere in the world via Pan American World Airways, the world's most experienced airline	31st-35th	Hallicrafters CR-44A Ranger portable shortwave receiver
2nd	RCA G-2000 color TV set	36th	Avanti Moonraker CB base-station antenna
3rd	Heathkit/Thomas Legato organ kit	37th	Ameco R-5A receiver
4th-5th	Heathkit GR-370 color TV kits	38th	DeltaAlert ultrasonic intrusion detector
6th-7th	Conar color TV kits by National Radio Institute	39th-41st	Hallicrafters S-240 entertainment/communications receiver
8th-13th	Your choice of home-study course from: Cleveland Institute of Electronics, CREI, ICS, National Radio Institute, National Technical Schools, RCA Institutes	42nd	Two CB mikes from Turner
14th	Hallicrafters SX-122A receiver	43rd	Edmund Scientific Deluxe Visual Effects Projections Set plus Rippling Color Accessory
15th-19th	Hallicrafters SX-133 receiver	44th-45th	Hallicrafters skip-band receiver
20th	Advent 201 cassette tape deck	46th	Eico 3450 four-channel color organ
21st	Sony STR-6055 stereo FM/AM receiver	47th	\$100 credit with Electro-Voice for any equipment in their latest catalog, including miniature 651C communications mike
22nd	RCA WO-505A solid-state scope	48th	Complete library designed for hams and SWLs from the Howard W. Sams Publishing Co.
23rd	Lafayette Radio Teistat SSB-25 SSB CB transceiver	49th	\$100 credit for any antenna in the latest catalog of Antenna Specialists
24th	RCA WR-52A Stereo FM Signal Simulator	50th	Mallory MCR-1232 portable cassette recorder
25th	Allied Radio Shack Patrolman PRO-3 VHF/UHF receiver	51st	\$100 credit with Shakespeare, one of the leaders in the CB antenna field
26th	Sansui QS-1 Quadphonic Synthesizer	52nd	A library of the latest bestsellers from Tab Books Co.
27th	Weston 666 solid-state VOM	53rd-100th	One year subscription to electronics hobbyist's favorite magazine— ELECTRONICS ILLUSTRATED
28th	Courier Citation solid-state base-station CB transceiver		
29th	Olson RA-280 stereo FM/AM solid-state receiver		
30th	RCA WR-502A solid-state color-bar generator		

magazines is prepared several weeks in advance of publication. So by the time you read these words the prize lineup of who has won what will have been decided.

If your name appears in our list, by now you should have received the good news that you're going to the country of your choice or that you've won a color TV set, a communications receiver or perhaps a subscription to EI . . . or you've been informed simply that we have to tell you that you were disqualified or, in the last runoff, ranked too low to qualify for a prize. In other words, all finalists will be informed about what happened, whether they win a prize or not. This

means anybody whose name appears in the box below.

In addition, we have decided to try to answer any questions posed by other contestants—those who did not become finalists. Queries should be addressed to EI at 1515 Broadway, New York, N.Y. 10036.

One point we'd like to make about the entries: a huge proportion of the contestants obviously went to great lengths to follow the rules scrupulously. We appreciate their effort and win or lose, we hope the contest was fun for all.

The final list of winners and their prizes will appear in our next (May) issue.

Kent Allingham, Manhattan, Kansas
 Jeff Angwin, Palo Alto, Calif.
 Michael Antonucci, Granby, Conn.
 Michael Barnard, Liberty, Ind.
 Peter Barthelson, Hockessin, Del.
 Marilynne Basrub, Gardena, Calif.
 Terry Batt, Elmhurst, Ill.
 John Bell, Quebec, Canada
 Doug Black, Thousand Oaks, Calif.
 Clyde Blake II, Ely, Vt.
 John Boegehold, Orchard Lake, Mich.
 Robert Borsell, Milwaukee, Wis.
 Robert Bowman, Roanoke, Va.
 John Brunst, Neptune Beach, Fla.
 Kip Butten, Girard, Ohio
 Thomas Carrigan, Worcester, Ma.
 Ira Castain, Menlo Park, Calif.
 Steve Ceder, Arverne, N.Y.
 David Chaffin, Memphis, Tenn.
 Richard Clem, Minneapolis, Minn.
 M. L. Cohen, Milton, Mass.
 W. J. Cronin, Worcester, Mass.
 David DiDomenica, Needham, Mass.
 Robert Dobson, Williamsburg, Va.
 Phil R. Donovan II, Lynn, Mass.
 Paul Dureno, Maidstone, Ont.
 Chuck Edwards, Fort Lauderdale, Fla.
 Bob Emery, Allentown, Pa.
 W. W. Forbes, Cudahy, Calif.
 Herbert Foster, Kalaheo, Hawaii
 Gary Franklin, Salinas, Calif.
 Robert Fritz, Moline, Illinois
 William Fulcher, Hendersonville, Tenn.
 Douglas Garlinger, Portland, Ind.
 Brian Garrison, Putnam Valley, N.Y.
 Karl Geag, Freiburg, W. Germany
 Rodney George, Urbana, Ohio
 Gregory Ginn, Hermosa Beach, Calif.
 Raymond Ginn, Hermosa Beach, Calif.
 Roger Goat, Antioch, Calif.
 Stanley Golemski, Passaic, N.J.
 Andrew Graham, Leavenworth, Kan.

Bruce Greene, Howell, Michigan
 James F. Hall, Champaign, Ill.
 E. H. Hamill, Burlingame, Calif.
 Garry Hammond, Ontario, Canada
 Philip Hanrahan, New York, N.Y.
 Randy Hanrahan, Whitetail, Mont.
 Russ Hayes, Massillon, Ohio
 S. A. Hayward, Dayton, Ohio
 E. P. Hollatz, Ontario, Canada.
 K. H. Hollatz, Ontario, Canada
 David Hudson, Lynchburg, Va.
 Alan Hunter, Saskatchewan, Canada
 Randy Iloff, Ailton, Ill.
 Larry Jardin, San Andreas, Calif.
 Steve Jess, Escondido, Calif.
 Michael Jones, Austin, Texas
 Stevem Kaplan, No. Miami Beach, Fla.
 Freddy Katz, Nashville, Tenn.
 Jim Kays, Ontario, Canada
 Chris Killingsworth, Ponca City, Okla.
 Richard Koret, Rochester, N.Y.
 Mark Korroch, Lansing, Mich.
 Joe Larabell, Brighton, Mich.
 D. Warren Lechthaler, Baltimore, Md.
 Silvi, Lee, Fairport Harbor, Ohio.
 Jim Leonard, Santa Ana, Calif.
 Joel Leonard, Rochester, N.Y.
 Mark Lewis, Kilmore, N.Y.
 D. McDonald, Ontario, Canada
 Alan McNeil, Chicago, Ill.
 C. Marietti, Chicago, Ill.
 Stephen Martin, Upper Marlboro, Md.
 Lewis Masson, North Chatham, Mass
 Raymond Merigold, Plainville, Mass.
 Rod Montrose, Ontario, Canada
 F. Murphy, Buena Park, Calif.
 Paul Murphy, Goshen, N.Y.
 Greg Nelson, Largo, Fla.
 Harry Okey, La Jolla, Calif.
 Leonard Dshushek, Camden, N.J.
 Jimmy Parker, Napa, Calif.
 Jeffrey Peltz, Brooklyn, N.Y.

Greg Pfauth, Michigan City, Ind.
 Charles Pfister, Bloomington, Ind.
 Matthew Popecki, Burlington, Vermont
 James Preston, San Diego, Calif.
 Jerome Pumo, Des Moines, Iowa
 V. J. Read, B. Columbia, Canada
 David Reed, Wilmington, Del.
 Lester Reynolds, Lyons, N.Y.
 Jordan Roderick, Port Washington, N.Y.
 Konstantine Rychalsky, Bridgeport, Conn.
 Gleason Sackman, Belcourt, N. D.
 T. Sattler, Jupiter, Fla.
 Richard Saxton, Middletown, N.Y.
 Richie Scalco, Wheaton, Md.
 Marc Schlessinger, Philadelphia, Pa.
 Henry Seidner, Pearl River, N.Y.
 M. H. Shepas, Pittsburgh, Pa.
 David Shultz, Tulsa, Okla.
 Ronald Shurtz, Topeka, Kansas
 Philip Sindermann, Watertown, Wis.
 Philip Singer, East Lansing, Mich.
 Steve Steckly, Madras, Oregon
 David Sternberg, Deerfield, Ill.
 Harold Sullivan, Fridley, Minn.
 Wendell Sweeney, Tampa, Fla.
 Ronald Szymczak, Chicago, Ill.
 Tibor, Tancs, Roselle, Park, N.J.
 Thomas Tesch, Millbrae, Calif.
 Ray A. Thompson, Decatur, Ill.
 Anthony Tiona, Bradenton, Fla.
 Don Twietmeyer, Rochester, N.Y.
 Thomas Twine, Suffolk, Va.
 J. H. Van Winkle, Tucson, Ariz.
 Robert Vance, Kansas City, Mo.
 James Wildrick, South Bend, Ind.
 Darrell Williams, Jr., Manton, Mich.
 Keith Witt, Mundelein, Ill.
 Harry Wong, San Francisco, Calif.
 Mike Wood, Rocky Mount, N.C.
 Mike Yuhas, Boulder, Colorado
 Phil Zurewsky, Baltimore, Md.

El Kit Report

Now...The AR-3a in Kit Form

Heathkit AS-103

THE YEAR was 1959. When Heath's Christmas catalog arrived, we were excited to discover a new speaker kit, the \$69.95 AS-2. It was their version of the Acoustic Research AR-2 which, with the AR-1, made headlines in the audio world in the mid-Fifties.

The AR-2 was AR's low-price acoustic-suspension speaker system. The AR-1, which was the top-of-the-line speaker, has since passed into history. Its direct descendant was the AR-3 which has now been updated by the AR-3a.

Heath recently introduced the AS-103, a kit version of AR's new top-of-the-line speaker—the \$250 AR-3a. In the same oiled-walnut cabinet as the AR-3a, the AS-103 sells for \$189.50.

In the world of hi-fi, AR's Model AR-3a and its predecessor the AR-3, have long been regarded as two of the best speaker systems available. In fact, many professional audio people, including our reviewer, use the AR-3a as a standard by which to judge other speaker systems.

The AS-103 and the AR-3a differ only in outward appearance. The grille cloth on the AS-103 looks a bit different and is removable, while on the AR-3a it is not removable. Also, on the rear panel, the mid-range and high-frequency driver level-control knobs and the binding posts are different. Most noticeable, however, is the 3-A fuse on the AS-103 which is not on the AR-3a. The fuse has been incorporated by Heath to prevent damage to the speaker in the event of severe overdrive. Here, the dissimilarities between the AS-103 and the AR-3a end. The sound of the two systems is indistinguishable.

Both the AR-3a and the AS-103 measure 25 x 14 x 11 $\frac{3}{4}$ in. and weigh 53 pounds. The woofer in both speakers is a 12-in. acoustic-suspension driver.



The acoustic-suspension principle is responsible for the AS-103's excellent low-frequency performance. When the AR-1 speaker system, the first to use the acoustic-suspension principle, was introduced in 1954, it radically changed previously held ideas about the size a speaker system had to be to re-



Low-frequency driver is at top; midrange and high-frequency drivers, crossover inductors are below. At the top right is 50/150 μ f crossover capacitor.

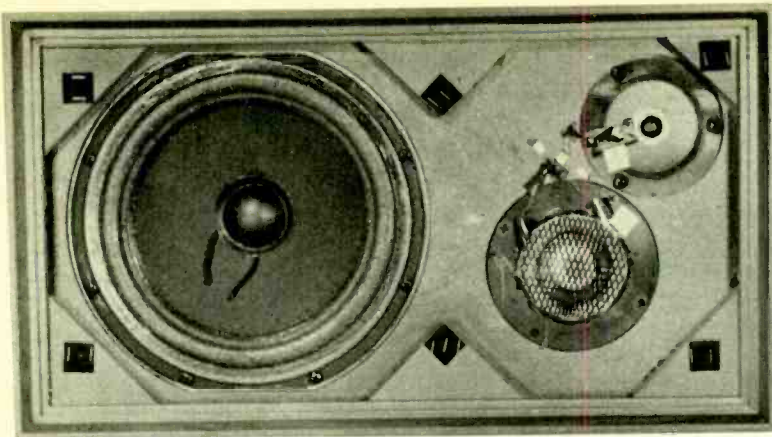

Front view. Six black squares are Velcro fasteners that hold grille frame in place. High-frequency hemispherical-dome driver is at top right. The midrange hemispherical-dome driver is just below it.

produce the lowest audio frequencies. Today, the acoustic-suspension principle is the most popular and successful approach to designing a small system capable of low-frequency, low-distortion performance.

Having developed the acoustic-suspension low-frequency driver, AR was not content to rest on its laurels. Instead, it developed a new type of mid-range and high-frequency driver. What resulted was the hemispherical-dome midrange and high-frequency drivers whose response is extremely flat. Even more important is the fact that this type driver has a wider dispersion than that of cone-type mid-range and high-frequency drivers.

The dome-type drivers first appeared in the AR-3a's predecessor, the AR-3. The mid-range and high-frequency drivers in the AR-3a and AS-103 have diameters of 1½ in. and ¾ in., respectively.

Construction of the AS-103 took us a little less than four hours. The first steps consisted of installing the three binding posts, two pots and the fuseholder on the control panel. This was followed by the mounting of the crossover capacitors and inductors in the cabinet. We next installed and connected the midrange and high-frequency drivers.

Then came a preliminary electrical check of the system using an amplifier and a program source.

At this point the low-frequency driver is connected but not installed in the cabinet. Upon completing this step we tore up a sheet of acoustic padding into small blocks. After stuffing them in the cabinet as directed, we installed the low-frequency driver and then the grille cloth. We encountered no problems along the way. As usual, Heath's well-illus-

trated manual left no stones unturned.

The superb sound of the AS-103 is not surprising since Acoustic Research supplies the three drivers and crossover network parts. Heath is responsible for the cabinet, fiberglass stuffing and grille cloth.

The woofer-midrange crossover frequency is 575 cps, while the midrange-high-frequency crossover frequency is 5000 cps. The measured anechoic-chamber frequency response of the AS-103 and the AR-3a is the same and extremely good. Their response curves are extremely flat over the entire audio spectrum.

The AS-103 *sounds* flat and smooth. Comparative listening tests of the AS-103 and other speakers quickly reveal the AS-103's superb low-distortion characteristics. Its low-frequency power handling ability and very low distortion are immediately apparent. The midrange and top-end sound is extremely clean and well defined. The AS-103 exhibited no high-frequency beaming effects. With no reservations, we'd say that for the money the AS-103 is one of the best speakers on the market today.

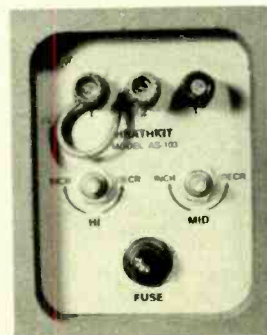

Rear control panel. Amplifier is connected to two right binding posts. In center are mid-range and high-frequency driver level controls. At bottom is a 3-A fuse holder.

Good Reading

By Tim Cartwright



Books, Pamphlets,
Booklets, Flyers,
Bulletins and
Application Notes.

STEALING is definitely a growth industry, say Wall Street analysts. Soon there may be more profit in alarms than in purse-snatching. This is the province of a new book called **Fire & Theft Security Systems** by Byron Wels (TAB Books, \$4.95, 176 pages). As the title promises, it covers everything from the simple switch systems for home and car, to sophisticated microwave detection and automatic telephone-dialers.

Mr. Wels has also written some screamingly funny lines. The author reveals that he has solved his personal mugging problem with a huge German Shepherd that is truly menacing. Another Wels-ian tip: carry small packets of pepper and when assaulted toss the entire contents into your assailant's eyes. In his somewhat more serious moments, Mr. Wels provides a good guide to many of the electronic systems now widely installed in homes and businesses.

Talking about fire alarms, there's a novel one featured in **This Month**, a periodical catalog mailed by Herbach & Rademan (40 E. Erie Ave., Phila., Pa. 19134). This alarm has no batteries, no wires and needs no electricity. Inside its housing is a fusible link which melts at 125°F to trigger the alarm bell. The powerful mechanism inside is probably a wind-up spring which allows the alarm to be re-set. The catalog is filled with other items of strong appeal to the industrial and research lab. It includes exotic test equipment, special transformers and timers—many offered at a considerable saving.

There is a critical shortage of trained service technicians in the home-entertainment field. So the industry has gathered under the banner of its trade organization, the Electronics Industries Association, to refill the servicing bucket emptied by technician drought. One notable effort is to sponsor the publication of training materials for use in schools.

A happy result is the newly published **Basic Television: Theory and Servicing**, (Second Edition, McGraw-Hill, \$8.95, 302 pages). It's a text and lab manual to accom-

pany vocational and technical courses. If you're beginning in the service game, even without benefit of classroom training, this book is an excellent reference for the bench. Unlike other works which deal in pure theory, this one unrelentingly points the reader toward a singular goal: to get him to a service bench fixing busted TVs in the shortest possible time. There is theory, to be sure, but the text is heavily loaded with the practical side of service.

If you're wondering what replaces a re-triggerable monostable flip-flop made by Indonesian craftsmen, you'll probably find it in the 1971 **HEP Semiconductor Cross-Reference Guide & Catalog**. It's offered free by Motorola wherever their HEP products are sold. The guide lists no less than 31,000 semiconductors replaceable by a mere 400 odd HEP numbers. There's a section on electrical ratings, outline drawings and terminal locations of HEP semiconductors.

RCA's replacement series of transistors, rectifiers, thyristors and ICs also has been updated with a new publication. Called the **SK Series Top-of-the-Line Replacement Guide** (SPG-202L), the 35¢ 72-pager shows how 96 SK numbers can interchange with over 20,000 semiconductors found in entertainment and industrial equipment.

Another experimenter's delight describing a company's products is the **Eveready Battery Applications and Engineering Data Book**. Only this one you pay for: it's \$6.95. Yet it's still a bargain if you do more than routine battery changing. Within its 752 pages it gives any spec, charging condition, or selection data you could ask for. This edition also introduces details on new nickel-cadmium cells that can be recharged.

If your work touches on microwave, take a look at **Bulletin 94** from Lectronic Research Labs (Atlantic & Ferry Ave., Camden, N.J., 08104). The 64-page catalog is filled with the plumbing which ducts the fragile signals of satellites, telephone relay, radar and other sky-high soup into the land of the galloping gigacycles. ●

The Listener

By C. M. Stanbury II



Uganda & Tanzania

AS a result of a Ugandan military coup early in 1971, two former East African allies have become bitter enemies. Tanzania leans toward the left, Uganda toward the right—although these categories are oversimplifications when applied to the African political scene.

Radio Tanzania at Dar-es-Salaam has its own international service, using a high-power transmitter provided by the Chinese. It sometimes is heard in North America on 15435 kc around 1800 EST but never too clearly.

Radio Tanzania's home service occasionally makes it on 5985 kc and 5050 kc. If you should hear the latter, try for Radio Uganda's Kampala transmitter on 5026 kc.

As we approach spring, chances of hearing 60- and 49-meter signals from lower Africa will improve. Shortly after the military takeover in Uganda last year, a British electronics firm announced that it had received a contract to build a new high-power broadcasting facility in Uganda so, everything considered, it might be a good idea to check all four channels regularly. You may hear some history being made—as well as some rare and attractive East African music.

A hot item from a European correspondent says that transmissions of German Freedom Station 904 have not been heard since October 1, 1971, and it is assumed the station has discontinued operations. This German-language station, based in East Germany, was the mouthpiece of the outlawed West German Communist Party (KPD) that began its broadcasts in August 1956.

Like its sister broadcaster, The German Soldier's Station, which continues to operate on 935 kc, Station 904 claimed to be operating from a secret location in West Germany. Actually, it was operating from Magdeburg, in East Germany (on 908 kc), using a 100-kilowatt transmitter. Prior to October 1, the station was on the air about 21 hours a week, carrying slanted news and commentaries generally critical of life in West Germany. It can be assumed the station was taken off the air as part of an effort to increase cooperation

and reduce tensions in the area.

We are now at the peak of the medium-wave BCB DX season. While conditions have not been spectacular during the past few years due to high sunspot count, every BCB season has its share of interesting loggings. This year is no exception.

At Rosarito Beach, Baja California's Mexican-border station, XERB (on 1090 kc) has become station XEPRS. Previous format was split equally between rock and religion. New format will be 100 percent underground rock. Best distant reception of XEPRS will be on Monday mornings around 0300 EST.

CJRN (Niagara Falls, Ont.) was scheduled to switch to 710 kc (from 1600 kc) and a new transmitter site last January 1. Construction and testing of the new facility took eight months. The new Radio Niagara will be highly directional and difficult to bag in most of the U.S.—despite its border location.

According to an unsubstantiated report from the International Radio Club of America, a major broadcast expansion is scheduled for the Bahamas. While none of the new frequencies have been announced yet, the Bahama's original BCB station, ZNS at Nassau, operates 24 hours a day on 1540 kc and has been logged in many parts of North America. The station might provide some clues as to what kind of programming the new broadcasting venture will feature and just when construction is likely to be completed.

By the time you read my column not only should Radio Nederland's new relay on the island of Madagascar (Malagasy Republic) in the Indian Ocean be operating but many DXers will have claimed reception when in fact they've still heard Radio Nederland's old transmitter site at Lopik. Best bet for a Madagascar logging is on 21480 kc between 0730 and 1020 EST. But up until Madagascar is on that frequency during this time period, the Lopik station will be. So be careful that you have correctly identified the transmitter site. Some people are still claiming to have logged the Netherlands when instead

[Continued on page 102]

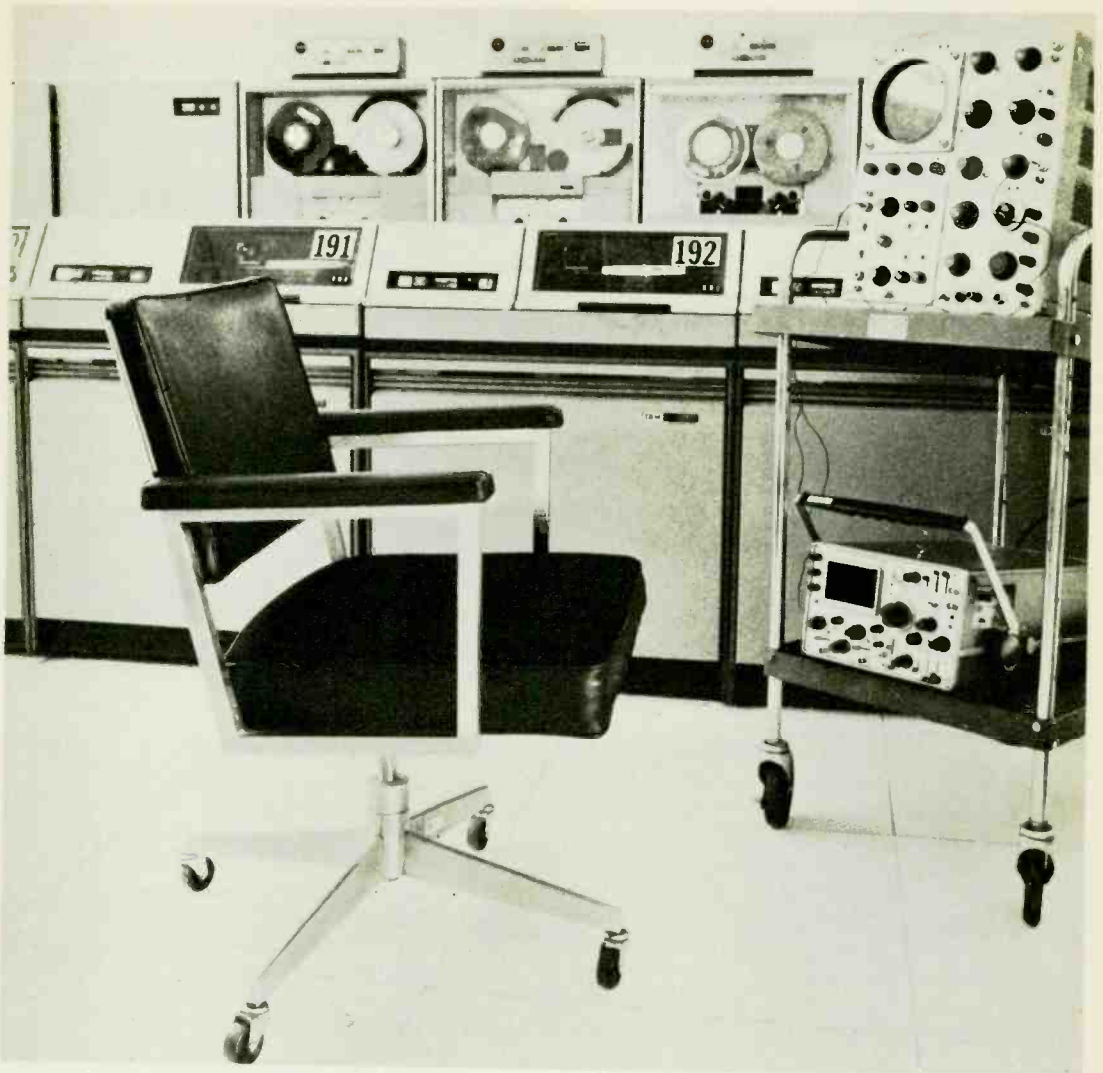

This important job (and its big income) is reserved for a qualified electronics technician. It can be you!

It's a fact. There are *thousands* of jobs like this one available *right now* for skilled electronics technicians. What's more, these men are going to be in even *greater* demand in the years ahead. But how about you? Where do you fit into the picture? Your opportunity will never be greater... so act *now* to take advantage of it. The first step? Learn electronics fundamentals... develop a practical understanding of transistors, trouble-shooting techniques, pulse circuitry, micro-electronics, computers and many other exciting new developments in this growth field. Prepare yourself now for a job with a

bright future... unlimited opportunity with lasting security... prestige and a steadily growing paycheck.

Cleveland Institute of Electronics courses have been stepping stones to good jobs in electronics for thousands of ambitious men. Why not join them? You can learn at home, in your spare time, and tuition is remarkably low. Read the important information on the facing page. Then fill out the postage-free reply card and drop it in the mail today. Without obligation we'll send you all the details. But act now... and get *your* high-paying job just that much sooner.

How You Can Succeed In Electronics ... Select Your Future From Seven Career Programs

The "right" course for your career

Cleveland Institute offers not one, but seven different and up-to-date Electronics Home-Study Programs. Look them over. Pick the one that is "right" for you. Then mark your selection on the bound-in reply card and send it to us. In a few days you will have complete details... without obligation.

1A. Electronics Technology

A comprehensive program covering Automation, Communications, Computers, Industrial Controls, Solid-State Devices, and preparation for a 1st Class FCC License.



1B. Electronics Technology with Laboratory

Includes all areas of Course 1A including 1st Class FCC License preparation. In addition, student receives 161-piece Electronics Laboratory and 17 "lab" lessons for "hands-on" experience.



2. Broadcast Engineering

Here's an excellent studio engineering program which will get you a 1st Class FCC License. Now includes Video Systems, Monitors, FM Stereo Multiplex, Color Transmitter Operation and Remote Control.



3. First Class FCC License

If a 1st Class FCC ticket is your goal, this streamlined program will do the trick and enable you to maintain and service all types of transmitting equipment.



4. Electronic Communications

Mobile Radio, Microwave and 2nd Class FCC preparation are just a few of the topics covered in this "compact" program. Highly recommended for jobs with telephone companies.



5. Industrial Electronics & Automation

This exciting program includes many important subjects such as Computers, Electronic Heating and Welding, Industrial Controls, Servo-mechanisms and Solid-State Devices.



6. Electronics Engineering

A college-level course for men already working in Electronics... covers Steady-State and Transient Network Theory, Solid-State Physics and Circuitry, Pulse Techniques, Computer Logic and Mathematics through Calculus.

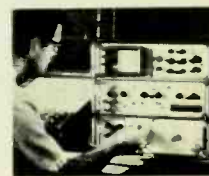

An FCC License... or your money back!

The CIE courses described here will prepare you for the FCC License specified. In fact, we are so certain of their effectiveness we offer this warranty: Should you fail to pass the FCC examination after completing a CIE license preparation course, we will refund all tuition payments. You get an FCC license... or your money back. This warranty is valid during the entire completion time established for your course.

CIE's AUTO-PROGRAMMED Lessons help you learn faster and easier

Cleveland Institute uses the new programmed learning approach. Our Auto-Programmed Lessons present facts and concepts in small, easy-to-understand bits... reinforce them with clear explanations and examples. Students learn more thoroughly and faster through this modern, simplified method. You, too, will absorb... retain... advance at your own pace.

Employment Assistance available for all CIE students... at no extra cost

Once enrolled with CIE, you will get a bimonthly listing of high-paying, interesting jobs available with top companies throughout the country. Many CIE graduates hold such jobs with leading companies like American Airlines, AT&T, General Electric, General Telephone and Electronics, IBM, Motorola, Penn Central Railroad, Raytheon, RCA, Westinghouse and Xerox... to name a few.

CIE Lessons are continually up-dated

All lesson books and materials from CIE are continually revised or replaced according to the current needs of industry and the rapidly advancing and changing state of the art.

New Revised G.I. Bill Benefits:

All CIE courses are approved for full tuition refund under the new G.I. Bill. If you served on active duty since January 31, 1955, OR are in service now with more than 180 days active duty, check box on reply card or coupon to get latest G.I. Bill information.

CIE Cleveland Institute of Electronics
1776 East 17th Street, Cleveland, Ohio 44114

If card has been removed, mail this coupon for 2 FREE BOOKS

Cleveland Institute of Electronics
1776 East 17th Street, Cleveland, Ohio 44114

Please send me without cost or obligation:

1. Your full-color book, "Succeed in Electronics."
2. Your book on "How To Get a Commercial FCC License."

I am especially interested in:

- | | | |
|---|--|--|
| <input type="checkbox"/> Electronics Technology | <input type="checkbox"/> Broadcast Engineering | <input type="checkbox"/> Electronic Communications |
| <input type="checkbox"/> Electronics Technology with Laboratory | <input type="checkbox"/> First Class FCC License | <input type="checkbox"/> Industrial Electronics & Automation |
| | <input type="checkbox"/> Electronics Engineering | |

Name _____ Age _____
(please print)

Address _____

City _____ State _____ Zip _____

- Veterans & Servicemen:
check here for G.I. Bill information.

EI-03

Accredited Member National Home Study Council.

The Ham Shack

By Wayne Green
W2NSD/1



When to Think Big

SOME ten years ago I got the bug to get into electronic manufacturing. I brought out a 10-watt dummy-load wattmeter for CB, complete with modulation monitor. It was a nice job and sold for \$15. Unless you have manufactured a product you have no realization of how inexpensive parts can be when bought wholesale. It's a lot different from buying parts at a radio store. My wattmeter, complete with meter, case and all parts, cost around \$4. You have to figure four to five times the parts cost as the end selling price for most equipment.

I took my wattmeter around to a few stores and in came the orders. When I signed on a manufacturer's rep to cover New York and New England, it was just a matter of days before I was completely swamped with orders. From then on there were just headaches. Getting delivery of parts, whipping the fellow who was supposed to assemble the units, then getting them shipped out.

I could see that either I had to be satisfied with a small business or else drop everything else I was doing and tend to wattmeters full time. I needed a plant, workers, shipping department, bookkeeper and so on or else time to do these things myself. I gave it up. The CB wattmeter was too successful for me! If I hadn't been working so hard at starting a new magazine I could have built the wattmeter business into a good-size company.

Back in the early '50s I started a small company to build and sell loudspeaker cabinets. I had no money so the first orders were filled by getting the money and then having the speakers built by a shop. This escalated during the next four years into a complex of seven factories and ended only when I blundered in trusting my partner. I lost the works but I did learn how to put a product on the market, starting with nothing, and make it a success. That's worth a couple years from anyone's life.

How many times have you wished there was some way you could make money from your electronics hobby? Just how practical is this dream? Is it really possible for a relative newcomer to get in there and compete

with old timers and established companies? Obviously it is or we wouldn't have so many new businesses coming into the field of electronic manufacturing.

What does it cost to start a new company?

That depends, of course, on what the product is. A relatively inexpensive product can be marketed for a few hundred dollars. But one of the major pitfalls for most new businessmen is underestimating the costs of getting started. You not only have to figure out how much your product will cost (for parts and assembly) but you have to add in the costs of advertising (which are not inconsequential), specification sheets, your profit, bookkeeping (you may not need much bookkeeping but the government has a lot of records they want you to keep for them and this can run up quite a bill), accounting (the accountant guides you through tax mazes and speaks on your behalf when the IRS has questions), shipping costs, secretarial costs, warrantee work and exhibit costs at shows and conventions. Shows are helpful, not only in getting customers to see your product, but in getting personal reactions which can benefit your design.

Aside from miscellaneous expenses, if you're going to sell through radio and parts stores you should figure on a 10 percent mark-up for your rep and another 50 percent for the store. Now you can see how a \$4 wattmeter escalates to \$15 without any big profits. Add \$2 for the cost of labor, a carton and instruction sheet—plus a 50 percent markup over overhead, sales, advertising, etc.—and you're at the \$9 level. Ten percent more for the rep brings you to \$10, 50 percent more for the distributor brings the net selling price to \$15.

If it's that easy to start a company and be successful why are there so many failures? It isn't as easy to fail as you might think. When looking back over the many companies that have tried and failed in the field of amateur radio it strikes me that most of them had to really work hard to fail.

There are some basic rules for success in
[Continued on page 104]

TIPS

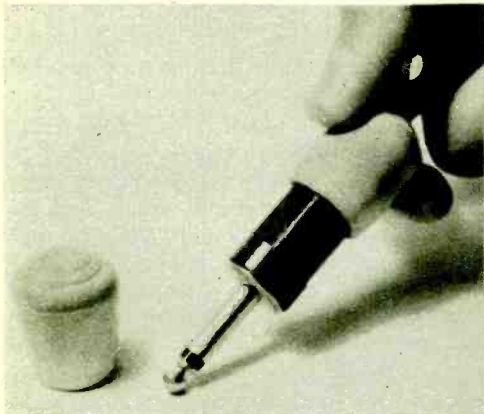

Excedrin headache No. 15—a tight phone-plug jack and greasy fingers. Such a combination is guaranteed to cause frustration when you go to remove a PL-55 phone plug with a Bakelite shell. But it is considerably easier to get a good grip on a Bakelite phone plug if you put a 3/8-in. rubber furniture tip over the shell as shown. And there's another benefit, too. The rubber tip will give a bit of protection if the plug should be stepped on.

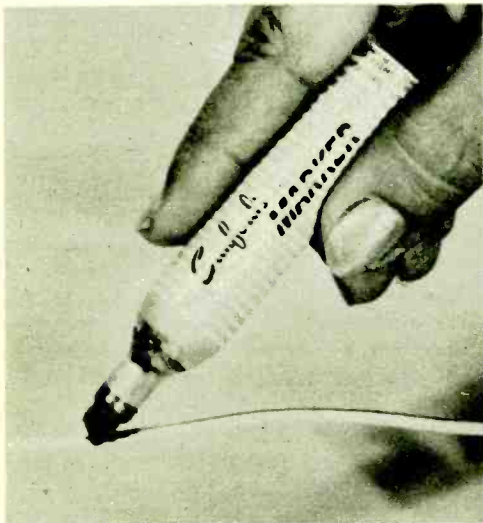

Ever wished you had just another 3 ft. of blue, or some other color wire? Here's a simple way to have any color, yet reduce your wire stock to use one roll of white wire in each type and size you need. Felt-tip marking pens will permanently mark white wire with stripes, or you can completely color the wire. To stripe, secure one end then twist, slide marker on wire. The wire will have a stripe.

STATEMENT OF OWNERSHIP, MANAGEMENT, AND CIRCULATION

(Act of August 12, 1970;

Section 3685, Title 39, United States Code)

1. Title of Publication: Electronics Illustrated.
2. Date of Filing: October 1, 1971.
3. Frequency of Issue: Bi-monthly.
4. Location of Known Office of Publication: Fawcett Place, Greenwich, Connecticut 06830.
5. Location of Headquarters or General Business Offices of the Publishers: Greenwich, Connecticut 06830.
6. Names and Addresses of Publisher, Editor, and Managing Editor: Publisher, George H. Allen, Darien, Connecticut 06820; Editor, Robert G. Beason, Stamford, Connecticut 06903; Managing Editor, Robert D. Freed, Stony Brook, New York 11790.
7. Owner: Fawcett Publications, Inc., Greenwich, Conn.; Alan Adams and Jack Adams, Trustees, Vallejo, Calif.; Marion Baeg, Kansas City, Mo.; Gordon W. Fawcett, Greenwich, Conn.; Estate of Helen A. Fawcett, New York, N. Y.; John R. Fawcett, Wilton, Conn.; Marie F. Fawcett, Greenwich, Conn.; Mary Blair Fawcett, Norwalk, Conn.; Roger Fawcett, New York, N. Y.; Roscoe Fawcett, Jarbridge, Nev.; Thomas K. Fawcett, San Francisco, Calif.; Vivian P. Fawcett, Greenwich, Conn.; Estate of W. H. Fawcett, Jr., Norwalk, Conn.; Mrs. Thomas Kerr, Bakersfield, Calif.; Gloria F. Leary, Santa Monica, Calif.
8. Known Bondholders, Mortgagees, and Other Security Holders Owning or Holding 1 Percent or More of Total Amount of Bonds, Mortgages or Other Securities: None.
9. For Optional Completion by Publisher Mailing at the Regular Rates (Section 132.121, Postal Service Manual) 39 U. S. C. 3626 provides in pertinent part: "No person who would have been entitled to mail matter under former section 4359 of this title shall mail such matter at the rates provided under this subsection unless he files annually with the Postal Service a written request for permission to mail matter at such rates."

In accordance with the provisions of this statute, I hereby request permission to mail the publication named in Item 1 at the reduced postage rates presently authorized by 39 U. S. C. 3626.

(signed) GORDON W. FAWCETT,
Business Manager

10. Not applicable.

11. Extent and Nature of Circulation:

Average No. Copies Each Issue During Preceding 12 Months:

- A. Total No. Copies Printed (net press run), 364,323. B. Paid Circulation: 1. Sales through dealers and carriers, street vendors and counter sales, 35,963; 2. Mail subscriptions, 245,103. C. Total Paid Circulation, 301,066. D. Free Distribution by Mail, Carrier or Other Means: 1. Samples, complimentary, and other free copies, 3,312; 2. Copies distributed to news agents, but not sold, 53,350. E. Total Distribution (sum of C and D), 357,668. F. Office Use, Left-over, Unaccounted, Spoiled After Printing, 6,655. G. Total (sum of E and F—should equal net press run shown in A), 364,323.

Actual Number of Copies of Single Issue Published Nearest to Filing Date: Total No. Copies Printed (net press run), 358,470.

- B. Paid Circulation: 1. Sales through dealers and carriers, street vendors and counter sales, 54,200; 2. Mail subscriptions, 247,761. C. Total Paid Circulation, 301,961. D. Free Distribution by Mail, Carrier or Other Means: 1. Samples, complimentary, and other free copies, 4,038; 2. Copies distributed to news agents, but not sold, 46,998. E. Total Distribution (sum of C and D), 352,987. F. Office Use, Left-over, Unaccounted, Spoiled After Printing, 6,373. G. Total (sum of E and F—should equal net press run shown in A), 358,470.

I certify that the statements made by me above are correct and complete.

(signed) GORDON W. FAWCETT,
Business Manager

WANT A JOB? PART TIME— FULL TIME?

**No Boss! No Experience!
No Capital! Your Own Hours!**

WHAT A JOB ! ! ! !

And yet selling subscriptions to ELECTRONICS ILLUSTRATED and other leading publications is just like being in business for yourself. But no business requires less capital, stock and space. The time you devote and the money you make is up to you. You need no experience to earn steady profits and you keep a cash commission on every sale. You operate in your own community by phone or personal calls. You will be authorized to sell new and renewal subscriptions along with special offers made by the publishers. You'll be amazed at the number of people wanting to take advantage of the convenience, service and savings you can offer them. To get started immediately—send us your name (on a postal card) requesting free supplies and selling materials.

Write to: Subscription Dept. DE
ELECTRONICS ILLUSTRATED
Fawcett Bldg., Greenwich, Conn. 06830

Lab-Grade Power Supply

Continued from page 30

meter will work just as well. Next mount and interconnect all chassis-mounted components.

Wire switches S2 and S3. Both switches should be the shorting type as indicated in the Parts List. Otherwise you stand the chance of eventually burning out the contacts as you advance either switch through their positions. After wiring both S2 and S3, mount them on the chassis and interconnect them as indicated in Figs. 5 and 7.

The last two subassemblies to be completed and interconnected into the circuit are the heatsinks holding transistors Q1 and Q2. Apply heat-sink compound to Q1 and Q2 liberally according to directions. Connect both transistors to the rest of the circuit with heavy gauge (at least No. 16) stranded wire.

Calibration. In order to calibrate the power supply, you will need a zero-center VTVM, a 1.35 V mercury battery and holder, and 1,350-ohm, 1% resistor. Connect one end of the resistor to the minus terminal of the battery holder. Solder a wire to the positive terminal. After allowing the VTVM to warm up and stabilize, attach the positive wire from the battery holder to the VTVM's positive lead, and the free end of the resistor to the meter's minus lead.

Before you turn on the power supply, set the Voltage Range switch to zero volts, and the Current Range switch to its 2 A position. Make sure you have inserted a wire jumper between terminals BP1 and BP2. Also insert a wire jumper between BP3 and BP4. Turn on the power—the voltage-mode lamp should light, and the voltage across R20 should be between -0.3 to -0.5 V as read on a VOM. If both Q1 and Q2 feel cool to your touch, connect the VOM to the output terminals. If you read zero volts, advance S2. Make sure that the voltmeter indicates upscale as you rotate R32. Your next step is to calibrate both voltage- and current-sense inputs of IC1 and IC2, respectively.

With the VTVM's function switch in the zero-center position, connect the meter's positive lead to circuit ground (terminal F on the perfboard). The negative lead goes to pin 4 of IC2. Disconnect the wire connecting IC2's pin 4 to pot R21. Adjust R30 until the meter needle returns to center scale position. Now reconnect the wire.

Repeat the above procedure for IC1, but

reverse meter/battery-resistor leads so that the meter's negative lead is attached to circuit ground. Attach the positive wire to pin 5 of IC1. Disconnect the wire from IC1's pin 5 to switch S4. Adjust R23 until the meter needle again returns to center scale position—then reconnect the wire.

After calibrating both E- and I-Sense Inputs (and with the current range switch in its 2 A position and R21 turned full counterclockwise), short the output terminals of the power supply. Current mode lamp L2 will light, indicating that the current-limiting circuit is working properly. Increase R21—the meter will advance as you turn the % Current pot.

Both Q1 and Q2 will become too warm to touch after a short time. When this happens, remove the short and set S3 to its 10 ma. position. With S2 turned down to zero volts, adjust R32 for 1 or 2 V. Connect a voltmeter across the output terminals. Compare the voltmeter reading with the voltage shown on R32's counter face.

If the voltages don't agree, or if the voltmeter's reading starts to change as Q1/Q2 cool off, adjust R19 until both counter face and voltmeter readings are the same. Repeat this procedure several times until output voltage remains the same whether both output transistors are cool or hot.

Using the Power Supply. Where both the power supply and project under test are at the same location, always connect both jumpers at the output binding posts as indicated in the schematic. Without the jumpers, the power supply won't work. Also, never jump BP1 to BP3 or BP4 to BP2. This can damage the power supply.

The programmable power supply outshines every other kind of power source when your project under test is separated from it by several yards of wire. For instance, you might be trying out a home-brewed RF preamplifier—up at the antenna. Voltage input from the supply to the preamp must be, say, exactly 12 V. Otherwise, gain measurements will be inaccurate.

Disconnect the jumper strapping BP3 to BP4 at the power supply. Run cables from BP1/BP2 and BP3 up to the roof-mounted preamp. Connect a separate wire to BP4 and run it up to the preamp. Connect this third wire to the end of the wire coming from BP3. The wire from BP4 senses the voltage drop in the power supply cable and adjusts the

supply's output to deliver the programmed output (12 V in this instance) *at the load*.

If you're more interested in keeping tabs on output current, remove the jumper linking BP1 and BP2. Follow our procedure outlined above. The power supply will automatically monitor current delivered to your project.

Of course, you may want to monitor both voltage and current simultaneously. Four cables—two sensing and two sending power—go from supply to the load. Simply make sure that BP1's polarity is always positive with respect to BP4.

How To Defeat Color TV Beat

Continued from page 82

do I actually get rid of it?"

"Well, sir, the reason you are losing color when you fine tune the beat pattern out is that a circuit in the TV called the *color killer* turns off the color circuits as soon as you detune slightly. This is the way it should be under normal conditions. However, you have exceptionally strong adjacent channels due to your cable installation. What you'll have to do is lower the color killer's threshold adjustment so that the color circuits will continue to operate even though you detune."

He said rather impatiently. "You are giving me quite a harangue. How do I do it?"

I laughed. "Turn on channel ten and detune until you get rid of the beat. Then go to the back of the TV and adjust the color killer control until it just brings in the color. That should do it. If you're not successful, call me and I'll stop by."

"Thank you, but I don't think that will be necessary." He hung up.

I shrugged and chalked it all up to public relations. That was until the following day when I received a check in the mail for \$9.95 plus tax and a thank-you note signed by John Barclay.

A Can of Colored Worms. A friend of mine, Jerry Hahn, has built up a good TV antenna business over the years. I give him jobs on a subcontract basis now and then, with the assurance he will leave the servicing to me.

One of his jobs was to install a new color rig for a customer who just moved into town. While Jerry was there finishing up I received a call from the set owner. He said, "Your

friend just installed a new antenna and the pictures are lousy. He says it's the fault of the TV, but I think there's something wrong with his installation."

"I'll be right over," I answered.

The TV did receive poor color pictures. Jerry was sitting on the sofa trying to mask his impatience. The customer just glared at the set.

The color picture showed a herringbone beat in the sections of solid color. Around the edges of chairs and doorways colored worms writhed round and round. I tried fine tuning the TV. The interference changed but could not be tuned out.

Since the interference was tunable the cause of the problem was inside the TV—any interference that remains fairly stable during tuning is usually external.

A common color beat that is caused by TV circuits is the 920-kc signal. This is a beat frequency that is developed due to intermodulation between the color subcarrier and the sound carrier. It must be suppressed. Otherwise it appears on the face of the CRT.

To suppress it, you have to trap out the sound that remains once the audio signal is tapped off and sent to the audio circuits. There are two traps installed in the output of the third video IF amplifier that are supposed to do this job. One is a small potentiometer with a screwdriver adjustment aptly called *sound reject*. The other is a hex-head diddlestick adjustment confusingly called a 41.25-mc trap. Both are usually mounted next to the third IF stage.

Most of the time, adjusting the sound-reject pot is all that is needed. On occasion, the 41.25-mc trap needs a touchup, too.

I tuned in the picture for best color reception. Then I watched the TV screen closely with the aid of my hand mirror and adjusted the sound-reject pot. As I turned it the colors brightened up and the beat all but disappeared. Next, I took my plastic diddlestick, inserted it into the 41.25-mc trap and gingerly rocked it about a quarter turn either way. The rest of the beat disappeared.

Even though this is a sound adjustment, you don't affect the audio at all. You're simply suppressing extra sound that is leaking into the picture.

Jerry had an "I told you so" smile on his face. The customer smiled, too. Then the customer said, "I'll have to confess, it's been that way a long time, but I figured a new antenna job would fix it."

ANOTHER SUPERB VALUE

from **Olson**
Electronics
ONLY \$300



**TV SYSTEM
with INTERCOM**

Compact camera and monitor is equipped for 2-way sound that offers new dimension in all-round protection for your family, home, business or industry. Simple plug-in installation. Complete - nothing else to buy.

Olson Electronics, Dept. D3, 260 S. Forge St.,
Akron, Ohio 44308

- I enclose \$300 plus \$1 for postage and handling. Send me the TV-300 TV System.
- Send me the next seven issues of the Olson Catalog, without cost or obligation. **FREE**

Name _____
Address _____
City _____
State _____ Zip _____

CIRCLE NUMBER 9 ON PAGE 15

FREE!

LAFAYETTE 1972 Catalog

**468 Pages
Our 51st Year**



- Stereo Hi-Fi ■ Citizens Band
- Ham Gear ■ Tape Recorders
- Test Equipment ■ TV and Radio Tubes and Parts
- Cameras ■ Auto Accessories
- Musical Instruments
- Tools ■ Books

**Your Complete Buying Guide
to Everything in Electronics**

Lafayette Radio Electronics
Dept 29032, P.O. Box 10
Syosset, L.I., N.Y. 11791

Send me my FREE Catalog 29032

Name _____
Address _____
City _____
State _____ Zip _____

CIRCLE NUMBER 8 ON PAGE 15

Converter for 2-Meters

Continued from page 78

installing transistor Q1. This type of transistor can be damaged by mishandling. Q1 comes with a small wire wrapped around the leads, shorting them together. Do not remove this strap until Q1 is soldered into the circuit. And don't handle Q1 by its leads. Hold the transistor by its case.

In the first RF amplifier, you will note that the transistor Q1 has its Source and Gate No. 2 leads soldered directly to two button capacitors (C1 and C3). Both capacitors are bolted to the mounting plate. This mounting method greatly improves the stability of this stage. One end of coils L2 and L4 are also connected to button capacitors.

Build the power supply so components C23-C24, R12 and R13 can be connected to the rest of the converter later. This will enable you to test the power supply separately. With a VTVM connected across C23, you should read from 12 to 13.5 VDC.

Aligning the Converter. Assuming that the power supply is working properly, connect it to the rest of the converter. A short piece of RG59/U coax serves to connect the converter to your receiver. Tune your rig to 16 mc. After turning on the converter, you'll hear a definite increase in background noise. Adjust coil L6 for maximum noise.

Operating the Converter. The 2-meter band appears on your receiver from 14 to 18 mc. The low end of the band, or 144 mc, is tuned at 14 mc on the dial, while 148 mc shows up at the 18 mc marking on your rig. If you plan on using the converter with a transmitter, install a transmit/receive relay or some other method of shorting the antenna input while you are transmitting.

COIL DATA

- (All wire No. 20 bare except as indicated)
- L1—six turns, 1/4-in. dia., tapped two turns from ground for antenna.
- L2—five turns, 1/4-in. dia.
- L3—four turns, 5/16-in. dia.
- L4—five turns, 5/16-in. dia.
- L5—four turns, 5/16-in. dia.
- L6—twenty-two turns No. 28 enameled wire wound (closewound) on a 3/8-in. dia. slug-tuned form. Secondary four turns No. 22 solid hookup wire wound on top of primary.
- L7—eight turns closewound No. 20 enameled wire on 1/4-in. slug-tuned form
- L8—five turns, wire 1/4-in. dia.
- L9—nine turns, 5/16-in. dia.

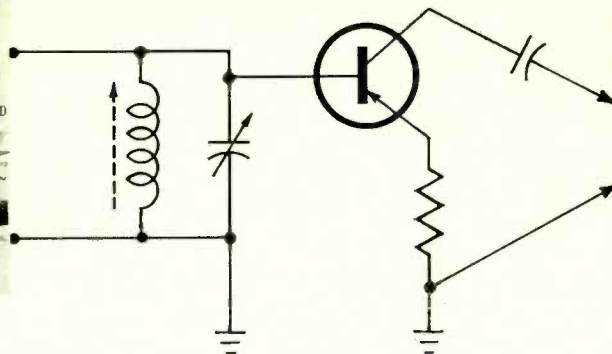

You've got the right hookup if you read **ELECTRONICS ILLUSTRATED**. But let us introduce you also to **MECHANIX ILLUSTRATED**, EI's companion publication. MI, America's favorite how-to-do magazine, tunes in electronics sometimes but also deals with the latest on cars, home improvements, family finances, workshop projects, health, the outdoors, recreation vehicles, boating, snowmobiles, power and hand tools and much, much more.

EI readers are invited to cash in on a special MI offer. Put in for one year—12 big issues—of MI, and it will cost you just \$2.95*. We'll bill you later. But if you send in \$2.95 today, we'll throw in one bonus issue. That's 13 information-packed issues in all! Take advantage of this deal pronto!

*Add 25¢ in Canada.

MECHANIX ILLUSTRATED, Circulation Dept.,
Fawcett Bldg., Greenwich, Conn. 06830.

EI

Please send me MI:

- Twelve issues—one year.
\$2.95. Bill me later.
- Thirteen issues—one year
plus one bonus issue. \$2.95.
Payment enclosed.
- I am now a subscriber, ex-
tend my subscription.

NAME _____

ADDRESS _____

CITY _____ STATE _____

ZIP CODE _____

Put it to Work!

NEW AND ONLY FROM EICO—THE INDUSTRY'S LOWEST-PRICED PROFESSIONAL FETVM.

Model 239
\$39.95
KIT



Use the battery powered Solid State EICO 239 on your bench or in the field. Check semiconductor and vacuum tube circuits. 11 Megohm DC input impedance. Read AC rms and DC voltages in seven steps from 1 to 1000 volts on large 4½" meter. Measure and read peak-to-peak AC to 2800 volts. Check resistance from 0.2Ω to 1000MΩ on seven ranges. Provides a total of 28 useful ranges on 12 accurate scales. Automatic battery check. Includes exclusive DC/AC ohms Uniprobe™. Factory Assembled, \$59.95.

FREE 32 PAGE EICO CATALOG

For latest catalog on EICO Test Instruments, Stereo, EICOCRAFT Projects, Environmental Lighting, Burglar/Fire Alarm Systems, and name of nearest EICO Distributor, check Reader Service Card.

EICO, 283 Malta Street, Brooklyn, N.Y. 11207



CIRCLE NUMBER 6 ON PAGE 15

SEE SOMETHING YOU WANT
ESPECIALLY MORE INFORMATION

Many products advertised in this issue offer you further information direct from the manufacturer. At the bottom of many ads will be a "Circle No." line. This means that the advertiser offers you further product information, free, right to your mailbox.

Look through the advertising, and turn to page 15. Circle the advertisers' number, complete the coupon, and we will take care of the rest.

ELECTRONICS ILLUSTRATED

Message Repeater

Continued from page 43

back speaker; but it's clear enough to check your recording.

Connect binding posts BP1 and BP2 to your phone line. Set S1 to *on* and S2 to *line*. Dial one digit to stop the dial tone and press PB1. The tape mechanism will start, and if T2's wiring is correct, you will hear the recording in the phone.

Next, have a friend call you. On the first or second ring RY1 should pull in, causing RY2 to close and the tape mechanism to start, thereby playing back your recording into the phone. If RY1 does not pull in when the phone rings there is a wiring error in the RY1, S1B's or S2B's circuit.

Before using the repeater you must adjust the tape-loop length to match the timing of the cam switch on the tape mechanism. Cycle the repeater twice by pressing PB1. When the loop stops, carefully mark the outside of the tape, with a marking crayon or a soft pencil, directly at the center of the record/playback head. Cycle the unit again. When the loop stops you will note the mark on the tape is not opposite the playback head. Don't disturb the tape, but apply another mark to the tape opposite the center of the record/playback head.

Carefully pull the capstan's rubber idler wheel away from the tape and feed the tape through by hand until the first tape mark is opposite the head. Take extreme care not to move the capstan (which drives the switch cam). When the first mark is opposite the head, release the idler and cycle the mechanism. When it stops the second tape mark should be opposite the center of the playback head. If it isn't, repeat the procedure until you have the two marks in precise position. Then cut out the tape between the two marks.

Cut between the marks and pull out the tape *from the right side*—where it feeds into the head. Line up the two marks and make the splice, pulling out as little tape as is necessary. You might have to remove a full loop of tape; if so, remove the tape by unspooling the piece from the left side. Don't worry if it appears there is too much slack; after a few cycles the loop will take up the excess slack.

Using the Repeater. The repeater can be left permanently connected to the phone lines through a phone jack as section S1B or S1

disconnects the repeater. To record a message set S2 to *record*; S2 disconnects the repeater even when power switch S1 is *on*. Set S3 to *record*, press PB1, wait a second and record your message. After the tape mechanism cycles off, set S3 to *playback* and set S2 to *line*. When you want the phone to repeat your message simply set S1 to *on*.

In case of difficulty. Start troubleshooting by first checking RY2's contact connections. The two contacts at the extreme right in the schematic latches RY2's coil to ground through the normally-closed contacts of RY3. Relay RY2's right contacts are initially triggered to ground through RY1's contacts, which close when the phone rings. Relay RY2's middle contacts connects T2's secondary to the phone line. The right contacts ground B1's positive terminal causing the tape mechanism's motor to start.

When the tape mechanism's cam contacts close they apply power to RY3. Relay RY3's normally-closed contacts open, releasing the holding contacts on RY2, causing RY2 to drop out. Simultaneously, RY3's contacts maintain B1's ground, keeping the motor running until the cam contacts open. When the cam contacts open, relay RY3 drops out and the motor stops. The repeater is then ready to receive another call, or to record a new message.

Career In Aerospace Electronics?

Continued from page 63

What about the future? Obviously, for the moment everything is not coming up roses. As the economy picks up and Vietnam winds down, however, the situation could brighten considerably. Gloomy prospects for the next two years could turn into glowing predictions for the coming decade if events take a turn for the better. Aerospace electronics is a viable alternative for a career if you make sure it is an alternative to something else.

A broad preparation in electronics, realism about your skills and the job market, flexibility about your goals and hopes and imagination concerning the future are the ingredients for a successful career in uncertain times.

Convert your stereo system to 4-dimensional sound!
QUATRASONIC™ BY EICO



KIT \$17.95
WIRED \$29.95

Enjoy 4-dimensional sound hidden in standard stereo records, tapes and FM broadcasts.
 Just add the QUATRASONIC™ adaptor and two speaker systems — No additional amplifiers required.

FREE 32 PAGE EICO CATALOG

For latest catalog on EICO Test Instruments' Stereo, EICOCRAFT Projects, Environmental Lighting, Burglar/Fire Alarm Systems, and name of nearest EICO Distributor, check Reader Service Card.
 EICO, 283 Malta Street, Brooklyn, N.Y. 11207



CIRCLE NUMBER 6 ON PAGE 15

AR guarantees its published specifications

At Acoustic Research we believe that the publication of complete performance data on our high fidelity components is obligatory. Otherwise, our guarantee would have little meaning.

Find out just what AR guarantees that its products will do. Mail the coupon below, and detailed technical literature will be sent to you free of charge.



Acoustic Research, Inc.
 24 Thorndike Street
 Cambridge, Mass. 02141
 Dept. EI-3

Please send measured performance data on AR products to

Name _____

Address _____

CIRCLE NUMBER 5 ON PAGE 15

AT LAST! PROFESSIONAL HOME PROTECTION EVERYONE CAN INSTALL AND AFFORD.

Model FC-100
\$49.95
WIRED



- Start your custom Burglar/Hold-up/Fire Alarm System with the FC-100. Add on Sensors, Alarms and Accessories to suit your own needs.
- "Do-it-Yourself" Installers Handbook included. No technical knowledge needed — No soldering.
- 100% Professional in Design, Reliability, Performance.



'Fail Safe'-SYSTEM BY EICO
A New Concept in "Do-it-Yourself" Home Protection

FREE 32 PAGE EICO CATALOG

For latest catalog on EICO Test Instruments, Stereo, EICOCRAFT Projects, Environmental Lighting, Burglar/Fire Alarm Systems, and name of nearest EICO Distributor, check Reader Service Card or send 25c for First Class mail service.

EICO, 283 Malta Street, Brooklyn, N.Y. 11207



CIRCLE NUMBER 6 ON PAGE 15

flameless 1000° heat

Instant, precise heat for 1001 uses — shrink tubing, soldering-desoldering, forming, bonding, deburring, drying, setting adhesives. World's most complete line. Models from 200-1000°F. Send for new free Catalog 75.

you can hold in your hand

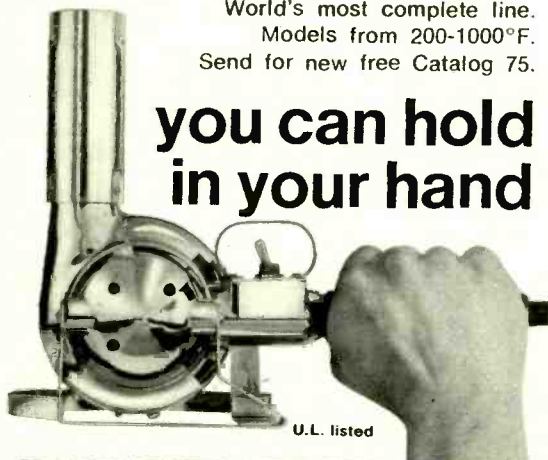

U.L. listed

MASTER HEAT GUNS

1745 FLETT AVE., RACINE, WI 53403

CIRCLE NUMBER 14 ON PAGE 15

The Listener

Continued from page 89

they are hearing super-power signals (evenings EST) from RN's Bonaire station.

Propagation Forecast. As the days get longer in the northern hemisphere—and static levels begin to increase—there will be fewer DX openings than during the winter months. Although transatlantic medium-wave DX will still be possible, opportunities will decline in number, particularly in April.

There will be a seasonal increase in shortwave propagation during April. This will permit more DX openings in the TV and FM bands than at any time since late last summer.

Reception in the shortwave bands generally will be fair to good, except during periods of abnormal atmospheric conditions. Ionospheric disturbances tend to peak during the equinox months.

Best daytime reception will be in the 15-17- and 21-mc bands. At night, reception will be satisfactory in all bands from 6 to 15 mc, depending on the location of the transmitting station. On circuits from southerly locations, for example, the higher bands will be satisfactory.

Light-Sensitive Light Controller

Continued from page 60

heat-sink assembly, toggle switch S1 and both terminal strips as shown in Fig. 3. Drill a 1/2-in. dia. hole in the front end of the Mini-box. Then cement PC1 in place with a thin layer of epoxy.

Finally, solder all resistors, capacitors and trigger diode D1 into their respective positions in the circuit. Incidentally, D1 is not polarity-sensitive—solder it into the circuit as you would a resistor. Be very careful to watch out for short circuits. They could accidentally connect the chassis to the power line and create a shock hazard.

Adjusting the Controls. This is partially a trial-and-error process. Both potentiometers interact as they are adjusted. Start by setting R2 to its midrotation position. Plug your lighting load into SO1 (up to 1,000 watts, remember) and flip S1 to on. Cover PC1 with your finger. Turn R1 (slope) until you've decreased the brightness of the lamps to any desired level.

Perform the next step late in the afternoon, preferably as the sky begins to grow dark. Expose PC1 to ambient light by aiming it away from your home. Next, adjust R2 (depth) until you bring the lamp's brightness down to the lowest possible level.

Repeat the adjustment of pots R1 and R2 until the response pleases you. Remember, as you calibrate and finally use the dimmer, position PC1 so that it can't see the lamps under control. Otherwise, the artificial light source will confuse PC1 and upset circuit calibration.

The Latest on Liquid Crystals

Continued from page 67

would require 65 leads (including those for decimal points). That's a lot of circuitry.

One recent attempt to overcome this problem stems from General Electric. In GE's nematic liquid-crystal display (which has eight digits), a system called AC Coincidence Addressing is used to reduce the number of connections and to simplify drive circuits. All eight digits are connected together by a single lead that connects common segments. Each digit also has a separate lead so it can be individually scanned in sequence (for a total of 16 leads).

Whereas most nematic liquid-crystal displays require a DC voltage to be activated, the GE display is activated by an alternating current. A high-frequency pulse makes the liquid-crystal film appear transparent, a low-frequency pulse makes it appear frosty. Thus, by sequentially addressing certain segments of the display with a low-frequency pulse you can create an alphanumeric (having both letters and numerals) display.

While the GE system is still in the R&D stage, two companies—RCA and Optel (a small company located at Princeton, N.J.)—now have liquid-crystal readouts for sale. Another small company, Ragen Semiconductor (located at Whippany, N.J.), is preparing to market a pocket calculator that will retail for under \$100. Its contents? Two large-scale integrated circuits and an eight-digit liquid-crystal display! The calculator will operate from a 12-V battery that, according to the company, should last some 2000 hours. A metropolitan New York department store chain, Alexander's, already has ordered 20,000 of the calculators. They should go on sale early this year.

Have your own Radio Station!

Learn AMATEUR RADIO



AT HOME IN YOUR SPARE TIME

Get your Amateur Radio license and "go on the air." NRI, leader in Electronics home training for more than 50 years, offers a choice of training plans leading to required FCC licenses, ranging from Basic Amateur Radio for the beginner to Advanced Amateur Radio for the ham who already has a license and wants to move up.

HAM RADIO EQUIPMENT INCLUDED

NRI's beginner's course includes your own Novice Class 25-watt transmitter, 3-band receiver and transistorized code practice oscillator with code key and headset. You learn code using special LP records. Choose from 3 Amateur Radio courses. Low tuition. Monthly payment plans. Get all the facts. MAIL coupon. No salesman will call. NATIONAL RADIO INSTITUTE, Washington, D.C. 20016.



.....MAIL COUPON TODAY.....

• NATIONAL RADIO INSTITUTE **53-032**
 • Washington, D.C. 20016
 • Please send me information on Amateur Radio training.

• Name _____ Age _____

• Address _____

• City _____ State _____ Zip _____

• ACCREDITED MEMBER NATIONAL HOME STUDY COUNCIL

LOW COST DIGITAL CLOCKS & TIMER KITS



Easy reading, 7 segment display tubes. Solid State MSI, IC electronic components. Accurate 60 cycle line time reference. Simple, push button settings. Clock displays hours, minutes and seconds. 10 minute timer.

Money back guarantee

ORDER TODAY
 OR WRITE
 FOR DETAILS

Clock kit: \$74.50

Timer kit: \$54.50

Add \$10 for clock case
 \$8 for timer case



506 Main St. • El Segundo, Ca 90245 / 772-6176

CIRCLE NUMBER 17 ON PAGE 15

QUICK-PICK Pat. Pend.

- Makes removal of transistors and capacitors from a "forest" of parts easy



- Seven (7) tools clamp on over 25 different outlines of transistors or can capacitors. *Therefore*, it can be used on hundreds of types of transistors and capacitors.
- Makes an excellent heat sink while unsoldering or replacing parts.
- Permits more attention to be given the soldering operation. *Will leave both hands free to unsolder the leads. A slight pull on the Quick-Pick will remove the part when the leads are free.*
- Colored handles permit Quick size selection.
- Packaged in an attractive carrying case.

Lendell Products set of 7 tools **995**
 939 S. 7th St. DeKalb, Illinois 60115 postpaid
 CIRCLE NUMBER 7 ON PAGE 15

#13 IN THE BESTSELLING TRAVIS MCGEE SERIES

M2513•95c

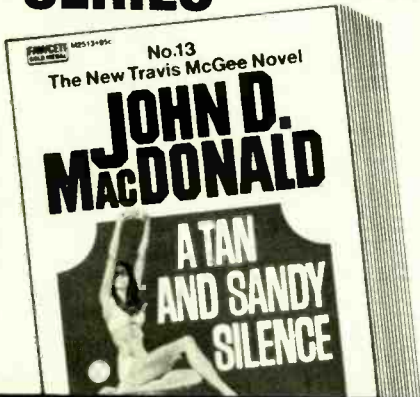

Buy this Gold Medal Book from your paperback book-seller. If he is sold out, send only price of book plus 15c for postage and handling to Gold Medal Books, Fawcett World Library, Greenwich, Connecticut 06830. Please order by number and title. No Canadian orders.

CB Corner

Continued from page 83

another party requires prearrangement so each station operates on the same channel. In this method, communications can be wiped out by skip interference and other stations working the desired frequencies. This is a colossal waste since a dozen other channels might be free of traffic at the same time. To solve this, the study calls for a system of *calling-channel, working-channel*.

First, you'd switch around the band to find an empty channel. This becomes the working channel—the one you will use for the main message. Then you'd quickly switch to the standard calling channel and call your station (who'd monitor only the calling channel). In a brief exchange, you'd tell your party to meet you on the clear or working channel.

The second part of the plan is even more novel and is designed to fight skip. To keep that previous calling channel free of interference from distant stations, the U.S. would be divided into four regions, each with its own calling frequency. No region would be assigned the same calling channel. Thus, if your calling channel is 12, you wouldn't ever be clobbered by skip, since Channel 12 would be assigned to none of the other three regions in the country. Actually, this idea of protecting a frequency is a standard method for keeping apart AM, FM and TV stations. It would require only a small rules change to introduce this benefit to CB. —

Ham Shack

Continued from page 94

a small business. Your product must be good and there must be market for it. Your advertising must be the best you can think up. Your mail should be answered immediately and all orders shipped quickly. You must work seven days a week and every waking hour until you can afford to hire additional personnel.

If you do all of these things—and you have a product which has the possibility of volume sales—you should be able to at least double the net worth of your company in a year. You may do a lot better but this would be a minimum figure. —

Classified Ads

ELECTRONICS ILLUSTRATED

Your advertisement can reach this mall-buying audience for only 50¢ per word . . . payable in advance (Check or M.O. please) . . . minimum 10 words. Closing dates are the 20th of 4th preceding month i.e. copy for the July issue must be in our office by March 20th. Mail to ELECTRONICS ILLUSTRATED, 1515 Broadway, New York, N. Y. 10036. Word count: Zipcode number free. Figure one word: Name of state (New Jersey), name of city (New York); sets of characters as in key (14-O); also abbreviations as 35MM, 6x10, A.C.

SAVE MONEY • ORDER BY MAIL

• • • FOR SALE

MAGNETS. ALL types. Specials: 20 disc magnets, or 2 stick magnets, or 10 small bar magnets, or 8 assorted magnets, \$1.00. Maryland Magnet Company, Box 192-F, Randallstown, Maryland 21133.

TREASURE HUNTERS! Prospectors! Helco's new instruments detect buried gold, silver, coins. Kits, assembled models. Transistorized. Weighs 3 pounds. \$19.95 up. Free catalog. Relco-A-19, Box 10839, Houston, Texas 77018.

TREASURE HUNTERS! Prospectors! Rockhounds! Hobbyist! Find gold, silver, relics with world famous Detectron Metal Detectors. Free information. Delivery immediate. Detectron, Dept. 3-EI, Box 243, San Gabriel, California 91778.

INVESTIGATORS, LATEST Electronic Aids. Free Literature. Clifton, 11500-X NW 7th Ave., Miami, Florida 33168.

WHOLESALE C.B. Transceiver and Multi-Band receivers. Lowest prices. Factory Warranty. Dealers welcome. List 25¢. G Enterprises, P.O. Box 14E, O'Fallon, Ill. 62269.

GUARANTEED MONEYSAVER! "How to Use Bargain Transistors" explains how to build 100 projects with old, unmarked and surplus semiconductors. 132 pages, illustrated. \$3. Capstone Corp., 9 Danbury Rd., Wilton, Conn. 06897.

CONVERT ANY television to sensitive, big-screen oscilloscope. Only minor changes required. No electronic experience necessary. Illustrated plans, \$2.00. Relco A-19, Box 10563, Houston, Texas 77018.

POLICE/FIRE RADIO Dispatcher directories! Exclusive listings, "confidential" frequencies, call signs. All areas. Send \$6 stamp for catalogs. Communications, Box 56-EX, Commack, N.Y. 11725.

HOW TO Break Into Radio Television Broadcasting Book \$2.00. I.Q. Engineering, Box 374, Canoga Park, California 91305.

TELETYPE EQUIPMENT and parts. New and used. Write: R.T.Y. Electronics, Box 655, El Cerrito, Calif. 94530.

NEW AMAZING telephone recorder. Automatically records every word each time your telephone is used. Only \$24.95. Amplicom, 4334 Tunjuna Avenue, North Hollywood, Calif. 91604.

CONSTRUCTION PLANS: Laser . . . \$2.00. Investigation Aids—2 FM Microphone Transmitters . . . \$1.00 FM Telephone Transmitter . . . \$2.00. Sound Telescope . . . \$2.00. Space Monitor—Missile Tracker . . . \$2.00. Free equipment and Kit Catalog. Howard 20174 Ward, Detroit, Michigan 48235.

SEMICONDUCTOR ASSORTMENT. Includes I.C.'s, diodes, transistors and assemblies, marked and manufactured by top U.S. manufacturers. Contains 100 pieces only \$4.95 prepaid anywhere in the U.S. Money back guarantee. Unित्रon Kits, P.O. Box 2584, Santa Fe Springs, Calif. 90670.

RUBBER STAMPS. First line \$1.00. Additional lines 50¢ each. Good quality. Prompt service. Moyers, 3031 Montrose, Chicago 60618.

FREE! GIANT Electronics Catalog. McCord Electronics, Box 41-E, Sylvania, Ohio 43560.

• • • GOVERNMENT SURPLUS

JEEPS TYPICALLY From \$53.90 . . . Trucks From \$78.40 . . . Boats, Typewriters, Airplanes, Multimeters, Oscilloscopes, Transceivers, Electronics Equipment. Wide Variety, Condition. 100,000 Bid Bargains Direct From Government Nationwide. Complete Sales Directory and Surplus Categories Catalog \$1.00 (Detachable First \$10.00 Order From Our Separate Included Catalog.) Surplus Service, Box 820-T, Holland, Michigan 49423.

GOVERNMENT SURPLUS. How and Where to buy in Your Area. Send \$1.00, Surplus Information, Headquarters Bldg., Box 30177-EI, Washington, D. C. 20014.

MANUALS FOR surplus electronic equipment. List 25¢. Books, 4905 Roanoke Drive, Washington, D.C. 20021.

• • • BUSINESS OPPORTUNITIES

VENDING MACHINES. No selling. Routes earn amazing profits. Big catalogue free. Parkway Corporation, 715E1 Ensor Street, Baltimore, Maryland 21202.

MAKE \$1.00 PER Sale selling engraved metal Social Security plates. Free Sales Kit. Engravaplates, Box 10460-7517, Jacksonville, Florida 32207.

\$200.00 DAILY IN Your Mailbox! Your Opportunity To Make Money Like Mail-order Experts. Free Details. Associates, Box 136-EI, Holland, Michigan 49423.

START SMALL, highly profitable electronic production in your basement. Investment, knowledge unnecessary. Postcard brings facts. Barta-Elmon, Box 248, Walnut Creek, California 94597.

BIG PROFITS in becoming a supplier to major industry through electroplating small parts and metalizing nonmetals. Write for free particulars: Mason, Room MC-120-BB, 1512 Jarvis, Chicago, Ill. 60626.

JAPAN HONG Kong Directory. World products information. \$1.00 today. Sekai Shogyo Annai, Hillyard, Washington 99207.

HOW TO Establish Your Own Successful Mail Order Business. Expert Sources. Many Free. AM Sales, 32-28-A 100 Street, East Elmhurst, N.Y. 11369.

• • • EMPLOYMENT OPPORTUNITIES

PRINTING—ADVERTISING Salesmen. Excellent moneymaking sideline selling Decalcomania Name Plates. Advertising Specialties. Sign Letters. Automobile Initials. Free Samples. Ralco EI, Box L, Boston, Mass. 02119.

EXCITING OVERSEAS Jobs. Directory \$1.00. Research Associates, Box 942-FW, Belmont, California 94002.

• • • EDUCATION AND INSTRUCTION

LEARN CARTOONING At Home. Free booklet: "Key to Cartoon Career." Approved for G. I. Bill. Write: Cartooning, Box 7069X, Colorado Springs, Colorado 80907.

HIGHLY EFFECTIVE home study courses in Electronics Engineering Technology and Electronics Engineering Mathematics. Earn your Degree. Write for Free Descriptive Literature. Cook's Institute of Electronics Engineering (Dept. 14), P.O. Box 10634, Jackson, Miss. 39209. (Established 1945.)

HOME STUDY COURSES IN WATCH-MAKING, ENGRAVING, DIAMOND SETTING AND CLOCK REPAIR. LEARN while you earn for a more secure future. For complete information write: Kansas City School of Watchmaking, Dept. E-1, 101 W. 11th St., Kansas City, Mo. 64105.

• • • BUILD-IT-YOURSELF (OR DO IT YOURSELF)

EXPERIMENTER'S KITS. Audio, test equipment, others. PAIA Electronics, Box HI4359, Oklahoma City, Okla. 73114.

LINEAR AMPLIFIERS: Build your own 250 Watt 10-15 Meters Linear. Plans \$1.00. Roberts, Box 8791, Ft. Lauderdale, Florida 33310.

NEW LOCATOR indicates difference in metals detected. Plans \$4.00. Taylor Electronics, P.O. Box 253, Cape May, New Jersey 08204.

• • • HI-FI, STEREO

BUY IRISH tape open reel and cassettes and 8-track blanks at discount prices. Write: Direct Mail Cassette Corp., Box 71, Plainview, N.Y. 11803.

• • • TAPE RECORDERS

RENT 4-TRACK open reel tapes—all major labels—3,000 different—free brochure. Stereo-Parti, 55 St. James Drive, Santa Rosa, Calif. 95401.

LEARN WHILE Asleep with your recorder, phonograph or amazing new "Electronic Educator" endless tape recorder. Details free. Sleep-Learning Research Association, Box 24-EI, Olympia, Washington 98501.

RADIO SHOWS. Stamp For Free Catalog, Box 724-EL, Redmond, Wash. 98052.

VIDEO COLLECTION must be liquidated. 100's of 1/2" tapes. Video, Box 33, Harvard Square, Cambridge, Mass. 02138.

SCOTCH TAPE #150, 7" reel, polyester \$2.59, postpaid, \$23.50 dozen. Record-ers, cassettes, open reel music tape (100-page discount catalog 25¢). Saxitone Tape Sales, 1776 Columbia Road N.W., Washington, D.C. 20009.

OLD RADIO Shows On Tape. Free Catalog. Write P. O. Box 18121, Louisville, Ky. 40218.

• • • RADIO & TV

OLD Radio Programs, Catalog \$1.00. (Refundable). Radio Vault, Box 9032, Wyoming, Michigan 49509

RADIO & TV Tubes—36¢. Free List. Cornell, 4213-15 University, San Diego, Calif. 92105.

FREE ELECTRONICS Catalog. Tremendous Bargains. Edu-Kits, Department C-625AE, Hewlett, New York 11557.

TV TUNERS rebuilt and aligned per manufacturers specification. Only \$9.50. Any make UHF or VHF. We ship COD. Ninety day written guarantee. Ship complete with tubes or write for free mailing kit and dealer brochure. JW Electronics, Box 51K, Bloomington, Indiana 47401.

FREE! BARGAIN Catalog. Fiber optics, LED's, transistors, diodes, rectifiers, SCR's, triacs, parts. Poly Paks, Box 942, Lynnfield, Mass. 01940.

BUILD DISTANCE Crystal Sets. 10 plans —25¢; 18 different—50¢; 20 different—50¢. Catalog. Laboratories, 745-K Cordone, Reno, Nevada 89502.

TV TUBES 29¢, Speakers Yokes 49¢. Free List. Surplus Electronics, 57 Torrens, Toronto 6, Ontario.

TELEVISION HIGH Voltage Test Probe Only \$2. No meter or electronic experience needed. Schek Television Company, 8101 Schrider Street, Silver Spring, Maryland 20910.

REPAIR TV Tuners—High Earnings. Details of Complete Course, 12 Repair Tricks, Many Plans, Two Lessons, all for \$1. Refundable. Frank Bocek, 3236 Enterprise Branch, Redding, Calif. 96001.

• • • ELECTRONICS SUPPLIES & EQUIPMENT

FREE CATALOG—Loads of Bargains. R.W. Electronics, 4005 West Belmont, Chicago, Illinois 60641.

RECORDING BUFFS Handle Up to Three Recorders For Dubbing, Editing, and Mixing. The Multimixer TMS-1 Does It. \$19.95 plus \$1.25 Postage. Russound/FMP, Inc., Dept. E, P.O. Box 204, Stratham, N.H. 03885.

KITS AND EQUIPMENT FM Wireless microphone transmitters, FM Telephone transmitters, Infinity transmitters. Security Electronics, P.O. Box 265, Huntington, W. Va. 25707.

O.E.M. POWER Supplies: Transformer isolated, regulated. 115vac plus or minus 10v 60 hz. dual output plus and minus 8vdc. at 8ma. Less than .3 percent ripple. Solid potting. Printed circuit board mounting. 1.25 inch square 1.0 inch high. \$12.50 plus 50¢ handling. Manchester Electronics, Dept. O2, 20 Meadow St., Manchester, N.H. 03103.

BARGAIN PRICES on Precision Resistors —100 for \$1.99 plus 10¢ for postage. R&R Electronics, 311 E. South St., Indianapolis, Ind. 46225.

• • • MISCELLANEOUS

NOW! ENJOY the great outdoors in comfort with your pocket size electronic Skeeter Skat mosquito repeller. \$9.95 postpaid, U.S.A. Satisfaction guaranteed. Detector, Dept. C-3, P.O. Box 243, San Gabriel, California 91778.

YOUR OWN Electronic Business. Easy—lucrative. Details Free. Barta-ELAS, Box 248, Walnut Creek, California 94597.

UNKNOWN? IF you've ever written an article, story, poem, or essay, you don't have to publish a book to see it in print. Our new national magazine—Spectra—will do it for only 7¢ per word! Any topic. No gimmicks. Write: Clearing House Publications, Box 10575, Denver, Colorado 80210.

PRINTED CIRCUITS for projects etched and drilled. Same day service! 25¢ square inch. Send pattern to: Gary Kramer Electronics, 25520 Graham, Detroit, Michigan 48239.

• • • MUSIC

SONGPOEMS URGENTLY Needed, Possible Recording/Publishing, 50-50 Agreement. Betty's Music Makers, 1417H Park Bldg., Pittsburgh, Penna. 15222.

SONGWRITERS! POETS! Spiritual and religious poems, songs wanted for recording by Chapel Symphony Orchestra and Choir. We pay all recording costs! Chapel Recording, P.O. Box 162-EI, Wollaston, Mass. 02170.

SONGS, POEMS Wanted! For publishing, recording at our expense! Talent, 17-EI Longwood Road, Quincy, Mass. 02169.

FREE CATALOG. Electronic musical accessories kits. PAIA Electronics, Box G14359, Oklahoma City, Okla. 73114.

• • • INVENTORS & INVENTIONS

INVENTORS! SELL your invention for cash or royalties! Our client manufacturers eagerly seek new items. Patented. Unpatented. Financial assistance if needed. 25 years proven performance. For free information, write Dept. 27, Gilbert Adams, Invention Broker, 80 Wall St., New York, N.Y. 10005.

MANUFACTURERS NEED New Products. Your ideas and inventions developed for commercial appeal and cash/royalty sales. Free "Invention Record" and "Product Marketing" brochure. Raymond Lee Organization, 230-X Park Avenue, New York City 10017.

PATENT SEARCHES including maximum speed, full airmail report and closest patent copies \$6.00. Quality searches expertly administered with complete secrecy guaranteed. Free Invention Protection forms and "Patent Information." Write Washington Patent Search Bureau, Dept. 20, 734 15th St. N.W., Washington, D.C. 20005.

ELECTRONICS ILLUSTRATED

Classified Advertising Order Form

For information on terms, closing dates, etc., see heading at top of Classified Section.

INSTRUCTIONS:

50¢ a word
Minimum Ad
10 Words

WORD COUNT: Zip code free. Figure one word for name of state (New Jersey); name of city (Little Falls); sets of characters as in key (M-14); abbreviation of Northwest (NW); but note separate initials as in a name (M. D. Brown), 3 words counted as a word each.

DEADLINE FOR ADS: Copy must be in by the 20th day of the fourth preceding month for the issue in which the ad is to appear.

BLANKLINE: May be placed both above and below the ad, if desired. Each blank line is charged as 5 words.

TO: ELECTRONICS ILLUSTRATED, One Astor Plaza., New York, N.Y. 10036 - Att.: Classified Advertising Dept.

Gentlemen: Here's our copy for the Classified Section of ELECTRONICS ILLUSTRATED. Remittance of \$_____ is enclosed to cover _____ insertion(s) in the _____ issue(s).

1	2	3	4	5
6	7	8	9	10
11	12	13	14	15
16	17	18	19	20
21	22	23	24	25
26	27	28	29	30
31	32	33	34	35

YOUR NAME _____ **PHONE** _____

FIRM _____ (PLEASE PRINT)

ADDRESS _____

CITY _____ **STATE** _____ **ZIP** _____

DATE _____ **YOUR SIGNATURE** _____

(PLEASE PRINT OR TYPE COPY • FOR ADDITIONAL WORDS ATTACH SEPARATE SHEET) **3/72**

BUY 20 RADIO

and Electronics Circuits

PROGRESSIVE HOME RADIO-TV COURSE



Training Electronics Technicians Since 1946

Now Includes

- ★ 12 RECEIVERS
- ★ 3 TRANSMITTERS
- ★ SQ. WAVE GENERATOR
- ★ SIGNAL TRACER
- ★ AMPLIFIER
- ★ SIGNAL INJECTOR
- ★ CODE OSCILLATOR
- ★ TRANSISTOR (Solid State) CIRCUITS
- ★ VACUUM TUBE CIRCUITS
- ★ PRINTED CIRCUITS
- ★ HAND WIRED CIRCUITS

YOU DON'T HAVE TO SPEND HUNDREDS OF DOLLARS FOR A RADIO COURSE

The "Edu-Kit" offers you an outstanding PRACTICAL HOME RADIO COURSE at a rock-bottom price. Our Kit is designed to train Radio & Electronics Technicians, making use of the most modern methods of home training. You will learn radio theory, construction practice and servicing. THIS IS A COMPLETE RADIO COURSE IN EVERY DETAIL. You will learn how to build radios, using regular schematics; how to wire and solder in a professional manner; how to service radios. You will work with the standard type of punched metal chassis as well as the latest development of Printed Circuit Chassis. You will learn the basic principles of radio. You will construct, study and work with RF and AF amplifiers and oscillators, detectors, rectifiers, test equipment. You will learn and practice code, using the Progressive Code Oscillator. You will learn and practice trouble-shooting, using the Progressive Signal Tracer, Progressive Signal Injector, Progressive Dynamic Radio Electronics Tester, Square Wave Generator and the accompanying instructional material.

You will receive training for the Novice, Technician and General Classes of F.C.C. Radio Amateur Licenses. You will build Receiver, Transmitter, Square Wave Generator, Code Oscillator, Signal Tracer and Signal Injector Circuits, and learn how to operate them. You will receive an excellent background for television, Hi-Fi and Electronics. Absolutely no previous knowledge of radio or science is required. The "Edu-Kit" is the product of many years of teaching and engineering experience. The "Edu-Kit" will provide you with a basic education in Electronics and Radio, worth many times the low price you pay. The Signal Tracer alone is worth more than the price of the Kit.

THE KIT FOR EVERYONE

You do not need the slightest background in radio or science. Whether you are interested in Radio & Electronics because you want an interesting hobby, a well paying business or a job with a future, you will find the "Edu-Kit" a worthwhile investment. Many thousands of individuals of all

ages and backgrounds have successfully used the "Edu-Kit" in more than 79 countries of the world. The "Edu-Kit" has been carefully designed, step by step, so that you cannot make a mistake. The "Edu-Kit" allows you to teach yourself at your own rate. No instructor is necessary.

PROGRESSIVE TEACHING METHOD

The Progressive Radio "Edu-Kit" is the foremost educational radio kit in the world, and is universally accepted as the standard in the field of electronics training. The "Edu-Kit" uses the modern educational principle of "Learn by Doing." Therefore you construct, learn schematics, study theory, practice trouble-shooting—all in a closely integrated program designed to provide an easily-learned, thorough and interesting background in radio. You begin by examining the various radio parts of the "Edu-Kit." You then learn the function, theory and wiring of these parts. Then you build a simple radio. With this first set you will enjoy listening to regular broadcast stations, learn theory, practice testing and techniques. Gradually, in a progressive manner, and at your own rate, you will find yourself constructing more advanced multi-tube radio circuits, and doing work like a professional Radio Technician.

Included in the "Edu-Kit" course are Receiver, Transmitter, Code Oscillator, Signal Tracer, Square Wave Generator and Signal Injector Circuits. These are not unprofessional "breadboard" experiments, but genuine radio circuits, constructed by means of professional wiring and soldering on metal chassis, plus the new method of radio construction known as "Printed Circuitry." These Circuits operate on your regular AC or DC house current.

THE "EDU-KIT" IS COMPLETE

You will receive all parts and instructions necessary to build twenty different radio and electronics circuits, each guaranteed to operate. Our Kits contain tubes, tube sockets, variable, electrolytic, mica, ceramic and paper dielectric condensers, resistors, tie strips, hardware, tubing, punched metal chassis, Instruction Manuals, hook-up wire, solder, selenium rectifiers, coils, volume controls and switches, solid state materials. In addition, you receive Printed Circuit materials, including Printed Circuits chassis, special tube sockets, hardware and instructions. You also receive a useful set of tools, a professional electric soldering iron, and a self-powered Dynamic Radio and Electronics Code Tester. The "Edu-Kit" also includes Code Instructions and the Progressive Code Oscillator, in addition to F.C.C. Radio Amateur License training. You will also receive lessons for servicing with the Progressive Signal Tracer and the Progressive Signal Injector, a High Fidelity Guide and a Quiz Book. You receive Membership in Radio-TV Club, Free Consultation Service, Certificate of Merit and Discount Privileges. You receive all parts, tools, instructions, etc. Everything is yours to keep.

Progressive "Edu-Kit" Inc., 1189 Broadway, Dept. 624AE, Hewlett, N.Y. 11557

PRINTED CIRCUITRY

At no increase in price, the "Edu-Kit" now includes Printed Circuitry. You will now receive a Printed Circuit Signal Injector, a unique servicing instrument that can detect many Radio and TV troubles. This revolutionary new technique of radio construction is now becoming popular in commercial radio and TV sets.

A Printed Circuit is a special insulated chassis on which has been deposited a conducting material which takes the place of wiring. The various parts are merely plugged in and soldered to terminals.

Printed Circuitry is the basis of modern Automation Electronics. A knowledge of this subject is a necessity today for anyone interested in Electronics.

UNCONDITIONAL MONEY-BACK GUARANTEE

Please rush my Expanded Radio-TV Course with "Edu-Kits"® to me.

- Send Course with Edu-Kits postpaid. I enclose full payment of \$34.95
- I enclose \$5.00 deposit. Send Course with Edu-Kits C.O.D. for balance of \$29.95 plus postage.
- Send me FREE additional information describing Course with Edu-Kits.

NAME

ADDRESS

CITY & STATE

ZIP

PROGRESSIVE "EDU-KITS" INC.

1189 Broadway, Dept. 624AE, Hewlett, N.Y. 11557

FREE EXTRAS

- SET OF TOOLS
- SOLDERING IRON
- ELECTRONICS TESTER
- PLIERS-CUTTERS
- VALUABLE DISCOUNT CARD
- CERTIFICATE OF MERIT
- MEMBERSHIP IN RADIO-TV CLUB
- HIGH FIDELITY GUIDE & QUIZZES
- TELEVISION BOOK & RADIO TROUBLE-SHOOTING BOOK
- CONSULTATION SERVICE & F.C.C. AMATEUR LICENSE TRAINING
- PRINTED CIRCUITRY

SERVICING LESSONS

You will learn trouble-shooting and servicing in a progressive manner. You will practice repairs on the sets that you construct. You will learn symptoms and causes of trouble in home, portable and car radios. You will learn how to use the professional Signal Tracer, the Radio & Electronics Tester. While you are learning in this practical way, you will be able to do many a repair job for your friends and neighbors, and charge fees which will far exceed the price of the "Edu-Kit." Our Consultation Service will help you with any technical problems you may have.

FROM OUR MAIL BAG

J. Statitis, of 25 Poplar Pl., Waterbury, Conn., writes: "I have repaired several sets for my friends, and made money. The "Edu-Kit" paid for itself. I was ready to spend \$240 for a course, but I found your ad and sent for your Kit."

Ben Valerio, P. O. Box 21, Magna, Utah: "The Edu-Kits are wonderful. Here I am sending questions and also the answers for them. I have been in Radio for the last seven years, but like to work with Radio Kits, and like to build Radio Testing Equipment. I enjoyed every minute I worked with the different kits; the Signal Tracer works fine. Also like to let you know that I feel proud of becoming a member of your Radio-TV Club."

Robert L. Shuff, 1534 Monroe Ave., Huntington, W. Va.: "Thought I would drop you a few lines to say that I received my Edu-Kit, and was really amazed that such a bargain can be had at such a low price. I have already started repairing radios, and phonographs. My friends were really surprised to see me get into the swing of it so quickly. The Trouble-shooting Tester that comes with the Edu-Kits is really swell, and finds the trouble, if there is any to be found."



Train on this
315 sq. in.
picture
color TV
and get the
skills that
mean a
high-paying
career!

Solid-State — the newest development

Count on NTS training to always
feature the latest electronic equipment.

Now included in two exciting NTS color TV courses, this set is the largest, most advanced color television made. Guided by the NTS "Lab-Project Method" of combining professional kits and easy-to-follow lessons, you build this color TV step by step — learning TV Servicing as you go! NTS has successfully trained thousands of men at home for rewarding careers as electronics technicians. Prepare for the great opportunity fields of TV-Radio Servicing, Computers, Communications, and Automation.

This solid-state color set contains: 45 transistors, 55 diodes, 2 silicon controlled rectifiers, and 4 advanced Integrated Circuits representing an addi-

tional 46 transistors and 21 diodes. The first solid-state color TV this large — yours to keep! It features Automatic Fine Tuning; "Instant On"; an Ultra-Rectangular Screen (25 in. diagonal measurement) that lets you see the complete transmitted image for the first time — a full 315 square inches; exclusive built-in Self Servicing features which eliminate the need to buy costly test equipment; exclusive design Solid-State VHF Tuner with an MOS Field Effect Transistor; 3-stage Solid-State IF; Automatic Chroma Control; Adjustable Noise Limiting and Gate Automatic Gain Control; High Resolution Picture Tube; and a specially formulated Etched Face Plate that eliminates unwanted glare, and heightens contrast. Colors are more vivid,

fresh tones more natural, and the picture is sharper than ever before. By training on this unique color TV, you'll gain the most up-to-date skills possible in TV Servicing!

Other valuable equipment you build and keep includes an AM SW Radio, Solid-State Radio, FET Volt-Ohmmeter, and Electronic-Tube Tester. All included in your tuition. You learn troubleshooting, hi-fi, multiplex systems, stereo, and color TV servicing. Step right into a technician's job at top pay or open a business of your own! For complete details on all NTS electronics courses, mail the coupon today for the full-color NTS Catalog. No obligation. No salesman will call.

**Build this set
and learn
solid-state
circuitry—the
electronics
of today!**

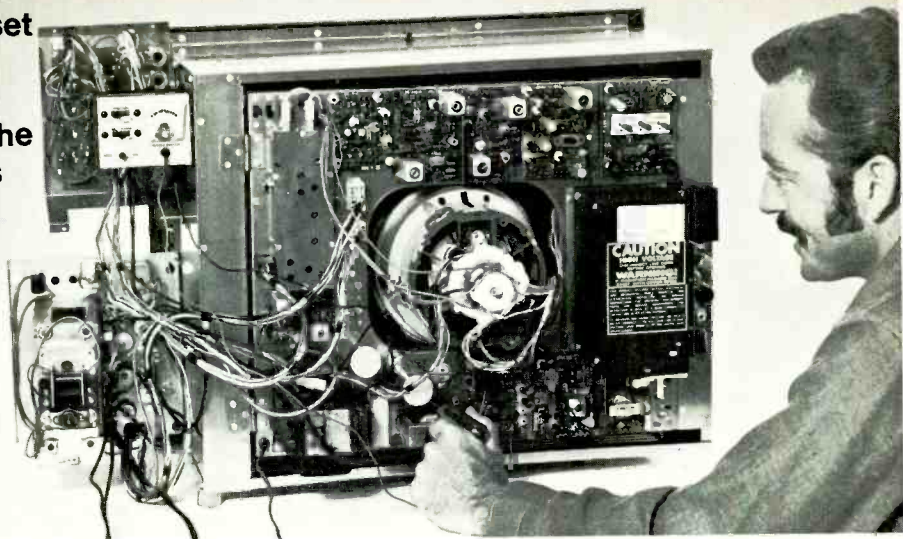

in color TV — comes to home training.

NTS ELECTRONICS & COMPUTER TECHNOLOGY

Build this exclusive NTS Computer-Trainer! Loaded with integrated circuits, it shows you the how, what, and why of computers. Learn this exciting field faster, more thoroughly. You also assemble and learn to operate a FET Volt-Ohmmeter and 5" wide band Oscilloscope.



NTS BLACK & WHITE TV AND RADIO SERVICING

Learn all phases of television, radio, stereo, and hi-fi. You receive this 74 sq. in. picture Solid-State B&W TV, Lo-Silho "Superhet" Radio, FET Volt-Ohmmeter, Solid-State Radio, Electronic Tube Checker, and Signal Generator.

Start earning extra money even before you complete the course!



NTS ELECTRONICS COMMUNICATIONS & F.C.C.

Gain the security and prestige of owning an F.C.C. First Class Radio-Telephone License! Two comprehensive NTS courses cover the big opportunity field of transmitting and receiving. You build 14 kits, including a 5 watt AM Transceiver, 6 Transistor Pocket Radio, and FET Volt-Ohmmeter. Learn 2-way radio, Citizens Band, micro-waves and radar.



NTS INDUSTRIAL & AUTOMATION ELECTRONICS

Automation is the future of industry and you can play an important part! Learn industrial controls by training on the NTS Electro-Lab — a complete workshop. You also build and operate this 5" wide band Oscilloscope. And you perform experiments that involve regulating motor speeds, temperature, pressure, liquid level, and much more.

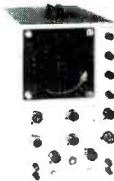

Classroom Training

at Los Angeles. You can take classroom training at Los Angeles in sunny Southern California. NTS occupies a city block with over a million dollars in technical facilities. Check box in coupon.

APPROVED FOR VETERANS

Accredited Member: National Association of Trade & Technical Schools; National Home Study Council.

NATIONAL TECHNICAL SCHOOLS

WORLD-WIDE TRAINING SINCE 1905

4000 South Figueroa Street, Los Angeles, Calif. 90037

Please rush Free Color Catalog and Sample Lesson, plus Information on course checked below. No salesman will call.



National Technical Schools

4000 S. Figueroa St.
Los Angeles, Calif. 90037

- Master Course in Color TV Servicing
- Color TV Servicing (For Advanced Technicians)
- Master Course in B&W TV & Radio Servicing
- Master Course in Electronic Communication
- Practical Radio Servicing
- FCC License Course
- Master Course in Electronics Technology
- Industrial and Automation Electronics
- Computer Electronics
- Basic Electronics
- High School at Home Dept. 000-00

Name _____ Age _____

Address _____

City _____ State _____ Zip _____

Check if interested in Veteran Training under new G.I. Bill.

Check if interested only in Classroom Training at Los Angeles.

if you go for four channel...



you don't have to go for broke

Buy yourself a miracle[®] for as little as \$209.95. That's all it takes to get your conventional two-channel stereo to do anything any total four-channel receiver and control center can do, now or in the future.

The Sansui QS500 and QS100 converters are complete Four-Channel Synthesizer-Decoder-Rear-Amplifier-and-Control-Center combinations that transform standard two-channel stereo totally. The only other equipment you need is another pair of speakers.

You can decode any compatibly matrixed four-channel broadcasts or recordings and reproduce them in four authentic channels. You can detect the ambient signals present in most two-channel recordings or broadcasts and propagate them through the rear channels. In Sansui matrixing, the exclusive phase-shift technique prevents the cancellation of some signals and the change in location of others that occur in many matrixing systems. And the exclusive phase modulators restore the effect of the live sound field.

You can plug in a four-channel reel-to-reel or cartridge deck or any other discrete source. In the future — if you should have to — you can add any adaptor, decoder or what-have-you for any four-channel system for disc or broadcast that anyone's even hinted at. And a full complement of streamlined controls lets you select any function or make any adjustment quickly and positively.

The QS500 features three balance controls for front-rear and left-right, separate positions for decoding and synthesizing, two-channel and four-channel tape monitors, electrical rotation of speaker output, alternate-pair speaker selection, and four VU meters. Total IHF power for the rear speakers is 120 watts (continuous power per channel is 40 watts at 4 ohms, 33 watts at 8 ohms), with TH or IM distortion below 0.5% over a power bandwidth of 20 to 20,000 Hz. In its own walnut cabinet, the QS500 sells for \$279.95.

An alternate four-channel miracle-maker is the modest but well-endowed QS100, with total IHF music power of 50 watts (continuous power per channel of 18 watts at 4 ohms and 15 watts at 8 ohms). In a walnut cabinet, it sells for \$209.95.

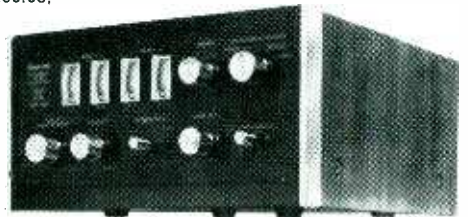

© COPYRIGHT BY SANSUI

SANSUI ELECTRONICS CORP.

Woodside, New York 11377 • Gardena, California 90274

SANSUI ELECTRIC CO., LTD., Tokyo, Japan • Sansui Audio Europe S. A., Antwerp, Belgium

CIRCLE NUMBER 18 ON PAGE 15