

Servicing Solid-State Television Sets

Electronics ILLUSTRATED®

JANUARY 1972 **50c**
By the Publishers of
MECHANIX ILLUSTRATED
06125

Video Cassettes—Where Are We?

ABCs of Sideband for CBers

Build:

All-Band Trap Antenna for SWLs

Stereo FM Signal Analyzer

Multi-Use Bench Power Supply



**Build This Low-Cost
Electronic Thermometer**

CONSISTENTLY THE BEST IN HOBBY ELECTRONICS

www.americanradiohistory.com

firsts

**make learning
Electronics at home
fast and fascinating—
give you priceless
confidence.**

Some NRI **firsts** in training equipment



first to give you Color Television training equipment engineered specifically for education—built to fit NRI instructional material, *not* a do-it-yourself hobby kit. The end product is a superb Color TV receiver that will give you and your family years of pleasure. You “open up and explore” the functions of each color circuit as you build.



first to give you a unique, exciting digital computer *with memory* built especially for home training. You learn organization, trouble shooting, operation, programming as you build and use it. Performs the same functions as commercial computers. Lessons stress computer repair. You conduct a hundred experiments, build hundreds of circuits. A solid-state VTVM is included among ten training kits.

NRI's "discovery" method is the result of over half a century of leadership simplifying and dramatizing training at home

The FIRSTS described below are typical of NRI's half century of leadership in Electronics home training. When you enroll as an NRI student, you can be sure of gaining the in-demand technical knowledge and the priceless confidence of "hands-on" experience sought by employers in Communications, Television-Radio Servicing and Industrial and Military Electronics. Everything about NRI training is designed for your education . . . from the much-copied, educator-acclaimed Achievement Kit sent the day you enroll, to "bite-size" well-illustrated, easy to read texts programmed with designed-for-learning training equipment.

YOU GET YOUR FCC LICENSE OR YOUR MONEY BACK

There is no end of opportunity for the trained man in Electronics. You can earn \$6 or more an hour in spare time, have a business of your own or qualify quickly for career positions in business, industry, government. And if you enroll for any of five NRI courses in Communications, NRI prepares you for your FCC License exams. *You must pass* or NRI refunds your tuition in full. No school offers a more liberal money-back agreement. The full story about NRI leadership in Electronics training is in the new NRI Catalog. Mail postage-free card today. No salesman is going to call.
NATIONAL RADIO INSTITUTE, Washington, D.C. 20016

APPROVED UNDER NEW GI BILL If you have served since January 31, 1955, or are in service, check GI line on postage-free card.

designed from chassis up for your education



first to give you true-to-life experiences as a communications technician. Every fascinating step you take in NRI Communications training, including circuit analysis of your own 25-watt, phone/cw transmitter, is engineered to help you prove theory and later apply it on the job. Studio equipment operation and troubleshooting become a matter of easily remembered logic.

first to give you completely specialized training kits engineered for business, industrial and military Electronics. Shown above is your own training center in solid state motor control and analog computer servo-mechanisms. Telemetry circuits, solid-state multi-vibrators, and problem-solving digital computer circuits are also included in your course.

Electronics ILLUSTRATED

A Fawcett Publication

January 1972

Vol. 15 No. 1

Member Institute of High Fidelity, Inc.

COVER: Ektachrome by Henry Ries Studios

COMING NEXT ISSUE

Lab-Grade Power Supply

Sony's Trinitron . . .

Report on Japanese Color TV

A New Type of Readout . . . Liquid Crystals

Telephone Message Repeater

AMATEUR RADIO

A 3000 Year Old Ham Shack	Robert Angus	49
The Ham Shack	Wayne Green, W2NSD/1	87

CITIZENS BAND

ABCs of Single Sideband for CBers	John T. Frye	58
CB Corner	Len Buckwalter, KQA5012	83

AUDIO & HI-FI

Multipath Scope for Stereo FM	Harry Kolbe	40
Cassettes Come On Strong	John Milder	66
Hi-Fi Today	John Milder	103

SHORTWAVE LISTENING

The Listener	C. M. Stanbury II	48
A Trap Antenna for SWLs	Ronald Lumachi	63
DXing Our Northern Neighbors	Alex Bower	80

SERVICE

Service Tips	Art Margolis	16
Servicing Those Solid-State TVs	Art Margolis	76

MEDICAL ELECTRONICS

Low-Cost Electronic Medical Thermometer	Walt Henry	27
---	------------	----

ENTERTAINMENT ELECTRONICS

Videocassettes—Where Are We?	Don Dunn	33
TV's Wheel of Color Spins Again	Len Buckwalter	84

SOLID-STATE ELECTRONICS

Multi-Purpose Bench Power Supply	Joseph Ritchie	68
--	----------------	----

AUTOMOTIVE ELECTRONICS

EI Breaks the World Land Speed Record		88
---	--	----

EI'S WIN-THE-WORLD CONTEST

		82
--	--	----

NEW PRODUCTS

Electronic Marketplace		22
------------------------------	--	----

HOBBY & BUSINESS OPPORTUNITIES

Classified Ads		105
----------------------	--	-----

REGULAR DEPARTMENTS

Uncle Tom's Corner	Tom Kneitel, K2AES/KB64303	8
Feedback		10
Product Information Service		11
Subscription Offer		25
The EI Ticker		32
EI's 1971 INDEX		94
Over & Out		104

KEEP PACE WITH SPACE AGE! SEE MOON SHOTS—LANDINGS, SPACE FLIGHT

AMAZING SCIENCE BUY

for FUN, STUDY or PROFIT

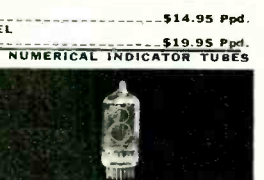
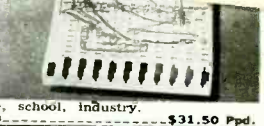

See moon shots,
orbits, stars,
craters!

NEW 3" REFLECTOR TELESCOPE

Deluxe Features at economy price 60 to 180X

Amazingly priced Apollo Space Explorer brings the wonders of the universe up close. 3" aluminumized & overcoated f/10 mirror. Reaches theoretical limits of resolution & definition. 60X standard size 1 1/4" O.D. eyepiece. 1/2" F.L. 3X adjustable barlow. 6X finder telescope; high impact plastic tube; metal fork mount w/ positive locking. 36" hardwood tripod. Included FREE: 272 p. Handbook, Star Chart, Instructions. Best value ever!

Stock No. 80,162EB \$59.50 Ppd.
REG. 3" REFLECTOR TELESCOPE
Stock No. 85,050EB \$34.50 Ppd.
4 1/2" ASTRONOMICAL REFLECTOR TELESCOPE
Stock No. 85,105EB \$94.50 F.O.B.
6" ASTRONOMICAL REFLECTOR TELESCOPE
Stock No. 85,086EB \$239.50 F.O.B.

Hand-sized solid state electronic strobe light at fantastically low price. Produces bright psychedelic effects like larger, far more expensive Xenon strobes; yet it's just 2 3/4 x 4 x 1 3/8" thick. Adjustable flash rate, approximately 3-10 flashes per second. Make stop motion effects, posters come alive. Great to take with you to parties, dances, outings, etc. Requires 2 9v transistor batt. (not incl.) Instructions.
Stock No. 41,443EB
4 REPLACEMENT LAMPS P-41,444EB

Solve problems, play games, predict weather with this actual working model of giant electronic brains. Amazing new fun way to learn all about computer programming . . . logic, decimal, binary systems, Laws of Sets. . . even do your own programming after completing simplified 116 page instructive booklet. Includes step-by-step assembly diagrams. Circuits easily changed. Readout from illuminated control panel. Req. 2 "D" batt. (not incl.). Best model we've . . . for home, school, industry.
Stock No. 71,434EB (11"x12 1/2"x4") \$31.50 Ppd.

Hi-resolution image-transmitter lets you see into remote, inaccessible illuminated areas; through pipes, tubes or any 3/8" opening no matter how intricate. Provides clear, wide field of view magnifying eyepiece focuses from less than 1/2" from subject to infinity. Ideal for monitoring hazardous surveillance instrument, demonstrate fiber optics. Over 4,000 coherent glass fibers (0.002"), 3/8" dia. semi-rigid gooseneck sheathing.
Stock No. 60,857EB \$40.00 Ppd.

Frighten prowlers, muggers, vicious dogs with 118 decibels. Just press and this Freon powered pocket-sized metal horn can be heard a mile away to signal for help or fun. Great for boating (it floats), hiking, camping, hunting, seachore, roofing for your team. Can be heard over traffic and constr. noises to sound fire drill, lunch break or emergency. Weighs only 3 oz. but contains up to 100 mile piercing blasts. A real bargain.
Stock No. 41,423EB \$3.25 Ppd.
2 Refill Cartrs. (P-41,424EB) \$2.75 Ppd.

Relatively small (12") fixtures give surprisingly bright black-light. Mirror-finished reflector makes instant starting easy, high-intensity bulb look like 40-watt. Up to 5,000 hours of safe, long-wave (3600A) black-light to really turn-on parties, light & theatrical shows, psychedelic decors, holiday decorations. Shockproof anti-caps remove for safe, easy replacement of bulb and starter. Stands upright or horizontal. Aluminum case.
Stock No. 71,272EB \$14.95 Ppd.
DELUXE OUTDOOR/INDOOR MODEL
Stock No. 71,299EB \$19.95 Ppd.

Designed as direct line, slide-view readout devices for basic counter and computer circuits. Gas filled cold-cathode numerical readout tubes use common anode 10 cathodes in shapes of numerals 0-9. Also give visual digital display of volts, cycles, etc. High reliability, long life, wide-angle viewing with brightness and stability.
TUBE W/ DECIMAL: No. 41,593EB \$5.95 Ppd.
Socket for above: No. 41,616EB
TUBE W/ DEC-TO-LEFT: No. 41,618EB \$5.95 Ppd.
Socket for above: No. 41,617EB 80c Ppd.

Automatically coordinates tape recordings with a series of slides. Just hook up recorder and slide projector to the TSS—then record what you wish for each slide. On playback, the TSS will automatically change slide in conjunction with that slide's recording. Makes 1 man show into no-man show. Your presentation "gives itself." Perfect for presentations, sales meetings, lectures. Make "talking album" of child's growth, add new dimension to vacation slides, pictures from zoo, party, ballpark . . . anywhere.
Stock No. 41,222EB \$21.95 Ppd.

Organ kit ideal for economical experimenting with an amazing L.E.D.s, the tiny solid state monochromatic lamps that use low voltage DC, last up to 1MM hrs. Used in card-tape readers, character recognition, hi-speed detectors, all kinds of electro-optical applications. Kit incl. 3 L.E.D.s; gallium arsenide (MLED) 000, MV 50, MLED 930; 2 visible red emitting (6600A); infra-red emitting (9000A); 6 resistors; 1" 20mm plastic fibre optic light pipe; instrs.
Stock No. 41,597EB \$5.95 Ppd.

Make a sensor alarm w/new low cost experimental kit. When infra red hits solid state sensor's LASCR (Light Activated Silicon Controlled Rectifier) it actuates the integrated circ. tone generator. Oscillations then amplified into loud speaker. Incl. 16 ohm 2 1/2" dia. spkr, perf. hd. batt. clip & holder; 2 1/2" .020 dia. plastic fibreoptics light gd. w/ infra red filter; wire; resistors; capacitors; transistor NPN. Req. 4 AA cells, not incl.
Stock No. 41,595EB \$6.95 Ppd.

Terrific Buy! Top Quality! Projects brilliant sharp 4 1/2 fl. sq. image from 8" using up to 5"x3" color, b&w, illustrations. Retains all original colors, proportions. Enlarges drawings, coins, maps, etc. Revolutionary peanut-size quartz Halogen lamp (50 hr. life), 200mm anastigmatic lens (f3.5, 8" F.L.), unique internal reflecting system give maximum brightness, entire field focus. Can be used upside down. Turbo-cooled. 5 1/2 fl. cord.
Stock No. 71,272EB (Wt. 1 1/4 lbs) \$98.75 Ppd.

Thrill to the fun of building your own see-through motorized model of revolutionary piston-less type engine, rights for which GM recently paid \$50 million! Only engine experts think economically modifiable to meet new pollution standards. Replaces piston, cylinder, crank assemblies with rotating discs sections removed for firing chambers). Smaller than conventional; fewer parts, greater reliability, same speed w/less horsepower. Feat: flashing plugs, rubber fan belt, stick-shift, on-off switch. Req. 2-1.5V batt. (not incl.).
Stock No. 71,424EB (4 1/2"x5"x9") \$6.75 Ppd.

MAIL COUPON FOR GIANT FREE CATALOG

148 PAGES!—1000's OF BARGAINS
EDMUND SCIENTIFIC CO. 300 EDSCORP BUILDING, BARRINGTON, NEW JERSEY 08007
Completely new edition. New items, categories, illustrations. Dozens of electrical and electromagnetic parts, accessories. Enormous selection of unique lighting items. Astronomical Telescopes, Microscopes, Binoculars, Magnifiers, Magnets, Lenses, Prisms. Many war surplus items: for hobbyists, experimenters, workshopers.
WRITE FOR CATALOG "EB."

EDMUND SCIENTIFIC CO. 300 EDSCORP BLDG. BARRINGTON, NEW JERSEY 08007

ORDER BY STOCK NUMBER - SEND CHECK OR MONEY ORDER - MONEY-BACK GUARANTEE

Electronics ILLUSTRATED

By the Publishers of MECHANIX ILLUSTRATED

editor **ROBERT G. BEASON**
 managing editor **Clifford L. Forbes**
 technical editor **Robert Collins**
 art editor **Lou Rubsamen**
 associate editor **Jean E. Lee**
 consulting editor **Robert D. Freed**
 production editor **Priscilla Moody**
 adv. director **John F. Webster**
 national adv. mgr. **Stanley Tessler**

publisher **George H. Allen**

CONTRIBUTING EDITORS

amateur radio **Wayne Green, W2NSD/1**
 citizens band **Len Buckwalter, KQA5012**
 swl-dx **C. M. Stanbury II**
 special projects **Herb Friedman**
W2ZLF/KB19457
 service **Art Margolis**
 audio **Harry Kolbe**
 audio **John Milder**

EXECUTIVE STAFF

president **Roger Fawcett**
 secretary-treasurer **Gordon Fawcett**
 circulation director **Roscoe K. Fawcett**
 vp., magazine div. **George H. Allen**
 exec. vp., book div. **Ralph Daigh**
 vp., asst. to pres. **Frederick A. Klein**
 vp., comptroller **F. Paul Simmering**
 vp., dir. admin. services **Joseph Cunningham**
 vp., circ. mgr., mag. div. **Luther Bugbee**
 subscription manager **Ted Sloat**
 vp., circ. mgr., book div. **Edmund Pendergast**
 production director **Thomas R. Marvel**
 art director **Ralph Mattison**

ELECTRONICS ILLUSTRATED is published bi-monthly by Fawcett Publications, Inc., Fawcett Bldg., Greenwich, Conn. 06830. Second-class postage paid at Greenwich, Conn., and at additional mailing offices.

EDITORIAL OFFICES: 1515 Broadway, New York, N.Y. 10036 (phone 212-869-3000). Contributions must be accompanied by sufficient postage and will be handled with care, though the publishers assume no responsibility for return thereof.

ADVERTISING OFFICES: 1515 Broadway, New York, N.Y. 10036 (phone 212-869-3000); Midwestern Representatives, Kinship Co., 5526 N. Elston Ave., Chicago, Ill. 60630 (phone 312-774-9660); 211 W. Fort St., Suite 1010, Detroit, Mich. 48226 (phone 313-962-4860); 3807 Wilshire Blvd., Los Angeles, Calif. 90010 (phone 213-287-8258); 691 Market St., San Francisco, Calif. 94105 (phone 415-EX 7-3441); 1422 W. Peachtree St., N.W., Atlanta, Ga. 30309 (phone 404-TR 5-0373).

SUBSCRIPTIONS: \$3 per year (6 issues) in U.S. and possessions and Canada. All other countries \$4 for 6 issues. All subscription correspondence, including changes of address (Form 3579), should be addressed to **ELECTRONICS ILLUSTRATED**, Subscription Dept., Fawcett Bldg., Greenwich, Conn. 06830. Foreign subscriptions and sales should be remitted by International Money Order in U.S. funds payable at Greenwich, Conn.

COPYRIGHT © 1971 by Fawcett Publications, Inc. The title **ELECTRONICS ILLUSTRATED** is registered in the U.S. Patent Office. Reproduction in whole or in part is forbidden without written permission of the publishers; however, permission is hereby granted to quote from this issue of this magazine on radio or television, provided a total of not more than 1,000 words is quoted and credit is given to the title of this magazine and issue, as well as the statement, copyright 1971, by Fawcett Publications, Inc. Member ABC, MPA.

PRINTED IN U.S.A. BY FAWCETT PRINTING CORP., LOUISVILLE, KY. 40201. Microfilm copies of current and back issues are available from University Microfilms, 313 N. First St., Ann Arbor, Mich. 48103.

we've gone magnetic!

NEW NUTDRIVERS STOP FUMBLING, SAVE TIME

Exclusive with Xcelite, 1/4" and 5/16" hex socket magnetic nutdrivers offer the ultimate in convenience for starting, driving, or retrieving screws, bolts, or nuts.

All types: Midget Pocket Clip, Regular, Extra Long, Super Long fixed handle... also interchangeable shanks for Series "99" handles.

Permanent Alnico magnet. Sockets remain demagnetized. Won't attract extraneous matter or deflect against metal surfaces.

New comfort-contour, color-coded handle makes one-hand driving easy, identifies tools as magnetic.

Sockets specially treated and hardened for use with hex head, self-tapping screws. Finished in black oxide for dimensional control and added identification.

REQUEST DESCRIPTIVE LITERATURE

*nationwide availability through
local distributors*



Made in U.S.A.

XCELITE

XCELITE, INC., 16 BANK ST., ORCHARD PARK, N.Y. 14127

Please send descriptive literature on Xcelite
Magnetic Nutdrivers.

name _____

address _____

city _____ state _____ zip _____

CIRCLE NUMBER 13 ON PAGE 11

Prepare now for a successful future!

ICS COURSES



Earn more money, enjoy greater security and faster promotion—and gain all the satisfaction of doing a job well that you like to do. Check the list of 266 ICS career opportunities for a better future. You receive individual

instruction, success-proved training you can apply immediately. And you earn the famous ICS diploma. Don't waste time! Send the coupon today for FREE information on a brighter career the ICS way!



LEADERS IN THE ICS SUCCESS PARADE...

Automobile Engine Tune-Up
Introduction to System/360 Computer
Business Administration Accounting
Civil Engineering
Practical Electrician
TV-Radio Servicing

Architectural Drafting High School Courses
High School Equivalency
Domestic-Commercial Refrigeration and Air Conditioning Serv.
Aircraft and Power Plant Mechanics

ACCOUNTING

Accounting (U.S.A.)
Accounting (Canadian)
Accounting for Business Programmers
Auditing
Business Law (U.S.A.)
Cost Accounting
CPA Review (U.S.A.)
General Accounting
Federal Tax (U.S.A.)
General Business Accounting
Junior Accounting
Office Accounting
Practical Accounting
Public Accounting
Small Business Accounting (U.S.A.)
Starting and Managing a Small Accounting Service (U.S.A.)

ARCHITECTURE AND BUILDING

Architectural Drawing and Designing
Architecture
Building Contractor
Building Estimator
Building Inspector
Building Maintenance
Carpenter-Building
Carpentry and Millwork
House Planning and Interior Design
Mason
Painting Contractor
Reading Architects Blueprints

ART

Amateur Artist
Commercial Art
Cartooning
Illustrating
—Advertising Layout
Interior Decorating and Design
Oil Painting
Show Card and Sign Painting and Designing

Show Card Writing
Sign Painting and Designing
Sketching and Painting

AUTOMOTIVE

Automatic Transmission Specialist
Automobile Air Conditioning Specialist
Automobile Body Rebuilding & Refinishing
Automobile Engine Tune-Up
Automotive Mechanic
Automobile Master Mechanic
Automotive Diesel-Gas Mechanic

BUSINESS

Advertising Acct. Exec.
Advertising Media
Advertising Copywriting
Advertising Production
Business Administration
Business Law
Canadian Business Course
Industrial Psychology
Basic Inventory Control
Managing a Small Store
Marketing Management
Marketing Research Management
Exec. Management
Office Management
Production Management
Purchasing Agent
Retail Bus. Management
Retail Buyer
Systems and Procedures Analysis

BUSINESS SALES

Real Estate Agent
Modern Salesman
Sales Manager

BUSINESS SUPERVISION

Advanced Management
Basic Management

Industrial Foremanship Management
Industrial Supervision
Sales Management
Personnel—Labor Relations (U.S.A.)
General Supervision

CHEMICAL

Chemical Analysis
Chemical Engineering
Chemical Laboratory Technician
Chemical Process Op.
Elements of Nuclear Energy
General Chemistry
Instrumental Laboratory Analysis

CIVIL ENGINEERING

Civil Engineering
Construction Eng'g Technician
Highway Eng'g Tech.
Principles of Surveying
Reading Highway Blueprints
Reading Structural Blueprints
Sanitary Engineering Technology
Sewage—Plant Operator
Structural Eng'g Tech.
Surveying and Mapping
Water-Works Operator

COMPUTERS

Fundamentals of Computer Programming
CBDBL Programming
Fortran IV Programming
Introduction to Digital Computer Programming
Programming the IBM 1401 Computer
Introduction to System 360 Computer

DRAFTING

Aircraft Drafting
Architectural Drafting
Design Drafting
Drafting Technology
Electrical Drafting
Electronic Drafting
Introductory Mech. Drafting
Mechanical Drafting
Pressure-Vessel and Tank Print Reading
Sheet Metal Layout
Structural Drafting

ELECTRICAL

Electrical Engineering — Electronics Option
— Power Option
Electrical Appliance Ser.
Electrical Contractor
Electrical Eng'g Tech.
Electrical Home Maint.
Electrical Instrumentation Tech.
Electric Motor Repairman
Industrial Elec. Tech.
Industrial Electrician
Industrial Maintenance Electrician
Power-Line Design and Construction
Power Plant Operator — Hydro Option
— Steam Option
Practical Electrician
Utility Lineman
Reading Elec. Blueprints

ENGLISH AND WRITING

Better Business Writing
English for Spanish (U.S.A.)
Free Lance Writing for Fun and Profit
Modern Letter Writing
Practical English
Reading Improvement
Short Story Writing

HIGH SCHOOL

High School Business
High School (Canadian)
High School General
High School Math.
High School Secretarial
High School Vocational
High School College Preparatory—Arts
High School College Prep—Engineering and Science
Preparatory Course for High School Equivalency Exam.

MACHINE SHOP PRACTICE

Industrial Metallurgy
Mach. Shop Inspection
Mach. Shop Practice
Metallurgical Tech.
Reading Shop Blueprints
Tool & Die Maker
Welding Foreman
Tool and Die Foreman

MATHEMATICS

Math and Mechanics for Engineers

Math and Physics for Engineers

MECHANICAL

Mechanical Engineering
Aircraft and Power Plant Mechanic
Principles of Hydraulic and Pneumatic Power
Industrial Engineering
Industrial Eng'g Tech.
Industrial Instrumentation
Machine Design
Quality Control
Safety Eng'g Tech.
Tool Design
Vibration Analysis and Control

PETROLEUM

Natural Gas Production and Transmission
Oil Well Servicing
Petroleum Production Operator
Petroleum Production Field Tech.
Petroleum Refinery Op.

PLASTICS

Plastics Technician

PLUMBING, HEATING AND AIR CONDITIONING

Air Conditioning Estimator
Air Conditioning Maint.
Domestic Heating with Gas and Oil
Heating & Air Conditioning with Drawing
Industrial Air Cond.
Pipe Fitting
Plumbing
Plumbing and Heating
Plumbing and Heating Est.

Practical Plumbing
Domestic-Commercial Refrigeration and Air Conditioning Serv.

PULP AND PAPER

Paper Machine Operator
Paper Making
Pulp Making
Pulp & Paper Tech.

SECRETARIAL

Clerk-Typist
Secretary, Private Sec'y, Legal Sec'y, Med. Secretary, Executive

Shorthand/Stenographic Typewriting

STEAM AND DIESEL POWER

Boiler Inspector
Building Eng's
Power Plant Engineering
Stationary Diesel Eng's (operation and maintenance)
Stationary Fireman
Stationary Steam Eng'g

TEXTILES

Carding and Spinning
Dyeing and Finishing
Loom Fixing
Textile Designing
Textile Mill Superintendent
Textile Mill Supervisor

TRAFFIC

Motor Traffic Man'g'mt
Traffic Management
TV Installer
Commercial Radio Telephone License

1st Class

2nd Class

3rd Class

Electronics Service Technician
Principles of Electronic Computers
General Electronics
Hi-Fi Stereo and Sound System Servicing
Industrial Electronics
Numerical Control Maintenance and Troubleshooting
TV and Radio Servicing
Solid State Electronics
Telephony

APPROVED FOR VETERANS FOR TUITION REFUND

(G.I.'s qualify after 180 days active service)
Accredited member, National Home Study Council.
Easy pay-as-you-learn plan.
Special rates to members
U.S. Armed Forces.

ICS[®]
International
Correspondence
Schools
Division of Intext
ICS, Scranton, Pa. 18515

Canadian residents:
Send coupon to Scranton.
Our affiliate in Canada will reply.
In Honolulu:
Use P.O. Box 418, Honolulu.

TAKE YOUR FIRST STEP... MAIL THIS COUPON TODAY—ICS, SCRANTON, PA. 18515

7K067L

I'm interested in a program of independent study.
Send me, without cost, your booklet on the principles of success,
sample text demonstrating famous ICS method, and your catalog for _____

(Print name of course. See list.)

Miss _____
Mrs. _____
Mr. _____

Age _____

Address _____

Apt. _____

City _____

State _____

Zip Code _____

Occupation _____

Employed by _____

Working Hours _____

A.M. to _____

P.M.

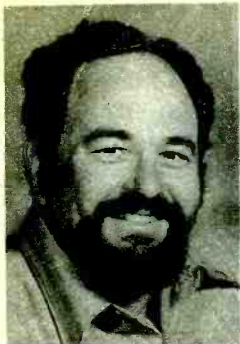

Uncle Tom's Corner

By Tom Kneitel, K2AES/KQD4552

Uncle Tom answers his most interesting letters in this column.
Write him at Electronics Illustrated, One Astor Plaza, New York, N.Y. 10036.

★ *I have a Canadian Military surplus set called the Mk 111 No. 19 made by RCA. Can you please tell me what this could be used for?*

*Steven Hajdu, Jr.
Brantford, Ont.*

One helluva novel paperweight.

★ *I'm making a valiant stab at firing up an old Army BC-348 receiver, but the sensitivity is really blah. I realize that it's more than 20 years old but is there anything I can do to bring back that old zing?*

*Willie Annarino
Bradford, Pa.*

When the Army got wise to the fact that the 6SK7 tube wasn't the answer to a front-end's prayer they designed a little tube called the 717A. It's a direct super-hot substitute which can still be found at many surplus stores; you can use it in any ancient set with a 6SK7 RF stage. If you can't dig up a 717A, get a Nuvistor preselector.

★ *Big problem: How can I rewire a negative-ground-system solid-state ham rig for use in my positive-ground-system foreign car?*

*Ron Campbell
Mineral Wells, Tex.*

Disconnect all of the DC ground-return leads from battery ground, connect them all together and bypass them to battery ground with a .01-1 μ f capacitor. Then connect all

of the other DC supply leads (those formerly connected to the hot side of the battery) to battery ground. If the gear has an antenna connector with one side grounded, lift the direct ground connection and bypass the connector ground terminal or shell to battery ground.

★ *I have been bombarded by some radar/audio instrument from people who know my every move with it. This has been going on for a year and a half. These wavelengths wake up the whole neighborhood and people can hear each other through this instrument. They cover about five states, Michigan, Indiana, Illinois, Iowa, and Wisconsin, and are located in several positions in the Chicago area. Tell me about this. What can I do about it?*

*M.P.R.
Evanston, Ill.*

Offhand I would suggest your moving to Arizona but I hear that they're setting up a franchise for this there too.

★ *A few issues back you told someone the frequency of the Minnesota Highway Patrol. How can I obtain this type of information for other areas?*

*Capt. Robin M. Lake
APO New York*

Directories of police-fire emergency-station callsigns-frequencies are published by
[Continued on page 12]

Fawcett Publications, Inc., is pleased to announce a Retail Display Plan available to all retailers interested in earning a display allowance on ELECTRONICS ILLUSTRATED. To obtain details and a copy of the formal contract, please write to Marketing Division, Fawcett Publications, Inc.,

ATTENTION, ALL MAGAZINE RETAILERS

Fawcett Pl., Greenwich, Conn. 06830. Under the Retail Display Plan, in consideration of your acceptance and fulfillment of the terms of the formal contract to be sent to you upon your request, you will receive a display allowance of 10 percent of the cover

price per copy sold by you. This plan will become effective with all issues of Electronics Illustrated delivered to you subsequent to the date your written acceptance of the formal FAWCETT PUBLICATIONS, INC. RETAIL AGREEMENT is received and accepted by our company.

RADIO SHACK ISSUES A NEW AND DIFFERENT CATALOG!

**FREE
NEW 1972
EDITION**

**ELECTRONICS
FROM A to Z**

ANTENNAS • BATTERIES

CAPACITORS • DIODES

EDUCATIONAL KITS

FIBER OPTICS

GRILLE CLOTH

HI-FI SPEAKERS • IC'S

JACKS • KNOBS • L-PADS

MIKES • NEEDLES

OSCILLATORS • P-BOXES

QUADRACS • RESISTORS

SEMICONDUCTORS

TELEPHONES

ULTRASONIC ALARMS

VHF ANTENNAS • WIRE

XENON STROBE LIGHT

"Y" ADAPTERS

ZENER DIODES

AND MUCH MORE!

**Get a Copy At Your Nearby
Store or Mail Coupon Today!**

**1000's of
Products!**

**100's of
Exclusives!**

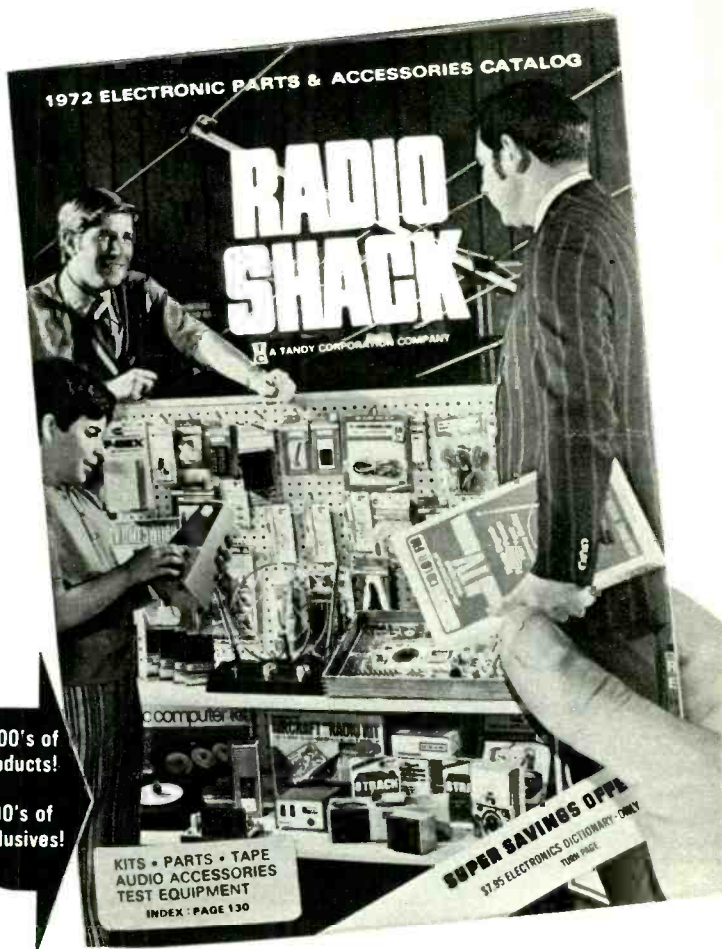

THE buying guide for kit builders, Hams, CB'ers, installers, experimenters, fix-it men, hobbyists, electricians, anyone in electronics in any way. It lists 1000's of things most stores don't stock. Things that keep equipment working, or make it work even better or do even more. Features our complete Science Fair and Knight-Kit lines of electronics and hobby kits, too. Use this catalog to find what you need, then go to our store near you and get it. Or you may order by mail.

Over 1100 Stores in 49 States

ALLIED RADIO SHACK
A TANDY CORPORATION COMPANY

Dept. EI-7

2725 W. 7th St. Fort Worth, Texas 76107

Send me your FREE 1972 Catalog #215

Please PRINT Clearly

Name _____ Apt. # _____

Street or Rte. & Box _____

City _____

State _____ Zip

January, 1972

CIRCLE NUMBER 1 ON PAGE 11

Feedback from Our Readers

Write to: Letters Editor, Electronics Illustrated, One Astor Plaza, New York, N.Y. 10036

● SQUAWK BOX

I can't understand why ham radio operators—or anyone else, for that matter—would be opposed to the new Class E service for Citizens Band. It seems to me that radio communications has been in the hands of special-interest groups long enough. Power to the people!

James P. Simpson
Salt Lake City, Utah

● WATER ON THE BRAIN!

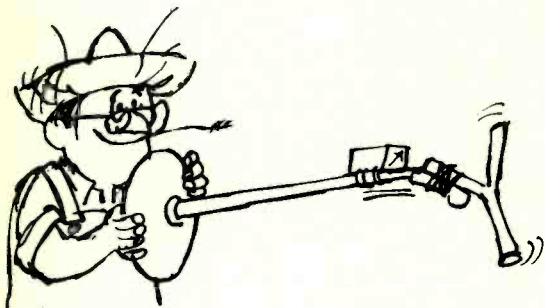

You're right about some of those cheapie metal detectors (SEMI-PRO METAL LOCATOR, Nov. '71 EI). While I'm sure the Heath instrument you describe is as good a nut as it is cracked up to be, I found that my \$19.95 special Super-Pro model was better for locating water than metal.

Floyd Ritchie
Houston, Tex.

● DEAL THE CARDS, FRIEND!

I enjoy reading EI very much, but I can't stand the format of placing send-away cards at various places within the magazine. It is impossible to flip through the magazine in search of a particular reference article or other item of interest because of these cards.

Charles A. Long
Bloomington, Ind.

Excuse us, Charlie, but when it comes to the habit of making money we're only too eager. Perhaps the cards—known as inserts—are a nuisance, but they do have a definite purpose. However, if you would care to donate a few hundred thousand dollars to EI, we'll see what we can do.

● FOUR-CHANNEL SQUARE



You know, you people—along with the rest of the industry—must be a little crazy. I saved for two years just to get my first stereo set and three years to obtain my latest professional stereo rig—and now, your latest story on four-channel stereo (BIG NOISE IN FOUR CHANNEL, Nov. '71 EI) tells me that my new equipment is obsolete and that what I really need is four-track stereo. Who's kidding who?

Mike Romano
Brooklyn, N.Y.

There's no arguing about taste, Mike. Kidding aside, just think what fun you'll have saving up for newer stereo gear another four years so that in 1975 somebody can show you where you are all wrong.

● SOME LOCAL TALENT

I have noticed that many of your readers have difficulty obtaining parts for your projects. I will be glad to supply EI readers with any but the most special types.

Vernon T. Cerny
7052 Sophia Street
Van Nuys, Calif. 91406

● BRAVE NEW WORLD

Thank you for your excellent article on semiconductors (UPDATE ON SEMICONDUCTORS) which appeared in the November issue. For a hobbyist like myself, such information truly enhances my enjoyment of electronics and my pleasure reading EI.

Herb Peterson
Willimantic, Conn.

Thanks for the praise, Herb. —



**Electronics
ILLUSTRATED**

Product Information Service



If you want more information about one or more of the products advertised in **ELECTRONICS ILLUSTRATED**, this service is for your convenience. The product information you request will be sent to you promptly free of charge.

Just complete the name and address portion of one of the handy coupons below and circle the **PRODUCT INFORMATION SERVICE** number or numbers you find beneath the advertisements in this issue.

**Mail a completed coupon to ELECTRONICS ILLUSTRATED
at the address shown — We'll take care of the rest.**

ELECTRONICS ILLUSTRATED P.O. Box 645, Princeton, N.J. 08540										ELECTRONICS ILLUSTRATED P.O. Box 645, Princeton, N.J. 08540									
1	2	3	4	5	6	7	8	9	10	1	2	3	4	5	6	7	8	9	10
11	12	13	14	15	16	17	18	19	20	11	12	13	14	15	16	17	18	19	20
21	22	23	24	25	26	27	28	29	30	21	22	23	24	25	26	27	28	29	30
31	32	33	34	35	36	37	38	39	40	31	32	33	34	35	36	37	38	39	40
41	42	43	44	45	46	47	48	49	50	41	42	43	44	45	46	47	48	49	50
Please Print										Please Print									
NAME _____										NAME _____									
ADDRESS _____										ADDRESS _____									
CITY _____										CITY _____									
STATE _____					ZIP _____					STATE _____					ZIP _____				
<small>1/72</small>										<small>1/72</small>									

Johnson put it all together.

low band and high band channels in any combination base and mobile operation with built-in power supply auto-scan with push-button "lock out" plus manual "lock in"

new
Duo-Scan™
\$169⁹⁵



Eight VHF FM channels, in any combination of high and/or low band, keep you on top of all the action. Operates mobile or base with performance features previously found only in professional public safety radio equipment. Two ceramic filters give unsurpassed adjacent channel rejection. Integrated circuit symmetrical limiting makes it really quiet. 0.4 μ V sensitivity lets you hear what others miss. Powerful transistor audio produces clear, undistorted sound. The new Duo-Scan puts it all together, for just \$169.95 (less crystals).



E. F. JOHNSON COMPANY
WASECA, MINNESOTA 56093

CIRCLE NUMBER 15 ON PAGE 11

1214

Uncle Tom's Corner

Continued from page 8

CRB Research Inc., P.O. Box 56-EI, Com-mack, N.Y. 11725. They'll send you their latest catalog if you send them a stamped No. 10 (4½ x 9½ in.) envelope.

Helpful Hint Dept. Here's a little trick which should appeal to six-meter hams. If you can bear up under the QRM, keep a CB receiver going in your shack. When you start to hear the skip signals popping through, you have 20 minutes to a half hour's advance notice that the six-meter band will be open. If you get your six-meter rig warmed up and on the band pronto, you'll be one of the first local stations in the hassle and can knock off some of the better DX before the megawatts come on and wipe you out.

★ *Why don't local broadcasting stations use inexpensive longwire antennas instead of costly towers? They would be less of a navigation hazard too.*

*Jimmy Tilman
Huntsville, Ala.*

Once I worked at a little 250 watt disaster in Coral Gables, Fla., which went under the callsign of WTTT. Our tower doubled over during a hurricane in 1950 and ended up looking like a giant upside-down V. Having barely enough money to pay the transmitter electric bill—much less fix the tower—we ran a long wire from the highest point of what was left of the tower to a tree. The signal was so powerful that in the antenna's best direction we could barely copy the station five miles down the road. Does that answer your question?

★ *Are hams allowed to contact ships at sea? I don't mean ones with ham stations aboard. I mean regular ship stations.*

*Bernard R. Quigley
Barre, Vt.*

Sometimes the FCC will grant special permission for hams to contact a ship station, providing the government which licensed the ship station has in turn given the ship the okay to operate on ham frequencies. When I was with United Artists, I arranged with the Norwegian Government to authorize our
[Continued on page 14]

Electronics Illustrated



NEW exciting home training to be a **COMPUTER TECHNICIAN**

NRI program includes a complete, operating computer, with memory, to make you thoroughly familiar with computer organization, design, operation, construction, programming, trouble shooting and maintenance.

You build your own digital computer step-by-step, circuit-by-circuit. You really get involved as you learn computer organization, operation and programming with this remarkable new training aid. It performs the same functions as bigger commercial computers—and it's yours to keep and use.

What better way to learn all about computers than to actually build and use one? That's exactly what you do in NRI's new Complete Computer Electronics home training program.

What you see illustrated may very well be the most unique educational aid ever developed for home training. This is not simply a "logic trainer." It is literally a complete, general purpose, programmable digital computer that contains a memory and is fully automatic. It's a small-scale model of larger, expensive commercial computers. Once you build it and it is operational, you can define and flow-chart a problem, code your program, store your program and data in the memory bank. Press the "start" button and, before you can remove your finger, the computer solves your problem and displays the results.

NRI is offering this new course because this is only the beginning of the "Computer Age." The computer industry continues to leap ahead. Qualified men are urgently needed, not only as digital technicians and field service representatives, but also to work on data acquisition systems in such fascinating fields as telemetry, meteorology and pollution control. Office equipment and test instruments also demand the skills of the digital technician. This exciting NRI program can give you the priceless confidence you seek to walk into a technician's job and know just what to do and how to do it.

You learn with your hands as well as your head

Planned from the beginning to include training equipment in the pioneering NRI tradition, this exceptional new course combines kits with educator-acclaimed NRI "bite-size" texts in an easy-to-understand package. But, unlike other home training, this is not a general electronics course. Lessons have been specifically written to stress computer repair. You perform a hundred experiments,

build hundreds of circuits, use professional test equipment. You build and use your own solid-state, transistorized voltmeter and your own oscilloscope in addition to your digital computer. Because you work with your hands as well as your head, your training is as much fun as it is education.

Train at home with the leader

There is so much to tell you about this latest NRI "first" in home training, you must fill out and mail the coupon today. Get the full story of Complete Computer Electronics and the amazing digital computer you build and use as you learn. The free NRI Catalog you receive also tells you about other NRI training plans in Color TV Servicing, Communications, Electronics Technology. There is no obligation. No salesman will call on you. NATIONAL RADIO INSTITUTE, Washington, D.C. 20016.

MAIL NOW FOR FREE CATALOG



NATIONAL RADIO INSTITUTE
Washington, D.C. 20016 92-012

Please send me your FREE CATALOG with details about new Complete Computer Electronics training. (No salesman will call)

Name _____ Age _____

Address _____

City _____ State _____ Zip _____

ACCREDITED MEMBER NATIONAL HOME STUDY COUNCIL

TURNER PUT A LOT INTO THE M+3 MOBILE MICROPHONE



Modu-Gard®
Compression circuit
to prevent over
modulation, ensure
constant output.

**Slide-Action
Volume Control**
Positive action,
precision adjustment
for transistorized pre-amp.

Modern Styling
An easy-to-grip design
so distinctive it's patented.

Hypalon Cord
Blue coil cord with a memory,
keeps its shape without stretching.

The Turner Name
Superior product design,
manufacturing and quality—made in USA.

YOU'LL GET A LOT OUT OF IT.

TURNER DIVISION
CONRAC
CORPORATION

909 17th Street N.E.,
Cedar Rapids, Iowa 52402
Telephone (319) 365-0421

Uncle Tom's Corner

Continued from page 12

viking longboat (made for the film *The Vikings*) to use its station (3YFG) to communicate with hams during its Atlantic crossing. The FCC said okay but the dear old ARRL refused to help spread the word. Because, they said, it smacked of being too commercial. No thanks to the League, a few hams did snag 3YFG.

Free Speech Department. While freedom of speech is guaranteed to each citizen, seems that freedom of music still doesn't rate. The FCC is still on their ridiculous anti-SCA (background music) adaptor kick. They just shut down another manufacturer, telling him that his gadgets are a violation of the secrecy of communication laws. Well, I have an SCA adaptor and I use the thing daily so if you fail to see this column in the next issue you'll know that I've been discovered listening to secret music and have been shuffled off to Ft. Leavenworth by the Feds.

★ *I've heard of some pretty far out ham radio prefixes in my time, but a WD6 is a new one on me. I really did hear it, and more than once last July. The callsign was WD6WD. Can you tell me if this guy was for real?*

Oscar Carlton
Lewes, Del.

The FCC is now assigning special fancy callsigns for temporary use at ham radio events. WD6WD was assigned for the Southwest Division Amateur Convention at Disneyland in California. Some of the other weirdo callsigns recently issued include: WF7AIR, KF4SJ, KC2GMF, WF7WBC, and KC0KC. Amooosin' but confoosin'.

★ *I was surprised when I saw how closely the new photo of you in EI resembled the drawing they had been running. I really didn't believe that anybody could actually look like the drawing.*

Charles N. McGraw
Eureka, Mont.

Charlie, sometimes I have trouble believing it myself.

The Perfect Intro to Electronics... Exciting Projects That Really Work, Really Teach!

\$1.95 to \$8.95 at Over 1100 Radio Shack stores nationwide!

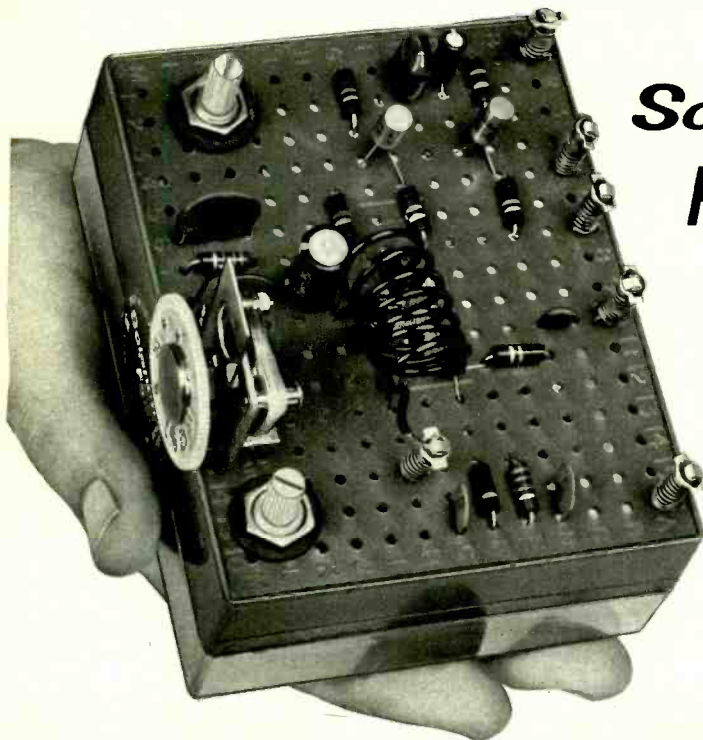

Science Fair^{T.M.}

P-Box Kits ...

**America's
Favorite!**

Shown:
Shortwave Radio Kit.
Earphone included.
Only \$7.95.

There are 21 Science Fair P-Box kits that make it "fun" to learn about electronics. Take our SW radio. It has 3 transistors, a regenerative high-gain detector, 2 audio stages and can pull in stations from around the world. Sounds complicated, but it's really not. Teacher-written instructions and big

pictorials guide you through the assembly. When you build a P-Box you get a working circuit that demonstrates electronic principles, the satisfaction of a job well done, plus a valuable learning experience. No wonder we've sold over 800,000 kits in just 3 years!



1-Tube DC Radio Kit, \$4.95.



Goofy-Lite Kit, \$5.95.

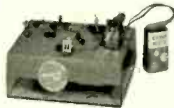

WWV Converter Kit, \$5.95.

See all 21 P-Box kits at our store near you. The 4 kits featured here also available postpaid. Address below. Add your state, local taxes.



**Ask for our
FREE
Kit, Parts &
Accessory
Catalog!**

ALLIED RADIO SHACK

A TANDY CORPORATION COMPANY

2725 W. 7th St. Fort Worth, Texas 76107



Service Tips

By Art Margolis

LET'S lay to rest the antenna grounding controversy. The National Electric Code flatly states that both mast and metal parts should be grounded. Obtaining a good ground means you've got to reach a soil-moisture level which is usually about eight feet below the surface. Drive a No. 8 aluminum or No. 10 solid copper grounding rod into the earth for satisfactory results. A metal cold water pipe is fine.

Never substitute a filter capacitor for replacement or even test purposes that has a voltage rating of less than what is called for. Higher voltages impressed across these capacitors can cause the electrolytic material to explode. The shrapnel thrown off flies with sufficient force to cause serious damage. Always observe proper working voltages of polarized capacitors.

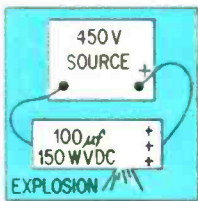

Don't throw away discarded recording tapes. They do not wear out. In fact, tests have shown that old magnetic recording tapes improve with age. The oxide coating eventually smooths out, producing a uniform recording surface. Many new tapes suffer from excess oxide dust that remains on the surface. The tape really is not satisfactory until the fine powder has worn off.

If you do not use distilled water in your steam iron a mineral deposit builds up quickly. Too much of a mineral deposit eventually clogs the iron, stopping the steam. Deposits can be cleaned out easily with distilled white vinegar. Just fill the iron with vinegar and run it at a low heat setting.

Is your automatic coffee percolator serving up consistently weak coffee? Is the coffee not exactly piping hot? If these two conditions occur, chances are the percolator has a defective thermostat. Remove the old one, buy a new thermostat and install it to restore the strength of your brew.

One TV trouble, the symptom of sound bars in the picture, is sometimes traced to the CRT electron-gun elements vibrating to a strong loud-speaker output. If this happens and you don't want to change to a tube with a better structured gun, remove the speaker and mount it in its own enclosure outside the TV set.

Serious trouble can occur in transistor radios if a battery leaks its electrolyte over the printed-circuit board. If you see the electrolyte (colored something like green ooze) when replacing batteries, be sure to scrape all of it off the radio's innards. Failure to remove it can cause serious damage.



IT'S ALMOST LIKE PRINTING YOUR OWN MONEY!

9¢ WORTH OF RAW MATERIAL becomes \$125

in less than 60 seconds—and ANYONE can LEARN to do it in a FEW SHORT HOURS!

Since 1922, Warner has enabled thousands of men and women to establish a business of their own—to reap the benefits of their own labor and have the personal satisfaction, and independence, that comes with operating a business of their own.

Now, a revolutionary new machine makes it possible for an Independent Business Man with no "PULL" . . . **No Big Money to Invest** . . . and, **No Experience** — to start a business of his own, at home in his spare time. Here's what J. H. of Pennsylvania says:

\$7,280.00 for 1 to 1½ hours work an evening in my spare time—and without advertising. When I start to advertise I will have my own full-time business. Right now I am using the extra income to give my family the luxuries my present job does not afford.

Now you can get into this highly lucrative business, and use your own home as headquarters. No experience needed because we supply everything. The new Warner Success Program, "Engraving as a Profitable Business," is now ready for you. We will send you a **FREE** illustrated brochure and no salesman will call. Send no money — just your name and address on the coupon or on a postcard. Be the first in your locality to cash in on this ground floor opportunity.

**Warner Electric Co., Dept. E-120-AP
1512 Jarvis Ave., Chicago, Ill. 60626**

Engraving Division, Dept. E-120-AP SEND NO MONEY
1512 Jarvis Ave., Chicago, Ill. 60626

Please rush your free illustrated brochure to:

Name _____

Address _____

City, State, Zip _____

STANLEY / WISS / DISSTON / BLACK & DECKER / PROTO / LUFKIN / RIDGID / COLUMBIAN / BRIDGEPORT / MILLERS FALLS / DASCO / WEN / GREAT NECK / SEYMOUR SMITH / MANNING-BOWMAN / CUMMINS / BURGES / RAM / DREMEL / SPEEDY / CA / BURGES / TOOLKRAFT / GENERAL ELECTRIC / EAGLE / YANKEE / XCELITE / CHANNELLOCK / VISE GRIP / MILWAUKEE / WILLIAMS / SHERMAN KLOVE / THOR / YALE

UP TO 50% OFF!

ON ALL TOOLS & HARDWARE

Get Up To 50% Off on Nationally Advertised Name Brands—Start Your Own Business—Huge Profits! More Money!

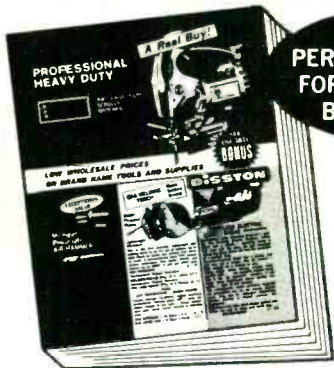

YOUR PERSONAL SOURCE FOR 12,000 NAME BRAND ITEMS

AT LOWEST WHOLESALE PRICES NOT AVAILABLE FROM ANY OTHER SOURCE!

4 WHOLESALE PRICES—UP TO 50% OFF AND MORE ON THE BEST STANDARD NAME BRANDS

Stanley, Thor, Wiss, Miller Falls, Disston, Skil, Kennedy, Lufkin, Black and Decker, and many many other name brand hand tools, power tools, appliances, motors, gardening equipment and others too numerous to mention.

5 YOUR COST IS IN SECRET CODE

The retail prices are plainly shown, but your confidential low wholesale costs are concealed in a code known only to you. You save as much as 50% and more off the advertised retail prices of over 12,000 items of famous name merchandise.

6 SAVE HUNDREDS OF DOLLARS A YEAR

Thanks to Hamilton House's arrangement with U.S. General Supply Corp. we can offer you an opportunity to have available an inventory of brand name tools and accessories in excess of one million dollars that you can draw against as you wish at prices up to 50% off.

7 \$1.00 PUTS YOU IN YOUR OWN PART TIME BUSINESS

And your \$1.00 is credited to your first purchase or refunded if not 100% satisfied. Your \$1.00 is just a deposit . . . you cannot lose. If you are not completely satisfied your dollar will be refunded—no questions asked!!!

1 188 PAGES OF HAND AND POWER TOOLS FOR THE SERIOUS MINDED CRAFTSMAN, MECHANIC OR HANDYMAN FOR HOME, FARM, WORKSHOP, BUSINESS

You can save hundreds of dollars a year on all types of tools and hardware. Nationally known makes, finest quality at WHOLESALE prices. THIS CATALOG DOES NOT OFFER YOU DISCOUNTS BUT RATHER WHOLESALE PRICES THAT GIVE YOU A REAL BREAK ON TOOLS FOR YOUR OWN USE, AND PRICES THAT GIVE YOU A HUGE PROFIT WHEN SELLING TOOLS TO OTHERS.

2 YOUR OWN WHOLESALE TOOL AND HARDWARE CATALOG

Build your own part time business taking orders for tools and hardware from this new giant fully illustrated Wholesale catalog which has only your name on it. Everyone you approach is your prospect for tools—homeowners, factories, farmers, contractors, machinists, carpenters, and hobbyists.

3 STOCK OF OVER 12,000 ITEMS

We stock over 12,000 kinds of tools and accessories; ship from our huge warehouse the day your order arrives. Every item is unconditionally guaranteed: money back without question. A million dollar wholesale inventory at fingertips—no stock to carry—just order as you need it.

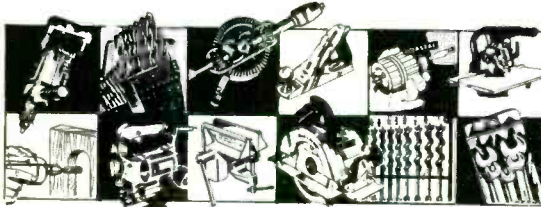

HAMILTON HOUSE
Dept. L-E1 Cos Cob, Conn. 06807

Money Back Guarantee

**Hamilton House Dept. L-E1
Cos Cob, Conn. 06807**

I enclose \$1. Please send me my giant new fully illustrated 188 page wholesale catalog of over 12,000 items including the best Brand Name tools. I understand that with my catalog I will receive a certificate worth \$1 on my first purchase or I will be refunded my \$1 if I am not 100% satisfied.

Name _____

Address _____

City & State _____ Zip _____

Does your mother-in-



law call you a meatball?

Does your boss?

Maybe even your wife? On payday.

Know what? If you have read this far, you are not meatball material. Because meatballs don't face the present, the future, the facts. They stay put. Dreaming and talking. And today, more than ever staying put means falling behind. Pretty tragic in a time when people with specific aptitudes are so necessary in so many interesting fields.

Today huge industries depend on people with electronics training.

Today there is a course of action that may lead you toward these well-paying, vital positions. It is RCA Institutes.

RCA Institutes is not for meatballs. RCA Institutes trains you for the fields where the action is: Computers • Color TV • Automation • Communications • Industrial Electronics • And more.

RCA Institutes not only has years of experience, it has an exclusive line-up of tested methods:

1. Hands-On Training

Over 250 interesting experiments. As many as 22 kits with some of the programs.

2. RCA Autotext

The easy-way-to-learn method that gets you started easier, faster.

3. Wide choice of courses and programs

Training in electronics fundamentals right up to solid state technology and communications electronics.

4. Low-Cost Tuition Plans

You'll find the one just made to fit your own budget.

5. FCC License Training Money-Back Agreement

RCA Institutes' money-back agreement assures you of your money back if you fail to pass the FCC examination taken within six months after completing RCA Institutes' FCC course.

RCA Institutes gets your training started even if you've not had previous experience or training. Just bring us your interest.

Set your own pace depending on your schedule.

If you like to tinker, fiddle, fix, put that ability to work to do a real repair job on your future now.

Don't wait. Get complete information right now. No obligation. Except to yourself. Send us the attached postcard. Or return the coupon.

Veterans: Train under GI Bill. Accredited Member National Home Study Council. RCA Institutes, Inc. is licensed by—and its courses of study and instruction facilities approved by—the N. Y. State Education Department.

RCA Institutes

Home Study Department 234-012-0
320 W. 31 Street, New York, N. Y. 10001

Please rush me FREE illustrated electronics career catalog. I understand that I am under no obligation.

NAME _____

ADDRESS _____

CITY _____ STATE _____ ZIP _____

Veterans check here



Build this magnificent Schober Theatre Organ

for only
* \$1730!

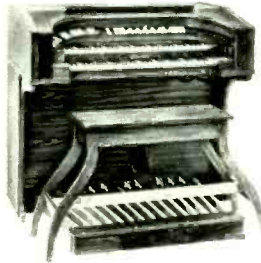

*Includes finished walnut console. Amplifier, speaker system, optional accessories extra. Only \$1256 if you build your own console.

You couldn't touch an organ like this in a store for less than \$3500—and there hasn't been a musical instrument with this vast variety of genuine Theatre Organ voices since the days of the silent movies! If you've dreamed of the grandeur of authentic big-organ sound in your own home, you won't find a more satisfying instrument anywhere—kit or no kit.

You can learn to play it. And you can build it, from Schober Kits, world famous for ease of assembly without the slightest knowledge of electronics or music, for design and parts quality from the ground up, and—above all—for the highest praise from musicians everywhere.

Send right now for your copy of the full-color Schober catalog, containing specifications of the five Schober Organ models, beginning at \$499.50. No charge, no obligation—but lots of food for a healthy musical appetite!

The *Schober* Organ Corp., Dept. EI-18
43 West 61st Street, New York, N.Y. 10023

- Please send me Schober Organ Catalog and free 7-inch "sample" record.
 Enclosed please find \$1.00 for 12-inch L.P. record of Schober Organ music.

NAME _____

ADDRESS _____

CITY _____ STATE _____ ZIP _____

CIRCLE NUMBER 14 ON PAGE 11

WANT A JOB? PART TIME— FULL TIME?

**No Boss! No Experience!
No Capital! Your Own Hours!
WHAT A JOB ! ! ! !**

And yet selling subscriptions to **ELECTRONICS ILLUSTRATED** and other leading publications is just like being in business for yourself. But no business requires less capital, stock and space. The time you devote and the money you make is up to you. You need no experience to earn steady profits and you keep a cash commission on every sale. You operate in your own community by phone or personal calls. You will be authorized to sell new and renewal subscriptions along with special offers made by the publishers. You'll be amazed at the number of people wanting to take advantage of the convenience, service and savings you can offer them. To get started immediately—send us your name (on a postal card) requesting free supplies and selling materials.

Write to: Subscription Dept. DE
ELECTRONICS ILLUSTRATED
Fawcett Bldg., Greenwich, Conn. 06830

Electronic Marketplace

Printed Circuits the Easy Way. Now you can make your own PC boards the way the pros do. Photo-etching is the process and Injectorall has a kit that uses photosensitive techniques



but requires no darkroom. You make photo-etched PC boards directly from magazine templates. The complete kit, Model 650, includes two sensitized copper-clad boards, a test negative and developing lamp. An exposure glass, clamps, etchant, developer, trays, resist remover and drills are there, too. \$10.80. Injectorall, 4 North Rd., Great Neck, N.Y. 11024.

A Clean Sweep. Want to debug your hi-fi? An audio sweep generator is one test instrument that can really pinpoint problem spots in any kind of amplifier stage. Model ASG-200 sweep generator has five sweep functions—sine, square, triangle, and positive- and negative-going sawtooth—that help track down gremlins in power amps and preamps. Output frequency is variable from 0.02 to 20,000 cps for all functions. Dial



accuracy is said to be within 2 percent. Added features are VCO access, and a linear dial. Output impedance: 50 ohms at 20 VAC peak-to-peak. \$84.85. Phase Corp., 315A Boston Ave., Medford, Mass. 10255.

WHEN THE EXPERTS TELL YOU... YOU BETTER BELIEVE IT!

The All New Fawcett Practical Workshop Library Does Just That. These Handsome Hardcover Books are Fully Illustrated, Indexed for Easy Reference to Hundreds of Money-Saving Projects and Ideas. Only \$1.49 each, plus 25 cents per book for postage and handling.



CARPENTRY 052 • This book takes the novice from the basic workshop to the building of frame houses. Step-by-step illustrations and charts supplement the easy to understand text. Topics covered include: use of tools, safety, planning and constructing your home workshop, buying your lumber, paneling walls, tips on furniture building, adding new ceilings, installing built-ins, storage, adding rooms, and more.

ELECTRICAL REPAIRS 055 • Filled with diagrams, pictures and easy-to-read charts, this is an indispensable guide to safe, simple ways to solve home electrical problems and to install new devices and wiring. Topics include: troubleshooting, repair of small and major appliances, safety, indoor/outdoor wiring and repair, installing light dimmers, fixing fluorescent lights, outdoor and indoor wiring, etc.

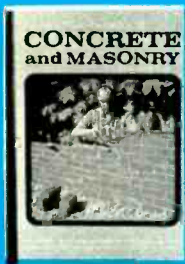
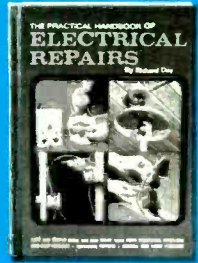

CONCRETE AND MASONRY 053 • Professional quality walks, drives, patios, walls, etc. can be made simply and inexpensively by using this handbook. It takes you through the rudiments of mixing and use of tools to the secrets of brick laying. Other topics include: the right way to use ready mix, mortar-making tips, beauty in stone, patching and resurfacing, casting footings, walls, floors, etc.

FURNITURE REFINISHING, RESTYLING AND REPAIR 057 • Contains valuable information on know-how and correct procedures for professional looking restoration and repair of furniture. Topics include: Repairing dressers, tables, chairs, beautifying odd pieces, use of varnishes, making wood satin smooth, minor repairs, matching woods, restoring antiques and picture frames, stripping old finish, etc.

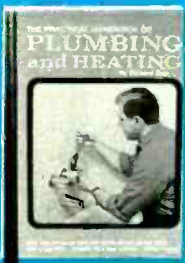

PLUMBING AND HEATING 054 • This book helps you cut those costly bills by showing you how to do it yourself. It is filled with easy to understand drawings, charts and photos and contains a wealth of information. Topics include: saving heating dollars, disposal systems, learn your home plumbing system, waste and heating repairs, fixing a furnace, heating controls, necessary plumbing tools, etc.

CAR CARE AND REPAIR 058 • Top performance information, easy to follow and amply illustrated, that the average motorist will find extremely useful. Topics include: Paint and body work, basic tools every owner should have, buying parts, lubrication, tuneups, electrical system, smooth shifting, valve grinds, overheating, exhaust system installation, overhaul tips, suspension, foreign cars, etc.

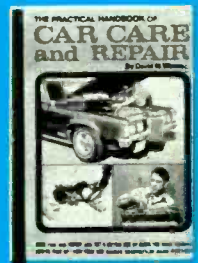

Send orders to: Fawcett Publications, Dept. PWL-EI
Fawcett Place,
Greenwich, Conn. 06830

Circle nos. wanted below:

NAME _____

ADDRESS _____

CITY _____ STATE _____ ZIP _____

Enclosed please find \$ _____

052 055

053 057

054 058



FRESH Face on 220. The Tempo, Model CT220-TR, is a solid-state transceiver that is crystal controlled and has double-conversion IF. The local oscillator is tuned precisely by a varactor diode, slipping you into five pre-set slots anywhere between 220-225 mc. Power output runs 1½ watts in AM mode, 4 watts in FM mode. Provision for adding internal power amps. \$179. C.T. Power, Hawthorne, Calif.

Electronic Marketplace

Pennypincher's FET-VTM. Model 239 multi-meter kit from Eico is battery powered and has an 11-megohm input impedance. This FET-VTM reads AC rms voltages and DC voltages in seven steps up to 1000 V. You can also read AC peak-to-peak voltages up to 2800 V. Resistance can be checked in seven ranges from 0.2 ohm to 1000 megohms. Eico's Uniprobe included. \$39.95. Eico, 283 Malta St., Brooklyn, N. Y. 11207.



Two-For-One Rig. CB transceiver Model 124-M in the Messenger line from Johnson lets you monitor channel 9 even while you're working another frequency. This rig's override circuit lets you either hear the message or see it via a panel lamp. \$339.50. E.F. Johnson, Waseca, Minn. 56093.



Four-On-The-Floor Quad. Toyo's Model 722 four-channel/two-channel cartridge tape player gives driver best arrangement of four-channel sound via four slide controls. Volume and tone controls regulate all channels. \$129.95. Toyo Radio Co., 1842-B West 169th St., Gardena, Calif. 90247.



Check This Message!

FLASH TO EI READERS!

MAKE DOLLARS GO FARTHER & SPREAD JOY! GIVE FRIENDS AND RELATIVES SUBSCRIPTIONS TO ELECTRONICS ILLUSTRATED.... AMERICA'S (AND SANTA'S) FAVORITE MAGAZINE FOR ELECTRONIC HOBBYISTS...EVERY ISSUE PACKED WITH TOP FEATURE AND CONSTRUCTION ARTICLES...EVERY AREA REPRESENTED...HAM RADIO...CITIZENS BAND...STEREO & HI-FI...SERVICING... SHORTWAVE LISTENING...PROJECTS FOR HOME & SHOP...FILL IN COUPON NOW AND JUST BEFORE CHRISTMAS EACH RECIPIENT WILL RECEIVE A GIFT ANNOUNCEMENT CARD SIGNED IN YOUR NAME...YOU CAN RENEW YOUR OWN SUBSCRIPTION AT SAME RATES... RATES DEFINITELY ANTI-INFLATIONARY...DO YOURSELF A FAVOR... MAIL ORDER COUPON TODAY!

MERRY CHRISTMAS
SANTA

SPECIAL CHRISTMAS GIFT RATES

Only \$2.00 each for 2 or more
one year subscriptions.

Single 1 year subscription \$3.00

Single 2 year subscription \$4.00

(Two or more 2 year subscriptions only \$3.50 each)

Please enter gift subscriptions to
ELECTRONICS ILLUSTRATED for:

Name Check if renewal
Street 1 yr.
City State Zip 2 yrs.

Name Check if renewal
Street 1 yr.
City State Zip 2 yrs.

Name Check if renewal
Street 1 yr.
City State Zip 2 yrs.

My Gift Card(s) Should Read
From —

Remittance enclosed Bill me

My Name
Street
City State Zip

If you also want ELECTRONICS ILLUSTRATED sent to you,
check: 1 yr. 2 yrs. New Order Renewal

**Electronics
ILLUSTRATED**

Fawcett Building, Greenwich, Conn. 06830

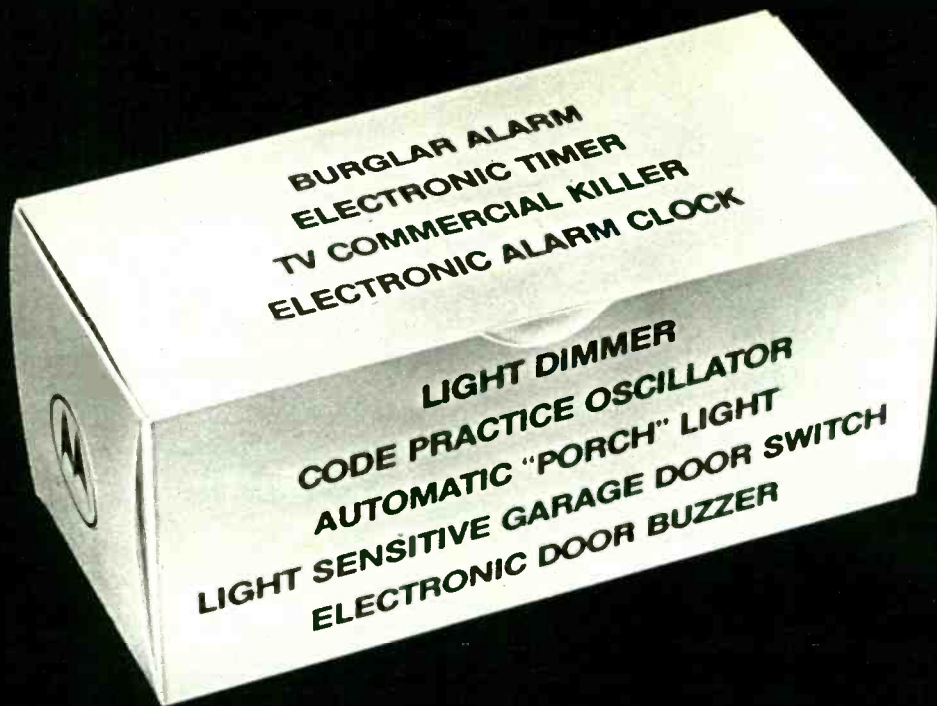

**Just a few of the projects for which
we've got solid state devices.**

All in one package.

For only \$4.95

If you bought the semiconductors for any one of these projects separately, they'd cost about seven bucks. Be our guest for \$4.95. And treat yourself to an easy, really fun electronic project with a really useful product on the other end.

The electronic timer is in great demand for darkroom and photography work, at sports events, etc. The automatic "porch" light and burglar alarm are, shall we say, quite timely. The TV commercial killer works off a regular flashlight, for stay-seated dousing of objectionable commercial audio. The code practice oscillator, the garage door switch, the alarm clock — all are excellent projects you'll be proud to have completed.

This project package (HEK-4) includes all five semiconductors needed, and a brochure with directions and circuit schematics for all projects (plus bonus project). Look for it. At your HEP supplier now.

Happy soldering.

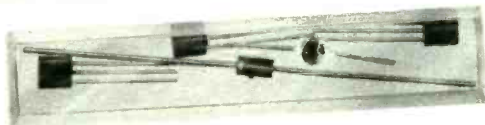

MOTOROLA HEP Semiconductors

P. O. Box 20924, Phoenix, Arizona 85001

By **WALT HENRY** THE glass fever thermometer is a little like your maiden aunt's secret potion for whatever ails you. Both won permanent niches in the home medicine cabinet years ago. And just like Auntie's herb-and-root brew, the clinical thermometer has several disadvantages. The thermometer has to be shaken down each time you use it and is easily broken. But the biggest problem of all is that fever thermometers are often difficult for either laymen or physicians to read.

Even with all of the glass thermometer's shortcomings, two centuries have provided ample time for it to dominate both hospital and home. Until recently, it has been the only accurate body-temperature measuring device.

However, 1954 marked a milestone for the instrument. That year it was officially mothballed by the U.S. Army. Representatives of Uncle Sam announced that Col. George T. Perkins had invented an electronic substitute for Gabriel Daniel Fahrenheit's fever meter.

Thanks to today's inexpensive electronic components and the IC, the hobbyist now can build his own accurate, reliable electronic fever thermometer. Furthermore, our electronic medical thermometer incorporates—by virtue of its solid-state design—a feature not even dreamed of in Fahrenheit's day: fast response. Fact is, our thermometer reacts to temperature changes so fast that there will be slightly varying meter indications with even a small movement of the probe. This may seem annoying at first but actually it is an advantage.

Many hospitals and doctors now use commercially produced electronic thermometers and within a couple of years we'll no doubt be able to buy one at the corner drugstore. Right now the commercial models are out of sight in price so the answer is—build one yourself.

Clinical thermometry's goal is to determine as accurately as

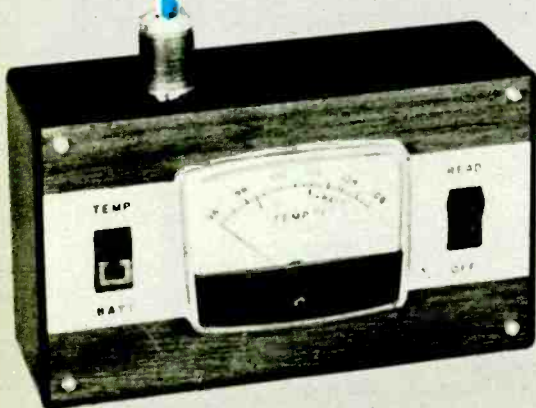

Low-Cost Electronic Medical Thermometer

Low-Cost Electronic Medical Thermometer

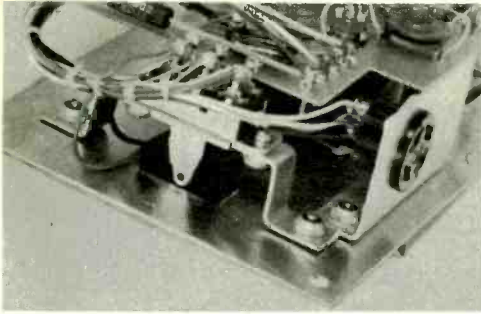

Fig. 1—Socket S01 plus switch S2 shown above. Connecting wires are laced into neat cable.

possible the temperature of arterial blood. Since our thermometer's probe is especially sensitive to changes in temperature, it must be placed towards the rear of the mouth—an area of the body where temperatures remain relatively stable.

You record the highest temperature reached after waiting about one minute. Naturally, your patient should avoid eating or drinking 15 minutes before you take his temperature.

How it Works. The base-emitter junction

resistance of all silicon transistors varies with temperature changes. This junction temperature-resistance characteristic is one of the reasons why silicon transistor Q1 works as a temperature-sensing element.

Substrate transistors Q3 and Q4 (both part of IC1) are connected as a differential (two-input) amplifier to drive meter M1. One input comes from Q1, while the other input comes from a constant-voltage source which consists of a divider network formed by resistors R11 and R12. The amplifier measures the voltage difference between these inputs and boosts it to a level high enough to drive M1.

Sensing transistor Q1's collector lead goes straight to the IC differential amplifier which provides current gain. This is another reason for using a silicon transistor as the temperature-sensing element. Since Q1 is an active device and provides some amplification of its own, less gain has to be squeezed out of the amplifier. The lower the amount of gain provided by any solid-state amplifier, the greater its ability to minimize changes of amplification levels as temperature varies within the solid-state devices.

The amplifier's power-supply voltage is also regulated to guard against ambient temperature and battery-voltage variations. This

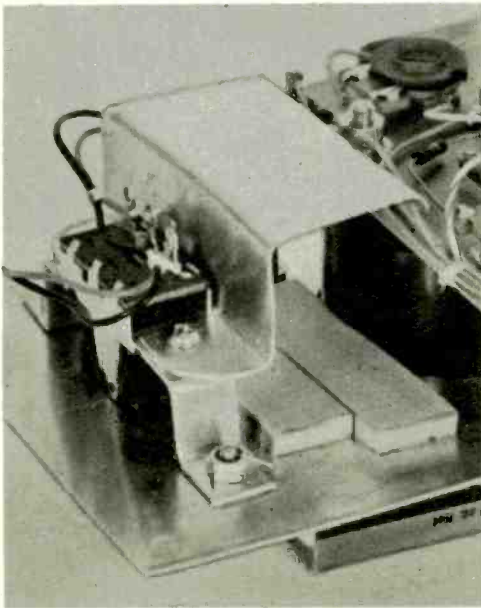

Fig. 2—Note how battery bracket is mounted to switch S1. Foam strips hold batteries in place.

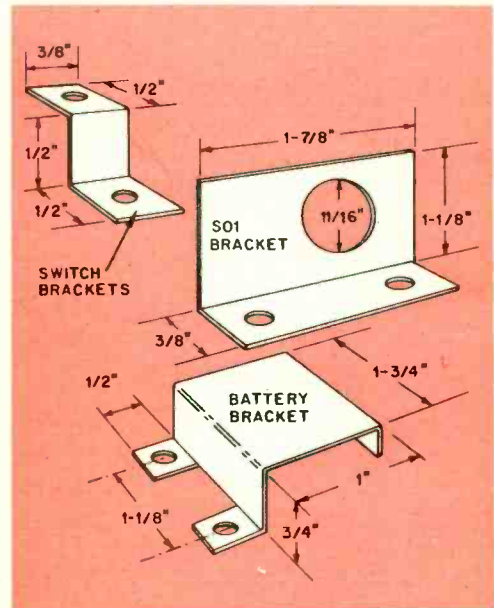

Fig. 3—Dimensional data for switch brackets. S01 bracket plus battery bracket are shown.

not only insures the thermometer's accuracy over the life of the battery, but also protects the differential amplifier from external temperature fluctuations.

Current flowing through zener diode D1 is maintained constant by FET Q2 and IC substrate transistors Q5 and Q6. This current-regulating circuit plus the zener diode gives such an accurate output that a temperature reading will vary less than 0.1°F with any battery voltage ranging between 12 and 20 V.

Potentiometer R7 (*balance*) provides for adjustment of emitter voltages in the IC in case a tolerance mismatch exists in resistor pairs R6-R10 and R5-R9. Potentiometer R16 (*calibration*) enables you to substitute a meter having a resistance different from that of the meter specified in our Parts List.

Finally, switch S1 controls power, while S2 enables you to check battery output voltage on the meter.

Construction. Except for the probe assembly, you can build the thermometer's electronics into almost any size or shape cabinet. Since one important criteria for this instrument is a large, easily read meter face, we

suggest that you buy the same size cabinet and meter specified in the Parts List.

The aluminum angle brackets (Fig. 3) which support the rocker switches are mounted to the front panel with flathead screws. After countersinking all holes for the angle brackets in the panel, apply decorative vinyl trim to hide the screw heads. Gently sand the uncovered portion and letter the front panel with dry transfer lettering. Protect your lettering with a coat of clear acrylic spray.

Circuit layout isn't critical but we suggest that your circuit board be similar to the one shown. Note how both terminals on M1 hold the circuit board. A right-angle bracket secures S01 to the front panel.

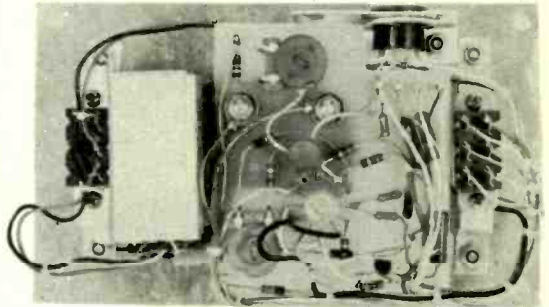

Fig. 4—All components mount on case's metal panel. Meter terminals support circuit board.

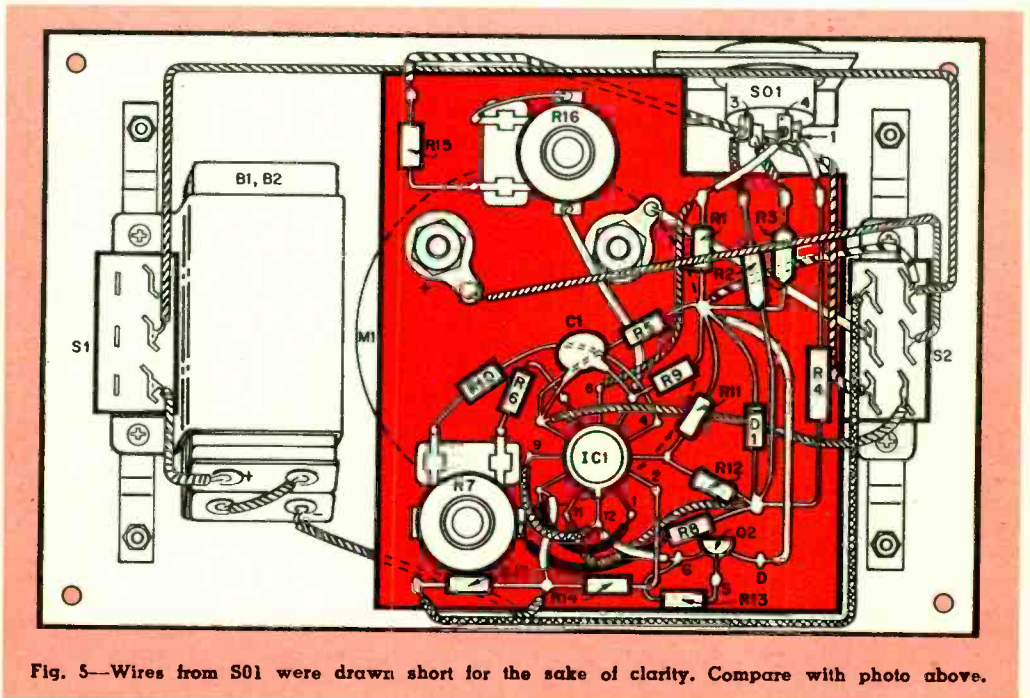

Fig. 5—Wires from S01 were drawn short for the sake of clarity. Compare with photo above.

Low-Cost Electronic Medical Thermometer

Potentiometer R18 (*trim*) is inside the probe's plug. Both R18 and PL1 are connected by a thin three-conductor cable to Q1. But if you plan to build only one probe, mount the trimmer pot on the circuit board. If you build two or more probes, solder a trimmer pot on each plug so all probes can be adjusted individually.

Note that some of the resistors have one percent tolerance. Precision resistors must be used wherever indicated by an asterisk in our Parts List. The actual value of other resistors is not critical, and you can substitute values of resistors having either 5 percent or 10 percent tolerance. Ordinary carbon composition resistors are too sensitive to ambient temperature changes and will upset the DC amplifier's balance as room temperature changes.

Don't omit capacitor C1—it prevents amplifier instability. Also note that B1 con-

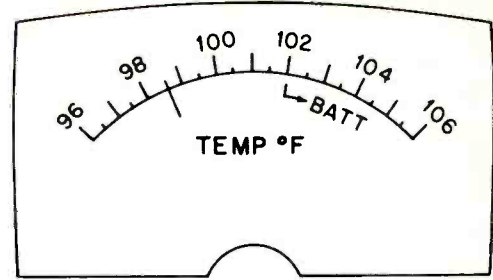
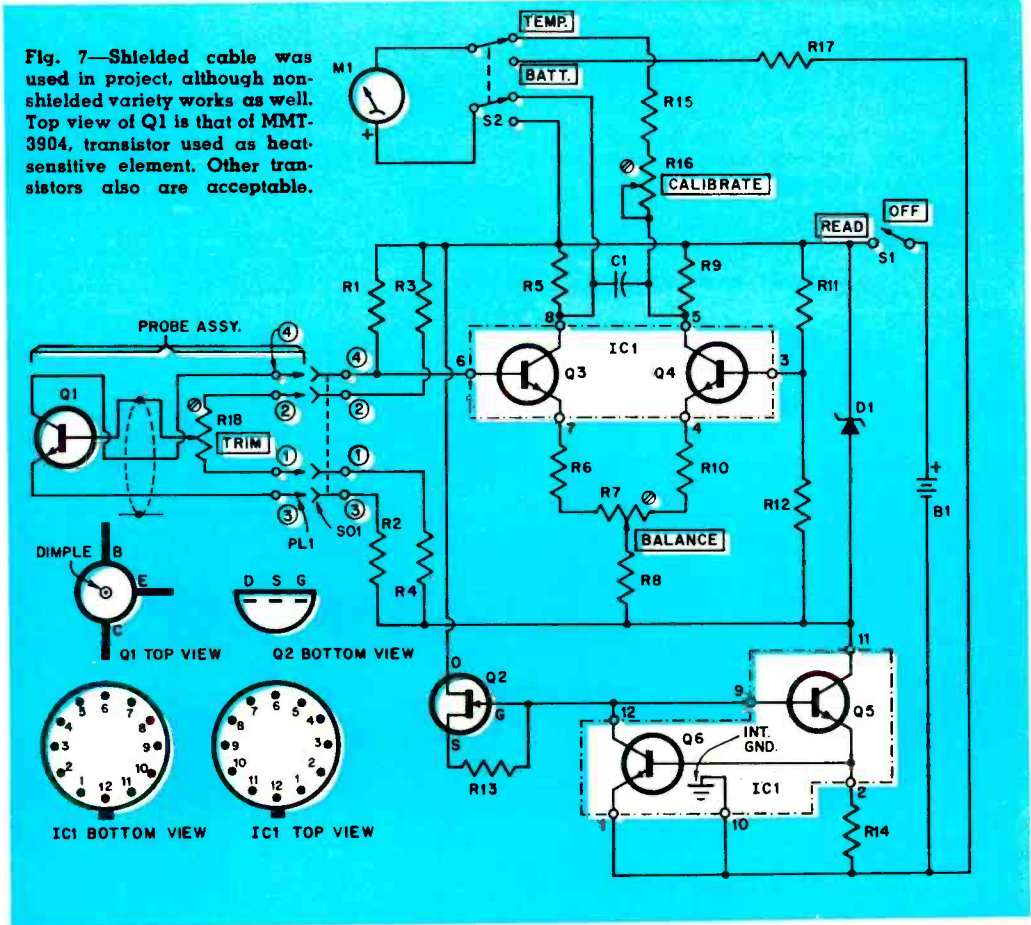

Fig. 6—Cut out meter scale above for project or make your own scale as described in text.

sists of two 9-V batteries connected in series. However, the circuit will operate from any battery voltage between 12 and 20 V.

The meter scale is calibrated from 96° to 106°F. Cut out the scale provided and glue it over your meter's scale. Or, if you have a

Fig. 7—Shielded cable was used in project, although non-shielded variety works as well. Top view of Q1 is that of MMT-3904, transistor used as heat-sensitive element. Other transistors also are acceptable.



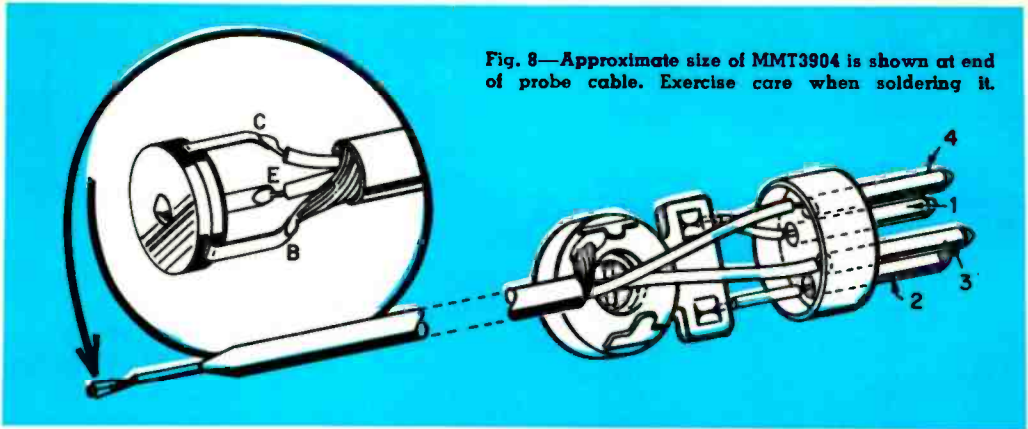

Fig. 8—Approximate size of MMT3904 is shown at end of probe cable. Exercise care when soldering it.

different style meter, an attractive scale can be made easily. Select a smooth, white opaque paper—adhesive-backed white labels sold at office-supply stores are ideal.

Using your meter's scale as a reference, draw an arc with india ink making sure that its ends correspond to your meter's old scale ends. Divide the arc into ten equal divisions and apply dry transfer lettering. Add the battery check mark at about 7/10 of full-scale reading. If you prefer fewer gradations on the scale, divide it into eight parts. Or, you can cover a wider temperature range by dividing the scale into, say amounts of 15°F.

Before you build the probe, select a suitable sensor transistor. You'll also need a length of flexible three-conductor cable, a

few in. of heat-shrinkable tubing and a tube of silicone rubber compound.

The transistor can be an npn silicon type having a high beta at a collector current of 1ma. Several suitable types are indicated in the Parts List. While the Motorola MMT3904 is the smallest transistor listed, it is somewhat more expensive than the slightly larger 2N4124. Both are encapsulated in plastic but metal-case transistors are also acceptable.

Our probe's connecting cable is a twisted two-wire pair with shield. The shield wire is connected to the base of Q1. Note, however, that the shield isn't required—any ordinary three-wire cable works as well. Just be sure that the wires are No. 28 or smaller.

(Continued on page 96)

PARTS LIST

B1—Two 9-V transistor radio batteries wired in series
 C1—.1 μ f, 10-V ceramic disc capacitor
 D1—1N938 temperature-compensated zener diode (International Rectifier)
 IC1—CA3018 integrated circuit (RCA)
 M1—0.50 μ a DC microammeter (Calectro D1-910 or equiv.)
 PL1—Four-pin plug (Amphenol 91-MPM4L)
 Q1—npn silicon transistor (MMT3904, 2N4124, 2N718A, 2N2222), see text.
 Q2—2N5457 FET
 Resistors: ¼ watt, 5% unless otherwise indicated
 *R1—3,830 ohms, 1%
 *R2—316 ohms, 1%
 *R3—6,190 ohms, 1%
 *R4—681 ohms, 1%
 R5, R8, R9—1,800 ohms
 R6, R10—100 ohms
 R7—100-ohm linear taper pot (CTS type U-201R101B or equiv.)
 *R11, R12—4,020 ohms, 1%
 R13—1,000 ohms
 R14—68 ohms

R15—10,000 ohms
 R16—25,000-ohm linear taper pot (CTS type U-201R353B or equiv.)
 R17—390,000 ohms
 R18—250-ohm linear taper pot (CTS type U-201R251B or equiv.)
 S1—SPST rocker switch
 S2—DPDT rocker switch
 S01—Four-pin jack (Amphenol 78-S4S)
 1—Case 6 $\frac{3}{8}$ x 3 3/16 x 1 $\frac{1}{8}$ -in. (Lafayette 99 R 62721)
 Misc. flea clips, heat-shrink tubing, vector board, three-conductor cable, dry transfer lettering sheets, etc.

*Available from Allied Industrial Electronics, 2400 W. Washington Blvd., Chicago, Ill. 60680. Stock No. 962C0055. \$2.58 each plus postage. Specify resistance when ordering.

Order dispensable probe covers from Diagnostic, Inc., P.O. Box 22115, 4030 West 10th St., Indianapolis, Ind. 46222. One pack of 500 covers costs \$4.75 postpaid.

The El Ticker

ACCORDING to the Stanford Research Institute, the impact of President Nixon's new economic policy on the electronics industry will be considerable. Two factors tell the story. First, the devaluation of the dollar making American goods cheaper throughout the world. Biggest overseas market will be for U.S. industrial electronics equipment; items will range from telecommunications gear and computers to test equipment and broadcasting facilities. According to SRI, inroads into the Japanese market are possible. Secondly, the 10-percent import surcharge may provide relief for battered and bruised U.S. manufacturers of consumer products. Devaluation and the surtax should team up to nullify price advantages of Japanese products—at least for the moment. International trade is a balancing act, says SRI, and short-term gains sometimes can become long-term losses.

★ ★ ★

New rules for cable TV (CATV) will go into effect March 1, 1972, if Congress gives its approval. The FCC has told Congress it believes that CATV systems should have a two-way capacity and that a channel for some other use than broadcasting should be available with each broadcast signal. These provisions would open up all kinds of possibilities for "at home" services. The FCC is asking that, for the top 50 markets, a minimum standard for cable systems should be three full network stations and three independent stations. A public-access channel, a state and local government channel and a local educational channel would also

have to be provided if the FCC rules are approved.

★ ★ ★

The Electronic Industries Association's Consumer Electronics Group says four-channel stereo will be a big seller early in 1972. Some insiders, however, advise consumers to hold up making a decision on what equipment they buy. While both discrete and matrix four-channel systems will be available in quantity, according to the EIA, you can bet the industry will concentrate its marketing (and price reductions) on only one of these versions as soon as a trend emerges.

★ ★ ★

The FCC is expected to act soon on the matter of the extent to which amateur radio stations should be used on behalf of non-amateur organizations. The deadline for comments was extended to August 31, 1971—at the request of the American Radio Relay League—and now all comments have been received. The chief of the FCC's Safety and Special Radio Services Bureau is expected to make a ruling soon.

★ ★ ★

New rules to set aside teleprinter channels for use by police, hospital and ambulance services have been proposed by the FCC. These proposals would make available two channels—base-and-mobile pairs—to the Police Radio Service. Channels would utilize non-voice communications between base and mobile locations to help develop mobile computer installations in the 20 largest cities. Five single frequencies would be made available for ambulance-to-hospital telemetry; and two of the five 460-mc pairs of frequencies would go to municipal systems.

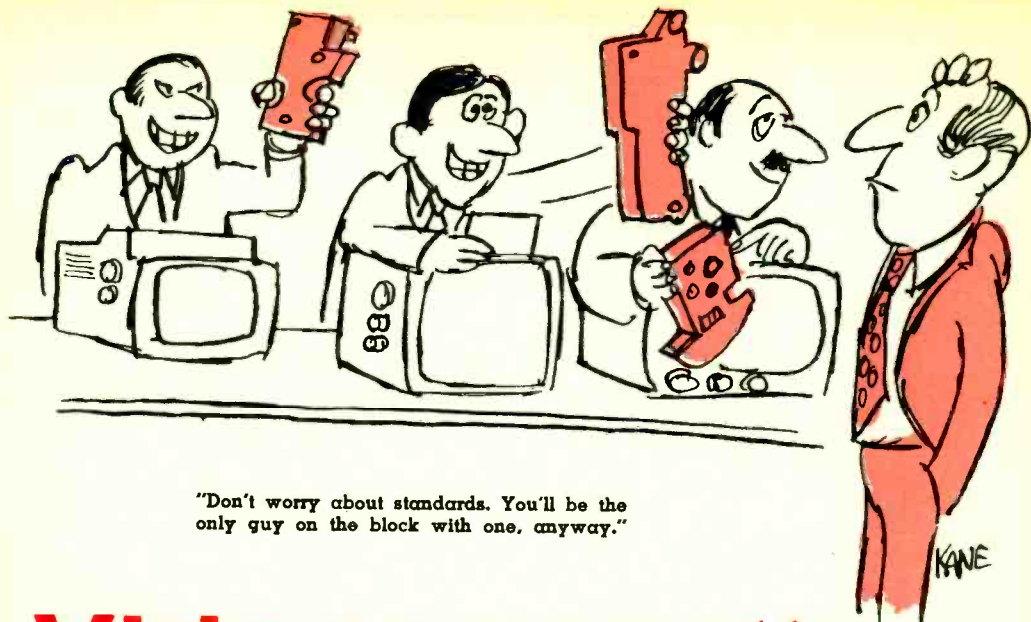

"Don't worry about standards. You'll be the only guy on the block with one, anyway."

Videocassettes— Where Are We?

Progress report on an industry still to hit the big leagues.

By DON DUNN

READE any good articles lately about the growing videocassette industry? If you have, you might be convinced that this miracle home-entertainment device is just your bag—if you're a millionaire.

Even if you have the bread, take another look. You may be surprised at what has happened since EI last reported on the industry in its January '71 issue (COMING? THE VIDEO GRAMAPHONE). Despite all the blown-up publicity and the big wheels who predicted a \$1 million market for videocassette players and cartridges by 1980, second thoughts now dominate the scene and all admit that growth is going to be at a snail's pace. Success is only to be had in the business and institutional market—so say the experts.

The skeptics have plenty of ammunition. They point out, for example, that it took RCA and two or three other competing companies more than ten years to sell the first million color TV sets to an apathetic public (at the same time, it took that long to get

the price of a color set below \$500).

Look at what has happened to videocassettes since CBS first announced in mid-1967 that it would market a player "for under \$280" which would play film cartridges costing "from \$7 to \$14." The CBS device—called EVR, for electronic video recording—now is being delivered to a few hundred industrial and institutional customers at \$795 a machine. A half-hour cartridge of color film costs \$37.50—and that's a processing and duplicating charge only. Production costs aren't included.

Or there's Cartrivision Television Inc. and its Cartrivision system. The company announced (in 1970) that it would offer a player to the general public early in 1971. Cost would be approximately \$800 to \$900. The introduction of the machine was pushed back to June, 1971 and now is slated for a mid-1972 delivery.

A subsidiary of AVCO Corp., the company has spent nearly \$6 million developing the Cartrivision system and also has offered

Videocassettes— Where Are We?

1.1 million shares of stock to the public (at \$20 a share) to raise some \$22 million to keep things going. Costs apparently keep going up as the R&D plods along, so Cartridge Television now says its cassette player will weigh in around \$900 to \$1000. A month after the stock was issued, the price was down to \$17.50 a share.

Another future vendor of magnetic-tape videocassettes, Sony Corp., recently introduced its third prototype cassette player. This model is ticketed at \$800 and is aimed primarily at the industrial/institutional market. The machine first will go on sale in the U.S., possibly early next year. Sony, along with CBS and Cartridge Television, is now busy lining up programming sources (movies, old TV programs, etc.) for distribution to customers all over the world. What the status of these ventures is—with all the delays in introducing playback equipment—is anybody's guess.

Along with the rising prices for playback machines, the proposed costs of cartridges have climbed, too. For instance, a two-hour blank tape for the Cartrivision machine will cost somewhere in the neighborhood of \$35. A 60-minute blank cassette from Philips

might want considerable sums of money before it gives anyone the right to duplicate *Patton, M.A.S.H.* or some other property.

Another major problem is that there are so many different techniques being considered for video playback. One method is the cassette using oxide-coated magnetic tape. Here you have Sony, Ampex, Cartridge Tele-



"When my wife sees how much I saved by going 16 mm she'll have to agree on a new color TV."

vision, Grundig and Philips (Norelco), among others. Then there is optical film. The leader here is CBS with its EVR system (which uses a flying-spot scanner), followed by RCA's SelectaVision (it uses laser-reproduced holographs). The RCA version seems to have a nebulous future, indeed. Some say the RCA system already has been scrapped.

Last but not least, there is the video disc. Manufacturers working on color-TV discs include Telefunken (Teldec) in Germany, MCA Inc. in the U.S., and possibly N.V. Philips in Holland. The video disc does represent a possible price breakthrough—Telefunken's projected price for its plastic discs is around \$2.50—but playing time is limited at the moment to 15 minutes. (A high playback speed, around 1500 rpm, is necessary to obtain an acceptable picture.)

Most people agree that the video disc still is a product of the future and that equipment prices will have to go down much further if the disc is to be competitive with other tape and film video recording systems. For instance, Telefunken doesn't expect to market a video disc player until early in 1973. Its black-and-white model will cost about \$250, while the color version (which includes magazine loading) will sell for around \$400. Discs, depending on their content, will cost between one and three dollars.

Standardization, then, is the major hang-up of the videocassette industry—if you feel

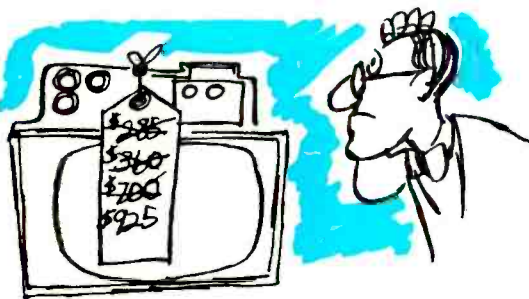

"Boy, think what the price will be when you actually can buy it!"

(Norelco) will cost about \$30. Since no one in the industry knows exactly what production costs of prerecorded tapes are likely to be, no definite estimates are available of prices for programmed tapes aimed at the consumer. Each producer could conceivably charge according to his own needs. A company like 20th Century-Fox, for example,

like calling it an industry. In Europe, Philips has been actively engaged in trying to get its magnetic-tape playback unit accepted by all major manufacturers. It is having some success. In the U.S., however, CBS and Motorola are concentrating on the industrial market, Cartridge Television has definitely committed itself to the consumer market, and other companies, like Ampex, are leaving themselves open to see what develops.

So you have optical film versus magnetic tape and consumers versus industry, and no system compatible with another. A manufacturer's video cartridge (or cassette) must be played on his own machine. In spite of efforts made by the Japanese, Philips and CBS, widespread standardization is unlikely until one system has proved its technical superiority, reliability and, more important, its sales appeal.

One of the reasons for this chaos is that manufacturers have been trying to beat the high cost of magnetic tape. Magnetic tape has been around for years as a record and playback medium, but mostly to reproduce audio frequencies. Video playback requires a larger bandwidth (a wide frequency spectrum) and to reproduce such high frequencies, the magnetic tape—usually ½-in. wide—must move past the tape heads at high speed (15 ips is standard in video tape recorders). This means an hour of video programming takes up much more tape than an hour of audio material.

When you put tape reels into a cartridge or cassette you make the machine easier to operate, but the cost of the tape is still very expensive for home use. Even when mass produced, it would be hard to see a half-hour blank videocassette selling for less than \$15.

With magnetic tape as expensive as it is—optical film systems, like CBS' EVR equipment, are no less expensive due to soaring production costs—the video disc seems to be the only alternative offered at a lower price. Four color discs, each playing for 15 minutes, would provide an hour of programming at a cost of about \$10 (assuming a price of \$2.50 per disc). However, when the playback devices will be available to the consumer, what the quality of the video will actually be, who will be marketing a successful video disc machine—all this is still up in the air.

The headache that ranks second on the list after playback gear (the hardware) is

programming (sometimes called software). The big question is what will the programming brains in the entertainment business come up with that people will be willing to pay for because they can't get it now on TV for free. Many entrepreneurs talk glibly about selling motion pictures, historical prize-fights, golf lessons, cooking courses and kiddie cartoons, but ignore the fact that such



"I wonder where he got his marketing know-how."

material has been around for years on 8-mm and 16-mm film.

A few experimental videocassette programs have been made, such as a comedy special with Jack Benny and another with Rowan and Martin (just what you see on TV), but most of the saleable programming in videocassettes up to now have been medical training films, training materials for police departments and hospitals, plus how to sell insurance.

CBS has printed a catalog of 600 films it can offer on EVR cassettes but most are already available in standard reel format. Since a sound-film projector costs far less than a \$795 EVR player plus cartridge (many schools and businesses have projection equipment), increasingly the question is being asked, "Do we need another audio-visual device to further burden our budget?"

There are many different companies, both large and small, busily preparing program materials for the time when videocassettes are a standard item in every household. The cassette materials planned range from exhibitions of paintings and photographs (accompanied by music) to underground movies and hard-core pornography. Many people are counting on the selling power of a different kind of program—that is, program-

[Continued on page 97]

Join "THE TROUBLESHOOTERS"

They get paid top salaries
for keeping today's
electronic world running

Suddenly the whole world is going electronic! And behind the microwave towers, push-button phones, computers, mobile radio, television equipment, guided missiles, etc., stand **THE TROUBLESHOOTERS**—the men needed to inspect, install, and service these modern miracles. They enjoy their work, and get well paid for it. Here's how you can join their privileged ranks—without having to quit your job or go to college in order to get the necessary training.

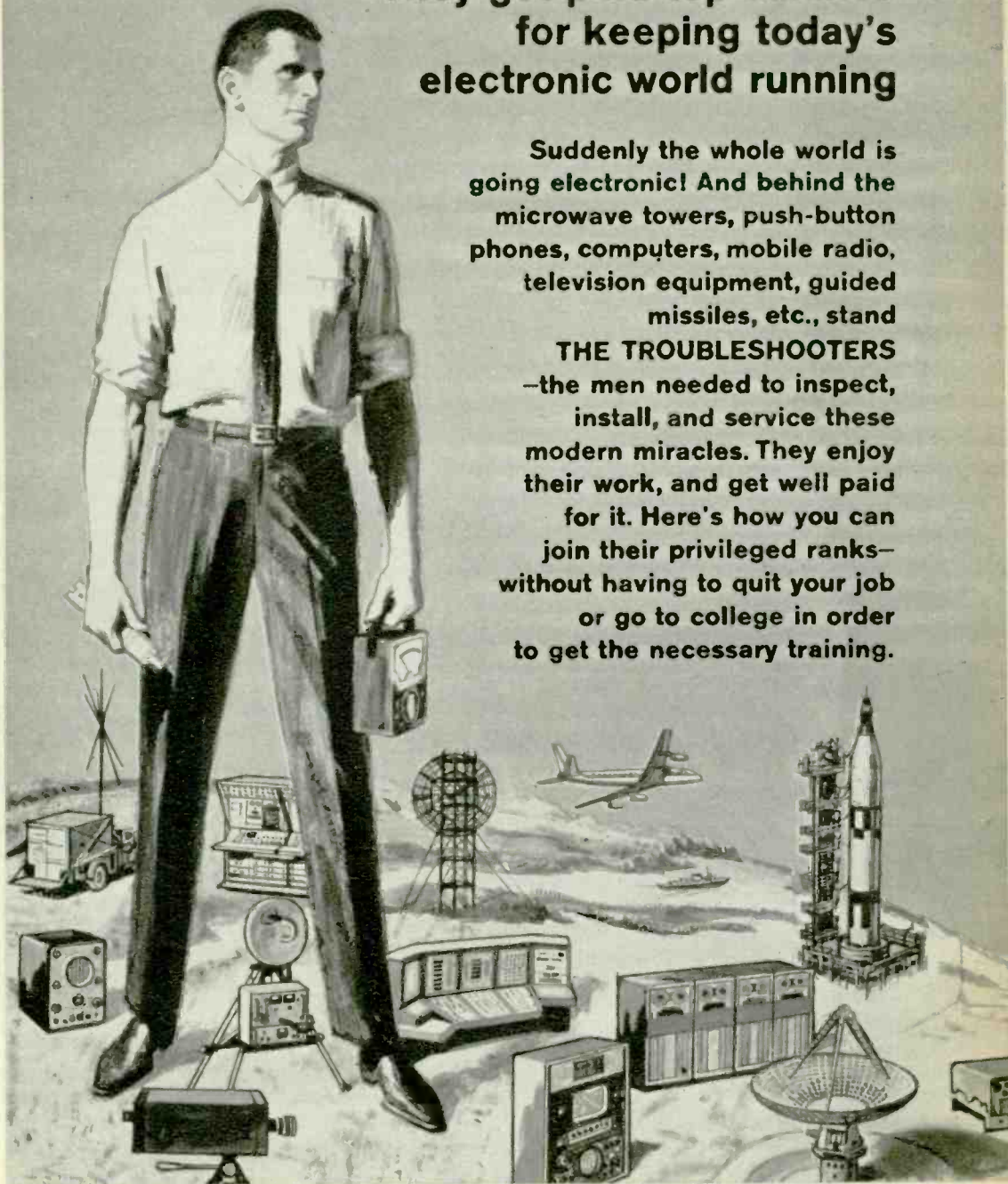

JUST THINK how much in demand you would be if you could prevent a TV station from going off the air by repairing a transmitter...keep a whole assembly line moving by fixing automated production controls...prevent a bank, an airline, or your government from making serious mistakes by servicing a computer.

Today, whole industries depend on Electronics. When breakdowns or emergencies occur, someone has got to move in, take over, and keep things running. That calls for one of a new breed of technicians—The Troubleshooters.

Because they prevent expensive mistakes or delays, they get top pay—and a title to match. At Xerox and Philco, they're called Technical Representatives. At IBM they're Customer Engineers. In radio or TV, they're the Broadcast Engineers.

What do you need to break into the ranks of The Troubleshooters? You might think you need a college degree, but you don't. What you need is know-how—the kind a good TV service technician has—only lots more.

Think With Your Head, Not Your Hands

As one of The Troubleshooters, you'll have to be ready to tackle a wide variety of electronic problems. You may not be able to dismantle what you're working on—you must be able to take it apart "in your head." You'll have to know enough Electronics to understand the engineering specs, read the wiring diagrams, and calculate how the circuits should test at any given point.

Learning all this can be much simpler than you think. In fact, you can master it without setting foot in a classroom...and without giving up your job!

For over 30 years, the Cleveland Institute of Electronics has specialized in teaching Electronics at home. We've developed special techniques that make learning easy, even if you've had trouble studying before. Our AUTO-PROGRAMMED® lessons build your knowledge as easily and solidly as you'd build a brick wall—one brick at a time. And our instruction is personal. Your teacher not only grades your work, he analyzes it to make sure you are thinking correctly. And he returns it the same day received, while everything is fresh in your mind.

Always Up-To-Date

To keep up with the latest developments, our courses are constantly being revised. This year CIE students are

NEW COLLEGE-LEVEL COURSE IN ELECTRONICS ENGINEERING

for men with prior experience in Electronics. Covers steady-state and transient network theory, solid state physics and circuitry pulse techniques, computer logic and mathematics through calculus. A college-level course for men already working in Electronics.

getting new lessons in Laser Theory and Application, Microminiaturization, Single Sideband Techniques, Pulse Theory and Application, and Boolean Algebra.

In addition, there is complete material on the latest troubleshooting techniques including Tandem System, Localizing through Bracketing, Equal Likelihood and Half-Split Division, and In-circuit Transistor Checking. There are special lessons on servicing two-way mobile radio equipment, a lucrative field in which many of our students have set up their own businesses.

Your FCC License—or Your Money Back!

Two-way mobile work and many other types of troubleshooting call for a Government FCC License, and our training is designed to get it for you. But even if your work doesn't require a license, it's a good idea to get one. Your FCC License will be accepted anywhere as proof of good electronics training.

And no wonder. The licensing exam is so tough that two out of three non-CIE men who take it fail. But our training is so effective that 9 out of 10 CIE graduates pass. That's why we can offer this famous warranty with confidence: If you complete a license preparation course, you get your FCC License—or your money back.

Mail Card for 2 Free Books

Want to know more? Send for our 44-page catalog describing our courses and the latest opportunities in Electronics. We'll send a special book on how to get a Government FCC License. Both are free—just mail the bound-in postpaid card. If card is missing, use coupon below.

ENROLL UNDER NEW G.I. BILL

All CIE courses are available under the new G.I. Bill. If you served on active duty since January 31, 1955, or are in service now, check box on card or coupon for G.I. Bill information.

CIE Cleveland Institute of Electronics

1776 East 17th Street, Cleveland, Ohio 44114

Cleveland Institute of Electronics

1776 East 17th Street, Cleveland, Ohio 44114

Please send me without cost or obligation:

1. Your 44-page book "How to Succeed in Electronics" describing the job opportunities in Electronics today, and how your courses can prepare me for them.

2. Your book on "How To Get A Commercial FCC License."

I am especially interested in:

- | | | |
|--|---|--|
| <input type="checkbox"/> Electronics Technology | <input type="checkbox"/> Broadcast Engineering | <input type="checkbox"/> First Class FCC License |
| <input type="checkbox"/> Electronic Communications | <input type="checkbox"/> Industrial Electronics | <input type="checkbox"/> Electronics Engineering |

Name _____ (PLEASE PRINT)

Address _____

City _____ State _____ Zip _____

Check here for G. I. Bill information.

EL-2

By HARRY KOLBE

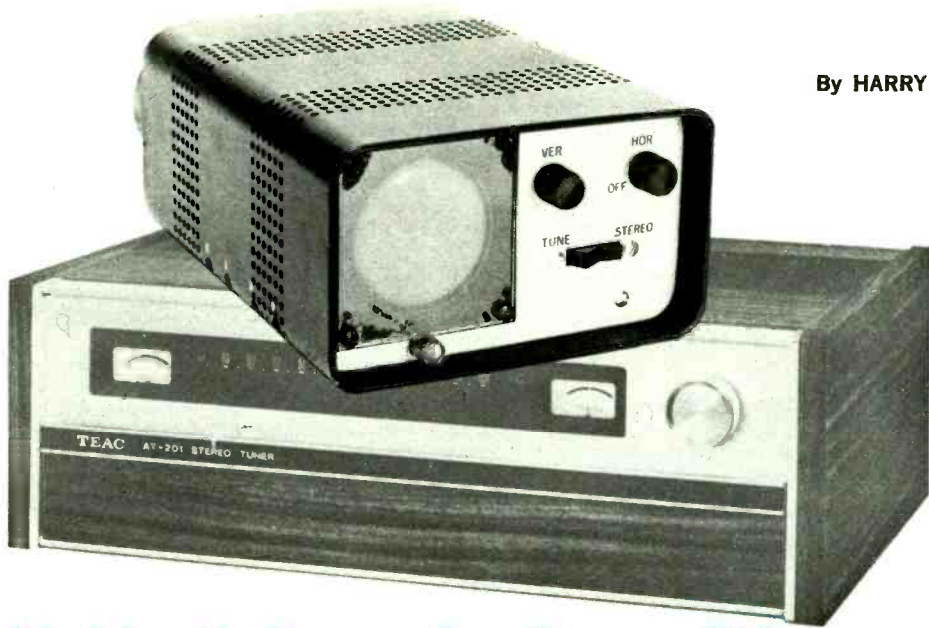

Multipath Scope for Stereo FM

Our scope shows both perfect tuning, low multipath for best stereo FM.

STEREO FM has been with us for almost a decade and a half. During this time, stereo FM's state-of-the-art has slowly evolved to the point where even the least expensive FM receiver is capable of good performance. Yet despite behind-the-scenes advances made in the lab and broadcast station, complaints are still being voiced by audiophiles over the poor quality of their stereo FM reception.

Don't blame the broadcast station. If the perfectly-transmitted stereo signal deteriorated as it travelled to your antenna, stereo separation is going to suffer, and background noise will increase.

The overwhelming majority of signal-degradation hangups can be traced to a type of distortion called *multipath*.

Multipath distortion occurs when the transmitted signal arrives at your antenna via two or more paths. One of the signal paths is direct line-of-sight from the station's antenna to yours. The other signal path is caused by reflections from the sides of buildings and hills.

The signal arriving at the antenna by the

reflected path travels a greater distance than the signal coming over a direct path. It's the time difference between the arrival of these two signals that makes the sound created by multipath distortion so objectionable.

Whenever two or more signals—differing in time of arrival at the antenna—pass into the tuner's mixer section, an amplitude-modulated voltage is generated. The amplitude of this voltage is proportional to the time delay between direct and reflected signals.

The mixer section of the FM tuner is a nonlinear device, and is particularly prone to multipath signals. Theoretically ideal mixers—those designed to be perfectly linear—would not respond to multipath. But for today's audio buff, the only way to remedy poor reception caused by multipath is to orient the receiver's antenna so that only one of the signal paths is intercepted.

It is not important whether you aim the antenna at the direct or reflected signal. An antenna with directional characteristics—and your ability to point it towards only one signal path—are the keys to good stereo FM reception.

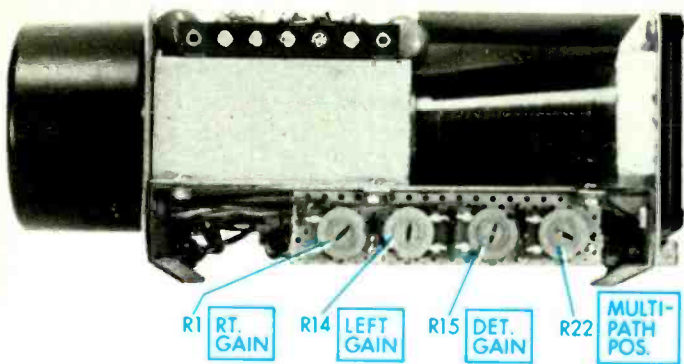

Fig. 1—View of left side of scope. Socket of CRT extends out back of cabinet and should be covered with top of discarded aerosol spray can. High-voltage power supply capacitors, diodes and resistors are mounted on terminal strip above home-brew metal shield at back of CRT. Trimpots are mounted on perforated circuit board under main chassis.

You can't assume that your antenna, whether a motor-driven, multi-element array, or a simple indoor dipole, has adequate directional characteristics. Even when you rotate the antenna until your receiver's signal-strength meter shows you the relative amount of RF energy appearing at the receiver input, it cannot indicate whether or not that RF energy comes by one or more paths. Fact is, multipath distortion must be seen in order to be eliminated.

Our Multipath Scope does more than just help you orient your antenna for least multipath distortion. It's also a stereo separation scope—a useful tool for indicating this all important parameter in your stereo system.

Our scope has two operating modes. When it is switched into the *tune* mode, it displays relative signal strength as you point your antenna for minimum multi-path.

After switching the scope into the *stereo* mode, you can now determine whether the detected audio signal is stereo or mono. Stereo signals displayed on the scope look like a continuously writhing Lissajous pattern.

How It Works. When the scope is in the *tune* mode, the vertical channel (left input), consisting of Q6-Q10 and IC2, is connected

to the outboard RF detector module (Fig. 10). The horizontal channel (Q1-Q5 and IC1) is connected to the right-channel audio output of the receiver.

The RF detector module (see Fig. 11) must be built into the FM tuner and connects to the IF amplifier stage. The detector's output is a DC voltage directly proportional to the amplitude of the receiver's IF signal which is proportional to the strength of the RF signal at the antenna.

Vertical deflection height of the scope trace is directly proportional to incoming signal strength. Meanwhile, the horizontal deflection is proportional to the frequency deviation of the FM signal. The swing of the deviated RF carrier frequency is proportional to the amplitude of the audio signal modulating the RF carrier.

What will the scope trace look like in the *tune* mode? Fig. 9 shows how received FM signals look on our scope. A direct FM signal will deflect the display trace vertically according to received-signal strength, as photos 1-4 show. The trace is deflected horizontally by the amplitude of the audio voltage. Complex program material like music shows up as a constantly changing horizontal line.

Fig. 2—Rear of scope. Protective cover over CRT's socket has been removed to show wiring. A clamp on outside of rear panel holds CRT's socket firmly to the rear panel.

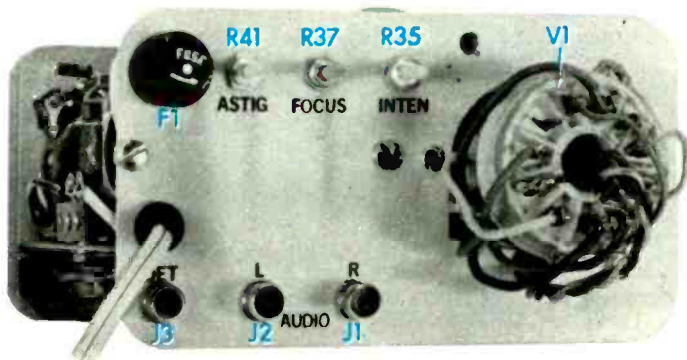

Multipath Scope for Stereo FM

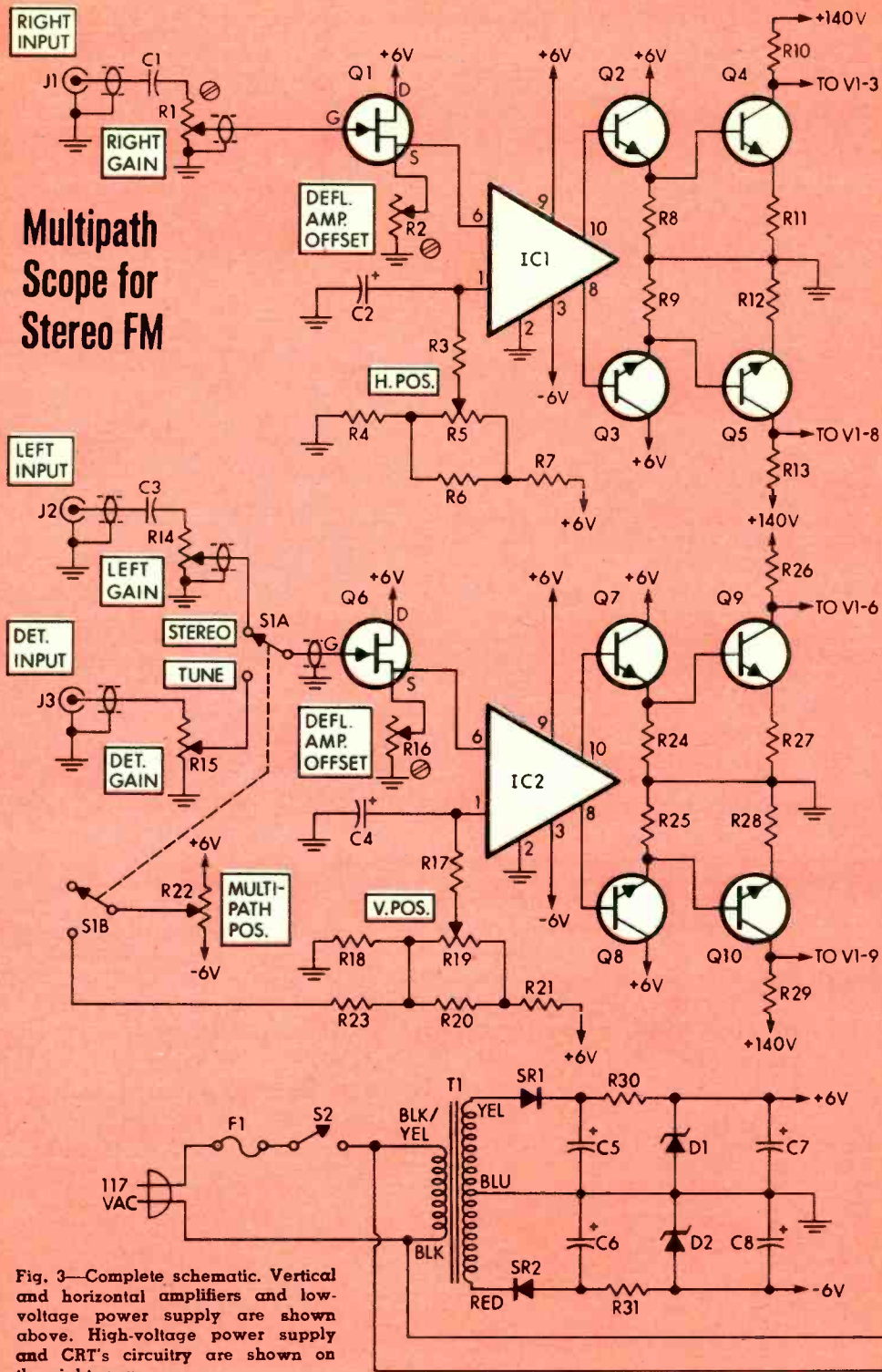
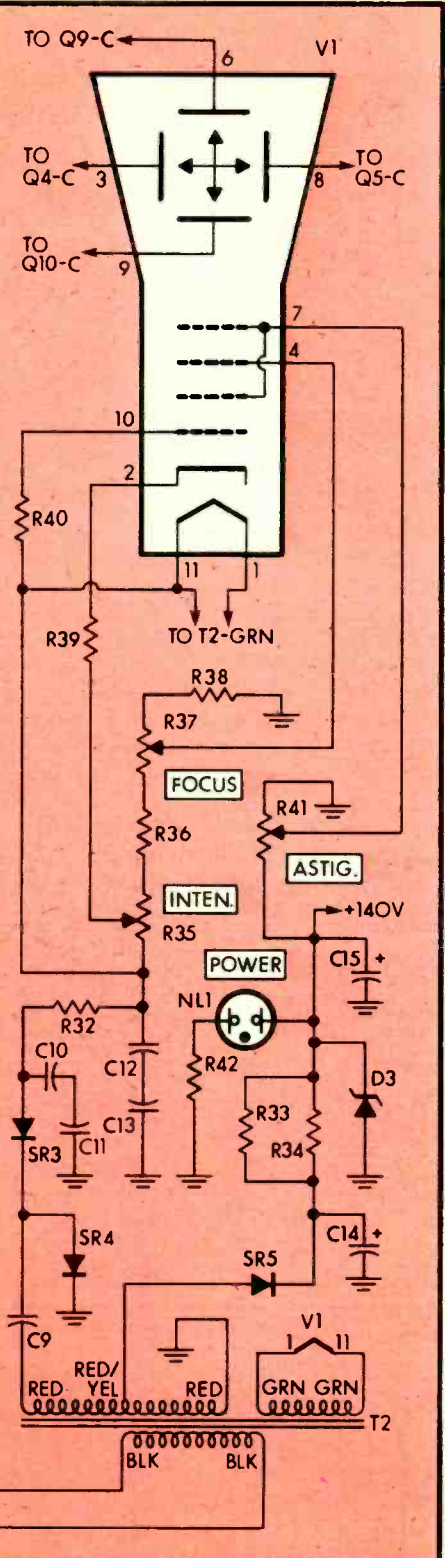

Fig. 3—Complete schematic. Vertical and horizontal amplifiers and low-voltage power supply are shown above. High-voltage power supply and CRT's circuitry are shown on the right page.



PARTS LIST

- C1, C3—.05 μ f, 25 V ceramic disc capacitor
 - C2, C4—25 μ f, 6-V electrolytic capacitor
 - C5, C6—100 μ f, 15 V electrolytic capacitor
 - C7, C8—220 μ f, 16 V electrolytic capacitor
 - C9, C10, C11, C12, C13—.22 μ f 400 V capacitor
 - C14—4 μ f, 450 V electrolytic capacitor
 - C15—40 μ f, 150 V electrolytic capacitor
 - D1, D2—6.2 V, 1-watt zener diode (Motorola HEP 103)
 - D3—150 V, 1-watt zener diode (Motorola IN3048)
 - D4, D5—1N60 diode (Sylvania)
 - F1— $\frac{3}{8}$ A type 3AG slo-blow fuse
 - IC1, IC2—CA3000 integrated circuit (RCA)
 - J1-J3—phono jack
 - NL1—Neon lamp, type NE-2
 - Q1, Q6—2N4220 transistor (RCA)
 - Q2, Q3, Q7, Q8—2N5184 transistor (RCA)
 - Q4, Q5, Q9, Q10—40412 transistor (RCA)
 - Resistors: $\frac{1}{2}$ watt, 5% unless otherwise indicated
 - R1, R14, R15—250,000-ohm linear-taper pot (CTS U-201R254B or equiv.)
 - R2, R16—5,000-ohm linear-taper pot (CTS U-201R502B or equiv.)
 - R3, R4, R8, R9, R17, R18, R24, R25—1,800 ohms
 - R5, R19—1,000-ohm linear-taper pot (Mallory MLC13L or equiv.)
 - R6, R20—1,000 ohms
 - R7, R10, R13, R21, R26, R29—15,000 ohms
 - R11, R12, R27, R28, R31—330 ohms
 - R30—240 ohms
 - R22—50,000-ohm linear-taper pot (CTS U-201R503B or equiv.)
 - R23—22,000 ohms
 - R33, R34—270 ohms
 - R32, R39, R40, R42—100,000 ohms
 - R35, R37, R41—1 megohm miniature audio-taper pot (Mallory MLCN16L or equiv.)
 - R36—270,000 ohms
 - R38—4.7 megohms
 - R43—470 ohms
 - R44—560,000 ohms
 - S1—DPDT rocker switch
 - S2—SPST switch (part of R5)
 - SR1, SR2—Silicon rectifier, 100 ma, 100 PIV
 - SR3, SR4—Silicon rectifier, 1A, 1,000 PIV (Motorola HEP 160 or equiv.)
 - SR5—Silicon rectifier (1A, 600 PIV (Motorola 1a HEP 158 or equiv.)
 - T1—Power transformer; secondaries: 10/20/40 V CT @ 35 ma (Triad F94X or equiv.)
 - T2—Power transformer; secondaries: 250 V @ 25 ma, 6.3 V @ 1A (Stancor PS-8416 or equiv.)
 - V1—2AP1A CRT (RCA See note below)
 - 1—Chassis and case (LMB CO-3 or equiv.)
 - 1—Tube shield for V1 (Millen 80042-A) See note below
 - 1—Tube clamp for V1 (Millen 33087) See note below
 - Misc. AC line cord, grommets, knobs, shielded wire, socket for V1.
- Note: Tube shield, clamp, and V1 available from Barry Electronics, 512 Broadway, New York, N.Y. 10012

When multipath signals are received, the formerly straight horizontal line now appears as a ripple as in photos 5-7 in Fig. 9. As the ripples grow larger, the more distorted the sound coming out of your FM

Multipath Scope for Stereo FM

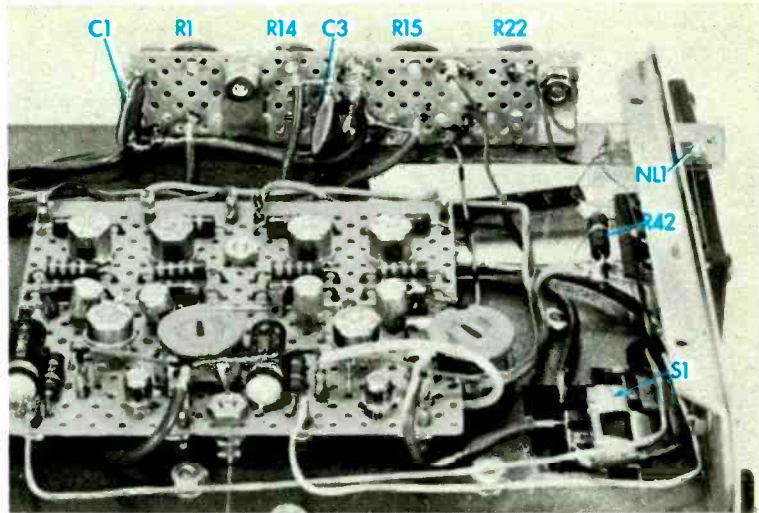

Fig. 4—Underside of scope. Board in foreground contains vertical and horizontal amplifiers. Small board at top of photo contains right, left and detector gain controls and the multipath position control.

component developed within the receiver's tuner will be. This ripple voltage is the AM mixer. With AM now present in the IF amplifier, the RF detector module no longer sees the constant amplitude of a pure FM signal. The RF detector output varies with the size of the AM component.

After placing stereo/tune switch S1 in

the *stereo* position, the scope will display stereo separation. The vertical-channel amplifier is connected to the left-channel output of the receiver, while the horizontal-channel amplifier still samples right-channel information. You'll see a constantly changing pattern consisting of both left and right channels. Photos 1 through 5 in Fig. 8 explain how to interpret the quality of stereo separation.

Building the Scope.

Start construction of the scope by building the detector probe first. Mount all of the components needed for the detector assembly on a piece of 2 x 3/4-in. perf board. Don't connect the detector probe into your FM tuner yet. The detector module has a

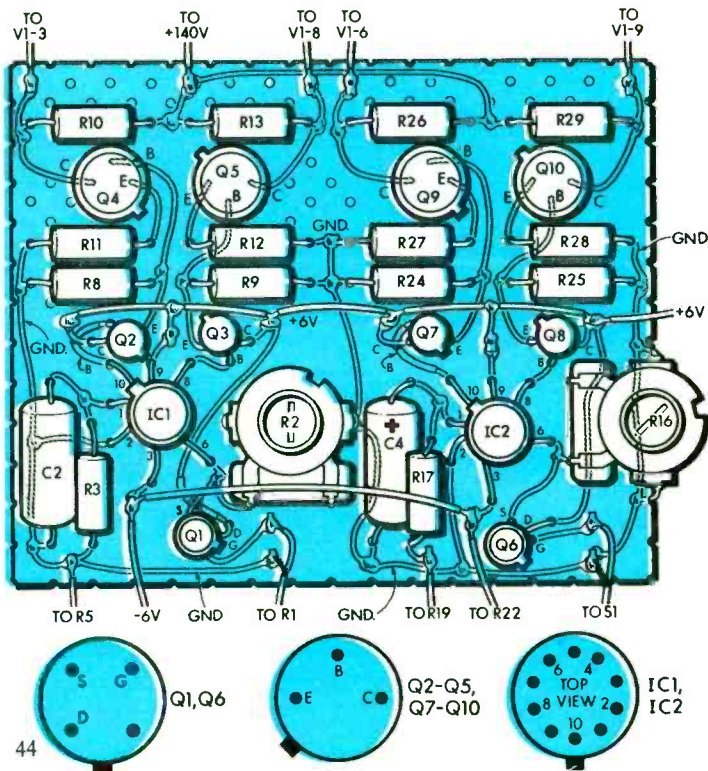

Fig. 5—Vertical and horizontal amplifier board is shown here full size. Wiring shown in color is on underside of board in our model, but could be on the top of the board. Leads of semiconductors are identified in sketches below. Q1-Q10 views are from bottom.

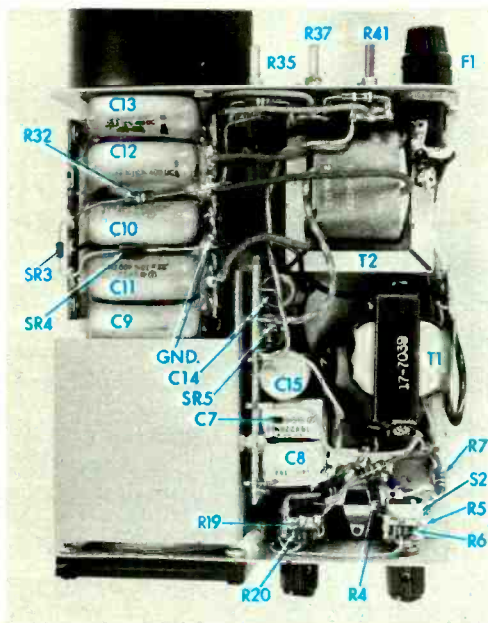

Fig. 6—Top view of scope. Note CRT shield over in lower left corner. Low-voltage supply board mounts vertically at right of shield via spacers.

two-foot long shielded audio cable which gets plugged into jack J3. The length of this cable isn't critical.

The case specified in our Parts List measures 3 x 5½ x 6-in. Unless you're used to soldering within limited space, we suggest that you either buy the specified cabinet or one having larger dimensions. Circuit layout isn't critical—just be sure to isolate the amplifier board from the power-supply board. Fig. 4 shows how we mounted the amplifier board under the chassis, while Fig. 6 shows how the power supply board was mounted vertically above the chassis on an aluminum plate surrounding the CRT shield.

The amplifier board is shown full-size in Fig. 5. Wire accordingly, taking care not

Fig. 7—Low-voltage power supply board is shown full scale. Again, wiring in color is on back of board but could also be on the top.

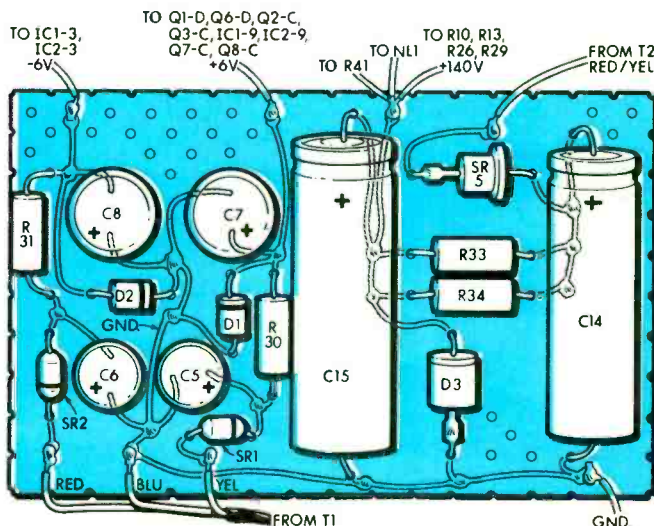

to create shorts by accidentally bridging wires together with solder. Note that the fourth lead on Q1 and Q6 is the case lead. It isn't used—cut it off at the case. All wiring shown in color in Figs. 5 and 7 is underneath the board.

We suggest that after the power-supply perf board is wired, you temporarily connect both power transformers T1 and T2 and proceed to make power supply output voltage measurements with a VTVM. It should supply the voltages called out in Figs. 3, 5 and 7. Incidentally, you should measure about -680 VDC from the junction of R32 and C12 to ground.

Mount pots R1 (*right gain*), R14 (*left gain*), R15 (*detector gain*), and R22 (*multipath position*) on a ¾ x 3¾-in. piece of perf board. Shielded audio cable connects pots R1, R14 and R15 to their respective input jacks, J1, J2 and J3. Also mount capacitors C1 and C3 on this perf board. Wire as shown in the schematic.

We made our own CRT graticule and both halves of the CRT bezel out of sheet plastic. The bezel is fabricated out of two pieces of ⅛-in. thick sheet plastic cut 2½-in. square. The inner bezel has a 2-in. dia. circle cut in its exact center—this serves to hold down the CRT. We also cut a 1½ x 2¼-in. U-shaped hole in the chassis for the purpose of lowering the CRT slightly within the cabinet. By lowering V1, space was made available on top of one of the CRT shields so that power supply capacitors C9-C13 could be wired to a pair of tie-strips in this space. Fig. 6 shows a top view.

STEREO MODE

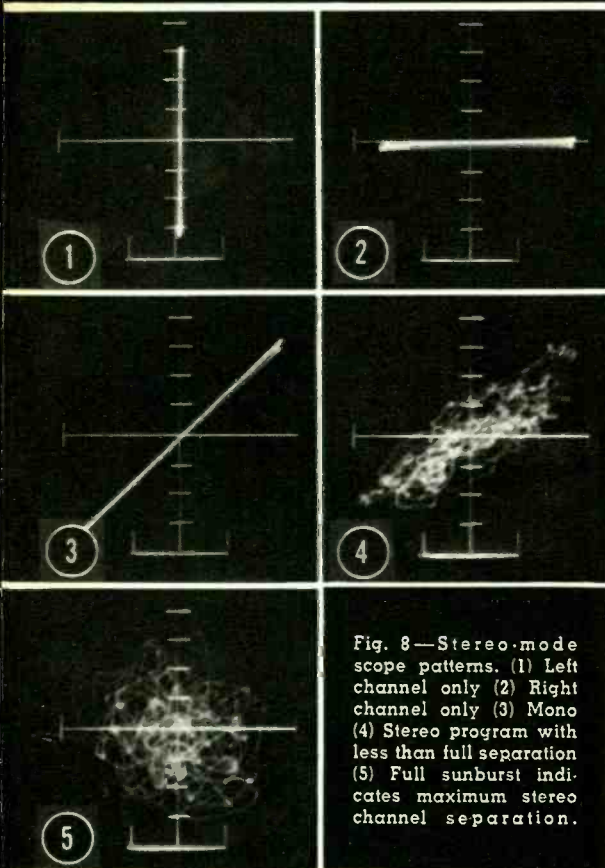

Fig. 8—Stereo mode scope patterns. (1) Left channel only (2) Right channel only (3) Mono (4) Stereo program with less than full separation (5) Full sunburst indicates maximum stereo channel separation.

Multipath Scope for Stereo FM

The graticule was made out of a piece of green plastic sheet cut 2½-in. square. The graticule is sandwiched between both halves of the bezel. Scribe lines into the graticule exactly as shown in either Figs. 8 or 9.

After you've drilled holes in both the front and back panels of the case, mount the pots, rocker switch S1, fuse holder F1, AC line cord, and J1-J3. Also cut out a hole for V1 on front and back panels.

Final construction of the scope consists of interconnecting all of the components.

Initial Alignment

- 1) Turn pots R1 (*right gain*) and R14 (*left gain*) about ¼ turn from full-counterclockwise position.
- 2) Turn pots R19 (*vertical position*) and R5 (*horizontal position*) to the center of their rotation.
- 3) Turn pot R15 (*detector gain*) ¼ turn from full-counterclockwise position.
- 4) Plug the scope into an AC outlet and turn on S2 (*on/off*).
- 5) Wait 60 seconds for the power supplies to stabilize, and then adjust R35 (*intensity*), R37 (*focus*), and R41 (*astig.*) for a small in-focus dot on the CRT screen.
- 6) Insert shorting jacks in J1 (*right input*)

TUNE MODE

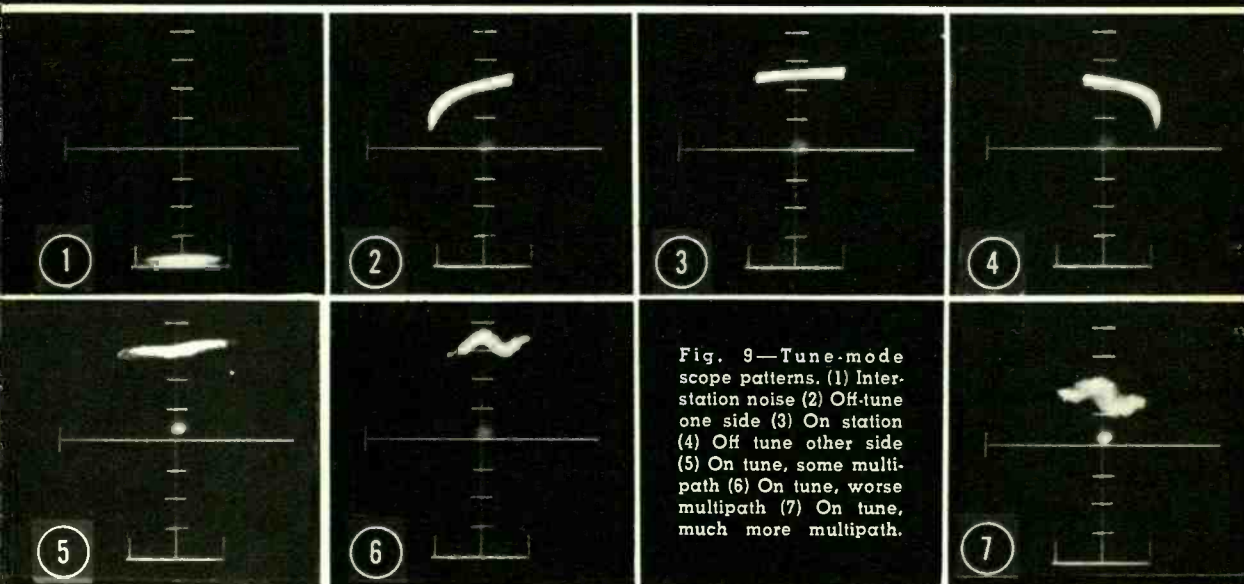

Fig. 9—Tune mode scope patterns. (1) Interstation noise (2) Off-tune one side (3) On station (4) Off-tune other side (5) On tune, some multipath (6) On tune, worse multipath (7) On tune, much more multipath.

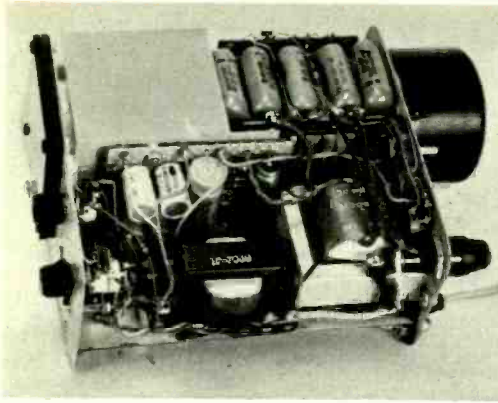

Fig. 10—View of side of scope shows both power transformers and low-voltage power supply board. Board is attached (with spacers) to CRT's shield.

and J2 (left input).

7) Measure the voltages at pin 1 of IC1 and IC2. Connect the negative, or ground, lead of the VTVM to circuit ground. You should read +0.64 VDC and +0.68 VDC, respectively.

8) Connect the VTVM's negative lead to pin 6 and the positive lead to pin 1 of IC1. Turn R2 (deflection amp. offset) until the voltage on the VTVM reads zero.

9) Repeat step 8 for IC2.

10) Remove the shorting jacks in J1 and J2.

Installation. There are two ways of connecting the scope to your stereo system. One hookup only connects the scope to the stereo FM tuner. In this case, when the scope is in the stereo mode, the CRT displays the audio signal output of the tuner. To make this hookup, connect two shielded audio cables from the left- and right-channel audio output of the tuner to the left- and right-input jacks of the scope.

If your tuner does not have an extra set of audio output jacks, a pair of Y-connectors plug the scope into the system. The only other connection is from the RF detector module to J3.

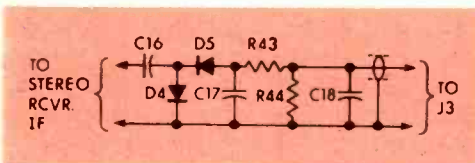

Fig. 11—Schematic of demodulator which must be installed in stereo receiver. Output is fed by short length of shielded cable to J3 on scope.

Use the second method of connecting the scope if you own a stereo FM receiver, or if your system consists of separate components. This hookup has the advantage of not only showing what the audio display of the stereo FM tuner looks like, but you can see stereo separation of the other program sources as well. For this hookup, connect the audio inputs of the scope to the *tape out* jacks of your receiver, integrated amplifier or pre-amp.

The RF detector module is wired into the FM tuner's IF section. Check your tuner's schematic and locate the FM IF amplifier section. Connect the RF detector to the input of the first or second IF limiter stage. Where you connect the RF module depends on the gain of the IF amplifier in your tuner. Since this is a trial-and-error process, first solder the module to the input of the IF stage immediately preceding the discriminator or ratio detector. Keep the ground lead and the input lead to the detector module as short as possible.

The module is small and light enough so that it is adequately supported by its own leads. Connect a shielded audio cable from the output of the RF module to a phono jack mounted on the rear apron of the tuner or receiver.

The IF input lead previously referred to is the base lead of the IF amplifier transistor (if your tuner is solid state), or the control grid lead if the IF stage utilizes a vacuum tube.

You are ready to make final adjustments.

Final Adjustment

With the scope switched into the *tune* mode:

1) Connect a shielded audio cable from the RF detector module to J3.

2) Connect a shielded audio cable from the right-channel output jack on the tuner or receiver (or from the *tape out* jack of an integrated amplifier) to J1.

3) Switch the tuner into the mono mode, or tune to a station transmitting a mono signal.

4) Adjust pot R1 so that audio peaks just deflect the trace to the ends of the horizontal marking on the graticule.

5) Disconnect the right-channel audio cable, and connect the left-channel audio cable (as outlined in step 2) to J2.

6) Adjust pot R14 so that the audio peaks deflect the trace upward to the highest vertical markings on the graticule.

7) Reconnect the right-channel audio cable and switch the tuner into its stereo mode.

[Continued on page 97]

The Listener

By C. M. Stanbury II



"Forgotten Corner"

ONE PART of the globe which has received little attention during the past few years is the multilingual, Northeastern sector of South America sometimes claimed by Venezuela (though, not too loudly at the moment), but in reality divided among the three Guianas.

Dutch Guiana (Surinam) is often heard by BCB DXers in many parts of North America during evenings on 725 kc via SRS (a government-owned service supported, in part, by commercials) at Paramaribo. Then, ORTF at Cayenne, French Guiana, occasionally makes the scene on 3385 kc. The French once talked about building an international relay there but nothing more has been heard of the project.

In Guyana (formerly British Guiana—which borders on Venezuela), R. Demerara at Georgetown is best heard on 5980 kc around 0415 EST. Programming is in Hindi. R. Demerara is owned by the Guyana Broadcasting Co., which recently has been reported operating under the call sign Action Radio on 3290 kc during evenings.

A Listeners' Revolution? Organized DX-ing, much to everyone's surprise, may be at a crossroads. Events started happening in July when D. H. Perry, newly appointed editor of the British-based World DX Club, proposed the formation of a World League of DX Clubs. The new body would augment (if not entirely replace) the European DX Council—which, at last report, is in a state of collapse—and the sometimes timid Association of North America Radio Clubs.

From the beginning, it was obvious that Perry's revolutionary plan would receive plenty of publicity in DX and shortwave circles. His hope (and ours) is that this more international posture will give organized SWLing a much broader foundation which can overcome the endless stream of nationalistic hangups that afflict radio clubs all over the world. Perry will certainly step on a number of toes. You can bet the coming year will determine whether his idea gets into orbit.

DXing Military Broadcasts. Mention AFRTS (Armed Forces Radio and Television

Service) to the average SWL and he immediately thinks of high-power program feeds from Greenville, Bethany and Delano. But for ex-GIs and medium-wave DXers, AFRTS and its subsidiaries, AFVN and AFCN, bring to mind local BCB stations (sometimes relaying SW transmissions) in a variety of exotic DX locations—such as Saigon (on 540 kc), Thule (Greenland) on 1425 kc, Stuttgart (along with several other West German stations) on 1142 kc, and Fort Clayton (Canal Zone) on 790 kc.

While some of these are high-power AFRTS BCB outlets (for instance, Saigon belts out of 50 kw), none is easy to log in North America. Fort Clayton, which operates 24 hours a day as part of the American Forces Caribbean Network, could be the first station you'll hear—especially if you're ready and willing to devote an unlimited number of Monday mornings (0300-0500 EST) to the task.

In some parts of the U.S., the AFCN Puerto Rican stations broadcasting on 1200 kc (QRM comes from WOAI and a Cuban outlet) and 780 kc (Monday mornings) are more readily heard, despite the fact they have only 50-watt outputs as compared with Fort Clayton's 5 kw.

The Canal Zone is a truly poor specimen; BCB broadcasts are rarer than those from Puerto Rico—which has several high-power commercial outlets (for instance, WKVM on 810 kc, WITA on 1140 kc and WRSJ on 1560 kc—all located in San Juan). Reception of any AFRTS Puerto Rican transmitter may be reported to the AFCN Ramey station.

Your report to any AFRTS station will reach it if you put the station's name (e.g., AFCN Fort Clayton, AFRTS Thule, etc.) on the envelope and send it care of APO New York—or APO San Francisco for stations in Asia and the Pacific. What makes these stations interesting is that—more than for any other type of outlet—military voices have a way of becoming history. In our own recollection, we have received QSLs from WVDI Trinidad and WIND Morocco. Both stations are now silent. [Continued on page 100]

A 3000 Year Old Ham Shack

The story of radio's link with pre-civilized man.

By ROBERT ANGUS

HISTORY has a habit of occurring by chance. David Sarnoff, former chairman of the board of RCA, sprang to notice in the early part of this century when from his perch atop the Wanamaker Building in New York he pulled in the desperate Mayday message of the Titanic as it sank in the icy waters of the North Atlantic.

History also has the habit of repeating itself. In the wee hours of a sleepy June day in 1969, a couple of dozen hams who had their receivers tuned to 14234 kc heard this message: "This is LI2B. We are approximately 920 miles from the nearest island in the Lesser Antilles and about 2,400 miles from Morocco. The papyrus raft Ra-2 came through enormous seas undamaged, but we are drifting sideways helplessly . . ."

If you were lucky enough to pull in that message and checked the call sign, you discovered that LI is a Norwegian call. How could a Norwegian ham be drifting sideways 920 mi. from the Lesser Antilles? LI2B was the call assigned the ham shack aboard explorer Thor Heyerdahl's reed raft, licensed by the Norwegian government to keep his expedition in touch with a band of avid followers reaching from Moscow to Tokyo and Genoa to Clearwater.

The amateurs, particularly Richard Ehrhorn (W4ETO) of Clearwater; Chris Bockelie in Oslo (LI3A); Franco Smoretti in Genoa (I1KFB), and Carl Lindemann (WV4FZ) of White Plains, N.Y., were taking part in Heyerdahl's historic attempt to prove that Central and South America could have been settled by Africans sailing across the Atlantic in tiny reed rafts, rather than by Asians travelling down from Russia via Alaska, as is com-

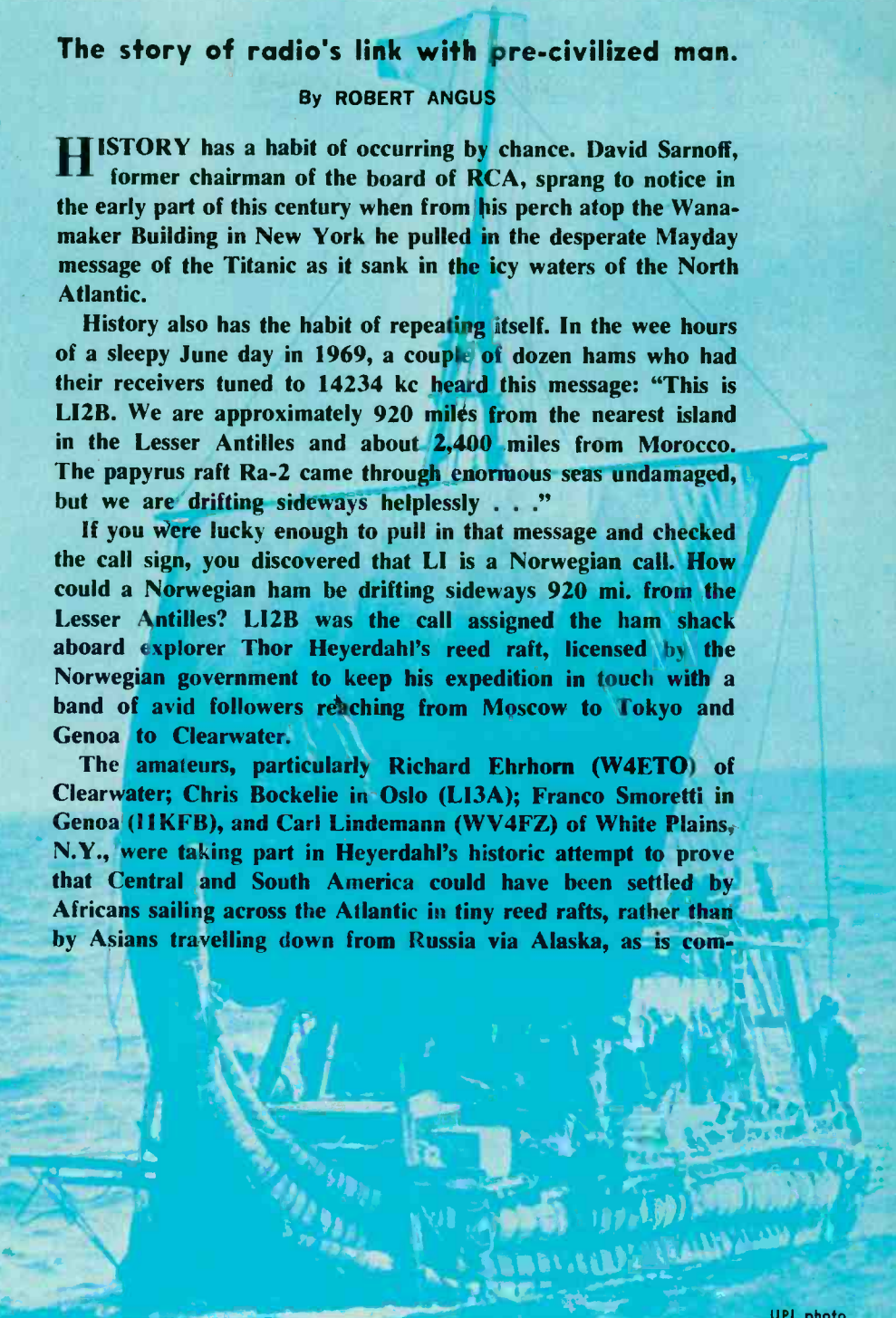

UPI photo

A 3000 Year Old Ham Shack

monly expounded by anthropologists.

The best way to prove the theory, Heyerdahl felt, was to build his own reed boat, similar in design to those he thought must have made the journey hundreds or even thousands of years before Columbus. He used the same materials—papyrus reeds from the marshes around Safi, Morocco, woven lovingly into a seaworthy vessel by four pure-blooded South American Indians. Heyerdahl's only concession to the 20th century on the Ra-2 was ham radio, which might qualify the papyrus raft as a 3,000-year-old ham shack.

The Ra-2 which set sail in May actually was Heyerdahl's second attempt to prove his theory. The Ra-1 floundered in heavy seas approximately a year earlier. The second voyage was almost a carbon copy of the first. The crew, in addition to Heyerdahl, consisted of navigator-radio operator Norman Baker, a civil engineer from New Rochelle, N.Y.; quartermaster Santiago Genoves, an anthropologist from Mexico; Carlo Mauri, a photographer and explorer from Genoa, Italy; physician Yuri Senkevich of Moscow; and Georges Sourial, a chemical engineer doubling as underwater expert. Joining the second voyage were Kei Chara, a Japanese cinematographer and Madani Ait Ouhanni, a Moroccan business executive.

The transmitter used on both voyages was a Heathkit, extensively remodeled and rebuilt by Ehrhorn, a communications specialist (See Fig. 2). The Heathkit HW-32A started life as a 20-meter SSB transceiver with upper or lower sideband operation, 200 watts P.E.P. input-power and built-in ALC. Ehrhorn waterproofed it, then proceeded to simplify the controls and operation. The front-panel bias adjustment switch was the first item to go. Ehrhorn simply set it up for mobile operation. Next came a redesigning of the function-selector switch into a push-to-talk button and calibration control. Although variable tuning was left on the set, Ehrhorn preset three channels 14190, 14215 and 14233 kc with lower and upper sideband adjustment. "The radio had to be simple to operate and easy to repair," Ehrhorn recalls, "because Norm Baker doesn't profess to be a radio technician. He stuck to the same frequencies all during the voyage and we did away with all unnecessary adjustments."

About the Heathkit, Norman Baker told

EI, "That set was so well designed and built that we used it on both voyages without any modifications. In fact, we didn't even replace any tubes. The set was checked out of course, before we set out the second time and we cleaned out some of the tube sockets. But Dick Ehrhorn advised us, as long as the tubes were working, not to take a chance on new ones."

The Heathkit was something of a last-minute substitute. At the time Ehrhorn was chief engineer of Signal One Communications in St. Petersburg, Florida, which was working on a transmitter designed specifically for jobs like Heyerdahl's. It was to be light-

UPI photo

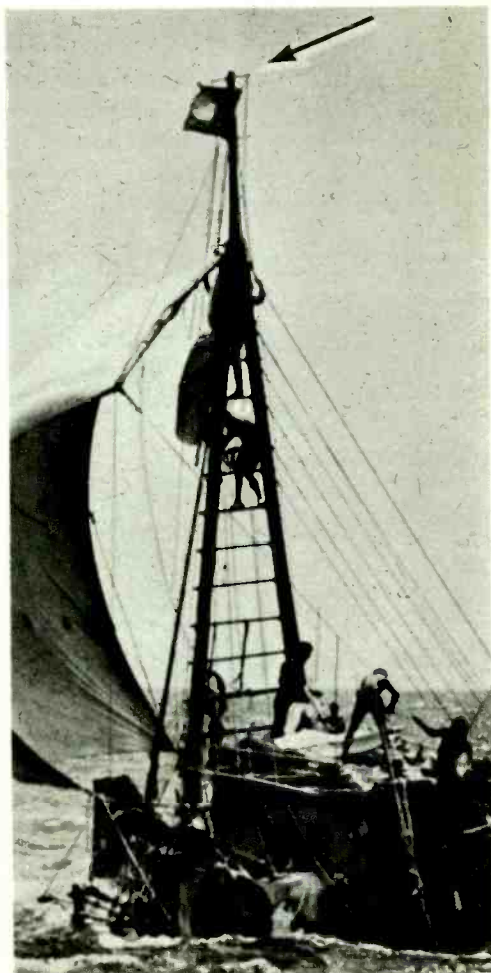

Fig. 1—Under the primitive conditions aboard the Ra-2, the designers had to resort to rather primitive ways to mount the antenna. Arrow points to the apex of a simple inverted-V type antenna.

weight, compact, waterproof and reliable. The trouble was that it became evident as the sailing date approached that it wouldn't be ready in time. At the last minute, Ehrhorn ordered the Heathkit, assembled it and modified it just in time for Baker to fly it to Morocco.

"When I arrived in Morocco, I thought all I was doing was delivering the set. I had no idea I'd be operating it," Baker recalls. During World War II, Heyerdahl himself had been trained as a radio operator by the British Army, first in the United Kingdom and later in Canada. The idea was that he could then be parachuted behind enemy lines in Europe to transmit information back to London. Heyerdahl was an apt pupil and was dropped at least twice, once into Norway and once into the Soviet Union, but he hated every minute of it and has since drawn a mental blank about things electronic.

Baker didn't know that—then. But Heyerdahl didn't know that Baker's experience in electronics was limited to the bridge of a Navy destroyer during the Korean War. "I knew enough about electronics to call for an electronics technician whenever anything went

wrong," joked Baker, "but that was about it." Fortunately, in addition to the simplified Heathkit, Ehrhorn provided a simplified instruction manual covering just about every contingency and written so that a layman like Baker could understand it.

Heyerdahl had made arrangements for a network of ham operators to report on the progress of the Ra-1 and Ra-2 and to alert rescuers if the need arose as it did on the first voyage. Under the plan, Ehrhorn in Florida and Bockelie in Oslo would act as the western and eastern contacts. In addition, there were such regulars as Smoretti, Lindemann, Morrison and perhaps half a dozen others, providing contact with the families of men on the raft. Baker was scheduled to transmit at 1000 GMT each Tuesday and Thursday beginning with an official message by Heyerdahl, usually prepared in advance and followed with more personal news, first for the United States, then for Oslo.

"You wouldn't believe the problems we had getting a license the second time," Baker says. "We were licensed by the Norwegian government, we were sailing under UN auspices and we flew the UN flag. But we had problems with the phone company." All things considered this is not an unusual malady, these days. The Ra's problems had to

[Continued on page 102]



Fig. 2—The photo above shows the original Heathkit HW-32A SSB transceiver that was used for both voyages. Richard Ehrhorn, in photo at right, redesigned the rig to simplify operation and make it resistant to water damage and shock.

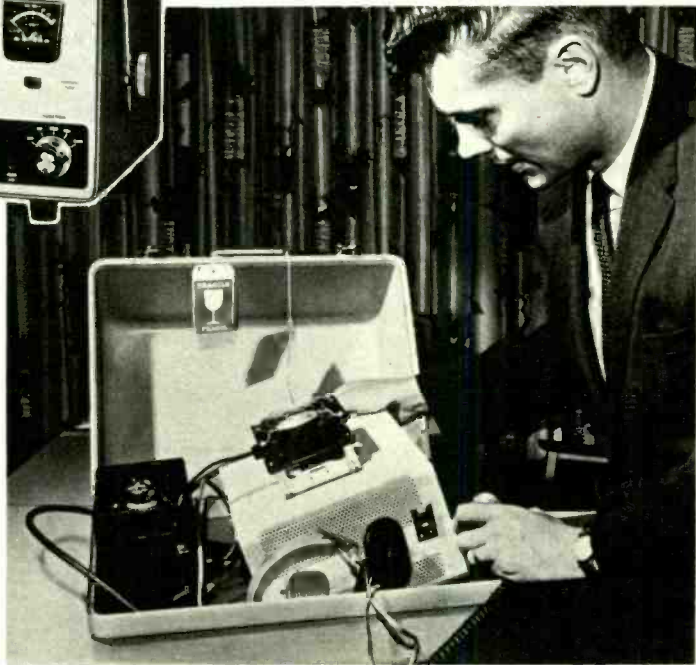

15 new Heath-gift ideas



Meet the second generation AR-15 ...new Heathkit AR-1500!

From the AR-15, hailed at the time of its introduction in 1967 as the most advanced receiver of its kind, comes the AR-1500... with impressive improvements in every critical area! **180 Watts Dynamic Music Power**, 90 watts per channel (8 ohm load); 120 watts dynamic music power per channel under 4 ohm load, with less than 0.1% intermod distortion, less than .25% harmonic distortion. A 14-lb. power transformer and massive output transistor heat sink are mute testimony to the power at your command. Direct coupled output and drive transistors are protected by limiting circuitry that electronically monitors voltage and current. **FM selectivity greater than 90 dB**, better phase linearity, separation, and less distortion are the result of two computer-designed 5-pole LC Filters. An improved 4-gang 6-tuned circuit front end offers better stability, 1.8 uV sensitivity, 1.5 dB capture ratio, and 100 dB image and IF rejection. Four ICs are used. Three in the IF and one in the Multiplex. Patented automatic FM squelch is both noise and deviation activated, fully

adjustable for sensitivity. **Vastly Superior AM**, an "also ran" with many receivers, has two dual-gate MOSFETS in the RF and Mixer stages, one J-FET in the oscillator, 12-pole LC Filter in the IF, and broad-band detector. Result: better overload characteristics, better AGC action, and no IF alignment. **Greatly simplified kit construction**. Ten plug-in circuit boards, two wiring harnesses and extensive use of pre-cut wiring with installed clip connections make the AR-1500 a kit builder's dream. Built-in test circuitry uses signal meter to make resistance and voltage checks before operation. **Other advanced features** include Black Magic panel lighting that hides dial markings when set is not in use; flywheel tuning; pushbutton function controls; outputs for two separate speaker systems, bi-amplification, oscilloscope monitoring of FM multipath; inputs for phono, tape, tape monitor and aux. sources — all with individual level controls. **Versatile installation** in optional new low-profile walnut cabinet, in a wall, or black-finish dust cover included. Join the "NOW" Generation in audio technology...order your Heathkit AR-1500 today!

Kit AR-1500, less cabinet, 42 lbs. 349.95*
ARA-1500-1, walnut cabinet, 6 lbs. 24.95*

New Heathkit Stereo Cassette Recorder



119.95*

Frequency response of ± 3 dB, 30-12 kHz, brings your stereo system into the cassette age. Features built-in bias adjustment to accommodate the new chromium dioxide tape; counter; automatic motor shutoff; preassembled and aligned transport mechanism. The AD-110 offers fidelity recording and playback of stereo or mono when used with your stereo system.

Kit AD-110, 10 lbs. 119.95*

New Heathkit Stereo-4 Decoder



29.95*

Compatible with your present stereo system and FM receiver, lets you hear all Stereo-4 material currently being broadcast by a number of stations across the country. Additionally, imparts a 4-channel effect to your existing stereo library. Requires second amplifier and 2 speaker systems for installation with conventional stereo system.

Kit AD-2002, 5 lbs. 29.95*

New Heathkit Stereo Phonograph with AM Radio



109.95*

Gets it together in a portable package with a purple plum snakey skin that's as far out as today's sounds. Solid-state 18-watt amplifier, fold-down 4-speed automatic changer and swing-out high compliance speakers. Speakers can be separated up to 5'. A flip of the mode switch and you're into AM radio! 45 spindle adapter included.

Kit GD-111, 50 lbs. 109.95*

CIRCLE NUMBER 3 ON PAGE 11

Electronics Illustrated

for a Heathkit Christmas

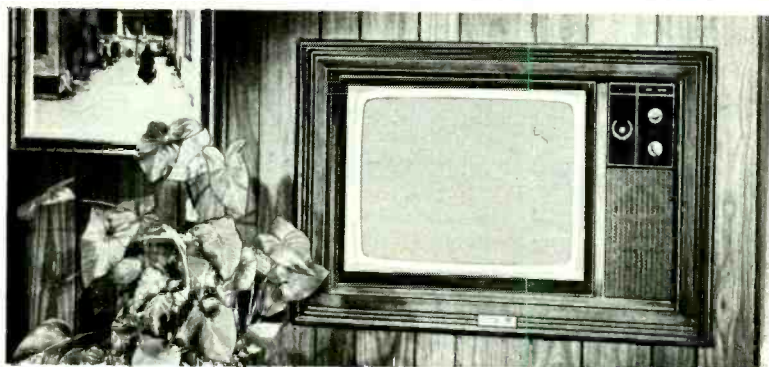

Heath's finest color TV, now available in optional new hide-away wall mount

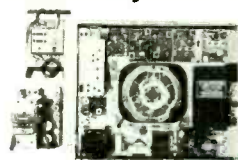

Here's the inside story... the Heathkit 25" solid-state color TV with exclusive MTX-5 ultra-rectangular tube to bring you the largest color picture in the industry! The etched, bonded tube face cuts glare, increases contrast for sharper picture,

purer colors, more natural flesh tones. But the true story of color TV reliability starts in the solid-state modular circuitry... 45 transistors, 55 diodes, 2 silicon-controlled rectifiers, 4 ICs containing another 46 transistors, 21 diodes, and just two tubes (picture and high-voltage rectifier). Major circuit functions are contained on individual plug-in glass epoxy boards (see chassis inset above) to simplify assembly, service and adjustment. And, of course, only Heathkit color TV offers you the money-saving advantages of home-serviceability... with the built-in dot generator and tilt-out convergence panel to let you perform the periodic adjustments required of all color receivers.

Other advanced design features include solid-state VHF tuner with MOSFET for greater sensitivity, lower noise and cross

modulation; solid-state UHF tuner with hot-carrier diode design for greater sensitivity; 3-stage solid-state IF for higher gain and superior picture quality; Automatic Chroma Control for constant color quality under different signal conditions; adjustable video peaking; adjustable noise limiting and gated AGC; "Instant-On"; VHF power tuning on 13 channels plus one preselected UHF channel; Automatic Fine Tuning; Tone-Control; and an output to your stereo/hi-fi system for the ultimate in sound reproduction.

And to wrap it all up... custom install your Heathkit GR-371MX in the exciting new Heathkit TV Wall Mount. Push the button on the picture frame — or on your optional GRA-70-6 Wireless Remote Control — and the carefully crafted tambour doors silently glide open to reveal your color TV with turned-on picture and sound. Another touch of the button and the doors slide closed, turning off the set. The Custom Wall Enclosure is available in either walnut or unfinished versions. Kit includes trim frame, sliding tambour doors, electric motor assembly — forms completely self-contained enclosure with tilt-out speaker baffle and convergence panel mount, slides easily into prepared opening. Also can be used to conceal wall safe, built-in bar, etc. Cabinet measures 23 $\frac{3}{4}$ " H x 38 $\frac{1}{4}$ " W x 22 $\frac{3}{4}$ " D. Frame measures 26 $\frac{1}{4}$ " H x 39 $\frac{3}{4}$ " W x 1 $\frac{3}{4}$ " D.

Kit GR-371MX, TV only, 125 lbs. 579.95*
 Kit GRA-402-25, TV Custom Mount (finished), 50 lbs. ... 114.95*
 Kit GRA-407-25, TV Custom Mount (unfinished), 50 lbs. 109.95*

New Heathkit Solid-State Wireless Intercom



29.95*

Plug two of them into standard 105-130 VAC outlets for 2-way communications. Three channels let you carry on 3 conversations in a 6-unit system, call one unit without disturbing the others in a 3-unit network. Intercoms have channel selectors, spring loaded "talk" button, slide-action volume control, and "dictate" for extended one-way communication.

Kit GD-113, 5 lbs. each 29.95*

New Heathkit Solid-State Shortwave Receiver



59.95*

Four over-lapping bands provide continuous coverage from 550 kHz to 30 MHz, giving you local AM plus international, amateur, marine & weather and citizens band broadcasts. Features band-spread tuning for close station separation; BFO control for receiving code; signal meter; front-panel headphone jack; noise limiter; built-in AM antenna.

Kit SW-717, 10 lbs. 59.95*

New Heathkit Automatic Battery Charger...



Charges 12-volt batteries automatically. 10 amp max. charge rate. Impossible to hook up wrong. No charge setting to make... can be left hooked up indefinitely. Meter monitor charge. Kit GP-21, 13 lbs. 29.95*

New Heathkit Automotive Timing Light...



Completely self-contained. Bright flash lets you work in sunshine. Adapter for connecting to distributor. Hi-impact plastic case. Kit CI-1020, 3 lbs. 19.95*

there's a Heathkit present



229^{95*}

New Heathkit Solid-State Digital Multimeter...

Here's a breakthrough in instrumentation. The new Heathkit IM-102 gives you a true digital multimeter for about half what you'd pay for comparable wired DMM's! And with an accuracy that's better than many wired digital units on the market... decidedly superior to most analog type instruments. This great new meter measures AC and DC voltages and currents, and resistance with no need to change probes or switch for changes in DC polarity. Automatically displays a positive or negative DC voltage and current, indicating the correct amplitude and polarity. Five overlapping ranges measure voltage from 100 μ V to 1000 V on DC (either polarity); five ranges cover 100 μ V to 500 V on AC; 10 ranges measure 100 nanoamperes to 2 amperes on AC or DC, and six ranges show resistance from .1 ohm to 20 megohms. Input impedance is exceptionally high — approximately 1000 megohms on 2V range (10 megohm on higher ranges), with overload protection built-in on all ranges. Decimal point is automatically placed with range selection and over-range is indicated by a front panel light.

Ends parallax and interpolation errors! There's no mistaking a digital display — everyone reads it the same way. High quality precision components, 3½ digits and ease of calibration contribute to the IM-102's lab-grade accuracy. Analog to digital conversion is accomplished by a patented, dependable Dual Slope Integrator that does not depend on a stable clock frequency for accuracy. A Heath-designed and assembled precision DC calibrator is furnished with each IM-102. An internal circuit and transfer method provides accurate AC voltage calibration. The all solid-state design incorporates cold cathode readout tubes and a "memory" circuit to assure stable, non-blinking operation. Features include detachable 3-wire line cord (no batteries needed), dual primary power transformer, isolated floating ground and completely enclosed, light-weight aluminum cabinet with die-cast zinc front panel and tinted viewing window. Kit includes standard banana jack connectors complete with test leads. Assembles in approximately 10 hours. The new Heathkit IM-102 Digital Multimeter will be the pride of your bench!

Kit IM-102, 9 lbs., mailable 229.95*

New Heathkit Vector Monitor...



49^{95*}

Designed for use with the Heathkit IG-28 Pattern Generator or similar units which display either "rainbow" (offset carrier) or NTSC patterns, the IO-1128 vector display helps you perform fine tuning, static and dynamic convergence,

purity, 3.58 oscillator, reactance coil, phase detector transformer, demodulator angle check, and chroma bandpass adjustments. Represents exactly the color signals fed to CRT guns.

Kit IO-1128, 10 lbs. 49.95*

New Heathkit Electronic Switch... 39^{95*}

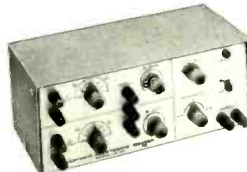

Provides simultaneous visual display of 2 input signals on a single trace oscilloscope. Has DC coupling and DC-5 MHz \pm 3 dB frequency response. Conventional binding posts permit fast

hook-up. Can be left connected to scope. Ideally suited for digital circuit work; amplifier input and output for gain and distribution checks; simultaneous monitoring of 2 stereo channels.

Kit ID-101, 6 lbs. 39.95*

CIRCLE NUMBER 3 ON PAGE 11

for every age, every hobby!

New Heathkit "Minimizer" kitchen waste compactor...

Today's most modern refuse handling method in easy-to-assemble kit form! Now you can own the most exciting kitchen appliance on the market for less than you'd pay for any other comparable compactor. The Heathkit Minimizer lets Mom throw out the unsightly waste baskets and garbage cans for the latest in clean, convenient, odor-free disposal. The Minimizer handles all normal household trash — food wastes, glass and plastic containers, tin cans, wrappings, boxes, floor sweepings, light bulbs, etc. The packing ram descends with 2,000-lb. force to reduce refuse to almost 1/4 of its original size, packaging the material in a strong disposable bag — one bag holds an entire week's trash for a family of four! When the bag's full, Mom simply folds over the top and removes a neat, dry package for normal rubbish pickup. And the Minimizer deodorizes the contents each time the drawer is opened and closed. The sanitation man will love Minimizer, too!

Simple, safe operation! To use, Mom merely inserts a Minimizer plastic-lined bag in the drawer and starts the compacting cycle. In less than a minute the ram forces down the trash, returns to its normal position, and the Minimizer shuts itself off. For maximum safety, the Minimizer uses a key lock switch and an interlock which automatically turns unit off if drawer is not fully closed or is accidentally opened during cycling. Your Heathkit Minimizer can be built-in under the kitchen counter or left free-standing. Its bright white enamel finish with marble-tone vinyl-clad top complements any decor. And you can build it yourself in 6 to 10 hours. Has long-life 1/2 hp motor, plugs into 110-120 VAC conventional household outlet. Kit includes 5 plastic-lined bags, one 9 oz. aerosol can of deodorant. Minimizer measures 34 3/8" H x 15" W x 25 1/2" D.

Kit GU-1800, 203 lbs. 199.95*
GUA-1800-1, 15 plastic-lined bags, 5 lbs. 4.99*

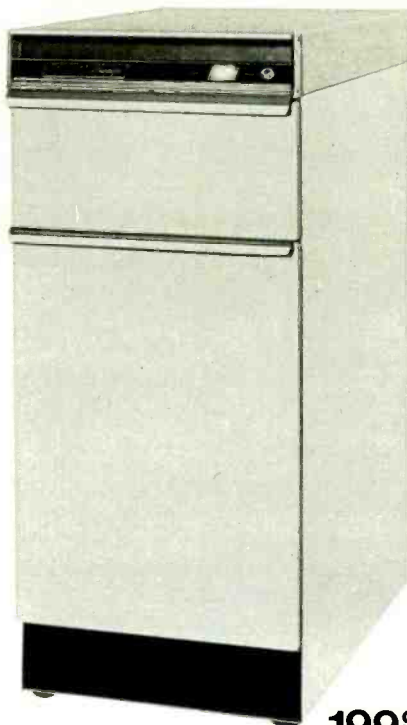

199.95*

New Heathkit Slotless 1/32-Scale Raceway

129.95*



You race up to 4 GT cars — each with independent acceleration, deceleration and steering! Make all the maneuvers of real high-speed drivers. You can even turn around completely and backtrack. Kit includes track sections for 8'x4' oval, power transformer, 2 cars and controllers.

Kit GD-79, 13 lbs., mailable 129.95*
Kit GDA-79-1, extra car and controller, 3 lbs., mailable .. 21.95*

New Heathkit Electronic Workshops



Completely self-contained electronics labs teach youngsters the basics of electronics.

Each contains basic electronic components in easy-to-work-with module form. Kids simply follow the instructions, arrange the blocks on the board to form actual working circuits for code flashers, timers, alarms, etc.

Kit JK-1033, 36 experiments, 11 lbs. 29.95*
Kit JK-1022, 25 experiments, 8 lbs. 24.95*
Kit JK-1011, 12 experiments, 6 lbs. 19.95*

SEE THESE KITS AT YOUR LOCAL HEATHKIT ELECTRONIC CENTER... or send for FREE catalog!

CALIF.: Anaheim, 330 E. Ball Road; El Cerrito, 6000 Potrero Avenue; La Mesa, 8363 Center Drive; Los Angeles, 2309 S. Flower St.; Redwood City, 2001 Middlefield Rd.; Woodland Hills, 22504 Ventura Blvd.; COLO.: Denver, 5940 W. 38th Ave.; GA.: Atlanta, 5285 Roswell Road; ILL.: Chicago, 3462-66 W. Devon Ave.; Downers Grove, 224 Ogden Ave.; MD.: Rockville, 5542 Nicholson Lane; MASS.: Wollastley, 165 Worcester St.; MICH.: Detroit, 18645 W. Eight Mile Rd.; MINN.: Hopkins, 101 Shady Oak Rd.; MO.: St. Louis, 9296 Gravois Ave.; N.J.: Fair Lawn, 35-07 Broadway (Rte. 4); N.Y.: Jericho, L.I.; 15 Jericho Turnpike; New York, 35 W. 45th Street; OHIO: Cleveland, 5444 Pearl Rd.; Woodlawn, 10133 Springfield Pike; PA.: Philadelphia, 6318 Roosevelt Blvd.; Pittsburgh, 3482 William Penn Hwy.; TEXAS: Dallas, 2715 Ross Avenue; Houston, 3705 Westheimer; WASH.: Seattle, 2221 Third Ave.; WIS: Milwaukee, 5215 Fond du Lac.

Retail Heathkit Electronic Center prices slightly higher to cover shipping, local stock, consultation and demonstration facilities. Local service also available whether you purchase locally or by factory mail order.

HEATHKIT
Schlumberger

HEATH COMPANY, Dept. 38-1
Benton Harbor, Michigan 49022

Enclosed is \$ _____, plus shipping.
Please send model (s) _____.

Please send FREE Heathkit Catalog.

Name _____

Address _____

City _____ State _____ Zip _____

*Mail order Prices; FOB factory.
Prices & specifications subject to change without notice. CL-422

CIRCLE NUMBER 3 ON PAGE 11



ABCs of Single Sideband for CBers

Six ways single sideband can cure the CBer's five-watt headache.

By JOHN T. FRYE

MANY experimenters don't realize that the technique of communicating via single sideband—SSB, for short—has been around for quite awhile. Much in the news lately, SSB's origins can be traced back to the year 1915. That year, an employee of the American Telephone and Telegraph Co., John R. Carson, filed for a patent explaining this improved method of transmitting signals.

After the patent was granted in 1923, the telephone company promptly put SSB to work on their new trans-Atlantic cable. Even then, American Tel & Tel must have seen the advantages of SSB. Today, the company uses SSB for its entire overseas communications loops.

Radio amateurs saw the need for SSB as early as 1933. But SSB didn't really catch on until September of 1947, when O.G. Villard, Jr., W6YX, fired up his SSB rig and worked W6VQD on the 75-meter band. A lot of amateurs must have been listening to this contact, for soon after it was made SSB found itself in the center of hamdom's lime-light.

For today's CBer fighting to be heard on his band, SSB is now beginning to prove itself. Until a few years ago, all CB rigs relied upon amplitude modulation, the more conventional—and considerably older—mode of transmitting and receiving messages. Although AM has been refined over the years, it is simply no match for SSB in terms of transmitting efficiency, or the ability to de-

FIVE SSB RIGS YOU CAN BUY TODAY

Shown clockwise are the following:
 Midland 13-878 \$409.95
 Lafayette Telsat-SSB 25 \$299.95
 Browning Golden Eagle Mark II \$495
 Tram Titan III \$614
 Regency Imperial II \$359

liver a readable signal to the listener under the worst atmospheric conditions.

Briefly, SSB has six big advantages over AM for the CBer. Single sideband:

- has eight times more talk power.
- occupies one-half the bandwidth of an AM signal.
- is carrier-free—it cannot beat against other incoming signals sharing the same frequency in the transceiver's mixer stage and cause squeals and howls.
- is not subject to signal fading peculiar to AM signals. There are no carrier frequencies to swing out of phase in the atmosphere and interfere with each other at your antenna.
- gear loafs along when you're not transmitting. Unlike AM equipment, there is no power-wasting carrier signal in the transmitter to support. Neither does SSB require large amounts of audio power to fully excite the transmitter. SSB equipment can be made lighter and more compact.
- uses switchless voice-control for changing from the transmit to receive mode. When

Fig. 1—Signal F1 is modulated by incoming signal F2 in converter stage. Difference frequency, 455 kc, is passed to next stage.

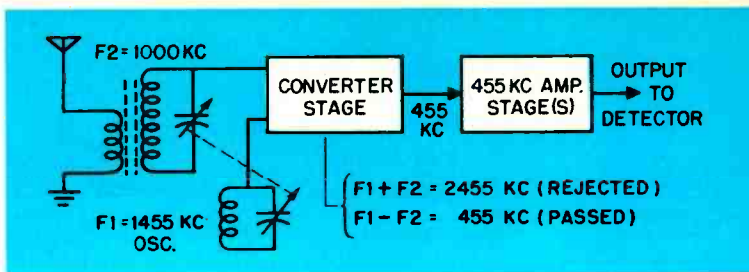

you're not talking, you're listening.

In order to fully appreciate SSB's advantages, first let's discuss a standard AM signal.

Modulation is essentially a frequency mixing process. It is called heterodying, beating, detection, or frequency conversion. Regardless of what you call the modulation process, two frequencies are fed into a device whose output does *not* respond in a linear fashion to the input. Examples are a diode, a tube without bias (or biased to cutoff) and special frequency-converting tubes. In all of these devices, the two input frequencies combine to produce two new frequencies equal to the sum and difference of the original pair.

You are probably familiar with the frequency-mixing process in the front end of a superheterodyne receiver (see Fig. 1). The desired incoming signal, 1000 kc, is mixed in a converter stage with a 1455 kc signal from an oscillator stage. The *difference* frequency in this particular receiver is fed into the IF amplifier, while the sum frequency is rejected.

Take a look at the block diagram of an AM transmitter shown in Fig. 2. The 27.065 mc RF signal generated by the crystal oscillator is amplified by the buffer and fed to the modulated RF amplifier stage. A 1000

cps signal from the audio generator is boosted by the speech amplifier and inserted into the modulator stage. From there, the audio signal is sent via the modulation transformer to the modulated RF amplifier which is already carrying the 27.065 mc carrier signal.

The two signals combine in the modulated RF amplifier. Produced are respective sum and difference frequencies of 27.066 mc and 27.064 mc. Since the output circuit of the RF power amplifier cannot discriminate between these frequencies, all three are fed to the antenna and radiated as a composite AM signal.

The best way to visualize what comes out of the modulated amplifier in Fig. 2 is to examine the output on a couple of test instruments employing CRT displays. Fig. 3 shows the patterns of a scope which monitors modulation, and of a panoramic receiver connected to the output of the rig.

The panoramic receiver is a broad-tuned superhet receiver whose IF output frequencies are swept across a CRT display. The trace shows a segment of the incoming RF by sweeping the panoramic receiver's local oscillator with a sawtooth-shaped voltage. The output of the rig's IF amplifier stage is shown on the scope as a band of frequencies.

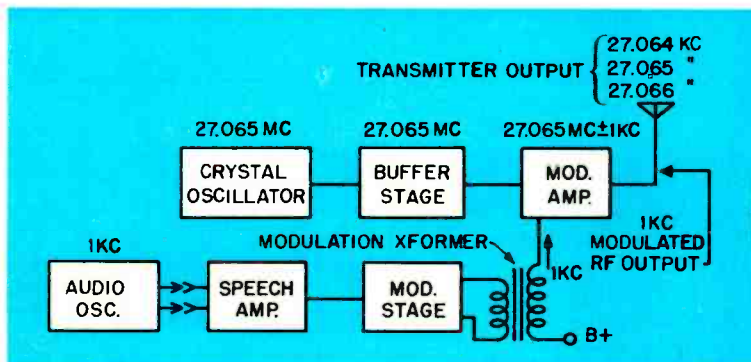

Fig. 2—Modulated RF amp mixes 1000 cps voltage with RF. Output from this stage consists of three distinct voltages appearing at rig's antenna terminals.

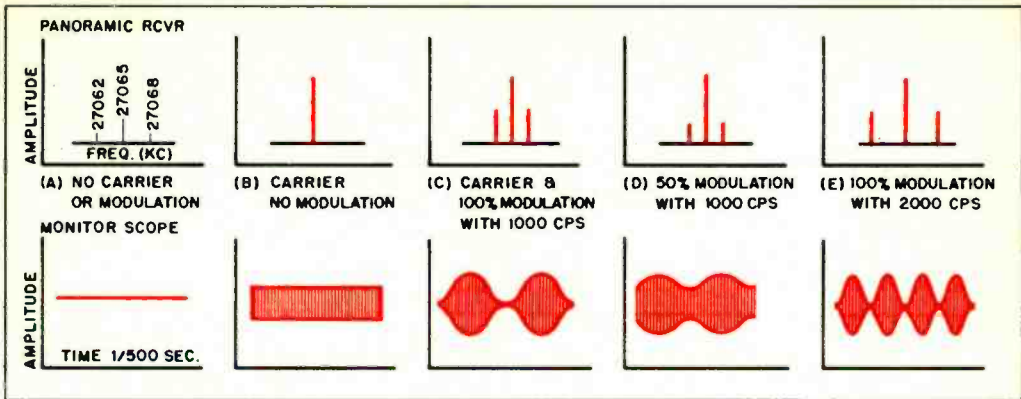

Fig. 3—RF output from CB rig in Fig. 2 as seen on panoramic receiver and monitor scope. Box A shows sidebands developed if 3000 cps signal is fed to modulator stage. Boxes C-E are for frequencies shown.

ABCs of Single Sideband for Cbers

The CRT graticule is calibrated in terms of the RF signal's frequency and amplitude. The panoramic receiver enables the user to determine how the RF signal was originally modulated, its frequency and the quality of modulation.

The horizontal baseline of the panoramic receiver represents the continuous segment of frequencies from 27.062 to 27.068 mc. Vertical height above the baseline indicates the amplitude of any signal displayed.

On the monitor scope, the trace is swept from left to right and, in our example, represents 1/500 of a second. Vertical height of the graticule represents the amplitude of the RF voltage fed to the antenna.

Fig. 3 illustrates what is seen on both instruments under a variety of conditions. At point A the transmitter is turned off. Only the vertically-centered horizontal sweep line is seen on the monitor scope, and nothing is seen above the base line of the panoramic receiver.

At point B the RF carrier is being transmitted, but no signal is fed to the modulator. Now the high-frequency alternating excursions of RF voltage deflect the trace up and down as the sweep moves from left to right to form a solid rectangular trace. On the panoramic receiver only a single, thin vertical line extends upward from the 27.065 mc point on the baseline of the CRT graticule. The thinness of the line, occupying a minimum portion of the displayed spectrum, indicates that the carrier consists of only one

frequency totally without bandwidth.

At point C of Fig. 3 the 1000 cps audio tone is applied to the modulator. The pattern on the monitor scope dimples and bulges like the neck of an ostrich swallowing oranges. The amplitude of the 1000 cps signal is increased until the peaks of the displayed signal are twice the amplitude of the unmodulated carrier and the valleys just touch the horizontal sweep line. This represents 100 percent modulation, the maximum possible without serious distortion.

On the panoramic receiver, a strange thing happened. The carrier signal, 27.065 mc, remains unchanged, but, two new sideband

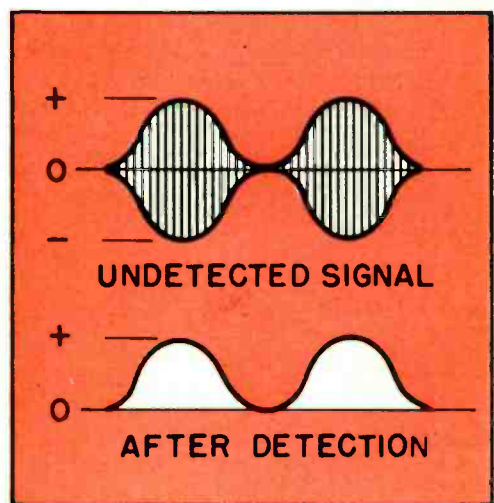
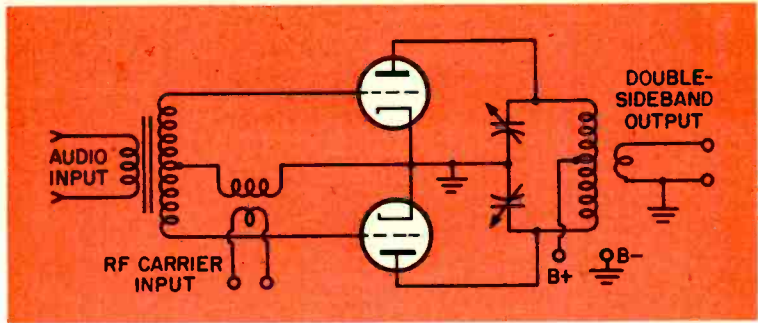

Fig. 4—Diode detector clips off lower half of waveform. Recovered audio matches RF envelope.

Fig. 5—Balanced modulator mixes audio and carrier. Output is RF voltage minus carrier. Both sidebands are present—only one is used.



signals have popped up—one at 27.064 mc and the other at 27.066 mc. Each is a thin line representing a single frequency, and is half as tall as the carrier line. This means each has a voltage amplitude half that of the carrier.

Remember that all three signals appear at the same antenna load. Also keep in mind that power in one of these new sidebands is equal to the square of its voltage divided by the resistance of the antenna. Assuming the antenna's resistance is one ohm, one-quarter the power of the carrier will be consumed by the sideband frequency. Therefore the sum of the power contained in both new frequencies equals half the power of the carrier.

Reducing the audio signal fed to the modulator by 50 percent produces the patterns at point D. On the monitor scope the height of the peaks and the depth of the valleys are both reduced 50 percent. The panoramic receiver trace shows the amplitude of the side

frequencies is now halved, but the carrier height remains unchanged.

Finally, at point E, the audio generator is set at 2000 cps and the amplitude again increased to produce 100 percent modulation. Our monitor now displays four bulges instead of two. Otherwise the display looks like the one at point C. On the panoramic receiver the side frequencies have the same amplitude as at point C, but they have moved away from the unchanged carrier to 27.063 mc and 27.067 mc.

We can deduce the following: (1) Modulating an AM carrier with an audio tone produces two side frequencies, each on either side of the carrier. (2) Each sideband frequency is displaced from the carrier by a spectrum distance equal to the modulating frequency. (3) A complex audio signal containing many frequencies such as voice or music will produce sets of identical side frequencies on either side of the carrier. All such frequencies on either side of the car-

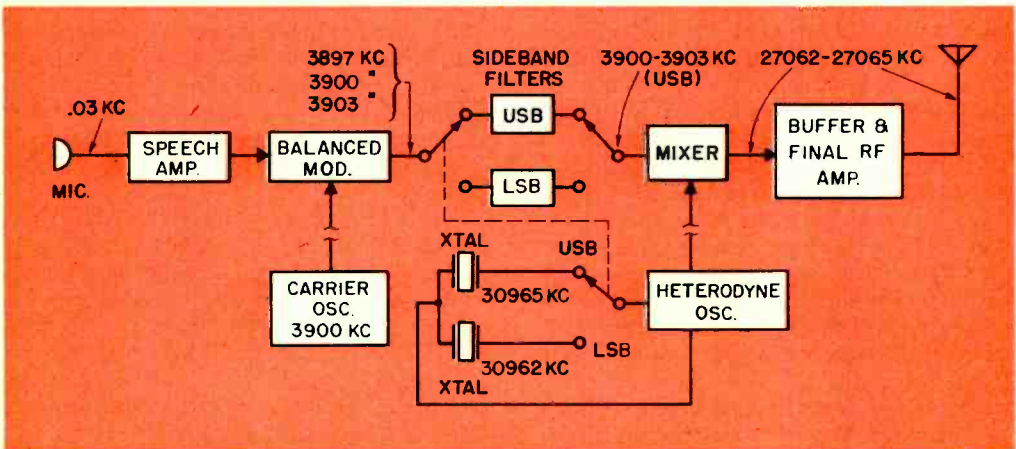

Fig. 6—Block diagram of single-sideband transmitter. Frequency values shown are for 300-cps signal fed to speech amp, with mode switch in upper sideband position. Note heterodyne oscillator frequency.

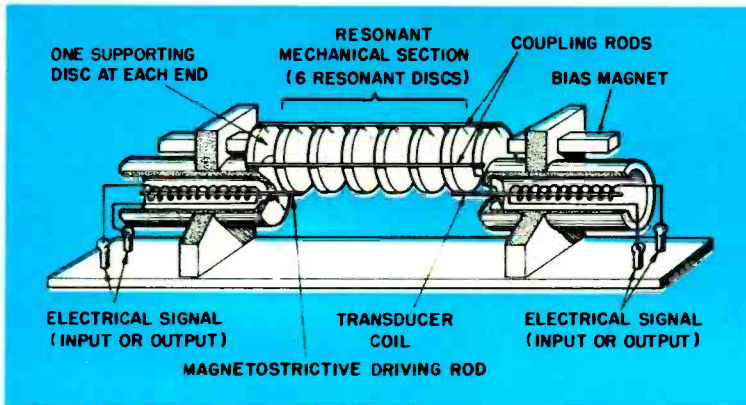

Fig. 7—Crystal filter eliminates one sideband from SSB signal. It's a bidirectional device: RF signal is fed into either end. Resonant mechanical section consists of ceramic discs which vibrate at band of frequencies to be removed.

ABCs of Single Sideband for CBers

rier are lumped into a sideband. (4) The carrier does not change with modulation, but the two sidebands do reflect any change in frequency or amplitude of the audio signal. The intelligence of a modulated signal is contained in the sidebands and not in the carrier. (5) The two sidebands contain identical information.

You may ask yourself: If all the essential information is contained in a single sideband, why transmit the carrier and the other sidebands? The carrier represents pure waste, and the other sideband is a duplication of the first. While we need a carrier to heterodyne with the modulating frequencies and produce the sidebands, the job could be done at a lower power level.

What would happen if we concentrated all the transmitter power on a single sideband? Assume the unmodulated power output of our AM transmitter is 5 watts. Under full modulation, signal peaks reach double the carrier voltage. Since the power increase equals the square of the voltage ratio, peak power is $(2)^2 \times 5$, or 20 watts.

But the total power in both sidebands—the intelligence power—is only $2\frac{1}{2}$ watts. If we eliminate the carrier and one of the sidebands, and amplify the remaining sideband until it has a peak power of 20 watts, our intelligence power will be eight times what it was using AM. What's more, our signal bandwidth will be only half as wide as the AM signal.

Sounds fine, but there's a catch. Without an RF carrier, how will we recover the intelligence at the receiver? This is a simple matter with AM. All we do is pass the modu-

lated carrier shown in Fig. 4 through a diode. The signal remaining after detection is an undulating DC waveform that reproduces the original audio signal exactly.

But this won't work with an SSB signal. If you listen to an SSB transmission on an AM receiver, all you hear is an unintelligible duck-like quacking.

A little thought reveals why. In an AM signal, the modulation is directly extracted from the carrier. But in SSB, there is no carrier to extract anything from. All we have is a series of shifting, pulsing RF frequencies collected in a bandwidth of about 3 kc away from a phantom-like carrier's center frequency. Each of those side frequencies, of course, is keyed to an audio tone—relative to the amount it is removed from the original carrier.

Detecting an SSB signal is simple. We simply insert a new carrier in the receiver precisely at the stage where the original carrier served as a reference for the generation of the sideband in the transmitter. The sideband signal received at the antenna modulates this inserted carrier just as the original audio modulated the original carrier. Resulting signal can be detected like ordinary AM signal.

The carrier can be inserted at any point in the RF or IF portion of the receiver. But in practice it is usually done via a special kind of detector. Called a *product detector*, it maintains a proper ratio between the strength of the received signal and the inserted carrier. The carrier must be inserted very precisely in relation to the sideband if the recovered modulation is to sound natural. If the carrier frequency is shifted too far one way, all tones are raised in pitch; if too far the other way, all tones are lowered in pitch.

[Continued on page 99]

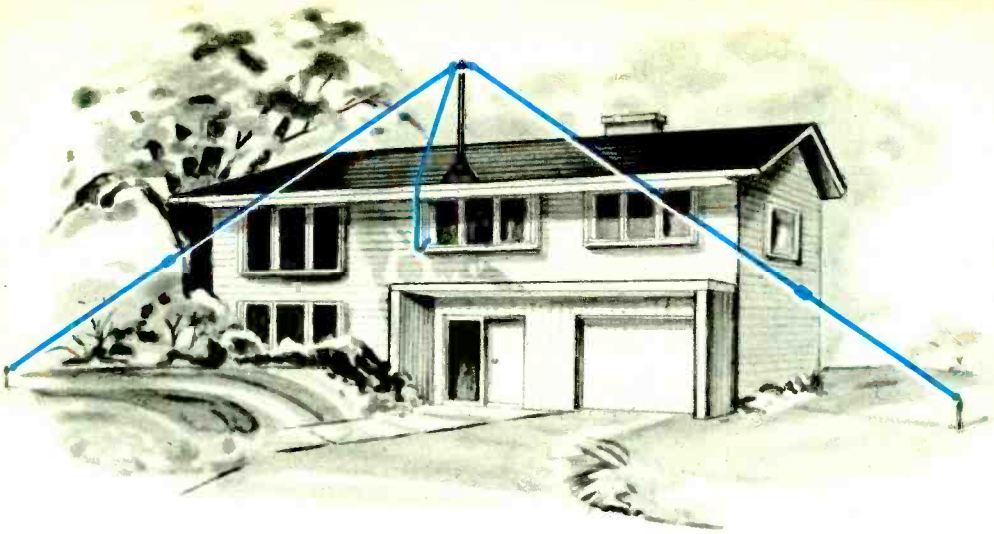

A Trap Antenna for SWLs

By **RONALD LUMACHI, WB2CQM** THE SWL with a host of QSLs in his pocket isn't just lucky. Besides being a careful listener, his equipment must be in top-notch shape. Most important, his antenna has to snag DX signals efficiently. If you want to snare weak stations, a good antenna should rank just as high on your list as a receiver—with the edge, in our opinion, going to the antenna.

For a couple of bucks and some spare time, you can put together a multi-band antenna specifically designed for the most-popular shortwave frequencies. Our antenna operates from 3 to 30 mc. Its impedance measures nearly 50 ohms consistently throughout this range. Because of its wide bandwidth you will be able to hear hams—and the MARS network as well.

How It Works. Trap antennas are most sensitive when they are tuned to a specific band of frequencies. This type of antenna works less efficiently at frequencies out of its range. But there is a technique an SWL can use to obtain multi-band performance.

By inserting parallel-tuned L/C traps into each leg of a half-wavelength skyhook you can resonate the elements to *submultiples* and *harmonics* of the antenna's basic tuned frequency.

Fig. 4 shows the schematic of our tuned trap antenna. Beam lengths A, in both elements, resonate the antenna at its fundamental half wavelength, 40 meters—or 7.5 mc. Both trap circuits (L1/C1 and L2/C2) are broadly tuned to 7 mc. These traps are inserted into each antenna leg at the point where they'll efficiently isolate 40-meter signals from lengths B.

Since the traps present an electrical barrier to the 40-meter signals trying to flow into the outer B sections, the antenna electrically consists only of the A lengths. It operates as a half-wavelength dipole tuned to 40 meters.

What happens when your station's frequency is a submultiple of the

A Trap Antenna for SWLs

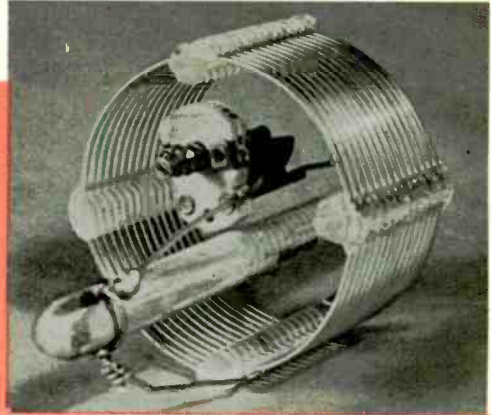

Fig. 1—Finished trap circuit, ready to be tuned to 7 mc with grid-dip meter.

Fig. 2—Basic parts for SWL's trap antenna shown at left. Leave insulation on wire.

antenna's fundamental frequency? In the case of 80-meter signals, both LC traps connect each leg's B Lengths to the A Lengths. Furthermore, each coil-capacitor combination (basically resonated to 7 mc) has a new effect upon signals flowing in lengths A and B.

The capacitor's reactance (opposition to flow of AC current) now has increased. The incoming 80-meter signal is now effectively blocked by the capacitor. The inductor's reactance, however, has decreased giving the signal an easy path into Length B of the antenna.

Each LC trap, therefore, has an overall inductive reactance on 80 meters and other sub-multiple frequencies. An incoming signal sees only the coil in series with lengths A to B in both legs of the antenna. Since both legs are now electrically connected, the antenna elements are longer, and the entire skyhook resonates at lower frequencies.

When tuned to harmonics of the inner dipole's resonant frequency the array takes on different electrical characteristics. At 20 and 10 meters, the LC circuits now exhibit low capacitive reactance. In each leg of the antenna the A Lengths now are isolated from the B lengths. The A sections operate as a full wavelength dipole on 20 meters and as a twice-wavelength dipole on 10 meters.

Building the antenna is a simple task.

Start by counting off 16 turns of a length of the 3-in. dia. Air Dux coil specified in the Parts List. Allow one turn on each end for slack. Since the antenna must be in perfect electrical balance, we recommend you buy the commercially-wound coil. However, if you have a grid-dip meter handy, you can wind your own.

To help cut through the heavy plastic coil supports of the Air Dux coil, use a heated single-edge razor blade. Count the turns carefully to make sure coils L1 and L2 are

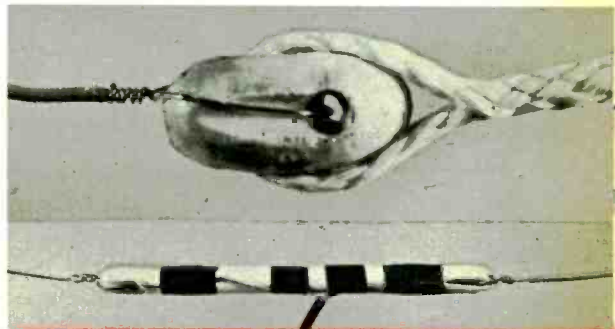

Fig. 3—Nylon rope anchors strain insulator to pole or mast. Secure coax to center insulator with electrician's tape.

HORIZONTAL

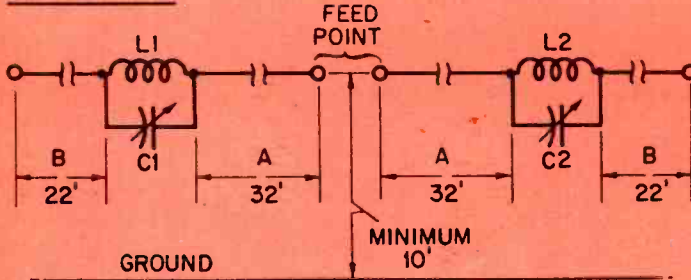

Fig. 4—Schematic of SWL's trap antenna. Note, too, Lengths A and B; these must be strictly adhered to in order to resonate both antenna dipoles.

the same length. You will eventually resonate both coils with two miniature variable capacitors (C1 and C2), each having a maximum capacitance of 75 μf . Fig 1 shows most of the trap antenna's components.

Mount each coil on a 6-in. porcelain insulator by guiding and then wrapping the coil's free ends through the insulator's holes shown in Fig. 1. Next, solder a length of stiff copper wire to the stator and rotor lugs of the variable capacitors. Mount one capacitor inside each coil by wrapping the wires coming from the stator and rotor through end holes in the insulator. As a precaution against vibration, cement the capacitor's ceramic base to the insulator with a dab of epoxy. Make two identical LC assemblies.

Mesh each capacitor's plates half way before trying to resonate each LC unit. If a grid-dip meter is available, fine-tune both traps to 7 mc.

Purchase about 110 ft. of No. 12 or No. 14 insulated copper wire from an electrical supply house. Thinner gauge wire works, too, but remember that thinner wire will not support both coils adequately once it stretches.

Measure off two pairs of wires, each cut
[Continued on page 101]

PARTS LIST

- C1, C2—4.6-75 μf miniature variable capacitor (Lafayette 40 F 28486 or equiv.)
- L1, L2—Inductor coil: 8 turns-per-in., 3-in. dia. No. 14 wire, Air Dux No. 2408T. (Jeff Tronics, 4252 Pearl Rd., Cleveland, Ohio 44109. \$6.05 plus postage)
- Antenna strain insulators. Two reqd. (Lafayette 33 F 32459 or equiv.)
- Coax (RG58/U or RG59/U)
- Copper wire, No. 12 or No. 14, 110 ft.
- Feeder spreaders, 6-in. length. Three reqd. (Lafayette 33 F 32426 or equiv.)

INVERTED-L

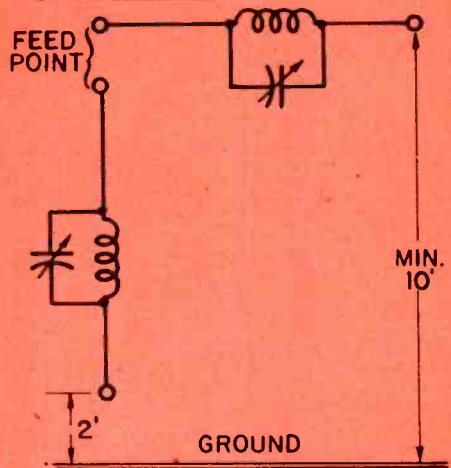

Fig. 5—Mount antenna in inverted-L if pole, mast, or tree is available.

INVERTED-V

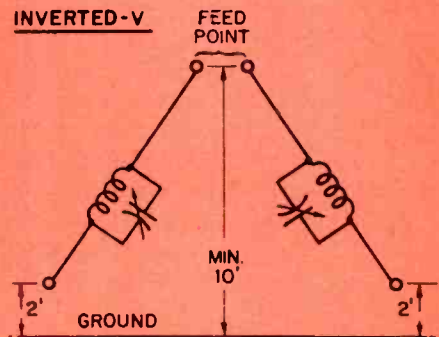

Fig. 6—Inverted-V installation is seen in picture on story's first page.



Cassettes Come On Strong

BY JOHN MILDER FROM modest beginnings, tape cassettes have evolved into the first really serious threat to the preeminence of the LP record. After a slow start, cassettes now clearly have the chance to become *the* medium for serious music listening.

The sales figures at the moment don't really look like something to worry the record industry. The entire consumer tape market accounts for only \$200 million in sales (versus about \$1½ billion for discs), and cassettes are only about one third of the whole tape market. But if the vinyl magnates are smart, that modest one-twentieth of the whole pie should appear really interesting. All the signs are that the cassette is only now beginning to climb into the growth segment of the sales curve. What may happen in just the next two years is enough for anyone with vinyl holdings to start worrying about.

The fact that cassettes now account for about \$70 million or so in sales might make it look as if growth has been pretty rapid already over the three years in which they've been around in any significant quantity. But, cassettes have done that well under very bad circumstances, including their having to compete not just with records but also with tape cartridges. They have also done well against the complacent mentality of many tape-equipment makers that took years to recognize that cassettes could sound as good as—or better than—records.

Two things did most to account for the cassette's current prospects. One was the application of the Dolby noise-reduction system to cassette recording. That made it possible to remove the hiss that always had plagued the slow-speed (1½ ips), narrow-track-width cassette tape. In turn that made not only for recording the full audible range on cassettes for the first time, but also for cleaning up all aspects of design (including mechanical design). Nobody had thought that worth bothering with so long as the cassette was just a medium-fi item.

The other development was the arrival of new tape formulations specifically designed for cassette use. TDK, Hitachi-Maxell, 3M, and Ampex

Cassettes Come On Strong

all developed radically new super iron-oxide tapes with very high magnetic particle density that made it possible for the first time to get to 10 kc and beyond in a cassette recording. And then DuPont made its Crolyn (chromium-dioxide) formulation available under license for cassettes. Its unique characteristics—lower noise level, greater signal-handling capacity plus much better high-end response—made it possible for cassette tapes to exceed standard disc quality for the first time.

The Dolby System seems slated for a major role in the cassette boom of the next few years. More than two dozen tape-equipment manufacturers (including Advent, Ampex, Concord, Fisher, Harman-Kardon, Teac and now, reportedly, Sony) have adopted the system. And the major duplicators of pre-recorded tapes, including Ampex (which itself markets the greatest variety of tape labels) and now Columbia, have Dolbyized their output—Columbia its whole output from now on.

Crolyn tape (made by several manufacturers under DuPont license) also seems sure of a major role. All the new top-of-the-line cassettes decks have the special bias required for Crolyn, and one manufacturer, Advent, has announced plans for issuing its own catalogue of cassettes that are both Dolbyized and on Crolyn. One other manufacturer, Memorex, is now doing saturation advertising on chromium-dioxide.

What now does the cassette have going for it?

It is not only convenient but very well suited to the casual style of most listeners, including the mass market which component manufacturers still haven't reached in significant numbers.

Its quality doesn't deteriorate significantly. Tape recordings of any kind, contrary to the usual folklore, do wear somewhat, and careful LP maintenance might make prime-quality sound longer-lasting on disc than on cassette. But over the average life span and use pattern of most recordings (playing a lot in the beginning, and less later on) cassettes are likely to come off better than records.

Cassettes now can sound as good as the best records, and in some respects (particularly the absence of echo heard on records because of impressions in adjacent grooves) even better.

For the negative side of the cassette picture, there is cost—for the immediate future about 20 per cent more than the average record—and the minor annoyances (such as finding your place in a recording) that still make the tape medium uncomfortable for some people. But they seem now to be no more than a flyspeck on the total picture—which is of immense sales of a small, long-lasting, easy-to-handle medium.

Only a few Dolbyized pre-recorded cassettes are around at the moment, but there will be a good 200 more in the next couple of months and a good library by any standards by the end of 1972. The standard garden-variety of cassette of the past years is still around in great numbers but it will disappear.

If that picture seems too rosy, those most active in cassette matters these days, including Ampex, Advent, and Sony are indicating they see a tremendous jump coming in sales. About the only thing now lacking for the listener is a choice of good, impressive Dolby-equipped playback-only decks. But they are on the way. And prices will drop, too.

If and when the economy recovers, there will be no stopping the cassette, and that its sales will come close to equalling that of records in a very few years. None of the marketing heavies in the audio industry are predicting that yet, but nobody seems to be saying no either. —

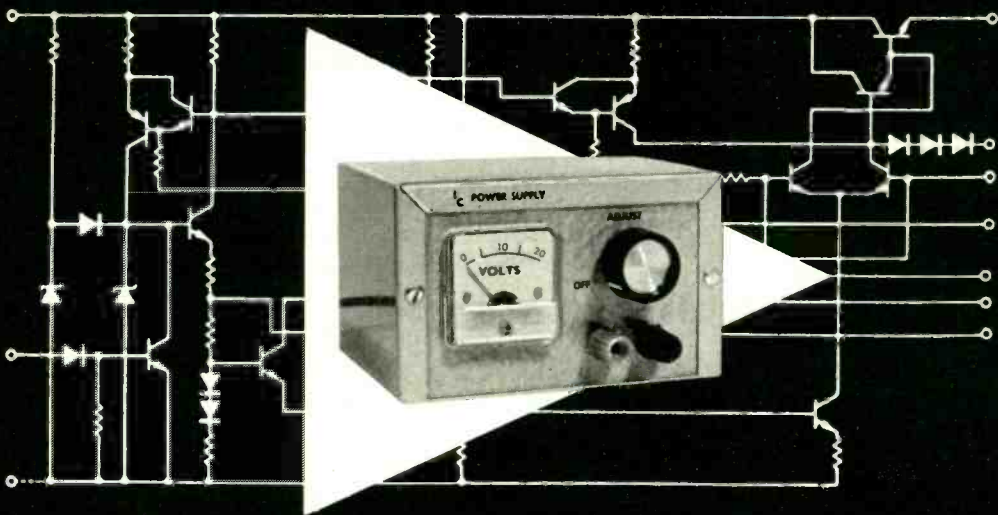

Multi-Purpose Bench Power Supply

An IC-regulated power source can make your projects more fun to build.

By VINCE DANIELS

REMEMBER when you didn't have to think twice about powering your transistor projects. Just about any reasonably conceived hookup did the trick—your choice often boiling down to battery power for low-current projects or a breadboard AC-to-DC supply for circuits consuming higher currents.

But hobbyists are working with integrated circuits now, and many are experiencing power-supply problems that never popped up in the days of the transistor. Today's hobbyist finds that the current drawn by an IC can vary wildly, especially as the power-supply output voltage rises and falls and the IC's current gain changes.

A regulated power supply is the answer—one with an adjustable output voltage that's held within tight limits over a wide range of output current. Problem is, a rock-steady power supply meant to breathe life into your favorite IC projects can be expensive. Our Multi-Purpose Bench Power Supply, however is designed for the do-it-yourselfer and is easy on the wallet.

One feature of this project is the latest in solid-state power technology—the IC voltage regulator.

You can build either a 17-V or a 38-V version of our power supply. It all depends on the IC you choose from our Parts List. Either model delivers up to 200 ma. as presented, but later on we'll tell you how to squeeze up to 400 ma. out of the supply. Buy Motorola's MC1460 IC for the low-voltage supply, or the MC1561 if you're opting for the high-voltage model.

The schematic is identical for both versions, but the low-voltage model allows you to cut costs—a lower voltage rating is specified for filter capacitor C1, and two rectifier diodes are omitted.

The regulator IC contains 22 transistors on a chip. Chances are you'd spend ten times the price of the IC if you were to build identical performance into a circuit using discrete components. Built into both Motorola ICs are provisions for current limiting, remote sensing and short-circuit protection. To simplify circuitry and keep costs down,

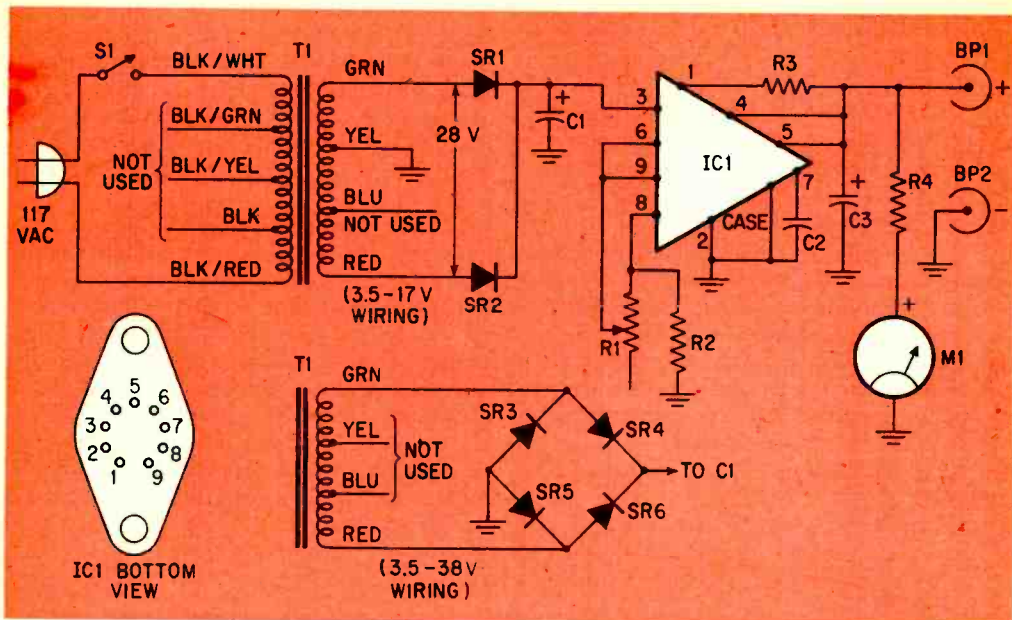

Fig. 1—Two ways to connect T1 and diodes into circuit. Also note that IC1's case is grounded.

our supply uses only the short-circuit protection and current-limiting features.

Remote sensing is a power supply's ability to compensate for voltage drops in the wires connecting it to the load. This feature is not needed in our supply because most IC projects built by the experimenter are immune, performance-wise, to this minute voltage loss.

The IC's entire circuit is built on a single slab of silicon. Because the regulator circuit and the pass transistors which it controls are on the same chip, the response to voltage variations is exceptionally fast. The payoff is that IC1 responds faster than a discrete-component power supply to load-current variations. The IC also has an extremely low output impedance—on the order of 20 milliohms. This built-in feature reduces the chances of your breadboarded IC project breaking into oscillations (motorboating) when it's not supposed to. The very low output impedance of the IC also helps to reduce the effects of a voltage drop in the wires connecting the power supply to your project.

The maximum current you can pass through either IC specified in our Parts List is 600 ma. Since we're supplying only 400 ma.—at most—to IC1, this safety margin helps to guard it against accidental burn out.

Our bench supply is also protected against

PARTS LIST

- BP1, BP2—Insulated binding post
- C1—500 μ f, 25 V electrolytic capacitor
- C2—0.1 μ f, 75 V ceramic disc capacitor
- C3—25 μ f, 25 V electrolytic capacitor
- IC1—Integrated circuit (Motorola MC1460 or MC1561, see text)
- M1—0.1 ma DC milliammeter (Lafayette 99 R 25074 or equiv.)
- Resistors: $\frac{1}{2}$ watt, 10% unless otherwise indicated
- R1—50,000-ohm linear-taper pot
- R2—6,800 ohms
- R3—6.8 or 3.3 ohms (see text)
- R4—20,000 or 39,000 ohms (see text)
- S1—SPST switch
- SR1-SR6—Silicon rectifier, 50 PIV, 1 A (Motorola HEP-154)
- T1—Low-voltage rectifier transformer; secondaries: 10/20 V CT, 40 V CT @ 0.3A (see note below)
- Misc. 3 x 4 x 5-in. aluminum minibox, printed-circuit board and supplies, AC line cord.
- Note: Order T1 from Allied Industrial Electronics, 2400 W. Washington Blvd., Chicago, Ill. 60680 Stock No. 705-0128 \$5.23 plus postage.

Multi-Purpose Bench Power Supply

external short circuits. The IC regulator is series-connected between the load and power transformer. Pins 4 and 5 of IC1 connect to circuits on the chip which reduce output current to a very low value if BP1 and BP2 are shorted together.

The IC's internal circuitry connected to these pins monitors the voltage developed across current-limiting resistor R3. Whenever this voltage exceeds a certain pre-set value, this circuit instantaneously biases the substrate output transistors into their non-conducting mode. Even if output terminals BP1 and BP2 are shorted together there still will be no damage to IC1 or its associated components.

How It Works. Fig 1 is the power sup-

ply's schematic. Shown is the 17 V, 100-ma. model intended for the general experimenter. Below the schematic is the transformer and diode configuration needed to increase the output to 38 V. Very few additional components are needed for our power supply—most of the regulating circuit is built into IC1.

Potentiometer R1 varies the output voltage. The same 50,000-ohm pot works in either the high or low-voltage version. Meter M1 indicates output voltage and resistor R3 determines maximum load current.

Resistor R3's value is 6.8 ohms for the 100-ma. current limit, and 3.3 ohms for a maximum load of 200 ma. In both instances, R3 is rated at ½ watt. Up to 400 ma. can be drawn from the supply if you limit the output voltage to a maximum of either 12 or 23 V, depending on the IC chosen and

Fig. 2—Pictorial below shows wired low-voltage version of power supply. Extra soldering lugs on M1's rear cover are for unused indicator lamps.

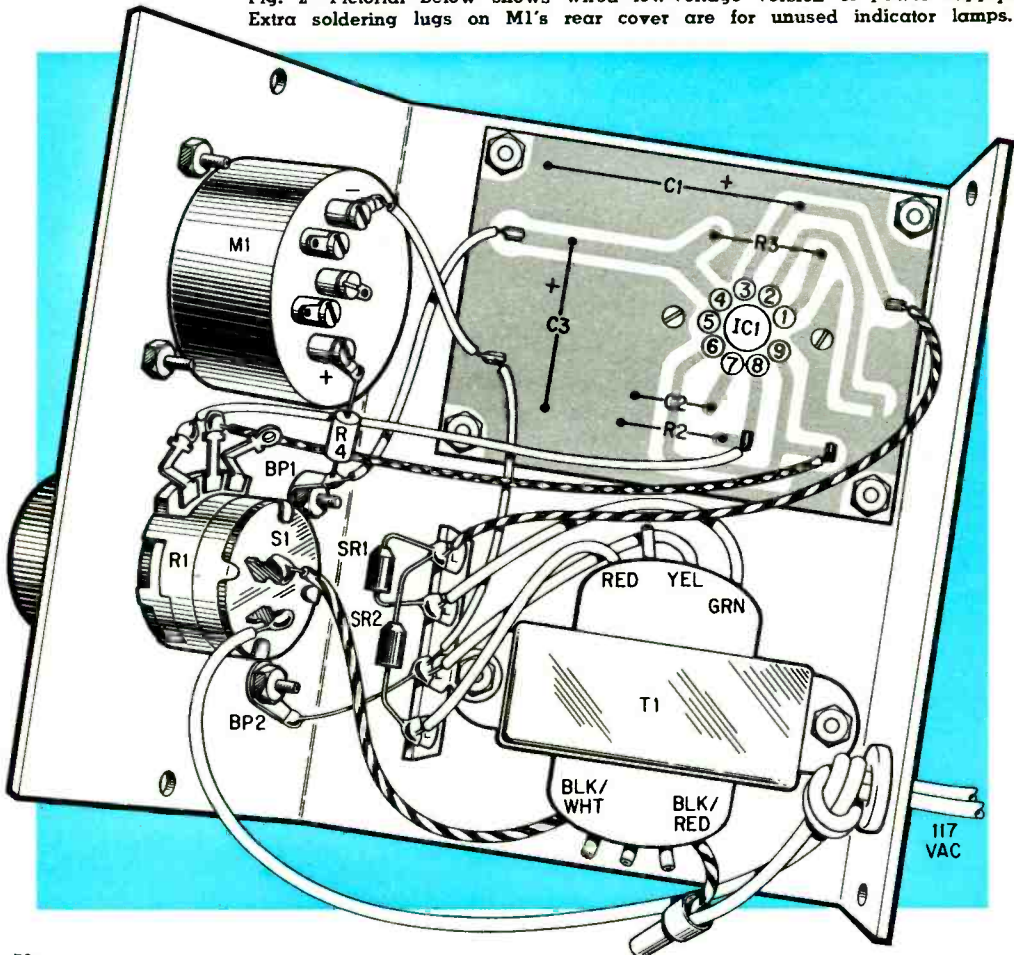

the tap arrangement of T1. This way T1's full 400-ma. current rating can be utilized. Resistor R3, in this instance, is rated at 1 ohm and ½ watt.

Except for power transformer T1 and the silicon rectifiers, the regulator circuit is assembled on a PC board. With the power transformer specified a 20-VDC input to IC1 is provided by a full-wave rectifier—SR1 and SR2. The same transformer connected to the alternate bridge rectifiers (SR3-SR6) provides a 40-VDC input in IC1.

Regardless of which secondary-winding taps are chosen, capacitor C1 will charge to the peak voltage delivered by T1. Transformer T1's secondary voltage is always 0.7 times the desired DC input voltage to IC1. For example, a 40-VDC input from T1 equals 40×0.7 , or 28 V (rms).

For our 17-VDC supply, filter capacitor C1 is rated at 25 VDC. Increase C1's rating to 50 VDC if you're building the 40-V version.

Voltage regulation is excellent—the output varies less than 0.5 V as load current increases from zero to maximum. But this ability to regulate also depends upon the capacitance rating of C1. With C1's specified rating of 500 μf , output voltage is regulated up to about half the maximum value.

For regulation throughout the entire range, C1 should be rated between 2,000 and 4,000 μf . Note that the PC board can only hold a 500- μf size filter capacitor. A larger electrolytic capacitor must be mounted externally.

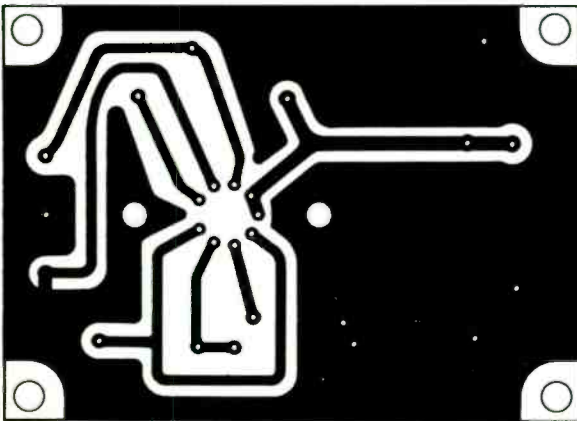

Fig. 3—Full-size pc board template. Copy foil pattern exactly as shown. Instability could occur otherwise.

Fig. 4—Scale shown is for 17-V model. Draw new meter scale and double numbers for 38-V supply.



Construction. Our power supply is housed in a 3 x 4 x 5-in. aluminum Minibox. The circuit is assembled on a 2¼ x 3-in. PC board drawn full size in Fig. 3. Make the foil layout exactly as shown. The IC regulator is a high-gain, high-frequency device and it can break into oscillation just like an RF amplifier. The foil layout prevents this instability.

Cut a section of PC board to size and clean it with a damp sponge dipped in a household cleanser. Dry the board and place a piece of carbon paper face down on its copper side. Tape the template in Fig 3 over the carbon paper.

Push through the template (with a scribe, ice pick or similarly pointed tool) at each indicated hole with sufficient force to indent the copper foil. When the board is completed these pockets provide drilling locations. Using a ball point pen, trace the foil outlines onto the copper. Remove the template and carbon paper and fill in the foil outlines with a resist pen.

Don't let the lead foils touch the ground foil. If necessary, leave extra space between the lead and ground foil. Etch away all excess copper and clean off the resist with steel wool or a resist solvent. Finally, drill all component wire holes with a No. 57 drill bit. A No. 27 bit is large enough to enlarge both corner mounting holes and the mounting holes for IC1.

Note that IC1 has only nine pins. The case is terminal 10. The IC can fit on the PC board only one way. If you try to jam-fit IC1 as it's being installed, you're mounting it incorrectly. Mount all remaining components and solder the connections quickly with a low-wattage soldering iron. Transformer T1 and the diodes are connected to the PC board with flea clips (see Fig. 2). [Continued on page 100]

Let Bell & Howell Schools help you get ready for a rewarding Color TV Service Business of Your Own

Ultra-rectangular,
25" diagonal with
full 315 sq. inch
screen. Lets you
view more of the
transmitted image.
25,000 volts. 45
transistors, 55 diodes,
4 advanced IC's.
3-stage solid-state IF.
Solid-state VHF, UHF
tuners. Automatic fine
tuning and many other
quality features.



**BUILD, KEEP, USE ALL FOUR OF
THESE PRECISION QUALITY KITS**

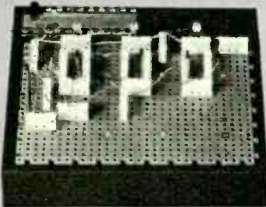

INCLUDES—
Design Console with built-in power supply, test light and speaker. Plus patented plug-in Modular Connectors.



INCLUDES—
Portable 5-inch, wide-band oscilloscope calibrated for peak-to-peak voltage and time measurements.



INCLUDES—
Transistorized Meter combines most desired features of vacuum-tube voltmeter and quality multimeter. Measures very small current values.

FREE! MAIL CARD TODAY FOR ALL THE FACTS
No Postage Needed

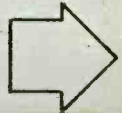

YOU'LL BE READY FOR COLOR TV . . . B&W AND MOST HOME ENTERTAINMENT ELECTRONICS DEVICES

This exciting new program offers you the *first* 315-sq. inch Solid-State Color TV available for at-home training.

As you follow the simple, step-by-step assembly procedures, you become thoroughly familiar with the most advanced solid-state TV circuitry. And as you build this kit you'll prepare yourself for a profitable Color TV service business of your own—either full or part time.

Why Color TV pays better.

Today, Color TV is the big seller. As Color Television goes completely solid-state, the man who has mastered this type of circuitry will be in demand. Obviously, this is where the money is going to be made.

This new Bell & Howell Schools program will also give you an in-depth knowledge of the basics as well as TV circuit theory and analysis. You'll get the theory and practical experience you need to handle radios, hi-fis, stereos, and tape recorders.

You will also receive three precision quality instrument kits which you assemble and keep. These are highly sensitive professional instruments which you'll use constantly.

**EXCLUSIVE ELECTRO-LAB®
IS YOURS TO KEEP, USE**

This unique at-home laboratory comes to you in 16 shipments and includes a remarkably instructive *design console*. You can rapidly "breadboard" a great variety of circuits without soldering. The *Oscilloscope* offers 3-way jacks to handle test leads, wires, plugs. Images on screen are bright, sharp. Your *Transistorized Meter* is fully portable, features a sensitive, 4-inch, jewel-bearing d'Arsonval meter movement. It registers the slightest power surge or lag on a large, easily read dial.

CONSIDER THESE ADVANTAGES:

Bell & Howell Schools' Electro-Lab-at-Home Plan gives you the most thorough background possible in solid-state Color TV. Everything

Note: TV picture is simulated.

comes to you by mail and you go at your own speed. You'll be prepared not only for a service business of your own but for many positions in the Electronics and Television industries. All without missing a paycheck!

When you have completed your program our *Lifetime National Employment Service* will help you locate in an area that interests you. This service is available at any time—now or in the future.

Approved for G.I. Benefits

Our programs are approved for Veterans' Benefits. If you're a Vet, check the space in the card at left for full details.

Student Loans now available

If you are a non-veteran and need financial assistance, you may qualify for a student loan. This may enable you to *learn now . . .* and to *repay later*.

Special Help Sessions. These are scheduled regularly (Saturdays) at seven Bell & Howell Schools and in many other cities. Here you can get expert guidance by top instructors to help you over the rough spots.

Bell & Howell Schools offers you even more. Once you have finished your program at home, you may decide you want more advanced preparation. In this case, you may transfer to any one of our seven schools which are located all across the country.

Mail the postage-free card today for all the facts. There is no cost or obligation of any kind.



**BELL & HOWELL
SCHOOLS**

4141 Belmont, Chicago, Illinois 60641

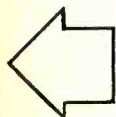

FREE! MAIL CARD TODAY FOR ALL THE FACTS
No Postage Needed

Servicing Those Solid-State TVs

As tubes depart, new problems appear. Case histories show what this means.

By ART MARGOLIS

AS solid-state TVs now appear on my workbench more frequently, some unusual troubles are beginning to surface. I can think of four right off. Two I haven't encountered for years and two are brand new, have never existed before and are special troubles that promise to become commonplace.

Shades of the old RF coil. This trouble occurred immediately after I had cleaned out my storage room. Among the items I planned to throw out was an old carton containing an unused replacement part. It was the RF coil that Westinghouse used back in the late Forties as a horizontal-output transformer.

I don't know if you remember this circuit but the horizontal-output transformer produced its own high voltage whether the horizontal oscillator was running or not. As a result there sometimes was a symptom called *no horizontal sweep*. It appeared as a bright vertical line on the screen, just like *no vertical sweep* except turned 90 degrees.

Well, a new Japanese solid-state portable on the bench faced me in exactly the same old *no horizontal sweep* condition. As I removed the back, I half expected to see an old RF high-voltage coil staring at me. There was no such item.

My first impulse was to test the horizontal

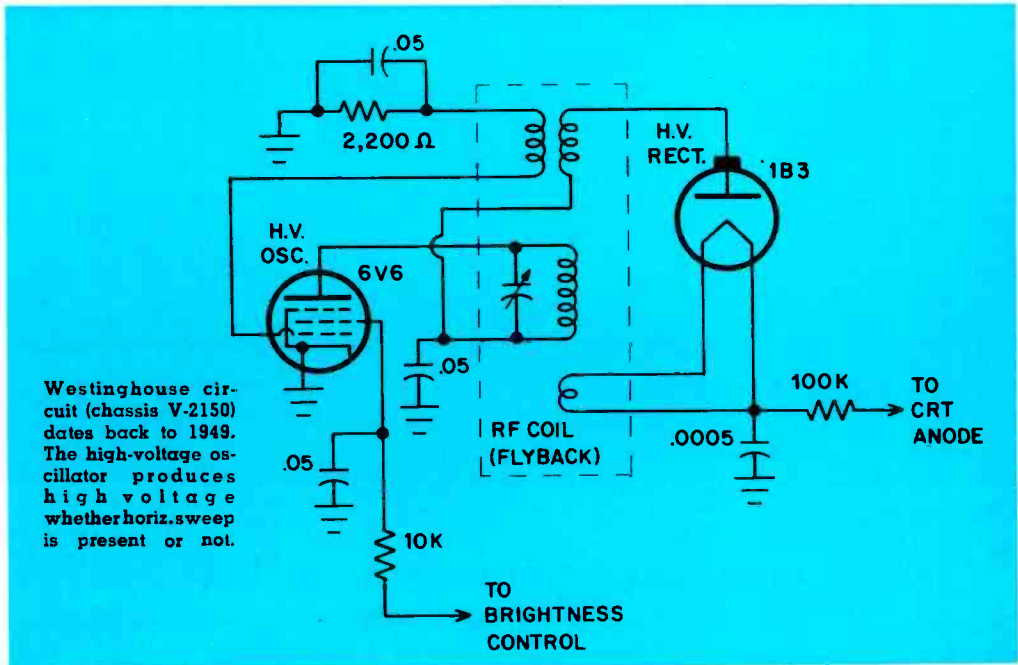

Case No. 1. Lack of horizontal sweep in Japanese solid-state b&w portable was caused by an open 1-microfarad capacitor in yoke circuit.

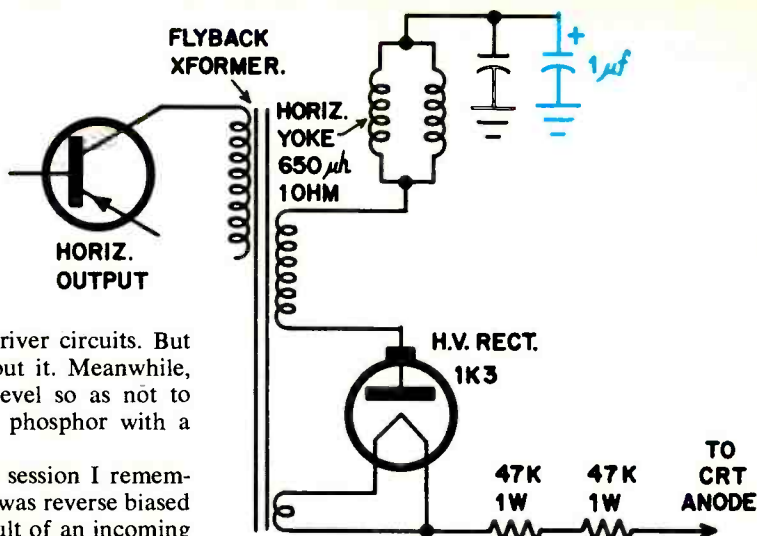

oscillator and horizontal driver circuits. But I stopped and thought about it. Meanwhile, I lowered the brightness level so as not to bombard a single strip of phosphor with a screenful of electrons.

From a factory training session I remembered the output transistor was reverse biased and that the bias was a result of an incoming horizontal oscillator pulse. While I didn't have to worry about the output transistor burning up—like an output tube—if the oscillator was out, I did know that there would be no high voltage.

The high voltage is produced by stepping up the positive pulse developed during retrace time. No oscillator output, no scanning, no retrace, no high voltage and therefore no symptom of *no horizontal sweep*.

The trouble had to be down the line from the high-voltage manufacturing plant. The only thing past this point was the yoke and associated components. I turned the set off and pulled the plug on the yoke. I measured the horizontal windings. They measured a little better than one ohm as they should.

The only components remaining in the circuit were two capacitors going to ground. I figured I'd better jump them first. One was a one-microfarad filter. I jumped it with another capacitor and turned on the TV. Lo and behold, the sweep returned. I replaced the filter—it had a ten megohm short.

Like a flash, I went out to the trash heap and found the old Westinghouse RF coil. I placed it back into inventory. If I wait long enough it's bound to come back.

A case of a familiar smell. An Emerson 21-in. color TV with a round tube was placed on my bench. I turned it on. There was no raster.

The roadman who brought it in said, "Funny thing, when I was working behind the TV I detected a faint odor that seemed familiar. But I just couldn't place it." I sniffed around the set but didn't smell any-

thing especially peculiar.

There was some high voltage present but it was low. I replaced the high-voltage tube just on the chance he had a bad tube in his caddy. The low voltage symptoms remained. I brought my B & K Analyt over and injected a pulse into the cap of the horizontal-output tube. The condition remained.

That meant the oscillator output circuits were good and the trouble would be in the area of the yoke and flyback transformer. I quickly checked the usual items—like the boost capacitors, the regulator cathode capacitor, the flyback, yoke, width control, etc. No sign of trouble.

I turned the set back on and looked over the plates of the output tube. It seemed to be running normally. I took a current reading of the cathode and it was about 200 ma as it should be. I felt safe in testing voltages with the output tube in place. No damage was going to occur even if the roadman had detected an odor.

I was reading voltages when I got a whiff. There was a very faint odor—and it was familiar. I couldn't quite place it. I leaned in close to the high voltage area, careful not to draw an arc to my nose and took a deep sniff. Aha! An old 10-in. Emerson from around 1949 flashed into view. Shorted seleniums! That's what it smelled like.

But there weren't any power seleniums in this modern-day Emerson. What in the world was causing the odor?

I reached around to the front of the TV and twisted the brightness control. A badly

Servicing Those Solid-State TVs

blooming, defocused picture appeared momentarily at one setting. I adjusted the control gingerly until I got a dim raster. It was badly defocused.

I looked over the focus circuit. Then it struck me. There was one of those long skinny focus diodes in there. Could it be made of selenium? Could it be shorted?

I snipped it out, grasped it with long-nose pliers and smelled it. It had the old hydrogen sulphide aroma. It was shorted and burned ever so slightly.

A new focus diode restored all. The old sniff and tell technique was back in business.

Beware of horizontal-output transistor! While you may not have to worry about loss of the horizontal oscillator blowing the horizontal-output transistor, there is another way the expensive output transistor can be shorted.

I had such a case on the bench the other day. It was a 19-in. Magnavox solid-state b&w portable. Two symptoms were present: insufficient width and a portion of the picture scrunched into a bright drive line in the center of the picture.

The raster would remain for about five seconds, then the circuit breaker would trip and cut everything off. If this had been a tube set, my first service move would have been to replace the horizontal-output tube. However, since it was a solid-state chassis and unfamiliar, I tried to follow past experience. I went to the horizontal-output transistor. I felt it. It was hot! It must have really drawn a lot of current before the circuit breaker tripped.

I began examining the schematic before going any further. The output transistor was still good but it was being overdriven for some reason. Also, the output transistor could never sustain such a high temperature for

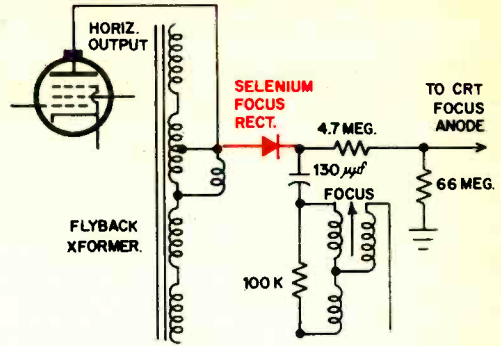

Case No. 2. No raster in an Emerson 21-in. color set was the result of shorted diode rectifier in the focus circuit. Selenium smell turned the trick.

any period of time. I had to find out why the transistor was drawing so much current.

I attached my scope probe to the collector terminal and turned the TV on. A raster appeared. A horizontal pulse appeared on the scope and I marked it for peak-to-peak voltage. Then I turned off the set. The peak-to-peak pulse measured about 800 V.

The schematic called for 500 V. The transistor was rated at 700 V. This excessive voltage was causing the overheating and subsequent symptoms.

The scope's trace showed an almost normal pattern occurring between the pulses, but the pulses were too high. This indicated trouble in the circuit forming the pulse. The pulse was obtained from the retrace part of the waveform. This retrace occurs when the magnetic field in the yoke suddenly collapses. This flyback action is supposed to produce 500 V peak-to-peak. It was developing over 800 V.

This meant the Q (quality factor) of the yoke circuit would have to be higher than the value specified. Now what components—when they conk out—could cause a higher Q?

In series with the yoke was the output tran-

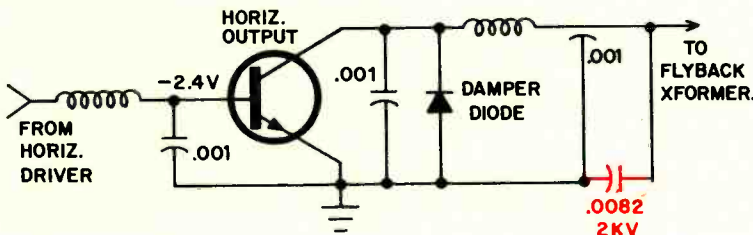

Case No. 3. Horizontal-output transistor in 19-in. Magnavox solid-state b&w portable was overdriven because Q of yoke circuit was affected by an open 8200-microfarad capacitor.

sistor's collector, a 1000-mf capacitor rated at 1kv, the damper diode and an 8200-mf capacitor rated at 2kv. I tested the diode first. It was perfect. I tested the two capacitors next with an ohmmeter. Neither was shorted.

I took some replacement capacitors and tacked them in to see if one was open. I turned on the TV. The drive line was gone. However, the width problem still existed. One of the capacitors was open.

I tested both capacitors with my capacitance meter. The 8200 job was open. I replaced it. Then I tested the transistor for beta. It was almost non-existent. I replaced the transistor. That was it. The TV picture came on beautifully and the set has been playing ever since.

Mystery of the prison bars. The customer said as she met me at the door, "My set has prison bars." I nodded and laughed to myself.

I turned on the color TV, a fairly new Zenith 23-in. model. The sound blasted forth, a raster appeared, contrast took form and color filled the screen.

Then it happened. Three or four solid black vertical bars appeared. They did, indeed, resemble prison bars. The scene looked like it was being viewed from a cell window.

It was a trouble I had never seen before. It was *ringing* such as the yoke causes. However, yoke ringing is different because there is a gradual change from light to dark. Here there were solid bars spaced across the screen. The symptom resembled snivets (also called Barkhausen) somewhat, but snivets place a ragged bar or two on the screen and the snivets move around. In fact, they can drift across the screen.

These bars were solid and stationary. There was no other problem with the picture or sound. She had said prison bars and that's exactly what they were.

I figured since they were vertical bars they were being formed by the horizontal scan. Also, as I said, they resembled snivets and snivets are caused by the horizontal output. I knew I'd better look there first.

Just for kicks, I changed the horizontal-output tube, a 6BL6. It didn't help. The bars were still there. I sat down and examined the schematic. The flyback transformer was large and had many windings. There were many waveforms displayed. One was a positive-going spike having a peak-to-peak value of 200 V. This was sent to the horizontal-

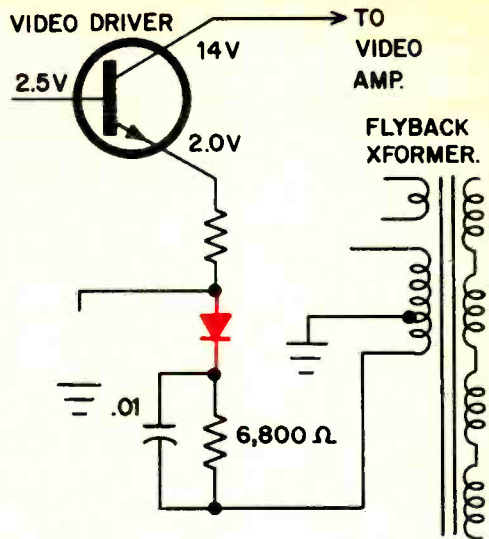

Case No. 4. Solid black bars on CRT of a 23-in. Zenith color set were caused by shorted horizontal blanking diode. Bars were harmonics of pulses.

phase detector, the burst amplifier, the color-phase detector, the bandpass amplifier and the plate of the horizontal oscillator.

There was another positive 6-V peak-to-peak spike sent to the convergence yoke. Then there was a negative 17-V peak-to-peak voltage sent to the video driver. Sent to the video driver? What was that for.

I examined the circuit carefully. The negative pulse was first sent through a parallel RC network (6.8 kilohms and .01 mf). The network attenuated the pulse down to about 10 V peak-to-peak.

The pulse was then passed into one end of two diodes that had their anodes tied together. The center tap of the diodes was tied into the emitter resistor and the DC voltage produced at the center tap controlled the emitter voltage and therefore the video driver bias. As the pulse went negative during retrace time, the emitter voltage went up and cut off the transistor, blanking out the horizontal retrace.

I checked the diodes. The diode in the emitter leg was shorted so horizontal blanking was not taking place. The emitter was emitting all the time.

I changed both diodes as insurance. Then I turned the set back on. The prison bars were gone. The customer said, "I figured that was an easy problem, because the picture was otherwise perfect."

DXing Our Northern Neighbors

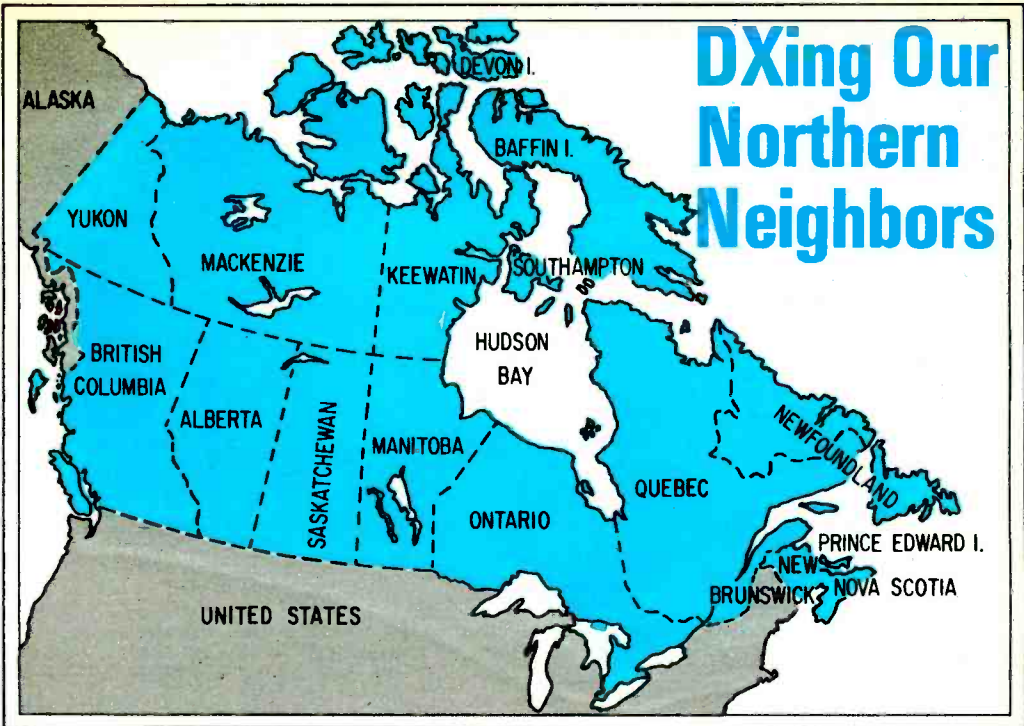

By **ALEX BOWER** MUCH has been written recently about controversial broadcasts from north of the U.S. border. But amid the sound and fury, how many of Canada's 10 provinces and two arctic territories can you actually log and verify? If you want to improve your score here's how to bag all 12.

Although R. Canada International (RCI), the overseas division of the Canadian Broadcasting Corp., maintains studios and mailing address at Montreal, its only transmitter is at Sackville (near Moncton), New Brunswick. This makes New Brunswick the easiest of provinces to log and verify. RCI, whose programs are supervised by the Dept. of External Affairs in Ottawa, is slowly modernizing the Sackville facility. It means that hearing New Brunswick should be even easier. The frequencies you need are listed in the chart.

Across Northumberland Strait lies Prince Edward Island (PEI), Canada's smallest, greenest and rarest DX province. Although PEI seldom receives publicity in DX circles, it's one of the most difficult islands in the world to log. At last report, CFCY at Charlottetown (one of PEI's two BCB stations) was operating non-stop on 630 kc. If you live east of the Mississippi and have unlimited

patience, you might bag this islander through considerable QRM during the wee hours of the morning. When CFCY is heard, also shoot for CJRW at Summerside on 1240 kc. The second station signs on at about 0500 EST but it's on a graveyard frequency so QRM may prove even worse.

Another way to add PEI to your collection is through a bit of aerial piracy. You might hear a transatlantic airliner passing over the island. Fortunately, pilots transmit their position regularly so you might catch one at right moment. While in the vicinity of PEI they work Moncton Aeradio on 2868 kc and atmospheric conditions at night could produce coast-to-coast reception. If you log a U.S. plane, send your report to: Communications Supervisor, (name of airline), JFK International Airport, Queens, N.Y. 11430. Be sure to include return postage. For European aircraft, direct your request to the Station Manager and airline at the same address. Remember, though that there are some DXers who don't accept this method of bagging a rare location.

Nova Scotia, next of Canada's three Maritime provinces, has two low-power regional SWBC outlets; CHNX, on 6130 kc, at Halifax (relaying CHNS on 960 kc) and

CJCX Sydney (6010 kc) relaying CJCB on 1270 kc. The CHNX transmitter is very old and is plagued with technical troubles, including off-frequency operation for the past few years. In the Eastern U.S. both CHNX and CJCX can occasionally be heard during daylight hours. Otherwise you'll have to chase them through a maze of night-time QRM. Nova Scotia is another province you might log via aircraft in flight (2868 kc.)

Newfoundland is Canada's newest and easternmost province. It was self-governing until March 31, 1949 and served as the North American end for Marconi's first transatlantic radio contact. Gander Aeradio today is a vital communications link for North Atlantic air traffic. Weather broadcasts from the station are heard at 20 and 50 minutes past each hour on 13272, 8868, 5656 and 3001 kc.

Gander Aeradio's QSL policies are uncertain at the moment but give it a try. After you log the station it won't do any harm to address a reception report to the Officer in Charge and see what happens. Meanwhile, CBC operates a low-power regional SWBC station at St. John's, CKZN (originally VONF before confederation) on 6160 kc, relaying the programs of CBN on 640 kc. DXers should be extremely careful when identifying this one. Another CBC regional, CKZU at Vancouver, British Columbia, also transmits on 6160 kc. CKZU relays CBU 690 kc on Canada's west coast.

On the subject of British Columbia, if you don't want to fight 49-meter QRM, try several inviting west-coast stations such as VAC (Cape Lazo) and VAK (Victoria). They have their own frequency to air weather broadcasts and to work ships. It's 1630 kc and tunable on a garden-variety AM receiver.

Moving eastward we come to Alberta and the prairie provinces of Saskatchewan and Manitoba. Low-powered CFVP on 6030 kc (24 hours a day) carries the programs of CFCN (1060 kc). Despite its lack of muscle, CFVP is a fair DX prospect around 0300 EST. Two 50-kilowatt, CBK Watrous (540 kc, Saskatchewan) and CBW Winnipeg (990kc Manitoba), are near the center of the continent so most readers should eventually be able to log them. Try CBK in the east after 0100 EST. If you have a local station on 990 kc, try CKY 580 kc or CJOB 680 kc in Winnipeg. For

(Continued on page 95)

GUIDE TO CANADIAN DX			
Freq. (kc)	Station	Location	Remarks
540	CBK	Watrous, Sask.	CBC
540	CBEF	Windsor, Ont.	CBC, French
580	CKY	Winnipeg, Manitoba	
600	CFCF	Montreal, Quebec	English language
620	CKCK	Regina, Sask.	
630	CFCY	Charlottetown, P.E.I.	Early AM
640	CBN	St. John's, Nfld.	CBC
680	CJOB	Winnipeg, Manitoba	
690	CBF	Montreal, Quebec	CBC, French
690	CBU	Vancouver, B.C.	CBC
740	CBL	Toronto, Ont.	CBC
860	CJBC	Toronto, Ont.	CBC, French
910	CBO	Ottawa, Ont.	CBC
960	CHNS	Halifax, N. S.	
990	CBW	Winnipeg, Manitoba	CBC
1010	CFRB	Toronto, Ont.	
1060	CFCN	Calgary, Alberta	
1070	CBA	Moncton, N.B.	CBC
1200	CFFB	Frobisher Bay, NWT	CBC
1240	CJRW	Summerside, P.E.I.	
1270	CJCB	Sydney, N.S.	
1630	VAC & VAK	Cape Lazo & Victoria	Coast stations
2868	North Atlantic flights	Moncton, Gander Aeradios	Night
3001	Gander Aeradio	Gander, Nfld.	Weather broadcasts, shares with N.Y.
5656	Gander Aeradio	Gander, Nfld.	As 3001, above
5970	RCI	Sackville, N.B.	Various times at night. Also carries CBC
6005	CFCX	Montreal, Quebec	Relays CFCF
6010	CJCX	Sydney, N.S.	Relays CJCB
6030	CFVP	Calgary, Alberta	Relays CFCN
6060	RCI	Sackville, N.B.	Sometimes replaces 5970
6070	CFRX	Toronto, Ont.	Relays CFRB
8130	CHNX	Halifax, N.S.	Relays CHNS
8868	Gander Aeradio	Gander, Nfld.	As 3001, above
8910	Polar flights Aeradio	Resolute Bay & Cambridge (NWT)	
8938			As 8910
9620	RCI	Sackville, N.B.	As 5970
11720	RCI	Sackville, N.B.	Various times day & night.
13272	Gander Aeradio	Gander, Nfld.	As 3001
15235	RCI	Sackville, N.B.	Day
21585	RCI	Sackville, N.B.	Day

Notes from EI's Win-the-World Contest

HOME STRETCH . . . The finish line is in sight! All entries have been received in EI's Win-the-World Contest (entries had to be postmarked on or before October 31 to be eligible) and now our editors are busy checking and verifying. Perhaps by now you have—or in the near future—you will receive a request from us in which we ask you to send in your QSL cards and letters for verification.

Being asked to prove your claims wouldn't necessarily mean you are in line for one of the 100 prizes offered (see list at right) since we'll be checking more than the top 100 entries (figuring that some will be disqualified), but it would mean that you're getting mighty close.

Down the Drain . . . Why might your entry be disqualified after you spent a goodly amount of time listening, logging, sending out reports and then waiting impatiently for the mailman to bring in those QSLs? In the early entries, we found most disqualifications came because of some simple mechanical failure, such as forgetting to enclose the entry blank in the envelope or failing to put name and address in the upper left corner on the front of the envelope.

How about Cash? . . . That was a question asked quite a few times. "If I win one of those prizes" the questioner would say, and then I already have something like it or would just rather have money, can I get the cash equivalent instead?" Sorry, the putting-together of a complicated prize structure takes a lot of time and the wholehearted cooperation of a great many manufacturers, who agree to supply their products. It's a kind of house of cards that, if the cards are dealt out properly, can work quite well. But only if it is played straight. So that's the way we do it. You get what you win. Interestingly enough, many of the products in our list received what one could term fan letters in which readers expressed hope of winning one particularly choice prize.

When? When? . . . The list of winners will be announced in our next (March) issue and the winners will be notified by mail. Note that this contest takes the place of the annual awards usually announced in this issue.

PRIZE	DESCRIPTION
GRAND	A trip to your favorite country anywhere in the world via Pan American World Airways, the world's most experienced airline
2nd	RCA G-2000 color TV set
3rd	Heathkit/Thomas Legato organ kit
4th-5th	Heathkit GR-370 color TV kits
6th-7th	Conar color TV kits by National Radio Institute
8th-13th	Your choice of home-study course from: Cleveland Institute of Electronics, CREI, ICS, National Radio Institute, National Technical Schools, RCA Institutes
14th	Hallicrafters SX-122A receiver
15th-19th	Hallicrafters SX-133 receiver
20th	Advent 201 cassette tape deck
21st	Sony STR-6055 stereo FM/AM receiver
22nd	RCA WO-505A solid-state scope
23rd	Lafayette Radio Telstat SSB-25 SSB CB transceiver
24th	RCA WR-52A Stereo FM Signal Simulator
25th	Allied Radio Shack Patrolman PRO-3 VHF/UHF receiver
26th	Sansui QS-1 Quadphonic Synthesizer
27th	Weston 666 solid-state VOM
28th	Courier Citation solid-state base-station CB transceiver
29th	Olson RA-280 stereo FM/AM solid-state receiver
30th	RCA WR-502A solid-state color-bar generator
31st-35th	Hallicrafters CR-44A Ranger portable shortwave receiver
36th	Avanti Moonraker CB base-station antenna
37th	Ameco R-5A receiver
38th	DeltaAlert ultrasonic intrusion detector
39th-41st	Hallicrafters S-240 entertainment/communications receiver
42nd	Two CB mikes from Turner
43rd	Edmund Scientific Deluxe Visual Effects Projections Set plus Rippling Color Accessory
44th-45th	Hallicrafters skip-band receiver
46th	Eico 3450 four-channel color organ
47th	\$100 credit with Electro-Voice for any equipment in their latest catalog, including miniature 651C communications mike
48th	Complete library designed for hams and SWLs from the Howard W. Sams Publishing Co.
49th	\$100 credit for any antenna in the latest catalog of Antenna Specialists
50th	Mallory MCR-1232 portable cassette recorder
51st	\$100 credit with Shakespeare, one of the leaders in the CB antenna field
52nd	A library of the latest bestsellers from Tab Books Co.
53rd-100th	One year subscription to electronics hobbyist's favorite magazine— ELECTRONICS ILLUSTRATED

CB Corner

By Len Buckwalter,
KQA5012



"CB Census"

TWO YEARS ago the FCC plunked down \$15,000 to have a thorough study made of the Citizens Band. The results are in. We spent a day in the commission's Washington office poring through this massive work of some 100 pages, plus hundreds of computer print-out tables. The study, done by Advanced Technology Systems, Inc., was based on a sampling of 9,296 CBers selected by the U.S. Census Bureau. CBers proved to be a dedicated lot since a whopping 95 percent responded to the questionnaire.

In many ways the computer confirms what CBers everywhere already suspect. Low cost, simple licensing and easy operation have generated tremendous enthusiasm and satisfaction among the 891,595 Americans who have taken to CB.

But widespread frustration also fills the ranks. Reason is, wholesale misuse of the airwaves by chatters and skip-workers. Yet, despite the wounding of CB's effectiveness, 70 percent of those surveyed said the service is still adequate for their needs. Only 13 percent said they won't renew their licenses. About 30 percent declared that CB would serve their communications if only the evils would go away.

The report had no shockers about where CB rigs operate. About 80 percent of us have rigs in both car and fixed station, while 29 percent own handie-talkies. Boats account for 13 percent, and farm vehicles take a 7 percent slice of the CB pie. Your chances of getting a call from above are increasing since nearly 8000 airplanes are CB-equipped, too.

There is one surprise amid the statistics. More than 300,000 CBers—that's almost one-third the entire CB population—have used their rigs for emergency purposes within a one-year period. What's more, the average number of emergency calls by each CBER was 17 a year! About 80 percent of the calls concerned auto trouble or an accident. Assistance to police and fire officials followed at 51 percent, with 23 percent of the calls accounting for illness and injury

and 21 percent tallied for natural disaster. Many CBers remarked that emergency Channel 9 seems to be working well and it's reasonably free of interference.

The ATS study bares the bones of CB and should provide government and industry with much-needed data. But once the report pushes aside statistics and starts to make recommendations, it's as exciting as my Aunt Tillie's recitation on Arbor Day. Much of what ATS suggests dates back to CB's more ball-and-chain-like legal era: stricter enforcement, more education, type-acceptance of equipment, and a ban on linear amplifiers.

Dubbing a new name on an old thought, they'd have the FCC create a "CB Specialist" for each of the country's 24 radio districts. Purpose of this specialist would be to serve as educator and enforcer. Maybe the researchers didn't do all of their homework. The Commission's field operation is ridiculously understaffed now. Some 200 men patrol the whole country looking for bigger game. Reading this section of the report was like being forced to sit through an Esther Williams swim flick twelve times.

One minor—but notable—suggestion is to drop the current 5-minute silent period rule. If you don't hear anyone else on the channel when your message is completed, you could continue to use the frequency without waiting five minutes. This makes sense and would remove one more mockery of the regulations. But further along, the report tosses out suggestions which, again, smack of corny police-state tactics. It says the FCC should require the buyer of CB gear to identify himself to the dealer—even sign his name, possibly, to a bill of sale. The report then suggests that dealers periodically submit a list of CB purchasers to the FCC.

Only when the writers of the report stick to their namesake's field—advanced technology—do they start to make sense. Their report is redeemed by one suggestion that could be worth the whole tab. It's an idea which demands neither additional equipment nor more channels but could improve CB
[Continued on page 96]

TV's Wheel of Color Spins Again

By LEN BUCKWALTER

A black-and-white-to-color TV converter may now be in sight!

MANY an inventor has dreamed of the riches that await him when—and if—he comes up with a practical converter that would produce color TV programs on a black-and-white set. It's such an intriguing idea that engineers and gyp artists alike have pursued it as a kind of Holy Grail for 20-odd years.

Their efforts have largely produced frauds—such as color filters that cover the screen but don't move—or valid circuits with one flaw . . . always fatal.

A few months ago there was a startling announcement in the Canadian press: Not only was someone promoting color from black-and-white TV but, it was said, there was electronic hardware to back up the claims. Furthermore, the system was supposed to be totally electronic with no spinning wheels or other mechanical gizmos.

EI sent me north to check out the story. As I headed toward the Place Du Canada, a posh Montreal skyscraper where the demonstration of the converter was to take place,

I recalled other alchemist schemes and formulas for turning video lead into gold.

Most attempts to make a true color converter have shared marked similarities. They usually begin with external filters to get around the standard tri-color CRT. Today's color picture tube generates hues from thousands of glowing red, blue and green phosphor dots—a vastly different process from the smooth b&w screen which shines only white.

Nearly everyone in the converter game gets around the dot problem with color filters placed outside the picture tube. Only one color is presented at a time in each full frame (or scene). A favorite tactic is a large color wheel of red, blue and green filters that turns in front of the b&w screen to tint each frame with the correct primary color. The wheel is synchronized with the color information broadcast at the studio. That's the route CBS tried to take in the '50s when the company embarked on its own pioneering color-wheel system.

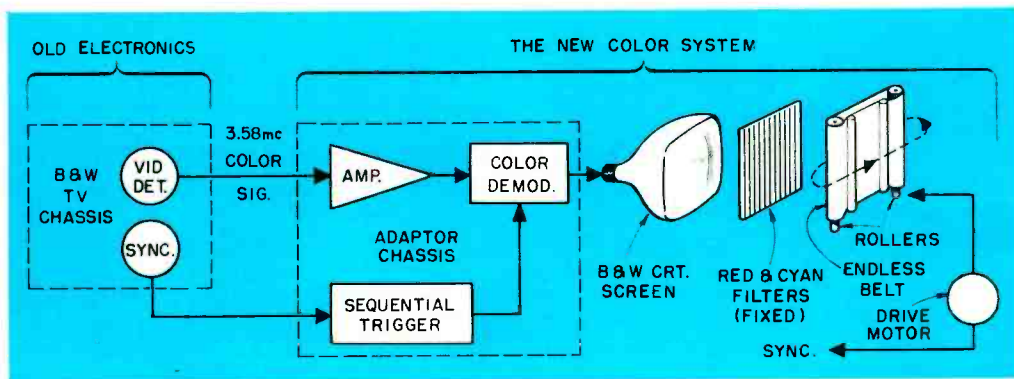

Fig. 1—Block diagram of color converter system. The 3.58-mc color signal is tapped from b&w set and amplified. Also tapped is 60-cps vertical sync. Sync controls sequential trigger which permits primary colors to pass single file into b&w picture tube. Endless belt is controlled so that correct filter is exposed.

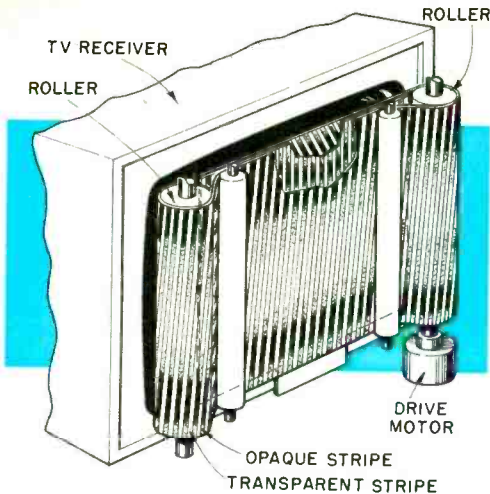

Fig. 2—Endless plastic belt consists of alternating transparent and opaque stripes. Stripes expose proper filter when color is transmitted at studio.

Today, it was said, the Canadians were going to attempt something similar. Except no big wheels. The mystery was how they got rid of the mechanical items.

It turns out that the electronics of this latest color adapter don't represent a breakthrough since the circuits are pretty well known. Like everyone else who has tried the trick, the Canadians take the broadcast color signal, which consists of red, blue and green signals sent out simultaneously, and convert to a repeating sequence. This allows the color signals to run single-file into the black-and-white picture tube.

At the same time, the correct color filter covers the screen to change the monochromatic white light to the right hue. For example, if the original scene contains a red apple, blue sky and a green plant, this information would appear in three successive frames. During the red frame, the screen would be dark except for the illuminated apple. A red portion of the color filter would now be in position across the face of the b&w tube.

During the next frame, only the blue signal modulates the picture tube as a blue filter appears and so on. The action repeats itself fast enough so the human eye sees only mixtures of primary colors.

The CBS color wheel and other electromechanical systems produced excellent color but they were doomed. A color wheel for large-screen sets must grow many feet in diameter to cover the screen. (Only a small segment of the wheel can sweep across the screen.) Furthermore, the setup is far too cumbersome for portable viewing.

When I was a young electronics hobbyist back in 1956, I built an electromechanical color converter. The electronics were easy to build and the completed circuit responded correctly. But, like CBS, I was bedeviled by mechanical monsters. Wheels, a motor, pulleys, spinning magnets and an outside color wheel were too much to cope with. The project soon melted into my junkbox.

That's why the Canadian inventor of this black-and-white-to-color converter, Frederick V. Topping, didn't even bother describ-

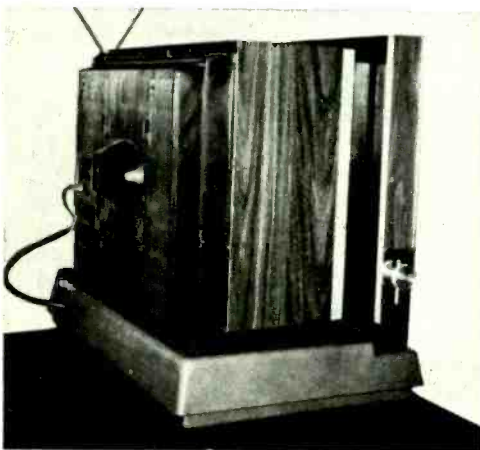

Rear view of b&w TV placed on adaptor chassis. Cable feeds 3.58-mc color signal and vertical sync pulses to color converter's demodulator circuits.



Head-on view shows mask in front of b&w picture tube. Two small knobs at lower right control color and hue—just as in a regular color TV.

TV's Wheel of Color Spins Again

ing his electronic device when he filed for a patent back in 1967. He and his associates were out to protect a far more important item—the special mask (substituted for a color wheel) that goes in front of the b&w screen.

The patent, granted in 1970, simply refers to a circuit that appeared in a series of Radio-Electronics magazine articles which showed the home experimenter how to convert TV to color with about \$50 worth of junk box parts. This circuit provides the basic electronics for Mr. Topping's present invention. His device, called Colortrak, utilizes a 16-transistor circuit similar in function to the 9-tube chassis described in the 1956 article. Let's see how it works.

The converter (see Fig. 1) taps a standard color signal received by any TV set (b&w or color). In a color receiver this signal is demodulated into simultaneous red, blue and green signal voltages. Since Topping's Colortrak adapter must create sequential signals his circuit operates somewhat differently.

The converter has an electronic switch (called a sequential trigger) which determines the color detected. In the red mode, the sequential trigger allows only red information to go to the screen. As explained earlier, a red color filter now blocks the screen so the viewer sees only red portions of the original scene.

When the electronic switch advances to the blue mode, the color demodulator detects the program's blue portion. Green is the last color voltage processed, then the trigger automatically advances back to red again. The

DIAMOND SHAPED OPENINGS FORM & APPEAR TO MOVE DOWNWARD

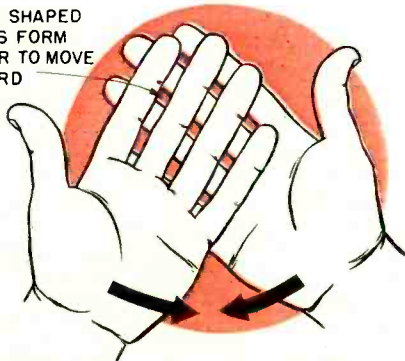

Fig. 3—Scanning pattern on endless belt can be demonstrated by moving hands in direction of arrows. Diamond shapes appear to move downward.

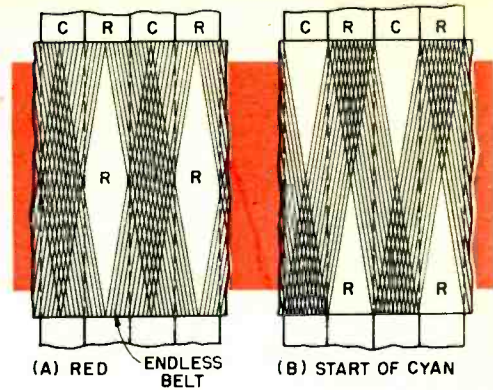

Fig. 4—Color filters (cyan and red) are exposed in repeating sequence as opaque and transparent stripes intersect to form diamond openings.

switch operates at 60 times per second to generate three consecutive color frames every 1/20th second.

During the demonstration in Montreal the first thing I looked for was color registration. Did all colors faithfully follow the outlines of objects (and people) on the scene? I'd seen fake filters pasted on TV screens before and they can fool you into believing they move. A few minutes' study of the faces proved there was genuine registration.

During the demonstration, the head of the investment company backing Topping pointed out the natural flesh tones. He adjusted color and tint controls (just like those on a regular set) to prove his point. Another benefit I noticed was a complete absence of misconvergence. In regular color TVs this causes color fringing around objects. Hues in the Topping system were soft and low-key.

Should Sarnoff and Sony cash in their chips—perhaps roast the peacock? Not yet. The new system would pale in any side-by-side comparison with today's considerably brighter tri-color kinescopes. It would be like comparing an over-exposed color photo with a color slide.

Topping's system, for example, cannot achieve the complete color saturation possible in a conventional color CRT. Also, his special belt and filter mask, as we'll soon see, reduce picture brightness. As I watched the demo, I had an uncertain feeling that a few tints might be missing. Later on, I learned I was watching a shrewd two-color system.

As good as Topping's system is, another deficiency appeared as a shimmering effect

[Continued on page 98]

The Ham Shack

By Wayne Green
W2NSD/1



FM Peaks in '70s

WITH the start of a new year, perhaps it's appropriate to ponder the past and take a stab at predicting the future.

Several factors have hindered the growth of amateur radio for some years. The change to sideband virtually stopped the influx of amateurs from the shortwave-listening route while the frustrations coming from CB traffic turned off a lot more potential amateurs. Most of all, the virtual absence of any planned promotion of the hobby by its controlling club has kept it a secret from teenagers—the largest potential group of newcomers.

Still, the rapid growth of 2-meter FM and the low cost of much FM equipment has done a lot to bring new amateurs into the hobby despite the lack of PR. There are few areas in the U.S. where even the simplest of handheld transceivers can't be used with repeaters for extended-range contacts. Many of the more-sophisticated rigs—such as the scanning-type transceiver—sell for under \$350. Some are available for around \$200.

While the Japanese are forging ahead, they will have their hands full keeping up with us. I've seen a prototype 220-mc transceiver manufactured in the U.S. which may be on the market in early 1972. It is supposed to sell for about \$180. This is not a compromise or cheapie job, either, but a product of the latest IC techniques.

The introduction of a scanning-type transceiver in late 1971 by Regency is typical of U.S. moves to stay ahead. This one scans eight 2-meter FM channels constantly, stopping when any one becomes active.

The proliferation of FM repeaters has made such a receiver a must item for the amateur who wants to keep up with local activity. Rest assured, things will move when American engineers start building in some new solid-state circuitry, such as the phase-locked loop IC. Such a device could give us an IF system on a chip as good as, or better, than the three-stage models of today. Also, this integrated circuit could make frequency-synthesizer techniques practical—and even less expensive than using two or three crystals.

After talking with some of the fellows who are working on the amateur-radio satellite program, it wouldn't surprise me to see space-minded hams change their ways and exchange broad-band repeaters for individual-channel repeaters—just like those being used for FM communications right now. A few of these satellites flying around above would, I suspect, transform the flood of newcomers into FM communications into a stampede. Imagine being able to contact most any amateur in the U.S. with a simple portable transceiver!

If the satellite builders were to start thinking in terms of a network of three repeating satellite stations spaced around the world and operating on, say, 1250 mc it is feasible that any amateur in the world might be able to contact any other amateur with just a small portable. There are enough channels in that portion of the spectrum to make this practical.

One such repeater could get pretty crowded, of course, but there is no reason why you can't put 500 or more repeaters into orbit. The 1250-mc band can handle 800 *up* and 800 *down* channels. Perhaps you would like a bit more than that? So how about 1,600 *up* channels on 1250 mc and 1,600 *down* channels on 2300 mc? No strain with the solid-state technology we have today.

If international contacts are restricted to one set of repeaters and domestic contacts to another—say on 146, 220 or 450 mc—then there should be enough channels to handle several times the present world population of amateurs. With an attraction like that, it seems likely we just might have several times today's ham population in the near future.

The '70s seem to be a period when it is possible to question the established way of doing things. For instance, there is a growing chorus of radio buffs demanding to know just what is so sacred about Morse Code. Code, they say—and I agree—has become irrelevant for most amateurs and has practically disappeared from the military and commercial bands. Even during emergencies, traffic is handled almost totally by phone.

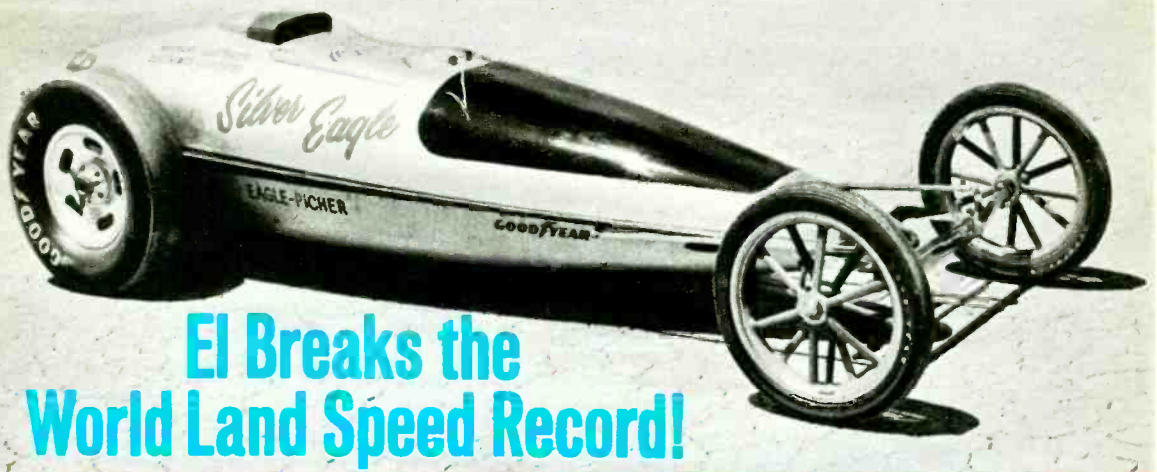

El Breaks the World Land Speed Record!

THE world Land Speed Record for electric cars finally is ours! Late last summer the Silver Eagle, a battery-powered racer of which Electronics Illustrated was a co-sponsor, set a new record of 146.437 mph for the flying mile on the Bonneville Salt Flats in Utah.

The Silver Eagle had its origins in a tiny electric car built as a project for our companion publication, *Mechanix Illustrated*, in 1967. The rig turned out to be unsuitable as a build-it-yourself electric car (so far, no one has designed a successful homebuilt electric) and was put on the shelf. Then in 1968 the Autolite Division of the Ford Motor Co. established a new world record for the mile at Bonneville with its Lead Wedge, operated by lead-acid batteries. The mark was 138.862 mph.

At that point MI and EI, in co-operation with Eagle-Picher Industries of Joplin, Mo., set about to redesign the old MI car and give it enough muscle for a go at the record. Needless to say, the first design turned out to be impractical and at least two other designs were discarded before the successful one was arrived at.

Two other companies—competitors—were involved in the project. In the fall of 1970 we took the Silver Eagle to Bonneville and tried for the world mark—running on Firestone tires. In 1971 our successful runs were made on Goodyear tires. The switching

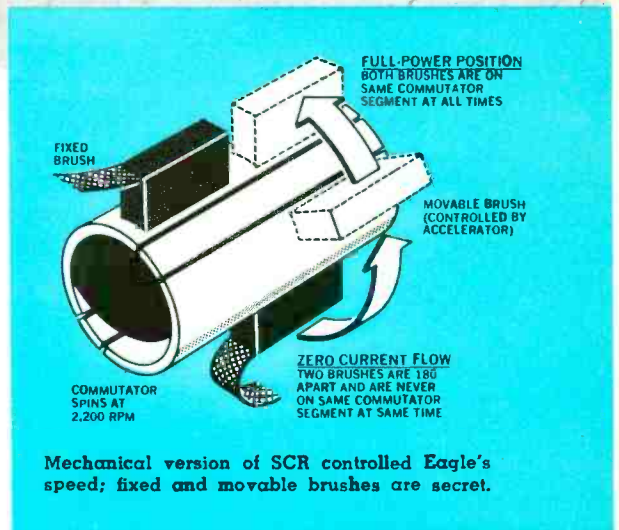

Mechanical version of SCR controlled Eagle's speed; fixed and movable brushes are secret.

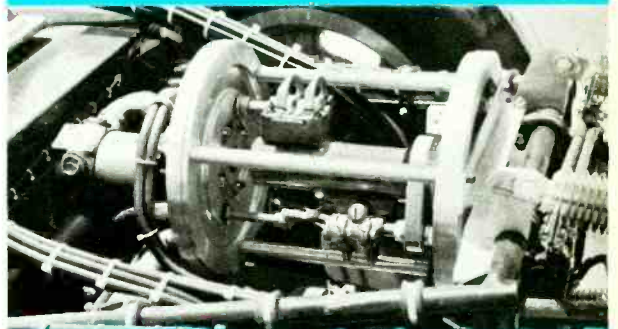

Side view of speed control, which is wired in parallel with resistors in photo at the right. Resistors limit current draw when motor starts.

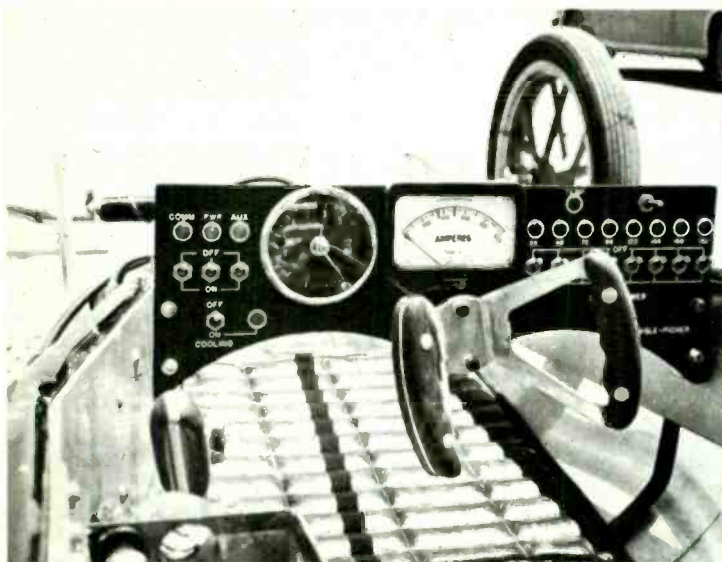

Control panel of Silver Eagle sits in front of butterfly steering wheel. The buttons on the right are used to switch in banks of batteries among the 180 cells. The cells were split into 8 banks. Main power and blower switches are at the left. Tachometer and ammeter round out the panel.

of tires was not a factor in whether we succeeded or failed, so far as we know. It was a matter of availability and convenience.

Last July we brought you a report about that first visit to Bonneville—and our failure. The two propulsion motors, being spun by exotic silver-zinc batteries, simply were unable to take all the electrical energy available and convert it to mechanical force to drive the car. The result was warm and then hot motors . . . and they burned out.

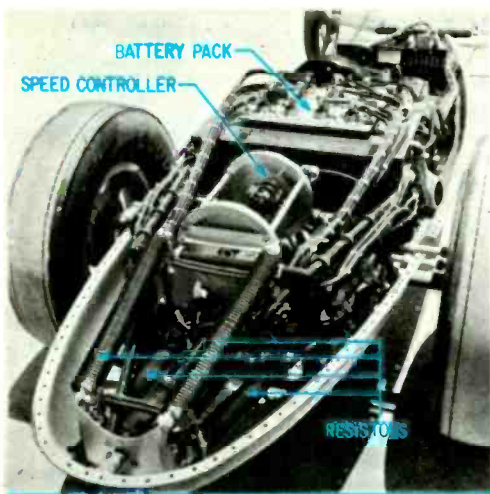

General layout of Eagle with top of body off. Current-limiting resistors totalled .0625 ohms.

Over the winter much of the car was re-designed. In the successful runs in 1971, the car still used the Apollo-bred silver-zinc batteries (180 cells of 1.25 V each) but there was a single new drive motor. It is a 120-VDC model built by GE and designed originally to run in the first MIT Clean Air Car Race. It is rated at 25 hp at 5,000 rpm and can put out as much as 80 hp for short periods. In this instance, it was able to make the electrical/mechanical conversion.

The motor's muscle was not the only secret in the Eagle's success, however. A kind of mechanical silicon controlled rectifier—or a mechanical version of an SCR—played a key role in controlling the amount of energy flowing to the motor in such a way that maximum speed was obtained after the motor was nursed through its lower rpm range.

The world Land Speed Record was by far the most important of the marks established by the Silver Eagle but by no means the only one. As a matter of fact, in three days at the Salt, no less than 20 other records in two weight classes (under 500 kilograms and over 500 kg) were set by our bird.

The Silver Eagle was driven on its record runs by Californian Jack Reed. The first record run through the timed mile established a new one-way mark of 152.355 mph. The return run over the bumpy end of the Bonneville course, which was in pretty bad shape at the time, was clocked at 140.955 mph. The record is based on total elapsed time, not an average of the two runs.



How to prepare for today's competitive job market, tomorrow's new opportunities in electronics

Competition for jobs and promotions is severe in the electronics industry today. But experts say that exciting new electronic products will create thousands of new jobs in the next few years.

One thing is certain: in good times or bad, the best opportunities come to the man with an advanced, specialized knowledge of electronics. He has a better chance of survival in a recession and will profit more in times of prosperity than the man with ordinary qualifications.

But how can you get the additional education in electronics you need to protect your future—and the future of your family? Going back to school isn't easy for a man with a job and family obligations.



College Credits for CREI Students

Recently CREI affiliated with the New York Institute of Technology for the express purpose of making it possible for CREI students to earn college credits for their studies. The New York Institute of Technology is fully accredited by the Middle States Association of Colleges and Universities and is chartered by the

FREE BOOK

tells all about
CREI Programs
SEND FOR IT
TODAY!



MAIL TODAY—NO POSTAGE REQUIRED

Founded 1927

CREI

Accredited Member of the National Home Study Council

**CREI, A Division of the McGraw-Hill
Continuing Education Company**

Dept. E1701C, Wisconsin Ave. at Tilden St.
Washington, D.C. 20016

Please mail me FREE book describing CREI Programs. I am employed in electronics and have a high school education.

Name _____

Age _____

Address _____

City _____

State _____ Zip _____ G.I. Bill

Employed by _____

Type of present work _____

Approved for training under new G.I. Bill
I am interested in:

- College Credit for CREI Study
- Space Electronics Computers
- Electronic Engineering Technology
- Nuclear Engineering Technology
- Industrial Electronics
- Electronics Systems Engineering
- Non-Technical Course
in Computer Programming

*In-depth
coverage of
SOLID-STATE
electronics
including
integrated circuits!*

SEND FOR FREE BOOK TODAY!

C

EI's 1971 Index

C—Construction Project

F—Feature Article

Name following title is author

Page number follows the date

AMATEUR RADIO

Antennas:

All-Band Whip for Your Car, An	Lumachi	(C)	Jan.	...63
Antenna for Boats, Low-Cost, High-Performance Ham Antenna with Remote Switching, Five-Band	Lumachi	(C)	July	...74
Skyhigh Skyhook	Lumachi	(C)	Sept.	...92
2-Meter Beam for 2 Bucks	White	(C)	May	...78
Budget Television for Hams, SSTV	Green,	(C)	Nov.	...92
Harmonic Killer for Hams	Wayne	(F)	July	...78
Kingly QSO, A	Kolbe	(F)	May	...60
Station Switchbox, Ham Transmitter for 40 & 80, Solid-State Ham	Margolis, Sylvia	(F)	Sept.	...84
Tropic of Cancer Award for Ham & SWLs	Green, Charles	(C)	Mar.	...84
	Charles	(C)	Jan.	...25
		(F)	Jan.	...45

AUDIO, STEREO & HI-FI

Audio Cassettes, EI Evaluates the new	Angus	(F)	Nov.	...68
Audio Generators, Control Center for	Friedman	(C)	Nov.	...44
Audio Servicing, Basic Equipment for	Friedman	(F)	Mar.	...38
Four-Channel, Big Noise in Level Control & Monitor, Performer's	Angus	(F)	Nov.	...58
Meter, Direct Reading Power	Ritchie	(C)	Sept.	...38
Mr. Dolby's Wonderful System	Ritchie	(C)	Nov.	...63
Rapping With Ray Dolby	Buckwalter	(F)	May	...41
Stereo Amplifiers, How to Service	Margolis, Sylvia	(F)	May	...39
Stereo Headphones, How to Give a Space Dimension to	Ritchie	(F)	May	...46
	Kolbe	(C)	Jan.	...92
Speakers:				
Slightly Stupendous Speaker System, A		(F)	Jan.	...86
Speakers for All Budgets, Super-Mod	Kolbe	(C)	Nov.	...49
Two Channels Into Four, Making		(F)	May	...48

CITIZENS BAND

All-Band Whip for your Car, An	Lumachi	(C)	Jan.	...63
CeeBeeper, The	Powell	(C)	Mar.	...59
CBing the USA	Kane	(F)	May	...63
CB Phone Patch	Friedman	(C)	Jan.	...56
CB Repeater	Daniels	(C)	Sept.	...80
CB Rigs, Quick Cure for Ailing	Kneitel	(F)	July	...48
Code Free Hobby Band, A? Build a	Green, Wayne & Kenitel, Tom	(F)	May	...72
Sideband Adaptor for CB, Build a	Daniels	(C)	Nov.	...76
Monitor, Channel 9	Green, Charles	(C)	May	...67

KIT REPORTS

Color Organ, Four-Channel (Eico 3450)			May	...85
Color TVs, Two Solid-State (Heathkit GR-370 & GR-169)			July	...67
Depthometer, Fish-Finding (Heathkit MI-29)			May	...32
Metal Locator, Semi-Pro (Heathkit GD-48)			Nov.	...38
Speaker System, A Slightly Stupendous (Acoustron LWE IV)			Jan.	...86
Stereo Receiver, Better Than First Rate (Allied-Radio Shack RK-100 Amplifier and RK-101 Tuner)			Sept.	...64
2 Channels Into 4, Making (Eicocraft EC-4700, Dynaco QD-1 and Eico QA-4)			Nov.	...48

SERVICING

Audio Servicing, Basic Equipment for	Friedman	(F)	Mar.	...38
Color Picture, Getting an Unbelievably Good	Margolis, Art	(F)	Sept.	...65
Color Picture Tube, How To Change a		(F)	Jan.	...38
Picture Tube, How to Stretch the Life of a	Margolis, Art	(F)	Mar.	...65
Signal Generator, How to Turn a Junked TV into a	Margolis, Art	(F)	July	...39
Servicing Stereo Amplifiers: Part I: Stereo Amplifiers, How to Service	Ritchie	(F)	May	...46
Part II: Preamps and Transistor Substitution	Ritchie	(F)	July	...82
TV Service Shop, On Opening your own	Margolis, Art	(F)	May	...81

SHORT-WAVE LISTENING

BCB DX, Basic Guide to Big Booster for the BCB DX Letter from Britain	Levesque	(F)	May	...57
	Friedman	(C)	Mar.	...77
	Margolis, Sylvia	(F)	Mar.	...93
DXing:				
Asian Islands, DXing the Bit of Broadcast History, DXing a	Bower	(F)	July	...56
Dual Frequency Standard for SWLs	Bower	(F)	Sept.	...56
Fuzz Flies to UHF, The Radio Euzkadi Mystery—Solved!	Benrey	(C)	Sept.	...61
	Kneitel	(F)	July	...64
Tropic of Cancer Awards for SWLs and Hams	Jensen	(F)	Mar.	...74
Win our New DX Award, How to	Jensen	(F)	Jan.	...45
	Stanbury	(F)	Mar.	...50

SPECIAL CONSTRUCTION PROJECTS

Antenna for Boats, Low-Cost High-Performance	Lumachi		July	...74
Battery Tester, Universal	Benrey		Jan.	...31
Color Organ, Turn On with a High-Power	Benrey		July	...59
Inverse Burglar Alarm, An Organ Tones to Your Piano, Our Synovox Adds	Ritchie		Mar.	...62
SCA Adaptor, For Soothing Music Around the Clock, Build an	Maynard		Jan.	...74
Sound-Meter You can Build, A Direct-Reading	Green, Charles		May	...27
Sub-Batt, Build a	Henry		Mar.	...27
Tightwad Tach for Tough Tune-Ups	Newmire		Sept.	...51
	Daniels		May	...90

SPECIAL FEATURE ARTICLES

Buyer in Electronics, On being a	Schell		Mar.	...81
Circuit Nobody Understands, The	Keyloun		Sept.	...29

EI's 1971 Index

Big Franchising Deal In Electronics	Belt	Jan.82
Ivan the Terrible, The Strange Saga of	Jensen	Nov.29
Mr. Dolby's Wonderful System	Buckwalter	May41
Rapping With Ray Dolby	Margolis, Sylvia	May39
The Video Gramophone—Coming?	Buckwalter	Jan.66

THEORY & PRACTICE

What Arecibo has told us	Freed	Jan.41
Can You Learn Electronics from Educational Kits?	Daniels	Mar.42
Counters are coming, The	Powell	Sept.75
Insulation with the Shrinks	Lumachi	Mar.46
Semiconductors, Update on	Benrey	Nov.81
Thou Watt 99 Band		
Streamline Mobcom Baby	Wren	July87
World Land Speed Record		
We go for a		July44

DXing Northern Neighbors

Continued from page 81

listeners with local QRM on 540 kc, CKCK on 620 kc. at Regina looks promising.

When the ANIK communications satellites are launched in 1972, the Yukon will be fed Toronto and Montreal programming from a powerful earth station at Shirley Bay (near Ottawa) for retransmission to cable systems in arctic communities. For the past year, CATV systems have been rapidly multiplying in Southern Ontario and Quebec and will be hooked into the satellite.

Only one far-north community, Frobisher Bay in the Northwest Territories, has a broadcast station that has much chance of being heard in parts of North America, CFFB operates on 1200 kc and, as the sunspot count drops, chances of hearing it will improve. CFFB aired a special after-midnight DX test in 1970 but prospects were spoiled by a harmonic of CFCF (600 kc, Montreal) appearing on the channel.

Your best bet for logging either the Northwest Territories or Yukon is via aircraft passing over them on the transpolar route. Optimum frequencies are 8910 kc and 8938 kc where you'll also find Resolute Bay Aeradio. This frigid community is also destined to have a satellite link. At this end of Ottawa's space empire, CFCF operates its well-publicized 49-meter outlet. CFCX on 6005 kc, while CBF on 690 kc, is widely received. From Toronto, CBC's English language CBL (740 kc) and French CJBC (860 kc) are also commonly heard.

Now, Find the Circuit You Need—in Minutes!



ALL NEW!

Over 3,000 advanced electronic circuits in one master volume. Locate any application in minutes. Beats any computer retrieval system now in existence—for speed, variety and range of circuits offered.

JUST OFF PRESS!

Electronic Circuits Manual

by John Markus

Over 950 pp., 8½"x11", \$19.75
More Than 3,000 Illustrations

For hobbyists . . . experimenters . . . engineers . . . technicians. Includes all latest developments in solid-state components . . . integrated circuitry . . . electronic tube designs. First use pays for book many times over.

115 new operational amplifier circuits . . . 93 motor control circuits . . . 39 lamp dimmer circuits . . . 56 automotive circuits . . . 23 optoelectronic circuits . . . 64 counter circuits—and over 2,000 more!

Special Features

- 99 chapters group similar circuits for easy comparison
- Complete data on all component values
- Concise descriptions of significant circuit features, performance and operating data, and source citations
- Circuits arranged for quick, accurate evaluation of advantages and drawbacks
- Many outstanding designs from other countries

Partial Contents: Audio Control Circuits . . . Automotive Control & Ignition Circuits . . . Code Circuits . . . Flasher Circuits . . . Hobby Circuits . . . High-voltage Circuits . . . Lamp Control & Dimmer Circuits . . . Metal Detector Circuits . . . Power Supply Protection Circuits . . . Tachometer Circuits . . . Telephone Circuits . . . and many, many more!

10-Day Free Trial-Order Today!

McGraw-Hill Book Company

330 W. 42nd St., N.Y., N.Y. 10036

Please send me *Electronic Circuits Manual* (040444-5) for 10 days on approval. At the end of that time I will remit \$19.75 plus local tax, postage, and handling or return the book and owe nothing. (This order subject to acceptance by McGraw-Hill.)

Name

Address

City

State Zip

Offer good only in the U.S. 23-EI 172

CIRCLE NUMBER 7 ON PAGE 11

Hear your police and firemen in action!

Listen on these channels, too...



WEATHER
TRAFFIC
UTILITY
BUSINESS
MARINE
CIVIL DEFENSE

WITH ALL-NEW **Bearcat III**

The Only Monitor Receiver You'll Ever Need

Meets present and future needs in any locality. Scans 1 to 8 FM emergency and business channels you select, in any 1 or 2 bands—low, high, UHF. Stops for any transmission, then resumes search. Plug-in interchangeable RF module for each band. Built-in front speaker. Complete band coverage. Comes with one or two RF modules, mobile mount and cords for AC and DC. American built by Electra, originator of the scanning receiver. At better dealers.

\$139.95 WITH RF MODULE FOR ANY 1 BAND

\$159.95 WITH RF MODULES FOR ANY 2 BANDS

Plus plug-in crystals at \$5 each. Additional modules \$20 each.

Electra CORPORATION
CUMBERLAND, INDIANA 46229
CIRCLE NUMBER 5 ON PAGE 11

From the creator of Matt Helm

THE TWO-SHOOT GUN BY DONALD HAMILTON

A taut, violent
novel of an
unforgettable era
in America's past.



Original title:
**THE MAN FROM
SANTA CLARA**

R2492 • 60¢

**FAWCETT
GOLD MEDAL**

Buy this Gold Medal Book from your paperback book-seller. If he is sold out, send only price of book plus 15¢ for postage and handling to Gold Medal Books, Fawcett World Library, Greenwich, Connecticut 06830. Please order by number and title. No Canadian orders.

CB Corner

Continued from page 83

communications and reduce skip.

It's based on one of CB's greatest, but least used, technical resources; the ability to operate on nearly two dozen different channels. Citing experience in the telephone field, the researchers talk about "trunking" CB channels. It is ingeniously simple and should have been implemented long ago. I'll talk more about this in my next column.

Medical Thermometer

Continued from page 31

After you've soldered the cable to Q1's leads, coat the transistor, its leads, and about 1/2-in. of the cable leading away from Q1 with silicone rubber compound. Slip the heat-shrinkable tubing over the transistor and cable and heat the tubing before the rubber cures. Wipe off any excess silicone rubber material and let the probe dry overnight.

Although these probe materials are non-toxic and harmless we recommend that, for sanitary reasons, you obtain thin, throw away plastic covers for your probe.

Checkout and Calibration. After double checking your wiring, set both the *balance* and *calibrate* pots to their midpoint positions. Temporarily connect a jumper lead between pin 6 and pin 3 of the IC. Connect a milliammeter in series with the battery and turn S1 on. Current should be between 9 and 11 ma. Now adjust *balance* potentiometer to zero-set the meter needle. Remove the jumper and plug in the probe.

Heat the probe's sensor to a known temperature corresponding to the lowest one on the meter scale. On our instrument this is 96°F. To obtain this temperature, we heated a large pan of water on the kitchen stove. The water temperature was monitored with a mercury-type laboratory thermometer. You can maintain water temperature at 96°F by turning the stove on and off.

Adjust the *trim* pot until the meter indicates 96°F. Carefully watch the reference thermometer as you raise the water temperature to full scale, or 106°F. Wait long enough to be sure the temperature has stabilized and adjust the *calibrate* pot until the

meter indicator corresponds to that of the reference thermometer.

If you build more than one probe, adjust them by dunking all probes simultaneously into the pan of water. Now adjust the reading of each probe to coincide with the lab thermometer's reading.

Videocassettes—Where Are We?

Continued from page 35

ming you'll only get via a videocassette.

Aside from the idealists who have dreams of saturating American households with Bach, ballet and opera, and the cynics who plan more exotic and erotic fare for special tastes, many constructive ideas are being formulated by people in institutions and industry. Thus, you may see operating manuals, instruction booklets, training manuals, etc. replaced by videocassettes.

When videocassettes are available and equipment standards have been established, the consumer is going to have some exciting choices. He can tape his own programs and then play the cassette back on his color TV. He can go to a dealer and purchase cassettes for either entertainment or utilitarian purposes. He may be able to go to a desk at the local library and take home cassettes for study. Finally, he'll be able to order a cassette from a number of manufacturers—it may be a feature film, a sporting event or an old TV program—use it for a couple of weeks and then return it to be erased and programmed with something else—all this for a fee of \$5 or so.

The potential is there. Once the publicity orgy is forgotten, along with the broken promises and the unrealistic expectations, a more mature industry will settle down to provide enjoyable entertainment—and we hope—at a realistic price.

Multipath Scope For Stereo FM

Continued from page 47

- 8) Tune for interstation noise between stations or tune to a clear spot on the FM dial.
- 9) Adjust pot R22 so that the trace is positioned on the graticule's lowest horizontal scale line.
- 10) Tune to the strongest station in your area. Adjust pot R15 until the trace is positioned one division short of the top ver-

ANOTHER SUPERB VALUE from **Olson** Electronics



ONLY
\$200
DELUXE
CLOSED CIRCUIT
TV CAMERA

Nothing keeps your family or business as safe as closed circuit TV. Now it's priced to fit every budget. Easily connects in minutes to any TV set so that you can see what's happening. Complete with nothing else to buy.

Olson Electronics, Dept. D1, 260 S. Forge St.,
Akron, Ohio 44308

- I enclose \$200, plus \$1 for postage and handling. Send me the TV-132 Closed Circuit TV Camera.
- Send me the next seven issues of the Olson Catalog, without cost or obligation. **FREE**

Name _____
Address _____
City _____
State _____ Zip _____

CIRCLE NUMBER 9 ON PAGE 11

CALL ME!



24 HOURS A DAY... 7 DAYS A WEEK

I'll send you 2 FREE BOOKS describing career opportunities in Electronics. Call me TOLL FREE: **800-321-2155**
(in Ohio, call 800-362-2105)

For details about the famous CIE home-study courses in Electronics, see our ad on page 36-39
Cleveland Institute of Electronics
1776 East 17th Street, Cleveland, Ohio 44114

tical line on the graticule. If you cannot make this adjustment properly, unsolder the RF module and reconnect it to the IF amplifier's stage preceding the one you originally soldered the module to.

11) If you had to reconnect the RF module, repeat the adjustment procedure for the RF detector module. Whether you had to resolder the RF module to a preceding IF amplifier stage or not, it may be necessary to repeat steps 9 and 10 several times.

TV's Wheel Of Color Spins Again

Continued from page 86

in the picture. This apparently is caused by incomplete synchronization somewhere in the circuitry. Despite these limitations, Topping did manage to eliminate color TV's spinning wheel. Here's how his version works.

As shown in Fig. 2, an endless belt is supported between two rollers and motor-driven across the screen. Because of the belt's special construction, it creates a series of transparent openings that appear to sweep down across the screen.

You can easily demonstrate the idea to yourself by holding your fingers as shown in Fig. 2 and sliding your hands together horizontally. You'll see diamond-shaped openings moving downward.

The endless belt (Fig. 2) creates this same effect via alternating stripes of clear and opaque plastic which move across the screen.

These stripes slope slightly (as did your fingers in the demonstration) to produce the pattern shown in Fig. 4. Numerous diamond-shaped intersections form as the eye looks through the front and rear surfaces of the belt.

Also shown in Fig. 4 are the color filters placed behind the belt. They alternate between cyan (C), a bluish-green color, and red (R). As the belt moves, transparent diamonds flash down the screen to expose the red vertical stripes.

At this instant, the electronic circuits in the adapter apply only red information to the black-and-white tube. The viewer sees the red portion through the red stripes for 1/30th of a second. Then the belt advances and new intersections expose the cyan stripes. This combination of blue and green now appears on the picture tube and the persistence of your eye's vision blends the stripes and sees mixtures of color.

Unlike the original electromechanical color disks which revolved at about 600 rpm, the endless belt's speed is snail-like by comparison. It crawls at a rate of about 1.3 ips. The system's high scanning speed is achieved by both the narrowness of the belt's stripes (.022 in.) and the illusion of those diamond openings flying down the screen.

Topping and his colleagues in Canada, at the time of this writing, are still deciding how to market the invention. Despite lack of exposure in the press, they've already received queries from television set manufacturers all over the world. If the converter

NEW! CB Transceiver SOLID STATE Pre-Amp

INTERCHANGEABLE 12VDC & 117VAC



- For mobile or base stations
- Improves receiver performance
- Works on tube or transistor equipment
- No modification to CB unit — Also works on SSB
- ON-THE-AIR sign automatically lights when transmitting

Model PCBU with universal built-in power supply, transfer relay, AC & DC connecting cables, domestic manufacture, wired & tested.

Write for free literature to —

GONSET/Division of AEROTRON, INCORPORATED
P.O. Box 6527 • Raleigh • North Carolina 27608

CIRCLE NUMBER 19 ON PAGE 11

goes into b&w sets coming off the assembly line, it could benefit from the addition of a three-color belt. As little as \$50 would be added to the TV's price tag.

The cost to add the converter to an existing b&w set is estimated at less than \$100. Installation can be performed by either a serviceman or home user. Since Colortrak requires only the insertion of a plug between the b&w TV's CRT neck and tube socket, the job can be done in about 15 minutes.

Topping's adapter is compatible with any existing b&w TV set sold in the U.S., Canada, or anywhere else, for that matter. When the Canadians produce a commercial model with bright, stable pictures, they could have a huge market waiting for them.

ABCs Of Single Sideband For CBers

Continued from page 62

Getting rid of the unwanted carrier at the transmitter is done by passing it through a balanced modulator. Fig. 5 shows how this device splits the carrier into two equal components, each 180 degrees out of phase with the other. The balanced modulator is like a push-pull amplifier. While the carrier cancels itself in the balanced modulator, the two sidebands pass through.

There are two methods of eliminating the unwanted sideband—the phasing system and the filter system. In the former, one of the sidebands self-destructs—via an elaboration of the phase-splitting technique used to get rid of the carrier. In the more popular filter system shown in Fig. 6, the double sideband signal is passed through a steep-skirted crystal or mechanical filter that allows one sideband to pass but rejects the other. This technique is often augmented by passing the received signal through a similar filter shown in Fig. 7 in the receiver. Provision is usually made for transmitting either the upper or lower sideband.

It doesn't matter which sideband you transmit on. If you find that the upper sideband on, say, Channel 13 is busy, flip the sideband-select switch to the lower sideband position and start talking. Similarly, the SSB receiver can be set to receive either sideband. This represents yet another advantage of SSB to the CBer. You've got 46 channels—not just 23—to work with.

FREE!

LAFAYETTE 1972 Catalog

468 Pages
Our 51st Year



Stereo Hi-Fi ■ Citizens Bands
■ Ham Gear ■ Tape Recorders
■ Test Equipment ■ TV and Radio Tubes and Parts
■ Cameras ■ Auto Accessories
■ Musical Instruments
■ Tools ■ Books

Your Complete Buying Guide
to Everything in Electronics

Lafayette Radio Electronics
Dept 29012, P.O. Box 10
Syosset, L.I., N.Y. 11791

Send me my FREE Catalog

29012

Name _____
Address _____
City _____
State _____ Zip _____

CIRCLE NUMBER 8 ON PAGE 11

Have your own Radio Station!

Learn AMATEUR RADIO



AT HOME IN YOUR SPARE TIME

Get your Amateur Radio license and "go on the air." NRI, leader in Electronics home training for more than 50 years, offers a choice of training plans leading to required FCC licenses, ranging from Basic Amateur Radio for the beginner to Advanced Amateur Radio for the ham who already has a license and wants to move up.

HAM RADIO EQUIPMENT INCLUDED

NRI's beginner's course includes your own Novice Class 25-watt transmitter, 3-band receiver and transistorized code practice oscillator with code key and headset. You learn code using special LP records. Choose from 3 Amateur Radio courses. Low tuition. Monthly payment plans. Get all the facts. Mail coupon. No salesman will call. NATIONAL RADIO INSTITUTE, Washington, D.C. 20016.



.....MAIL COUPON TODAY.....

• NATIONAL RADIO INSTITUTE 53-012
• Washington, D.C. 20016

• Please send me information on Amateur Radio training.

• Name _____ Age _____

• Address _____

• City _____ State _____ Zip _____

• ACCREDITED MEMBER NATIONAL HOME STUDY COUNCIL

Put it to Work!

NEW AND ONLY FROM EICO—THE INDUSTRY'S LOWEST-PRICED PROFESSIONAL FEETVM.

Model 239
\$39.95
KIT



Use the battery powered Solid State EICO 239 on your bench or in the field. Check semiconductor and vacuum tube circuits. 11 Megohm DC input impedance. Read AC rms and DC voltages in seven steps from 1 to 1000 volts on large 4 1/2" meter. Measure and read peak-to-peak AC to 2800 volts. Check resistance from 0.2Ω to 1000MΩ on seven ranges. Provides a total of 28 useful ranges on 12 accurate scales. Automatic battery check. Includes exclusive DC/AC ohms Uniprobe™. Factory Assembled, \$59.95.

FREE 32 PAGE EICO CATALOG

For latest catalog on EICO Test Instruments, Stereo, EICOCRAFT Projects, Environmental Lighting, Burglar/Fire Alarm Systems, and name of nearest EICO Distributor, check Reader Service Card.

EICO, 283 Malta Street, Brooklyn, N.Y. 11207



CIRCLE NUMBER 6 ON PAGE 11

AMAZING NEW TELEPHONE



STARTS RECORDER AS SOON AS PHONE IS LIFTED!

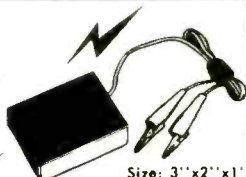

Size: 3" x 2" x 1"

RECORDER SWITCH!

AUTOMATICALLY STARTS YOUR RECORDER WHEN TELEPHONE IS PICKED UP . . . RECORDS ENTIRE CONVERSATION . . . THEN AUTOMATICALLY STOPS RECORDER WHEN TELEPHONE IS PUT DOWN!

If you want to record BOTH sides of any telephone conversation automatically whenever a call comes in, this unit is for you!

This amazing unit plugs into ANY cassette or reel to reel recorder and causes absolutely no interference or noise on telephone!

Extremely useful around the HOME or OFFICE for making ACCURATE and PERMANENT record of all incoming and outgoing calls!

NOW ONLY

NOTE: federal law requires that at least one party to the conversation be aware that it is being recorded!

\$19.95

Complete

ORDER TODAY! 10 DAY FREE TRIAL!

If you're not completely satisfied, simply return unit for a full and prompt refund! NO QUESTIONS ASKED!

SEND ONLY \$3.00 and pay postman \$16.95 plus c.o.d. fee or send \$19.95 in full and we pay postage.

SONIC DEVICES, Dept. 52, 69-29 Queens Blvd., N.Y.C. 11377

CIRCLE NUMBER 21 ON PAGE 11

The Listener

Continued from page 48

If you don't care to DX the hard way and log the transmitter sites in the Canal Zone or Puerto Rico (let alone Greenland), you might find it interesting to keep tabs on the kinds of programs distributed to these stations via SW. Frequencies to watch are 15330 kc (afternoons) and 17765 kc (evenings).

Propagation Forecast. The 21-mc band will continue to hold up for daytime DX from all parts of the world. The amateur 10-meter band will still be open into Africa and Latin America during the morning hours—from local sunrise to about noon. There will be few openings between the United States and Europe in this band.

During nighttime hours, the 6-, 7- and 9-mc bands will be best for European DX, while the 9-, 11- and 15-mc bands will be best for Latin American and African DX.

Transpacific DX will be best in the 17- and 21-mc bands around local sunset and in the 9- and 11-mc bands at local sunrise. BCX DX will still be good due to low winter noise levels in the northern hemisphere.

Multi-Purpose Bench Power-Supply

Continued from page 71

The meter specified in Parts List has a 0-1 ma. DC/1,000 ohms-per-volt movement. It mounts in a 1 1/2-in. dia. hole. Cut it out with a standard chassis punch. The meter scales of all versions of the power supply are linear. You can cement the scale shown in Fig. 4 over the meter scale specified if you're building the 17-V model.

The value of meter multiplier resistor R4 depends on which version of our supply you build. For the 17-V supply, R4's rating is 20,000 ohms. If you're building the 38-V model, change R4's value to 39,000 ohms.

Checkout and Operation. Apply power and measure the DC voltage across C1. The reading should be 1.4 times T1's applied rms secondary voltage. Now measure the voltage between BP1 and BP2. Look for approximately 3.5 VDC with R1 turned down (fully counterclockwise). Advance R1 until the output voltage increases to its maximum value which is about 3 V less than the voltage across C1. If the output voltage doesn't increase as R1 is advanced, check to see that R1 and R2 are not reversed, or that IC1's terminals 4 and 5 are not shorted.

A Trap Antenna For SWLs

Continued from page 65

to 32 and 22 ft., respectively. Tensilize each length by attaching one end of the wire to a gate or garage door and pulling firmly on the other end. This procedure will stretch and straighten out the copper. Now re-measure each length and cut off the excess. Allow about 4 in. on each end for twisting around the insulator.

Assembly. Lay out both 32-ft. lengths of wire and install a 6-in. porcelain insulator at the center. Measure the length of transmission line (50 or 75 ohm) needed to run from the antenna to your rig and install it at this point, as shown in Fig. 3. Connect the pretuned LC trap assembly in series with the 32- and 22-ft. lengths wire in each antenna leg.

At the end of each leg, mount a small strain insulator. Again, remeasure both legs carefully after rigging your antenna since electrical balance is important. When you've soldered all connections you're ready to connect the coax to your rig.

Final Installation. The antenna can be installed in almost any position. However, it should be at least 10 ft. off the ground at its center. See the schematics in Figs. 4, 5 and 6 for possible orientations.

The design has a moderate degree of directivity which can be used to advantage. Whichever configuration you choose (inverted-V, horizontal dipole, or inverted-L) the reception pattern is about the same. As the antenna ends move away from the horizontal (as the ends of each leg drop towards the earth) its impedance will fall. At worst, the antenna's impedance may drop a maximum of 10 to 15 ohms. Its bidirectional pattern will remain, however. Ultimately the antenna orientation selected will be dictated by the amount of available room.

You'll probably need a small compass, plus a dimestore globe or a map of your geographical area before you orient either dipole. Best signal pickup occurs when the antenna is mounted broadside to the radiation pattern of the station you want to hear.

For instance, SWLs interested in DXing North or South America should direct their antenna on an east-west line. Listeners interested in European transmissions should orient their skyhook elements north-to-south. DXers who wish to tune in both areas will have to compromise with a northeast or southwest installation. 

January, 1972

Convert
your stereo system
to 4-dimensional sound!
QUATRASONIC™ BY EICO

KIT \$17.95
WIRED \$29.95



Enjoy 4-dimensional sound hidden in standard stereo records, tapes and FM broadcasts.
Just add the QUATRASONIC™ adaptor and two speaker systems — No additional amplifiers required.

FREE 32 PAGE EICO CATALOG

For latest catalog on EICO Test Instruments, Stereo, EICOCRAFT Projects, Environmental Lighting, Burglar/Fire Alarm Systems, and name of nearest EICO Distributor, check Reader Service Card, EICO, 283 Malta Street, Brooklyn, N.Y. 11207

EICO®

CIRCLE NUMBER 6 ON PAGE 11

CALL ME!



24 HOURS A DAY... 7 DAYS A WEEK

I'll send you 2 FREE BOOKS describing career opportunities in Electronics. Call me TOLL FREE: **800-321-2155**
(in Ohio, call 800-362-2105)

For details about the famous CIE home-study courses in Electronics, see our ad on page 36-39

Cleveland Institute of Electronics
1776 East 17th Street, Cleveland, Ohio 44114

AT LAST! PROFESSIONAL HOME PROTECTION EVERYONE CAN INSTALL AND AFFORD.

Model FC-100
\$34.95
 WIRED



- Start your custom Burglar/Hold-up/Fire Alarm System with the FC-100. Add on Sensors, Alarms and Accessories to suit your own needs.
- "Do-it-Yourself" Installers Handbook Included. No technical knowledge needed — No soldering.
- 100% Professional in Design, Reliability, Performance.



'Fail Safe'-SYSTEM BY EICO

A New Concept in "Do-it-Yourself" Home Protection

FREE 32 PAGE EICO CATALOG

For latest catalog on EICO Test Instruments, Stereo, EICOCRAFT Projects, Environmental Lighting, Burglar/Fire Alarm Systems, and name of nearest EICO Distributor, check Reader Service Card or send 25c for First Class mail service.

EICO, 283 Malta Street, Brooklyn, N.Y. 11207



CIRCLE NUMBER 6 ON PAGE 11

AR guarantees its published specifications

At Acoustic Research we believe that the publication of complete performance data on our high fidelity components is obligatory. Otherwise, our guarantee would have little meaning.

Find out just what AR guarantees that its products will do. Mail the coupon below, and detailed technical literature will be sent to you free of charge.



Acoustic Research, Inc.
 24 Thorndike Street
 Cambridge, Mass. 02141
 Dept. E1-12

Please send measured performance data on AR products to

Name _____

Address _____

CIRCLE NUMBER 11 ON PAGE 11

A 3000 Year Old Ham Shack

Continued from page 51

do with Ma Bell's complaints about the use of their lines for third party communication. Stateside hams were doing a fair amount of phone patching during the first voyage. Baker recalls the second voyage: "We had to promise that there would be no personal messages. Of course there were, but we had to resort to childish subterfuges like asking Herb Morrison if everybody was plugged in the line which meant 'is my family there.'"

"Obviously we didn't have time to send out QSL cards during the voyage (even if it had been possible) and we did want to keep the channels open as much as possible for essential conversation. But we did work some 60 to 70 stations during the trip," Baker continues. "Then, when we arrived in Barbados, amateurs in Bridgetown took over the transmitter for 48 hours and continued working the wavebands." During that period, they logged another 500 calls from 34 countries. All of these hams have or will shortly receive the Ra-2's QSL card—a full-color picture of the raft with Thor Heyerdahl.

For SWLs there was plenty of excitement in the Ra broadcasts. Listeners learned for the first time that, in Heyerdahl's words, "At least a continuous stretch of 1,400 miles of the open Atlantic is polluted by floating lumps of solidified asphalt-like oil." There were descriptions of unexplained orange-colored lights in the sky, translated by the press into "unidentified flying objects" and explained by Heyerdahl as possibly ships signalling one another or rocket activity at Cape Kennedy (a check onshore ruled out both possibilities). And on June 19, there was Baker's dramatic account of the loss of one of the steering oars in 30-ft. waves. Knowing that his own wife and Yvonne Heyerdahl were listening over Morrison's shoulder, he concluded the broadcast, "To all who are listening, all is well, all is well aboard Ra."

Today, the transmitter that was used on Ra-1 and Ra-2 resides at the St. Petersburg offices of Signal One. Baker is back on the job supervising construction of a telephone office on Long Island and Heyerdahl has written his account of the trip across the Atlantic. For them, and for the hundreds of hams who took part in the project or just eavesdropped, there'll be no forgetting the 3,000-year-old ham shack. 

Hi-Fi Today

By John Milder



Too Much Gadgetry

THE high-fidelity scene got its start when people began to walk into radio stores looking for playback equipment that didn't exist. Because audiophiles couldn't get anything better than a mediocre phonograph from the major manufacturers, they began to put together their own systems from components that included public-address amplifiers and theater speakers.

Soon so many people were doing their own thing that the hi-fi business got its start as a separate specialty industry. Stereo gear attracted an even bigger audience for componentry shortly thereafter.

Now we're at the point where the audio component business is big and traditional console phonographs are on the way out. The retailing—including both the design and advertising—of stereo components is rather like the foreign and sporty-car business. Much of the selling relates to human psychological weaknesses. But it's still a business that thinks of itself as relating to music and people's feelings about music.

Just where is the hi-fi industry today? My feeling is that it is approaching a saturation point with regard to gadgetry—a state of overkill in the consumer market. I believe, for instance, that four-channel stereo may have fatal weaknesses in any—or all—of its proposed versions, discrete or matrix, and that the symptoms may be clear by about this time next year. This will be especially obvious if a projected economic recovery takes place and four-channel buyers are slow to show up.

Unless component manufacturers start retailing with more expertise, the present confusion over four-channel stereo could curb the coming boom in high-quality cassette playback equipment. Four-channel stereo clearly may be too much for the consumer. Price is one reason, lack of program material would be another.

Its advantages as now seen don't seem to be proportional to the added cost and complexity of the simplest and cheapest four-channel arrangement. It is, I feel in my bones, a product that listeners are looking at closely

and critically. Four-channel could hang in the balance.

I have a feeling that most listeners find a large amount of available hi-fi gear is good enough for general music appreciation in the home.

The component market is getting into a tight corner since the amount of enjoyment offered to the consumer for increasingly large investments steadily decreases. The most expensive components are only slightly superior to equipment costing half as much. This kind of saturation of consumer needs means you have a law of diminishing returns at work: you ask people to put a lot in to get very little out.

The psychology of hearing will prove to be the truth behind consumer buying patterns. Emotion and gadgetry will get lost along the road. The fact is that most people wish to relax at home, even when they do serious listening. And whether the purists like it or not, many are satisfied to listen to background music.

I think in the '70s good equipment—that is, stereo gear which offers satisfying performance in a system of great simplicity and moderate cost—will always be in demand. Music will continue to play a big part in most lives. But the time has come, I believe, for the hi-fi industry to stop sacrificing people—and their savings—to gadgetry. Satisfying a market is one thing; creating one artificially is quite another.

Speaking of Cassettes . . . Improvements in materials and methods—and ultimately in listener enjoyment—are coming down the pike faster and faster and faster. Chromium dioxide (Crolyn) tape is being pushed quite hard by Ampex, Certron, Memorex and BASF, amongst others. There were some reservations at first (was it really that much better or wasn't it?) but now apparently everybody in the industry agrees that, yes, it really is better. And then along came 3M with a cobalt-doped cassette tape. Still better, they said. Yes, things are happening fast. —

RENT 4-TRACK open reel tapes—all major labels—3,000 different—free brochure. Stereo-Parti, 55 St. James Drive, Santa Rosa, Calif. 95401.

OLD RADIO Shows On Tape. Free Catalog. Write P. O. Box 18121, Louisville, Ky. 40218.

NOSTALGIC RADIO Programs On Tape. Six Hours \$7.00, Catalogue 25¢. Nostalgic Radio, Box 29E, Peoria, Ill. 61601.

RADIO SHOWS. Stamp For Free Catalog. Box 724-El, Redmond, Wash. 98052.

• • • RADIO & TV

BLACKED OUT SPORTING EVENTS—amazing new All American Sports Amplifier brings in TV stations up to 150 miles with games not broadcast locally. Featured September **POPULAR ELECTRONICS**. Available kit or wired and tested. For data sheet, CADCO TV, 4444 Classen Blvd., Oklahoma City, Oklahoma 73118.

TV TUNERS rebuilt and aligned per manufacturers specification. Only \$9.50. Any make UHF or VHF. We ship COD. Ninety day written guarantee. Ship complete with tubes or write for free mailing kit and dealer brochure. JW Electronics, Box 51K, Bloomington, Indiana 47401.

FREE! BARGAIN Catalog. Fiber optics, LED's, transistors, diodes, rectifiers, SCR's triacs, parts. Poly Paks, Box 942, Lynnfield, Mass. 01940.

TUBES: WHOLESALE only. 1000 Different. Fantastic savings. All new. Free list for same. SS Dist. 920 South Main, Kokomo, Indiana 46901.

"**DISTANCE ONE Tuber**" Handbook—50¢. 15 Distance one tube plans—25¢. Catalog. Laboratories, 745-K Cordone, Reno, Nevada 89502.

REPAIR TV Tuners—High Earnings. Details of Complete Course, 12 Repair Tricks, Many Plans, Two Lessons, all for \$1. Refundable. Frank Bocek, 3236 Enterprise Branch, Redding, Calif. 96001.

TELEVISION HIGH Voltage Test Probe Only \$2. No meter or electronic experience needed. Schek Television Company, 8101 Schrider Street, Silver Spring, Maryland 20910.

FREE ELECTRONICS Catalog. Tremendous Bargains. Edu-Kits, Department C-623AE, Hewlett, New York 11557.

RADIO & TV Tubes—36¢. Free List. Cornell, 4213-15 University, San Diego, Calif. 92105.

• • • ELECTRONICS SUPPLIES & EQUIPMENT

IMPROVE RECORDINGS — Impedance Converter Terminates High Impedance Microphones Properly. Allows Use of up to 500 feet Extension Cable. Impedaverter IMP-1, \$29.95 plus \$1.25 Postage. Russound/FMP, P.O. Box 204 El, Stratham, N. H. 03885.

ELECTRONICS HOBBYIST and professional builders love our 3¢ film resistors; 16¢ electrolytics and 1¢ micas. Great catalog 35¢. Electrovalue-America, Box 27D, Swarthmore, Pa. 19081.

KITS AND EQUIPMENT FM Wireless microphone transmitters, FM Telephone transmitters, Infinity transmitters. Security Electronics, P.O. Box 265, Huntington, W. Va. 25707.

• • • MUSIC

SONGPOEMS URGENTLY Needed, Possible Recording/Publishing, 50-50 Agreement, Betty's Music Makers, 945H Central, St. Petersburg, Florida 33705.

FREE CATALOG. Electronic musical accessory kits. PAIA Electronics, Box G14359, Oklahoma City, Okla. 73114.

• • • INVENTORS & INVENTIONS

PATENT SEARCHES including maximum speed, full airmail report and closest patent copies \$6.00. Quality searches expertly administered with complete secrecy guaranteed. Free Invention Protection forms and "Patent Information." Write Washington Patent Search Bureau, Dept. 20, 734 15th St. N.W., Washington, D.C. 20005.

INVENTORS! SELL your invention for cash or royalties! Our client manufacturers eagerly seek new items. Patented. Unpatented. Financial assistance if needed. 25 years proven performance. For free information, write Dept. 27, Gilbert Adams, Invention Broker, 80 Wall St., New York, N.Y. 10005.

• • • ROCKETS

NEW SPACE Posters List 25¢. Refund First Order. Hol-land Posters, Box 1025 Bonita Springs, Fla. 33923.

• • • PERSONAL

MAKE FRIENDS WORLDWIDE through international correspondence. Illustrated brochure free. Hermes, Box 17/44, Berlin II, Germany.

• • • MISCELLANEOUS

WINEMAKERS SPECIAL!!! Fermentation Locks 3/\$1.00. Illustrated Catalog, \$5.00 Credit Coupon Free. Werth Wine, Box 1902BZ, Cedar Rapids, Iowa 52406.

YOUR OWN Electronic Business. Easy-lucrative. Details Free. Barta-ELAS, Box 248, Walnut Creek, California 94597.

ELECTRONICS ILLUSTRATED

Classified Advertising Order Form

For information on terms, closing dates, etc., see heading at top of Classified Section.

INSTRUCTIONS:

50¢ a word
Minimum Ad
10 Words

WORD COUNT: Zip code free. Figure one word for name of state (New Jersey); name of city (Little Falls); sets of characters as in key (M-14); abbreviation of Northwest (NW); but note separate initials as in a name (M. D. Brown), 3 words counted as a word each.

DEADLINE FOR ADS: Copy must be in by the 20th day of the fourth preceding month for the issue in which the ad is to appear.

BLANKLINE: May be placed both above and below the ad, if desired. Each blank line is charged as 5 words.

TO: ELECTRONICS ILLUSTRATED, One Astor Plaza., New York, N.Y. 10036 • Att.: Classified Advertising Dept.

Gentlemen: Here's our copy for the Classified Section of ELECTRONICS ILLUSTRATED. Remittance of \$_____ is enclosed to cover _____ insertion(s) in the _____ issue(s).

1	2	3	4	5
6	7	8	9	10
11	12	13	14	15
16	17	18	19	20
21	22	23	24	25
26	27	28	29	30
31	32	33	34	35

YOUR NAME _____ **PHONE** _____
(PLEASE PRINT)

FIRM _____

ADDRESS _____

CITY _____ **STATE** _____ **ZIP** _____

DATE _____ **YOUR SIGNATURE** _____
(PLEASE PRINT OR TYPE COPY • FOR ADDITIONAL WORDS ATTACH SEPARATE SHEET) 1/72

BILL 20 RADIO

and Electronics Circuits

Reg. U.S.
Pat. Off.



Training Electronics Technicians Since 1946

PROGRESSIVE HOME RADIO-TV COURSE

Now Includes

- ★ 12 RECEIVERS
- ★ 3 TRANSMITTERS
- ★ SQ. WAVE GENERATOR
- ★ SIGNAL TRACER
- ★ AMPLIFIER
- ★ SIGNAL INJECTOR
- ★ CODE OSCILLATOR
- ★ TRANSISTOR (Solid State) CIRCUITS
- ★ VACUUM TUBE CIRCUITS
- ★ PRINTED CIRCUITS
- ★ HAND WIRED CIRCUITS

YOU DON'T HAVE TO SPEND HUNDREDS OF DOLLARS FOR A RADIO COURSE

The "Edu-Kit" offers you an outstanding PRACTICAL HOME RADIO COURSE at a rock-bottom price. Our Kit is designed to train Radio & Electronics Technicians, making use of the most modern methods of home training. You will learn radio theory, construction practice and servicing. THIS IS A COMPLETE RADIO COURSE IN EVERY DETAIL.

You will learn how to build radios, using regular schematics; how to wire and solder in a professional manner; how to service radios. You will work with the standard type of punched metal chassis as well as the latest development of Printed Circuit chassis.

You will learn the basic principles of radio. You will construct, study and work with RF and AF amplifiers and oscillators, detectors, rectifiers, test equipment. You will learn and practice code, using the Progressive Code Oscillator. You will learn and practice trouble-shooting, using the Progressive Signal Tracer, Progressive Signal Injector, Progressive Dynamic Radio & Electronics Tester, Square Wave Generator and the accompanying instructional material.

You will receive training for the Novice, Technician and General Classes of F.C.C. Radio Amateur Licenses. You will build Receiver, Transmitter, Square Wave Generator, Code Oscillator, Signal Tracer and Signal Injector circuits, and learn how to operate them. You will receive an excellent background for television, Hi-Fi and Electronics.

Absolutely no previous knowledge of radio or science is required. The "Edu-Kit" is the product of many years of teaching and engineering experience. The "Edu-Kit" will provide you with a basic education in Electronics and Radio, worth many times the low price you pay. The Signal Tracer alone is worth more than the price of the Kit.

THE KIT FOR EVERYONE

You do not need the slightest background in radio or science. Whether you are interested in Radio & Electronics because you want an interesting hobby, a well paying business or a job with a future, you will find the "Edu-Kit" a worth-while investment. Many thousands of individuals of all

ages and backgrounds have successfully tried the "Edu-Kit" in more than 79 countries of the world. The "Edu-Kit" has been carefully designed, step by step, so that you cannot make a mistake. The "Edu-Kit" allows you to teach yourself at your own rate. No instructor is necessary.

PROGRESSIVE TEACHING METHOD

The Progressive Radio "Edu-Kit" is the foremost educational radio kit in the world, and is universally accepted as the standard in the field of electronics training. The "Edu-Kit" uses the modern educational principle of "Learn by Doing." Therefore you construct, gram designed to provide an easily-learned, thorough and interesting background in radio.

You begin by examining the radio parts of the "Edu-Kit." You then learn the function, theory and wiring of these parts. Then you build a simple radio. With this first set you will enjoy listening to regular broadcast stations, learn theory, practice testing and trouble-shooting. Then you build a more advanced radio, learn more advanced theory and techniques. Gradually, in a progressive manner, and at your own rate, you will find yourself constructing more advanced multi-tube radio circuits, and doing work like a professional Radio Technician.

Included in the "Edu-Kit" course are Receiver, Transmitter, Code Oscillator, Signal Tracer, Square Wave Generator and Signal Injector Circuits. These are not unprofessional "breadboard" experiments, but genuine radio circuits, constructed by means of professional wiring and soldering on metal chassis, plus the new method of radio construction known as "Printed Circuitry." These circuits operate on your regular AC or DC house current.

THE "EDU-KIT" IS COMPLETE

You will receive all parts and instructions necessary to build twenty different radio and electronics circuits, each guaranteed to operate. Our Kits contain tubes, tube sockets, variable, electrolytic, mica, ceramic and paper dielectric condensers, resistors, tie strips, selenium rectifiers, punched metal chassis, Instruction Manuals, hook-up wire, solder, hardware, tubing, coils, volume controls and switches, solid state materials.

In addition, you receive Printed Circuit materials, including Printed Circuits chassis, special tube sockets, hardware and instructions. You also receive a useful set of tools, a professional electric soldering iron, and a self-powered Dynamic Radio and Electronics Tester. The "Edu-Kit" also includes a Code Instruction and the Progressive Code Oscillator, in addition to F.C.C. Radio Amateur License training. You will also receive lessons for servicing with the Progressive Signal Tracer and the Progressive Signal Injector, a High Fidelity Guide and a Quiz Book. You receive Membership in Radio-TV Club, Free Consultation Service, Certificate of Merit and Discount Privileges. You receive all parts, tools, instructions, etc. Everything is your to keep.

Progressive "Edu-Kit" Inc., 1189 Broadway, Dept. 622AE, Hewlett, N.Y. 11557

PRINTED CIRCUITRY

At no increase in price, the "Edu-Kit" now includes Printed Circuitry. You build a Printed Circuit Signal Injector, a unique servicing instrument that can detect many Radio and TV troubles. This revolutionary new technique of radio construction is now becoming popular in commercial radio and TV sets.

A Printed Circuit is a special insulated chassis on which has been deposited a conducting material which takes the place of wiring. The various parts are merely plugged in and soldered to terminals.

Printed Circuitry is the basis of modern Automation Electronics. A knowledge of this subject is a necessity today for anyone interested in Electronics.

FREE EXTRAS

• SET OF TOOLS

- SOLDERING IRON
- ELECTRONICS TESTER
- PLIERS-CUTTERS
- VALUABLE DISCOUNT CARD
- CERTIFICATE OF MERIT
- TESTER INSTRUCTION MANUAL
- HIGH FIDELITY GUIDE & QUIZZES
- TELEVISION BOOK & RADIO TROUBLE-SHOOTING BOOK
- MEMBERSHIP IN RADIO-TV CLUB: CONSULTATION SERVICE & F.C.C. AMATEUR LICENSE TRAINING
- PRINTED CIRCUITRY

SERVICING LESSONS

You will learn trouble-shooting and servicing in a progressive manner. You will practice repairs on the sets that you construct. You will learn symptoms and causes of trouble in home, portable and car radios. You will learn how to use the professional Signal Tracer, the unique Signal Injector and the dynamic Radio & Electronics Tester. While you are learning in this practical way, you are learning to do many a repair job for your friends and neighbors, and charge fees which will far exceed the price of the "Edu-Kit." Our Consultation Service will help you with any technical problems you may have.

FROM OUR MAIL BAG

J. Stataitis, of 25 Poplar Pl., Waterbury, Conn., writes: "I have prepared several sets for my friends, and made money. The "Edu-Kit" paid for itself. I was ready to spend \$240 for a Course, but I found your ad and sent for your Kit."

Ben Valerio, P. O. Box 21, Magna, Utah: "The Edu-Kits are wonderful. Here I am sending you the questions and also the answers for them. I have been in Radio for the last seven years, and like to work with Radio Kits, and like to build Radio Testing Equipment. I enjoyed every minute I worked with the different kits; the Signal Tracer works fine. Also like to let you know that I feel proud of becoming a member of your Radio-TV Club."

Robert L. Shuff, 1534 Monroe Ave., Huntington, W. Va.: "Thought I would drop you a few lines to say that I received my Edu-Kit, and was really amazed that such a bargain can be had at such a low price. I have already started re-getting into the swing of it so quickly. My friends were really surprised to see me get into the swing of it so quickly. The Trouble-shooting Tester that comes with the Kit is really swell, and finds the trouble, if there is any to be found."

UNCONDITIONAL MONEY-BACK GUARANTEE

Please rush my Expanded Radio-TV Course with "Edu-Kits"® to me.

- Send Course with Edu-Kits postpaid. I enclose full payment of \$39.95.
- I enclose \$5.00 deposit. Send Course with Edu-Kits C.O.D. for balance of \$34.95 plus postage.
- Send me FREE additional information describing Course with Edu-Kits.

NAME
ADDRESS
CITY & STATE ZIP

PROGRESSIVE "EDU-KITS" INC.

1189 Broadway, Dept. 622AE, Hewlett, N.Y. 11557

CIRCLE NUMBER 10 ON PAGE 11



Train on this
315 sq. in.
picture
color TV
and get the
skills that
mean a
high-paying
career!

Solid-State — the newest development

Count on NTS training to always
feature the latest electronic equipment.

Now included in two exciting NTS color TV courses, this set is the largest, most advanced color television made. Guided by the NTS "Lab-Project Method" of combining professional kits and easy-to-follow lessons, you build this color TV step by step — learning TV Servicing as you go! NTS has successfully trained thousands of men at home for rewarding careers as electronics technicians. Prepare for the great opportunity fields of TV-Radio Servicing, Computers, Communications, and Automation.

This solid-state color set contains: 45 transistors, 55 diodes, 2 silicon controlled rectifiers, and 4 advanced Integrated Circuits representing an addi-

tional 46 transistors and 21 diodes. The first solid-state color TV this large — yours to keep! It features Automatic Fine Tuning; "Instant On"; an Ultra-Rectangular Screen (25 in. diagonal measurement) that lets you see the complete transmitted image for the first time — a full 315 square inches; exclusive built-in Self Servicing features which eliminate the need to buy costly test equipment; exclusive design Solid-State VHF Tuner with an MOS Field Effect Transistor; 3-stage Solid-State IF; Automatic Chroma Control; Adjustable Noise Limiting and Gate Automatic Gain Control; High Resolution Circuitry; Matrix Picture Tube; and a specially formulated Etched Face Plate that eliminates unwanted glare, and heightens contrast. Colors are more vivid,

fresh tones more natural, and the picture is sharper than ever before. By training on this unique color TV, you'll gain the most up-to-date skills possible in TV Servicing!

Other valuable equipment you build and keep includes an AM SW Radio, Solid-State Radio, FET Volt-Ohmmeter, and Electronic-Tube Tester. All included in your tuition. You learn troubleshooting, hi-fi, multiplex systems, stereo, and color TV servicing. Step right into a technician's job at top pay or open a business of your own! For complete details on all NTS electronics courses, mail the coupon today for the full-color NTS Catalog. No obligation. No salesman will call.

**Build this set
and learn
solid-state
circuitry—the
electronics
of today!**

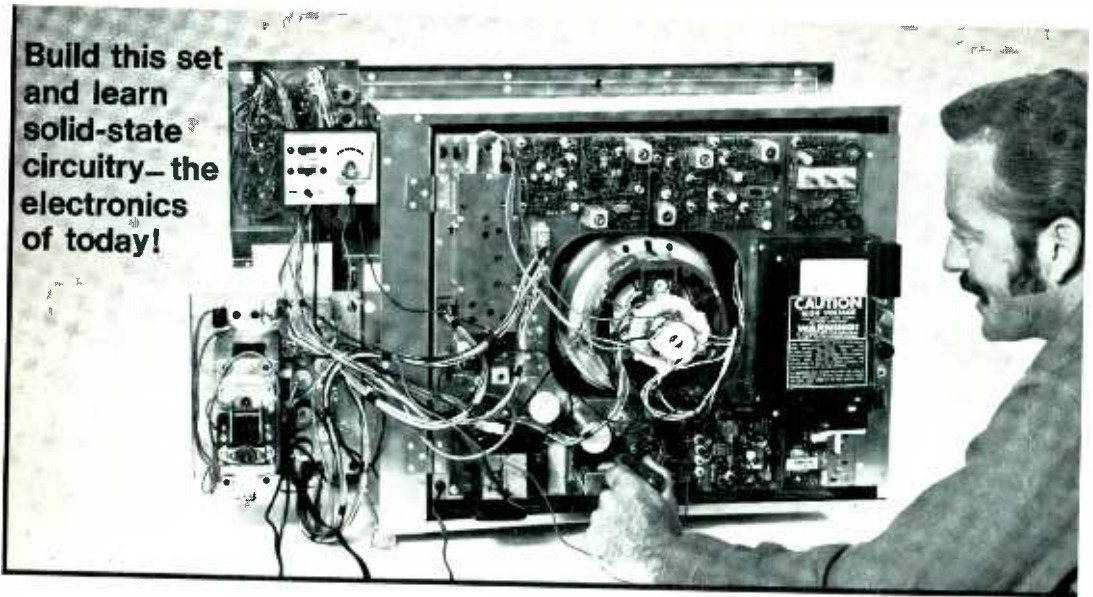

in color TV — comes to home training.

NTS ELECTRONICS & COMPUTER TECHNOLOGY

Build this exclusive NTS Computer Trainer! Loaded with integrated circuits, it shows you the how, what, and why of computers. Learn this exciting field faster, more thoroughly. You also assemble and learn to operate an FET Volt-Ohmmeter and 5" wide band Oscilloscope.

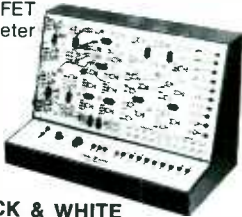

NTS BLACK & WHITE TV AND RADIO SERVICING

Learn all phases of television, radio, stereo, and hi-fi. You receive this 74 sq. in. picture Solid-State B&W TV, Lo-Silho "Superhet" Radio, FET Volt-Ohmmeter, Solid-State Radio, Electronic Tube Checker, and Signal Generator. Start earning extra money even before you complete the course!



NTS ELECTRONIC COMMUNICATIONS & F.C.C.

Gain the security and prestige of owning an F.C.C. First Class Radio-Telephone License! Two comprehensive NTS courses cover the big opportunity field of transmitting and receiving. You build 14 kits, including a 5 watt AM Transceiver, 6 Transistor Pocket Radio, and FET Volt-Ohmmeter. Learn 2-way radio, Citizens Band, micro-waves and radar.



NTS INDUSTRIAL & AUTOMATION ELECTRONICS

Automation is the future of industry and you can play an important part! Learn industrial controls by training on the NTS Electro-Lab — a complete workshop. You also build and operate this 5" wide band Oscilloscope. And you perform experiments that involve regulating motor speeds, temperature, pressure, liquid level, and much more.



Classroom Training

at Los Angeles. You can take classroom training at Los Angeles in sunny Southern California. NTS occupies a city block with over a million dollars in technical facilities. Check box in coupon.

APPROVED FOR VETERANS

Accredited Member: National Association of Trade & Technical Schools; National Home Study Council.

NATIONAL TECHNICAL SCHOOLS

WORLD-WIDE TRAINING SINCE 1905

4000 South Figueroa Street, Los Angeles, Calif. 90037

Please rush Free Color Catalog and Sample Lesson, plus information on course checked below. No obligation. No salesman will call.



National Technical Schools

4000 S. Figueroa St.
Los Angeles, Calif. 90037

- Master Course in Color TV Servicing
- Color TV Servicing (For Advanced Technicians)
- Master Course in B&W TV & Radio Servicing
- Master Course in Electronic Communication
- Practical Radio Servicing
- FCC License Course
- Master Course in Electronics Technology
- Industrial and Automation Electronics
- Computer Electronics
- Basic Electronics
- High School at Home Dept. 000-00

Name _____ Age _____

Address _____

City _____ State _____ Zip _____

Check if interested in Veteran Training under new G.I. Bill
 Check if interested only in Classroom Training at Los Angeles

6 good reasons why the revolutionary Avanti Astro Plane is the best omni-directional C.B. antenna you can buy.

1. It has **top radiation** which means that your signal gets out from the highest part of your antenna. This is especially important where antenna height is limited because your signal radiates about 15 feet higher than other antennas which radiate near the bottom. This 15 feet means you get increased range and fewer dead spots.
2. The **ASTRO PLANE** has a **lower angle of radiation** which makes more efficient use of the radiated signal by allowing it to hug the curvature of the earth instead of shooting your power up into the sky. This also gives you greater distance than an ordinary omni-directional antenna, one thing the professional users really look for.
3. The **ASTRO PLANE** has **4.46 db gain** (over an isotropic source) which gives you a stronger signal and better, clearer reception.
4. You'll get **long lasting, trouble free performance** because it is compact in design—without long drooping radials, without coils to burn or short out, and with direct ground construction to dissipate static charges and lightning.
5. You'll find it **easy to install** because of its lightweight construction (less than 5 lbs.) and only 12 feet of total height and 30 inches in diameter.
6. **All of these features need not cost you more money.** Part of good engineering is how to make a better product for less money—by eliminating the coils for example we not only make the Astro Plane more reliable, but cheaper. Just like a radio back in the 30's cost \$100.00, today they're even better for \$20.00 or \$30.00! So you can buy this advanced antenna for only \$29.95 and it is guaranteed for one full year against mechanical or electrical defects.

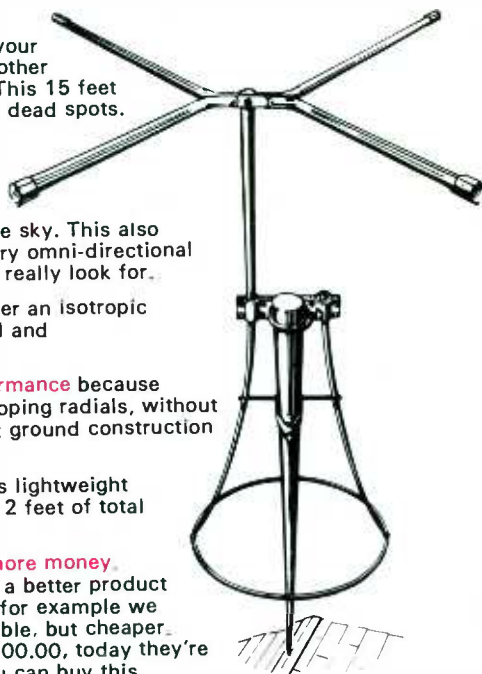

If your local C.B. Dealer does not have an **ASTRO PLANE** in stock, have him order you one or write direct to **AVANTI**.



avanti

AVANTI RESEARCH & DEVELOPMENT, INC.

THE PACESETTER IN HIGH PERFORMANCE ANTENNAS

33-35 WEST FULLERTON AVENUE,
ADDISON, ILLINOIS 60101