

Balancing Stereo the Electronic Way

ELECTRONICS ILLUSTRATED®

By the Publishers of MECHANIX ILLUSTRATED

MARCH 1970 50¢

Service Series: Keeping the Color in Color TV

How to DX Counties ★ Crystalline-Pure FM

How to Put Up a Cubical Quad Antenna for CB

Dual-Scale SWR Meter for Hams

SPECIAL SECTION: Electronics for Pleasure Boats

How to Choose Basic Gear, DX the Marine Band, Build a Marine Band Converter, Automatic Hornblower, Loudhailer, Radio Direction Finder

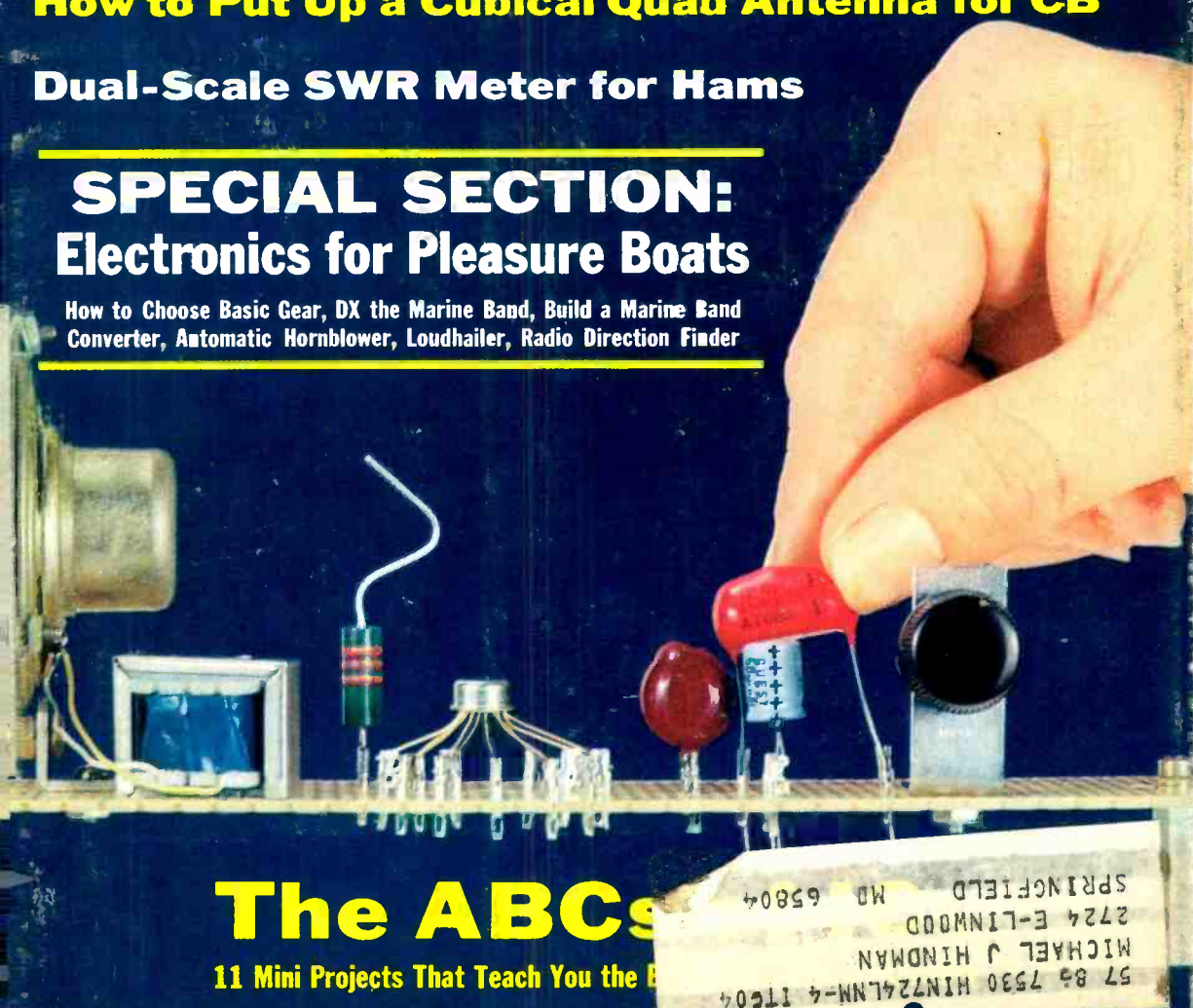

The ABCs

11 Mini Projects That Teach You the B

57 82 7530 HIN24LNM-4 1TC04
MICHAEL J HINDMAN
2724 E-LINWOOD
SPRINGFIELD MD 65804

266 ways to make more money

ICS is the oldest, largest school of its kind. 266 courses for men and women. High school, business, secretarial, interior decorating, engineering. One for you. Direct, job-related. Bedrock facts and theory plus practical application. You learn from experts. Diploma to

graduates. Clip and mail the card now or write ICS, Scranton, Pa. 18515. You'll receive, absolutely FREE, 3 valuable booklets that have helped thousands. But don't delay. Make your move for a more successful future today.

ACCOUNTING

Accounting (U.S.A.)
Accounting (Canadian)
Accounting for Business Programmers
Accounting for Mgt. Decisions
Auditing
Business Law (U.S.A.)
Canadian Business Courses
Cost Accounting
CPA Review (U.S.A.)
General Accounting
Income Tax (U.S.A.)
Industrial Accounting
Junior Accounting
Office Accounting
Practical Accounting
Public Accounting
Small Business Accounting (U.S.A.)
Starting and Managing a Small Bookkeeping Service (U.S.A.)

ARCHITECTURE AND BUILDING

Architectural Drawing and Designing
Architecture
Building Contractor
Building Estimator
Building Inspector
Building Maintenance
Carpenter-Builder
Carpentry and Millwork
Fundamentals of Urban Planning
House Planning and Interior Design
Mason
Painting Contractor
Reading Architectural Blueprints
Review in Architectural Design and Practice
Review of Mechanical Systems in Buildings

ART

Amateur Artist
Commercial Art
Commercial Cartooning
Illustrating with Options:—Magazine
—Advertising Layout and Illustration
Interior Decorating
Oil Painting for Pleasure
Show Card and Sign Production
Show Card Writing
Sign Painting and Designing
Sketching and Painting

AUTOMOTIVE

Automatic Transmission Specialist
Automobile Air Conditioning Specialist
Automobile Body Rebuilding & Refinishing
Automobile Engine Tune-Up
Automobile Mechanic
Automobile Technician
Diesel-Gas Motor Vehicle Engines

BUSINESS

Advertising
Business Administration
Business Prac. (Cond.)
Canadian Business Course
Condensed Marketing
Direct Mail and Mail Order Advertising
Industrial Psychology
Inventory Control
Magazine & Newspaper Advertising
Managing a Retail Business
Managing a Small Store
Marketing Management
Marketing Research
Modern Exec. Mgt.
Office Automation
Office Management
Production Management
Purchasing Agent
Retail & Local Adv'ting
Retail Bus. Management
Retail Merchandising
Retail Selling
Systems and Procedures Analysis

BUSINESS: SALES

Creative Salesmanship
Real Estate Salesmanship
Salesmanship
Sales Management

BUSINESS: SUPERVISION

Basic Supervision
Industrial Foremanship
Industrial Supervision
Management, Salesmanship and Sales
Modern Woman as a Supervisor
Personality Development
Personnel-Labor Relations (U.S.A.)
Supervision

CHEMICAL

Analytical Chemistry
Chemical Engineering
Chemical Laboratory Tech.
Chemical Process Equip. Design & Operation
Chemical Process Op. Elements of Nuclear Energy
General Chemistry
Instrumental Laboratory Analysis

CIVIL ENGINEERING

Civil Engineering
Construction Eng'r'g Tech.
Highway Eng'r'g Tech.
Principles of Surveying
Reading Highway Blueprints
Reading Structural Blueprints
Sanitary Engineering Tech.
Sewage Plant Operator
Structural Eng'r'g Tech.
Surveying and Mapping
Water Works Operator

COLLEGE COURSES

American History
Calculus Economics

APPROVED FOR VETERANS

Accredited member, National Home Study Council.
Convenient payment plan.
Special rates to members
U.S. Armed Forces.

COMPUTERS

COBOL Programming
Fortran Programming for Engineers
Programming for Digital Computers
Programming the IBM 1401 Computer
Programming the IBM System/360 Computer, Introduction

DRAFTING

Aircraft Drafting
Architectural Drafting
Design Drafting
Drafting Technology
Electrical Drafting
Electrical Eng'r'g Drafting
Electronic Drafting
Introductory Mech. Drafting
Mechanical Drafting
Pressure-Vessel and Tank Print Reading
Sheet Metal Layout for Air Conditioning
Structural Drafting

ELECTRICAL

Electrical Engineering—Electronics Option
—Power Option
Electrical Appliance Ser.
Electrical Appliance Ser. with Equip. Training
Electrical Contractor
Electrical Eng'r'g Tech.
Electrical Home Maint.
Electrical Home Maint. with Equip. Training
Electrical Instrument Tech.
Electric Motor Repairman
Industrial Elec. Tech.
Power-Line Design and Construction
Power Plant Operator—Hydro Option
—Steam Option
Practical Electrician
Practical Electrician with Equipment Training
Practical Lineman
Reading Elec. Blueprints

ENGINEERING

(Refresher Courses for Graduate Engineers)
Chemical Civil Electrical Industrial Mechanical Sanitary Structural

ENGLISH AND WRITING

Better Business Writing
English for Spanish (U.S.A.)

Free Lance Writing for Fun and Profit
Introductory Tech. Writing
Modern Letter Writing
Practical English
Short Story Writing

HIGH SCHOOL

High School Business
High School (Canadian)
High School General
High School Math.
High School Secretarial
High School Vocational
High School College Preparatory—Arts
High School College Prep—Engineering and Science
Preparatory Course for High School Equivalency Test

MACHINE SHOP PRACTICE

Grinder Operator
Industrial Metallurgy
Lathe Operator
Mach. Shop Inspection
Mach. Shop Practice
Metallurgical Eng'r'g Tech.
Multicraft Maintenance Mechanic
Practical Millwrighting
Reading Shop Prints
Rigging
Tool & Die Making
Tool Engineering Tech.
Welding Engineering Tech.
Welding Process

MATHEMATICS

Advanced Mathematics
Math. and Mechanics for Engineering Techn.
Math. and Physics for Engineering Techn.

MECHANICAL

Mechanical Engineering
Aircraft and Power Plant Mechanic
Hydraulic and Pneumatic Power
Industrial Engineering
Industrial Eng'r'g Tech.
Industrial Instrumentation
Machine Design
Quality Control
Safety Eng'r'g Tech.
Tool Design
Vibration Analysis and Control

PETROLEUM

Natural Gas Production and Transmission
Oil Well Technology
Petroleum Production
Petroleum Production Engineering Tech.
Petroleum Refinery Op.

PLASTICS

Design of Plastic Prod.
Plastics Techn.

PLUMBING, HEATING AND AIR CONDITIONING
Air Conditioning

Air Conditioning Maint.
Domestic Heating with Gas and Oil
Heating
Heating & Air Conditioning with Drawing
Industrial Air Cond.
Pipe Fitting Plumbing
Plumbing and Heating
Plumbing & Heating Est.
Practical Plumbing
Refrigeration and Air Conditioninz Serv.

PULP AND PAPER

Paper Machine Operator
Paper Making
Pulp Making
Pulp & Paper Engineering Tech.

SECRETARIAL

Clerk-Typist Commercial Secretary, Engineering Sec'y, Legal Sec'y, Med. Secretary, Professional Shorthand Stenographic Typewriting

STEAM AND DIESEL POWER

Boiler Inspector
Industrial Building Eng'r
Power Plant Engineering
Stationary Diesel Eng'r
Stationary Fireman
Stationary Steam Eng'r'g

TEXTILES

Carding
Carding and Spinning
Dyeing and Finishing
Loom Fixing Spinning
Textile Mill Supervision
Textile Technology
Warping and Weaving

TRAFFIC

Motor Traffic Man'g'm't
Traffic Management

TV-RADIO-ELECTRONICS

Color Television Principles & Serv.
Electronics Instrumentation and Servo Fundamentals
Electronics Technician First Class Radio Telephone License
Fundamentals of Electronic Computers
General Electronics
General Electronics with Equipment Training
Hi-Fi Stereo and Sound System Servicing
Industrial Electronics Technician
Numerical Control Electronics & Maint.
Practical Telephony Principles of Semiconductor Radio & TV Servicing
Radio & TV Servicing with Equip. Training
Second Class Radio Telephone License
Sound Systems Specialist
Telephony, Electronics, and Radio Comm.

And a brand new one!

Special \$5 Offer

Learn TV repair...10 day trial!

Don't take *our* word for it—prove it to yourself! If you don't agree with every word we say about ICS's new TV Servicing/Repair course—we lose the bet and you lose *nothing*.

Send Just \$5

Simply send us \$5 for the first text of the course. Read through it. See how simple and easy-to-understand the instruction is. And how thorough. Then decide for yourself. While this first text will not, by any means, give you a complete training—it will convince you how easy it is to learn—the ICS way.

And, if by chance you're not convinced—simply return the text within the 10 day trial period and receive a full refund.

Worth Much More

As a part of the complete course, this text is worth much more than \$5. This special trial is simply our way of showing you how completely confident we are that the ICS TV Servicing/Repair course can stand up to *any* TV Repair training you can get *anywhere*, at *any price*—yet the full cost is only \$99.

In just a few months you can be trouble-shooting on color sets. Just the first two texts combined will enable you to repair 70 percent of *all* TV troubles. Instruction is simple, very easy to grasp. Photos show you what a TV screen looks like when everything is normal, and what it looks like when trouble fouls it up. The texts tell you how to remedy the problem and why that remedy is best. What's more, quizzes are spotted throughout the course so you can check your progress.

Course is Short . . . Complete

All in all, the course consists of 6 texts . . . 936 pages of concise, easy-to-follow instruction . . . plus 329 detailed illustrations . . . a dictionary of TV terms geared directly to course material—which will be invaluable during the course and later.

At the end, you get the coveted ICS diploma,

plus membership in the ICS TV Servicing Academy. And by that time you will be able to handle tough, multiple TV problems on color sets as well as black and white—100% of all TV malfunctions! This could mean a tremendous future for you. Full-time, part-time, your own business.

The National Electronic Associations found this ICS course so thorough, so helpful, easy to grasp that they approved it (first home study course ever to receive such an honor) for use in their own apprenticeship training program.

Act Now

You have nothing to lose. Send coupon today or write ICS, Scranton, Pa. 18515. Then examine the first text. See for yourself. If, during the 10 day trial period, you're not convinced—just return the text. And we'll refund quickly.

ICS International Correspondence Schools Division of Intext

ICS, Scranton, Pa. 18515

Q2876A

Here's my \$5.00. Send me the first text of the ICS TV Servicing/Repair Course. If I'm not convinced within 10 days that this is the most thorough and easy to understand way to learn TV repair, you'll refund my money and that's that.

Name _____
(please print)

Address _____

City _____ State _____ Zip# _____

Send the full course. I've included \$99—plus state tax. (And I'll still have the 10 day trial refund privilege.)

Return This Coupon Today For 10 Day Trial.

SPECIAL PLEASURE BOAT ELECTRONICS SECTION

How To Choose Electronic Gear For Your Boat	Len Buckwalter, K1ODH	47
Horatio's Hornblower	Rudolf F. Graf and George J. Whalen	58
Kit Reports: RDF plus, Foghorn, etc.		62
Marine-Band Converter	Charles Green, W6FFQ	64
DXing The Marine Band	Tom Kneitel, K2AES	68

AMATEUR RADIO

Dual-Scale SWR Meter	Ronald Lumachi, WB2CQM	77
----------------------	------------------------	----

CITIZENS BAND

Dual-Scale SWR Meter	Ronald Lumachi	77
Cheapie Quad for CB	Dave G. Koller	84

AUDIO & HI-FI

Hi-Fi Today: The New Stereo	John Milder	76
Crystal Clarity for Stereo FM	David Walker	81
Electronic Balancer for Stereo	Joseph Ritchie	92

SHORT-WAVE LISTENING

DXing the Counties	Alex Bower	38
Notes from El's DX Club		103

THEORY AND PRACTICE

ABCs of ICs	Darrell Thorpe	27
-------------	----------------	----

SERVICE

Service Tips	Art Margolis	12
The ABCs of Color Television Servicing: Part V, Chroma Circuits: Operation & Troubleshooting	Forest H. Belt	41

YOUR LIBRARY

Broadsides		14
Good Reading	Tim Cartwright	40

NEW PRODUCTS

Electronic Marketplace		21
------------------------	--	----

HOBBY & BUSINESS OPPORTUNITIES

Swap Shop		14
Classified Ads		104

REGULAR DEPARTMENTS

Uncle Tom's Corner	Tom Kneitel, K2AES/KQD4552	6
Feedback		10
Product Information Service		23
Subscription Blank		100

NOTE: Part II of *Build the Micro Oscilloscope for Your Test Bench* and some of our Regular Departments have been withheld from this issue to make room for our Special Section on Pleasure Boat Electronics. They will appear in our next issue.

Dazzle your friends with lightworks.



Sound n' Color

The new dimension to music pleasure. EICO All Electronic Solid-State Audio-Color Organs transform sound waves into moving synchronized color images. Connect easily to speaker leads of hi-fi or radio. From \$29.95.



Translators

The electronics you need to create audio-stimulated light displays to your own imagination. Actuates: Light Display Units, Strobe Lites, any lamp configuration (Xmas trees, patio lights, etc.). From \$24.95 kit, \$39.95 wired.



Strobe Lites

High-intensity bursts of white light from Xenon tube flash in cadence with each beat of audio. From \$24.95 kit, \$39.95 wired.

Build the Stereo Kits praised by experts.

All amplifier power ratings according to IHF standards. Cortina® designed and manufactured in U.S.A. and guaranteed by EICO.

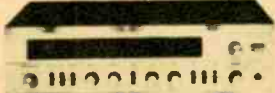

70-Watt AM/FM Stereo Receiver including cabinet. Cortina 3770, \$189.95 kit, \$279.95 wired.

70-Watt FM Stereo Receiver including cabinet. Cortina 3570, \$169.95 kit, \$259.95 wired.



150-Watt Silicon Solid-State Stereo Amplifier, including cabinet. For the audio perfectionist. Cortina 3150, \$149.95 kit, \$225 wired.

70-Watt Silicon Solid-State Stereo Amplifier, including cabinet. Cortina 3070, \$99.95 kit, \$139.95 wired.



FM Stereo Tuner including cabinet. Cortina 3200, \$99.95 kit, \$139.95 wired.



EC-1100
FM WIRELESS MIKE \$9.95

Build for fun and use with Eicocraft jiffy project kits.

The newest excitement in kits. 100% solid-state and professional. Expandable, interconnectable. Excellent as introductions to electronics. No technical experience needed. Finest parts, pre-drilled etched printed circuit boards, step-by-step instructions. 36 kits to select from, \$2.50 to \$9.95. Just released: EC-2600 "Super Snoop" \$8.95; EC-2700 Police & Fire Converter



(to band) \$7.95; EC-2800 Aircraft Converter \$7.95; EC-2900 Police & Fire Converter (hi band) \$7.95; EC-3100 2-Station Intercom (with cases) \$10.95; EC-3200 "Do-It-Yourself" PC Etching Kit \$4.95; EC-2300 Audio Preamplifier \$8.95; EC-2400 Bullhorn \$8.95; EC-2500 Fuzzbox \$8.95.



EC-1900 TREASURE FINDER \$9.95

Shape up your own car/boat with EICO Engine Analyzer

For all 6V/12V systems; 4, 6, 8-cyl. engines. Now you can keep your car or boat engine in tip-top shape with this solid-state, portable, self-powered universal engine analyzer.

Completely tests your total ignition/electrical system. Complete with comprehensive Tune-up & Trouble-shooting Manual. EICO 888, \$49.95 kit, \$69.95 wired.



The first and only solid state test equipment GUARANTEED FOR 5 YEARS

Only EICO brings you laboratory precision and long life at lowest cost.



EICO 240 Solid-State FET-TVOM \$59.95 kit, \$79.95 wired



EICO 379 Solid-State Sine/Square Wave Generator \$69.95 kit, \$94.50 wired



EICO 242 Solid-State Deluxe FET-TVOM \$69.95 kit, \$94.50 wired

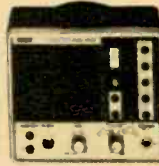

EICO 150 Solid-State Signal Tracer \$49.95 kit, \$69.95 wired



EICO 330 Solid-State RF Signal Generator \$59.95 kit, \$84.50 wired

You save up to 50% with EICO Kits. Since 1945, Best Buys in Electronics. Over 3 Million EICO Instruments Now in Use.

FREE 1970 CATALOG

Send me FREE catalog describing the full EICO line of 200 best buys, and name of nearest dealer.

EI-3



EICO Electronic Instrument Co., Inc.
283 Malta Street, Brooklyn, N.Y. 11207
Available in Canada

Name _____

Address _____

CIRCLE NUMBER 6 ON PAGE 23

Fast easy soldering is a gift from

Weller®

Give a Weller soldering tool for Christmas and you give a man the ability to make secure soldered connections quickly and easily. And because no other soldering tools match Weller for features and dependability, you know you're giving the best.



8-Piece Dual Heat Soldering Gun Kit

Gun tip heats instantly when trigger is pulled. Two trigger positions for instant switching to high 140 watt or low 100 watt heat. Built-in spotlight. Included: 3 soldering tips, tip wrench, flux brush, soldering aid, solder, plastic case. Model 8200PK. **\$95** list



New TEMPMATIC® Temperature Controlled Soldering Tool

Combines all the advantages of a fast heating soldering gun, a lightweight pencil iron and tip temperature control. Gives maximum component protection in the most delicate work situations. Yet it does heavy jobs like chassis soldering. Weighs only 7 ounces. Powerhead contains Weller's temperature control system. Model GT-7A has 700°F. $\frac{3}{4}$ " chisel point Powerhead. Model GT-6B has 600°F. conical **\$129** list

Weller MARKSMAN Soldering Iron Kit

Lightweight 25-watt iron outperforms all other irons of its size and price. Has replaceable tip, stainless steel barrel, cool handle. Included: 2 extra tips, soldering aid, solder. Model SP-23K. **\$44** list



WELLER ELECTRIC CORPORATION, EASTON, PA.
— WORLD LEADER IN SOLDERING TOOLS —

CIRCLE NUMBER 12 ON PAGE 23

ELECTRONICS ILLUSTRATED

By the Publishers of MECHANIC ILLUSTRATED

editor **ROBERT G. BEASON**
 managing editor **Robert D. Freed**
 feature editor **Clifford L. Forbes**
 art editor **Lou Rubsamen**
 editorial associate **Jean E. Lee**
 production editor **Priscilla Moody**
 adv. director **John F. Webster**
 eastern adv. mgr. **Stanley Tessler**
 publisher **George H. Allen**

CONTRIBUTING EDITORS
 amateur radio **Wayne Green, W2NSD/1**
 citizens band **Len Buckwalter, KQA5012**
 swl-dx **C. M. Stanbury II**
 special projects **Herb Friedman, W2ZLF/KBI9457**
 service **Art Margolis**
 audio **Harry Kolbe**
 audio **John Milder**

EXECUTIVE STAFF
 chairman of the board **W. H. Fawcett, Jr.**
 president **Roger Fawcett**
 secretary-treasurer **Gordon Fawcett**
 circulation director **Roscoe K. Fawcett**
 vp., magazine div. **George H. Allen**
 vice president **Ralph Daigh**
 circulation manager **Luther Bugbee, Jr.**
 vp., comptroller **F. Paul Simmering**
 production director **Thomas R. Marvel**
 vp., art director **Al Allard**
 art director **Ralph Mattison**

ELECTRONICS ILLUSTRATED is published bi-monthly by Fawcett Publications, Inc., Fawcett Bldg., Greenwich, Conn. 06830. Second-class postage paid at Greenwich, Conn., and at additional mailing offices.

EDITORIAL OFFICES: 67 W. 44th St., New York, N.Y. 10036 (phone 212-661-4000). Contributions must be accompanied by sufficient postage and will be handled with care, though the publishers assume no responsibility for return thereof.

ADVERTISING OFFICES: 67 W. 44th St., New York, N.Y. 10036 (phone 212-661-4000); 101 E. Ontario St., Chicago, Ill. 60611 (phone 312-DE 7-4680); 1532 Guardian Bldg., Detroit, Mich. 48226 (phone 313-WO 2-4860); 2978 Wilshire Blvd., Los Angeles, Calif. 90005 (phone 213-DU 7-8258); 681 Market St., San Francisco, Calif. 94105 (phone 415-EX 7-3441); 1422 W. Peachtree St., N.W., Atlanta, Ga. 30309 (phone 404-TR 5-0373); 123 S. Broad St., Philadelphia, Pa. 19109 (phone 215-PE 5-3636).

SUBSCRIPTIONS: \$3 per year (6 issues) in U.S. and possessions and Canada. All other countries \$4 for 6 issues. All subscription correspondence, including changes of address (Form 3579), should be addressed to **ELECTRONICS ILLUSTRATED**, Subscription Dept., Fawcett Bldg., Greenwich, Conn. 06830. Foreign subscriptions and sales should be remitted by International Money Order in U.S. funds payable at Greenwich, Conn.

COPYRIGHT © 1970 by Fawcett Publications, Inc. The title **ELECTRONICS ILLUSTRATED** is registered in the U.S. Patent Office. Reproduction in whole or in part is forbidden without written permission of the publishers; however, permission is hereby granted to quote from this issue of this magazine on radio or television, provided a total of not more than 1,000 words is quoted and credit is given to the title of this magazine and issue, as well as the statement, copyright 1970, by Fawcett Publications, Inc. Member ABC, MPA.

PRINTED IN U.S.A. BY FAWCETT-HAYNES PRINTING CORP., LOUISVILLE, KY. 40201. Microfilm copies of current and back issues are available from University Microfilms, 313 N. First St., Ann Arbor, Mich. 48103

Grantham School of Engineering EI-3-70
 1505 N. Western Ave., Hollywood, Calif. 90027

Gentlemen:

Please mail me your free Bulletin which explains how the Grantham home-study educational program can prepare me for my Associate in Science Degree in Electronics Engineering.

Name _____ Age _____

Address _____

City _____ State _____ Zip _____

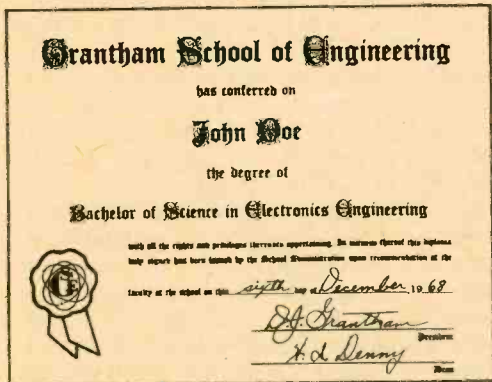
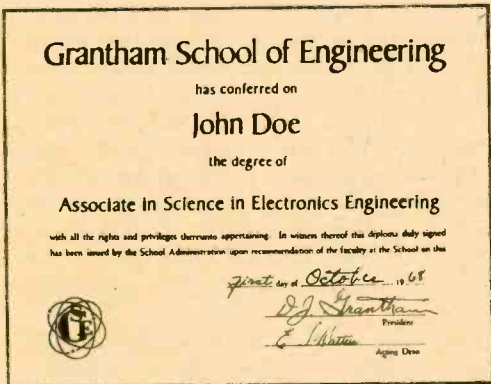

Grantham School of Engineering
 Home Study Division



1505 N. Western Ave.
 Hollywood, Calif. 90027

Telephone:
 (213) 469-7878

March, 1970

Three Big Steps
 to Success...
 in

**ELECTRONICS
 ENGINEERING**

There they are—three big steps that lead electronics technicians to *greater success*—three deliberate steps to *greater recognition* and *more income*. Your future is shaped by the moves you make—by the steps you take. Begin now with Step #1.

STEP #1 is a simple request for full information on the Grantham Electronics Degree Program. You take this first step by filling out and mailing the coupon. Then, we mail our catalog to you; we do not send a salesman.

STEP #2 is earning your Associate in Science Degree in Electronics Engineering (the ASEE). If you have completed at least one year of fulltime experience as a bona fide electronics technician, you may earn your ASEE Degree almost entirely by correspondence—including a minimum resident attendance of only two weeks.

STEP #3 is earning your Bachelor's Degree in Electronics Engineering. Upon earning your ASEE Degree you may have reached your objective, or you may wish to continue and earn your BSEE Degree. The Grantham BSEE Degree program is offered in evening classes in Hollywood, and is designed especially for employed engineering technicians who hold the ASEE Degree.

Accreditation and G.I. Bill Approval

The Home Study Division of Grantham School of Engineering is accredited by the Accrediting Commission of the National Home Study Council. Both the Home Study Division and the Resident Division are approved under the G.I. Bill, and both divisions are legally authorized to grant academic degrees.

The Home-Study Method

Grantham School of Engineering is a *specialized*, college-level, educational institution—established in 1951—which teaches engineering by the so-called "new approach." This is the method (often referred to by names such as "independent study") that has recently created great interest among college educators. Actually, this "new approach" is not new at all. Grantham and many other good schools have been using it for years, under such names as "home study" and "correspondence instruction."

Now that the method has become "respectable" and is being used by reputable colleges to lead to bachelor's degrees, Grantham can offer electronics technicians the opportunity to study for an accredited ASEE Degree mostly by correspondence. As a technician, you already know the "hardware" side of electronics, and you can upgrade from technician to engineer while you continue your employment as a technician. Get complete details. Mail the coupon for our free bulletin.



Uncle Tom's Corner

By Tom Kneitel, K2AES/KQD4552

Uncle Tom answers his most interesting letters in this column.
Write him at Electronics Illustrated, 67 West 44th St., New York, N.Y. 10036.

★ *I'm just starting out in radio and want to buy a good general-coverage receiver which also picks up ham bands. I want to spend about \$400, but salesmen I have talked to suggest different sets. I don't want to be railroaded into buying a set which was suggested solely because it happens to be a high-commission item for a salesman. What do you suggest?*

*George M. Bean
Pittsburgh, Pa.*

★ *I have a low-cost receiver which tunes from the broadcast band to 30 mc. It does a good job up to about 20 mc, but then becomes silent and won't even crackle with static. What's my problem?*

*Randy Hutcheson
Lincoln, Neb.*

★ *Recently I purchased a cheap general-coverage receiver for SWLing. At many points on the dial I can pick up the audio portions of TV programs. The signals are strong but badly distorted. How can I cure this?*

*Joel Gannett, WNØZBS
Davenport, Iowa*

These letters point up the dilemma which seems to snag many newcomers. As far as I am concerned, a rank beginner doesn't need to spend \$400 to achieve general coverage. But if you wind up with a cheapie set you've got problems. While a tunable preselector would probably help readers Hutcheson and Gannett, they would have made a better investment had they picked up a decent name-brand receiver right from the start.

Anybody seriously interested in pursuing SWLing or Novice hamming should be prepared to spend a bare minimum of \$150 on a receiver. Although the latest Japanese solid-

state rigs do an excellent job for only \$100 if your funds are limited. Reader Bean can explore the bands in high style for about half of what he is planning to spend. However, if you're planning on branching out into ham radio, then a ham-band-only receiver is the thing to buy.

★ **Secrecy Dept.** With each passing year, governmental agencies have forgotten an inch or two more of the secrecy of communications provision (Section 605) of the FCC's Communications Act—so that now they don't even make the pretense that it exists. Telephones and rooms are bugged at the whim of even the most insignificant martinet in the bureaucratic structure. On the other hand, the public is quietly forced to tow the mark on Section 605 with increasing severity.

Latest tightening of the choker is the FCC's recent decision to force a major electronic retailer to stop selling SCA receivers on the grounds that their use by the public violates secrecy of communications regulations. SCA receivers permit reception of background music which is sent piggy-back on the signals of many FM broadcast stations. The signals are undetected by the listener using a regular FM receiver, but an SCA receiver permits them to be filtered through regular broadcast signals, giving the listener continuous, uninterrupted background music.

The FCC's previous standards on violations of Section 605 did not prevent an individual from sitting in the privacy of his home and tuning to any and all radio frequencies, providing that he did not reveal the contents of any transmissions (except on the ham and broadcast bands) or derive any kind of personal or business advantage from their contents. That's all out the window now. The background-music industry's lobby persuaded the rulemakers that the personal enjoyment the home listener gets from SCA music is a violation of Section 605. Thus, the FCC has taken another major step towards total con-

[Continued on page 8]

LAFAYETTE®

YOUR ONE SOURCE FOR EVERYTHING IN ELECTRONICS!

**SOLID-STATE BATTERY/ELECTRIC 4-BAND TWIN SPEAKER
AM/FM/POLICE/AIRCRAFT RADIO**



99-35503W*

34⁹⁵ Was 44.95
SAVE \$10.00

Price in Effect Thru March 1, 1970

- 147-174 MHz FM/VHF Police Band
- 108-136 MHz Aircraft Band
- 88-108 MHz FM Band
- 540-1600 kHz Standard AM Band

**Model RK-70 SOLID-STATE
PORTABLE CASSETTE
RECORDER**

24⁹⁵

- Ideal For Office and Classroom
- Automatic Record Level Control
- 5-Pushbutton Controls Including Cassette Pop-Up



27-01738L*

**6½" DWELL
TACHOMETER**

28⁹⁵

- Electronically Tunes Up Any Car
- Three Dwell Scales plus Dual Range Tachometer For Carburetor Adjustments
- Operates on 4, 6 or 8 cylinder—6 or 12 Volt



11-01013W

**HB-23 SOLID-STATE MOBILE 23-CHANNEL
Crystal-Controlled CB Transceiver**



99-31494WX*

FCC TYPE ACCEPTED
D.O.T. APPROVED

99⁹⁵

Comes with crystals for 3 channels (9, 13 and 19), but its unique frequency-synthesis circuit makes all 23 channels available at low cost. Each time you buy one of the 10 optional plug-in crystals you add 2 more channels . . . lets you add your choice of extra channels at any time, economically!

FREE!

1970 Catalog 700



*Imported.

Featuring Everything In Electronics

- Stereo Hi-Fi • Citizens Band • Amateur Gear
- Tape Recorders • Test Equipment • TV and Radio Tubes and Parts • Cameras • Musical Instruments • Auto Accessories • Tools • Books

LAFAYETTE Radio ELECTRONICS
Dept. 29020 P.O. Box 10
Syosset, L.I., N.Y. 11791

Send me the FREE 1970 Lafayette Catalog 700
29020

Name _____
Address _____
City _____
State _____ Zip _____

CIRCLE NUMBER 8 ON PAGE 23

Have your own Radio Station!

Learn AMATEUR RADIO



AT HOME IN YOUR SPARE TIME

Get your Amateur Radio license and "go on the air." NRI, leader in Electronics home training for more than 50 years, offers a choice of training plans leading to required FCC licenses, ranging from Basic Amateur Radio for the beginner to Advanced Amateur Radio for the ham who already has a license and wants to move up.

HAM RADIO EQUIPMENT INCLUDED

NRI's beginner's course includes your own Novice Class 25-watt transmitter, 3-band receiver and transistorized code practice oscillator with code key and headset. You learn code using special LP records. Choose from 3 Amateur Radio courses. Low tuition. Monthly payment plans. Get all the facts. Mail coupon. No salesman will call. NATIONAL RADIO INSTITUTE, Washington, D.C. 20016.



.....MAIL COUPON TODAY.....

NATIONAL RADIO INSTITUTE 53-030
Washington, D.C. 20016

Please send me information on Amateur Radio training.

Name _____ Age _____

Address _____

City _____ State _____ Zip _____

ACCREDITED MEMBER NATIONAL HOME STUDY COUNCIL

UNUSUAL BARGAINS FREE! GIANT CATALOG

VISUAL EFFECTS PROJECTOR SET

Dazzling, avant-garde visual effects. Fantastic variety. Incredibly beautiful. Special package offer contains all necessary apparatus: floating, exploding, fiery bursts of color like "Symphony of Spheres," "Chromatic Starbursts," "Crystal Starbursts." Features 35mm 800 W. fan cooled projector—produces big image at short distance. Accepts two 3" diam. wheels (Dry Kaleidoscope & Hexidosecope), 2 cylindrical accessories (6" Colored internal mirrored walls). Perfect for Cloud & 5" Hexidosecope w/air entertaining, parties, photography. Complete instructions. \$79.50 Ppd. Stock No. 71-212EB

3-CHANNEL COLOR ORGAN BARGAIN!

Create tremendous variety of unusual & beautiful lighting effects with this low-cost top quality, 1500 Watt unit (500 W. per channel). Compares with others selling for twice the price. Has pilot lights plus individual sensitivity controls & channel indicator lights. Can operate ten 150 W. "spots" or 200 Xmas lights. Uses reg. house current—attaches to audio source w/RCA-type phono plug. 2 1/2" x 9 1/2" x 2 1/2". 2 1/2 lbs. Thermal setting plastic case. 6 ft. cord. Incl. compl. instruct. \$34.95 Ppd. Stock No. 71-223EB

'BRIGHT IDEAS' IN UNIQUE LIGHTING

Big New 100 page handbook packed with facts, loaded with illustrations. All latest developments, applications, equipment. 8 1/2" x 11" looseleaf paper punched to fit 3 ring binder. \$3.00 Ppd. Stock No. 9100EB

Order by Stock No.—Send Check or M.O.—Money-Back Guarantee.
EDMUND SCIENTIFIC CO., 300 EDCORP BUILDING, BARRINGTON, N.J. 08007

GIANT FREE CATALOG

148 PAGES!—1000's OF BARGAINS

EDMUND SCIENTIFIC CO., 300 EDCORP BUILDING, BARRINGTON, NEW JERSEY 08007
Completely new 1970 edition. New items, categories, illustrations. Dozens of electrical and electronic items. Enormous selection of Astronomical Telescopes, Microscopes, Binoculars, Magnifiers, Magnets, Lenses, Prisms. Many war surplus items: for hobbyists, experimenters, workshop, factory.



WRITE FOR CATALOG "EB."

CIRCLE NUMBER 16 ON PAGE 23

Uncle Tom's Corner

Continued from page 6

trol of your right to listen how, when and to whatever you wish.

★ I read an article once on radar speed meters. It said that there was a completely legal way to throw radar signals out of whack when they're beamed at your car. It's done by gluing a rubber membrane over the face of a 15-in. speaker and then pasting 6-in. aluminum-foil strips on the membrane. The speaker is then mounted on the front of the car; when a 2-kc signal is fed into the speaker, your car should not register properly on their speed indicator. Will such a gadget really work?

David Grassbaugh, WNSWVG
Corpus Christi, Tex.

Probably, by throwing the meter's doppler shift out of gear. But a 15-in. speaker tacked to the hood of your Hudson isn't going to let you go fast enough to make the effort worthwhile.

★ In reference to your comments (July '69 EI) which stated that hams have been bothered for years by broadcasters but nobody seems to care. As a ham yourself you should be better informed and not hand out false information. Look up the ARRL Intruder Watch—I am a member. It will inform you about who cares and who doesn't.

WA0TNQ
Minneapolis, Minn.

When I said nobody cares, I didn't mean the ham operators. Hams are the only ones who do care, though, and their concern is of little interest to 300 broadcasters who are fully licensed and operating within their rights. The ARRL's project, like most other League efforts of late, was started to pacify the troops and keep them busy. The idea is to amass tons of evidence of broadcast interference and then yell about it at the next International Frequency Conference with the aim of evicting the broadcast stations.

I wonder what these broadcasters will have to say at the conference and who might be bounced if it comes to a showdown. If this ARRL project does as much for ham radio as some of their other boondoggles (like incentive licensing) then you'd better do some boning up on the joys of SWLing.

THE CALECTRO SUPERMARKET



EVERYTHING IN ELECTRONICS!



VARIABLE BALANCE STEREO HEADPHONE
 Unique "Sound Level" control on each earpiece permits adjustment.
 Frequency range: 20 to 20,000 cps
 6 1/2' cord with stereo plug. Impedance: 4 to 16 ohms
 Cat. No. Q4-132 \$17.95 Net

MINIATURE LAMPS



Type PR2 - 2.5 volt - 0.50 amp -
 Cat. No. E2-430 - Pkg. of 2 \$2.29 Net
 Type PR3 - 3.6 volt - 0.50 amp -
 Cat. No. E2-431 - Pkg. of 2 \$2.29 Net



TAPE RECORDER MICROPHONE
 Outstanding performance on music and speech for the price. Low impedance matches late model solid state recorders. Removable desk stand; 4 1/2' cord with dual plugs that fit most models. Freq. Response: 100-8k Hz. Output: -77 dB. Impedance: 200 ohms
 Cat. No. Q4-105 \$4.95 Net

AUDIO ADAPTORS

"Y" Audio Adaptor has a phono pin jack on one end and dual phono pin plugs on the other.
 Cat. No. Q4-280 \$3.99 Net



RESISTORS

Attractively packaged 2 per pack, showing values, color codes and formulas.

Type	Rating	Available	Price	Unit
Carbon	1/2 Watt	10 Ohm - 10 Meg	\$.19	Pkg. of 2
Carbon	1 Watt	10 Ohm - 1 Meg	.19	Ea.
Carbon	2 Watt	10 Ohm - 100K	.25	Ea.
Wire	10 Watt	10 Ohm - 15K	.36	Ea.



HOBBYIST'S SOLDERING AND TOOL KIT

Diagonals, long nose pliers, soldering iron and solder, solder aid tool, heat sink, and screwdriver. An ideal gift item.
 Cat. No. M-378 \$7.95 Net.



STANDARD 1000 VOLT CAPACITOR
 High quality, compact and reliable. Minimum capacity change with varying temperature. Rating: 1000 volts; tolerance: 20%.

Cat. No.	Description	Net	Unit
A1-060	220pf	\$.25	Pkg. of 2
A1-061	330pf	.25	Pkg. of 2
A1-062	470pf	.25	Pkg. of 2
A1-063	680pf	.25	Pkg. of 2
A1-064	0.001uF	.19	Ea.
A1-065	0.005uF	.19	Ea.
A1-066	0.01uF	.19	Ea.

EXPERIMENTER'S CIRCUIT BOARD KIT

Contains a 3 1/2" x 4" perforated board - 15 terminals (No. M-636) and 4 mounting feet/screws. Build small circuits, hobby and science projects, etc.
 Cat. No. M-560 \$3.98 Net



The "GC Calectro Hobbyist Handbook" is available at your nearest Calectro Electronic Supermarket. One is located near you. WRITE TODAY and we'll rush you the name and address of your nearest Calectro Supermarket.



TWO STATION WIRELESS INTERCOM
 Just plug into any electrical outlet. Completely portable. Expand system anytime with additional units. Two unit system complete in display pack.
 Cat. No. M-113 \$34.95 Net

CALECTRO G-C ELECTRONICS

400 SO. WYMAN ST. ROCKFORD, ILLINOIS 61101



A DIVISION OF
 HYDROMETALS, INC.

CIRCLE NUMBER 4 ON PAGE 23

Feedback from Our Readers

Write to: Letters Editor, Electronics Illustrated, 67 West 44th St., New York, N. Y. 10036

● INSIDE STORY

You roundeyes don't believe everything the Army tells you about electronics in the Signal Corps, do you? I certainly hope not judging by the accuracy of the caption appearing on page 40 of your article (THE REAL TRUE FACTS ABOUT MILITARY ELECTRONICS TRAINING, Sept. '69 EI). It's funny to see the same equipment that I've been working on for seven months called radar. If Track-29 (AN/TRC-29) is radar than I am a sergeant-major. When the rest of the team on the site saw the photo we figured that one of those second lieutenants in the class must have given you the information. For what it's worth, Track-29 is line-of-sight microwave communications gear.

SP5 J. Bennett
Ninh Hoa, Vietnam

● LARGE SCREAM

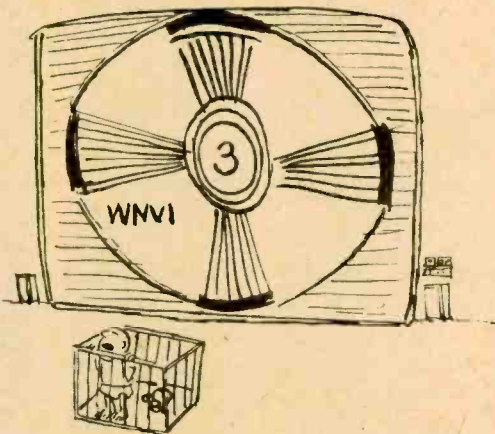

John Milder's article on WHAT'S AHEAD FOR HI-FI (Jan. '70 EI) mentions that wall-size TV may be the thing of the future. Can you imagine all the violence that's on TV magnified to that extent? Heck, even a station pattern will frighten our children!

Paul Emery
Tacoma, Wash.

● DOWN UNDER

I was happy to see that a new series on DXing in various parts of the world started with the DX SCENE IN NEW ZEALAND (Nov. '69 EI). Being a New Zealander, I

was especially interested in the article. However, I did notice a mistake. There are 46 MW stations in New Zealand, not 33, as you state. Most of these run ultra-high power.

Ross Wood
Chevy Chase, Md.

● BIGGEST CHEESE



In your article on Granny Goose (Ronald Ramsey) in the Jan. '70 EI, you mention that Axis Sally and Lord Haw-Haw were the two most important broadcasters of propaganda during World War II. Obviously you weren't stationed in the South Pacific—you overlooked Tokyo Rose.

Michael Rotello
Louisville, Ky.

● PLUNK PUNK

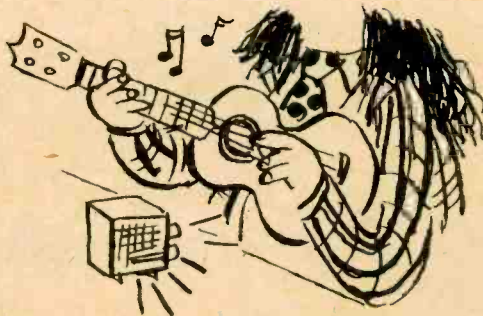

Look dad, your Mini Metronome (Jan. '70 EI) was a groovy project, but, like, where was the juice? I didn't dig the beat at first, so I put it through a 300-watt amp to get a real sound—almost blew my head off, man.

Peter—the Plunker—Hewett
Greenwich Village, U.S.A.—

Now there is a better Color-Bar Generator for your servicing work



THE RCA WR-502A.

New ... solid state ... battery or AC operated ... portable, weighing only four pounds.

The RCA WR-502A "CHRO-BAR" color-bar generator provides six separate test signals: color bars, dots, cross-hatch, vertical lines, horizontal lines, and blank raster.

The sound carrier, pattern, RF output, and color subcarrier are all crystal controlled. Designed for exceptional stability with no flicker.

Included as part of the package — at no extra cost — is an AC adaptor for line operation. This unit was formerly available only as an accessory at a cost of \$9.00*.

The new CHRO-BAR Generator WR-502A, complete with separate AC adaptor — now only \$148.50*.

RCA Electronic Components,
Harrison, N. J. 07029.

* Optional Distributor resale price.



CIRCLE NUMBER 25 ON PAGE 23

March, 1970

11

CLEAN YOUR TUNER THE PROFESSIONAL WAY! WITH TUN-O-FOAM

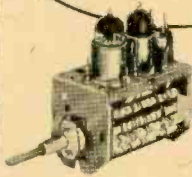

The pros know how to clean TV tuners so they really work. That's why more than 5 million tuners a year are cleaned, lubricated and restored by TUN-O-FOAM.

TUN-O-FOAM foams into the tightest places, melting away gunk and dirt. Then, it keeps on cleaning and lubricating contacts every time the channel is changed.

It's the only tuner cleaner that carries a six month guarantee. Try TUN-O-FOAM TODAY. It's easy to use and your set will play like new again.



1260 RALPH AVE.
BROOKLYN, N.Y. 11236

FOR EXPORT: BOBURN AGENCIES INC., NEW YORK, N.Y.

CIRCLE NUMBER 5 ON PAGE 23

Quick, easy access to thousands of vital electronic circuits



This first-of-its-kind book contains over 3,000 electronic circuits, complete with values of all components. Covers many specialized as well as everyday circuits—all arranged in logical sequence to help you create new circuits quickly.

SOURCEBOOK OF ELECTRONIC CIRCUITS

By JOHN MARKUS

888 pages, over 3000 illustrations, \$19.75

McGRAW-HILL BOOK COMPANY
330 W. 42nd St., N.Y., N.Y. 10036

Send me Markus's SOURCEBOOK OF ELECTRONIC CIRCUITS (404434) for 10 days on approval. In 10 days I will remit \$19.75, plus delivery costs and local tax (if any), or return postpaid.

Name _____

Address _____

City _____

State _____ Zip _____

23-E1-170

CIRCLE NUMBER 7 ON PAGE 23

SERVICE TIPS

By
ART MARGOLIS

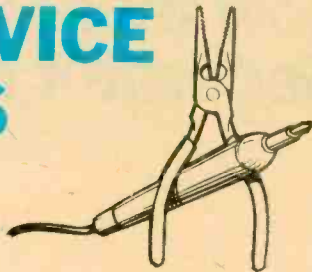

WHEN changing transistors, dual diodes or other such components in tight spots on PC boards, be sure to cut the leads to different lengths. This way you can insert one lead at a time into the holes instead of having to manipulate three or more leads into holes at the same time. The extra lengths can be snipped off after soldering.

Remember that a battery test, regardless of size, should not be just a straight voltage measurement.

You must load down the battery or even the weakest variety will give a full-voltage indication. Just take a 100-ohm resistor and short it across the test leads, as shown in the diagram. If the battery reads okay with this load, it's probably good. If not, discard it.

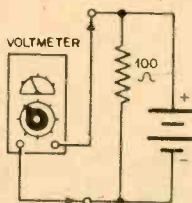

A good way to locate capacitors or resistors that are breaking down under heat is to use a freezing agent which comes in a spray can. Turn on the equipment, then wait until the trouble occurs. When you spray the culprit it will freeze and the trouble will disappear for a time. Substitution is the answer.

Confusing problem in vacuum-tube, instant-on TV sets is exhibited by symptoms of a dead set but with tube filaments still lit. It usually turns out that there is no B+ voltage present anywhere in the set. What happened? The power switch is open but the filaments still get power by means of a diode placed across the switch.

Don't defeat three-wire (safety) plugs on electrical equipment. They are there for a purpose—to ground the case. In fact, it's a good idea to install the third wire whenever possible. This way you can be sure that a metallic case on appliances and test equipment is at ground potential.

Small speakers are a problem. It's amazing how many items (TVs, etc.) are supplied with them. Audio distortion at low volume invariably results from a bad speaker. The voice coil sometimes rubs, the cone dries out or the small cone simply cannot vibrate well at low power levels. Always test by replacing the speaker—preferably with a bigger one if it's possible.

Electric shoe polishers draw a lot of current from batteries, so the batteries tend to run down. When contact lugs get corroded take small pieces of brass and replace them.

Electronics Illustrated

*It took more than skill
to design the world's
smallest complete mobile
5-watt CB
transceiver*



Johnson Messenger 125

\$99⁹⁵



Only the famous Johnson "talk-power" is big as ever on Johnson's radically new Messenger 125! Virtually every vehicle on the road, including the 1969 and 1970 models, can easily accommodate this versatile new radio. Its far-ahead features make operation extremely simple and enjoyable. Best of all, we sliced the most out of the price!

Features

- 5 push button channels—no knobs
- slide-lever vol. and squelch
- World's smallest panel configuration— $1\frac{1}{8}$ " by $4\frac{1}{32}$ ", just 7" deep
- 4 watts output at 13.8 VDC
- Accessories for portable use



E. F. JOHNSON CO.
WASECA, MINNESOTA 56093

Broadsides

Pamphlets, booklets, flyers, application notes and bulletins available free or at low cost.

IF you're ever up the creek with equipment having dirty contacts, noisy switches, dirty tape heads, etc., an eight-page catalog of electronic servicing chemicals made by Chemtronics, Inc., 1260 Ralph Ave., Brooklyn, N.Y. 11236, will be just the thing. It's free to distributors and TV technicians upon request. Included are tuner sprays, contact and control cleaners, insulating sprays and lubricants.

RCA has a new battery guide which covers types of more than 300 manufacturers. The brochure runs to 28 pages and has suggested list price of 25 cents. Batteries for radios, phonographs, tape recorders, CB gear, etc. are among those listed. Write for Replacement Guide BAT-137 from RCA Electronic Components, Harrison, N.J. 07029.

Looking for a skyhook that'll get your signal airborne? You might want to look at the Hustler line of CB antennas for 1970 in their 28-page catalog which lists over 80 different models. Items range from center-loaded mini antennas to base station arrays, monitor antennas and mobile antenna accessories. For your free copy write to Sales Dept., New-Tronics Corp., 15800 Commerce Park Dr., Brookpark, Ohio 44142.

A new 1970 Home Entertainment and Electronics catalog is available from Sears, Roebuck and Co., Dept. 657, 925 S. Homan Ave., Chicago, Ill. 60607. It's free, just specify catalog number 39AL-7166. As usual, just about everything in consumer electronics equipment is inside its 68 pages.

An eight-page brochure describes the Bogen line of solid-state intercom systems. Included are Series IM, IE and IE-4S, along with wiring diagrams and applications. Write for free catalog No. 431 from Bogen Communications Div., Lear Siegler Inc., Box 500, Paramus, N.J. 07652.

A new guide to stereo components is available from Scott. A series of illustrated brochures describes their 1970 line in detail. This includes receivers, tuners, amplifiers, speakers and kits. Novel features such as tuning indicators, plug-in modules and electronic circuit protection are described. For free copies, write to H. H. Scott, Inc., Dept. P, Maynard, Mass. 01754.

An MATV product guide is available from JFD Electronics Co., Systems Div., 15th Ave. at 62nd St., Brooklyn, N.Y. 11219. Called the TV Distribution Systems Catalog, it covers a complete line of solid-state 82-channel MATV equipment and is available free to dealers, distributors and installers. Its 16 pages deals with everything from antennas to terminators. ●

Swap Shop

Individual readers (not commercial concerns) may swap electronic gear by sending one listing, name and address to Swap Shop, ELECTRONICS ILLUSTRATED, 67 West 44th Street, New York, N.Y. 10036. Space is limited; only most interesting offers are published.

AUDIO & HI-FI

GE CAPSTAN-DRIVE tape recorder with AC adaptor, mike and 10 reels of tape. Want Panasonic or Aiwa cassette recorder with AC adaptor, mike and blank cassettes. Lyle Kruckenberg, WA3SUF, Rt. 2, Hazen, N.D. 58545.

CLARICON 32-W stereo amp and Goodmans speakers. Swap for Knight TD-1030 tape deck, KN-900 or similar tuner. Greg F. Miller, 2635 Crabtree La., North Brook, Ill. 60062.

VOX CHURCHILL PA amp, R/C transmitter & receiver, Twoer & VFO and three dynamic mikes. Will swap for 2- or 6-meter ham gear or will sell. Dave Bear, WA3MBP, 5 Atlas Ct., Greensboro, N.C. 27405.

WILSON cassette recorder (battery/AC). Will swap for 23-channel CB rig. Alan Goldstein, 1334 Virginia St., Far Rockaway, N.Y. 11691.

TAPE RECORDERS, CB gear, photo equipment. Want ham gear. Roland Kulish, 5075 Heisig St., Beaumont, Tex. 77705.

PLAYMASTER record player plus preamp, Weston 695(3A) power-level indicator. Want 54-174 mc public-safety receiver. R. N. Roth, 13617 Bell Rd., Caledonia, Wis. 53108.

SCOTT 22-W mono transistor amplifier and service manual. Want mono HF, ham gear. Tom McLaughlin, WB4NEX, College Box 622, North Manchester, Ind. 46962.

AMATEUR RADIO

AMECO R5A receiver. Swap for best offer. John Polran, 421 Willow Rd., Marengo, Ill. 60152.

IC ELECTRONIC KEYSER, range of 5 to 50 wpm with paddle; portable tape recorder. Swap for Heath Twoer, Sixer or other VHF gear. Rick Miller, WA9UAY, Rt. 3, Sumner, Iowa 50674.

JOHNSON Viking Challenger. Will swap for 2- or 6-meter converter, preamp, or other VHF equipment. Richard Allman, WN8EFY, 2019 South 8th St., Ironton, Ohio 45638.

CONAR model 500 receiver and manual. Want Heath GR-64 or similar receiver. Justin Bowser, 8215 Broadmoor, Caledonia, Mich. 49316.

HEATH DX-60B, HR-10B plus accessories. Want Eico Cortina stereo amp or best offer. David Jenkins, WB6YZO, 521 Potter St., Fallbrook, Calif. 92028.

NATIONAL NC-270 ham receiver. Will swap for low-band beam or best offer. Gary Prant, 320 White Birch Dr., Cinnaminson, N.J. 08077.

AMECO AC-1 Novice transmitter. Swap for best offer. Bruce Blechmann, WN2KJJ/KCL5574, 22-88 Mott Ave., Far Rockaway, N.Y. 11691.

VIBROPLEX semi-automatic key with extra counterweight, carrying case, lock and key. Swap for best offer. Lawrence Lazar, 3329 N. Seeley, Chicago, Ill. 60618.

KNIGHT T-60 transmitter (60 W). Assembled, new and works. Want BC-312, BC-342, BC-348 or similar surplus receiver. Samuel Hevener, K3JBU/8, 1088 Beachview Dr., Willoughby, Ohio 44094.

TRANSMITTERS, full assortment of radio parts. Will swap (or pay cash) for a Solovox. Fred Howard, Box 77, Hansen, Idaho 83334.

SHORT-WAVE LISTENING

LAFAYETTE HA-63A receiver. Will swap for best offer. James D'Amato, 2565 Marion Ave., N.Y., N.Y. 10458.

HEATH GR-64 SW receiver. Will swap for Swan VX-1 vox unit or Astatic GD-104 mike. William Halas, 51-08 Van Horn St., Elmhurst, N.Y. 11373.

HALLICRAFTERS S-38D receiver, 110 assorted tubes and TV parts. Swap for VHF-FM receiver, test equipment or best offer. Edward Bechler, 511 Allen, DeSoto, Mo. 63020.

[Continued on page 20]

The New 1970 Improved Model 257 **A REVOLUTIONARY NEW TUBE TESTING OUTFIT**

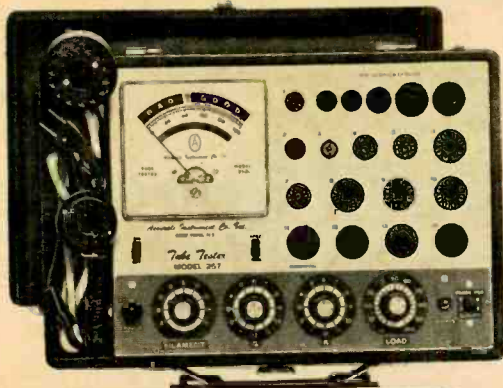

COMPLETE WITH ALL ADAPTERS AND ACCESSORIES, NO "EXTRAS"

STANDARD TUBES:

- ✓ Tests the new Novarás, Nuvistors, 10 Pins, Magnovals, Compactrons and Decals.
- ✓ More than 2,500 tube listings.
- ✓ Tests each section of multi-section tubes individually for shorts, leakage and Cathode emission.
- ✓ Ultra sensitive circuit will indicate leakage up to 5 Megohms.
- ✓ Employs new improved 4½" dual scale meter with a unique sealed damping chamber to assure accurate, vibration-less readings.
- ✓ Complete set of tube straighteners mounted on front panel.

The Model 257 is housed in a handsome, sturdy, portable case. Comes complete with all adapters and accessories, ready to plug in and use. No "extras" to buy. Only

BLACK AND WHITE PICTURE TUBES:

- ✓ Single cable used for testing all Black and White Picture Tubes with deflection angles 50 to 114 degrees.
- ✓ The Model 257 tests all Black and White Picture Tubes for emission, inter-element shorts and leakage.

COLOR PICTURE TUBES:

- ✓ The Red, Green and Blue Color guns are tested individually for cathode emission quality, and each gun is tested separately for shorts or leakage between control grid, cathode and heater. Employment of a newly perfected dual socket cable enables accomplishments of all tests in the shortest possible time.

\$52⁵⁰

NOTICE

We have been producing radio, TV and electronic test equipment since 1935, which means we were making Tube Testers at a time when there were relatively few tubes on the market, way before the advent of TV. The model 257 employs every design improvement and every technique we have learned over an uninterrupted production period of 34 years.

Accurate Instrument Co., Inc.

Pay Cash or in **EASY MONTHLY PAYMENTS AFTER 15 Day Trial!**

SEND NO MONEY WITH ORDER
PAY POSTMAN NOTHING ON DELIVERY

Try it for 15 days before you buy. If completely satisfied remit \$52.50 plus postage and handling charge. (If you prefer you may **PAY MONTHLY ON OUR EASY PAYMENT PLAN.**) If not completely satisfied, return to us, no explanation necessary.

ACCURATE INSTRUMENT CO., INC. Dept. 718
2435 White Plains Road, Bronx, N. Y. 10467

Please rush me one Model 257. If satisfactory I agree to pay at the terms specified at left. If not satisfactory, I may return for cancellation of account.

Name

Address

City State Zip

Save Money! Check here and enclose \$52.50 with this coupon and we will pay all shipping charges. You still retain the privilege of returning after 15 day trial for full refund.

CIRCLE NUMBER 11 ON PAGE 23

You get more for your money from NRI—

America's oldest and largest Electronic, Radio-Television home-study school

Compare. You'll find—as have so many thousands of others—NRI training can't be beat. From the delivery of your first lessons in the remarkable, new Achievement Kit, to "bite size," easily-read texts and carefully designed training equipment . . . NRI gives you more value.

Shown below is a dramatic, pictorial example of training materials in *just one* NRI Course. Everything you see below is included in low-cost NRI training. Other major NRI courses are equally complete. Text for text, kit for kit, dollar for dollar—your best home-study buy is NRI.

All this is yours—from Achievement Kit to the only Color TV specifically designed for training—when you enroll for NRI's TV-Radio Servicing course. Other courses are equally complete. But NRI training is more than kits and "bite-size" texts. It's also personal services which have made NRI a 50 year leader in the home-study field. Mail the postage-free card today.

Approved under GI BILL

If you served since Jan. 31, 1955, or are in service, check GI line in postage-free card.



GET A FASTER START WITH NRI'S NEW EXCLUSIVE ACHIEVEMENT KIT

The day your enrollment is received your Achievement Kit will be on its way to you. It contains everything you need to make an easy, fast start in the Electronics training of your choice. This attractive, new starter kit is an outstanding, logical way to introduce you to home-study the way NRI teaches it . . . backed by a dedicated staff and the personal attention you should expect of a home-study school. It is your first special training aid . . . designed to make your adventure into Electronics absorbing, meaningful. Your Achievement Kit contains your first group of lesson texts; rich vinyl desk folder to hold study material; the industry's most complete Radio-TV Electronics Dictionary; valuable reference texts; lesson answer sheets; envelopes; pencils, pen; engineer's ruler—even postage. No other school has anything like it.

LEARNING BECOMES AN ABSORBING ADVENTURE WITH NRI TRAINING KITS

What better way to learn than by doing? NRI pioneered and perfected the "home lab" technique of learning at home in your spare time. You get your hands on actual parts and use them to build, experiment, explore, discover. Electronics come alive! NRI invites comparison with training equipment offered by any other school. Begin NOW this exciting, practical program. It's the best way to understand the skills of the finest technicians—and make their techniques your own. Whatever your reason for wanting to increase your knowledge of Electronics . . . whatever your field of interest . . . whatever your education . . . there's an NRI instruction plan for you, at low tuition rates to fit your budget. Get all the facts about NRI training plans, NRI training equipment. Fill in and mail the attached postage-free card today.
NATIONAL RADIO INSTITUTE, Wash-
ington, D.C. 20016.

OVER 50 YEARS OF LEADERSHIP



IN ELECTRONICS TRAINING

Accredited by the Accrediting Commission of the National Home Study Council

NEW COLOR TV

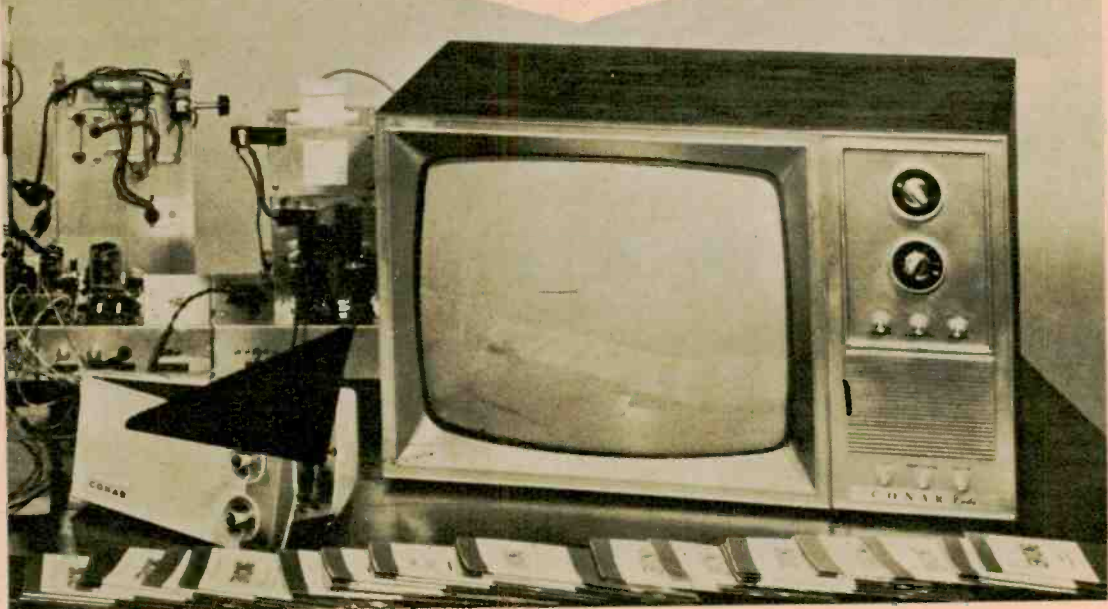

March, 1970

19

Build this magnificent Schober Theatre Organ



for only
* \$1730!

*Includes finished walnut console. Amplifier, speaker system, optional accessories extra. Only \$1256 if you build your own console.

You couldn't touch an organ like this in a store for less than \$3500—and there hasn't been a musical instrument with this vast variety of genuine Theatre Organ voices since the days of the silent movies! If you've dreamed of the grandeur of authentic big-organ sound in your own home, you won't find a more satisfying instrument anywhere—kit or no kit.

You can learn to play it. And you can build it, from Schober Kits, world famous for ease of assembly without the slightest knowledge of electronics or music, for design and parts quality from the ground up, and—above all—for the highest praise from musicians everywhere.

Send right now for your copy of the full-color Schober catalog, containing specifications of the five Schober Organ models, beginning at \$499.50. No charge, no obligation—but lots of food for a healthy musical appetite!

The *Schober* Organ Corp., Dept. EI-16
43 West 61st Street, New York, N.Y. 10023

- Please send me Schober Organ Catalog and free 7-inch "sample" record.
- Enclosed please find \$1.00 for 12-inch L.P. record of Schober Organ music.

NAME _____
ADDRESS _____
CITY _____ STATE _____ ZIP _____

CIRCLE NUMBER 18 ON PAGE 23

HEATH GR-64 receiver and GD-125 Q-multiplier. Want Heathkit HD-10 keyer. Doug Brede, WA3JH, 101 Twin Oaks Dr., Pittsburgh, Pa. 15237.

HALLICRAFTERS S-120 receiver. Will swap for best offer. Daniel Romanchik, 24249 Beierman, Warren, Mich. 48091.

KNIGHT VHF receiver (30-54 or 152-174 mc). Will swap for SW all-band receiver with Q-multiplier. Carl Iverstrom, 490 Main St., S.W., Wash. D.C. 20024.

SURPLUS BC-375E transmitter with TV-5-B tuning unit. Want hi- or low-band VHF-FM police monitor. Bob Langdon, 6 Sussex Pl., Deer Park, N.Y. 11729.

TRUE-TONE 5-band SW receiver with tuning eye. Will swap for base or mobile CB rig with crystals and antenna. Ray Brandt, Rt. 4, O'Fallon, Mo. 63366.

OTHER EQUIPMENT

LAMPKIN 250A FM modulation meter (25-500 mc). Want good receiver or oscilloscope. Tim Gieseler, 336 Hihn Rd., Ben Lomond, Calif. 95005.

CATHODE-RAY TUBE (3BP1-A), new and unused. Will swap for best offer. Randy Sandusky, 875 Saratoga Ave., San Jose, Calif. 95129.

VOM or VTVM wanted. Will trade as desired. Tony Buck, 415 Amesbury Dr., Gahanna, Ohio 43230.

ACCURATE Model 157 tube tester. Swap for signal generator plus manual, or hi-band VHF receiver. Henry Jenkins, 218 E. 7th St., Erie, Pa. 16503.

SURPLUS Navy scope (OS-29/UPM-4A) and radar analyzer (SM-45/UPM-4A), with power supply, instructions and schematic. Swap for best offer. Harvey Bodine, 460 S. 1st St., Silsbee, Tex. 77656.

EICO Model 666 tube/transistor tester, Philco Model G-3055BL 17-in. portable TV. Want best offer. Walter Mazurek, 301 W. 45th St., N.Y., N.Y. 10036.

MAGAZINES and books on electronics. Will swap for reel-to-reel tape recorder or test equipment. Dale Smith, 2202 Maysville Rd., Huntsville, Ala. 35811.

SLOT CAR sets (Revell & Strombecker) for both 1/32 and 1/24 scale cars. Want Heath IO-18 scope or best offer. Marty Wamsley, Box 22, Otway, Ohio 45657.

BANDPASS FILTER (FR-2409) wanted. Swap or pay cash. Ira Curtis, WAORGQ, 2526 E. 23rd. St., Des Moines, Iowa 50317.

KNOX 601 guitar amplifier. Want SW or ham equipment, or best offer. Barry Klein, 13122 St. Thomas Dr., Santa Ana, Calif. 92705.

BOOKS on electronics and amateur radio wanted. Swap for Aurora roadrace set. Martin Brosnan, 8699 Artesian, Detroit, Mich. 48228.

R/C MODEL Ford Mustang. Will swap for best offer. Tom Christian, 2212 North 106th, Seattle, Wash. 98133.

TUBES, assorted resistors & transistors, DeVry tech. course. Trade for Van de Graaff generator or test equipment. Steve Donahue, 1831 S. Cedar, Sioux City, Iowa 51106.

BACK ISSUES of EI, 40 issues of Scientific American (1962-1967). Swap for battery-operated antique radio. Alan Douglas, Box 225, Pocasset, Mass. 02559.

WESTERN ELECTRIC lineman's phone. Want 1-EP-1 cathode-ray tube or best offer. Jerry Keelin, 1311 N. Madden, Shamrock, Tex. 79079.

ASSORTED TUBES (85), all good, plus Telefunken T-20 mike. Will swap for Electro-Voice mike or guitar amp. George Tsotsos, 184 Canlish Rd., Scarborough 733, Ont., Canada.

NEW/CB TRANSCEIVER SOLID STATE PRE-AMP



- Improves CB Base Station Performance
- Works on tube or transistor equipment
- No Modification to CB unit
- On-the-air sign automatically lights when transmitting

Model PCB with built-in power supply, transfer relay, connecting cables, wired and tested..... \$59.95

Write for free literature



AMECO / DIVISION OF AEROTRON, INCORPORATED
P. O. BOX 6527 · RALEIGH, NORTH CAROLINA 27608

CIRCLE NUMBER 19 ON PAGE 23

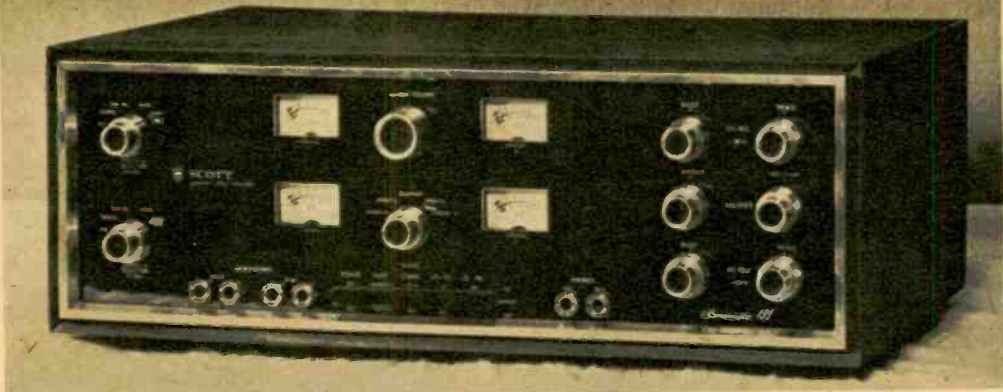

STEREO SQUARED. Model 499-Quadrant amplifier is designed to be compatible with current two-channel stereo and future four-channel programming. Mode switch selects either four-channel stereo, two-channel stereo on two or four speakers, or mono on two or four speakers. An acoustic dimension control permits left to right and front to rear balancing. \$599.95. H. H. Scott Inc., Maynard, Mass. 01754.

Electronic Marketplace



Quick Detection. Model 162 transistor and FET tester permits in-circuit and out-of-circuit testing of transistors, FETs, diodes, unijunctions, SCRs and Triacs. The tester comes with a programmed instruction guide which gives instructions on go-no-go conditions for Beta and leakage; this is said to eliminate need for reference manuals. The tester has front-panel sockets, five current ranges and current capability up to 1A. \$99.95. B & K Div., Dynascan Corp., Chicago, Ill. 60613.



SWLs On The Move. Got the camping bug? Want to stay in touch? Model S-120A solid-state Star Quest receiver tunes 540 kc to 31 mc and operates from either 117 VAC, or 12-V supply (D-cells, car battery or lantern battery) via external power jack. Has BFO, AM/CW/SSB reception on four bands. \$59.95. Hallcrafters Co., Rolling Meadows, Ill. 60008.

A FUNNY THING HAPPENED ON THE WAY TO THE MOON

by Bob Ward



Now they can be told! Hilarious true stories from behind the scenes of NASA—the wisecracks and practical jokes that kept the astronauts aloft even when the Apollo project seemed most earthbound...

A FAWCETT GOLD MEDAL BOOK

Buy this Gold Medal Book from your paperback bookseller. If he is sold out, send only price of book plus 10c for postage and handling to Gold Medal Books, Fawcett World Library, Greenwich, Connecticut 06830. If order is for five or more books, there is no postage or handling charge. Please order by number and title. No Canadian orders.

FIND BURIED TREASURE

\$28⁹⁵
post paid

60 DAY
UNCONDITIONAL
MONEY BACK
GUARANTEE

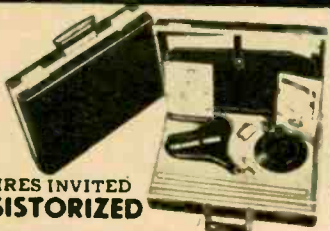

DEALER INQUIRES INVITED
ALL TRANSISTORIZED

Unclaimed Treasures Exceed
Combined Wealth Of All Nations
Electronics Changes Luck To Science.

All models find buried coins, gold, silver, war relics and signal thru earphone with loud "beep". Features silicon planar transistors, PC boards, two separated colpitts oscillators for maximum stability, thumbwheel tuner allowing one hand operation, 5" search head for most useful range. All complete in "Unilite" black attache case with slide action locks, keys, grey foam interior cushions instrument. Included are sensitive earphone, battery, fascinating 196-page book "Lost Treasures and How to Find Them", and instructions.

FREE bibliography "Treasure Maps & Books of US"

MAIL THIS COUPON TODAY!

- MAVERICK KIT** _____ only **\$28⁹⁵**
complete do it yourself instrument that we guarantee to work when completed.
- CONTINENTAL** _____ only **\$32⁹⁵**
completely assembled and ready to use
- IMPERIAL** _____ only **\$38⁹⁵**
an advanced model that includes a powerful built in speaker that automatically is disconnected when earphone is in use, completely assembled.

TO ORDER: send cash, check or money order. In N.J. add **TREASURE HOUSE**
3% Sales Tax. \$3.00 deposit for C.O.D. Dept. EGAO Trenton, N.J. 07763

CIRCLE NUMBER 24 ON PAGE 23

Electronic Marketplace

Mini-Rig. Raycom III 23-channel CB radio is designed for marine use or general-purpose base and mobile operation. Since circuitry employs synthesizing techniques, additional crystals are unnecessary; unit comes factory tuned for im-



mediate 23-channel operation. Transmit/receive relative-strength meter, illuminated channel selector switch, and squelch control are included. Accessories enable operation off of 117 VAC and either 24- or 32-VDC lines. Current drain in transmitting mode is 1.2 A from 12-VDC supply. A separate speaker can be accommodated. \$179. Raytheon Marine Products, San Francisco, Calif. 94080.

Sensitive Stereo. Model 4000 AM/FM stereo receiver incorporates four ICs and an FET front end in its solid-state design. Output of 160 watts IHF music power is claimed, providing continuous power of 65 watts per channel into 4 ohms. FM tuner sensitivity is said to be 1.8 μ V; selectivity, better than 40db at 98 mc; stereo separation, better than 35db. According to the manufacturer, the amplifier is flat from 10 cps



to 50 kc. Snapout, modular circuitry is used in the preamplifier, multiplex and driver sections for easier servicing and replacement. Outputs are available for three separate stereo speaker systems, as well as input and output connections for two extra tape recorders. Tuner section includes dual tuning meters, muting control, multiplex noise canceller, 300-ohm and 75-ohm FM antenna inputs and ferrite AM antenna. Amplifier has provision for headphone listening and DIN output for tape. Clip connectors are used for antenna and speaker terminals; power transistors are protected by fuses. \$379.95. Sansui Electronics Corp., Woodside, N.Y. 11377.

**ELECTRONICS
ILLUSTRATED**



Product Information Service



If you want more information about one or more of the products advertised in ELECTRONICS ILLUSTRATED, this service is for your convenience. The product information you request will be sent to you promptly free of charge.

Just complete the name and address portion of the handy coupon below and circle the PRODUCT INFORMATION SERVICE number or numbers you find beneath the advertisements in this issue.

**Mail the completed coupon to ELECTRONICS ILLUSTRATED
at the address shown — We'll take care of the rest.**

ELECTRONICS ILLUSTRATED This coupon will not be processed if received after April 15, 1970
P.O. BOX 7474, PHILADELPHIA, PENNSYLVANIA 19101

1	2	3	4	5	6	7	8	9	10	11
12	13	14	15	16	17	18	19	20	21	22
23	24	25	26	27	28	29	30	31	32	33
34	35	36	37	38	39	40	41	42	43	44
45	46	47	48	49	50					

NAME (PLEASE PRINT) _____

ADDRESS _____

CITY _____

STATE _____

ZIP _____

3/70

IT COSTS ONLY
1/100 OF 1¢ MORE
PER SOLDER JOINT
TO KNOW YOU ARE USING THE
WORLD'S FINEST CORED SOLDER

New Easy
Dispenser
Pak
60/40
18 S.W.G.



Latest PC
(Printed
Circuit) Pak
60/40 Extra Thin
22 S.W.G.—.028"



each only 69¢ per package at your dealer

ERSIN **Multicore** FIVE-CORE SOLDER

MULTICORE SALES CORP., WESTBURY, N.Y. 11590
CIRCLE NUMBER 14 ON PAGE 23

Olson
ELECTRONICS
FREE
Catalog

Fill in coupon for a FREE One Year Subscription to OLSON ELECTRONICS' Fantastic Value Packed Catalog — Unheard of LOW, LOW PRICES on Brand Name Speakers, Changers, Tubes, Tools, Stereo Amps, Tuners, CB, and other Values. Credit plan available.

NAME _____
ADDRESS _____
CITY _____ STATE _____
GIVE ZIP CODE _____

If you have a friend interested in electronics send his name and address for a FREE subscription also.

OLSON ELECTRONICS

582 S. FORGE STREET, AKRON, OHIO 44308

CIRCLE NUMBER 9 ON PAGE 23

Electronic Marketplace

Six-Bander. Model HA-800 solid-state amateur receiver provides AM/CW/SSB reception on six bands (6 through 80 meters). The receiver's circuitry incorporates three FETs and two mechanical IF filters, which is said to assure high



selectivity and adequate noise suppression. Built-in power supply has zener regulation and operates on either 117 VAC or 12 VDC. Also included are an S-meter, product detector and crystal calibrator (less crystal). Sensitivity on 20-80 meters is better than 1 μ V; on 10-15 meters, 0.5 μ V; on 6 meters, 2.5 μ V. Selectivity: -6db at \pm 2kc, -60db at \pm 6kc. Image rejection: better than -40db. \$149.95. Lafayette Radio Electronics Corp., Syosset, N.Y. 11791.

Controlled Heat. Designed especially for work involving critical soldering of integrated circuits and FETs, Model 6760 solid-state (transformerless) soldering gun provides protection by isolating the soldering tip from the heating element



with a grounded three-wire cord that renders the tip electrically inert. Two temperature ranges are available via a high-low selector switch, giving choice of either 500° or 900°F. Heat cartridge locks into gun barrel via a knurled nut and can be rotated to orient tips. Soldering tips are independent of heating element. Gun weighs 5 oz. and comes with three different tips. \$13.25. Ungar Div., Eldon Inds., Inc., Compton, Calif. 90220.

Electronics Illustrated

America's Top-Rated Stereo Kits Now a Best Buy!*



- * **LT-112B-1 FM Stereo Monitor Tuner Kit:**
Now \$149.95
- LK-60B 160-Watt Stereo Amplifier Kit:**
Now \$149.95
- LR-88 135-Watt AM/FM Stereo Receiver Kit:**
Now \$299.95

SCOTT®

Write for new Scott Kit Catalog. H. H. Scott, Inc.,
111 Powdermill Road, Maynard, Mass. 01754.
Export: Scott International, Maynard, Mass. 01754.
© 1969, H. H. Scott, Inc.

POPULAR SCIENCE SAYS:

"... How does it perform? In a word, flawlessly; stereo performance is superb, and the set's sensitivity will cope with the deepest fringe-area reception conditions ... I rate the LT-112B as one of the finest FM tuners available — in or out of kit form."

STEREO REVIEW SAYS:

"We measured the IHF sensitivity of the Scott LT-112B tuner as 1.4 microvolts, which certainly makes it one of the most sensitive tuners we have encountered."

AMERICAN RECORD GUIDE SAYS:

"Scott LT-112B tuner must be placed in the very top echelon of today's components."

AUDIO SAYS:

"Here's a stereo FM/AM receiver kit with a real hot front end, fairly high power output, low distortion, and excellent operating flexibility ... The Scott LR-88 offers a most competent design at a price well below that for an equivalent factory-assembled unit."

ELECTRONICS ILLUSTRATED SAYS:

"One of the finest examples of solid-state integrated-amplifier kit design, packaging and performance we have seen is the Scott LK-60."

HIGH FIDELITY SAYS:

"... an unprecedented high sensitivity, one which surprised even us ... This is certainly a tuner for use in the most difficult of reception areas; stations seem to pop in all across the tuner dial."

CIRCLE NUMBER 17 ON PAGE 23

Electronic Marketplace

High-Band Rig. Model FM-210 2-meter FM transceiver is designed for use in either direct or repeater communications. Base or mobile operation is possible wherever reliable local communication is necessary. This solid-state trans-



ceiver has an FET front end and uses independent three-channel switches for transmit and receive modes. A squelch system is said to be highly effective for mobile operation; a speech compressor provides optimum intelligibility under adverse transmitting conditions. Power requirement is 12-14 VDC. An optional power booster accessory permits operation from 117-VAC line. FM-310, \$199.95; power booster, \$39.95. Galaxy Electronics, Council Bluffs, Iowa 51501.

Spectrum Sweeper. General-coverage receiver Model GR-78 provides AM/CW/SSB coverage from 190 kc to 30 mc on six separate bands. Its solid-state circuit employs FETs in the RF stages and four ceramic IF filters. The filters are

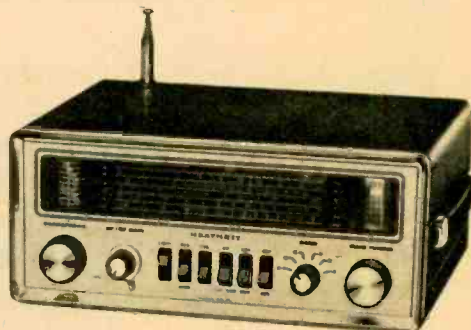

said to eliminate need for alignment of IF stages. Bandsread tuning can be calibrated for either short-wave or amateur bands; a switchable 500-kc crystal calibrator is included. The receiver comes with rechargeable nickel-cadmium battery pack. Wiring options permit either 120- and 240-VAC or 12-VDC operation \$129.95. Heath Co., Benton Harbor, Mich. 49022.

enter the vehicular base gain antenna.



With five words, Antenna Specialists Co. creates a far-reaching new concept of mobile performance—

THE VEHICULAR BEAM ANTENNA SYSTEM.

✓ **Breakthrough!** Up to 2.5 dB gain—first true gain mobile antenna system in CB history!

✓ **Breakthrough!** World's first mobile beam!

✓ **Breakthrough!** Antenna Specialists' exclusive Scanner® principle of electronic sector focusing goes mobile!

✓ **Breakthrough!** Dashboard control of your mobile antenna performance!

Mobile Scanner Vehicular Beam Antenna Systems.

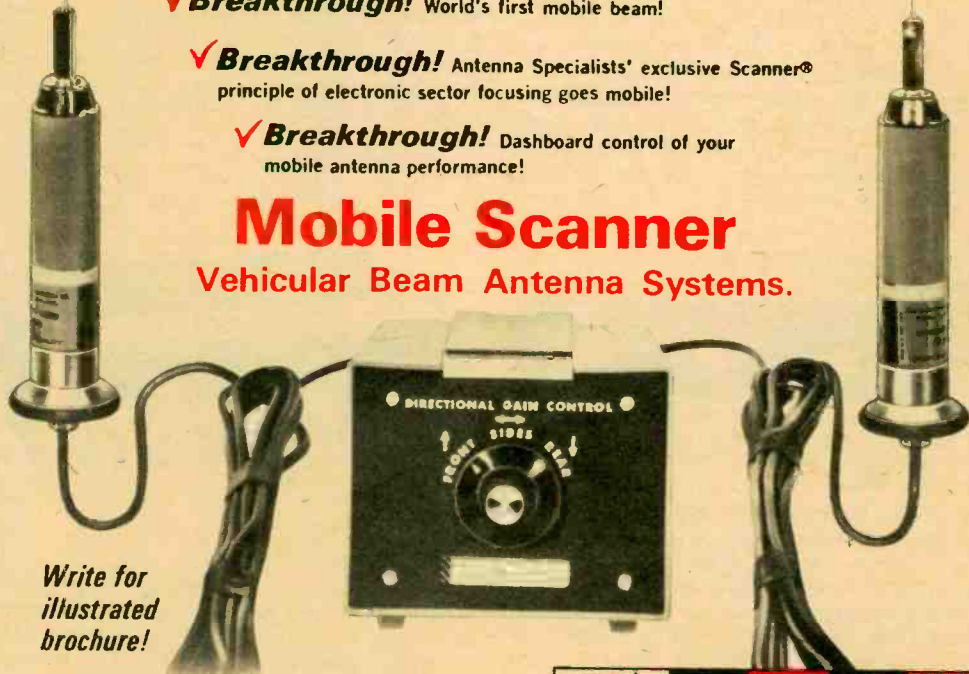

*Write for
illustrated
brochure!*

the antenna specialists co.

Division of Allen Electric and Equipment Company
12435 Euclid Avenue, Cleveland, Ohio 44106
Export Offices, 2200 Shames Dr., Westbury, N.Y. 11590



Stripes of Quality®

CIRCLE NUMBER 21 ON PAGE 23

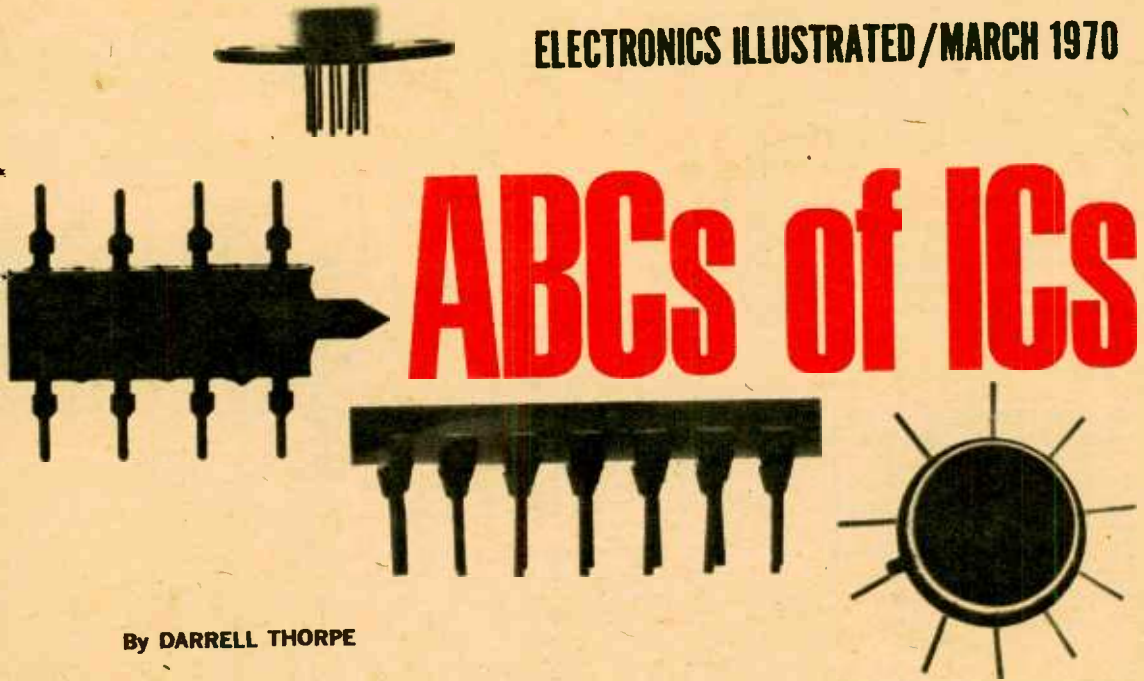

ABCs of ICs

By DARRELL THORPE

YOU don't have to look very far to realize that integrated circuits are the wave of the future. Limited to computers, industrial and military applications just a few years ago, ICs now are becoming quite commonplace in hi-fi equipment and TV receivers.

And more and more EI projects use ICs. In fact EI was the first magazine to publish construction projects using an IC in the March '65 issue. The article's title was **AND NOW . . . INTEGRATED CIRCUITS FOR HOBBYISTS**. The projects were an audio-frequency square-wave generator and a regenerative reflex broadcast radio.

A good way to get a feel for ICs and what they are capable of doing is to experiment with them in working circuits. We're going to do just this by building 11 audio and RF projects using the same IC. The projects are easy to set up and take apart because we've designed a breadboard on which several basic parts are permanently mounted. Using clip leads to make connections, you can change circuit configurations quickly and easily.

An inexpensive (\$2.56) IC we will use is the RCA CA3020. It offers a lot of gain (58db) in a small package (12-lead TO-5). The CA3020 is a multi-purpose wide-band audio amplifier that produces a relatively high (½ watt) output. (The output is class B, push-pull.)

Let's get acquainted with what's inside this tiny package. A schematic of the CA3020 is shown in Fig. 2. The IC contains seven transistors and associated bias networks. You'll be able to get a better idea of the IC's functions from Fig. 3. There are four direct-coupled amplifier stages that perform the functions of preamplification, phase inversion, driver and power output. The IC also includes a temperature-tracking voltage regulator (D1, D2, D3, R10 and R11) that permits operation over a wide temperature range. The operating voltage range of the CA3020 is from 3 to 9 V; a heat sink is required.

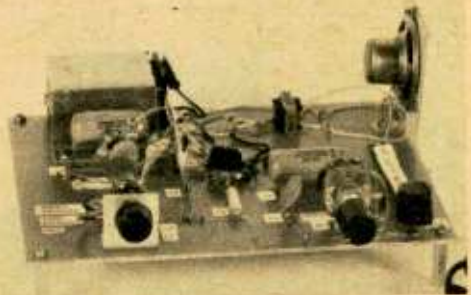
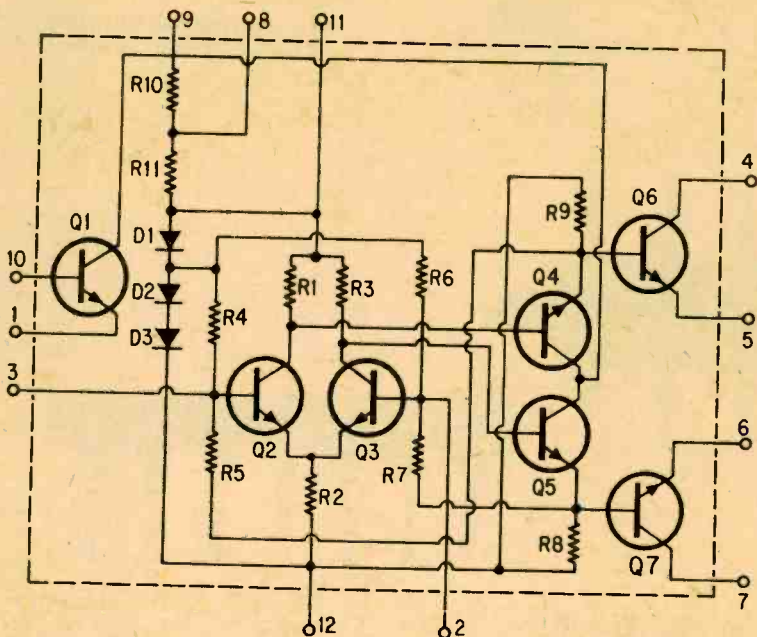

Fig. 1—Breadboard used for projects is 6 x 8-in. piece of perforated board. Connecting leads are made with hook-up wire and mini-gator clips.

Fig. 2—Schematic of the CA3020. IC is multi-purpose wideband power amplifier. When operated at 9 V its output power is 550 mw and current drain is 22 ma. Input impedance at terminal 3 is about 700 ohms. Input impedance is about 50,000 ohms at terminal 10 (Q1's base).



ABCs of ICs

The audio input signal can be capacitor coupled to terminal 3 or to terminal 10 (buffer-amplifier Q1) and then coupled to terminal 3. With about a 35-mw input signal to terminal 10, the output will be around 1/2 watt. External bias need be applied only to Q1 (terminal 10). The remainder of the transistors are biased by the internal voltage-regulator circuit. The output signal is taken from terminal 4 and from terminal 7.

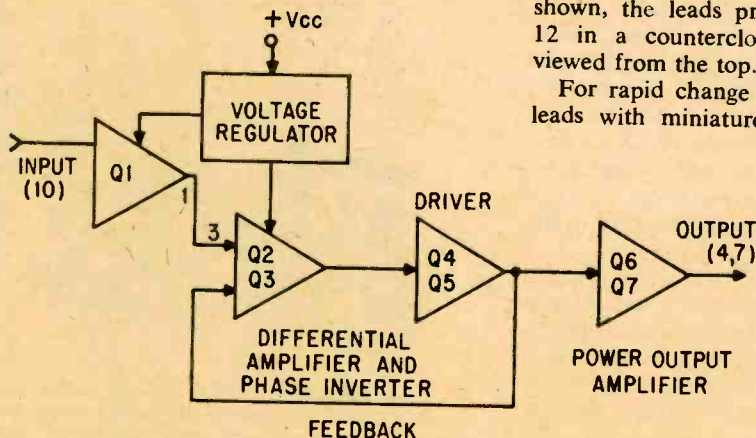

Fig. 3—Functional block diagram of IC. Four direct-coupled stages act as preamp (Q1), phase inverter (Q2,Q3), driver (Q4,Q5) and power output (Q6,Q7). Voltage regulator stabilizes circuit.

Basic Board

The breadboard shown in Figs. 1, 4 and 11 is a 6 x 8-in. piece of glass epoxy in which we drilled holes for push-in terminals. However, standard perforated circuit board will do just as well. Size is not critical, but use a large enough board to make a convenient work area.

Start by spreading the leads on the CA3020 and then bend them at a 90° angle. Do not shorten the leads. Then install 12 push-in terminals in a circle near the center of the board. Solder the IC to the terminals with the tab positioned as shown. The lead under the tab is No. 12. When mounted as shown, the leads progress from 1 through 12 in a counterclockwise direction when viewed from the top.

For rapid change from circuit to circuit, leads with miniature alligator clips (mini-

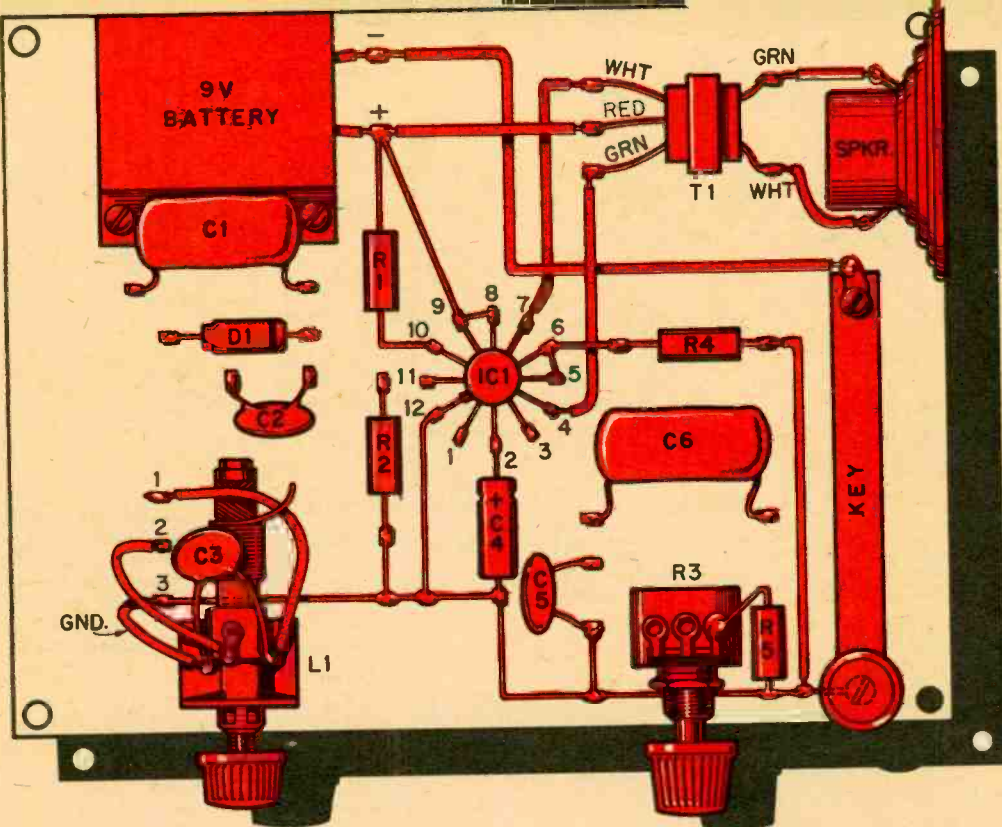

Fig. 4—Build breadboard on 6 x 8-in. piece of perforated board. Key at right can be replaced by switch.

gator) work well. Fahenstock clips could be used, but we found we could not get good connections with them. The rest of the parts should be mounted where shown with small brackets being used to support the tuning coil and the volume control. Most of the experiments use the components as mounted on the basic board. However, to give a better idea as to what the CA3020 can do, two advanced projects that require several additional parts are also described. The key also functions as the power switch. For most circuits put a jumper wire across it.

1—Basic Audio Amplifier

The basic audio amplifier is shown in Fig. 6. With minor modifications this circuit is used for several of the projects. Very few additional parts are needed to build this audio amplifier or the other circuits. For the microphone use a 1,000- or 2,000-ohm headphone. If at some time you want a higher quality amplifier, a better microphone with a one-stage transistor preamp can be used.

The addition of a preamp will be left up to you so you can get some practice at designing circuits on your own.

As a practical application, this amplifier can be used as a signal tracer to probe the audio portions of a radio or TV. The audio amplifier circuit would be useful for the audio portion of many construction projects.

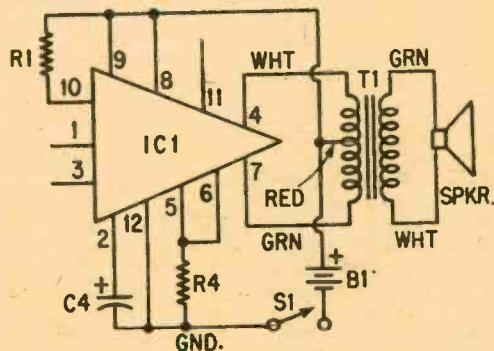

Fig. 5—Schematic of basic wiring shown in pictorial in Fig. 4. S1 replaces key in pictorial.

ABCs of ICs

Fig. 6—Basic wiring of board is in black. Added wiring for audio amplifier is shown in color. Earphone serves as mike; R3 is volume control.

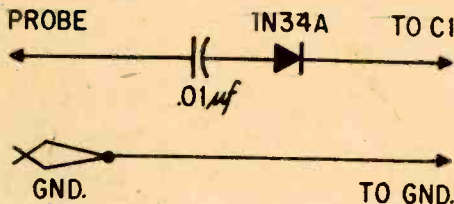
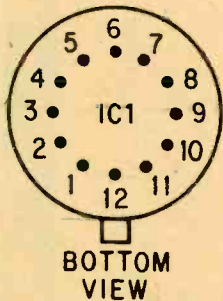
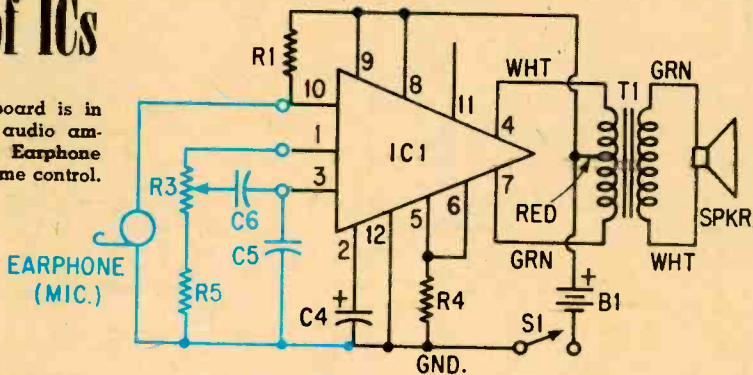

Fig. 7—At far left is view of underside of IC that shows numbering of leads. Pin 12 is opposite tab. At right is schematic of probe that converts audio amplifier to RF signal tracer.

2—RF Signal Tracer

For a second project it's a simple step to add a diode probe (as shown in Fig. 7) to the basic audio amplifier and come up with an RF signal tracer. This signal tracer is a great aid in troubleshooting RF and IF sections of radios.

3—Broadcast Radio

You will be able to get acquainted now with three different types of basic broadcast radios and each will drive the speaker to a pretty good volume level. From the previous RF signal tracer circuit, it's only necessary to connect L1 to the circuit and you have the old standby crystal detector/audio amplifier type radio. These additions are shown

in color in the schematic in Fig. 8.

Note that the coil has three terminals. Connect the diode to terminal 1 and connect terminal 3 to ground. Also be sure you have a $120\text{-}\mu\text{f}$ capacitor (C3) across terminals 1 and 3. If you have a long antenna connect it to terminal 2. Connect a short antenna to terminal 1. With a little experimenting you can determine the best antenna and where to connect it for best selectivity and sensitivity. A good ground is also needed. Stations are tuned by turning the slug in and out of the coil.

Radio stations picked up by the antenna are fed to the L1/C3 tuned circuit. This signal is then rectified (detected) by D1, and the audio is coupled into the IC through C1.

Fig. 8—Additional wiring (color) added to basic wiring (black) to make a diode-detector broadcast radio. Signal tuned by L1 is detected by D1. Audio is amplified by IC which drives a small speaker.

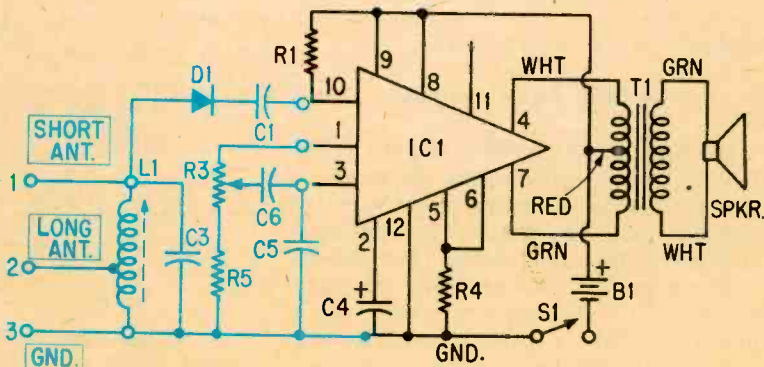

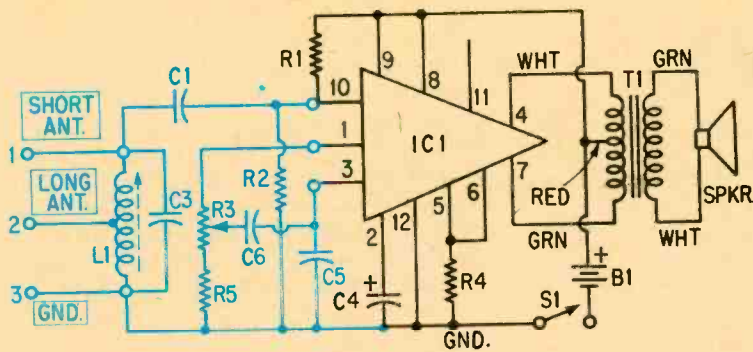
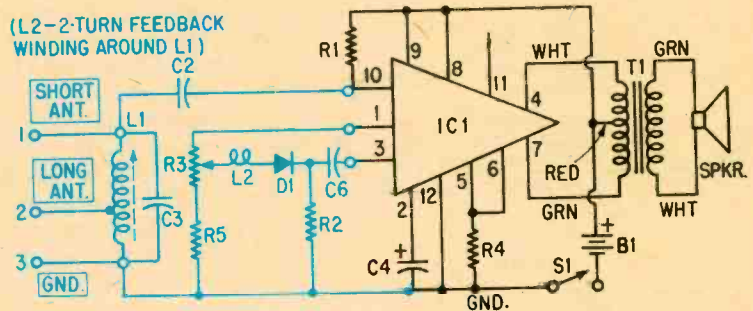

Fig. 9—Transistor detector radio (added circuit in color). Addition of R2 puts small amount of bias on Q1 (see Figs. 2 and 3) making it operate as amplifying detector. Detected signal (audio) at terminal 1 is fed to IC via R3, C6.

Fig. 10—TRF/regenerative radio is made by adding circuit shown in color. Feedback winding is L2, a two-turn coil of wire wound over L1. In this circuit R3 acts as regeneration control.



The IC amplifies this weak audio signal to loudspeaker volume.

4—Transistor-Detector Radio

By giving transistor Q1 a very small bias (adding R2) instead of full bias in the earlier circuits, Q1 will function as an amplifying detector. The detected signal is then coupled into the remainder of the circuit and further amplified. A diode is not needed for this receiver.

The small bias makes the transistor detector more sensitive while still maintaining the process of detection. That is, the RF signal is converted to audio by clipping the negative half.

5—TRF/Regenerative Radio

By giving transistor Q1 full bias and connecting the diode as shown in Fig. 10, Q1 functions as a tuned regenerative RF amplifier. That is, it amplifies the RF signals before they are detected by the diode. Control R3 functions as a gain/regeneration control; turning R3 up too far will result in oscillation. Setting it correctly will result in a sensitive receiver. The remainder of the IC functions as an audio amplifier for the detected signals. The output is sufficient to drive a speaker to comfortable volume levels.

6—Audio Oscillator

With just a little feedback, that is connecting some of the output signal to the input through a capacitor, you get an audio oscillator. Wire the basic amplifier as shown in Fig. 6, and then connect a wire from pin 4 to the input through C1 or C2. This little ex-

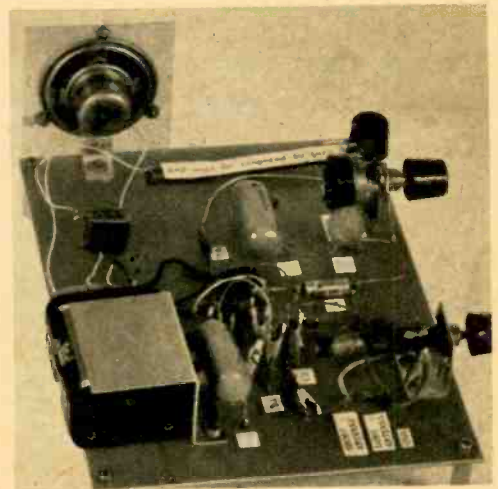

Fig. 11—Side view of breadboard. Holder with six penlite cells (left) is held with bracket. Coil's (lower right on board) bracket comes with the coil.

ABCs of ICs

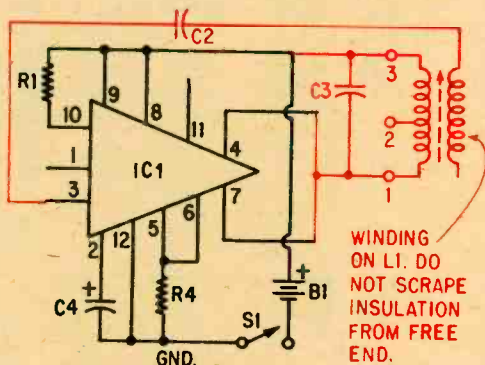

Fig. 12—RF oscillator (added wiring in color). Disconnect T1 from terminals 4 and 7 on the IC and connect L1 as shown. Substitute C5 for C4.

PARTS LIST

- B1—9 V battery (six penlite cells)
- C1, C6—.5 μ f, 200 V mylar capacitor
- C2, C5—.01 μ f, 500 V disc capacitor
- C3—120 μ mfd, 500 V disc capacitor
- C4—5 μ f, 15 V electrolytic capacitor
- D1—1N34A diode
- IC1—CA3020 integrated circuit (RCA)
- L1—Slug-tuned ferrite rod antenna (Radio Shack 270-1430, 79¢ plus postage)
- R1—510,000 ohm, 1/2 watt, 5% resistor
- R2—100,000 ohm, 1/2 watt, 10% resistor
- R3—10,000 ohm, audio-taper potentiometer with SPST switch
- R4—3.3 ohm, 1/2 watt, 10% resistor
- R5—47 ohm, 1/2 watt, 10% resistor
- S1—SPST switch (on R3)
- SPKR.—3.2 ohm speaker
- T1—Transistor output transformer (primary: 500 ohms, center tapped; secondary: 3.2 ohms. Radio Shack 273-1379, 89¢ plus postage)

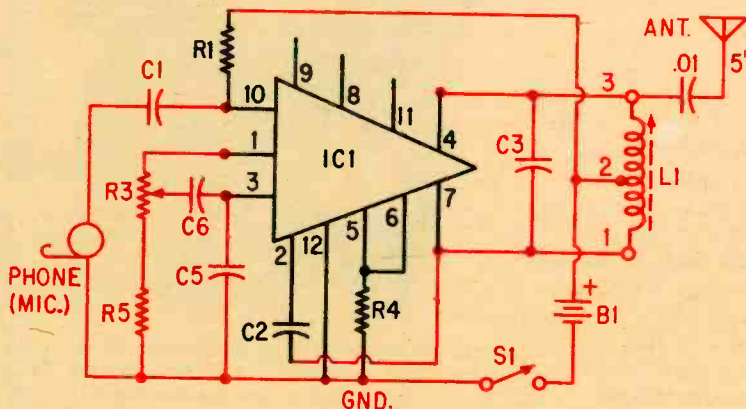

Fig. 13—Make these additions to the basic RF oscillator in Fig. 12 and you have a wireless broadcaster. C5 must be connected directly to pin 3 on IC and not to the lead on C6.

periment can teach a good lesson about feedback in both audio circuits and RF circuits. With a little experimenting, you will discover that you don't need direct connections at both the input and output to get oscillation. This is good to remember when building either audio or RF circuits; that is, keep the input and output leads separated. By removing the jumper wire from the key, the audio oscillator can be used for code practice.

7—RF Oscillator

An RF oscillator requires a little greater change in the circuitry, as shown in Fig. 12. In this circuit, L1 is connected to the collectors of Q6 and Q7 and capacitor C2 feeds back part of the output signal from L1 to the base of Q2. Notice that the coil has a winding of heavy wire one end of which is not connected to any of the coil's terminals. Carefully scrape the insulation from the end of this free wire. Connect the feedback from here to terminal 3 of the IC.

This circuit is basically a Hartley oscillator. The RF oscillator's operation depends upon circulating current going back and forth in the tuned circuit consisting of L1 and C3. The frequency of oscillation depends upon the values of both the capacitance and inductance of the tuned circuit.

Oscillation starts because of the change in voltage and current when the power is first applied. Some of these first oscillations are connected back to the base of Q2. The circuit amplifies these signals and returns them to the tuned circuit to keep the oscillation going. Without this replenishment of power, oscillation would quickly die because of resistance in the wires, etc. After wiring the circuit, turn the RF oscillator on and put a small radio

Fig. 14—This audio amplifier has better fidelity than amplifier shown in Fig. 6. The resistor values are in ohms; capacitor values are in microfarads. The coupling capacitors are larger to provide better low-frequency response.

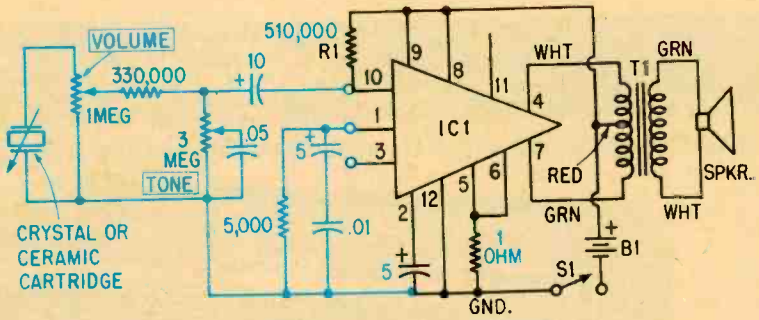

near it. We found the best place to tune the radio is to a clear spot near the high end of the broadcast band. Turn the knob on L1 until you hear the signal in the radio. By connecting several ft. of wire through a .001 μ f capacitor to terminal 1 on L1, the signal should radiate a fair distance. If you have a long antenna, simply drape the end over the coil. This will provide sufficient signal radiation. A long antenna may kill oscillation.

8—Code-Practice Transmitter

By removing the jumper wire across the key in the previous circuit the oscillator can be keyed and used as a wireless code-practice oscillator. To get a beat note, tune the broadcast receiver to a weak station then adjust the RF oscillator to give a beat tone:

9—Wireless Broadcaster

With the minor modifications shown in Fig. 13 the RF oscillator can be made into a wireless broadcaster. Again, for the microphone, a 1,000-or 2,000-ohm headphone does a pretty good job. Any other high-impedance high-output microphone will also give good results.

Tune in the signal as described above, adjust R3, which is now a modulation control, and if necessary, the tuning knob (L1) for maximum signal and best voice reproduction. The signal from the microphone is amplified by Q1 and then applied to the base of Q3 where it modulates the RF signal.

10—Phono Amplifier

A phono amplifier of much higher fidelity than the audio amplifier previously described is shown in Fig. 14. This amplifier can be used with a high-output crystal cartridge. Note that several of the components are different than in the previous circuits. In particular the coupling capacitors have a higher capacitance to provide better low-frequency response.

11—High-Power Audio Amplifier

While not fully a part of the experimental board this project demonstrates the versatility of the CA3020 in hi-fi circuitry. This project uses the CA3020 to drive a complementary pair of power transistors as shown in Fig. 15; this circuit will produce better than 3 watts. The power transistors should be mounted on a heat sink.

Fig. 15—In this circuit the IC is used to drive a complementary pair of power transistors (40465 and 2N2148, RCA) for a 3-watt audio amplifier. Heat-sink output transistors and use larger power supply.

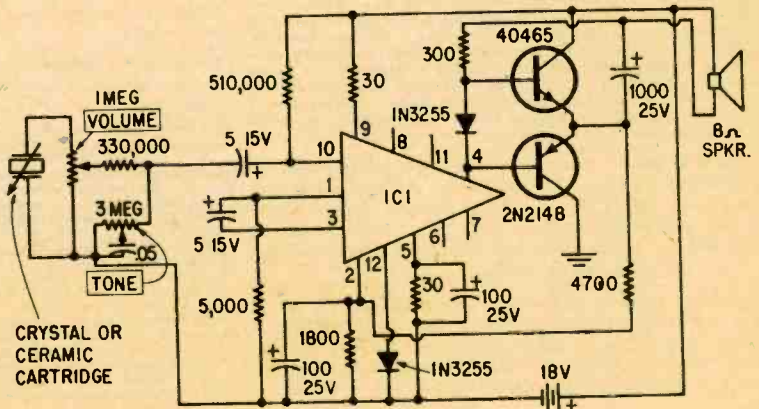

More New Kits From

Introducing The Advanced New Heathkit 60-Watt AM/FM/FM Stereo Receiver

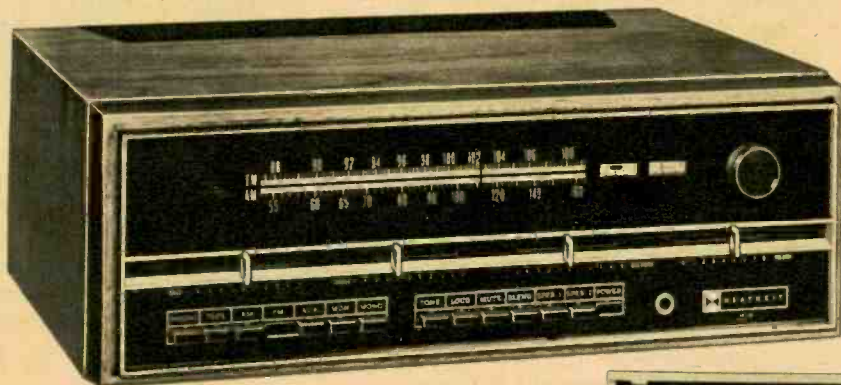

Heathkit AR-19

\$225.00*

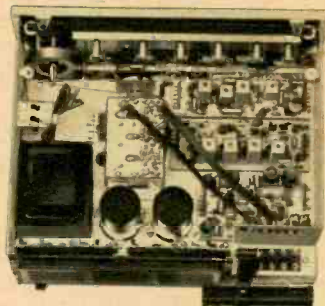

Third In The New Generation Of Superb Solid-State Receivers From Heath . . . And Low In Cost

• Advanced solid-state circuitry with 108 transistors, 45 diodes and 5 integrated circuits • 60 watts music power output at 8 ohms • Less than 0.25% Harmonic & IM Distortion at any power level • Frequency response from 6 to 35,000 Hz • Direct-coupled, transformerless outputs for lowest distortion and phase shift • Dissipation-limiting circuitry protects outputs from damage even with a short circuit • Assembled, aligned FET-FM tuner has 2.0 uV sensitivity to give you more listenable stations • Ball-bearing inertia flywheel tuning for smooth, accurate station selection • Preassembled, factory aligned FM IF circuit board speeds assembly and eliminates IF alignment, gives 35 dB selectivity • Multiplex IC circuit provides inherent SCA rejection • Pushbutton Mute control attenuates between-station FM noise • Bland control reduces on-station FM noise with a push of a button • Tone-flat pushbutton disables bass & treble controls for perfectly "flat" response • New linear motion controls for volume, balance, bass & treble • Individually adjustable level controls for each input including tape monitor eliminate annoying volume changes when switching sources • Switches for two separate stereo speaker systems for stereo sound in two different locations • Center channel speaker capability • Two front panel tuning meters give exact station selection • Stereo indicator light • Front panel stereo headphone jack • 300 & 75 ohm FM antenna inputs • High fidelity AM reception • Built-in AM rod antenna swivels for best reception • Massive power supply includes section of electronically regulated power • New Heath modular plug-in circuit board design speeds assembly, aids servicing • Built-in Testing facilities aids construction, simplifies servicing • Circuit board & wiring harness construction for easy, enjoyable 25 hour assembly

Ahead of its time . . . those who want to hear stereo high-fidelity as it will sound in the 70's can begin right now, at a modest price, with the Heathkit AR-19. Its design is an extension of the advanced circuitry concepts first introduced in the AR-15. These receivers are truly of a new generation . . . they've expanded audio engineering horizons and set the pace for the 70's.

Field Effect Transistor And Integrated Circuit Design. The AR-19 uses advanced semi-conductor circuitry . . . including five integrated circuits, with a total of 108 transistors and 45 diodes. The pre-assembled FM tuning unit uses an RF field effect transistor to provide high sensitivity and low cross modulation with no overloading

on strong local stations. In the AM RF circuit also, field effect transistors give superior sensitivity and large signal handling capacity.

Ideal For Most Home Stereo Installations. The AR-19 is just right for the medium and high efficiency speaker systems that are so popular today. It can form the nucleus of a fine stereo system . . . and will probably be the most attractive part, thanks to its rich oiled pecan wood cabinet and to the "Black Magic" front panel. The scale and dial readings appear only when the power is on.

Features To Aid The Kit Builder. All 8 circuits of the AR-19 snap in and out in seconds. Think of the resulting convenience and ease of assembly! In addition, the AR-19 has built-in test circuitry . . . two test probes with the front panel meter for indications. With it, the user can check out circuit parts without the need for expensive external test equipment. Proper use of this feature is fully covered in the manual.

Don't Wait For Something Better To Come Along . . . it'll be a long wait. Up-grade your stereo system now, with this outstanding receiver value.

Kit AR-19, 29 lbs. \$225.00*
Assembled AE-19, cabinet, 10 lbs. \$19.95*

PARTIAL AR-19 SPECIFICATIONS — AMPLIFIER: Continuous power output per channel: 20 watts, 8 ohms. IHF Power output per channel: 30 watts, 8 ohms. Frequency response: (1 watt level) —1 dB, 6 Hz —35 kHz. Power bandwidth for constant 0.25% THD: Less than 5 Hz to greater than 30 kHz. Harmonic distortion: Less than 0.25% from 5 Hz to 20 kHz at 20 watts rms output. Less than 0.1% of 1000 Hz at 1 watt output. IM Distortion: Less than 0.25% with 20 watts output. Less than 0.1% at 1 watt output. Hum and noise: Phono input, —65 dB. Phono input sensitivity: 2.4 millivolts overload, 155 millivolts. FM: Sensitivity: 2.0 uV. IMF. Volume sensitivity: Below measurable level. Selectivity: 35 dB. Image rejection: 90 dB. IF Rejection: 0.5% or less. Spurious rejection: —90 dB. FM STEREO: Separation: 35 dB of midfrequencies, 30 dB at 50 Hz, 25 dB at 10 kHz, 20 dB at 15 kHz. Frequency response: ±1 dB from 20-15,000 Hz. Harmonic distortion: 1.5% or less @ 1000 Hz with 100% modulation, 19 kHz & 38 kHz. Suppression: 50 dB. SCA Suppression: 50 dB. AM SECTION: Sensitivity: Using a radiating loop, 120 uV/M @ 1000 kHz. Selectivity: 25 dB at 10 kHz. Image rejection: 60 dB @ 600 kHz, 60 dB @ 1400 kHz. Rejection: 60 dB @ 1000 kHz. Harmonic distortion: Less than 2%. Hum & noise: —40 dB.

CIRCLE NUMBER 3 ON PAGE 23

New Heathkit 100-Watt AM/FM/FM-Stereo Receiver

World's finest medium power stereo receiver... designed in the tradition of the famous Heathkit AR-15. All Solid-State... 65 transistors, 42 diodes plus 4 integrated circuits containing another 56 transistors and 24 diodes. 100 watts music power output at 8 ohms — 7 to 60,000 Hz response. Less than 0.25% distortion at full output. Direct coupled outputs protected by dissipation-limiting circuitry. Massive power supply. Four individually heat sinked output transistors. Linear motion bass, treble, balances and volume controls. Push-button selected inputs. Outputs for 2 separate stereo speaker systems. Center speaker capability. Stereo headphone jack. Assembled, aligned FET FM tuner has 1.8-uV sensitivity. Two tuning meters. Computer designed 9-pole L-C filter plus 3 IC's in 1F gives ideally shaped bandpass with greater than 70 dB selectivity and eliminates alignment. IC multiplex section. Three FET's in AM tuner. AM rod antenna swivels for best pickup. Kit Exclusive: Modular Plug-In Circuit Boards... easy to build & service. Kit Exclusive: Built-In Test Circuitry lets you assemble, test and service your AR-29 without external test equipment. The AR-29 will please even the most discriminating stereo listener.

Kit AR-29, (less cabinet), 33 lbs.....\$285.00*
 AE-19, Assembled oiled pecan cabinet, 10 lbs.....\$19.95*

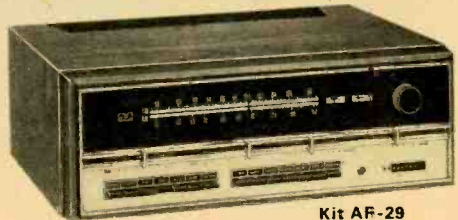

Kit AR-29
\$285.00*

New Heathkit Deluxe 18-Watt Solid-State Stereo Stereo

Looks and sounds like it should cost much more. Here's why: 16-transistor, 8-diode circuit delivers 9 watts music power per channel to each 4 1/2" high-compliance speaker. Speaker cabinets swing out or lift off... can be placed up to 10' apart for better stereo. Has Maestro's best automatic, 4-speed changer — 16, 33-1/3, 45 & 78 rpm. It plays 6 records, shuts off automatically. Ceramic stereo cartridge with diamond/sapphire stylus. Has volume, balance & tone controls. Changer, cabinet & speaker enclosures come factory built... you build just one circuit board... one evening project. Wood cabinet has yellow-gold & brown durable plastic coated covering. This is a portable stereo you can take pride in.

Kit GD-109, 38 lbs.....\$74.95*



Kit GD-109
\$74.95*

New Heathkit 80-10 Meter 2 KW Linear Amplifier

Incomparable performance and value. The new SB-220 has 2000 watts PEP input on SSB & 1000 watts on CW and RTTY. Uses a pair of Eimac 3-500Z's. Pretuned broad band pi input coils. Requires only 100 watts PEP drive. Solid-state power supply operates from 120 or 240 VAC. Circuit breaker protected. Safety interlocked cover. Zener diode regulated operating bias. Double shielded for max. TVI protection. Quiet fan — fast, high volume air flow. Also includes ALC to prevent over-driving. Two meters: one monitors plate current; the other is switched for relative power, plate voltage and grid current. Styled to match Heath SB series. Assembles in about 15 hours.

Kit SB-220, 55 lbs.....\$349.95*



Kit SB-220
\$349.95*

**New Heathkit
 Solid-State Portable
 Fish-Spotter**



Kit MI-29
\$84.95*

Costs half as much as comparable performers. Probes to 200 ft. Spots individual fish and schools... can also be used as depth sounder. Manual explains typical dial readings. Transducer mounts anywhere on suction cup bracket. Adjustable Sensitivity Control. Exclusive Heath Noise-Reject Control stops motor ignition noise. Runs for 80 hrs. on two 6 VDC lantern batteries (not included). Stop guessing — fish electronically.

Kit MI-29, 9 lbs.....\$84.95*



Kit MI-19
\$69.95*

New Heathkit Solid-State Depth Sounders

Let its flashing indicator light guide you through strange waters... day or night. Sounds to 200 ft. Has Noise Rejection and Sensitivity controls. Operates from your 12 VDC boat battery. Sun-shielded dial. All solid-state.

Kit MI-19-1, (with thru-hull transducer), 7 lbs.....\$69.95*
 Kit MI-19-2, (with high speed transom mount), 7 lbs.....\$69.95*



**NEW
 FREE 1970 CATALOG!**
 Now with more kits, more color. Fully describes these along with over 300 kits for stereo/hi-fi, color TV, electronic organs, guitar amplifiers, amateur radio, marine, educational, CB, home & hobby. Mail coupon or write Heath Company, Benton Harbor, Michigan 49022.

HEATH COMPANY, Dept. 39-3
 Benton Harbor, Michigan 49022

Enclosed is \$_____ plus shipping.

Please send model(s).
 Please send FREE Heathkit Catalog. Please send Credit Application.

Name _____

Address _____

City _____ State _____ Zip _____

*Mail order prices; F.O.B. factory. Prices & specifications subject to change without notice. CL-373 R

DXing the Counties



By **ALEX BOWER** WANT to get to know the U.S.A. or Canada? If so, EI's latest awards for hams and SWLs should be just your bag of DX. The Counties Award—either two-way communications with or reception of any 25 counties in the U.S. or Canada—will expose your log book to localities you never knew existed.

In many respects, the new award is a challenge for non-amateur DXers. It will be extremely difficult to earn for those who listen to SW frequencies exclusively (few counties in the U.S. or Canada boast a SW station), relatively easy for BCB listeners, and a middling challenge for monitors of FM and TV. Trying for a mixture of these bands, however, should provide real sport.

To earn the award, it should be easy for you to log 25 counties on the 535-1605 kc BCB band during the course of a couple of nights, no matter how crude your receiver. But be sure you take time to QSL what you hear. Entrants who don't will be disqualified.

If you earn your award on this band, there are really only two major hurdles. First, not

all BCB stations will verify a listener's report, even when return postage is enclosed. Therefore, it's a good idea to send reception reports to five or ten extra counties. Second, many BCB stations, particularly in the larger urban areas, have their studios in one county and transmitter in another. For the purpose of this award it is the transmitter site which counts! For instance, WIL (1430 kc) announces its location as St. Louis, but the station actually transmits from St. Clair County in Illinois.

A solution to this second problem is to ask each station to specify the transmitter location on their QSL card (be sure to explain you are trying for as many different counties as possible). If you can't get this information, it might be a good idea to list only one station from each different urban area on your award application. Thus, claim only one county in the Philadelphia/Camden area, only one in the Chicago/Gary area, etc.

You will encounter variations of the county concept according to geography—they're called parishes in Louisiana, election

El's Guide to DXing Counties

Announced Location (County)		Station	Frequency	Notes
Albuquerque	(Sandova)	KOB	770	
Atlanta	(Cobb)	WSB	750	
Bethany	(Hamilton)	Voice of America	Many, incl. 11830 at 1900-2100 EST	
Boston	(Suffolk)	WBZ	1030	
Casper	(Natrona)	KTWO	1030	
Chicago	(Cook)	WMAQ	670	
		WBBM	780	
		WLS	890	
Cincinnati	(Hamilton)	WLW	700	
Cleveland	(Cuyahoga)	WKYC	1100	
Delano	(Kern)	Voice of America	Many, incl. 6110 at 0600-1000 EST	
Des Moines	(Polik)	WHO	1040	
Detroit	(Wayne)	WJR	760	
Dixon	(Solano)	Voice of America	Many, incl. 6185 at 0400-1100 EST	
Greenville	(Pitt)	Voice of America	Many, incl. 6190 evenings	
Kalispell	(Lathia)	KOFI	1180	
Los Angeles		KFI	640	
		KNX	1070	
Louisville	(Henderson)	WHAS	840	
Marathon	(Monroe) (Fla.)	Voice of America	1180	
Metropolitan		CBL	740	
Toronto		CJBC	860	
		CFRX	6070	
Minneapolis	(Ramsey)	WCCO	830	
Montreal	(Laval)	CBF	690	in French
		CBM	940	
		CFCX	6005	
Nashville	(Davidson)	WSM	650	
New Orleans	(Orleans)	WWL	870	
New York		WNBC	660	
		WCBS	880	
Philadelphia	(Delaware)	KYW	1060	
		WCAU	1210	
Pittsburgh	(Alleghany)	KDKA	1020	
Red Lion	(York)	WINB	17720 11795	1200-1500 EST 1505-1700 EST
Rochester	(Monroe) (N.Y.)	WHAM	1180	
Roswell	(Chaves)	KSVS	1020	
Sackville	(Westmurland)	R. Canada	Many, incl. 9625 & 11720 evenings	
Salt Lake City	(Salt Lake)	KSL	1160	
San Antonio	(Comal)	WOAI	1200	
San Francisco		KGEI	15240	
Scituate	(Norfolk) (Mass.)	R. New York	Many, incl. 9615 evenings	Evenings Will move to Burlington Co. (N.J.)
St. Louis		KMOX	1120	

districts in Alaska. In the heavily industrialized areas of southern Ontario, Canada, counties are being systematically merged into regions. Station CHOW (see photo) on 1470 kc, for example—located halfway between Welland and Port Colborne—was previously in Welland County, but now counts as the Niagara Region effective January 1, 1970, along with stations in Niagara Falls (CJRN on 1600 kc, eventually to move to 710) and St. Catherine's (CKTB on 610 kc and CFSC on 1220 kc). So now is the time for county hunters in Canada to bag the smaller and more numerous districts before the regional switch spreads to other areas.

Remember that some counties—such as Linn in Kansas—have no broadcast stations

at all. These will be game solely for the amateur.

The Niagara Region with four full-time stations will be a fairly easy target, while Monroe County in Florida (notable for Dry Tortugas and Sugar Loaf) can be logged readily via the VOA's 50-kw relay at Marathon (1180 kc). DXers west of the Mississippi should look for their sign-on at 0300 PST. The 33 easiest chances for the DXer are listed in the table. Hamilton County is repeated twice.

The purpose of El's new award is also to show you how to DX in style and to turn you on to domestic DXing. Therefore, instead of bagging Monroe County the easy [Continued on page 102]

Good Reading

By Tim Cartwright

FUNK & WAGNALLS DICTIONARY OF ELECTRONICS. Funk & Wagnalls, New York. 230 pages. \$6.95

Ever since Rowan and Martin, engineers have been telling each other to go look it up in your Funk and Wagnalls. (Not having too many jokes, engineering people tend to use the ones they get.) Now we all have one of our very own, and a very good one it is for looking things up. Possibly because they tend to become dated so quickly, the great majority of electronics dictionaries seem to be skimpy, patchwork affairs which appear as if they had simply plagiarized from each other. Not this one. It's complete, well put together and highly readable—the latter being very unusual for a technical dictionary. And despite a handsome format (see illustration which accompanies entry for *composite video signal*) and good paper, it isn't one of those prohibitively expensive volumes. Nothing in electronics stands still very long, and there are already some things visibly missing from this compendium, but that doesn't (or shouldn't) keep it from being a valuable reference for anyone involved with electronics.

INSTALLING AND SERVICING HOME AUDIO SYSTEMS. By Jack Hobbs. Tab Books, Blue Ridge Summit, Pa. 250 pages. \$7.95

Most books of this sort start with the premise that component hi-fi is an area which really belongs to the old-time radio-TV repairman and then proceed to tell him how to get into it by describing circuits and components long-since obsolete, thus making sure that he will be unable to deal with the first knowledgeable audiophile who comes along. Well, this book is also aimed at the radio-TV service technician. However, while it is not all that in tune with the realities of getting into a new business, it is at least accurate and complete—and reasonably up-to-date on the actual workings of hi-fi components. It is likely to get its readers to practice the right ways of thinking about high-performance audio circuitry, squelching their tendency to do free-style, make-shift repairs on sensitive equipment. I'm not convinced

that this book can achieve its stated purpose of getting the repairman into the action, but it is a well-written guide for the man who wants to try.

FM FROM ANTENNA TO AUDIO. By Leonard Feldman. Howard Sams & Bobbs Merrill, New York & Indianapolis. 158 pages. \$3.95

When we reviewed Leonard Feldman's book on antennas not too long ago, we assumed (correctly) that the *From Antenna* section of this book would be a light treatment. But the rest of this book contains a thoroughgoing and able treatment of modern FM reception, one that could be interesting and useful to both the hobbyist and the professional serviceman. The coverage is up-to-date, though the focus is on general areas of design rather than on specific circuits. The final chapter on alignment procedures should be helpful to advanced audiophiles who want to tackle this themselves.

AMATEUR TESTS AND MEASUREMENTS. By Louis M. Dezettel, WSREZ. Editors and Engineers, New Augusta, Ind. 206 pages. \$5.50

Most amateur radio operators take a good deal of pride in the working condition of their gear and, of course, its operating within the law. This valuable little book provides as good and pertinent information as a ham is likely to get anywhere on how to use inexpensive test equipment to make really accurate and revealing checks on performance. Very well done.

And make note of . . .

CB RADIO SERVICING GUIDE. By Leo G. Sands. Howard Sams & Bobbs-Merrill, New York & Indianapolis. 160 pgs. \$3.95.

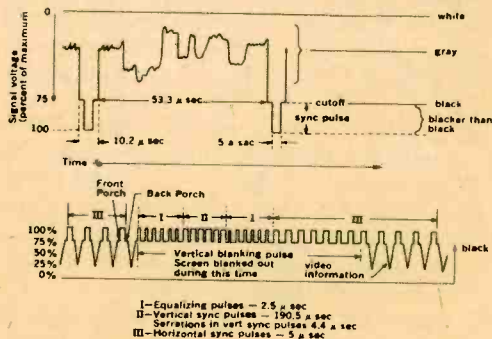

The ABCs of Color Television Servicing

By Forest H. Belt

Part V:

Chroma Circuits: Operation

& Troubleshooting

IN the preceding installment we discussed symptoms of troubles that develop in the chroma sections of color receivers. However, before you can do an efficient job of tracking down chroma faults you should understand the basics of operation. Therefore, before you tackle specific troubleshooting techniques, let's examine how the chroma stages work. And don't forget to take the quiz on Part IV on the last page.

The block diagram in Fig. 5-1 is your best guide to the chroma stages and their inter-relationships. It is taken from a transistor color set; a partial schematic of the chroma section is shown in Fig. 5-2 on the next two pages. Compare both illustrations carefully.

Chroma information is in the form of 42.17-mc sidebands when it comes through the set's video IF strip. With it are the 41.25-mc sound carrier and the 45.75-mc picture carrier. The chroma sidebands are recovered by heterodyning the 42.17-mc sidebands with the picture IF carrier. This happens in the video detector. Once recovered, the color information comprises only sidebands above and below 3.58 mc. The sidebands are called simply the 3.58-mc chroma signal.

Following Color Signals. A video-detector amplifier transistor (not shown

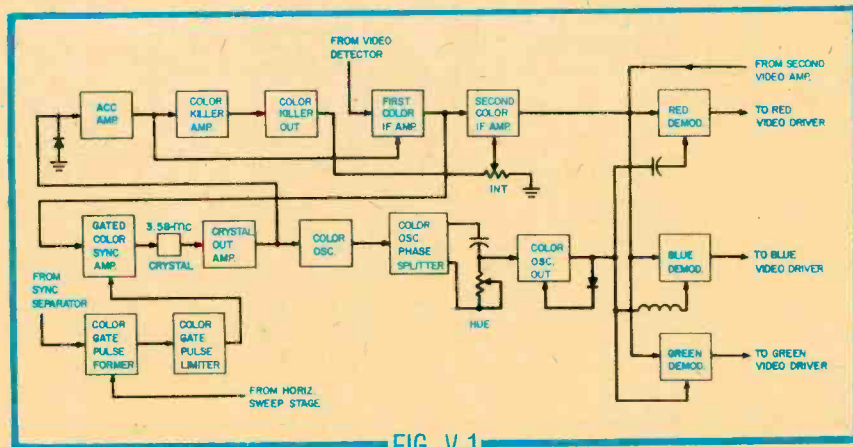
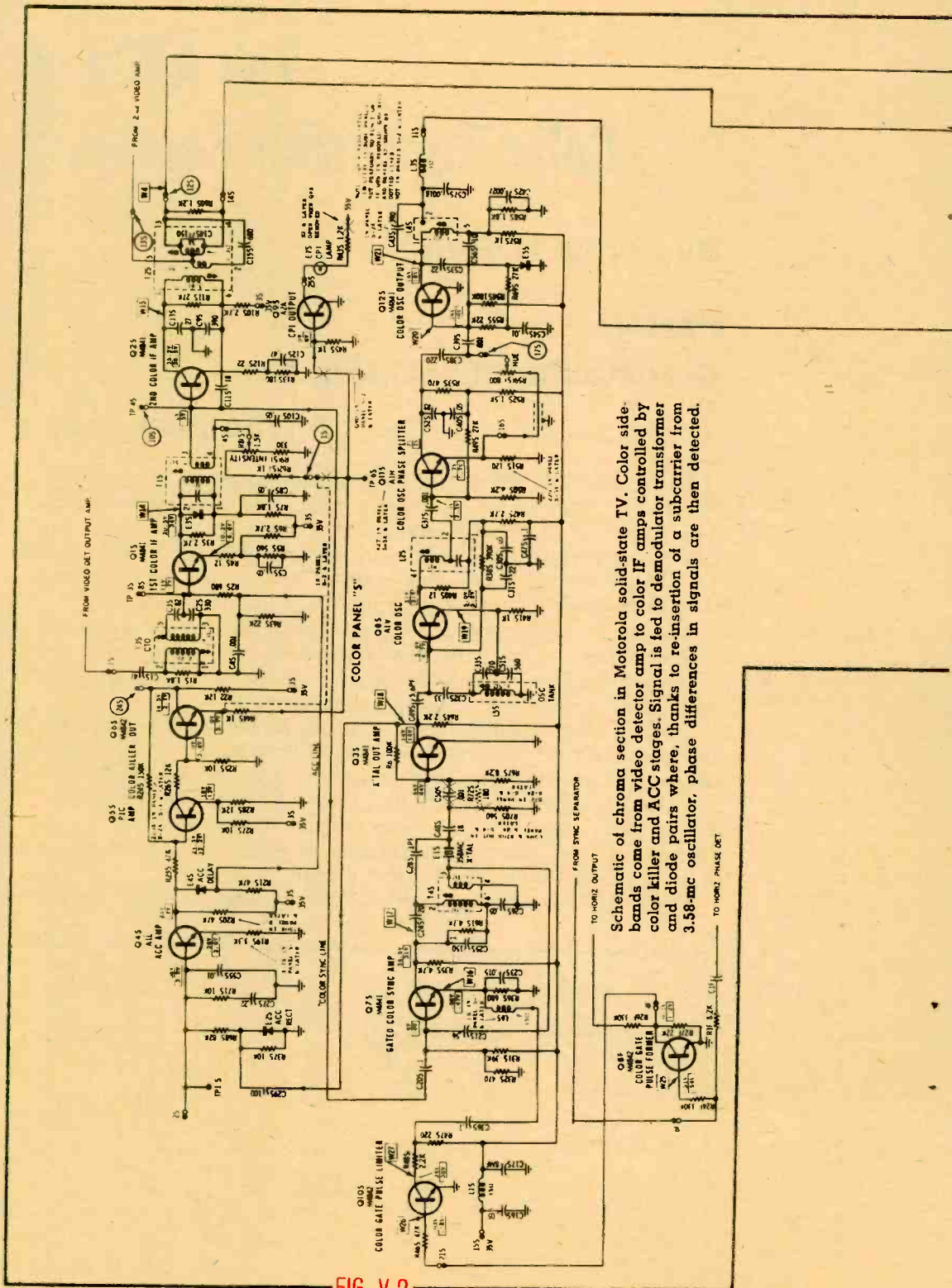
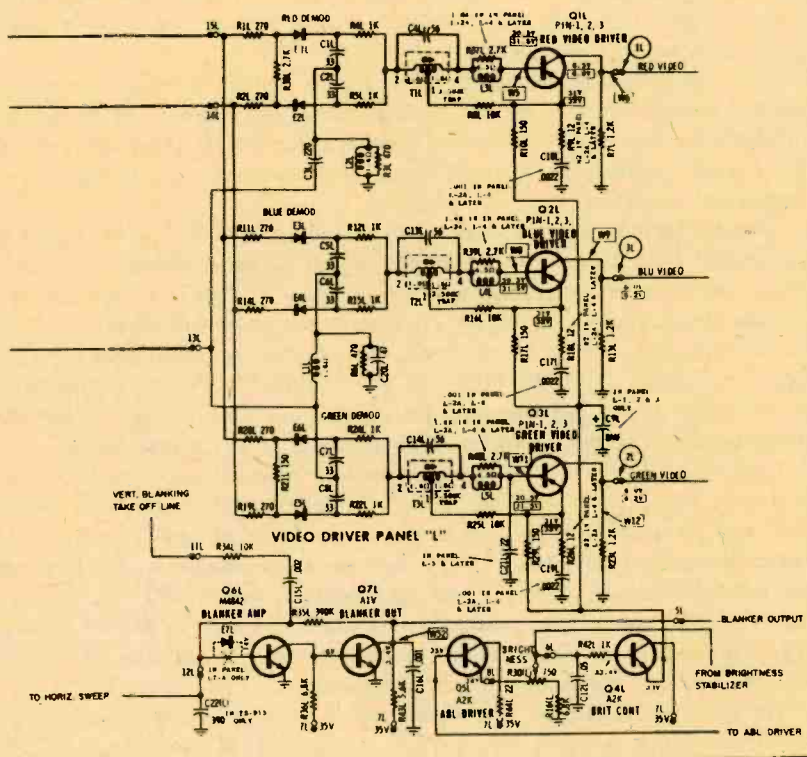

FIG. V-1



Schematic of chroma section in Motorola solid-state TV. Color sidebands come from video detector amp to color IF amps controlled by color killer and ACC stages. Signal is fed to demodulator transformer and diode pairs where, thanks to re-insertion of a subcarrier from 3.58-mc oscillator, phase differences in signals are then detected.

FIG. V-2



in Fig. 5-2) builds up the 3.58-mc chroma signal. It is then fed through a 47- μ f capacitor to the chroma takeoff transformer (labeled CTO at top of Fig. 5-2). This is a double-tuned transformer that's resonant at 3.58 mc. An 1,800-ohm resistor (R15) across the primary broadens the response enough to pass the sidebands effectively.

The color IF amplifier is so named for the same reason the sound-intercarrier amplifier of any TV set is called a sound IF stage. The 3.58 mc is a sort of intermediate frequency for the color sideband information. In some other color sets, amplifiers for the chroma signal are called bandpass amps because their response is broad enough to include the sidebands.

The amplified 3.58-mc chroma signal is coupled through transformer T1S to another color IF amplifier (Q2S). Gain in the first stage is set by a DC voltage from the automatic color control (ACC) stage. This connection runs from the ACC delay diode E4S through R2S to the base of Q1S. Thus, the ACC stage is an automatic gain control for the color IF stages. If the incoming signal is strong, the ACC lowers the first color IF gain so the second color IF amp isn't overloaded. Should the chroma signal grow weak, the color IF base bias supplied by the ACC stage becomes stronger (to override the bias already there) and the first color IF gain increases. The ACC stage assures a steady level of 3.58-mc signal for the demodulator stages.

The second color IF amplifier, Q2S, has an interrelated stage, too; that's the color killer. When no color program is being received, the color IF stages add only unnecessary thermal noise (confetti) to the picture. So the killer stage, transistors Q5S and Q6S, feeds a reverse-bias DC voltage to the second

color IF amp Q2S. With that transistor cut off, the chroma section is disabled. The color killer senses when the TV signal contains color sync. Since a monochrome signal lacks this sync, the color killer cuts off the second color IF amplifier when it is present.

Note the potentiometer (R8) in the base circuit of Q2S. It's an operating control labeled *intensity* on the front panel of this color receiver. It can be labeled *color*, *chroma* or *saturation* in other color sets. It gives the viewer control over the color IF gain, which determines how harsh or soft the colors will appear on the screen.

The three-winding transformer (T2S) that couples the 3.58-mc signal from the second color IF stage to the three pairs of diodes may look familiar. The whole arrangement resembles a ratio detector. The diodes are part of the chroma demodulator. To supply (re-insert) the color information contained in the sidebands of the 3.58-mc signal, this stage must also restore the subcarrier to the signal. (See EI's THE ABCs OF COLOR TV, Part 4, July '67, for an explanation of *suppressed-carrier modulation*.) This signal comes from transistor Q12S through various reactive networks which alter phase.

Each demodulator section (pair of diodes) recovers only one of the three primary colors that combine to make a full-color picture. The blue demodulator and green demodulator are in parallel with the red demodulator. All are fed by the same transformer (T2S). The three demodulators are alike except for one thing—the 3.58-mc signal (the restored subcarrier) inserted at the junction of the two bridge capacitors (C1L, C2L, etc.) is fed to each in a *different* phase. This phase difference permits each demodulator to pick out (or demodulate) the right color information.

The Missing Subcarrier. The signal which must be added to make the demodulators work is supplied by a color oscillator. It is also called a reference oscillator, a 3.58-mc oscillator or CW oscillator. This stage generates a continuous signal at the same frequency as the original 3.58-mc subcarrier at the transmitter. The color oscillator in the receiver must be controlled precisely so that each cycle of its 3.58-mc signal starts at precisely the same instant as the corresponding cycle at the transmitter. In other words, the signals must be exactly in phase. It's the job of the color-sync pulses to keep them that way.

Fig. 5-3 (A) shows an expanded view of a horizontal-sync pulse on top of its blanking pulse. That portion of blanking signal to the left of (preceding) the sync pulse is called the front porch; the part to the right (following) is called the back porch.

Fig. 5-3 (B) shows both horizontal sync and blanking for a color transmission. On the back porch of the blanking pedestal you can see a few cycles of the waveform which makes up the color-sync signal. This *color burst* consists of about eight cycles at a frequency of 3.579545 mc and is generated at the transmitting station. During a color program, the color burst is transmitted on the back porch of each horizontal sync pulse, as shown.

The waveforms in Fig. 5-3 appear only on a laboratory oscilloscope. Waveforms observed on a service-grade oscilloscope don't show as much detail. Examples of these appear in Fig. 5-4. The first waveform (A) is of a monochrome signal. The second (B) is of a color signal—the color-sync burst can be seen on the back porch. The third waveform (C) also represents a color signal, but the color burst is less distinct.

What is done with the burst when it reaches the receiver? When the composite signal goes through the color-takeoff transformer (CTO), each 15,750-

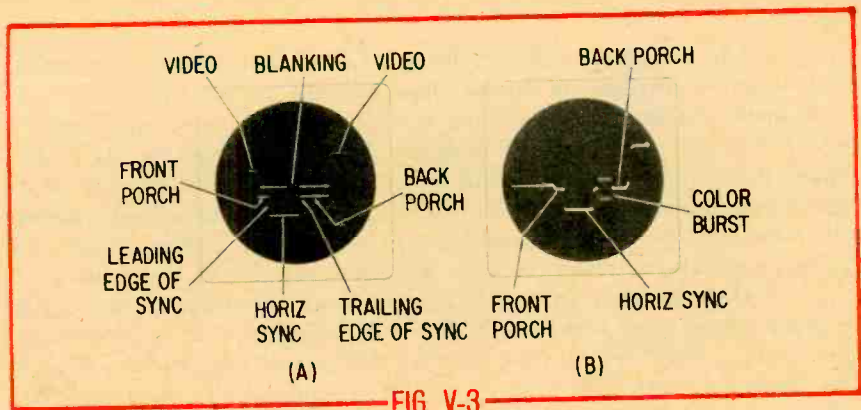

FIG. V-3

cps horizontal-sync pulse is eliminated. However, the little burst of color sync is at nearly 3.58 mc, so it is coupled right on through the tuned transformer and is amplified by the first color IF stage along with the chroma signal.

Following interstage IF transformer T1S, the color-sync signal flow is coupled through a 0.1- μ f capacitor (C20S) to the base of the gated color-sync amplifier. The term *gated* (keyed) means that the stage remains off until a high-amplitude pulse—in this case from a special gating stage—turns it on. The gating pulse originates in the horizontal-sync leg of the sync separator stage. Amplified, shaped and clipped to a proper level by limiter Q10S, this strong pulse is applied to the emitter of color-sync amplifier Q7S, allowing the transistor to conduct as long as the pulse lasts.

Why a gated stage? The signal arriving at the base of sync amp Q7S through the 0.1- μ f capacitor contains both the color-sync burst and the rest of the chroma signal (the sidebands). Only the burst is needed to synchronize the color oscillator, so gating eliminates the chroma signal. The sidebands come along with the video and occur while the transistor is cut off. Thus, the burst is the only output from transistor Q7S.

Color oscillator Q8S (see Fig. 5-2) is of the Colpitts variety. It oscillates near 3.58 mc. Note that a special controlling stage (Q3S) follows the gated color-sync amplifier; it's activated primarily by a 3.579545-mc crystal. Bursts of color-sync signal are coupled via transformer T4S to this crystal. Since the color-sync signal originates at the transmitter it is exactly at the frequency and phase required by the receiver's demodulators, and so pulls the 3.579545-mc crystal into exact synchronization. Thus, the crystal and its amplifier Q3S produce a control signal, locked solidly in phase with the transmitter, which

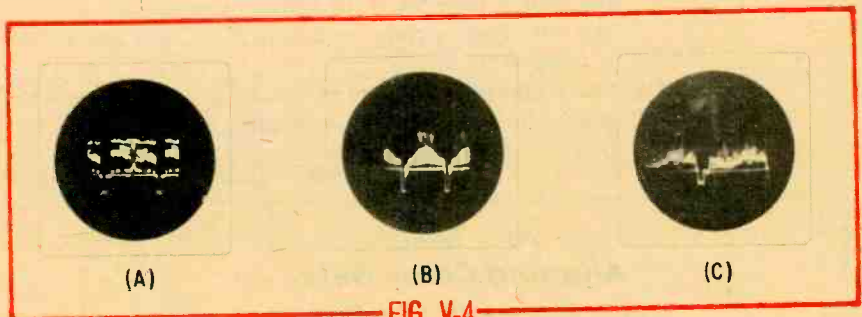

FIG. V-4

is applied to the color oscillator through C49S, a small 5.6- $\mu\mu\text{f}$ capacitor. This locks the oscillator in precise phase with the transmitter.

A small sample of the gated and synchronized signal from the crystal is also fed to the ACC amplifier through C29S. This is how the ACC stage senses the strength of the signal in the color IF stages. The strength of the signal from the crystal depends on how much color-sync signal comes through the gated amplifier, so it's a good place to get the ACC sensing voltage. The same source also activates the color killer through the ACC amplifier.

Color Demodulation. The synchronized color-oscillator signal goes through a phase-splitter stage where the *hue* control is situated. This is an operating control also called *tint* or *phase* in some receivers. It can alter the phase of the oscillator signal slightly, so the viewer has some control over the phase-difference range of the demodulators.

After passing through the *hue* control in this color chassis, the 3.58-mc reference signal goes through a stage of amplification and then is divided up to feed the color demodulators. There is significance in the way the voltage is divided. If you examine the schematic closely, you'll see that the phase-corrected oscillator signal is coupled to the green demodulator directly, to the blue demodulator through a coil (with an RC network going to ground), and to the red demodulator through a capacitor (with a resistor-coil network going to ground). These two special feed systems for blue and red are called phase-shifters.

You may have noticed adjustable tuned circuits in the output legs of the demodulators. All three are 3.58-mc traps. Once the color information is recovered the 3.58-mc signal is of no further use. The balanced phase-detector circuits (used here as color demodulators) eliminate most of it, but these traps clean out any that's left. The signals fed to the color drivers and output stages—which are simple amplifiers—should be pure color.

The next and last installment of this series will cover alignment of the chroma section—an excellent, though not always obvious, troubleshooting technique. It's the best example of how to isolate problem areas. And to wrap it all up, there will be hints for easier color servicing.

Examination on Part IV

1. Dynamic convergence is only necessary after what other adjustments have been checked?
2. How can you make it easier to adjust only two colors on the picture tube when the instructions call for it?
3. What is the first thing to do after dynamic convergence is completed?
4. Can monochrome programs be affected by troubles which arise in the chroma section of color sets?

[Turn to page 101 for correct answers]

Next Issue:
Aligning Color Sets
Plus Examination on Part V

SPECIAL SECTION: PLEASURE BOAT ELECTRONICS

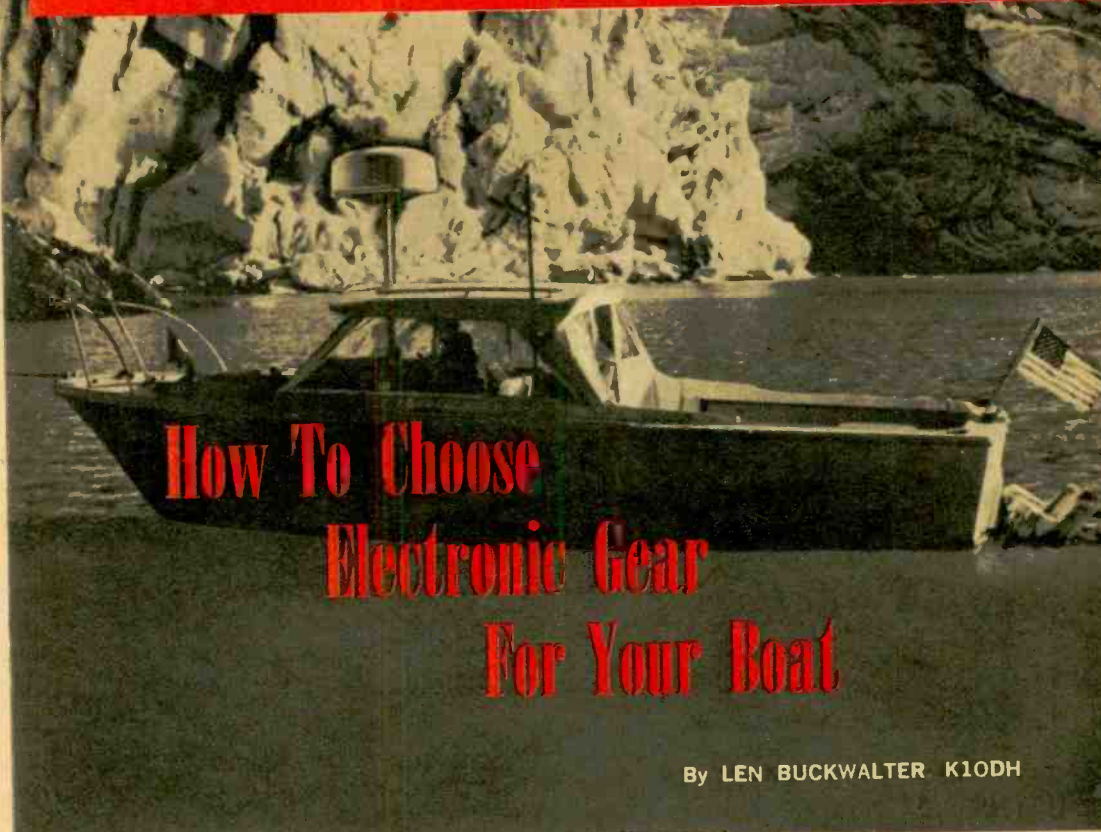

How To Choose Electronic Gear For Your Boat

By LEN BUCKWALTER K10DH

PLEASURE-BOAT electronics is making waves. Some eight million tiller-happy Americans now enjoy boating and manufacturers are coming up with something for everyone. Even if you just sail an oil drum and bedsheet around the bay, you'll feel safer with a low-cost ESSA receiver which continuously spouts marine weather. If you chase tuna off the coast of California on a Chris-Craft, you could creep back a bit safer in the smog with a \$2,500 radar. Between these extremes are loads of other electronic goodies which not only enhance safety, but make the bounding main more fun and convenient to ply.

Before sampling the exotic—like an electronic speedometer or odometer—let's see what's happening to the *big three*. According to a leading marine manufacturer, Raytheon, the three most popular electronic items for the small-boat owner rank this way: (1) depth sounder, (2) radiotelephone and (3) direction finder. Let's find out how each is being touched by some new design or function.

Ping-Ping. Depth sounders dominate the scene because of an irresistible combination of low price and a multiplicity of applications. For about \$100 (cheapest model is about \$90) you can keep from ripping out your bottom thanks to a flashing neon lamp which continuously measures depth (in ft.). Most popular models work by emitting a burst of ultrasonic energy from a transducer element mounted below the water line. After bouncing off the bottom,



Model 200 Digital Depth Computer made by Ray Jefferson costs \$249; indicates depths to 200 ft.



Model MI-29 Fish Spotter made by Heath Co. Kit costs \$79.95, is portable and sensitive to 200 ft.

How To Choose Electronic Gear For Your Boat

the returning echo enables the device to convert the time from *ping* to *ping* to depth in ft.

Something new can now be added to the depth sounder. An accessory called a depth alarm assures that a helmsman won't be hypnotized by watching the little orange light spinning hour after hour. He can select, in advance, any minimum safe depth and cruise without peering at the dial. An alarm jangles when the boat is about to run out of water.

Other trends are apparent in depth sounders. Early models were vacuum-tube gluttons that guzzled amps shamelessly. When you tried to install one in a small boat, the first question was: "Where do you plug it in?" The electrical system of an outboard motor is merely a magneto used to fire the spark. Today, however, sounders are solid-state de-

vices and draw only a fraction of their former power requirements. They may consume only 100 ma or, as they say, less current than your car's dome light! Now it's practical to power a depth sounder on a boat with no 12 VDC source; the circuit will work on regular dry cells. Not only has this prompted new models for sailboats, but it has opened up other areas for the instrument.

Since a depth sounder can be portable, you can remove it from the boat at the end of the day and foil marauders who plunder the anchorages at midnight. It also means you can use a depth sounder on a boat *temporarily*. Manufacturers now provide the hardware to install and remove a complete system with a minimum of fuss—there are even clamp-on and suction-cup arrangements to mount the transducer on the boat transom.

Besides measuring depth, depth sounders are also useful for navigation. It takes some skill, but if you have charts of local waters, you can take a succession of depth readings



Bimini 550 50-watt AM radiotelephone made by Pearce-Simpson. Four-channel model costs \$159.90.



Sonar solid-state 75-watt AM radiotelephone operates off 12 VDC, costs \$299.95, has three channels.



At left is Model AF36M 10-channel VHF-FM radiotelephone made by Apelco. It costs \$599 and has 25-watt output. Maximum range is about 40 mi.

Below is Model 6100 8-channel VHF-FM radiotelephone made by Ray Jefferson. It costs \$575, has 100-watt output, four crystals.



and compare them with those on the chart. You may be able to check your approximate position by spotting a characteristic depth contour also shown on the chart. A sounder is an excellent navigational aid when returning to a fog-bound harbor. You can keep in the center of the channel by steering toward maximum depth as shown on the flashing indicator.

But it's in the next category that depth sounders are enjoying a sudden burst of notoriety. This is due to an additional pay-off known as *fish spotting*. The action commences by using the instrument (average price is \$150, one model costs \$80) to locate a likely fishing spot. Fishing Editor A. J. McClane, for example, says that lake trout seek a rocky bottom below the 40-ft level to keep cool during hot summer months. When the sounder indicates this depth, a wide band of light should appear if the bottom is muddy: a narrow, bright band if there's a rocky surface. This sort of sonic snooping sharpens anyone's fishing instincts.

As if depth analysis weren't enough, the hapless fish can also return the echo. The sounder dial is carefully observed for blips which return before the bottom-to-surface echoes. They indicate either large individual fish or a school of smaller ones. But it's mostly an ability to locate fishy haunts that makes the sounder so useful. In salt water,

for example, these might be holes, drop-offs, mud flats or submerged wrecks.

Though the new flurry of fish spotters are depth sounders in disguise, they have special features which suit them to the job. One is a wide-dispersion transducer that searches a larger area than the conventional device. Also, the case of a fish finder is usually waterproof and will float in the event of a watery mishap. One manufacturer calls his portable model a Fisherman's Kit, which means that even the occasional boat-renter can do his own thing.

Radiotelephones, Moving Up. Ever since Marconi transmitted a running account of the America's Cup race of 1899, marine radio has grown. Tune in 2 to 3 mc on a sunny weekend and it'll sound like the sinking of the Titanic. To rescue the band from mayhem, in 1967, an international conference of maritime nations agreed to create a new marine band up in the VHF region of 156 mc. It will mean more channels, less ignition interference, no ground-plate on the hull, simpler antennas and line-of-sight transmission.

The last item should really clear the air. Low-frequency radio waves at 2 to 3 mc not only curve around the earth, they skip long distances through the ionosphere. This means local marine communications are often hampered by distant stations sharing the same

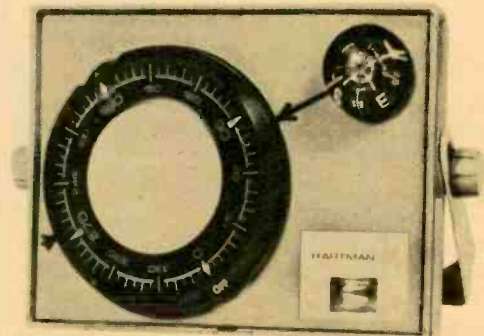

Model RDF102 direction finder by Hartman costs \$59.95. This model works on standard AM stations.



Model DF-1301 direction finder made by Sonar costs \$249.50. It works on both AM and beacon stations.

How To Choose Electronic Gear For Your Boat

channels. On the VHF bands, radio waves are effective only to the horizon, so operating range is limited to less than 50 mi. It's deemed ample for small-boat communications.

The changeover to VHF will affect nearly 200,000 marine radios now operating in the low band. Besides the frequency change, modulation will convert from AM to FM, which should reap some noise-reducing benefits. The new radios will have a power-reduction switch to allow an operator to reduce power from 25 watts (the maximum) to one watt for short-range talking. This, too, should ease channel congestion.

To protect the public's investment in existing equipment, the FCC has issued a timetable to make the transition as painless as

possible. Though these dates are not yet final, they should serve as an approximate guide: After 1971 or 1972 no further installation of regular 2-3 mc radios will be permitted; if you already have a set, you'll be allowed to use it until 1977.

Since we're in a transitional period, you may well ask: "What should I buy today?" First some pros and cons. If you purchase a regular AM radiotelephone now, you'll have at least seven years of service. The radio costs about \$300 (cheapest models cost around \$200), so you'll have to amortize your investment over that period. To get on the new band, you'll need a VHF-FM radiotelephone which costs about twice as much (\$600 is average cost)—but it won't become obsolete.

Sales of the new VHF equipment have been slow. There's no great rush by boatmen to hop aboard the VHF-FM bandwagon. Only some 2,000 such sets are now in operation, so the band is still a lonely place (though



Model MD-19 5-function foghorn/loudhailer made by Heath Co. Kit costs \$84.95; remote speaker, \$9.50.



Model 2x2 100-watt radiotelephone also serves as a loudhailer/listener. Raytheon sells it for \$399.



ELECTRONICS
AFLOAT



Loran (above) and radar (right) made by Kelvin-Hughes for large craft. Model LC-1 loran receiver costs \$1,495; Model 17 radar costs \$3,535.

the Coast Guard and marine telephone operators are on the job). VHF-FM equipment, though, is expected to spurt ahead in the next year or two, when low-band gear is dropped from manufacturers' production lines. And old sets already installed on boats should start expiring from electronic exhaustion.

Actually, the old 2-3 mc band will continue to exist, but not for the average pleasure boater. It will be reserved for boats which demonstrate a need for offshore or long-range communications. What's more, all 2-3 mc equipment *must* change over to single-sideband (SSB) modulation to conserve power and frequency space. Not only will SSB be the most expensive gear but it will be prohibited unless a boat is already equipped with the new VHF-FM equipment. You won't be concerned with SSB, however, unless you have some professional interest in the sea.

Citizens Band radio (on 27 mc) is also making sporadic forays into the marine radiotelephone field. In fact, its range compares favorably with that of the new VHF sets. It's not uncommon for a marine CBR to talk 20 or 30 mi. over water. CB's big liability is the lack of any continuous monitoring facility for emergencies. Some Coast Guard units unofficially monitor Channel 13 in popular boating areas, but they don't guard the frequency the way they do 2182 kc and 156.8 mc, the two marine distress channels.

Getting Your Bearings. Leif Ericsson might have traded Greenland for a direction finder. This instrument, third on the popularity poll, lets you either home in on a

radio station, or tune two different stations to fix your position. Though you may never venture beyond sight of land, a radio direction finder (RDF) is valuable during times of low visibility—a dark night, or when fog shrouds your way. Most sets make use of standard AM broadcast stations and low-
[Continued on page 57; directory, page 56]



Model 1900A radar by Raytheon has basic price of \$2,770. National Park Service boat shown on title page sports antenna and radome for this model.

**“He’s a good worker.
I’d promote him
right now if he had
more education
in electronics.”**



Could they be talking about you?

You'll miss a lot of opportunities if you try to get along in the electronics industry without an advanced education. Many doors will be closed to you, and no amount of hard work will open them.

But you can build a rewarding career if you supplement your experience with specialized knowledge of one of the key areas of electronics. As a specialist, you will enjoy security, excellent pay, and the kind of future you want for yourself and your family.

Going back to school isn't easy for a man with a

full-time job and family obligations. But CREI Home Study Programs make it possible for you to get the additional education you need without attending classes. You study at home, at your own pace, on your own schedule. You study with the assurance that what you learn can be applied to the job immediately.

CREI Programs cover all important areas of electronics including communications, radar and sonar, even missile and spacecraft guidance. You're sure to find a program that fits your career objectives.



**IN-DEPTH
COVERAGE OF
SOLID STATE
ELECTRONICS
...including
integrated circuits!**

You're eligible for a CREI Program if you work in electronics and have a high school education. Our FREE book gives complete information. Mail postpaid card for your copy. If card is detached, use coupon at right or write: CREI, Dept. 1703A, 3224 16th St., N.W., Washington, D.C. 20010

**CREI, Home Study Division
McGraw-Hill Book Company
Dept. 1703A, 3224 Sixteenth Street, N.W.
Washington, D.C. 20010**

Please mail me FREE book describing CREI Programs. I am employed in electronics and have a high school education.

NAME _____ AGE _____
 ADDRESS _____
 CITY _____ STATE _____ ZIP CODE _____
 EMPLOYED BY _____
 TYPE OF PRESENT WORK _____ G.I. BILL

- I am interested in
 Electronic Engineering Technology Computers
 Space Electronics Nuclear Engineering Technology
 Industrial Automation NEW! Electronics Systems Engineering



APPROVED FOR TRAINING UNDER NEW G.I. BILL

How To Choose Electronic Gear For Your Boat

Directory Of Equipment Manufacturers

Directory Of Equipment Manufacturers

Companies ▼	Products ▼	Radiotelephone	Depth Sounder	Direction Finder	Loudhailer	Alarm System	Radar	Loran	Antenna	Misc.
Antenna Specialists 12435 Euclid Ave. Cleveland, Ohio 44106									✓	
Apelco 213 East Grand Ave. S. San Francisco, Calif.	✓	✓	✓	✓		✓				
Astaron 79 Fourth St. New Rochelle, N.Y. 10801				✓		✓				
Benmar Div., Bendix Corp. 3000 W. Warner Ave. Santa Ana, Calif. 92704	✓	✓	✓			✓	✓			
C/P Corp. Div. The Shakespeare Co. RFD 3 Columbia, S.C. 29205									✓	
Courier Communications 100 Hoffman Pl. Hillside, N.J. 07205										MONITOR
Emergency Beacon Corp. 238 Hueguenot St. New Rochelle, N.Y. 10801										MONITOR
Francis Industries 11855 Broad St. Pataskala, Ohio 43062									✓	
Hartman Marine Inc. 65 Seventh Ave. Newark, N.J. 07104				✓						
Heath Co. Benton Harbor, Mich. 49022	✓	✓	✓	✓	✓					
Hy-Gain Electronics Corp. 8405 N. E. Highway 6 Lincoln, Neb. 68501									✓	
Kaar Electronics Corp. 2250 Charleston Rd. Mountain View, Calif. 94040						✓				

Companies ▼	Products ▼	Radiotelephone	Depth Sounder	Direction Finder	Loudhailer	Alarm System	Radar	Loran	Antenna	Misc.
Kelvin-Hughes Box 1951 Annapolis, Md. 21404	✓	✓					✓	✓		
Konel Corp. 271 Harbor Way S. San Francisco, Calif.	✓	✓	✓				✓	✓		
Mico Inc. 1928 Green Spring Dr. Timonium, Md. 21093									✓	
Mosley Electronics, Inc. 4610 N. Lindbergh Blvd. Bridgeton, Mo. 63042									✓	
Novatech 630 Meyer La. Redondo Beach, Calif. 90278				✓						
Pearce-Simpson Inc. 4701 N. W. 77th Ave. Miami, Fla. 33152	✓	✓	✓	✓						CONVEYER
Ray Jefferson Main & Cotton Sts. Phila., Pa. 19127	✓	✓		✓	✓					CONVEYER
Raytheon Co., Marine Div. 213 East Grand Ave. S. San Francisco, Calif.	✓	✓	✓	✓		✓	✓			
Sonar Radio Corp. 73 Wortman Ave. Brooklyn, N.Y. 11207	✓	✓	✓							
Stinger Antenna Co. Box 8456 Dallas, Tex. 75205									✓	
Walco Electronics Co. 9404 Ventnor Ave. Margate, N.J. 08402	✓									
Zenith Radio Corp. 1900 N. Austin Ave. Chicago, Ill. 60639				✓						MONITOR

frequency radio beacons found in the 150-400 kc band. Prices average \$200, the minimum is about \$90.

The latest improvement in RDF is an added provision for receiving the new ESSA stations—a meteorological bonanza for the boatman. About two dozen stations, operated by the U.S. Government's Environmental Science Services Administration, broadcast marine weather continuously to boats on the three major coasts and the Great Lakes. It's vastly superior to earlier weather services and includes radar advisories, weather conditions, temperatures, observations of wind, visibility, and sea and lake conditions. If you miss a report, keep tuned—it repeats every few minutes. Since a VHF frequency is used, 162.55 mc, manufacturers have added a special converter to RDF equipment for ESSA reception. If you choose one of the smaller portable RDF units, see if it contains the high VHF band (150 to 174 mc). On these sets, this is the band that harbors the new weather stations.

Blow-Up. One cup of spilled gasoline is said to have the explosive force of 15 sticks of dynamite. No wonder the U.S. Coast Guard reports that fire and fuel explosions cause more boating damage than anything else. These accidents also account for most personal injuries, except collisions.

That's reason enough to have a gas-fume detector aboard an inboard-powered craft. It can trigger an alarm just before your bilge is about to blow. The detector element (which is mounted where vapors are apt to collect) is usually a fine platinum wire surrounded by an aluminum screen. Gas vapors hitting the platinum produce a change in electrical resistance, an electronic bridge in the circuit is unbalanced and the alarm sounds.

Though these devices aren't new, manufacturers are putting them in fresh packages. One new concept is the safety center—a combination approach which centralizes several functions on one console. Cost is around \$120. The result is fewer electronic boxes aboard and the economy of one basic circuit performing several jobs. By hooking various input sensors to one such console, the boatman may continuously monitor gas fumes, flooding in the bilge, engine water temperature and oil pressure.

Further ingenuity with this concept is demonstrated in the new crop of loudhailers. By jockeying connections to basic audio circuitry, they've managed to come up with

some half dozen applications. First, there's the loudhailer—or public-address system—that'll carry your voice to boats, swimmers and skiers hundreds of yards away. Then the unit becomes an intercom or an automatically cycling foghorn (5 sec. on, 15 sec. off). Connect sensors and it becomes a fuel-vapor detector or burglar alarm. You can even reverse the loudhailer circuit so the system converts to an electronic ear to help you hear sounds, like distant bell buoys.

Sail on in Style. What are they showing this year for the sloop set? Though purists may deign to sully their decks with electronic devices, they're getting them anyway. You can now buy a \$375 electronic speedometer that'll detect speed changes down to an incredible one-fiftieth of a knot. It's done with a small through-the-hull sensor and a transistor indicating circuit that operates off a 12-V battery. For \$270 more, there's an odometer to measure distance traveled.

Another recent item capturing attention is an emergency locator beacon. It costs about \$80. This palm-size device, originally developed for aircraft, simultaneously broadcasts on the civil-aircraft distress frequency of 121.5 mc and the emergency military frequency of 243 mc. When the device is actuated it sends out a warbling audio tone on both channels. This is sensed as a distress signal on receivers which continuously monitor the channels and a search is initiated to locate the signal source. All commercial airliners flying over water and most military aircraft now guard the channels so there is an excellent chance that a distress signal will be heard. Range can extend to about 250 mi. These beacons are already used by Bermuda yacht racers and other sailors.

What's left for the helmsman who has everything? There's radar, of course, to help you pick your way through the sloppiest weather. A small radar that can range from 30 yards to 18 mi. is priced at about \$2,700. Cheapest models are \$2,620 (Bendix) and \$2,770 (Raytheon).

Another de luxe item is loran (Long Range Navigation) for approximately \$1,200 (cheapest model runs \$1,195). After a little dial juggling to merge two pips on a cathode-ray tube, you'll fix your position to within a few hundred yards. It's an important navigational aid for long-range craft and is also the secret of how some charter boat captains can return to a fishing hotspot somewhere out on a trackless sea. —●—

Horatio's Hornblower

By RUDOLF F. GRAF and GEORGE J. WHALEN

IT'S real pea soup and you can barely see your bow for the fog. In addition to keeping your eyes and ears on the lookout for other boats, you must watch the compass and sound your horn at periodic intervals. Caution is the word when a small boat gets caught in fog or heavy rain.

According to the book, *Rules of the Road, International-Inland*, (Publication CG-169 prepared by the U.S. Coast Guard and available from the U.S. Government Printing Office) a motor vessel should sound, when underway in a fog, one prolonged (four to six seconds duration) blast repeatedly at intervals of not more than one minute. (The book also contains the *International Regulations for Preventing Collisions at Sea and Inland Rules of the Road* which must be followed by all vessels when navigating on certain inland waters of the U.S.)

Horatio's Hornblower is a valuable safety accessory for a boat. It will prove to be worth its weight in gold during conditions of poor visibility because it takes over the function of periodically sounding a horn to warn all nearby craft of your presence. Thus it frees your attention for lookout and navigation. HH in no way affects the normal operation of a horn because it is simply connected in parallel with the horn button.

HH has two controls. One sets the frequency at which the blast is repeated and the

other sets the length of the blast. This allows for adjustment of the interval (up to 45 seconds) between blasts and independent regulation of the length of each blast (up to 10 seconds).

Circuit Description

The circuit (Fig. 5) consists of a Schmitt trigger (Q1 and Q2) which drives a transistor switch (Q3) that controls relay RY1. The relay is a DPDT type; one set of contacts activates the horn and the other set is used in the rate and duration-determining portion of the circuit.

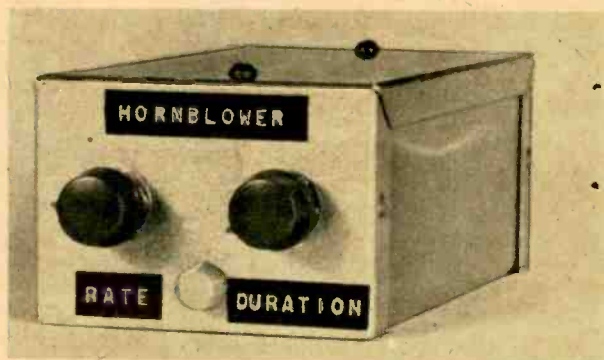

Fig. 1—Hornblower's controls. Pot at left sets number of blasts per minute. Pot at right sets their length. Light at bottom shows when unit is on.

The Schmitt trigger senses the voltage across capacitor C1 and switches Q3 on when the voltage across C1 is about 7.6 V. It switches Q3 off again when the voltage across C1 drops below 4.7 V. When Q3 is off, RY1's normally closed contacts 4 and 5 connect rate potentiometer R8 to C1 so C1 charges from the + bus. The rate of charge is determined by the setting of R8. When the

voltage across C1 reaches 7.6 V, Q1 and Q2 reverse their state, Q3 is turned on and RY1 closes. Closed contacts 3 and 4 connect C1 to ground through duration potentiometer R9 and C1 begins to discharge. The discharge rate is determined by the setting of R9. Relay RY1 now remains closed until

Fig. 2—In our model all wiring is on underside of board. Drill all holes in cabinet before installing board then install terminal strip (left) and pots and pilot light at right. After board is wired, mount it with spacers to keep it above the cabinet and make connections between board and pots, terminal strip, and the power-on pilot light.

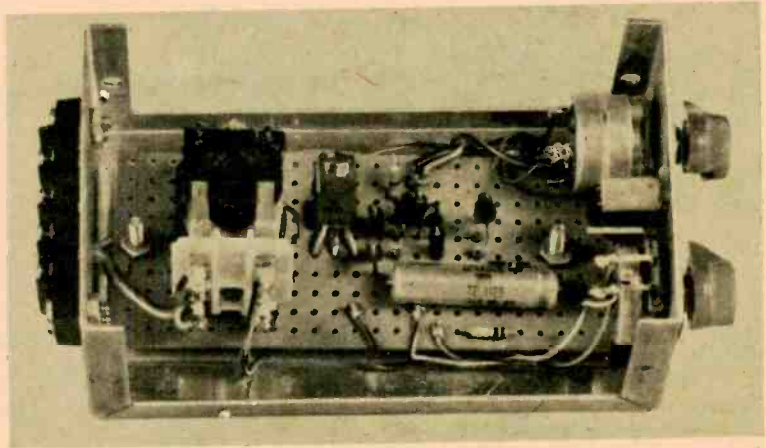

Fig. 3—Be sure of the identification of the leads of transistors Q1 and Q2. Sketch at right aids in identifying them.

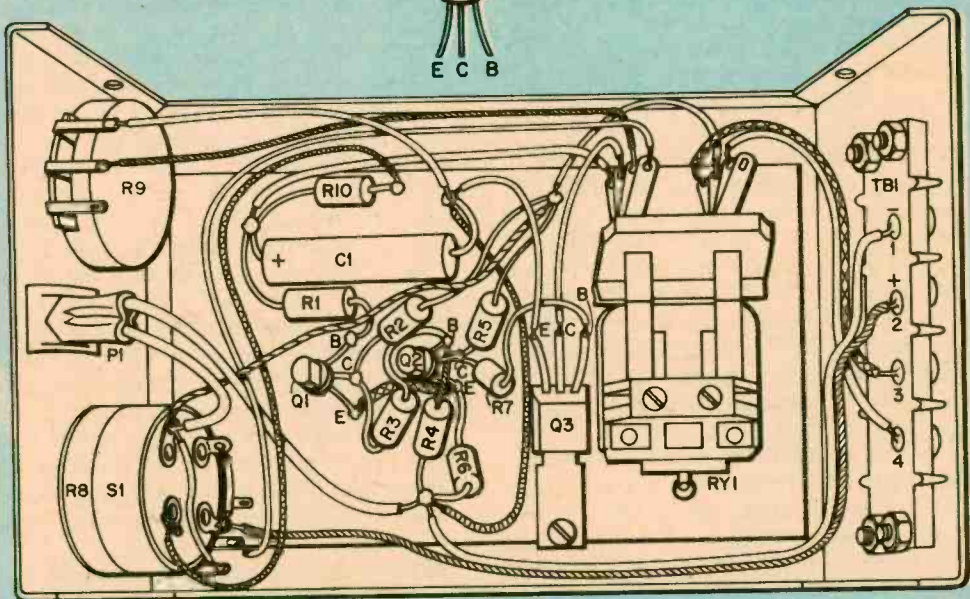

Fig. 4—To simplify construction, we show all wiring on top of board; push-in terminals are used for the points. TB1, at right, is shown on inside of cabinet for clarity. Mount it on outside.

Horatio's Hornblower

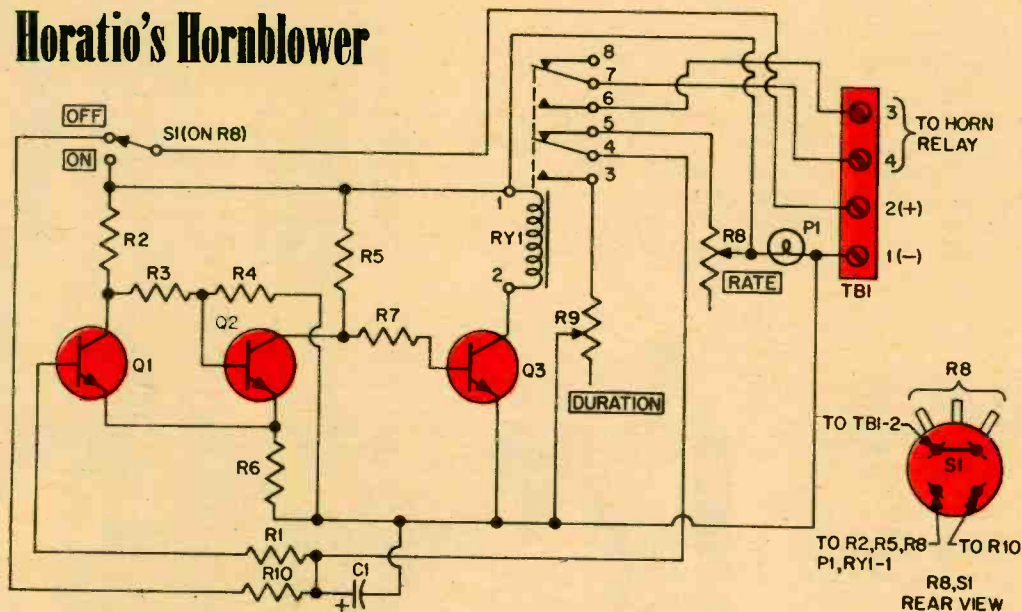

Fig. 5—When S1 is on, Schmitt trigger (Q1, Q2) turns Q3 on and RY1 is energized. Contacts 6,7 close and sound horn; contacts 3,4 close and discharge C1. When C1's voltage drops to 4.7 V, Schmitt trigger reverses state and RY1 is deenergized. The horn stops, contacts 3,4 open, C1 charges to 7.6 V, cycle repeats.

the voltage across C1 drops below 4.7 V. Now Q3 is turned off, RY1 is deenergized and the cycle starts over again. Thus, the setting of R8 (*rate*) determines the time interval between closures of RY1 and the setting of R9 (*duration*) determines the time RY1 remains closed.

Another set of RY1's contacts (6 and 7) is connected to the horn relay of the boat, or in parallel with the horn button, to control the sounding of the horn.

The switch on the *rate* control is a DPST type which is so connected that when it's in the off position, all active circuits are disconnected from 12 V except R10 which is connected to the + 12-V bus to put a residual charge on C1. This provision assures that HH will cycle correctly as soon as it is turned on. The horn will start to blow immediately, which is the normal starting condition of HH. If capacitor C1 were not maintained fully charged, a prolonged and potentially dangerous delay would occur because of the time required to put a charge on C1 to bring it up to the trigger-voltage level of the Schmitt trigger. The charge is limited to a few microamperes by R10 and assures not only immediate turn-on, but also that the timing cycles are accurate every time HH is used, no matter how long the

standby period should happen to be.

Construction

HH is built in the main section of a 5¼ x 3 x 2½-in. Minibox. Except for controls R8, R9, pilot light P1 and barrier-type terminal strip TB1, all parts are mounted on a 2 x 4½-in. piece of perforated board. First thing to do is mount the controls, pilot light and terminal strip on the ends of the Minibox. Next, mount all parts on the board as shown in Figs. 2 and 4. Note in the photo in Fig. 2 that the wiring in our model is under the board. To make construction easier, we show the wiring above the board in Fig. 4. Push-in terminals are ideal for tie points.

We used a different relay in our model that specified in the Parts List; therefore, double check the lugs in the specified relay before making connections to them.

Also note in Fig. 4 that the terminal strip appears to be mounted on the inside of the cabinet. We show it this way for clarity; actually it is mounted on the outside of the cabinet as shown in Fig. 2.

After you are satisfied that all board wiring is correct, mount the board in the cabinet using ⅜-in. spacers to keep the ends of the push-in terminals on the underside of the



PARTS LIST

- C1—350 μ f, 16 V electrolytic capacitor (Lafayette 34 E 85570 or equiv.)
- P1—12 V pilot lamp and holder
- Q1,Q2—2N5172 transistor (Sprague, Allied 49 D 2N5172-SPR. 19¢ plus postage, not listed in catalog)
- Q3—D27C1 transistor (GE, Newark Electronics Corp., 500 N. Pulaski Rd., Chicago, Ill. 60624. \$1.44 plus postage. \$5 minimum order)
- R1—10,000 ohm, 1/2 watt, 10% resistor
- R2—4,700 ohm, 1/2 watt, 10% resistor
- R3,R5,R7—2,700 ohm, 1/2 watt, 10% resistor
- R4—6,800 ohm, 1/2 watt, 10% resistor
- R6—68 ohm, 1/2 watt, 10% resistor
- R8,R9—1 megohm linear-taper potentiometer
- R10—100,000 ohm, 1/2 watt, 10% resistor
- RY1—DPDT relay, 12 VDC (120 ohms) coil (Potter & Brumfield KA11DY, Newark 24F1215. \$3.75 plus postage.)
- S1—DPST switch on R8
- TB1—Barrier terminal strip (4 terminals, Cinch-Jones 4-140)
- Misc.—5 1/4 x 3 x 2 1/2-in. Minibox, perforated board, 1/4-in. spacers.

that RY1's contacts are closed. The length of time RY1 will remain closed is a function of R9. Maximum duration is obtained with the control fully counterclockwise. As the control is turned clockwise, RY1 will remain held in for shorter and shorter periods. Set R8 so that RY1 closes every second. Set R9 so that RY1 remains closed for 1 second. Try other combination of settings for R8 and R9. Maximum rate, that is, time between closures of RY1 should be about 50 seconds. Maximum duration should be about 10 seconds. Once you have determined the desirable settings you can mark these points on the front of the box with a grease pencil or scribing tool.

Installation

You can install HH in just about any convenient spot on your boat. It is compact and easily adapted to undershelf mountings, or you can choose some other convenient point. Specific mounting instructions are not given because the method is determined by the space available.

Many horn circuits make use of a relay that is activated by a button located in the boat's cabin. The relay applies 12 V to the horn. In general, the horn button is located between the cold end of the relay's coil and the negative terminal of the battery or ground.

To install HH, merely connect a pair of wires so that one goes to ground and the other to the hot side of the horn relay's coil. If it is more convenient, connect directly across the horn button. Run the leads to terminals 3 and 4 on TB1.

board from touching the cabinet. Finally, make the connections between the controls, pilot light and terminal board to the circuit board.

Checkout

To check the operation of HH hook a buzzer and a battery connected in series to terminals 3 and 4 on TB1. Next, connect terminals 1 and 2 to a source of 12 VDC. Let the unit sit for a minute or two with S1 in the off position. This allows a charge to accumulate on C1. Turn rate control R8 so that S1 turns on and turn R8 further until RY1 pulls in. The buzzer should sound indicating

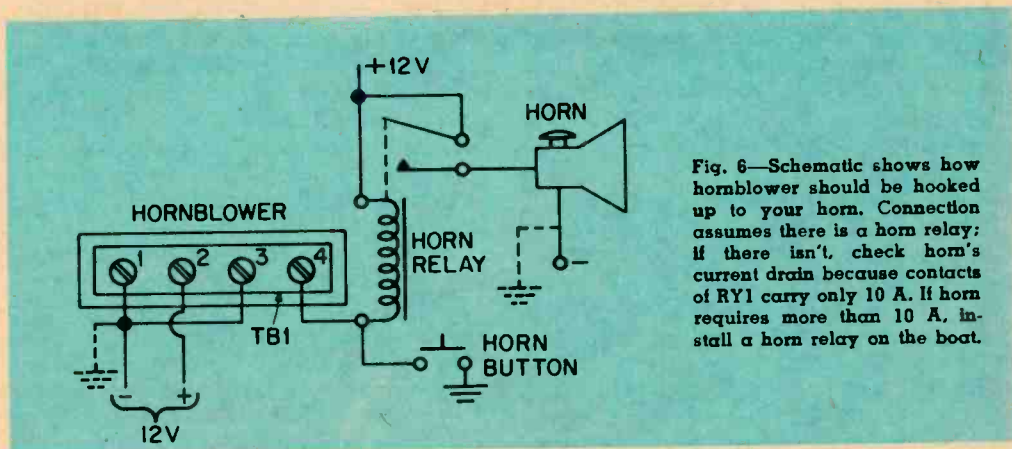
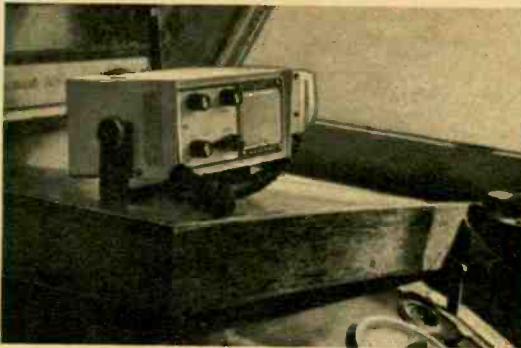

Fig. 6—Schematic shows how hornblower should be hooked up to your horn. Connection assumes there is a horn relay; if there isn't, check horn's current drain because contacts of RY1 carry only 10 A. If horn requires more than 10 A, install a horn relay on the boat.

El Kit Report

Heathkits



**MR-18 RDF plus
MD-19 Foghorn, etc.**

UPPERMOST in the mind of all boat owners is safety at sea. In addition to being able to judge weather conditions and knowing you have enough fuel and life preservers on board, it is vitally important to always be sure of where you are and that other boats are aware of you. Such security comes best from electronic equipment.

Assume you are miles from shore and lost. Landmarks won't help because there are none. If your compass is on the fritz and there's no sun, you've just about had it.

To the rescue to get you headed toward land is the Heathkit MR-18 Mariner (\$124.95) four-band radio direction finder. Using the MR-18 and charts you will be able to plot your position accurately by means of either broadcast stations or beacon stations (on the set's 200 to 400-kc long-wave band). On the long-wave band you'll also be able to tune in the FAA's continuous hourly-updated weather reports. On the receiver's 1.6 to 4 and 4 to 11-mc bands you'll be able to monitor (among other things) the 2 to 3-mc and 4 to 5-mc marine bands.

After the MR-18 has gotten you back to land you might run into thick fog. Nothing to worry about if you have a five-function MD-19 (\$84.95) on board. When operated as a *foghorn* the MD-19 will let other boats within a mile know you're groping around in the fog, too. In the *listen* mode (to which it automatically switches between foghorn blasts) the MD-19 picks up and amplifies

the sounds of bellbuoys and other boats. Put the MD-19 in the *boathorn* mode and you can signal other boats near port to get out of your way.

In the *hailer* mode you can call out to boats near the dock to move aside. Then after you've tied up you can switch to the *intercom* mode to ask someone down in the galley to bring you a beer and sandwich.

The MR-18 RDF has many useful features. It operates off its own nicad battery which can be charged from either 117 VAC or your boat's power. A switch-selected product-detector and BFO are used for CW and SSB reception.

To solve the problem of what's called 180° ambiguity when taking a bearing (getting a second null when you turn the direction-finding antenna 180°), there is a whip sensing antenna. When taking a bearing with the sensing antenna up, one null will be greater than the other. The greater null indicates the correct antenna orientation. The MR-18 has a noise-limiter circuit, sensitivity control, and dial light that can be turned on momentarily.

It took our builder about 30 hours to finish the MR-18 (it was his first kit). There were no serious problems. The step-by-step instructions were precise and easy to follow. Our builder's only problem at times was getting into tight places to solder.

The kit worked the first time and the alignment procedure was not difficult. Sen-



sitivity on the long-wave band was excellent. From the south shore of Long Island he pulled in an FAA weather broadcast from Newark, N.J. The broadcast band was as hot as any AM radio he has used. The short-wave band was alive with stations.

The last band he checked was the 2-3 mc marine band. After charging the RDF for about 30 hours he took it down to his boat and installed the mounting plate. By the way, the mounting plate is an excellent feature. You mount it permanently on the boat. The RDF snaps on the plate where it is held firmly. But it can easily be pulled off for indoor use and battery charging.

After tuning and aligning the marine band (with the aid of a friend who transmitted to our builder with his radiotelephone) our builder headed out to sea to try the inlet radio beacon on the long-wave band. At this point he had his first problem—the battery went dead and wouldn't hold a charge. It turned out that one section in the battery was bad; a new one did the trick.

The manual devotes 13 pages to direction-

Photo below shows MD-19's horn speaker installed above cabin. 30 watts of power give foghorn a range of over a mile. Control unit is in front of helm in cabin (left photo, first page). At right is MD-19.

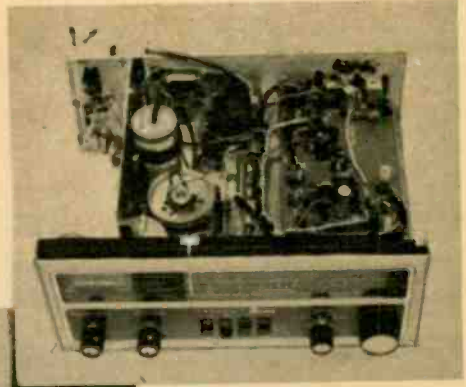
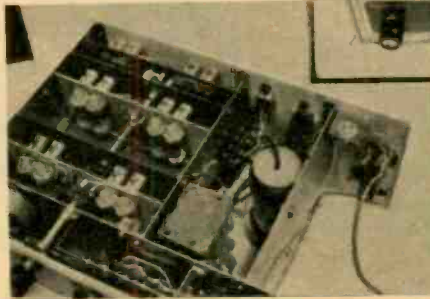
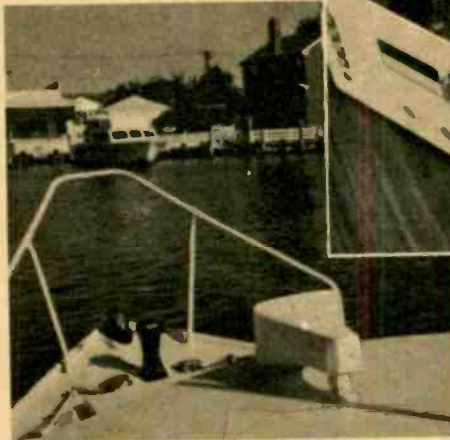

Photo above shows top of RDF. Cylindrical object at left, rear is rechargeable battery. (Right photo on first page shows RDF installed in cabin.) Photo at left shows underside. Cover plate has been removed to show trimmers on antenna, RF and the oscillator boards.

finding theory and includes a comprehensive bibliography of charts, tide tables, light lists and other publications. Armed with charts and the manual's theory under his belt, our builder set out to sea again. He was very satisfied with the way the MR-18 aided him in plotting his position.

The MD-19 (\$84.95) was our builder's next project. The horn is a weather-proof Jensen horn-type speaker. The unit operates off a boat's 12 VDC system.

Each of its five functions is selected by a spring-return switch which automatically returns to the listen mode. When operated as a

foghorn the full 30-watt output of the solid-state amplifier gives the unit a range of more than a mile. The duration and rate of the horn blast can be adjusted by two rear-panel controls to conform to Coast Guard regulations. Between fog- [Continued on page 102]

Marine-Band Converter

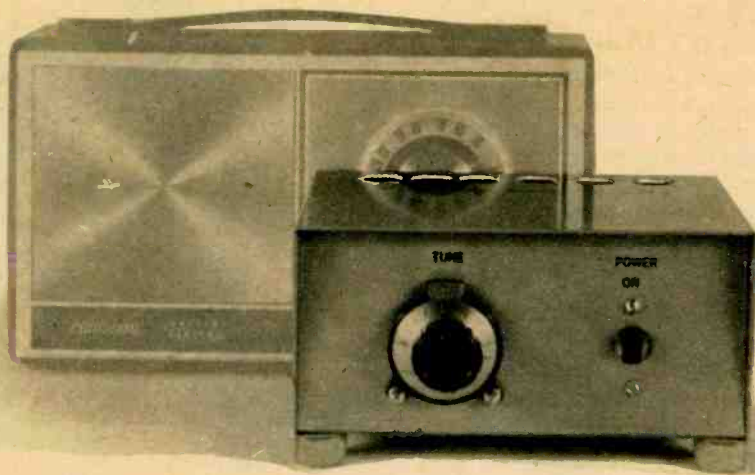

By CHARLES GREEN, W6FFQ RIDING the bounding airwaves just above the broadcast band are radio messages spiced with salty talk of the sea. Active since the era of spark-gap transmitters, the marine band is busy 24 hours a day. Tune in and you'll hear weekend yachtsmen, passenger liners, freighters, tugs, commercial fishing boats and government marine-weather broadcasts. (For more information about DXing the marine band, see page 68 in this issue.)

You don't have to run out and buy a special radio to tune the 2-3 mc band. With our one-transistor converter, you can listen to all the ships at sea (and shore stations, too) on any broadcast radio. As a bonus, the converter also tunes the 80-meter amateur band and WWV (at 5 mc).

The converter can be connected directly to a broadcast radio or can be operated piggyback fashion by radiating signals directly to a radio sitting on its top. The construction of the converter is simple; most of the components are mounted on a perforated board in a 4 x 6 x 3-in. aluminum cabinet. The converter is battery powered so it can be used at home, in your car or on your boat.

The Circuit

Look at the schematic in Fig. 2. Signals from the antenna go via J1 to the primary winding of antenna coil T1. The signals are tuned by C2A, which is connected across the secondary winding of T1. The two-turn winding (L1) couples the tuned signal to the base of transistor Q1.

The base of Q1 is also coupled to oscillator coil T2. Coil T2 is tuned by C2B (ganged to C2A) so that the oscillator always operates about 550 kc above the signal. The resultant IF frequency of about 550 kc is produced in the collector of Q1 and coupled through C6/L2 to L3 and J2. The radio's input is connected to J2 or its antenna coil is placed near L2 to pick up the radiated 550-kc signal.

Marine-Band Converter

ELECTRONICS
AFLOAT

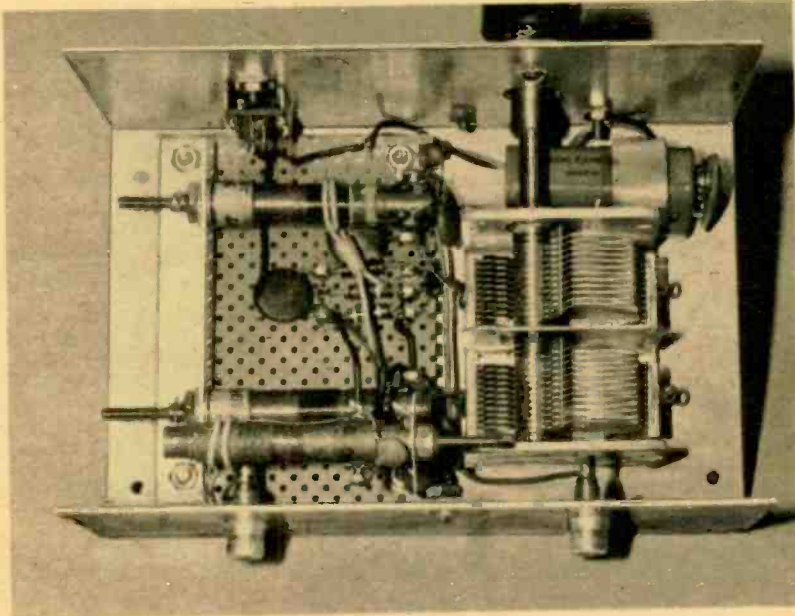

Fig. 1—Trimmer capacitors C3A,C3B are on side of tuning capacitor near board. They are adjusted with long alignment tool from under board. Put sleeving over L1's leads to keep the winding tight.

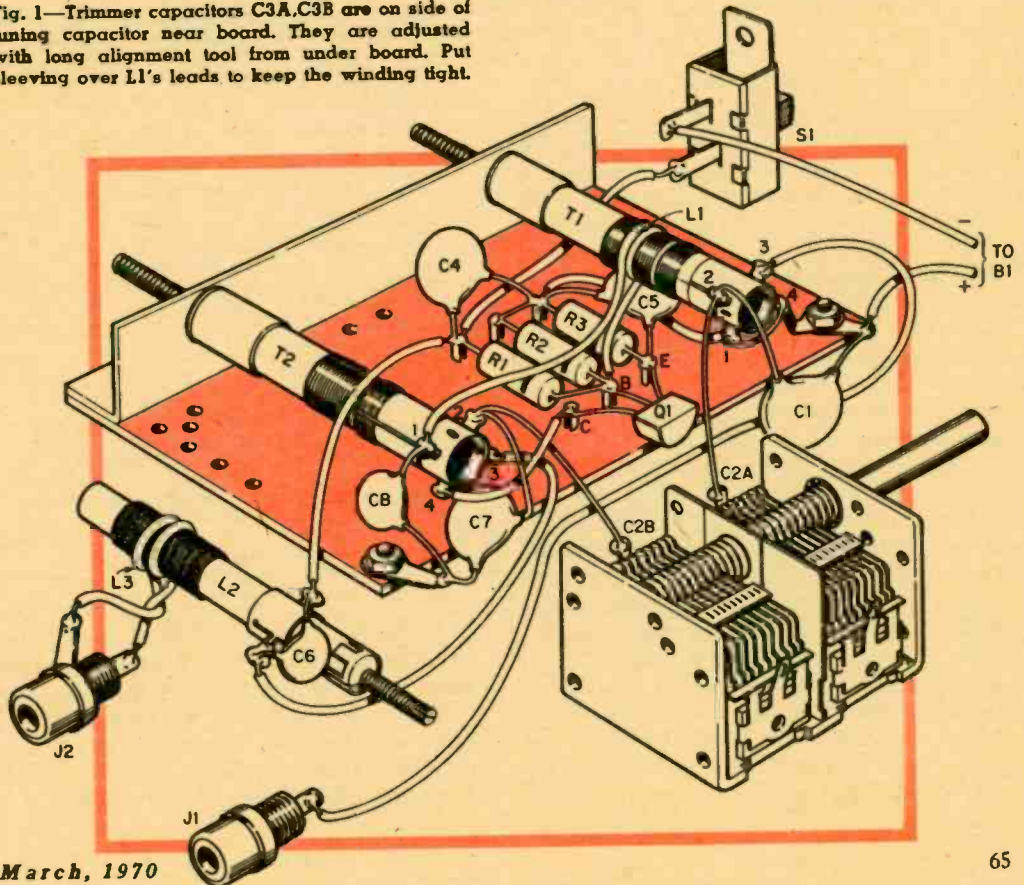
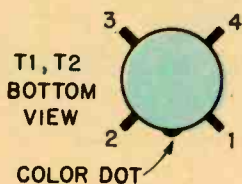
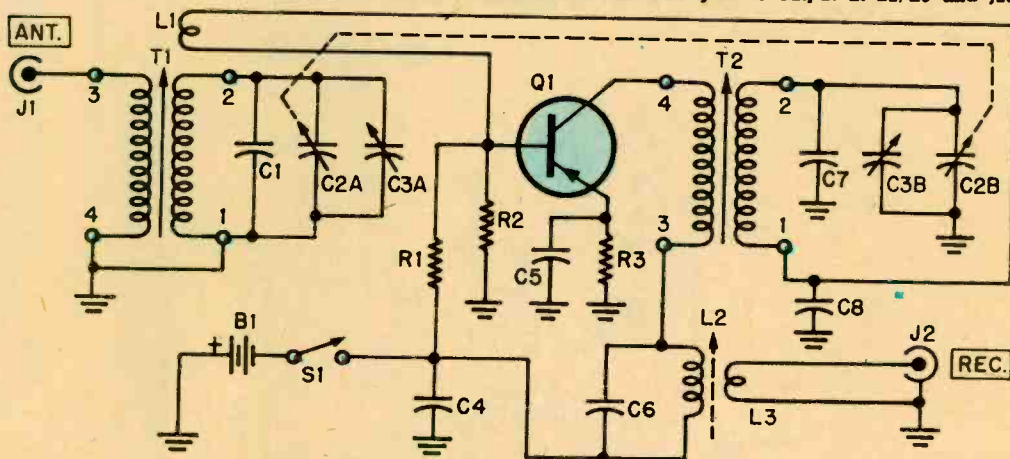

Fig. 2—Incoming signal is fed to T1 and tuned by C2A. L1 couples Q1's base to T1 and oscillator coil T2. C2B tunes oscillator 550 kc above incoming signal. Resultant 550-kc IF in Q1's collector goes to output at L2/L3 and J2.



Construction

Our converter is built in a 4-in. deep, 6-in. wide, and 3-in. high aluminum cabinet. The exact size of the box is not important as long as the components are kept in the same position as in our model. Even though the converter operates at low RF frequencies, the wiring layout is critical.

Most of the components (except B1, C2A/C2B and L2) are mounted with flea clips on a 2½ x 3½-in. piece of perforated board. Begin construction by locating the mounting holes in the cabinet for C2A/C2B and the vernier dial in the places shown in the photo in Fig. 1. Then fasten these components in place.

Cut the perforated board to size and install it about ¼ in. to the left of the tuning capacitor with a ⅜-in. metal spacer at each corner. Install S1 on the front panel, and J1 and J2 on the rear panel as shown. Mount coils T1 and T2 on a ¾-in. high x ½-in. deep x 3½-in. long aluminum bracket on two of the perforated board mounting screws. Space the coils ⅜ in. above the board and away from S1. Scrape the paint from the cabinet under all mounting screws.

PARTS LIST

- B1—9 V battery (Eveready 216 or equiv.)
- Capacitors: disc, 10%, 25 V or higher unless otherwise indicated
- C1, C7—47 μ f
- C2A, C2B—10.3-365.7 μ f, two-gang (TRF) variable capacitor (Lafayette 32 E 11026 or equiv.)
- C3A, C3B—Trimmer capacitors on C2A, C2B
- C4—.02 μ f
- C5—.0047 μ f
- C6—470 μ f
- C8—.002 μ f
- J1, J2—Phono jack
- L1, L3—Two turns No. 22 hookup wire wound on L2, T1 (see text)
- L2—Tunable ferrite-core antenna coil (J. W. Miller 6300, Lafayette 34 E 87055)
- Q1—HEP-57 transistor (Motorola)
- Resistors: ½ watt, 10%
- R1—4,700 ohms
- R2—2,700 ohms
- R3—1,500 ohms
- S1—SPST switch
- T1—1.7-5.5 mc antenna coil (J. W. Miller B-5495-A, Lafayette 34 E 87147)
- T2—1.7-5.5 mc oscillator coil (J. W. Miller B-5495-C, Lafayette 34 E 87162)
- Misc.—1½-in. vernier dial (Lafayette 99 E 60311), cabinet, perforated board, push-in terminals, No. 22 hookup wire, ⅜-in. metal spacers, sheet aluminum

Mount B1 with an aluminum strap in the space between the tuning capacitor and the front panel. Mount L2 on a metal bracket about ½ in. away from the rear panel and close to the top as shown. Wire the components keeping all leads as short and direct. Wind two turns of No. 22 hookup wire over

Marine-Band Converter

the center of T1's secondary (wider winding) and slip on a piece of tubing to keep the wires together. Solder one end to the base connection of Q1 and the other end to lug 1 of T2. Wind two turns of No. 22 hookup wire around the center of L2's winding, twist the leads together and connect the leads to J2. Cut off the flea clips under the perforated board so you'll have easy access to trimmers C3A and C3B during alignment.

Layout and drill several $\frac{5}{8}$ -in. holes across the rear of the cabinet top as shown in Fig. 3. The holes are necessary to allow RF radiation from L2 to a radio on top of the cabinet. Position the holes so that they are over L2 when the cover is in place.

Alignment

Tune a broadcast radio to a clear spot on the dial near 550 kc. Connect J2 via a coax cable or twisted pair of wires to the radio's antenna and ground terminals. Make sure that the center connector of J2 is connected to the antenna terminal of the radio. If there are no antenna and ground terminals, wind 2 turns of No. 22 hookup wire around the radio's loopstick antenna and connect the wire to J2 via coax or twisted pair. If the radio will fit on top of the converter, position the radio so that its loop antenna is over the holes on the converter top and aligned parallel and close to L2.

Set up a signal generator for a 550-kc modulated output and connect it to J1. Adjust L2 for maximum output from the radio. If necessary, tune the radio and shift its position (if on top of the converter) for maximum output.

Adjust the converter's tuning capacitor for almost maximum capacitance (plates closed) and set up the signal generator for a 2-mc modulated output. Adjust T1 and T2 for maximum signal.

Set up the signal generator for a 5-mc modulated output and set the tuning capacitor to almost minimum capacitance (plates open). Adjust trimmers C3A and C3B for maximum signal. Repeat the preceding adjustments.

Operation

For best reception a good high-mounted outside antenna is required. Use either a dipole or a long-wire antenna and a good

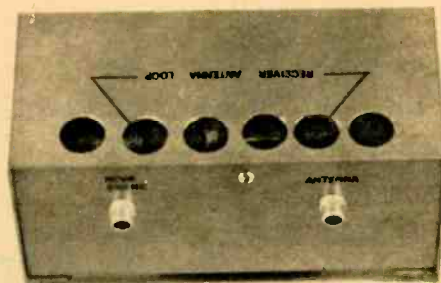

Fig. 3—Top and back of cabinet. $\frac{5}{8}$ -in. dia. holes permit radiation of output signal from L2 to loopstick antenna in radio placed on top of cabinet.

ground. Short-wave antenna kits (such as Allied 11 A 1239) are ideal for this. For strong signals, a whip antenna and ground can be used. Connect the antenna to the center connector of J1 and the ground to the outside ring or shell of J1.

As we said, the converter can be connected to your radio in two ways: J2 connected via coax or a twisted pair of leads to the receiver's antenna and ground terminals. Or, if there are no antenna and ground terminals, wind two turns of No. 22 hookup wire around the radio's ferrite-rod antenna and connect the leads to J2.

Connect the antenna and ground to J1, set S1 to *on* and adjust the radio's tuning dial for a clear spot near 550 kc. If the radio is on top of the converter, move the radio around for maximum background noise. Then tune the converter for signals. The radio also can be tuned slightly to act as a bandspread to separate crowded signals.

If you can't find a clear frequency near 550 kc, tune to a clear spot on the dial nearby and readjust L2 for maximum sensitivity. We used a vernier dial with a 0-10 logging scale on our model and used a chart to determine frequency. If you want to, mark frequencies on the dial with transfer lettering. There may be some spurious signals caused by reception of the radio's local oscillator.

DIAL CALIBRATION CHART			
Dial No.	Freq. (mc)	Dial No.	Freq. (mc)
0.4	1.9	5.9	3.5
1.0	2.0	6.5	3.75
2.3	2.25	7.0	4.0
3.2	2.5	7.6	4.25
4.0	2.75	8.3	4.5
4.7	3.0	8.6	4.75
5.3	3.25	9.5	5.0

DXing The Marine Band

By TOM KNEITEL, K2AES



Now's the time to climb aboard for fast and furious DXing on our waterways!

MANY SWLs sit at their rigs for years getting their jollies by listening to the stately chimes of Big Ben or the haunting strains of *Columbia the Gem of the Ocean*. Little do they know that with a little flexing of their hand they can drop down on the dial into the exciting world of maritime DX.

Now is the time to start wading into the marine frequencies because one batch of stations is soon to be eliminated while a whole new group of stations is about to take to the ether. In one shot you can log and verify stations which will soon be totally extinct and

at the same time get in on the ground floor for what promises to be a swinging type of utility DX.

Dropping into oblivion are the AM stations in the 2-mc band; ships, shore stations, marine operators—all must move up to VHF-FM frequencies. The death notice from the FCC has already been posted. It calls for a freeze on new licenses to go into effect after January 1, 1970. All AM stations must be off the air (except for SSB channels) not later than January 1, 1977.

While rigor mortis hasn't set in yet, there

HPLM			
<small>U.S.C. SAUTILLUS (SSA-571)</small>			
<small>THIS WILL CONFIRM YOUR RECEPTION OF</small>			
<small>RADIO STATION</small>	<small>ON</small>	<small>ON</small>	<small>ECS AT</small>
0250	GMT ON	JULY 28 1958	19 58
<small>POWER</small>	<small>WATTS ANTENNA</small>	<small>SS BATT.</small>	
160	29.50 W	67.16 W	
<small>REMARKS - First station of mine ever off the air.</small>			
<small>As normal 24 hr. UT for 24 hr. 24 hr. 24 hr. 24 hr.</small>			
<small>Signed: <i>Robert Kneitel</i></small>			

TEXAS TOWER-4			
<small>U.S.C. SAUTILLUS (SSA-571)</small>			
<small>THIS WILL CONFIRM YOUR RECEPTION OF</small>			
<small>RADIO STATION</small>	<small>ON</small>	<small>ON</small>	<small>ECS AT</small>
47.4	GMT ON		19
<small>POWER</small>	<small>WATTS ANTENNA</small>	<small>SS BATT.</small>	
10	10	19	
<small>REMARKS - First station of mine ever off the air.</small>			
<small>As normal 24 hr. UT for 24 hr. 24 hr. 24 hr. 24 hr.</small>			
<small>Signed: <i>Robert Kneitel</i></small>			

NWCL			
<small>U.S.C. SAUTILLUS (SSA-571)</small>			
<small>THIS WILL CONFIRM YOUR RECEPTION OF</small>			
<small>RADIO STATION</small>	<small>ON</small>	<small>ON</small>	<small>ECS AT</small>
11.8	GMT ON	25 AUGUST	1957
<small>POWER</small>	<small>WATTS ANTENNA</small>	<small>ATTENORATE</small>	<small>RECF</small>
16	16		
<small>REMARKS -</small>			
<small>Signed: <i>Robert Kneitel</i></small>			

These QSLs, prepared by the author, turned out to be rare. First card, HPLM, was returned by staff of SS Yarmouth, a passenger liner which burned at sea. Second is from Texas Tower 4, a radar platform which toppled over in a storm. Station NWCL is aboard the USS Nautilus, the Navy's first atomic sub.

PUBLIC CORRESPONDENCE—SHIP 'N SHORE CHANNELS

AREAS	Ship (kc)	Shore (kc)	AREAS	Ship (kc)	Shore (kc)	AREAS	Ship (kc)	Shore (kc)
Alabama	2430	2572	Great Lakes	4128.2	4433.2	New York	4088.5	4393.5
California	2003	2450		4129.9	4434.9		4089.9	4394.9
	2009	2566		4131.3	4436.3		4091.6	4396.6
	2126	2522		8247.5	8797.5		4093	4398
	2206	2598		8249.2	8799.2		4101.3	4406.3
	2382	2466		8250.6	8800.6		4102.7	4407.7
	2406	2506		2830	—		4104.4	4409.4
	4069.3	4374.3	Gulf of Mexi	2134	2530		4105.8	4410.8
	4070.7	4375.7	Hawaii	2198	2582		4126.8	4431.8
	4072.4	4377.4		4114.1	4419.1		4129.9	4434.9
	4073.8	4378.8		4115.5	4420.5		4131.3	4436.3
	8201.3	8751.3		4117.2	4422.2		8220.5	8770.5
	8202.7	8752.7		4118.6	4423.6		8221.9	8771.9
	8204.4	8754.4		8214.1	8764.1		8223.6	8773.6
	8205.8	8755.8		8215.5	8215.5		8225	8775
	12379.2	13179.2		8217.2	8267.2		8258.8	8808.8
	12380.6	13180.6		8218.6	8268.6		8260.2	8810.2
	12382.5	13182.5		12372.2	13158.2		8261.9	8811.9
	12383.9	13183.9		12373.6	13173.6		8263.3	8813.3
	16509.2	17339.2		12375.5	13175.5		12358.2	13158.2
	16510.6	17340.6		12376.9	13176.9		12359.6	13159.6
	16512.5	17342.5		16474.2	17304.2		12361.5	13161.5
	16513.9	17343.9		16475.6	17305.7		12362.9	13162.9
	22042.2	22692.2		16477.5	17307.5		12393.2	13193.2
	22043.6	22693.6		16478.9	17308.9		12394.6	13194.6
	22045.5	22695.5	Intership	2003	—		12396.5	13196.5
	22046.9	22696.9		2214	—		12397.9	13197.9
Columbia Riv.	2784	2784		2638	—		16488.2	17318.2
Delaware	2166	2558		2738	—		16489.6	17319.6
Florida	2009	2466		2830	—		16492.9	17322.9
	2031.5	2490	Louisiana	2166	2558		16523.2	17353.2
	2118	2514		2206	2598		16524.6	17354.6
	2158	2550		2382	2482		16526.5	17356.5
	2390	2566		2458	2506		16527.9	17357.9
	2406	2442	Massachusetts	2366	2450		22028.2	22678.2
	4120.5	4425.5		2406	2506		22029.6	22679.6
	4121.9	4426.9	Mississippi	2782	2782		22031.5	22681.5
	4123.6	4428.6	River	4070.7	4070.7		22032.9	22682.9
	4125	4430		4072.4	4072.4		22063.2	22713.2
	4128.2	4433.2		4073.8	4073.8		22064.6	22714.6
	8241.1	8791.1		4375.7	4375.7		22066.5	22716.5
	8242.8	8792.8		4377.4	4377.4		22067.9	22717.9
	8244.2	8794.2		4378.8	4378.8	Oregon	2009	2442
	12352.6	13152.6		6238.3	6238.3		2031.5	2566
	12354.5	13154.5		6240	6240		2206	2598
	12355.9	13155.9		6241.4	6241.4		2134	2530
Georgia	2366	2450		6453.3	6453.3	Puerto Rico	2390	2566
Great Lakes	2003	—		6455	6455	So. Carolina	2134	2530
	2118	2514		6456.4	6456.4	Texas	2366	2450
	2158	2550		8209.1	8209.1		2738	2738
	4114.1	4419.1		8210.8	8210.8	Virginia	2142	2538
	4115.5	4420.5		8212.2	8212.2	Washington	2126	2522
	4117.2	4422.2	New York	2126	2522		2430	2482
	4118.6	4423.6		2198	2590	Distress	2182	—
	4126.8	4431.8		2382	2482	SW Inland	2782	2782

Table I—Ship channels currently in use in U.S., along with their corresponding shore channels. Note that 2-mc channels may be paired differently from harbor to harbor (i.e., 2382 kc pairs with 2466 or 2482).

is evidence already that the 2-mc band is thinning out. There's life in the old gal yet, but she's noticeably losing stations to the new VHF-FM band. Now's the time to run down to 2 mc and start jotting down stations. A QSL from any one of these vessels might be a prized collector's item in only a few years.

Whether they're scruffy tugs, military vessels, stately passenger liners, rusting freighters, or weekend admirals on their yachts, you'll hear these 2-mc stations work-

ing each other (ship to ship) and the many Coastal Harbor Telephone stations—commonly known as marine operators—which dot the coastlines and inland waterways (ship to shore).

Nighttime is your best bet for listening on this band—and during the winter. With a little luck and a good receiver you should be able to copy ships located hundreds and even thousands of miles away. Even a run

[Continued on page 74]

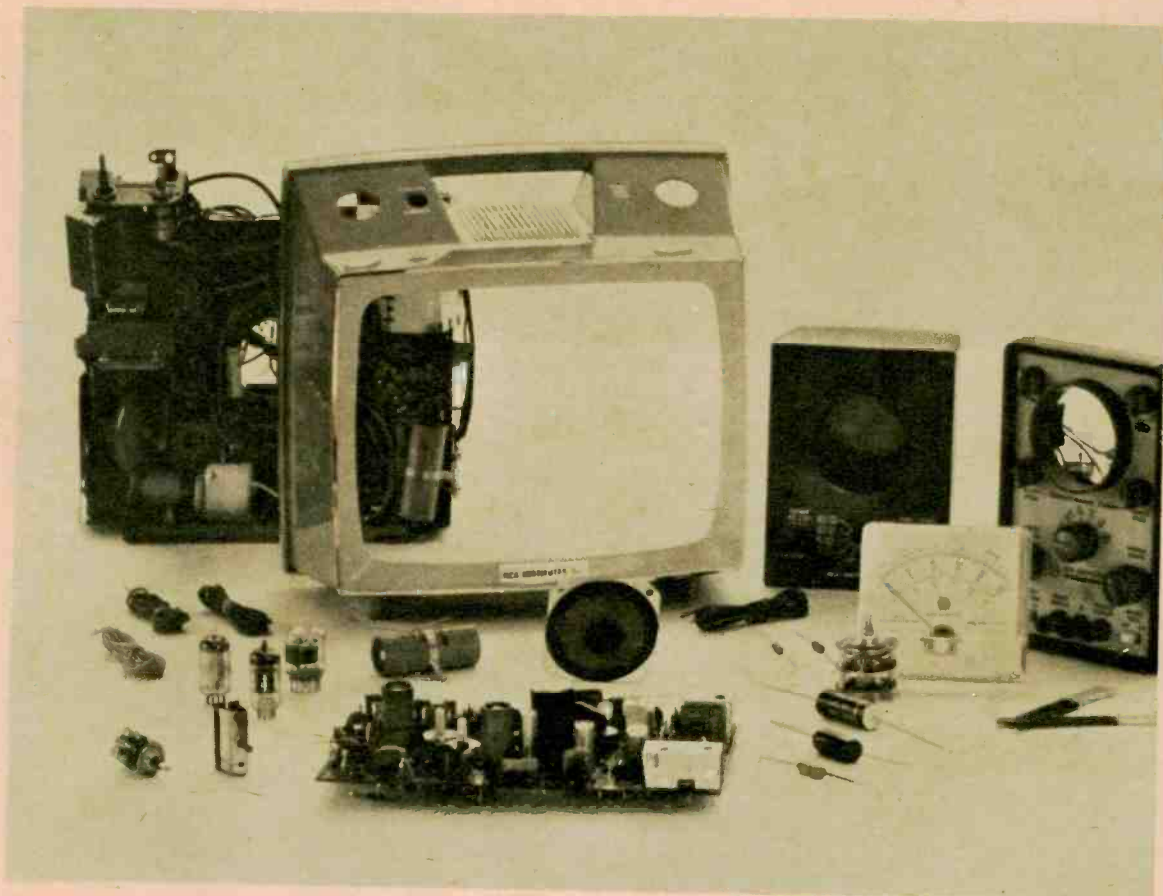

**Look! You get 25 kits...
more than ever before at no extra
cost...for your practical "hands-
on" learning of electronics and
TV with RCA Institutes Home
Training! Send postcard today!**

RCA

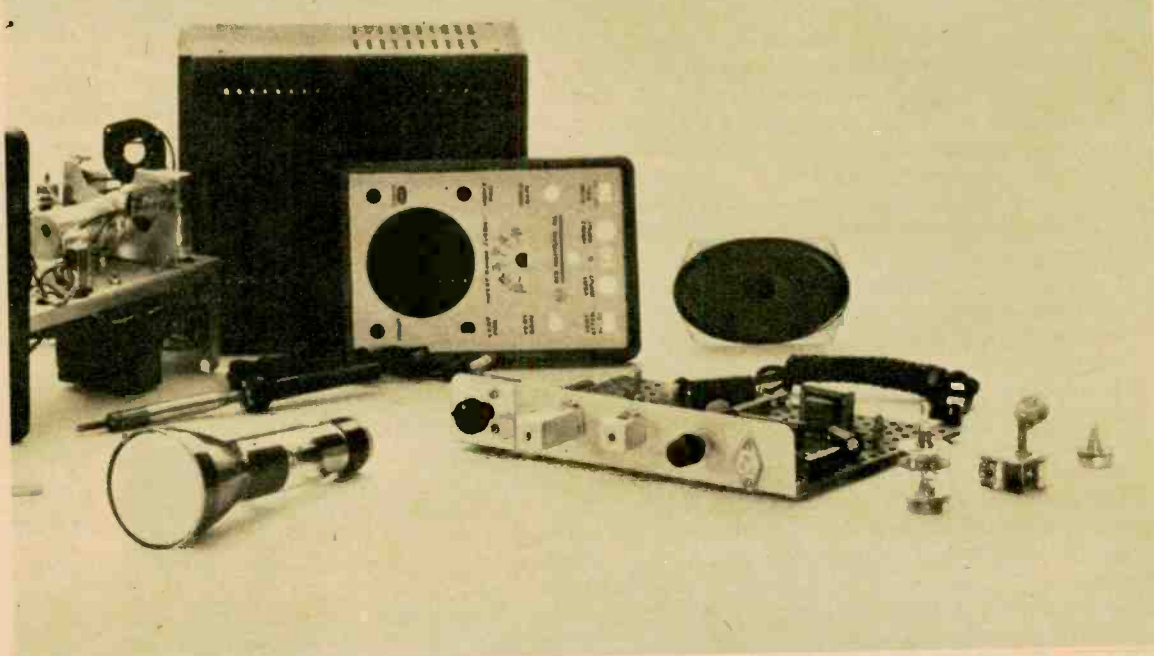

Now, RCA supplies 25 kits in its home-study career program—at no extra cost! Be sure to compare this with other home-study electronics programs. And note, you never have to take apart one kit to build another piece of equipment because there are literally thousands of parts making up the kits. Information on them is included in the catalogue which you'll get when you mail in the reply postcard or the coupon.

Absolutely practical, your kits are used to build such permanent, professional and useful equipment as an oscilloscope, a signal generator, a multimeter, and a fully transistorized breadboard superheterodyne AM receiver. They will give you years of valuable service.

In addition, an easy way to learn—the career programs are all based on the easy, step-by-step AUTOTEXT method. AUTOTEXT is unique and exclusive with RCA Institutes. Math and circuitry problems simply melt away! So check the wide range of electronics and TV career programs.

Eleven Career Programs: Television Servicing (including color TV and

CATV) • FCC License Preparation • Automation Electronics • Automatic Controls • Industrial Electronics • Nuclear Instrumentation • Electronics Drafting • including these four all-new: Semiconductor Electronics • Digital Electronics • Solid State Technology • Communications Electronics.

Also check the new Computer Programming course—trains you to work on today's largest data processing systems including IBM/360 and RCA Spectra 70, the Third Generation Computers.

You get tuition plans as flexible as you wish: pay-as-you-order or pay-by-the-month...you choose! No interest charges! No other electronics home study school offers both these choices.

Classroom training also available— day and evening coeducational classes start four times a year. No previous training required—you can take preparatory courses if you haven't completed high school.

Placement service, too—with RCA Institutes classroom training, you get the full benefits of the RCA Job Placement Service. RCA Institutes grad-

uates are now with companies that include Bell Telephone, GE, Honeywell, IBM, RCA, Westinghouse, Xerox, and major radio/TV networks. This placement service is also available to Home Study Graduates.

Veterans: enroll now—all courses are approved under the GI bill

Accredited Member National Home Study Council.

If reply postcard has been removed, mail this coupon.

.....

• RCA INSTITUTES, INC.
 • Home Study Dept. 234-003-0
 • 320 West 31 Street, New York, N.Y. 10001

• Please send me free illustrated career catalog.

Age _____

Name _____
 (please print)

Address _____

City _____

State _____ Zip _____

• For GI information, check here

.....

DXing The Marine Band

of bad luck and a bare-essentials receiver will grab many local vessels and a raft of distant shore stations.

The ships identify using their vessel name and callsign; marine operators answer to the name of their city followed by the words *marine operator* (Boston Marine Operator, Galveston Marine Operator, etc.). Shore stations seldom announce their callsigns over the air. Ship and shore channels for a particular geographic area come in pairs (see Table I). However, there's a trick here you must watch out for. Very often you will tune to a marine operator and hear *both* sides of the conversation—the shore and the vessel.

Hearing this, many DXers immediately make two loggings, one for the ship and one for the shore station; but this is a mistake. Actually, what they are hearing is the ship station (which is transmitting on another frequency) being rebroadcast by the shore station. The shore station is supposed to transmit a busy signal while receiving a message from a ship but, often as not, they merely pipe the ship's audio back into their own transmitter and let it function as a busy signal.

Sending a reception report to a ship station heard in this manner is definitely a bad scene. The right way is to seek out the ship's own frequency and see if you can hear it via the direct route. This is a great little game since it puts you in direct competition with the marine operator. She has thousands of dollars worth of professional receiving gear and a huge bank of antennas which can be

switched into different directions, and yet there are times when you'll be able to squeak out a signal while she draws a total zero. Such are the fortunes of DXing.

Naturally, ships can also be heard on their own intership channels; this avoids problems which might come up due to a marine operator. By just sitting on 2182 kc (the distress channel) for a few hours, you'll find plenty of stations to keep your log book expanding.

Above the 2-mc band there are a number of frequencies (4, 8, 12, 16 and 22 mc) in use by phone stations (usually using SSB) located too far from shore to be able to depend on lower frequencies for reliable communications. These channels are also paired off, so unless you have some inside information on the pairs (see Table I), the chance of your ever having much-luck on these bands is rather poor.

Armed with a listing of the paired-off channels, you should be able to cut a wide DX swath through stations which utilize high-frequency channels on the Mississippi, on the Great Lakes and on the high seas. Since radio is the only link these vessels have with civilization, there is a need for plenty of channel space.

The VHF-FM band of 150 to 174 mc has been around officially for several years, but the place has been as quiet as Davy Jones' locker until just recently. Now things are picking up. With a high-band VHF-FM monitor receiver and a small ground-plane antenna, you should be able to get an effective range of 40 to 60 mi. in all directions.

There are more channels available for

ELECTRONICS
AFLOAT



U.S. COASTAL STATIONS ON 2 mc

City	Callsign	Operator	Channels (kc)	City	Callsign	Operator	Channels (kc)
Astoria, Ore.	KFX	Pacific N.W. Bell	2442 2598	Miami, Fla.	WDR	Southern Bell T. & T.	2442 2498 2514
Atlanta, Ga.	WAN/WAZ	Southern Bell T. & T.	2458	Mobile, Ala.	WLO	Mobilradio WLO	2572
Boston, Mass.	WOU	New England T. & T.	2458 2506	New Orleans, La.	WAK	Southern Bell T. & T.	2482 2558 2598
Buffalo, N.Y.	WBL	Radio Corp. of Am.	2514 2558 2582	New York, N.Y.	WOX	New York Tel Co.	2482 2522 2538
Charleston, S.C.	WJO	Southern Bell T. & T.	2566	Chesapeake & Potomac Tel Co.	WAE		2538
Chicago, Ill.	WAY	Illinois Bell T. & T.	2514 2558 2582	Chesapeake & Potomac Tel Co.	WGB		2458 2538
Coos Bay, Ore.	KTJ	West Coast Tel Co.	2566	Radio Corp. of Am.	WCM		2782
Corpus Christi, Tex.	KCC	S.W. Bell T. & T.	2538	Lorraine Co. Radio Corp.	WAD		2514 2558 2582
Delcambre, La.	KGK	Delcambre Tel Co.	2506	Portland, Ore.	KQX	Pacific Tel & Tel	2598
Detroit, Mich.	WFR/WFS/WVW	Mich. Bell Tel Co.	2514 2558 2582	Rogers City, Mich.	WLC	Gen. Radio Tel Co.	2514 2558 2582
Duluth, Minn.	WAS	Lorraine Co. Radio Corp.	2514 2558 2582	San Francisco, Calif.	KLH	Pacific Tel & Tel Co.	2438 2506
Eureka, Calif.	KOE	Pacific N.W. Bell	2458 2506	St. Louis, Mo.	WGG	Radio Corp. of Am.	2782
Galveston, Tex.	KQP	S.W. Bell T. & T.	2458 2538	Seattle, Wash.	KOW	Pacific Tel & Tel Co.	2466 2558
Jacksonville, Fla.	WNJ	Southern Bell Tel Co.	2566	Tampa, Fla.	WFA	Pacific Inland Navigation	2784
Lorain, Ohio	WMI	Lorraine Co. Radio Corp.	2514 2558 2582	The Dalles, Ore.	KLP	Pacific Inland Navigation	2784
Los Angeles, Calif.	KOU	Southern Calif. Tel Co.	2466 2522 2566 2598	Umatilla, Ore.	KIW	American T. & T. Co.	2558
Louisville, Ky.	WFN	Warner & Tumble Radio	2782	Wilmington, Del.	WAQ	Diamond State Tel Co.	2558
Memphis, Tenn.	WEN	Warner & Tumble Radio	2782 2783.4		WEH	Diamond State Tel Co.	2558
	WTG	Warner & Tumble Radio	2782		WLF	Diamond State Tel Co.	2558

Table II—Most often reported shore stations on 2 mc. along with those vital statistics required when you send in reception report in hopes of getting QSL card. Homemade QSLs are the rule on the marine band.

CANADIAN STATIONS ON 2 mc

City	Callsign	City	Callsign	City	Callsign
Belle Isle, Nfld.	VCM	Gore Bay, Ont.	VFG2	Riviere du Loop, Que.	VCD
Burin, Nfld.	VCP	Gt. Whale River, Que.	VAV	St. John, N.B.	VAR
Burlington Bridge, Ont.	XLI46	Halifax, N.S.	VCS	St. Johns, Nfld.	VON
Canso Canal, N.S.	VAX	Harrington, Que.	CJZ34	Sarnia, Ont.	VBE
Cape Hodes Adv., Que.	VAY	Hay River, N.W.T.	CJV40	Sault Ste. Marie, Ont.	VBB/VDX23
Cape Race, Nfld.	VCE	Inuvik, N.W.T.	VFA6	Seven Islands, Que.	VCK
Cardinal, Ont.	VDO	Kingston, Ont.	VBH	Tofino, Que.	VAE
Cartwright, Nfld.	VOK	Lachine Lock #5	VAO	Toronto, Ont.	VBG
Charlottetown, P.E.I.	VCA	Lakehead, Que.	VBA	The Pas, Man.	CFX5
Chesterfield, N.W.T.	VBZ	Mt. Joli, Que.	VCF	Three Rivers, Que.	VBK
Churchill, Man.	VAP	Montreal, Que.	VFN	Twillingate, Nfld.	VOO
Coral Harbor, N.W.T.	VFU2	N. Sydney, N.S.	VCO	Vancouver, B.C.	CFW300
Corner Brook, Nfld.	VOJ	Norway House, N.W.T.	CFX2	Welland Canal, Ont.	VDX22
Ft. Franklin, N.W.T.	CVJ29	Nottingham I., N.W.T.	VCB	Wiarton, Ont.	VBC
Fox River, Que.	VCG	Pt. Burwell, Ont.	VBF	Yarmouth, N.S.	VAU
Frobisher, N.W.T.	VFF	Quebec, Que.	VCC	Yellowknife, N.W.T.	CJM334
Gimli, Man.	CFX	Ramea, Nfld.	CZA94	Dept. of Transport	2514, 2550, 2582 kc
Goose Bay, Lab.	VAZ/VFZ	Resolution, N.W.T.	VAW/VRF4		

Table III—Most Canadian stations on 2 mc are heard on three channels shown. They will all move up to VHF. VHF marine channels start at 156.275 mc and extend to 157.425 mc (161 mc has some channels, too).

communications on VHF and they've been assigned in a more orderly sequence than the helter-skelter 2-mc band. Some VHF channels are so new they've only been opened up within the past few months; two of them, channels 65 and 66, won't be available until early 1970. But things are on the rise and there are already many stations to be extracted from the marine VHF airwaves. Table IV lists all new VHF-FM maritime channels (around 156 mc) together with their channel-designation numbers and intended use.

Trying to extract QSL cards (an official verification of a reception report) from mari-

time stations has caused many a DXer to contemplate spending his leisure time doing something a little more rewarding than mailing out letters which bring no replies. Still, many DXers can claim a high percentage of returns from their reports. Obviously there are a few tricks of the trade.

First of all, never put into your reception report any specific details concerning a conversation or message heard on any of these stations; this is a violation of the FCC's Secrecy of Communications law and is certain to earn you report a one-way airmail trip into the nearest wastebasket.

[Continued on page 100]

NEW VHF-FM MARITIME CHANNELS

Channel Designation	Ship (mc)	Shore (mc)	Use	Channel Designation	Ship (mc)	Shore (mc)	Use
7	156.35	156.35	Commercial	65	156.275	156.275	Port Operations
8	156.40	—	Commercial/Intership	66	156.325	156.325	Port Operations
9	156.45	156.45	Commercial/Pleasure	67	156.375	—	Commercial/Intership
10	156.50	156.50	Commercial	68	156.425	156.425	Pleasure craft
11	156.55	156.55	Commercial	69	156.475	156.475	Pleasure craft
12	156.60	156.60	Port Operations	70	156.525	—	Pleasure craft/Intership
13	156.65	156.65	Navigational	71	156.575	156.575	Pleasure craft
14	156.70	156.70	Port Operations	72	156.625	—	Pleasure craft/Intership
15	—	156.75	Environmental	73	156.675	156.675	Port Operations
16	156.80	156.80	Safety & Calling	74	156.725	156.725	Port Operations
17	156.85	156.85	State Control	77	156.875	—	Commercial/Intership
18	156.90	156.90	Commercial	78	156.925	156.925	Pleasure craft
19	156.95	156.95	Commercial	79	156.975	156.975	Commercial
20	157.00	161.60	Port Operations	80	157.025	157.025	Commercial
21	157.05	157.05	Government	81	157.075	157.075	Government
22	157.10	157.10	Government	82	157.125	157.125	Government
23	157.15	157.15	Government	83	157.175	157.175	Government
24	157.20	161.80	Marine Operator	84	157.225	161.825	Marine Operator
25&XW	157.25	161.85	Marine Operator	85	157.275	161.875	Marine Operator
26&XY	157.30	161.90	Marine Operator	86	157.325	161.925	Marine Operator
27&XL	157.35	161.95	Marine Operator	87	157.375	161.975	Marine Operator
28&XJ	157.40	162.00	Marine Operator	88	157.425	—	Commercial/Intership

Table IV—The new VHF marine channels. Like TV and CB, channels are designated with numbers. Coast Guard shore stations monitor channel 16 for distress calls and channel 22 for Coast Guard communications.

Hi-Fi Today * The New Stereo

By John Milder

ALL of a sudden, everybody and his brother are experimenting in one way or another with the psychoacoustics of stereo sound. More precisely, something like a dozen audio manufacturers are committed to products that challenge the usual methods of stereo reproduction in a living room. Not all of these products (or concepts) tackle the challenge in the same way. At the moment, there are at least *three* distinctly different approaches.

Omnidirectional Sound. By now, several speaker manufacturers are offering models which replace the standard forward-facing loudspeaker arrangement with one that radiates all or most of the sound indirectly at the listener—bouncing it off the back or side walls of a room. The rationale for this approach is not the same in each case (most manufacturers, in fact, insist that the other guy is doing it all wrong), but the broad umbrella above them all is the idea that *indirect* radiation can provide some of the spaciousness of sound normally found only in the concert hall.

This duplication of concert-hall sound, of course, depends just as much on the original recording and the degree of this hall sound

miked by the engineers. But the indirect-sound principle does create a bigger sonic image in a living room. As I've said before, I don't think this is necessarily more realistic or faithful, but those words may not apply here any more than big-screen movies can be measured against some standard of three-dimensional reality. Reproduced sound (and sight) must necessarily be different from the real thing.

One of the most recent indirect-sound entries, the Wharfedale Variflex, allows both the degree and direction of indirect radiation to be varied by the listener for different room placements and acoustic conditions. I haven't heard this speaker system, but the idea seems sensible.

Single-Cabinet Stereo. There have been lots of speakers, from JBL's mammoth Ranger-Paragon to the long-defunct Ravenswood line, which have combined two stereo speaker systems in a single enclosure. But Jensen's new Stereo system is a different approach, and its single cabinet is very small. The Stereo 1 employs a special *matrixing network* which feeds a monophonic L+R (left+right) sum signal to a single forward-pointing speaker. A L-R stereo difference signal is fed to the left-pointing speaker and a -(L-R) signal is fed to the right-pointing speaker. The signals mix acoustically (you can prove it with a little algebra) to send a left signal out of the left side of the cabinet and a right signal out of the right side of the cabinet. The principle is essentially the same as that used by some recording companies (particularly in Europe) for mono-stereo recording. I've heard only a short demonstration, but the principle does work. It could make life much easier for the man with a very small listening area and might also have (eventually) some interesting applications in four-channel stereo.

Four-Channel Stereo. By now, I guess, most people have read about the experiments in four-channel stereo being conducted by AR and two recording companies, but not too many actually have *heard* these experiments. The idea, if you haven't heard of it yet, is to provide two more stereo channels

[Continued on page 101]



Wharfedale W80 Variflex speaker system is example of omnidirectional loudspeakers; degree and direction of radiation may be controlled.



Dual-Scale SWR Meter

SWR is indicated directly by a dual-scale meter that simultaneously shows forward and reflected power.

By RONALD LUMACHI, WB2CQM

JUST because you're getting good reception reports, don't go off half cocked thinking your antenna system is operating at 100 per cent efficiency. Perhaps as little as only half your potential power is really getting out. Without an SWR meter (bridge) you'll never know it.

The SWR bridge is the accepted standard by which most amateurs and CBers determine how much of their power is being radiated into space. The lower the SWR the more signal is getting into the antenna and is not being lost in the transmission line.

Most bridges utilize a pickup circuit to sample both the forward and reverse power. The information is indicated on one meter (a switch selects the mode of operation) and is used to calculate SWR.

Our meter handles over 2 kw of power and incorporates the standard SWR measurement principle. However, it improves on the ease of determining SWR. The dual-scale meter indicates simultaneously both the forward (relative output) power and reflected power without the annoyance of switching to determine each on only one meter.

Construction

Our meter handles over 2 kw of power and incorporates the standard SWR the meter, sensitivity control R3 and calibrate switch S1 on the front panel is not critical. However, keep the components as close together as possible to shorten the wiring. The meter requires a 2¾-in. hole. On the rear apron, install two SO-239 connectors exactly 4½ in. (centers) apart.

To make the pickup device, cut a piece of RG58/U coax to a length of 5¼ in. (See Fig. 4). Carefully slit the rubber jacket, peel it away and discard it. Remove and discard the shield also. Remove ⅜ in. of dielectric at each end to

Dual-Scale SWR Meter

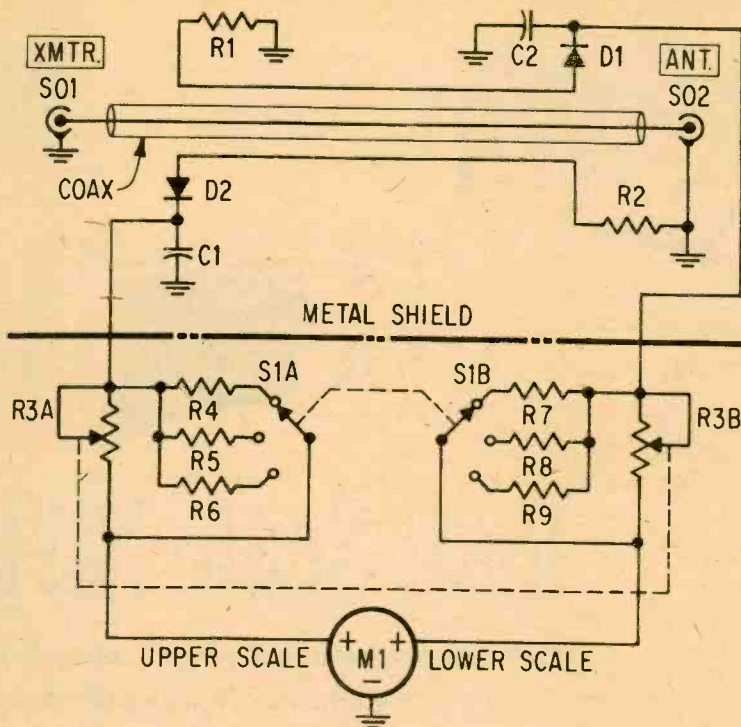

Fig. 1—RF going from SO1 along coax to SO2 induces voltage in parallel wires from D1 to R1 and from D2 to R2. Forward voltage in line from D2 to R2 is rectified by D2 and applied to upper scale of meter. Reflected voltage in line from D1 to R2 is rectified by D1 and applied to lower meter scale. When R3 is adjusted for full-scale deflection of upper meter, lower meter's calibrated scale indicates SWR. S1 is for the coarse calibration of the instrument.

expose the center conductor. Bend the center conductor at each end 90° and tin with solder.

Cut two 3 $\frac{3}{8}$ -in. lengths of No. 14 wire and bend the ends slightly; tin the ends. Position the two pickup wires on opposite sides of the coax (in a plane parallel with the Minibox's rear apron) and tape to the coax. Install the anode ends (no color band) of the diodes on one end of each pickup wire. Ground one lead of each .01 μ f capacitor (C1, C2) and connect the other lead to the cathode leads of each diode. On the other ends of the pickup diodes, install 270-ohm, 5-per cent resistors for 50-ohm installations. (Use 220-ohm, 5-per cent resistors for a 75-ohm installa-

PARTS LIST

- C1,C2—.01 μ f, 1,000 V disc capacitor
- D1,D2—1N34A diode
- M1—Dual movement meter (200- μ a movements. Burstein-Applebee, 3199 Mercier St., Kansas City, Mo. 64111. Stock No. 18A1366. \$5.95 plus postage)
- R1,R2—270 ohm, $\frac{1}{2}$ watt, 5% resistor
- R3—Dual 1 megohm, audio-taper potentiometers
- R4,R7—13,000 ohm, $\frac{1}{2}$ watt, 5% resistor
- R5,R8—33,000 ohm, $\frac{1}{2}$ watt, 5% resistor
- R6,R9—50,000 ohm, $\frac{1}{2}$ watt, 5% resistor
- S1—3 pole, 3-position rotary switch (Burstein-Applebee Stock No. 18A531. 49¢ plus postage)
- SO1,SO2—SO-239 coax connector
- Misc.—3 x 8 x 6-in. cowl-type Minibox Allied 42 A. 8686, RG58/U coax, knobs

Fig. 2—RF pickup device. Note that No. 14 wires are positioned at right angles to coax's bent center conductor. Use electrical tape to hold two wires in correct position; the wires must be exactly on opposite sides of the coaxial cable.

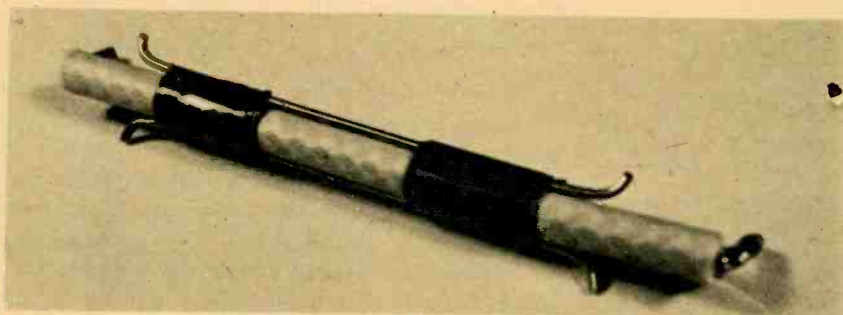

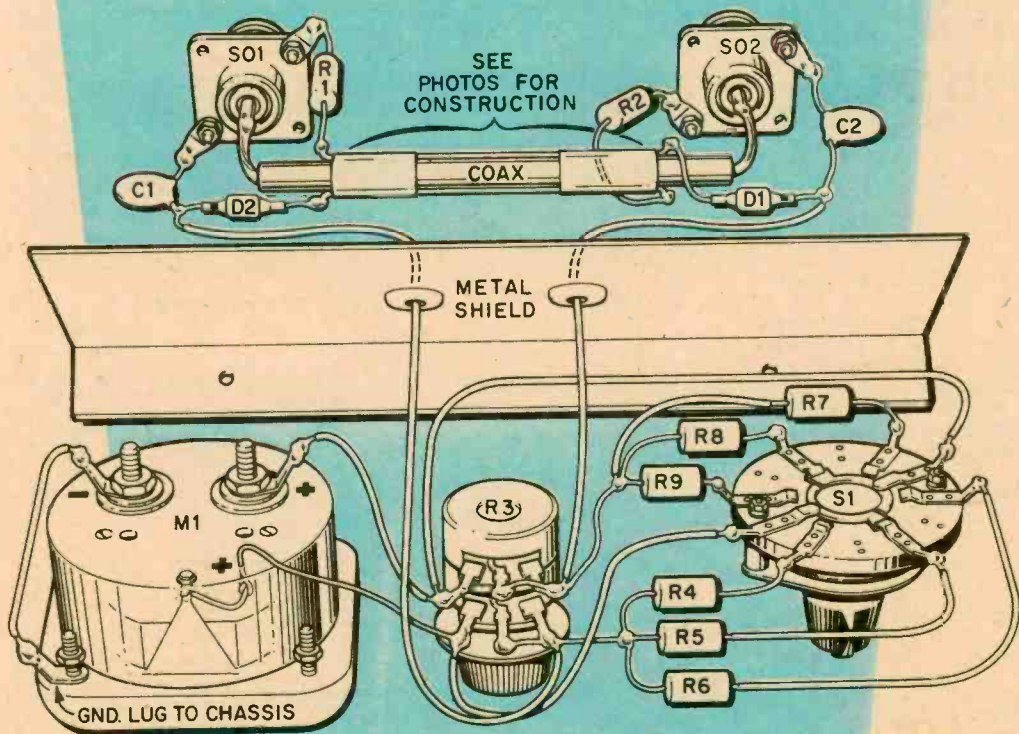
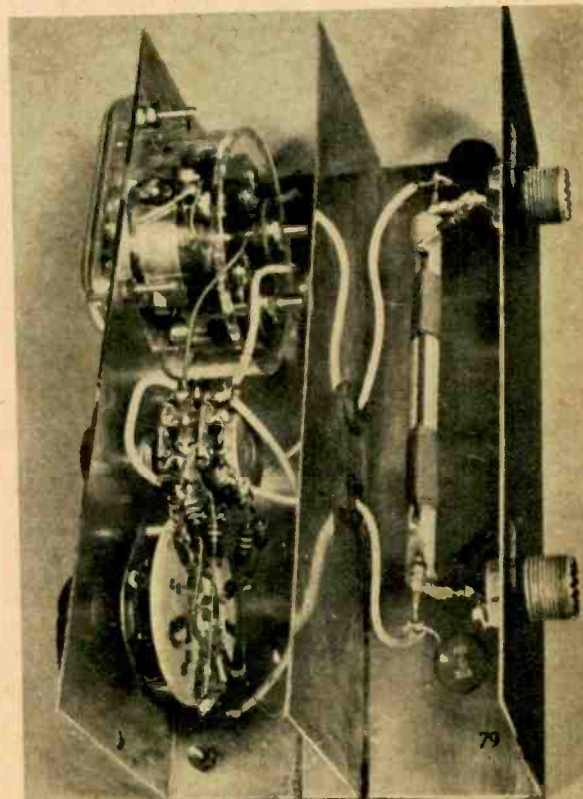

Fig. 3—Install the meter shield about midway between the front and rear cabinet panels. Wires pass through grommets holes in shield. SO-239 coax connectors must be mounted on 4½-in. centers.

tion.) When installing the diodes make certain that the cathode end (color bar) is positioned way from the pickup unit. Use a heat sink when soldering.

To prevent stray RF from interfering with the meter's operation, form an L-shaped partition from a scrap piece of aluminum (2½ x 7½ in.) and install it midway between the front and rear panels (see Fig. 3). Cut small notches in the cover so the partition will not interfere when the cover is fitted into position.

The pickup wires are connected at the junction of the diodes and capacitors. Connect the wire from the antenna side (output) to two lugs of the rear section of control R3. Connect the other wire to two lugs of the front section of R3. In both cases, use the two right hand lugs as you face the shaft and front of the control. Connect the meter's



Dual-Scale SWR Meter

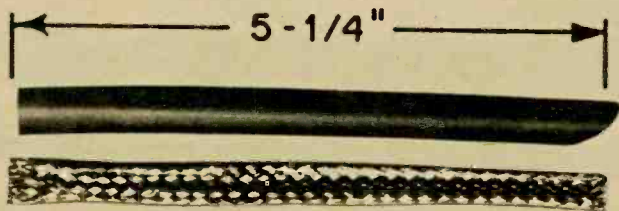
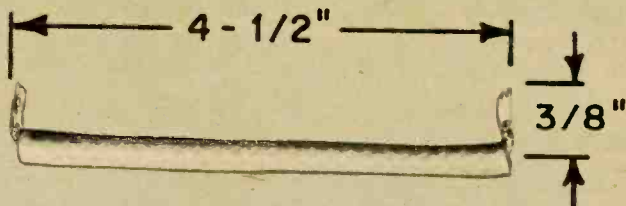

Fig. 4—Cut a 5¼-in. piece of RG58/U coax and remove jacket and shield. Remove ¾-in. of dielectric from center conductor at each end, bend center conductors at right angles and tin. Form two pickup wires from 3¾-in. lengths of No. 14 wire, bend the ends and tin. Assemble RF pickup device as shown in Fig. 2.



red lead (factory installed) to the remaining lug of the front section of R3. The lead from the output end of the pickup device and the lead from the + lug (See Fig. 3) of the meter are connected to the remaining lug on the rear section of R3. Connect the meter's common ground lug to the cabinet.

Install the six resistors as shown in the pictorial. Install wires from the wiper lugs on switch S1 to the lugs on R3 to which the meter leads are connected. By switching to one of the three positions, the sensitivity of the meter is adjusted to compensate for transmitter power from 5 to 1,000 watts.

Calibration and Operation

Connect the SWR meter between the transmitter and a 50-ohm resistive load. If the meter is connected in reverse, it will indicate in reverse. Tune the transmitter for maximum deflection on the meter's upper scale while simultaneously adjusting sensitivity control R3 for full-scale indication. There should be no indication on the lower meter scale. If SWR is indicated on the lower meter scale, the diodes are not well matched. Check the reverse resistance of diodes with

an accurate ohmmeter and, if possible, choose two diodes with identical forward and reverse resistance. Also check the resistance of the two 270-ohm resistors.

Connect the meter between the transmitter and antenna. The meter may also be placed between the transmitter and a linear amplifier to insure a good match. Tune the transmitter for maximum deflection of the output (top) meter while at the same time adjusting sensitivity control R3 and calibrate switch S1. The top scale should always indicate full scale. The SWR can be read directly from the lower meter scale.

The lower scale on the meter (marked *right* because the meter was originally used in a stereo application) should be modified so you can read SWR directly.

The total scale length is 1¼ in. The left-most ¼ in. corresponds to an SWR of 1.5:1. The next ¼ in. to the right corresponds to an SWR of 2:1. The third ¼-in. area to the right is the 3:1 SWR area. The ½-in. area at the extreme right of the scale is the danger zone. If the meter needle ends up in this area, you'd better check your antenna system line because you're wasting power.

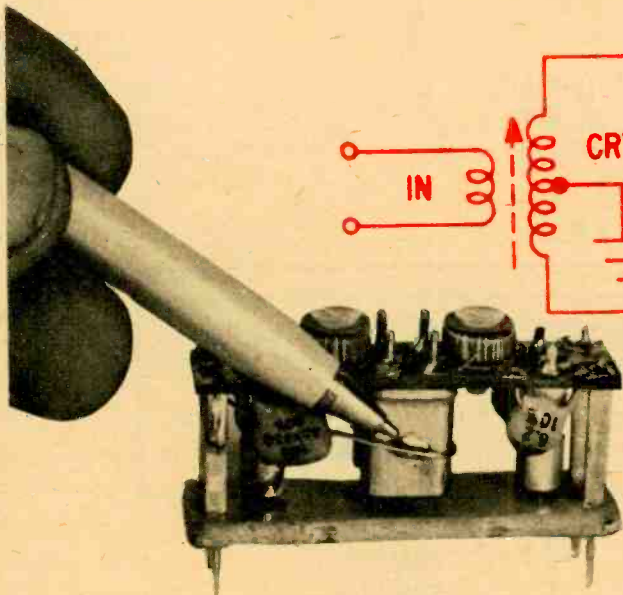

CTS-Knights crystal filter is used in Heathkit AR-15 receiver—first set to have one. Pen point spots one crystal.

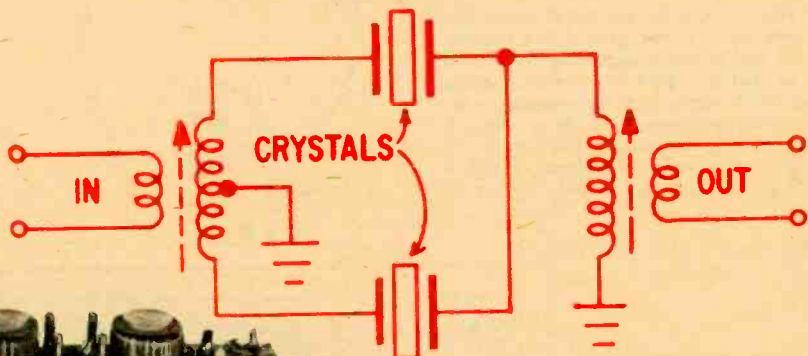

Crystal Clarity for Stereo FM

FETs!, ICs! . . . Top-of-the-line

FM tuners now are boasting

crystal IF filters, too!

By DAVID WALKER

THOSE FM receivers are enjoying a fresh technical boomlet. As some of the glitter fades from field-effect transistors and IC microcircuits, a new electronic device is illuminating the stereo scene. It's the crystal filter.

In 1968 only one FM tuner had it—the Heathkit AR-15. Today at least eight hi-fi manufacturers are installing some form of filter in the intermediate-frequency (IF) stages of their de luxe FM receivers. The idea is catching on so fast that lower-price equipment may sport them by the time you read this. Why?

- **Improved Selectivity.** Filters do a better job than conventional IF transformers of pulling apart closely spaced stations. This is more of a problem as the population spills into the suburbs and people try to capture distant stations offering fringe reception.
- **No Alignment.** Filters replace conventional IF transformers. Since filters are fixed-tuned and sealed, they eliminate nearly all IF alignment. No tuning means easier kit building, too.
- **Lumped Selectivity.** The new filters *lump* selectivity. Lumped selectivity means selectivity which appears in one stage as opposed to selectivity which is distributed over several stages. Conventional IF transformers distribute selectivity over several stages. For reasons we'll see later on, the crystal filter attacks interference in one stage, at an earlier point in the receiver, and is thus more effective.
- **Joining the IC.** Filters complement the integrated circuits now pervading FM tuners. Since the IC also provides *lumped* gain, it mates nicely with lumped selectivity. (This is gain in one stage which is much greater than in a conventional amplifier. It occurs because one IC may contain as many as ten transistors. Again, this is opposed to distributed gain, where a combination of transformers and transistors builds up signals over several stages.)

Fig. 1—FCC assigns FM channels according to geography. If two stations (A and B) are in same city, they must be 400 kc apart (on alternate channels). If station C is far enough away, it may be only 200 kc from either A or B (on an adjacent channel). In theory, listeners of stations A and B are not supposed to hear station C.

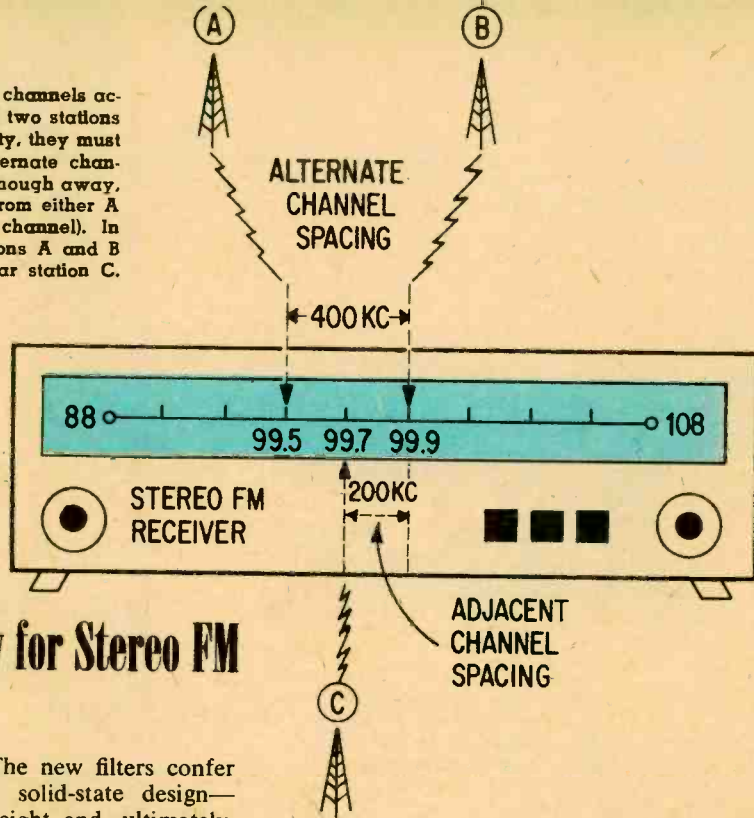

Crystal Clarity for Stereo FM

- **More Solid-State.** The new filters confer the usual benefits of solid-state design—small size, reduced weight and, ultimately, lower circuit cost.

Look at that first benefit—improved selectivity. The reason it's so important is that people are upsetting an old FCC concept called alternate and adjacent channel spacing. To prevent stations from interfering with each other the FM band is split into channels according to geography. If you receive several stations from one city or town, you'll see they're never closer than 400 kc on the dial (if one station broadcasts on 99.5 mc, its closer neighbors would be on 99.1 or 99.9 mc). By leaving gaping frequency holes between stations, the FCC assures that even

an inexpensive radio can pull apart local FM programs. This brand of protection is called *alternate channel spacing*.

Over the horizon, however, a distant FM broadcaster may occupy an *adjacent* channel. This might be only a slim 200 kc away from one of your local stations. You shouldn't suffer interference, though, since the adjacent channel is off in another part of the world and not meant for your ears. So goes the theory.

But we're a roving population. As we leave

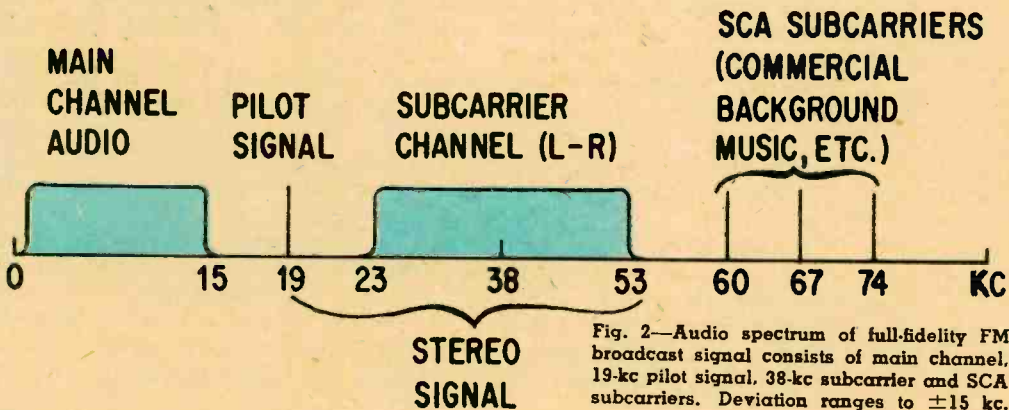
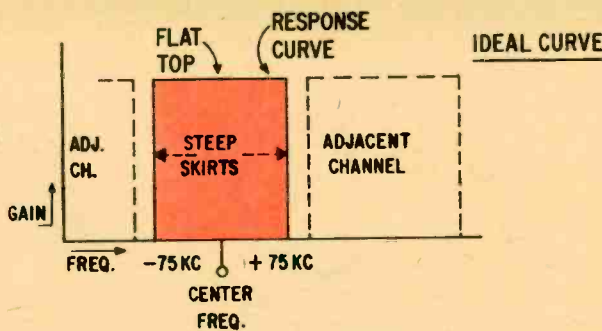
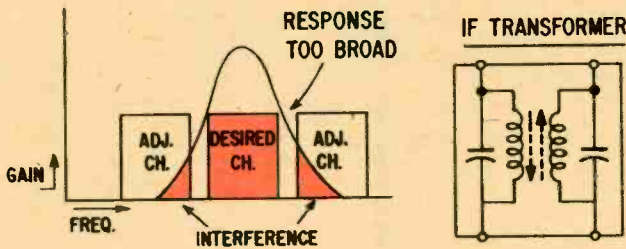

Fig. 2—Audio spectrum of full-fidelity FM broadcast signal consists of main channel, 19-kc pilot signal, 38-kc subcarrier and SCA subcarriers. Deviation ranges to ± 15 kc.

(A) THE IMPOSSIBLE DREAM



(B) TUNED CIRCUIT APPROACH



(C) SINGLE CRYSTAL

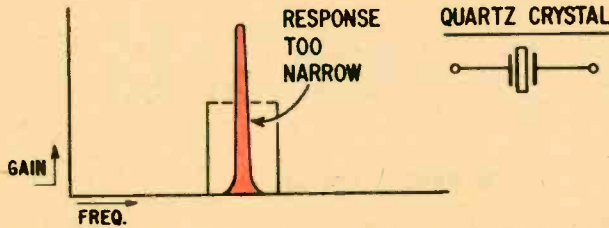

Fig. 3—Ideal response curve (A) for a receiver has flat top and steep skirts; undesired signals cannot pass through IF stages. Ordinary IF transformers (B) are tuned circuits whose response is not sharp enough. Single crystals (C) pass only a narrow band of frequencies, so they must be used in pairs (and with coils) to achieve adequate pass-band that can accommodate stereo FM signal.

central city, holes are blown in the protective shield of alternate channel spacing. In the suburbs, or between towns, anything on the air becomes fair game. Distant signal snatching is abetted by the hot front ends of today's tuners; it raises the specter of adjacent channel interference! Fig. 1 illustrates the problem for a mythical region that may become a reality as our population fills the countryside. For conventional tuners, the

presence of strong adjacent channels will mean total distortion.

This is where crystal filters fit in. They come close to creating what engineers call ideal selectivity. It's a theoretical response curve of such perfection that a receiver of this quality could surgically slice away adjacent channel interference (interference from another FM station 200 kc above or below the desired signal), yet leave the desired program unscathed.

The curve, really a rectangle, is shown in Fig. 3 (A). The most prominent features are its flat top and steep skirts—a shape which would exactly fit the desired signal. By comparison, Fig. 3 (B) indicates how a conventional FM tuner handles selectivity. Note that the IF transformers create a sloping skirt that allows adjacent channels to sneak through. Finally, Fig. 3 (C) shows how a very basic crystal filter would shape the response. It's *too* sharp, in fact; the desired program would be clipped severely.

This is due to the crystal itself. A slab of
[Continued on page 97]

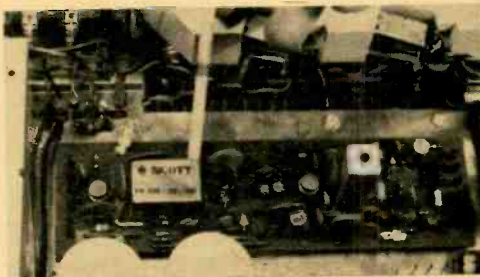

Look what's happened to this IF circuit board! Ratio-detector transformer and crystal filter are all that's left in this streamlined Scott 342C receiver.

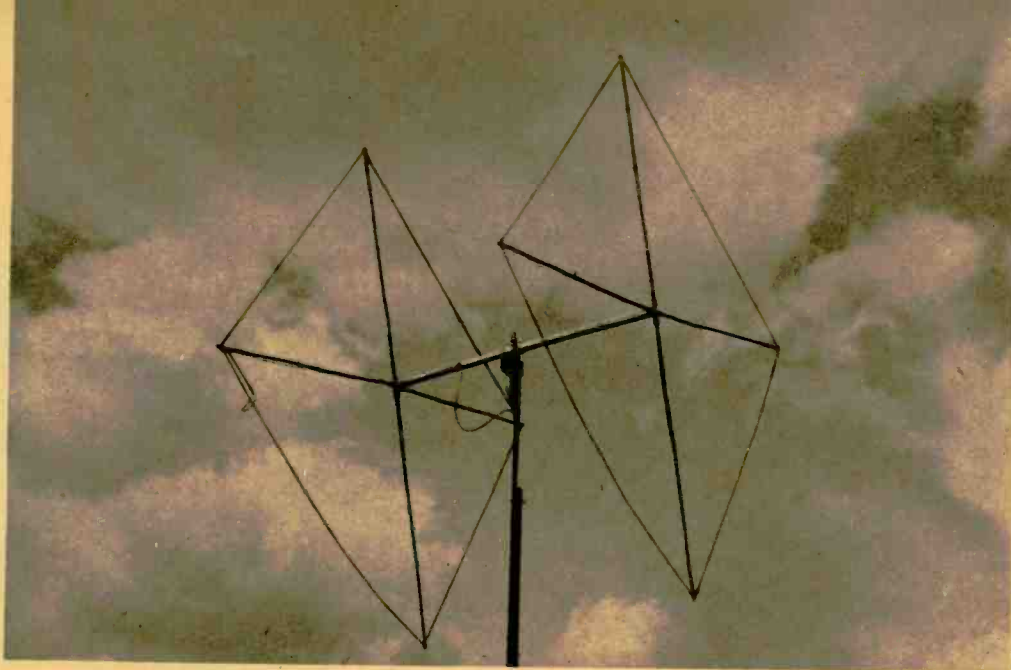

Cheapie Quad for CB

By DAVE G. KOLLER

AFTER countless unsuccessful attempts to reach out to the great silent majority, many CBers give up and start on a trip of defeat to their electronic parts distributor to find out what's wrong.

A discussion of the problem leads to the conclusion that the old ground-plane antenna just doesn't have it and will have to go. What is needed is a quad antenna. While a quad may look like a glorified box kite, its performance more than compensates for its appearance.

A commercially-made quad can set you back \$40 or so. Our quad will dent your wallet to the tune of only about \$10. For this you get a gain of 7.5db and the convenience of being able to purchase most material at a hardware store. In addition, our quad's SWR can be brought way, way down because both its driven and director elements are tunable.

The horizontal-radiation patterns of a ground plane and a quad are shown at right. The ground plane's gain is 3.5db and its pattern is omni-directional. The quad's gain is

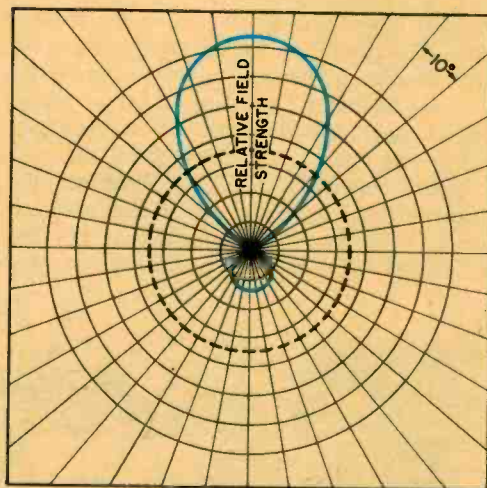

--- GROUND PLANE OMNI-DIRECTIONAL PATTERN (3.5 DB)

QUAD UNI-DIRECTIONAL PATTERN (7.5 DB)
(TUNED FOR MAXIMUM FRONT-TO-BACK RATIO)

Radiation patterns for a ground-plane antenna (black) and a quad (color). Former's pattern is omni-directional, latter's pattern is uni-directional.

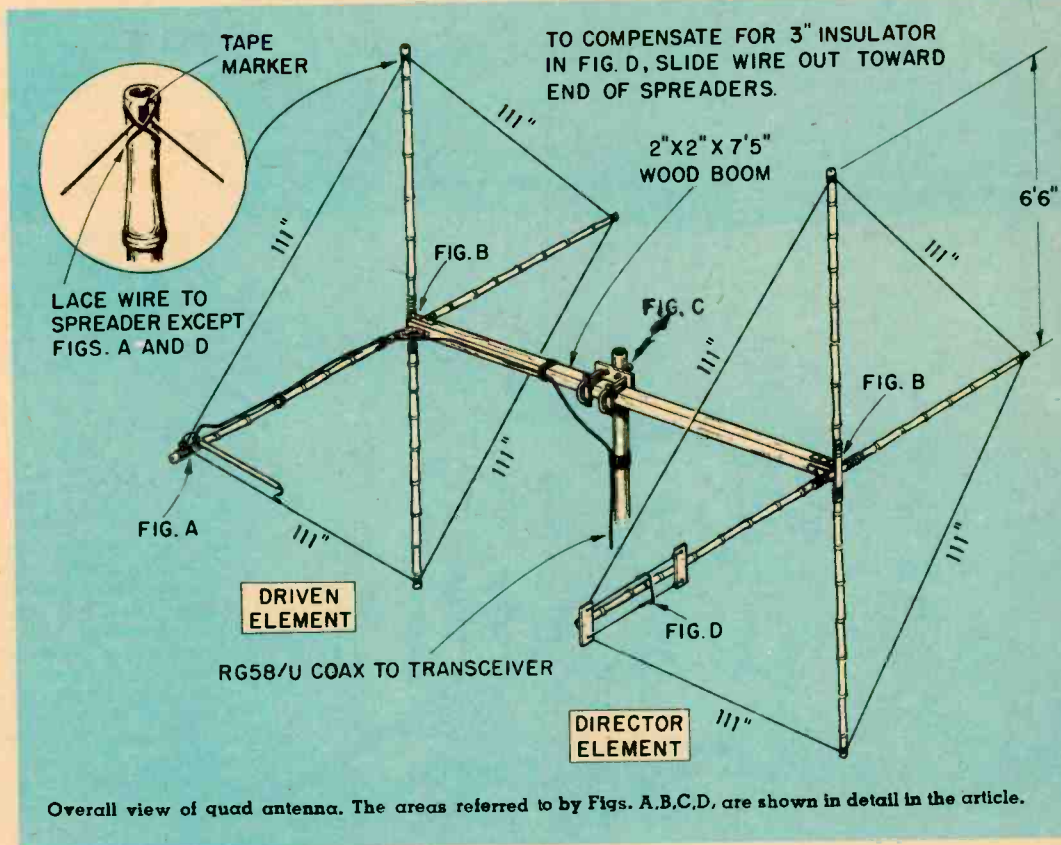

Overall view of quad antenna. The areas referred to by Figs. A,B,C,D, are shown in detail in the article.

7.5db and its radiation pattern is uni-directional. Sound good? Then let's build it.

Take a look at the diagram above to get the big picture of a quad. It is nothing more than two squares of wire held in position by a crosswork of arms (spreaders) that are separated by a boom. One wire square, the driven element, is connected to the transceiver. The other square, the director, is aimed in the direction you want to concentrate your signal.

Construction. Your best bet is to first prepare the metalwork by cutting, bending and drilling $\frac{1}{2}$ -in. wide x $\frac{3}{32}$ -in. thick metal stock in accordance with the details in Fig. B. For the spreaders you'll need eight 6-ft. 6-in. lengths of bamboo (a rug store has these). The boom is made from a 7-ft. 5-in.-long piece of 2 x 2-in. hardwood.

For the matching and termination section (Fig. A) you'll need a protractor (or a good eye) and a small butane torch to do the soldering (a good iron should work). Flatten with hammer or vise about $\frac{3}{4}$ in. of one

end of the 11-in. long x $\frac{5}{16}$ o.d. piece of copper tube. Drill a $\frac{3}{8}$ -in. hole in the flat end and position this hole in line with $\frac{3}{8}$ -in. holes in the $\frac{3}{4}$ -in. semi-circular support pieces of copper tube shown in Fig. A. Solder the 11-in. copper tube to the supports at a 45° angle.

While you're drilling, drill the holes in the boom-to-mast mounting plate in Fig. C. The holes in the plate should correspond to the width of the U-bolts. Cut the plastic insulators (Fig. D) from a stiff plastic ruler. Cover the ruler with masking tape before drilling to prevent splitting, or heat a nail and melt the holes.

Next, prepare the antenna wires. Make a $\frac{1}{4}$ -in. loop at one end of wire and solder it to prevent it from pulling apart. Measure from the center of this loop exactly 37 ft. of wire. Make another $\frac{1}{4}$ -in. loop at the end of the wire. Divide the wire into four 111-in. sections and mark each with a small piece of tape. This will be the driven-element wire.

The director element is made from 41 ft.

Fig. D—Director tuning section. Tightly lace stiff plastic on bamboo spreader. Attach director antenna wire to plastic at right, pass through piece at left, then attach to ends of other spreaders. Bring end through left piece then attach to plastic at right. Shorting link must be able to slide.

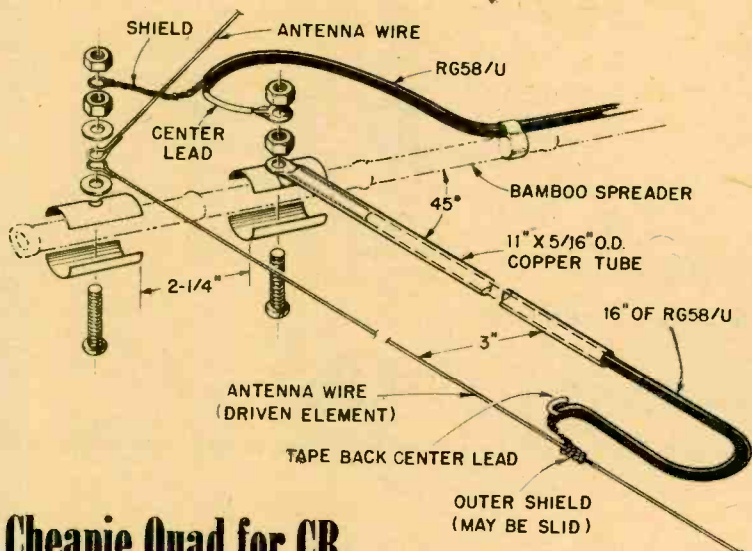
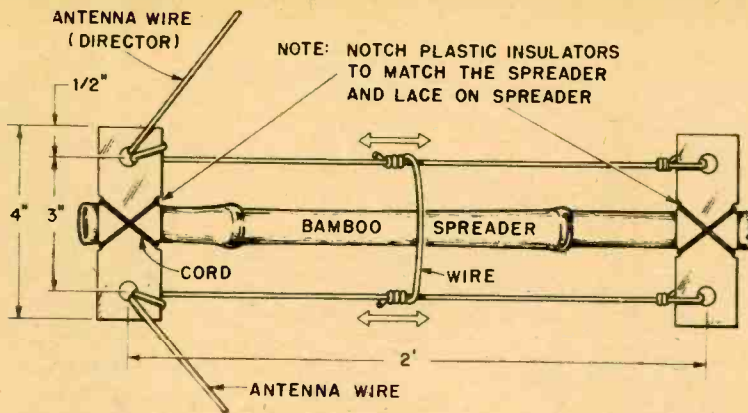

Fig. A—Matching and termination section. To be sure 11-in. copper tuning tube and antenna wire are firmly attached to bamboo spreader, put lengths of 3/4-in. copper tubing (slit down the center) around the spreader. Solder tuning tube to pieces of slit tubing at 45° angle.

Cheapie Quad for CB

4 in. of wire. Find the center of this wire (20 ft. 8 in.) and mark it with tape. Then measure another 111 in. in both directions, mark, and measure another 111 in. in both directions. The result will be four 111-in. sections plus equal and lengths of 2 ft. 2 in.

Select two 6-ft. 6-in. bamboo spreaders. On one, mount the plastic ruler insulators, and lace as shown in Fig. D. On the other mount the copper supports as shown in Fig. A.

Prepare the piece of coupling coax in Fig. A by cutting a 16-in. length of RG58/U coax and peeling off 1 in. of insulation from one end only. Unbraid the shield and twist the strands together. Take the center conductor and bend it back along the cable and tape it out of the way. Go to the other end of the coax and check that the braid is not shorted to the center conductor.

MATERIALS	
Quantity	Description
100 ft.	Stranded copper antenna wire
8	Bamboo poles, 6-ft., 6-in. long
2	Copper tubing, 3/4-in. dia. x 3/4-in. long
1	Copper tubing, 5/16-in. o.d. x 11-in. long
1	Electrical-junction-box cover plate
-	Electrical tape
8	Flat stock, 6-in. long x 1/2-in. wide
4	Flat stock, 8-in. long x 1/2-in. wide
1	Hardwood (boom), 2 x 2 in., 7-ft. 5-in. long
-	Lacquer spray
1	Plastic ruler
50 ft.	Twine (chalk line cord)
2	U-bolt, 2 1/2-in. long x 2-in. wide (with spreader)
2	U-bolt, 2-in. long x 1 3/4-in. wide

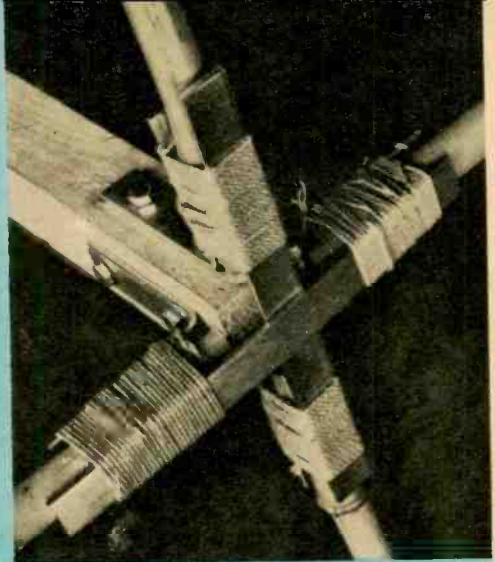
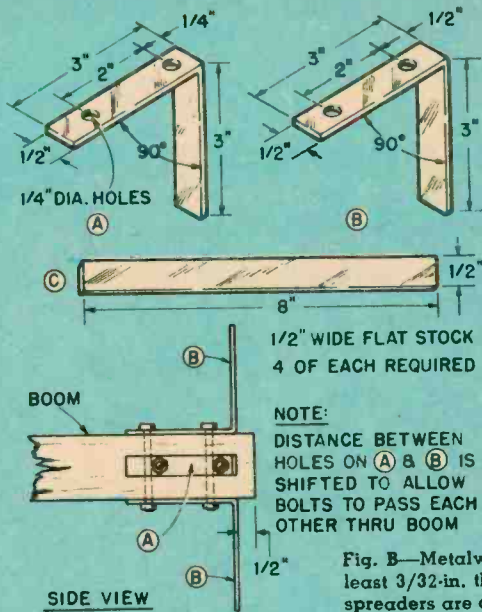

Fig. B—Metalwork cutting details. 1/2-in. wide stock should be at least 3/32-in. thick to provide good support. Photo shows how the spreaders are attached to the boom using angles and heavy twine.

It is important that nothing is exposed to short against the 5/16-in. o.d. tube when the cable is shoved inside. We now have made an adjustable capacitor to aid in tuning (which we will get to later).

Before you drag everything out to the front lawn bolt angles A and B (Fig. B) on the ends of the boom. If you wonder why you can't use store-bought angles, it's because of the hole alignment. You may, however, drill extra holes in one set to obtain the offset necessary for the bolts to pass each other.

On to the open spaces. If you have a tree handy, attach the boom to it (about 7 ft. above the ground). Lace the spreader with the matching and termination section and the spreader with the plastic insulators on the same sides of the boom. The matching and termination section should be aimed down and toward the boom.

[Continued on page 98]

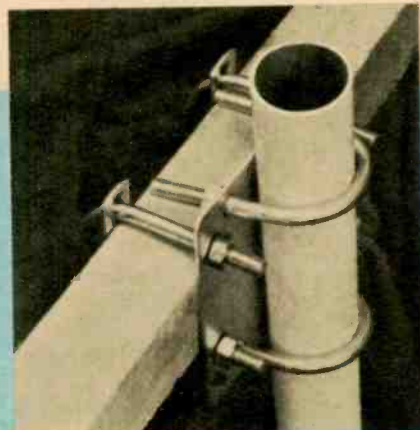
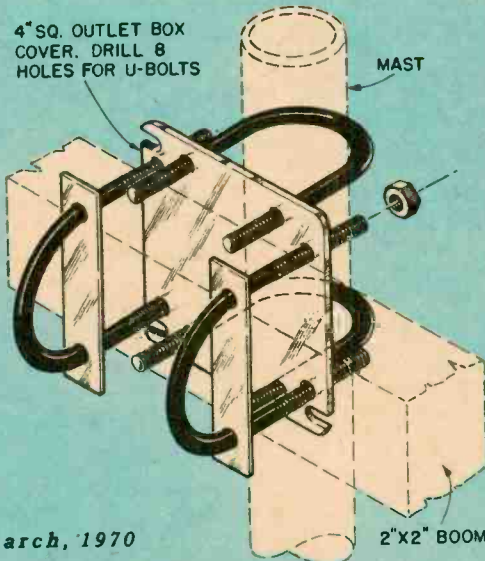

Fig. C—Diagram shows method of attaching boom to the mast. 1 1/4-in. wide and 2-in. wide U-bolts work well with a cover plate from a 4-in. electrical outlet box. Use spreaders on boom's U-bolts so bolts don't dig into wood.

How to get into One of the hottest money-making fields in electronics today— servicing two-way radios!



HE'S FLYING HIGH. Before he got his CIE training and FCC License, Ed Dulaney's only professional skill was as a commercial pilot engaged in crop dusting. Today he has his own two-way radio company, with seven full-time employees. "I am much better off financially, and really enjoy my work," he says. Read here how you can break into this profitable field.

More than 5 million two-way transmitters have skyrocketed the demand for service men and field, system, and R&D engineers. Topnotch licensed experts can earn \$12,000 a year or more. You can be your own boss, build your own company. And you don't need a college education to break in.

HOW WOULD YOU LIKE to start collecting your share of the big money being made in electronics today? To start earning \$5 to \$7 an hour... \$200 to \$300 a week... \$10,000 to \$15,000 a year?

Your best bet today, especially if you

don't have a college education, is probably in the field of two-way radio.

Two-way radio is booming. Today there are more than *five million* two-way transmitters for police cars, fire department vehicles, taxis, trucks, boats, planes, etc. and Citizen's Band uses—

and the number is still growing at the rate of 80,000 new transmitters per month.

This wildfire boom presents a solid gold opportunity for trained two-way radio service experts. Many of them are earning \$5,000 to \$10,000 a year *more* than the average radio-TV repair man.

Why You'll Earn Top Pay

One reason is that the United States Government doesn't permit anyone to service two-way radio systems unless he is *licensed* by the Federal Communications Commission. And there simply aren't enough licensed electronics experts to go around.

Another reason two-way radio men earn so much more than radio-TV service men is that they are needed more often and more desperately. A home radio or television set may need repair only once every year or two, and there's no real emergency when it does. But a two-way radio user must keep those transmitters operating at all times, and *must* have their frequency modulation and plate power input checked at regular intervals by licensed personnel to meet FCC requirements.

This means that the available licensed experts can "write their own ticket" when it comes to earnings. Some work by the hour and usually charge at least \$5.00 per hour, \$7.50 on evenings and Sundays, plus travel expenses. A more common arrangement is to be paid a monthly retainer fee by each customer. Although rates vary widely, this fixed charge might be \$20 a month for the base station and \$7.50 for each mobile station. A survey showed that one man can easily maintain at least 100 stations, averaging 15 base stations and 85 mobiles. This would add up to at least \$12,000 a year.

Be Your Own Boss

There are other advantages too. You can become your own boss—work entirely by yourself or gradually build your own fully staffed service company. Instead of being chained to a workbench, machine, or desk all day, you'll move around, see lots of action, rub shoulders with important police and fire officials and business executives who depend on two-way radio for their daily operations. You may even be tapped for a big job working for one of the two-way radio manufacturers in field service, factory quality control, or laboratory research and development.

How To Get Started

How do you break into the ranks of the big-money earners in two-way radio? This is probably the best way:

1. Without quitting your present job, learn enough about electronics fundamentals to pass the Government FCC Exam and get your Commercial FCC License.
2. Then get a job in a two-way radio service shop and "learn the ropes" of the business.
3. As soon as you've earned a reputation as an expert, there are several ways you can go. You can move *out* and start signing up and servicing your own customers. You might become a franchised service representative of a big manufacturer and then start getting into two-way radio sales, where one sales contract might net

you \$5,000. Or you may even be invited to move *up* into a high-prestige salaried job with one of the major manufacturers either in the plant or out in the field.

The first step—mastering the fundamentals of Electronics in your spare time and getting your FCC License—can be easier than you think.

Cleveland Institute of Electronics has been successfully teaching electronics by mail for over thirty years. Right at home, in your spare time, you learn electronics step by step. Our AUTO-PROGRAMMED® lessons and coaching by expert instructors make everything clear and easy, even for men who thought they were "poor learners." You'll learn not only the fundamentals that apply to all electronics design and servicing, but also the specific procedures for installing, troubleshooting, and maintaining two-way mobile equipment.

Get Your FCC License... or Your Money Back!

By the time you've finished your CIE course, you'll be able to pass the FCC License Exam with ease. Better than nine out of ten CIE-trained men pass the FCC Exam the first time they try, even though two out of three non-CIE men fail. This startling record of achieve-

ment makes possible the famous CIE warranty: you'll pass the FCC Exam upon completion of your course or your tuition will be refunded in full.

Ed Dulaney is an outstanding example of the success possible through CIE training. Before he studied with CIE, Dulaney was a crop duster. Today he owns the Dulaney Communications Service, with seven people working for him repairing and manufacturing two-way equipment. Says Dulaney: "I found the CIE training thorough and the lessons easy to understand. No question about it—the CIE course was the best investment I ever made."

Find out more about how to get ahead in all fields of electronics, including two-way radio. Mail the bound-in postpaid reply card for two FREE books, "How To Get A Commercial FCC License" and "How To Succeed In Electronics." If card has been removed, just mail the coupon below.

ENROLL UNDER NEW G.I. BILL

All CIE courses are available under the new G.I. Bill. If you served on active duty since January 31, 1955, OR are in service now, check box on reply card for G.I. Bill information.

CIE Cleveland Institute of Electronics
1776 East 17th Street, Cleveland, Ohio 44114

A Leader in Electronics Training... Since 1934 • Accredited Member National Home Study Council



2 New CIE CAREER COURSES

1 BROADCAST (Radio & TV) ENGINEERING... now includes Video Systems, Monitors, FM Stereo Multiplex, Color Transmitter Operation and CATV.

2 ELECTRONICS ENGINEERING... covers steady-state and transient network theory, solid-state physics and circuitry, pulse techniques, computer logic and mathematics through calculus. A college-level course for men already working in Electronics.

Cleveland Institute of Electronics
1776 East 17th Street, Cleveland, Ohio 44114

Please send me without cost or obligation:
Your 44-page book "How To Succeed In Electronics" describing the job opportunities in Electronics today, and how your courses can prepare me for them.
Your book on "How To Get A Commercial FCC License."

I am especially interested in:

- Electronics Technology Electronic Communications
 Broadcast Engineering Industrial Electronics
 First Class FCC License Electronics Engineering

Name _____ (PLEASE PRINT)

Address _____

City _____

State _____ Zip _____ Age _____

Check here for G.I. Bill information.

EI-86

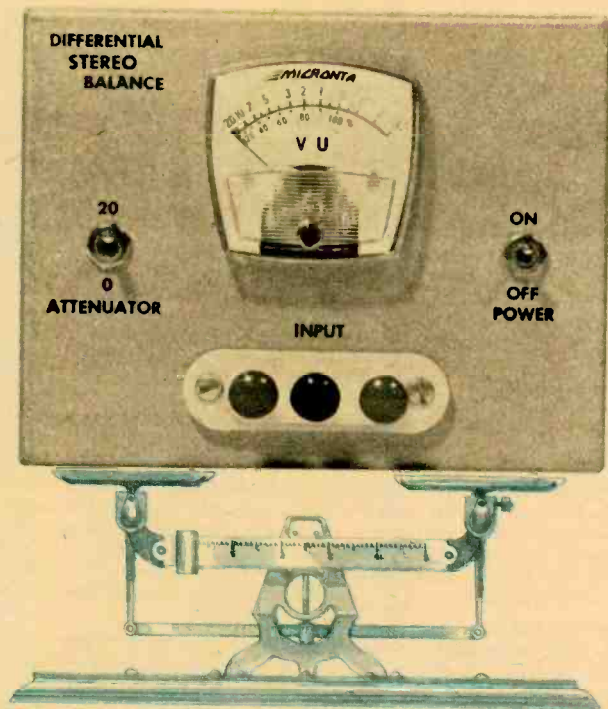

Electronic Balancer for Stereo

By JOSEPH RITCHIE

EVERY serious audiophile strives for what he considers perfect sound. It's a noble goal but as far away as the pot of gold at the end of the rainbow. One way of getting your stereo system closer to the gold is with our Electronic Balancer.

The Balancer is a device that indicates stereo balance, volume-control tracking (in terms of balance), tone-control tracking and phasing. As a bonus it will also indicate separation.

Unlike conventional VU-meter balancing devices, where balance is checked by comparing the output of the left channel with the right through separate amplifiers and meters, our Balancer compares the two channels in terms of a difference voltage. This means that balance is shown by a single meter; an indication of 7db would mean 7db separation, while a 40db indication means 40db separation.

To adjust an amplifier for precise tone or volume balance it is only necessary to adjust the amplifier controls for a minimum meter indication. For example, to adjust for volume balance you simply feed to the amplifier (set to *mono*) either tone or program material and adjust the balance control for a zero meter indication. To adjust dual tone-control tracking you feed a bass tone to the amplifier and

adjust one bass control until the meter indicates zero. The same is done to the treble controls.

Amplifiers with speaker phase switches can be instantly set for proper phasing of the amplifier output by simply setting the phase switch for zero meter indication.

Volume-control tracking is similarly easy to check and adjust with the Balancer. Because of normal tolerances—particularly in low-cost amplifiers—a dual (ganged) volume control does not necessarily track over the normal listening level range. For example, if the balance is set at a low listening level it may not be balanced at a higher listening level. The balancer will indicate this error immediately. Since the Balancer can work with program material as well as with a tone, the amplifier balance can be instantly corrected.

How it Works. The heart of the device, shown in Fig. 5, is operational amplifier (op-amp) IC1. An op-amp is a device, which among other things, responds to the difference in voltage between two inputs: hence, we say the op-amp has a differential input, meaning the output is a function of the difference in input voltages. If the voltage fed to the two inputs is identical there is no difference volt-

age and the op-amp's output is zero. The greater the difference voltage the greater the output fed to meter M1.

And when dealing with differential inputs the voltage phase must be kept in mind. For example, assume both inputs receive a 1 V (peak-to-peak) signal and that both inputs are in phase. At the peak of the input waveform both inputs receive a positive (in phase) 1-V input. There is no differential so the amplifier's output is zero.

But assume that you reverse the phase of one input so that it is 180° out of phase with the other input. At the peak of the waveform

one input is +1 V while the other input is -1 V. The differential input is now 2 V and the op-amp output will reflect a 2 V differential input. It is this feature of seeing phase that allows the Balancer to easily indicate the phasing of an amplifier output if the stereo amplifier is equipped with a phase-reverse switch.

Amplifier balance is obtained by utilizing the differential input characteristics. Ideally, the level of a stereo amplifier's output should be identical from both channels. When the amplifier is set to mono, the same signal—with the same phasing—appears at both speaker terminals. With the Balancer connected to the speaker terminals any output voltage variation between the L and R channel's will be indicated by the meter. When the channels are precisely balanced there is no difference voltage, and the meter shows no indication.

The frequency response of the Balancer is only limited by the characteristics of meter M1. Low-cost VU meters, such as the type specified in the Parts List, are flat from approximately 50 to 12,000 cps. Standard (more expensive) VU meters are flat from 20 to 20,000 cps. Low-cost meters have attenuated response at the frequency ex-

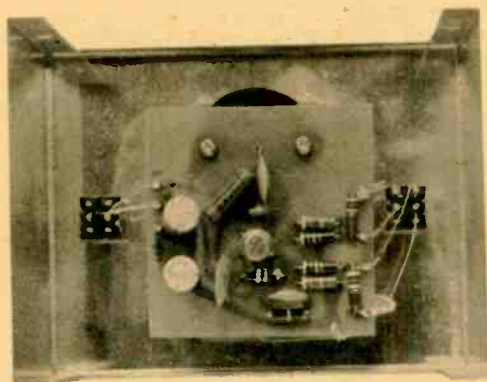
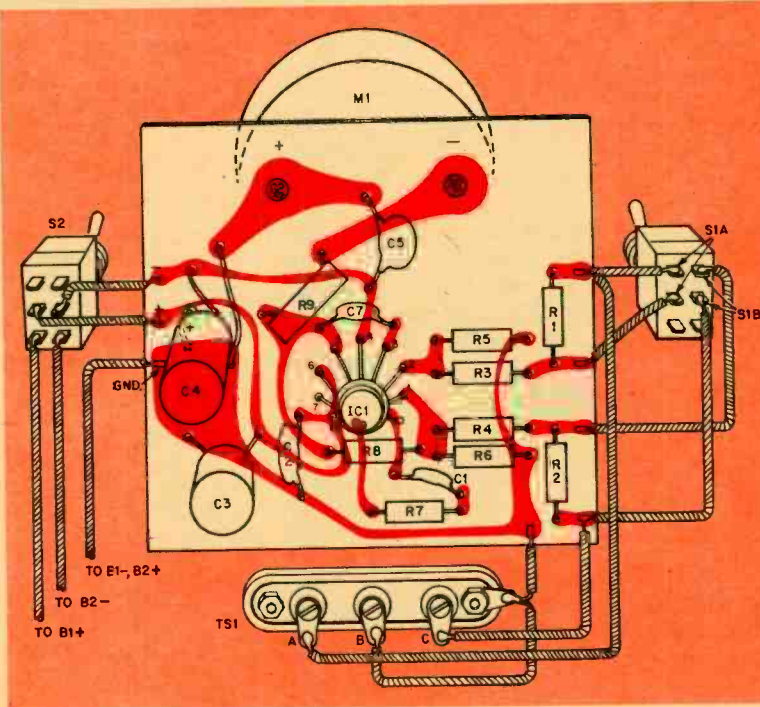

Fig. 1—Photo above is inside view of Balancer which is built in main section of Minibox. Circuit board is attached to posts on meter by two screws at top. Batteries go to holders on U-section of cabinet. View at right shows connections from board to cabinet-mounted switches and input terminal strip. Circuit-board part locations are all indicated in Fig. 2.



Electronic Balancer for Stereo

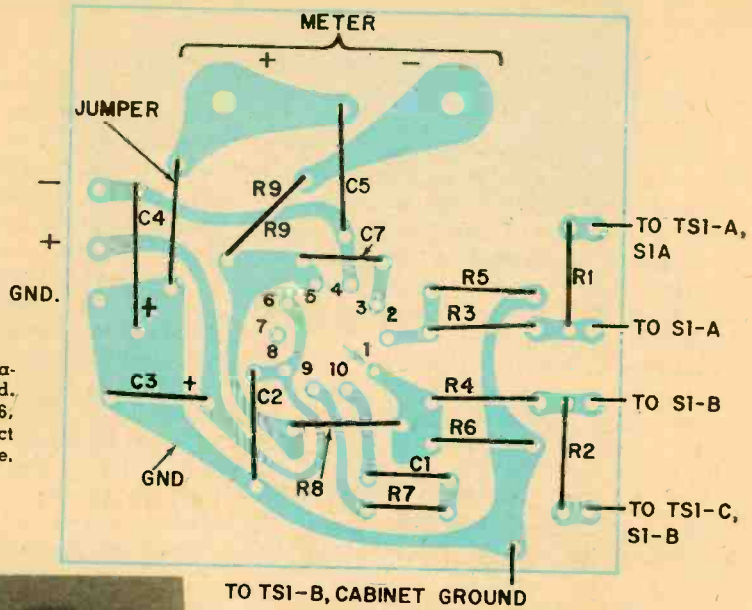

Fig. 2—Diagram shows location of parts on circuit board. If you are going to install C6, as explained in text, connect it in place of the jumper wire.

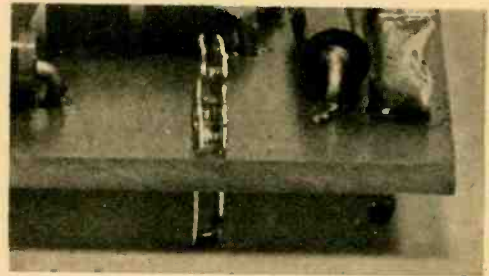
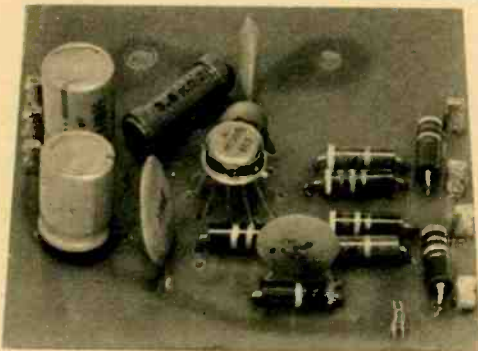

Fig. 3—Finished board, left. Battery and input connections are made to push-in terminals (above) which are soldered to foil on board's underside.

tremes but since you are primarily interested in no indication (showing balance) the Balancer can be used from 20 to 20,000 cps for tests.

The Balancer is capable of indicating, with a reasonable degree of accuracy, channel separation. It does this by comparing one channel against the other. For example, with the left channel *off* (right channel *on* and amplifier in the mono mode) the amplifier gain is adjusted for a zero meter indication. Then the left channel is turned *on*; the meter indication that occurs when the left channel is *on* is the stereo separation. (The meter indication falls below 0 VU.) If the meter indicates 0 VU on the right channel and -10db when the left channel is turned on the separation is 10db.

The Balancer shown is intended for use with an amplifier whose output is reasonably high. If you want to use the Balancer with low-level devices having less than a 1 to 10 V (rms) output simply change the

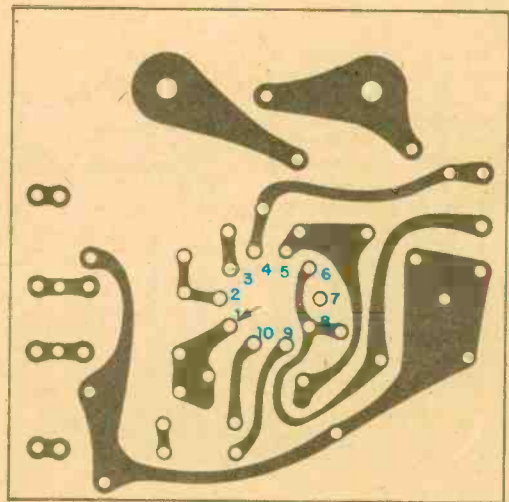

Fig. 4—Circuit board foil template. Cut out and transfer black-area outlines with carbon paper to foil on board. Don't trace lines at edges.

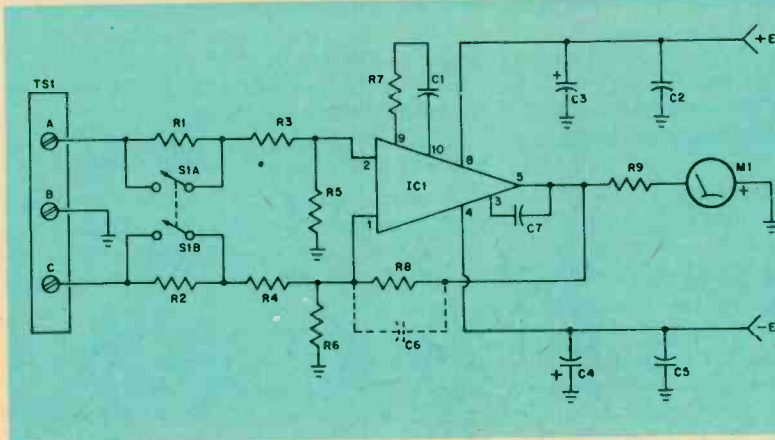

Fig. 5—Schematic. When input signals from amplifier to op-amp IC1 are equal, IC1's output is zero. Difference between input signals produces output from IC1. When S1 is open, Balancer's sensitivity is lowered. Add C6 to increase sensitivity as explained in the text.

value of R8 and add C6 (more on increasing sensitivity later).

Construction. The Balancer is built in the main section of a 3 x 4 x 5-in. Minibox. Batteries B1 and B2 are mounted in polarized battery holders in the cover.

The entire electronic circuit is assembled on a 2 $\frac{3}{4}$ -in. square circuit board. The parts layout is extremely critical; therefore the unit should be constructed only on the PC board, using the foil layout shown. The board mounts directly on the meter terminals. In the event you don't use the VU meter specified in the Parts List, make certain you position the foil pads correctly. We have left considerable space on the board so the spacing of the pads can be adjusted to your particular needs.

Making the Board. Cut a 2 $\frac{3}{4}$ -in. square of XXXP or epoxy board and clean the surface with a household cleanser such as Ajax. Place a piece of carbon paper face down on the foil and tape the board directly under the template in Fig. 4. Using a ball point pen, trace the foil outlines on the template. Using a pick, indent the foil through the template and carbon paper at each component mounting hole. (Don't waste time trying to use resist circles for the drilling points.) When the board is etched to remove the excess copper, each indent will indicate a drilling location.

Remove the foil and carbon paper, and using a resist ink pen such as the Kepro RMP-700 (Allied 47 A 1102) fill in the foil outlines traced on the foil by the carbon paper. Make certain you place a dot of resist over the IC1 No. 7 pin indent so the indent will remain when the excess copper is etched

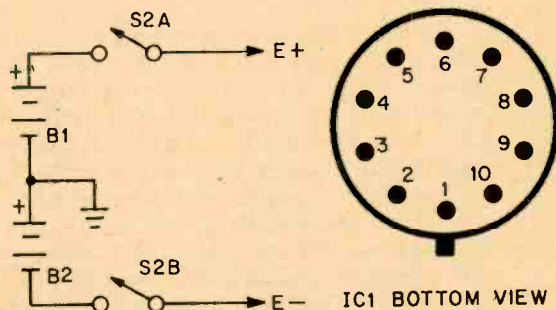

Fig. 6—Schematic at left is of batteries and power switch (ganged sections). Diagrams at right shows IC1's lead numbering (bottom view).

PARTS LIST

B1, B2—9 V battery (Burgess 2U6 or equiv.)

Capacitors: indicated voltage or higher

C1—.05 μ f, 10 V disc

C2, C5—.1 μ f, 10 V disc

C3, C4—50 μ f, 15 V electrolytic (see text)

C6—25 μ f, 10 V disc (see text)

C7—47 μ f, 10 V disc (see text)

IC1—MC1433G operational amplifier

(Motorola, Allied 50 D 26 MC1433G-MOT.

\$3.90 plus postage, not listed in catalog)

M1—VU meter (Radio Shack 22-019 or equiv.)

Resistors: $\frac{1}{2}$ watt, 5% unless otherwise indicated

R1, R2—910,000 ohms

R3, R4—91,000 ohms

R5, R6—9,100 ohms

R7—10 ohms, 10%

R8—100,000 ohms (see text)

R9—3,600 ohms (see text)

S1, S2—DPDT switch (Lafayette 99 E 61624 or equiv.)

TS1—three-lug terminal strip (or equiv.)

Misc.—5 x 4 x 3-in. Minibox, printed-circuit supplies, battery holders

away. Let the resist dry for a few minutes and then place the board in a plastic container and cover with approximately 1 in. of etchant solution.

Remove the board from the etchant with tweezers or pliers when *every bit* of excess copper is etched away (about 20 minutes) and wash the board under running water for approximately two minutes. Then remove the resist covering the foil areas with resist solvent or steel wool. Using a No. 53 bit, drill out the component holes marked with indents in the foil. Don't forget to drill for the IC1 No. 7 terminal. Then, using a larger drill, enlarge the holes in the meter terminal pads so they just clear the meter terminal screws; don't make the meter holes too large or the pads might not contact the meter terminals.

There are two extra holes indicated; they are for C6 which is located next to R8. Capacitor C6 is not used for the speaker-(high) level model, which uses a 100,000-ohm resistor for R8. If you want a high-gain model, which can be used with preamps or at low speaker volume levels, change R8 to 1 megohm and install a 25- μmf ceramic disc capacitor at C6's location. If C6 is not used in a high-gain model the unit may break into oscillation. (The high-gain model has 20db greater sensitivity.)

Resistor R9, 3,600 ohms, is the one generally supplied with low-cost VU meters. If your meter isn't supplied with such a resistor use a $\frac{1}{2}$ watt size.

Integrated circuit IC1 must be installed correctly the first time. If it isn't there will be no second chance when power is applied. Looking at the bottom of IC1, the lead opposite the tab is No. 1. Install this lead opposite the small arrow indicated on the foil—the foil pad that has holes for R3, R5, R8 and C6. After you're certain IC1 is installed correctly, check it again to prevent damage to the IC.

Capacitors C3 and C4 can be 50- μf electrolytics, though you'll avoid component crowding if the capacitors are 30 μf . There is a jumper wire near C4—make certain it doesn't touch the wires from C4.

Terminal connections are made to the board through Vector T28 or similar push-in terminals. Note that there is only one connection to the chassis. It is to the ground lug next to the input terminal strip. Do not ground the power supply center tap to the cabinet; connect it to the terminal provided

on the board. The batteries are mounted in a Keystone type 206P polarized battery holder in the cabinet cover. We strongly suggest the polarized holder to avoid reversing the battery voltage to the IC.

Checkout. Apply power by turning S2 *on*. The meter pointer may rise and fall back to zero—this is normal. If the meter pointer pins either full scale or reverse off-scale, one side of the battery supply is open. Turn S2 off quickly and then check the battery holder connections.

If all is well, set attenuator switch S1 to zero (no attenuation, R1 and R2 shorted out). Touching either input terminal should have no effect unless you built the high-gain model in which case the meter pointer should rise very slightly.

Connect TS1-B (ground) to the amplifier's common output terminal. Connect input terminals TS1-A and TS1-C to the L and R speaker terminals. Set S1 to zero and feed some sound through the amplifier at a reasonable volume level. The meter pointer should move in step with the program material, or rise to a constant level if the signal is a tone. Set the amplifier to mono and turn the amplifier's balance control. At some setting the meter should fall to zero or almost zero depending on the type of program material and the amplifier output level. If the meter does not zero at what your ear senses as approximate amplifier balance check the connections between the amplifier and the balancer.

Using the Balancer. The Balancer can be left connected to the amplifier at all times, but to prevent overloading IC1 keep S1 in the 20db position (attenuation) until you are ready to make an adjustment to your amplifier's controls.

Balance can be checked by simply setting the amplifier to mono and adjusting the balance control for a meter null. We say null rather than zero because many devices such as a phono pickup or stereo broadcasts have reduced high-frequency separation, of say 15db, and the meter would therefore indicate this reduced separation as an above zero meter indication.

Separation measurements can be made as described previously by comparing both channels against the reference level of a single channel, but a tone must be used as the input signal. Similarly, tone must be used when adjusting the tone controls for optimum tracking balance. —●—

Crystal Clarity for Stereo FM

Continued from page 83

Brazilian quartz is cut precisely to vibrate on the receiver's IF frequency (10.7 mc). The IF frequency entering the filter delivers an electrical twang which kicks the crystal into mechanical resonance. Since the crystal vibrates at its design frequency with great accuracy, it is sensitive only to the desired IF signal; adjacent channels producing IF frequencies slightly above and below 10.7 mc are lost in a piezoelectric shuffle.

But if the crystal filter's response is too sharp, why has it been celebrated for years as a superb component for ham, police, fire and other receivers? The reason is that all these services use narrow-band FM. To receive code, voice, SSB, teletype and other communications, the receiver rarely needs more than 10 kc of bandwidth. This would spell disaster for a hi-fi FM broadcast signal (see Fig. 2) which must fatten out to 150 kc (± 75 kc) during loud passages.

Then came the breakthrough in crystal filters for FM stereo receivers. In 1967, Robert Kinsman presented a paper before the Radio Technical Commission for Marine Services in Washington. Mr. Kinsman, chief crystal engineer for the CTS-Knights Co., spoke of a new IF strip for stereo FM that could nearly achieve the classic curve of ideal selectivity.

There had been problems, to be sure, in fashioning the wide-band response needed by the stereo FM signal. Early filters would distort the *phase* of the signal traversing the IF strip; but since a stereo signal is based on complex phase relationships, phase linearity must be maintained. The problem was solved by manufacturing better crystals and by using coils to tune out off-frequency signals. Another fault was a lopsided response in the filter which would cause the receiver's tuning meter to flicker wildly as the listener tuned a station. This, again, was cured by eliminating false, off-frequency resonances in the crystal structure.

So the bugs were finally designed out. The company developed special crystals to dampen and reduce spurious vibrations and pairs of crystals were teamed with special toroid coils (two round objects atop the crystal filter in the photo on the first page—and see schematic on first page) to mold a broad response curve that could admit the

full FM signal and attenuate adjacent signals.

Other manufacturers weren't slow to realize that crystal filters might well be the wave of the future. How they responded can be seen in the hi-fi literature of almost every leading producer. But in rigging their circuitry for the new devices, the engineers, true to hi-fi tradition, followed somewhat different routes in pursuit of the same goal.

Fisher elects to place one crystal filter well forward in the receiver. Containing four crystals, the filter intercepts the signal as it emerges from the tuner's front-end and enters the IF strip. Fisher's chief engineer, Fred Mergner, says this is where the filter does the most good. In conventional tuners, the IF amplifiers will not operate with the same degree of selectivity under changing signal strengths. (The AGC circuit affects not only signal gain but also the capacitance of the semiconductors used as IF amplifiers. Thus, a changing AGC will detune the IF transformers—from a nominal 10.7 mc—to a degree which depends on signal strength. Should an FM tuner not have AGC, the limiter stages will create the same problem. However, the crystal filter's selectivity remains fixed and it concentrates selectivity up front to attack the problem closer to the source.)

Another manufacturer, H. H. Scott, introduced a crystal filter in its deluxe 342C and 386 stereo receivers and Kenwood has selected two crystal filters for its new KT-7000 stereo tuner. These models are in the de luxe category because crystal filters come at a price. For instance, if your cat swallows one of the Heath filters while you're building the kit, a replacement will cost more than \$13.

Yet, signs are that the high cost of IF filtering may be on the downswing. A close cousin to the crystal filter is making an appearance in at least two stereo receivers. It's the *ceramic filter* which works on the same principle as the crystal variety. (The IF signal excites the ceramic material into mechanical vibration and this results in an electrical signal stripped of off-frequency interference.) The ceramic filter, however, operates with less sharpness than a quartz crystal. Also, ceramics don't have the degree of frequency stability inherent in crystals.

Another leading manufacturer, Sherwood, is following a two-fold path for IF filtering. In its de luxe stereo receivers, the company is using a toroidal IF filter. The kicker, though, is that Sherwood will use ceramic filters in its line of lower-priced models. —

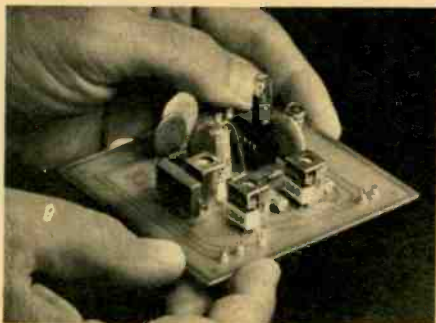

IC Stereo Decoder Uses Miller High Q Coils

A monolithic integrated FM stereo decoder system developed by Motorola provides excellent channel separation, good ultrasonic rejection and low THD content at the output.

Write for 6-page "Coil Forum" construction article.



J.W. MILLER COMPANY
19070 Reyes Ave. • P.O. Box 5825
Compton, California 90224

AVAILABLE NATIONWIDE FROM DISTRIBUTORS

CIRCLE NUMBER 1 ON PAGE 23

WANT A JOB? PART TIME— FULL TIME?

**No Boss! No Experience!
No Capital! Your Own Hours!**

WHAT A JOB ! ! ! !

And yet selling subscriptions to **ELECTRONICS ILLUSTRATED** and other leading publications is just like being in business for yourself.

But no business requires less capital, stock and space. The time you devote and the money you make is up to you. You need no experience to earn steady profits and you keep a cash commission on every sale. You operate in your own community by phone or personal calls. You will be authorized to sell new and renewal subscriptions along with special offers made by the publishers. You'll be amazed at the number of people wanting to take advantage of the convenience, service and savings you can offer them.

To get started immediately—send us your name (on a postal card) requesting free supplies and selling materials.

Write to: Subscription Dept. DE
ELECTRONICS ILLUSTRATED
Fawcett Bldg., Greenwich, Conn. 06830

Cheapie Quad for CB

Continued from page 87

When you have all the spreaders laced to the boom you can place the loops of the driven-element wire, between the washers on the matching and termination section. Do not tighten the nuts yet. Tie each taped section of wire to a spreader, keeping the wire taut all around. Now tighten the bottom nut. Attach your transceiver feed line as shown in Fig. A, then tape the coax along the spreader and down the boom. Slip the 16-in. piece of coax into the copper tube and twist the stranded end to the antenna wire about 11 in. below the spreader.

Take the director element wire and wire it through the plastic insulators first, observing the tape markers, and proceed with tying as before. Install on the two parallel tuning wires a 4-in. piece of wire as shown in Fig. A. Again, do not solder.

When you have the antenna up in the air (not too high yet) you're ready to tune. You'll need a SWR bridge, and the RF meter in your rig to do this. Don't attempt to tune the antenna on the ground because you'll only have to tune it again in the air. First, connect the SWR bridge and check your SWR; we're working toward a 1:1 SWR with full output.

At the antenna slide the wire termination of the piece of coax on the matching and termination section (Fig. A) along the driven-element wire until the SWR meter indicates as low as possible (this is not necessarily 1:1 yet). When you've gotten the SWR as low as possible, slide the coax out or in the copper tube to get the SWR closer to 1:1. Check the RF output on your rig; it should be as high as it normally would be into a 50-ohm load. If it's not, re-tune the matching and termination section.

Tuning the director is less of a job. Aim the antenna at a distant (local) station and tune by sliding the shorting wire till maximum signal strength is achieved. Another way is to use a field-strength meter and tune for maximum indication with transmitter on.

Check the SWR again and re-tune if necessary. Wrap tape around the end of the copper tube and coax to prevent further movement in or out. Take three 2-in. pieces of solder and wrap them around the wire terminations on both the matching and termination section and the director shorting wires and crimp tightly to hold each in place.

What a Beauty,
What a Build
And Boy!!!!
What Performance!



The 176 is the up-top CB
base antenna for on-top
people . . . from

 *Shakespeare*

C/P Corporation Division, The Shakespeare Co., P. O. Box 5207, Columbia, S. C. 29205

CIRCLE NUMBER 2 ON PAGE 23

Don't miss...



...a single issue



Subscribe!

In issue after issue Electronics Illustrated gives its readers interesting and detailed coverage of the hobby electronics field plus great step-by-step construction projects. It's the kind of coverage you not only can't afford to miss... but don't WANT to miss. Make sure you get every issue. How? Subscribe now! EI costs just \$3 for a year's subscription (six issues).

ELECTRONICS ILLUSTRATED 3-70
 Circulation Department
 Fawcett Building
 Greenwich, Conn. 06830

Dear EI: Just to make sure I don't miss a single issue, I want to subscribe right now. Please put my name on your subscription list—pronto!

I enclose \$3 New Order
 Bill me later Renewal

NAME

ADDRESS

CITY STATE ZIP

DXing The Marine Band

Continued from page 75

In your report, you should say something like: "Your station was in contact with WHI362 aboard the yacht Terri at 1822 EST." This still dents the Secrecy of Communications statute, however.

Since few maritime ship or shore stations have their own printed QSL cards, you'll have to make up a stamped and prepared card for the station to sign and return to you. This counts as a genuine QSL. Just copy the standard QSL card format, leaving blanks to be filled in for callsign, frequency, time, date, power and antenna type. Also, remember:

- When writing to marine operator stations, address your report to: Station Manager, Marine Operator Station _____, c/o (name of owner), (city, state).
- Locating the owners of vessels can be tricky. Military vessels can be reached at the Fleet Post Offices in either New York or San Francisco. Address your report to: Chief Radio Officer, USS _____, Fleet Post Office, (city, state). Generally speaking, it's not good policy to request that military vessels fill you in on technical details about their equipment (such as power and type of antenna).

- Some owners of tankers, freighters, and even tugs are easily identified by the names which they give their vessels; such as the tanker Esso Greenville, or the tug Kevin Moran (belonging to the Moran Towing & Transportation Co. of New York).

- Each year, the Superintendent of Documents, Government Printing Office, Washington, D.C. 20402, publishes a book titled *Merchant Vessels Of The United States* which shows the names, sizes, callsigns and owners of all commercial vessels and many of the larger pleasure boats.

- Listings of callsigns and frequencies of U.S. and foreign ship and shore stations are published by the International Telecommunication Union located in Geneva, Switzerland. These lists are usually available in North America from Gilfer Associates, Box 239, Park Ridge, N.J. 07656.

- Valuable data on maritime VHF stations and marine operations in many larger cities is included in some of the Emergency Radio Service Monitoring Bulletins published by the Communications Research Bureau, Box 56-EX, Commack, N.Y. 11725.

Continued from page 76

primarily (though by no means exclusively) to carry the effect of reverberation and thus offer a more realistic three-dimensional sound than conventional stereo. The technique places the usual set of stereo mikes in the same places, plus an extra set somewhere back in the hall.

I've done a good bit of listening to both the Vanguard and Columbia four-channel tapes being played in AR music rooms and to the special four-channel broadcasts being simulcast by WGBH and WCRB in Boston, and I don't think there's any disputing the extra measure of immediacy (remember, I'm wary of that word realism).

Just what it's all worth, though, can't be judged until we get a real idea of the actual cost—both in dollars and complexity. I have seen an experimental four-channel amplifier made by AR, and Scott will have one on the market soon. Four-channel tapes from Vanguard may also be on sale and at least four tape recorder manufacturers have four-channel decks.

The ABCs of Color Television Servicing

Answers to Examination on Part IV:

Continued from page 46

1. The adjustments for purity, gray-scale tracking (also called color temperature) and static convergence. Even then, dynamic convergence is required only if there is color fringing away from the center of the screen.
2. Kill the electron gun for the unneeded color (the third installment).
3. Recheck the adjustments for purity and gray-scale tracking.
4. Yes. Faults in the demodulators and color-difference amplifiers can affect the color of a raster during monochrome programs.

have you any idea
how many ways you can
use this handle?



as a screwdriver...



for slotted, Allen hex, Phillips, Frearson, Bristol, Clutch Head, Scrulox® screws

as a nutdriver... for hex nuts, screws, and bolts



as an awl/scraper and reamer



It accommodates 49 interchangeable blades of various types and sizes.

Its patented spring device permits quick blade insertion and removal.

It's shockproof, breakproof (UL) plastic. Comes in three sizes — regular, junior, stubby — also Tee type.

It's available in a great variety of sets from 39-piece roll kits to compact, pocket cases.

For information on time-saving, space-saving Xcelite "99" tool kits and sets, mail coupon below.



XCELITE

XCELITE, INC., 16 Bank St., Orchard Park, N. Y. 14127
Send Catalog 166 with information on "99" sets and kits.

name _____

address _____

city _____

state & zip _____

In Canada contact Charles W. Pointon, Ltd.

CIRCLE NUMBER 13 ON PAGE 23

Continued from page 39

way, you might try for Key West's WKWF on the regional channel of 1600 kc. For several years, beginning in 1960, WKWF aired anti-Castro transmissions in Spanish. At the beginning of the missile crisis, while the VOA stations at Dry Tortugas and Marathon were being set up, WKWF also relayed VOA programs into Cuba. You could also try for the other Marathon station—WFFG on 1300 kc. Both WKWF and WFFG are heard best when ionospheric disturbances knock out Northern QRM.

Another interesting county (the list probably has no end) is Polik in Iowa, where WHO in Des Moines (50 kw) tested a new alerting device for the Emergency Broadcast System this summer. WHO is a cinch on 1040 kc. Or how about Baltimore County in Maryland? The VOA obtained its Sugar Loaf transmitter from station WBAL (1090 kc).

In the interests of style, you might also try for this TV pair—Baltimore's WMAR with skip on channel 2, and WHO-TV by way of troposcatter on channel 13. Also possible, depending on where you live, WBAL-TV on channel 11.

FOR SPEEDY SERVICE

1102171 647 98 24 0664
 T M BROWN
 5936 23rd PARKWAY
 WASHINGTON, D. C. 20031

WE'RE LOST WITHOUT THIS LABEL

Well, not really lost — but we can do things faster for you if you send along the ADDRESS LABEL from your magazine any time you write to us about your subscription.

CHANGE OF ADDRESS

If you're moving, please let us know six weeks before changing your address. Better still, attach the magazine address label to this form, and print your new address here.

name _____
 street _____
 city _____ state _____ zip _____

attach label here

ELECTRONICS ILLUSTRATED Sub. Dept., Greenwich, Conn. 06830

Continued from page 63

horn blasts, the MD-19 automatically goes into the listen mode.

When operated as a horn, a higher pitched tone, similar to the boat's power horn is produced. A push-to-talk switch on the hand-held microphone turns on the hailer which has a range of several hundred yards. Using up to two accessory speakers (MDA-19-1, \$9.50 ea.) the unit operates as an intercom.

Our builder found the instruction manual clear and easy to follow. His only error was easy to correct, he found the last resistor to be installed was the wrong value. It was easy to backtrack to find where it belonged. The MD-19 was completed in eight hours.

Installation was a simple job. The horn speaker was mounted well forward on the cabin top and the main unit fit nicely on the shelf in front of the helm. Our builder finds the hailer function useful when coming into docks to speak to other boats that might not have their marine radio on. In the listen mode it is valuable as an intercom between the helmsman and the man at the bow during anchoring.

STATEMENT OF OWNERSHIP, MANAGEMENT AND CIRCULATION
 (Act of October 23, 1962)

- Section 4369, Title 39, United States Code
1. Date of Filing: October 1, 1969.
 2. Title of Publication: Electronics Illustrated.
 3. Frequency of Issue: Bi-monthly.
 4. Location of Known Office of Publication: Fawcett Place, Greenwich, Connecticut 06830.
 5. Location of the Headquarters or General Business Offices of the Publishers: Greenwich, Connecticut 06830.
 6. Names and Addresses of Publisher, Editor, and Managing Editor: Publisher, Fawcett Publications, Inc., Greenwich, Conn. 06830; Editor, Robert G. Beason, Stamford, Conn. 06903; Managing Editor, Robert D. Freed, Stony Brook, N. Y. 11790.
 7. Owner: Fawcett Publications, Inc., Greenwich, Conn.; W. H. Fawcett, Jr., Norwalk, Conn.; Marlon Bagg, Kansas City, Mo.; Roger Fawcett, New York, N. Y.; V. D. Fawcett, Greenwich, Conn.; M. B. Fawcett, Norwalk, Conn.; Gordon W. Fawcett, Greenwich, Conn.; Gloria Leary, Santa Monica, Cal.; V. F. Kerr, Bakersfield, Cal.; Allan Adams & Jack Adams—Trustees, Greenwich, Conn.; John R. Fawcett, Wilton, Conn.; Thomas K. Fawcett, New York, N. Y.; Roscoe Kent Fawcett, Reno, Nevada; M. F. Fawcett, Greenwich, Conn.; H. A. Fawcett, New York, N. Y.
 8. Known Bondholders, Mortgagees, and Other Security Holders Owning or Holding 1 Percent or More of Total Amount of Bonds, Mortgages or Other Securities: None.
 9. Not Applicable.
 10. Extent and Nature of Circulation:
 Average No. Copies Each Issue During Preceding 12 Months:
 A. Total No. Copies Printed (net press run), 369,473. B. Paid Circulation: 1. Sales through dealers and carriers, street vendors and counter sales, 69,173; 2. Mail subscriptions, 228,316. C. Total paid circulation, 297,489. D. Free distribution (including samples) by mail, carrier or other means, 3,051. E. Total distribution (sum of C and D), 300,539. F. Office use, left-over, unaccounted, spoiled after printing, 68,934. G. Total (sum of E & F—should equal net press run shown in A), 369,473.
 Actual Number of Copies of Single Issue Published Nearest to Filing Date: A. Total No. copies printed (net press run), 375,146. B. Paid Circulation: 1. Sales through dealers and carriers, street vendors and counter sales, 66,400; 2. Mail subscriptions, 246,410. C. Total paid circulation, 312,810. D. Free distribution (including samples) by mail, carrier or other means, 2,990. E. Total distribution (sum of C and D), 315,800. F. Office use, left-over, unaccounted, spoiled after printing, 59,346. G. Total (sum of E & F—should equal net press run shown in A), 375,146.

I certify that the statements made by me above are correct and complete.

(signed) GORDON W. FAWCETT

Notes from EI's DX Club

JUST because you're a Novice operator don't think DX is beyond you. While on the air as WN2FBI, member Martin L. Shulman (New York) worked DL4QP in West Berlin and OK2PO in Czechoslovakia on 15 meters. But if you are a Novice and, as one Illinois applicant did, claim a catch like CR9AAC (Macao), you'd better be certain you have a QSL. Our friend from Illinois didn't.

A hot prospect for BCB DXers is the BBC relay on the island of Malta—it recently switched from 1178 to 1546 kc. Sign-on is 2245 EST; all transmissions are in Arabic.

Back on the ham front, EIDXCer Robert W. Baker, WB2SCK (New Jersey) has worked the Mediterranean island of Cyprus in the person of ZC4MO on 15 meters around 1745 EST.

All special transmissions to Rhodesia have now been dropped by the BBC. Official reason is a lack of suitable material for the program. In another development, the BBC's Ascension relay is using 49 meters for the first time—6010 kc is beamed to West Africa at 2330-0115 EST in English.

We learn from member Bob Hagerman (Michigan) that R. Nacional de El Salvador has switched from 6010 to 5980 kc. This station sometimes provides good reception during evening hours.

Despite the fact that RAE (the Voice of Argentina) is listed and sometimes reported on 9690, they continue to operate—as Florida's Dan Ferguson points out—7 kc below that spot. Their final English transmission begins at 0100 EST (2200 PST).

A comparatively rare Ecuadorian catch, La Voz del Rio Carrazol, can sometimes be logged on the offband frequency of 3570 kc around 2300 EST.

A relay of East Germany's home service, Deutschlandsender, has been logged on 7185 kc; program was classical music around midnight EST. The ham QRM does wonders for

Wagner. Another East European home-service relay heard a bit earlier is Warsaw's on 7145, 7125 and 6010 kc.

Another Dan Ferguson logging is R. Sana (Yemeni Rep.) on 5804 kc; their sign-on seemed to be at 2159 EST. He also reports reception of the Saudi Arabian broadcasting station at Riyadh on 6000 kc around 2220 EST.

The Environmental Science Services Administration (ESSA) is operating WWI at Long Branch, Ill. on 8900 and 11100 kc for propagational studies. Transmissions consist of an open carrier with good cw IDs every half hour.

EIDXCer Gerry Dexter (Wisconsin) has received a letter from 4VOD, R. Valparaiso at Port-de-Paix, Haiti, claiming that station 4VGA, R. Capois la Mort (at same location and often reported on 5040 kc) has been silent since 1967 and that they, 4VOD, are actually the station being heard on 5040. Anybody want to argue?

In Venezuela, R. Rumbos' Caracas station has purchased a new 250-kw Continental Electronics BCB transmitter. Watch for better coverage on their present frequency of 670 kc. This tip from Ross Harp Jr. (Colorado).

Propagation: During daylight hours, DX will be possible on frequencies ranging from 15 to 26 mc. The amateur 10-meter band will be open to South America and Africa regularly, and some openings to Europe will occur during the midday period, local time. Trans-Pacific 10-meter openings will occur during the late afternoon and early evening periods.

During nighttime hours, good to excellent DX should be possible in all bands from 6 to 15 mc, depending on the direction of the station. The amateur 20- and 40-meter bands will be optimum for nighttime QSOs.

Because of a seasonal increase in noise levels, BCB DX will not be as good as it has been during the winter months.



Classified Ads

ELECTRONICS ILLUSTRATED

Your advertisement can reach this mail-buying audience for only 50¢ per word . . . payable in advance (Check or M.O. please) . . . minimum 10 words. Closing dates are the 20th of 4th preceding month i.e. copy for the July issue must be in our office by March 20th. Mail to ELECTRONICS ILLUSTRATED, 67 West 44th St., New York, N. Y. 10036. Word count: Zipcode number free. Figure one word: Name of state (New Jersey), name of city (New York); sets of characters as in key (14-D); also abbreviations as 35MM, 8x10, D.C., A.C.

SAVE MONEY • ORDER BY MAIL

• • • FOR SALE

TREASUREPROBES. PATENTED transistorized detector signals "dig" by ear-phone "beeping". 5" search head, PC boards, two colpitt oscillators improve stability. Kit \$13.95, assembled \$18.88, with speaker \$24.88, 60 day guarantee. Free literature. Treasure House, EG-10, Tennent, N.J. 07763.

TREASURE HUNTERS! Prospector! Relco's new instruments detect buried gold, silver, coins. Kits, assembled models. Transistorized. Weighs 3 pounds. \$19.95 up. Free catalog. Relco-A19, Box 10839, Houston, Texas 77018.

CONSTRUCTION PLANS: Laser . . . \$2.00. Surveillance devices—two F.M. bugging transmitters . . . \$1.00. Tail transmitter . . . \$1.00. Telephone transmitter . . . \$1.00. Infinity transmitter . . . \$2.00. Equipment and kits available. Howard, 20174 Ward, Detroit, Michigan 48235.

ULTRA-SENSITIVE and Powerful Metal Detectors—join the many who are finding buried coins, minerals, relics and artifacts. Don't buy till you see our Free catalog of new models. Write Jetco—Box 132—El—Huntsville, Texas 77340.

SUBMINIATURE LISTENING Devices, low priced, high performance direct from manufacturer. Dealers welcome. Audiotronix SL103, 156 Fifth Ave., New York, N.Y. 10010.

INTEGRATED CIRCUIT kits: Computer, audio, others. New catalog free. Kaye Engineering, Box 3932-C, Long Beach, California, 90803.

CONVERT ANY television to sensitive, big-screen oscilloscope. Only minor changes required. No electronic experience necessary. Illustrated plans, \$2.00. Relco A-19, Box 10563, Houston, Texas 77018.

MUSIC LOVERS, continuous, uninterrupted background music from your FM radio, using new inexpensive adaptor. Free literature. Electronics, 11500-W.N.W. 7th Ave., Miami, Florida 33168.

GOLD, SILVER, relics! Located with powerful Detectron Metal Detectors. Free information. Terms. Detectron, Dept. EI-3, Box 243, San Gabriel, California 91778.

EXPERIMENTERS—STEPPERS, relays, micro-switches, and more. Discount priced. Send stamped self-addressed envelope to: Gust & Company, Box 24081, Edina, Minn. 55424.

INVESTIGATORS, LATEST Electronic Aids. Free literature. Clifton, 11500-X NW 7th Ave., Miami, Florida 33168.

• • • GOVERNMENT SURPLUS

JEEPS TYPICALLY From \$53.90 . . . Trucks From \$78.40 . . . Airplanes, Typewriters, Boats, Clothing, Camping, Sporting, Photographic, Electronics Equipment, Wide Variety, Condition. 100,000 Bid Bargains Direct From Government Nationwide. Complete Sales Directory and Surplus Catalog \$1.00 (Deductible First \$10.00 Order). Surplus Service, Box 820-T, Holland, Michigan 49423.

GOVERNMENT SURPLUS. How and Where to Buy In Your Area. Send \$1.00. E.I. Surplus Information, Headquarters Bldg., Washington 6, D. C.

• • • PRINTING

1000 EMBOSSED BUSINESS cards \$4.95. Free samples. Joseph Winters, Box 333, Pleasantville, New Jersey 08232.

• • • BUSINESS OPPORTUNITIES

EXCLUSIVE FRANCHISE—Millex precision auto tune-up and air conditioning centers, largest diagnostic repair chain nationally, is seeking qualified investors wanting to earn \$30,000-\$50,000 owning their own business. Cash required—\$24,500 (balance financeable). Write for free facts on \$20 billion auto market. Director, Millex, Dept. EI-1, 650 Park Ave., King of Prussia, Penna. 19406.

UHF ANTENNAS Open Field Big Profits. Build 14dB gain antenna at home for less than \$5.00, sell for \$30 or more. For plans and information send \$1.00 to E&A Enterprises, 757 North Elmwood, Springfield, Missouri 65802.

VENDING MACHINES. No selling. Routes earn amazing profits. Big catalogue free. Parkway Corporation, 715E1 Ensor Street, Baltimore, Maryland 21202.

MAKE BIG Money raising chinchillas, rabbits, guinea pigs for us. Catalog—25¢. Keeney Brothers, New Freedom, Pa. 17349.

• • • EMPLOYMENT OPPORTUNITIES

PRINTING — ADVERTISING Salesmen. Excellent moneymaking sideline selling Decalcomania Name Plates, Advertising Specialties, Sign Letters, Automobile initials. Free Samples. Relco-EI, Box L, Boston, Mass. 02119.

• • • EDUCATION AND INSTRUCTION

REI CAN train you for the First Class Radio Telephone License in only five (5) weeks. Approved for Veterans Training. REI has schools in Sarasota, Florida; Glendale, California; Fredericksburg, Virginia; and Kansas City, Missouri. For free brochure write REI, 1336 Main Street, Sarasota, Florida 33577 or call 813-955-6922.

HIGHLY EFFECTIVE home study courses in Electronics Engineering Technology and Electronics Engineering Mathematics. Earn your Degree. Write for Free Descriptive Literature. Cook's Institute of Electronics Engineering (Dept. 14), P.O. Box 10434, Jackson, Miss. 39209. (Established 1945).

LEARN CARTOONING at home. Free book, "Key To A Cartoon Career." Write: Cartooning, Box 3176-X, Colorado Springs, Colo. 80907.

• • • TAPE RECORDERS

LEARN WHILE Asleep with your recorder, phonograph or amazing new "Electronic Educator" endless tape recorder. Details free. Sleep-Learning Research Association, Box 24-El, Olympia, Washington.

RENT 4-TRACT open reel tapes—all major labels—3,000 different—free brochure. Stereo-Parti, 55 St. James Drive, Santa Rosa, CA. 95401.

• • • RADIO & TV

TV TUNERS rebuilt and aligned per manufacturer specification. Only \$9.50. Any make UHF or VHF. We ship COD. Ninety day written guarantee. Ship complete with tubes or write for free mailing kit and dealer brochure—JW Electronics, Box 51K, Bloomington, Indiana.

REPAIR YOUR own T.V. tuners—color—transistor—VHF—UHF. Earn to \$1,700 monthly. No customer headaches. Simple, complete course. First of its kind. Copyrighted. Years in preparation. Six sections, 33 chapters. All field-tested. Jigs—fixtures—adapters—"settling-up". Special probes. Quick-checks. How alter and use test sets. Repairs without equipment. Unique power supplies. Fast-fix luxuries. Equipment you can build. Professional tricks. Pictures, drawings, sketches. Plans for all items. Troubleshooting. Alignment. All tests and adjustments. Common mistakes. How and where to buy parts. Specific repairs common problems. Index of all tuners. Much, much more. Programmed teaching. Details of major course, introduction, plus two sample lessons, \$1, refundable. Frank Bocek, 3236 Enterprise Branch, Redding, Calif. 96001.

THOUSANDS AND thousands of types of electronic parts, tubes, transistors, instruments, etc. Send for Free Catalog. Arcturus Electronics Corp., MEL, 502-22nd St., Union City, N. J. 07087.

DISTANCE CRYSTAL set construction handbook—50¢. 10 crystal plans—25¢; 20 different—50¢. Catalog. Laboratories, 12041-K Sheridan, Garden Grove, Calif. 92640.

POLICE—FIRE—Aircraft—Marine—Amateur Calls on your Broadcast Radio with Tunavertor! Tunable—Crystal control! Free catalog! Salch Company, Woodsboro El, Texas 78393.

RADIO & T.V. Tubes—33¢. Free List. Cornell 4213-15 University, San Diego, Calif. 92105.

BLACK AND white television converted to color by means of a new patented color convertor adaptor circuit. Installation all do it yourself. Write for free brochure, Bete Electronics Corp., 121 S.E. First St., Miami, Florida 33131.

FREE! GIANT bargain catalog on transistors, diodes, rectifiers, SCR's, zeners, parts. Poly Paks, P. O. Box 942E1, Lynnfield, Mass.

• • • INVENTIONS & INVENTORS

PATENT SEARCHES Including maximum speed, full airmail report and closest patent copies \$6.00. Quality searches expertly administered with complete secrecy guaranteed. Free Invention Protection forms and "Patent Information." Write Washington Patent Search Bureau, Dept. 20, 711 14th St. N.W., Washington 5, D. C.

INVENTORS! SELL your invention for cash or royalties! Our client manufacturers eagerly seek new items. Patented. Unpatented. Financial assistance if needed. 25 years proven performance. For free information, write Dept. 27, Gilbert Adams, Invention Broker, 80 Wall St., New York, N.Y. 10005.

• • • ROCKETS

ROCKETS: IDEAL for miniature transmitter tests. New illustrated catalog 25¢. Single and multistage kits, cones, engines, launchers, trackers, rocket aerial cameras, technical information, etc. Fast service. Estes Industries, Penrose 13, Colorado 81240.

• • • STAMPS & COINS

FREE! 25 WORLDWIDE approvals. Ellis, 12-14 John, Orangeville, Ontario, Canada.

• • • MUSIC

POEMS, SONGS wanted for new song hits and recordings by America's most popular studio. Tin Pan Alley, Dept. EL, Lake Grove, New York 11755.

• • • PERSONAL

SUBMINIATURE LISTENING Devices, low priced, high performance direct from manufacturer. Dealers welcome. Audiotronix L101, 156 Fifth Ave., New York, N.Y. 10010.

BOSTON REMAILS, 25¢, \$3.00 Monthly; Forwarding-Receiving, Dycko, 18 Redcoat, Lexington, Mass. 02173.

• • • MISCELLANEOUS

PSYCHEDELIC CATALOG. 50 pages of Psychodelia. Send 25¢. Hole In Wall, 6055E1 Lankershim, No. Hollywood, Calif. 91606.

315 FREE MAGAZINES directory only \$2.00. Limited supply! Kerr Enterprises Box 177-E1, Old Washington, Ohio 43768.

OVER 2,000,000 BACK Issue Magazines! Send Needs. No Catalog. Midtown, Box 917-E1, Maywood, N. J. 07607.

ELECTRONICS ILLUSTRATED

Classified Advertising Order Form

For information on terms, closing dates, etc., see heading at top of Classified Section.

INSTRUCTIONS:

50¢ a word
Minimum Ad
10 Words

WORD COUNT: Zip code free. Figure one word for name of state (New Jersey); name of city (Little Falls); sets of characters as in key (M-14); abbreviation of Northwest (NW); but note separate initials as in a name (M. D. Brown), 3 words counted as a word each.
DEADLINE FOR ADS: Copy must be in by the 20th day of the fourth preceding month for the issue in which the ad is to appear.
BLANKLINE: May be placed both above and below the ad, if desired. Each blank line is charged as 5 words.

TO: ELECTRONICS ILLUSTRATED • 67 W. 44th St., New York, N.Y. 10036 • Att.: Classified Advertising Dept.
Gentlemen: Here's our copy for the Classified Section of ELECTRONICS ILLUSTRATED. Remittance of \$_____ is enclosed to cover _____ insertion(s) in the _____ issue(s).

1	2	3	4	5
6	7	8	9	10
11	12	13	14	15
16	17	18	19	20
21	22	23	24	25
26	27	28	29	30
31	32	33	34	35

YOUR NAME

(PLEASE PRINT)

FIRM

ADDRESS

CITY

STATE

ZIP

DATE:

YOUR SIGNATURE

(PLEASE PRINT OR TYPE COPY • FOR ADDITIONAL WORDS ATTACH SEPARATE SHEET)

3

BUILD YOUR OWN RADIO

and Electronics Circuits

Reg. U.S.
Pat. Off.



Training Electronics Technicians Since 1946

PROGRESSIVE "Edu-Kit"® HOME RADIO COURSE

Now Includes

- ★ 12 RECEIVERS
- ★ 3 TRANSMITTERS
- ★ SQ. WAVE GENERATOR
- ★ SIGNAL TRACER
- ★ AMPLIFIER
- ★ SIGNAL INJECTOR
- ★ CODE OSCILLATOR
- ★ No Knowledge of Radio Necessary
- ★ No Additional Parts or Tools Needed
- ★ EXCELLENT BACKGROUND FOR TV
- ★ SCHOOL INQUIRIES INVITED
- ★ Sold in 79 Countries

**YOU DON'T HAVE TO SPEND
HUNDREDS OF DOLLARS FOR A RADIO COURSE**

The "Edu-Kit" offers you an outstanding PRACTICAL HOME RADIO COURSE at a rock-bottom price. Our Kit is designed to train Radio & Electronics Technicians, making use of the most modern methods of home training. You will learn radio theory, construction practice and servicing. THIS IS A COMPLETE RADIO COURSE IN EVERY DETAIL. You will learn how to build radios, using regular schematics; how to wire and solder in a professional manner; how to service radios. You will work with the standard type of punched metal chassis as well as the latest development of Printed Circuit chassis.

You will learn the basic principles of radio. You will learn with the standard type of RF and AF amplifiers and oscillators, detectors, rectifiers, test equipment. You will learn and practice code, using the Progressive Code Oscillator. You will learn and practice troubleshooting, using the Progressive Signal Tracer, Progressive Signal Injector, Progressive Dynamic Radio & Electronics Tester, Square Wave Generator and the accompanying instructional material.

You will receive training for the Novice, Technician and General Classes of F.C.C. Radio Amateur Licenses. You will build Receivers, Transmitter, Square Wave Generator, Code Oscillator, Signal Tracer and Signal Injector circuits, and learn how to operate them. You will receive an excellent background for television, Hi-Fi and Electronics.

Absolutely no previous knowledge of radio or science is required. The "Edu-Kit" is the product of many years of teaching and engineering experience. The "Edu-Kit" will provide you with a basic education in Electronics and Radio, worth many times the low price you pay. The Signal Tracer alone is worth more than the price of the Kit.

THE KIT FOR EVERYONE

You do not need the slightest background in radio or science. Whether you are interested in Radio & Electronics because you want an interesting hobby, a well paying business or a job with a future, you will find the "Edu-Kit" a worth-while investment. Many thousands of individuals of all

ages and "backgrounds" have successfully used the "Edu-Kit" in more than 79 countries of the world. The "Edu-Kit" has been carefully designed, step by step, so that you cannot make a mistake. The "Edu-Kit" allows you to teach yourself at your own rate. No instructor is necessary.

PROGRESSIVE TEACHING METHOD

The Progressive Radio "Edu-Kit" is the foremost educational radio kit in the world, and is universally accepted as the standard in the field of electronics training. The "Edu-Kit" uses the modern educational principle of "Learn by Doing." Therefore you construct, learn schematics, study theory, practice trouble-shooting—all in a closely integrated program designed to provide an excellent background in radio.

You begin by examining the various radio parts of the "Edu-Kit." You then learn the function, theory and wiring of these parts. Then you build a simple radio. With this first and trouble-shooting. Then you build a more advanced radio, learn more advanced theory and techniques. Gradually, in a progressive manner, and at your own rate, you will find yourself constructing more advanced multi-tube radio circuits, and doing work like a professional Radio Technician.

Included in the "Edu-Kit" are Receiver, Transmitter, Code Oscillator, Signal Tracer, Square Wave Generator and Signal Injector Circuits. These are not unprofessional "breadboard" experiments, but genuine radio circuits, constructed by means of professional wiring and soldering on metal chassis using the new method of radio construction known as "Printed Circuitry." These circuits operate on your regular AC or DC house current.

THE "EDU-KIT" IS COMPLETE

You will receive all parts and instructions necessary to build twenty different radio and electronics circuits, each guaranteed to operate. Our Kits contain tubes, tube sockets, variable, electrolytic, mica, ceramic and paper dielectric condensers, resistors, tie strips, hardware, tubing, punched metal chassis, instruction Manuals, hook-up wire, solder, selenium rectifiers, coils, volume controls and switches, etc.

In addition you receive Printed Circuit materials, including Printed Circuit chassis, special tube sockets, hardware and instructions. You also receive a useful set of tools, a professional electric soldering iron, and a self-powered Dynamic Radio and Electronics Tester. The "Edu-Kit" also includes Code Instructions and the Progressive Code Oscillator, in addition to F.C.C. Radio Amateur License training. You will also receive lessons for servicing with the Progressive Signal Tracer and the Progressive Signal Injector, a High Fidelity Guide and a Quiz Book. You receive Membership in Radio-TV Club. Free Consultation Service, Certificate of Merit and Discount Privileges. You receive all parts, tools, instructions, etc. Everything is yours to keep.

Progressive "Edu-Kits" Inc., 1189 Broadway, Dept. 60E-AE, Hewlett, N. Y. 11557

UNCONDITIONAL MONEY-BACK GUARANTEE

Please rush my Progressive Radio "Edu-Kit" to me, as indicated below:
Check one box to indicate choice of model

- Regular model \$26.95.
- Deluxe model \$31.95 (same as regular model except with superior parts and tools plus valuable Radio & TV Tube Checker).

Check one box to indicate manner of payment

- I enclose full payment. Ship "Edu-Kit" post paid.
- I enclose \$5 deposit. Ship "Edu-Kit" C.O.D. for balance plus postage.
- Send me FREE additional information describing "Edu-Kit."

Name _____

Address _____

City & State _____

Zip _____

PROGRESSIVE "EDU-KITS" INC.

1189 Broadway, Dept. 60E-AE, Hewlett, N. Y. 11557

FREE EXTRAS

• SET OF TOOLS

- SOLDERING IRON
- ELECTRONICS TESTER
- PLIERS-CUTTERS
- VALUABLE DISCOUNT CARD
- CERTIFICATE OF MERIT
- TESTER INSTRUCTION MANUAL
- HIGH FIDELITY GUIDE & QUIZZES
- TELEVISION BOOK & RADIO TROUBLE-SHOOTING BOOK
- MEMBERSHIP IN RADIO-TV CLUB: CONSULTATION SERVICE & F.C.C. AMATEUR LICENSE TRAINING
- PRINTED CIRCUITRY

SERVICING LESSONS

You will learn trouble-shooting and servicing in a progressive manner. You will practice repairs on the sets that you construct. You will learn symptoms and causes of trouble in home, portable and car radios. You will learn how to use the professional Signal Tracer, the unique Signal Injector and the dynamic Radio & Electronics Tester. While you are learning in this practical way, you will be able to do many a repair job for your friends and neighbors and charge fees which will far exceed the price of the "Edu-Kit." Our Consultation Service will help you with any technical problems you may have.

FROM OUR MAIL BAG

J. Statitis, of 25 Poplar Pl., Waterbury, Conn., writes: "I have repaired several sets for my friends, and made money. The "Edu-Kit" paid for itself. I was ready to spend \$240 for a course, but I found yours ad and sent for your Kit."

Ben Vateria, P. O. Box 21, Magna, Utah: "The Edu-Kits are wonderful. Here I am sending you the questions and also the answers for them. I have been in Radio for the last seven years, but like to work with Radio Kits, and like to build Radio Testing Equipment. I enjoyed every minute worked with the different kits; the Signal Tracer works fine. Also like to let you know that I feel proud of becoming a member of your Radio-TV Club."

Robert L. ShuM, 1534 Monroe Ave., Huntington, W. Va.: "Thought I would drop you a few lines to say that I received my Edu-Kit, and was really amazed that such a bargain can be had at such a low price. I have already started repairing radios and phonographs. My friends were really surprised to see me get into the swing of it so quickly. The Trouble-shooting Tester that comes with the Kit is really swell, and finds the trouble, if there is any to be found."

PRINTED CIRCUITRY

At no increase in price, the "Edu-Kit" now includes Printed Circuitry. You build a Printed Circuit Signal Injector, a unique servicing instrument that can detect many Radio and TV troubles. This revolutionary new technique of radio construction is now becoming popular in commercial radio and TV sets.

A Printed Circuit is a special insulated chassis on which has been deposited a conducting material which takes the place of wiring. The various parts are merely plugged in and soldered to terminals.

Printed Circuitry is the basis of modern Automation Electronics. A knowledge of this subject is a necessity today for anyone interested in Electronics.

CIRCLE NUMBER 10 ON PAGE 23

Electronics is opportunity, action and NTS!

Pick any one of the four big fields in electronics: COLOR-TV, INDUSTRIAL or COMPUTER ELECTRONICS, or COMMUNICATIONS. Each is packed with opportunity for the men who want to move up. If you're among them, mail the card below. Because NTS training is fast, easy and thorough.

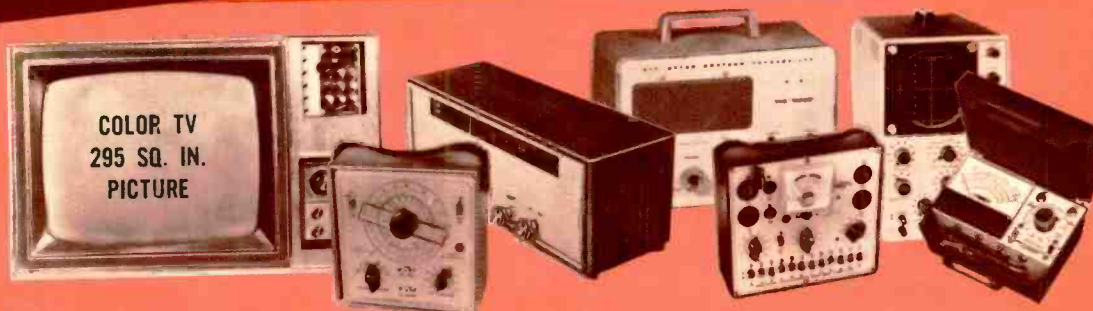

ALL NEW KITS...ALL NEW COURSES, WITH NTS PROJECT-METHOD TRAINING! MORE BIG KITS THAN EVER OFFERED FOR TRAINING ANYWHERE!

A 295 sq. in. picture COLOR TV, a desk-top computer trainer, oscilloscope solid-state radios. Integrated circuits, too! All part of NTS Project-Method: The sure-fire system that builds everything you need to know around practical kit projects. And NTS gives you professional "test-center" equipment, including signal generator FET-VOM, and tube checker for your troubleshooting and servicing work. NTS shows you how to use them early in your training. You earn money repairing TV sets and electronic equipment even before you've completed the course. Brand new Color Catalog describes in detail all the exciting equipment that comes with each course.

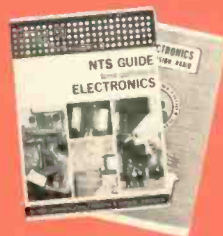

Get the full story! See all the exciting new kits you get from NTS! Cut out and mail reply card for new, color catalog and sample lesson! No obligation. No salesman will call.

CLASSROOM TRAINING AT LOS ANGELES:

You can train at our resident school in Los Angeles. NTS occupies a city block with over a million dollars in facilities devoted to technical training. Check special box in coupon.

HIGH SCHOOL AT HOME:

NTS offers accredited high school programs. Take only the subjects you need. Study at your own pace. Everything included at one low tuition. Check special box in coupon for free catalog.



Accredited Member:
National Home
Study Council



Accredited Member:
National Association of
Trade and
Technical Schools.

NATIONAL TECHNICAL SCHOOLS

World Wide Training Since 1905
4000 S. Figueroa Street
Los Angeles, California 90037

APPROVED FOR VETERANS

ACT NOW! DON'T DELAY! **10** TRAINING PROGRAMS TO INSURE YOUR FUTURE

Please rush new Color Catalog and Sample Lesson plus information on course checked below. No obligations. No salesman will call.

- MASTER COURSE IN COLOR TV SERVICING
- COLOR TV SERVICING
- MASTER COURSE IN TV & RADIO SERVICING
- PRACTICAL TV & RADIO SERVICING
- MASTER COURSE IN ELECTRONIC COMMUNICATIONS
- FCC LICENSE COURSE
- MASTER COURSE IN ELECTRONICS TECHNOLOGY
- INDUSTRIAL AND AUTOMATION ELECTRONICS
- COMPUTER ELECTRONICS
- BASIC ELECTRONICS
- High School at Home
- Major Appliances Servicing Course

Dept. 213-020

Name _____ Age _____
Address _____
City _____ State _____

Please fill in Zip Code for fast service _____

- Check if interested in Veteran Training under new G.I. Bill
- Check here if interested ONLY in Classroom training in Los Angeles



Now you may
earn double-time
pay without
working over-time.



National Technical Schools makes it easier to double your income. All you need is your own ambition. The NTS Project Method simplifies your training... makes it easy for you to enter Electronics... a whole new world of opportunity. You can have a solid career and probably double your present earnings. Start moving up today. In Color TV. Or in computer and industrial electronics. Or in communications and aerospace. It's easier than you think.

NTS will show you how!

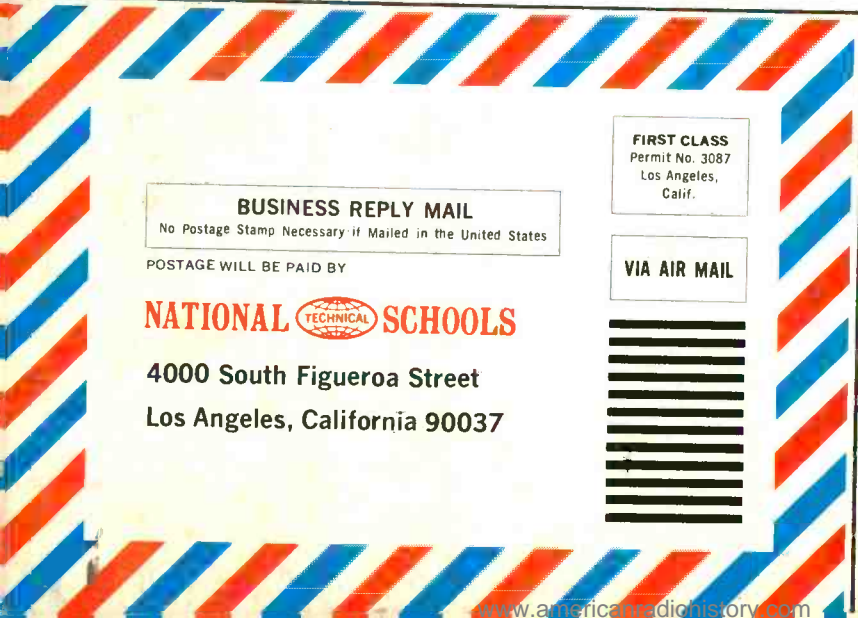

BUSINESS REPLY MAIL
No Postage Stamp Necessary if Mailed in the United States

POSTAGE WILL BE PAID BY

NATIONAL TECHNICAL SCHOOLS

4000 South Figueroa Street
Los Angeles, California 90037

FIRST CLASS
Permit No. 3087
Los Angeles,
Calif.

VIA AIR MAIL



(see other side for more information)

NATIONAL TECHNICAL SCHOOLS

World Wide Training Since 1905
4000 So. Figueroa St., Los Angeles, Calif 90037



APPROVED FOR VETERANS

NTS... An Accredited School devoted to both Resident and Home Study Training

NTS... Occupies a city block with over a million dollars in facilities.