

Unique Airborne Operating Test for CB Rigs

ELECTRONICS ILLUSTRATED

By the Publishers of MECHANIX ILLUSTRATED

NOVEMBER 1969 • 50¢

ABCs of Color TV Servicing—Part III

Up-to-Date Guide to the Surplus Market



**Integrated Circuit Speech
Compressor Fits Inside
Microphone Shell!**

Great for Home Tape Recording!

**Pocket Crystal Checker for Hams
The DX Scene in New Zealand**

57 86 7530 HINDMAN-4 ITC06
MICHAEL J HINDMAN
2724 E-LINWOOD
SPRINGFIELD MD 65804



Finally, a course for less than \$100 that will train you as a professional TV repairman. In fact, with the first two texts, you can repair 70 percent of all TV troubles.

And you need no previous experience to take this complete and practical training program.

The course consists of 6 texts to bring you along quickly and easily. 936 pages of concise, easy-to-follow instruction, plus 329 detailed illustrations. You also receive a dictionary of TV terms geared directly to course material so you'll understand even the most technical terms.

Whether you now know a vacuum tube from a resistor, you can be doing troubleshooting on color sets in a matter of months.

Instruction is simple, very easy to grasp. Photos show you what a TV screen looks like when everything is normal, and what it looks like when trouble fouls it up. The

texts tell you how to remedy the problem, and why that remedy is best.

Quizzes are spotted throughout the texts so you can check your progress. At the end of the course, you take a final examination. Then you get the coveted ICS diploma, plus membership in the ICS Institute of TV Servicing.

Cost Less Than \$100

You could pay up to \$600 and still not get professionally approved TV training. The ICS TV Servicing/Repair Course costs you only \$99. And it's approved by the National Electronic Associations. (The first time a self-taught training program has been approved by the NEA.)

Get all the facts. Free. Mail the reply card on the attached flap or return the coupon. Learn how you can become a professional TV repairman—and find out about the bonus offer—an invaluable portfolio of 24 late-model schematics. Do it now.

IN JUST A FEW MONTHS YOU CAN BE EARNING \$200 PER WEEK AS A TV REPAIRMAN

Act Today!

ICS International Correspondence Schools
Division of Intext

ICS, Scranton, Penna. 18515

80628J

Yes, I'm interested in the new ICS TV Servicing/Repair Basic Training Package. Send me the free brochure giving details.

Name _____

Address _____

City _____

State _____ Zip _____

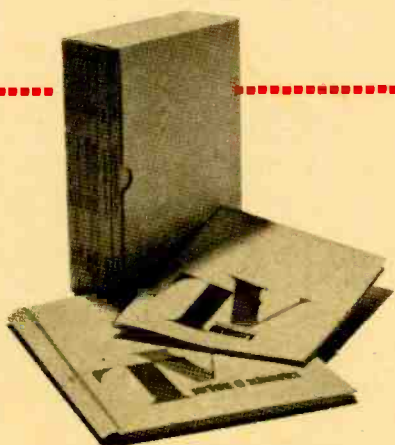

APPROVED BY NATIONAL ELECTRONIC ASSOCIATION FOR
USE IN THEIR NATIONAL APPRENTICESHIP PROGRAM

November, 1969

1

ELECTRONICS ILLUSTRATED

A Fawcett Publication
November 1969 Vol. 12 No. 6

AMATEUR RADIO

Gnat-Size Crystal Checker	Gary McClellan	101
The Ham Shack	Wayne Green, W2NSD/1	108

CITIZENS BAND

CB Corner: Does Anybody Repair CB rigs?	Len Buckwalter KQA5012	68
EI Tests CB in the Air	Vernon Simms	94

AUDIO & HI-FI

Compress-O-Phone	Joseph Ritchie	29
A Speaker for Cool Cats	Fred Savage	43
Hi-Fi Today: Setting It Straight	John Milder	60

SHORT-WAVE LISTENING

Notes from EI's DX Club		38
The Listener: Hawaiian DX	C. M. Stanbury II	73
The DX Scene in New Zealand	Dallas A. McKenzie	92

ELECTRONIC SERVICING

Service Tips		14
The ABCs of Color Television Servicing: Part III, Adjusting Color Sets	Forest Belt	61
Electrolytic Leakage Checker	Victor Kell	82

THEORY AND PRACTICE

How Color TV Tunes Itself	Len Buckwalter K10DH	48
Resistor with a Real Twist	Jorma Hyypia	76

YOUR CAREER

For Great New Career Opportunities, Think CATV!	David Walker	39
---	--------------	----

ELECTRONICS FOR THE HOME

The Tipoff Intruder Alarm	Victor Kell	69
---------------------------------	-------------	----

HISTORICAL ELECTRONICS

New Fun From Olden, Golden Radios	Franklin Atlee	56
---	----------------	----

SURPLUS ELECTRONICS

A Modern Guide to the Surplus Market	H. B. Morris	88
--	--------------	----

ENTERTAINMENT ELECTRONICS

My Life and Hard Times with a Home Video Tape Recorder	Robert D. Freed	97
---	-----------------	----

KIT REPORT

Everyman's Sideman		74
--------------------------	--	----

YOUR LIBRARY

Broadside		8
Good Reading	Tim Cartwright	47

NEW PRODUCTS

Electronic Marketplace		20
Electronics in the News		86

HOBBY & BUSINESS OPPORTUNITIES

Swap Shop		22
Classified Ads		120

REGULAR DEPARTMENTS

Feedback	6	Product Information Service ..	13
Over & Out	Rodrigues 110	Subscription Blank	118
Uncle Tom's Corner		Tom Kneitel, K2AES/KQD4552	10

Dazzle your friends with lightworks.



Sound n' Color®

The new dimension to music pleasure. EICO All Electronic Solid-State Audio-Color Organs transform sound waves into moving synchronized color images. Connect easily to speaker leads of hi-fi or radio. From \$29.95.



Translators

The electronics you need to create audio-stimulated light displays to your own imagination. Actuates: Light Display Units, Strobe Lites, any lamp configuration (Xmas trees, patio lights, etc.). From \$24.95 kit, \$39.95 wired.



Strobe Lites

High-intensity bursts of white light from Xenon tube flash in cadence with each beat of audio. From \$24.95 kit, \$39.95 wired.

Build the Stereo Kits praised by experts.

All amplifier power ratings according to IHF standards. Cortina® designed and manufactured in U.S.A. and guaranteed by EICO.



170-Watt AM/FM Stereo Receiver including cabinet. Cortina 3770, \$189.95 kit, \$279.95 wired.

70-Watt FM Stereo Receiver including cabinet. Cortina 3570, \$169.95 kit, \$259.95 wired.



150-Watt Silicon Solid-State Stereo Amplifier, including cabinet. For the audio perfectionist. Cortina 3150, \$149.95 kit, \$225 wired.

70-Watt Silicon Solid-State Stereo Amplifier, including cabinet. Cortina 3070, \$99.95 kit, \$139.95 wired.



FM Stereo Tuner including cabinet. Cortina 3200, \$99.95 kit, \$139.95 wired.



EC-1100
FM WIRELESS MIKE \$9.95

Build for fun and use with Eicocraft jiffy project kits.

The newest excitement in kits. 100% solid-state and professional. Expandable, interconnectable. Excellent as introductions to electronics. No technical experience needed. Finest parts, pre-drilled etched printed circuit boards, step-by-step instructions. 36 kits to select from, \$2.50 to \$9.95. Just released: EC-2600 "Super Snoop" \$8.95; EC-2700 Police & Fire Converter



(to band) \$7.95; EC-2800 Aircraft Converter \$7.95; EC-2900 Police & Fire Converter (hi band) \$7.95; EC-3100 2-Station Intercom (with cases) \$10.95; EC-3200 "Do-It-Yourself" PC Etching Kit \$4.95; EC-2300 Audio Preamplifier \$8.95; EC-2400 Bullhorn \$8.95; EC-2500 Fuzzbox \$8.95.



EC-1900 TREASURE FINDER \$9.95

Shape up your own car/boat with EICO Engine Analyzer

For all 6V/12V systems; 4, 6, 8-cyl. engines. Now you can keep your car or boat engine in tip-top shape with this solid-state, portable, self-powered universal engine analyzer.

Completely tests your total ignition/electrical system. Complete with comprehensive Tune-up & Trouble-shooting Manual. EICO 888, \$49.95 kit, \$69.95 wired.



Be a technocrat with EICO® solid-state test equipment

Only EICO brings you laboratory precision and long life at lowest cost.



EICO 240 Solid-State FET-TVOM, \$49.95 kit, \$69.95 wired



EICO 379 Solid-State Sine/Square Wave Generator \$54.95 kit, \$74.95 wired



EICO 242 Solid-State Deluxe FET-TVOM \$59.95 kit, \$79.95 wired.



EICO 150 Solid-State Signal Tracer \$49.95 kit, \$69.95 wired



EICO 330 Solid-State RF Signal Generator \$59.95 kit, \$79.95 wired

You save up to 50% with EICO Kits. Since 1945, Best Buys in Electronics. Over 3 Million EICO Instruments Now In Use.

FREE 1969 CATALOG

Send me FREE catalog describing the full EICO line of 200 best buys, and name of nearest dealer.

EI-11



EICO Electronic Instrument Co., Inc.
283 Malta Street, Brooklyn, N.Y. 11207
Available In Canada

Name _____

Address _____

City _____ State _____ Zip _____

CIRCLE NUMBER 6 ON PAGE 13

You can pay more
for bigger irons
that can't match
MARKSMAN

by
Weller®

MARKSMAN soldering irons give you a combination of soldering efficiency, light weight and low cost unmatched by any other irons. What's more, they have a replaceable tip, stainless steel barrel, heat and impact-resistant handle.

25 watt soldering iron for homecraft chores, electrical work, hi-fi building, model making. Weighs only 1½ oz. ⅛" diameter replaceable tip. Model SP23. **\$298** list

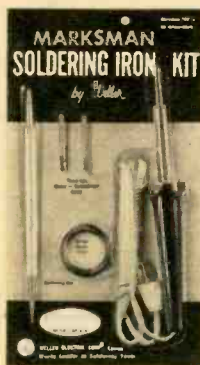

**MARKSMAN
Soldering Iron Kit**

25 watt soldering iron—plus screwdriver, cone and chisel tips, soldering aid and solder. Model SP23K. **\$444** list

Available in Canada

WELLER ELECTRIC CORP.
Easton, Pa.

World Leader in Soldering Tools

CIRCLE NUMBER 12 ON PAGE 13

ELECTRONICS ILLUSTRATED

By the Publishers of MECHANIX ILLUSTRATED

editor **ROBERT G. BEASON**
managing editor **Robert D. Freed**
feature editor **Clifford L. Forbes**
art editor **Lou Rubsamen**
editorial associate **Eileen M. Wallach**
production editor **Rosanne Walsh**
adv. director **John F. Webster**
eastern adv. mgr. **Stanley Tessler**

CONTRIBUTING EDITORS
amateur radio **Wayne Green, W2NSD/1**
citizens band **Len Buckwalter, KQA5012**
swl-dx **C. M. Stanbury II**
special projects **Herb Friedman,
W2ZLF/KBI9457**
audio **Harry Kolbe**
audio **John Milder**

EXECUTIVE STAFF
chairman of the board **W. H. Fawcett, Jr.**
president **Roger Fawcett**
secretary-treasurer **Gordon Fawcett**
circulation director **Roscoe K. Fawcett**
asst. general manager **William Kopta**
vp., magazine div. **George H. Allen**
vice president **Ralph Daigh**
vp., marketing **Jack B. Adams**
v.p., comptroller **F. Paul Simmering**
production director **Thomas R. Marvel**
v.p., art director **Al Allard**
art director **Ralph Mattison**

ELECTRONICS ILLUSTRATED is published bi-monthly by Fawcett Publications, Inc., Fawcett Bldg., Greenwich, Conn. 06830. Second-class postage paid at Greenwich, Conn., and at additional mailing offices.

EDITORIAL OFFICES: 67 W. 44th St., New York, N.Y. 10036 (phone 212-661-4000). Contributions must be accompanied by sufficient postage and will be handled with care, though the publishers assume no responsibility for return thereof.

ADVERTISING OFFICES: 67 W. 44th St., New York, N.Y. 10036 (phone 212-661-4000); 101 E. Ontario St., Chicago, Ill. 60611 (phone 312-DE 7-4680); 1532 Guardian Bldg., Detroit, Mich. 48226 (phone 313-WO 2-4860); 2978 Wilshire Blvd., Los Angeles, Calif. 90005 (phone 213-DU 7-8258); 681 Market St., San Francisco, Calif. 94105 (phone 415-EX 7-3441); 1422 W. Peachtree St., N.W., Atlanta, Ga. 30309 (phone 404-TR 5-0373); 123 S. Broad St., Philadelphia, Pa. 19109 (phone 215-PE 5-3636).

SUBSCRIPTIONS: \$3 per year (6 issues) in U.S. and possessions and Canada. All other countries \$4 for 6 issues. All subscription correspondence, including changes of address (Form 3579), should be addressed to **ELECTRONICS ILLUSTRATED**, Subscription Dept., Fawcett Bldg., Greenwich, Conn. 06830. Foreign subscriptions and sales should be remitted by International Money Order in U.S. funds payable at Greenwich, Conn.

COPYRIGHT © 1969 by Fawcett Publications, Inc. The title **ELECTRONICS ILLUSTRATED** is registered in the U.S. Patent Office. Reproduction in whole or in part is forbidden without written permission of the publishers; however, permission is hereby granted to quote from this issue of this magazine on radio or television, provided a total of not more than 1,000 words is quoted and credit is given to the title of this magazine and issue, as well as the statement, copyright 1969, by Fawcett Publications, Inc. Member ABC, MPA.

PRINTED IN U.S.A. BY FAWCETT-HAYNES PRINTING CORP., LOUISVILLE, KY. 40201. Microfilm copies of current and back issues are available from University Microfilms, 313 N. First St., Ann Arbor, Mich. 48103.

Electronics Illustrated

from Technician to ENGINEER

Advance beyond the technician level

Become an electronics engineer

In the Grantham electronics engineering program, you can earn the Degree of *Associate in Science in Electronics Engineering* (the ASEE) mostly by home study — and can continue in resident classes to earn your BSEE. In this program you can acquire an extensive knowledge of engineering, for greater prestige and better pay.

In America's race to the moon and outer space, *more and more* engineers are needed. By becoming an electronics engineer, you can move into the forefront of technology and engineering, and be an important part of this exciting age. You can help make things happen and be properly rewarded for doing so.

The demand for engineers continues to increase; electronics engineers are needed in the space program and in many other military and domestic projects. In a recent survey conducted by the Engineering Manpower Commission of the Engineers Joint Council, it was found that engineering employment in the electrical and electronics industries is expected to increase by 40% in ten years. The need for engineers is increasing faster than the population as a whole. The survey report indicates that in the next decade, employers expect to need almost *twice as many* new engineering graduates as are likely to be available.

If you have the desire to be an engineer, the determination to stick to your objective, and a reasonably good aptitude for mathematics and technology, the Grantham educational program can produce the wanted results for you. But make no mistake about it, to become an electronics engineer requires work. You must be willing to do that work; otherwise you can never reach your objective, regardless of what course of instruction you may choose.

Grantham School of Engineering

Specializing in Electronics since 1951



1505 N. Western Ave.
Hollywood, Calif. 90027

Telephone:
(213) 469-7878

November, 1969

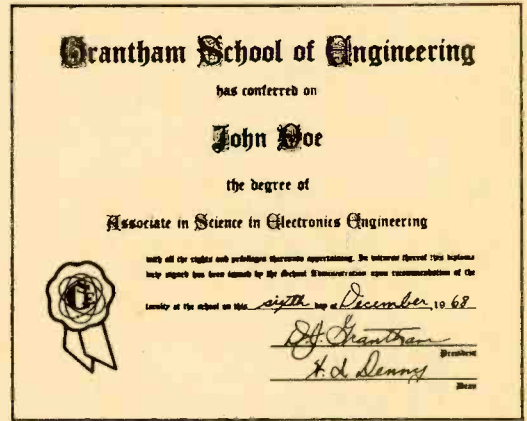

The Grantham *home study* program in electronics engineering consists of five "correspondence semesters" made up of a total of 370 lessons, followed by a two-week period of review and examination at the School. The prerequisite for enrollment in this program is high school graduation (or equivalent) and at least one year of experience as an electronics technician.

This *accredited* ASEE Degree program covers a review of basic electronic circuits and systems, applied engineering mathematics (including algebra, trigonometry, and calculus), classical and modern physics, technical writing, computer systems, electrical networks, and semiconductor circuit analysis and design. The ASEE Degree is awarded upon satisfactory completion of the 370 correspondence lessons and the final two-week residency at the School.

The Grantham educational program in electronics places heavy stress on fundamental concepts of logic and mathematics rather than on superficial manipulative skills. Since these fundamental ideas are largely unfamiliar to many electronics technicians, it is necessary to develop them in a systematic manner.

Accreditation and G.I. Bill Approval

Grantham School of Engineering is *accredited* by the Accrediting Commission of the National Home Study Council, is *approved* under the G.I. Bill, and is *authorized* under the laws of the State of California to grant academic degrees.

Grantham School of Engineering EI-11-69

1505 N. Western Ave., Hollywood, Calif. 90027

Please mail your free Bulletin, which explains how the Grantham educational program can prepare me for my Associate in Science Degree in Electronics Engineering.

Name _____ Age _____

Address _____

City _____ State _____ Zip _____

Feedback from Our Readers

Write to: Letters Editor, Electronics Illustrated, 67 West 44th St., New York, N. Y. 10036

● APPLE A DAY

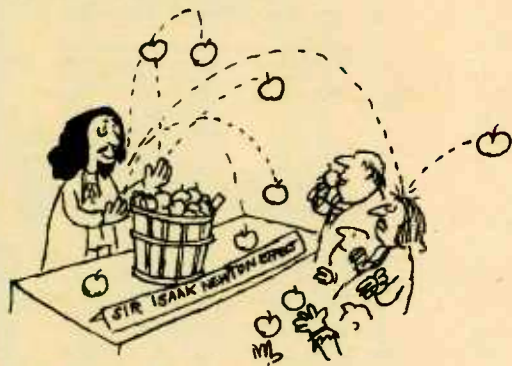

I read your story on the Incredible Ovshinsky Affair (September '69 EI) and found the whole thing quite unbelievable. It's hard to imagine that Wall Street and the press could be so gullible. One can't help wondering about what would have happened if Newton or Einstein had pushed their effects via press conferences and press kits.

Robert A. Wilson
Seattle, Wash.

● SOUR LEMON

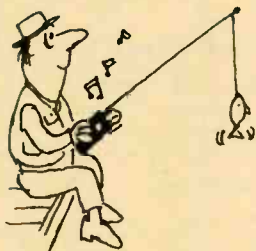

That was a pretty stupid article on AM-FM Pocket Radios in your September issue. Who do you think you are, telling people \$8 will get them what \$30 will? Antennas, tuning dials, performance . . . all nonsense. The important thing is how you feel when you're playing it. It's psychology, man!

Timmy Bates
Port Washington, N.Y.

Or, as Cousin Osbert says, it's not the hay; it's how you stack it, man.

● SECRET STATIONS

I've noticed numerous articles in your magazine concerning the revelation of clandestine radio stations (including R. Libertad in the September EI). I am just as curious as the next guy and when I hear a mysterious station I'd kind of like to find out where it's located. Uncovering these stations is great when they are just harmless pawns of some political group. However, I think some DXers go a little too far when they publicize information which puts the CIA or the U.S. government on the hot seat. Why can't they leave well enough alone when they find they are stepping on someone's toes?

Mike Craig, WPE6GPA
Tustin, Calif.

Any comments from DXers?

● STIRS THE BLOOD



I play the guitar, and though it's electric my teacher demands that I play in a strictly classical, Spanish manner. I thought your Guitar Tripler (September '69 EI) might give me just the effect (mandolin, etc.) he wants. No luck. He thinks I'm cornier than ever. What should I do?

Carlos Valasquez
Casa Grande, Ariz.

Consider the vibes, Carlos.



The CB Jungle is suddenly still...

There's a new Cobra Lurking!

The new Cobra 24: with more power, intelligence, and beauty than any of the others in its class!

The Cobra 24 preys on the others' weaknesses. With *more talk power*—a full, legal-limit 5-watt input and exclusive Dynascan DYNA-BOOST Speech Compression. And a selective dual-conversion superhet receiver with ceramic filter to give outstanding selectivity and gain.

And *more intelligence*—it always gets the message through crisp and sharp, even when others are garbled and unclear. Crystal-controlled transmit and receive on all 23 channels. (No extra crystals to buy!)

And *more beauty*—a striking, no-nonsense exterior. Designed for attack... with a push-to-talk mike, automatic noise limiter,

and positive or negative ground operation without internal wiring changes, featuring reverse polarity protection. There's a PA/CB switch with adjustable volume. And the illuminated channel selector and "S" meter makes even night transmission easy. Beautiful, with all silicon transistor, F.E.T. and integrated circuit. It uses 12 volt DC; AC adapter available. Meets FCC requirements. It even comes with its own mounting bracket.

See your dealer or write us for full details.



Cobra 24 Net \$169.95.

Product of DYNASCAN CORPORATION
1801 W. Belle Plaine. Chicago, Illinois 60613

CIRCLE NUMBER 20 ON PAGE 13

FOR MEN WHO NEED WEATHER INFO

RADIO SHACK

*Invents the
World's
1st and Only*
**Instant
Weather
Radio**

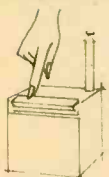

Touch— It's ON



Touch—
It's OFF



Pre-Set
Controls

*Unique 3" Square
"Talking Barometer"* **14⁹⁵** Post Paid

From your desk or deck—monitor the new U.S. Gov't 24-hour VHF weathercasts on 162.55 MHz with a palm-size cube radio that's battery-operated and PRE-SET for instant automatic listening. Invented by 47-year-old Radio Shack for its brilliant "Realistic" line. Volume, fine tuning controls hidden under the set! Just touch the Play Bar to turn on and off! Rosewood details. Solid state circuit. An unusual and inexpensive gift.

**AVAILABLE COAST TO COAST
IN 600 RADIO SHACK STORES***

*See phone book. Or order by mail.



Free Color Catalog

See what's really new in electronics

RADIO SHACK

DIV. OF TANDY CORP

EAST: 730 Comm. Ave., Boston, Mass. 02215

MID: P.O. Box 9027, Ft. Worth, Texas. 76107

WEST: 7340 Lampson, Garden Grove, Calif. 92641

Weatheradios @ 14.95 Postpaid

FREE Radio Shack 1970 Catalog

Dept. 20

Name (print) _____

Street _____

City _____ State _____ Zip _____

CIRCLE NUMBER 11 ON PAGE 13

Broadsides

Pamphlets, booklets, flyers, application notes and bulletins available free or at low cost.

EXPERIMENTERS and technicians alike will be glad to know that Motorola has put out a second edition of the HEP Semiconductor Cross-Reference Guide. This handy volume runs to 61 pages with the supplement and can be had for 25 cents from Motorola Semiconductor Products, Box 20924, Phoenix, Ariz. 85034.

We all want our equipment to look good. For a starter, a complete line of standard, off-the-shelf instrument and control knobs, including 35 new designs, is described in a 20-page catalog offered primarily for the edification of designers and parts specifiers. Hundreds of knobs, dials and assemblies are available for commercial and military applications. Ask for catalog 112 from Kurz-Kasch, Inc., 1421 S. Broadway, Dayton, Ohio 45401.

If it's sound equipment you're interested in, a handy pocket-size color folder illustrates the Craig line of sound entertainment products. From reel-to-reel portable and stereo tape recorders to cassette recorders and stereo cartridge systems, it's all there. For a free copy write the Craig Corp., 2302 E. 15th St., Los Angeles, Calif. 90021.

Ohmite has two catalogs which may interest you. Catalog 300 is a component selector which gives, in condensed form, complete information on their line of resistors, rheostats, potentiometers, solid-state power controls, RF chokes and relays. Most popular resistance values and model numbers are indicated in boldface print. On the other hand, catalog 750 zeroes in on Ohmite SSA solid-state relays. Features include inherent isolation of contacts (input from output) and universal operating-voltage range. Full electrical and mechanical specifications are provided, along with necessary applications data. For copies of both items write the Ohmite Manufacturing Co., 3601 West Howard St., Skokie, Ill. 60076.

Please make note that when we were discussing James B. Lansing in our July issue we slipped up on their two manuals, CF802 and CF706, on speaker enclosures. These items are 50¢ each.

Looking at the maze of cables that covers your workbench, you're bound to agree that it's handy to have the right connectors for your equipment. With this in mind, Amphenol now offers you their GL-1 catalog, which contains 18 pages of such items as plugs, jacks, mike connectors, sockets and switches. A free copy may be had by writing Amphenol Distributor Div., Bunker-Ramo Corp., 2875 S. 25th Ave., Broadview, Ill. 60153

FREE!

1970
CATALOG
NO. 700

JUST OFF THE PRESS!!
SEND FOR YOUR EXCITING COPY NOW!



Latest Releases!
Best Bargains!
496 Pages

YOUR 1st GUIDE TO
EVERYTHING IN
ELECTRONICS

- ★ CITIZENS BAND
2-WAY RADIO
 - ★ STEREO/HI-FI
COMPONENTS
 - ★ MUSICAL INSTRUMENTS
AND AMPLIFIERS
- ★ PUBLIC ADDRESS
 - ★ AMATEUR RADIO
 - ★ TEST EQUIPMENT
 - ★ PARTS
 - ★ PORTABLE AND
TABLE RADIOS
- ★ PHOTO EQUIPMENT
 - ★ TOOLS—BOOKS
 - ★ AUTO ACCESSORIES
 - ★ EDUCATIONAL
AND OPTICAL
 - ★ TV AND ANTENNAS

Your Complete Buying Guide to Everything in Electronics

LAFAYETTE Radio ELECTRONICS
Dept. 29119, P.O. Box 10
Syosset, L.I., N.Y. 11791

Send me the FREE 1970 LAFAYETTE Catalog 700 29119

Name _____

Address _____

City _____ State _____

Zip _____

(please include your Zip Code No.)

Mail the Coupon Today
for your FREE 1970 Lafayette
Catalog 700

CIRCLE NUMBER 8 ON PAGE 13

November, 1969

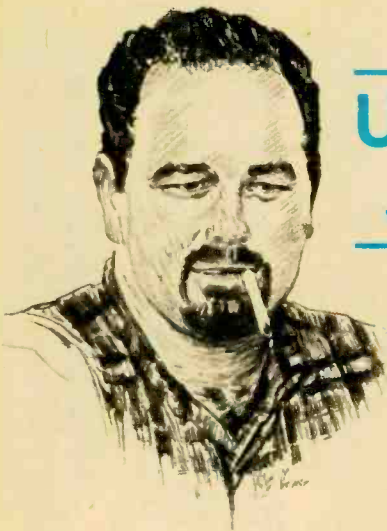

Uncle Tom's Corner

By Tom Kneitel, K2AES/KQD4552

Uncle Tom answers his most interesting letters in this column.
Write him at Electronics Illustrated, 67 West 44th St., New York, N.Y. 10036.

★ *I've belonged to the Radio New York Worldwide Listeners' Club for some time now. When I sent in my renewal I had my money returned with a form letter saying that they didn't want North American members any longer. Any opinions?*

Jay Longinaker
Randolph, Iowa

Plenty. This is a perfect example of the law of supply and demand in action. When the station started this public relations endeavor a few years ago the only members they could get were local Americans and Canadians. When word-of-mouth in club bulletins spread news of this so-called club overseas they began collecting members in areas the station was more interested in. When a sufficient number of overseas listeners had joined, it became, "Sorry, Charlie," for North Americans. Radio New York Worldwide, together with their station, WNYW, are recipients of Uncle Tom's Golden Digit Award for 1969.

★ *I've got the mystery of the century in my hands. While looking through a junk box in a radio shop I came across a strange radio tube marked Westinghouse CEW/CFC. The shop owner didn't know what it was and when it didn't appear in any of the tube manuals I began checking around. The more I checked the less I found out. How can a tube be totally unlisted? My guess is that it is some sort of classified military component. What's your guess?*

Theodore Halvorsen
Norfolk, Va.

Sorry to pop the bubble, Teddy. It's a

garden-variety lamp for home movie projectors. Don't feel bad, though. Your problem had the folks at Westinghouse's tube division going batty for a few days when I tossed it at them.

★ *In the 1969 version of the book, Broadcasting Stations of the World, published by the Government Printing Office, there is a note saying that the book was compiled by the Foreign Broadcast Information Service. What is this service and does it relate to the Foreign Broadcast Intelligence Service of World War II days?*

Elmo M. Moist, Jr.
Royal Oak, Mich.

The Foreign Broadcast Intelligence Service was created during World War II as a section of the FCC which was supposed to record, translate, analyze and report on foreign broadcast programs to interested government agencies. It was transferred to the War Department late in the war and was supposed to be dissolved right after the Japanese armistice.

Instead, it was kept alive until the CIA was formed and then was absorbed into that merry band. Today it is simply the good ol' CIA doing business as usual, publishing the broadcast station list under the inoffensive byline of the Foreign Broadcast Information Service. The list is compiled by the CIA's vast network of monitoring stations.

★ *Don't you agree that the FCC is handling the CB situation in a mysterious manner? They never survey the operators to see what they want, the rules are confusingly written and new rules and modifications seem to appear suddenly from out of nowhere without any justification.*

Owen Arnold
Irving, Tex.

I don't think it's so much a question of their being mysterious as it is with their being complacent—and also disinterested in CB.

[Continued on page 12]

Ours isn't color blind.

Before you buy a color TV set, there's one thing you ought to know.

All color antennas are not created equal.

If you get the wrong one, it'll give you smeary, washed-out colors on your picture tube.

Sylvania color antennas are sensitive and built to last. They're designed for fast setup on the roof. And you can bet they won't send any off-color signals down the line.

We knock ourselves out to give you good antennas, because the set you buy could be our own.

SYLVANIA
GENERAL TELEPHONE & ELECTRONICS

UNUSUAL BARGAINS

FREE!
GIANT
CATALOG

INSTANT ELECTRONIC PROJECTS!



Build 50 electronic marvels in minutes—that actually work! Simply match symbols of amazing new solid state building blocks with those in easy-to-follow diagrams. Pronto—Instant radios, organs, alarms, etc. No soldering wiring, tools. Magnetic connectors hold see-thru blocks containing proper components in place. Safe. Easy. Unique new funway to learn electronics. Requires ordinary 9V transistor battery (not incl.).

Stock No. 71.17EB \$ 33.50 Ppd.
Stock No. 71.177EB \$ 12.00 Ppd.
Stock No. 71.179EB \$ 200.00 Ppd.

LONG-WAVE BLACK LIGHT FIXTURE



Extremely versatile, compactly designed, long wave (3200-4000 angstroms) black light (ultra-violet) fixture. Has 6-watt, 110-V lamp with built-in filter—eliminates harmful shorter wave ultra-violet rays. Use to identify minerals, fungi, bacteria—check for surface flaws, oil and gas leakage—perfect for displays with fluorescent paper, paints, chalk, crayons, trace powder, incl. adjustable aluminum reflector.

Mount vert., horr., or on corner. 10" L. 1 1/2" W. 1 1/4" H.
Stock No. 70.364EB \$12.00 Ppd.
Stock No. 60.124EB (Replacement Bulb) \$3.25 Ppd.

'BRIGHT IDEAS' in UNIQUE LIGHTING

Big New 100 page handbook packed with facts, loaded with illustrations. All latest developments, applications, equipment. 8 1/2" x 11" looseleaf paper punched to fit 3 ring binder.

Stock No. 9100EB \$3.00 Ppd.

Order by Stock No.—Send Check or M.O.—Money-Back Guarantee.

EDMUND SCIENTIFIC CO., 300 EDCORP BUILDING BARRINGTON, N.J. 08007

GIANT FREE CATALOG

148 PAGES!—1000's of BARGAINS

EDMUND SCIENTIFIC CO., 300 EDCORP BUILDING, BARRINGTON, NEW JERSEY 08007
Completely new 1970 edition. New items, categories, illustrations. Dozens of electrical and electromagnetic parts, accessories. Enormous selection of Astronomical Telescopes, Microscopes, Binoculars, Magnifiers, Magnets, Lenses, Prisms. Many war surplus items for hobbyists, experimenters, workshop. factory.

WRITE FOR CATALOG "EB."



CIRCLE NUMBER 16 ON PAGE 13

NEW from NRI Home training in AMATEUR RADIO

NRI, leader in Communications, Television, Electronics and TV-Radio home training, now offers the first in Amateur Radio courses, designed to prepare you for the FCC Amateur License you want or need.

Don't lose your favorite frequency

The FCC has said "either-or" on licensing, but to pass Advanced and Extra Class exams, you need the technical guidance as offered by NRI. NRI Advanced Amateur Radio is for the ham who already has a General, Conditional or Tech Class ticket. Basic Amateur Radio is for the beginner and includes transmitter, 3-band receiver, code practice equipment. Three training plans offered. Get all the facts. Mail coupon. No obligation. No salesman will call on you. NATIONAL RADIO INSTITUTE, Washington, D.C. 20016.



..... MAIL NOW

• NATIONAL RADIO INSTITUTE 53-119

• Washington, D.C. 20016

• Please send me information on Amateur Radio training.

• Name _____ Age _____

• Address _____

• City _____ State _____ Zip _____

• ACCREDITED MEMBER NATIONAL HOME STUDY COUNCIL

Uncle Tom's Corner

Continued from page 10

★ For my forthcoming debut on the 2-meter ham band (as soon as my ticket comes through), I hope to use a military surplus AN/CRC-7 transceiver. The set seems to be in good condition but has no manual or other pedigree papers. Can I use it as is, or does it need conversion? Also, where can I get the battery it needs?

Bill Sharman, Jr.
Phoenix, Ariz.

This is a Korean War vintage Naval/Air Force survival rig in a waterproof case. While it has only a few watts output, it is a nifty little gem for short-range ham operation and, since they're inexpensive, they are popular.

You'll have to convert the set from its present 140.58-mc operating frequency and dump it somewhere within the limits of the 2-meter band. The crystal must be filed or pried from its hermetically-sealed housing and replaced with a new one cut to 1/8th the 2-meter ham frequency you want. The coils will also have to be trimmed a bit. The thing feeds on 1.5 V for the filaments and 97.5 V for the plates; I've found that one C cell and one RCA VS-219 cell will do.

★ On a push-button phone I just had installed there are two buttons on either side of the Operator button. One is marked with a numerical sign and the other has an asterisk. The installer didn't know what they were for. Just what are they?

Wally Reynolds
Williston Park, N.Y.

Wally, someday Ma Bell hopes to hook telephones into computers at banks, stores and other commercial enterprises. A few pushes will enable you to deposit all sorts of data into the computers; such things as buying-by-phone will also be handled by the two buttons and a machine miles away.

★ You know why I don't like your column? It's because you're always showing your ignorance.

Michael Pleasance
Simi, Calif.

I have as much right to show my ignorance as anyone else.

**ELECTRONICS
ILLUSTRATED**



Product Information Service



If you want more information about one or more of the products advertised in **ELECTRONICS ILLUSTRATED**, this service is for your convenience. The product information you request will be sent to you promptly free of charge.

Just complete the name and address portion of the handy coupon below and circle the **PRODUCT INFORMATION SERVICE** number or numbers you find beneath the advertisements in this issue.

Mail the completed coupon to **ELECTRONICS ILLUSTRATED**
at the address shown — We'll take care of the rest.

ELECTRONICS ILLUSTRATED This coupon will not be processed if received after December 15, 1969
P.O. BOX 7474, PHILADELPHIA, PENNSYLVANIA 19101

1	2	3	4	5	6	7	8	9	10	11
12	13	14	15	16	17	18	19	20	21	22
23	24	25	26	27	28	29	30	31	32	33
34	35	36	37	38	39	40	41	42	43	44
45	46	47	48	49	50					

NAME (PLEASE PRINT) _____

ADDRESS _____

CITY _____

STATE _____

ZIP _____

11/69

IT COSTS ONLY
1/100 OF 1¢ MORE
PER SOLDER JOINT
TO KNOW YOU ARE USING THE
WORLD'S FINEST CORED SOLDER

New Easy
Dispenser
Pak
60/40
18 S.W.G.



Latest PC
(Printed
Circuit) Pak
60/40 Extra Thin
22 S.W.G.—.028"



each only 69¢ per package at your dealer

ERSIN *Multicore* FIVE-CORE SOLDER

MULTICORE SALES CORP., WESTBURY, N.Y. 11590

CIRCLE NUMBER 14 ON PAGE 13

CONTROLLED
QUALITY
CRYSTALS by



CRYSTEK

The "On-Channel" Crystals

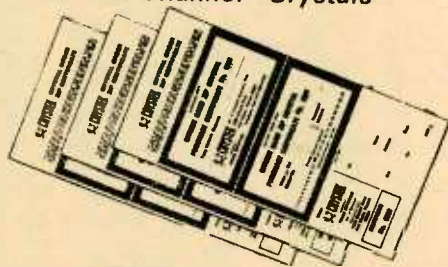

NOW ZIP-ORDER CRYSTALS

Your dealer has new, fast, direct-factory ZIP Order Purchase Certificates to enable you to get CRYSTEK CB, Monitor or Amateur Crystals mailed direct to you promptly. Ask about them.

CRYSTEK formerly Texas Crystals
Div. of Whitehall Electronics Corp.

1000 Crystal Drive
Fort Myers, Florida 33901

4117 W. Jefferson Blvd.
Los Angeles, California 90016

CIRCLE NUMBER 22 ON PAGE 13

SERVICE TIPS

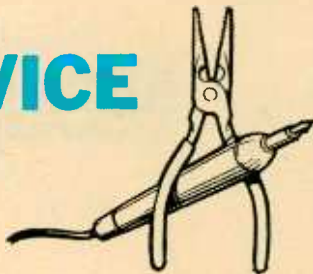

MUCH has been made about the care you should exercise when you test filters in solid-state circuits. Yes, you can jump power-supply circuits in a test. Only precaution you must observe, don't jump a filter with a charged filter. Discharge your test filter before every touchdown.

Perhaps you'd like to get just a bit more width in your portable's TV picture but you can't find the width control? In lots of sets, manufacturers have made the width control a keeper (shorting bar placed across the poles of a magnet) on the magnetic field within the yoke.

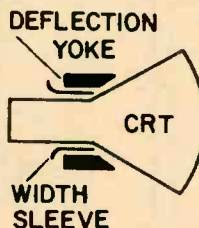

Sliding this sleeve (see diagram) back and forth about its location around the neck of the CRT inside the yoke will change the width.

Lots of needless repairs have been appearing on troubleshooters' benches due to a lack of understanding about zener diodes. If you should find a bad zener don't install a conventional diode in its place. A zener is not there to rectify pulses, but to set DC levels according to its reverse-bias breakdown point. Always replace zeners with zeners.

Blurry sound in TV sets which have quadrature sound detectors (you'll know when it has a quadrature detector because there is a buzz control on the rear apron of the chassis) is easy to touch up if you observe one trick. Tune the set to the weakest channel you can find; the snowier the picture, the better. Then adjust the buzz control and quad coil for the loudest, clearest audio.

You can check the charger unit in your electric toothbrush with a penlight bulb to which two leads are soldered. Touch the leads to the contacts on the bottom of the well where the brush handle sits. If the bulb lights at all the charger unit is good.

Should you be sniffing around a color TV that has lost its brightness but still has good sound and you smell something like rotten eggs, you can fix the set right away. There is a long, skinny selenium rectifier which is now being used in lots of color TVs as the focus rectifier. When you smell it, replace it, 'cause it's bad.

Never take apart electric hedge trimmers near thick foliage. The brush springs are powerful and can catapult the cap into the wilds where you'll never see it again. Take the unit apart indoors, so you'll find whatever flies.

The New 1969 Improved Model 257 **A REVOLUTIONARY NEW**
TUBE TESTING OUTFIT

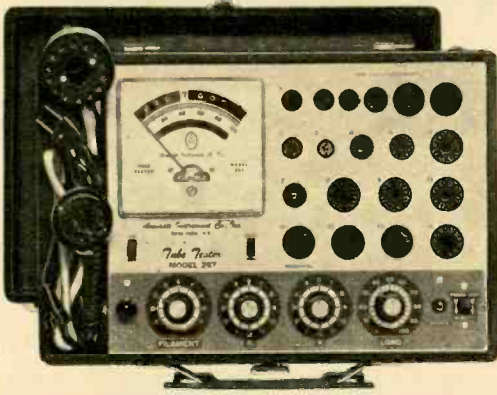

**COMPLETE WITH ALL
 ADAPTERS AND ACCESSORIES,
 NO "EXTRAS"**

STANDARD TUBES:

- ✓ Tests the new Novars, Nuvisitors, 10 Pins, Magnovals, Compactrons and Decals.
- ✓ More than 2,500 tube listings.
- ✓ Tests each section of multi-section tubes individually for shorts, leakage and Cathode emission.
- ✓ Ultra sensitive circuit will indicate leakage up to 5 Megohms.
- ✓ Employs new improved 4½" dual scale meter with a unique sealed damping chamber to assure accurate, vibration-less readings.
- ✓ Complete set of tube straighteners mounted on front panel.

The Model 257 is housed in a handsome, sturdy, portable case. Comes complete with all adapters and accessories, ready to plug in and use. No "extras" to buy. Only

- Tests all modern tubes including Novars, Nuvisitors, Compactrons and Decals.

- All Picture Tubes, Black and White and Color

ANNOUNCING...for the first time

A complete TV Tube Testing Outfit designed specifically to test all TV tubes, color as well as standard. Don't confuse the Model 257 picture tube accessory components with mass produced "picture tube adapters" designed to work in conjunction with all competitive tube testers. The basic Model 257 circuit was modified to work **compatibly** with our picture tube accessories and those components are not sold by us to be used with other competitive tube testers or even tube testers previously produced by us. They were custom designed and produced to work specifically in conjunction with the Model 257.

BLACK AND WHITE PICTURE TUBES:

- ✓ Single cable used for testing all Black and White Picture Tubes with deflection angles 50 to 114 degrees.
- ✓ The Model 257 tests all Black and White Picture Tubes for emission, inter-element shorts and leakage.

COLOR PICTURE TUBES:

- ✓ The Red, Green and Blue Color guns are tested individually for cathode emission quality, and each gun is tested separately for shorts or leakage between control grid, cathode and heater. Employment of a newly perfected dual socket cable enables accomplishments of all tests in the shortest possible time.

\$47⁵⁰

NOTICE

We have been producing radio, TV and electronic test equipment since 1935, which means we were making Tube Testers at a time when there were relatively few tubes on the market, way before the advent of TV. The model 257 employs every design improvement and every technique we have learned over an uninterrupted production period of 32 years.

Accurate Instrument Co., Inc.

**SEND NO MONEY WITH ORDER
 PAY POSTMAN NOTHING ON DELIVERY**

Try it for 10 days before you buy. If completely satisfied you may remit \$47.50 plus postage and handling charge. (If you prefer you may use our **EASY PAYMENT PLAN.**) If not completely satisfied, return to us, no explanation necessary.

ACCURATE INSTRUMENT CO., INC.

Dept. 690 2435 White Plains Road, Bronx, N. Y. 10467

Please rush me one Model 257. If satisfactory I agree to remit \$47.50 plus postage and handling charge. (If you prefer you may use our **EASY PAYMENT PLAN.**) If not satisfactory, I may return for cancellation of account.

Name
 Address
 City Zone State

Save Money! Check here and enclose \$47.50 with this coupon and we will pay all shipping and charges. You still retain the privilege of returning after 10 day trial for full refund.

CIRCLE NUMBER 7 ON PAGE 13

Discover the ease and excitement of learning Electronics with programmed equipment NRI sends you

When you train at home with NRI, you train with your hands as well as your head. You learn the WHY of Electronics, Communications, TV-Radio the NRI pioneering "3-Dimensional" way. NRI training is the result of more than half a century of simplifying, organizing, dramatizing subject matter, and providing personal services unique for a home study school. You get the kind of technical training that gives you priceless confidence as you gain experience equal to many, many months of training on the job.



NRI—The 53 Year Leader in Electronics Training

APPROVED UNDER NEW GI BILL

If you served since January 31, 1955, or are in service, check GI line in postage-free card.



*Earn \$5 or more an hour
spare or full time in*

TV-RADIO SERVICING

Color Television has arrived. Sales are soaring, along with the continuing popularity of other home entertainment equipment like portable radios, tape recorders, hi-fi sets, phonographs and auto radios. TV-Radio servicing is one of your best routes to spare-time earnings, a good paying job or a business of your own. NRI not only trains you quickly and expertly, but also shows you how to get started in Servicing soon after you enroll, earning as you learn. NRI trains you in today's methods of installing and repairing all Electronic equipment for the home—including booming Color TV. You even build, experiment with and keep to enjoy your own solid-state radio and your choice of black-and-white or Color TV receiver. Like thousands of others, you can be earning \$5 or more an hour extra in spare time starting soon.

There's money and success awaiting you in **BROADCASTING— COMMUNICATIONS**

The experience you gain from intensely practical NRI training in Complete Communications equals as much as two years of training on the job. With NRI, you can train for a choice of careers ranging from mobile, marine and aviation radio to TV broadcasting and space communications. You learn how to install, maintain and operate today's remarkable transmitting and receiving equipment by actually *doing* it. You build and experiment with test equipment, like a VTVM you keep. You build and operate amplifier circuits, transmission line and antenna systems, even build and use a phone-cw transmitter suitable for transmission on the 80-meter amateur band. Whichever of five NRI Communications courses you choose, you prepare for your FCC License exams, and you must pass your FCC exams or NRI refunds your tuition in full.

Move ahead in America's fast growing industry as **ELECTRONICS TECHNICIAN**

Electronics touches everyone's lives. This vast field of opportunity is open to you with NRI training. Industrial/Military Electronics training—like all NRI courses—prepares you quickly, thoroughly the practical "hands on" way. You build with, and learn to understand the functions of, today's miracle solid-state components like printed circuits, diodes and transistors. You build and experiment with Electronic circuitry used in automation, data processing, ultrasonics, telemetry. Whatever your interest in Electronics, NRI training can fill your needs. Prove to yourself what nearly a million NRI students could tell you . . . that you get more for your money from NRI. Check the postage-free card and mail it today for your FREE NRI Color Catalog. No salesman will call. NATIONAL RADIO INSTITUTE, Electronics Division, Washington, D.C. 20016.

YOU GET MORE FOR YOUR MONEY FROM NRI — Build, test, explore, discover. Everything you see here is included in one NRI course—including Color TV. Other courses equally complete. And you'll be surprised at the low tuition costs. Text for text, kit for kit, dollar for dollar—you get more for your money from NRI.



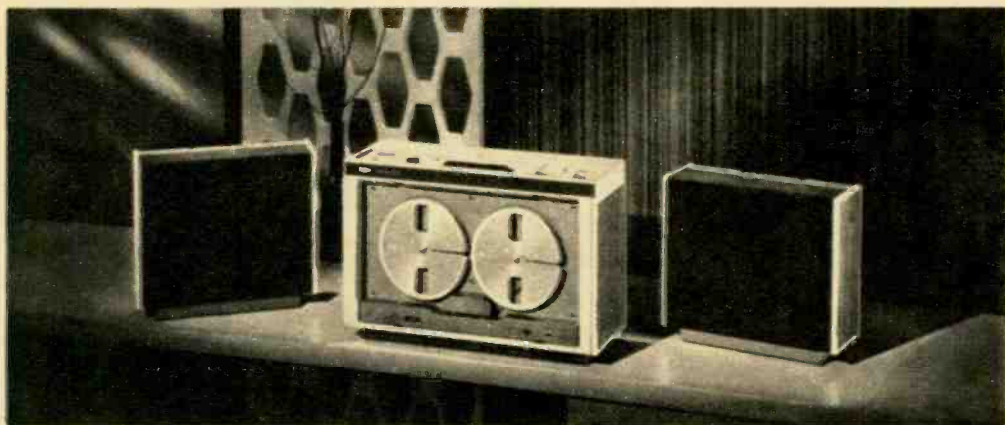

COBOL REELS. Model YZG-570 is one of the goodies RCA has in its bag of tricks for 1970. Called the Royale, it's a reel-to-reel stereo tape recorder with computer styling. This four-track model has 7-in. reels and automatic shutoff when tape runs out. New sound may be added to a previously recorded tape and a PA switch allows voice transmission through the speaker system. Each speaker enclosure contains an 8-in. woofer and a tweeter; speakers can be separated by a distance of up to 24 ft. \$250. RCA Consumer Electronics Division, Indianapolis, Ind. 46224.

Electronic Marketplace

Rainbow Look. Latest addition to Heath line of test equipment is the IG-28 Color Bar-Pattern Generator. This solid-state model uses computer circuitry, including ICs, to provide 12 patterns plus a raster. Six standard 9 x 9 patterns—dots, cross hatch, shading bars, color bars, vertical and horizontal lines—are available, along with same patterns in 3 x 3 format. Model IG-28 (kit), \$79.95; Model IGW-28 (wired), \$114.95. Heath Co., Benton Harbor, Mich. 49022.

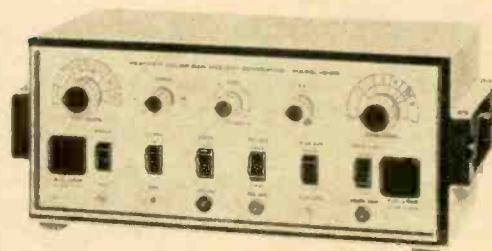

Continuous Play. Qatron 48 is said to be first automatic 8-track stereo tape changer on the market for car or home use. Changer accepts up to 12 tapes and plays them in three sequences. Individual tapes can be dialed manually and repeated at any time. The unit may be used as a playback deck or self-contained music system providing a 24-watt output into optional speakers. \$199. Qatron Corp., Rockville, Md. 20852.

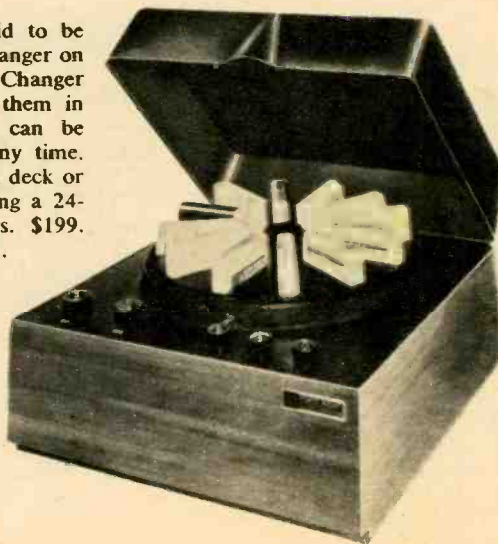

Electronic Marketplace

Moving or Standing. Messenger 124 is 23-channel CB rig with built-in 117-VAC and 12-VDC power supply for base or mobile operation. Solid-state circuitry is used throughout; dual-conversion receiver has 4.3-mc crystal filter



to eliminate interference. Receiver sensitivity is said to be 0.5 microvolts for a 10db signal-to-noise ratio. Noise limiter, delta tune, squelch, mike gain and tone control are included. Delta tune feature allows fine tuning of receiver by a factor of ± 3 mc so stations which are slightly off frequency can be pulled in. Panel meter monitors per cent of modulation, SWR, power output and signal strength. \$289.95. E. F. Johnson Co., Waseca, Minn. 56093.

Mixer plus Reverb. Model M68RM microphone mixer is solid-state unit designed for commercial public address and paging systems. The mixer has built-in; adjustable reverberation which, according to the manufacturer, can simulate the rich sound quality of a large concert hall. The four microphone input channels have separate volume controls and slide switches which select

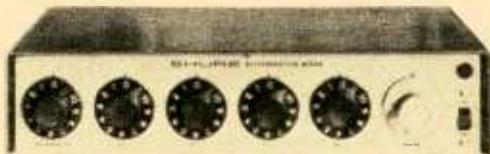

either a high or low impedance for the input. One channel also doubles as an auxiliary high-level input for tape recorder, tuner, etc. A master volume control governs all four inputs. One jack accepts a remote on/off switch, and there is a facility for stacking two or more mixers to gain additional input capacity. Optional accessories include a battery power supply, output cable kit, locking panel, phono preamplifier and rack panel and stacking kits. \$180. Shure Brothers Inc., Evanston, Ill. 60204.

Mini-Screen TV. Panasonic (Matsushita Electric) says the world of tomorrow is here now—mainly because of its Model TIC-3000 portable b&w TV that may not fit in your pocket but does fit the palm of your hand. Weighing $1\frac{1}{3}$ lbs., measuring $5\frac{1}{2}$ in. deep, with a picture tube that has a $1\frac{1}{2}$ in. screen, the set has a 2-in. magnifying lens for easy viewing. Eight ICs, a flat speaker and a mini deflection coil are inside, while other features include instant warmup, VVC (voltage - variable capacitance) tuning and rechargeable nickel cadmium batteries. \$199. Panasonic, New York, N.Y. 10017.



Push-button Meter. Model TE-235 uses push-buttons for function and range selection and has taut-band meter suspension said to provide greater accuracy and extended life. Meter has



built-in mirror for parallax correction. Sensitivity is 30,000 ohms/V. VDC range: 0 to 1000; VAC range: 0 to 250; db: -10 to +36; resistance: 0 to 5 megohms; DC current: up to 10 A. \$39.98. Olson Electronics, Inc., Akron, Ohio 44308.

Electronic Marketplace

Multi-Mode CB. Corsair is mobile rig designed as a companion model to firm's Titan II base station. This solid-state transceiver operates in AM mode and also offers SSB reception and DSB-suppressed transmitting which is compati-

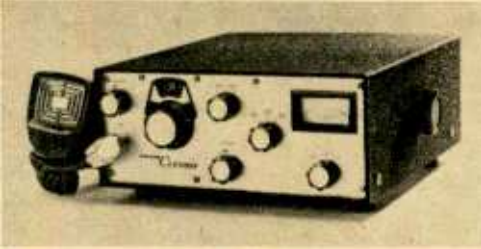

ble with any type of CB rig. Unit measures 4 x 9 x 8 in. and easy installation in cars, boats and aircraft is claimed. Sideband can be used for greater range and receiver uses mechanical filter to increase selectivity, adjacent channel interference being 90db down, according to the manufacturer. Noise blanker circuits are backed up by a noise limiter which is said to greatly reduce interference from ignition systems. \$415. Tram Corp., Winnisquam, N.H. 03289.

Power on the Bench. Two solid-state, regulated DC power supplies, Models WP-703 (shown) and WP-704, have negative feedback circuitry to maintain constant output voltage with low ripple regardless of varying line voltage or load resistance, according to the manufacturer. Both units use silicon transistors and diodes. It's

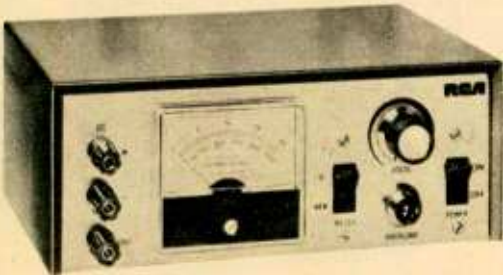

claimed that no damage will occur if either supply is connected to an external short circuit. Output voltage of the WP-703 is continuously adjustable from 0 to 20 V at current levels up to 500 ma, while the WP-704 is adjustable from 0 to 40 V at current levels up to 250 ma. Five-way output terminals and overload indicator lamps are used. Each model is \$58.50. RCA Electronic Components, Harrison, N.J. 07029.

Swap Shop

Individual readers (not commercial concerns) may swap electronic gear by sending one listing, name and address to Swap Shop, ELECTRONICS ILLUSTRATED, 67 West 44th Street, New York, N.Y. 10036. Space is limited; only most interesting offers are published.

AUDIO & HI-FI

PHONO AMPLIFIER (home-brew). Swap for item of equivalent value. Steve Peterson, 382 W. 870 N., Sunset, Utah 84015.

GUITAR AMPLIFIER, Gibson CA-20-RUT. Want Lafayette LA-125T stereo amplifier or best offer. Mike Johnson, Smith Park, Wentworth, S.D. 57075.

CALRAD HP-3 stereo headphones and 25-ft. cable. Swap for semiautomatic key or coax relay. Rick McMillen, 4109 S.E. Concord Rd., Milwaukie, Ore. 97222.

CROWNCORDER CR-5800 two-speed tape recorder with built-in AM radio. Swap for best offer. Tim Violitto, 16 High St., Van Buren, Me. 04785.

RADIO SHACK Build-In Radio. Unopened. Will swap for field-strength meter, VOM, or best offer. Carl Adkins, 5421 Mallory, Ft. Worth, Tex. 76117.

UTAH three-way speaker system, less woofer. Want strobe light or guitar amplifier. Dave Felix, 1741 Thames St., Clearwater, Fla. 33515.

CONCORD 350 portable tape recorder with VOX, AC adaptor and auto-reverse. Swap for best offer. Elliott S. Kohn, 1634 Popham Ave., New York, N.Y. 10453.

DECCA stereo turntable and amplifier. Will swap for ham or SW receiver. John Shear, 42 Helwig St., Gloversville, N.Y. 12078.

TAPE RECORDER plus 1926 Encyclopedia Britannica. Want Star-Roamer, AM/FM portable or cassette recorder. D. Moore, Jr., 6905 Cloverdale, Little Rock, Ark. 72204.

GRUNDIG stereo recorder (needs work), Uher SRI. EICO 2080 amplifier and 2200 stereo tuner, cabinets. Swap for best offer. James M. Cotton, 1016 1/2 Lakeshore Ave., Los Angeles, Calif. 90026.

ELECTRO-VOICE 664 Mike. Will swap for DX-60B, EICO 720 or similar transmitter. John Gorton, 414 McKennan's Church Rd., Wilmington, Del. 19808.

HEATH FM tuner, changer, crystals, etc. Want CB rig, SW receiver or best offer. Bob Riley, 6 Richfield Rd., West Chester, Pa. 19380.

SHURE PE-57 microphone. Will trade for Heath code oscillator or similar. Randy Buch, 4503 Lowell Rd., Montgomery, Ala. 36105.

NATIONAL two-speed tape recorder plus RCA radio and other assorted gear. Want 8-track tape player or best offer. Ronald Odums, 110 Hat St., Sylvania, Ga. 30467.

AMATEUR RADIO

HEATH DX-40 transmitter. Want electronic keyer or best offer. Larry Feick, WA8BHS, 3048 Elmwood Dr., Port Huron, Mich. 48060.

KNIGHT R-100 general-coverage receiver. Swap for 23-channel CB equipment or best offer. Paul Schladenhauffen, 303 Market St., Watseka, Ill. 60970.

HORNET TB750 tri-band beam. Swap for best offer. Frank Kamlowsky, 802 N. Rodney, Helena, Mont. 59601.

ARC-5 75-meter mobile rig, with dynamotor, remote tuner, antenna and converter. Want scope, signal generator or best offer. Steve Fox, WA7EDK, 4439 Frieda, Klamath Falls, Ore. 97601.

JOHNSON Matchbox plus cash. Want amateur receiver or IR-5 oscilloscope CRT. Frank Camposano, 2049 Hendrickson St., Brooklyn, N.Y. 11234.

HOME-BREW 500-W transmitter (AM/CW, 80-15 meters, VFO), other gear, tubes. Want VFO xmtr for 160/80 to 10 meters or best offer. Joseph M. Adams, 1402 W. 13th St., Panama City, Fla. 32401.

EICO 720 transmitter. Want Heath Sixer. Scott R. Meyer, 567 West Highland Ave., Wooster, Ohio 44691.

EICO 720 and T-150 transmitters, other assorted receivers (SX-101A, S-120). Will swap for best offer. S. Mersky, WA3JJH, 7544 Brockton Rd., Philadelphia, Pa. 19151.

LAFAYETTE HA-350 receiver and Globe Chief 90-W CW transmitter. Want transceiver for 10, 15 or 20

[Continued on page 24]

the Super Scanner

**MODEL
OF THE
MONTH**

**It took us two years
to make the CB
Scanner scan 360°
automatically**



**NEW
OMNI-LOCATOR
POSITION**

**It takes the
Super Scanner
1/3 of a second
to do it!** suggested
resale **\$79.95**

- **Beam Mode:** positive electronic "beaming" in choice of sectors—no mechanical rotator needed!
- **Omni Mode:** Special position for omni-directional "searching"—just switch to use!
- **Tremendous 7.75 dB forward gain** in beam mode; 2.5 dB gain in omni mode!
- **Front-to-back ratio 23 dB**—cuts back-side noise drastically, increases effective forward range.
- **Compact design**—beats all beams for size and weight (just 17 lbs.) yet ruggedly constructed to take 100 MPH winds!

**the antenna
specialists co.**

Division of Allen Electric and Equipment Co.
12435 Euclid Ave., Cleveland, Ohio 44106
Export offices: 2200 Shames Dr., Westbury, N.Y. 11590



"Stripes of Quality"

CIRCLE NUMBER 21 ON PAGE 33

Electronic Marketplace

Long Distance. Model 20Y33-19 mobile CB transceiver operates from 12-V source and comes with mounting bracket for installation in car or boat. A 20-mi. range between mobile



units is said to be possible, and 30 mi. mobile to base. Transceiver uses transistors and has crystals for channel 11; additional crystals permit 9-channel operation. Included are modulation limiter, noise limiter, squelch and connections for external antenna. Unit measures 6 x 2 1/4 x 7 in. \$89.95. Arvin Industries, Inc., Electronic Systems Div., Columbus, Ind. 47201.

Loud 'n Clear. Portable amplifier/speaker system is designed for use with cassette recorders. Battery operated (9 V) and weighing 4 lbs., the system converts cassette recorder or pocket radio into PA system for group listening. Mike input (from recorder) may be amplified and recorded at the same time, thus allowing a per-



manent record of speech, conference, etc. to be made on the spot. Heavy-duty 6-in. speaker is used for full response. Solid-state amplifier has 4-watt output with frequency response of 40 to 10,000 cps. Several units may be interconnected. Device measures 12 x 8 3/4 x 5 in. \$34.95. Dynaphonics, Inc., 2975 Far Hills Ave., Dayton, Ohio 45419.

meters. Steven Rechter, 30 Roger Williams Green, Providence, R.I. 02904.

CONAR RECEIVER for 15 40 80 meters. Want CB Transceiver. Eugene Mascotte, 30 Third St., Riverhead, N.Y. 11901.

HEATH 2-meter transceiver. Will swap for SW receiver or tape recorder. Mack Humber, KOM 6021, Box 15, Johns, Ala. 35086.

SWAN 406B, other equipment. Want Swan 410 or 508. George Csahanim, WB2DYB, 95 Woodland Ave., Fords, N.J. 08863.

BC-654A 80-meter station with PE-103A dynamotor. Will swap for 2-meter transmitter and converter. Mike Ball, 2693 Dellridge Dr., Holt, Mich. 48842.

JOHNSON PHONE PATCH. Will swap for SW receiver. Sherman A. Harrison, WB4FJO, 1509 Carolina Ave., Kingsport, Tenn. 37664.

GLOBE DSB-100 AM/CW/DSB transmitter, with VOX-10 unit. Would like good 6-meter AM transmitter. Byron Tatum, WA5TH, Box 506, Alvin, Tex. 77511.

AN/TRC-28 2-meter gear for base or remote operation over phone lines. Want ham gear, what have you, or cash. Carey Coggins, 7125 Hunters Branch Dr., Atlanta, Ga. 30328.

LAFAYETTE HA-63 Receiver and Hallicrafters HT-40 transmitter. Want hi-fi equipment. Lonnie Moore, RT 1, Box 296, Leander, Tex. 78641.

SHORT-WAVE LISTENING

STAR-ROAMER receiver. Will swap for ham-band receiver or best offer. Doug Goodman, WB9AVY, 1324 S. Main St., Lombard, Ill. 60148.

KNIGHT KIT Span-Master. Will swap for 30-40 mc VHF receiver. Richard Bragy, 39 Pleasant St., Fox-Craft, Ill. 04426.

HEATHKIT GR-64 receiver. Will swap for Astatic GR-104 mike or best offer. William P. Halas, 51-08 Van Horn St., Elmhurst, N.Y. 11373.

EIMAC PMR-6A receiver. Want Telex-Phonola stereo or similar. Steve Bryant, Star Rt., Central Bridge, N.Y. 12035.

KNIGHT Star-Roamer receiver, and cassette recorder. Want musical-instrument amplifier. Thomas Clark, 9115 Yellowwood Dr., Cincinnati, Ohio 45239.

HALLICRAFTERS S-240 AM/FM/SW receiver. Swap for stereo receiver. Walt Ewing, 2359 S. Lilly, Fresno, Calif. 93706.

HALLICRAFTERS S-119 receiver, Empire 888-E cartridge. Swap for best offer, preferably novice gear. Michael Blase, 119 Brookmoor Rd., W. Hartford, Conn. 06107.

HALLICRAFTERS S-38 receiver, headset; Hitachi marine AM rig, parts. Want SX-99 receiver or best offer. Steve Clark, 26154 Coleman Ave., Hayward, Calif. 95444.

HALLICRAFTERS S53A receiver. Will swap for CB gear. Mike Eckhout, 27901 Roy St., Clair Shores, Mich. 48081.

STAR-ROAMER receiver. Want Heath H6-10B VFO, HD-10 keyer, or Twoer. Ian A. Carah, WNG6AF, 2028 Hoover Ave., Oakland, Calif. 94602.

AN/APR 4Y receiver, 38 to 1000 mc. Continuous-coverage AM/FM reception. Swap for immaculate SX-42 or will sell. Bryon Stickland, 5510 Pinelawn Ave., Chattanooga, Tenn. 37411.

KNIGHT R100-A SW Receiver with S-meter and Xtal calibrator. Want Hammarlund SQ 129-X SW Receiver, 5-in. scope or best offer. Frank J. Lunn, RT. 1, Box 43, Tyler, Minn. 56178.

KNIGHT R-55A Q-multiplier. Will swap for 6-meter AM or FM transceiver. Robert C. Bailey, WB6WVK, 14272-118 Hoover St., Westminster, Calif. 92683.

BC-348R and **BC-453 receivers** with built-in power supplies. Want BC-314, or other surplus rigs. L. F. Watkins, Jr., Box 188, El Durado, Kan.

PHILCO 64 AM/SW receiver (1.8-22 mc) and portable tape recorder. Want 2 1/4 x 2 1/4 or 35-mm enlarger, or other photo gear. Gary K. Hills, 910 Lexington Ave., Greensboro, N.C. 27403.

CRYSTALS for 20-27.9 mc. Want two dual headphones with boom mikes. Bruce Holmen, 14 Field Rd., Silver Bay, Minn. 55614.

TRANS-OCEANIC six-band portable. Will swap for SW receiver. Gary Cormier, 1411 S. Maple Ave., Green Bay, Wis. 54304.

KUHN 348A 150-162 mc. converter. Want ham receiver, AM transmitter, or best offer. James Wornick, 426 Stockbridge, Buffalo, N.Y. 14215.

SERVICE GEAR

DeVRY technical training scope, with test leads. Will swap for Safari III and bumper whip antenna.

America's Top-Rated Stereo Kits Now a Best Buy!*



- * **LT-112B-1 FM Stereo Monitor Tuner Kit:**
Now \$149.95
- LK-60B 160-Watt Stereo Amplifier Kit:**
Now \$149.95
- LR-88 135-Watt AM/FM Stereo Receiver Kit:**
Now \$299.95

SCOTT

Write for new Scott Kit Catalog. H. H. Scott, Inc.,
111 Powdermill Road, Maynard, Mass. 01754.
Export: Scott International, Maynard, Mass. 01754.
© 1969, H. H. Scott, Inc.

POPULAR SCIENCE SAYS:

"... How does it perform? In a word, flawlessly: stereo performance is superb, and the set's sensitivity will cope with the deepest fringe-area reception conditions ... I rate the LT-112B as one of the finest FM tuners available — in or out of kit form."

STEREO REVIEW SAYS:

"We measured the IHF sensitivity of the Scott LT-112B tuner as 1.4 microvolts, which certainly makes it one of the most sensitive tuners we have encountered."

AMERICAN RECORD GUIDE SAYS:

"Scott LT-112B tuner must be placed in the very top echelon of today's components."

AUDIO SAYS:

"Here's a stereo FM/AM receiver kit with a real hot front end, fairly high power output, low distortion, and excellent operating flexibility ... The Scott LR-88 offers a most competent design at a price well below that for an equivalent factory-assembled unit."

ELECTRONICS ILLUSTRATED SAYS:

"One of the finest examples of solid-state integrated-amplifier kit design, packaging and performance we have seen is the Scott LK-60."

HIGH FIDELITY SAYS:

"... an unprecedented high sensitivity, one which surprised even us ... This is certainly a tuner for use in the most difficult of reception areas; stations seem to pop in all across the tuner dial!"

CIRCLE NUMBER 17 ON PAGE 13

Craig Gilbertson, 502 W. Wash. St., Dewitt, Mich. 48820.

HICKOK 470 VTVM and manual. Want SW or ham receiver. Glenn Hansen, Rt. 2, Box 128-B, Burton, Wash. 98013.

CORNELL DUBILIER BF-90 capacitor checker, stereo or SWL headset, meters. Want medium-priced ham or AM/SW receiver. L. Simpson, 502 Red River Ave., White Sands, N.M. 88002.

EICO 232 VTVM, 147A signal tracer, antique tubes. Want Colordaptor chassis, less motor, wheel. Darcy Brownrigg, Chelsea, Que., Canada.

HEATH signal generator. Will trade for Rider manual No. 1. Arthur Dineen, Box 792, Janesville, Wis. 53545.

RCA WO-91B oscilloscope, other test equipment. Want car stereo tape player or good stereo system. Brian O'Grady, 212 Midland Ave., Montclair, N.J. 07042.

ARGOS tube caddy, with over 150 tubes. Will swap for stereo amplifier. Paul Jackson, Rt. 1, Box 150, Elkmont, Ala. 35620.

OTHER EQUIPMENT

TV CHASSIS with tubes, no CRT. Will trade for FM receiver or best offer. Ralph Wondra, 1359 El Centro, Oakland, Calif. 94602.

PEOPLE DETECTOR, assembled project, in working order, from PE story June '68. Want best offer. David Selinger, 1830 Vineyard Pl., Bronx, N.Y. 10460.

SYLVANIA 21T206M TV set. Will swap for Lafayette HA-600T, Drake SW4A or similar SW receiver. Randy Rothenberg, 0-51 Elden Pl., Fairlawn, N.J. 07410.

NATIONAL GEOGRAPHIC for 1968 (12 issues). Want EI for 1967-68. A. Lysak, 11455 Des Recollets, Montreal 459, Que., Canada.

ASSORTED TUBES, TV parts, motors. Will swap for scopes, test equipment. Stephen B. Kruger, Jr., Rt. 2, Box 428, Tampa, Fla. 33610.

ST. GEORGE guitar with amplifier. Swap for CB transceiver or set of walkie-talkies. Gordon A. Duncan, Box 11078, Tahoe Paradise, Calif. 95705.

INTERCOM, three station with 100 ft. of wire. Want Star-Roamer or best offer. Kurt Ullman, 1220 Summit Ave., Bluffton, Ind. 46714.

BIG EAR Soundscope, with headphones and battery. Will swap for AM or FM tuner, tape recorder or best offer. Mike Castrogiovanni, Ridge Rd., Milton, N.Y. 12547.

MICROWAVE OVEN with large capacity. Will swap for good SW receiver, CB rig or TV camera. Jack Rosenbach, 1001 W. 79th Pl., Denver, Colo. 80221.

NORTHERN ELECTRIC power supply: 24 VDC @ 1A (filtered), 24 VDC @ 2A (unfiltered) and 10 VAC @ 8A; with fuses. Swap for CB rig. George Peer, 230 Woolner Ave., Apt. 404, Toronto 9, Ont., Canada.

BLACK LIGHT, 48-in. Swap for Heath GR-64 or Star-Roamer. Kim Harloff, 2302 Afton St., Hillcrest Hgts., Md. 20031.

OSCILLOSCOPE in need of minor repair. Want un assembled Knight-Kit KG-221A. Bruce Holmen, Silver Bay, Minn. 55614.

ESTES model rockets with engines. Swap for ham receiver or 5-watt CB rig. Rob Schmitt, Box 279, Pavoan, Ariz. 85541.

RAYTHEON QKH-713 magnetron and pulse transformer. Want receiver or test equipment. E. A. Sjolander, Jr., 119 7th St. W., Ashland, Wis. 54806.

POWER SUPPLY: 250mA/250V with 6.3-V tap (home-brew). Will swap for surplus gear or best offer. Arthur Nelson, 7650 Park St., Rockford, Ill. 61105.

KAHN FM modulation monitor. Want Knight-Kit oscilloscope or best offer. Denny Moeller, 700 W 178 St., Apt. 63, New York, N.Y. 10033.

RELAYS, hundred models including telephone and others; enclosures. For best offer. Clifford Wind, 5805 236th St. S.W., Mountlake Terrace, Wash. 98043.

ASSORTED TUBES, some oldies. Will swap for chemicals, lab equipment, pyrotechnic material or best offer. Craig Allen, RD 2, Box 267, Gowanda, N.Y. 14070.

GENERAL RADIO VTVM. Swap for RCA test equipment or best offer. D. E. Williams, 4614 Broad meadow, Huntsville, Ala. 35810.

SCOPE (TS-34 A/P) and accessories. Will trade for TV sweep/marker generator or service gear. William B. Gifford, Mt. Airy, Md. 21771.

(Continued on page 111)



7241

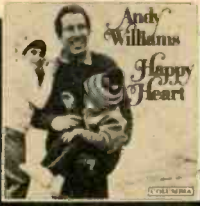

7705



7499



6479



7677

Now...you save almost 50% on the hit records you want!

Savings are off regular Club prices



7540



7463



7150



7562



7460



7559



6415



7115



7566/7567



7273



7669



7563



7541



7771



7226



7411



7342



7501

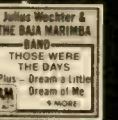

7436



7239



7763



7596



6742



7340/7341



6550



7560



6703



6313



7225



7715



7051



2081

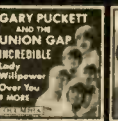

7029



7114



6876



1210



2276



7028



6898



1057



6915



1037

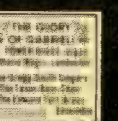

6141



6903



6994



7613



5553



7751



5584



6592



5561



6897



5788



1645



7085



7117



4302



7496



1001

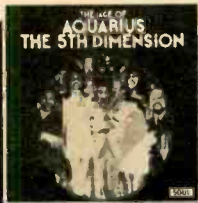

7840



7662



5302

2 Records count as one



2431



7747

AND HERE ARE YOUR SAVINGS IN ADVANCE:

ANY 12 HIT RECORDS \$3.98 FOR ONLY

plus mailing and handling

if you join the Club now and agree to purchase just ten records during the coming ten months (you will have up to 300 records a month to choose from)



7637



7389



7684



7520



7358



7503



7084



7433/7434



7731



6429



6489



7508



7745



7249



7188



7561



7172



7746



7099



7374



6964



7556



6558



7372



6366



7708



6340



7272



2639



6825



7673



3442



7116



5944



5874



7035



3858

THINK OF IT! Now you can get ANY 12 of these hit records—all 12 for less than the price of one! That's right—if you join the Columbia Record Club now, you may have ANY 12 of these records for only \$3.98. And all you have to do is agree to buy ten records (at the regular Club price) during the coming ten months. In short, within ten months you'll have a sizable library of 22 records of your choice—but you'll have paid for just half of them... that's practically a 50% saving off regular Club prices!

AS A MEMBER you will receive, every four weeks, a copy of the Club magazine. Each issue describes the six regular selections and almost 300 other records... hit albums from every field of music, from scores of different record labels.

If you want only the regular selection for your musical interest, you need do nothing—it will be shipped to you automatically. Or you may order any of the other records offered... just tell us which albums you want by returning the convenient selection card by the date specified. Furthermore, from time to time the Club will offer some special albums, which you may reject by returning the special dated form provided... or accept by simply doing nothing—the choice is always entirely up to you!

RECORDS SENT ON CREDIT. Upon enrollment, the Club will open a charge account in your name... you pay for your records only after you have received them—played them—and are enjoying them. They will be mailed and billed to you at the regular Club price of \$4.98 (Classical and occasional special albums somewhat higher), plus a mailing and handling charge.

FANTASTIC BONUS PLAN. As soon as you complete your enrollment agreement, you will automatically become eligible for the Club's bonus plan—which entitles you to one record of your choice free (only 25¢ for mailing and handling) for every one you buy!

SEND NO MONEY—MAIL COUPON TODAY! Just write in the numbers of the twelve records you want, for which you will be billed only \$3.98, plus mailing and handling. Be sure to indicate the type of music in which you are mainly interested. Act now!

SEND NO MONEY—JUST THIS COUPON

Columbia Record Club, Terra Haute, Indiana 47808 Please enroll me as a member of the Club. I've indicated below the twelve stereo records I wish to receive for only \$3.98, plus mailing and handling. I agree to purchase ten records during the coming ten months, under the terms outlined in this advertisement... and I may cancel membership at any time thereafter. If I continue, I will then be eligible for the Club's generous bonus plan.

SEND ME THESE 12 RECORDS FOR ONLY \$3.98

Table with 12 empty boxes for record selection.

MY MAIN MUSICAL INTEREST IS (check one):

- Listening and Dancing
Teens Hits
Classical
Broadway and Hollywood
Country and Western
Jazz

Name (Please Print) First Name Initial Last Name

Address

City

State Zip

Do You Have A Telephone? (Check One) YES NO APO, FPO addresses: write for special offer

COLUMBIA RECORD CLUB Terra Haute, Indiana

229-1/N4

Unless you are an advanced CBer,
you probably can't use Johnson's
new solid state Messenger 124



New Messenger 124 full-function, 23-channel base station. **\$289⁹⁵**
(less mike)

If you're an operator with a purpose . . . consider this, the most sophisticated of all Johnson 27 MHz base stations . . . from the largest and most experienced of all manufacturers of citizens and industrial two-way radio.

To the advanced CB operator, the Messenger 124 means complete mastery of the equipment—a degree of control and measurement that permits, for the first time, full utilization of all the enormous power, hairline selectivity, sensitivity and noise suppression of which the incomparable Johnson circuitry is capable.

Whatever your requirement, the Messenger 124 offers a new experience in base station performance.

Features

- ± 3 kHz Delta fine tuning • Adjustable microphone gain with modulation adjustment to 100% • 2½" four-way professional meter measures SWR, output, % modulation and receive • 4.3 MHz crystal filter for unequalled selectivity • Built-in speech compression • Panel-controlled, series-type threshold noise limiter • Built-in tone control • Built-in 117 VAC/12 VDC power supply • 14 tuned circuits • FET for superior gain • Dual conversion receiver

E. F. JOHNSON COMPANY

Waseca, Minnesota 56093



CIRCLE NUMBER 15 ON PAGE 13

Electronics Illustrated

Compress-O-Phone

Roar into it like a lion or whisper like a church mouse but the output from this microphone will remain constant within 3db.

By JOSEPH RITCHIE

A PERENNIAL hang up when making live recordings is keeping the record level constant (or nearly so). You know what it's like. After setting up to tape, say, a group discussion, you set the level on one person's voice. After the talking starts people speak louder; now and then they quiet down. The result: a tape with overload distortion and passages where you can just about (but not quite) hear what someone is saying. To solve this you must ride gain constantly, which means full attention to the machine's record-level indicator and gain control.

The Compress-O-Phone makes this unnecessary. It will give you hands-off uniform-level tape recordings, crushing CB and ham talk power, a super-loud PA system without feedback and hidden-mike tape recordings of top clarity.

The Compress-O-Phone is a dynamic microphone with a built-in speech compressor the likes of which hasn't been seen outside of a James Bond thriller. The compressor is so effective it almost wipes out dynamic range. Regardless of the sound level into the microphone—a soft whisper, a shout or murmurs 20 ft. away—the microphone's output remains constant within 3db.

Used with a ham or CB transmitter the compressor can add nominally 30db of talk power (and that's not *up to*, it is 30db). In fact, some SSB transmitters designed for peak voice power may not be able to handle the sustained constant level signal from the compressor.

When used with a PA system the tendency to break into microphonic howling is reduced some 20 to 30db, allowing that much of an increase in volume level. The only time you should not use the compressor is when recording music because it will eliminate the desirable dynamic range of the instruments; everything will come out sounding like a player piano—no expression.

The heart of the compressor is the op-amp (operational amplifier) shown in the schematic in Fig. 9. Unlike clippers, which chop down the dynamic range by clipping waveform peaks (thereby creating distortion) or standard compressors, which go into compression only above a reference sound level, our compressor introduces no distortion and goes into maximum compression at signal levels representing a very low whisper. Regardless of the sound level into the microphone, the compressor's output level is essentially flat.



Compress-O-Phone

How it Works. Integrated circuit IC1 is an op-amp whose gain is determined by the ratio of resistance of feedback resistor R3 to the resistance represented by FET Q1, which is in parallel with resistor R1. Since R1's re-

sistance is greater than Q1's static resistance, R1 is effectively out of the circuit and the gain depends on R3 and Q1. At very-low-level inputs (from the microphone) Q1 appears as a low resistance and the op-amp's gain is maximum. As the mike input level increases part of the output at terminal 5

Fig. 1—At right is template for circuit board. Cut it out and trace outline of black areas with carbon paper on foil side of board. Fine line at top, right and bottom, right does not have to be traced.

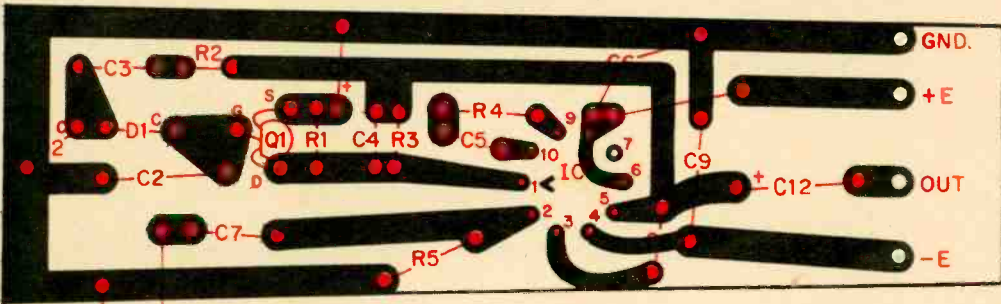
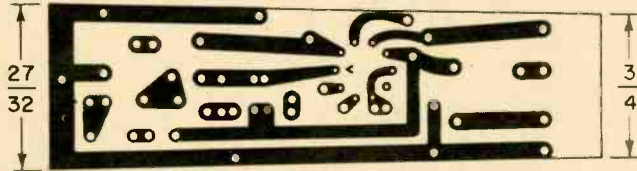

TO MIC. (GND)

Fig. 2—Diagram above is an X-ray view of board from side on which parts are installed. Designations show location of parts. Note foil from pin 3 on IC1 to bottom edge; foil should be trimmed slightly at edge so it won't touch mike case.

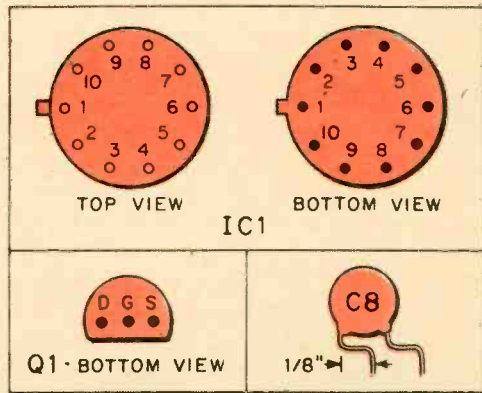
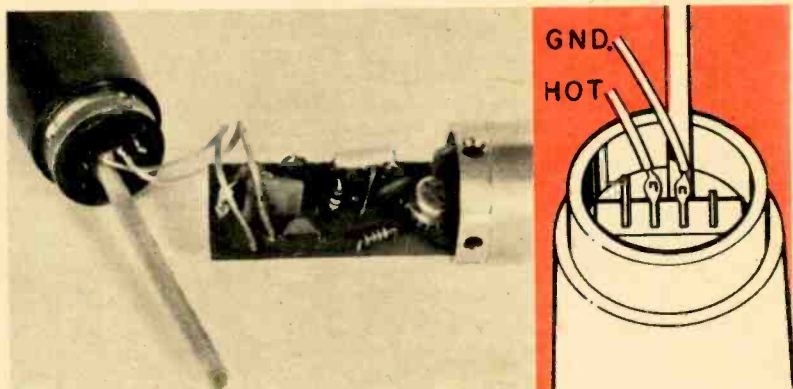

Fig. 3—Diagrams at right show top and bottom-view numbering of IC1's pins. Get these right when installing the IC or it will be destroyed. Q1's leads are drain, source and gate. Bend leads on C8 so it will be in from edge of mike case.



Fig. 4—Compressor is built on a printed-circuit board which just fits in mike case. Note that the electrolytic capacitor (white) in foreground is folded flat to board. Leave capacitor's leads a trifle long so it can be folded this way. Output of compressor is at left. Circuit's input is at the right.

Fig. 5—Hollow tube sticking out of back of front half of mike is air-pressure relief tube for mike element. Tube slips under board during final assembly; don't damage it. Sketch at right shows connections to lugs in mike.



on IC1 is rectified by D1 and D2; the resultant DC is applied to Q1's gate, which effectively increases Q1's resistance, thereby lowering the gain of the op-amp.

When the input increases the DC feedback to Q1's gate similarly increases, thereby holding the op-amp's output at a fixed level. Compression is lost only when the input signal exceeds 200 mv (rms) which is considerably more than the maximum output level of a dynamic microphone, even when you shout into it. For all practical purposes, therefore, the op-amp's output is constant regardless of the sound level into the microphone, until the input signal becomes so weak it is unusable anyway.

Normally, when heavy compression is employed, the higher voice frequencies representing sibilant sounds are highly articulated because they are amplified with respect to the more powerful lower voice frequencies. Part of this excess sibilant articulation is attenuated by C4 and C8, which provide a slight high frequency roll-off.

The compressor is built on a printed circuit board that fits in the case of an Allied Radio Model 3311 dynamic microphone, making the entire unit self-contained except for the battery box which is located at the tape recorder, transmitter or amplifier. The circuit is specifically designed for the Allied mike and may not work with other dynamic mikes with which we haven't tried it.

Since the gain of IC1 is extremely high the circuit must be assembled as shown using the exact parts specified in the Parts List. Any departure from layout or component type can cause complete instability and the chance of destroying IC1. As long as the unit is assembled on the board shown in Figs. 1 & 4 it will fit in the mike case or in a box

at the end of a mike cable no longer than 20 ft. If the circuit breaks into oscillation when mounted at the end of the cable, shorten the cable until oscillation stops. We suggest the microphone installation shown.

Construction. First, disassemble the microphone. At about in the center of the case there's a metal band secured by a single screw. Remove the screw and the band and you'll see three screws that hold together the front and back halves of the case. Remove the three screws and gently pry the halves apart. As the sections separate you will see two wires connected to lugs on the back of the front section. Note which wire connects to which lug and unsolder them. Separate the halves. You will see a long length of sleeving (spaghetti) attached to the back of the front section. Be very careful because this is the mike element's air-pressure relief tube and must not be damaged. Set the front section aside and remove the switch and the connector at the back of the rear section.

Cut a section of copper-clad circuit board $2\frac{7}{8}$ in. long which measures $27/32$ in. wide at the front and $3/4$ in. at the rear as in Fig. 1. The front of the board will be near the front section of the mike when the unit is completed.

Slide the board into the rear section; it should go in easily and sit slightly *below* the diameter of the case from front to back. If the back or front lies on the diameter of the case, file the edges of the board so that it fits correctly. Insert a $1/2$ -in. rubber grommet in the rear of the case where the jack used to be and set the case aside.

Making the Board. Remove any protective plastic cover which may be on the board and scrub the copper foil with a cleanser such as Ajax; wash thoroughly and dry. Place a piece

Compress-O-Phone

of carbon paper face down on the foil and tape the template in Fig. 1 on top of the carbon paper. Using an ice pick or pointed tool, indent the copper foil at the drilling points (small holes) by pushing the tool through the template and carbon paper. Using a fine-tip ball-point pen, carefully trace the template outline. And make certain you trace the arrowhead which is opposite pin 1 on IC1. Remove the template and carbon and using a Kepro RMP-700 resist pen (Allied 47 C 1102) fill in the outline traced on the foil. Be very careful the foil outlines don't touch. It is better to make the resist fill-in lines thinner rather than thicker. Don't worry about the drilling circles; pass the pen directly over the indents in the foil. When the excess copper is etched away the indents will indicate the drilling location.

Don't forget to place a drop of resist on the arrowhead pointing to pin 1 on IC1. Also put a dot of resist for the pin 7 lead in IC1. While pin 7 isn't used you will have to have a hole for the lead. Make certain the resist line from pin 3 doesn't touch the edge of the board, because if it does it will short to the mike case.

Allow about 15 minutes for the resist to

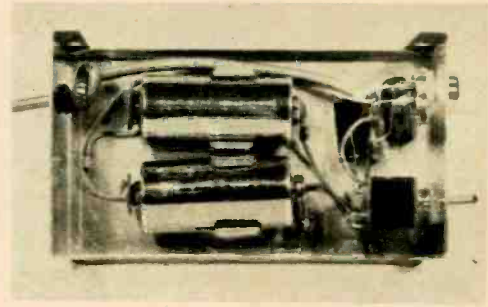

Fig. 6—Power box contains two batteries, on-off switch, input connector and output cable. Secure the batteries with clamps or wire loops.

dry and then immerse the board in at least 1/4 in. of etchant solution. After about 20 minutes of agitation inspect the board to see if all the excess copper is dissolved. If any trace of unwanted copper remains, immerse the board again until all areas not covered with resist are free of copper. Thoroughly rinse the board and remove the resist with steel wool or resist solvent.

Inspect the board carefully to make certain no foil areas are touching. Also, check that there is at least 1/32-in. between the foil going to pin 3 and the edge of the board. If foils touch, or there is no clearance trim away some of the excess with a very sharp utility

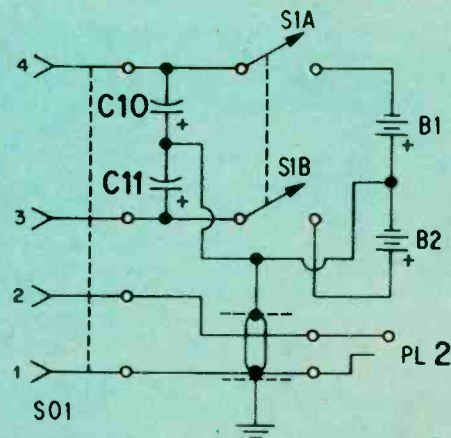
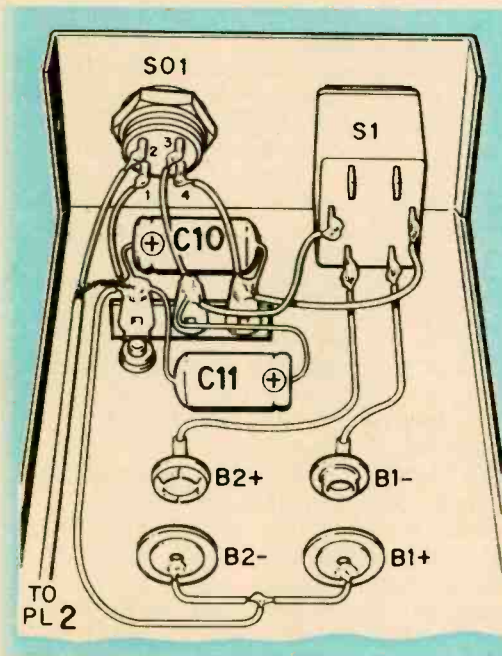

Fig. 7—Schematic above is of power supply. Circuit supplies positive, negative DC to compressor.

Fig. 8—Pictorial, left, shows parts layout in our power box. Watch polarity connections of C10,C11.

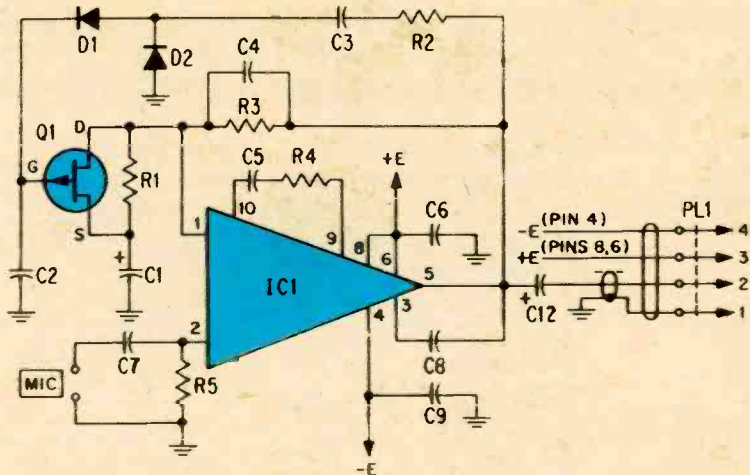

Fig. 9—Compressor schematic. Gain of op-amp (IC1) is determined by ratio of resistance of R3 to the resistance represented by Q1 in parallel with R1. At low input levels to op-amp, Q1 represents low resistance and op-amp's gain is maximum. As input signal increases, part of output at pin 5 is rectified by D1, D2 and DC is applied to Q1's gate, increasing Q1's resistance. This lowers gain of op-amp.

knife or an X-acto knife.

Drill the board with a No. 57 (0.043 in.) drill at the indents in the foil. With the parts in position it is more than likely that attempting to solder with a standard-size iron tip will result in shorts. The board must be soldered with a fine-point soldering tip. We suggest the Ungar 4037 heating element with a PL-111 pencil tip.

Except for R5 all resistors are mounted on end as shown in the photo in Fig. 4. All components must be inside the edge of the board or the board won't fit into the mike case. Except where shown, all parts must be flush with the board. Solder capacitor C1 in place with 1/4-in. leads between its body and the board so that it can be folded flat against the board. Capacitor C9 should have about 1/32 in. of lead between its body and board so it can be tilted inward to allow clearance in the case.

Form the leads of capacitor C8 with a 1/8-in. jog as shown in Fig. 3 so C8 will be inside the edge of the board. The right side of C8 (Fig. 3) faces the edge of the board.

Install transistor Q1 with at least 1/4 in. leads between it and the board. Integrated circuit IC1 is the last component to be installed and should have at least 1/8-in. clearance between its bottom and the board.

When installing IC1 make certain pin 1, which is opposite the tab on the case, is opposite the arrowhead on the foil. You don't get a second chance; if power is applied with IC1 incorrectly installed, it's bye-bye IC1.

Connect about 20 ft. of 3-conductor/single-shielded cable (Belden 8734 or equiv.) to the board. Connect the shielded hot wire

to the connection from C10. Connect the shield to the foil ground, the red wire to the +E foil and the black wire to the -E foil.

Solder the original microphone wires to the board's input terminals. Slip the free end of the 20-ft. cable through the microphone case and slide the board into the case. Then slide the front of the microphone with the relief tube *under* the board toward the rear of the case. Connect wires to their matching front-half terminals and reassemble the case

[Continued on page 112]

PARTS LIST

- B1, B2—12.6 V mercury battery (Mallory TR-289 or equiv.)
- C1—10 μ f, 6-V electrolytic capacitor, single-ended leads (Lafayette 99 T 6073)
- C2, C6—.22 μ f, 25-v capacitor (Sprague 5C224, Allied 43 C 6698)
- C3, C7—.1 μ f, 3-V capacitor (Sprague HY-120, Allied 43 C 6671)
- C4, C8—50 μ f, 500-V disc capacitor
- C5—.002 μ f, 500-V disc capacitor
- C9—.05 μ f, 500-V disc capacitor
- C10, C11—100 μ f, 15-V electrolytic capacitor
- C12—2 μ f, 6-V electrolytic capacitor
- D1, D2—1N60 germanium diode
- IC1—MC1433G integrated circuit (Motorola Allied 50 F 26 MC1433G-MOT. \$8.25 Not listed in catalog)
- PL1—Four-contact male cable plug (Ampheno 91-MPM4L, Allied 47 C 0326 or equiv.)
- PL2—Phone plug
- Q1—2N3820 field-effect transistor (Texas Instruments)
- Resistors: 1/4 watt, 10%
 - R1—100,000 ohms
 - R2—4,700 ohms
 - R3—1 megohm
 - R4—100 ohms
 - R5—47,000 ohms
- S1—DPST toggle or slide switch
- SO1—Four-contact female chassis connector (Amphenol 78-PCG4, Allied 47 C 0331)
- Misc.—Microphone (Allied Model 3311, Stock No. 12 C 7156), 5/8 x 3 x 2 1/2-in. Minibox

10 New Exciting Kits For Home & Hobby



NEW
Kit ID-29
\$29.95*



NEW
Kit TD-17
\$12.95*

NEW
Kit IP-28
\$47.50*



\$49.95*
each



NEW
Kit GR-88

NEW
Kit GR-98

NEW
Kit GR-38
\$32.95*

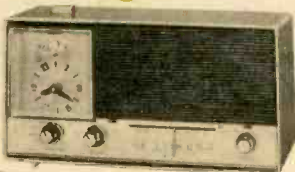

NEW Kit GD-209A
\$149.95*



NEW Heathkit Solid-State Auto Tune-Up Meter . . . Measures Dwell, RPM And DC Voltage

The new Heathkit ID-29 is most versatile . . . really three automotive test instruments in one . . . and its low price makes it even a better value. Measures Dwell on all 4-cycle 3, 4, 6, or 8 cylinder engines . . . measures RPM in two ranges 0-1500 and 0-4500 . . . measures DC voltage from 0 to 15 volts. And no batteries are needed . . . running engine provides both signal and power. Easy to use . . . on both 6 and 12 volt system without changing leads. It's lightweight, easy to carry . . . comes equipped with black polypropylene case that has a built-in lead storage compartment and is resistant to virtually everything. Fast, simple assembly . . . takes just one evening. The perfect accessory for the handyman who wants to do his own car tune-up, emergency road service personnel, or shop mechanics . . . order your ID-29 now. 4 lbs.

NEW Heathkit Electronic Metronome

The new Heathkit TD-17 is a low cost, precise performing electronic Metronome . . . a handy helper for any music student. Battery operated . . . no springs to wind . . . accurate, steady calibration is always maintained . . . from 40 to 210 beats per minute. Instruction label on bottom gives conversion from time signature and tempo to beats per minute. Stylish fruit wood finished cabinet. Easy solid state circuit board construction . . . assembles and calibrates in only 2-3 hours. The new Heathkit TD-17 Electronic Metronome is so low in cost every music student can afford one . . . order yours now. 1 lb.

NEW Heathkit 1-30 VDC Solid-State Regulated Power Supply

The new modestly priced IP-28 is an excellent power supply for anyone working with transistors whether it be in a laboratory or in a home workshop . . . and its low price makes it the ideal power supply for classroom use. Compact brown and beige. Heathkit instrument styling with large easy-to-read meter . . . with two voltage ranges 10 v. and 30 v. . . . and two current ranges 100 mA, 1 A. External sensing permits regulation of load voltage rather than terminal voltage. Adjustable current limiting prevents supply overloads and excessive load current. Convenient standby switch. Fast, easy assembly with one circuit board and wiring harness. Order yours today. 9 lbs.

NEW Heathkit GR-88 Solid-State Portable VHF-FM Monitor Receiver

Tunes both narrow and wide band signals between 154-174 MHz . . . for police, fire, most any emergency service. Exceptional sensitivity and selectivity, will outperform other portable receivers. Features smart compact styling . . . with durable brown leatherette case, fixed station capability with accessory AC power supply, variable tuning or single channel crystal control, collapsible whip antenna, adjustable squelch control and easy circuit board construction. The new GR-88 receiver is an added safety precaution every family should have . . . order yours today. 5 lbs.

NEW Heathkit GR-98 Solid-State Portable Aircraft Monitor Receiver

Tunes 108 through 136 MHz for monitoring commercial and private aircraft broadcasts, airport control towers, and many other aircraft related signals. Has all the same exceptional, high performance features as the GR-88 above. The perfect receiver for aviation enthusiast . . . or anyone who wants to hear the whole exciting panorama of America in flight. 5 lbs. GRA-88-1, AC Power Supply \$7.95

NEW Heathkit GR-38 Solid-State AM Clock Radio

Discover An Easier Way To Get Up In The Morning . . . with the new GR-38. Set the front panel switch to "Alarm" to hear both alarm and news & music of AM radio, or use "Auto" position for only the radio. The "Snooze" alarm lets you turn off the alarm for ten minutes but keeps the radio on to wake you up gradually, and cycles continuously until selector switch is reset. The accurate, dependable clock controls the accessory AC socket so you can have coffee perking or lights turned on in the morning. The all solid-state radio really pulls in those stations and runs cool, maintenance-free. AGC keeps stations at a constant volume and a full wave transformer power supply eliminates power line hum. Styled in coral with matching grille. There IS a better way to get up in the morning . . . with the Heathkit GR-38 . . . order yours now. 6 lbs.

NEW Heathkit Deluxe Radio-Controlled Screw-Drive Garage Door Opener Semi-Kit

The next best thing to a personal doorman. The "wireless" factory assembled transmitter operates up to 150 feet away. Just push the button and your garage door opens and the light turns on . . . and stays on until you're safely inside your home. The giant 7 ft. screw mechanism coupled with the 1/4 HP motor mean real power and reliability, and the adjustable spring-tension clutch automatically reverses the door when it meets even the smallest obstruction . . . extra safety for kids, pets, bikes, even car tops. Assembles completely without soldering in just one evening. Easy, fast installation on any 7' overhead track door and jamb & pivot doors with GDA-209-2 Adaptor at \$7.95. Order yours now. 66 lbs.

From The Leader



NEW Heathkit Ultra-Deluxe "681" Color TV With AFT . . . Power Channel Selection & Opt. RCA Hi-Lite Matrix Tube

The new Heathkit GR-681 is the world's most advanced Color TV with more built-in features than any other set on the market. Automatic Fine Tuning on all 83 channels . . . power push button VHF channel selection, built-in cable-type remote control . . . or you can add the optional GRA-681-6 Wireless Remote Control any time . . . plus the built-in self-servicing aids that are standard on all Heathkit color TV's. Other features include high & low AC taps to insure that the picture transmitted exactly fits the "681" screen, automatic degaussing, 2-speed transistor UHF tuner, hi-fi sound output, two VHF antenna inputs, top quality American brand color tube with 2-year warranty. With optional new RCA Matrix picture tube that doubles the brightness, Model GR-681MX only \$535.00.

GRA-295-4, Mediterranean Cabinet shown . . . \$124.95*

Heathkit "295" Color TV

With Optional RCA Matrix Tube . . . with the same high performance features and built-in servicing facilities as GR-681 above . . . less AFT, VHF power tuning and built-in cable-type remote control. You can add the optional GRA-295-6 Wireless Remote Control at any time. New optional RCA Matrix tube doubles the brightness, Model GR-295MX, \$485.00.

GRA-295-1, Contemporary Walnut Cabinet shown . . . \$64.95*

Both the GR-681 and GR-295 fit into the same Heath factory assembled cabinets; not shown Early American style at \$109.95*

NEW Deluxe Heathkit "581" Color TV With AFT

The new Heathkit GR-581 will add a new dimension to your TV viewing. Brings you color pictures so beautiful, so natural, so real . . . puts professional motion picture quality right into your living room. Has the same high performance features and exclusive self-servicing facilities as the GR-681, except with 227 sq. inch viewing area, and without power VHF tuning or built-in cable-type remote control. The optional GRA-227-6 Wireless Remote Control can be added any time you wish. And like all Heathkit Color TV's you have a choice of different installations . . . mount it in a wall, your own custom cabinet, your favorite B&W TV cabinet, or any one of the Heath factory assembled cabinets. **GRA-227-2, Mediterranean Oak Cabinet shown . . . \$109.95***

Heathkit "227" Color TV

Same as the GR-581 above, but without Automatic Fine Tuning . . . same superlative performance, same remarkable color picture quality, same built-in servicing aids. Like all Heathkit Color TV's you can add optional Wireless Remote Control at any time (GRA-227-6). And the new Table Model TV Cabinet and roll around Cart is an economical way to house your "227" . . . just roll it anywhere, its rich appearance will enhance any room decor.

GRS-227-5, New Cart and Cabinet combo shown . . . \$64.95*

Both the GR-581 and GR-227 fit into the same Heath factory assembled cabinets; not shown, Contemporary cabinet \$64.95*

NEW Heathkit Deluxe "481" Color TV With AFT

The new Heathkit GR-481 has all the same high performance features and exclusive self-servicing aids as the new GR-581, but with a smaller tube size . . . 180 sq. inches. And like all Heathkit Color TV's it's easy to assemble . . . no experience needed. The famous Heathkit Color TV Manual guides you every step of the way with simple to understand instructions, giant fold-out pictorials . . . even lets you do your own servicing for savings of over \$200 throughout the life of your set. If you want a deluxe color TV at a budget price the new Heathkit GR-481 is for you.

GRA-180-1, Contemporary Walnut Cabinet shown . . . \$49.95*

Heathkit "180" Color TV

Feature for feature the Heathkit "180" is your best buy in color TV viewing . . . has all the superlative performance characteristics of the GR-481, but less Automatic Fine Tuning. For extra savings, extra beauty and convenience, add the table model cabinet and mobile cart. Get the value-packed GR-180 today.

GRS-180-5, Table Model Cabinet & Cart combo . . . \$42.50*

Both the GR-481 and GR-180 fit the same Heath factory assembled cabinets; GRA-180-2, Early American Cabinet \$94.95*

Add the Comfort And Convenience Of Full Color Wireless Remote Control To Any Rectangular Tube Heathkit Color TV . . . New Or Old!

Kit **GRA-681-6**, for Heathkit GR-681 Color TV's . . . **\$64.95***

Kit **GRA-295-6**, for Heathkit GR-295 & GR-25 TV's . . . **\$69.95***

Kit **GRA-227-6**, for Heathkit GR-581; GR-481 & GR-180 Color TV's . . . **\$69.95***

Now There Are 6 Heathkit® Color TV's To Choose From

2 Models In 295 Sq. Inch Size

NEW
Kit GR-681
With AFT
\$499.95*
(less cabinet)



Kit GR-295
\$449.95*
(less cabinet)

2 Models In 227 Sq. Inch Size

NEW
Kit GR-581
with AFT
\$419.95*
(less cabinet)



Kit GR-227
NOW ONLY
\$379.95*
(less cabinet & cart)

2 Models In 180 Sq. Inch Size

NEW
Kit GR-481
with AFT
\$359.95*
(less cabinet)



Kit GR-180
NOW ONLY
\$329.95*
(less cabinet & cart)

Reception Is Simulated
On All Sets Shown



NEW

FREE 1970 CATALOG!

Now with more kits, more color. Fully describes these along with over 300 kits for stereo/hi-fi, color TV, electronic organs, electric guitar & amplifier, amateur radio, marine, educational, CB, home & hobby. Mail coupon or write Heath Company, Benton Harbor, Michigan 49022.

HEATH COMPANY, Dept. 35-68

Benton Harbor, Michigan 49022

Enclosed is \$ _____

plus shipping.

Please send model(s)

Please send FREE Heathkit Catalog.

Please send Credit Application.

Name _____

Address _____

City _____

State _____

Zip _____

*Mail order prices. F.O.B. factory.

Prices & specifications subject to change without notice.

CL-364

Notes from EI's DX Club

JOHN M. Gabler, W3BMB (Pennsylvania), has come up with a nice QSO on 10 meters from the Mediterranean. He worked EA6BJ on the Balearic Islands around 0915 EST.

EIDXCer Thomas E. Richardson, WB4ADT (Alabama), can boast some fine low-band DX QSOs—like CR6AI, Angola, on 40 meters and GM3JZK, Scotland, on 80 meters.

For propaganda watchers, we learn from Randy Curtis (Nebraska) that R. Havana now has an English-language transmission directed especially at the West Coast. It is aired at 2230-2400 PST on 11930 kc. And speaking of RHC, Mike Macken (Massachusetts) and Bob LaRose (New York) report that this broadcaster has, for some mysterious reason, been airing the Havana telephone station's interval signal on some SWBC frequencies, such as 11760 and 17735 kc.

Regular Gerry Dexter (Wisconsin) has bagged a rare Guatemalan station—La Voz de Nanhuala on 3360 kc around 2110 EST. It was an educational program.

R. Nederland is now feeding programs to its Bonaire (South American) relay via a special single-sideband link. This relay has been heard on 10870 around 2000 EST. Another new SSB link belongs to the Voice of Germany (Deutsche Welle) at Cologne. It's heard on 15473 kc until 1400 EST.

English-language broadcasts now can be heard from Peru. These programs are from R. del Pacifico at Lima on 9675 kc around 2100 to 2200 EST. Sideband QRM from the VOA on 9670, however, can make reception tough.

A new country is now on the air—Muscat & Oman (near the mouth of the Persian Gulf), where the BBC has opened a powerful new MW relay. This is a double unit consisting of twin 750-kw transmitters formerly used by the BBC in Aden and Somalia. Since one of the frequencies is 701 kc, medium-wave

DXers may have a chance to grab this rare catch. The station is on Masirah Island.

A relay of the RAI (Italy) multi-lingual, all-night service has been logged by member Bill Migley (Ohio) on 17770 at 2230 EST. This may be the Sicilian relay. Transmitter location was not given.

The Rhodesian Broadcasting Corp. is currently being logged on two 60-meter frequencies—by Mike Macken on 5012 kc at 1700 sign-off, and by Gerry Dexter on 4826 shortly after 2300 EST.

Chris Lobdell (Massachusetts) hears HJIG, Ondas del Meta, in Colombia on 4885 around 0500. Another good Colombian prospect is R. Sutatenza's new 250-kw BCB transmitter on 810 kc.

Cap Haitien, Haiti, 4VEH, which has been experimenting on 19 meters, is now being heard on 15275 kc. The station is providing fair signals during morning, afternoon and evening hours.

Propagation: As days grow shorter the trend toward winter conditions continues. Because the earth is closer to the sun, solar radiation is more intense; as a result, the range of useful daytime frequencies increases. The 21- and 26-mc bands, which were at their worst during the summer months, have begun to come back and during daytime hours signals in these bands will grow progressively stronger. DX on the higher frequencies will become more frequent and originate from more locations. The 15- and 17-mc bands will continue to be useful for DX during daylight hours.

As nights grow longer, the hours increase during which the ionosphere is not under the influence of solar radiation. Since the ionosphere is formed by radiation from the sun, it grows weaker with the approach of winter and the range of frequencies it will support constantly decreases. As a result of these seasonal changes, signals in the 15- and 11-mc bands will progressively weaken, but the 6- and 9-mc bands will become more useful for DX. —

For great New Career Opportunities, Think CATV!

By DAVID WALKER

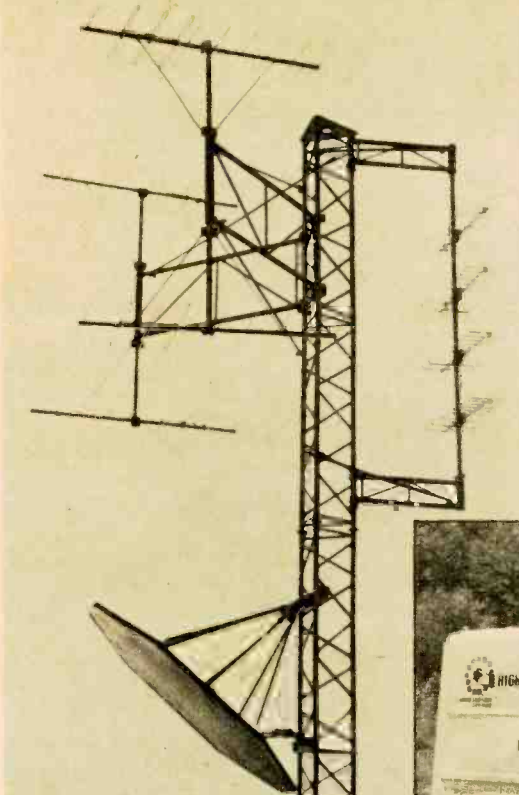

Typical CATV tower and antenna array are shown above. Antennas are oriented toward available VHF and UHF signals. Reflector at bottom bounces microwave signals toward shack. At right is truck used for CATV program origination.



THERE are now more TV sets in American homes than there are bathtubs. This could explain why CATV—Community Antenna TV—is a burgeoning industry whose growth astonishes even its own developers. By delivering on a promise of more channels and better reception, CATV's coaxial tentacles have spread through nearly 2,500 communities. About 2,000 more towns have granted franchises to new systems and big cities like New York and San Francisco are starting to feel the impact of pictures coming through a wire. Nearly 5 million homes now receive them that way and the end is nowhere in sight.

CATV's success also has spawned a huge electronic headache: a shortage of technical people to install and maintain CATV systems. This year alone the industry is expected to grow by about 30 per cent and will need more than 5,000 new technicians. Anyone planning a future in electronics may find that CATV offers just the right opportunity. Some people even predict that as the air-

waves become increasingly crowded, all TV will be transmitted to the home via coaxial cable.

Most CATV systems begin in a small town that's situated beyond the fringe area of big-city TV stations. The town is often surrounded by hills which prevent signals from reaching roof antennas, so the inhabitants may see only one or two local outlets and squint at fractured images from distant channels. Some viewers claw at microvolts with an expensive antenna array, a precarious mast and a rotator. But reception inevitably suffers from chronic ghosts and snow-blindness. Then, one day, a full-page ad in the paper announces: CATV is coming to town. What follows is often a technical and economic spectacular.

A helicopter weaves over nearby hills like a bee exploring a flower garden. The whirlybird, though, is seeking something far richer than honey. With an antenna slung under its belly, it's probing for TV signals. A technician inside the bubble watches a tiny TV

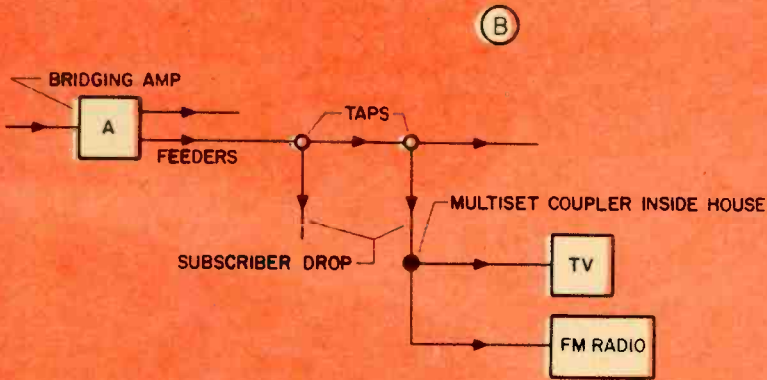
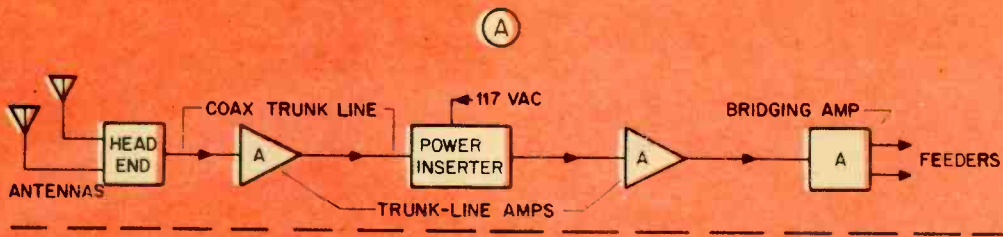

CATV system is shown in two stages: (A) antennas pick up signals which are amplified and combined in head end, a shack located near tower. Coax carries signals to town which are boosted by line amps powered by DC from inserter; (B) bridging amp splits up signals for feeder lines that are tapped at the subscriber drops.

CATV Opportunities

screen to help pinpoint the best area. That's where they'll erect a steel tower loaded with an array of antennas oriented in any direction that'll intercept a signal. These antennas feed fragile signals into a system (see diagram) where amplifiers boost, process and combine the channels in a single coaxial cable. The cable then runs to town as a trunk line and splits into feeders which fan through the streets on telephone poles.

Meanwhile, townfolk will be lining up at the CATV office, ready to sign on the dotted line. And that's hardly an exaggeration. In Lafayette, Ind., almost half the population subscribed to a CATV system before it was turned on. It's common for operators to snare 80 to 90 per cent of all homes within reach of the cable. As each household signs up, it receives a subscriber drop (a connection from the outdoor pole to the back of the TV set).

The technical coup pulled off in Lafayette explains CATV's lure. Viewers there went from a lone local channel to ten channels from such diverse points as Chicago, South Bend, Indianapolis and Elkhart. As a bonus, the system also carries FM music and feeds an unused channel with continuous weather reports. For this service subscribers pay an

installation fee of \$18.50 and a monthly charge of \$4.50—about average for most of the country. In Lafayette these fees help pay for such items as the head-end site, miles of coaxial cable strung on 6,000 telephone poles and 400 amplifiers to keep signals strong throughout the system.

Each year CATV technology becomes more sophisticated. It can drop a station into every position of your main channel selector and there is new equipment capable of boosting that number to more than 20 channels. Distance rarely is a problem for the CATV operator. If a nearby mountain isn't high enough to pluck distant signals from over the horizon, he can import them via microwave relay.

All this takes manpower to install and service. Here is where the job opportunities lie. Positions in the industry generally begin with *installer*, continue to *technician* and go on to *chief technician*. Actually, most CATV systems are still relatively small operations having only two or three technicians, so responsibilities overlap. A man may install, maintain or troubleshoot, depending on what has to be done.

The job of the installer is to tap into the cable distribution system outdoors and bring a drop into the subscriber's home. He has to know how to check signal levels, select the correct tapping devices and handle a multitude of installation wrinkles. Some locations require several outlets, others may suf-



Some CATV companies go to great effort to train their men. This mock-up, with pole, cable and line amps, is at Tri-County Cable TV Co. in Salem, N.J. Set-up allows men to make tests in working system.

fer severe interference that needs the right cure. An installer must also understand basic building construction so he can fish wires through walls and provide a good grounding system for protection against lightning.

His job will stop at the back of the subscriber's TV set. It's completed as he brings in the 75-ohm coaxial cable and connects it to a transformer which converts the cable to the 300-ohm impedance of most TV an-

tenna terminals. When the installer leaves, the subscriber should be receiving 1000 microvolts of ghost-free signal on all advertised channels.

Sometimes the installer may do his job too well. Hearty CATV signals may overload an aging TV set and cause distorted images. But according to industry practice an installer is forbidden to touch anything beyond the set's antenna terminals. Troubles inside the subscriber's receiver must be handled by a regular TV serviceman.

The CATV technician will troubleshoot and maintain equipment in several areas. One day he may travel to the head-end site where signal pickup occurs. Though such sites are usually unattended, they're filled with electronic gear that needs care. Above the head-end shack is an antenna array that will deteriorate under the assault of weather. Inside the shack he must check items like channel amplifiers, modulators and converters. Elsewhere in the system, there may be *local origination* equipment to be serviced. This could be a TV camera which scans weather instruments and feeds their indications over an unused channel. A tape recorder may pipe background music through the system. There is also maintenance on the cable network with its numerous amplifiers and miles of cable.

The CATV technician learns to pinpoint trouble by analyzing symptoms. For example,



One of technician's most valuable instruments is a field-strength meter. This portable unit measures TV signals down to level of 10 microvolts.

CATV Opportunities

complete system failure can be caused by a defective trunk-line amplifier or a cable break. Program loss in only one area suggests a faulty bridging amplifier. Loss of only one channel throughout the system might mean a downed antenna or failure of that channel's amplifier at the head end. Ghosts could mean a mismatch in a trunk line and weak signals might arise from low line voltage at a power insertion point.

The CATV technician detects these problems with the special instruments of his trade. Most important is the field-strength meter. With it he can measure at any point in the CATV system and determine signal strength on any channel. A small portable TV receiver allows him to check the quality of any signal. He may use a spectrum analyzer which can display an entire TV band, thus revealing carrier strengths and spurious signals. With a sweep generator, the technician will examine response curves on an oscilloscope and be able to align channel amplifiers. Besides these devices, he'll use the same in-

struments found in regular radio-TV servicing: the VOM, VTVM, tube and transistor tester.

As you might suspect, a background in TV fundamentals can help launch a career in CATV. Any good TV repairman should have little problem making the transition. Biggest change is that circuitry shifts mainly to RF frequencies since CATV is concerned with capturing, juggling, transporting and splitting a wide range of VHF and UHF signals.

You'll be introduced to techniques of equalization—tilting or shaping an amplifier's frequency response—to prevent signal loss at the receiver, and you'll learn to predict gain and loss in terms of db, and know how much amplification to insert at a weak point, or how much attenuation is needed to knock down a strong signal that's causing overload. As the technician matures in his profession he'll learn how to plan complete distribution systems using every piece of available hardware—like splitters, taps and repeaters—and be able to wire anything from a one-horse hamlet to a megalopolis.

What if you don't know the difference between a combiner and a kitchen sink? Don't despair. Though CATV training is still sparse, training in the CATV area is offered by most of the well-known schools. Information on courses can be obtained directly from the schools or from the National Home Study Council, 1601 18th St. N. W., Washington, D.C. 20009. In addition, two small schools now are offering specialized training in CATV and both are little known. One is the National Cable Television Institute, the other is the Colorado Electronic Training Center. Even the Ivy League is entering the CATV sweepstakes in the person of Penn State. These specialty courses line up as follows:

Pennsylvania State University. This school expects to start offering CATV courses by the fall of 1969. Courses first will be through correspondence, then be offered as complete packages (instructor outlines and audio-visual aids) to other schools. The university will then start holding CATV classes at its main campus and also at Altoona, Pa. Courses will include basic electronics, CATV systems and principles, and advanced CATV systems. To find out the school's current timetable, write: Pennsylvania State University, Continuing Education, J. Orvis Keller Bldg., University Park, Pa. 16802.

National Cable Television Institute. This

(Continued on page 109)

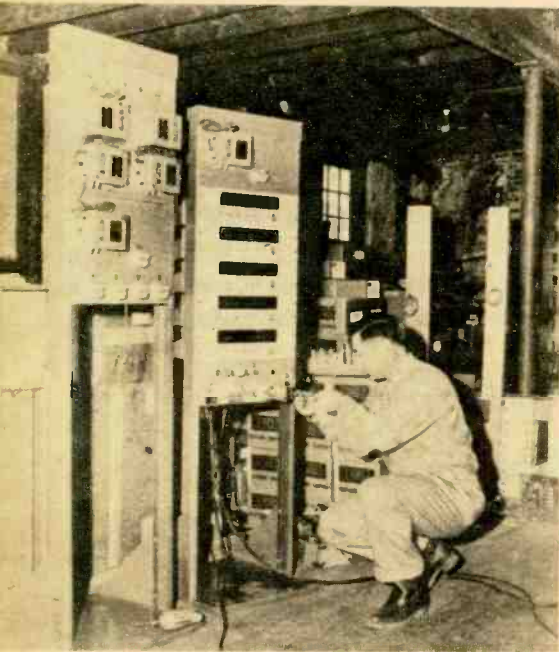

CATV technician is called upon to repair and install equipment in head end. Here, technician from Jerrold Electronics installs new components.

A Speaker for Cool Cats

By FRED SAVAGE



Over there we have Big Momma Abbie herself in a nursery box that turned into the speaker above, where you also see the reason for the nursery

WOULD you believe that this catamountainous speaker cabinet was made from a corrugated-cardboard carton in two evenings at a cost of less than a dollar? Thereby hangs a tail!

I am an impoverished person, conspired against by the U.S. Treasury, the state-income-tax bureaucrats and the robber beer barons who collectively pick my pockets clean.

Together with a pauper-type cat named Abbie Katz, I live in a little tumble-down house. Each night as we sup our gruel, or maybe share a can of tuna or a bowl of Friskies, we listen to hi-fi.

Now hi-fi is generally known to be an expensive hobby suitable only for the gentry or people of great wealth--far above our station in life.

But it is our passion and, therefore, we scrimp and scrape,



We cut reinforcing strips for Abbie's box



In go the strips with
water-soluble paste.
We fill all cracks and
make every thing
3 layers thick!

saving the price of a bit of
catnip or a chew of tobacco.

But hi as fi may be, it ends up
sounding low if the speakers do
not deliver. Unless speakers are
ensconced in proper acoustic
 housings their pear-like tones
become dissipated like a shot of
whiskey in a barrel of water.

Good speaker cabinets are
difficult to make and expensive
to buy, requiring wood, tools and
skills beyond our meager means.

Abbie suggested something for
a cabinet first. It was her old
nursery box, which once had held
three dozen bottles of toilet
water and later cradled a half-
dozen of her prize offspring.
For sentimental reasons we
couldn't discard it.

And, come to think of it, a card-
board box wasn't a bad suggestion
at all. They are as available as
the nearest grocery store. Glued-
in inserts provide excel-
lent strength, and water-soluble
linoleum paste is cheap. (Our
cabinet's inside dimensions are
10-1/2 x 6-3/4 x 6-1/2 in. The
outside dimensions are 12 x 7-7/8
x 7-1/4 in.) Acoustically the



Abbie says staplers do come in handy!



Nails and glue hold the wooden
mounting strips. That black
thing is the hole for the speaker.

A Speaker for Cool Cats

We put cotton over the speaker and fill the box with newspaper balls. Abbie says it's to kill resonances.



We solder leads to the lugs — hot stuff!

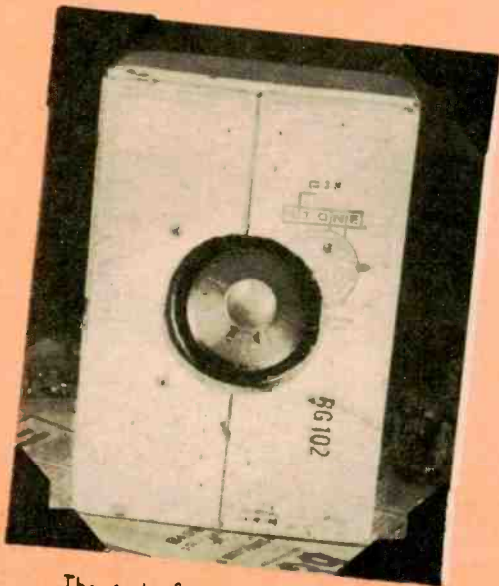

The end of our first evening
It plays!

trapped air in the corrugations provides sound absorption far superior to wood. For tools—our hands and a serrated knife! And perhaps a claw or two.

We were off! Cutting, gluing, yowling and cussing at a furious pace. The box began to take on shape and weight. Everything was three layers thick. Our excitement grew.

Then we dried it for two hours over a gas heater. The hole for the speaker was cut and an Olson S-845 (\$4.98) high-compliance 5-in. speaker was mounted. We glued and nailed in the wood stripping for mounting the back, soldered wires to the speaker and connected them to terminals.

To prevent annoying resonances we filled the cabinet with balls of lightly crumpled newspaper. But first we covered the back of the speaker with cotton batting—meaning sheets of cotton, though it could have been

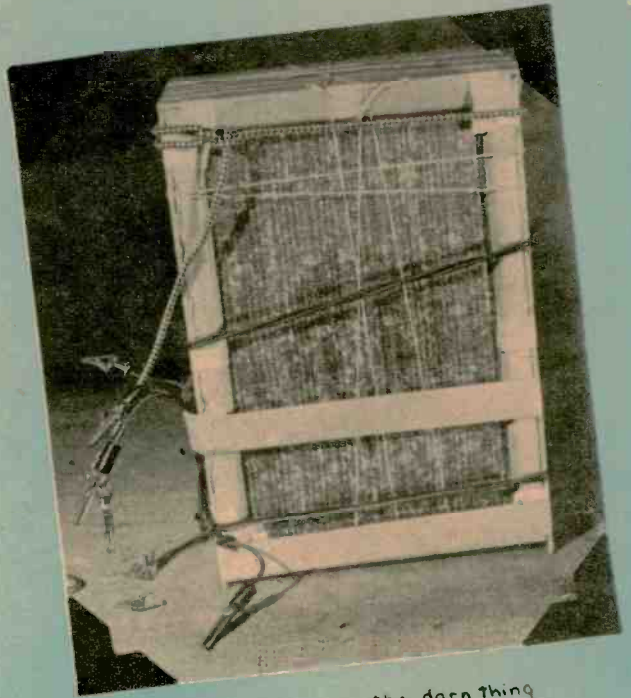

We use linoleum paste again to attach the grille cloth and frame. Eighth-inch plywood is used to dress up the outside.

We had to tie up the darn thing before it fell apart. That's Abbie's leash—and was she mad!

fiberglass wool, old socks, you name it—to prevent annoying buzzing sounds caused by the paper touching the speaker cone.

We screwed the back on and, trembling with apprehension, connected the speaker to our rig. We placed our favorite platter on the turntable and flipped the switches. The turntable rumbled, the currents circulated, and then yeow! Music from heaven! Out-sight! We settled back in contentment eating our Friskies.

The following evening we covered the cabinet with grille cloth and 1/8-in. mahogany veneer. When dry, we sanded it down and surveyed it critically. Staining and waxing would be nice but our funds were exhausted. Abbie was suggestively rolling something on the floor—a can of shoe polish.

That became the finish. Now she's looking for a new nursery box. Mistakes happen to everybody, she says.



Finished! And it's the absolute cat's pajamas, purrs Abbie, a catastrophically wonderful success that will catapult her, the Catalyst of the whole project, right into the catbird seat.

Good Reading

By Tim Cartwright

YOUR FUTURE IN COMPUTER PROGRAMMING. By Sidney Davis. Richards Rosen Press, New York, 142 pages. \$4.00

When you come right down to it, there's hardly a better example of the generation gap than the difference in attitude between us over-thirty types who still don't trust an adding machine to help balance our checking accounts every month and those seventeen-year-olds who would think nothing of designing a paper airplane by feeding all the necessary data into a computer. Now there's a gap for you.

The reason for introducing this book like that is a hunch. Namely, that many EI readers who, after being out of school for a few years, are looking for a career to get their teeth into still tend to think more of courses in radio and television servicing, rather than of getting involved with something like data processing. But the latter is much more related not only to today's opportunities but also to the kind of work you can really get your teeth into. It's probably the first thing that anyone who's restless ought to investigate.

This book explores the opportunities in computer programming. It is intended for high-school seniors and others just finishing their formal education, but I think it has even more pertinence for the kind of guy mentioned above. In an accessible and easygoing way, it talks both about the field in general and specific ways of getting into it. And the author is a man who has worked in the field and hasn't just taught a few courses. If you're one of the restless ones, I commend it to your attention.

RCA COLOR TV SERVICE MANUAL. By Carl Babcoke. Tab Books, Blue Ridge Summit, Pa. 176 pages. \$7.95

That first review wasn't intended to put down anyone really interested in servicing radio and television, because the technician shortage is growing worse and good servicemen are a joy forever in any neighborhood. If they are to be as effective as they should be, manuals like this one are really needed. It explores the specifics of RCA color circuitry (now in use, if my memory isn't faulty,

in something like 30 per cent of the color sets on the market), and it does so with a thoroughness (see illustration in box) that's very rare in servicing guides. A very complete and well organized treatise.

RADIO AMATEUR QUESTION AND ANSWER LICENSE GUIDE. By Martin Schwartz. Ameco Publishing, Willis-ton Park, N.Y. 48 pages. 50¢

Few feel more insecure than the novice ham who is about to take a license exam. This is one of those books that serve a useful function for that edgy soul, bypassing the general in favor of providing the kind of specifics he's probably going to be asked on the quiz. It won't add to your knowledge of radio theory, however.

RCA POWER CIRCUITS. RCA Electronic Components Div., Harrison, N.J. 445 pages. \$2.00

For basic information on current circuit design, nothing beats the guidebooks published by companies like RCA and Motorola. This one covers every conceivable aspect of modern solid-state power circuitry, and does so with the thoroughness and specifics we've all come to expect from this kind of publication. A must reference.

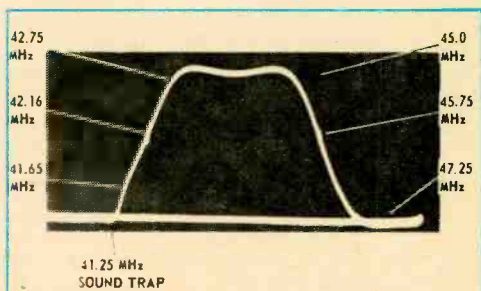

Fig. 11-5. This is the ideal theoretical IF curve.

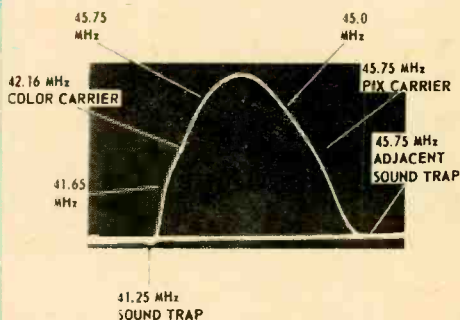

Fig. 11-6. This 'hoystack' curve gives good color, stronger than with the standard curve.

How Color TV Tunes Itself

By LEN BUCKWALTER, K10DH

THE picture looks like Technicolor worms wriggling on a hot tin roof. Or the screen goes gray when it should sparkle with the Wonderful World of Color. That's what happens when color TV isn't tuned with care. Brought up on black-and-white, which tolerates sloppy settings, most people find color tuning touchy and troublesome. But help's on the way. Virtually every TV manufacturer now offers some kind of tuning aid to tame the trickiest control of all—the fine tuning knob, the one located on the main channel selector.

Fine tuning is an unforgiving adjustment in color receivers for good reason. A color program picked off the air must penetrate a precisely aligned bandpass tunnel through much of the set. Unless the signal aims squarely at the opening, one side shears away like a woozy driver losing a fender at a toll booth. The fine tuning control lets the viewer wobble signal frequency slightly until it plops into perfect alignment.

The best way to get fine tuning on the nose manually is to select a fairly strong station and rotate the control in both directions. "You'll notice that the picture breaks down in two ways, at the two extremes; in one direction the color simply fades from the

picture, in the other it disintegrates into what looks something like a convention of hyperthyroid, multi-color dots. If you mistune even farther in the second direction audio bars begin to appear, jumping in time to the station's sound. If you *carefully* tune back until the wormy or wiggly effect *just* clears your tuning is perfect. After touchup of color and tint controls you should have the best picture your receiver can deliver on that channel.

Let's say color's perfectly tuned and you've settled in for the evening. Maybe ten minutes later color begins to fade—or writhe, as the case may be. Normal heating in the TV set causes drift that knocks off your fine-tuning adjustment. You must get up and reset it once or twice before circuit temperatures finally settle down.

Of the two systems TV setmakers have introduced to fight finicky fine tuning, the simpler is a *manual tuning aid*. It's hardly a new idea. Many's a radio set that had a Magic Eye—a green, glowing orb whose narrowing shadow revealed the best tuning point for an AM station. FM receivers use a tuning meter to prevent distortion caused by a mistuned dial. Hams and CB operators know the indicator as the familiar S-meter.

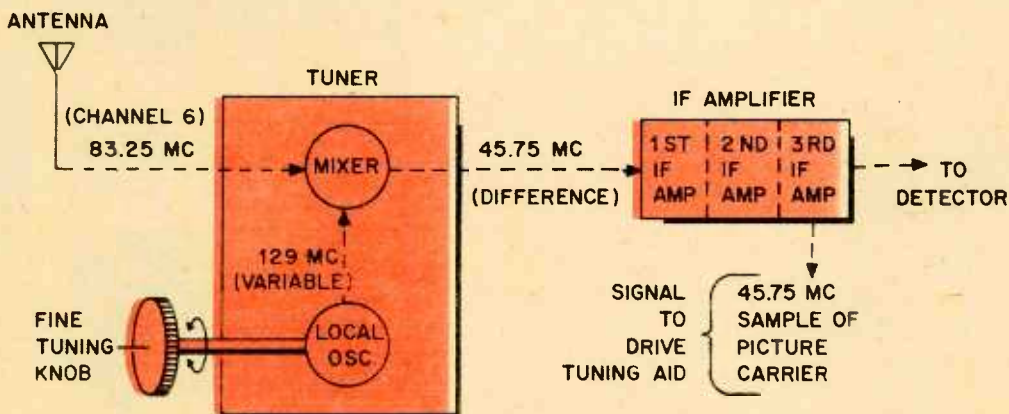

FIG. 1

Basic TV tuning circuits (shown here turned to channel 6) should deliver IF at precisely 45.75 mc for perfect tuning. Sample of IF tells whether it's at 45.75 (manual tuning) or corrects it (with AFT).

The same idea is transferred to the TV receiver, but in more elaborate form.

Most important feature of manual tuning aids is that they eliminate skill and judgment in setting the fine tuning control. The viewer, however, still must manipulate the control on each station and make corrections for drift after the set warms up.

The second tuning system is fully automatic. Again, it's neither new nor revolutionary and is used widely in FM receivers under the name AFC (automatic frequency control). When AFC appears in a TV set, though, it generally is termed AFT—for *automatic fine tuning*.

Manual tuning indicators come in a variety of guises. General Electric sets have Meter-Guide, TV's answer to a transceiver's S-meter. A needle is observed by the viewer for maximum swing while he rotates the fine tuning control. Philco and Andrea accomplish the same action with a tuning eye. Other setmakers rely on a lamp to signal when tuning's best. Motorola's called FTI (Fine-Tuning Indicator), goes dark when tuning is correct. The lamp relights to warn the viewer when drift disturbs the setting. Both Setchell-Carlson and Coronado also have a lamp indicator. (Hoffman sets have a device called Colorcaster that isn't a full-fledged tuning device. Neon lamps illuminate three color controls and merely announce that a program in color is being received.)

Westinghouse wins the prize for indicator

novelty. Called On-Screen Tuning, the system uses the TV screen itself as an indicating device. The viewer first presses a bar that causes two vertical lines to appear on the screen. As fine tuning is varied one line moves about, coinciding with the other when tuning is perfect. But the novelty comes at a price—it requires more circuits than just about any other indicator system now in use.

Nearly every leading TV maker includes completely automatic fine tuning in some model. Most AFT units operate this way: the viewer first sets up the system by pressing a switch to defeat AFT action. Next, he flips around the dial and fine-tunes each channel for best color reception. Then, AFT is switched on and left there. Whenever the main channel selector is turned from now on stations are railroaded into precise tuning. On weak signals, though, somewhat better reception is possible when the receiver is slightly mistuned. So the viewer simply disables AFT for that channel. On some sets, AFT is switched off automatically by touching the fine tuning knob. Release it and AFT returns.

Virtually all tuning aids, manual and automatic, are based on the same operating theory. They start by snaring a bit of the picture-carrier IF signal as it rides through the receiver. If the set is tuned correctly on any channel that signal always will occur on 45.75 mc. In Fig. 1, for example, the picture carrier for channel 6 enters the antenna on 83.25 mc. It is knocked down to the lower

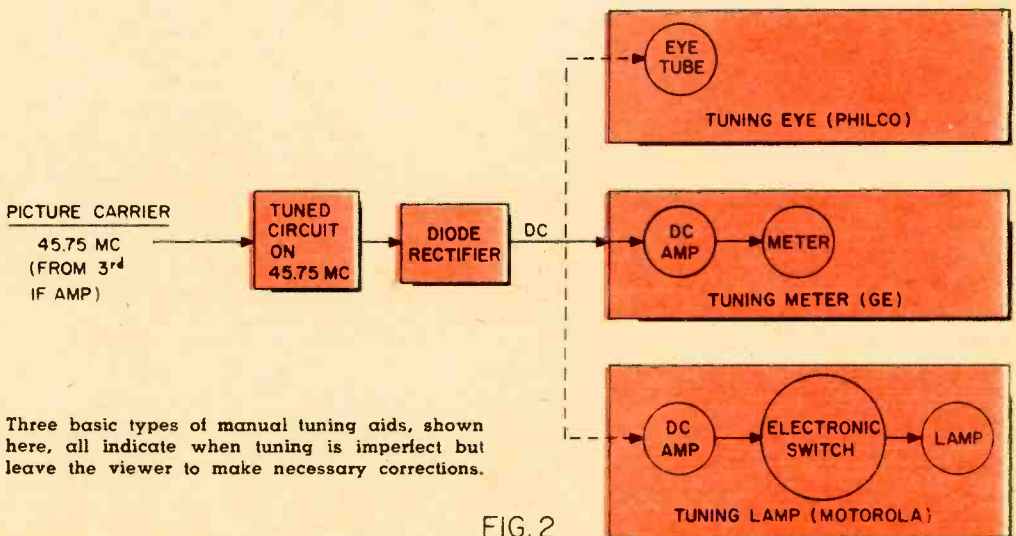

Three basic types of manual tuning aids, shown here, all indicate when tuning is imperfect but leave the viewer to make necessary corrections.

FIG. 2

How Color TV Tunes Itself

figure by mixing with the local oscillator, at the moment producing 129 mc. The difference between the two signals is the desired 45.75 mc.

The fine tuning control lets the viewer vary the local oscillator a couple of megacycles above or below 129 mc. (Other channels produce other oscillator frequencies so the result—45.75 mc—always is the same.) If the oscillator stage drifts, say, down to 128 mc, the IF signal drope (to 44.75) and picture quality suffers. The picture carrier won't fit the precisely shaped path in the IF amplifier.

The three types of indicators are shown in the simplified diagram in Fig. 2. As the viewer operates the fine tuning control, picture-carrier frequency varies. When the carrier hits 45.75 the tuned circuit resonates and the highest possible voltage appears across it. Now that the correct frequency has been selected it's converted from 45.75 mc to DC by the rectifier diode (DC is more convenient for controlling an indicator).

This DC signal, varying in strength with tuning, can operate an eye, lamp or meter. Philco for example, feeds the DC to the control grid of an eye tube. Increasing (negative) DC voltage squeezes the shadow so the viewer fine-tunes to close it. GE's system ampli-

fies the DC through a transistor to operate a tuning meter. In Motorola's tuning lamp, three transistors form an amplifier and electronic switch that highest DC signals turn off, extinguishing the lamp when tuning is perfect.

The Westinghouse On-Screen tuning system is the most elaborate of the lot. Its circuit is shown simplified in Fig. 3. The two vertical lines are created by an electronic marker that fires off a pair of voltage blips as each line scans across the screen. The marker is an electronic switch that's produced by the set's horizontal sync pulses. Since the marker interrupts the horizontal scan twice during each line, the overall result appears to the eye as vertical stripes.

Movement of the shifting vertical line is determined by a DC control voltage derived from the picture-carrier frequency. Only when the carrier is on 45.75 mc will the movable line overlap and seem to merge with the stationary line.

All AFT systems which eliminate fine tuning by the viewer can be summed up by the block diagram in Fig. 4. The system starts, like the others, with a sample of the picture-carrier signal from the set's IF amplifier stages. If that signal is exactly on frequency it will split in half at the tuned coil and cause equal and opposite DC voltages to emerge at the two diodes. At the tap-off point midway between the diodes there will be a voltage

Most elaborate manual tunings aid is the Westinghouse On-Screen Tuning. Electronic marker circuit produces two vertical lines on screen. They merge into single line when fine tuning (IF frequency) is on the nose.

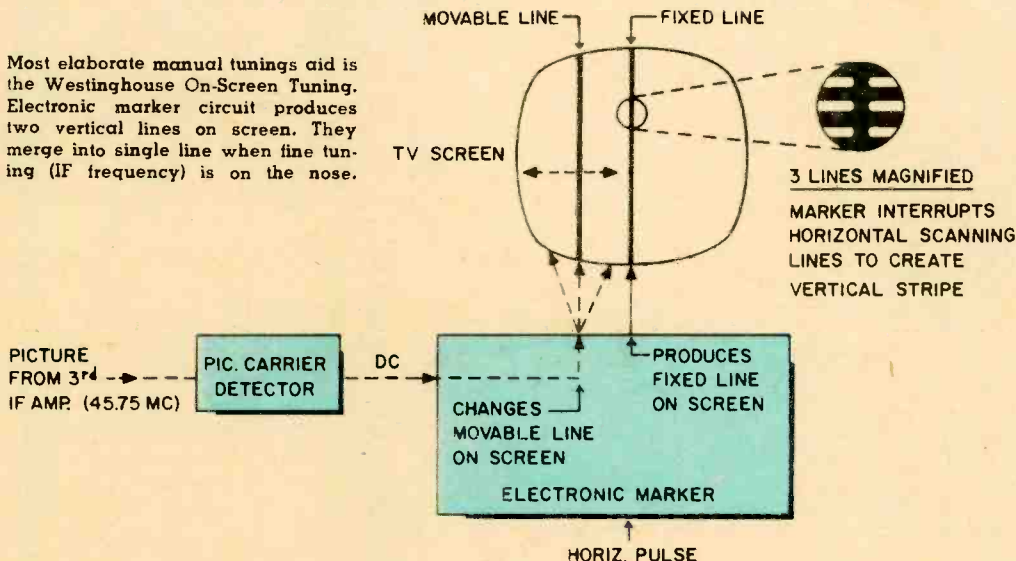

FIG. 3

sum, or 0 volts. Nothing further happens so long as the set stays perfectly tuned.

But let's assume the picture carrier has climbed to 46 mc. The coil is factory-tuned to 45.75 mc and a higher frequency splits unequally to cause unequal voltage outputs at the diodes. Now the sum voltage at the tap-off point is positive. And the higher the local oscillator drift goes the greater will be the positive output voltage. The tap-off point, therefore, becomes the source of a DC correction voltage containing two kinds of information needed to make the correction: *polarity* (+ or -) to indicate whether the carrier is high or low and *voltage* level to indicate the degree of frequency error.

To convert this information into tuning action the DC correction voltage is fed back to a varactor diode connected across the local oscillator's tuning circuits. The varactor is a semiconductor capacitor that will change capacitance when a DC voltage is applied to it. That's what the DC correction voltage does. Because the DC voltage is positive, it produces an increase in the varactor's capacitance, reducing the local oscillator's frequency. The picture carrier is shifted back toward 45.75, correcting the tuning.

If the oscillator drifts in the opposite direc-

tion (downward), an opposite (negative) correction voltage develops. It reduces varactor capacity and raises oscillator frequency back to normal. The viewer now may flip among various channels without a worry about fine tuning. It's always adjusted automatically.

To check out any tuning aid, start by adjusting the fine tuning control manually for best picture. It may be easier, incidentally, to fine-tune with the set's color control turned down for a b&w image. Add color when tuning is correct.

If the set is equipped with a tuning indicator—eye, meter or lamp—its indication should agree with the correct tuning you've set manually. If there's disagreement (and your manual adjustment is better than what the indicator says) chances are the indicator circuit is out of alignment. These devices depend on coils tuned precisely to 45.75 mc and sloppy factory alignment could upset their operation. Another possibility is that the set's IF amplifier is out of alignment.

Checking an AFT color set for correct automatic fine tuning is easy. Start by defeating AFT (with the switch provided) and tune a fairly strong station. Adjust fine tuning manually and then flick AFR back on. There

[Continued on page 117]

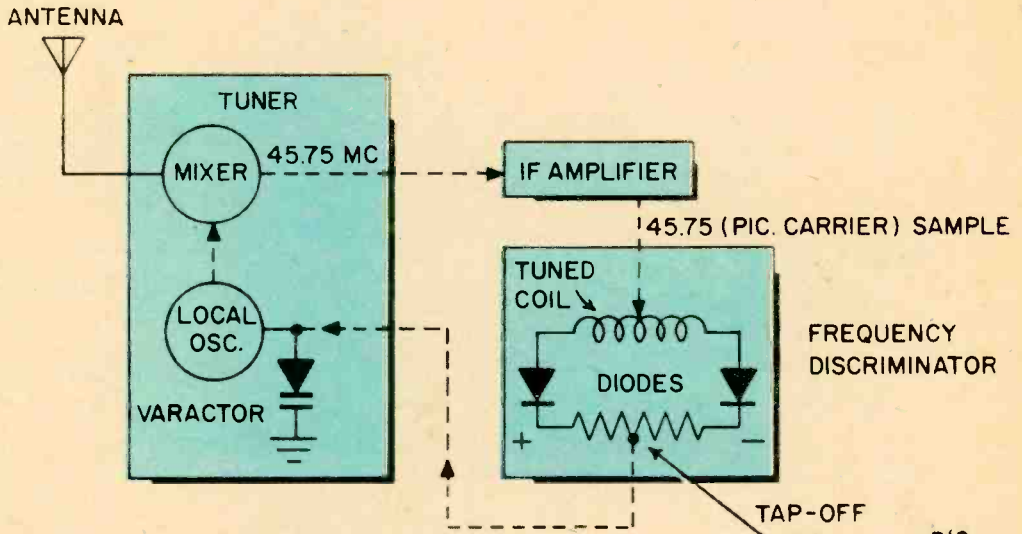

AFT (automatic fine tuning) does the job without help from the viewer. DC correction voltage fed from frequency discriminator in IF circuit to varactor in local oscillator corrects its frequency.

DC CORRECTION VOLTAGE	TAP-OFF DC VOLTS	PIC CARRIER
+	=	TOO HIGH
0	=	CORRECT
-	=	TOO LOW

FIG 4

In today's electronics boom the demand for men with technical education is far greater than the supply of graduate engineers. Thousands of real engineering jobs are being filled by men without engineering degrees—provided they are thoroughly trained in basic electronic theory and modern application. The pay is good, the future is bright... and the training can now be acquired at home—on your own time.

THE ELECTRONICS BOOM has created a new breed of professional man—the non-degree engineer. Depending on the branch of electronics he's in, he may "ride herd" over a flock of computers, run a powerful TV transmitter, supervise a service or maintenance department, or work side by side with distinguished scientists on a new discovery.

But you do need to know more than soldering connections, testing circuits and replacing components. You need to really know the fundamentals of electronics.

How can you pick up this necessary knowledge? Many of today's non-degree engineers learned their electronics at home. In fact, some authorities feel that a home study course is the best way. *Popular Electronics* said;

"By its very nature, home study develops your ability to analyze and extract information as well as to strengthen your sense of responsibility and initiative."

Cleveland Method Makes It Easy

If you do decide to advance your career through home study, it's best to pick a school that specializes in the home study method. Electronics is complicated enough without trying to learn it from texts and lessons that were designed for the classroom instead of the home.

Cleveland Institute of Electronics concentrates on home study exclusively. Over the last 30 years it has developed tech-

How to become a "Non-Degree Engineer"



niques that make learning at home easy, even if you once had trouble studying. Your instructor gives the lessons and questions you send in his undivided personal attention—it's like being the only student in his "class." He not only grades your work, he analyzes it. And he mails back his corrections and comments the same day he gets your lessons, so you read his notations while everything is still fresh in your mind.

Students who have taken other courses often comment on how much more they learn from CIE. Says Mark E. Newland of Santa Maria, Calif.:

"Of 11 different correspondence courses I've taken, CIE's was the best prepared, most interesting, and easiest to understand. I passed my 1st Class FCC exam after completing my course, and have increased my earnings by \$120 a month."

Always Up-to-Date

Because of rapid developments in electronics, CIE courses are constantly being revised. This year's courses include up-to-the-minute lessons in Microminiaturization, Laser Theory and Application, Suppressed Carrier Modulation, Single Sideband Techniques, Logical Troubleshooting, Boolean Algebra, Pulse Theory, Timebase Generators...and many more.

CIE Assures You an FCC License

The Cleveland method of training is so successful that better than 9 out of 10 CIE

graduates who take the FCC exam pass it. This is despite the fact that, among non-CIE men, 2 out of every 3 who take the exam fail! That's why CIE can promise in writing to refund your tuition in full if you complete one of its FCC courses and fail to pass the licensing exam.

This Book Can Help You

Thousands who are advancing their electronics careers started by reading our famous book, "How To Succeed In Electronics." It tells of many non-degree engineering jobs and other electronics careers open to men with the proper training. And it tells which courses of study best prepare you for the work you want.

If you would like to cash in on the electronics boom, let us send you this 44-page book free.

Just fill out and mail the attached post-paid card. Or, if the card is missing, mail the coupon at right.

NEW COLLEGE-LEVEL CAREER COURSE FOR MEN WITH PRIOR EXPERIENCE IN ELECTRONICS

ELECTRONICS ENGINEERING... covers steady-state and transient network theory, solid state physics and circuitry, pulse techniques, computer logic and mathematics through calculus. A college-level course for men already working in Electronics.

CIE
Cleveland Institute
of Electronics
1776 East 17th Street
Cleveland, Ohio 44114

Please send me without cost or obligation:

Your 44-page book "How To Succeed In Electronics" describing the job opportunities in Electronics today, and how your courses can prepare me for them.

Your book on "How To Get A Commercial FCC License."

I am especially interested in:

- Electronics Technology
- Broadcast Engineering
- First Class FCC License
- Electronic Communications
- Industrial Electronics
- Electronics Engineering

Name _____ (PLEASE PRINT)

Address _____

City _____

State _____

Zip _____ Age _____

ENROLL UNDER NEW G.I. BILL. All CIE courses are available under the new G.I. Bill. If you served on active duty since January 31, 1955, or are in service now, check box on card or in this coupon for G. I. bill information.

EI-84

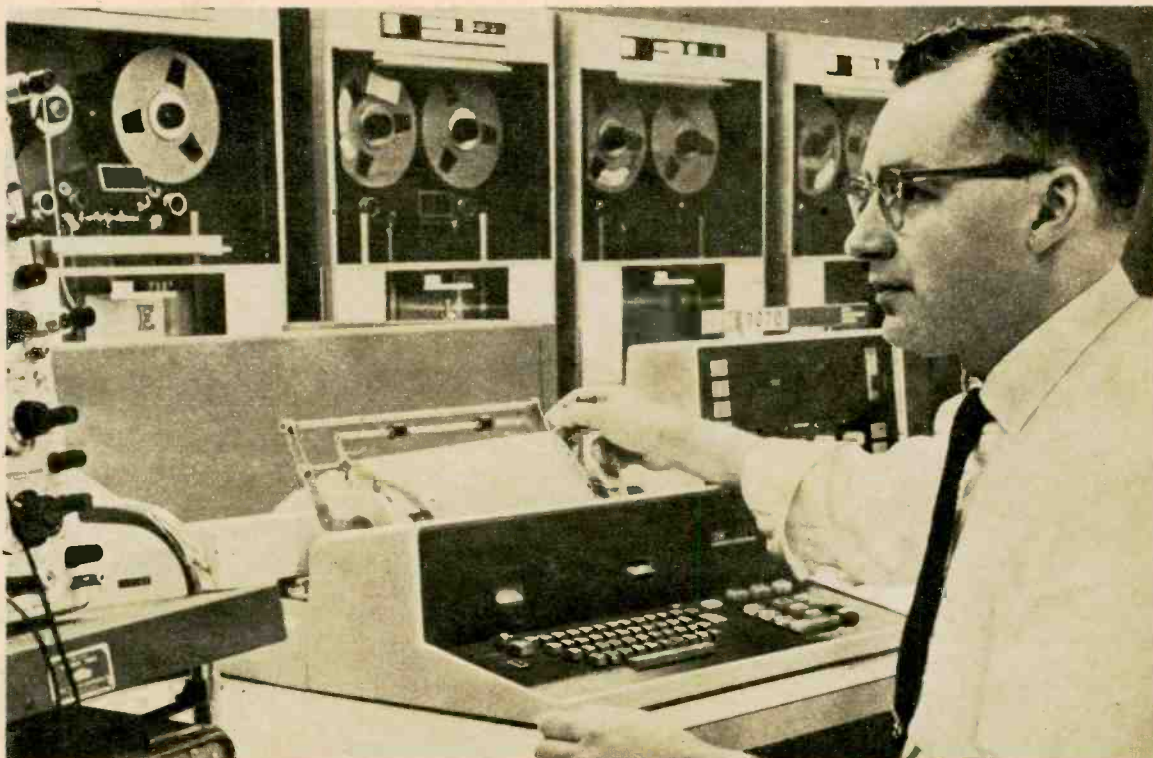



New Fun from Olden, Golden Radios

By FRANKLIN ATLEE

THE LAST five years have seen an amazing growth in the hobby of collecting antique radios. While precious few facts explain this phenomenon, no one can deny that old-time radios are a going thing.

In spite of the heavy chassis, bulky knobs, awkward speakers and tinny sound involved in old sets, people are on the prowl for better and bigger relics out of radio's glorious past. Our photos (radios from the collection of Ralph O. Williams, Wayne, Pa.) show a few examples of how engineers worked at their trade at the dawn of radio broadcasting.

A conservative estimate of the number of today's addicts would be 1,500. In one club alone, the Antique Wireless Association, there are 500 members who follow the hobby with passionate zeal. The club was established ten years ago and reached its present proportions just during the past few years. Any active member of the AWA will be glad to help you get started in what has become a fascinating and challenging hobby.

Early Receivers. Many of you know that the first official broadcast in the U.S. was made by station KDKA in Pittsburgh in 1920, when election returns went out over the air. Shortly after, additional and more powerful stations started broadcasting in large cities on the East Coast. Then stations sprang up all over the U.S., operating within the small frequency band available (250-550 kc). The Department of Commerce allocated the frequencies so as to eliminate interference. Early in 1921 the craze for tunable receivers began, and soon interest in radio grew by leaps and bounds. Manufacturers and dealers had a tremendous backlog of orders, so many small, local manufacturers got into the act to handle local distribution only.

Crystal sets were first on the market. They used a simple tuning device, a rectifying crystal and a pair of headphones. Some sets were equipped with multiple binding posts so that members of the family could enjoy listening simultaneously. Soon after the crystal set appeared, vacuum tubes requiring battery

power came on the market. Receivers using three or more tubes supplied enough power to operate a simple magnetic loudspeaker. These speakers were made in a great variety of shapes and sizes.

Of course, the cost of a multi-tube receiver (including loudspeaker, batteries and outside aerial) was high, prohibitive, in fact, to many even during the financial boom of the 1920's. As early as 1925 there were probably upwards of a *thousand* different brands, but just like the automobile business, most of them fell by the wayside, even before the Great Depression of 1929.

How To Locate 'em. When you decide to become a collector, best way to start would be to check with your parents, grandparents, older friends and neighbors. They may have old radios stored away in attics, cellars or spare rooms and be glad to get rid of them. Next, visit antique stores, country auctions, open air sales and used-furniture stores. If

the stores have nothing on hand, give them your name and address or a self-addressed postcard. Even junk shops—especially out in the country—have been known to yield remarkable finds.

If you can afford it, don't hesitate to pick up duplicates. Then when you become acquainted with fellow collectors you can arrange swaps. Prices of early radios depend upon both their internal and external condition and whether they are a brand name or a home-brew set. You may have to do a little bargaining to buy the set you want at a price you can afford, but luckily many antique dealers have no idea of the relative value of the various early models. Finally, you can always place a small classified ad in a local paper or national magazine. The Swap Shop column in EI would be a good example.

Knowing The Makes. In addition to well-known brand names such as RCA, Atwater Kent, Grebe, Fada and Freed-Eisemann.

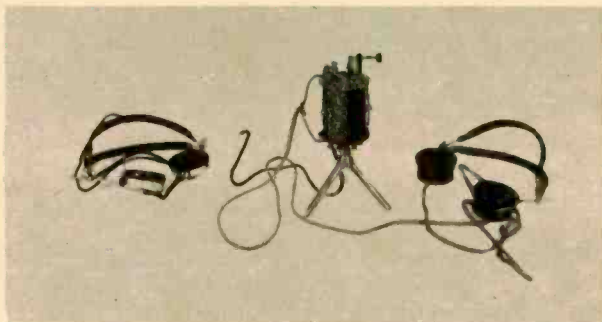

Above is **Martian Big Four** manufactured circa 1922. The circuit uses a crystal detector and features two sliders, as well as a single tuning coil.



Above is **Freed-Eisemann Model NR-5** manufactured in 1923. Three-stage TRF-Neutrodyne circuit uses five 201A tubes. It's also battery powered.

At right is **DeForest Radio's Model D-10** manufactured in 1923. Its reflex circuit uses four DeForest DV2 tubes and is powered by a battery.

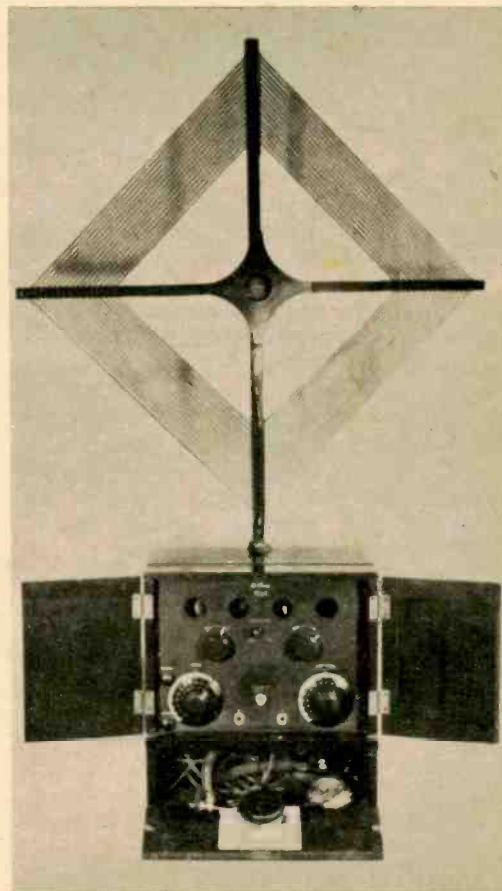

Golden Radios



Above is Federal 58 manufactured in 1922. TRF circuit has one RF stage, two audio stages and detector. Battery-powered set uses four tubes.

At right is Atwater Kent Model 12 manufactured in 1923. Six tubes are used in circuit having three TRF stages, a detector and three audio stages.



Above is Westinghouse Electric's Radiola III-A manufactured in 1924 for RCA. Circuit uses four WD-11 tubes; has regen detector, push-pull output.



there were several hundred other excellent makes, each having its own distinct characteristics and advantages. The easiest way to identify the best known models is to obtain a copy of *Greenwood's Pictorial Manual of Wireless and Radio (1905-28)* published by the Clymer Publishing Co., 1268 S. Alvarado St., Los Angeles, Calif. Price is \$3. This booklet contains illustrations, dates, descriptions and list prices of the most popular radios of the 1920's and was written by a long-time collector.

You might try to obtain early copies of *Radio News* magazine (1923-29); a local radio amateur who goes back a bit may have saved some of them. In addition, if your local library has copies of popular national magazines from the 1920's you will find full-page ads in them showing many of the leading radio receivers of that era. Inquiries in your neighborhood may also lead you to an experienced collector who knows the game. And if you can visit the Ford museum at Dearborn, Mich., the AWA museum at Holcomb, N.Y., or the Smithsonian Institute at Washington, D.C., you'll see many of these early models—most are in excellent condition. The Smithsonian has received a large quantity of this material and has had it all on display.

What Should You Pay? Make, model number, year of manufacture, internal and external condition, and appearance are the main factors which establish the list price. But

don't overlook the fact that many antique dealers and country auctioneers have no knowledge of the value of early radio sets (some antique dealers don't even handle old radios because of a lack of knowledge about their value). Those who do have them may start out by asking an exorbitant price. Still, all are anxious to make a sale, and by doing a little bargaining you often can pick up a desirable model at a reasonable price.

Some examples of my purchases during past years, all picked up at country auctions or antique dealers, are the following: a Radiola 25 (1925) with loop antenna and horn speaker for \$9; a Radiola 20 (1924) with an RCA Model 100 matching speaker for \$12; a Freed-Eisemann (1925) three-dial neutrodyne (needed only cleaning up) for \$20; an Atwater Kent (1924) five-tube breadboard set for \$1.25; a six-tube version of the same model was offered by a country antique store for \$2. Note, however, that prices have gone way up since these purchases were made.

These may have been a bit exceptional but, on the average, prices won't vary too much except for sets in nearly mint condition. A practically brand new five-tube, three-dial Grebe Syncrophase (1925) was bought for \$25 and a new Music Master horn speaker for \$20. One of the first popular sets on the market, the RCA Radiola Senior, brings from \$15 to \$30. These sets were made in large quantities and soon dealers became overstocked when larger and more



Grebe Model CR-5, above, was manufactured in 1921. Regenerative detector circuit uses one tube (either 200A or 201A) and is battery powered.

At right is General Electric's Radiola 26 manufactured in 1925 for RCA. Powered by a battery, its superheterodyne circuit uses six 199 tubes, arranged in a row.

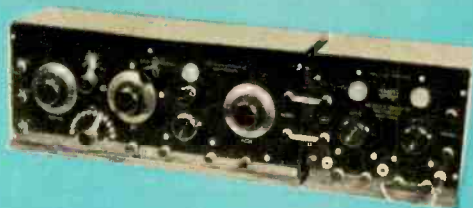

Above is Model 281 manufactured by Colin B. Kennedy Co. in 1921. Regenerative detector circuit has two audio stages; radio uses three tubes.

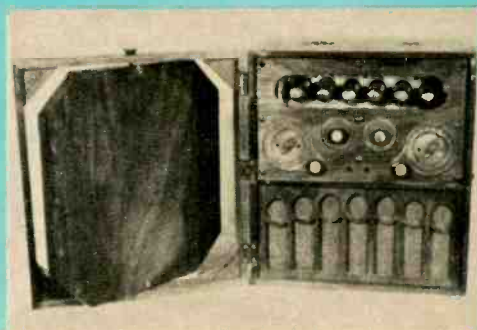

powerful models were brought out.

Condition and Restoration. Inspect the wood finish of the cabinet (dust and grease can be cleaned off), and check the condition of the control panel, knobs, dials and binding posts. Then open the lid and inspect the interior of the set for rust, mildew, missing parts or broken wiring. If you intend to make the set operative, you can, in most cases, obtain suitable replacement parts. Original replacement parts are hard to come by, but if you obtain two similar sets and need a replacement part for the better model you can cannibalize the other set for the needed parts.

Some sets have the schematic diagram pasted (or tacked) inside the lid. If not, most of the large manufacturers published service manuals for all their models, usually in a bound volume; as a last resort you can look at the complete volume of schematics for early models published by John F. Rider of New York City. Most radio wholesalers have these volumes on hand for their own reference. After making your inspection, you can then bargain with the seller and often make a satisfactory deal.

When you restore your purchase to get it in a workable and displayable condition, you'll need the usual wood refinishing items—wood putty for filling holes and dents, steel wool, a refinishing kit to restore the original finish. For interior cleaning you'll need spray contact-cleaner, old tooth brushes and pipe cleaners. Loose dust and particles can be re-

moved with the smallest tool of a vacuum cleaner. Cream furniture polish which both cleans and waxes can be used for cabinets and Bakelite panels. Use standard metal polish for metal parts. Note that it is best to remove metal parts and polish them separately.

Circuits Used in Early Sets. The earliest vacuum-tube receiver employed the famous Armstrong regenerative circuit. It used a coil in the plate circuit of the detector tube to feed back and amplify the signal. For some of these sets separate audio-amplifier units were made to permit use of a loudspeaker instead of headphones.

Next came the multi-tube tuned radio frequency (TRF) sets which had several stages of RF amplification. They used a combination of a tube, coil and variable capacitor to amplify the incoming signal before it reached the detector tube. After that, the famous neutrodyne circuit, patented by Mr. Hazeltine, came on the market. Its advantage was in preventing the squeals and whistles radiated from regenerative sets (called bloopers) that could be heard in nearby receivers. Finally, the superheterodyne circuit, first used by RCA in 1925, came into general use due to its greater selectivity. This circuit, however, was not used by most manufacturers until early in the depression when conditions rapidly took their toll on the radio industry.

[Continued on page 112]

Hi-Fi Today * Setting It Straight

By John Milder

I AM more tired than I can say (in polite language) of the increasing number of advertisements which state or imply that the tape cassette obsoletes (has obsoleted, will obsolete) the good old phonograph record. Let us say it simply—baloney. The LP record remains a miracle of information storage and retrieval (if terms like that don't make it modern, nothing will) and if it were invented now to follow tape, it would be greeted with deafening huzzahs. Oh yes, cassette machines are getting better and they have an unquestionable place in the world. But saying that the cassette will supplant the record is not unlike saying that today's excellent single-lens reflex cameras will replace the movies. Purposes and strengths are different in the case of records and cassettes as well, and the difficulties of duplicating magnetic tape economically and of finding selections on that inscrutable strip of oxide particles still remain formidable.

When the LP record is replaced, if it ever is, it will be by something resembling the CBS EVR system I mentioned last column, not by the tape cassette. In the meantime, perhaps the cassette can be applied to automated copywriting to replace the propagandists. If

anything in this world is obsolete, it's the term *new and improved*—and all that goes with it.

Now an apology. A couple of columns back, while discussing the electronic contouring of loudspeaker response, I referred to the active equalizer supplied by the Bose Corp. as part of its Model 901 speaker system. Though I said its contouring action was well-thought-out and flexible, I reported that it involved suppression of everything above the bass frequency range to equalize overall response. This isn't so, it develops—nor is the assumption that the equalizing is done to compensate for poor bass coupling occasioned by the size and placement of the 901.

I realized that the Bose device is an active one and not simply a passive loss network but I didn't know, as I should have, that it provides unity gain at frequencies above the bass range. Instead of suppressing the range above the bass segment, it boosts the low bass range as part of the system's technique for achieving extended bass at low distortion. This is independent of any need to compensate for small size or the system's unusual out-from-the-wall placement. This does call for power (a good bit of it) from an amplifier at moments when large amounts of low bass are present in musical material. At other times, only normal power is required.

I also assumed (on the basis of a listening test in an audio showroom) that the 901 was relatively inefficient. Not so, says Mr. Bose. While I don't have the time or equipment to determine the system's overall efficiency, and while the 901's use of the active equalizer makes showroom A-B comparisons extremely difficult to conduct, I have done enough listening in the meantime to be able to place the system's general efficiency within the present normal range.

All speakers in the ambitious perfectionist category, including the 901, bring out the subjectivity in most of us, and all of them have limitations (the best speaker I ever heard in my own living room was so impractical as a day-to-day device that I refused to give it houseroom for long). But I have no desire to discourage the people who make them. —

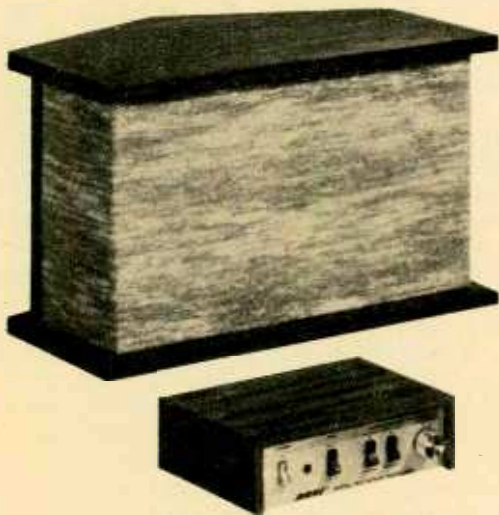

Bose 901 system uses nine 4-in.-excursion speakers but no crossover network. Equalizer (below) controls both frequency response and phase response.

The ABCs of Color Television Servicing

By Forest H. Belt

Part III: Adjusting Color Sets

COLOR TELEVISION adjustments are checked and made with a color-bar generator. The keyed-rainbow (or gated-rainbow) generator is the most popular type because it's easy to keep accurate. The patterns you will obtain are shown in Fig. 3-1 (A-E); to get these, you simply clip the generator's output cable to the antenna terminals of the receiver. The first four are white patterns—dots, vertical and horizontal bars and crosshatch; they contain no color at all. They are a guide to help you converge the three color rasters precisely all over the screen. You also can use the crosshatch pattern to inspect linearity. A nonlinear raster can make a color set hard to converge.

(By the way, it's time to take your exam on Part II. Flip to the last page, answer the questions and then return here.)

The last pattern, Fig. 3-1 (E), shows the keyed-rainbow display in black and white. A rainbow pattern, developed by circuits in the generator, is turned on and off (keyed or gated) at regular intervals along each horizontal raster line. On the full screen, the rainbow-hued raster lines make a sequence of colored bars. At the extreme left would be yellowish orange then the hue of the bars should proceed through red and blue to green at

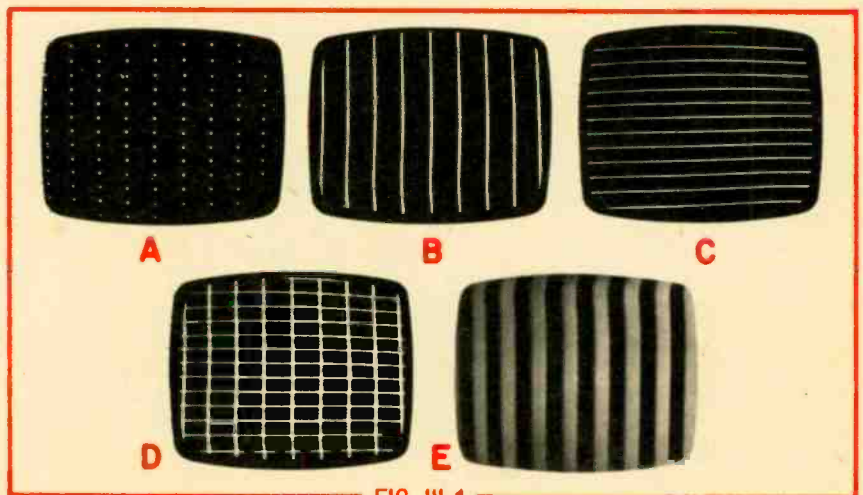

FIG. III-1

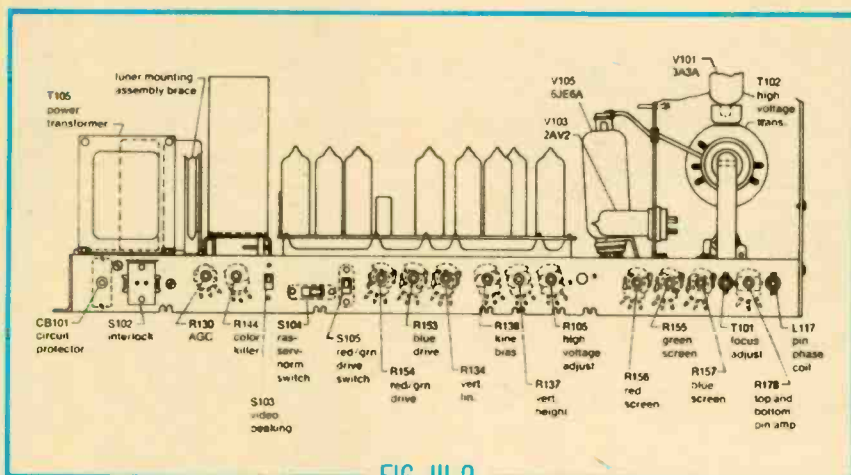

FIG. III-2

the far right. The positioning of these colors and their intermediate hues will indicate which color circuits require adjustment.

Preliminary Steps. Before you make any color adjustments, go through the same adjustments you use to set up a monochrome receiver. Before you begin the color part you should have the following equipment on hand:

- Degaussing coil
- Volt-ohm-milliammeter (VOM)
- Vacuum-tube voltmeter (VTVM) plus HV probe
- Color-bar generator
- Service data for the set
- Gun-killer jumpers (unless generator has built-in gun killers)

CAUTION: Don't undertake the color setup with the chassis out of the cabinet—or with extension cables attached. You may have to do the job over. Do any servicing first; then make sure everything is reassembled and tightened down before you start the color setup.

The service data will help you find the controls. Fig. 3-2 shows the rear-apron controls for the RCA CTC-25 chassis which we are using as the basis for this description. A service manual will often list color-setup adjustments in the order they should be carried out. By all means, use that list whenever you can. If you can't obtain the service data, don't let that scare you away. The order of adjustment is the same for most color sets.

Degaussing. Demagnetizing the screen is the first step; you should do this even if the set has automatic degaussing. For if the shadow mask is even slightly magnetized, it will be almost impossible to get good purity or convergence (explained later on). Plug the degaussing coil into the AC outlet and turn it on. The receiver can be either on or off. Move the coil around and around in circles close to the front of the screen; then do the same thing all over the sides of the cabinet so as to eliminate any slight magnetism in the metal of the chassis or the tuner assembly. Once you have gone over the entire set go over the screen once more. Then slowly back away, still moving the coil in slow circles. When you are about 6 ft. away, slowly turn the loop so it is *perpendicular* to the screen and then turn off the power. Be sure you go through this backing-away routine because turning off the coil near the screen can leave magnetized spots.

Purity of the Rasters. The object of purity adjustments is to make each of the three colored rasters pure in color. Purity is observed best with the red raster alone and with the set warmed up for at least 30 minutes. You start by disabling two of the electron guns in the color picture tube. This can be done with 100,000-ohm resistors that ground the DC voltages on the CRT control grids, thereby cutting the guns off. A few receivers already have these resistors wired to the grid-lead terminals on the printed-circuit board—all you have to do is jumper the other end to ground. Some color generators have built-in gun-killer switches. Typical gun-killer switches can be seen in Fig. 3-3 (A). In Fig. 3-3 (B) you can see the puncturing-type clips that connect the gun-killer to the solid-color wires leading to the blue and green electron guns. This feature allows you to turn these guns on and off at will.

With the blue and green guns cut off, look for signs of impurity in the red raster. An impurity would be any color other than red, even a shade of pink. The slightest off-color indicates need for a purity adjustment. You start this adjustment with the deflection yoke. Loosen its clamps and slide it backward along the neck of the picture tube. The set must be *on* so keep your fingers away from hot terminals. With the yoke pulled back, you'll see a red splotch on the screen. The position of that red splotch is what you adjust.

Now look at the rear of the yoke. You'll see thin rings that look just like positioning rings on a monochrome yoke, with tabs and all. These are the purity rings. Adjust them until the red splotch is centered. Slide the yoke forward, an inch or so at a time. Stop when the red fills the screen. A little more adjustment with the purity ring should cure any remaining impurity. However, if a pure red raster seems impossible to achieve (even when the yoke goes all the way to the bell of the CRT), degauss the CRT face again and start over. If it still isn't perfect, come back to this procedure after you're done with convergence. Also, before you tighten the yoke clamps, make sure you haven't rotated the yoke accidentally. While this doesn't affect purity noticeably, it does make the picture slant.

Horizontal and High Voltage. Next, make sure the high voltage is up to (but not exceeding) the rated voltage of the manufacturer. **CAUTION:** when you work around high-voltage and horizontal-output circuits be exceedingly cautious; unpleasant voltages often remain in the high-voltage section for

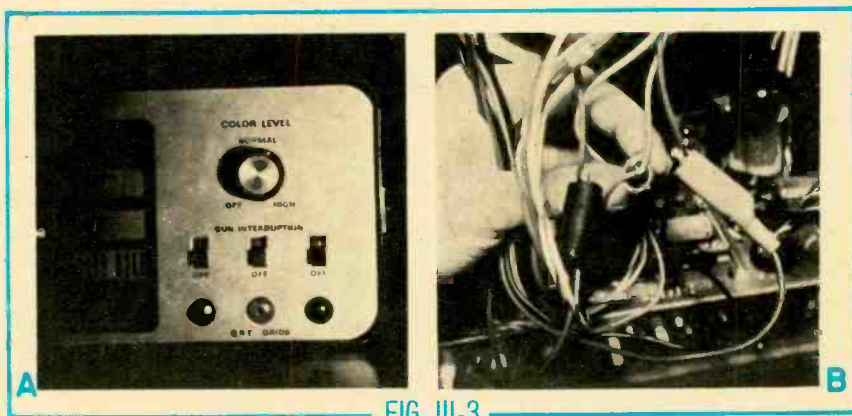

FIG. III-3

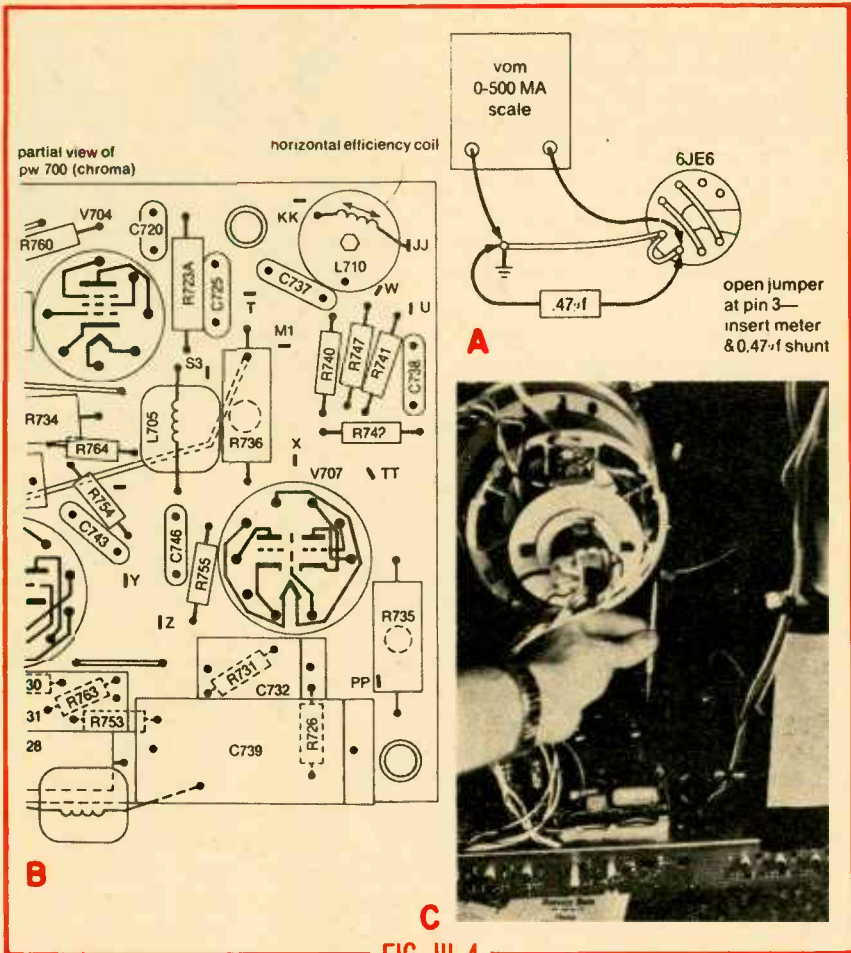

FIG. III-4

hours, even days, after the interlock cord has been unplugged.

You need your VOM, and either a VTVM with a high-voltage probe or a special HV probe that has its own built-in meter. Turn the receiver off while you ready it for these adjustments. Connect the milliammeter to measure the cathode current of the horizontal-output tube. Use the 500-ma scale. The sketch in Fig. 3-4 (A) shows how to make the connection beneath the socket of the 6JE6 tube in the CTC-25 chassis. Use a 0.47- μ f capacitor to shunt any stray AC voltages past the meter.

Turn on the set and let it warm up for five minutes. The sketch in Fig. 3-4 (B) shows the location of the horizontal efficiency coil (top right). Using the alignment tool as shown in Fig. 3-4 (C), twist the core back and forth until the exact minimum cathode current is indicated on the VOM. Then turn it counterclockwise just enough to increase the reading by 3 or 4 ma. Current shouldn't exceed 230 ma on the meter. If it does, the horizontal-output stage isn't operating correctly. If the current at minimum *dip* is less than 180 ma, the output tube is weak or some other trouble is making current low.

Now attach the high-voltage probe to the VTVM. Set the range switch

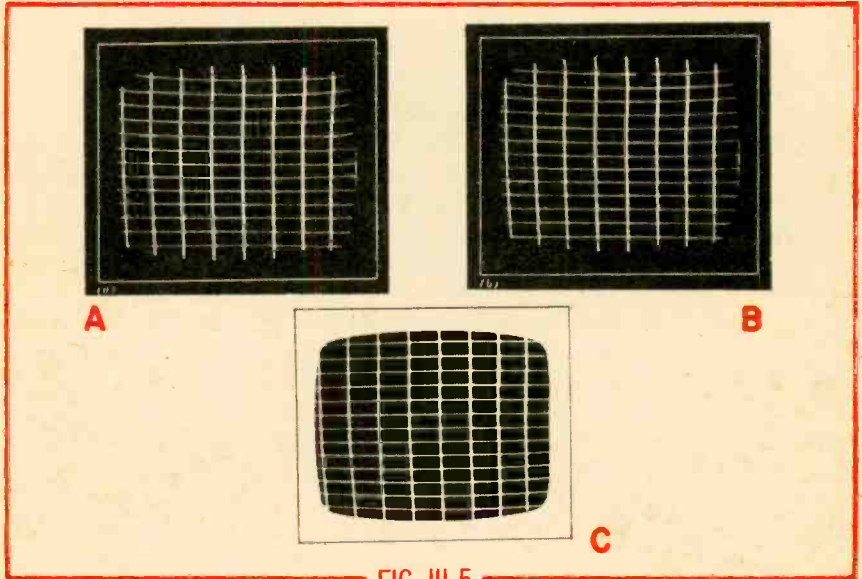

FIG. III-5

for maximum DC voltage and turn the set's brightness control all the way down. Hold the probe carefully at the rear of its handle. Clip the common lead of the VTVM to chassis ground and touch the tip of the probe to the second-anode connection of the picture tube. You may have to push the probe tip under the rubber cover. Adjust the HV Adj. potentiometer until the high voltage is exactly at the manufacturer's recommended value—no more, no less. If you don't get it exact, the chassis may produce undesirable soft X-rays. Now recheck the horizontal-output tube's cathode current (first disconnect the VTVM). If tuning the efficiency coil can't dip the current below 230 ma, check the tube's DC operating voltages. Also, try a new horizontal-oscillator tube. A weak oscillator tube can sometimes allow current in the output tube to reach too high a value.

Gray-Scale Adjustment. This step is also called the *color temperature* adjustment by some manufacturers. The object of this procedure is to make all three raster colors just the right intensity so that all shades of white

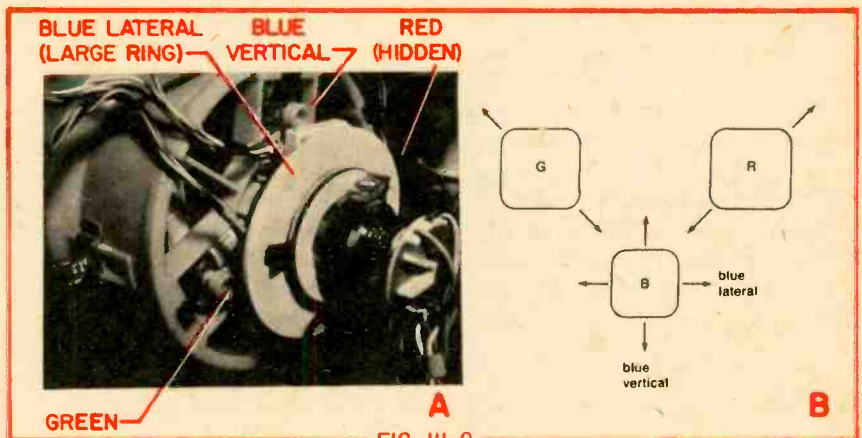

FIG. III-6

and gray will track properly. If the CRT beams don't maintain the same proportions throughout all settings of the brightness and contrast controls, the b&w raster can turn brown or some other off-color.

Several controls are provided to help maintain this tracking of grays and whites. They all affect the DC operating voltages on the electron-gun elements. The basic controls are *kine bias* (pronounced kinney and short for kinescope), *red/grn drive*, *blue drive*, *red screen*, *green screen* and *blue screen* (refer to Fig. 3-2 again). Start by turning all these controls full counter-clockwise. Turn the brightness and contrast controls to midposition. Don't worry if there's no raster on the screen once you have all the controls set.

Set the *ras-serv-norm* (Raster-Service-Normal) switch to its Service position. Turn up the *red screen* control until you get a slightly noticeable red line across the center of the screen. Next, turn the control down until the line barely disappears. Then turn the *green screen* control up and down the same way. Finally, do the same with the *blue screen* control. If one of the controls won't go high enough to make a line, turn the *kine bias* control clockwise until it does. Then do all three screen adjustments over.

Move the *ras-serv-norm* switch to *raster* and turn the control all the way up. Now adjust *blue drive* and *red/grn drive* so the raster is gray. If the raster is slightly pinkish or brownish, set the *red/grn drive* switch (on the rear apron) to *grn* and the *red/grn* control will then affect green mainly. If green dominates, change the switch to the *red* position. A few receivers have three drive controls; others have no *red drive* at all. Now move the *ras-serv-norm* switch back to *normal*. Adjust the set for a normal b&w picture. Rotate the brightness control up and down. The picture should stay black and white throughout the range of the control. If it doesn't, the gray scale is not tracking. Try again.

Pincushion Correction. Pincushioning is a bowing effect of raster lines. It is important that this adjustment be completed before an attempt is made at adjusting convergence. Fig. 3-5 (A) shows a crosshatch pattern (from your color generator) with pincushioning at both top and bottom. Pincushioning is easy to adjust; the controls that do it in the CTC-25 are labeled *pin amp* and *pin phase*. The phase control moves line curvature to the right or left, as shown in Fig. 3-5 (B). Adjust it until the bow is exactly centered. Then move the *pin amp* control to straighten the lines at both top and bottom. This effect can be seen in Fig. 3-5 (C). That completes the pincushion-correction adjustment. If you have trouble, make sure the vertical height and linearity controls are correct. If pincushioning persists, there may be a fault in the pincushion-correction circuits.

Static Convergence. All three rasters must be perfectly superimposed on one another. The beam from each electron gun must pass through the aperture-mask holes at exactly the right angle or it will light the wrong dots. Aligning the three raster beams is called convergence. There are two parts to this procedure. The first is called *static* convergence and can be done quickly. You adjust the three CRT beams so they converge perfectly at the center of the screen. The other step is called *dynamic* convergence and is more time-consuming. Here you make sure the beams converge over the rest of the screen.

Your color-bar generator should be connected to the receiver; make sure both have warmed up for at least 15 to 30 minutes. Start with a dot pattern. The only dots you are interested in are at the center of the screen.

You'll have to watch them carefully in a mirror. Even a quick glance away can make it hard to find the center ones again, so draw a grease-pencil circle on the front of the CRT; it's easily wiped off afterward and will help you keep track of the center dots. Of course, a piece of Scotch tape will do the same thing. Fig. 3-6 (A) shows the static-convergence magnet adjustments in the CTC-25. The magnets are controlled by wheels on the deflection-coils' housing. There is one static-convergence magnet for each gun. Each moves its respective beam in the direction indicated in Fig. 3-6 (B). The red and green beams move diagonally, while the blue beam moves vertically. A fourth magnet, the *blue lateral* adjustment, moves the blue beam from side to side.

You first move the green dot or the red dot into the diagonal path of the other, and then bring them together. If the blue dot gets in your way, you can temporarily kill the blue electron gun as you did earlier in the purity adjustments. Superimpose red and green so that they blend to make a yellow dot. Next, reactivate the blue gun and use the blue vertical adjustment to move the blue dot down so it's level with the yellow dot. Then move the blue dot sideways with the lateral adjustment until both blue and yellow blend to make white. At this point, examine the center dots closely. If a little red, green or blue still peeps out from behind the white dot, reset that adjustment just enough to clear it up. If necessary go through all the steps again, refining the adjustments until you get a near-perfect overlap.

So much for the center of the screen. In Part IV of this series you will tackle dynamic convergence. This part of color-set convergence affects the electron beams as they sweep across the screen with each line, and down the screen with each field. While the circuits for dynamic convergence are several and complex, the controls are gathered into a neat single subassembly. This step should prove an interesting challenge.

Examination on Part II

1. What particular stage can affect all the others?
2. Which adjustment eliminates color confetti in a black-and-white picture?
3. If you see color programs in black-and-white, the entire chroma section is inoperative. True or false?
4. Why must you consider the whole set when looking for trouble in a specific stage?
5. Which stage is most likely at fault when color is running or floating around the screen?

[Turn to page 109 for correct answers]

Next Issue:
Dynamic Convergence & Chroma Servicing
Plus Examination on Part III

CB Corner

By Len Buckwalter, KQA5012

Does Anybody Repair CB rigs?

IF you have carbuncles, see your family doctor. If your timepiece won't tick, consult a horologist. But if your CB rig is sick you may be beyond professional help. Try running your fingers through the Yellow Pages for a CB repairman and you could end up with hangnails. Shops which specialize in CB repair are about as common as Shirley Temple movies at a drive-in.

"My buddy fixes mine" is an answer more than one CBER would give. And many's the local electric tinkerer who'll succeed without a \$1,000 frequency counter or a fancy signal generator. Some sets are fixed by radio-TV technicians while a few sometimes reach a specialist in two-way communications. But he's usually too busy maintaining police, taxi or other high-price gear.

The CB repair problem, though, isn't entirely bleak. There is an occasional shop that not only welcomes your ailing CB set but boasts the technical and FCC qualifications as well. I visited one recently in Norwalk, Conn., and spoke to its owner, Burton Rudolph. After two years of catering to CBERs

and their woes, Burt has some amusing and worthwhile observations.

When I asked him about the biggest problems CBERs have with their equipment, he began discussing the open antenna circuit. Plenty of CBERs still aren't aware of what happens if they key the mike when there's no antenna connected to a solid-state rig. It usually means blown transistors in the final. Burt feels that the manufacturers still haven't come up with a foolproof system to protect these semiconductors. He urges that you avoid that button until the antenna is installed and checked.

Another antenna wrinkle shows up when CBERs come into the shop and ask him why they can't get out. After investigation, Burt usually finds that the hot side of the antenna is connected directly to the car body. Thus, the signal is effectively shorted to ground.

He also remarked that it's becoming increasingly difficult to find room to install a set under the dash of new cars. In a new Pontiac he had to fasten the rig upright along the side of a console. In another custom job he sank the rig directly into the dashboard in a neat but costly installation. In a Lincoln he located the rig in the trunk, using a small remote-control unit on the dash.

What happens when you turn on a mobile rig for the first time and reception is wrecked by ignition noise? Burt's recommendation: Install Champion Series X spark plugs. They're suppressor type and he's convinced they'll cure interference better than most. He singles out the VW and some Fords as the most prolific noise generators.

Burt thinks solid-state transceivers now can be quite good (though you only get what you pay for). He points out that transistors are no longer so sensitive to heat and overload. This was a problem several years ago when early transistors operated close to maximum ratings. Today semiconductors loaf along at about half rated wattage so there's more tolerance to prevent damage.

Otherwise, the new sets develop the same old troubles: transistors blowing, small components becoming defective, contacts getting dirty. He had few kind words about the larger

[Continued on page 116]



Believe it or not, there are professional service shops which handle CB rigs. This one, located in Norwalk, Conn., is owned by Burton Rudolph.

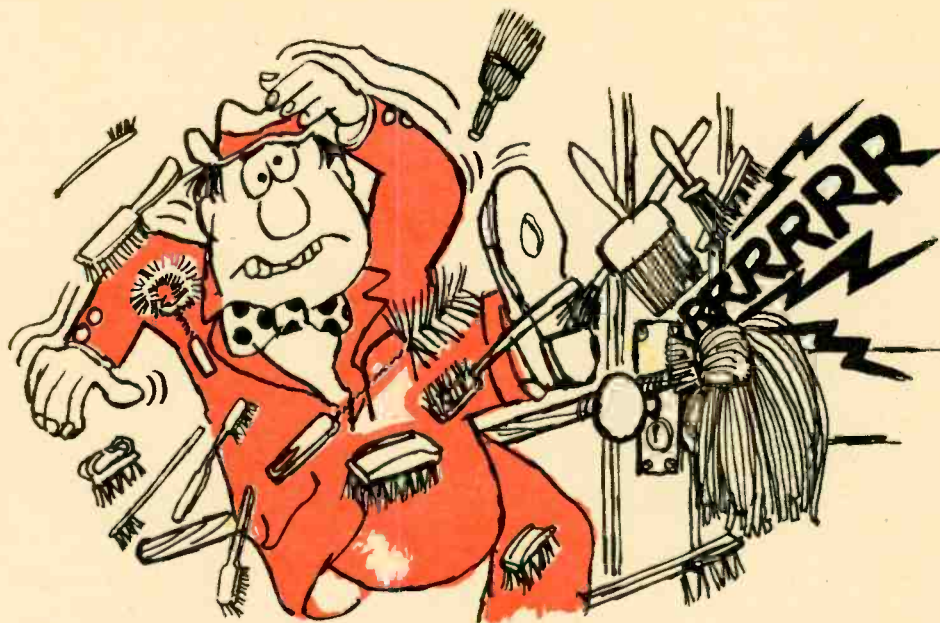

The Tipoff Intruder Alarm

By VICTOR KELL YOU'RE sitting at home alone on a grim winter night. Wind shakes the house and the darkness and rattles begin to creep in on you until suddenly you have the uncanny feeling that someone is trying the front doorknob. Your scalp tingles and your palms sweat.

By morning the terror of the night will have disappeared but at the time there's just one word for it—terror. But there's also a way to keep from getting yourself into such uncomfortable circumstances. With our Tipoff Intruder Alarm hung on the knob you'd have known instantly whether someone was trying to open the door. The alarm triggers a loud bicycle-horn buzzer if anyone so much as touches the doorknob. And in addition to alerting you, the alarm will frighten off the intruder.

The alarm is self-contained, as shown below. A wire loop connected to the binding post on top of the cabinet is used to hang the alarm on the inside doorknob. Operating current is low (about 4 ma) and the 6-V battery will deliver 100 to 200 hours of service. The circuit has been designed so the alarm's sensitivity will increase as the battery runs down. The battery will power the alarm long after it has reached its cutoff voltage. You'll know when to change the battery because the unit will become so sensitive it will be almost impossible to keep the alarm from sounding (a safety feature).



Construction. Our model is built in a 3½ x 2½ x 5-in. Minibox. Parts are crowded and if you have no experience at tight assembly we suggest you use a larger cabinet.

First step is to cut and drill holes in the main section of the Minibox and mount the cabinet components. Binding post BP1 is mounted in the center

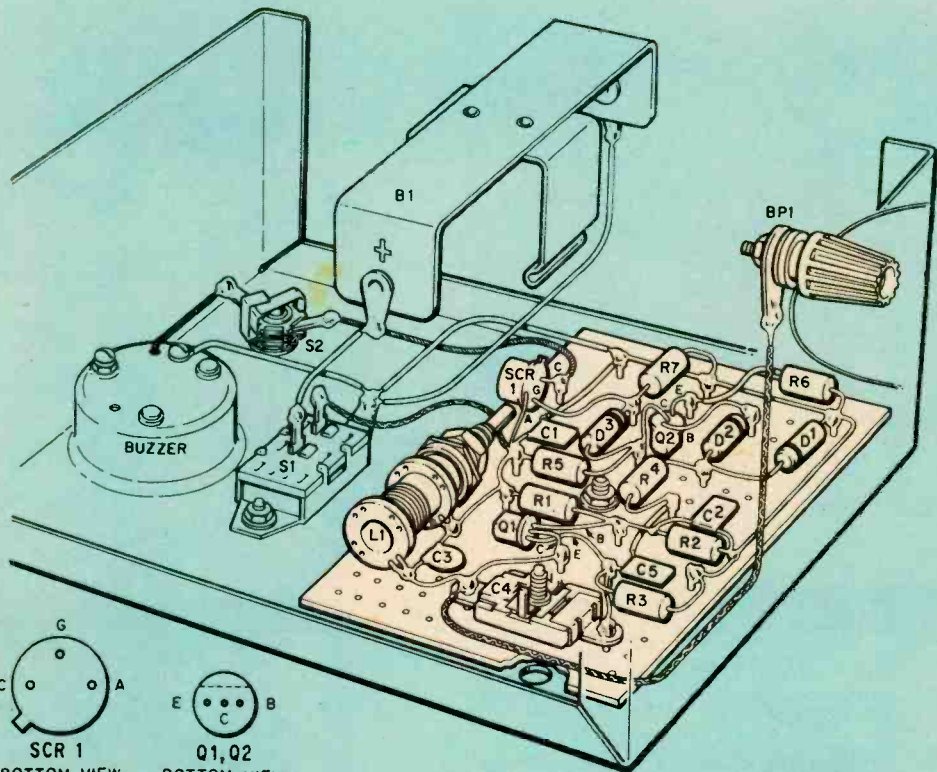

Tipoff Alarm

Placement of parts on board is critical. therefore, duplicate our layout. Note hole in cabinet under C4's adjustment screw. Route wire from BP1 to C4 as shown.

of the top of the cabinet. Using epoxy cement, mount the buzzer (from a bicycle horn) as close as possible to the bottom of the cabinet; power switch S1 goes directly above the buzzer. The *reset* switch, S2, can be mounted in any convenient space between the buzzer and S1.

Don't worry about the buzzer's voltage rating as anything from 1.5 to 6 VDC will do. Just make certain (by checking with a milliammeter) that the buzzer does not pull more than 500 ma when operated at 6 V. Even if one lug is connected directly to a ground connection. Run a separate ground lead from the case to the cabinet. Other parts are mounted on a 2½ x 2¾-in. piece of perforated board; Vector T28 terminals are used for tie points.

Drill a hole in the center of the board for a 6-32 mounting screw. Position trimmer capacitor C4 where shown, mark the location

of its adjustment screw on the board; and drill a ⅜-in. hole at the mark. Position the board so it is up against the top of the cabinet (under BP1) and mark the center of the board's mounting hole and C4's hole on the cabinet. Then drill the No. 6 and ⅜-in. holes in the cabinet and set the cabinet aside.

Mount C4 on the T28 terminals and tack-solder the lugs to the terminals. Press C3's leads through L1's terminals and solder—do not cut C3's leads short at this time. (Don't substitute for L1. Proper operation depends on L1's high Q; a coil of equal inductance but with a lower Q will not work.) Position L1 as shown, with the bottom terminal next to C4's lug and connect the lead from L1's bottom terminal to the lug. Insert a T28 terminal in the board opposite L1's top terminal and connect to L1; don't strap L1 to the board.

Mount the remaining board components, leaving R1 until last. Resistor R1 should be

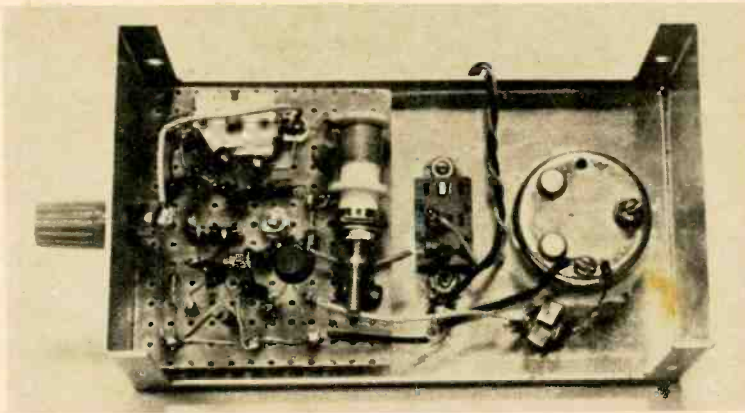

To allow room for battery, which is mounted in cover, the board assembly should be mounted against the top of the cabinet (model is shown lying on its side). Note that L1's slug must be run all the way out of the coil form.

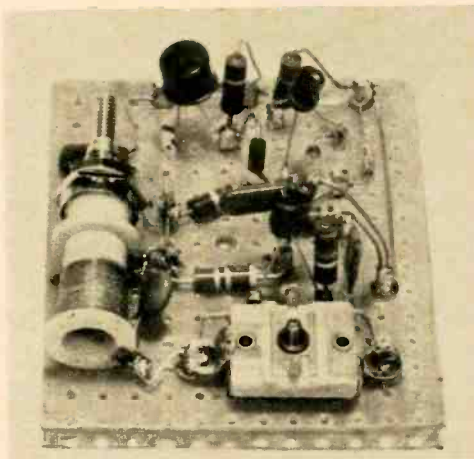

Electronic components are mounted on a $2\frac{3}{4} \times 2\frac{1}{2}$ -in. piece of perforated board. Keep area around mounting hole in the center clear of all parts.

tack-soldered and in the clear as you may have to use a different value than that given in the Parts List.

Use the transistor leads full length and use a heat sink when soldering. Cut SCR1's leads to $\frac{3}{4}$ -in., and do not cut the diode leads shorter than $\frac{1}{2}$ -in. Be sure to use a heat sink, such as an alligator clip, on each diode's lead when soldering.

Run L1's lug all the way out (full counter-clockwise) and then mount the board in the cabinet. Place a $\frac{1}{2}$ -in. stack of washers between the board and the cabinet to prevent the T28 terminals from shorting to the cabinet.

Connect BP1 to Q1's collector with insulated wire. Do not take a direct route; instead route the wire as shown. Do not make



The first construction step is to mount cabinet components. Bicycle horn's buzzer should be cemented in main section of Minibox with epoxy.

the connection from S2 to SCR1 yet. Mount battery in the cabinet cover, using a D-cell battery holder. Connect the battery's ground lead but do not connect the positive lead to S1.

Checkout. Connect an 10-ma DC milliammeter between the battery's positive lead and S1 and set S1 to *on*. The meter should indicate between 1.5 and 6 ma. If it indicates well outside this range check for a wiring error.

Disconnect the meter and connect the bat-

Tipoff Alarm

When hand touches door-knob, oscillator Q1 goes off and positive voltage is removed from Q2's base. Q2's collector voltage rises and SCR1 is turned on. This turns on buzzer.

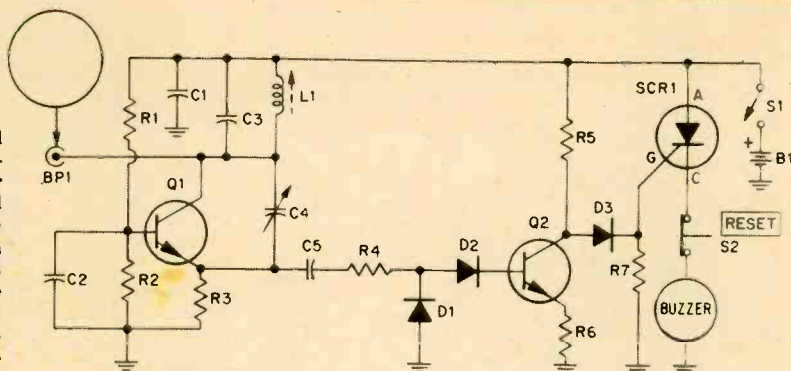

PARTS LIST

- | | |
|---|--|
| B1—6-V battery (Burgess Z4 or equiv.) | Q2—2N3391 transistor (GE) |
| BP1—Insulated binding post | Resistors: ½ watt, 10% |
| Capacitors: 9 V or higher | R1—47,000 ohms (see text) |
| C1,C2,C5—.01 μ f disc | R2—10,000 ohms |
| C3—50 μ f disc | R3,R7—1,000 ohms |
| C4—25-280 μ f trimmer capacitor (Lafayette 34 T 6832 or equiv.) | R4—470 ohms |
| D1,D2—1N60 (or equiv.) germanium diode | R5—5,600 ohms |
| D3—Small-signal silicon diode (1N907 or equiv.) | R6—15 ohms |
| L1—6.05-15.5 μ h adjustable RF coil (J. W. Miller 42A105CB1, Newark Electronics Corp., 500 N. Pulaski Rd., Chicago, Ill. 60624. Stock No. 59F188, \$2.40 plus postage. Minimum order: \$2.50) | S1—SPST switch |
| Q1—2N3394 transistor (GE) | S2—Normally-closed push-button switch |
| | SCR1—C6U silicon controlled rectifier (GE. Allied Stock No. 49 F 3 C6U-GE. \$1.57 plus postage. Not listed in catalog) |
| | Misc.—buzzer (bicycle horn), 5¼ x 3 x 2½-in. Minibox, battery holder, perforated board, push-in terminals |

tery to S1. Connect a VOM (20,000 ohms/volt) or a VTVM from ground to Q2's base. Close C4's plates (turn the screw clockwise); the meter should indicate zero or near zero. Turn C4's screw counterclockwise very slowly; the voltage should rise to slightly over 0.5 V indicating the oscillator is okay. If the voltage at Q2's base is less than 0.5 V there is a wiring error or Q1 has been damaged by soldering. If you get more than 0.5 V (between 0.6 and 0.8) move the meter probe to Q2's collector where the voltage should be zero or very close to zero (if less than 0.3 V there is a wiring error or Q2 has been damaged).

While holding the meter probe on Q2's collector touch your finger to BP1; the voltage at Q2's collector should instantly rise to more than 0.5 V, possibly even to 3 V. Removing your finger from BP1 should cause Q2's collector voltage to fall close to zero.

If everything checks out, connect the lead from S2 to SCR1's cathode (C). Turn S1 on; the buzzer should sound. Reset the buzzer by pressing S2. Now place your finger on BP1; the buzzer should sound.

If the buzzer comes on and stays on—you

cannot turn it off with S2—check the voltage at Q2's collector. If it is nearly zero (below 0.3 V) SCR1 is defective. If the buzzer can be reset the alarm is ready for installation and use.

Using the Alarm. Attach a small wire loop to BP1 and hang the alarm on a doorknob. Hold down S2 so the buzzer won't sound and set S1 to on; release S2. If the buzzer sounds when S2 is released adjust C4 in a very small increments starting from full clockwise until S2 resets the alarm. Touch your finger to the doorknob and the buzzer should sound. If it fails to, check for and remove paint which might be insulating the wire loop from the doorknob.

Depending on the transistor characteristics the alarm might be so sensitive it will be tripped when a hand just gets near the doorknob. To reduce sensitivity change R1 to 39,000 ohms.

The alarm will always work with a doorknob or latch assembly mounted on a wood door. It will not work if the door is metal unless there is no electrical connection between the doorknob or latch and the metal door.

The Listener

By C. M. Stanbury II

Hawaiian DX

ACCORDING to a report carried by the North American SW Association, the Billy Graham Evangelistic Association is considering construction of a short-wave broadcast station on the island of Maui; most of the programming would be produced in Honolulu, where Graham people already operate BCB Station KAIM on 870 kc. If the FCC says okay, it will be the first such license issued since the FCC put a freeze on all new international broadcast stations after the WINB-Carl McIntire fiasco.

Looking into our crystal ball, we predict the FCC will delay as long as possible before making a decision on this one. If the Commission does give the go-ahead, it probably will have to let WINB stay on the air, too. So if the Graham Association can't be persuaded to operate from another country (and in view of the close personal relationship existing between Billy Graham and President Nixon) you can expect both KAIM and WINB will become permanent fixtures on the American short-wave scene.

Now, focusing still more attention on our 50th state (which counts as a separate DX country), the same issue of NASWA's publication *Frendx* claims that the VOA's Honolulu relay has returned to the short-wave wars (note that the Voice rates as WINB's arch-enemy). However, with the exception of regular maintenance checks which have been carried on ever since the station closed, the latest official VOA frequency schedule clearly denies the *Frendx* claim. But who knows, maybe this NASWA story will turn out to be as prophetic as the KAIM piece.

In any event, to log Hawaii, DXers don't have to wait for either Billy Graham or the Voice of America, as two excellent prospects are already on the scene—the Maui time station WWVH (on the air 24 hours a day using 5,000, 10,000 and 15,000 kc) and Honolulu Aeradio (KVM), which has weather broadcasts 25 and 55 minutes past each hour on 2980, 5519 and 8905 kc. Both WWVH and KVM are excellent verifiers.

Space Note . . . For some time DXers have been looking for an inexpensive, fully as-

sembled VHF converter which takes in the 136-138 mc space band. Tompkins Radio Products, Woodsboro, Tex. 78393, is now offering such a unit. The Tunaverter Pro works with any BCB receiver (though a local on 1500 kc might cause some problems) and is powered by a small 12-V dry cell or a 12- or 6-V car battery. The converter can be ordered for any 10-mc segment between 108 and 175 mc, but we suggest the 128-138 band so that you can cover both aircraft and satellites. It costs \$34.95 plus \$5 for each crystal (it can hold two at a time).

The Tunaverter Pro's big feature is that you can pick the satellite you want to hear in advance, and then by purchasing the appropriate crystals, know you are tuned dead on that space vehicle's channel. Though the converter is advertised for space monitoring, it's not tremendously sensitive (being designed for 1-mv signals; DX techniques, though, could stretch this), so only satellites directly overhead would be audible—using a good antenna.

Those who have a few dollars to gamble on their DX talents might try a couple of the following frequencies (in mc):

- 136.080....Isis-A and Alouette II/Canadian
- 136.560....Ariel 3/British
- 136.620....Explorer 39/American
- 136.800....EGRS III/American

There is a great need to develop DX techniques in space.

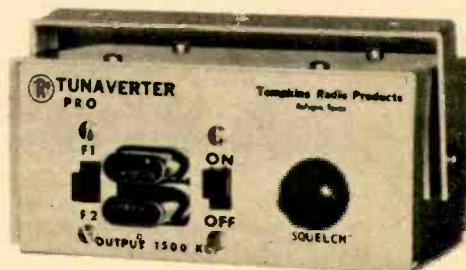

Tunaverter Pro manufactured by Tompkins Radio Products allows you to DX in space with little expense. It covers frequencies from 108 to 175 mc.

El Kit Report

Everyman's Sideman

Knight-Kit KG-392



TAKE a rock group or solo guitar, add a dash of hard-rhythm accompaniment and the audience will swing as it never did. But what if you don't know a good drummer or can't afford one?

No problem. Allied Radio's Knight-Kit KG-392 Combo Sideman (\$49.95) can spice your music with the sounds of a bass drum, snare drum and cymbals. Measuring only 7½ x 7¼ x 2-in., the Combo Sideman produces six rhythms whose speed can be varied over a wide range. Powered by a 9-V battery, its output can be fed to any musical-instrument or hi-fi amplifier.

Take a look at the controls in the photo above. The *tempo* knob at the left sets the speed. The *rhythm* knob in the center selects any one of six rhythms which can be changed while the unit is operating. The *volume* control at the right controls signal level to external amplifier. The dark push button at top, right, starts and stops the rig. (The Combo Sideman also can be started or stopped with a foot pedal.) Press the light button and the circuit produces repetitive drum beats. Another foot switch can be plugged in to control this function.

The start-to-finish assembly time was just under two hours—an easy one-evening project. The band-in-a-box worked the first time it was connected to an amplifier/speaker system. Allied includes a phone-jack patch cord, a 9-V battery, one foot switch and solder.

Construction is almost foolproof. However,

care is required when soldering the ends of the cable harness to the various terminals on the circuit board and on the controls. The harness is supplied assembled with every colored wire cut, positioned and stripped.

Following the clear instructions almost guarantees that the Sideman will work the first time. The critical sound generators and rhythm counters and decoders are supplied assembled on a circuit board. A few bare wires, one insulated wire and one resistor complete the assembly. Wiring is somewhat tight on the rhythm-selector switch. We would advise using a small-tip pencil iron of approximately 30 watts.

How does the Sideman perform? Great! Six rhythms are available and they can be changed while one is playing. Tempo is variable from the slowest blues rock to the speed of a galloping thoroughbred. The output signal level is adequate for just about any amplifier.

The sound is realistic and the rhythms are precise. The cymbal effect rings true and the bass drum is as good as the real thing. To a purist the snare drum might not sound authentic but it is adequate and gives the drive you want.

Several rhythms are clearly hard rock. One rhythm is well suited to slow rock ballads while three rhythms played at high speed make a pretty good samba/merengue accompaniment. One setting, which beats out a hard rock beat at slow tempos, becomes a good

polka beat at a fast tempo setting.

Best way to describe the rhythm the Sideman produces is to look at musical notations A through D below. The top notes represent cymbals. The middle notes represent the snare drum. The bottom notes represent the bass drum. To our ears, the sounding of the snare and bass drums seemed as though they were governed by the repetitive cymbal beats; the snare drum supplies the accents.

Rhythm A differs in tempo range from the other five rhythms since the cymbal (in all settings and with the tempo control at the same setting) triggers four quarter notes every 12 cymbal notes. In the other five positions (B, C, D, E, F) the cymbal triggers four quarter notes every eight cymbal notes. In other words, in rhythm A, the cymbal sounds as eighth triplets (three eighth notes in one quarter note) while in position B through F the cymbal sounds as regular eighth notes (two eighth notes in one quarter note). The tempo range in position A is $\text{♩}=40$ (40 quarter notes per minute) to $\text{♩}=180$. Thus, the tempo range ratio is 4.5:1. For positions B through F the range is $\text{♩}=60$ to $\text{♩}=270$. (The $\text{♩}=270$ should really be written $\text{♩}=135$ since no one can count four beats in one second.) The tempo range ratio, of course, still is 4.5:1. The minimum and maximum tempo speeds can be adjusted internally over a wide range. The factory setting however, will be satisfactory for most music.

The adjustments to the circuit-board controls produced the following effects. *Bass-drum pitch*: Some control; lowered pitch slightly. *Bass-drum sustain*: No control. Factory setting is fine; however, no improvement judged necessary. *Bass-drum volume*: Wide

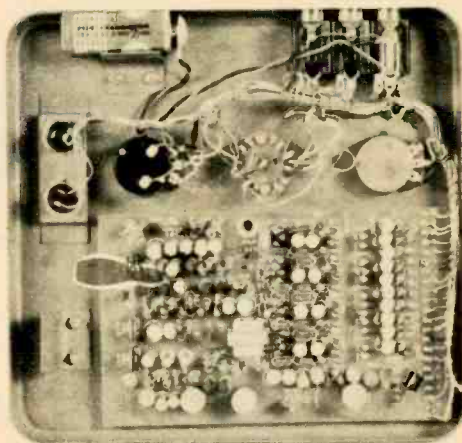

Circuit board in lower half is supplied assembled, as is cable harness. All you do is connect cable harness to board, jacks, controls and switches.

degree of control. Slightly increased volume from factory setting although factory setting is adequate. (Really depends on speaker.) *Noise volume*—(cymbal ring): Wide degree of control. Preferred setting is at maximum. Factory setting was less than maximum. *Overall Gain*: Factory set at maximum. No point in decreasing. *High-Hat volume*: (cymbal): Wide degree of control. Increased volume slightly over factory setting.

To sum it up, rhythm A simulates the well known eighth triplet slow-rock ballad and is variable from $\text{♩}=40$ to $\text{♩}=180$. The remaining five rhythms vary from $\text{♩}=60$ to $\text{♩}=135$. A simple screwdriver adjustment of a potentiometer on the circuit board affords complete tempo variation. Whatever your bag, the Combo Sideman will fill it perfectly. 



A



B



C



D



E



F

Rhythms produced by the Combo Sideman are shown as musical notations in the construction manual. Top notes represent the cymbal. The middle notes represent the snare drum. Bottom notes represent bass drum.



At ultra-high frequencies electronic components take on weird shapes!

By JORMA HYYPIA

HOW CAN you squeeze troublesome inductance and reactance (resistance to changes in AC) out of a resistor? One way is to make a resistor in the shape of a Moebius loop—a century-old mathematical oddity that is based on a geometric surface having only one side and one edge.

Under ideal circumstances, a resistor should provide only resistance, a capacitor only capacitance and an inductor only inductance. Unfortunately, in high-frequency circuits (UHF and microwave) and especially in pulse applications such as radar, the design and operation of such circuits is greatly affected by the unwanted reactance inherent in these components. The higher the frequency, the more critical these parasitic values are.

A unique solution to one of these problems (making low-value resistors non-reactive) has been found by Richard L. Davis, an electronics engineer with the Sandia Laboratories in Albuquerque, N.M. Davis reasoned that if current passing through a resistor could be divided into two equal components whose electromagnetic fields cancel out, the reactance of the resistor would be small. How could such a resistor be made? The Davis solution was to add a simple Moebius twist to a ribbon- or wire-conductor resistor.

Kooky Loops. Perhaps the best way to visualize the construction (and operation) of a Moebius resistor is to make a couple of Moebius loops from long strips of paper that are about an inch wide. First make the basic loop by joining (with tape) the two ends of a single strip after you have given the strip a half twist. This loop has only one surface! Prove this by drawing a line along the full length of the strip, right back to your starting point (see lead photo). The line will cover both sides of the strip.

A Moebius resistor, however, must be constructed with two conductive ribbons, with or without a separating dielectric layer. So now make another Moebius loop, this time using two identical strips of paper, one on top of the other; again, give the strips a half twist before joining the opposing ends together. Label one of the splices *input*, the other *output*.

It may appear that there are still two separate loops—a pencil between the strips can be slid completely around the loop back to the starting point. Actually, there is just one loop. You'll see this when you attempt to separate them. The two paths that the input current will take to the output terminal can be traced once the loop is opened.

How It Works. The input pulse that's ap-

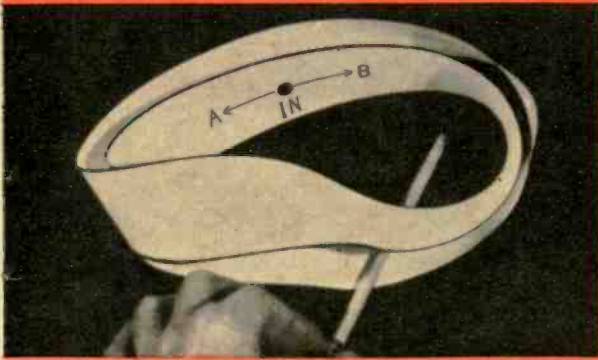

Two paper loops simulate Moebius resistor made of two conducting ribbons and separating dielectric. Input and output terminals must be opposite.

Actual prototype of Moebius resistor is shown at right. The resistor strip can be wound into a compact bundle without adversely affecting its performance. Thin films may be next design.

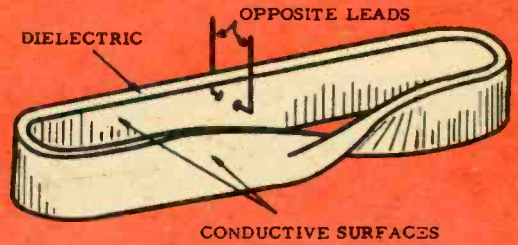

Moebius loop resistor has only one continuous conducting surface. Dielectric material separates opposing surfaces of the conductor. Leads are exactly opposite.



▲ Sandia Laboratories ▼

plied to one of the terminals divides into two equal components which travel in opposite directions. This happens because the impedances of the two paths to the output terminals are identical. Since one pulse loops to the right while the other heads left, they cannot interfere with each other. Then, when the pulses have traveled half way to the output—where DC resistance is one half the total value—the pulses are at equal potential and of opposite phase. By the time they reach the output, their potentials fall to zero.

The two terminals must be exactly opposite each other otherwise the resistor becomes inductive (the pulses wouldn't be 180° out of phase and residual magnetism would be present). While it is preferable to eliminate lead wires whenever possible (to avoid stray capacitance), a resistor that is slightly capacitive can be nulled into balance if you adjust the lengths of the leads.

Davis' first experimental resistor was made of aluminum-tape conductor placed on masking tape. The masking tape serves as the dielectric. It had a 0.022-ohm resistance and 0.003- μ h residual reactance. The time constant (1.3×10^{-7}) was very low for such a small resistance. These values may seem ridiculously low to people who experiment at audio and lower RF frequencies, but as you get up into the spectrum such component values have tremendous effects on a circuit.

Tuned UHF [Continued on page 117]



Richard L. Davis, inventor of Moebius resistor, shows how this component looks before it's bundled into a compact package.

Someone
should develop
an easy way
to learn
electronics at
home

**RCA Institutes
did!**

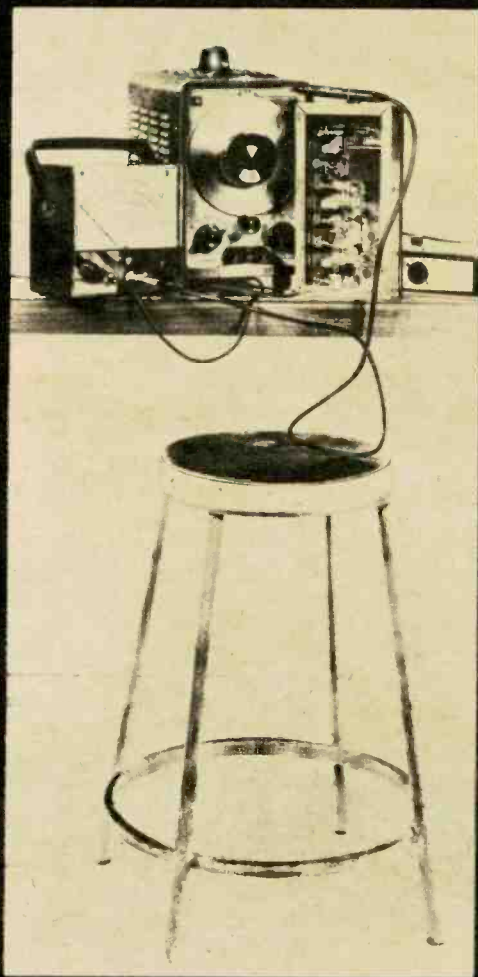

Here is a modern approach to learning electronics at home! RCA Institutes, one of the nation's largest schools devoted to electronics, has developed a faster, easier way for you to gain the skills and the knowledge you need for the career of your choice. Here for the first time is a student-proved, scientifically designed way to learn. If you have had any doubts in the past about home training in electronics—if you have hesitated because you thought you might not be able to keep up—or that electronics was too complicated to learn—here is your answer! Read how RCA Institutes has revolutionized its home training ideas!

**NEW courses
in Solid State Technology
and Communications
Electronics.**

**Mail card today
for full information.**

**ALL CAREER PROGRAMS
BEGIN WITH "AUTOTEXT"
INSTRUCTION METHOD!**

**Prepare for the field of your
choice immediately!
No previous training or
experience in electronics
needed!**

With this new revolutionized method of home training you pick the career of your choice—and RCA Institutes trains you for it. RCA's Career Programs assure you that everything you learn will help you go directly to the field that you have chosen! No wasted time learning things you'll never use on the job! The Career Program you choose is especially designed to get you into that career in the fastest, easiest possible way!

And each Career Program starts with the amazing "AUTOTEXT" Programmed Instruction Method—the new, faster way to learn that's almost automatic! "AUTOTEXT" helps even those who have had trouble with conventional home training methods in the past. This is the "Space Age" way to learn everything you need to know with the least amount of time and effort.

CHOOSE A CAREER PROGRAM NOW

Your next step may be the job of your choice. Each one of these RCA Institutes Career Programs is a complete unit. It contains the know-how you need to step into a profitable career. Here are the names of the programs and the kinds of jobs they train you for. Which one is for you?

Television Servicing. Prepares you for a career as a TV Technician/Serviceman; Master Antenna Systems Technician; TV Laboratory Technician; Educational TV Technician; CATV Technician. Available with or without a TV Receiver Kit. Kit complete except for picture tube... an optional extra.

FCC License Preparation. For those who want to become TV Station Engineers, Communications Laboratory Technicians, or Field Engineers.

Automation Electronics. Gets you ready to be an Automation Electronics Technician; Manufacturer's Representative; Industrial Electronics Technician.

Automatic Controls. Prepares you to be an Automatic Controls Electronics Technician; Industrial Laboratory

Technician; Maintenance Technician; Field Engineer.

Digital Techniques. For a career as a Digital Techniques Electronics Technician; Industrial Electronics Technician; Industrial Laboratory Technician.

Telecommunications. For a job as TV Station Engineer, Mobile Communications Technician, Marine Radio Technician.

Industrial Electronics. For jobs as Industrial Electronics Technicians; Field Engineers; Maintenance Technicians; Industrial Laboratory Technicians.

Nuclear Instrumentation. For those who want careers as Nuclear Instrumentation Electronics Technicians; Industrial Laboratory Technicians.

Solid State Electronics. Become a specialist in the Semiconductor Field.

Electronics Drafting. Junior Draftsman, Junior Technical Illustrator; Parts Inspector; Design Draftsman Trainee Chartist.

SEPARATE COURSES

In addition, in order to meet specific needs, RCA Institutes offers a wide variety of separate courses which may be taken independently of the Career Programs, on all subjects from Electronics Fundamentals to Computer Programming. Complete information will be sent with your other materials.

CONVENIENT PAYMENT PLANS

RCA Institutes offers liberal monthly payment plans to suit your budget. Be sure to check out all the RCA extras included at no additional cost.

VALUABLE EQUIPMENT

You receive valuable equipment to keep and use on the job—and you never have to take apart one piece to build another.

Programmed Electronics

Breadboard. You now will receive a scientifically programmed electronic breadboard with your study material. This breadboard provides limitless experimentation with basic electrical and electronic circuits involving vacuum tubes and transistors and includes the construction of a working signal generator and superheterodyne AM Receiver.

Bonus From RCA—Multimeter and Oscilloscope Kits. At no additional cost, you will receive with almost every RCA Institutes Career Program the instruments and kit material you need to build a multimeter and oscilloscope. The inclusion of both these kits is an RCA extra.

**CLASSROOM TRAINING
ALSO AVAILABLE**

RCA Institutes maintains one of the largest schools of its kind in New York City where classroom and laboratory training is available in day or evening sessions. You may be admitted without any previous technical training; preparatory courses are available if you haven't completed high school. Coeducational classes start four times a year.

JOB PLACEMENT SERVICE, TOO!

Companies like IBM, Bell Telephone Labs, GE, RCA, Xerox, Honeywell, Grumman, Westinghouse, and major Radio and TV Networks have regularly employed graduates through RCA Institutes' own placement service.

**SEND ATTACHED POSTAGE PAID CARD
FOR COMPLETE INFORMATION, NO OB-
LIGATION.**

All RCA Institutes courses and programs are approved for veterans under the new G.I. Bill.

Accredited Member
National Home Study Council

IF REPLY CARD IS DETACHED—SEND THIS COUPON TODAY

RCA INSTITUTES, Inc., Dept. EI-N9
320 West 31st Street, N.Y., N.Y. 10001

Please rush me FREE illustrated catalog. I understand that I am under no obligation.

Name _____ Age _____
(please print)

Address _____

City _____

State _____ Zip _____



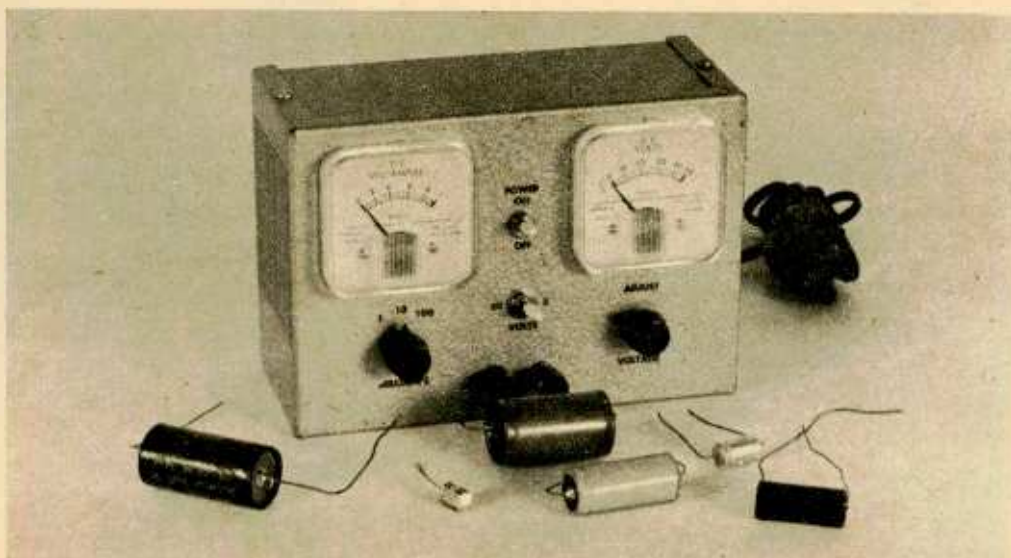

Electrolytic Leakage Checker

Leaky electrolytics change transistor bias and foul up electronic circuits.

By VICTOR KELL

CAPACITOR problems once could be solved easily—in the days of vacuum-tube equipment, that is. Nine times out of ten the trouble was a bad electrolytic filter capacitor which gave itself away with hum from the speaker, bars in a TV picture or severe audio distortion.

But solid-state equipment is different. Because of low transistor bias currents, just a slight excess current leakage through what appears to be a good capacitor is all it takes to completely disable a circuit. The higher the transistor's gain the more prone it is to this type of failure. As examples of allowable tolerances, a 320 μa leakage current in a 1- μf coupling capacitor is sufficient cause for rejecting the capacitor. A leakage current of 600 μa rejects a 25- μf capacitor. And that big 2,000- μf transistor-amplifier output capacitor has a limit of only 10 ma maximum leakage. Admittedly, these limits often are many times greater than the leakage that will disable a solid-state circuit, but they illustrate how low the acceptable limits are.

With our leakage checker you can be certain that the capacitors used for projects and service are within the test limits. The checker tests capacitors under voltage as

they will be used in a circuit—from 0 to 50 VDC. And the checker can be used to troubleshoot defective capacitors in existing equipment. Finally, the checker can be used to re-form large capacitors that have been sitting on the shelf for ages, thereby avoiding the possibility of their developing high leakage current through the sudden application of full operating voltage.

As shown in the schematic, the checker consists of a transistor-regulated 0 to 50-VDC power supply, which is well filtered to prevent AC ripple from giving inaccurate indications. To provide precise voltage adjustments, and so a large variation in the adjustment of potentiometer R1 will produce a small change in test voltage, there are two output-voltage ranges. These are 0 to 5 and 0 to 50 V and are selected by range switch S2. Meter M2 indicates the leakage current of the capacitor connected to test terminals BP1 and BP2. Meter M1 indicates the test voltage. It is a 50 VDC meter and you should understand that the zero is dropped off the scale when operating on the 5 range. For example, with S2 in the 5-V position, an indication on M2 of 30 means 3 V.

To avoid getting a shock when removing

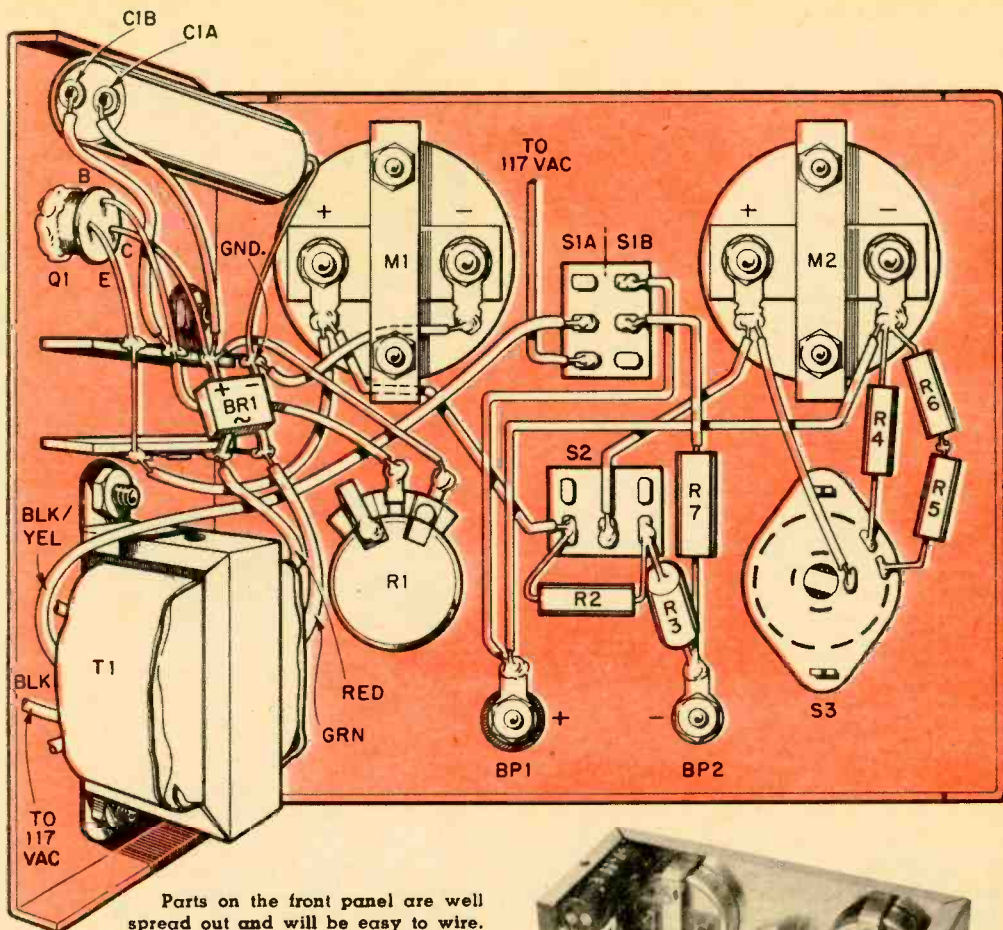

Parts on the front panel are well spread out and will be easy to wire. Things are a little crowded on the left. Leave transformer to last so it won't be in your way. Note that transistor Q1 is mounted on side of cabinet with epoxy; photo on next page shows how.

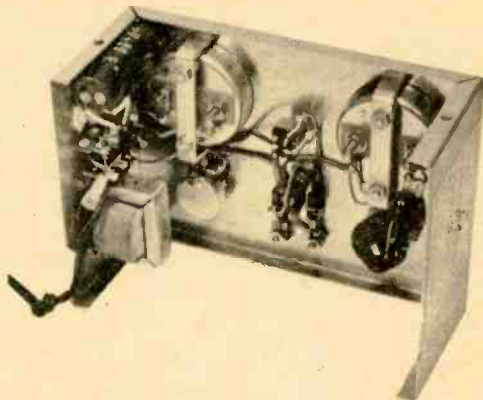

the capacitor from the binding posts, S1B shorts the capacitor under test through R7, a low-value resistor, when the checker is switched off.

Note in the schematic and photographs that M2 is provided with a 100-ma range. While no capacitor you will test will have 100-ma leakage unless it's internally shorted, the 100-ma range protects M2 against shorted capacitors and against damage when testing large value capacitors of 100 μf and higher. Large capacitors pull a very heavy surge (charge) current when the test voltage is first applied.

Construction

The tester is built on the main section of a 7 x 5 x 3-in. Minibox. The layout is not at all critical and just about any arrangement will work; the layout shown in the pictorial,

however, makes for easy assembly.

Except for T1 and M1, make no substitutions as the component values are selected for the Q1 and M2 specified in the Parts List. Transformer T1 can be any type with a 40-V, 20-ma (or higher) secondary while M1 can be any 50 VDC meter. Meter M2 cannot be substituted for as meter shunts R4, R5 and R6 are selected for the internal resistance of M2. Resistor R7, the discharge resistor, can be a 1-watt between 15 and 27 ohms.

First step is to temporarily mount the meters and then mark the position for the power-supply components on the left panel.

Electrolytic Leakage Checker

The meters must be mounted to insure that there is sufficient clearance for the terminal-strip lugs and C1. Then remove the meters and install all cabinet components. The meters may be damaged if you attempt to drill holes with them secured to the panel.

Double check S1's connections before soldering the wires to it. When the power terminals (S1A) are open the discharge terminals (S1B) are closed. When power is applied the discharge terminals (S1B) open. Meter M2's shunt switch, S3, can be any rotary type that will provide at least three positions; two positions are used for the 10- and 100-ma ranges while the unused terminal provides the 1-ma range—the basic meter range.

Transistor Q1 should be installed with full-length leads. Through Q1 can easily handle the dissipation required by capacitor tests, it should be protected against a long-term high-current load (such as would be caused by a shorted capacitor), by heat-sinking its case to cabinet. Cut a section of plastic tape about ½-in. square and coat one side with epoxy cement. Place the epoxy-coated side on the cabinet near Q1. Then coat the other side of the tape with epoxy and bend Q1 down so the top of the case is in the epoxy—the case should be resting against the tape. With a toothpick or Q-tip, spread the epoxy up the sides of Q1's case as shown in the photo. When the epoxy dries Q1 will be cemented and heat-sunk to the cabinet, yet the tape will insulate Q1 from the grounded cabinet.

Checkout

Connect a VOM or VTVM set to read greater than 50 VDC to BP1 and BP2. Set S2 to the 50-V position and S3 to the 100-ma position. Apply power by closing S1. With R1 in the off—full counterclockwise—position, both meters should indicate zero. If either meter indicates anything other than zero there is a wiring error. Slowly advance R1; both the VOM (or VTVM) and M1 should indicate an increasing voltage as R1 is advanced. Both meters should indicate the same voltage within the normal tolerance of a few volts. There should be no indication on M2 at this time. If M2 does indicate a current flow shut the checker down instantly and check for a wiring error. When R1 is full clockwise both M1 and the VOM should in-

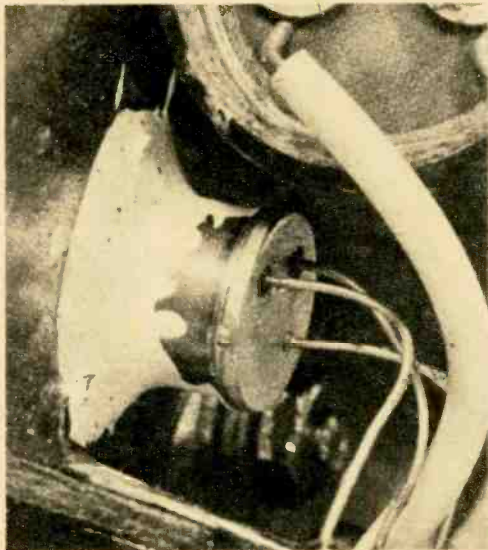

Q1 is cemented to side of cabinet with epoxy. But put electrical tape between top of transistor and cabinet so the transistor case won't be grounded.

dicating the full test voltage of 50 V, or slightly higher depending on the particular T1 you use.

Set R1 to off, then S1 to off. Set S2 to the 5-V range. Apply power and advance R1. The VOM and M1 should indicate a voltage range of from 0 to 5 V as R1 is advanced. Again, there should be no indication on M2.

Using the Checker

It is most important that R1 be set to off—full counterclockwise—when the checker is turned either on or off. Applying power with R1 advanced and a capacitor connected to the binding posts can destroy the capacitor if R1 is set to a higher test voltage than the capacitor's maximum rated voltage. Switching S1 to off with R1 advanced can cause excess current through Q1 and M2 because R7 is switched across BP1 and BP2 when S1 is set to off. Remember, *tests are started and completed with R1 in the off position.*

Observing polarity, connect a capacitor to BP1 and BP2. Set S1 to on and S2 to the correct voltage and S3 to the 100-ma range. Very slowly advance R1 until M1 indicates the capacitor's rated voltage. As voltage is applied M1 will indicate a relatively high current as the capacitor charges—almost 100 ma on very large capacitor. Within a few seconds M2's indication will fall sharply, showing the capacitor has reached

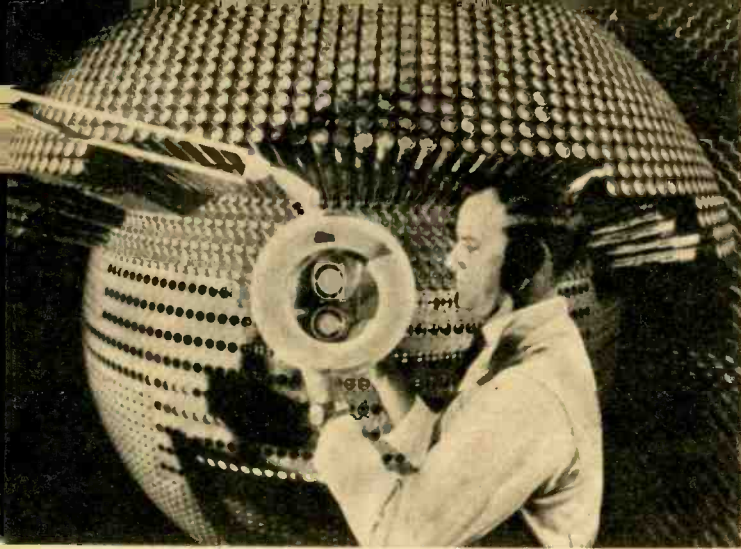

CLEAN SWEEP . . . Radars break down frequently because motors and gears are hard pressed to turn antennas. Phased-array radars change all this by sweeping radar beams electronically. Hughes Aircraft now has a prototype of what may be the most powerful phased-array radar ever. Called ADAR and developed for the Air Force, it has hundreds of energy feeds which are adjusted with a high-power magnifying device.

Electronics in the News

Smile, Fellas! . . . This gal has a determined look, and determined she should be. She's at the controls of a color TV camera which, according to its manufacturer, Toshiba, is the smallest and lightest ever made. Weighing 10 lbs. and designed for CCTV, VTR and industrial TV applications, the 11 x 4 x 7-in. camera has a new optical system and control unit which permit a simplified design. Two pick-up tubes are used—one for luminance and one for color signals—which have been combined with control circuits that provide a standard NTSC signal. Just one cable connects camera's signal to TV receiver below.

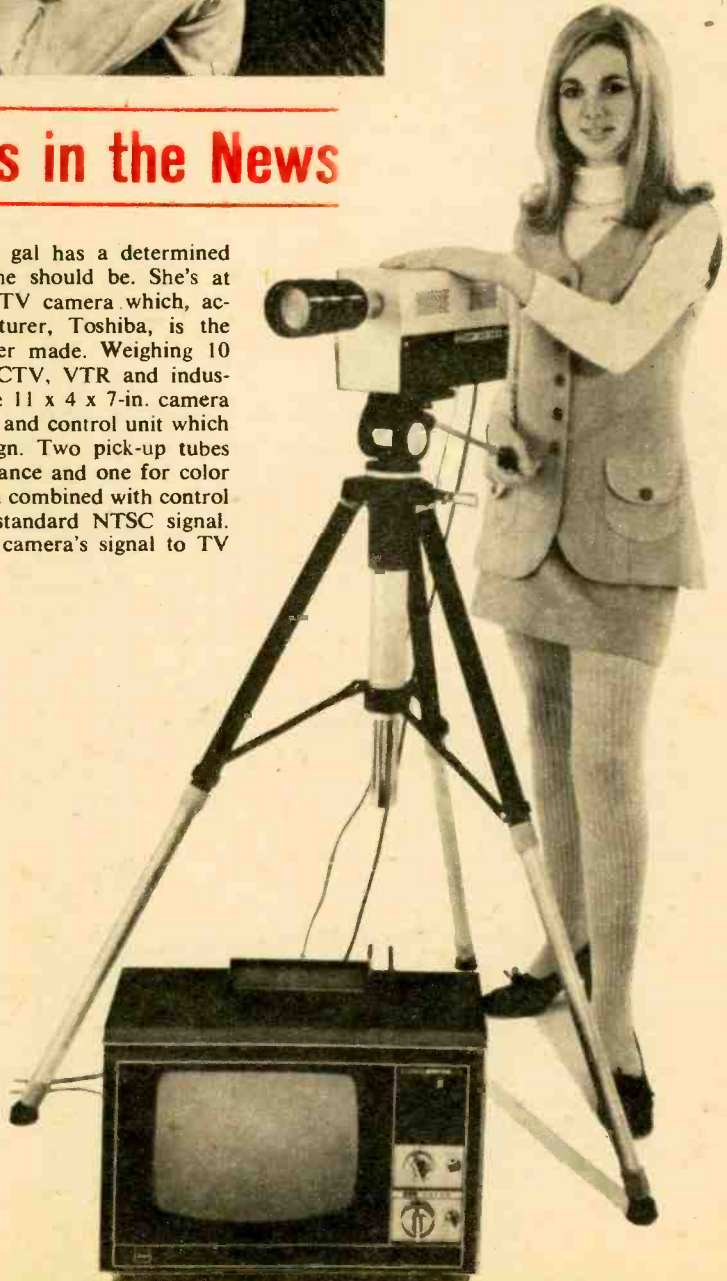

Good Deed . . . Machlett Laboratories (Raytheon) has been making power and image intensifier tubes for some time . . . now they're cleaning chimneys, too. Whatever her makeup is, this pretty girl is holding an ML-100 high-power rectifier that can develop 150,000 VDC in the wink of an eye. Originally used to separate uranium isotopes during early experiments with atomic weapons, now the ML-100's electrostatic charge attracts unburned products of combustion gases and thereby cleans particles out of smoke stacks which could cause deadly air pollution.



Lunar Combo . . . What do astronauts talk about on the moon? With little time available for rag chewing, important information dare not be lost. RCA's EVCS (extra-vehicular communications system) is designed to do this for our lunar explorers during Apollo 11 and following missions. Each set (examined here by a technician) weighs 6.5 lbs. With them, astronauts can talk to one another, or to the lunar module (LM) and then via the LM to ground control on AM and FM circuits. Telemetry data is also relayed back to earth so their health is never in doubt.

A Modern Guide to the Surplus Market

By H. B. MORRIS

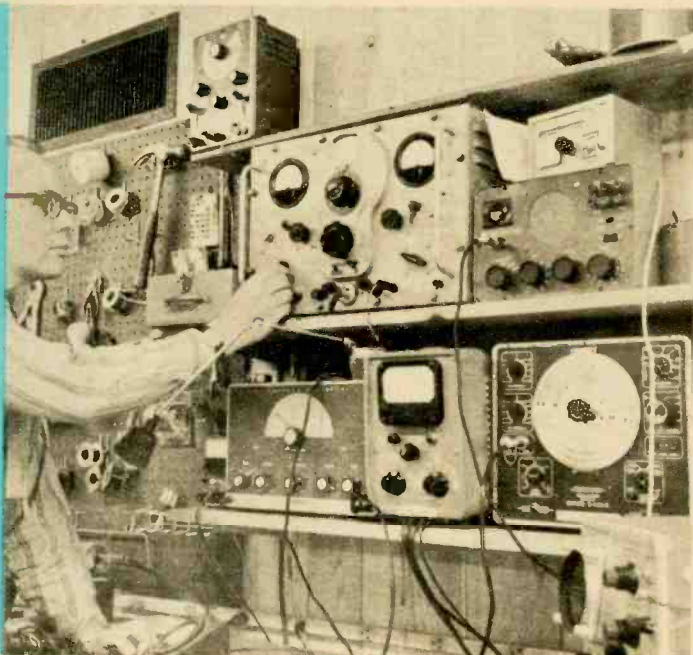

FOR ONLY \$29.50 you can buy a radar jammer that cost the U.S. Government hundreds to purchase. But, like, who wants to jam radar? Or you can acquire a superb \$1,500 loran receiver for \$89 and navigate your boat like an old sea dog, even though your credit might sink under the ballast of a 46-tube chassis. And how do you get 28-V power from your Evinrude?

That's one side of the surplus story. On the other hand, you can almost steal ham gear, crystals, meters, test equipment and other electronic doo-dads at prices right out of the Great Depression. The surplus market, as you may already suspect, is a two-headed hydra that can trap the unwary or heap gifts upon the choosy. Fortunately, some simple rules given later on may keep the novice from squandering his cash on an item as outlandish as a CR-SPW/1898 (crystal radio from Spanish-American War).

Where do these goodies come from? Surprisingly, much military surplus still is of World War II vintage. That 30-year-old material continues to be released by the government as ships are refitted and military equipment in general is updated. Some aircraft, in fact, fly today with beacon receivers that are simultaneously being peddled from dealer junk heaps. The Korean War temporarily created a trickle of newer equipment, while

the Vietnam conflict is adding almost nothing. As today's military equipment is retired, much of it is being stored in warehouses just in case.

Another big surplus generator is the phenomenon of a civilian manufacturer overtaken by fast-moving technology. He designed tube-type titillators when every one else started selling solid-state satisfiers. On the surplus market these items can be spotted as manufacturers' close-outs, overruns and overstocks. Bargains such as these often sift through the same channels followed by military surplus.

Also in the surplus pipeline is fall-out from semiconductor manufacturers. Items are mostly transistors and diodes that didn't score high enough during testing. While these semiconductors may not be good enough to fly to the moon they can be excellent buys for the experimenter. They're usually available in plastic packets for as little as \$1 for 15 gizmos and sometimes are packaged by the manufacturer especially for the hobbyist. One precaution, however. If you're going to buy surplus semiconductors for pennies apiece, have some type of transistor checker handy (even a cheap one will do). Experience has shown that an occasional batch will have as many as 50 per cent rejects because of excessive current leakage. But at

those prices you'll have no right to complain. Expect a fair number of cheapie transistors to show signs of flood, fire and other damage, yet be electrically sound.

The first big consumer of surplus gear was the ham just after a glut of military equipment became available following World War II. Easily the most popular piece of equipment was the Command set—a series of transmitters and receivers designed for aircraft. This set was a ham's dream. It had a built-in VFO so he could tune his transmitter frequency continuously and dispense with costly crystals. There were models conveniently calibrated for the ham bands, and sets could be converted to house current with little fuss. New models in sealed cartons were incredibly cheap (about \$10) so nothing on the commercial market could beat these rigs for the price. Today, the Command set is still advertised (costs about \$15 to \$20), but it's becoming a legend in its own time. Tech-

nology has passed it by. Now the novice most likely builds a kit.

The seasoned ham also may shun the surplus route when getting on the air. He's probably thinking of single-sideband gear that comes in a neat package and isn't easily available in surplus. Another blow for surplus markets was the rise of the semiconductor. Virtually all surplus transmitters have tubes and need about 10 lbs. of circuitry to produce one watt. Semiconductors can do the job at only 10 oz. per watt.

The complete military-surplus rig still is much in demand but the action generally is limited to specialized interests; it bypasses the bread-and-butter rig used to launch a ham station. One fast-mover today is surplus facsimile (Fax). This gear is being snapped up by experimenters who want to receive (and reproduce) pictures directly from weather satellites. Active surplus buying also involves radio-teletype converters and printers. Engi-



Separate components often are best buys in surplus market. Examples above include plastic bag full of transistors, a panel meter, a wirewound potentiometer, a telegraphy key (the classic J-38) and, at the rear, a Variac for voltage control.

Surplus crystals for transmitters usually are fine buys. Of course, you may have to search around a little before you find one cut for the exact frequency you need. Transceiver is Heath Sixer.

November, 1969

Solid-state FM tuner made in West Germany for Magnavox is good example of manufacturer's closeout. It's sold for under \$5 by Olson Electronics.





Surplus test equipment can be useful on your workbench. While signal generator may have limited coverage, VOM above always works.

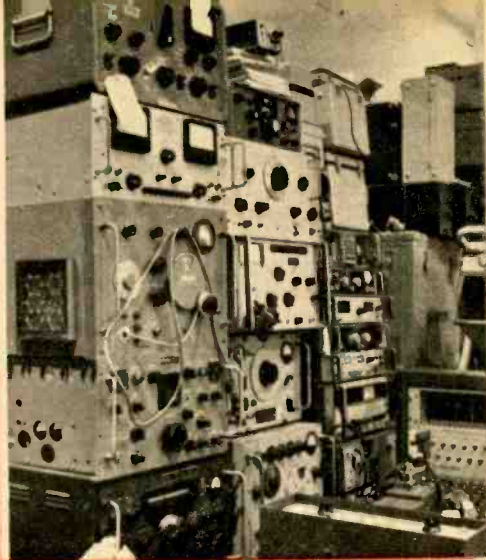

Good collection of surplus gear waiting at a dealer. Most of it probably will go to schools, labs and industry, and fetch a good price.

is offering before taking the plunge. Even old timers have been stung on this point—a subject whimsically summed up by Gordon White, a columnist on surplus topics, when he recalls his first surplus purchase (a B-29 bombsight). When it arrived, he was disappointed because it turned out to be just a bunch of gears. But the dealer couldn't be faulted. He had, indeed, sent a B-29 bombsight, as advertised.

So the first caveat in acquiring surplus gear is to know in advance what you're buying. One of the best ways is to enlist the help of a ham or experimenter who's actually using the item you want. Get on the ham bands, if you can, and ask advice from the pros. You'll garner plenty of good information.

Once you're certain a particular piece of gear is desirable, study all the published information on it you can get. There are some books on surplus, but check their content before you buy. Some are merely compilations of schematics and don't offer conversion information. The best info for the beginner appears in books and articles which cover the conversion step by step.

Watch out for unusual power requirements. Precious little surplus gear operates on ordinary house current. Much works on 24-28 VDC and must be converted (often by rewiring the filament circuit) and fitted with a new power supply. Be careful if a set

is advertised for 115 VAC—it might require that voltage at 400 cps, about 340 more than you have.

Be sure it's really a bargain. One catalog I know of advertises a standard broadcast-band receiver (550 to 1500 kc) formerly used in aircraft. It's a [Continued on page 118]

SOME PLACES TO BUY

Barry Electronics
512 Broadway
New York, N.Y. 10012

B & F Enterprises
Box 44
Hathorne, Mass. 01937

Columbia Electronic
Sales
4365 W. Pico Blvd.
Los Angeles, Calif. 90019

Denson Electronic Corp.
Box 85
Rockville, Conn. 06066

Fair Radio Sales
1016 E. Eureka St.
Lima, Ohio 45802

G & G Radio Supply Co.
77B Leonard St.
New York, N.Y. 10013
(Catalog: 25¢)

JAN Crystals
2400 Crystal Drive
Fort Myers, Fla. 33901

Jeff-Tronics
4252 Pearl Road
Cleveland, Ohio 44109
(Catalog: 10¢)

John Meshna, Jr.
19 Allerton St.
Lynn, Mass. 01904
(Catalog: 25¢)

Poly Paks
Box 942
Lynnfield, Mass. 01940
(Catalog: 10¢)

Quaker Electronics
Box 215
Hunlock Creek, Pa. 18621
(Catalog: 35¢)

Slep Electronics Co.
2412 Highway 301 N.
Ellenton, Fla. 33532

TAB
56 Pearl St.
Brooklyn, N.Y. 11201
(Catalog: 25¢)

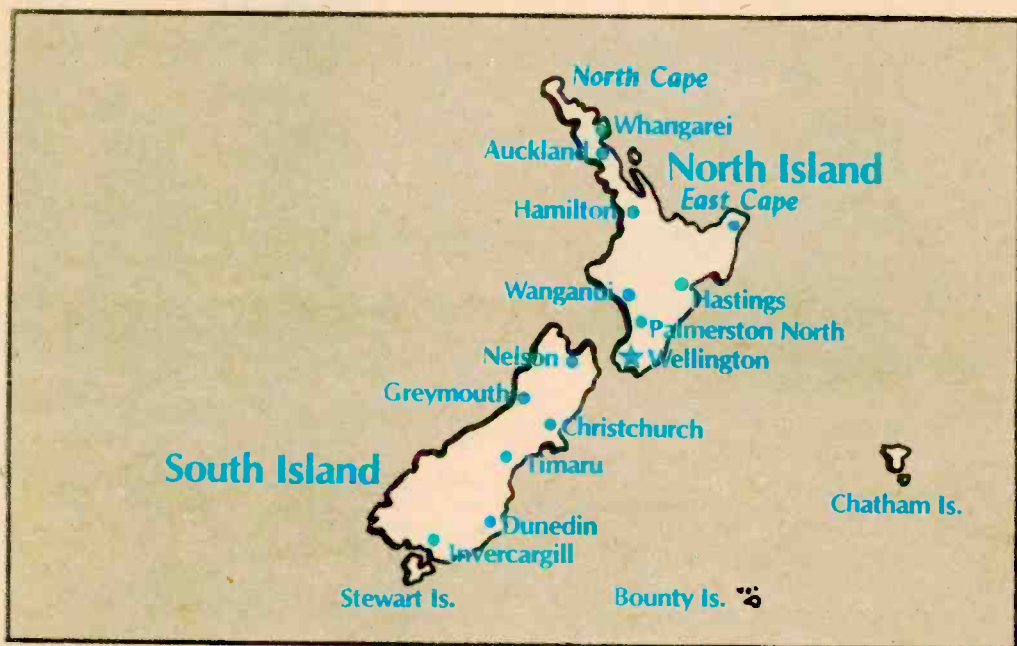

The DX Scene in New Zealand

First in a series of special reports on what it's like being a DXer in various parts of the world and what the challenges are.

By DALLAS A. MCKENZIE

SOUTH PACIFIC DXing sometimes conjures up dreams of DXers and SWLs sitting around near huts, casually adjusting battery-powered radios and listening to distant signals which float in between the palm trees. Of course dusky girls always bring out refreshments, etc. . . . well, nice work if you can get it. Actually, DXing in the South Pacific is as hectic as anywhere else and a somewhat lonely affair. Remember that New Zealand is 1,200 miles distant from her nearest neighbor. And most foreign-service short-wave activity is directed at the Pacific Islands, Australia and the Antarctic. R. Australia is the only Pacific station which beams transmissions to North America.

Small Band. In New Zealand, DXers are a rather cohesive lot, most being members of either the New Zealand Radio DX League (NZRDXL) or the New Zealand Radio Association (NZRA); both clubs have over 400 members between them. These down-under DXers are a breed apart only with regard to geography; otherwise, their activities are much the same as with DXers everywhere. One exception, however, is the problem of equipment.

Due to the balance of payments problem and the government's import restrictions on radio equipment, communications receivers are a luxury in New Zealand. Only the more experienced SWLs and hams have them, and even then the rigs are generally of much older vintage than the equipment in use in Canada or the United States. Such name brands as Hallicrafters, Heathkit, National, Trio (equivalent to Lafayette), Eddystone and Knight are available if you're inclined to spend a small fortune on your hobby. (The New Zealand pound was recently changed to a dollar worth about \$2.75 in U.S. currency.)

Domestic sets, including such brands as Philco, Bell, Rye and Philips, are used by almost half of the DX community in New Zealand. Sets usually preferred have at least six or more tubes and a good bandspread on both the medium- and short-wave bands. A second-hand rig having nine tubes and of 1940 vintage can be purchased for about \$20 (U.S.). Even though there is a greater tendency toward DXers owning communication receivers, the younger enthusiast is usually more than happy (unless he can get surplus equipment from WW II) to use a domestic radio with a home-brew converter and preselector.

Listening Posts. Time often works to the advantage of the NZ DXer. When he starts to warm up his set to log North American stations he has an unusual opportunity in that he is a day ahead because of his location on the international date line. New Zealand time (PST) is 12 hours ahead of GMT, so it's midnight there when it is noon at Greenwich and 1 p.m. in most of Europe. This means that when it's midnight in Los Angeles on January 1, 1969, it will be 5 p.m. of January 2 in New Zealand. Thus, a DXer down-under can work both the past and the present once he turns on his rig in the late afternoon.

New Zealand is comprised of North Island (44,281 sq. mi.) and South Island (58,092 sq. mi.), the two being cut asunder by Cook Strait. The climate of the former is somewhat akin to Portugal, while the latter—graced with both Mt. Cook and numerous glaciers—is very much like Switzerland. At no point are you very far from water, so interference is no problem, just distance. Thus, DXers have a religious belief in outdoor antennas.

These aerials usually stretch out anywhere from 30 to 1,000 ft. A medium-wave DXer will have as much wire as he can lay his hands on; this is usually oriented in a northeasterly direction so that MW signals from North America can be received. This also picks up the few MW [Continued on page 115]



Above left is DXer Arthur Cushen monitoring a rig at the NZRDXL convention held in 1966. Seated next to him is Betty Brown, former secretary of the Wellington branch of NZRDXL. The rig is a National NC-190. Arthur has over 3,000 SW and 1,800 MW QSLs and has his own program, DX



World, which is broadcast over the foreign service of R. New Zealand. Above right is our author, Dallas McKenzie, who is director of the program World Tapes for Education. Below left is his listening post in Wellington. There is a Trio 9R-59 receiver, as well as an Eddystone 870-S rig.



El Tests CB in the Air

It's up, up and away as we take a walkie-talkie aloft to find out what kind of range you get.

By VERNON SIMMS



WE communicated a distance of nearly 100 mi. on a CB walkie-talkie. But before you insist it was done on skip, through a linear amplifier or from atop the Golden Gate Bridge, let me add that no skulduggery was involved. We simply obeyed what the experts have advised for years: Want more range? Raise your antenna! CB signals, they claim, travel line-of-sight and fritter away at the horizon. Therefore, raise the antenna so it sees farther over the earth's curvature.

But the slide-rule sachems rarely mention our signal-strangling height rule—the one that says a CB antenna may not be more than 20 ft. over a natural or man-made formation. It means your signal, like ours, probably collides with the ground about 10 mi. away, then merely excites the earthworms.

To test the height theory we searched for the highest man-made formation in the neighborhood. It turned out to be a Cessna 150 at the airport. This is a light plane guaranteed by the manufacturer to attain an altitude of 12,650 ft. Since we'd really be high at that altitude (partly from a lack of oxygen above 10,000 ft.), the test could disclose once and for all whether the antenna engineers should have their heads in the clouds.

To avoid slicing into the aircraft's electrical system or ruining the paint job with some antenna-mounting holes, our CB station would have to be completely self-contained. So we selected the new Courier Clipper 23, a set which conveniently provides

23-channel operation and a full 5 watts of input power on internal dry-cell batteries. Communications on the ground proved the rig had plenty of range on its telescoping whip so we packed it aboard the plane and took off solo (having a private license tucked away in the jeans). It was the fastest antenna-raising we ever attended: our skyhook was hoisted aloft at the rate of 650 ft. per minute.

Following our flight plan, we headed

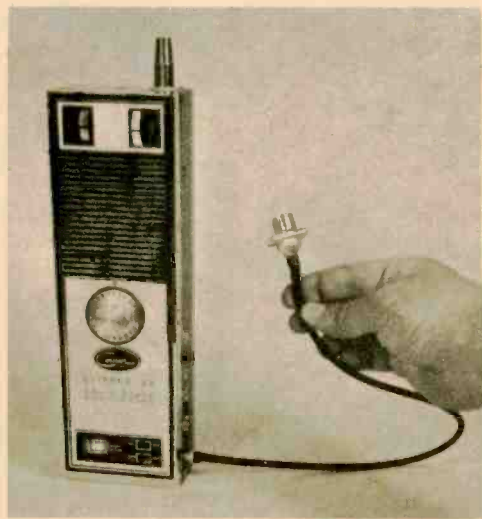

Rig used for airborne CB test was Courier Clipper 23 which operates on internal batteries. Connector is for external antenna. Long trailing wire was used.



Permanent installation wasn't practical in all-metal Cessna 150, so battery-powered walkie-talkie was used. Rig was first checked out on ground.



Hudson River Valley, 30 mi. north of New York City, was site of most tests. Mothball fleet of Liberty ships was visible in Hudson river below.

toward the Hudson River Valley about 30 mi. north of New York City. We had picked a fitting place for our historic CB communication. As the aerial photo shows, a rather ghostly mothball fleet of WW II Liberty ships rode at anchor below. Five mi. to the north lay legendary West Point. Our CB signal, according to calculation, would spill down the towering Palisades along the Hudson River toward a population center that contains 100,000 licensed CBers. As insurance, our base station at home would stand by for the first airborne transmission. We extended the whip on the rig, squeezed the mike button and uttered the first call: "... Come in base ... do you hear us? ... come in, please ... it's us, aeronautical mobile ... over ... over ..."

We strained to hear the reply (and also to fly the plane—operating both CB gear and the controls turned out to require somewhere between three and five hands). No signals issued from the speaker. What's more, apparently no stations were operating in the area. Since this was impossible, it was obvious that our experiment was laying a huge technological egg. As we banked homeward to comprehend our failure, a smokestack in Peekskill, N.Y. belched air pollution up toward our flight path. Was it an omen?

We knew CB had been used in aircraft

before with some success. The rigs, in fact, were then merely small walkie-talkies with whips extended, like ours, inside the cockpit. Also, hams operate aeronautical mobile with no external antenna fastened to the fuselage. That night we used an automobile to simulate an airplane cockpit in an attempt to solve the mystery.

It took only minutes to discover that it was a matter of windows and wavelengths. The airborne ham probably operates on the 2-meter band. His frequency (144 mc) requires an antenna about 18 in. long. Radio waves at this length easily slither through aircraft windows. This is confirmed by the fact that pilots, too, sometimes operate portable transceivers on aircraft bands in similar fashion. Their 120-mc frequencies also produce the same short radio waves. Our attempt to squeeze CB signals out through the plane's windows failed because of oversize wavelengths—at 27 mc they're about four times longer than those at 120 mc. Our frequencies were simply too fat to fly out.

One more mystery remained. Why had others succeeded with CB signals transmitted from inside a cockpit? We'd even heard that 100-milliwatt walkie-talkies—little more than piddling toys—were used for communications between sailplanes and cars that follow them cross-country (to recover pilot and

Color line on aeronautical chart shows distance of longest, record-shattering contact. Plane was near Peekskill, N.Y. (near finger)—some 30 mi. north of New York City; CBer was located north of Hartford, Conn. (at upper right where line stops). Distance of contact battered 90 mi.

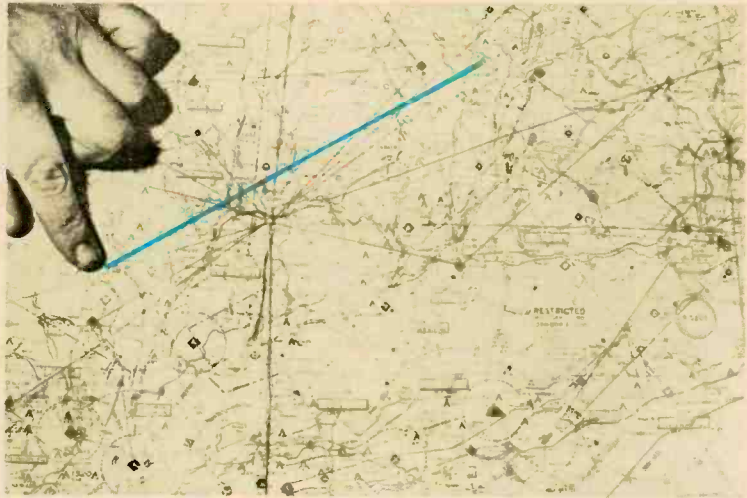

EI Tests CB in the Air

plane when the flight runs out). Then it struck us—sailplanes are covered with fabric, as are a huge number of smaller aircraft. Linen or cotton simply aren't visible to radio waves. But our Cessna 150 is covered from wingtip to tail with a metal skin.

We solved the problem of our flying metal screen with an ancient aeronautical technique known as the *trailing* antenna. A thread-like wire was cut and resonated to the CB band and allowed to fly free of the cockpit.

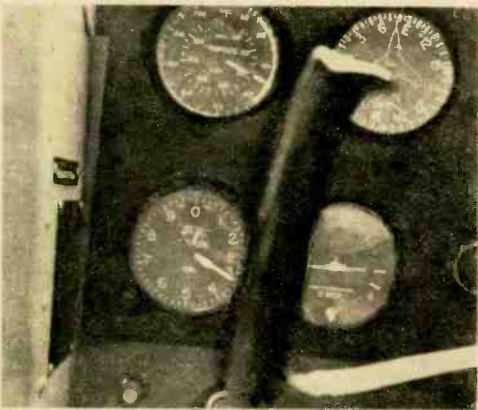

Instruments show plane's altitude (3,300 ft.) and air speed (90 mph) just before longest contact. During most contacts, plane cruised at 105 mph.

As we took off the next morning (with copilot aboard this time), we thought about the possible wording for our initial communication. Back home, the little wife was standing by at the base station, waiting to answer the first call. On reaching altitude we pressed the push-to-talk button, spoke and waited tensely for the reply.

Would the answer be significant, like Morse's "What hath God wrought?" Or whimsical, like Edison's "Mary had a little lamb?" Maybe it would be cryptic, like Marconi's first transatlantic *dit . . . dit . . . dit*. Hardly. The momentous reply was: "Will you be home for lunch?" (But, then, that's what CB is all about.)

Now we were blasting through with a signal that nearly split the speaker at the base station, while the signal received aloft from base could curl Orphan Annie's hair. The distance between us at this time was about 35 mi. and our altitude was only 2,500 ft. If this is what height can do, we'll take more of it!

We pushed the throttle to the firewall, pointed the nose up and started climbing. As the plane leveled off at 3,500 ft. we quickly established contact with another station. He sounded like a strong local—solid audio, no noise behind him. He, in turn, reported back that we were transmitting powerful signals. Then came a double-barrelled shock. We told him we were aeronautical mobile and operating CB from an airplane. He said, "Yeah, sure." He didn't believe us! Then the second jolt. We asked his location and learned

[Continued on page 119]



My Life and Hard Times with a Home Video Tape Recorder

By ROBERT D. FREED

IS IT POSSIBLE to find eternal happiness with a home video tape recorder after being jaded by home movies, color TV, audio tape recorders and Swedish flicks? I had to find out.

Three years ago EI's Advertising Department spent about \$1,300 for a Sony Model TCV-2010 video tape recorder and VCK-2000 camera to make sales presentation tapes. However, after a few gropings it became apparent that it would not be feasible to use a VTR for this purpose. The VTR and camera then were up for grabs and I ended up with them. I felt this would be a marvelous opportunity to use a home video tape machine to find out

Home Video Tape Recorder

whether it really was the entertainment miracle I kept reading about in magazines such as *EI*.

What, I thought, could I possibly do with it? Right off, no ideas came to mind. Well, maybe I could tape a movie on TV at 3:30 in the morning (using an external timer) for viewing at a more convenient hour. I dropped this idea when I learned that the longest tape available ran an hour and cost \$40. Because the VTR and camera weighed 72 lbs., I wasn't anxious to do much of anything except let them sit in our lab.

Don't Burn the Butter

One Sunday evening it hit me. While my wife and I were watching Julia Child's 30-minute French Chef program of cooking lessons on channel 13 (New York's educational TV station) my wife decided she would like to prepare the same dish. She wished, however, she could see the program again because it was too condensed and fast to absorb all the details. The following Sunday, I promised, I'd tape the program so she could watch it several times before going off on her own.

The first problem was to get the VTR home, and to do this I rented a car to take it from the office to our place 50 mi. out on Long Island. I set up the VTR and loaded it with tape. Then I turned its built-in 9-in. monitor TV and tried to tune a program with the set's whip antenna. No luck. I went to connect the set to my 300-ohm master-antenna system and found that TV set's input was 75 ohms and the connector was a miniature phone jack. A 300/72-ohm transformer and phone plug took care of this.

Then I felt it would be a good idea to make some practice tape recordings off the air. After about three hours the VTR died. Cleaning the video record/playback head and a few routine checks did nothing. Back to Sony the VTR went to be repaired—and after only about 20 hours of operation. Sony told me it needed a new video head which would cost, including labor, about \$90. (The machine was well out of its 90-day guarantee.) When I told Sony that the need for this \$90 repair after 20 hours operation would be mentioned in this article, they repaired the machine free.

Back to my house it went and I taped the French Chef program. My wife watched the

tape two or three times to make up the shopping list and become familiar with the routine. I showed her how to set up, start and stop the VTR so she could prepare the dish (a jelly roll) at her convenience. On second thought I decided to hang around just in case her buttery fingers slipped off the function lever should she have to stop the tape after a step.

The dish turned out perfectly and it was an unusual way to follow the recipe. But was it worth the trouble? That was three years ago and we haven't repeated it since. It's an awful lot of bother to set the VTR up in one place, move it to another and operate it while mixing ingredients.

My wife now has a copy of the French Chef Cook Book and watches the program fairly regularly. Over the period of a year she has seen many of the recipes in the book prepared on TV. Reading the book in advance then watching the TV program are sufficient. I returned the VTR to our office.

A week later *EI* Feature Editor Bob Long asked if he could borrow the VTR for a while. I gave him the key to our lab and off he went with the VTR and camera in his station wagon. A month later over lunch he told me of his adventures with the machine.

A Show for the Kids

Bob's wife has established a reputation among the neighborhood children as a producer of puppet shows. The shows have been a feature of birthday parties for some years, but they always present a problem: how to put on the performance and still keep track of the ice cream, cake, lost hair-ribbons, and

Be careful if you have to stop the VTR while separating egg yolks and whites. My wife wanted the tape stopped and asked me (clean hands) to do it.





Say a, e, i, o, u, children. This tiny-tot class got a big kick out of seeing themselves mouth vowels. In a large classroom there were some problems with placement of camera, VTR, wires and locating an AC outlet. Even when camera accidentally got some footage of the outdoors through the classroom windows, only the brightest patches of sky produced image reversal — although the camera was set for the relatively low intensity of ambient light in class.

all the other details of a children's party.

The VTR proved to be a workable answer. Instead of a live show, the children could now watch a tape. Not only did the VTR allow his wife to sit with the children and keep an eye on things, it simplified the production itself by allowing retakes and instant scene changes. Bob's wife very quickly saw other advantages of tape and began reworking the action to suit the new medium as she went along.

A VTR for the Teacher

It was Thanksgiving, and Bob and his wife

saw the VTR as a means by which their son's first-grade class could present the Pilgrims-and-Indians bit to the rest of the school without the miseries and complications of the usual pageant.

When the teacher readily agreed to his bringing the equipment into the classroom, he hit his first snag. Moving a VTR from one room to another is awkward, but not exhausting. Hefting it up a couple flights of stairs and down endless corridors is another matter. After the first 100 ft., the carrying handles seem a mockery. Had the janitor and his dolly not come to his aid, he might have

The setup for taping papier-mache techniques for the women's club was quite simple. One of the members did the demonstrating while our gang ran the camera and the VTR, simultaneously explaining in detail what was taking place for audio track.



Home Video Tape Recorder

given up on the spot. (A bad cold didn't help matters, either.)

The next problem became apparent as soon as he walked (perspiring) into the classroom. He needed AC outlets, a place for the camera, a place for the VTR and a place for the microphone. It took a good deal of experimentation. As it was, microphone pickup was barely adequate; the audio signal hardly registered on the VTR's level meter. However the audio did turn out to be clear enough at playback.

Before he was entirely set up, the teacher arrived. "I'm so glad you offered your television recorder," she told him. "It should be an ideal way for the children to see their own vowel formation." He started the VTR and taped several vowel formations. The children paid little attention to the camera, although they stared delightedly at the playback, mouthing the vowels along with themselves and calling out answers to questions they had missed the first time around.

The teacher looked pleased, the children looked pleased, even the principal looked pleased. So he packed up, convinced he had contributed something to the educational process. But he still isn't sure quite what.

All Together, Girls

Bob's next project also was educational, but produced much more tangible results. His wife was asked to demonstrate papier-mache

techniques for the local women's club, which planned to make boutique ornaments to sell at a charity bazaar. But the problem of getting fifty women close enough to the demonstration so that they could see it clearly appeared insuperable without repeating the demonstration several times.

The VTR was the solution—and an extremely successful one. A good deal of time is wasted in papier-mache—particularly in waiting around for the work to dry so that it can be painted; but, the entire sequence could be telescoped on tape. And processes like oven drying that would have been impossible in the club room could be included easily in the recorded demonstration. Moreover, the tape could be run several times so that club members could get the process firmly in mind before making their own ornaments.

One problem worried the ladies when he was setting up: exposure. "We don't know how to set the camera," they complained. His services really were unnecessary. Unlike film-type cameras, the Sony video camera has a wide tolerance to different light levels. Automatic control in the camera combined with the brightness and contrast controls (on the monitor TV set) used during playback produced usable pictures within wide latitudes.

VTR on the Job

When Fawcett production man Charlie Lake gave a series of talks on printing technology for non-production members of the staff, the conference room was full to over-

[Continued on page 119]

Fawcett production man Charlie Lake wanted to see how effectively he delivered a lecture on printing and production. VTR was placed at right so audience could see how he might look if one of the networks ever bought the tape. Poor lighting and mirrored wall behind podium worked against us. Charlie improved his technique in his second talk after studying the first one.



YOU hit the push-to-talk switch, call your mobile and then wait for a reply. No dice. You try again and again but to no avail. When the car gets home you try again at close range and discover your signal wasn't even getting out of the shack.

So you check the antenna, transmission line and tubes. Still no luck. The thing you forgot was the crystal. It could be ready for the trash can, because when crystal activity falls, so does your transmitter's output power. And insufficient drive to a final due to a weak crystal can adversely affect modulation. A bad crystal in a receiver will mean you won't be able to hear a call from a station three blocks away.

Then there's the reverse situation. In this scene the operator first considers the crystal the source of poor reception or transmission. First thing he does is pull the rock, toss it out and put in a new one. Two minutes and \$3 later he finds it wasn't the crystal after all.

What one thing will prevent all these things from happening again? Our Gnat-Size Crystal Checker. Not much larger than a pack of cigarettes, the checker will spot a bad crystal in seconds. It will test almost any crystal at its fundamental frequency. Unlike some checkers, there are no controls to set. The only control you have to contend with is the push-button power switch. As a special bonus, the checker will, with an appropriate crystal, serve as a signal generator or a band-edge marker. And, if you replace the meter circuit (D1 and M1) with an antenna, you have a low-power CW transmitter.

The parts will cost about \$10. However, they are all common and you should be able to save money by digging into your trusty old junk box. Construction is easy and you can build it in an evening.

Construction

Our checker was built in a miniature plastic case sold by the Radio Shack. However the size or type of box you use is unimportant. The main thing that will determine the box to be used is the size of the meter you can obtain. Our model uses a 1¼-in. square imported job that is stocked by many stores. If you can't find anything like it, try one of those miniature tuning meters. But if it doesn't have a 1-ma movement you will have to shunt it.

Once you have the parts you can start working on the box. The meter and crystal socket go on the front panel. Position the meter as far to the top of the box as possible

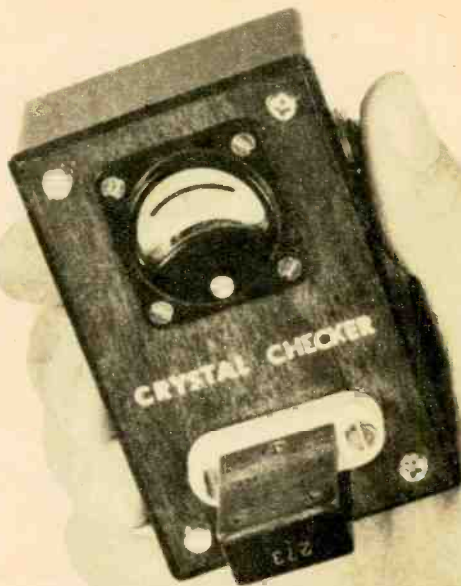

Gnat-Size Crystal Checker

By GARY McCLELLAN

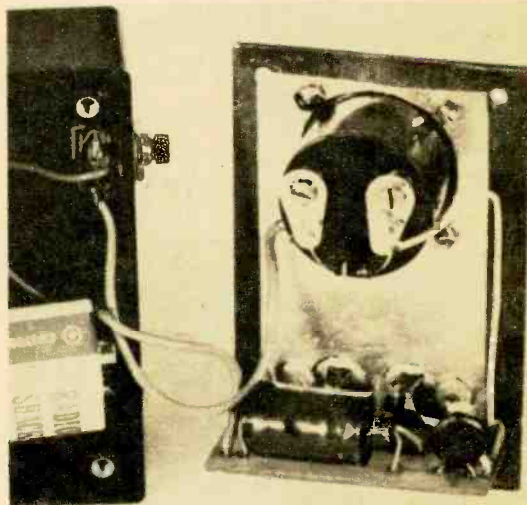

Inside of author's model. Note closeness of circuit board to crystal-socket lugs at bottom. Aluminum panel is covered with decorative paper.

Gnat-Size Crystal Checker

and the crystal socket about 3/4-in. from the bottom. This dimension applies mainly to the Radio Shack box; you are free to use some other layout with a different box.

The oscillator circuit was built on a 1 x 1 7/8-in. circuit board. (The author made his own printed-circuit board. However the oscillator can be built on perforated board as we show in the pictorial.) Start construction by laying out the parts following the schematic and pictorial. Solder them to push-in terminals and clip off the excess leads. Make a small L-bracket out of scrap metal and attach it to the board as shown in the

photo. Mount the board on the front panel with the components facing the crystal-socket terminals. Connect the wires. The power leads must be soldered directly to the battery if you used the box we specify because there isn't room for a connector. Connect diode D1 across the meter and ground the positive side of each. Check the wiring, and if all's well, button up the box.

Checkout and Operation

Checking crystals couldn't be easier. Plug a good crystal into SO1 and press S1. The meter, which shows relative crystal activity, should show a steady indication. If it doesn't, check the circuit. Once you are sure the

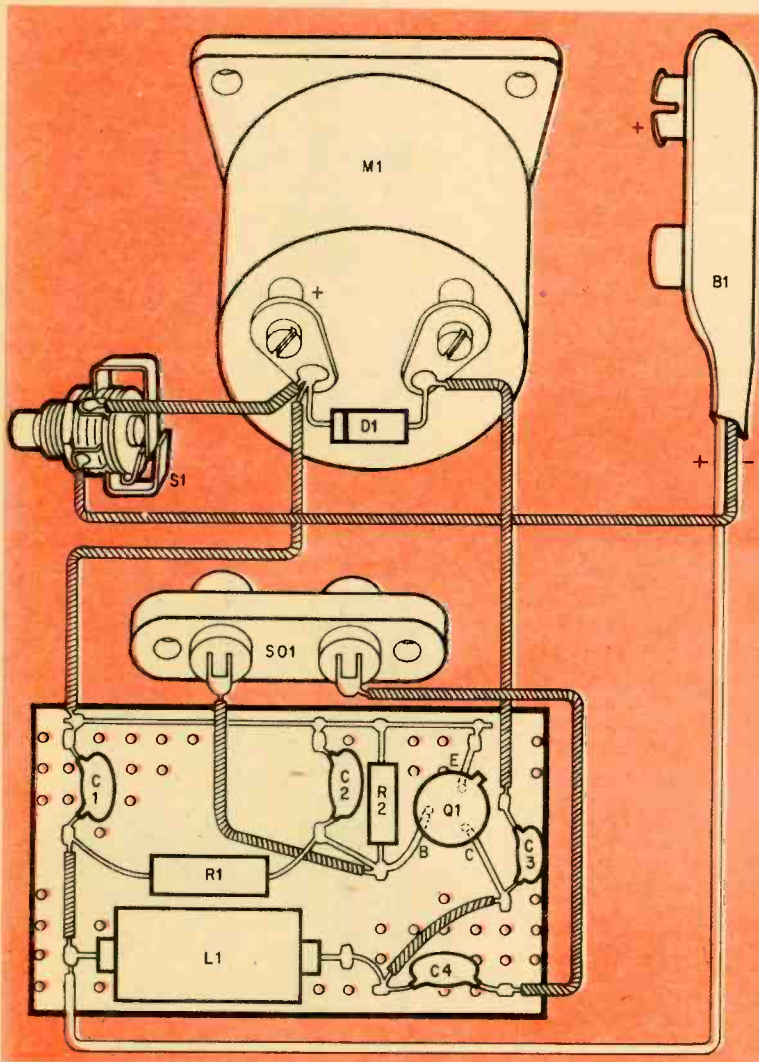

In the photo at the left you can see that the author built his model on home-brew printed-circuit board. We show parts mounted on a 1 x 1 7/8-in. piece of perforated circuit board on which push-in terminals were used for tie points. Use a small bracket to attach the board to the case's metal panel. Connect ground bus (top of board) to bracket.

Checker is a crystal-controlled oscillator circuit in which crystal to be tested is inserted in socket SO1. If crystal is good, oscillator starts and RF at Q1's collector is rectified by D1 and applied to the meter, M1.

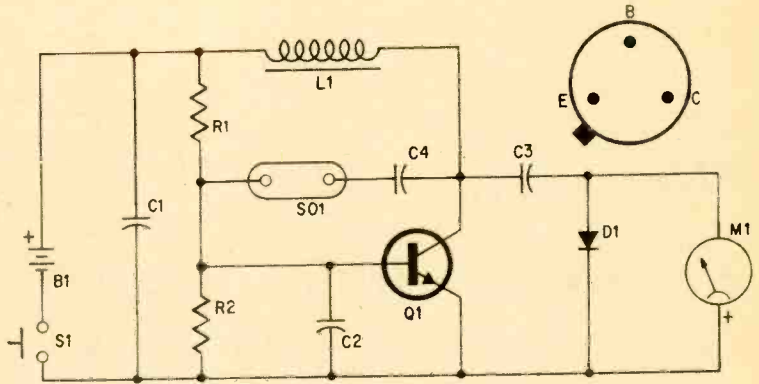

PARTS LIST

- B1—9 V battery (Burgess 2U6 or equiv.)
- C1, C4—.001 μ f, 30 V or higher disc capacitor
- C2—47 μ f, 30 V or higher disc capacitor
- C3—33 μ f, 30 V or higher disc capacitor
- D1—1N34A diode
- L1—2.5 mh RF choke (J. W. Miller No. 6302, Lafayette 34 T 8792 or equiv.)
- M1—0-1 ma miniature DC milliammeter
- Q1—2N706 transistor
- R1—100,000 ohm, $\frac{1}{4}$ watt, 10% resistor
- R2—10,000 ohm, $\frac{1}{4}$ watt, 10% resistor
- S1—SPST normally-open push-button switch
- SO1—Socket for FT-243-type crystal (Millen Type 33102, Newark stock No. 38 38F656, Newark Electronics Corp., 500 N. Pulaski Rd., Chicago, Ill. 60524. 43¢ plus postage. \$2.50 minimum order)
- Misc.— $3\frac{1}{4}$ x $2\frac{1}{2}$ x $1\frac{1}{2}$ -in. utility case (Radio Shack 270-230 or equiv.)

checker is working try several good crystals to get an idea of what indications to expect. When checking other crystals, reject those that produce fluctuating, weak or no indication.

You might want to build an adaptor for checking crystals that won't plug into SO1. Simply disassemble an old FT-243 crystal and discard the element. In it's place solder a short piece of hookup wire to each pin. Drill a hole in the top of the holder for the wires to pass through. Reassemble the holder and solder an alligator clip to each lead. Plug the adaptor into the checker and the clip leads to the crystal to be tested.

To keep track of how a crystal should perform, paste a chart on the back of the cabinet showing the indication you get when you check a new crystal. (The indications will simply be the numbers printed on your meter's scale.) Such a scale will let you compare questionable crystals against the reference values.

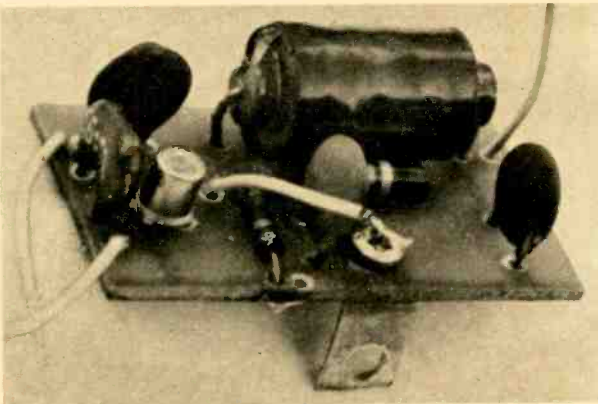

Author's circuit is built on an etched circuit board. Layout is as ours, shown in pictorial. Bracket mounts and grounds the board to box's panel.

Adaptor, at left, is made from discarded crystal. It is used to check three crystals at right that can't be plugged in socket used to check FT-243-type crystals.



**“He’s a good worker.
I’d promote him
right now if he had
more education
in electronics.”**



Could they be talking about you?

You'll miss a lot of opportunities if you try to get along in the electronics industry without an advanced education. Many doors will be closed to you, and no amount of hard work will open them.

But you can build a rewarding career if you supplement your experience with specialized knowledge of one of the key areas of electronics. As a specialist, you will enjoy security, excellent pay, and the kind of future you want for yourself and your family.

Going back to school isn't easy for a man with a

full-time job and family obligations. But CREI Home Study Programs make it possible for you to get the additional education you need without attending classes. You study at home, at your own pace, on your own schedule. You study with the assurance that what you learn can be applied to the job immediately.

CREI Programs cover all important areas of electronics including communications, radar and sonar, even missile and spacecraft guidance. You're sure to find a program that fits your career objectives.



NEW!

Expanded coverage of solid state electronics including integrated circuits!

You're eligible for a CREI Program if you work in electronics and have a high school education. Our FREE book gives complete information. Mail postpaid card for your copy. If card is detached, use coupon at right or write: CREI, Dept. 1711H, 3224 16th St., N.W., Washington, D.C. 20010.



**CREI, Home Study Division
McGraw-Hill Book Company
Dept. 1711H, 3224 Sixteenth Street, N.W.
Washington, D.C. 20010**

Please send me FREE book describing CREI Programs. I am employed in electronics and have a high school education.

NAME _____ AGE _____

ADDRESS _____

CITY _____ STATE _____ ZIP CODE _____

EMPLOYED BY _____

TYPE OF PRESENT WORK _____ G.I. BILL

- I am interested in
- Electronic Engineering Technology Computers
 - Space Electronics Nuclear Engineering Technology
 - NEW! Digital Communications
 - NEW! Industrial Automation

APPROVED FOR TRAINING UNDER NEW G.I. BILL

The Ham Shack

By Wayne Green
W2NSD/1



SOMEONE wanted to take a look at the logs at my station the other day so I began rounding them up from file cabinets, desk drawers and closets. Naturally, I started looking back through the contacts of the last few years, remembering some of the outstanding ones that I had made. You know, I'm surprised at how many well known—even famous—people are active on our bands.

A few of them are so well known to amateurs that they're pestered for contacts whenever their signals show up. Barry Goldwater, K3UIG/K7UGA and Arthur Godfrey, K4LIB, are treated about the same as rare DX when they operate. This is unfortunate and probably gives them pause when they are considering going on the air. I suspect that if they'd recognize the problem and cope with it the way a DX operator does, by taking a few days to work all the operators that are after them for QSL cards, they might be able to live in relative peace. I note that even the rarest of DX—after about 10,000 fast contacts—finds it easy to rag chew from then on.

If you don't pay attention and ask questions you can find later on that you've had a contact with someone quite well known or successful and that you missed your chance to draw them into an interesting contact. What turned out for me to be a fascinating contact with the president of Times Wire & Cable started as a quick hello-goodbye, 2-meter QSO while I was mountain-topping one night.

So if you run into KØHWY, you're talking with Tex Beneke, the band leader. He has been active many years. W6UK is Alvino Rey. WB6RER is Andy Devine. Peew Wee Hunt. W1AYA, is another old timer. Keep your ears peeled for W6SGP, Cliff Arquette (Charlie Weaver), and K2ORS, Jean Shepherd, who broadcasts on Station WOR every evening and has written prize-winning humor

in Playboy for the last few years. Then there's Dave Mann, K2AGZ, a writer of many song hits.

There are many more you should recognize, such as Harry Gumm, K6MDD, the famous circus clown; Mel Shavelson, W6VLH, the screen writer and producer; Bob Mersey, W2TXI, conductor and recording producer, and Wilmer Allison, W5VV, the U.S. Davis Cup Player. Miss Universe for 1959 is Luz Zuluage. HL6LT. Don't miss that one!

If you frequent the DX bands you may find yourself in contact with a king, prince, industrialist or an ambassador. The King of Sikkim operates AC3PT. OE3AH is Archduke Anton von Hapsburg, the Austrian pretender. The King of Morocco is Moulay Hassan. CN8MH. If you contact HZ1SS, HZ1TA or HZ1AF you have worked a Prince of Saudi Arabia. William Porter, K1YPE/XV5, the Deputy Chief of Missions in Vietnam, has been the principal active amateur radio station in that country. Maurice Bienbaum, HC2KX, is our ambassador to Ecuador. Armin Meyer, OD5XX, is the ambassador to Lebanon. I contacted him when he was the ambassador to Iran (as EP3AM) and had a nice eyeball QSO with him during my visit to Tehran. About the only link with the outside world from Wake Island is via ham radio. When I last visited there they had more active hams per capita than any other country in the world. The Governor of Wake is Dudley Mason. KW6CJ

You don't have to be active to run into Captain Kurt Carlson, W2ZXM/MM, the skipper of the Flying Enterprise. He's on the air a good deal of the time while at sea.

Many well-known people are just in there rag chewing and you should watch out for them, too. K2GL is Buzz Reeves of Reeves Sound Studios. Cyril Staud, K2DQ, is a vice president of Kodak. Don't ask for free film. Harry Vickers, W8HBY, is the president of Sperry Rand. Herb Scofield is president of TMC systems. Carl Lindemann, W1MLM, is a vice president of NBC. Findley Carter, K6GT, is director of Stanford Research. Art Collins, WØCXX, is president of Collins Radio. For that matter, most of the manufacturers of ham equipment are licensed active and can be contacted. Herb Johnson of Swan, Andy Andros of Hy-Gain, Bob Waters of Waters Manufacturing, Leo Meverson of Galaxy, Les Cushman of Cushman, etc.

The ABCs of Color Television Servicing

Answers to Examination

on Part II:

Continued from page 67

1. The low-voltage power supply.
2. The color killer control.
3. False. The fact that there is video at all means that some circuits in the chroma section are okay, including the demodulator stages and color-difference amplifiers.
4. Many stages are dependent on other stages for proper operation.
5. Any stage that processes the color-sync signal.

CATV Opportunities

Continued from page 42

organization offers three home study courses:

CATV Installer. This is an introduction to the industry and the knowhow needed to qualify for an installer's job. It covers installation techniques, a review of math used by an installer, customer relations, safety and basic TV fundamentals. Though the student works at his own pace, the course is designed to be completed in a year by studying one hour a day, five days a week. Total cost is \$265, which you can pay over fifteen months at a small interest charge.

CATV Technician. The course teaches basic electronic theory and its role in a CATV system. It penetrates CATV circuit analysis, cable transmission principles and CATV measuring equipment. Costing \$345, it also prepares the student to pass the FCC radiotelephone license examination. It should take 18 months to complete at about an hour per day of study.

CATV Advanced Technician. The last course assumes some background in electronic theory. It's designed for a CATV technician who wants to learn advanced theory that could help him qualify as a chief tech-

nician. The program also teaches electronic technicians working in other fields specialized knowledge of CATV which could prove helpful in securing a job. This course costs \$425 (payable over two years, if desired) and includes personnel relations, management practices and public relations in CATV. It should take about 21 months if the student studies an hour per day.

As in most home study courses, those offered by NCTI include such items as a text (which is periodically updated), lesson material, coaching, grading and a diploma. For a complete catalog and course outlines send a request to: National Cable Television Institute, 207 N.E. 38th St., Oklahoma City, Okla. 73105.

Colorado Electronic Training Center. If you like the Rockies and wish to take a residence CATV course, this school offers it. It's 60 mi. from Denver at the foot of Pikes Peak, has classrooms, labs and is approved for GI-Bill training. Prerequisite is a high-school diploma or the equivalent. The CATV course starts with basic electronics and narrows to TV in about 300 hours. It then continues with 100 more hours devoted strictly to CATV. There's practical work in a lab which has four different head ends plus a complete CATV system mock-up that works. There are also field trips to actual systems during off-hours.

You can take the CATV course as a full-time day student and complete it in 16 weeks; night students require 33 weeks. Tuition, including books and lab fees, is \$550. For a catalog write to: Colorado Electronic Training Center, 513 Manitou Ave., Manitou Springs, Colo. 80829. The school now has about 60 CATV students and its president, Robert Turkisher, reports he receives letters from almost every state requesting resumes on its graduates.

The pay scale for CATV jobs shifts under competition from other industries wooing technicians, and according to the section of the country. Bob Turkisher of CETC gives this picture. One graduate last year started as an installer/technician in Colorado Springs for \$2.50 an hour. Upon passing his second-class FCC radiotelephone exam, he received a raise of \$50 per month. He then won his first-class FCC ticket and received another raise of \$100 per month. Turkisher reports that in larger cities, like Denver, the hourly rate for CATV technicians is \$3, while in Los Angeles it runs up to \$4.75 per hour.

Over and Out

rodriguez

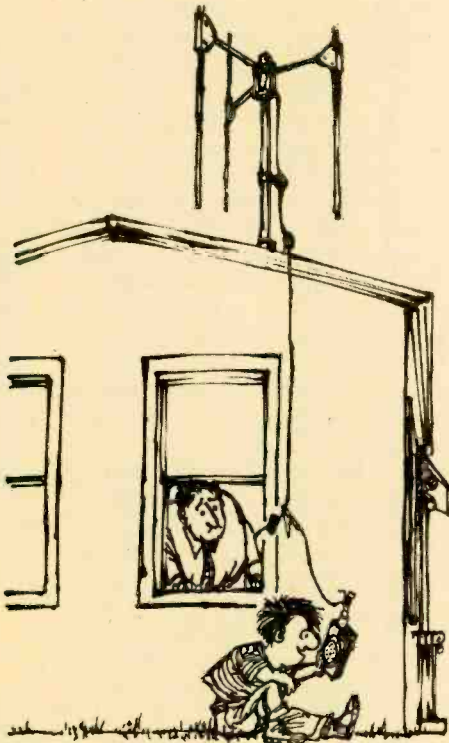
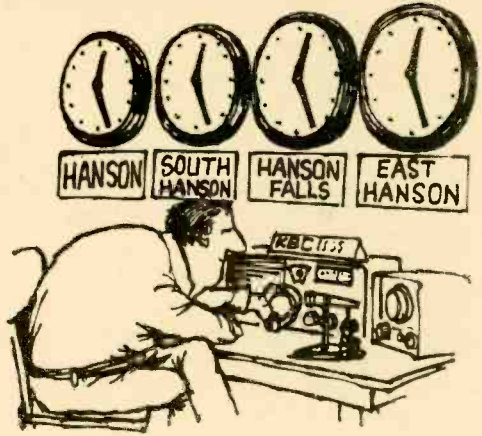
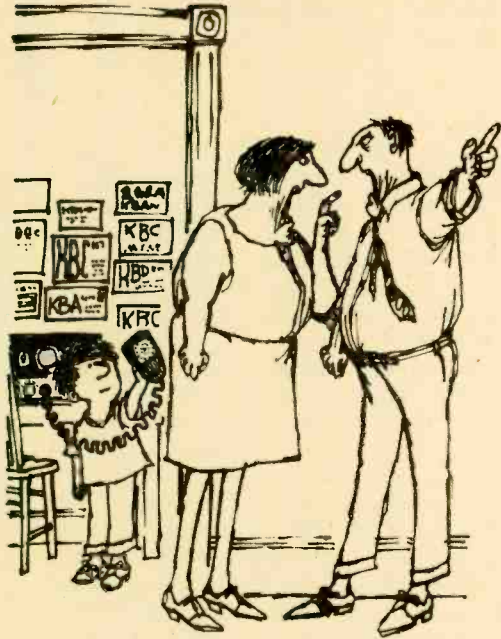

"... And do you, Stanley, take Janice as your lawfully wedded XYL ...?"

Continued from page 25

NRI first-class FCC commercial license course. Want hi-fi gear or best offer. Mark Firestone, 315 Ocean Pkway, Oceanside, N.Y. 11572.

TYPE CWD-21 AAX Dynamotor keyer unit and radio transceiver. Trade for best offer. John Benitz, 108 Carolina Ave., East Liver Pool, Ohio 43920.

MISC. transistors, transformers, diodes. Swap for test equipment, other parts or tape recorder. Bob Wurth, 495 Myrtle, Florissant, Mo. 63031.

SEVERAL 4PR60A tubes. Will swap for short-wave receiver. John O. Sanborn, 2312 N. E. 92nd Ave., Seattle, Wash. 98115.

REBEL proportional R/C motor, 0.19 engine. Want Johnson Kilowatt Matchbox Deluxe with bridge and meter. Robert Blitz, 2 Charles St., Wellsboro, Pa. 16901.

HICKOK model 6000 tube tester and EICO scope. Want tape recorder or TV. George Schumacher, 4054 Laclede, St. Louis, Mo. 63108.

SUPERIOR cross-bar generator. Want Altec-Lansing 21B microphone and 150A base. W. H. Mitsch, 46 Bethany Pike, Wheeling, W. Va. 26003.

WD-11 tubes needed. Will swap for other types. Art Trauffer, 120 Fourth St., Council Bluffs, Iowa 51501.

RECEIVER (BC-946 BCB) and 4-65A, 8020, other tubes. Swap for battery-operated antique radio. Alan Douglas, Box 225, Pocasset, Mass. 02559.

ANTIQUÉ ELECTRONICS

MAJESTIC 5A430 floor-model, four-band radio made by GE. Swap for ham, CB gear, or best offer. Earle DuRard, Jr., 214 4th Ave., N. Franklin, Tenn. 37064.

KIPP (Toronto) six-tube BC radio, working, with built-in speaker. Swap for small stereo amplifier or test equipment. D. Pronovost, 1315 Jules Poitras #103, Montreal 380, Que., Canada.

RADIOLA III (1924), pre-1930 tubes. Swap for other early radio or best offer. Dr. Robert A. Lane, 2603 Independence Ave., Kansas City, Mo. 64124.

RIDER Perpetual Troubleshooter's Manuals, Volumes I to XI. Also, Grigsby Majestic 90B. For best offer. E. D. Kymiston, 3743 Onyz Ave., Klamath Falls, Ore. 97601.

PHILCO Steeple radio and RCA 18 radio. Want ham gear or stereo tape recorder. Scott Mitchell, 71 Summer St., Claremont, N.H. 03743.

BRUNSWICK Radio-phone with 78 rpm automatic changer (circa 1928). Swap for tape equipment or best offer. Henry Bouw, 216 Depew Ave., Nyack, N.Y. 10960.

TUBES: 80's, 84, 76, 56, etc., plus old circuit boards. Want El Library, Jan. '63 to May '68 complete, or novice transmitter. Danny M. Watson, Star Route, Northport, Ala. 35476.

OLD PA SYSTEM and SW radio (1921). Both in need of minor repairs. Will swap for novice ham gear, photo enlarger or best offer. Jody Whitman, Box 327, Buna, Tex. 77612.

RCA two-tube battery radio (1921). Want SW receiver less tubes. James M. Cash, Rt. 1, Sparta, Tenn. 38583.

50 ANTIQUE TUBES, 30's through 85's and more. Will trade for test equipment or reasonable offer. Martin DerOvanesian, 725 Opa-locka Blvd., Opa-locka, Fla. 33054.

ZENITH 1938 SW receiver console (1.8 to 18 mc) Will swap for ham gear—local only. Tom Dornback 19 W. 167 21st Pl., Lombard, Ill. 60148.

ASSORTED TUBES (27, 24A, 80, 35-51, etc.). Want VHF or aircraft receiver. John Comney, 6 Andries Rd., Red Mill Farms, Newark, Del. 19711.

CITIZENS BAND

EICO NOVA 23 transceiver—mobile rig. Will swap for base unit. John Palencak, 3714 Keyes, Flint, Mich. 48504.

ASSORTED CB CRYSTALS. Want 80-meter novice-band crystals. Jeff Sykes, 6442 Canastota Dr., Hamilton, Ohio 45011.

RCA MARK VII 8-channel CB transceiver (5 watts). Mike and antenna included. Swap for SW or police-band receiver. Dwight Bray, 1290 Newfound Har. Dr. Merritt Island, Fla. 32952.

47 CB CRYSTALS. Want 1-mc/100-kc crystal calibrator similar to Lafayette JE-27, Mastercraft 24-hour clock, or photo timer. Eugene R. Klos, 205 West Park St., Lee, Mass. 01238.

LAFAYETTE HB-525 23-channel CB rig. Want mobile or base ham gear. Steven Rechter, 30 Roger Williams Green, Providence, R.I. 02940.

THROW AWAY THE SOLDER OR MY DADDY USES CUSS WORDS

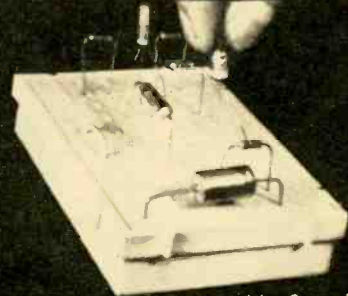

Some years ago two men, Mr. S. and Mr. deC had an idea. Wearing white hats they dutifully offered it to the giant electronics conglomerate under whose roof they laboured. He sneered so they left and developed it on their own.

It's a solderless breadboard and the secret lies in a precision clip of firm grasp and low resistance. These clips are leafspring contacts of phosphor bronze or silverplate.



As with all good things customers came up with more ideas in using S-DeCs than the originators believed possible and the demand for added flexibility resulted in a box with two interlocking S-DeCs known as DeCSTOR, (pronounced Deck-Store). Not content with this, users circuits out-grew the DeCSTOR and so a 4-DeC kit was created for the man with ideas bigger than his breadboard. Today there is a whole range of DeC solderless breadboards covering conventional and integrated circuit requirements.

So, if you need to throw away the solder, keep the skin on your fingers and the black words buried down below, write to us for more information, or better still send us a check.

INTRATEC

399 Jefferson Davis Highway
Arlington, Virginia 22202

Please send me postage paid:

- S-DeC's @ \$5.75 each
- DeC STOR's @ \$11.75 each
- 4-DeC's @ \$20.75 each

I enclose a check/money order for \$.....
Va. residents add 4% sales tax

I am interested in the IC versions. Send literature and prices.

Name

Address

City

State Zip Code

Box El

CIRCLE NUMBER 5 ON PAGE 13

Olson ELECTRONICS FREE Catalog

Fill in coupon for a FREE One Year Subscription to OLSON ELECTRONICS' Fantastic Value Packed Catalog — Unheard of LOW, LOW PRICES on Brand Name Speakers, Changers, Tubes, Tools, Stereo Amps, Tuners, CB, and other Values. Credit plan available.

NAME _____
ADDRESS _____
CITY _____ STATE _____
GIVE ZIP CODE _____

If you have a friend interested in electronics send his name and address for a FREE subscription also.

OLSON ELECTRONICS

504 S. FORGE STREET, AKRON, OHIO 44308

CIRCLE NUMBER 9 ON PAGE 13

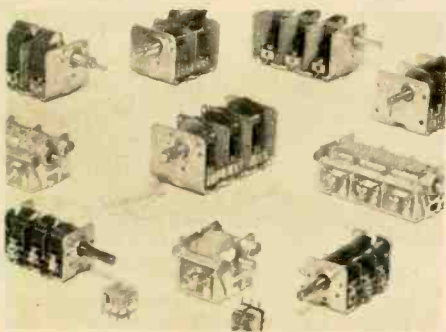

Variable capacitors with ranges from 3-19 pf through 10-365 pf

All models in stock for immediate delivery — 1, 2 and 3 sections... PC board and chassis mounting types... direct and 6:1 turning ratios. Prices from \$2.31-\$9.75.



Write for full line catalog.

J.W. MILLER COMPANY

19070 Reyes Ave. • P.O. Box 5825
Compton, Calif. 90224

AVAILABLE NATIONWIDE FROM
DISTRIBUTORS AND MAIL ORDER HOUSES

CIRCLE NUMBER 1 ON PAGE 13

Compress-O-Phone

Continued from page 33

After the mike is checked, pack the rubber grommet at back of handle with silicon adhesive to secure the cable. Install PL1.

The battery power supply is assembled in a 5¼ x 3 x 2½-in. Minibox; the layout isn't critical. Just make certain the polarity of C10 and C11 is correct and be sure of the connections to SO1. Plug PL2 is connected to a length of shielded cable—any length necessary.

Using the Compressor. The Compress-O-Phone can be connected to any input with an impedance of 10,000 ohms or higher. While it can be used with input impedance of less than 10,000 ohms (down to 2,000), the distortion increases sharply below 10,000 ohms. The compressor's output level is approximately 1 V (rms). This is just about right for a high-level (tuner or auxiliary) input, and we suggest using a high-level input rather than a mike input to avoid overload.

Turn on power with S1, speak into the mike and adjust the recorder's or amplifier's volume control for normal meter indication or sound level. That's the whole bit. As you record you will note that the level meter always peaks at the same spot. With transmitters, adjust the modulation level control for 100 per cent (actually 85 per cent is correct) modulation—it will be 100 per cent constantly. With PA amplifiers, adjust the level control until the system starts to howl, then back off slightly on the gain for maximum volume level at the verge of howling. Or, simply adjust the volume control for the desired volume level. Even if the speaker turns his head while talking the sound level will remain constant.

New Fun From Olden, Golden Radios

Continued from page 59

An Investment? While we recommend this hobby primarily for your personal enjoyment, it can also be an investment. Many newer collectors who are anxious to obtain early models of certain makes are now paying five to ten times what the original collector paid, and a few models are almost unobtainable unless a collector passes on and his estate is liquidated by the executor, or he retires to a smaller home and disposes of his collection piecemeal or as a job lot.

COLUMBIA STEREO TAPE CLUB now offers you

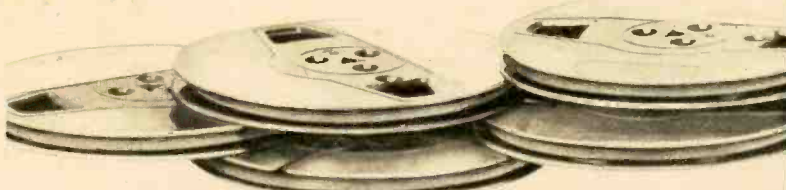

ANY
5
7" REEL-TO-REEL
STEREO TAPES
\$100
FOR ONLY EACH
plus mailing and handling

If you give now and agree to buy five additional tapes during the coming year, from the hundreds to be offered

 7705	 7708	 7684	 7677	 7499	 7273	
 7731	 7559	 7751	 7035			
 7496	 7520	 7374	 7460	FREE - if you join now REVOLUTIONARY SELF- THREADING TAKE-UP REEL Just drop the end of the tape over this reel, start your recorder, and watch it thread itself! Unique Scotchwe process automatically threads up tape of any thickness, releases freely on rewind.		
 7463	 7358	 7465	 7241	 7457/7458	 7150	
 7226	 7765	 7840	 7114	 6366	 7188	
 7662	 5944	 6415	 5547	 7747	 2276	
						 5874

JUST LOOK AT THE FABULOUS SELECTION of best-sellers the Columbia Stereo Tape Club is now offering new members! The greatest stars... the biggest hits... and all available in the incomparable stereo fidelity of 4-track reel-to-reel tape! To introduce you to the Club, you may select any 5 of the stereo tapes shown here, and we'll send them to you for only one dollar each! That's right... 5 STEREO TAPES for only \$5.00, and all you need to do is agree to purchase as few as five more tapes during the coming year.

AS A MEMBER you will receive, every four weeks, a copy of the Club's entertaining and informative music magazine. Each issue describes the regular selections for each musical interest... hits from every field of music, from scores of different labels.

If you do not want a tape in any month — just tell us so by returning the selection card by the date specified... or you may use the card to order any of the other tapes offered. If you want only the regular selection for your musical interest, you need do nothing — it will be shipped to you automatically. And from time to time, the Club will offer some special tapes which you may reject by returning

the special dated form provided... or accept by doing nothing.

YOUR OWN CHARGE ACCOUNT! Upon enrollment, we will open a charge account in your name. You pay for your tapes only after you've received them. They will be mailed and billed to you at the regular Club price of \$7.98 (occasional Original Cast recordings somewhat higher), plus a mailing and handling charge.

FANTASTIC BONUS PLAN! Once you've completed your enrollment agreement, you will be entitled to a FREE stereo tape of your choice for every two tapes you buy... or an additional stereo tape for only \$2.00 with every tape you purchase.

SEND NO MONEY NOW! Just fill in and mail the coupon today!

Note: All tapes offered by the Club must be played back on 4-track reel-to-reel stereo equipment.

APO, FPO addresses: write for special offer

COLUMBIA STEREO TAPE CLUB
Terre Haute, Indiana 47808

SEND NO MONEY — JUST MAIL COUPON

COLUMBIA STEREO TAPE CLUB, Terre Haute, Indiana 47808
Please enroll me as a member of the Club. I've indicated at the right the 5 tapes I wish to receive for only \$1.00 each, plus postage and handling. Include the self-threading takeup reel FREE.

SEND ME THESE 5 TAPES (fill in numbers)

_____	_____	_____	_____	_____
-------	-------	-------	-------	-------

My main musical interest is (check one)

CLASSICAL POPULAR

I agree to purchase five selections during the coming year, under the terms outlined in this advertisement and I may cancel membership at any time thereafter. If I continue, for every tape I purchase I will get an additional stereo tape of my choice for only \$2.00... or I may choose a FREE tape for every two tapes I buy.

Name: (Please Print) _____
First Name Initial Last Name

Address: _____

City: _____

State: _____ Zip: _____ 457-6711

Hamilton House, Cos Cob, Conn. 06807, Dept. 113L-11

Gentlemen: Enclosed please find \$_____ for _____ Auto-Loks at \$7.95 each plus 95¢ pp. & hdlg. I must be satisfied with my purchase or I may return same within 10 days for an immediate refund.

NAME _____

ADDRESS _____

CITY _____

STATE _____

ZIP _____

Auto-Lok Prevents Auto Theft

LAST YEAR 815,000 CARS WERE STOLEN
YOURS MAY BE NEXT!

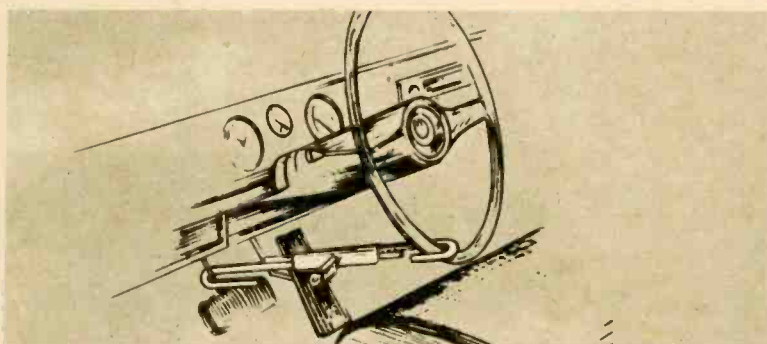

Protect Your Car With New Patent-Pending Theft-Proof AUTO-LOK

Auto thieves are an ingenious lot. They can open locked car doors, cross ignition wires to get your car started, and take off . . . not only with your car but possibly with valuable possessions, credit cards, business papers, etc.

JUST 10 SECONDS TO PROTECT YOUR CAR!

In just 10 seconds, the Auto-Lok securely locks your steering wheel to the brake, making it impossible for anyone to drive off. Made of $\frac{3}{8}$ " square hardened steel with heavy steel bracket that adjusts easily to fit most make and model cars. Auto-Lok has a heavy-duty Pad-Lok with 2 keys and vinyl shielded upper guard. Easily slips under car seat when not in use. There's no wiring to worry about . . . no fittings whatsoever . . . and no installation charge. Here's a unit you can use to protect any cars you may own for the next 25 years . . . and more! Use handy coupon above to order. \$7.95 plus 95¢ pp. & hd.

Hamilton House, Cos Cob, Conn. 06807

DX Scene in New Zealand

Continued from page 93

signals that come in from Europe. A serious SWL tries to have several aeri-als if space permits, but length is always stressed in the hope that a tricky 1-kw MW station that's several thousand miles away will be logged.

Long Wires. At last count, the NZRDXL hut at Spencerville, eight miles out from Christchurch on South Island, had three 800-ft. wires. No wonder I recently heard a 1-kw station, ZMB1 (1235 kc at Pembroke, Bermuda), which is 6,000 miles away! At Invercargil, DXer Arthur Cushen has his aeri-als stretching the length of a city block.

As one drives through New Zealand towns and cities, ham and SWL antennas can be seen mostly in the yard or garden, with the serious DXer being fairly obvious by his 100-ft. wire. I used to have a 250-ft. antenna when I lived in the Wellington suburb of Roseneath. That's when I got the first New Zealand report on station WNEL on 1430 kc. Now that I'm living in an apartment house, however, I'm down to a 95-ft. V-shape out-door wire and an army surplus SC1 16-ft. whip. I still manage to pull in KOMA on 1520 kc, XERF on 1570 kc and both KFBK (1530) and WLAC (1510), while European stations come in during the wee small hours of New Zealand's morning.

If you look at the number of islands which surround New Zealand and Australia, you will understand why medium-wave broad-casts are used for island hopping. While New Zealand alone has 33 MW stations, only five have a 24-hour operation and many close down on Sundays for a number of hours. This leaves Fiji, Samoa, New Caledonia, the five Australian states and Papua handy for DX. MW transmissions do not always give a wide coverage in the tropics so SW broadcast-ing is sometimes preferred for distance.

On the short-wave bands, things get some-what better, but not much. New Zealand has only one SW station (R. New Zealand, which can be heard your way during morning hours in the summer after 0100 EST on 9540 kc and during winter months—our summer—on 11780 kc at the same time); Australia has just three stations (ABC, its foreign service, R. Australia and VL2UV on 1750 kc) which provide rather good DX for North America.

You should find the challenge of DXing down-under an exciting one. I do.

SAMS BOOKS

on SPACE SCIENCE



Space Age Technology Series

Prepared under the guidance of
Training and Retraining, Inc.

Inertial Guidance Systems. by Robert L. Gates. Fully describes the inertial guidance systems used in all U.S. ballistic missiles as well as in space projects. The basic theory and equipment techniques of these systems are also being applied to aircraft operation. Discusses coordinate systems and earth effects, inertial sensors, the inertial-measurement unit, the guidance computer, and system operation. 176 pages. Order 20605.....\$4.95

Controlled Guidance Systems. by Hal Hellman. This programmed text covers the fundamentals of guid-ance systems, including ballistic trajectory, hyperbolic guidance, motion, translation, proportional navigation, celestial navigation, and stellar-inertial guidance. Explains principles, construction, and operation of various systems. 224 pages. Order 20573.....\$4.95

Synchros and Servos. by Robert J. Britte & Carlo H. Florenelli. A programmed text presenting the basic principles of synchro and servo motors and gener-ators and their applications. Includes maintenance and troubleshooting methods. 192 pages. Order 20533.....\$4.95

Lasers and Masers. by Charles A. Pike. This pro-grammed text describes in detail the basic oper-ating principles of the laser and maser. Also covers the early history and development of atomic struc-ture which provides the framework for the develop-ment of laser and maser devices. 176 pages. Order 20559.....\$4.95

Microminiature Electronics. by Israel Kallish. Pre-sents the basics of this vital new field which is playing an increasingly important role in space, military, commercial, and industrial electronic equipment design. The text is programmed and supported by numerous illustrations. 304 pages. Order 20582.....\$5.75

SPECIAL OFFER! All 5 Volumes at a savings, in beautiful slip case. Order 20724, only.....\$24.95

Howard W. Sams & Co., Inc.

Order from any Sams Distributor or bookstore, or mail to Howard W. Sams & Co., Inc., Dept. EI-11 4300 West 62nd St., Indianapolis, Ind. 46268

Send me the following books:

20605 20533 20582 \$ _____
 20573 20559 20724 enclosed

Name _____

Address _____

City _____ State _____ Zip _____

CIRCLE NUMBER 23 ON PAGE 13

NEW/CB TRANSCEIVER SOLID STATE PRE-AMP



- Improves CB Base Station Performance
- Works on tube or transistor equipment
- No Modification to CB unit
- On-the-air sign automatically lights when transmitting

Model PCB with built-in power supply, transfer relay, connecting cables, wired and tested..... **\$59.95**

Write for free literature



AMECO / DIVISION OF AEROTRON, INCORPORATED
P. O. BOX 6527 • RALEIGH, NORTH CAROLINA 27608

CIRCLE NUMBER 19 ON PAGE 13

**His newest outrages—
For the first time in paperback**

Very Sneaky, Andy Capp



By
SMYTHE

D2124

50¢

A FAWCETT GOLD MEDAL BOOK

Buy this Gold Medal Book from your paperback bookseller. If he is sold out, send only price of book plus 10¢ for postage and handling to Gold Medal Books, Fawcett World Library, Greenwich, Connecticut 06830. If order is for five or more books, there is no postage or handling charge. Please order by number and title. No Canadian orders.

CB Corner

Continued from page 68

portable transceivers. Servicemen must be good at solving Chinese puzzles just to take these rigs apart. A similar problem occurs in sets with ICs; it's time consuming getting them out of the circuit. Thus, ICs can mean a larger repair bill.

What does it cost to have a CB set repaired by a pro? Burt estimates that the average bill for a set brought into his shop is \$8 to \$10. This might include correcting a problem in a PC board and realigning the set. He showed me one repair that came to \$10.54—for replacing a defective oscillator transistor and realigning the circuit. Another bill totaled \$24.50 and covered the installing of a new S-meter and several new crystals. One frequent job is wiring in a new microphone because, in Burt's words, "CBers change mikes like mad."

Finally, I asked what a CBER can do to prevent trouble. Many big users of two-way radio equipment follow preventive maintenance programs to head off failure in the field. It's not for the ordinary CBER, Burt said, meaning the individual who owns a rig for personal use. The business user of CB is another story. Downtime on his equipment means lost revenue. So Burt suggests a thorough checkout once a year—it costs about \$6.

One good reason, though, for any CBER to seek out a professional serviceman once a year is for a frequency check. Transmitting crystals can age and shift far enough off frequency to violate FCC specs. And off-frequency operation is a common cause of monetary fines. An annual frequency check (about \$4) isn't mandatory but it's reasonable insurance against a possible violation.

Resistor with a Real Twist

Continued from page 77

Circuits have resonant frequencies requiring almost invisible capacitors and coils, and the short wavelengths are too large for most any component. In fact, most radar circuits use resonant cavities rather than individual capacitors and coils. Cavities and waveguides act on electromagnetic fields, while resistors, capacitors and coils are designed primarily to control electrons flowing in wires. The former act like distributed constants, the latter are lumped constants. A Moebius resistor is a lumped-constant component.

Great Versatility. One striking feature of a Moebius resistor is that it does not couple electromagnetically to other metallic objects or to itself, even if the shape of the finished resistor is changed. There are only two requirements for this: the conductors must not touch physically and the spacing between the conducting layer must not be altered. This non-coupling characteristic makes it possible to wrap Moebius resistors around cards.

Moebius resistors are simple—and inexpensive to make. Problem is, unless you've got a rig that works at frequencies from around 500 to 4000 mc, you won't find much use for them. Of course, if you're a mathematician you can always reach for a textbook on topology—just to find out what Mr. Moebius was really talking about.

How Color TV Tunes Itself

Continued from page 51

should be no change in the picture sharpness or tuning. Now defeat the AFT again and turn the fine tuning manually until there's an obvious degrading of the color picture. Flick on AFT and the picture should automatically snap back into perfect tuning. If it fails to pull in, it's a sign of trouble—possibly a bad varactor diode in the tuner or a malfunction in one of the AFT stages.

Now that the industry has proved it can ease the job, what's next?

Our guess is that tuning indicators needing a manual assist may prove a passing fancy. One leading manufacturer told us his tuning meter will be phased out in favor of a full AFT system. We bet the indicator quietly will disappear, leaving AFT as standard in color sets as automatic transmission is in cars.

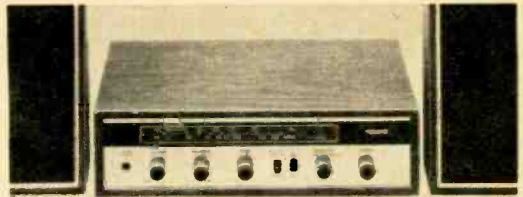

NEW COMPACT STEREO SYSTEM

15 Watts AM/FM/FM MPX Tuner Amplifier with matching speakers \$79.95

Mikado introduces a quality engineered stereo set with a low price. . . . Mikado Model No. 1912. This compact sound system performs as low as 5% harmonic distortion. Frequency response: 100-12,000. Fully equipped with bass, treble, balance and volume controls; selector control; headphone jack; stereo indicator; FM and AM indicator; two speakers; phono-input, and hand-oiled walnut cabinet. All this for \$79.95. Limited supply.

Write Mikado for your nearest dealer's address and for free brochure on Mikado's complete line of Hi-Fi Stereo products.

For private listening try Mikado's headphone set No. DH03 \$9.95



Quality sound at a price that you can afford.

MIKADO ELECTRONICS CORP.

1072 Bryant Street, San Francisco, California 94103
Telephone: (415) 861-1811

CIRCLE NUMBER 24 ON PAGE 113

WANT A JOB? PART TIME— FULL TIME?

**No Boss! No Experience!
No Capital! Your Own Hours!**

WHAT A JOB ! ! ! !

And yet selling subscriptions to **ELECTRONICS ILLUSTRATED** and other leading publications is just like being in business for yourself.

But no business requires less capital, stock and space. The time you devote and the money you make is up to you. You need no experience to earn steady profits and you keep a cash commission on every sale. You operate in your own community by phone or personal calls. You will be authorized to sell new and renewal subscriptions along with special offers made by the publishers. You'll be amazed at the number of people wanting to take advantage of the convenience, service and savings you can offer them.

To get started immediately—send us your name (on a postal card) requesting free supplies and selling materials.

Write to: Subscription Dept. DE
ELECTRONICS ILLUSTRATED
Fawcett Bldg., Greenwich, Conn. 06830

Don't miss...



...a single issue



Subscribe!

In issue after issue *Electronics Illustrated* gives its readers interesting and detailed coverage of the hobby electronics field plus great step-by-step construction projects. It's the kind of coverage you not only can't afford to miss... but don't WANT to miss. Make sure you get every issue. How? **Subscribe now!** *EI* costs just \$3 for a year's subscription (six issues).

ELECTRONICS ILLUSTRATED 11-69
 Circulation Department
 Fawcett Building
 Greenwich, Conn. 06830

Dear EI: Just to make sure I don't miss a single issue, I want to subscribe right now. Please put my name on your subscription list—pronto!

I enclose \$3 New Order
 Bill me later Renewal

NAME

ADDRESS

CITY STATE ZIP

Modern Guide to Surplus Market

Continued from page 91

28-VDC tube set that requires new wiring and a new power supply. But you can buy an AM transistor radio for \$7.95, battery included.

Be sure to figure all the required parts. Dealers often break down interconnected components and price them separately. This could take the bloom off the rose. I nearly ordered a BC-733 aircraft navigational receiver for \$7.95. Looking further, I discovered it required an indicator (\$1.95), a plug to fit the indicator (\$1.50), a control box (\$2.95), cable and connectors (\$4.95), a ram's horn antenna (\$5.95) and a twin-coax plug for the antenna (\$1.00). The \$7.95 receiver now comes to nearly \$27 and there's still the shipping, circuit conversion and power supply for AC operation.

Watch out for the lingo. When something is classed as *new* it could be 40 years old, though officially unused. It may have even a touch of rust or fungus but work well. When something is *as is* it could mean trampled on by stampeding elephants. Such terms as *like new*, *re-new* and *reconditioned* are highly variable. When the ad reads, "It cost the government \$10,000 to buy—your price: \$14.95, this might mean it's worth \$2. Original cost is often no clue to value.

There are good buys in test equipment but know what you're buying. Tektronix scopes and Ballantine meters are probably on the market because they have tubes and are rather bulky. They might be valuable to you, but compare them with what's available in kits. One clue: A lot of good surplus equipment is whisked out of ham channels by commercial dealers because it's in demand by labs and industry. If you see a famous-make instrument appraise it with a fishy eye before buying. For example, that beautiful signal generator with a hand on it in the photo on the first page of this article stops at 40 mc, so it's no good for TV or FM work.

Finally, be sure a surplus item is really surplus and is being offered at a bargain. Sometimes a standard item slips into ads at same price as in conventional catalogs.

Too many pitfalls in buying surplus? Not at all. Go ahead and convert your first transmitter at a savings of \$100, or buy an \$8 crystal for \$1. Before long, friends and family will be saying, "Look at him, an Arab rug dealer."

EI Tests CB in the Air

Continued from page 96

it was north of Hartford, Conn. A plotter placed on an aeronautical chart proved the distance between us was more than 90 mi. And we were only at 3,500 feet. If we were to climb to 10,000, range would surely reach the legal limit of 150 mi. But a low ceiling that day precluded any further trials.

Our airborne tests that day, though, certainly prove that CB aloft—as the experts intimated—produces scorching coverage. Some other observations? We could hear a large number of stations at a time when most kids should have been in school and bread-winners should be toiling at the fertilizer works. Once stations got wind we were airborne, they called us, we suspect, from as far as Minsk, Pinsk and Smolinsk.

But the prize for inventive thinking goes to a girl we spoke to from Stratford, Conn. Distance was about 30 mi., with superb signals, when she popped the perplexing question: "Can you see any good-looking ladies up there?" What could she mean? I glanced at my co-pilot, who hardly fit the description. But I did have an answer—thanks to a CB rig's remarkable ability to communicate directly from airplane to home. "I have to be home for lunch," I said, "with my wife."

My Life and Hard Times

Continued from page 100

flowing at each session.

To save Charlie the work of repeat performances for the benefit of those who couldn't squeeze through the door, Bob and I taped key parts of his talk.

Our conference room is provided with spotlights built into the ceiling—fine for dramatic effect, but poor at providing the kind of even, all-over light that video (like film) handles best. Moreover, Charlie used slides and movies to illustrate parts of his talks—parts that we finally left untaped because of illumination and sync problems.

Where's the VTR today? Sitting in our lab again. Maybe I'll use it to tape some antics at this year's office Christmas party. But I'd just as soon leave it there so I can enjoy the wassail bowl without worrying about someone tripping over wires or spilling a drink on that expensive record/playback head.

**now... a better way
to drive and adjust
hex socket screws**

...IN PRECISION WORK

With the tools in this new, compact convertible screwdriver set, you can turn all types of hex socket screws... in all types of locations... faster, easier than with conventional keys.

Handy midgets are ideal for such delicate, precision work as assembly and servicing of instruments and controls. Remarkable "piggyback" torque amplifier handle adds grip, reach, and power needed for other applications, lets you do more jobs with fewer tools.



PS-89 SET

8 midgets (hex size .028" thru 1/8") plus hollow, "piggyback" handle. Slim, trim, see-thru plastic case fits pocket or tool box, doubles as bench stand.

REQUEST COMPLETE HAND TOOL CATALOG

which includes information on other Xcelite Compact Sets, too — slot tip/ Phillips/Scrulox® screwdrivers, nutdrivers, and combinations.

Nationwide availability through local distributor



XCELITE, INC., 16 Bank St., Orchard Park, N. Y. 14127
Send complete tool catalog, which includes information on all Xcelite Compact Sets.

name _____
address _____
city _____ state & zip _____

In Canada contact Charles W. Pointon, Ltd.
CIRCLE NUMBER 13 ON PAGE 13

ELECTRONICS ILLUSTRATED

Classified Ads

Your advertisement can reach this mail-buying audience for only 50¢ per word . . . payable in advance (Check or M.O. please) . . . minimum 10 words. Closing dates are the 20th of 4th preceding month. E. copy for the March issue must be in our office by November 20th. Mail to ELECTRONICS ILLUSTRATED, 67 West 44th St., New York, N. Y. 10036. Word count: Zipcode number free. Figure one word: Name of state (New Jersey), name of city (New York); sets of characters as in key (14-D); also abbreviations as 35MM, 8x10, D.C., A.C.

SAVE MONEY • ORDER BY MAIL

• • • FOR SALE

TREASURE HUNTERS! Prospectors! Relco's new instruments detect buried gold, silver, coins. Kits, assembled models. Transistorized. Weighs 3 pounds. \$19.95 up. Free catalog. Relco-A19, Box 10839, Houston, Texas 77018.

ULTRA-SENSITIVE and Powerful Metal Detectors—join the many who are finding buried coins, minerals, relics and artifacts. Don't buy till you see our Free catalog of new models. Write Jetco—Box 132—El—Huntsville, Texas 77340.

CONSTRUCTION PLANS: Laser . . . \$2.00. Surveillance Devices—Two F.M. Bugging Transmitters . . . \$1.00. Tail Transmitter . . . \$1.00. Bug Detector . . . \$1.00. Surveillance equipment and kits available. Howard, 20174 Ward, Detroit, Michigan 48235.

INVESTIGATORS, LATEST electronic aids. Free literature. Clifton, 11500-X NW 7th Ave., Miami, Florida 33168

CONVERT ANY television to sensitive, big-screen oscilloscope. Only minor changes required. No electronic experience necessary. Illustrated plans, \$2.00. Relco A-19, Box 10563, Houston, Texas 77018.

MUSIC LOVERS, continuous, uninterrupted background music from your FM radio, using new inexpensive adaptor. Free literature. Electronics, 11500-W N.W. 7th Ave., Miami, Florida 33168.

POLICE-FIRE RADIO Dispatcher directories! Exclusive official listings, "confidential" frequencies, call signs. Now all areas. Catalog for stamp. Communications, Box 56-El Comack, N.Y. 11725.

INTEGRATED CIRCUIT Kits: Computer, Audio, Others. New catalog free. Kaye Engineering, Box 3932-C, Long Beach, California 90803.

• • • GOVERNMENT SURPLUS

JEEPS TYPICALLY From \$53.90 . . . Trucks From \$78.40 . . . Airplanes, Typewriters, Boats, Clothing, Camping, Sporting, Photographic, Electronics Equipment, Wide Variety, Condition, 100,000 Bid Bargains Direct From Government Nationwide. Complete Sales Directory and Surplus Catalog \$1.00 (Deductible First \$10.00 Order). Surplus Service, Box 820-T, Holland, Michigan 49423.

GOVERNMENT SURPLUS. How and Where to Buy in Your Area. Send \$1.00. E.I. Surplus Information, Headquarters Bldg., Washington 6, D. C.

• • • PRINTING

250 EACH—LETTERHEADS, statements, envelopes and business cards. Send copy (up to 5 lines) and \$17.75 to The Wrightway, 404 East Green, Champaign, Illinois 61820.

• • • BUSINESS OPPORTUNITIES

HOW MUCH does being your own boss or making \$25,000.00 per year interest you? The Warner breakthrough in the Engraving field could be your future. Write: Warner, Room CE-120-C, 1512 Jarvis, Chicago, Ill. 60626.

SELL YOUR Photos, Report Tells How, Where, Color Slide Markets, Only \$1.00, Satisfaction Guaranteed. Almac Company, 690-a Joyful Street, Columbus, Ohio 43204.

VENDING MACHINES—No selling. Operate a route of coin machines and earn high profits. 32-page catalog free! Parkway Machine Corp., 715E1 Ensor St., Baltimore 2, Md.

• • • EMPLOYMENT OPPORTUNITIES

PRINTING — ADVERTISING Salesmen. Excellent moneymaking sideline selling Decalcomania Name Plates. Advertising Specialties. Sign Letters, Automobile initials. Free Samples. Relco-El, Box L, Boston, Mass. 02119.

BOOMING AUSTRALIA Wants You! Good jobs, Adventure. Forms and Australian Handbook (1969) describing Australian assisted passage, passport-visa, advantages, opportunities \$1.00. Buckeye, Box 1032PJ, Fairborn, Ohio 45324.

• • • EDUCATION AND INSTRUCTION

REI CAN train you for the First Class Radio Telephone License in only five (5) weeks. Approved for Veterans Training. REI has schools in Sarasota, Florida; Glendale, California; Fredericksburg, Virginia; and Kansas City, Missouri. For free brochure write REI, 1336 Main Street, Sarasota, Florida 33577 or call 813-955-6722.

BLUE BOOKS and Arco Books. Write for book lists. Heffner Books, Box 5766, Pasadena, Calif. 91107.

HIGHLY EFFECTIVE home study courses in Electronics Engineering Technology and Electronics Engineering Mathematics. Earn your Degree. Write for Free Descriptive Literature. Cook's Institute of Electronics Engineering (Dept. 14), P.O. Box 10634, Jackson, Miss. 39209. (Established 1945).

• • • BUILD-IT-YOURSELF (OR DO-IT-YOURSELF)

PSYCHEDELIC LIGHTING Manual! Make light-machines, strobes, organs, slides, etc. Send \$2.00. Lightrays, 713 Pine, Philadelphia, Pa. 19106.

35,000 VOLT CONTINUOUS spark generator, cheaply made in minutes. Plans, \$1.00 and self-addressed stamped envelope. Lawrence Engineering, Box 18366, Phila., Pa. 19120.

• • • S. W. LISTENING

DXers! SWL's! For information on radio listening clubs in North America write ANARC, 227 Hanna Road, Toronto 350, Ontario, Canada.

• • • TAPE RECORDERS

LEARN WHILE Asleep with your recorder, phonograph or amazing new "Electronic Educator" endless tape recorder. Details free. Sleep-Learning Research Association, Box 24-El, Olympia, Washington.

OLD RADIO Programs On Tape. Gangbusters, Whistler, hundreds more. Sample 2-hr. \$6.00, 4-hr. \$9.00. Catalog \$1.25 (or free with sample). Nostalgia, 9875 SW 212 St., Miami, Fla. 33157.

RENT 4-TRACT open reel tapes—all major labels—3,000 different—free brochure. Stereo-Parti, 55 St. James Drive, Santa Rosa, CA. 95401.

• • • RADIO & TV

TV TUNERS rebuilt and aligned per manufacturers specification. Only \$9.50. Any make UHF or VHF. We ship COD. Ninety day written guarantee. Ship complete with tubes or write for free mailing kit and dealer brochure. JW Electronics, Box 51K, Bloomington, Indiana.

FREE! GIANT bargain catalog on transistors, diodes, rectifiers, SCR's, teners, parts. Poly Paks, P. O. Box 942E1, Lynnfield, Mass.

REPAIR YOUR Own TV Tuners—Color—
 Transistor—VHF—UHF. Earn to \$1,700
 monthly. No customer headaches. Simple,
 complete course. First of its kind.
 Copyrighted. Years in preparation. Six
 sections, 33 chapters. All field-tested.
Jigs—Fixtures—Adapters—"Setting-up."
 Special probes. Quick-checks. How to alter
 and use test sets. Repairs Without
 Equipment. Unique power supplies. Fast-
 fix luxuries. Equipment you can build.
 Professional tricks. Illustrated schematics,
 pictures, drawings, sketches. Plans for
 all items. Troubleshooting. Alignment.
 All tests and adjustments. Common mistakes.
 How And Where To Buy Parts.
 Specific repairs common problems. Index
 of all tuners. Much, much more.
 Programmed teaching. Major Course:
 Details, introduction, plus two sample
 lessons \$1., refundable. Optional condensed
 courses (complete in themselves):
 VHF \$9.50, UHF \$4.50, Transistor Tuners
 \$4.50. Frank Boccek, Box 3236E, Redding,
 Calif. 96001.

POLICE—FIRE—Aircraft—Marine—Amateur
 Calls on your Broadcast Radio
 with Tuner! Tunable—Crystal control!
 Free catalog! Salch Company,
 Woodsboro El. Texas 78393.

THOUSANDS AND thousands of types of
 electronic parts, tubes, transistors, instruments,
 etc. Send for Free Catalog. Arcturus
 Electronics Corp., MEL, 502-
 22nd St., Union City, N. J. 07087.

15 DISTANCE ONE tube plans—25¢.
 "One-Tube Handbook"—50¢. Includes
 Data Sheets, catalog. Laboratories,
 12041-K Sheridan, Garden Grove, Calif.
 92640.

RADIO & T.V. Tubes—33¢. Free List.
 Cornell 4213-15 University, San Diego,
 Calif. 92105.

• • • ELECTRONICS SUPPLIES & EQUIPMENT

FREE CATALOG Over 80 different solid
 state electronic products. New Electronic
 Strobe Kit, \$9.95 ppd. See complete
 line of Bowman solid state products
 at your local authorized dealer. Bowman
 Electronics, Inc., 155 E. 1st Ave., Roselle,
 N.J. 07203.

• • • INVENTIONS & INVENTORS

PATENT SEARCHES including maximum
 speed, full airmail report and closest
 patent copies \$4.00. Quality searches
 expertly administered with complete
 secrecy guaranteed. Free Invention
 Protection forms and "Patent Information."
 Write Washington Patent Search Bureau,
 Dept. 20, 711 14th St. N.W., Washington
 5, D. C.

INVENTORS! SELL your invention for
 cash or royalties! Our client manufacturers
 eagerly seek new items. Patented.
 Unpatented. Financial assistance if
 needed. 25 years proven performance.
 For free information, write Dept. 27,
 Gilbert Adams, Invention Broker, 80
 Wall St., New York, N.Y. 10005.

• • • MUSIC

POEMS, SONGS wanted for new song
 hits and recordings by America's most
 popular studio. Tin Pan Alley, 1650-EL
 Broadway, New York 10019.

• • • ROCKETS

ROCKETS: IDEAL for miniature transmitter
 tests. New illustrated catalog 25¢.
 Single and multistage kits, cones, engines,
 launchers, trackers, rocket aerial cameras,
 technical information, etc. Fast service.
 Estes Industries, Penrose 13, Colorado
 81240.

• • • GREENHOUSES

BACKYARD GREENHOUSE. An easy-to-
 build greenhouse that uses standard
 size panes of glass, a redwood frame and
 concrete foundation. Dimensions are 11
 x 21 ft. but length may be varied. For
 detailed plans send \$5 to Mechanix
 Illustrated Plans Service, Fawcett Bldg.,
 Greenwich, Conn. 06830. Specify Plan
 No. GH-5-67.

• • • PERSONAL

SUBMINIATURE LISTENING Devices, low
 priced, high performance direct from
 manufacturer. Dealers welcome.
 Audioironix LII, 156 Fifth Ave., New York
 N.Y. 10010.

• • • MISCELLANEOUS

PSYCHEDELIC CATALOG. 50 pages of
 Psychedelia. Send 25¢. Hole In Wall,
 6055E1 Lankershim, No. Hollywood, Calif.
 91606.

OVER 2,000,000 BACK Issue Magazines!
 Send Needs. No Catalog. Midtown,
 Box 917-E1, Maywood, N. J. 07607.

32 PAGE BIG illustrated joke and novelty
 catalog. 25¢. Joke, Box 7212GG,
 Chicago 60680.

ELECTRONICS ILLUSTRATED Classified Advertising Order Form

For information on terms, closing dates, etc., see heading at top of Classified Section.

INSTRUCTIONS:

50¢ a word
 Minimum Ad
 10 Words

WORD COUNT: Zip code free. Figure one word for name of state (New Jersey); name of city (Little Falls); sets of characters as in key (M-14); abbreviation of Northwest (NW); but note separate initials as in a name (M. D. Brown), 3 words counted as a word each.

DEADLINE FOR ADS: Copy must be in by the 20th day of the fourth preceding month for the issue in which the ad is to appear.

BLANKLINE: May be placed both above and below the ad, if desired. Each blank line is charged as 5 words.

TO: ELECTRONICS ILLUSTRATED • 67 W. 44th St., New York, N.Y. 10036 • Attn.: Classified Advertising Dept.

Gentlemen: Here's our copy for the Classified Section of ELECTRONICS ILLUSTRATED. Remittance of \$ _____ is enclosed to cover _____ insertion(s) in the _____ issue(s).

1	2	3	4	5
6	7	8	9	10
11	12	13	14	15
16	17	18	19	20
21	22	23	24	25
26	27	28	29	30
31	32	33	34	35

YOUR NAME _____

PHONE _____

FIRM _____

(PLEASE PRINT)

ADDRESS _____

CITY _____

STATE _____

ZIP _____

DATE: _____

YOUR SIGNATURE _____

(PLEASE PRINT OR TYPE COPY • FOR ADDITIONAL WORDS ATTACH SEPARATE SHEET)

11

Reg. U. S. Pat. Off.



Training Electronics Technicians Since 1946

BUILD YOUR OWN RADIO

CIRCUITS AT HOME

with the New Improved
PROGRESSIVE RADIO "EDU-KIT"® only **\$26.95**
A Practical Home Radio Course

- Now Includes**
- ★ 12 RECEIVERS
 - ★ 3 TRANSMITTERS
 - ★ SQ. WAVE GENERATOR
 - ★ SIGNAL TRACER
 - ★ AMPLIFIER
 - ★ SIGNAL INJECTOR
 - ★ CODE OSCILLATOR
- ★ No Knowledge of Radio Necessary
 - ★ No Additional Parts or Tools Needed
 - ★ EXCELLENT BACKGROUND FOR TV
 - ★ **SCHOOL INQUIRIES INVITED**
 - ★ Sold in 79 Countries

YOU DON'T HAVE TO SPEND HUNDREDS OF DOLLARS FOR A RADIO COURSE

The "Edu-Kit" offers you an outstanding PRACTICAL, HOME RADIO COURSE at a rock-bottom price. Our Kit is designed to train Radio & Electronics Technicians, making use of the most modern methods of home training. You will learn radio theory, construction practice and servicing, THIS IS A COMPLETE RADIO COURSE IN EVERY DETAIL.

You will learn how to build radios, using regular schematics; how to wire and solder in a professional manner; how to service radios. You will work with the standard type of punched metal chassis as well as the latest development of Printed Circuit design.

You will learn the basic principles of radio. You will construct, study and work with RF and AF amplifiers and oscillators, detectors, rectifiers, test equipment. You will learn and practice code, using the Progressive Code Oscillator. You will learn and practice troubleshooting using the Progressive Signal Tracer, Progressive Signal Injector, Progressive Dynamic Radio & Electronics Tester, Square Wave Generator and the accompanying instructional material.

You will receive training for the Novice, Technician and General Classes of F.C.C. Radio Amateur licenses. You will build Receiver, Transmitter, Square Wave Generator, Code Oscillator, Signal Tracer and Signal Injector circuits, and learn how to operate them. You will receive an excellent background for television, Hi-Fi and Electronics.

Absolutely no previous knowledge of radio or science is required. The "Edu-Kit" is the product of many years of teaching and engineering experience. The "Edu-Kit" will provide you with a basic education in Electronics and Radio, worth many times the low price you pay. The Signal Tracer alone is worth more than the price of the kit.

THE KIT FOR EVERYONE

You do not need the slightest background in radio or science. Whether you are interested in Radio & Electronics because you want an interesting hobby, a well paying business or a job with a future, you will find the "Edu-Kit" a worth-while investment. Many thousands of individuals of all

ages and backgrounds have successfully used the "Edu-Kit" in more than 79 countries of the world. The "Edu-Kit" has been carefully designed, step by step, so that you cannot make a mistake. The "Edu-Kit" allows you to teach yourself at your own rate. No instructor is necessary.

PROGRESSIVE TEACHING METHOD

The Progressive Radio "Edu-Kit" is the foremost educational radio kit in the world, and is universally accepted as the standard in the field of electronics training. The "Edu-Kit" uses the modern educational principle of "Learn by Doing." Therefore you construct, learn schematics, study theory, practice troubleshooting—all in a closely integrated program designed to provide an easily learned, thorough and interesting background in radio.

You begin by examining the various radio parts of the "Edu-Kit." You then learn the function, theory and wiring of these parts. Then you build a simple radio. With this first set you will enjoy listening to regular broadcast stations, learn more advanced theory and techniques. Gradually, in a progressive manner, and at your own rate, you will find yourself constructing more advanced multi-tube radio circuits, and doing work like a Professional Radio Technician.

Included in the "Edu-Kit" course are Receiver, Transmitter, Code Oscillator, Signal Tracer, Square Wave Generator and Signal Injector Circuits. These are not unprofessional "breadboard" type, but genuine radio circuits, constructed by means of professional wiring and soldering on metal chassis, plus the new method of radio construction known as "Printed Circuitry." These circuits operate on your regular AC or DC house current.

THE "EDU-KIT" IS COMPLETE

You will receive all parts and instructions necessary to build twenty different radio and electronics circuits, each guaranteeing to operate. Our Kits contain tubes, tube sockets, variable, electrolytic, mica, ceramic and paper dielectric condensers, resistors, tie strips, hardware, tubing, punched metal chassis, Instruction Manuals, hook-up wire, solder, selenium rectifiers, coils, volume controls and switches, etc.

In addition, you receive Printed Circuit materials, including Printed Circuit chassis, special tube sockets, hardware and instructions. You also receive a useful set of tools, a professional electric soldering iron, and a self-powered Dynamic Radio and Electronics Tester. The "Edu-Kit" also includes Code Instructions and the Progressive Code Oscillator. The "Edu-Kit" also includes Code Instructions and the Progressive Code Oscillator. The "Edu-Kit" also includes Code Instructions and the Progressive Code Oscillator.

Progressive "Edu-Kits" Inc. 1186 Broadway, Dept. 604AE, Hewlett, N. Y. 11557

UNCONDITIONAL MONEY-BACK GUARANTEE

Please rush my Progressive Radio "Edu-Kit" to me, as indicated below:
Check one box to indicate choice of model

Regular model \$26.95.

Deluxe model \$31.95 (same as regular model except with superior parts and tools plus valuable Radio & TV Tube Checker).

Check one box to indicate manner of payment

I enclose full payment. Ship "Edu-Kit" post paid.

I enclose \$5 deposit. Ship "Edu-Kit" C.O.D. for balance plus postage.

Send me FREE additional information describing "Edu-Kit."

Name _____

Address _____

City & State _____ Zip _____

PROGRESSIVE "EDU-KITS" INC.
1186 Broadway, Dept. 604AE, Hewlett, N. Y. 11557

FREE EXTRAS

- SET OF TOOLS
- SOLDERING IRON
- ELECTRONICS TESTER
- PLIERS-CUTTERS
- VALUABLE DISCOUNT CARD
- CERTIFICATE OF MERIT
- TESTER INSTRUCTIONAL MANUAL
- HIGH FIDELITY GUIDE QUIZZES
- TELEVISION BOOK & RADIO TROUBLE-SHOOTING BOOK
- MEMBERSHIP IN RADIO-TV CLUB: CONSULTATION SERVICE & F.C.C. AMATEUR LICENSE TRAINING
- PRINTED CIRCUITRY

SERVICING LESSONS

You will learn troubleshooting and servicing in a progressive manner. You will practice repairs on the sets that you construct. You will learn symptoms and causes of trouble in home, portable and car radios. You will learn how to use the professional Signal Tracer, the unique Signal Injector and the dynamic Radio & Electronics Tester. While you are learning in this practical way, you will be able to do many a repair job for your friends and neighbors, and charge fees which will far exceed the price of the "Edu-Kit." Our Consultation Service will help you with any technical problems you may have.

FROM OUR MAIL BAG

J. Statulis, of 25 Poplar Pl., Waterbury, Conn., writes: "I have repaired several sets for my friends, and made money. The "Edu-Kit" paid for itself. I was ready to spend \$240 for a Course, but I found your ad and sent for your Kit."

Ben Valerio, P. O. Box 21, Magna, Utah: "The Edu-Kits are wonderful. Here I am sending you the questions and also the answers for them. I have been in Radio for the last seven years, but like to work with Radio Kits, and like to build Radio Testine Equipment. I enjoyed every minute I worked with the different kits; the Signal Tracer works fine. Also like to let you know that I feel proud of becoming a member of your Radio-TV Club."

Robert L. Shuff, 1534 Monroe Ave., Huntington, W. Va.: "Though I would drop you a few lines to say that I received my Edu-Kit, and was really amazed that such a bargain can be had at such a low price. I have already started repairing radios and phonographs. My friends were really surprised to see me get into the swing of it so quickly. The Trouble-shooting Tester that comes with the Kit is really swell, and finds the trouble, if there is any to be found."

PRINTED CIRCUITRY

At no increase in price, the "Edu-Kit" now includes Printed Circuitry. You build a Printed Circuit Signal Injector, a unique servicing instrument that can detect many Radio and TV troubles. This revolutionary new technique of radio construction is now becoming popular in commercial radio and TV sets.

A Printed Circuit is a special insulated chassis on which has been deposited a conducting material which takes the place of wiring. The various parts are merely plugged in and soldered to terminals.

Printed Circuitry is the basis of modern Automation Electronics. A knowledge of this subject is a necessity today for anyone interested in Electronics.

CIRCLE NUMBER 10 ON PAGE 13

Electronics is opportunity, action and NTS!

Pick any one of the four big fields in electronics: COLOR-TV, INDUSTRIAL or COMPUTER ELECTRONICS, or COMMUNICATIONS. Each is packed with opportunity for the men who want to move up. If you're among them, mail the card below. Because NTS training is fast, easy and through.



ALL NEW KITS... ALL NEW COURSES, WITH NTS PROJECT-METHOD TRAINING! MORE BIG KITS THAN EVER OFFERED FOR TRAINING ANYWHERE!

A 295 sq. in. picture COLOR TV, a desk-top computer trainer, oscilloscope solid-state radios, Integrated circuits, too! All part of NTS Project-Method: The sure-fire system that builds everything you need to know around practical kit projects. And NTS gives you professional "test-center" equipment, including signal generator FET-VOM, and tube checker for your troubleshooting and servicing work. NTS shows you how to use them early in your training. You earn money repairing TV sets and electronic equipment even before you've completed the course. Brand new Color Catalog describes in detail all the exciting equipment that comes with each course.

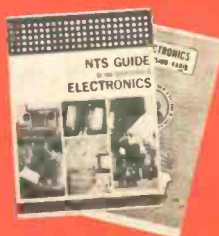

Get the full story! See all the exciting new kits you get from NTS! Cut out and mail reply card for new, color catalog and sample lesson! No obligation. No salesman will call.

CLASSROOM TRAINING AT LOS ANGELES:

You can train at our resident school in Los Angeles. NTS occupies a city block with over a million dollars in facilities devoted to technical training. Check special box in coupon.

HIGH SCHOOL AT HOME:

NTS offers accredited high school programs. Take only the subjects you need. Study at your own pace. Everything included at one low tuition. Check special box in coupon for free catalog.



Accredited Member:
National Home
Study Council



Accredited Member:
National Association
of Trade and
Technical Schools.

NATIONAL TECHNICAL SCHOOLS

World Wide Training Since 1905
4000 S. Figueroa Street
Los Angeles, California 90037

APPROVED FOR VETERANS

ACT NOW! DON'T DELAY! **10** TRAINING PROGRAMS TO INSURE YOUR FUTURE

Please rush new Color Catalog and Sample Lesson plus information on course checked below. No obligations. No salesman will call.

- MASTER COURSE IN COLOR TV SERVICING
- COLOR TV SERVICING
- MASTER COURSE IN TV & RADIO SERVICING
- PRACTICAL TV & RADIO SERVICING
- MASTER COURSE IN ELECTRONIC COMMUNICATIONS
- FCC LICENSE COURSE
- MASTER COURSE IN ELECTRONICS TECHNOLOGY
- INDUSTRIAL AND AUTOMATION ELECTRONICS
- COMPUTER ELECTRONICS
- BASIC ELECTRONICS
- High School at Home
- Major Appliances Servicing Course

Dept. 213-109

Name _____ Age _____

Address _____

City _____ State _____

Please fill in Zip Code for fast service _____

- Check if interested in Veteran Training under new G.I. Bill
- Check here if interested ONLY in Classroom training in Los Angeles

www.americanradiohistory.com



Now you may
earn double-time
pay without
working over-time.

\$\$\$\$\$\$\$\$\$\$\$\$

National Technical Schools makes it easier to double your income. All you need is your own ambition. The NTS Project Method simplifies your training... makes it easy for you to enter Electronics... a whole new world of opportunity. You can have a solid career and probably double your present earnings. Start moving up today. In Color TV. Or in computer and industrial electronics. Or in communications and aerospace. It's easier than you think.

NTS will show you how!



BUSINESS REPLY MAIL
No Postage Stamp Necessary if Mailed in the United States

POSTAGE WILL BE PAID BY

NATIONAL TECHNICAL SCHOOLS

4000 South Figueroa Street
Los Angeles, California 90037

FIRST CLASS
Permit No. 3087
Los Angeles,
Calif.

VIA AIR MAIL



(see other side for more information)

NATIONAL



SCHOOLS

World Wide Training Since 1905
4000 So. Figueroa St., Los Angeles, Calif. 90037



APPROVED FOR VETERANS

NTS... An Accredited School devoted to both Resident and Home Study Training

NTS... Occupies a city block with over a million dollars in facilities.