

COMMON SENSE ABOUT CB ANTENNAS

ELECTRONICS ILLUSTRATED®

By the Publishers of MECHANIX ILLUSTRATED

JULY • 35¢

Easy-to-Build

TV SIGNAL BOOSTER

is **POWERED
BY SUNLIGHT!**

Mounts on your mast,
gives you
a 35-fold increase
in signal strength

**THE RAREST DX OF ALL
BUILD A MILES-PER-GALLON
INDICATOR & TACH FOR YOUR CAR**

**IMPEDANCE:
HOW TO HOOK ANYTHING TO ANYTHING**

**MAKE YOUR OWN
7-FUNCTION SERVICE INSTRUMENT
WIRED WIRELESS MUSIC BROADCASTER**

THE AMAZING FREE-POWER RADIO

**TV PAGING SYSTEM
FLEA-POWER FUN FOR HAMS**

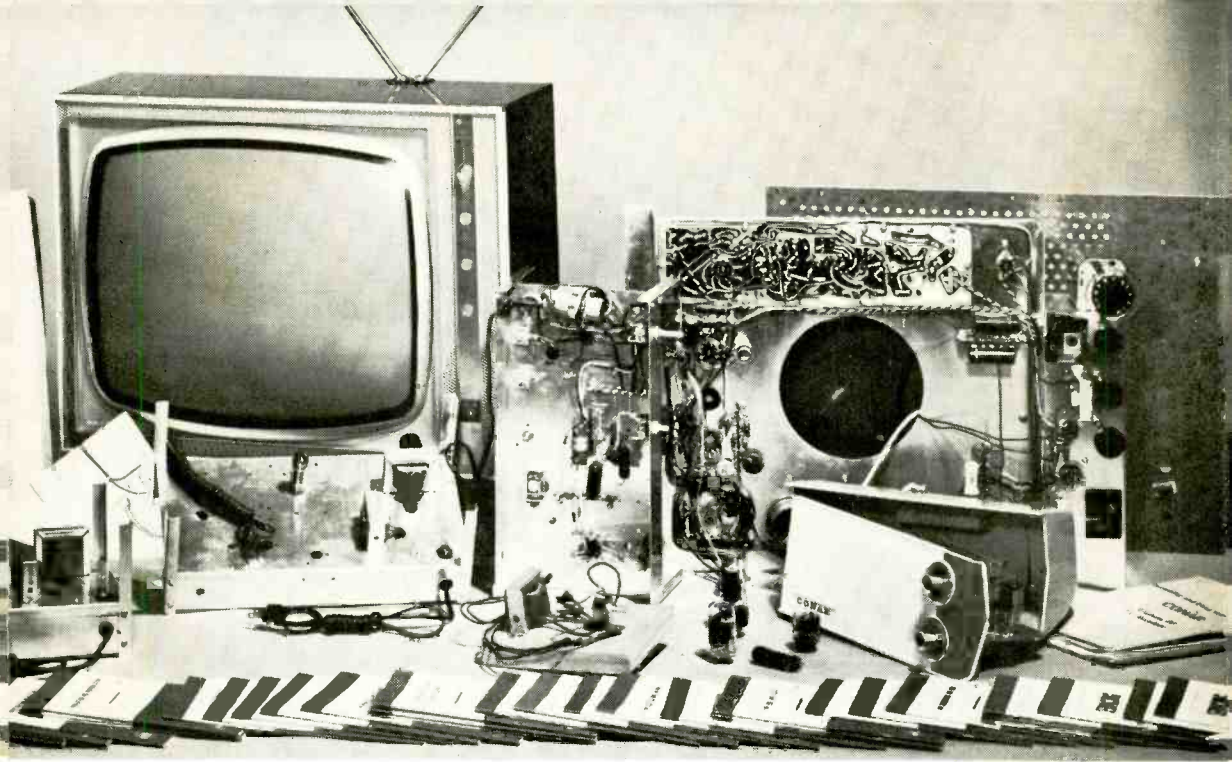

COMPARE. You'll find—as have tens of thousands of NRI graduates—that NRI training gives you more value. From the delivery of your first lessons in the remarkable NRI Achievement Kit we send you on enrolling, to “bite size” easily-read texts carefully programmed with custom-designed training kits . . . NRI can't be beat. Text for text, kit for kit, dollar for dollar—your best home-study buy is unquestionably NRI. (And NRI training costs you less than one semester's tuition at most colleges.)

New Achievement Kit Starts You Fast

The day we receive your enrollment application we mail out your new NRI Achievement Kit. This attractive starter kit is an outstanding, logical way to help you get an easier, faster start in the training of your choice. It is the first of a number of special training aids developed in the NRI laboratories to make your adventure into Electronics exciting, meaningful. What's

NOW 10 WAYS to Train at Home with the Leader

1. TELEVISION-RADIO SERVICING

—Learn to fix black-and-white and color sets. AM-FM radios, stereo hi-fi, etc. A profitable field for part or full-time business of your own.

2. COMPLETE COMMUNICATIONS*

—Teaches and gives actual practice in operation, service, maintenance of AM, FM, and TV broadcasting stations. Also covers marine, aviation, mobile radio, facsimile, microwave, radar.

3. INDUSTRIAL-MILITARY ELECTRONICS

—From basic principles to computers. A comprehensive training plan that starts with fundamentals, then covers servos, telemetry, multiplexing, phase circuitry, other subjects.

4. FCC LICENSE*

—Specifically designed to prepare you for First Class FCC Radiotelephone License exams. You

begin with Electronic fundamentals, advance to required subjects covering equipment, procedures.

5. MATH FOR ELECTRONICS

—A brief course for engineers and technicians who need a quick review of math used in industry, communications, government jobs. Short-cut formulas, digital number systems, much more.

6. BASIC ELECTRONICS

—Concise course in modern Electronic terminology and components. Practical, useful information to help you understand the field, give you some technical knowledge of Radio-TV, Electronics.

7. AVIATION COMMUNICATIONS*

—Prepares you to install, maintain, service aircraft equipment like direction finders, ranges, markers, Loran, Shoran, Radar, landing systems. Prepares you for

in it? Your first group of lesson texts; a rich, vinyl desk folder to hold your material; the industry's most complete Radio-TV Electronics Dictionary; valuable reference texts; lesson answer sheets; envelopes; pencils; pen; engineer's ruler; even postage. No other school has anything like it.

Build, Discover with NRI Equipment

Electronics comes alive with NRI training kits. What better way to learn than by *doing*? NRI pioneered and perfected the “home lab” technique of training at home in spare time. You get your hands on actual parts to build, experiment, explore, discover. NRI invites comparison with training equipment offered by any other school. Begin *now* this exciting program of practical learning. Whatever your need . . . whatever your education . . . there's an NRI instruction plan for you, at low tuition rates. Get all the facts. Fill in and mail the postage-free card today. NATIONAL RADIO INSTITUTE, Electronics Division, Washington, D. C. 20016

FCC License exams.

8. MOBILE COMMUNICATIONS*—

Learn to install, maintain mobile equipment and associated base stations. Covers transmitters and receivers used by police, fire departments, taxi companies, etc. Prepares for FCC exams.

9. MARINE COMMUNICATIONS*—

Covers transmitters, direction finders, depth indicators, Radar, Sonar, other equipment used on commercial ships and pleasure boats. Prepares you for FCC License exams.

10. ELECTRONICS FOR AUTOMATION

—Not for beginners, but for men with some fundamental knowledge of Electronics who want an understanding of Automation. Process control, ultrasonics, telemetering and remote control, etc.

*NOTE: You must pass your FCC License exams (any Communications course) or NRI refunds in full the tuition you have paid.

What most people don't know about hi-fi kits could fill a book.

This one. (And it's free!)

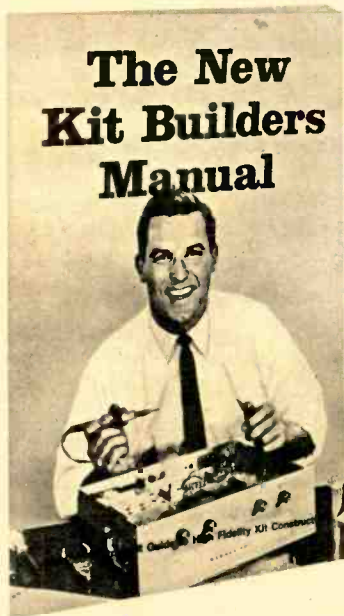

FREE! \$1.50 VALUE! 32 PAGES! *The New Kit Builder's Manual* is a completely new version of the authoritative Fisher guide to high-fidelity kit construction. It is new in format, twice as long in content, and contains detailed specifications of all Fisher StrataKits. Here is an introduction to kit building presented in a manner so nontechnical and lucid, even your wife will understand it. Included are comprehensive, illustrated articles on every phase of assembly, wiring and soldering. *The New Kit Builder's Manual* is the handiest tool a do-it-yourself audiophile can have: the first thing you need before investing in stereo amplifier, tuner or loudspeaker kits.

Mail this coupon today for your *free* copy of *The New Kit Builder's Manual!*

Fisher Radio Corporation 217
21-40 44th Drive, Long Island City, N.Y. 11101
Please send me *The New Kit Builder's Manual*
without charge or obligation.

Name _____

Address _____

City _____

State _____

OVERSEAS RESIDENTS PLEASE WRITE TO FISHER RADIO INTERNATIONAL, INC., LONG ISLAND CITY, N. Y. 11101.
CANADIAN RESIDENTS WRITE TO TRI-TEL ASSOCIATES, LTD., WILLOWDALE, ONT.

The Fisher

ELECTRONICS ILLUSTRATED

JULY, 1965

A Fawcett Publication

Vol. 8, No. 4

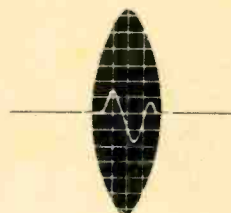

General Features

The Dream That Won't Die	Ken Gilmore	25
How to Hook Anything to Anything	Bert Mann	36
Radio's Impossible Impasse	Steve Conway	59
How Do Planes Find Their Way?	Frank Deems	64
New Light From the Ionosphere	Bob Swearingin, W5HJV	76
Coffee, Milk or TV?	Bob Swathmore	86
Our Friendly Secret Police	Marshall Lincoln, K9KTL	93
Telcan, You Say?	Bob Angus	102
Electro-Toot School	H. F. Kutschbach	112

Construction Projects

Build Your Own Broadcast Station	Al Toler	32
7-In-1 Analyst	Forrest H. Frantz, Sr.	41
Sun-Powered TV Booster	Kevin Redmond, K2HTZ	48
VTVM Ammeter Adaptor	Rudolf F. Graf	63
Miles-Per-Gallon Indicator/Tachometer	Steven E. Summer	70
TV Call Box	Homer L. Davidson	90
Skyway Monitor	Edward Lininger	96

Radio: CB • Amateur • SWL

Common Sense About CB Antennas	Len Buckwalter, KBA4480	29
Ham Shack	Robert Hertzberg, W2DJJ	40
Watch Your Modulation!	Herb Friedman, KB19457	54
SWL Club Shape-Up	Don Carter	56
Kit Report: Budget Ham Station		68
Flea-Power Hams: The Davids In Goliath Land	Bob Brown, K2ZSQ	74
The Listener	C. M. Stanbury II	81
CB Corner: Ready When You Are, CB	Len Buckwalter	82
Rarest DX of All	Alex Bower	87
Notes From EI's DX Club		99
The Serious Side of CB	Casey Probett, Jr.	100

Audio & Hi-Fi

What The Heck's a XAM?	Ron Sommers	45
Far-Out Facts on Tape	Bob Angus	52
Stereo Speaker Simulator	Edward H. Johnson	57
Hi-Fi Today	John Milder	73

Theory & Practice

Beginners Page: Free-Power Radio	H. B. Morris	78
--	--------------	----

Regular Departments

Feedback From Our Readers		8
Electronics in the News		12
Electronic Swap Shop		16
Electronic Marketplace		19
Broadsides		23
Good Reading	Tim Cartwright	39
Subscription Blank		115

MEMBERSHIPS

Audit Bureau of Circulations



Magazine Publishers Association, Inc.



COVER — Ektachrome by
R. J. Capotosto

Announcing

World-Famous NATIONAL RADIO INSTITUTE'S

Completely New Training-at-Home

for the man who wants to SAVE MONEY and MAKE MONEY
— spare time or full time — cashing in on the demand for men who know how to

SERVICE ELECTRIC APPLIANCES

NRI's 50th Anniversary Brings You This Opportunity of a Lifetime To Become a Master Appliance Technician . . . Save on YOUR OWN Home, Shop or Farm Repairs . . . Make \$3 to \$5 an Hour Fixing and Servicing Appliances for Your Neighbors!

FOR 50 years, NRI has been successfully training men like you to become top-notch Technicians. Now NRI training is bigger and better than ever — YOU gain bigger and better profits from it!

NRI's new, completely revised and expanded home-training course offers you EVERYTHING YOU NEED TO KNOW—whether you want to fix your own appliances to save money, or make money.

Easier Than You Think!

You DON'T need technical experience. You DON'T need higher education. Everything is explained in plain English — shown in big, detailed, clear pictures. You start from scratch — learn how electricity works — then rapidly advance to installing new outlets, rewiring, fixing and servicing every kind of home, farm and business appliance.

NRI's special new section on modern air conditioning and refrigeration gives you complete know-how in this fast-growing field. Other sections are invaluable for men who work on farms, or in stores or plants. No matter what you're called on to fix, in no time you'll be making repairs like a pro. And — you now get special bonus lessons on 2- and 4-cycle gasoline engines!

Make Extra Money

More than a MILLION appliances and engine-powered tools are sold each week! Once you can fix them, you'll "cash in" on this boom. It's a fact: NRI-trained men earn \$3.00 to \$5.00 an hour in spare time alone!

Don't worry how little you may now know about repair work. Former student John D. Pettis, who works out of his basement, says: "I had practically no knowledge of any kind of repair work. Now I am busy almost all my spare time and my day off — and have more and more repair work coming in all along."

No matter where you live, everyone owns and depends on appliances. And once you know how to service them, the owners depend on YOU!

MAIL COUPON TODAY

Wouldn't you like right now to be able to repair your own broken appliances? Wouldn't you like right now to have money coming in each week? Let NRI show you how. Free Book and Free Sample Lesson describe the new, expanded, low-cost NRI Course in full . . . show how you can quickly master repairing appliances in your spare time. Mail coupon TODAY (or write direct to) National Radio Institute, Dept. 504-075, Washington, D.C. 20016. (No obligation, of course — and no salesman will call on you.)



This FREE BOOK

will open your eyes to a whole world of new opportunities for making money, saving money, through time-tested, low-cost NRI training.



This FREE LESSON

will show how simple and clearly illustrated NRI training is — how it can quickly prepare you to be an expert Service Technician in your community!



Earn While You Learn with this Professional APPLIANCE TESTER KIT — Yours at No Extra Charge!

FIX ALL THESE — AND MORE!

- Travel Irons
- Steam Irons
- Lighting Fixtures
- Fluorescent Lights
- Switches
- Heaters
- Fuses
- Plugs
- Lamps
- Electric Blankets
- Toasters
- Coffeemakers
- Chafing Dishes
- Automotive Air Conditioners
- Water Heaters
- Centrifugal Pumps
- Egg Cookers
- Bottle Warmers
- Vaporizers
- Paint Sprayers
- Waffle Irons
- Roasters
- Deep Fryers
- Electric Shavers
- Clocks
- Food Mixers and Blenders
- Tank Vacuum Cleaners
- Canister Vacuum Cleaners
- Upright Vacuum Cleaners
- AC Motors
- Non-automatic Washers
- Automatic Washers
- Refrigerators
- Freezers
- Vegetable Coolers
- Soda Fountain Coolers
- Bench Grinders
- Two-cycle Gasoline Engines
- Four-cycle Gasoline Engines

MAIL NOW FOR FREE BOOK AND SAMPLE LESSON

Mr. J. M. Smith, President
NATIONAL RADIO INSTITUTE
Appliance Servicing Division
Dept. 504-075, Washington, D.C. 20016

Please send Free Book and Free Sample Lesson. I am particularly interested in:

- Business of my Own Spare-Time Earnings
 Repairing My Own Appliances

No salesman will call

Name..... (Please Print)

Address.....

City..... Zone..... State.....

Accredited Member National Home Study Council

send for New FREE
CRYSTAL CATALOG
 . . . with New
TRANSISTOR OSCILLATOR CIRCUITS

Citizen Band Class "D" Crystals

CITIZEN BAND CLASS "D" CRYSTALS
 3rd overtone — .005% tolerance — to meet all FCC requirements. Hermetically sealed HC6/U holders. 1/2" pin spacing. .050 pins. (Add 15c per crystal for .093 pins). **\$2.95 EACH**

All 23 channels frequencies in stock: 26.965, 26.975, 26.985, 27.005, 27.015, 27.025, 27.035, 27.055, 27.065, 27.075, 27.085, 27.105, 27.115, 27.125, 27.135, 27.155, 27.165, 27.175, 27.185, 27.205, 27.215, 27.225, 27.255.

Matched crystal sets for ALL CB units (Specify equipment make and model numbers) **\$5.90 per set**

CRYSTALS IN HC6/U HOLDERS

SEALED OVERTONE .486 pin spacing — .050 diameter — .005% tolerance
 15 to 30 MC **\$3.85** — 30 to 40 MC **\$4.10** — 40 MC to 65 MC **\$4.50** — 65 MC to 100 MC **\$6.00 ea.**

FUNDAMENTAL FREQ. SEALED From 1601 KC to 2000 KC **\$5.00**; from 2001 KC to 2500 KC **\$4.00**; 2501 KC to 5000 KC **\$3.50**; 5001 KC to 7000 KC **\$3.90**; 7001 KC to 10,000 KC **\$3.25.**

RADIO CONTROL Specify frequency. .05 pins spaced 1/2" (Add 15c for .093 pins). **\$2.95 ea.**



QUARTZ CRYSTALS FOR EVERY SERVICE

All crystals made from Grade "A" imported quartz—ground and etched to exact frequencies. Unconditionally guaranteed! Supplied in:

- FT-243 holders Pin spacing 1/2" Pin diameter .093
- MC-7 holders Pin spacing 3/4" Pin diameter .125
- CRIA/AR holders Pin spacing 1/2" Pin diameter .125
- FT-171 holders Pin spacing 3/4" Banana pins

MADE TO ORDER CRYSTALS . . . Specify holder wanted

1001 KC to 1600 KC: .005% tolerance	\$4.50 ea.
1601 KC to 2000 KC: .005% tolerance	\$3.55 ea.
2001 KC to 2500 KC: .005% tolerance	\$2.75 ea.
2501 KC to 9000 KC: .005% tolerance	\$2.50 ea.
9001 KC to 11,000 KC: .005% tolerance	\$3.00 ea.

Amateur, Novice, Technician Band Crystals

.01% Tolerance **\$1.50 ea.** — 80 meters (3701-3749 KC)
 40 meters (7152-7198 KC), 15 meters (7034-7082 KC), 6 meters (8335-8650 KC) within 1 KC
 FT-241 Lattice Crystals in all frequencies from 370 KC to 540 KC (all except 455 KC and 500 KC) **\$1.25 ea.**
 Pin spacing 1/2" Pin diameter .093
 Matched pairs — 15 cycles **\$2.50 per pair**

Nearly:
 IF YOUR PARTS DEALER DOES NOT STOCK TEXAS CRYSTALS, OR IS OUT OF STOCK, SEND TO THE FACTORY NEARER YOU! Minimum order, check or C.O.D., is \$5.00. Remember to add postage and handling.

3 PLANTS TO SERVE YOU BETTER

ORDER FROM CLOSER PLANT TEXAS CRYSTALS

DEPT. E-75
 1000 Crystal Drive
 FORT MYERS, FLORIDA
 Phone 813 WE 6-2109

Division of



AND
 4117 W. Jefferson Blvd.
 LOS ANGELES, CALIF.
 Phone 213-731-2256

ELECTRONICS ILLUSTRATED

By the Publishers of MECHANIC ILLUSTRATED

editor **ROBERT G. BEASON**
 managing editor **Robert D. Freed**
 feature editor **Richard A. Flanagan**
 art editor **Lou Rubsamen**
 editorial associate **Albert P. Lahndt, Jr., K2IAG**
 production editor **Rosanne Walsh**
 advertising mgr. **John F. Webster**
 eastern adv. mgr. **Don Daily**

CONTRIBUTING EDITORS

amateur radio **Robert Hertzberg, W2DJJ**
 citizens band **Len Buckwalter, KBA4480**
 swl-dx **C. M. Stanbury II**
 special projects **Herb Friedman, W2ZLF/KBI9457**
 audio **Harry Kolbe**
 audio **John Milder**
 audio **David Muirhead**

EXECUTIVE STAFF

vice president **Ralph Daigh**
 art director **Al Allard**
 associate art director **Ralph Mattison**
 advertising director **Mortimer Berkowitz, Jr.**
 production director **George H. Carl**

ADDRESSES

Editorial and Advertising Offices: 67 West 44th St., New York, N.Y. 10036. Subscriptions: Change of address Form 3579 to Subscription Dept., Fawcett Bldg., Greenwich, Conn. 06830.

ELECTRONICS ILLUSTRATED is published bi-monthly by Fawcett Publications, Inc., Fawcett Place, Greenwich, Conn. W. H. Fawcett, Jr., President; Gordon Fawcett, Secretary and Treasurer; Roger Fawcett, General Manager; Roscoe K. Fawcett, Circulation Director; Donald P. Hanson, Assistant General Manager.

Second-class postage paid at Greenwich, Conn., and at additional mailing offices.

Subscription price \$4 for 12 issues in U.S. and possessions and Canada. All other countries \$6 for 12 issues. Foreign subscriptions and sales should be remitted by International Money Order in U.S. funds payable at Greenwich, Conn.

Printed in U.S.A. Copyright © 1965 by Fawcett Publications, Inc. Permission hereby granted to quote from this issue of this magazine on radio or television provided a total of not more than 1,000 words is quoted and credit is given to the title of the magazine and issue, as well as the statement, copyright 1965 by Fawcett Publications, Inc.



50,000 MEN HAVE FOLLOWED OUR ADVICE.. HOW ABOUT YOU?

Profit and Grow as a DeVry-Trained Electronics Technician

"FOR REAL MONEY, A SOLID FUTURE AND EXCITING WORK, GET INTO THIS GREAT INDUSTRY!" — that's the kind of advice we've given ever since DeVry Tech started more than three decades ago. And our advice still holds true, for today's electronics industry is a multi-billion-dollar field, growing fast, calling for more and more trained men, offering some of the greatest opportunities in its history.

There is an air of excitement about electronics, whether you are in radio and television, space and missile electronics, communications, computer work, your own service business, or other branch of the field. Thousands of men much like yourself, men with ambition to be somebody — have learned electronics the DeVry way, either at home or in day or evening classes at one of our well-equipped resident schools. You, too, may keep your present job while preparing for a better one; make extra money in spare time while you learn. And . . . you don't need previous technical experience or advanced education to get started.

When you graduate, our efficient Employment Service will help you get started toward a good job, a promotion or a business of your own. Get the full story — no obligation! All you have to do is fill out the coupon and send it in.

MODERN TRAINING AIDS
 "Programmed" texts . . . visual aid training movies . . . actual equipment to build. DeVry's programs are designed with progress in mind.

2,200 RESIDENT STUDENTS
 DeVry Tech now has 2,200 resident students attending day and evening classes.

5,000 FIRMS HAVE EMPLOYED DeVRY GRADUATES
 Our men are "wanted" in many industries. There must be a reason!

FREE!



Get two valuable booklets telling about today's opportunities in electronics.

MAIL THIS COUPON TODAY!

DeVRY TECHNICAL INSTITUTE
 4141 Belmont Ave., Chicago, Ill. 60641, Dept. EI-7-V

Please give me your two free booklets, "Pocket Guide to Real Earnings" and "Electronics in Space Travel"; also include details on how to prepare for a career in Electronics. I am interested in the following opportunity fields (check one or more):

- | | |
|--|---|
| <input type="checkbox"/> Space & Missile Electronics | <input type="checkbox"/> Communications |
| <input type="checkbox"/> Television & Radio | <input type="checkbox"/> Computers |
| <input type="checkbox"/> Microwaves | <input type="checkbox"/> Industrial Electronics |
| <input type="checkbox"/> Automation Electronics | <input type="checkbox"/> Broadcasting |
| <input type="checkbox"/> Radar | <input type="checkbox"/> Electronic Control |

NAME _____ AGE _____
 ADDRESS _____ APT. _____
 CITY _____ ZONE _____ STATE _____

Check here if you are under 16 years of age.
 Canadian residents: Write DeVry Tech of Canada, Ltd.
 2097 970 Lawrence Avenue West, Toronto 19, Ontario

DeVry Technical Institute

Chicago • Toronto

BECOME A RADIO

Build 20 Radio and Electronic Circuits at Home

ALL GUARANTEED TO WORK!

YOU DON'T HAVE TO SPEND HUNDREDS OF DOLLARS FOR A RADIO COURSE

The "Edu-Kit" offers you an outstanding PRACTICAL HOME RADIO COURSE at a rock-bottom price. Our Kit is designed to train Radio & Electronics Technicians, making use of the most modern methods of home training. You will learn radio theory, construction practice and servicing. THIS IS A COMPLETE RADIO COURSE IN EVERY DETAIL.

You will learn how to build radios, using regular schematics; how to wire and solder in a professional manner; how to service radios. You will work with the standard type of punched metal chassis as well as the latest development of Printed Circuit chassis.

You will learn the basic principles of radio. You will construct, study and work with RF and AF amplifiers and oscillators, detectors, rectifiers, test equipment. You will learn and practice solder, using the Progressive Code Oscillator. You will learn and practice trouble-shooting, using the Progressive Signal Tracer, Progressive Signal Injector, Progressive Dynamic Radio & Electronics Tester, Square Wave Generator and the accompanying instructional material.

You will receive training for the Novice, Technician and General Classes of F.C.C. Radio Amateur Licenses. You will build Receiver, Transmitter, Square Wave Generator, Code Oscillator, Signal Tracer and Signal Injector circuits, and learn how to operate them. You will receive an excellent background for television, Hi-Fi and Electronics.

Absolutely no previous knowledge of radio or science is required. The "Edu-Kit" is the product of many years of teaching and engineering experience. The "Edu-Kit" will provide you with a basic education in Electronics and Radio, worth many times the complete price of \$26.95. The Signal Tracer alone is worth more than the price of the entire Kit.

THE KIT FOR EVERYONE

You do not need the slightest background in radio or science. Whether you are interested in Radio & Electronics because you want an interesting hobby, a well paying business or a job with a future, you will find the "Edu-Kit" a worth-while investment. Many thousands of individuals of all

ages and backgrounds have successfully used the "Edu-Kit" in more than 79 countries of the world. The "Edu-Kit" has been carefully designed, step by step, so that you cannot make a mistake. The "Edu-Kit" allows you to teach yourself at your own rate. No instructor is necessary.

PROGRESSIVE TEACHING METHOD

The Progressive Radio "Edu-Kit" is the foremost educational radio kit in the world, and is universally accepted as the standard in the field of electronics training. The "Edu-Kit" uses the modern educational principle of "Learn by Doing." Therefore you construct, learn schematics, study theory, practice trouble-shooting—all in a closely integrated program designed to provide an easily-learned, thorough and interesting background in radio.

You begin by examining the various radio parts of the "Edu-Kit." You then learn the function, theory and wiring of these parts. Then you build a simple radio. With this first set you will enjoy listening to regular broadcast stations, learn theory, practice testing and trouble-shooting. Then you build a more advanced radio, learn more advanced theory and techniques. Gradually, in a progressive manner, and at your own rate, you will find yourself constructing more advanced multi-tube radio circuits, and doing work like a professional Radio Technician.

Included in the "Edu-Kit" course are Receiver, Transmitter, Code Oscillator, Signal Tracer, Square Wave Generator and Signal Injector circuits. These are not unprofessional "breadboard" experiments, but genuine radio circuits, constructed by means of professional wiring and soldering on metal chassis, plus the new method of radio construction known as "Printed Circuitry." These circuits operate on your regular AC or DC house current.

THE "EDU-KIT" IS COMPLETE

You will receive all parts and instructions necessary to build 20 different radio and electronic circuits each guaranteed to operate. Our Kits contain tubes, tube sockets, variable, electrolytic, mica, ceramic and paper dielectric condensers, resistors, tie strips, coils, hardware, tubing, punched metal chassis, Instruction Manuals, hook-up wire, solder, selenium rectifiers, volume controls and switches, etc.

In addition, you receive Printed Circuit materials, including Printed Circuit chassis, special tube sockets, hardware and instructions. You also receive a useful set of tools, a professional electric soldering iron, and a self-powered Dynamic Radio and Electronics Tester. The "Edu-Kit" also includes Code Instructions and the Progressive Code Oscillator, in addition to F.C.C.-type Questions and Answers for Radio Amateur License training. You will also receive lessons for servicing with the Progressive Signal Tracer and the Progressive Signal Injector, a High Fidelity Guide and a Quiz Book. You receive Membership in Radio-TV Club, Free Consultation Service, Certificate of Merit and Discount Privileges. You receive all parts, tools, instructions, etc. Everything is yours to keep.

NOW, TRAIN AT HOME

IN RADIO AND ELECTRONICS

ORDER DIRECT FROM AD . . . USE COUPON ON NEXT PAGE

RECEIVE FREE RADIO & TV PARTS JACKPOT

SERVICING LESSONS

You will learn trouble-shooting and servicing in a progressive manner. You will practice repairs on the sets that you construct. You will learn symptoms and causes of trouble in home, portable and car radios. You will learn how to use the professional Signal Tracer, the unique Signal Injector and the dynamic Radio & Electronics Tester. While you are learning in this practical way, you will be able to do many a repair job for your friends and neighbors, and charge fees which will far exceed the price of the "Edu-Kit." Our Consultation Service will help you with any technical problems you may have.

J. Statkalis, of 25 Poplar Pl., Waterbury, Conn., writes: "I have repaired several sets for my friends, and made money. The "Edu-Kit" paid for itself. I was ready to spend \$240 for a course, but I found your ad and sent for your Kit."

FROM OUR MAIL BAG

Ben Valerio, P. O. Box 21, Magna, Utah: "The Edu-Kits are wonderful. Here I am sending you the questions and also the answers for them. I have been in Radio for the last seven years, but like to work with Radio Kits, and like to build Radio Testing Equipment. I enjoyed every minute I worked with the different kits; the Signal Tracer works fine. Also like to let you know that I feel proud of becoming a member of your Radio-TV Club."

Robert L. Shuff, 1334 Monroe Ave., Huntington, W. Va: "Thought I would drop you a few lines to say that I received my Edu-Kit, and was really amazed that such a bargain can be had at such a low price. I have already started repairing radios and phonographs. My friends were really surprised to see me get into the swing of it so quickly. The Trouble-shooting Tester that comes with the Kit is really swell, and finds the trouble, if there is any to be found."

PRINTED CIRCUITRY

At no increase in price, the "Edu-Kit" now induces Printed Circuitry. You build a Printed Circuit Signal Injector, a unique serving instrument that can detect many Radio and TV troubles. This revolutionary new technique of radio construction is now becoming popular in commercial radio and TV sets.

A Printed Circuit is a special insulated chassis on which has been deposited a conducting material which takes the place of wiring. The various parts are merely plugged in and soldered to terminals.

Printed Circuitry is the basis of modern Automation Electronics. A knowledge of this subject is a necessity today for anyone interested in Electronics.

TECHNICIAN for only \$26⁹⁵

THE NEW IMPROVED DELUXE

Progressive Radio "Edu-Kit"[®]

is now ready

Reg. U.S.
Pat. Off.



NOW INCLUDES

- ★ 12 RECEIVERS
- ★ 3 TRANSMITTERS
- ★ SQ. WAVE GENERATOR
- ★ AMPLIFIER
- ★ SIGNAL TRACER
- ★ SIGNAL INJECTOR
- ★ CODE OSCILLATOR

PRACTICAL
HOME
RADIO
COURSE

only
\$26⁹⁵

SCHOOL INQUIRIES INVITED

Unconditional Money-Back Guarantee

The Progressive Radio "Edu-Kit" has been sold to many thousands of individuals, schools and organizations, public and private, throughout the world. It is recognized internationally as the ideal radio course.

By popular demand, the Progressive Radio "Edu-Kit" is now available in Spanish as well as English.

It is understood and agreed that should the Progressive Radio "Edu-Kit" be returned to Progressive "Edu-Kits" Inc. for any reason whatever, the purchase price will be refunded in full, without quibble or question, and without delay.

The high recognition which Progressive "Edu-Kits" Inc. has earned through its many years of service to the public is due to its unconditional insistence upon the maintenance of perfect engineering, the highest instructional standards, and 100% adherence to its Unconditional Money-Back Guarantee. As a result, we do not have a single dissatisfied customer throughout the entire world.

TRAINING ELECTRONICS
TECHNICIANS SINCE 1946

FREE EXTRAS

- SET OF TOOLS
- SOLDERING IRON
- ELECTRONICS TESTER
- PLIERS-CUTTERS
- VALUABLE DISCOUNT CARD
- CERTIFICATE OF MERIT
- TESTER INSTRUCTION MANUAL
- HIGH FIDELITY GUIDE • QUIZZES
- TELEVISION BOOK • RADIO TROUBLE-SHOOTING BOOK
- MEMBERSHIP IN RADIO-TV CLUB: CONSULTATION SERVICE • FCC AMATEUR LICENSE TRAINING
- PRINTED CIRCUITRY

*You Will Find That The Progressive
Radio "Edu-Kit" Is Perfect*

- • • FOR anyone who wishes to learn more about radio construction, theory and servicing.
- • • FOR anyone who is looking for an interesting hobby.
- • • FOR anyone who would like to learn radio but does not have time to attend regular school hours.
- • • FOR anyone who wants to start studying for a high-paying radio job.
- • • FOR anyone who wishes to start in Television.

- Send "Edu-Kit" postpaid. I enclose full payment of \$26.95.
- Send "Edu-Kit" C.O.D. I will pay \$26.95 plus postage.
- Rush me FREE descriptive literature concerning "Edu-Kit."

Name

Address

City State Zip

PROGRESSIVE "EDU-KITS" INC.

(ATT: S. Goodman, M. S. in ED., Pres.)
1186 Broadway, Dept. 566AE Hewlett, N. Y. 11557

WORTH \$15.00

July, 1965

FEEDBACK

from our readers



Write to: Letters Editor, Electronics Illustrated, 67 West 44th Street,

New York, N.Y. 10036

● NUTS

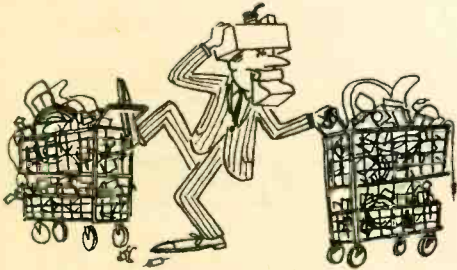

What's with you guys? You some kind of nuts or something? Any interest I may have had in building a spectrum monitor was short-circuited the minute I reached the Parts List (SPECTRUM MONITOR, May '65 EI). You don't find radio parts in a supermarket but it doesn't take an Einstein to figure out that you would need a couple of shopping carts to tote that list home. How about taking it easy on us poor amateurs?

Fen Aleroad
Elizabeth, N.J.

Have to separate the men from the boys sometime, Fen.

● FLASH

Is it true what they say about transistors?
M. Gordon
Tacoma, Wash.

Definitely.

● OSCILLATING

I think you people got your wires crossed in a couple of stories last issue. Seems to me it's the organs that howl and the transmitters that oscillate (THE ORGANS THAT OSCILLATE and THE TRANSMITTER THAT HOWLS, May '65 EI). If you ask me, the electronic organ is the screamiest, screechiest, squawkiest machine I have ever had the misfortune to listen to. I call it a machine because by no stretch of the imagination could it be considered a musical instru-

ment. Next thing we know you'll be telling us about how jazzy electric guitars sound when everybody knows they're twangy.

Richard Irwin
Chicago, Ill.

● INFORMATION, PLEASE

A pythoness is a female python. Am I right?

Al Stewart
Toronto, Ont.

Wonder what strange question was in your letter to the Museum of Natural History?

● NOSEY

Sometime ago I read that there was a thing such as you could hear whispered conversations thru solid walls. Would you have any information regarding the above?

Alex Kaplan
Knoxville, Tenn.

What do you have against privacy?

● REAL THING



To any of your readers who may still be dubious as to what talk power really means (STRAIGHT TALK ABOUT TALK POWER, May '65 EI), I do hereby cordially invite one and all to my home on any Thursday night about 2000. At that time my wife's bridge club assembles and talk power becomes a self-explanatory term.

Grant Jamieson
Chicago, Ill.

[Continued on page 10]

TWO NEW KITS FROM CONAR

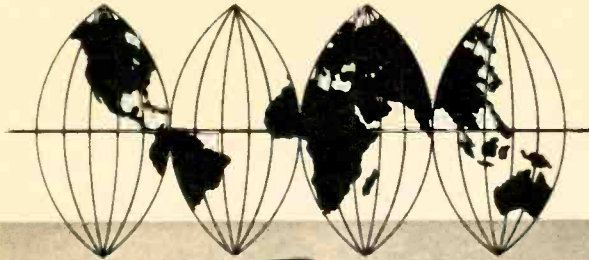

'ROUND THE WORLD RADIO FOR \$64.00



MODEL 500
3 Band Novice Receiver

MODEL 400
3 Band Novice Transmitter

Designed with the novice ham radio enthusiast in mind. A complete, low cost, easy to build and easy to use amateur radio set-up that sends and receives signals around the world. Everything you'll need to begin a new, fascinating hobby is included . . . and you'll be on the air in one evening. Complete set-up includes transmitter, receiver, code key, assembly manuals, instruction manuals, ARRL Handbook and complete data about getting your Novice License. All this for just \$64.00. Use coupon below now. Cash or terms.

THE MODEL 400 25-WATT TRANSMITTER

Inside this attractive 10" x 7½" x 6½" dark blue cabinet is a remarkable power house. Yet, it's so simple to build, so easy to tune, even an inexperienced kit builder can be on the air in one evening. Covers the popular Novice bands—80, 40 and 15 meters. 3" square panel meter for fast "tuning up". Special variable-impedance current-limiter assures pure signal on any band, protects your valuable crystals (crystals not included). Other features: Pi-network output; transformer power supply with dual silicon rectifier to produce ripple-free DC for plate power; bleeder resistor to regulate and discharge high-voltage capacitors when gear is turned off; co-ax output.

KIT PRICE: \$32.50
(Stock #400UK)
Assembled: \$46.50
(Stock #400WT)

THE MODEL 500 3 BAND RECEIVER

Identical in size and color to the Transmitter. Offers features of receivers priced much higher. Superhet circuit has TWO stages of i-f amplification to "dig down" for weak signals. Antenna trimmer lets you adjust front end for peak reception on each of three bands. Bands cover stretches over nearly full travel of large tuning dial. Separate, stable bfo for clear reception of CW and SSB signals. Variable i-f gain. Following the detector are two stages of audio amplification to drive either the built-in speaker or headphones. Transformer operated with semiconductor rectifier to supply power for various circuits. Receives AM, CW and SSB. So easy to build, so easy to use, so easy to own. Order today.

KIT PRICE: \$37.50
(Stock #500UK)
Assembled: \$56.50
(Stock #500WT)

CONAR GE5C

Division of National Radio Institute
3939 Wisconsin Ave.,
Washington, D.C. 20016

Please send me both new Conar Ham Radio Kits @ \$64.00 Complete

Please send only Model 400 Transmitter Kit @ \$32.50 (Assembled \$46.50)

Please send only Model 500 Receiver Kit @ \$37.50 (Assembled \$56.50)

Tell me how I can buy this equipment on easy terms.

Name _____

Address _____

City _____ State _____ Zip Code _____

CHAMPION PERFORMERS

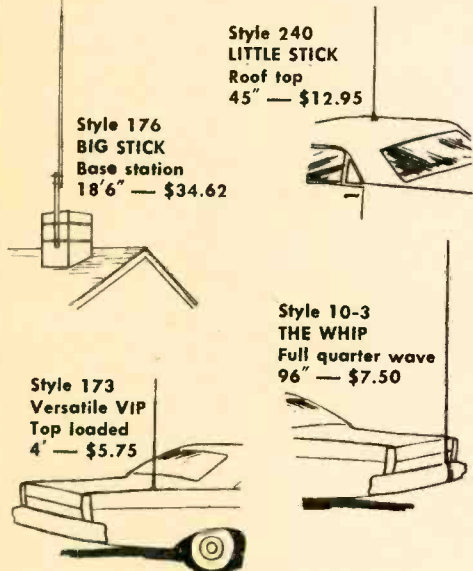

Style 176
BIG STICK
Base station
18'6" — \$34.62

Style 240
LITTLE STICK
Roof top
45" — \$12.95

Style 173
Versatile VIP
Top loaded
4' — \$5.75

Style 10-3
THE WHIP
Full quarter wave
96" — \$7.50

- they're all fiberglass
- they're all WONDERSHAFT

Choose the versatile VIP, the WHIP, or combine the LITTLE STICK with the BIG STICK for a "talking team." You'll pride yourself on the outstanding performance, the rugged good looks and easy installation of a **WONDERSHAFT**.

Look for the **WONDERSHAFT** trademark. It's a mark of distinction for all CB'ers . . . a guarantee of superior quality and performance.



COLUMBIA PRODUCTS COMPANY
SUBSIDIARY OF SHAKESPEARE COMPANY
ROUTE 3, COLUMBIA, SOUTH CAROLINA

FEEDBACK

Continued from page 8

● SNOWED

Last winter I had occasion to spend a week end in Danville, Penn. My aunt, who goes to Florida in the winter, offered me the use of her home. She sent me a note explaining that the phone and the television had been disconnected. I laughed, knowing how fussy she is, and assumed she meant the television had been unplugged from the wall. I had gone for a rest and my first evening there I decided to spend it watching television. Sure enough, it had been unplugged. Well, I plugged it in, turned it on and relaxed into my chair, when suddenly I was in the middle of the worse snowstorm since the late forties. There were no rabbit ears, no bull's-eye, no outside antenna—nothing. I was completely baffled, and upon questioning a neighbor, found out that the entire town is hooked up to a master antenna which they pay for on a monthly basis. Well, I didn't want it for a month—I only wanted it for two days.

Harry Dean
Albany, N.Y

So live a little, Harry.

● BITING QUESTION



The more I think about those musical molar people who claim to hear music through their teeth (FEEDBACK, Jan. and May '65 EI), the screwier it sounds. I don't know very much about electronics, but it seems to me the only way they could get more than one station is with a lot of teeth.

James Bols
San Mateo, Calif.

No, the other teeth are amplifiers. —

LAFAYETTE "Everything in Electronics"

Model HB-500 Solid-State Dual Conversion 5-Watt CB Transceiver with Authentic Mechanical Filter

99-3027WX **139⁵⁰** \$7.50 Monthly

- ✓ Only 3" high—fits easily in any car
- ✓ Special multi-stage noise limiting circuit
- ✓ The same output as the most powerful tube unit yet uses only 1/50 of the battery power

When your needs call for a high performance CB transceiver and space is a problem, then the compact solid-state HB-500 is for you. Battery drain is really low. The HB-500 draws as little as 1/10th of an amp on receive, 8/10ths of an amp on transmit. Quiet too. Rugged design offers instantaneous operation with high sensitivity and razor-sharp selectivity. Plus 23-channel tunable receive, 12 crystal transmit and receive positions. Equipped with easy-mount mobile bracket, push-to-talk dynamic microphone and .003% crystals for channel 12.



Perfect for Mobile —
You'll Wonder Where the Noise Went!

Model HB-400 23-Channel Crystal-Controlled Dual Conversion 5-Watt CB Transceiver with Advanced "Range-Boost" Circuit

99-3001WX **169⁵⁰** \$9 monthly

- ✓ 13 Tubes, 8 Diodes
- ✓ Low Noise Nuvistor Front End

Efficient, dependable communications on all 23 CB channels with crystal-controlled accuracy is made possible by an advanced frequency synthesizer circuit. No extra crystals to buy or install! Delta tuning offers fine tuning of ± 2.5 Kc. on receive. Range-Boost lets your voice cut through noise to reach further. Has every feature CB users want! Built-in power supply for 117V AC or 12V DC. Complete with crystals, push-to-talk ceramic mike.



Double Side Band Full Carrier

The Widely Acclaimed Lafayette RK-137A Tape Recorder

FEATURING **4**-TRACK STEREO PLAYBACK*
4-TRACK MONAURAL RECORD PLAYBACK 99-1511WX

89⁵⁰

- ✓ With Electronic Track Selector Switch, VU Recording Level Meter and Pause Switch for Instant Editing \$5 monthly

The compact recorder for the whole family. Two speeds, 3 $\frac{3}{4}$ and 7 $\frac{1}{2}$ ips record babies first words, sister's language lesson and mom's opera. Dad will appreciate its heavy-duty 6x4" speaker and fast, rugged shift lever control. Complete with carrying case, dynamic microphone, patch cords and 7" reel.



Takes Reels
Up To 7"

* adaptable to
stereo playback

DYNAMIC
MICROPHONE

FREE!

Send for the Most
Complete Electronic
Buying Guide, 516 pages.

LAFAYETTE RADIO ELECTRONICS

Dept. EIF-5 P.O. Box 10

Syosset, L.I., N.Y. 11791

Send me the FREE 1965 Lafayette Catalog 650.

Name.....

Address.....

City..... State..... Zip.....

Be sure to include Zip Code No.

COME IN, CASSIOPEIA. . . . Girl friends who live 11,000 or so light years away ordinarily are seen once in a blue moon, if ever. But seeing a chick called Cassy isn't quite what the men at the Sagamore Observatory in Ipswich, Mass. have in mind. For the Cassiopeia they're after is a constellation, not a flesh-and-blood earthling, and radio astronomers want to find out what she has to say. Accordingly, the crane rider in our photo is directing the observatory's attention to the curvaceous heavenly body by tilting an 84-ft. parabolic dish antenna in Cassy's precise direction.



...electronics in the news



Big Eye . . . Though the RCA engineer in our photo is engaged in the very down-to-earth task of calibrating a camera, his labors aren't long for this world. Truth is, the big eye he's working on will be mounted spoke-fashion on the new TIROS weather satellite. Forerunner of a group of globe-girdling cloud reporters, TIROS will make like a wheel in orbit. As a result, this camera and its twin will be able to provide continuous photographic coverage of the earth's every corner.

Nifty Sniffer . . . If the pooch in our picture looks unhappy it's only because he has good reason. For though he once was renowned the world over as the best sniffer ever, the bloodhound now must take a back seat. Explanation is that an electronic gadget developed by Honeywell engineers outsniffs Fido clean across the board. Matter of fact, the device is so odor-conscious it can detect gases in concentrations of one part per million—a stunt Fido plain can't pull.





Your ticket to a good job in electronics.

These men will tell you how to get it!



Matt Stuczynski, Senior Transmitter Operator, Radio Station WBOE.

"The Commercial FCC License is a 'must' for a career in broadcasting. I took CIE's Home Study Electronics Course and, thanks to their 'Auto-Programmed' teaching method, passed the 1st Class FCC License Exam on my first try! I now have a good job in studio operation, transmitting, proof of performance, equipment servicing."



Chuck Hawkins, Chief Radio Technician, Division 12, Ohio Dept. of Highways.

"My Cleveland Institute Course enabled me to pass *both* the 2nd and 1st Class License Exams on my *first* attempt . . . even though I'd had no other electronics training. I'm now in charge of Division Communications and we service 119 mobile units and six base stations. It's an interesting, challenging and extremely rewarding job."



Glenn Horning, Local Equipment Supervisor, Western Reserve Telephone Company.

"I owe my 2nd Class FCC License to Cleveland Institute. Their FCC License Program really teaches you theory and fundamentals . . . is particularly strong on transistors, mobile radio, troubleshooting and math. Our Company has 10 other men enrolled with CIE and it's going to help every one of them just like it helped me."

How about you? If lack of an FCC License is holding you back, it's time you looked into Cleveland Institute of Electronics Home Study. All you have to do is send us the coupon . . . and in a few days, you'll have the complete story. And remember . . . Cleveland Institute backs their programs with this exclusive, money-back warranty: "A CIE License Course will quickly prepare you for a Commercial FCC License exam. If you complete the course but fail to pass the exam on *your first attempt*, CIE will refund all tuition."

Get started now. Send coupon for free booklet "How To Get an FCC License." There's no obligation.

Cleveland Institute of Electronics

1776 E. 17th St., Dept. EI-58 • Cleveland, Ohio 44114



Cleveland Institute of Electronics

1776 E. 17th St., Dept. EI-58
Cleveland, Ohio 44114

HOW TO GET A COMMERCIAL FCC LICENSE



Yes! I want to know how to get a Commercial FCC License. Please send me your **FREE** booklet . . . without obligation.

My Occupation is _____

Name _____ Age _____

Address _____ County _____

City _____ State _____ Zip _____

A leader in Electronics Training . . . since 1934

ANSWER YOUR HOME PHONE FROM YOUR CAR

- Make and receive phone calls from your car
- Comes with dial and telephone handset
- Can be connected to any CB radio in minutes
- Operates through your own base station

The Mobile Telephone System is a complete unit which when connected to your CB radio will permit you to make and receive phone calls from your car at no extra cost. "Operates through your own base station." Just two connections to your two way radio and it's ready to use. These units have been removed from commercial service, fully reconditioned and are warranted for one full year. All units are complete with dial, telephone handset and base, we can not mention the manufacturers name at this price but you will recognize it immediately. The ideal unit for private phone systems. \$29.95 satisfaction guaranteed or full purchase price refunded within 10 days. NOTE—We can not insure the number of these fine units that will be available.

SEND COUPON TODAY TO INSURE IMMEDIATE DELIVERY.

EASTERN ELECTRONICS, Dept. E-7
1511 Sheridan Ave., New York, N. Y. 10457

- Please send ----- Mobile Telephone Systems at \$29.95 each. You pay postage. I understand that I may return it within 10 days for full refund.
- Enclosed find one dollar. Please send my Mobile Telephone COD. I will pay postman \$29.95 plus COD charges. Same money back guarantee.

NAME

ADDRESS

CITY STATE ZIP

New York City Residents Add 4% Tax

WANT A JOB? PART TIME— FULL TIME?

No Boss! No Experience!

No Capital! Your Own Hours!

WHAT A JOB ! ! ! !

And yet selling subscriptions to **ELECTRONICS ILLUSTRATED** and other leading publications is just like being in business for yourself.

But no business requires less capital, stock and space. The time you devote and the money you make is up to you. You need no experience to earn steady profits and you keep a cash commission on every sale. You operate in your own community by phone or personal calls. You will be authorized to sell new and renewal subscriptions along with special offers made by the publishers. You'll be amazed at the number of people wanting to take advantage of the convenience, service and savings you can offer them.

To get started immediately—send us your name (on a postal card) requesting free supplies and selling materials.

Write to: Subscription Dept. DE
ELECTRONICS ILLUSTRATED
Fawcett Bldg., Greenwich, Conn. 06830

...electronics in the news

Dazzling Diodes . . . Some 576 light-emitting diodes on a single chip barely 5/8-in. square represent Fairchild's latest entry into the

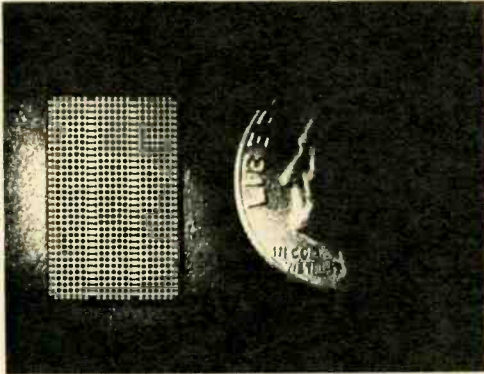

integrated-circuit field. About the size of a U.S. 10-cent piece, the chip contains more active elements than ever before tucked into a single integrated circuit. The device will see application as a digital data recording head.

Mini and Magog . . . The long and short of telecasting equipment is being held by the pretty miss in our photo, a secretary at Cohu



Electronics. The 7-in. TV camera, said to be the world's shortest, is teamed up with one of the world's longest telephoto lenses, a 500mm, 20-in. would-be howitzer. Applications of this mighty/minature coupling will include remote coverage of golf tournaments, military troop movements, boat races and—well, you name it!

WORLD'S ONLY RECHARGEABLE "HANDS FREE" FLASH

New, Versatile, Life-time **CYCLOPS**

WEIGHS JUST 2½ OZ ... THROWS MORE LIGHT THAN A REG. 3-BATTERY FLASH

- Wear it on your head, wrist or belt
- Stand it on your desk or work-table
- Strap it on your car or boat
- Hang it from the wall

AND...the swivel beam will pinpoint light where you need it

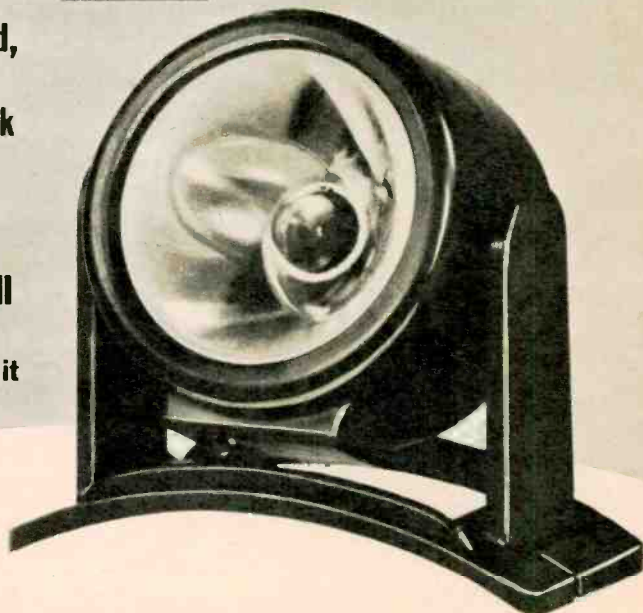

CYCLOPS is ideal for repairmen, sportsmen, kids on bikes, work-shoppers, firemen, mechanics etc.



This remarkable all-purpose light is a major breakthrough in permanent illumination. It is compact, lightweight, has a special tune-beam dial so that you can literally dial the beam you want for size, brilliance (on full strength it's more powerful than a large 3-battery flashlight) and pinpoint focus. It can be recharged on regular house current (uses same recharger as tiny hand flashlight below), should last you a lifetime. It has been dropped from a 3-story building onto concrete, run over by a Chevy Impala station wagon, and still worked perfectly. Drop it in water—it floats, and keeps working. It operates off the same nickel cadmium batteries used in miniaturized components for space flights. It will save you time and money because when you strap it on your head, it leaves your hands free to work on your car, tv set, in the shop, garage, on trips etc. Cyclops with strap and stand, \$7.95; recharger (you only need one for the Cyclops and the miniature flash below), \$2.95; set complete, \$9.95.



World's Smallest, Most Powerful Flashlight

This mighty midget weighs just 2 oz., fits in the palm of your hand. Gives hours of continuous light (stronger than a big 2-battery flash), then the permanent battery can be recharged right from your house current. (Never buy batteries again.) 2 powerful beams can be used together or separately, disperse light in 4 directions. Powered by a space-age cadmium dyna-cell. Flash, \$4.95; recharger unit (you need it), \$2.95. Set, \$8.95.

ORDER TODAY—MONEY BACK GUARANTEE

HAMILTON HOUSE
Dept. 24L-7, Cos Cob, Conn. 06807

Enclosed is check or m.o. for \$ _____

.....CYCLOPS Lights @ 7.95Rechargers @ 2.95 Sets @ 9.95
.....Miniature Flash @ 4.95Rechargers @ 2.95 Sets @ 6.95

NAME

ADDRESS

CITY STATE ZIP

(Add 85¢ postage & handling each set)

ELECTRONIC SWAP SHOP

El's Swap Shop provides a way for readers to obtain equipment they want in exchange for items they no longer have use for. Notices must be from individuals, not commercial concerns. Entries must include your name and address as well as a description of what you now have and what you would like in exchange. Address: El's Swap Shop, ELECTRONICS ILLUSTRATED, 67 West 44th Street, New York, New York 10036.

PACO G15W grid dip meter. Will trade for VTVM. Clement Sousa, 1076 County St., New Bedford, Mass. 02746.

HEATH AJ-53 AM tuner. Will trade for stereo preamp. Phil Strohbehn, Rte. 1, Reinbeck, Iowa. 50669.

HEATH AR-3 receiver and homebrew 50-watt Novice transmitter. Want tape recorder. Fred Cox, 228 4th Ave., N. Wahpeton, N.D. 58075.

KNIGHT-KIT C-555 walkie talkies (pair) and miniature tape recorder. Will swap for Knight-Kit T-60 transmitter or Knight-Kit KG-400 stereo amp. Bruce Houston, Rte. 1, Stark City, Mo. 64866.

RECEIVERS—R-55, RAX-1 and RAX-2. Will trade for Hammarlund HQ-129 or HQ-110 A, B or C. Mike Linger, 1005 Village Dr., College Station, Tex. 77840.

SURPLUS RADAR indicator with schematic. Will trade for oscilloscope. Phil Dawson, 9 Haney Rd., Colorado Springs, Colo. 80906.

EICO tube tester, VOM, signal generator, other equipment. Will trade for anything of equal value. J.H. Barnett, 3419 Crockett Lane, Freeport, Tex. 77541.

ELECTRO-VOICE 630 microphone. Want pair of walkie-talkies. M.D. Burke, 5140 Chevy Chase, Houston, Tex. 77027.

MOVIE PROJECTOR, other photographic equipment. Will trade for hi-fi record player. Rod Hamilton, Box 744, Battle Creek, Mich.

GLOBE CHIEF 90-A with extra tubes and crystals. Will swap for 2-meter equipment. Joe Misinski, WN2MQE, 16 Olympic Terr., Irvington, N.J. 07111.

COMPLETE AMATEUR STATION in 19-in. rack, including Heath DX-100, Hallicrafters SX-100, Heath SB-10 and accessories. Will trade for hi-fi gear. George Verrett, 715 Timilo Dr., San Antonio, Tex.

HEATH DX-100, other ham equipment. Will swap for Collins 30L1 linear and tape deck. T.K. Brown, W2CUH, 1111 Chenango St., Binghamton, N.Y. 13901.

TEST EQUIPMENT by RCA, Heath, etc. Want capacitor checker, EICO 1140 substitution box and Garrard record changer. C.A. Lougee, 38 Main St., Francetown, N.H. 03043.

NATIONAL NC60 receiver. Will swap for anything of equal value. Walter Page Pyne, 540 N. Locust St., Hagerstown, Md. 21740.

HEATH DX-20 transmitter. Will swap for Atwater-Kent model 10 radio. T.M. Turner, K8VBL, 301 Sabin St., Kalamazoo, Mich.

ELMAC PMR 7 receiver. Will swap for CB transceiver. J.L. Hall, 623 E. Broadway, Bolivar, Mo. 65613.

GO-KART with two McCullough MC-6 engines. Will swap for Heath HA-10. Keith James, WA9HKA, 1044 Poplar St., Huntington, Ind.

TYPE 245 oscilloscope. Want signal generator and signal tracer. Irving J. Braussard, 3303 63rd St., Port Arthur, Tex., 77640.

SUPERIOR Instruments model 79 meter, Wen 2-speed drill. Make swap offer. Stephen Clifton, WA2TYF, 800 W. End Ave., New York, N.Y. 10025.

NAVY ATD transmitter and ARR-15 receiver. Want ham-band or general-coverage receiver. John Shea, 15-13 Carr St., Watsonville, Calif. 95076.

TRANSMITTING TUBES: 304TH's and TL's with Johnson sockets. Need test equipment. Brewer, W0AG, 2208 11th Ave., Greeley, Colo.

OD7 vacuum-tube analyzer. Will swap for anything of equal value. Harvey E. Williams, 181 Rockland St., S. Dartmouth, Mass. 02714.

KNIGHT C-100 CB transceiver. Will trade for El's 10-watt ham transmitter. (THE SCROUNGER, Sept. '64 E). Carl Jacobson, 3716 W. Frier Dr., Phoenix, Ariz. 85021.

BOULEVARD Prince 17-watt mono amplifier over equipment. Will swap for anything of equal value.

Dennis Zonia, 21 Batten St., Webster, Mass. 01570.

WESTERN ELECTRIC GI telephone. Make swap offer. Mike Rosenzweig, 1275 Nelson Ave., Bronx, N.Y. 10452.

STEREO-120 amplifier. Will swap for equipment of equal value. David Powell, Box 306, Danville, Ky. 40422.

UNDERWOOD typewriter, 9-volt battery eliminator, microscope. Want 0-1 milliammeter, 8-channel CB transceiver and voltmeter. Stanley Jones, Box 488, Hollandale, Miss. 38748.

AMECO AC1 transmitter, tubes, 12-inch TV set, portable radio, other equipment. Make swap offer. Jim Baughman, 4219 Manor, Royal Oak, Mich. 48073.

QST library, 1923 through 1953. Want 2- or 6-meter equipment. Louie C. Hardy, 522 Shirley Ave., Franklin Lakes, N.J. 07417.

POLYCOM PC-1 CB transceiver, other items. Will swap for stereo tape recorder. Thomas R. Sundstrom, Box 8503, Philadelphia, Pa. 19101.

MOTOROLA 10-meter mobile transceiver and Knight Span-Master receiver. Will swap for TV camera. David Zembryski, Spencers Court, N. Rte. 45, Lot 14, Mattoon, Ill. 61938.

HEATH CB-1 transceivers. Will trade for oscilloscope. Merlin W. Preuss, Weyauwega, Wis. 54983.

FOUR-BAND short-wave receiver. Want CB transceiver. Ron Stolarski, 7711 Avonwood Ct., Orlando, Fla. 32810.

HEATH HR-10 receiver, other items. Will swap for unwired kits, test equipment or TA-33 beam. Bob Bolger, 1003 Electra St., Longview, Tex. 75601.

EICO 324 signal generator. Want tube tester or tape recorder. Clarence L. Griffith, Box 33, Coal City, Ill. 60416.

RCA 9-W-101 AM/FM tuner and 45-rpm record changer. Will swap for equal-value items. Mike Long, 4009 Central Ave., Shadyside, Ohio 43947.

ZENITH receiver. Make swap offer. Bill Hartman, 3151 Maxwell Dr., Trenton, Mich. 48183.

MAGICIAN's equipment. Want stereo-FM tuner. Ralph White, 76 Barber St., Springfield, Mass. 01109.

AMPLIFIERS, antique radio parts, test equipment and books. Interested in grid-dip oscillator, camera or CB transceiver. John D. Martin, Wyaconda, Mo. 63474.

COMMAND 5-transistor tape recorder. Will swap for Knight C-555 walkie-talkie. Peter Fedkiw, 241 Linden Ave., Wilmington, Del. 19805.

LAFAYETTE HE-52 communications receiver. Will swap for portable tape recorder. J.B. Ballard, 300 N. King St., Xenia, Ohio 45385.

SCREEN MODULATOR and dynamotor. Make swap offer. Howard Epstein, WB2KJD, 218-01 67 Ave., Bayside, N.Y. 11464.

POWER TRANSFORMER and transmitting tubes. Want FM receiver or CB transceiver. Thomas C. Blow II, 7309 Cedar Ave., Takoma Park, Md. 20012.

LAFAYETTE CB transceiver. Will swap for Atwater-Kent table receiver or crystal set. Tom Anthony, 213 Stuyvesant Ave., Lyndhurst, N.J. 08408.

JOHNSON Viking Messenger and Knight-Kit Star Roamer receiver. Will trade for CB transceiver. Joe Spurgeon, Rose Polytechnic Institute, 5500 Wabash Ave., Terre Haute, Ind. 47801.

HALLICRAFTERS SX-28 receiver. Want HRO-50 or SX-100. Paul Meredith, 1851 Welland Dr., Clearwater, Fla. 33516.

VM CHANGER with mono cartridge. Need capstan-drive tape recorder. Bruce Komito, 350 Ormsby Rd., Akron, Ohio 44313.

HEATH AA-32 stereo amplifier. Will swap for Dyna 35-watt amplifier. Vic Owen, 29 W. 731 Cape Ave., West Chicago, Ill. 60185.

HEATHKIT GR-91 SW receiver. Want 12-volt FM car receiver. Ronald R. Ryerson, 185 Ball St., Port Jervis, N.Y. 12771.

KNIGHT KG-4000 CB walkie-talkie. Will trade for items of equal value. James R. Norr, 335 Mt. View, Brigham City, Utah 84302.

HEATH GW-12 CB transceiver. Make swap offer. John Ackley, 818 W. Main, Waxahachie, Tex. 75165.

GONSET G-11 transceiver. Want Heathkit Twoer. Marc Webb, 645 Arnow Ave., Bronx, N.Y. 10467.

KNIGHT C-22 transceiver and Knight transistor checker. Want Ameco 6-meter preamp, CB walkie-talkie or VTVM. Morrie S. Goldman, 8046 Euclid Ave., Chicago, Ill. 60617.

VICTOR 16-mm projector. Looking for CB or ham transceiver or communications receiver. Diane MacKay, Box GGG, Wickenburg, Ariz. 85358.

Choose Your Tailor-Made Course in N.T.S. "PROJECT METHOD" ELECTRONICS!

Now! N.T.S. — one of America's oldest leading home-study and resident technical schools — offers you GREATER CAREER OPPORTUNITIES IN ELECTRONICS. N.T.S. "Project Method" home training lessons are shop-tested in the Resident School in Los Angeles. The Schools' practical methods, plus more than 60 years of experience, have helped thousands of students all over the world to successful careers. Choose your field and prepare now for a secure future with one of 8 N.T.S. Electronics Courses designed to fit your own particular needs.



SEE OTHER SIDE

- 1 ELECTRONICS-TV-RADIO-SERVICING & COMMUNICATIONS**
A basic course thoroughly covering fundamentals of electronics, radio, TV servicing and communications.
- 2 MASTER COURSE IN ELECTRONICS-TV-RADIO, PLUS ADVANCED TV & INDUSTRIAL ELECTRONICS**
This course covers everything included in Course No. 1 plus Automation and every phase of the Electronics industry.
- 3 FCC LICENSE**
Preparation for this government license essential for interesting jobs in radar, radio, television, communications, guided missiles, many others. Upon completion of this course, if you do not pass the FCC exam for a 1st Class Commercial Radiotelephone License your tuition will be refunded.
- 4 RADIO SERVICING (AM-FM-Transistors)**
Train for radio sales and service with dealer or distributor.
- 5 TELEVISION SERVICING (Including Color)**
Covers installation, adjustment, repair and servicing of black and white and color television . . . prepares you for your own sales and service business.
- 6 STEREO, HI-FI AND SOUND SYSTEMS**
A growing field. Prepares you to build, install and service modern sound equipment for home or industry.
- 7 BASIC ELECTRONICS**
Gives you the fundamentals you must know to build on for a future Electronics career. Also offers an excellent background for Salesmen, Purchasing Agents, and others in Electronics.
- 8 ELECTRONICS MATH**
Simple easy-to-follow instructions in the specialized math you need in many electronics jobs.



HIGH SCHOOL AT HOME

Learn easily. New modern method. National offers accredited high school programs for men and women. Take only subjects you need. Study at your own pace. Latest approved textbooks — yours to keep — everything included at one low tuition. Check High School box in coupon for information.

CLASSROOM TRAINING AT LOS ANGELES

You can take classroom training in our famous Resident School at Los Angeles in Sunny Southern California. N.T.S. is the oldest and largest school of its kind. Associate in Science Degree also offered in our Resident Program. Check Resident School box in coupon for full details.



Send Postcard for Free Book & Sample Lesson.

CUT OUT & MAIL TODAY. NO POSTAGE NECESSARY.

Please Rush FREE Electronics "Opportunity Book" and sample lesson on course checked below:

- | | |
|---|---|
| <input type="checkbox"/> Electronics-TV-Radio Servicing & Communications | <input type="checkbox"/> Television Servicing (Including Color) |
| <input type="checkbox"/> Master Course in Electronics-TV-Radio Advanced TV & Industrial Electronics | <input type="checkbox"/> Stereo, Hi-Fi and Sound Systems |
| <input type="checkbox"/> FCC License | <input type="checkbox"/> Basic Electronics |
| <input type="checkbox"/> Radio Servicing (AM-FM-Transistors) | <input type="checkbox"/> Electronics Math |
- Dept. 213-65

Name _____ Age _____

Address _____

City _____

State _____ Zip _____

- Check here for High School Department Catalog only.
 Check here if interested ONLY in Classroom training at L.A.



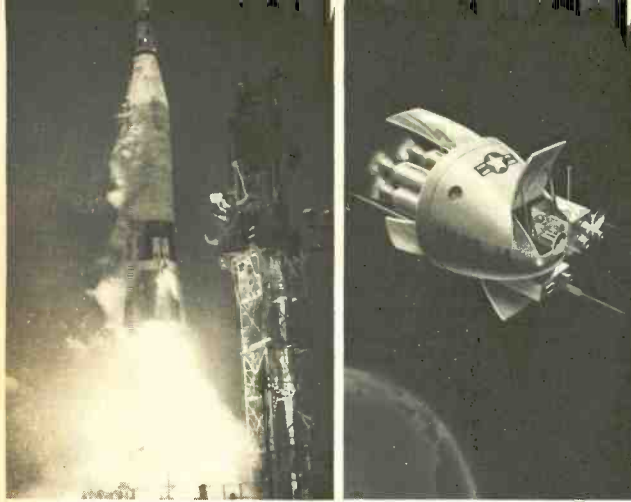

You can install and maintain electronic circuitry in missiles and rockets . . . specialize in microwaves, radar, and sonar, or succeed in your own business.

You can succeed in TV-Radio Communications . . . prepare for F.C.C. License, service advanced satellites for industry and defense.

Most courses include Equipment Kits. **THERE ARE NO KIT DEPOSITS.** Everything Included in your low tuition.

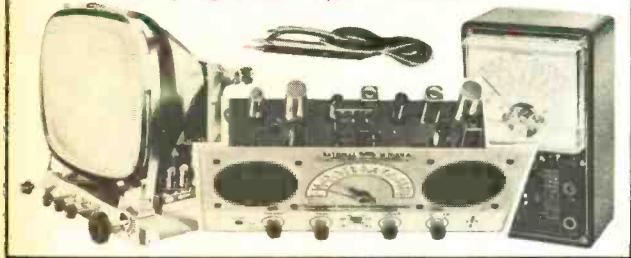

CLIP & MAIL POSTAGE FREE CARD TODAY FOR FREE BOOK AND SAMPLE LESSON
 in Field of Your Choice. You enroll by mail under N.T.S. "No Obligation" Plan. We have No Salesmen; This means lower tuition for you.

TAKE THE QUICK WAY TO HIGHER PAY, LIFELONG BENEFITS, WITH N.T.S. HOME TRAINING!

N.T.S. "Project Method" Courses can help you get

a new and better job — or move up to higher pay in your present one. You work on practical job projects, learn to use shop manuals and schematics. Your N.T.S. training is individual. You proceed at your own pace.

BENEFIT NOW AND ALL YOUR LIFE WITH N.T.S. HOME TRAINING

The personal guidance you receive during your training can be very helpful to your progress. Many N.T.S. students are able to earn more money within a few months. You can pick and choose your career. Work in industry or go into business for yourself. Your services will always be in demand wherever you go — and you can pick your spot!

N.T.S. Graduate Advisory Service can help you answer technical questions in establishing your own business and in countless other ways after you've completed your training.

BUSINESS REPLY MAIL
 No Postage Stamp Necessary If Mailed in the United States

—POSTAGE WILL BE PAID BY—

NATIONAL TECHNICAL SCHOOLS

WORLD-WIDE TRAINING SINCE 1905

**4000 South Figueroa Street
 Los Angeles, California 90037**

FIRST CLASS
 Permit No. 3087
 Los Angeles, Calif.

See other side of this card for description of all courses.



Accredited Member
 National Home Study Council



NATIONAL TECHNICAL SCHOOLS
 WORLD-WIDE TRAINING SINCE 1905
 4000 So. Figueroa
 Los Angeles, California 90037

ELECTRONIC MARKETPLACE



DUTIFUL DOC . . . A unit that might pass for a VOM in reality is a transceiver analyzer. Measuring five functions and generating three signals, it can diagnose most



CB-circuit ills. \$37.95. Lafayette Radio Electronics Corp., 111 Jericho Tpke., Syosset, N.Y. 11074.

Sound Camera . . . Though the F-85 is on the small side, the portable, battery-powered unit sports a capstan drive and push-button

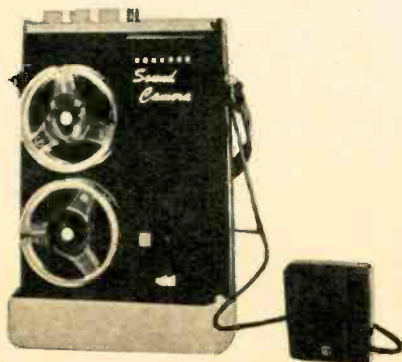

operation—features ordinarily found only on larger, more expensive tape recorders. \$39.50. Concord Electronics Corp., 809 N. Cahuenga Blvd., Los Angeles, Calif. 90038.



LOOK! A NEW ELECTRONICS SLIDE RULE WITH COMPLETE INSTRUCTION COURSE

Professional 10" all-metal Electronics Slide Rule. Designed specifically for technicians, engineers, students, hobbyists. Has special scales not found on any other rule. Enables you to solve electronics problems quickly, accurately. Made to our rigid specs by Pickett, Inc. Slide Rule plus four lesson AUTO-PROGRAMMED Instruction Course with grading service, and top-grain leather carrying case all for \$14.95. Satisfaction warranted or your money back. Cleveland Institute of Electronics, Dept. EI-105, 1776 E., 17th St., Cleveland, Ohio 44114.

SEND COUPON TODAY!

Cleveland Institute of Electronics
1776 E. 17th St., DEPT. EI-105, CLEVELAND, OHIO 44114

- Send Electronics Slide Rule with Instruction Course and leather case. I'm enclosing \$14.95.
- Send descriptive brochure only . . . without obligation.

NAME _____
ADDRESS _____ COUNTY _____
CITY _____ STATE _____ ZIP _____

ELECTRONICS

TELEVISION ELECTRICITY
TECHNICIAN COURSES

ALSO
Electronics
Engineering
Technology



Founded
1899

COYNE ELECTRONICS INSTITUTE

Learn on a quarter of a million dollars worth of equipment for top salaries and an Exciting Career. Many special finance plans. Part time employment service while in school. Also free graduate employment service.



Use this coupon to get our FREE BOOK
"YOUR OPPORTUNITIES IN ELECTRONICS"
COYNE ELECTRONICS INSTITUTE, Dept. of Electronics B-5A
1501 W. Congress Parkway, Chicago, Illinois 60607

Name _____ Age _____
Address _____ Phone _____
City _____ Zone _____ State _____

Unlike most other schools, we do not employ salesmen
 I only want information on Home Study Courses

zip code
helps
keep
postal
costs



down

BUT ONLY IF YOU USE IT.



TO HELP
CURE MORE
GIVE MORE

AMERICAN
CANCER
SOCIETY

MARKETPLACE

Faster Fist . . . A CW monitor that can double as a code-practice oscillator promises to help most any ham improve his fist. Connected to the transmitter key jack and a



spare speaker, the monitor pumps out audio when the transmitter is keyed. Controls permit you to adjust tone and volume exactly to your liking, and the fact that the transistorized circuit is battery-powered means it can be used anywhere. The monitor is supplied complete with cable and plug for a standard key jack. \$29.95. Galaxy Electronics Inc., 10 S. 34th St., Council Bluffs, Iowa 51501.

Listen Longer . . . Everyone is familiar with the kind of AM/FM portable radio that goes with you to beach, basement or bedroom. But the Duo-Vox AMF-16B promises all this and



more. Installed in a car, truck or boat, it operates from the vehicle's 6- or 12VDC electrical system. Removed from its special mounting bracket, it is powered by self-contained penlight cells and is ready to go where you go. A patented mechanism makes it impossible to remove the radio from its mount without a key. \$89.95. Duosonic Corp. of America, 255 Park Ave. S., New York, N.Y. 10010.

MARKETPLACE

Crystal Clear . . . A general-coverage receiver tuning 540 kc to 30 mc in four bands, the HQ145AX affords dual conversion above 10



mc for image-free performance. Further, a six-position crystal filter attenuates adjacent-channel signals some 60db. The manufacturer claims a sensitivity of 1 μ v and a 10:1 S/N ratio throughout the receiver's range. \$349. Hammarlund Mfg. Co., 73-88 Hammarlund Dr., Mars Hill, N.C. 28754.

SSBer . . . A desk-top powerhouse, the SB-200 is a linear sideband amplifier capable of reaching some rare DX. And though this grounded-grid linear puts out a 1,200-watt PEP SSB signal (1,000 watts CW) on 80 through 10 meters, it takes only 100 watts to



drive it. Other features include a solid-state power supply that operates on 120/240 VAC with the convenience and protection of a built-in circuit-breaker. Two blower-cooled 572B/T-160-Ls pump out the talk power. Kit, \$200. Heath Co., Benton Harbor, Mich. 49022.

NO MATTER WHAT YOUR JOB IS TODAY

There's **BIG MONEY** to be Made In **COLOR TELEVISION!**

DUE TO SHORTAGE OF TRAINED MEN



Get into fast-growing field! Learn **COLOR TV** servicing at home in spare time. Many *earn cash* while training! Move ahead to a better job, a business of your own!

Get 20 Valuable Kits to Build 21" TV Set and Test Instruments!

Become expert the fast, easy way . . . by working on actual TV problems. Your training includes 20 valuable kits of parts and tools, yours to keep. Build a complete 21" TV set, tube tester, and electronic voltmeter as part of your training.

**HERE'S HOW TO GET STARTED:
MAIL COUPON TODAY FOR
FREE BOOKLET!**

Commercial Trades Institute
1400 Greenleaf Ave., Chicago, Illinois 60626

Dept. T-31

Rush my **FREE** booklet (without cost or obligation) on C.T.I. training for job opportunities in television-electronics—including **COLOR TV** servicing.

NAME _____

ADDRESS _____

CITY _____ STATE _____ ZIP _____



Accredited Member National Home Study Council

Solid-state CB mate

The best way to ring up more 10-2s with the new solid-state transceivers is by using one of the new low-impedance Sonotone Ceramikes®. They are designed specifically for all-transistor transceivers. Transmission is loud and clear, and Ceramikes are built to take abuse. Get the low-impedance "CM-3050" or the "CM-3050M" with Magnetic Mount, today. Also Models "CM-30" and "CM-30M" for tube transceivers. Prices start at \$15.75. Write for Free catalog SAH-7.



Sonotone Corp., Electronic Applications Div., Elmsford, N. Y.

Perform other calculations

Help Wanted Male

342
IBM

TECHNICIANS

342
IBM

Two to ten years experience in either aircraft structural and mechanical design or electronic circuit design and electronic systems engi-

342
IBM

QUALITY CONTROL

etc. advanced aircraft developments research. Reliability as solid

342
IBM

WILL YOU FILL THE BILL— TOMORROW?

In a few years, the job market will be different. New skills, new abilities will be wanted. The "good job" you have today may not even exist in the future.

Machines and new methods are always replacing jobs. That's progress. But progress also provides new opportunities—for *better-paying* jobs. That's where you come in.

You won't get tomorrow's jobs with yesterday's skills

To qualify for the good jobs of tomorrow, you have to re-train. Acquire new abilities, so you *can* fill the bill. And earn a better living at the same time.

It won't be that easy. But nothing as important as your future ever is. Take a step in the right direction this week, and talk to the local office of your state employment service.

Train now for tomorrow's jobs



PUBLISHED AS A PUBLIC SERVICE BY FAWCETT PUBLICATIONS

BROADSIDES

Pamphlets, booklets, flyers, application notes and bulletins available free or at low cost.

Better TV and FM reception is one of the things promised by equipment pictured and described in publication DS-C-004.3. Entitled "TV-FM Distribution Systems Equipment," the booklet covers such items as amplifiers, converters, filters and traps for use in multiset installations in buildings ranging in size from homes to hotels. Request your copy from Jerrold Electronics Corp., 15th and Lehigh Ave., Philadelphia, Pa. 19132.

A new bulletin shows four-layer diodes in the principle multivibrator circuits—astable, monostable, bistable and polarized. And for applications requiring high-speed switching, a separate section of the brochure outlines some of the ways the circuits may be made to operate at frequencies of 500 kc and higher. Obtain your copy by requesting Application Sheet E-506 from National Transistor, 500 Broadway, Lawrence, Mass. 01840.

Latest in the New-Tronics line of ham and CB antennas and accessories are illustrated and described in bulletin NT-106. For your copy, write New-Tronics Corp., 3455 Vega Ave., Cleveland, Ohio 44113.

High-voltage selenium rectifiers in a number of voltage-multiplier circuits are the subject of booklet S-4. Containing some 12 pages, the brochure includes basic schematics and also offers a brief discussion of how the selenium rectifier came into being. Copies are available from the Recticon Corp., 22 Summit Grove Ave., Bryn Mawr, Pa. 19010.

Neon pilot lights in enough types, sizes and styles to grace most any project are discussed in Omni-Glow's four-page brochure. For your copy, write Industrial Devices, Inc., Edgewater, N.J. 07020.

A 24-page catalog lists the entire line of Hoffman semiconductors which now compromise more than 50 separate families. Products included cover the gamut from regulators to rectifiers, and there's even mention of a solar battery. Request your copy from Hoffman Electronics Corp., El Monte, Calif. 91731.

BIG MONEY IN THE 4 CORNERS OF THE WORLD!

in TELEVISION, RADIO,
ELECTRONICS, RADAR, SONAR

**ONLY CHRISTY OFFERS
COMPLETE TRAINING!**

Investigate the Christy Complete Course. Why be satisfied with less? CTS Shop Method, Home Training makes learning easy. You learn by working with actual equipment. You receive Comprehensive training from the start. **CAN EARN AS YOU LEARN.** You become qualified to open your own Electronics Repair business or to gain high pay as a TV, Radio, Electronics, etc., Technician.

19 TRAINING KITS INCLUDED! You receive a Multi-Tester, Oscillator, Signal Tracer, Oscilloscope, Signal Generator, Electronic Timer, Regenerative Radio, 24" TV set (optional) and other valuable testing equipment. **FREE BOOK AND TWO FREE LESSONS** yours for the asking! No obligation.

CHRISTY TRADES SCHOOL
Dept. T-2813, 3214 W. Lawrence Ave.
Chicago, Illinois 60625



Send for 3
FREE
BOOKS



CHRISTY TRADES SCHOOL, Dept. T-2813
3214 W. Lawrence Ave., Chicago, Illinois 60625

Please send me the 3 FREE BOOKS and Special Form for
PAYING LATER from EARNINGS MADE WHILE LEARNING.

NAME AGE

ADDRESS

CITY ZONE STATE

Olson

* FREE

Fill in coupon for a FREE One Year Subscription to OLSON ELECTRONICS' Fantastic Value Packed Catalog—Unheard of LOW, LOW PRICES on Brand Name Speakers, Changers, Tubes, Tools, Stereo Amps, Tuners, CB, and other Values. Credit plan available.

NAME

ADDRESS

CITY ZONE STATE

If you have a friend interested in electronics send his name and address for a FREE subscription also.

**OLSON ELECTRONICS
INCORPORATED**

356 S. Forge Street Akron, Ohio 44308

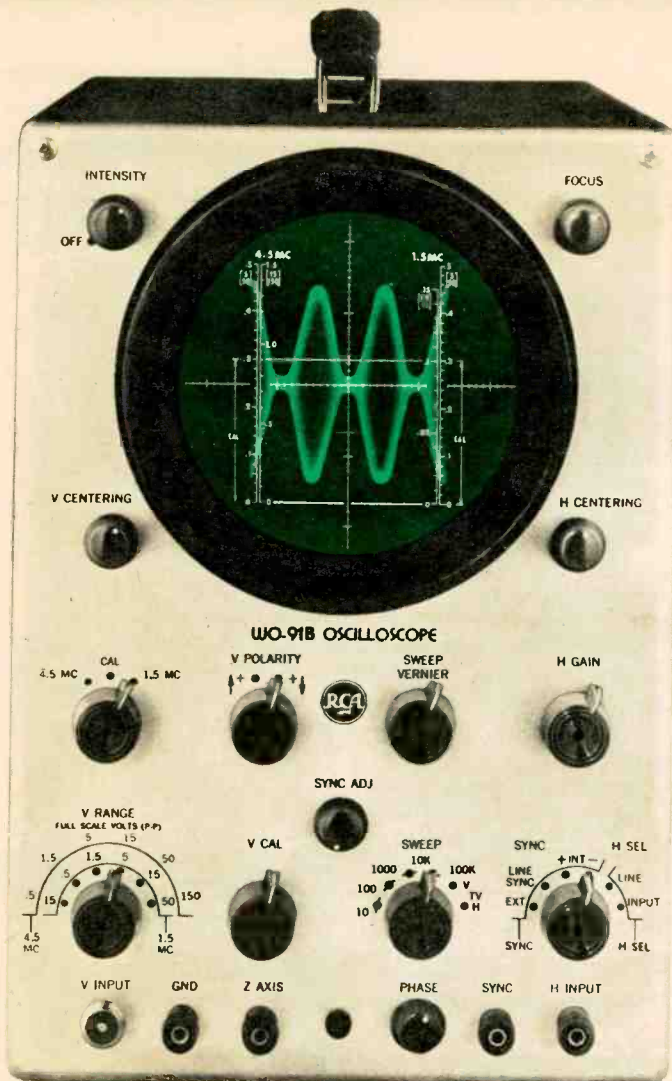

The famous RCA 5-inch scope NOW WITH MORE FEATURES TO SIMPLIFY YOUR JOB

Here's the latest model of the famous RCA 5-inch scope: the **NEW WO-91B**

- Provision for connecting signals directly to the vertical deflection plates of the CRT. Permits observation of high frequency RF waveforms, such as trapezoidal and wave-envelope modulation patterns.
- Two-stage sync separator simplifies checking of TV horizontal and vertical sweep synchronization... provides exceptionally solid lock-in action on composite TV signals.
- Choice of wide-band or high-sensitivity, narrow-band display.
- Complete with RCA WG-300B Direct/Low Cap. Probe and Cable.

- Optional at slight extra cost: RCA WG-354A slip-on capacitance-type voltage-divider probe that extends the range of the scope to permit observation of signal pulse amplitudes up to 5000 volts. RCA WG-302A slip-on RF/IF/VF signal tracing probe for RF applications from 100 Kc to 250 Mc.

<input type="checkbox"/> WO-91B Scope:	\$249.60*
<input type="checkbox"/> WG-354A Probe:	\$ 7.50*
<input type="checkbox"/> WG-302A Probe:	\$ 8.20*

Ask to see it at your Authorized RCA Test Equipment Distributor.

*Optional distributor resale price. All prices subject to change without notice. Prices may be slightly higher in Alaska, Hawaii and the West.

RCA Electronic Components and Devices, Harrison, N.J.



The Most Trusted Name in Electronics



ELECTRONICS
ILLUSTRATED

JULY 1965

The Dream

By

KEN GILMORE

That Won't Die



Bettmann Archive

IT LOOKED like a joke: a 2-foot-square bedspring with a skinny, 6-foot-long pivoted slat fastened on top. But industry officials and military brass gathered nearby didn't laugh as the decades-old dream of famed inventor Nikola Tesla (the man in our photo above) all but came true before their eyes. Silently, and most eerily, the slat began to revolve, though the source of its energy was nowhere to be seen. As its rotor whirled faster and faster the weird contraption began to rise. Finally, helicopter-like, it hovered motionless at a point 50 feet above the crowd.

This awesome display took place only last fall at the Raytheon's Burlington, Mass., laboratories. And it nearly marked realization of a vision that once seemed doomed.

The Dream That Won't Die

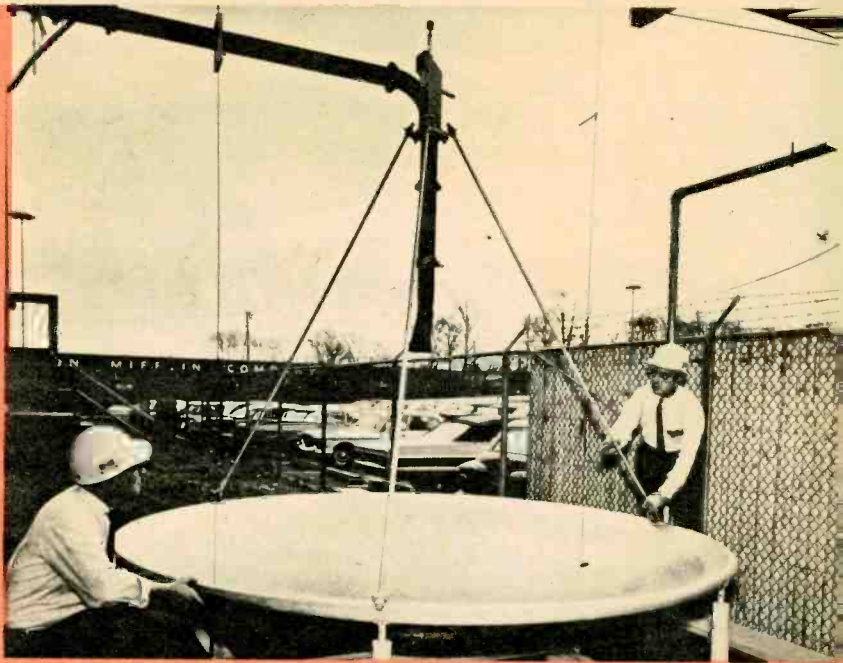

Raytheon demonstration proved Tesla's decades-old dream may yet become a workable reality. Microwave energy from pipe-like waveguide was directed at parabolic antenna, then reflected upward to power model helicopter.

For the model helicopter was powered not by the customary fuel-burning engine but by a silent, invisible beam of energy from the ground. Generated by a microwave transmitter, the energy was received by the bed-spring-like antenna, converted to direct current, then used to drive the electric motor turning the rotor. With its fuel supplied continuously from the ground, the strange craft could go on flying indefinitely.

Raytheon's startling stunt—the first public showing of wireless power doing a useful job—opens up a whole new realm of exciting possibilities. Large unmanned helicopters, hovering continuously ten miles above the earth, would make dandy platforms for long-range surveillance radar. Other platforms could broadcast television programs over several states simultaneously. Or they could relay microwave signals half across the country in a single hop.

Another proposal would have balloons do a similar job. Small engines aboard—run by radio energy from the ground—would compensate for drift and keep the balloons on station. The magic beam also would power the electronic gear aboard. Even

satellites ultimately might receive power to run electrical and electronic equipment directly from the earth.

For more than half a century, scientists have been trying to figure out how to transmit electric power without wires. First to tackle the problem seriously was the eccentric genius, Nikola Tesla. Now remembered chiefly for the type of coil that bears his name, Tesla once was smack in the middle of the power-transmission problem. In 1899 he got \$30,000 from Col. John Jacob Astor, the wealthy owner of New York's Waldorf Astoria Hotel, to conduct a breathtaking experiment.

What Tesla proposed was to set up a gigantic sending set and radiate electrical energy all over the world. He would create standing waves of electricity that would cover the earth. People almost anywhere then could stick antennas up into this sea of invisible energy and tap off enough power to light lamps, drive motors or heat homes.

With the money from Col. Astor, Tesla went to Colorado Springs and built a strange 200-foot tower with a 3-foot copper ball on top. At the bottom, he connected a huge

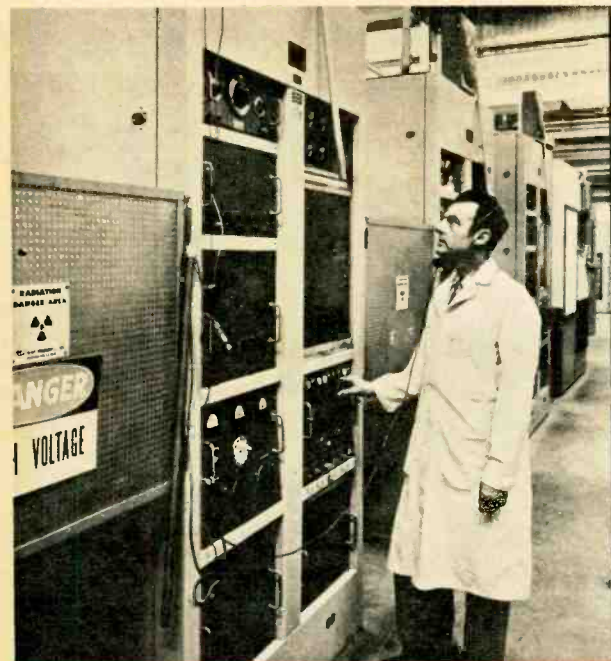

Helicopter relied on magnetron tube to convert alternating current to microwave energy. This station controlled output of magnetron.

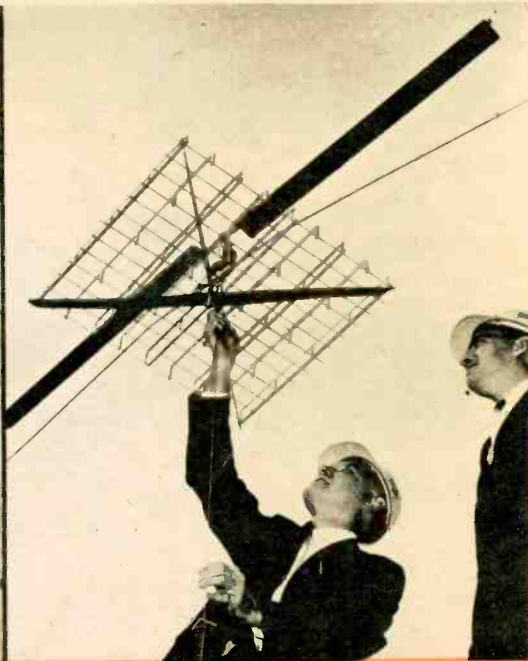

Powered by an invisible beam of microwave energy, model helicopter takes off for the heavens in a flight that could become a major mark in history.

Tesla coil, a special kind of transformer. The monster machine, similar in principle to ignition coils now used in automobiles, was designed to generate tremendous jolts of 150-kc RF power. (The photo on the first page of this article shows Tesla seated beneath just such a coil.)

When Tesla threw the switch, huge surges of energy ran up the tower. The inventor estimated that the potential on the ball reached 100 million volts. Spectacular bolts of man-made lightning forked viciously through the air and crashes of deafening thunder rolled across the countryside.

The show was spectacular but worthless. Engineers now know that the energy actually radiated probably was only a small percentage of the total involved. Worse yet, it was dissipated quickly in the earth's surface. And since the antenna spewed out its power in all directions, the amount available at any one location was extremely small.

Tesla, however, wasn't discouraged. He next convinced tycoon J.P. Morgan that his work had promise. Morgan, in turn, gave him another bundle of cash to carry on. This time, Tesla built a somewhat similar con-

traption on Long Island, about 60 miles east of New York City. The tower was wooden, 154 feet high. On top was a giant copper doughnut, 100 feet in diameter.

But Tesla never had a chance to test his second wireless-energy rig. He ran out of money before it was completed and couldn't find another backer. And when World War I came along, the government saw fit to tear his tower down. Since the structure could be seen for miles, the thinking was that it might give enemy ships an unmistakable landmark for plotting positions.

Next serious attempt to send power through thin air was somewhat more successful. In the early 1930's a Westinghouse researcher named H.V. Noble set up a couple of dipole antennas. Using a 100-mc signal, he managed to transfer several hundred watts of energy from one dipole to the other across his laboratory. But the amount of power transferred was too little and the distance was too short for the device to be practical. The setup was relegated to providing an eye-catching display in the Westinghouse exhibit at the 1933 World's Fair in Chicago.

Main problem during the early years of

The Dream That Won't Die



New hope for Tesla's dream lies in Raytheon's Amplitron. No paltry powerhouse, the tube can produce some 425 kw of microwave power, nearly 100 times the amount used in the model-helicopter experiments.

wireless power research was a sticky one. Engineers after Tesla knew that most of the power leaving the transmitting antenna would have to reach the receiving antenna if they were to transmit power through the air efficiently. This obviously meant that the energy would have to be focused into a narrow beam. But that ran squarely into the problem of wavelength.

By far the most effective beam-forming device, engineers knew, was the parabolic antenna now used on many radar and microwave devices. But the size of the dish depends on the wavelength of the signal to be focused. A high-frequency signal can use a small dish; a low-frequency, long-wavelength signal needs a big one. And that's where the trouble came in.

The only high-power signals electronic researchers knew how to generate back in the 1930's were low-frequency ones. Thing was, a dish to focus them would have to be miles in diameter and this obviously was impractical. The outlook for wireless power transmission was glum.

Prospects began to brighten, however, during World War II. The military services needed more-powerful high-frequency vacuum tubes for radar and scientists got to work on the promising magnetron and klystron

tubes. After the war, work continued on these tubes and other types of high-power, high-frequency generators.

By 1958, Raytheon had developed what it called its Amplitron tube. Estimates were that this monster could be made to generate 400,000 watts of continuous power at a wavelength of 10 centimeters (3,000 mc), high enough to work beautifully in practical-size antennas. The company asked the Defense Department to back the design of a radio-powered helicopter it called RAMP, for *Raytheon Airborne Microwave Platform*. And military planners were impressed enough to give the company \$90,000 to work out details.

Plan Raytheon came up with called for a strange monster that would hover 65,000 feet—about 12 miles—above the earth. An array of antennas on the ground would beam 15,000 kw of microwave energy into the sky, focused like spotlight rays to converge at 65,000 feet. The helicopter, hovering in this sea of energy, would absorb 750 kw (the equivalent of about 1,000 horsepower) to drive the rotor and operate the electronic equipment. The micro-wave power received would be used to heat air or gas and drive a turbine engine. The engine, in turn, would

[Continued on page 113]

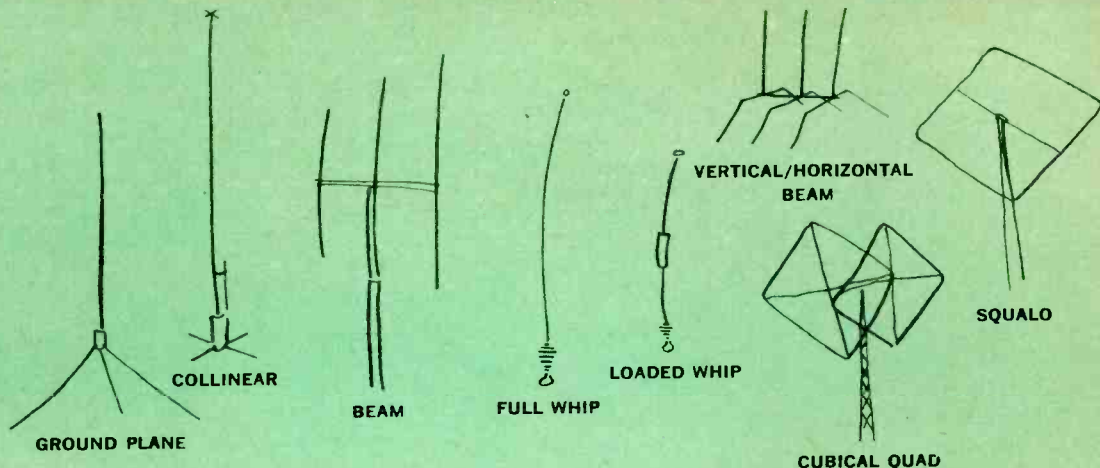

common sense about CB ANTENNAS

By LEN BUCKWALTER, KBA4480

WORSHIPPING the decibel rating, kneeling before SWR figures and sanctifying S-units. These are the *in* things to do at bull sessions following CB club meetings. Antenna lore has reached the proportions of a religion.

Just try to challenge the value of an extra half db and you'll get a reaction that well might melt warts off a rock. To be sure, specs can make or break an antenna. But keeping them where they belong also is mighty important. And doing so can net the practical CBer what he most needs: the biggest bang for the least buck.

CB technology has developed for some seven years now, which might seem ample time to produce the end-all antenna. But in fact we don't yet have it. Truth to tell, the mystery surrounding antennas has been in the process of being stripped away for some 80 years. Old Henry Hertz himself fired the starting shot by transmitting sparks between a couple of wire loops. And advances since then have been grudgingly slow. Right now you can look through most any text book and see the old-timers—the half-wave Hertz, the quarter-wave Marconi—still clinging on.

In short, anyone boasting that his new Purple Pumper (Guaranteed to Perform in a Storm) beats anything else on the market ought to be asked where he buys his marbles. And he also should be pinned down with this question: if that antenna is the absolute end, why are there hundreds of other models now on the market?

Thing to remember is that today's antenna producers are no laggards. They're well into the space age. Many, in fact, also produce antennas that make the military madly happy or do a bang-up job on industrial two-way radio. But despite their considerable experience, antenna manufacturers have yet to topple most of the old fundamentals. What their engineers *are* doing with those varied designs is provide the CBer with a personal choice. And that choice can gyrate wildly between factors of price, gain, durability and installation method.

Dubious Decibels. Common sense suggests that the best antenna isn't necessarily the one boasting the most gain. To back up that statement, let's get into a decibel duel. You're in a dark room with just a single candle to light the way. There's not enough illumination, so you light the other end of the candle. Aside

CB ANTENNAS

from burning the candle at both ends, something else still will be wrong, a fact that will hurdle home as you bark your shins against the Morris chair. Instead of *twice* the illumination, the increase in room brightness will be just barely noticeable.

Antenna power and decibels work out much the same way. If a particular design doubles the radiated power over that of a simpler antenna, there is an approximate 3db gain. And this holds true whether the power is upped from 1 to 2 watts or 50 to 100 watts.

What weight can be given to those additional db? Let's assume you switch antennas quickly during a transmission as a friend, miles away, studies his S-meter and listens carefully. With a 3db increase from your antenna he might see his S-meter swing up perhaps one piddling unit. (There's no general agreement on how many db equal an S-unit.) What's more, because of the nature of human hearing, he would hear a barely perceptible increase in loudspeaker sound—not a doubling, as twice the power might suggest.

The point is clear. Those squabbles about 1db differences in antennas are for paper tigers, not nuts & bolts antenna men. A better argument in the 3db class would be that this much gain might thrust signals up over the noise and make them readable.

Radiation Angle. Even if you obtained an antenna of super gain, its power literally would be for the birds unless it was fired off at correct angles. Here's a silly picture, but a good analogy: imagine you're lying flat on your back, blowing up a balloon. The growing balloon represents the radiation pattern from the antenna bulging outwards and upwards at the same time.

Unless you're talking to the birds, though, it's much better to squash down the top part of the pattern and add it to the sides. This is equivalent to lowering the antenna's radiation angle. And the closer this angle is to zero degrees, the better. Otherwise, much energy is beamed uselessly upwards and out into space.

Antenna Height. A hundred miles on 5 watts is yours! The price: \$500 for flying lessons, \$5,000 for the plane. Though height is touted as the panacea for antenna problems, it's not an unmixed blessing. The

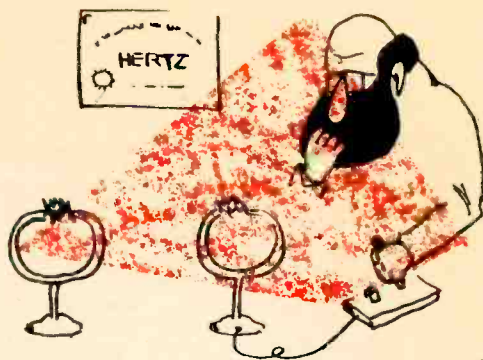

Old Hank Hertz agitated world's first antennas way back in Queen Victoria's day. Basic types have changed little in the decades since his death.

least obstructed mounting point is, of course, the best, assuming it complies with the FCC's 20-ft. height limitation. But, other things being equal, differences of a few feet can introduce expensive mounts, masts, guy wires and other headaches.

Handling a chimney mount, for example, is child's play and entails merely fastening a couple of TV-type straps. But try to install an antenna on a sloping roof several feet higher than the chimney and you could spring some roof leaks. Question is, are the few extra feet worth it?

Let's say your antenna is 50 feet above ground. This height could produce a working signal in a receiver some 17 miles away (assuming the receiver has an antenna of the same height and the terrain is free of mountains, hills or towering structures). Raise your antenna by as much as 10 feet, though, and operating range might increase a mere mile.

In other words, the situation here is much like those S-units, which lag way behind db. In this case, range trails behind height in painfully slow fashion. Your local Big Voice, in fact, may be getting a boost from an illegal amplifier, a tower or, more likely, a shack on a high hill-top.

Types. You may have a kidney-shaped antenna, but an old-fashioned dipole likely is hidden somewhere inside. (A half-wave dipole for CB purposes usually stacks up as an 18-ft. radiator of some sort, split in the middle with a feedline.)

Even so, seeing the dipole in each of the many CB antennas now on the market frequently is impossible. For, while the dipole

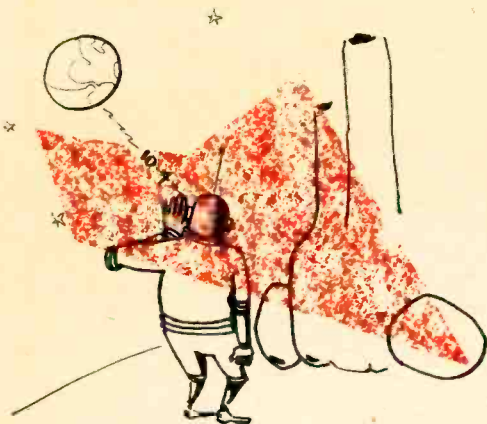

High radiation angles may be great for sending 10-4's to Martians and Venusians, but common sense says that the lower the angle, the better.

still is the basis for most CB antennas, it's modified in various ways to make it more practical for CB communications. Reason is that the conventional dipole's drawbacks are three-fold: it's too big to fit on a car, it doesn't lend itself easily to vertical mounting and it tends to radiate most power at the center in a less-than-optimum angle.

Detecting the dipole in its many variations could be playful fun but it won't net you much in the range-and-rubles game. However, there are a few basic base-station types any CBer should be familiar with.

One, the ground-plane, is an early model that still appears in a good many installations. A 9-foot vertical with radial elements sticking out at the base, it provides no more gain than the basic dipole. What's more, its rather high radiation angle limits its coverage somewhat. But despite these limitations, the ground-plane enjoys a durable existence.

Scurrying to get some gain into base antennas, manufacturers began putting more iron up on the pole. Antennas grew from the 9-foot quarter-wave to today's extremely popular collinear types extending upwards of 19 feet. These newer units add significant gain with the increased length since, on transmit, they approximately double the power (a 3db gain). Fact is, they presently rank among the most powerful non-directional antennas available.

The collinear also offers an improvement at the receive end. This is due to transformers which tend to short-circuit some types of atmospheric noise. But because of the more complicated construction and the associated

transformers, cost of the collinear is about double that of the simpler ground-plane.

Beyond these types is the big blast of a directional beam. With a potent, over-10db gain, it can convert the 5-watt transmitter into the equivalent of a 50 watt. Beams, however, remain the most expensive route to a high-power antenna. And they must be used within their big limitation: point-to-point communications. You have to know in advance where the distant station lies, then swing the beam on it.

Mobiles. Sorting out mobile antennas is mostly a matter of determining how long an antenna is and where its loading coil is positioned. Again, you can search out and discover a dipole if you have a mind to, though this time what you see is a 9-foot quarter-wave element. (The car body acts as a ground-plane to make up the missing 9 feet of the original half-wave dipole.)

Assuming you can get a 9-footer onto the family buggy, a full-length whip well might prove a top performer. But the 9-footer often is a mechanical problem-child, jutting up into trees or whipping in the wind. And mounting it low, on the rear bumper, can affect coverage in certain directions. Reason is that the trunk deck blocks radiation.

To overcome these objections, designers have come up with the loading-coil technique. This permits the whip to be shorter physically, though it's the electrical equivalent of a 9-

[Continued on page 110]

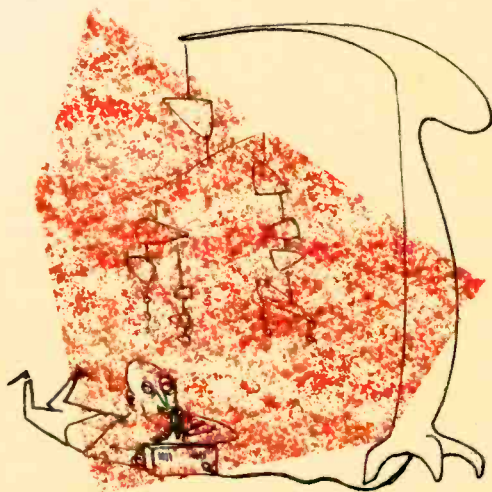

Oddball antennas frequently look exotic enough for spacemen, but there's usually a more conventional sky-wire tucked somewhere or other inside.

At camp, school or home, would-be disc jockeys have it made with this closed-circuit wireless broadcaster.

THE entertainment you want when you want it. That takes a lot of patient dial-twisting these days. In fact, you may never be able to locate the station that plays *your* kind of music and with few commercials. But before you and your friends give up radio as an entertainment medium, have you ever thought about operating a station with your *own* programs?

We don't mean a 50-kilowatt. What we have in mind is a low-cost, low-power radio station. With such a setup you can broadcast your newest records, deliver hardhitting commercials and give your own inaccurate weather forecasts. It's the chance to show what a witty disc jockey you could be if only somebody would discover you and give you a break.

With EI's low-power broadcast station you can do all this and more. It has inputs for a microphone and record player (or tape), mixing controls and a modulation-level meter. Just turn it on, pick a clear spot on the broadcast band and you're on the air!

Because the FCC frowns on unlicensed broadcast stations, and since a licensed station costs a pile of dough, our rig was designed for limited range. Its low power is perfectly legal and you won't get into trouble with the FCC. You won't be heard all over town—in fact, you won't even be heard at the other end of the block. But in your own apartment building, your neighbor's house, at camp or in a college dorm, you'll be top dog on the band.

Our station actually is a deluxe version of the old wireless microphone. But instead of having an antenna wire hanging out of the back, our rig uses the AC power line that it's plugged into to carry the signal. And with good conditions the range may exceed that of the wireless mike of old.

Our station doesn't produce the usual barely-readable signal like many wireless mikes. It has extra power-supply filtering for low hum, and its low-distortion mike and phono preamps make its signal sound as if it is coming from a commercial station. The sound quality will be good enough for you to broad-

build your own



BROADCAST STATION

By AL TOLER





cast your best hi-fi records.

For adults kept at home because of a shortage of baby sitters, there's another application for the station. Just eliminate some of its deluxe features and you have an electronic baby sitter. Put the station's mike in the baby's room, turn on the radio in the neighbor's apartment where you're visiting, and the first peep out of junior will be broadcast to the world.

Construction

The station will fit on a 5x7x2-in. aluminum chassis. Parts layout and wiring are critical; therefore, we urge you to duplicate our layout. After the chassis has been drilled, mount VU meter M1. Space is at a premium and it might be difficult to install M1 after other components are mounted. Coil L1 should be mounted last to protect its slug-adjustment screw, which protrudes a considerable distance outside the can. Pay special attention to the values we specify for components associated with V2; do not make changes or substitutions.

Coil L1 must be modified, as shown in the diagrams on the third page of this article, to work in the station's oscillator circuit. The modification is not difficult but must be done with care to avoid damaging the delicate coil wires.

First, remove the single screw which holds the coil assembly in the can. If your coil is supplied with a rivet instead of a screw, use a 1/4-in. drill to remove the rivet's head. Then punch the rivet through the can with a nail

or a center punch. Carefully slide the coil assembly out of the can. The slug remains attached to the can, so don't move the coil to the side when taking it out. Slide it straight down.

Note that the coil has a terminal board at the bottom and that the color-coded leads are attached to only four of the five terminals. The remaining terminal is the junction for two 100-mmf capacitors.

Remove the capacitor going to the green-lead lug by clipping its leads (don't try to unsolder it). Then cut out the 100K resistor and remove the blue lead. Cut off the green lead and attach it to the terminal that was the junction of the two capacitors. Install the coil in the can again. Disregard the instructions supplied with L1 and connect it as shown.

Install C3 so it can be removed easily. If you want to use the station for baby-sitting purposes only, eliminate J2, R5, R6, R7, C5 and M1 and connect R4's wiper directly to pin 7 on V1B.

Make certain that C8 is connected to the contact on S1 that goes to T1. It should *not* connect to the line side of S1. Twist the leads going to switch S1 and to neon lamp NL1. Use shielded wire to connect J2 to R5.

Checkout

Turn on power by rotating R5 until the



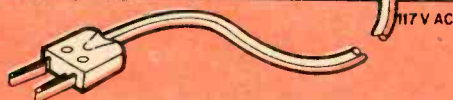
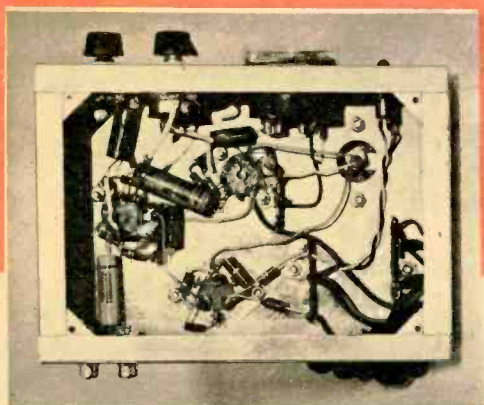
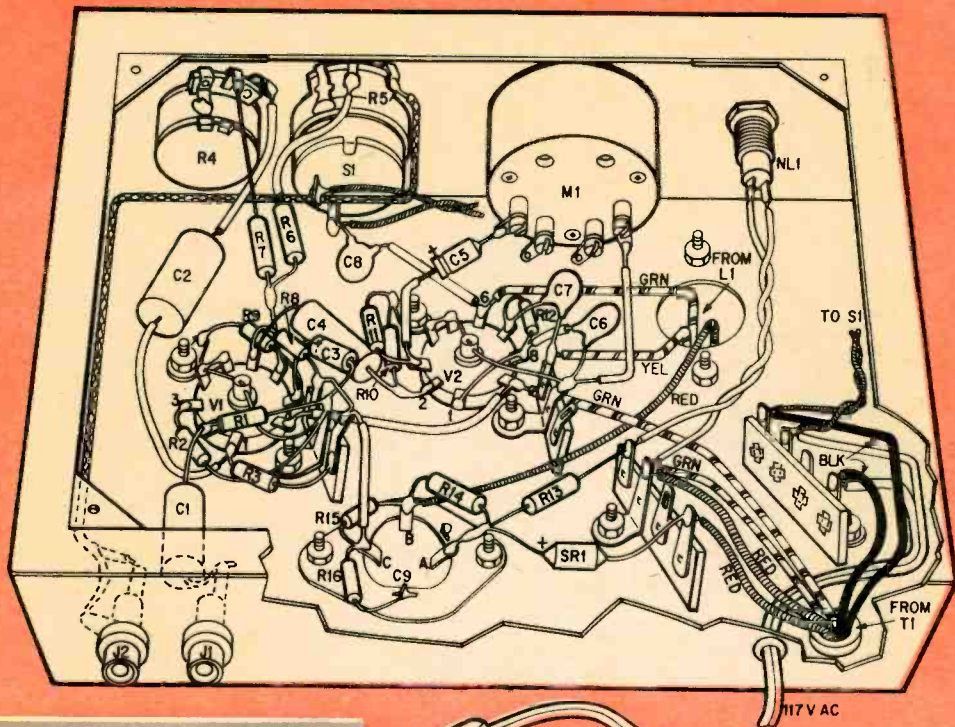

There's plenty of room for all parts in the chassis we selected. All leads should be short and direct to keep hum and distortion low and to assure proper oscillator (V2) operation. Braid on shielded lead from J2 to R5 is grounded at J2 only. Twist AC lead to S1 and position it near the chassis.

BROADCAST STATION

power switch clicks. Allow the unit to warm up for a few minutes, then turn on an AC or AC/DC radio plugged into the same circuit and tune the radio to a spot where there is no station. Adjust L1's slug until you pick up the signal on the receiver. The radio will get quiet and the background noise will disappear. Check to make certain the rig is not interfering with a commercial station. If the receiver is physically too close to your station you may pick up two signals, one on the high end of the dial and one on the low end. The low-end signal usually is false; it will not be received when the radio is moved to another room. (It is possible that the high-end signal is false, although this is rare.)

Connect a mike to J1 and plug a record player with a crystal or ceramic cartridge

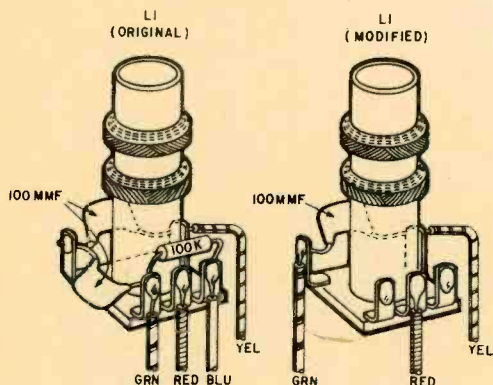

Coil L1 as it appears when removed from can. at left. Modify it by removing 100 mmf capacitor, 100 K resistor, blue lead; also move the green lead.

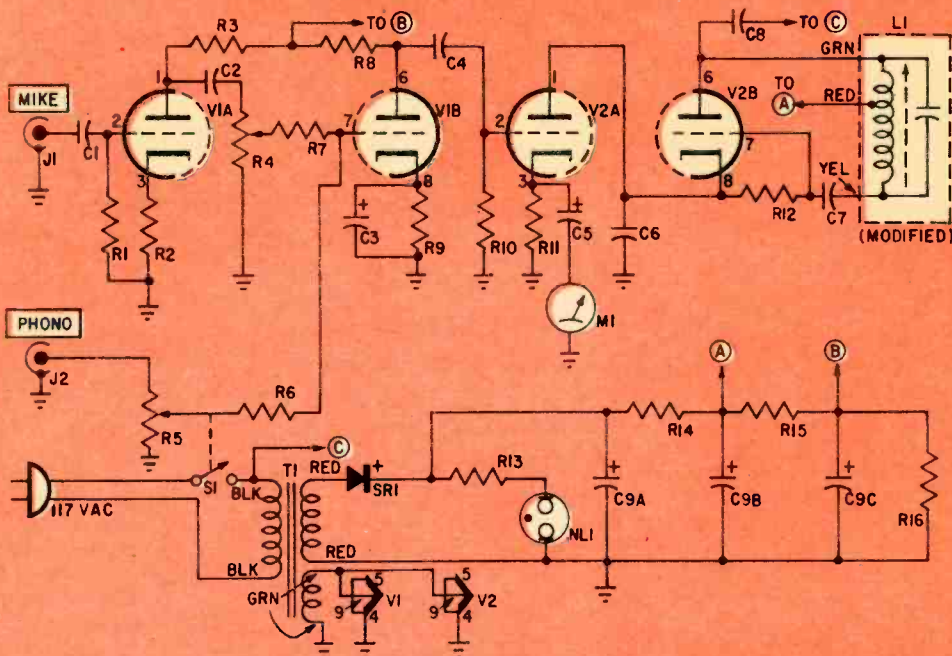

Mike signal is amplified by V1A and fed via R4 to V1B and further amplified. The signal continues to V2A which, because it is connected between Hartley oscillator V2B and ground, modulates the oscillator.

PARTS LIST

Capacitors:

C1—.01 mf, 400 V tubular
 C2—.02 mf, 400 V tubular
 C3, C5—30 mf, 15 V electrolytic
 C4—.05 mf, 400 V tubular
 C6, C8—330 mmf, 500 V disc
 C7—.001 mf, 500 V ceramic disc
 C9A, B, C—20/20/20 mf, 250 V electrolytic
 J1, J2—Phono jack
 L1—Phono oscillator coil: J. W.

Miller No. 522, Allied Radio stock
 No. 61 G 005, \$2.97 plus postage.
 (Not listed in catalog)
 M1—VU meter (Lafayette 99 G 5024)
 NLI—NE-2 neon lamp and holder
 Resistors: ½ watt, 10% unless otherwise stated. Values in ohms.
 R1—1 megohm R2, R9—1,500
 R3, R8, R10—100,000
 R4, R5—250,000 ohm audio-taper

potentiometer
 R6, R7—470,000 R11, R15—2,200
 R12—22,000 R13—220,000
 R14—1,200 R16—270,000
 S1—SPST switch on R5
 SR1—Silicon rectifier: 500 ma, 400 PIV or higher
 T1—Power transformer: secondaries; 125 V @ 15 ma, 6.3 V @ 0.6 A Lafayette 33 G 7502.
 V1—12AY7 tube V2—12AX7A tube

in J2. (You would also connect a tape deck output to J2). If your record player has a magnetic cartridge, plug it in J1 and connect a 22K-ohm resistor from J1 to ground.

Adjust volume controls R4 and R5 until M1 indicates between 60 and 85 per cent modulation. (Don't try to push the modulation any higher or you will produce a distorted signal.) Move the radio away to check the station's range. If the range is only a few feet, reverse the station's plug.

Since power lines have considerable losses at broadcast frequencies the station's operating range will depend on the type of house wiring (metal-clad BX or insulated Romex) and the equipment connected to the line, such as lights, heaters or motors. The range also will depend on power-line transformers. If you are on one side of a distribution transformer and your neighbor is on the other, he won't be able to pick up your signal.

If the operating range is too restricted by power-line problems, it can be extended by converting the station to wireless operation. To do this, install an insulated binding post on the chassis, disconnect C8 from S1 and connect C8 to the binding post. Then connect a 50-in. length of wire to the binding post. If the station's frequency changes when the wire antenna is approached, change C8's value to 50 mmf. If you find the mike or phono signal has too much bass, remove C3.

Service Hints

If L1's slug does not lower the output frequency sufficiently, increase the value of C8 by 50 mmf. If L1's adjustment can't raise the output frequency sufficiently, lower the value of C8 by 50 mmf. If the sound is distorted severely and M1 doesn't indicate, or just barely wiggles, check C5's polarity. Be sure the positive end connects to pin 3 of V2A.

How To Hook

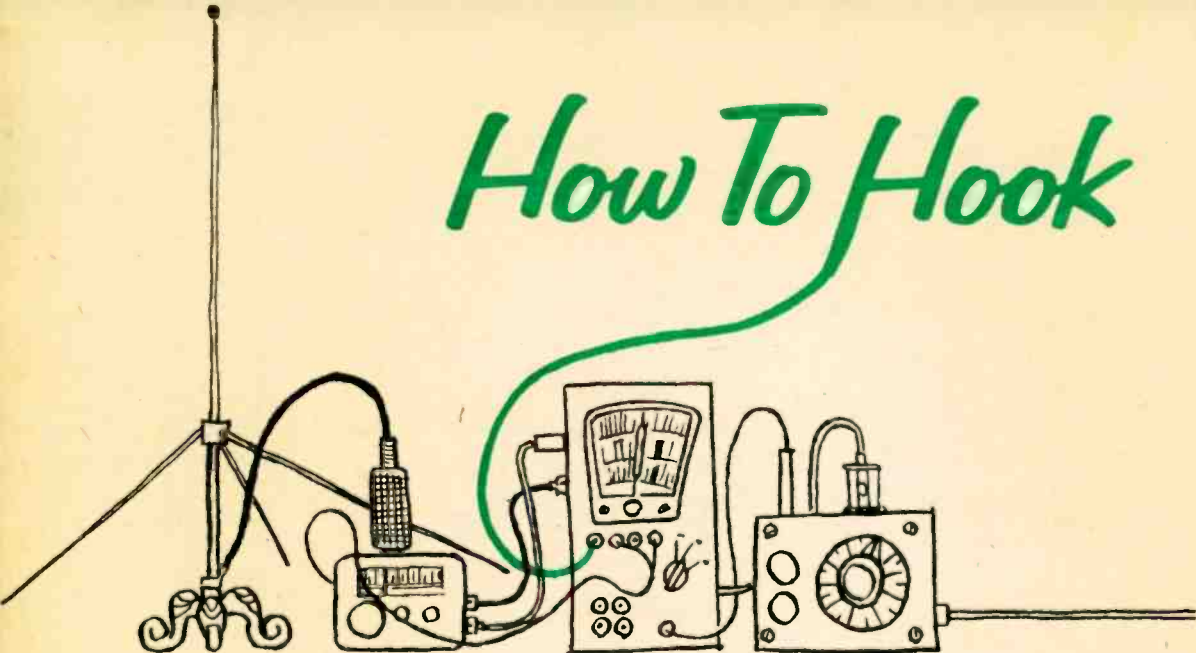

JUST ABOUT all hobbyist equipment—be it for the amateur, SWL, audio buff, CBER or experimenter—is designed to hook into something or to have something hooked into it. And questions frequently are raised about some odd hookups that are unheard of if not plain unthought of.

Most such hookups are a matter of impedance, of course, though we won't go into the theory of impedance here. Instead, we'll deal with the practical matter of results.

Q. *I need more gain for the mike on my tape recorder. I saw a simple transistor booster that connects between the mike and the recorder input; it claims a 20db gain. Can I use it? (P.S. The mike is a ceramic.)*

A. Assuming you want to maintain maximum fidelity, the answer is no. A ceramic (or crystal) mike, unless it's one of the low-impedance types, requires a high-impedance load—usually in the neighborhood of 2 meg-ohms. A lesser load will result in low-frequency attenuation.

Since the typical one-transistor booster has an input impedance of 500 to 20,000 ohms, only the midrange and highs from your mike would be boosted 20db. Lows you wouldn't have. If you insist on transistors, use an emitter-follower ahead of the amplifier. Or try a tube.

Q. *In order to hear weak signals on my communications receiver I have to use a preamp between the antenna and the receiver.*

It works great on weak signals but rotten on strong ones. What's wrong?

A. Sounds like your preamp has no AVC (automatic volume control) line to your receiver to reduce gain on strong signals. The preamp probably is overloading because the received signal is greater than the preamp's grid bias.

If you must use a preamp without an AVC connection to the receiver, install a bypass switch. This way, you'll be able to remove the preamp from the receiver antenna circuit when receiving strong signals.

Q. *I have a four-channel mike mixer which I use to record the school dance band. It has plenty of output: 2 volts rms into a 500,000-ohm load. I thought I'd connect a VU meter across the output so I could get better balance between the instruments but when I connect the meter it hardly wiggles. The meter is supposed to indicate 0db (100%) at 0.775 volts, so I can't understand why 2 volts won't drive it.*

A. The basic VU meter has an impedance of 3900 ohms (0dbm at 0.775 volts rms). Assuming you series-connect the resistor supplied with the meter, the impedance becomes 7500 ohms (the 0db mark now indicates +4dbm). But connecting 7500 ohms across the output of a mixer designed to work into 500,000 ohms only can result in severe loading of the mixer.

If you check the mixer's output voltage with the meter connected, you'll find the out-

Anything To Anything

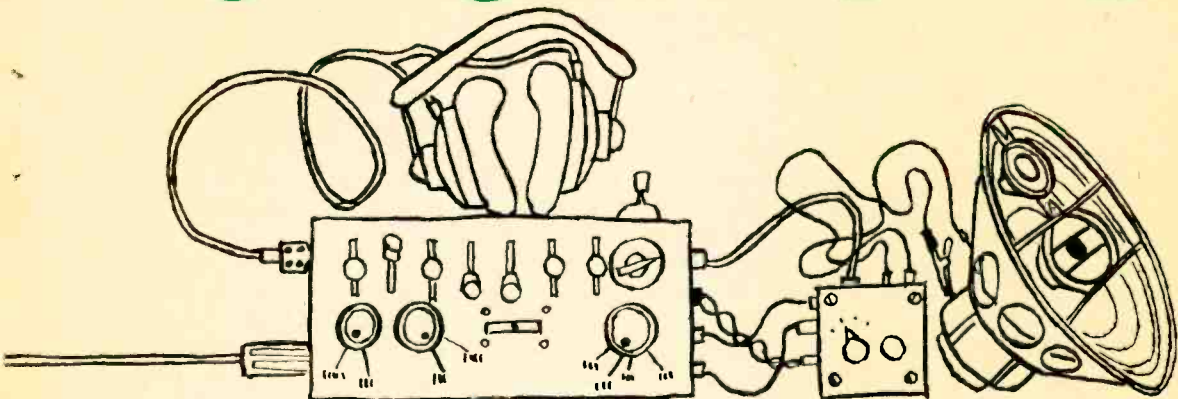

put level is considerably less than 2 volts. You also probably will find that the lows have disappeared with the signal. If you want to use a VU meter, you'll have to provide a high-impedance amplifier—such as a tube cathode-follower or transistor emitter-follower—between the mixer and the meter.

Q. *I can't seem to get good stereo-FM reception. The service shop is tired of hearing my complaints but they say my gear's in top shape. I have a quality stereo-FM tuner, a rotated yagi antenna and 72-ohm coaxial cable to reduce noise pickup. There are no metal towers or tall buildings anywhere near me which can cause multipath.*

A. Most likely you're generating your own multipath. A 72-ohm lead-in connected to a 300-ohm tuner input transfers only about 75% of the signal into the tuner. The remaining 25% travels back up to the antenna where part of it is reflected back down the lead-in. And this process gets repeated and repeated.

Naturally, each reflection arrives after the primary signal, so it's much the same as multipath. It's also something like ghosts on a TV receiver; instead of a sharp picture, the image fuzzes out with nothing really adequately defined.

As a general rule, the lead-in impedance must match the tuner's input impedance. If you can't avoid a mismatch it's better to have it between the antenna and the lead-in than between lead-in and tuner. Or use a 72/300

matching transformer at the end of the lead-in.

Q. *To get the best stereo-FM reception possible, I installed a directional antenna and a mast-mounted booster amplifier. But my reception got worse; in fact, I got better results with an indoor rabbit-ears TV antenna. With the outdoor antenna and booster I get one station at several spots on the dial and the extra signals jam my favorite stations. Considering that I purchased the best antenna and booster and that my tuner is rated among the finest, what could possibly be the matter?*

A. You've got too much of a good thing. Nothing wrong with a directional antenna (it's a must for really good stereo-FM) but you don't need the booster. A booster is fine if signals normally are marginal, but you live in the city and you're probably receiving good signals without one.

Your problem presumably stems from the fact the booster is amplifying the signal to the point where it overloads the tuner. Result is that the tuner's front-end generates the extra signals.

Q. *In order to get better modulation I connected a speech compressor to my CB rig. But now everyone says I sound distorted. I know broadcast stations and amateurs use compressors; don't they work with CB transceivers?*

A. A compressor increases the modulation density of any communications system, but you must keep in mind that they also are

Hook Anything To Anything

preamplifiers. If your transceiver already has sufficient gain to insure 85 to 100% modulation, the compressor's additional gain will cause overmodulation.

Best solution to your problem is to set the compressor for 6 to 12db compression. Then connect a modulation meter to the transceiver and adjust the compressor's output for 85 to 100% modulation on speech peaks. Always keep in mind that whatever the compressor does to increase modulation density, it does in spades once you overmodulate.

Q. I have a tape deck which connects to an amplifier. So as not to wake up the household late at night I listen with headphones. But I can't see any reason to run a 90-watt amplifier just to drive a set of headphones. I tried connecting my hi-fi phones to the tape-deck output, but the sound is weak and shrill. What can I do?

A. You can buy new headphones. Your recorder's output probably is 1 volt rms into 100,000 ohms—a level representative of most nonprofessional recorders. Hi-fi headphones designed to connect in place of speakers have impedances in the neighborhood of 8 to 100 ohms. And impedances this low connected across an output intended for high-impedance loads (50,000 ohms or higher) will load the circuit heavily. Result is sharply reduced output and, generally, severely impaired low-frequency response.

Q. I have a semi-professional tape recorder which I want to connect to my hi-fi amplifier. My problem is that the recorder has a 500-ohm output impedance and the lowest input impedance on my amplifier is 1/2-megohm. I can't locate a matching transformer in the catalogs, and I wonder if you can suggest one.

A. Who said you needed a matching transformer? Anytime the input impedance is ten times that of the source impedance we have what is called a bridging circuit. This means that there essentially are no terminating effects present. In your case, all you have to do is connect a 500-ohm resistor across the tape recorder's output and bridge your amplifier across the resistor.

Q. I get practically nothing out of my tape-recorder's monitor jack when I use high-

impedance headphones. Would low-impedance (8- or 16-ohm) hi-fi phones give me more output?

A. Many years ago headphone impedance often was an indicator of sensitivity. With magnetic earphones of approximately 2,000 ohms impedance, it still can be used as a rough guide. But you can't compare sensitivities of low-impedance phones with the standard-impedance jobs (2,000 ohms or so). Nor can you meaningfully place crystal headphones in the same picture. Sensitivities must be compared strictly within each group, and impedance often has no relationship to sensitivity.

Something else to keep in mind is that you generally can't use low-impedance phones in a high-impedance circuit. Reason is that the loading often will reduce the circuit efficiency to almost zero. As a general rule, however, high-impedance phones can be used in low-impedance circuits. In your case, therefore, it appears that your phones are defective.

Q. When I plug phones into my SWL receiver, I get a very annoying hum that masks the signal. But I don't get any hum out of the speaker. What's wrong?

A. You're suffering from the same problem as the hi-fi buff who uses a 100-watt power amplifier when only 5 watts could rattle the windows. The power-output stage generally has a minimum amount of B+ filtering which goes unnoticed because of the relative proportions between it and the power needed to push a signal out of the speaker. But your phones are much more sensitive than a speaker and you have to reduce the volume to avoid blowing out your eardrums.

Trouble is that the volume control is ahead of the output stage, so though the signal is reduced the residual hum is not. And the more sensitive the headphones, the more the signal volume must be reduced. End result is that the hum level actually appears to increase.

A simple cure is to connect a 100,000-ohm potentiometer in series with the phones. You then can adjust the pot until you get a usable sensitivity which also allows the signal to be boosted well above residual hum.

Q. I have an 8-ohm speaker hooked to the 8-ohm output terminals of my amplifier. What happens if I put another 8-ohm speaker in another room and hook it into the 16-ohm terminals? Will I get less sound or none?

[Continued on page 102]



By Tim Cartwright

GOOD READING

SURPLUS CONVERSION HANDBOOK.
By Tom Kneitel. Cowan Publishing Corp., Port Washington, N.Y. 192 pages. \$3

For many a ham, military-surplus radio gear helps make life worth living. It's not just that the surplus stuff is cheap; there's also that challenge-to-convert-to-peaceable-ham-shack-use angle. But unless you know how, this latter bit often smacks of converting a Sherman tank into a mobile home. The basics are there—but oh, brother!

The book at hand represents an attempt to scrounge up every conversion that's appeared in one of the major ham publications—*CQ*—since World War II. And if the book is a pretty rough-and-ready, un-slick sort of job, so is the subject. Take a look at it if your soldering iron has been getting rusty lately.

UNDERSTANDING LASERS AND MASERS. By Stanley Leinwoll. John F. Rider, New York. 87 pages. \$1.95

No discovery since atomic energy seems to have attracted quite the attention the laser and maser have. To the layman, they conjure up images of ray guns and other exotic gadgets; to the scientist and the knowledgeable technician, they represent an almost incredible potential for applications ranging from communications to treatment of disease.

For those who haven't been able to get into the subject very deeply, here's a good, detailed introduction. Tightly written and well illustrated, the book should provide all of the background that most of us need to be up-to-date on one of this century's most important discoveries.

BASIC THEORY AND APPLICATION OF TRANSISTORS. Prepared by the U.S. Department of the Army. Dover Publications, New York. 263 pages. \$1.25

This text is no classic, and the military-training-manual style tends to leave one glassy-eyed with fatigue. But there's about as much basic and detailed material on transistors in this reprint as one could hope to get between covers.

The material's new format makes the data much more digestible than it possibly could have been in its training-manual days—so much so that the military well might take a hint from the civilian approach to the problem. All in all, this is a good, low-priced addition to your reference shelf.

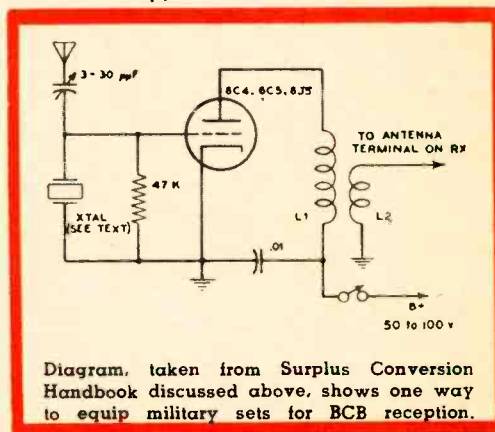

Diagram, taken from *Surplus Conversion Handbook* discussed above, shows one way to equip military sets for BCB reception.

RADIO AND TELEVISION RECEIVER CIRCUITRY AND OPERATION. Revised Edition. By Alfred A. Ghirardi and Jess E. Dines. Holt, Rinehart and Winston, New York. 556 pages. \$10

A hefty, expensive volume presumably intended as a classroom text, this book probably is as comprehensive as anything else around. And its subject is one that's bound to interest most anyone in electronics.

But there's a problem spelled t-r-a-n-s-i-s-t-o-r to be dealt with.

Yes, a chapter at the end touches on the solid-staters. But more—much more—is needed. And while this doesn't limit the book's usefulness as a refresher for technicians, it does point to reason for another revision (for both classroom and practical use) before too long.

And make note of . . .

FUNDAMENTALS OF TELEVISION. By Walter H. Buchsbaum. Rider. 291 pages. \$9.95

TAPE RECORDING THE SOUNDS OF YOUR LIFE. Robins Industries, Flushing, N.Y. 128 pages. \$1.35



TOP BRASS . . . When a new facility opens at a military post, the ranking officer usually makes like a wind-up doll. He delivers a little speech, cuts a ribbon for the benefit of attending photographers and then goes back to the golf course. But this routine took on a new twist when the U.S.

Army Signal Center and School inaugurated a new shack for AA2USA, the MARS station at Fort Monmouth, N.J.

To no-one's great surprise, Brig. Gen. H. McD. Brown, the commanding general, made a speech and cut a ribbon. But he then walked over to the operating table and made the first QSO in expert fashion. Something he'd been coached to do? Hardly, for the General is also a ham, W2MNO, a call he now holds for the third time in 25 years.

Still Growing . . . If the 20-meter band sometimes sounds like brawlers gone batty, it's only because more hams than ever are taking advantage of all that band now has to offer. And fact is, there are more hams than ever to do so.

According to the FCC's last count, there are 264,007 of us these days. Unquestionably, many of this number are newcomers from the CB ranks. And more no doubt will be forthcoming as the 5-watt boys discover the delights of 50, 150, 500 and 1,000 hot watts of RF energy.

It Figures . . . Western Union's recently named president is Russell McFall, at 43 the youngest man ever to head this famed firm. More significant is the fact that he is active as W3JAB and that his favorite method of operating is pounding brass.

Significant, too, is the origin of that expression. Seems it first saw light, years before Mr. McFall was born, in the very company he now runs.

Emerging Nations . . . Catching some of the strange prefixes that now permeate the DX bands caused us to mull over a point or two. And one thing we immediately realized was the need for an up-to-date atlas.

As we have learned to our expense, any

such book or map more than four or five years old is of little value—especially in regard to Africa. Our advice is simple: before buying, look carefully for a copyright or publication date.

How's That? . . . Al Dolid, W2GLP, happens to travel around a bit for Western Electric. And Al swears he saw the following notice on the door of a Milwaukee hotel room: "Warning, Electric Current. Please use care with electric appliances. The current varies from AC to DC without notice. For information call Ext. 55. The Management."

Explanation behind this one proved to run as follows. The establishment normally gets AC from the local utility, though this poops out occasionally. When it does, the hotel's electrician fires up an old steam-driven dynamo. Crude, maybe, but it does keep the lights on and the elevators running.

Who Needs an Antenna? . . . Every ham does, but a ridiculously simple one sometimes suffices. Take this tale as a fr'instance.

While his beam was down for repairs after a storm, K2DUX wanted to make a quick check on a Knight-Kit T-60 transmitter assembled by a friend. So he tossed an 8-ft. scrap of lamp cord across the floor of his shack and crammed one end into the coax fitting on the back of the chassis.

And what happened? Well, within five minutes he had raised a PJ station in the Netherlands West Indies, just off the coast of Venezuela! And this on AM fone, with an output of perhaps 25 watts on the 21-mc band.



Ribbon-cutter with a difference, Brig. Gen. H. McD. Brown recently dedicated a brand-new ham station in perfect ham fashion. See text for details.

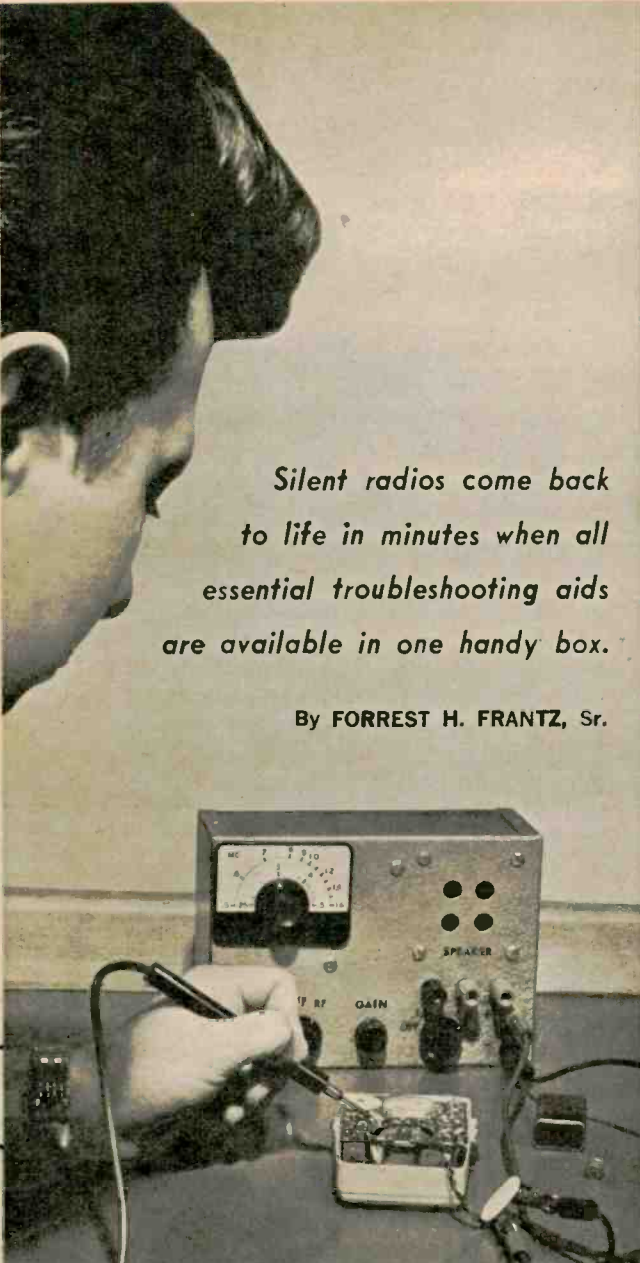

*Silent radios come back
to life in minutes when all
essential troubleshooting aids
are available in one handy box.*

By FORREST H. FRANTZ, Sr.

FIX a dead radio? Why, that's no problem. You just replace one of the tubes or a dead battery. But only if lady luck is with you will the job always be that simple.

Fortunately, many of the ills that plague AC/DC or transistor radios can be cured by this simple technique. But just as often the cards will be stacked against you and the set still will be as dead as a blown fuse after you've tried all the usual tricks. And guesswork is no way to track down the trouble, either. To make every troubleshooting minute count, you've got to be able to look for the signal in each stage of the radio to determine where it disappears.

And this is the sort of sleuthing the 7-in-1 Analyst is designed for. You'll find it to be one of the handiest pieces of test equipment on your bench. Take a look at its functions and what they'll do for you. To begin with, you can feed three different signals into it: audio, IF or RF. You set it up for an audio signal to look for trouble in an amplifier or the output section of a radio. Set the function switch to *IF* position and you'll be able to track down the signal in the IF stage (250 to 500 kc) of a radio. Set the function switch to *RF* and you can look for a lost RF signal at the input stage of a radio.

If you need an audio signal to check the output stage of a radio or amplifier, set the function switch to *RF*, connect an antenna to the Analyst's input, and the Analyst becomes a radio that will tune the broadcast band. In this case you take the audio signal from output binding posts J4 and J6.

If you suspect a radio's speaker is defective, substitute the Analyst's speaker by connecting the secondary

7-IN-1 ANALYST

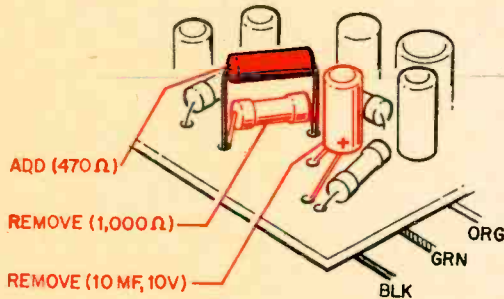
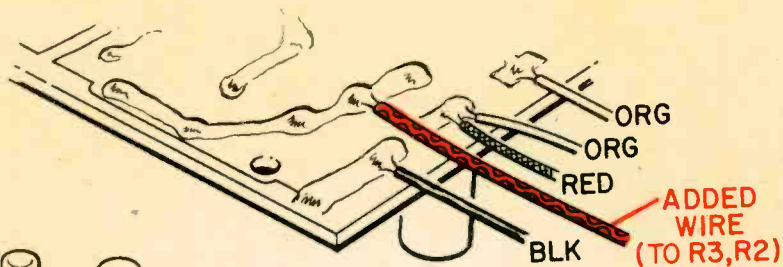

The audio amplifier must be modified for use in the Analyst. Turn the amplifier over (above), hold it so that the attached wires are in the position shown and connect wire to the foil as indicated. On the top side of the amplifier (left), remove the 10-mf, 10-V electrolytic capacitor, which is used for C5. Then remove the 1,000-ohm resistor and replace it with a 470-ohm, ½-watt, 10% resistor.

7-IN-1 ANALYST

of the radio's output transformer to binding posts J5 and J6.

For transistor radios, whose power requirements vary all over the lot, the Analyst can furnish 1½, 3, 6 or 9 volts of operating power.

No matter what the trouble, the Analyst will locate it in a matter of minutes at the mere flick of its switches. It's light in weight for those service jobs in the field. The parts bill is about \$15 and construction time about eight hours.

The heart of the Analyst is a ready-made

four-transistor audio amplifier which you modify slightly. There's a one-transistor preamp ahead of the amplifier to keep the Analyst's input impedance high. The amplifier output and speaker terminals permit the instrument to be used as an audio signal source or test speaker. Another switch taps the internal battery power supply to provide power at front-panel binding posts for operating external transistor circuits.

Construction

First thing to do is modify the transistor amplifier. Turn it over and hold it so the leads are facing you as in our diagram. Then solder a 7-inch-long wire to the foil where indicated.

Turn the amplifier over and again hold it so the leads face you. In the left corner you'll

PARTS LIST

- Amplifier—4-transistor audio amplifier (Lafayette 99 G 9042)
- B1-B6—1½ V size C battery
- C1—.1 mf, 600 V mylar paper capacitor
- C2—10-365 mmf variable capacitor (Lafayette 32 G 1103)
- C3—100 mmf, 500 V ceramic disc capacitor
- C4—10 mf, 6 V electrolytic capacitor
- C5—10 mf, 10 V electrolytic capacitor (removed from amplifier)
- D1—1N34A diode
- J1—Phone jack
- J2-J6—5-way binding post
- L1—IF coil: 13 feet of litz wire (Lafayette 32 G 1485) wound on 3-inch long x ¼-inch diameter ferrite rod (Lafayette 32 G 6101)
- L2—RF coil: 7 feet of litz wire wound on 2-inch long

- x ¼-inch diameter ferrite rod
- Q1—2N1378 transistor
- R1—1 megohm audio taper potentiometer
- R2—1 megohm, ½ watt, 10% resistor
- R3—10,000 ohm, ½ watt, 10% resistor
- R4—2,200 ohm, ½ watt, 10% resistor
- S1A, B, C, D—4-pole, 3-position rotary switch (Lafayette 99 G 6156)
- S2A, B, C—2-pole, 5-position rotary switch (Lafayette 99 G 6164)
- SPKR—2½-inch, 10-ohm speaker
- Misc.—Battery holders (3 reqd., Keystone No. 174; Allied 55 J 907), 7x5x3-inch Mlnibox, perforated board, knobs, test-lead wire (RG62/U coax), 25 mmf, 500 V ceramic disc capacitor for RF test lead.

see a 10 mf, 10 V upright electrolytic capacitor. Remove it and save it; it will be used for C5. Right next to the capacitor there is a 1,000-ohm resistor. Remove it and replace it with a 470-ohm, ½- or 1/10th-watt resistor. The amplifier is now ready to be installed.

Using our pictorial as a guide, drill holes in the main section of a 7x5x3-inch Minibox for the controls, jack, binding posts, speaker, amplifier and the perforated circuit board. After deburring the holes, letter the front of the case with transfer-type decals.

Mount the amplifier on the side of the cabinet, using a stack of washers to keep the foil side of the board from touching the case. Now install all other parts in the cabinet except the perforated circuit board.

Next, wind the coils. The piece of ferrite rod we specify in the Parts List is 7¼ inches long. To obtain the required 3- and 2-inch lengths of rod, scratch the rod with a triangular file to break each piece off.

Leaving a 4-inch lead, wind 13 feet of litz wire on the 3-inch ferrite rod and 7 feet of litz wire (wound to fill the length of the rod) on the 2-inch ferrite rod. Secure the beginning and end leads with electrical or masking tape.

Build the preamp on a 1½x2½-inch piece of perforated board and fasten both coils in place with electrical tape. All other parts are held in place on the board by their leads. Fasten the board on the front of the case with ½-inch-long spacers to keep the back of the board away from the case.

Mount the three battery holders in the U-section of the Minibox, as shown in the photo. Complete the wiring between the

various components on the front and back of the case. The leads to the batteries should be about 10 inches long.

Next step is to make the test leads. Use three feet of shielded single-conductor wire, such as RG174/U coax, for the AF test lead. But use only 1½ feet of RG62/U coax for the RF test lead. The reason for using RG62/U is that its low capacity (13.5 mmf per foot) and short length only puts about 20 mmf across the circuit under test. Low input-lead capacitance is essential in RF circuits.

Calibration

Apply an audio-modulated signal from an RF signal generator through a 25 mmf mica capacitor to the RF test lead. Set function switch S1 to *IF* and check the IF range of C2 for coverage from about 250 to 500 kc. Set S1 to *RF* and check for coverage from about 600 kc to 1,500 kc. Then mark the Analyst's dial to correspond to the frequencies on the signal generator. If the ranges aren't covered sufficiently, or if there's too much overlap, you may have to add or remove turns from L1 or L2.

Using the Analyst

To use the Analyst as a signal tracer to troubleshoot the RF section of a radio, set S1 to *RF*. Set S1 to *IF* to check IF strips.

To use the Analyst as an AF signal tracer or amplifier, use the audio test lead and set switch S1 to *AF*. To measure the relative output of a receiver when peaking the IF's, connect a VTVM or VOM set to a low AC range to binding posts J4 and J6.

To test an external speaker, remove the

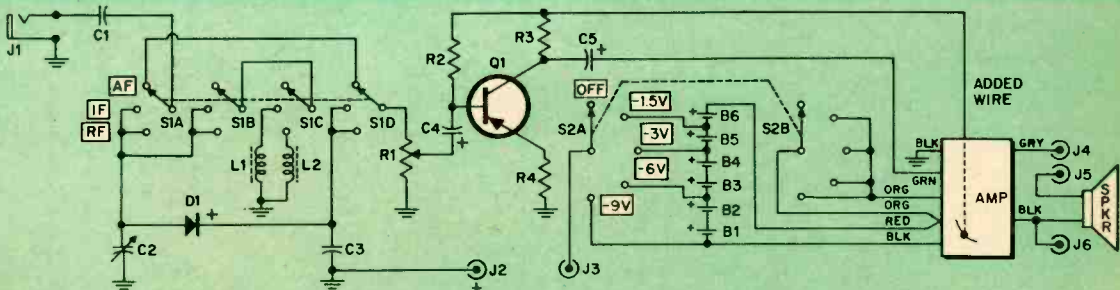

Analyst schematic. When switch S1 is in AF position, input signal is fed from J1 to gain potentiometer R1. Signal is amplified by Q1 and fed to amplifier. IF or RF signals are tuned by C2 and L1 or L2, demodulated by D1 then fed to R1. Switch S2 selects voltage available at J2, J3. Feed external audio to speaker at J5, J6 and take audio signal out at J4, J6. Connect a jumper from J4 to J5 for normal operation.

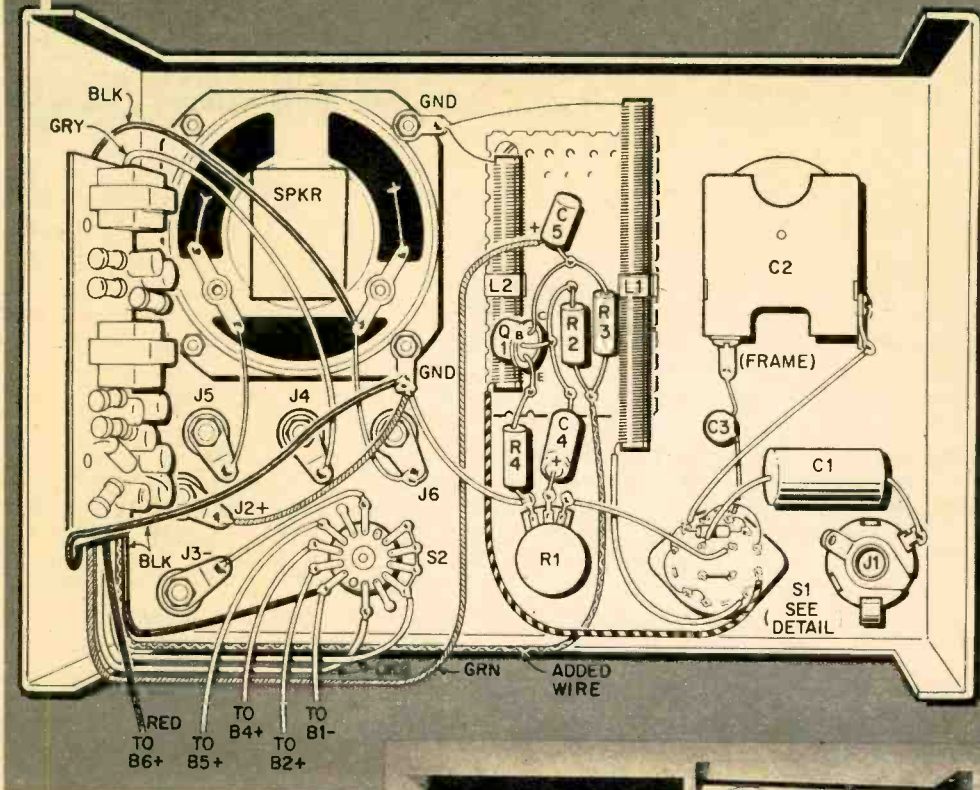

Audio amplifier is mounted on left side of Minibox with spacers so that its foil side does not touch cabinet. Perforated board on which L1, L2, R2, R3, C5 and Q1 are mounted is held above cabinet with 1/2-inch-long spacers. Be sure all binding posts are insulated with fiber-shoulder washers.

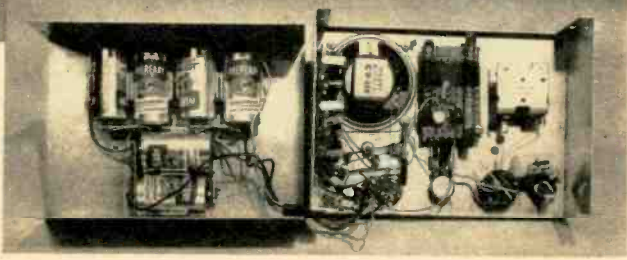

7-IN-1 ANALYST

jumper between J4 and J5 and connect the speaker to binding posts J4 and J6. Set S1 to AF and feed a signal to J1. Or, connect an antenna to J1, set S1 to RF and tune in a broadcast station.

To obtain power for external transistor devices, set voltage-range switch S2 to the desired voltage—1 1/2, 3, 6 or 9 volts and connect the device to binding posts J2 and J3. Watch the polarity! And, remember, the positive binding post is at ground potential. This means the Analyst can be used only with PNP transistor circuits—not with NPN circuits. This won't be a problem since most radios have PNP transistors.

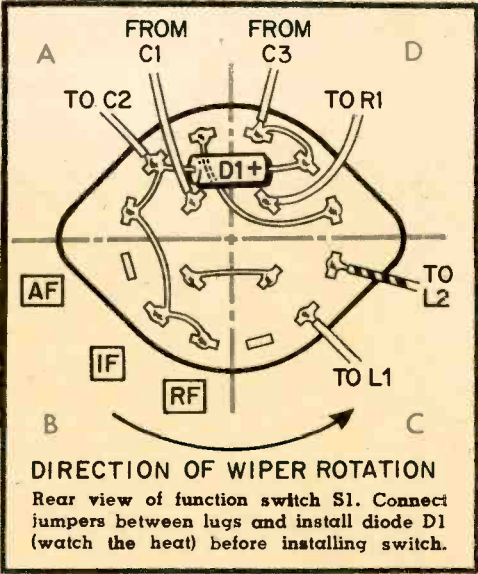

Macy's

John Wanamaker

ALLIED

LAFAYETTE

SAM GOODY

E. J. Korvette

RADIO SHACK

ELIPTOFLEX

decor-ette

REALISTIC

RADIO
craftsmen

XAM

KN

SMG

WHAT THE HECK'S A XAM?

By RON SOMMERS

ANYONE who believes the largest-selling speaker system in New York City last year was an Acoustic Research, a Jensen or an Electro-Voice is in for a surprise. For the hottest item speaker-wise in the big town was something called a XAM, a brand name you're likely not to know unless you're a customer of E. J. Korvette, the discount department-store chain.

Other strong sellers in 1964 included the SMG, Radio Craftsmen, the Colbert and Lafayette bookshelf systems. Together, these five accounted for better than 50 per cent of all speaker sales in the nation's leading audio market. And when combined with Allied Radio's Knight (KN), Olson Radio's Olson, Radio Shack's Realistic and other so-called private-label speakers, they accounted for every fourth speaker system bought during the year.

But exactly what is a private-label speaker system? And do they represent value, as their developers claim? Or do they tend to restrict sound in an otherwise good component hi-fi

system, as some speaker manufacturers contend?

In actual fact, a private-label speaker is nothing more than a normal speaker mounted in a box and sold under a proprietary store name. At left in the box above the title are some private-label retailers; at right are the trade names they use. See if you can match stores and trade names. (You'll find the answers to this which-store-sells-which-system game contained within this article.)

Some private-labels, such as Sam Goody's SMG and Audio Exchange's Colbert, are the exclusive property of a single store. Others, such as the Radio Craftsmen, can be found in several stores—John Wanamaker in Philadelphia; Hess Brothers in Allentown, Pa., Kaufman's in Pittsburgh, and Macy's in New York and New Haven, Conn.

When you come right down to it, there are almost as many different private-label speakers as there are stores featuring them. They range from the one-of-a-kind custom speaker systems developed by such stores as Pecar

WHAT THE HECK'S A XAM?

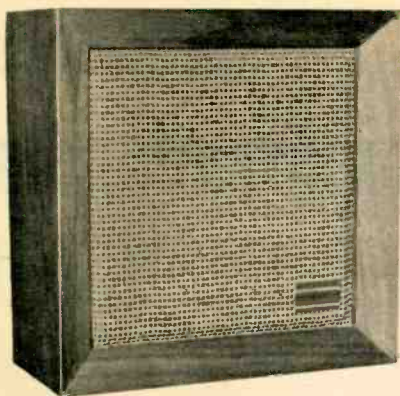

Many private-label speakers carry trade names as far out as the XAM in our title. Shown here are the Radio Craftsmen, distributed by several large stores, and the Decor-ette, distributed by Lafayette Radio Electronics.



Electronics in Detroit or David Beatty in Kansas City for a specific installation to mass-produced speaker-in-a-box jobs sold by dealers all across the country.

Some are manufactured by major speaker producers for large stores to sell under their own labels—frequently a popular model disguised by styling changes and sold for \$10 or \$15 less than the unit it's patterned after. Others, such as Korvette's, Goody's and Audio Exchange's, are designed by store personnel and manufactured locally by a woodworking shop which buys naked speakers from foreign or domestic suppliers, builds a box to specification, mounts the speaker and delivers it to the store.

Still other systems are designed by the carpenters themselves from textbooks on speaker design. And some simply are slapped together in an attractive box, in the hope that the customer can't tell the difference.

Can such systems save you money? Maybe. After all, there are a number of costs in brand-name speakers which private-label speakers don't have to carry. Even such stores as Allied, Olson and Lafayette (distributor of the Eliptoflex), which buy speakers from brand-name manufacturers, don't pass along the costs of nationally advertising and selling a branded speaker system. However, they well may have freight and development costs which stores such as Goody's and Korvette's are able to avoid.

Because speaker systems are bulky, the cost of shipping them from factory to local audio salons adds to the price. But a dealer who's able to buy naked speakers at cut-rate European prices can ship them cheaply to a local woodworking shop to have his systems assembled. He thus avoids heavy freight costs and, therefore, can cut his price.

A name-brand speaker system selling for \$100, say, might cost only \$89 in similar private-label version. And a large store manufacturing a comparable unit locally might be able to sell it for \$79 or less. Obviously, both these latter prices well may represent real value—provided, of course, that all three products are roughly equivalent.

One nationally-known speaker manufacturer has acknowledged that most private-labels offer much better value per dollar in systems selling below \$75. Korvette spokesman Harold Weinberg, the man credited with launching the private-label boom, says, "They can't even touch us on speakers priced below \$49." His *they* refers to the brand-name speaker people.

Herb Horowitz, president of Empire Scientific Co., says that "when you buy a speaker priced above \$75, you expect a product which has been engineered and designed properly. Below that level, engineering and design don't mean much." He adds: "This situation doesn't apply to any other class of hi-fi component. In amplifiers,

tuners, cartridges, turntables and so on, it actually costs more to make a comparable product private-label because the dealer must go to a manufacturer. But when he can do it himself with speakers, he can save money."

What happens to the money that's saved? Most stores pass it along to customers in the form of lower prices. But some stores have discovered they can give whopping discounts off inflated list prices and still make a handsome profit. Reason is that bookshelf speaker systems are something of a blind item, in the way that blankets and bedding are blind items. You can't tell the relative merits of a \$75 or \$150 bookshelf speaker system just by looking. Both may be the same size and shape, both may have the same oil or shellac finish. Only difference may lie in the sound, and a good many audio novices can't tell a difference even after listening.

Hard facts of the matter are these: an unscrupulous dealer can mount a \$9.95 replacement-type coaxial speaker in a 2-cubic-foot box with a minimum of acoustic damping, finish the box attractively in walnut or mahogany and stick a \$79 price tag on it. Even if he offers a 50 per cent discount from this price—far more than is possible with most audio products—he can make a tremendous profit. This means that price can't be considered a reliable guide to private-label speaker quality.

Thing that precipitated the private-label speaker boom was pre-packaged component systems. Such ready-made parcels are viewed smilingly by non-audiophiles bewildered by the array of components found in the ordinary audio salon. And many are grabbed

gleefully by the man looking for value at purse-pinching prices. Such systems oftentimes include a Fisher, Scott, Harman-Kardon or other top-name stereo receiver or amplifier, a brand-name automatic turntable equipped with a quality stereo cartridge and two private-label speaker systems—often at a cost only slightly in excess of the list price of the amplifier or receiver alone.

Since such systems usually offer substantial value, some customers buy the package and simultaneously pick up two quality brand-name speakers. They then either scrap the private-label units or use them as extension speakers in a rumpus room or den.

"The real problem, though," says Electro-Voice's Lawrence LeKashman, "is that non-audiophiles who buy these systems take them home assuming they've got a complete component outfit. That's fine if the store has included good speakers. But if it hasn't, the owner will soon begin wondering why his component setup doesn't sound as good as his neighbor's console."

LeKashman further notes that most stores specializing in packaged systems don't demonstrate alternative speakers unless the customer insists. "Many of these people feel they're not qualified to tell the difference, anyway," he says. "But they become aware of the difference when they get the system home and start living with it."

Truth of the matter is that there are good and bad private-label systems just as there are good and bad brand-name systems. And there are values to be had in each category. Problem is to know a value when you're

[Continued on page 105]

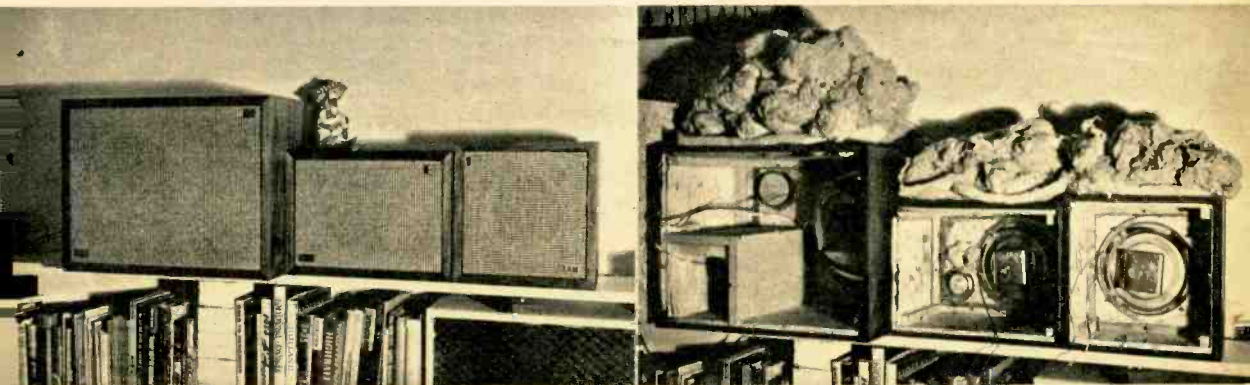

One of the few private-label speaker dealers to cooperate freely in the preparation of this article, New York's E. J. Korvette, Inc., also is one of the few to publish specification sheets for its line. Photos show front and rear views (the latter with backs removed) of firm's XAM-2D, XAM-4D and XAM-5D systems.



SUN
POWERED

TV BOOSTER

FOR the first time anywhere, EI presents a TV signal booster that is self-sustaining. Instead of getting power from downstairs, our booster receives its energy directly from the sun!

The booster gives you a gain of 18db on channels 2 through 6 and a 10db gain on channels 7 through 13 and on the FM band. This means a power increase of 10-fold to 63-fold, or an average of roughly a 35-fold boost.

Even with a pair of rabbit ears, our booster will greatly improve your TV picture—so long as rabbit ears alone provide even a fair picture. And our booster has several power-supply options to fit your particular requirements and budget:

- You can operate the booster on penlite batteries only and forget about the solar cell, rechargeable batteries and AC power supply.

- You can omit the AC power supply and run the booster on nickel-cadmium (N-C) batteries which are charged by the solar cell during the day. In fact, the solar cell will power the booster and charge the batteries at the same time. In bright sunlight, the Hoffman HSSP-6 solar cell can deliver up to 25 ma of charging current. Because of this and the fact that the booster's current drain is only 4 ma at 4½ volts, the batteries will be kept well charged even during long periods of bad weather or in areas where sunlight generally is not intense or does not exist for



By KEVIN REDMOND, K2HTZ

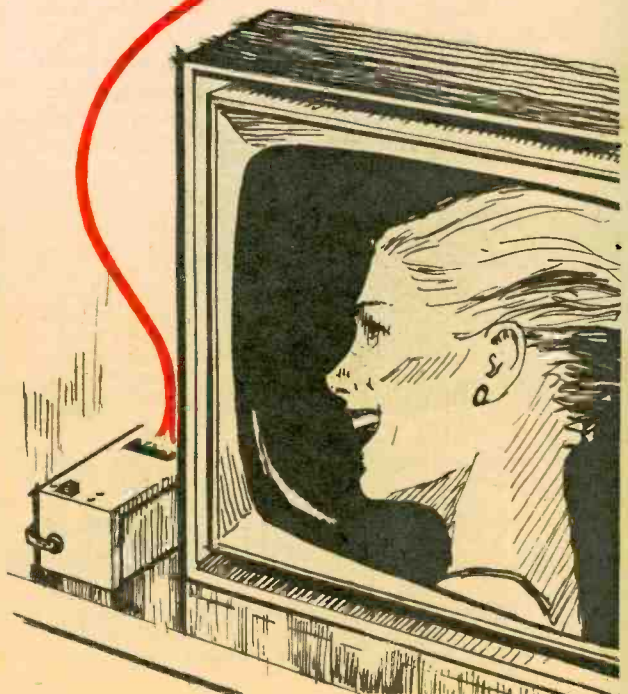

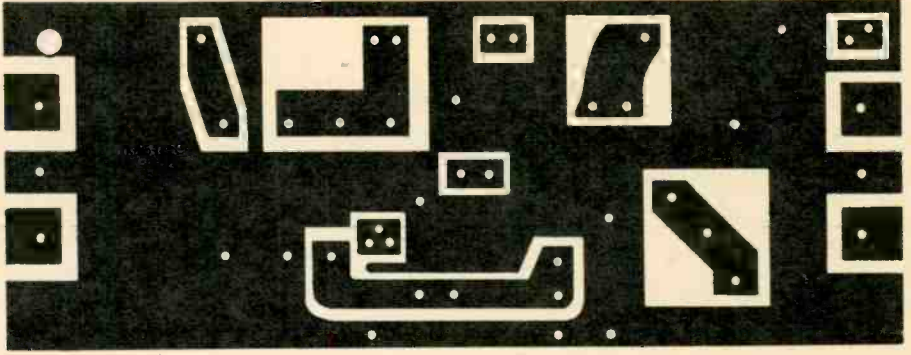

Fig. 1—Use this pattern as a guide for removing foil from the copper-clad circuit board. Cut out the pattern and paste it on the foil side of the board. Then, using a single-edge razor blade or a sharp knife, remove foil from all areas shown in white. Drill all holes for the component leads.

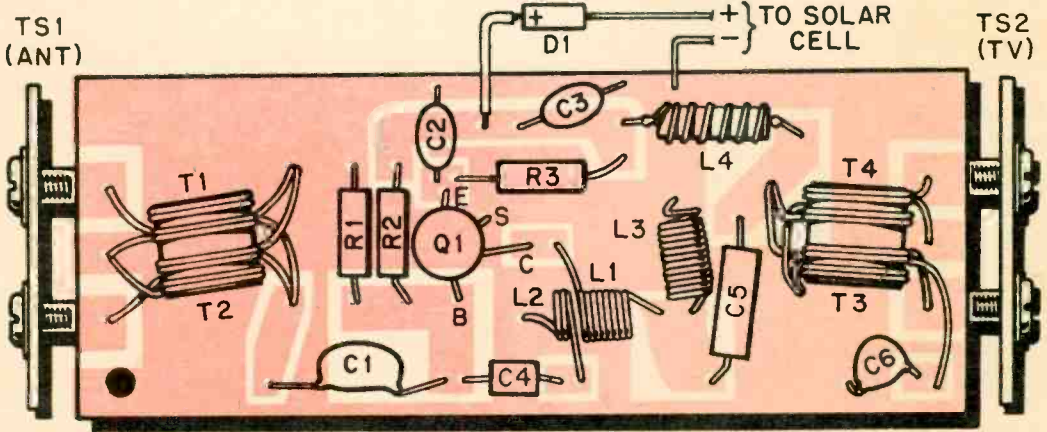
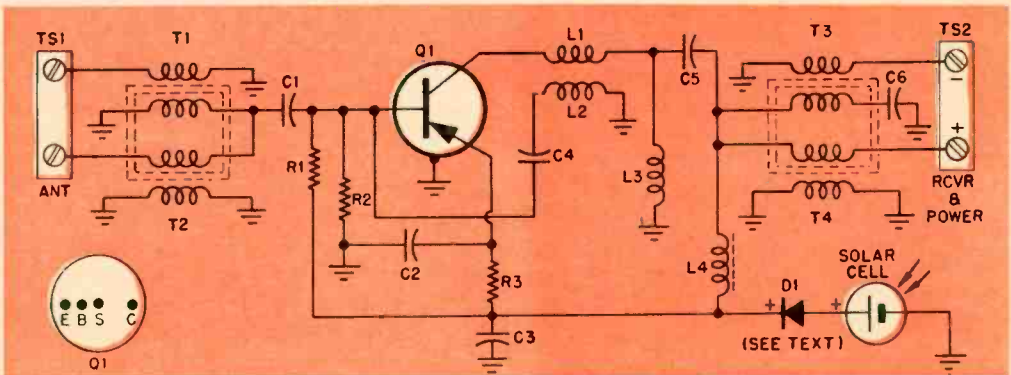

Fig. 2—X-ray view (above) of amplifier board from component side; copper foil is shown in color. Install parts exactly where shown and keep leads short. Finished amplifier at left is ready for case. Balun transformers T1-T4 (schematic below) convert balanced signal from antenna to single-ended signal at booster's input and vice versa at output.



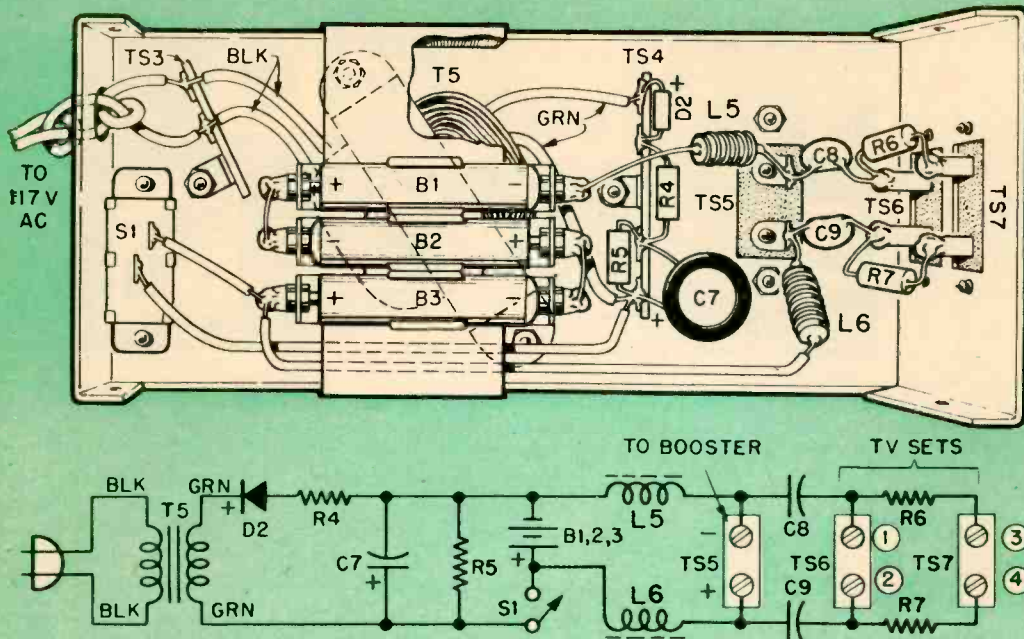

Fig. 3—Power-supply schematic and pictorial. L5 and L6 prevent the supply from shorting RF on the twin-lead. C8 and C9 prevent the TV set from shorting the DC supply. Leave the supply plugged in all the time and close S1 only to charge the batteries (long spell of bad weather) or to operate booster if your model is AC-powered only.

TV SET CONNECTIONS

- | | |
|--------|------------------|
| 1 SET | 1 AND 2 |
| 2 SETS | 1 AND 3, 2 AND 4 |

SUN-POWERED TV BOOSTER



Fig. 4—Power supply is a bit crowded. The battery holder is mounted on a homebrew aluminum bracket over transformer. Terminal strip TS5 on top of cabinet is for twin-booster. TV sets are connected to the terminal strips at end of the cabinet.

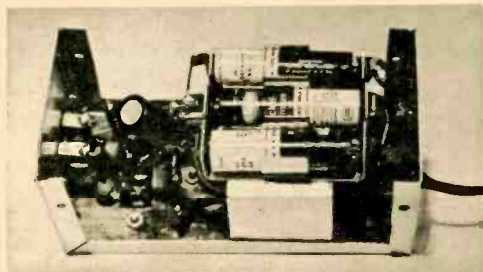

many hours during the day.

- You can omit the solar cell and the N-C batteries and operate the booster from AC power alone. You'd build it this way if you live where sunlight is in exceedingly short supply (such as in lands of the midnight sun).

- You can build the booster using the solar cell, N-C batteries and include the AC power supply. Then when weather is bad for many days, you can recharge the N-C batteries from house current.

The booster must be mounted on the mast near the antenna, as shown on our cover, with the solar cell oriented to obtain maximum sunlight. If necessary, the solar cell may be located a distance from the booster to pick up more sunlight.

Your antenna is connected to the booster's input (TS1). The existing twin-lead from your TV set is connected between the booster's output (TS2) and the power supply (TS5). The TV set is connected to the power supply (TS6 or TS7). The signal from the booster goes down the twin-lead to the power supply and is distributed to one or two (3db



Fig. 5—Booster (left) and solar cell (right) are mounted on mast with home-brew brackets made from twin-lead clip-on standoff insulators. Watch the pressure on the solar cell or its case may crack. Apply waterproofing material or tape to booster-case seams and the wire hole on the solar cell to keep all moisture out.

signal loss to each set) TV sets which are isolated to prevent local-oscillator interaction.

In addition to carrying the signal to the TV, the twin-lead carries the DC from the solar cell to the batteries during the day. At night, DC goes up the twin-lead to the booster. The RF signal is isolated from the power supply by chokes in both the power supply and the booster.

Construction. Several parts used in the booster are special and are not available from electronic distributors. Therefore, we have made arrangements with PR Laboratories (see Parts List) to supply these parts.

Because of the frequencies at which the booster operates, it must be built on a piece of copper-clad circuit board and the layout must be exactly the same as we show in Fig. 2. The board is made by cutting out the pattern in Fig. 1 and pasting it on the foil side of the board. Cut out the areas in white with a single-edge razor blade or a sharp knife. Drill the holes for all component leads.

Balun transformers T1-T4 are wound with special miniature 300-ohm twin-lead on ferrite balun cores (both supplied by PR Labs). To make the transformers, insert two turns of balun wire in each hole in the ferrite form. Pull the wire tight, and connect the lead ends where shown in the pictorial in Fig. 2. Check the individual wires of each pair with an ohmmeter to be sure the wire connected to, say, the top antenna-lug foil goes to ground and *not* to the foil to which C1 is connected. The lead connected to the bottom antenna lug should go to C1's foil.

Coils L1, L2 and L3 (7½, 2 and 17 turns respectively) are close-wound with No. 24 enameled wire on a No. 12 (3/16-inch

[Continued on page 104]

PARTS LIST

- B1-B3—1.25 V nickel-cadmium battery (Eveready N46 or equiv.) or 1½-V zinc-carbon penlite battery
 C1—50 mmf, 500 V, 5% silver-mica capacitor
 C2,C3,C6,C8,C9—.001 mf, miniature ceramic capacitor (Lafayette 33 G 6902 or equiv.)
 C4—1.5 mmf, 600 V ceramic tubular capacitor (Centralab TCZ-1R5 or equiv.)
 C5—15 mmf, 600 V ceramic tubular capacitor (Centralab TCZ-15 or equiv.)
 C7—100 mf, 12 V electrolytic capacitor
 D1,D2—1N87A diode
 Coils: L1,L2,L3 No. 24 enameled wire evenly wound on 3/16-in. dia. (No. 12 drill) form.
 L1—7½ turns L2—2 turns L3—17 turns
 L4—11½ turns No. 24 enameled wire evenly wound on a Speer Type E ferrite form
 L5,L6—10 turns No. 24 enameled wire evenly wound on a Speer Type E ferrite form.
 Q1—2N2494 transistor (Amperex: Newark Electronics Corp., 223 West Madison St., Chicago, Ill. 60606. Stock No. 22F2633. \$2.36 plus postage.)
 Resistors: ½ watt, 10%
 R1—47,000 ohms R2—27,000 ohms
 R3—220 ohms R4—100 ohms
 R5—680 ohms R6,R7—62 ohms
 Solar cell—Hoffman HSSP-6 Newark Electronics Stock No. 22F2173 (not listed in catalog), \$20 plus postage.
 S1—SPST slide switch
 T1,T2,T3,T4—input and output balun transformers wound on Ferroxcube K5050-06 ferrite balun core (see text)
 T5—Filament transformer: 6.3 V @ 1 A (Lafayette 33 G 3702 or equiv.)
 TS1,TS2,TS5,TS6,TS7—2-lug screw-type terminal strip (Cinch-Jones 17-2 or equiv.)
 TS3—3-lug terminal strip
 TS4—5-lug terminal strip
 Misc.—Aluminum flashing, 4½x1¼-inch copper-clad board (Lafayette 19 G 7104), 2¼x2¼x5-inch Minibox, battery holder (Keystone No. 171, AC line cord, hardware
 The following parts kit is available from PR Laboratories, South Hillside Ave., Nesconset, New York:
 Basic booster: \$9.00, postage included: consists of TS1, TS2; ferrite balun cores for T1-T4; 300-ohm balun wire; C1-C6; No. 24 enameled wire; ferrite forms for L4,L5,L6; R1;R2;R3;D1;Q1; aluminum; copper-clad board; hardware.

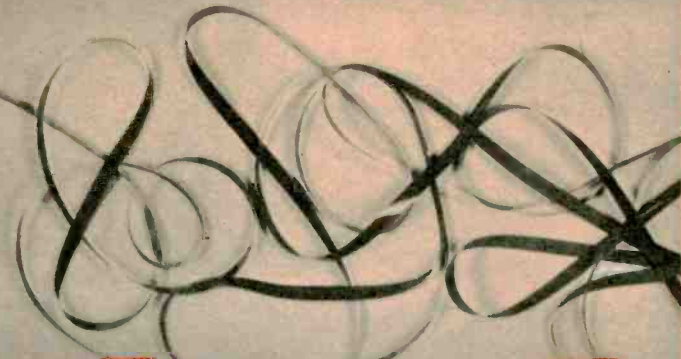

FAR-OUT

By BOB ANGUS

MORE THAN a decade ago, one of tape's pioneers was testifying before a Senate committee investigating what the Defense Department might do with magnetic tape. A Southern Senator broke in halfway through the man's detailed explanation of tape manufacture.

"Son," said the Senator, "what y'all are tryin' to tell us is that you take a strip of cellophane and paint it with iron rust."

That explanation satisfied the U.S. Senate and it remains one of the clearest, most concise statements of what magnetic tape is all about. But it doesn't tell why one manufacturer markets as many as eight different types of tape, why you can pay as little as 99¢ or as much as \$12 for a single 7-in. reel or why some (but not all) the world's major sound archives prefer tape as a storage medium.

The Senator was quite right in pointing out that tape consists of two major ingredients and a process—the ingredients being a base material (cellulose acetate or polyester film rather than cellophane) and a formulation of iron rust (iron oxide). The process is that of bonding one to the other, so the oxide doesn't flake, shed or peel off its base.

With one major exception, the nation's tape manufacturers buy their films from such outside suppliers as the Celanese Corporation of America and E.I. DuPont. And though there are different grades of acetate, the main differences between polyester film lie in its thickness. In other words, contrary to popular belief, all brands of tape using 1-mil Mylar (DuPont's trade name for its polyester) are of equal strength.

Where the brands differ is in the iron-oxide formulation used, the freedom from impurities and the skill with which the iron

rust is fixed to the film. This bonding determines how much oxide the tape will shed during use (the more shedding, the poorer the tape).

In the early days of tape manufacture in the United States—1948 until approximately 1950—iron rust was applied to long strips of paper. But paper proved a poor medium for several reasons. It was inflexible, coatings tended to flake and crack off, the paper itself aged and it lacked strength.

Next move was to cellulose acetate, a stock similar to that used for motion-picture film. Acetate offered longer life than paper. And its greater strength permits processing in thicknesses of only 0.0015 and 0.001 in. (1½ and 1 mils), with significantly longer playing times the reward. Acetate's increased flexibility also permits better bonding between base and oxide.

More recently, polyester film has been used for tape manufacture. True, it costs more than acetate. But it doesn't age, won't break as acetate does (though it stretches under extreme tension) and can be made thinner than acetate—half as thin, if necessary. Ordinary polyester comes in thicknesses of 1½ and 1 mils, while a special pre-stretched (or *tensilized*) version is used for extremely thin tapes.

To most users, acetate and polyester look much alike. You can tell the difference, though, by holding a reel broadside to a light source. If no light passes through the reel, the tape is polyester. If you can see some light and the outline of your fingers on the opposite side of the reel, the tape is acetate.

These differences in base material account for five of the basic tapes marketed by every major manufacturer, ranging from the \$3.50



FACTS ON TAPE

reel of 1½-mil acetate to the \$11.95 reel of tensilized polyester. Coatings remain identical. Price differences stem from varying costs of the base material and the fact that reels vary widely in the amount of uninterrupted playing time they offer.

As you might expect, there have been several changes in tape manufacture during recent years. One new factor, introduced several years ago, was the use of polyvinylchloride film as a base. This material combines some of the economy of acetate with some of the strength of Mylar and has been sold under the trade name of Tenzar.

Another change stems from the emergence of Eastman Kodak as a tape manufacturer. Kodak is one of the few in the business to manufacture its own tape bases—stronger versions of acetate called Durol.

Like the base materials, oxide formulations also have come under scientific scrutiny. One of the earliest developments was low-print tape. This came about because some tapes, especially thin ones and those recorded at top volume, tend to leak a recorded signal from one layer to the next during prolonged storage. Low-print tapes, with thicker bases and special oxide formulations, were designed to eliminate such leakage.

Another problem, encountered in recording studios, was the loss of particularly quiet musical passages in the hiss of ordinary tapes. Accordingly, the industry developed high-output and low-noise tapes, using special types of oxide formulations to reduce background noise and enhance recording characteristics. And to meet the demands of slower tape speeds, some companies have modified this principle to produce tapes which are particularly sensitive to high frequencies.

Tapes even come in a variety of widths these days, ranging from less than ¼ in. to 2 in.—the former used in mini-recorders and the Minnesota Mining tape-cartridge system. Usually on polyester bases, ½-in. tapes are used by computers and instrumentation recorders, while 1- and 2-in. tapes are used in video recording. Another specialized size is 1½ in., used for both video and instrumentation recording.

Interestingly enough, nearly half the tape sold in the U.S. last year was so-called white-box tape. While unbranded, much of it is the product of major manufacturers. Prices for white-box tape are low—as little as 99¢ buys a 7-in. reel of 1½-mil acetate, though the branded equivalent may cost as much as \$3.50.

There are good reasons for these low prices, however. Fact is, much white-box tape is simply inferior—rejects of brand-name tapes, cut-down instrumentation-tape rejects, outdated tape, odds and ends from duplicators which have been spliced together, and tape specially formulated to bear bargain-base-name tags.

This last type in particular usually represents a poor buy for anyone who owns a good recorder. It consists of an inexpensive oxide formulation—frequently with impurities—glued onto a quality base, often with cheap binders. A little use soon shucks off the oxide and cracks the coating.

Old tapes, too, can prove a bad bargain. Some, from broadcasters, are as much as ten years old. Others represent stock returned by dealers and may or may not be a good buy, depending on how long the dealer kept them before sending them back.

[Continued on page 108]

NOW that you've used the Spectrum Monitor in the May, '65 EI to show you other CBERs on the band, it's about time to take a close look at yourself. To be sure you're putting out a good signal, it's essential that you know your modulation percentage and distortion. Besides, you should *see* your modulation to be able to make accurate adjustments of mike preamps, clippers, compressors and other transmitter accessories.

For less than \$5 worth of parts for an adaptor you can make the Spectrum Monitor, or for that matter *any* oscilloscope, do double duty as a modulation monitor. The adaptor is permanently connected in series with your transmission line. It has no effect on transceiver performance, does not change the antenna system SWR and causes no measurable change in output power. It is merely plugged in the Spectrum Monitor or oscilloscope.

The adaptor is built in the main section of a 1½x2½x3¼-inch Minibox. Study the layout in the photo as parts placement is critical.

First step in winding T1's secondary is to tensilize about a foot of No. 24 enameled wire. You do this by clamping one end in a vise and pulling the other end until the wire goes dead slack. Attach one end of the wire to one of the form's terminals near the mounting collar and wind 8 turns close together in the center of the form. Solder the other end of the wire to the terminal directly opposite at the other end of the form.

Then tensilize a piece of No. 22 enameled wire and wind a two-turn primary tightly and next to the ground end of the secondary. If the windings are loose, do the job over again or you won't be able to tune T1 and the transmitter will not load into the antenna system.

The shielded lead from C2 to PL1 can be coax or audio-type cable and should not be longer than six inches. Connect the transceiver to either SO1 or SO2 and connect the antenna

WATCH YOUR

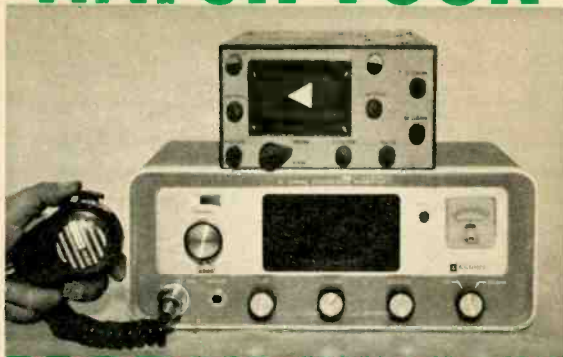

MODULATION!

Connect our adaptor to the EI Spectrum Monitor or any oscilloscope and you'll be able to see what your modulation looks like.

By HERB FRIEDMAN, KB19457

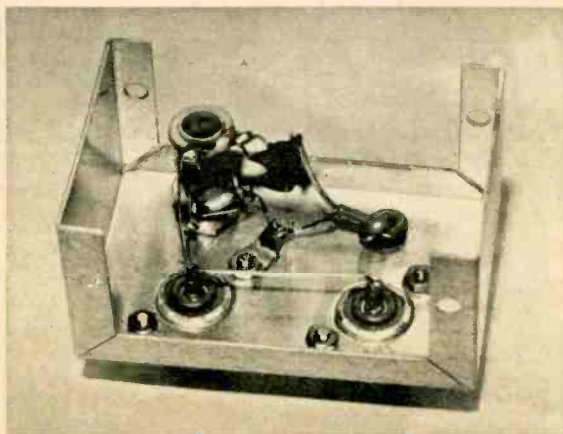

Modulation adaptor fits in 1½x2½x3¼-inch Minibox. Duplicate our layout carefully and wind transformer T1 exactly as specified in text. RF from transmission line is stepped up by T1 and fed via PL1 to vertical plate of CRT in Spectrum Monitor or scope's vertical plate.

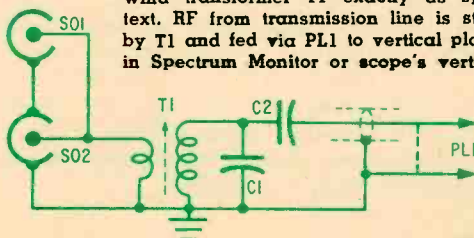

PARTS LIST

- C1—24 mmf, 500 V silver-mica capacitor
- C2—25 mmf, 500 V ceramic disc capacitor
- PL1—Phone plug
- S01, S02—S0-239 coax connector
- T1—Input transformer: wound on Cambridge Thermionic Corp. coil form No. 1534-3-2 Newark Electronics stock No. 40F3372. 84¢ plus postage. (Newark's minimum order is \$2.50) see text.
- Misc.—1 1/8 x 2 1/8 x 3 1/4-inch Minibox, shielded wire

to the other connector. Connect PL1 to J2 on the Spectrum Monitor or the vertical plates on a scope and set the monitor's *MON/PAN* switch S1 to *MON*.

Adjust T1 using either setup shown in our block diagram. (Your Transceiver's built-in tune-up or power-output meter cannot be used.) Turn on your transmitter and adjust T1's slug for minimum SWR or maximum output as indicated on the output-or field-strength meter.

On the face of the CRT you'll see the carrier as a solid band (see diagram at right). Mark the height of this band on the face of the CRT, measure its height and add a second set of marks double the carrier height, as shown in the diagram. The second set of marks represents 100 per cent positive modulation. When you speak and the carrier level reaches the 100 per cent set of marks, your transmitter is 100 per cent positive modulated. When the carrier collapses to the base line, the transmitter is modulated 100 per cent negatively.

If the carrier level is half way between the carrier marks and the 100 per cent marks, modulation is 50 per cent. Three-quarter ex-

[Continued on page 109]

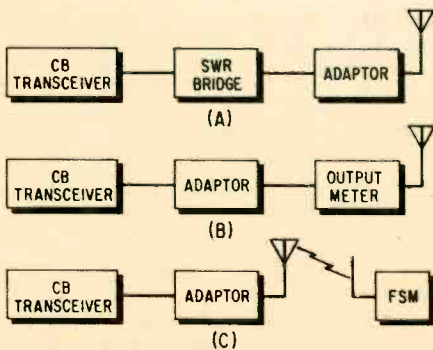

The adaptor can be adjusted by using either of the setups shown depending on the test equipment that's available. Do not rearrange the instruments.

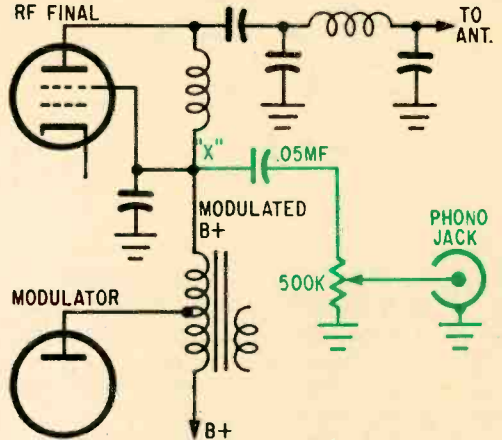

For a trapezoid display, add components in color to transceiver. Connect the jack to J3 on Spectrum Monitor or to the horizontal input jacks on a scope.

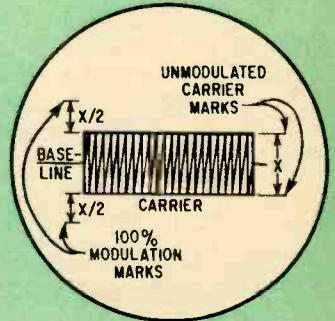

Height of pattern is carrier level. Mark the CRT's face then add second set of marks twice the height. Second set of marks indicates 100% modulation.

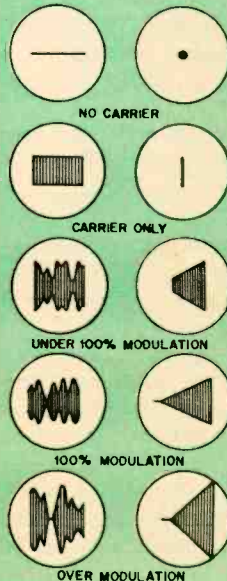

Typical patterns. Those at the left are called modulation waveforms. Patterns at right are called trapezoid displays. The latter, which require a slight modification to the transceiver, are produced by feeding part of the transceiver's audio to the Spectrum Monitor's or an oscilloscope's horizontal input connectors.

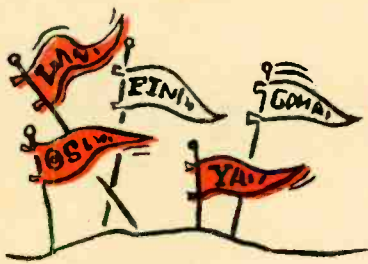

SWL CLUB Shape-up

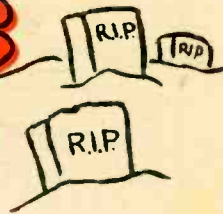

WHETHER SWL, all-band DXer or BCB fan, every Distant Radio Listener (DRL) should belong to at least one club. Why? Well, belonging to a club—a good one, at any rate—is one way to get an inside view of this vast and complex field.

Trouble is, DX clubs have a habit of going the way of all flesh. Over the past couple decades only two or three have managed to stay the ravages of time. The reason, we suspect, is that DX clubs are no different from clubs of any sort. One or two people seemingly provide all the impetus and energy to set the club in motion and keep it going. Let that energy fade or let the members become dissatisfied with it for one reason or another and the club likely will lose steam, if not poop out altogether.

Because the membership of most DX clubs is pretty far-flung, regular meetings are on the rare side. Instead, clubs ordinarily publish monthly bulletins to keep members abreast of what's going on. All the current clubs print bulletins and most will send a sample copy for a nominal sum—25¢, say. As you might guess, the content of a particular club bulletin will depend on that club's chief field of DX interest—BCB, SW, all-band and so on.

The organizational structure of each club varies, too. Some fall under strict control of the chief organizer, who usually ends up being president as well. Others sport both a written constitution and an elected board of officers, a practice which would seem to fit in a little better with the way we do things this side of the Iron Curtain.

But representative or no, each of today's clubs deserves a bow if for no other reason than the fact that it has managed to stay around. To find out which club you might like to lend support to, we suggest you read through our listing. This done, you might write the clubs concerned, enclose 25¢ and ask for a copy of the bulletin as well as information on how to join.

The Clubs:

- **American Central Radio Club**, c/o Richard E. Wood, 207 E. 16th St., Bloomington, Ind. 47403. Founded by a student while attending college in Indiana, this one is relatively new but shows real promise in its SW news coverage. Annual dues are \$2.
- **American SWL Club**, c/o Gerry Klinck, 223 Potters Rd., Buffalo, N.Y. 14220. Club has both a constitution and an elected board of directors. And, while its bulletin contains news from every quarter, emphasis is on SWBC happenings (frequency changes, new stations, QSL policies and so on). The club produces a DXcast for pioneer SWBC station WRUL every Saturday at 1400 EST; annual dues are \$3.
- **Canadian DX Club**, 160 Tecumseh Ave., E., London, Ont. Though this is the only major DX organization in Canada, it has neither elections nor a constitution. Its bulletin occasionally forces some contrived humor, but by and large it offers fair all-band coverage. Ace DXer Dave Bennett is Utility Editor; dues are \$4 a year.
- **Canadian International DX Radio Club**, c/o John Peters, 616 Stewart St., St. Charles 22, Man. This club doesn't compare with the CDXC in size or coverage but it does have a constitution and elections. Dues are \$3 a year.
- **DX Inter-Nationale**, c/o Inter-Nation Program, 91 Court St., Newton, Mass. 02160 Formerly known as the Folcroft Radio Club this organization now describes itself as a world-wide communications club. Membership is open to persons of any nationality engaging in "all types of communication"—SW, FM/TV, CB, amateur, medium-wave/BCB, utilities, microwaves and so on. Monthly bulletin runs up to 50 pages in length; annual dues are \$2.50.
- **International Radio Club of America**, Box 5181, Denver, Colo. 80217. Founded by a group of NRC members (see below) who

[Continued on page 105]

THE children are asleep and the house is quiet. At last you and your wife have time to enjoy those new tapes. Ten minutes after you get started everything goes dead. A check tells you the amplifier has pooped out.

As you begin this little service job you realize what will happen upstairs when the amp comes back to life and puts full power into the speakers. The kids will start screaming before you have a chance to pull the power plug.

But there's a way out. Instead of leaving the speakers hooked up, just connect the Stereo Speaker Simulator to the output terminals and you'll be able to crank those gain controls all the way up without making a sound. The Simulator permits you *silently* to test and service stereo amplifiers with outputs up to 20 watts per channel. Connected to one channel at a time, the Simulator has a power-handling capability of 40 watts. It is equipped with binding posts that permit you to con-

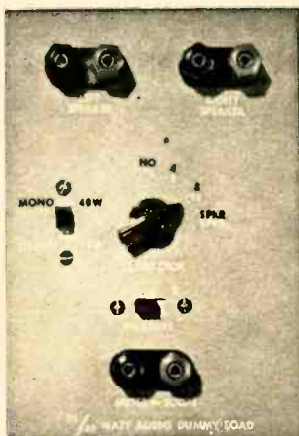

nect R1, R2 for the right channel and R7, R8 for the left channel) is two 10-watt resistors connected in parallel to provide a power capability of 20 watts. Resistance values were chosen to match 4, 8 and 16-ohm output impedances.

Switch S2 is used to select the appropriate pairs of resistors to match the amplifier's output impedance. Connect your speakers to J1, J2 and J5, J6, turn S2 to *spkr* and the speakers, rather than the resistors, will be connected to the amplifier.

The 20-watt, 40-watt slide switch (S1) parallels the test leads internally (and the resistors connected to them through S2) to double the power-handling capability of the Simulator for checking higher-power mono amplifiers or one channel of a stereo amplifier at a time.

The meter/scope switch (S3) provides a means of switching an oscilloscope or VTVM, connected to J3, J4, from one channel to the other

STEREO SPEAKER SIMULATOR

By EDWARD H. JOHNSON

nect test equipment to it to measure or monitor each of the amplifier's outputs.

In our little drama at the beginning we pictured a hi-fi fan using the Simulator in a late-night application. Actually, the unit can be used any time and in any place—at home or in the service shop—when you prefer not to listen to blaring speakers.

The Simulator can be built for about \$14, using all new parts. It's an easy one-evening project which will pay big dividends in simplified servicing.

How It Works

The Simulator substitutes high-wattage *non-inductive* resistors for speakers. Note in the schematic that each selected load (e.g.,

so you don't have to change leads.

Note that the markings on the front of the Simulator (in the picture on the first page of this story) are in black and white. Switches S1 and S2 should be set opposite a *white* marking for stereo amplifiers and opposite a *black* marking for mono amplifiers. The markings opposite S2 indicate the load resistance.

The black *no* position should not be used when S1 is set to 40 watts. Reason is the load resistance will be approximately 1.8 ohms—too low to be of any value. Either test lead may be connected to a mono amplifier. The black lug on each test lead should be connected to the C, or common, output terminal on the amplifier. Test equipment or

J1, J2, J3, J4, J5, J6 — Dual five-way binding posts (H. H. Smith Type 224. Allied Radio 41 H 328)
 Resistors: All Sprague Type 457E 10-watt non inductive. Allied No. 25 MM 948

PARTS LIST
 R1, R2, R7, R8—7.5 ohms
 R3, R4, R9, R10—15 ohms
 R5, R6, R11, R12—30 ohms
 S1, S3—DPDT slide switch
 S2 — Two-pole, four-position shorting-type (make before

break) rotary switch. (Centralab type PA-1002 or equiv.)
 Misc. — 7x5x3-inch aluminum Minibox; four, eight-lug terminal strips (Cinch-Jones 2008); spade lugs; hardware; knob; rubber feet

To simplify construction, mount terminal strips temporarily on a piece of wood, then connect resistors to them. Next, install banks of resistors on the ends of main cabinet section. Do not substitute ordinary resistors for the non-inductive type specified in the Parts List or critical tests of amplifier's performance will be affected adversely.

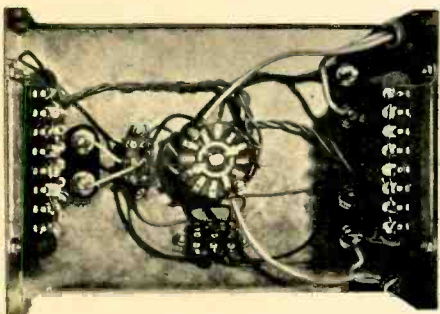
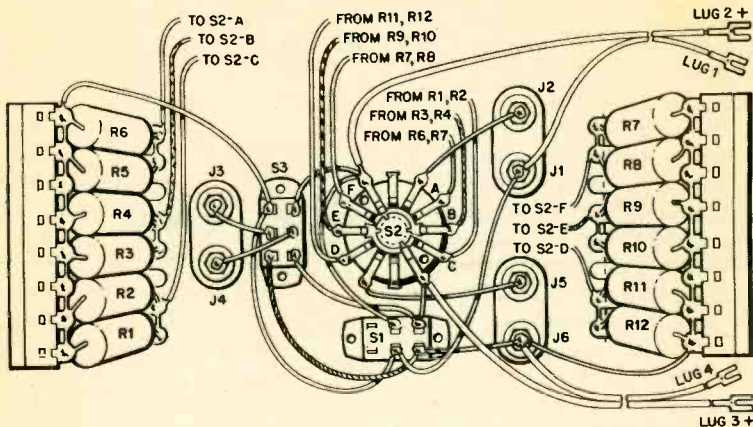

STEREO SPEAKER SIMULATOR

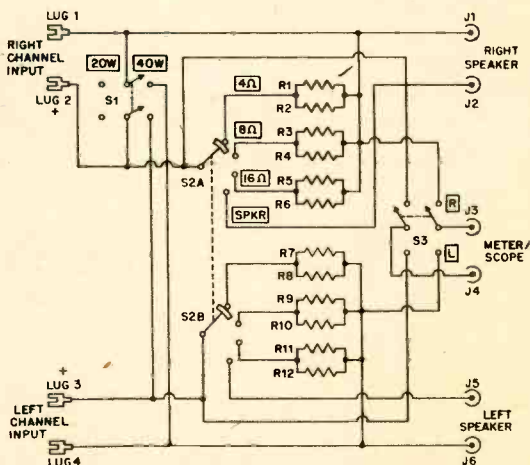

Each channel's load resistance is selected by S2. S1 parallels loads to double power capability.

even a speaker may be connected to the Simulator at J3 and J4. S3 has no effect when S1 is in the 40-watt position.

Construction

Drill all holes in a 7x5x3-inch Minibox before you start mounting or wiring parts. To simplify construction, we wired our resistors on terminal strips which were mounted temporarily on a piece of scrap wood. The banks of resistors then were mounted on the sides of the cabinet. We used

eight-lug terminal strips to keep resistor spacing tight. Before mounting S2, limit its rotation to four positions by installing the adjustable stop supplied with it.

Thirty-inch-long test leads can be made from ordinary lamp cord. One conductor at the amplifier end of each pair of leads should be cut 1½ inches shorter than the other lead to prevent shorts. Connect a spade lug painted red to the short lead and a lug painted black to the other lead. All internal wiring should be No. 18 solid insulated wire.

RADIO'S IMPOSSIBLE IMPASSE

By STEVE CONWAY

● In New York an executive's desk is cluttered with the usual tools of the trade—a cigarette lighter, a pen-and-pencil holder, a tiny white telephone. Thing is, all are miniature AM radios.

● In Connecticut, a hat manufacturer is building AM radios into men's and women's hats.

● In Tokyo, two engineers have developed an AM radio no larger than the eraser on a lead pencil.

● In St. Louis, the demand for radios in wooden cabinets recently outran the supply.

What's up? Truth to tell, nobody knows. But looking over the broadcast-radio scene is at once both heartbreaking and hilarious. Household radios, once so standardized that even circuits were carbon-copies, now are an anything-goes proposition. Worse yet, manufacturers—who once could expect the reasonable profit they are entitled to—currently make next to nothing on broadcast sets. Many, in fact, are taking a severe knocking. (Our photo shows one set that's presently going at \$6.80, a price that well may set some sort of all-time low.)

Meanwhile, the purchasing public, faced with the widest choice and the biggest bargains ever seen in the field, is about as impressed as a doctor looking at a galloping hangnail. Many would-be buyers aren't any more able than ever

to make up their minds. Net result is an impasse, with manufacturers producing millions of radios they can't seem to make a profit on and the public faced with a profusion of bargain-priced sets they can't get enthused about. How either party is going to get out of the dilemma is as clear as a set of rules for poker written by Casey Stengel.

To be sure, there were some 32.3 million home radios sold in the U.S. last year—enough to provide a new radio for every second household in the nation and enough to make radio retailing, distributing and manufacturing one of the nation's largest industries. But competing for this giant jackpot were 130 importers and 70 domestic manufacturers, each looking for new ways to increase his slice of the pie. And interestingly enough, all this took place only ten years after industry leaders had pronounced AM radio dead.

Approximately half of all radios sold in 1964 in the U.S. were cigarette-pack-size, six-transistor sets, offered at prices in the \$10-\$20 region. Many manufacturers still wondered how to cut prices—which may have been the wrong thing to worry about, in view of quality and profit margins.

"We can't go much cheaper and have anything worth listening to," one manufacturer says. "And at the \$9.95 level, we're not mak-



RADIO'S IMPOSSIBLE IMPASSE



Big set or little set? Japanese import or American-made? Never have radios represented better bargains and never have more been offered. Yet the public remains unmoved.



ing any money. But neither are our competitors."

The real task, then, was to guess what the public might want other than the cigarette-pack, \$9.95 jobs.

There's one school of thought which says that what the public is after is quality. As a result, companies such as RCA, Motorola, Emerson, Channel Master and dozens of others are beefing up their more expensive radios—making them larger, heavier, putting them in more attractive cabinets, using better speakers. But another school of thought holds that the public wants smallness—so Panasonic recently introduced The World's Smallest Transistor Table Radio, while engineers in Japan are debating the merits of producing the eraser-size receiver.

Still another school argues that the public really wants low prices—and as a result many manufacturers (including some who also believe in quality) are trimming features from last year's models in order to lower their tabs. Finally, some producers believe that the right gimmick—radios built into clothing, handbags or eye glasses—can create a whole new market.

Question is, what does the public want? Dirt-cheap, cigarette-pack-size transistor jobs (still coming from Japan by the millions)?

Could be, but argument is that their sound is thin, their reproduction tinny.

Larger transistor radios—something with a sizable cabinet and a speaker big enough to produce fair sound? Maybe, but these radios aren't selling.

A return to AC/DC tube sets of the All-American 5 variety? Perhaps, but transistors would seem to be getting all the attention.

Accounting for 20 per cent of total home-radio sales, AC/DC five-tube sets usually are priced from \$9 to \$15. The basic pattern for these units is the All-American 5, first introduced in 1939 and modified only slightly since.

"It's in this range that tubes still offer an advantage over transistors," an RCA executive explains, "both in terms of price and performance. They will continue to do so for at least another five years. By that time, it seems likely that a transistor manufacturer will have come up with a unit to beat it. Of course, if there is a breakthrough in technology, it could happen as soon as next year."

As is the case with transistor miniatures, however, most manufacturers believe the profit has gone out of the AC/DC radio. Accordingly, they've set about finding variations on the theme which will prove both popular and profitable.

Proof that the profit has gone out of household radios is revealed by the window of a radio store located in the downtown section of a large U.S. city. Note sign offering a 5-tube radio in a choice of colors for a mere \$6.80—less than the cost of the tubes alone.



"We made a survey a year or so ago which showed that most of the radios used in homes were on night tables in the bedroom," a manufacturing executive points out. "We found that many of the radios were so light you had to use two hands to work them—one to hold the set steady, the other to turn the dial. So we and our competitors promptly brought out larger, heavier radios. Then the clock radio got hot and a number of manufacturers began adding clocks. And so it goes."

The trend back to table radios may have gotten under way in earnest last fall when some manufacturers decided to beef up the quality of components, spruce up styling and raise the price accordingly. The public seemed willing to go along with the idea. Fact is, some stores reported the demand for wooden cabinets outrunning the supply. A distributor in the Mid-West, for example, fell way behind in Christmas orders.

"Personally, I believe a plastic cabinet can sound just as good as wood if it's properly designed," one industry official observes. "But most people are convinced that wood sounds better and they're willing to pay for the difference."

A New York dealer thinks customer ages have a lot to do with what they buy. "The

people who purchase the small six-transistor jobs today are the kids—or adults who are buying them as presents for their kids. The kids don't care how bad the sound is as long as they can hear the beat of the records being played.

"But as they get older, they get more critical. They also get more money. We have a lot of young housewives coming in for their first table radios. They are willing to spend more for features that appeal to them, like clocks or FM. By the time they're 30 or so, they're ready for a really good table radio."

In actual fact, the home radio well may have come full circle in its 40 or so years of existence—from battery-operated console standing four feet high to battery-operated portable no larger than a pack of cigarettes. Question is, what's ahead? Have radios gotten as small as they can get? Will the pendulum swing back, bringing bigger, better-sounding radios? If so, when?

History may provide a clue, since much of what's happening in radio today has happened before. Battery-powered sets, of course, are nothing new. The pre-1930 Atwater Kents, Crosleys and Capeharts, each standing shoulder high, were operated with batteries, many of the automobile-storage variety. Nor are earphones an item the radio world hasn't seen

RADIO'S IMPOSSIBLE IMPASSE

before. Matter of fact, the headset was as much in evidence in the late 1920's as it is today. But then, of course, it often was coupled to an acoustic horn to provide full-room volume.

Early radio designers had to work with the components at hand to provide any sound at all. It wasn't until the early 1930's that manufacturers first were able to provide low-cost (\$40) sets for buyers on a budget and quality (\$75 or so) sets for the audiophiles of the day. This split between quality and price has continued ever since.

Today, of course, it's been converted at least in part to a debate over size. The cigarette-pack receivers are inexpensive and all right for kids listening to rock-'n'-roll on the way home from school. But for a kitchen or a den a larger, better, more expensive set is in order.

As early as 1955 the transistor was recognized as the coming thing by progressive engineers. In Japan, researchers at the Sony Corporation put together the first six-transistor, cigarette-pack miniature, thus launching a trend which continues to this day. Its price was \$40, and its sales limited. But it paved the way for others and, by 1959, these tiny portables made up a substantial share of the total number of sets sold. Today, they account for roughly 50 per cent of the total.

Meanwhile, a growing number of radios are being designed for use in the office, rather than at home. Some of the more elaborate are a miniature telephone containing a radio, selling for \$29.95; a cigarette lighter cum radio for somewhat more, and a pen-and-pencil holder for somewhat less. The telephone allows the busy executive to listen privately to the phone's earpiece or to disconnect it so the radio can play at normal room volume.

But are gimmicks the answer? One old-line tube-radio manufacturer asserts that "novelty radios never have sold and never will." Maybe not, but the Hat Corporation

of America has sunk a fair amount of money into research on how to build a radio into a hat. Same philosophy evidently lies behind the move of a Southern garment manufacturer to include radios in men's overcoats and a ladies' handbag manufacturer in Chicago to build them into purses.

"There have been fewer novelty radios in the last few years, and they have accounted for fewer sales," one trade observer reports. "But remember that not so many years ago, the clock radio was a novelty. And so was the first cigarette-pack radio when Sony introduced it in 1955."

But research and guesswork continue. RCA's Commercial Receiving Tube and Semiconductor Division manager, George Janoff, recently hinted that a breakthrough in AC/DC transistor construction may be imminent. He predicts a line of all-transistor, transformerless AC/DC radios as the result of a new complement of RCA products. Whether the price of such sets will be below the \$10 level, of course, remains a burning question.

Engineers in Japan are hard at work to find some new device for turning electrical impulses into sound which doesn't involve
[Continued on page 111]



Hat Corporation's new lid (for him or her) has a 7-transistor radio in side pocket, costs \$20.

VTVM AMMETER ADAPTOR

Add an Ohm's Law calculator to your VTVM and it will measure current.

NO getting away from it, the vacuum-tube voltmeter is a mighty valuable instrument for measuring voltage and resistance. On the other hand, the VTVM's inability to measure current is an annoying shortcoming. A simple and inexpensive way to avoid having to turn to a VOM to measure current is to build our adaptor to convert current into voltage which your VTVM can measure.

The adaptor consists of a rotary switch and seven resistors. You connect your VTVM's probes to the adaptor (J3,J4) and connect leads from the adaptor (J1,J2) to the circuit. Current through the adaptor causes a voltage drop across a selected resistor which your VTVM measures.

The adaptor has seven ranges from 1 microampere to 1 amp. To use it, you set the VTVM to its lowest DC range (full scale could be 1, 1.2 or 1.5 volts). The 1-volt scale marking will now correspond to 1 μ a, 10 μ a, 100 μ a, 1 ma, 10 ma, 100 ma or 1 A.

Let's see what happens when the adaptor is set to 1 ma and the VTVM indicates .5 volt (equivalent to .5 ma). When S1 is set to 1 ma, you connect R4, a 1,000-ohm resistor, across the adaptor's input jacks (J1,J2). Ohm's Law ($I = E/R$) tells us that .5 volt at J3,J4 means there is .5 ma flowing through R4 because .5 volt/1,000 ohms equals .0005 A, or .5 ma.

Do not use the adaptor to measure, say, 2A (on a higher VTVM scale) with S1 set to the 1-amp position. Reason is, 2 amps will produce a voltage drop of 2 volts across R7. The power dissipated in R7 will be 4 watts ($W = E^2/R$). Since R7 is rated at 5 watts, it may overheat and change value.

If VTVM behavior is erratic on low-current ranges, connect a .001 mf capacitor across the VTVM's input terminals.

—Rudolf F. Graf

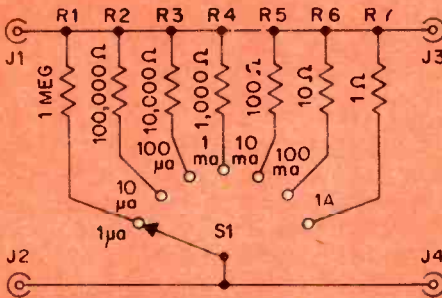

ALL RESISTORS 1/2 W, 5%
EXCEPT R7 WHICH IS 5W, 5%

S1 selects resistor across which voltage is measured at J3, J4. Use a Mallory 1-pole, 12-position switch No. 32112J. It has extra positions that can be used for other ranges.

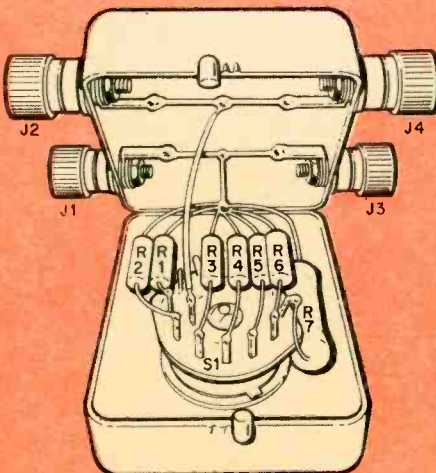

How do planes

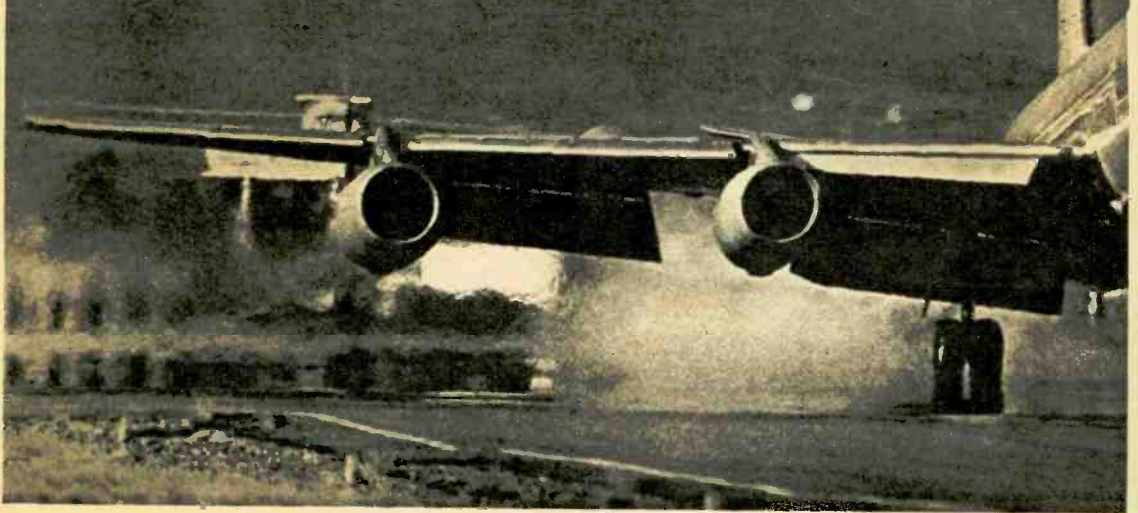

By FRANK DEEMS **T**HE NIGHT is cold and hazy, with a touch of rain in the air. You barely can make out the house lights in the next block. Yet you hear the whine of a jetliner passing overhead, inbound for a landing at the airport only a few miles away. And you don't doubt for a second that the landing will be smooth and safe.

Ever wonder just how pilots land so reliably in weather not fit for ducks? After all, their eyes aren't necessarily better than yours. How do they know there will be a long, smooth runway waiting when they glide down out of the clouds?

The answer is radio, of course. Several different types of radio and radio waves are involved. They include radar, which is merely extremely-high-frequency radio, but we will confine ourselves here to more conventional forms. Our tour would start on the flight deck (or cockpit, if you prefer).

Most everyone is impressed with the fantastic assortment of dials, lights and switches facing a pilot and co-pilot. This gear is far more intricate than anything Detroit has dreamed up for cars and, unlike much found on auto dashboards, the airliner's instruments aren't just frills. Fact is, every piece is there for a purpose.

In the midst of nearly every plane's instrument panel are indicators and lights connected to oddball antennas that jut out here and there on the fuselage. And connected between those antennas and the instruments are some black boxes that decode signals the antennas pick up. Simultaneously, these boxes feed information to the instruments which tell the pilot what he needs to know.

But just what sort of information does a pilot require to bring his plane to a safe landing through rain, haze or snow? And how do the black boxes give it to him?

Basically, a pilot must know his location over the earth's surface as well as the location of the airport to which he is headed. And he must be able to pinpoint both without so much as a glance at the ground. Two radio systems are used to guide airplanes to their destinations, and a third guides them down to landings.

Crisscrossing the country (and many other parts of the world, as well) is a system of airways which could be called highways in the sky. These are the routes followed by most cross-country flights and by all flights under instrument flight rules (so-called blind flying).

There are no signposts up there to mark these highways. Instead, a series of automatic

find their way?

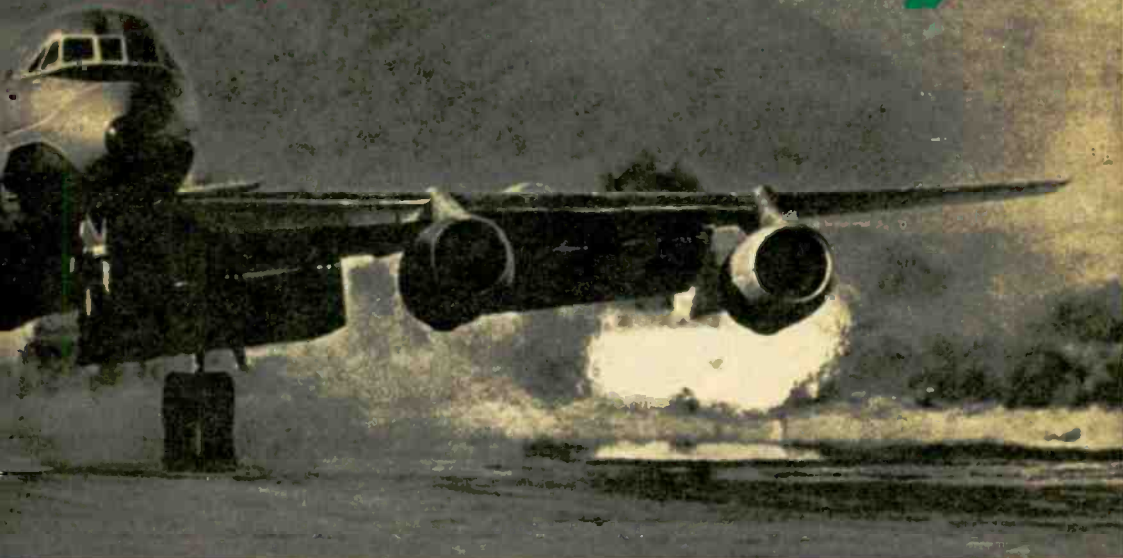

ground transmitters beams signals to pilots, giving them accurate information on the location of the highways. This system is the VHF Omnidirectional Range, abbreviated VOR and frequently called Omni.

The VOR transmitters generally are located about 50 miles apart and spaced over the country along the most frequently traveled air routes. By last count, there were 844 of these stations, operating on frequencies between 108 and 118 mc.

Most long-distance flights follow established routes, shown on aeronautical charts, connecting adjacent VOR stations. A pilot making such a flight tunes in a VOR station along his route and flies either to or from that station along a certain compass radial. Upon reaching the station's fringe area, where the signal might be weak and unreliable, he tunes in the next VOR station along his route.

Shorter flights may involve using transmissions from only one VOR. The pilot merely determines, from his chart, the appropriate compass radial to or from the VOR which will take him where he wants to go. He then sets his receiver for this radial and flies the course determined for him by the receiver.

But how can a pilot ascertain his precise direction to or from a VOR station? This chore is performed automatically by ingeni-

ous electronic circuitry in the VOR transmitter and the aircraft receiver. Fact is, each VOR transmitter radiates two signals which are interpreted continuously by the aircraft receiver to indicate which direction the plane is moving relative to the VOR station.

One signal is a steady carrier aimed in a sharp beam and rotated round and round the transmitter site like a high-speed beacon light. An aircraft receiver tuned to this signal hears it briefly each time it sweeps by. Since the signal is rotated at 1,800 rpm, or 30 revolutions a second, it is heard in the receiver as though it were 30-cycle amplitude modulation.

Interesting enough, the four antenna elements which radiate this directional signal are stationary. But the RF energy is fed to them through a motor-driven goniometer—a sort of rotating inductive coupler—which fires the elements in successive rotation. Result is a radiated signal of the same sort that would be transmitted if the antenna elements themselves were rotating.

Second signal radiated by the VOR transmitter is non-directional and is called the reference. It is composed of a 10-kc sub-carrier, frequency-modulated at 30 cps. (FM is used so the aircraft receiver can discriminate between the reference signal and the directional

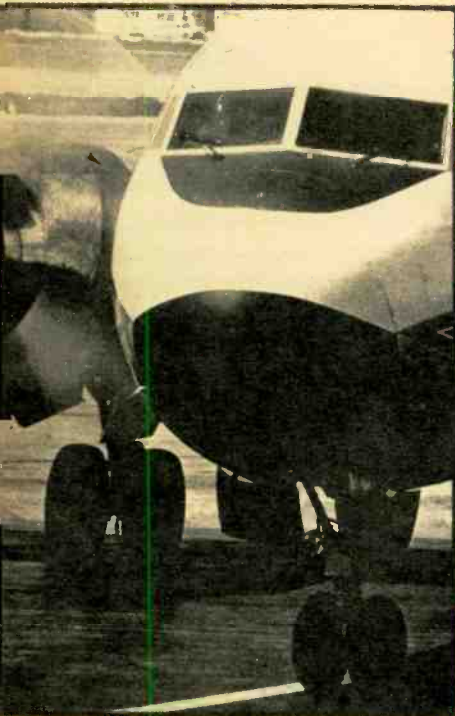

Airborne radar, housed in the nose of this airliner, gives pilot an electronic picture of weather conditions ahead. This enables him to steer his craft around areas of extremely poor visibility or pronounced air turbulence.

Fiberglass domes contain antennas which transmit instrument landing system's (ILS) centerline signals. Highly directional signal pattern from special phase-feeding arrangement guides plane almost to runway.

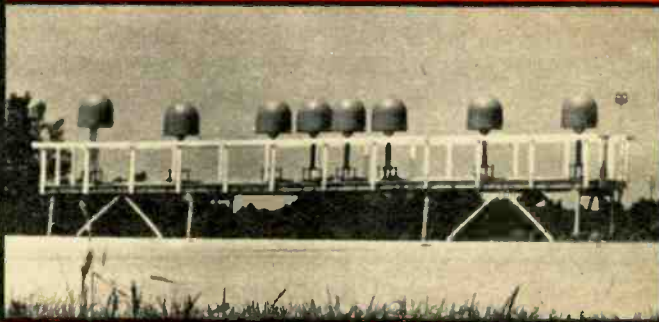

How do planes find

signal.) The reference signal is synchronized with the directional signal so that they are exactly in phase when received due north of the transmitter.

In other words, when the directional signal is aimed north, the non-directional reference signal reaches a modulation peak. But let the directional signal be beamed in any other direction and it will be received in the aircraft at a different point in the cycle of the 30-cps modulation on the reference signal. The directional signal makes one complete revolution during one cycle of the reference-signal modulation.

If you tuned an ordinary receiver to a VOR frequency you wouldn't be able to distinguish the modulated signals which carry the directional information. Just the same, you would hear three letters in Morse which identify that particular station. Some VOR transmitters also carry a voice recording, in addition to the Morse, further to identify the station. The ID's are required by law, of course, and the pilot normally does not *listen* to the station at all. Instead, he is watching the needle controlled by his VOR receiver.

The locations of all VOR stations are shown on aeronautical charts. And the stations are so close to one another that a pilot

usually can receive two or more of them at the same time (on different frequencies, naturally). By determining his direction from two or more stations and by drawing directional lines on his chart and noting where they cross, the pilot can map his exact position—even though he may be far from an airport or an established route.

But how does a pilot get down to a safe landing when the weather is thick enough to slice with a knife? How does he know that when he breaks through overcast a runway will be right out there ahead of him?

This, too, involves a basically simple set of directional radio signals. Coded by modulation, this group is known as ILS (for Instrument Landing System).

At every airport with an instrument runway, a set of transmitters beams signals outward from the runway along the path that a landing aircraft will follow. As with the VOR system, these signals cause certain instruments in the cockpit to give the pilot the information he needs to make a correct approach, even though he can't see the ground.

In an ILS installation, three sets of AM signals, on different frequencies, are received simultaneously by the aircraft receiver from ground transmitters.

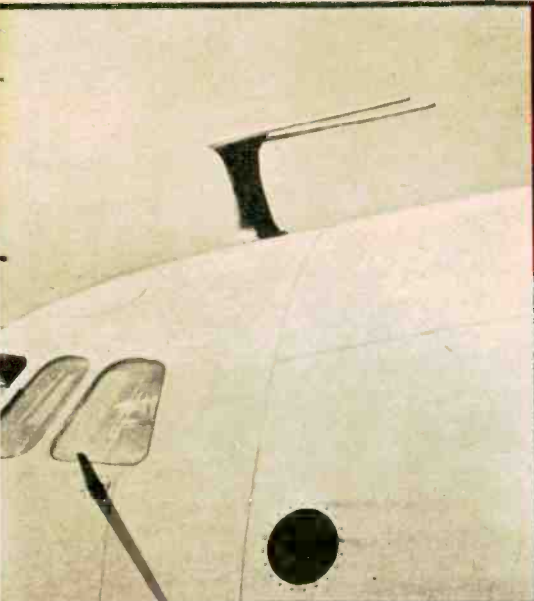

V-shape antenna behind flight deck on top of plane receives VOR transmitter signals. Scattered about the country and around the world, VOR stations furnish planes with well-delineated highways in the sky.



Teardrop enclosure on plane's belly houses antennas for automatic-direction-finder (ADF) equipment. Simple streamlining reduces air drag on antenna structure, yet results in no significant impairment of its operation.

their way?

One is the centerline signal (called the *localizer* by pilots), which tells the pilot whether he is left, right or exactly in line with the runway. The second is the glide-slope signal, which tells the pilot whether he is too high, too low or at just the right altitude for his approach to the runway. The third set of signals are markers which tell him how far he is from the end of the runway.

Though the centerline and glide-slope signals are similar, they are transmitted at right angles to one another. Result is that one measures horizontal distance and the other measures vertical distance.

In the case of the centerline signal, separate modulators and antennas are used. This permits a signal with 150-cps modulation to be beamed to the right of the runway centerline (that is, to the pilot's right as he approaches the runway), and a signal with 90-cps modulation to be beamed to the pilot's left.

The aircraft ILS receiver has filters which separate the two modulation frequencies. Once separated, they are applied to a circuit which measures their relative strengths and displays the result on a meter on the pilot's instrument panel. If, say, the plane is to the right of the runway centerline, the 150-cps

modulation will be stronger than the 90-cps modulation. This will place the localizer needle on the ILS instrument off center, showing the pilot that he is to the right of his intended course.

As he flies to the left, the 90-cps signal will pick up strength, swinging the localizer needle toward the center of the dial. When the 90- and 150-cps signals are being received with equal strength the localizer needle will be centered. This tells the pilot that he is directly in line with the runway.

The glide-slope signals work in much the same manner. The 90-cps modulation is aimed above the normal glide path of a landing aircraft while the 150-cps signal is aimed below the glide path. Another instrument needle shows the pilot he is above, below or right on the glide path for a normal landing.

The centerline signals are transmitted on frequencies from 108.1 to 111.9 mc, and the glide-slope signals are transmitted on frequencies from 331.1 mc to 334.7 mc. However, centerline and glide-slope frequencies are paired. Tuning in a centerline frequency on an aircraft ILS receiver automatically tunes in the corresponding glide-slope frequency.

[Continued on page 108]

BUDGET HAM STATION

**Conar 400 Transmitter
 500 Receiver**

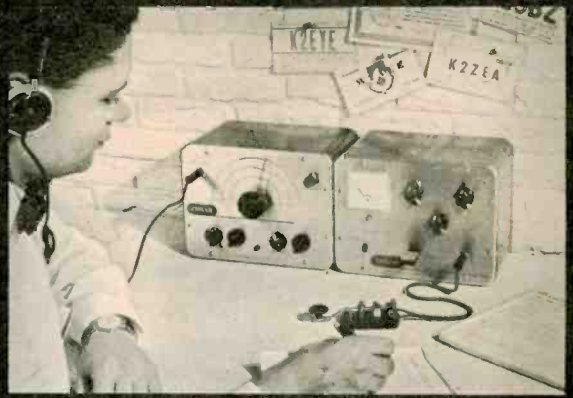

KITS: CONAR 400 3-Band Transmitter
 500 3-Band Receiver
MANUFACTURER: Conar Division, National Radio
 Institute, 3939 Wisconsin Ave., N.W., Washing-
 ton, D.C. 20016
PRICES: Transmitter: \$32.50
 Receiver: \$37.50
 Both Kits: \$64
CONSTRUCTION TIME: Transmitter about 6 hours,
 receiver about 10 hours.

ONE of the big problems faced by begin-
 ning hams is selecting equipment for
 the first station. Do you build or buy—and
 what?

Excellent answers to these questions are
 Conar's 25-watt Model 400 CW transmitter
 and Model 500 receiver. Both units are de-
 signed for 80, 40, and 15-meter operation,
 giving the Novice (and others) everything
 needed to get on the air.

Included with the kits at no extra cost are
 a copy of the ARRL Radio Amateur's Li-
 cense Manual and a key. The construction
 manuals tell you how to get a Novice license,
 how to set up antennas, and station operating
 procedure. The transmitter and receiver are
 available factory-wired for \$46.50 and
 \$56.50, respectively.

Since the transmitter is the simpler of the
 kits, we tackled it first. It consists of a one-
 tube (6DQ6B) crystal-controlled oscillator
 with a pi-network output which works into a
 50-to-600-ohm load.

Components and hardware are neatly at-
 tached to a large piece of cardboard which is
 covered with clear molded plastic. This makes
 for fast and easy identification of parts when
 they are needed. Observe the easy-to-follow
 instructions and pictorials, which are on large

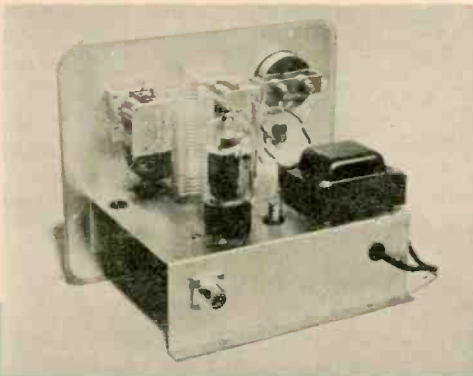

Rear of transmitter. Loading capacitor is at left,
 80- and 40-meter tank coil is just behind it. Pilot
 lamp on chassis is used to limit crystal current.

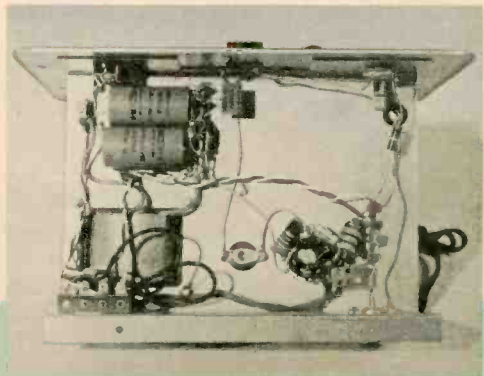

Underside of the transmitter. With so few parts
 it's difficult to make a wiring error. The full-
 wave voltage-doubler power supply is at the left.

fold-out sheets, and you'll be on the air in good time.

Although the transmitter has a pi-network output, which is supposed to work into any resistive 50-to-600-ohm antenna, it did not at first load into 50 ohms on 80 meters. We solved this by disconnecting the pi-network loading capacitor which is switched in on 80 meters. The transmitter input power is 25 watts and it delivers about 10 watts output on all bands. Keying is clean and rock steady. We received no reports of chirp.

The receiver is designed specifically for the Novice, covering only the 80, 40, and 15-meter bands. These bands are spread out over the entire 180-degree dial, making it a snap to dig out weak signals hidden in QRM. The Novice-band segments are marked clearly on each dial scale.

Although the circuit has a minimum of parts, its performance is tops. The tube line up consists of a 6BE6 converter-oscillator followed by a 6BZ7 in the 455-kc IF stage. Unlike many all-band receivers in this price class, this rig has a second (pentode section of a 6U8A) 455-kc IF stage. The triode section of the 6U8A is the BFO. The detector is a semiconductor diode. Another 6U8A is used for the output stage, with the triode section driving the pentode section.

The receiver's components and hardware are packaged in the same way as they are for the transmitter. We had a few small problems during construction.

Several IF transformer leads were extra long and we weren't told to cut them to length. Unless they are shortened and routed

exactly where shown, the receiver may oscillate. The instructions did not tell us to connect a jumper between two terminal-strip lugs, but the jumper was shown in the pictorial. And a terminal strip called LL in the instructions was marked II in the pictorial. An arrow pointing to a detail drawing of tube socket P should have referred to the socket as V. It took us a few minutes to find out which end of the crystal diode is the cathode.

Although the alignment procedure without instruments is not difficult (the coils are pre-aligned), instrument alignment really is necessary for top performance. The job is no more complicated than it would be for an AC/DC radio.

How did the receiver work when we turned it on? Reception on 80 and 40 meters was outstandingly good—virtually drift free. On 15 meters there was a little drift that caused a slight chirp, even on the best of signals. But this is common to many budget receivers.

Although there is no RF stage, sensitivity and selectivity are better than that of most older budget all-band receivers and close to that of the newer models, which include an RF stage. Reason for this is the 500's second IF stage.

The mode switch provides for CW, AM or standby operation. In standby, B+ is not removed from the oscillator or the IF stages. (One of the problems with many budget receivers is that in the standby mode—when you're transmitting—B+ is removed from the the oscillator and IF stage. When B+ is

[Continued on page 112]

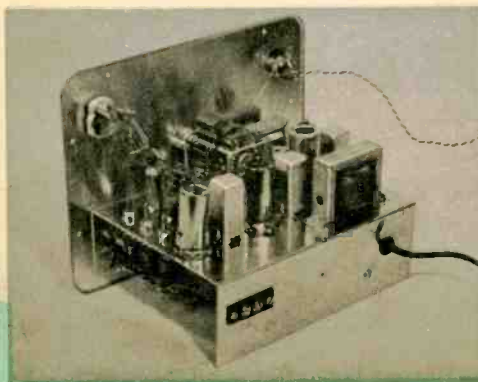

Rear of receiver. Antenna trimmer capacitor is in upper left corner of panel; phone jack is at upper right. Speaker mounts on side of cabinet.



Underside of receiver is crowded. You must be careful to position leads where shown in manual or else the IF stages will break into oscillation.

Monitor your driving with a...

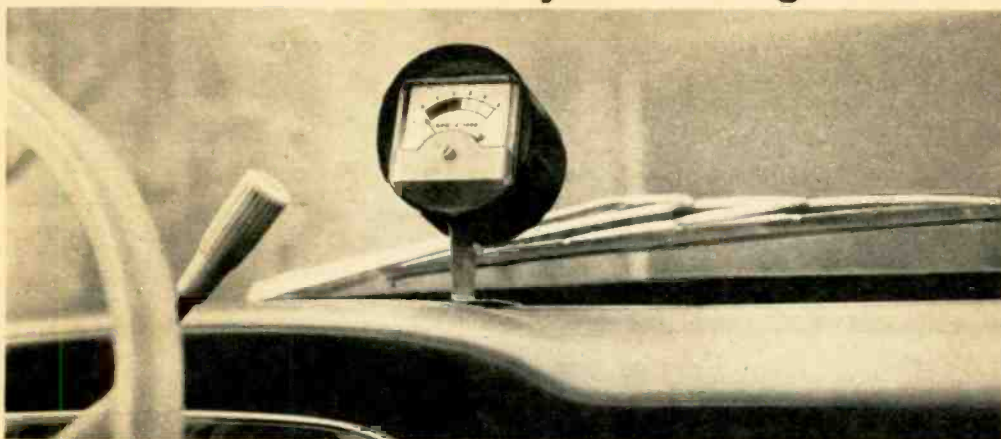

MILES-PER-GALLON INDICATOR / TACHOMETER

By STEVEN E. SUMMER

DON'T blame Detroit if your car doesn't deliver what you think it should in miles per gallon (MPG). It takes a really skilled driver to get top gasoline economy from a car. But by keeping the needle on our relative MPG indicator in the color area of its dial, you'll be driving like an expert.

The indicator doesn't tell you the exact MPG you're getting while you're driving. Instead, it shows you whether you're driving at an economical speed.

How does our indicator work? To explain it, let's see how you figure MPG the conventional way. Say you fill the tank with 18 gallons of gas before a trip. After you drive 300 miles, you fill the tank again with 16 gallons. Since you drove 300 miles on 16 gallons, you averaged 300 divided by 16 or 18.7 MPG for the trip. Mathematically,

$$\text{MPG} = \frac{\text{distance traveled}}{\text{gas consumed.}}$$

Assuming the other quantity does not change, the greater the *gas consumed* (denominator) the lower the MPG. The greater the *distance traveled* (numerator), the higher the MPG.

If you're not good at long division you could obtain the answer another way. First, you'd have to install a flow meter in the fuel line to give you a signal proportionate to how much gas is going to the engine.

Then you'd connect a device to the speedometer to give you a signal proportionate to the speed of the car. Feed these two signals into a little black-box computer and you'd have it made. The computer would divide the car speed (related to *distance traveled* in our formula) by the gas flow (related to *gas consumed* in our formula) and tell you the *instantaneous*, rather than the average, MPG.

Our MPG indicator, which is basically a tachometer, does not have to be connected to your speedometer or the fuel line. It is connected to your ignition coil. The tach circuit converts engine rpm to a voltage which is proportionate to your car's speed. (The ratio of engine speed to car speed is best when you are in high gear.)

To make it unnecessary for you to break into the fuel line, our indicator has connected to it a potentiometer (R9) which is mounted under the accelerator pedal. As you press down on the accelerator, the potentiometer

Fig. 1—All the parts in our indicator are mounted on a 3-in.-diameter piece of perforated board. Connections between components are on the rear of the board. Rather than solder the leads of transistors Q1, Q2 and Q3 to other wiring, connect them to flea clips or brass eyelets. Switch S1 is supported above the board with a ½-in. spacer. Completed unit ready for mounting on dashboard is shown in the photo below.

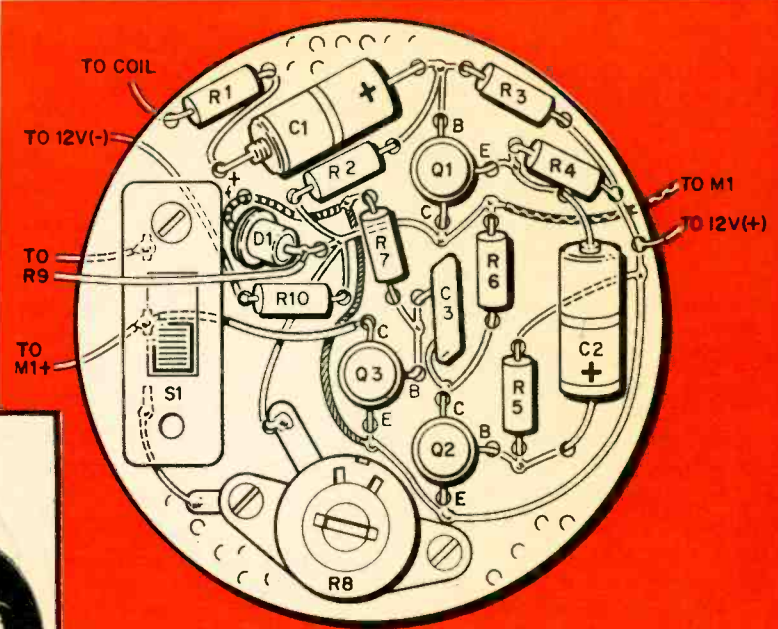
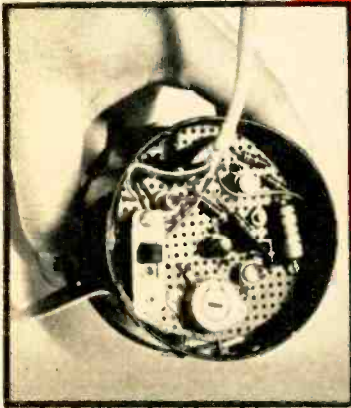
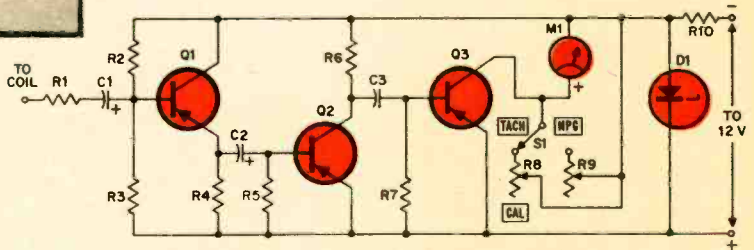

Fig. 2—Pulses from ignition coil are fed from Q1 to Q2, which clips them. Pulses are converted to spikes by R7, C3 and are then amplified by Q3 to drive M1. R9 is under the accelerator.



PARTS LIST

- C1, C2—50 mf, 50 V electrolytic capacitor
- C3—.1 mf, 75 V, or higher, ceramic disc capacitor
- D1—Zener diode: 10 V, 1 W, International Rectifier 1N1523 (Newark Electronics Corp. Stock No. 21FX981, \$2.95 plus postage.)
- D2—Silicon rectifier, 750 ma, 400 PIV (Lafayette 19 G 5001)
- M1—0.1 ma DC milliammeter. Shurite Type 850 (Lafayette 38 G 6008)
- Q1, Q2, Q3—2N404 transistor
- Resistors: ½ watt, 10% unless otherwise indicated
- R1—10,000 ohms R2—27,000 ohms
- R3—3,300 ohms R4—680 ohms
- R5—1,000 ohms R6, R12—4,700 ohms
- R7—560 ohms
- R8—1,000 ohm, 2 watt flange-mount rheostat. Mallory FL-1K (Lafayette 33 G 1241)
- R9—2,000 ohm, 4 watt wirewound, linear-taper potentiometer. IRC type WPS-2000 (Lafayette 33 G 4512) or equiv.
- R10—150 ohms R11—47,000 ohms
- S1—SPDT slide switch

produces a signal that is directly related to gas flow. (Naturally, the harder you step on the accelerator, the more gas goes into the engine.) To convert the tach to an MPG indicator, potentiometer R9 is used to relate engine speed to fuel consumption. Here's how.

The faster the car goes, the higher the tach voltage to M1. But in order to make the car go faster, you have to press more on the accelerator. And as you do, R9 continuously reduces the increasing tach voltage fed to M1 by shunting M1. Because of the way the indicator is designed and calibrated, this causes M1's needle to remain in the color area. As long as the engine speed changes the same amount that the accelerator position changes, the needle will stay in the color area.

INDICATOR / TACHOMETER

If the distance the accelerator is depressed increases out of proportion to the increase in engine speed, the R9's shunting effect across M1 increases at a greater rate than the voltage to M1 increases. This causes M1's needle to drop below the color area of the dial. In other words, M1's needle will remain in the color area as long as the shunting effect of R9 on M1 changes at the same rate that the increase in voltage to M1 changes.

Think of the voltage from the tach circuit to M1 as being the *distance-traveled* part of the MPG formula, and the shunting effect of R9 on M1 as being the *gas-consumed* part of the formula. The action of one signal on the other at M1 amounts to long division—electrically.

By putting switch S1 in the tach position, the MPG indicator operates as a straight tach—a useful accessory for telling you your engine's rpm.

Construction. Our indicator's case is a 3 3/8-in.-diameter by 2-in.-thick, 8-oz. tuna can with a 2 1/2-in.-diameter hole cut in one end for M1. All parts are mounted on a 3-in.-diameter piece of perforated phenolic board. The disc is mounted on M1's two retaining-bracket screws with spacers to keep it away from M1's terminal.

Calibration. Connect the indicator to a 12-volt battery and connect the circuit in Fig. 5 to the indicator's input and the +12 V buss. Set S1 to *tach* and adjust R8 for the rpm figure shown in the chart in Fig. 6. For example, if your car has an 8-cylinder, 4-stroke engine, adjust R8 until M1 indicates 225.

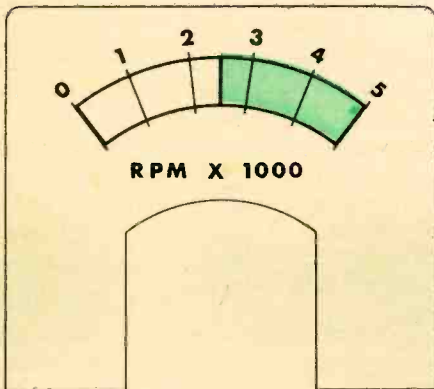

Fig. 3—Use this special scale for meter face.

Installation. Connect the +12 V lead to the cold side of the ignition switch and connect the negative lead to a ground point. Connect the input lead to the distributor side of the ignition coil.

The dimension of R9's mounting bracket (Fig. 4) and the length of the accelerator contact arm on R9's shaft must be determined by cut-and-try for your particular car. But it is of utmost importance that R9's wiper turns through 100 degrees of arc as the accelerator goes from its top position to the floor. Be sure after R9 is installed that you connect the cable to the lugs across which the resistance *decreases* as the accelerator is depressed.

Loosen the set screw in the coupler that connects R9 and the accelerator contact arm.

[Continued on page 104]

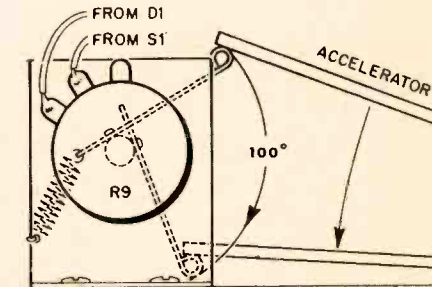

Fig. 4—Method of installing R9 under accelerator. Coupling arm (broken lines) is made of scrap aluminum and connected with 1/4-in. shaft coupler.

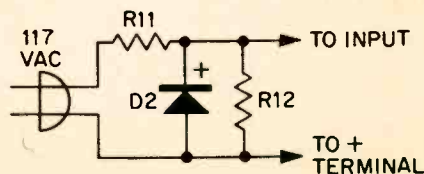
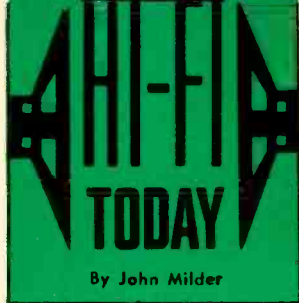

Fig. 5—Tach calibration circuit converts 60-cycle AC to 60 pulses per second. Connect its output to the indicator input at R1 and to the +12 V buss.

CALIBRATION CHART		
CYLINDERS	2-STROKE	4-STROKE
4	900 rpm	450 rpm
6	600 rpm	300 rpm
8	450 rpm	225 rpm

Fig. 6—Use figures above to calibrate the tach.



- ✓ Pitfalls in putting eyes ahead of ears
- ✓ The transistor makes its cartridge debut

IN AND OUT of the line of duty, I tend to answer quite a bit of audio correspondence. And one of my pet peeves is a request for specifications on amplifier *A*, tuner *B* or speaker *C*. Almost always, the letter-writer asks for “complete frequency-response and distortion curves on . . .”

Now I won't deny for a minute that specs mean a great deal, given the right kind of consideration. But when I see a stock phrase like the one above, I'm reasonably certain that the questioner (like the lady in our cartoon) *doesn't* know how to use specs. I'm sure, for instance, that he doesn't know that the only kind of speaker distortion—as such—that can be shown on a graph is the low-frequency harmonic kind. Or that a speaker's high-frequency response is meaningless if not measured off- as well as on-axis.

Yes, specs *can* be useful. But they also can encourage a kind of single-mindedness that defeats the whole purpose of specs in the first place. Take the subject of tuner sensitivity, for instance. It's important as a spec, no doubt about it. But is a tuner with an IHF rating of 2 μv better than one with a 4 μv figure?

Perhaps. But maybe the lower figure was achieved by sacrificing some of the tuner's selectivity. If so, strong local stations and images may blot out a weak signal from a distant station. Yet that same station well might come in clearly on the apparently less-sensitive tuner with better selectivity. Whether or not the selectivity figures for both tuners also are given in the specs, you may discover little about a unit's *effective* sensitivity from its specified rating. And so it goes in many practical matters.

Another thing that bothers me is that some audio buffs seem to take specs like our better halves take Emily Post. That is, they want to be *told* what's right or good, instead of listening and judging for themselves. But this really is bad news. Anyone who doesn't have faith in his own critical faculties is best off with a 1920 Victrola.

By all means, learn what specs are worthwhile to help you narrow down your choice of audio gear. But then use your own common sense—and your own ears.

Now an item for the you-heard-it-here-first

department. Some months back, I talked about Raytheon's subminiature transistor mike and I conjectured that a transistor phono pickup couldn't be too far away. Well, it's here. Euphonics, a relatively young company previously involved in making ceramic

cartridges for the console market, now has announced a semiconductor pickup.

What impresses me most about the TK-15 (also known as the CK-15 without its matching tone arm) is that it achieves a stylus-groove resonance of 47,000 cps. That—a resonance more than an octave out of the audio range—is quite something in a pickup. It well may indicate not only superb sound but also (because it implies extremely low dynamic mass) ultra-low record wear at a light tracking force.

Over the past couple of months, I've been doing a lot of listening to commercial pre-recorded tapes—the standard 7½-ips, four-track variety. And I'm happy to report that commercial tapes sound better than ever.

[Continued on page 115]



By **ROBERT M. BROWN, K2ZSQ** **I**N A BIBLICAL battle a young featherweight named David knocked out a heavyweight named Goliath. And though the incident forever established the superiority of brains over brawn, pint-size wonder-workers didn't end with David. In the radio world, for instance, a new variety of hams currently is making like David in a land teeming with Goliath-size gallons and California Kilowatts.

Headed by power-transistor specialists and propagation experts, and backed by an international organization, the Davids in Goliath land frequently get out as much with milliwatts as others do with full kilowatts.

Basic idea—by no means new—is that long-distance communication isn't really dependent on the power involved. Instead, it is the operator and his skills that are all-important, with a little something called propagation characteristics (or luck) thrown in. Listen around a bit on the 40- and 80-meter ham bands and you well may hear such phrases as, "More power is wasted power," "Switch to QRP," and "Down with the kilowatts!" Somewhat dramatic utterances—but the chaps are proving a point. Fact is, once contact has been established, many non-kilowatt-crazy hams reduce input deliberately to see how little power they can get by on.

Flea-power hamming had its beginnings overseas, where amateurs are even harder-pressed for pennies than in the U.S. Came the deluge of military-surplus equipment after World War II and necessity soon mothered her first flea-power

THE DAVIDS IN

ham stations. Prices naturally varied, though as a rule of thumb a European peanut-whistle station still can be assembled and put on the air for a total cost of perhaps \$15. Customized rigs, with two tubes in the final and another stage of preamplification, run as high as \$25, antenna included.

World's first flea-power ham club, the QRP Society was formed in London in 1948 (QRP is one of the Q signals, meaning, "Decrease Power," or, "Must I decrease power?"). The society did an admirable job of keeping its members informed of where flea-power bargains could be found. Simultaneously, of course, the group reminded hams everywhere of a message Marconi had suggested decades before—that communications is an art and that the artistry depends on the operator, not the equipment involved.

These early flea-power-ites understandably took due pride in their homebrew creations. Each new transmitter under construction offered opportunity to eliminate still another stage. On the air a battle-in-earnest for best peanut-whistle DX soon was underway. A German operator running 5 watts readily claimed 14 countries confirmed. Undismayed, a Swede went to work on all American states with only 2 watts to the final.

Long about 1959, U.S. hams began making discoveries of their own. In California, long famed for those oversize kilowatts, Don Stoner, W6TNS, laid claim to working all continents with a homebrew CW transmitter running only 80 milliwatts. And on the East Coast, Clayton Brown, W3RZL, Upper Darby, Pa., spearheaded a movement toward transistorized gear. Fellow hams in the area soon reported astonishing success with their

Though QRPers differ in their definition of flea power, 100 watts is tops, with many arguing for a 5-watt limit. Rig in photo delivers 7 watts but can be cranked down so output drops to a few milliwatts.

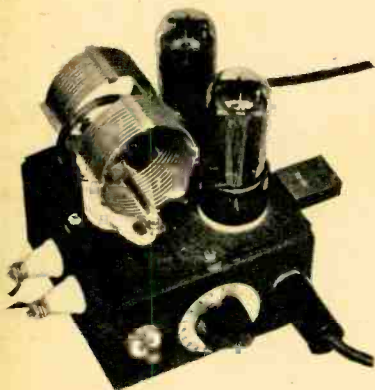

new 1/8-watters—like working into South America every day on 15 meters.

South Americans were so impressed that they, too, joined the QRPers and soon were boasting of powers even slimmer than those of the Upper Darby crew. Meanwhile, a Kentucky station worked Les Earnshaw, ZL1AAX, in New Zealand on 20-meter sideband—only to learn that Les' final was an RCA 2N247 running 20 milliwatts.

How can flea power turn such tantalizing tricks? Actually, there currently are two schools of thought on how to explain flea-power DX. One school credits antennas for much of flea-power's success. For, quite unsurprisingly, QRPers have found that the more antenna they have, the less power they need for a contact.

Second school of thought credits skill for the successes of the QRP gang. Allen Katz, K2UYH, a prominent UHF experimenter who delights in doing things people call impossible, explains it this way:

"The trick is in the listening. So many operators hear only the loud signals, or the potent, interference-free stations. What they don't realize is that they are missing out on ham radio's most exciting challenge: working DX others can't hear. It's there. All you have to do is develop the perseverance and patience to wait it out."

Though the original London QRP Society folded in the mid 50's, the newer, U.S.-based QRP Amateur Radio Club since has snowballed into one of amateur radio's largest independent fraternities. With supporters all over the world,

GOLIATH LAND

the QRP A.R.C. sponsors contests for its members, presents awards for the best performances with the least power and publishes a quarterly newsletter brimming with interesting case histories and regular organization news.

Any ham who runs 100 watts or less (200 watts p.e.p. on sideband) is eligible to join the over 2,000 QRPers affiliated with this organization. One dollar to QRP A.R.C. secretary John E. Huetter, K8DZR, 2146 Chesterland Ave., Lakewood, Ohio 44107, covers lifetime dues and a year's subscription to the club's quarterly, QRP News. But when you become a David you must watch your step. If you exceed the 100-watt power limit you're disqualified—and presumably become a Goliath again. 

Our illustration shows QRP Amateur Radio Club is open only to hams interested in low power, though its secretary admits the club's 100-watt limit more properly is high power to some members. Illustration shows club's membership certificate.



from

NEW LIGHT ON THE

Feed the ionosphere enough energy, says one physicist, and it may fall to

MAN-MADE moonlight that can be switched on and off sounds like the background for a science-fiction story. Toss in the fact that this same lunar light well may come in colors, and you're set for the funny fable of the year. But don't laugh. Scientists someday may produce an artificial aurora from a radio beam. And it's not even a new idea.

Long ago as the early 1930's an Australian scientist named Victor A. Bailey theorized it might be possible to produce such an artificial glow in the ionosphere. Bailey now holds an Australian patent on his artificial-moonlight concept. And for those who still are skeptical, a word on credentials might be in order.

A research professor emeritus of physics at the University of Sydney, Bailey was the first physicist to receive a Ph.D. degree from England's famed Oxford University. One of the world's foremost experts in ionospheric research, he has been studying the transmission of radio waves through space since 1933. And though retired now, Bailey has published more than 50 major scientific papers on electricity in gases, radio-wave interaction and related subjects.

The physicist's theory on man-made moonlight is closely allied with his work on the behavior of radio waves in the ionosphere—that portion of the atmosphere which reflects transmitted waves back to distant points on the earth's surface. And it was the inexplicable interaction of two radio waves in the ionosphere that first led Bailey to his unusual idea.

It all started with the Luxembourg Effect, an atmospheric phenomenon which puzzled radio physicists in the early 1930's. A new broadcast transmitter with a frequency of 250 kc had been installed in the little grand duchy of Luxembourg. Listeners in The Netherlands, tuned to a Swiss station on 650

kc, complained of interference from the Luxembourg station.

But there simply wasn't a logical explanation. The two signals were 400 kc apart and unrelated by any of the usual harmonic principles. Bailey stepped in, solved the problem and theorized about artificial moonlight to boot.

Bailey was able to provide a solution by disproving a then-current theory about the ionosphere, where free electrons, ions and molecules are in constant motion and are colliding continually with one another. Before 1933, physicists believed these collisions to be relatively constant, regardless of external circumstances.

The Australian was first to argue that these collisions increase as the strength of an entering radio wave is increased. He also said that part of the energy of an entering wave actually is transferred to the electrons in the ionosphere.

As for the Luxembourg Effect, Bailey theorized that the Luxembourg signal was absorbed partially by the ionosphere. As a result, it effectively increased the random motion of the ionospheric electrons. And because of this increased activity, the modulation of Radio Luxembourg was impressed on the Swiss signal when it passed through the ionospheric region near the Luxembourg transmitter. The effect might be compared to the operation of the plate modulator in your ham or CB rig.

Bailey's theory on the Luxembourg Effect later was proved in extensive transmitting tests with the cooperation of scientists throughout Europe. But his related theory on artificial moonlight created a great deal of controversy among physicists.

Bailey recently toured the U.S. and recalled his early idea to a number of interested audiences.

IONOSPHERE

eating right out of your hand.

"I asked myself what would happen if the strength of a radio wave which was being absorbed in the ionosphere were continually amplified," he said in a lecture at the University of Oklahoma. His answer was that the incoming wave well might raise the electron temperature in the ionosphere to a point where an artificial aurora would be produced.

"If the sky were clear," said Bailey, "a transmitter power of one- to two-million kilowatts should produce a glow bright enough to allow vehicle traffic with no lights."

According to Bailey, such ionospheric light would cover a large area. The color of the glow, he said, could be changed by varying transmitter frequency. With a grin, he even pointed out that his idea might have romantic implications!

As a result of his studies, the physicist determined that a certain type of radio wave would be absorbed almost completely by the ionosphere. He called his new wave a gyro wave, since its frequency was determined by the gyration of a free electron in the earth's magnetic field. The proper gyro-wave frequency for Armidale, New South Wales, figured out to be 1,515 kc—near the top of the broadcast band.

Bailey and four other physicists conducted experiments in 1950-52 at Armidale on this frequency. By means of oscilloscope observation of the reflected radio signals, they were able to compile information on the strength of the earth's magnetic field, the collision frequency of electrons in the ionosphere and the amount of energy lost by an electron in these collisions.

Initial experiments indicated that a transmitting station for the study of radiowave interaction in the ionosphere might turn out to be a worthwhile investment. As a result,



the University of New England, New South Wales, in 1960 received a \$320,000 grant from the U.S. Air Force Cambridge Research Laboratories for a greatly enlarged program of research. The university placed an order with Amalgamated Wireless (Australasia) Ltd., Sydney, for a 500-kw transmitter and an array of 40 horizontal dipoles to be supported on twenty-five 90-ft. poles.

The transmitter currently is in use with full power and is quite versatile, according to Dr. R. A. Smith, associate professor of physics at the University. It will transmit on frequencies in the 1,430- to 1,600-kc range and pulses at full power can be varied from a millisecond to a full minute in length.

Initially, the purpose of the experiments is to investigate increases in ionospheric electron temperature and changes in electron density caused by collision of high-temperature electrons with molecules. Such changes are produced by the gyro wave from the big transmitter.

A 66,000-V power line supplies the necessary electricity for the transmitter. By changing links in a rectifier bank, voltages of 8,000, 16,000 or 24,000 can be selected with a resulting transmitter power of 55, 220 or 500 kw.

During the current experiments, the ionosphere is probed with short pulses from a second transmitter operating on 1,780 and

[Continued on page 103]

Free-Power Radio

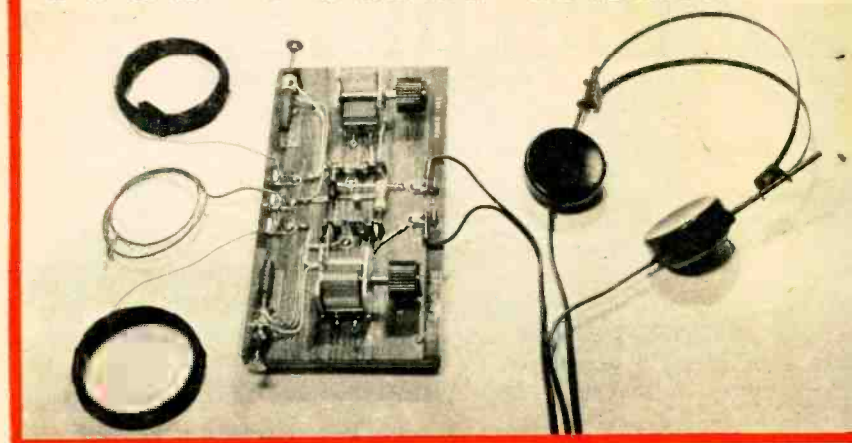

BACK in the days when broadcasting began, radio receivers were mighty simple devices. All they contained was a coil, a crystal and a cat whisker—plus a pair of headphones. You couldn't ask for less.

Compared to modern radios, which all require a source of power in order to operate, the first crystal sets were what you might call self-powered. That is, the power that drove the phones came from, or was, the transmitted radio wave itself. The power wasn't much in comparison to the output of a modern-day transistor or AC/DC table radio but there was enough to produce sound.

Electronics has developed quite a bit since the days of the crystal set. Operating power now is supplied by AC house current or by small batteries, of course.

Our Free-Power Radio enables you to combine the past with the present. It actually is two radios in one. One receiver uses a transistor that can act as a detector and amplifier at the same time. The other receiver (which we'll call the power receiver) is of the same design as the first crystal sets. It snags the signal from a powerful local broadcast station and converts the power to DC. The DC is applied to the transistor in the first, or signal, receiver. The transistor then amplifies the signal from the station you want to listen to. The result of this is greater earphone volume than would be possible from one of

those early-day crystal sets alone.

Take a look at the schematic of our Free-Power radio. Coil L1 and variable capacitor C1 tune the station you want to hear. The radio-frequency signal is coupled to the transistor (Q1), which trims away the radio frequencies (detects them), leaving only audio. So far, the action of the transistor is similar to that of a crystal and cat whisker or their more modern equivalent, the semiconductor diode.

But the transistor can be made to amplify the signal by providing it with operating power. And this power is obtained and supplied by the other circuit at the bottom of the schematic. The L2-C4 coil-capacitor combination forms a resonant circuit which is tuned to a strong local station. The signal is fed to diode D1, which rectifies or converts it to direct current. A large electrolytic capacitor, C5, filters out the audio modulation to produce a steady negative DC voltage which appears at point A in the schematic. The voltage is applied through the phones to transistor Q1. Q1 will now amplify the signal to produce greater earphone volume.

Construction

The simplest way to build the Free-Power Radio is on a wood panel or other non-metallic material. Our radio is built on a 4½x9x¼-inch-thick piece of plywood. Not

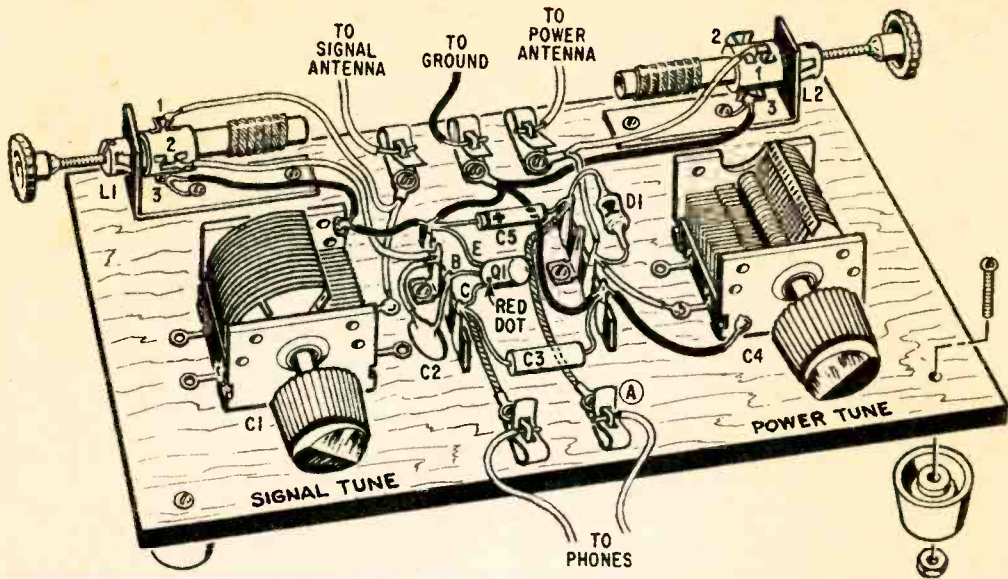

readily apparent in our pictorial is a connection from lug 3 on coils L1 and L2 to their mounting bracket. Be sure to make this connection.

You can prevent the metal coil knobs from unthreading by putting a drop of solder on the spot where the knob and threaded slug-adjustment screw touch. But don't apply the solder until the coil is clipped into its bracket.

Tuning capacitors C1 and C4 are mounted on the board by means of the threaded holes in the underside of their frame. It's easy to locate the points for the holes in the board for the capacitors' mounting screws. First screw 6-32 screws into the holes. Then press the screw heads into the wood. The marks are where you drill the holes. Don't use long mounting screws or you'll short the capacitor plates to the frame when the screws are tightened. Note, too, that each capacitor frame is grounded. Solder wires directly to the capacitor frames.

Connect the 4-lug terminal strips and the Fahnestock clips to the board with wood screws, putting a solder lug under each clip's mounting screw. Be careful when soldering the leads of D1 and Q1 to the terminal strip lugs that you don't apply the heat for too long. Excess heat could damage the diode and transistor.

By the way, it's possible to save a few dollars on the Free-Power Radio if you have

Our model was built on a 4½x9¾-inch-thick piece of plywood. The receiver is at the left side of the board. The parts at the right are used to tune a strong local station whose signal powers radio. Watch the heat when soldering D1 and Q1.

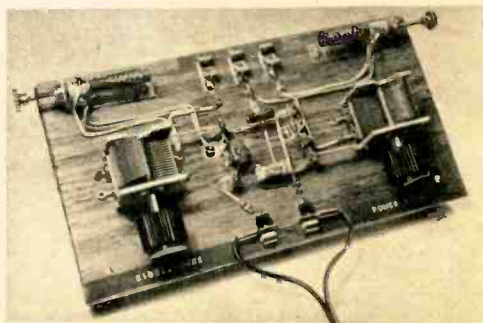

a couple of old AC/DC table radios around. Remove the tuning capacitors and use the large sections for C1 and C4.

Operation

The most important requirement for top performance from the Free-Power Radio is a good antenna system. You should use at least 100 feet of wire for each antenna. And mount the antenna as high as possible. (You should not use the same antenna for both receivers.) Radio signals must be strong, especially for the power receiver. You'll be able to hear stations located as far as 60 miles

Free-Power Radio

away, but only if operating power is obtained from a strong local station. And a ground could mean the difference between good and poor reception. Run a wire from the ground terminal to a cold-water pipe.

To calibrate the receiver, use a 1½-volt battery as a temporary source of power; any size, such as a flashlight or penlite cell, will do. Connect the battery's positive end to the ground terminal and connect its negative end to point A in the schematic.

Now set signal tuning capacitor C1 so its plates are about half-meshed. While listening, start turning the slug on coil L1 until you hear a station whose frequency is around the center of the broadcast band. By going back and forth between coil and capacitor, you should be able to pick up the station at the approximate correct position of the tuning capacitor. Stations of lower frequency should be heard as the plates close.

Since full coverage of the broadcast band is not possible at one setting of L1, it's necessary to readjust the coil to get the tuning capacitor to tune low or high ends of the band. Going from low to high is just a matter of turning the coil slug several turns. Now disconnect the battery and be sure to leave C1 tuned to the same station.

Next thing to do is tune in power. Adjustments to C4 and to L2 are made in the same way as they were to C1 and L1, only now it is necessary to find a strong local station. Since you can't hear the local station on the power receiver, listen to the same or another station on the signal receiver. When you tune in a strong local station with C4 the sound should get louder. Then adjust L2 so volume is greatest when the plates of power-tuning capacitor C4 are nearly fully meshed. If a voltmeter is handy, you can tune the power section precisely for maximum voltage between point A (negative test lead) and ground (positive test lead). The voltage should be 0.1V or higher.

Another source of free power is the sun. Try connecting an International Rectifier type B2M solar cell (Allied 7 E 876) to the radio. The cell's red lead is connected to the ground clip and the black lead goes to point A.—H. B. Morris

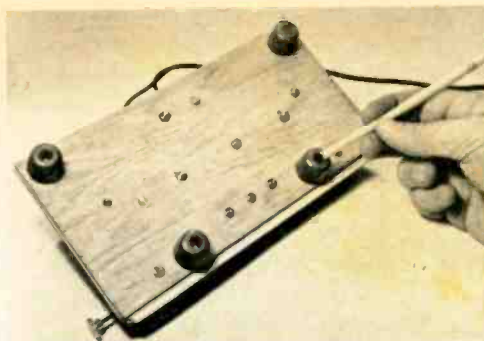

Underside of board. Screws, which are used to hold the rear feet in place, also go through the metal coil brackets that are on the top of the board.

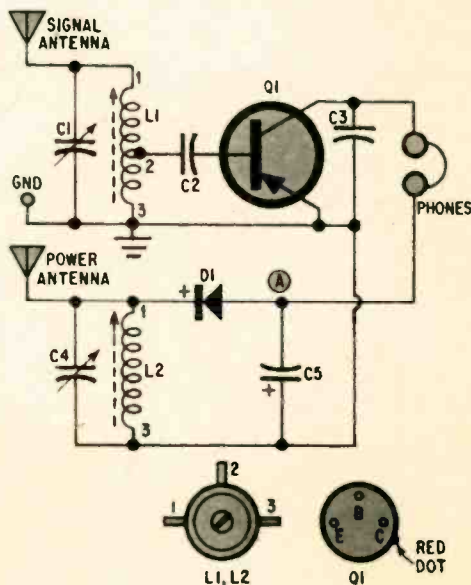

Signal tuned by C1 is fed to Q1 and detected. Audio will be amplified when voltage from lower receiver is fed through phones to Q1's collector.

PARTS LIST

- C1, C4—10-365 mmf variable capacitor (Lafayette 32 G 1103 or equiv.)
- C2—.2 mf, 10 V ceramic disc capacitor (Centralab UK10-204 or equiv.)
- C3—.005 mf, tubular or 75 V miniature ceramic capacitor (Lafayette 99 G 6062 or equiv.)
- C5—10 mf, 6 V electrolytic capacitor
- D1—1N34 diode
- L1, L2—Loopstick antenna (Superex VLT-240: Allied Radio 91 C 286)
- Q1—2N2613 transistor
- PHONES—Dual headphones, 2,000 ohms (Allied 86 S 083)
- Misc.—Fahnestock clips, 200-foot No. 20 enameled wire, 4-lug terminal strips, rubber feet, mounting board



LOGGING P.R. . .

When Trans World Radio withdrew its application for an SWBC station in Puerto Rico, DXers lost a chance to put this island commonwealth in the

easy column. But the country still can be logged, even by a patient novice. There are two ways to turn the trick.

Puerto Rico often reaches into continental North America on the BCB, even through the current summer static. Best bet is early Monday morning when many U.S. stations which normally operate all night go off the air. At such time you could try for WITA, Radio Imparcial, in San Juan. Its frequency is 1140 kc and sign-on is at 0400 EST.

Or there is WIVV (1370 kc, at Vieques, with sign-on at 0430 EST). Owned by the Calvary Baptist Mission of Puerto Rico, WIVV's early-morning programs are in English. And the station happens to be an excellent verifier.

If such early-morning DX isn't appealing, or if static is too heavy, there's still another route. As it happens, the Radio Corporation of Puerto Rico's telephone transmitters operate at all hours of the day and night on a wide variety of frequencies. Most consistently good is one on 9490 kc, just below the 31-meter SWBC band. R.C.P.R., by the way, verifies all correct reports by QSL card.

A second good utility target is WWA (San Juan Aeradio), operated by Aeronautical Radio, Inc., at the Puerto Rico International Aerodrome. Again, a multitude of channels is used: 8871 kc frequently is good during the daytime and 5566.5 or 2966 kc at night.

Cay Sal . . . Readers who carefully perused our Official Countries List (Mar. '65 EI) undoubtedly spotted this seldom-heard name. But where and what is it?

Cay Sal is Bahamian territory, but is separated from the rest of the Bahamas by over 100 miles. Excluding Guantanamo Bay, it is Cuba's closest (and non-Communist) neighbor.

The so-called country actually consists of Anguila Island, the Dog Rocks, Marion Rocks, Elbow Cay and Cay Sal itself, all arranged in a triangle. None has a radio station (unless you believe that one of this

odd assortment is the home of R. Americas).

Even so, Cay Sal can be bagged. Every day and night planes that fly along the airline route called *I* or *India* pass over the mysterious outcroppings as they fly from Nassau toward Havana. Cay Sal falls between two reporting points—Varadero North (just above Varadero Beach, Cuba) and Santaren (an arbitrary reporting point over Santaren channel at 24.14 degrees north latitude, 79.27 degrees west longitude). Let an aircraft bound from Nassau to Mexico City have any kind of prolonged contact after reporting Santaren and the DXer has it made. All it takes is patience and a little luck—both familiar DX ingredients.

The choice target amongst airlines is British West Indian Airways, which flies the *I* route from Nassau to Mexico City. A flight between Nassau and Havana would turn the trick, too, but we know of no airline making that hop these days.

Once you bag the aircraft, send your report to the station manager of the airline at Nassau International Aerodrome. Be sure to state the exact time the aircraft reported Santaren, since this is your only means of proving reception.

Frequencies and times, by the way, are the same as those mentioned previously for San Juan Aeradio (8871, 5566.5, 2966 kc). Who knows? You might chalk up two different DX targets almost simultaneously.

[Continued on page 111]

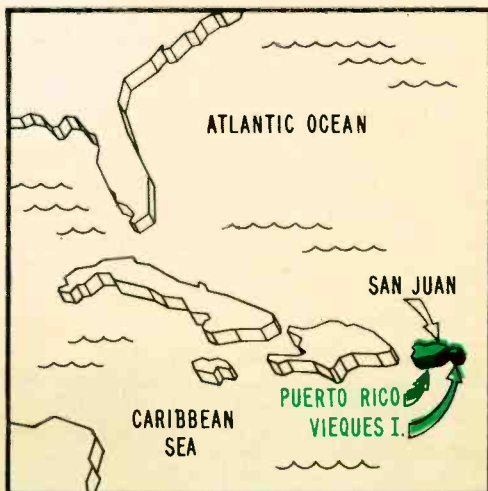

Puerto Rico can be logged on the BCB, though chiefly in the wee hours. See text for tips on stations in San Juan and nearby Vieques Island.



CB CORNER

BY LEN
BUCKWALTER
KBA4480

Ready when you are, CB

SUNDAY-PUNCHED by national news-magazines (Time, Newsweek) and rode over roughshod by more than one newspaper, CB of late even has come under the glaring lights of Broadway. But to glorify and praise our service? Huh-uh. For though the play that ran in a Manhattan theater for a bit was called Ready When You Are, C.B.!, we say "Foul." Here's why.

That play was about a girl who kept salami in a safe, laced Scotch into her grapefruit and jammed an automobile jack inside a treasure chest. In short, to clear the air here and now, it wasn't about us at all. Its real subject was an earlier CBer who went by the name of DeMille.

Help! Cecil B. DeMille himself, famed for casts of multitudinous millions, would have blinked at the throng headed toward CB radio. And such a throng we will have if a plan proposed by the Automobile Manufacturers Association reaches fruition.

Seems the big guns of Detroit are trained on CB with an idea called HELP—for *Highway Emergency Locating Plan*. It plumps for CB in every car and argues that such an arrangement could provide speedy assistance for distressed motorists suffering anything from a blowout to an acid stomach.

The AMA convincingly states that CB can work where other methods—roadside telephones, road patrols and the like—have failed. And few can deny that highway emergencies only can increase as more and more limited-access roads fan out over the country.

Though it sees the CB equipment now in use as a running start, the AMA looks toward a greater day. When it comes, new cars will be offered with an optional CB set as part of the regular radio. The rig will be nothing elaborate—just a black box to send and receive a signal on channel 9. But with about seven million new cars sold yearly, HELP just might provide the image-builder sorely needed by much-maligned CB.

Beetle-mania. Beetles and CB don't mix. No, we're not referring to those Prince Alberts with the long hair, but to a much earlier beetle—the Volkswagen. It's ignored by most new rigs on the market.

Problem facing the growing number of VW owners stems from the fact that the new CB rigs are designed for house current or 12-volt mobile operation. And the VW, right up to 1965, doggedly sticks to a 6V electrical system. Drivers of American cars dated pre-1955 or thereabouts also must come to grips with the same problem.

One way around the matter would be a DC-to-DC inverter, a device capable of changing 6VDC to 12VDC. But try and get one.

A more practical answer is to power the rig with regular house current—117VAC. Getting it into the car is simple. There are many DC-to-AC power packs on the market which convert 6VDC to 117AC and thus provide plug-in power for the rig. Both transistor and vibrator types are available. Transistorized units last longer and tend to gene-

[Continued on page 109]



Lovely Karen Poole shows how motorists might ask for aid via HELP. But even Karen won't get help unless she moves in on the mike she's holding.

SOMEONE SHOULD DEVELOP AN EASY WAY TO LEARN ELECTRONICS AT HOME

RCA INSTITUTES DID!

RCA introduces new CAREER PROGRAMS—beginning with the student-proved "AUTOTEXT" Programmed Instruction Method—the faster, easier way to learn. You start to learn the field of your choice immediately. No previous training or experience needed.

Pick the career of your choice—and RCA Institutes will do the rest! RCA's new, revolutionary "Career Programs" help you go directly to the career you want! You waste no time learning things you'll never use on your job! Each Career Program is designed to get you into the kind of job you want in the fastest, easiest possible way!

SEPARATE COURSES

In addition, in order to meet specific needs, RCA Institutes offers a wide variety of separate courses which may be taken independently of the above Career Programs, on all subjects from Electronics Fundamentals to Computer Programming. Complete information about these courses will be sent with your other materials.

CHOOSE A CAREER PROGRAM NOW
your first step to the job of your choice!

- Television Servicing
- Telecommunications
- FCC License Preparation
- Automation Electronics
- Automatic Controls
- Digital Techniques
- Industrial Electronics
- Nuclear Instrumentation
- Solid State Electronics
- Electronics Drafting

RCA INSTITUTES BONUS EXTRAS

Only RCA Institutes offers you a Liberal Tuition Plan, one of the most economical ways to learn. Plus, you get top quality equipment in all kits furnished to you with your courses—yours to keep and use on the job. And now, RCA's NEW PROGRAMMED ELECTRONIC BREADBOARD GIVES YOU LIMITLESS EXPERIMENTATION—scientific laboratory procedures

right in your own home! You build a working signal generator, AM Receiver, Multimeter, Oscilloscope, and other valuable equipment—ALL AS A PART OF YOUR COURSE! Get the facts today!

Classroom Training Also Available. Day and Evening Classes are available to you in New York City at RCA Institutes Resident School. You may be admitted without any previous technical training; prep courses are available if you haven't completed high school. Coeducational classes start four times a year.

SEND ATTACHED POSTCARD TODAY FOR COMPLETE INFORMATION. NO OBLIGATION. NO SALESMAN WILL CALL. FREE BOOK INCLUDED. CHECK HOME STUDY OR CLASSROOM TRAINING.

RCA INSTITUTES, INC., Dept. EI-75

A Service of the Radio Corporation of America
350 West 4th St., New York City 10014



The Most Trusted Name in Electronics



COFFEE, MILK OR TV?



"YOU REALLY don't have to fly to see a good movie!" argues a local movie theatre. And though what the theatre says is true enough, of course, there's no denying that being on wings may help. Fact of the matter is that movies now are as commonplace on transcontinental airliners as on *The Late Show*. And even the nation's railroads are getting in on what yet may prove the greatest boon to travel since airlines discovered hostesses.

Trans-World Airlines set some sort of ball rolling some years ago when it decided to fill the New York/Los Angeles travel time-drag with views of first-run flicks. But film is pretty old-fashioned in today's world of electronics one-upmanship, and before long videotape was offering its all. Reason was that passengers then could read, work or view as they chose, since cabins no longer were blacked out at film time.

But even movies weren't enough. Two airlines—American and Continental—soon went one better by providing passengers with a couple of stereo music programs: one popular, one classical. Later, both companies also installed provisions to pick up telecasts from commercial stations on the ground.

"It means that passengers can watch the ball game while they're in a holding pattern," an American official explains. "It's not of much use on a transcontinental hop, but we do expect it to become popular at World Series time."

To American also goes credit for still another electronic innovation. Tucked away in the nose cones of the company's 707 jetliners are closed-circuit TV cameras which well should provide American's passengers with the last word in in-flight entertainment. Not only can passengers watch their takeoffs and landings, but aerial views of Chicago and St. Louis also are quite within the scheme of things. So, too, are in-flight glimpses of anything from the Grand Canyon to Mount Rushmore.—*Bob Swathmore*

RAREST DX OF ALL

By ALEX BOWER

AT ONE time or another, most radio men have been known to pass up everything from milkshakes to mermaids. But such abstinence isn't without good reason. For if hams and SWL's frequently make like glassy-eyed monsters before their rigs, refusing food, drink and so on, it is only because something else is much dearer to their hearts. That something consists of a couple of letters in the alphabet—DX—and it has to do with distance. And to hear or work a distant station, most short-wave listeners and hams will go to any length.

All DX, by definition, is rare. It has to be, or it plain wouldn't be worth the having. But the collector of DX trophies—QSL's, for the most part—wants them to be as rare as rare can be. For as in the case of a collection of coins, stamps or antiques, quality—not quantity—becomes the deciding factor. And quality more often than not depends on the item's rareness.

But precisely how do you define the rarest DX? Distance? Power? Frequency? Location? The station itself? Unfortunately, there are almost as many answers to this question as there are hams and SWL's. Just the same, let's take a walk through the maze and see what we come up with.

In modern ham circles, rarity first of all means a QSO which adds to the operator's countries list. Further, since many top operators have worked all the world's populated countries, they must turn to isolated bits of soil and rock sticking up out of the earth's oceans. Annobon Island (300 miles SW of Africa in the Gulf of Guinea and not on most maps) is one example. To accommodate this need, various organizations (the Hammarlund Co. is famed in this role) send DXpeditions to these spots. Result is a flurry of activity, which in due course is marked by issuance of what well may be hundreds of QSL's. But is our chosen spot rare any longer? Hardly. Paper is cheap and, as any stamp collector well knows, the more of a given issue in circulation, the less

RAREST DX OF ALL

valuable it becomes. So, too, with QSL's.

Better, it seems, to define DX as working or hearing little-known stations in little-known countries. This definition takes care of two of the ingredients already mentioned—station and location. The other factors—power, frequency and distance—remain floating and are free for a DXer to mix to his heart's content.

In actual fact, all the rare DX the ham looks for also is available to the SWL. These stations generally are more difficult to dig out of ham-band QRM, but sometimes less difficult to locate than standard SW stations. Reason is that a multitude of stateside stations ordinarily can be heard calling them, so the stations likely are well identified.

As already mentioned, some of the rarest ham DX comes from isolated areas of the globe, frequently uninhabited islands put on radio logs through DXpeditions. But since these normally are one-time shots they scarcely can be considered available DX.

Still, it is worth noting that the legendary Gus Browning, W4BPD, made scores of these countries available to DXers during his safari through Africa, the Indian Ocean, the isolated Himalaya areas of Asia and the East Indies. And though Gus ended his globe-trotting a little over a year ago, he now has gone back to the high Himalayas. Gus recently opened up from Bhutan as AC8H which, indeed is a rare one.

In the same general area is another rare spot—the Mongolian Peoples' Republic. This first was placed on the ham bands by a Czech husband-and-wife team, JT1AA and JT1YL. They since have returned to Czechoslovakia, though they trained several students before their return and an occasional JT ham station now can be heard.

With the ever-changing country status of African nations, a fertile DX field can be found in this area—much of it with new and exotic prefixes. And out in the broad Pacific there are many rare islands that can be counted as countries. Australian weather crews make regular trips down through the Antarctic areas of the South Pacific and the men they leave behind on lonely islands invariably set up ham stations to keep in touch with the outside world. A current good bet among this group is VKØTR on the Island of Macquarie.

Even all the activity in Europe these days doesn't rule out a few rare ones well worth looking for. Up in the cold Arctic region of the U.S.S.R. a station called UA1KED in Franz Josef Land sometimes can be heard. Those fortunate enough to snag this one can try for a QSL via Box 88, Moscow. And choice bits of rare ham DX even can be found right here on our own continent, particularly down in the Caribbean area. Station HKØAI on the island of San Andres is but one example.

Best digging for any ham DX currently is on the 20-meter ham band, though 15 meters also can provide a rarity or two when conditions are right. Most stations are on phone, though a few are on CW only. Obviously, anyone who can't copy code doesn't stand a chance with the CW stations.

Because two-way contact always is considerably more difficult than mere reception,

BLUE MOON FIVE FOR SWLs

Station	Location	Address	Freq.	Remarks
YS18	British West Indies	Cable and Wireless Ltd. Mercury Hse., Grand Turk Is.	4560 kc	English at 1630 (all times EST) Verification by letter
CR4AC	Cape Verde Is.	R. Barlavento C.P. 29, S. Vicente	3960 kc	Portuguese at 0930 and 1700 Verification by QSL card
9NB7	Nepal	Dept. of Broadcasting, Katmandu	7105 kc	English at 1100 Verification by QSL card
VRH2	Fiji Is.	Fiji Broadcasting Comm. Box 334, Suva	930 kc	English at 1100
CR6RW	Angola	R. Cl. de Cabinda C. P. 116, Cabinda	5034 kc	Verification by QSL card or letter

the SWL enters the rare-DX game with a big advantage over the ham. Further, an SWL can listen to any station he chooses, illegal or otherwise, and if he can locate an address, he can send a report. (Hams, too, can listen to any station, though there are restrictions regarding two-way contacts.) In short, politics make no never-mind to the SWL. Whether his target is R. Libertad (an anti-Communist station) or R. Teje Iran (a Communist outlet), the SWL still is free to listen, log and, if possible, verify.

Fortunately, too, even clandestine stations frequently will verify. N.T.S. (R. Free Russia) issues an attractive QSL card and also will verify for R. Libertad if you log the latter's N.T.S. relay to Cuba Saturday nights. R. Americas, a quasi-clandestine, also QSLs readily, though power and proximity hardly make this one rare DX.

SWL's have still another advantage over the amateur fraternity, which again stems from the fact that they listen only. Consider those Venezuelan elections last winter. Venezuelan BCB stations stayed on well into the wee hours Monday morning when North American QRM was at a minimum.

Result was that BCBers had a field day with so many seldom-heard Venezuelans coming in they couldn't count them all. Rarest was YVQX, R. Nueva Esparta (920 kc) at Porlamar on Isla Margarita—40 miles from the mainland and, incidentally, the last place explored by Columbus.

But Isla Margarita may hold an even rarer target. R. Nueva Esparta also is licensed to operate as YVPL on 2340 kc (120 meters). However, no one in North America seems to know whether this or any other 120-meter YV actually is on the air. Which fact, of course, makes YVPL all the rarer.

While no one's QSL collection goes back

to Columbus' time, history is important to every real DXer. The first SWL who logs and verifies YVPL, for example, may have the catch of his lifetime. However, every confirmation on 120 meters after this is just another QSL, so the ardent DXer next will turn to richer lore—like Isla Margarita's aeronautical beacon, PMV (410 kc) with a mere 50 watts.

Low powers and low frequencies, incidentally, when accompanied by sizable distances, frequently can make for rare DX. Fact is, some truly outstanding examples have occurred on the broadcast band.

In the early 50's, for instance, 5DR at Darwin, Northern Australia, made it into eastern North America (about 9,000 miles away) on 1500 kc with a mere 200 watts. And in the spring of 1964, a station tentatively identified as R. South Africa's 400-watter at East London reached into Washington State on 1025 kc. Unfortunately, in this latter case, neither DXer (one of the world's best) nor station could be sure, but this type of frustration often accompanies the rarest DX.

In another area, distance and minute power have been tied in closely with history. Though thousands of Sputnik QSL's were issued, they still are prized trophies. Reception of the first men to orbit the earth obviously makes for a high point in many an SWL's rare-DX annals. Similarly, the Lunik probes have provided SWL's with fantastic distance records (like 150,000 miles or better).

Saddest part about the rare-DX game is the fact that QSL's issued by the rarest stations aren't always as attractive as those from other, less rare ones. Confirmation of rare DX often comes in the form of a handwritten letter or a typed postcard.

Conversely, some stations can be consid-

[Continued on page 111]

...AND HAMS

Station	Location	Name and/or Address	Probable Band	Remarks
VQ8AM	Mauritius	France Dumont, St. Antoine Sugar Estate, Poudre D'Or	20 meters	QSLs via VQ8AD
ZS2MI	Marion Is.	"Wynand"	20 meters	QSLs via ZSICZ
VR6TC	Pitcairn Is.	Tom Christian	20 meters	QSLs via W4TAJ
CE0AC	Easter Is.	Fuerza Aerea De Chile, Observatorio Meteorologico	20 meters	QSLs via R. Club de Chile
HVICN	Vatican City	Domenico Petti	20 meters	QSLs direct

THE chief cook and bottle washer is busy preparing dinner in the kitchen. For the time being, junior is contentedly watching his favorite TV program instead of being under-foot. Things go pretty smoothly—at least until chow time arrives. Chances are the TV program will not end the same time things come out of the oven. One or two calls from the kitchen don't produce any action. And as a matter of fact a dozen or more shouts don't get results.

Invariably mom's blood comes to a boil about the same time she's completely lost her voice from shouting. There's a neat way to solve this age-old problem without locking up the TV set.

Install the TV Call Box and you become an effective KP sergeant. It's one of the best ways to get the attention of small fry. When it's time to eat, you throw a switch on the control box and bark the command into its combined mike/speaker. At the TV set, the program sound is interrupted and your voice comes blazing forth.

The call box has an added bonus. It allows you to listen to the TV sound while you're working in the kitchen. In a way you might describe the Call Box a one-way intercom. You can talk, but you can't be talked back to.

If there aren't children around the house, the Call Box can do just as effective a job in paging someone stuck in a chair in front of the TV when there's a telephone call. Matter of fact you could connect the Call Box to a radio in the shop to tell the man of the house to come up when soup is on.

You could even connect it to a short-wave receiver or a CB transceiver to call an absorbed listener. In all cases, the person at the control box can hear the sound from whatever it's connected to. The volume in the control box is variable and you can even kill it entirely if you don't want to be disturbed.

The cost of parts is low. The major component is a preassembled transistor amplifier. It costs \$6.95 and with the other parts, the total bill should not exceed about \$15. And

you could shave a few dollars off this by using a smaller amplifier than the one we specify.

Construction

There are two units to the TV Call Box. The control



unit, which can be built in a metal or a wood cabinet, contains the amplifier, volume controls and function switch.

The relay box, which is a 5½ x 3 x 2½-inch Minibox, is attached on the rear of the TV receiver and is connected by three-conductor cable to the control box. It is also connected to the speaker circuit in the TV set. The connection is not difficult to make and requires disconnecting and soldering only two wires.

Best place to start is the control box. First drill a few large holes in the main section of a 3x4x5-inch Minibox for the 3-inch speaker as shown in the photo on the first page of this article. The holes can be most any size such as ¾ or 1-inch diameter. Then put a piece of grill cloth or perforated metal behind the holes to protect the speaker's cone. Mount the speaker and set the assembly aside.

In the U-section of the Minibox, mount the *listen* volume control (R1) on the bottom. Also mount the amplifier on the bottom using

PARTS LIST

- Amplifier—5-transistor audio amplifier (Lafayette 99 G 9037)
- B1—9 V battery (RCA VS 323 or equiv.)
- B2—6 V battery (RCA VS 068 or equiv.)
- R1—50 ohm, 5 watt wirewound potentiometer (Mallory VW-50, Allied 28 M 099)
- R2—5,000 ohm, audio taper potentiometer
- R3—4.7 ohm, 1 watt, 10% resistor
- RY1—SPDT relay: 6 VDC, 335-ohm coil (Potter and Brumfield RS5D; Allied 75 P 896)
- S1A, B, C, D—4P, 3 pos. non-shorting rotary switch (Centralab type 1415; Allied stock No. 35B170. \$3.06 plus postage. Or, Lafayette 4P, 3 pos. miniature rotary switch stock No. 99 G 6156)
- SPKR—2- or 3-inch 8-ohm speaker
- T1—Transistor output transformer: 500 ohm center-tapped primary; 3.2 ohm secondary (Lafayette 99 G 6127)

TV CALL BOX

By HOMER L. DAVIDSON

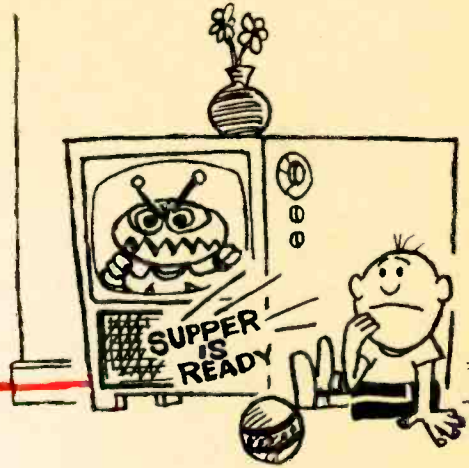

¼-inch long spacers to prevent foil on the back of the board from touching the cabinet. Mount transformer T1 on a two-lug terminal strip near the amplifier's input. Now mount function switch S1 and the *talk* volume control R2 on the front of the U-section. If you feel you may have trouble making connections to the switch, connect all wiring to it before mounting it in the cabinet.

The detailed diagrams on the last page of this article show connections to each wafer of the Centralab switch we specify in the Parts List. If you use the Lafayette switch, which has a different lug arrangement, disregard the diagrams.

There isn't much to building the TV set relay box. Simply mount the relay and a bracket for the battery in the main section of the small Minibox and you're ready to go. Connect the two boxes with a length of three-conductor cable.

Preliminary Checks

Before you install the units it is wise to check them out. Connect a small speaker to lugs 1 and 5 on RY1. Set S1 to *talk* and advance the *talk* volume control (R2) just below the point where you hear a feedback howl. Then talk into the speaker in the control unit. You should hear your voice out of the temporarily connected speaker. If you don't check the wiring. Now, set S1 to *listen*. Touch a flashlight battery to lugs 1 and 4 on RY1. You should hear a clicking from the speaker in the control unit. Again, if you don't check your wiring—especially on S1.

Watch RY1's armature when S1 is set to *talk*. It should move and close contacts 3 and 4. You can verify this with an ohmmeter.

TV Set Connections

Remove the rear cover from your TV set and locate the two leads going to its speaker.

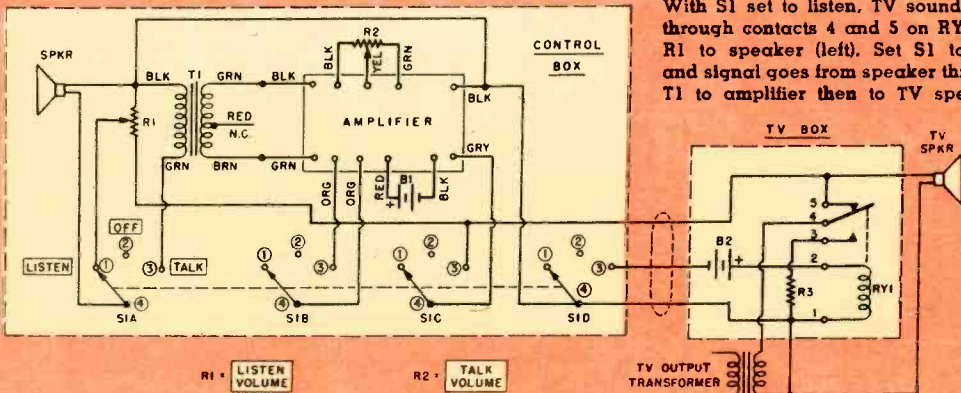

TV CALL BOX

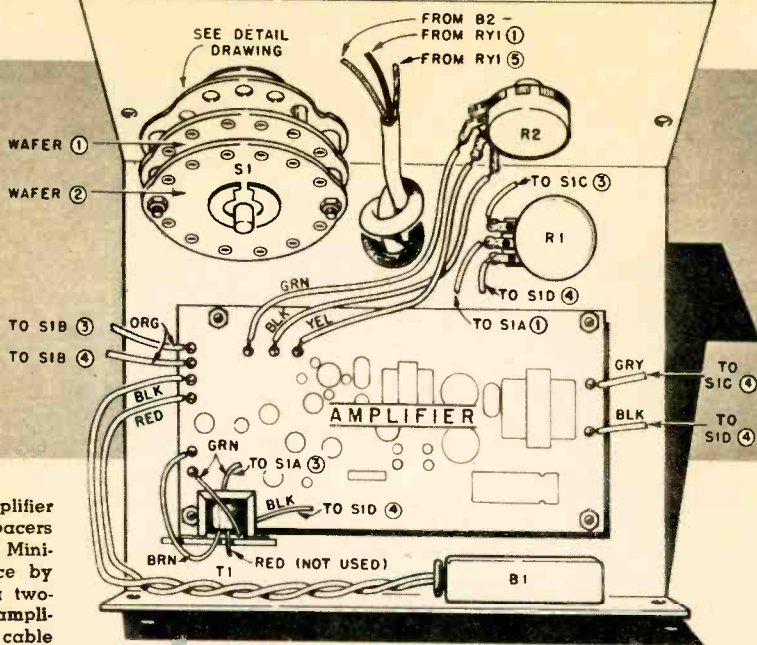

Inside of control box. Amplifier is mounted on 1/4-inch spacers on bottom of U-section of Mini-box. T1 is held in place by soldering its frame to a two-lug terminal strip near amplifier's input. Leads from cable at top are connected to S1.

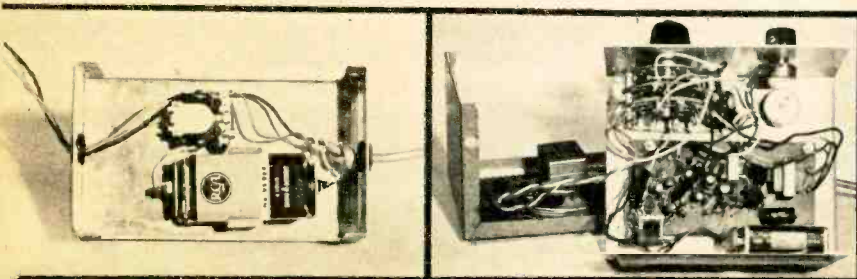

TV relay box, left, and control box, right. You may find it easier to connect some wires to S1 before installing it in the cabinet. The speaker should be connected to S1 with long leads and mounted in main section of cabinet.

Disconnect one lead and connect the lead from lug 5 on RY1 to the speaker. Now connect the lead from lug 4 on RY1 to the TV output transformer lead that formerly went to the speaker. Tape the connection.

[Continued on page 112]

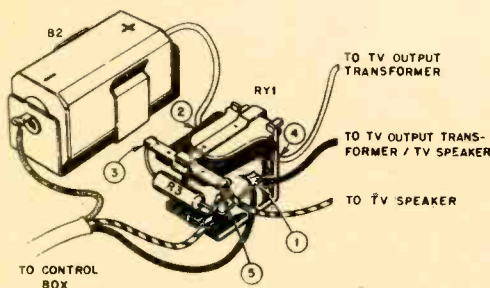

TV relay box, left, and diagrams of connections to S1, right. Load resistor R3 is connected to TV output transformer when S1 is set to talk.

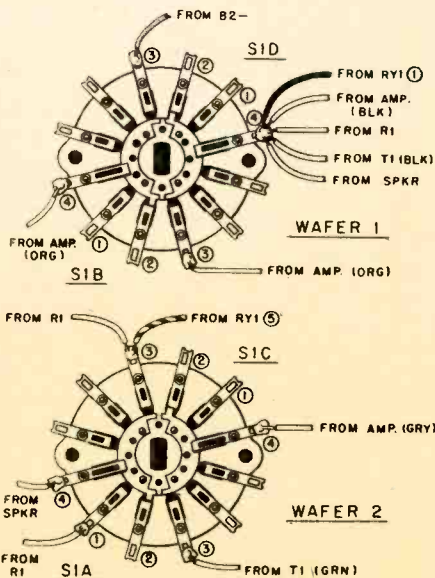

Our Friendly SECRET POLICE

By MARSHALL LINCOLN, K9KTL



Photos show three of our secret policemen:
1. Al Schuerman, W0PFG, Wichita, Kan.
2. Rev. John Healy, W2BLP, Palmyra, N.Y.
3. Cecil C. Kahn, W3BFF, Towanda, Pa.

TUNE across a ham band and you just might hear a signal sour enough to suggest a throwback to the old spark-gap and modulated-oscillator days. And you might ask yourself why someone doesn't tell the ham involved the truth about his signal. After all, you say, old Frank Charlie Charlie down Washington way will raise the roof if he chances upon the chap.

Fortunately, somebody likely will clue the errant ham in on what he's doing wrong. And, hopefully, they will do so before Frank Charlie Charlie gets wind of what's up.

This somebody will be one of the ham world's friendly secret police. More properly known as Official Observers, this devoted crew daily scans the ham bands in search of sour signals. The service, entirely voluntary, was organized by and is operated by the American Radio Relay League. The force is composed of experienced amateur operators whose chief interest is to help others put their houses in order before they get in official trouble.

Through the Official Observer corps, hams have been policing themselves for nearly 40 years. Consequently, they haven't had the troubles some other radio services have had with large-scale rule infractions.

Transmitters can go bad without warning. Spurious radiation suddenly may plop down on another ham's previously-clear frequency. Worse yet, a signal well may wallow right out of the band into forbidden territory—a commercial channel, say—and raise a real howl.

To keep these embarrassing lapses to a minimum, the Official Observers pass the word quietly to errant ops that they have strayed beyond the confines of Part 97. The postcard notifications Official Observers send aren't intended as criticism and they seldom are received as such. Instead, they are viewed as an organized, purposeful extension of the traditional helpful spirit for which most amateurs are noted.

Our Friendly SECRET POLICE

FCC officials frequently have acknowledged the service OO's render in helping fellow amateurs clean up defective signals and remedy illegal operating practices. Frank M. Kratokvil, chief of the FCC's Field Engineering Bureau, has this to say:

"The amateur fraternity's philosophy of providing self-regulation to the greatest extent possible . . . has placed the ARRL in high regard by the FCC and its predecessors. The Commission encourages self-regulation in all radio services. In the Amateur Radio Service, the voluntary work done by organized groups such as the ARRL Official Observer stations and the more than 700 TVI committees is exemplary. . .

"The Field Engineering Bureau, which operates the FCC network of radio monitoring stations, has long recognized the service to fellow amateurs that the dedicated OO group performs in reporting signal discrepancies and allowing for correction before they come to the official attention of our monitoring service."

The OO setup goes back to 1925, when a Better Operating Program was introduced by Ed Handy, WIBDI, ARRL Communications Manager.

According to Handy, "The major purpose for Observers in the twenties was detecting non-observance of assigned wavelengths by amateurs. Proper frequency observance became even more important with the coming of new regulations and the new Federal radio law in 1927. The ARRL introduced the Official Observer program as a measure for self-regulation to head off any drastic policy of license suspensions or loss of esteem for amateurs in the new Federal Radio Commission."

With the rapid growth of radio, especially those services operated by the Navy and commercial communications companies, amateurs ran an increasing risk. Severe criticism and possible curtailment of their operations well could result if they interfered seriously with other radio services. So Official Observers got busy, seeking to keep fellow hams out of the hair of commercial and military operators.

As radio regulations grew more complex and amateur operations expanded, so did the jobs of the OO's. And from a handful of OO's in the early days, there now are nearly 700 scattered over the U.S., with a few more (about 30) in Canada.

Except for recommendations from ARRL headquarters for intensive monitoring during special ham activities, each OO is on his own. He alone determines what frequencies and modes to monitor and how to set about doing so. The active OO soon learns where the trouble spots are and concentrates on them. For example, Charles E. Wilson, K8RFU, of New Philadelphia, Ohio, starts a monitoring session by checking around 7400 kc for harmonics from 80 meters. He then switches to 40-meter CW, where he looks for chirps, clicks and AC notes.

The message printed on the postcards which the ARRL supplies to the OO's is a diplomatic notification that an FCC rule has been broken. But it just as firmly states that in the interests of all amateurs, the offense should not be repeated. The ARRL reminds all OO's to use the cards, rather than call an offending ham on the air to tell him of his misdeeds. Reason is that an on-the-air comment might embarrass the violator within earshot of his friends.

As it is, only the operator who receives the postcard and the OO who sent it know about it (with the possible exception of the postman). Result is the guy who goofed can correct his mistake with no one else the wiser.

Among the FCC rule infractions which OO's are especially on the look-out for are chirping CW, CW key clicks, unstable signals of any type, overmodulated AM or flattopping SSB, modulation effects outside the phone sub-bands, any signal (fundamental or harmonic) outside the amateur bands, incorrect station identification and AC hum on phone signals or rough notes on CW signals.

Obviously, many of these violations may

Tickets issued by the Official Observer police force more properly might be termed calling cards since they are reminders, not citations, and carry no legal weight. An OO simply mails out a postcard, such as the one shown here, in order to advise a fellow amateur that he has appeared "to violate an FCC regulation."

occur accidentally, through unnoticed breakdown or misadjustment of the rig. Procedural violations, such as incorrect station identification, can occur through simple ignorance of the rules. By reminding amateur operators of their responsibilities, the OO's have helped many hams realize they should keep a closer check on operating—and in so doing probably have saved many the embarrassment of receiving an FCC citation.

In one case, for example, an OO found a violator who was radiating harmonics outside the band. This operator had bypassed his antenna tuner because he thought it killed his signal. Unfortunately, this not only allowed the fundamental to get through, but some harmonics as well.

Harmonics, incidentally, always are serious business so many top OO's devote a large part of their monitoring time to watching the harmonic shadows of the ham bands. One such segment is the 7400-7500 kc region, sometimes called Novice harmonic alley. This band of frequencies often is cluttered with harmonics from the 80-meter Novice band (3700-3750 kc).

Any ham effectively can help the OO's just by giving honest signal reports, comments Al Schuerman WØPFG, of Wichita, Kan., who spends three to four hours an evening and about six hours on Saturday and Sunday monitoring the ham bands.

"The best thing other hams could do is learn how to report a substandard signal," he says. "Since we have to rely on the other fellow's report, it should mean something.

Too many don't know what it is to give a chirp or click report or anything other than a T9. Some operators do not realize they are doing the guy a favor and not belittling his ability as an amateur."

To receive an appointment as an OO, an interested amateur must have at least four years of experience as a General or higher-class licensee, must possess suitable monitoring equipment and must pass an exam on how to recognize and analyze defective signals. Passing this test will qualify the applicant for a Class III or Class IV appointment. (Class III OO's concentrate on detecting defective phone signals, and Class IV ops concentrate on CW and RTTY.)

Appointments, incidentally, are made by Section Communications Managers in the ARRL field organization. There is at least one SCM in each state and the more populous states have several.

There also are two classes of OO's who are qualified to make precision frequency measurements, essential in verifying out-of-band operation. Class I appointments go to applicants who have demonstrated ability to measure frequencies with an error of no more than 71.43 parts per million. Class II appointments go to those applicants who can measure frequencies within 357.15 parts per million.

To maintain these standards, each Class I and Class II observer must participate in at
(Continued on page 110)

A.R.R.L. OFFICIAL OBSERVER'S COOPERATIVE REPORT

Dear Your signals were at ST
(RST) (time) (date)

calling You were using a frequency of
 when you working kc.

Your signal was

This report is *not* a citation or a "bawling out" in any sense. It is simply a friendly notice from one amateur to another, calling attention to a condition observed that appears to violate an FCC regulation. The ARRL-Observer program is designed to help amateurs help each other, keep our bands clean, and assist all amateurs to avoid FCC citation, with potential risks to amateur operating privileges. In this your cooperation is requested.

Details above may suggest a special check by yourself, or with a nearby amateur to try to duplicate conditions reported, in order to initiate corrective measures. Chapter 23 of The Radio Amateur's Handbook, as well as several QST articles may be of aid to you. Let's fix the signal today, OM. 73.

Sincerely,

.....
 ARRL Official Observer, Class
 Printed in U. S. A.

.....
 Address

Form 10 10M - 463

SKYWAY



MONITOR

There's excitement and adventure in the skies. A handful of parts lets you listen in on any broadcast radio.

By EDWARD LININGER

Kennedy control to American 000. American, you're doing 170 and United 00 up ahead is doing 150. Better slow down so you don't overtake him.

United 00 to Newark Control. I'm now over Lakewood, New Jersey.

Newark control to United 00. Would you tell me where Lakewood is in relation to Newark?

[Pause.] United 00 to Newark control. Lakewood is south of Newark.

SOUND exciting? You bet it is. Conversations between planes and airport control towers will keep you breathless for hours. (The transmissions above are approximations of what you hear; divulging exact messages is illegal.)

Last year there were 30 million aircraft flights in the United States. The number of messages required to handle them was astronomical. There are messages to move planes on the ground, directions for take-offs and landings and special instructions in bad weather.

A routine message from a private plane may ask to have a cab sent to the airport or to notify someone that the pilot will be late for dinner. From commercial planes you may hear the pilot report a stuck landing gear or trouble with an engine and request permission for an emergency landing.

You can tune in these messages with our one-transistor converter, using it in conjunction with any broadcast radio. The converter can be built for about \$10 and is a short evening's work.

Transmission and reception on the 108-136-mc VHF aircraft band usually is line-of-sight. Under optimum conditions, it may be possible to hear a plane at a high altitude that is as far away as 50 miles. If you live near an airport, the converter will keep your radio humming with activity.

But if you live in a place distant from an airport (and perhaps has many tall buildings), the band may be quiet. Chances are, you'll hear the planes, but it may be difficult to hear the tower at all times. And the band isn't always filled with continuous conversation. There will be long periods of silence, then suddenly a pilot will break through and deliver his message—and fast. Reports are snappy and to the point.

Landing a commercial or private plane re-

Electronics Illustrated

quires several carefully timed procedures. First, the pilot must call approach control when he's about 25 miles away from the airport. He identifies his airline and gives his flight number, altitude and possibly aircraft type.

It is the job of approach control to tell the pilot the positions of other aircraft near the airport. When the plane is about five miles away from the airport, approach control hands the pilot over to the control tower, which places him in the pattern. The pilot may then be told which plane to follow in and will then be cleared to land.

In instrument, (bad) weather, the pilot might be asked by approach control to make a turn so he can be accurately identified on the radar screen when there are other planes in the area. Once on the ground, a special frequency is used to give the pilot directions to the terminal.

During a flight there are numerous position and altitude reports. You may hear, "Delta 208 over Deer Park." This means Delta airlines flight 208 is over a navigational radio station named Deer Park. Or, you might hear, "Delta 208 leaving 5 for 7." This means Delta is leaving a 5,000-ft. altitude and going to 7,000 feet.

There is one important restriction to be observed. You must never use your converter inside an airplane to listen to your own pilot. Reason is, the converter radiates a signal that could interfere with the plane's communications. And the FAA prohibits the use of electronic equipment that might cause interference.

Construction. The converter doesn't have many parts but they must be kept close together and arranged the way we show them in our pictorial and photo. Our model is built on the cover of a standard bakelite box. On the back of the cover there's a piece of aluminum which was cut from a chassis bottom-plate. But you could build the converter on a piece of aluminum plate alone. The plate is required to prevent the converter from being detuned when you put your hands near it. Because of the frequencies at which the converter operates, component leads that are too long will change the tuning range.

Coil L2 is three close-wound turns of No. 18 enameled wire, wound on a 1/4-in.-diameter drill. Be sure the turns touch each other; the thickness of the three turns on our coil is 1/8 inch. If, after you remove L2 from the

drill, the windings expand, squeeze them together so that the inside diameter is exactly 1/4 in. The outside diameter of our coil is 11/32 in.

Solder L2 directly to C5's lugs as shown in our pictorial. Then mount C5, a five-lug terminal strip and potentiometer R2 close together as shown. The distance between centers of C5's and R2's shafts is 2 1/2 in. in our model.

Connect C5's lugs to the terminal strip

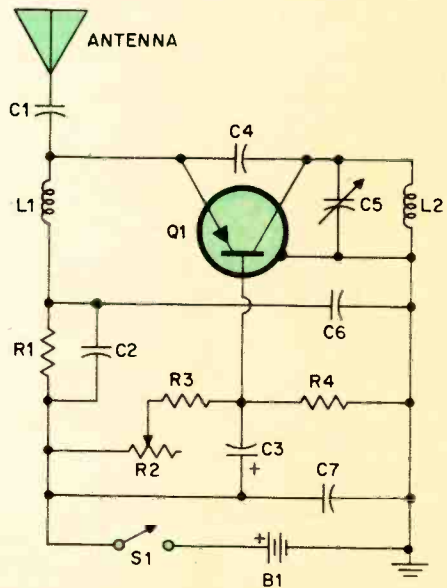

Converter is a superregen receiver (high sensitivity, wide selectivity) whose radiated oscillation is picked up by nearby broadcast radio.

PARTS LIST

- B1—9 V battery (Burgess 2U6 or equiv.)
- C1—3.3 mmf, 500 V disc capacitor
- C2,C6,C7—.005 mf, 500 V disc capacitor
- C3—5 mf, 15 V electrolytic capacitor
- C4—5 mmf, 500 V, 10% silver-mica capacitor (Arco-Elmenco DM10-050, Lafayette 30 G 3504)
- C5—2.8-17.5 mmf variable capacitor (Hammarlund HF-15, Newark Electronics Corp. 41F331. \$1.14 plus postage. \$2.50 minimum order)
- L1—1.72 microhenry RF choke (J.W. Miller RFC-144, Newark 59F259. 51¢ plus postage)
- L2—Coil: 3 turns No. 18 enameled wire (see text)
- Q1—2N2654 transistor (Amperex, Newark 21FX2685, \$1.42 plus postage)
- R1—1,500 ohm, 1/2 watt, 10% resistor
- R2—2,500-ohm potentiometer (linear or audio taper) Mallory U-7 or equiv.
- R3—3,300 ohm, 1/2 watt, 10% resistor
- R4—15,000 ohm, 1/2 watt, 10% resistor
- S1—SPST switch on R2

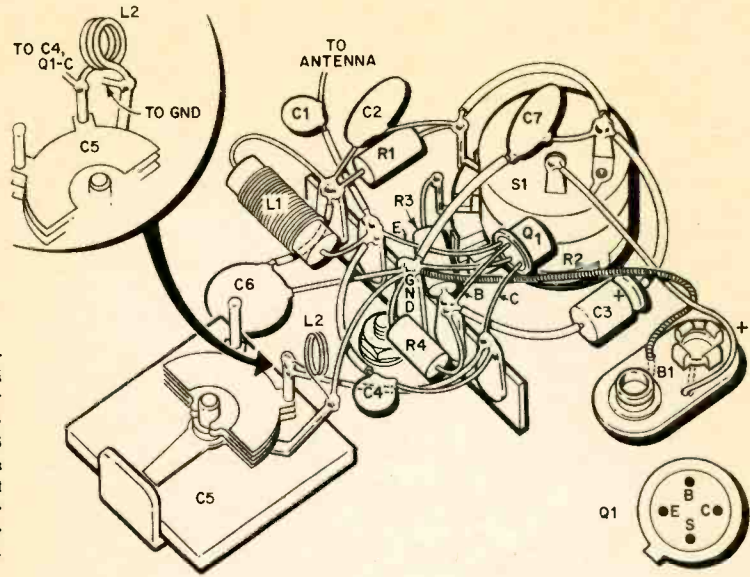

Coil L2 should look exactly like sketch above and must be mounted directly on C5 in order to tune 108-136 mc. Leads (No. 16 tinned copper wire) from C5 to terminal strip must be short and direct. The position of C4 and the length of its leads affects unit's frequency coverage

SKYWAY MONITOR

with No. 16 tinned copper wire. Mount all other components, then solder Q1's leads directly to the terminal strip. Q1's leads must be short, so use a heat sink on them when soldering. Mount the antenna (a 48-in. whip, Lafayette 99 G 3005) in the cabinet with epoxy cement and connect it via C1 to the emitter of Q1.

Adjustment. Place the converter next to a radio that is tuned to a quiet spot on the dial between 900 and 1600 kc. Extend the converter's antenna and fully mesh C5's plates. Then adjust R2 until you hear a loud hiss from the radio (you may hear this at several settings of R2).

Set up an RF signal generator for a modulated output at 108 mc and couple its output to the converter by wrapping a wire around the converter's antenna. Adjust C5 and R2 to obtain maximum volume from the radio. Mark the dial at 108 mc and calibrate the rest of the dial every 5 mc. Whenever C5's setting is changed, it is necessary to readjust R6 to obtain hiss from the radio.

If you have difficulty calibrating the low end of the dial, modify L2 by spreading or squeezing its turns slightly. The calibration of the high end is determined by C4. You may have to shorten its leads, reposition it, or use a slightly different capacitance to compensate for a different circuit layout.

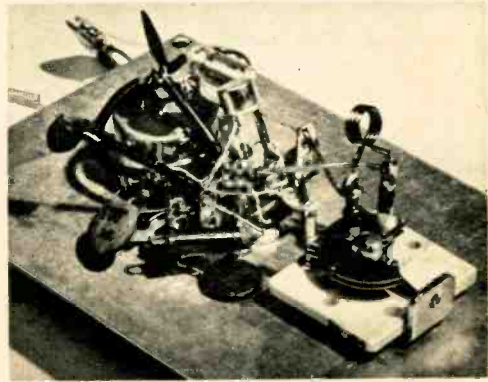

Distance between C5's and R2's shafts in our model is 2½ inches. Inspect C5 to make sure spacing between rotor and stator plates is equal.

Commercial airline traffic usually is slow during the day. But it picks up in the late afternoon and evening. Some aircraft frequencies are listed below.

FREQUENCY (mc)	SERVICE
108.1—117.9	Ground Navigation stations
118.0—121.4	Air traffic control (commercial planes)
121.5	Emergency
121.7—121.9	Ground control, airport utility
121.1—122.2	Private planes enroute
122.4—122.7	Private planes to towers
122.8—123	Private planes to airport offices
123.1—123.5	Flight test and flying schools
123.6—135.9	Air traffic control (commercial planes)

Notes

from EI's DX CLUB

LOGGING the Saudi Arabia Broadcasting Service at Jeddah now is a trick most any North-American DXer can bring off without much difficulty. Reason is SABC's new 50-kw transmitters on 9670 and 11855 kc. One of the first to spot this potent pair was Bob LaRose of Binghamton, N.Y., who says they sign off at about 1800 EST.

Perry Bradshaw, WAØBGU, has received a QSL from YS1HUKE in El Salvador. We first reported this one erroneously as YF1HUKE (NOTES FROM EI'S DX CLUB, Mar. '65 EI). It still may stand as the world's only four-letter amateur suffix.

Robert T. McDonaugh really has been around. First he claimed Virginia as home where, as K4HHW, he worked some 50 countries. Singapore came next, where, as VS1IF, he managed to lay claim to some real DX. Now residing in the Philippines, Bob currently is sweating out a reciprocal operating agreement between that country and the U.S. which he expects to come through shortly. And Bob ought to know—he's Telecommunications Officer for the U.S. Embassy there.

At last report, R. Nigeria and R. South Africa still were fighting it out for the 11900-kc spot between 1300 and 1500 EST. Nigeria has the edge east of the Mississippi, though the two broadcasters are about even in the Western states.

The Communist Voice of Vietnam has English at 1900 EST on approximately 9760 kc, with transmissions in Vietnamese before that hour. QSL's pose a problem, though you might try sending your report c/o R. Peking. (There's no postal service between the U.S. and North Vietnam itself, for obvious reasons.)

Dave Bennett of British Columbia reports hearing Govorit Kamchtski at Petropavlovsk.

Siberia, on 4485 kc. Try for this one after 2200 PST.

R. Tahiti has moved its 49M transmitter up 5 kc to 6140 where it often has a clear channel into North America. This one should be best after 0100 EST.

Another station that's taken up new residence is R. Commerce (Port au Prince, Haiti) which has moved down to 9480 kc. Station is official spokesman for Papa Duvalier and usually rules this channel from 0700 until sign-off around 2230. R. Commerce, by the way, is one of the few SWBC stations to broadcast a "live" execution. They play rough down there.

Venezuela now is on Atlantic Standard Time, i.e., one hour ahead of EST. Further, as noted by John Pirnat (Ohio), probably the easiest Venezuelan of all to log is YVLK (R. Rumbos, 4970 kc, at Caracas.) YVLK verifies all correct reports via QSL card.

Propagation: Reasonably good FM and TV DX conditions will continue through July and into the latter part of August, dropping to fair by the end of that month. Openings ranging from several hundred up to 800 miles will occur, with extremely strong signals being received for relatively short periods of time. Duration of such openings may vary from several minutes to several hours.

Conditions on the 10-meter ham band and the Citizens Band will be similar. Best time for these openings will be between 8 AM and 4 PM local time.

Broadcast-band DX will be poor during July, with some improvement toward the middle of August. Some trans-Atlantic DX may occur, but it will be rare.

Of the SWBC bands, 15 mc will be good during the day, 17 mc fair to good and 21 mc generally fair. At night, 6, 7 and 9 mc will be fair to good, with 11 mc fair.

the **SERIOUS SIDE** of **CB**

By CASEY PROBETT, JR.

HOW'S that? *Serious* CB? And who ever heard anything even slightly serious on the Citizens Band?

It is the unfortunate truth that mention of CB is likely to bring to mind a picture of idle chit-chat and sundry other illegal shenanigans. But there *is* a sober side to CB, too. CB is a serious communications medium in many areas of the country, often providing vital services to a community. For proof, consider the case of the Ridgeway-Crystal Beach Kinsmen Club volunteer ambulance service. A busy and occasionally boisterous resort area in Ontario, Ridgeway-Crystal Beach is too small to have a full-time home-town ambulance crew. And therein lies the explanation as to how a hobby was turned into a lifesaver.

When not on call, the town's ambulance and its volunteer crew can be summoned only by telephone. During such peaceful periods, CB (or GRS as it's known in Canada) conceivably could be dispensed with. But once the ambulance and crew swing into action, this radio link becomes vital.

Coming back from a run, the ambulance can respond immediately to a second call without first returning to base. Such a saving in time can mean the difference between life and death. And if the vehicle is disabled either by motor failure or collision (as happened on one occasion), a message back to base brings out another ambulance from a neighboring community. Same thing happens when the ambulance receives a second call

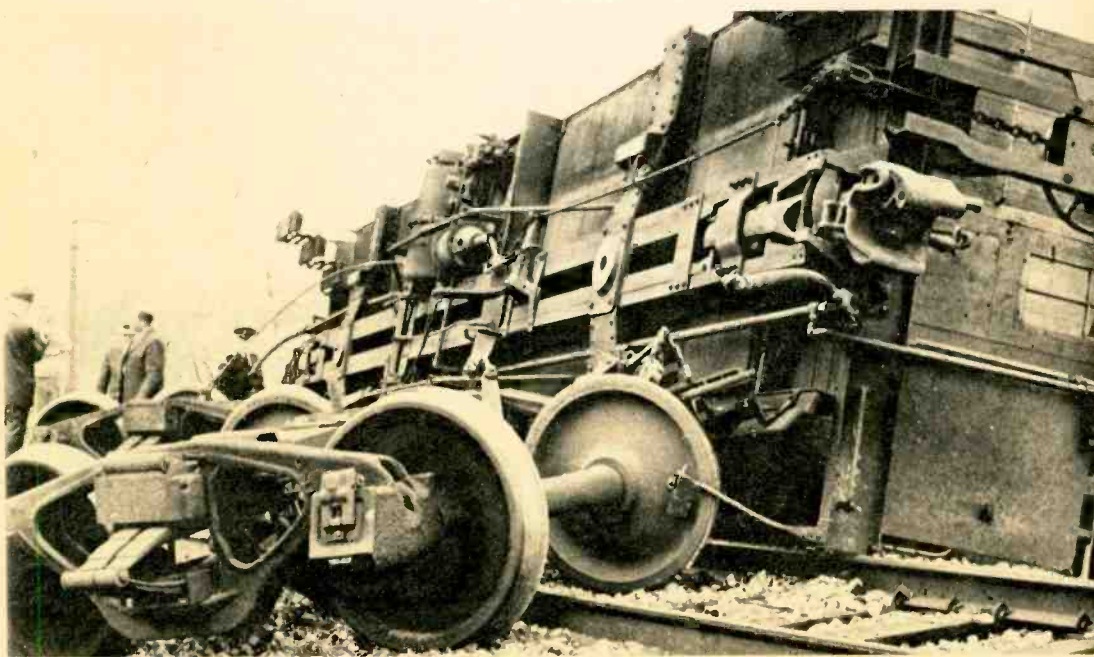

Disaster may strike once in a decade in a small community, though this doesn't lessen the need for preparedness. CBers form ready-made communications net and can rush into action any time disaster calls.

which it is unable to answer immediately.

Since Ridgeway-Crystal Beach is only ten miles west of Buffalo, N.Y., some QRM does come from this metropolis. But it's seldom a problem on channel 6, the ambulance's primary frequency. Matter of fact, the common reaction by Buffalo Cbers is to stop and listen when XM43953 goes on the air. Comments ordinarily run along the lines of, "Something is happening in Canada." And truth to tell, something is happening. Reason is that XM43953 takes to the air only for things on the serious side.

Cost of the system fortunately was low. The ambulance rig is new, though the base station (XM43256) already was in use for business and personal communications. Price of the ambulance's transceiver (a Lindsay C27, Canadian-made but similar to the Utica line in the U.S.) was \$175, a basement figure for GRS equipment. As you might guess, CB prices run quite a bit higher in maple-leaf country. And it just might be this higher price scale that has kept QRM down to the point that a serious business communications service is practical on CB most anywhere in Canada.



Canadian-built CB rig in Ridgeway-Crystal Beach volunteer ambulance cost a mere \$175, yet it multiplied vehicle's effectiveness countless times. Though emergency crew is recruited by telephone, they rely on CB for instant communications when a moment lost can mean a human life.



Volunteer ambulance, a natural for serious CB, easily can be radio-equipped.

Smile on volunteer medic's face reassures accident victim that the worst is over. Serious CB speeded rescue operation.

Continued from page 38

Would it ruin the speaker?

A. It depends on the amplifier. If it's a PA amplifier with heavy feedback, you might get passable sound with reduced output at each speaker (compared to one speaker alone). If it's a hi-fi amplifier, you most likely will get reduced output with heavy bass and distortion. Then again, you might get no bass with lots of distortion. You won't ruin the speakers but you might ruin your ears.

Q. *I have a pair of stereo headphones. When I plug them into my SWL receiver I just get sound in one ear. What do you think is wrong with my left ear?*

A. We are not permitted to make medical recommendations. However, if reversing connections to the headphones doesn't give you sound in the other ear, you are suffering from plugitis. Explanation is that stereo phones utilize a three-circuit plug. The left channel is connected to tip and sleeve, and the right channel connects to ring and sleeve (or vice versa).

An SWL receiver, in contrast, relies on a two-circuit hook-up—tip and sleeve. What this means in your case is that there's no connection to ring and sleeve on the stereo plug and the associated earpiece, therefore, receives absolutely nothing. You must convert the stereo plug to mono operation by soldering a jumper across the tip and ring terminals. Or you could install a matching jack in the receiver and short the tip and ring terminals.

Q. *I have a \$1.50 earphone. What will happen if I plug it into the headphone jack on my SWL receiver? Would it get blown out?*

A. No. As a general rule (and there are exceptions), any headphone can be used on an SWL receiver.

Q. *I have a 37-37 watt stereo amplifier and a pair of stereo phones (hi-fi type). What would happen if I hooked the phones directly to the speaker terminals (output terminals on the amplifier, that is)?*

A. If you have crystal phones, you might—though it's rare—burn out the output transformer or arc-over the output tubes. But if you have low-impedance phones, go ahead and connect them—that's what you're supposed to do. And if this results in excess hum, follow the manufacturer's recommendations for reducing sensitivity.—*Bert Mann*

Telcan, You Say?

IN THE beginning was the word. And the word was Telcan.

Our story, of course, is about the famous home video tape recorder. Many happy Telcan owners are taping away at this very minute. Their instruments were purchased from local department or electronics stores for a paltry \$160. Or \$500. Or so. We know, because just about every publication (except EI) said that this was going to happen.

That promise was given some eight or nine home videocorders ago. A lot has happened in the meantime. Which just may explain why we've had trouble finding a friend who owns a home video taper (let alone a store that sells one).

Not that we haven't tried. Soon as we got word that Telcan had reached a working



First slow-speed home video taper. Loewe-Opta's Optacord 600, will sell for \$2,500, is supposed to be on the market this year.

agreement with Cinerama, Inc., here in the U.S., we notified Cinerama of our desire to be first on the block with our own videocorder. Howard Minsky, Cinerama's vice-president in charge of something or other, wrote us back. He thanked us for our interest and promised us brochures—but no recorders.

Undaunted, we next tried to beard Telcan in its den near Sherwood Forest in England. Telcan's commercial director, J. Jones, acknowledged our efforts with a mimeographed letter. It told us our neighborhood stores would have recorders in plenty of time for Christmas shopping. That was last year.

Then Telcan declared bankruptcy.

Fortunately for us, we hadn't been putting

The Ionosphere

Continued from page 77

all our eggs in one basket. For Fairchild Camera, meanwhile, had demonstrated a somewhat better machine, going at what Fairchild said would be a slightly higher price. So we contacted Fairchild—only to learn that the slightly higher price was \$3,000 (or \$6,000, depending on which Fairchild executive answers your letter).

If you happen to have that kind of loose change lying around, you probably already have a Fairchild recorder. They went on sale in April, according to company forecasts.

These machines, by the way, like others announced by the Illinois Institute of Technology and Ampex, are alleged to consume tape at 120 inches per second or thereabouts.

So the battle of the speeds began, with Fairchild adding 60 ips to its machine. Par, Ltd., a research group in Baltimore, countered with a two-speed, 60- and 30-ips recorder, which has yet to see the light of the marketplace. Then Loewe Opta, a German firm; Philips Industries of Eindhoven, Holland; and Sony Corporation of Tokyo all moved in with machines operating at 6 or 7½ ips.

The German and Dutch models, which the respective press releases assure us will be in your neighborhood stores by the time you read this, are priced competitively with Fairchild's unit. The Sony Videocorder 2000 is intended to compete with the Par device for the \$500-\$600 market. And Sony vice-president Akito Morita said last December that his firm's machine would be in the stores by now for sure.

But England wasn't about to give up its paper-publicity lead in videocorders. In Worcester, a scant 70 miles from the remains of Telcan, Wesgrove Electronics' chief sales agent, Jack Jones, announced that his company had a video tape-recorder. Offered to American do-it-yourselfers through an agent of an agent, the VKR 500 is supposed to come in 20 packets at a total cost of \$450.

We haven't seen this one yet, either—because Mr. Jones at press time still hadn't found an American distributor and the only firm we could discover in on the act didn't have a unit on hand for some reason or other.

But to return to Telcan: we know, because we read other electronics publications, that our local dealer has at least four videocorders in stock right now. Trouble is, our man doesn't have any.

We're thinking of switching dealers.

—Bob Angus

2,120 kc. These signals pass through the region affected by the gyro wave from the big transmitter and are reflected from a higher point in the ionosphere.

Echoes of these probing pulses are measured electronically. And the extremely sensitive instruments used enable the physicists to detect even the smallest changes in ionospheric density.

Some idea of the nature of the antenna array used for these experiments may be gained from our photo below. In addition to the above-ground installation, 31 copper wires running under each plane-wave array have been buried in the ground in an effort to maintain the system's stability and reduce its energy losses. Generally speaking, the installation looks something like that of a low-voltage power line.

Unfortunately, Bailey's man-made moonlight remains only a romantic theory. No visible glow yet has been produced and Smith says little satisfaction is expected in this direction at present. Reason is that the transmitter is well below the projected power requirements.

But while the current project has been costly, the installation well may uncover new facts on a number of current unknowns. And Bailey's theory that man can effect ionization with beams of radio waves yet may have practical applications. Who knows? You even may be able to order a 10-meter-band opening one of these days!

—Bob Swearingin, W5HJV

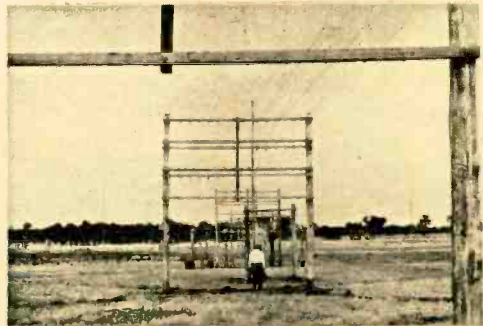

Antenna now being used for ionospheric research in Australia consists of a circularly polarized array containing 40 horizontal half-wave dipoles.

Sun-Powered TV Booster

Continued from page 51

diameter) drill. Wind $\frac{1}{2}$ turn more than required to allow the coil to spring back when the winding tension is removed.

RF chokes L4, L5 and L6 are each 10 turns of No. 24 enameled wire wound on pig-tail ferrite forms. Solder the wire to the leads at each end of the form.

After the coils are wound, install them and all other parts on the board. Clip all leads short and tin the entire copper foil to protect it from the weather.

Install terminal strips TS1 and TS2 exactly where shown by soldering their lugs directly to the board. Their position is important as they form the ends of the enclosure for the booster.

A case for the booster can be made with a plastic box or from lightweight aluminum—the type used for flashing in construction work. It is available from hardware stores or building-supply firms. Line the inside of the case (if metal) with masking or electrical tape to prevent the rear of the circuit board from touching the case.

The top and sides of the case must be sealed to protect the booster from the weather. If the sides extend slightly below the board, a bottom will not be required on the case. Wrap tape around the hole in the case where the lead from the solar cell enters. And to be on the safe side, add rubber cement around the hole. Details for mounting the solar cell and the booster are covered in the caption for Fig. 5. The power supply is built in a $2\frac{1}{4} \times 2\frac{1}{4} \times 5$ -inch Minibox. Its construction is straightforward.

Checkout. Connect your TV antenna to the booster's input (TS1). Connect short lengths of twin-lead between the booster's output (TS2) and the power supply (TS5), and between the power supply (TS6) and the TV set. Put the solar cell about a foot away from a 60-watt light bulb. If the booster is working properly the TV picture will be better than it was before. If the picture is not improved reverse the connection at one end of the twin-lead between the power supply and the booster.

While watching a picture, peak the booster for best picture on channels 2-6 by squeezing together or spreading apart L3's turns. Channels 7-13 are peaked by adjust-

ing L1 in a similar manner.

If there is no improvement in the picture, connect a voltmeter to TS2 or TS5. It should indicate approximately $4\frac{1}{2}$ volts. If it indicates zero, disconnect the TV set. If you now get $4\frac{1}{2}$ volts, it means C8 or C9 is shorted. If the voltage is substantially higher than $4\frac{1}{2}$ volts or there's AC on TS2 or TS5, there's trouble in the power supply.

Another reason for no voltage at TS2 or TS5 is a short in the power supply. To check this, connect the TV set directly to the booster output (TS2) through .001 mf capacitors. With the solar cell supplying power, there should be $4\frac{1}{2}$ to 6 volts (depending on the light intensity on the solar cell) at TS2. **Caution!** Do not use a lamp larger than 60 watts and do not place it closer than a foot from the solar cell. Voltages at the base, emitter and collector of Q1 should be 4.28, 4.5 and 0 volts respectively.

Diode D1 permits power from the solar cell to charge the batteries and prevents power from the batteries from damaging the solar cell. S1 should be opened when the AC power supply is not being used to prevent R5 from discharging the batteries.

Note: The circuits we have shown in this article are for combined AC, solar cell/N-C battery operation. For solar cell/N-C battery operation only, omit T5,D2,R4,C7,R5 and S1. For AC operation only, omit the solar cell, B1,B2 and B3. For penlite battery operation only, omit the solar cell, T5,D2,R4,C7, R5 and S1.

MPG Indicator/Tachometer

Continued from page 72

Set S1 to MPG and put the car in neutral. Depress the accelerator to the point where the engine just speeds up (this was about 1,000 rpm in our car). Adjust R9 so M1 indicates mid-scale, then tighten the coupler set screw.

Drive off slowly, keeping the accelerator moving downward so you accelerate at a steady 1 mph per second (at the end of 30 seconds you should be going 30 mph). M1 should stay at mid-scale. If M1's indication increases, shunt R9 with a 5,000 ohm resistor. If M1's indication goes down-scale, put a 500-ohm resistor in series with R9. Then, with the car stopped, reset R9 for a mid-scale position as before.

What The Heck's a XAM?

Continued from page 47

standing face-to-face with one.

Some private-label speaker people simply don't invite comparison. One man we contacted was quite polite in letting us look over his wares. But another flatly declined on the grounds that any examination of the interior of his unit would "ruin the acoustic seal," thus rendering the unit useless—which only makes us wonder what he's putting inside.

How can you tell what you're getting when you go shopping for a speaker? So long as you know what you're getting and how to buy, you'll have no problem. But there are some ground rules:

- Ask to see what's inside the private-label system the salesman is demonstrating. If he won't show you, ask for a detailed description. If you can't get one, beware.

- If you do get a look inside, notice the size and type of magnet on each speaker. The more massive the magnet, the better the sound the speaker should be able to produce. Is the basket which holds the speaker die-cast or stamped metal? The latter usually indicates a low-cost replacement-type speaker.

- Buy from a store which will let you exchange the speaker if you're not happy with it. Reputable dealers are willing to let you try the equipment you select at home. If you don't like the speaker you've selected after a reasonable trial, be sure you can take it back.

- Listen carefully when you shop. And remember there are differences between listening conditions in a dealer's showroom and those in your living room.

- Careful listening can be an accurate guide to speaker sound only when you know what to listen for. High-frequency reproduction presents little challenge for speaker designers and manufacturers. What does present problems are such matters as crisp, clean bass reproduction and proper reproduction of transients. You can get a pretty good idea of a speaker's quality by listening to a female pop vocalist singing with a small combo. Does she sound as though she's holding her nose? Then there's a pinched quality in the upper frequencies. Does the combo tend to drown her out or move her to the rear? Then the speaker system lacks definition.

Or take a small instrumental group. Can you follow the violin all the way through the

score, next the cello and finally the bass viol? Or do they tend to get lost in a blend of sounds? The ability to reproduce each instrument or vocalist separately and distinctly is the mark of a good speaker system.

And how about that bass viol? Does it boom, or are you merely aware that it's present? Remember that bass viols don't boom in the concert hall. Can you hear the breath of the flutist in a flute solo? You should be able to. And when the percussionist strikes a triangle, it should stop when he wants it to, rather than continuing to ring.

In short, a speaker is supposed to reproduce the sound, the whole sound, and only that sound which is fed into it. And brand-name or private-label, it's still up to the would-be purchaser to nibble at the pudding and see what the eating proves. —

SWL Club Shape-Up

Continued from page 56

wanted a constitution and elected officers, both of which they now have. The club bulletin deals primarily with BCB matters and, during the BCB DX season, at least, it appears weekly. Annual dues are \$4.

- **Kentucky DXers Assoc.**, 546 Pond Run Rd., Raceland, Ky. 41169. A small, all-band organization with original ideas, a constitution and elections. Dues are \$2 a year.

- **National Radio Club**, Box 63, Buffalo, N.Y. 14215. Founded in 1933, this BCB DX organization did away with all elections a few years ago. Its bulletin offers good DX coverage and appears weekly during the BCB DX season. The club provides taped reports for station WRUL's DXcast; annual dues are \$4.

- **Newark News Radio Club**, 215 Market St., Newark, N.J. 07001. Largest and oldest of all DRL clubs, this one was founded in 1927. Its bulletin offers good, all-band coverage; dues are \$5 a year.

- **North American Shortwave Assoc.**, 1503 Fifth Ave., Altoona, Pa. 16602. Second-largest DRL club in North America, this one has neither elections nor a constitution, though the latter supposedly is in the works. Its bulletin offers lively reading and fair all-band coverage, and the club on occasions has produced DX programs for station WINB, Red Lion, Pa. Dues are \$3 annually.

—Don Carter —

WHO SAYS HOBBIES HAVE TO BE EXPENSIVE?

**for less than \$50
you can open a
new world of fun
with**

HEATHKIT® ELECTRONICS!

start now by sending for this FREE catalog 

Shortwave!



GR-64
\$39.95

Heathkit Shortwave Listener's Radio

Covers 550 kc to 30 mc—includes AM plus 3 shortwave bands; 5" speaker; lighted bandspread tuning dial, relative signal strength indicator & 7" slide-rule dial; 4-tube circuit plus 2 rectifiers; low-boy cabinet styling; 13 lbs.

Ham!



HW-30 \$44.95

Heathkit 2-Meter Transceiver

Ideal for local net, MARS, CAP, & emergency operations; crystal-controlled transmitter; 5 watt input; tunable super-regenerative receiver with RF stage; 9 lbs. (6-meter model HW-29A... \$44.95).

Repair!

Heathkit Vacuum Tube Voltmeter

Single AC/Ohms/DC probe; 7 AC/DC/7 ohm ranges; 1% precision resistors; freq. response ± 1 db from 25 cps to 1 mc; voltage doubler rectifier; 5 lbs. (also available wired, IMW-11... \$39.95).



IM-11
\$24.95

Stereo!

AA-32
\$39.95



Heathkit 16-Watt Stereo Amplifier

4 stereo inputs... mag. & ceramic cartridges, tuner & auxiliary; 20 watts IHF music power; full controls; easy-to-build; 16 lbs. (matching FM stereo tuner AJ-13 available @ \$49.95).

CB!



Heathkit 9-Transistor "Walkie-Talkie"

Up to 1-mile inter-unit operation; no FCC license required; crystal-controlled transmit & superhet receiver; includes crystal (specify freq.); less battery; 3 lbs. (pair @ \$74.95).

GW-21 \$39.95 each

Auto!

GDP-134
\$34.95



Heathkit/NELI "Trans-nition" System

4-transistor, zener diode protected circuit; operates on 6 or 12 v. DC batteries; completely sealed against moisture, corrosion; simple to assemble & install; save \$35! 7 lbs.

Workshop!



GD-973
\$17.50

Heathkit Motor Speed Control

Reduces power tool speed without loss of efficiency; maintains high torque power; extends life of any power tool with AC-DC motor rating of 10 amps or less; simple to build; 3 lbs.

Home Study!

EK-2A
\$19.95
Part I



Heathkit 2-Part Basic Radio Course

Learn radio & communications theory; simplified text & kit; Part I results in regenerative receiver; Part II, also, \$19.95, results in 2-band superhet radio; 7 lbs.



FREE CATALOG!

See these & over 250 other Heathkits. Save up to 50% by doing the easy assembly yourself. Send for your free copy today.

HEATH COMPANY, Dept. 39-7
Benton Harbor, Michigan 49023
In Canada: Daystrom, Ltd., Cooksville, Ontario



Enclosed is \$ _____, plus postage. Please send

model(s) _____

Please send my Free 1965 Heathkit Catalog.

Name _____ (Please Print)

Address _____

City _____ State _____ Zip _____

Prices & specifications subject to change without notice. CL-201

How Do Planes Find Their Way?

Continued from page 67

Third set of signals essential to a complete ILS installation are the markers. An outer-marker transmitter is located between four and seven miles from the approach end of and in line with the runway. Middle markers are about 3,500 ft. from the runway. (The exact distances for a particular airport are shown on charts used by pilots.) Each of these markers transmits a characteristic signal straight up so that a pilot knows when he passes over the marker.

All markers transmit on 75 mc and are received on fixed-tuned receivers in aircraft equipped for instrument flight. The outer marker is amplitude-modulated with a 400-cps note keyed with a rapid series of dashes. The middle marker is modulated with a 1,300-cps note, keyed with alternate dots and dashes.

In a few cases, there is a boundary marker about 300 ft. from the end of an instrument runway, modulated with a 3-kc note keyed with a continuous series of dots. Most airports, however, do not have boundary markers.

The bulk of ILS receivers incorporate audio filters so that reception of each marker signal causes a light on the instrument panel to flash. The outer marker triggers an amber light, the middle marker a purple light. The audio notes from these marker transmitters also can be heard in the pilot's speaker or headphones.

It often comes as a surprise, even to people fairly familiar with aeronautics, to learn that there is no such thing as true blind flying. Radio and radar bring an airliner close to the end of a runway but if the pilot can't see it he is not going to land. Our equipment still is not good enough for safe landings in zero-zero (no forward visibility, no ceiling) weather. Many true blind landings have been made but all were experimental and without passengers. The touch down remains a job for human eyes, though work is under way on equipment that would bring a plane all the way down. (Brief descriptions of systems currently in use appear in our glossary at the end of this article.)

The misconception probably lies in the fact that cadets talk much about practicing blind flying (what they mean is *almost-blind*

flying) and airliners long have been able to fly blind so long as they stay up. They just can't land. Radio can get them close. But it can't do everything—yet.

A GLOSSARY OF AERONAUTICAL FLIGHT TERMS

- ADF**—Automatic Direction Finder—Indicates direction from aircraft or ground station to another ground station or aircraft.
- ARSR**—Air Route Surveillance Radar—High-power, long-range radar used by air-traffic control centers to track aircraft over hundreds of miles and keep adequate separation between aircraft.
- ASR**—Airport Surveillance Radar—Low-power radar which scans sky in vicinity of airport to enable ground controllers to track all aircraft in vicinity.
- DME**—Distance Measuring Equipment—Measures distance from ground station to aircraft. Frequently combined with VOR stations in installations called VORTACs.
- ILS**—Instrument Landing System—Informs pilot whether he is too far left or right, too high or too low, for proper landing.
- PAR**—Precision Approach Radar (also known as GCA, for Ground Controlled Approach)—Enables ground radar operator to monitor descent of any aircraft toward runway. Voice commands given pilot by ground operator guide his descent along correct glide path.
- TACAN**—Tactical Air Navigation—A military system combining the functions of VOR and DME. Measures direction and distance from a ground station to an aircraft.
- VOR**—VHF Omnidirectional Radio Range—Basic radio navigational system used by commercial and private aircraft. Indicates direction from a ground station to an aircraft.

Far Out Facts On Tape

Continued from page 53

Studying the relative capabilities of records and tapes as storage media several years ago, the Library of Congress concluded that tape based on polyester might be expected to last virtually forever, given proper conditions. Acetate tapes, in contrast, would last at least a decade. These facts help explain why tape is used as a sound-storage medium by every major recording company in the world, by most of America's broadcasters and by the Library of Congress (which maintains one of the nation's largest sound archives).

Interestingly enough, Britain's largest sound archive, that of the British Broadcasting Corporation, prefers to store its sounds on discs. Reason is that the BBC, ever conservative, feels tape is more difficult to handle. Besides, argues the BBC, it hasn't yet proven itself.

Watch Your Modulation

Continued from page 55

pansion is 75 per cent modulation.

Set the Spectrum Monitor's rate control R44 full clockwise and you will see the waveforms of your voice. The previous adjustment gives you what is called a modulation waveform.

To obtain the trapezoid display, make the modification to your transceiver shown at the top of the second page of this article. Rotate the Monitor's rate control R44 full counterclockwise until you just hear the switch click. As you speak, the carrier level will appear as a straight vertical line. Advancing the pot on the transceiver will cause the pattern to expand horizontally. The pattern will form the familiar trapezoid (a perfect triangle) at 100 per cent modulation.

If you over modulate the pattern will expand beyond the 100 per cent marks and there will be a bright line or tail on the baseline. Our diagrams show several typical modulation patterns that you can expect to see on the Spectrum Monitor. For more extensive coverage of modulation displays, consult the Radio Amateur's Handbook.

CB Corner

Continued from page 82

rate less hash. The vibrator kind, however, is far from obsolete and currently is priced significantly lower.

Choosing the proper pack is chiefly a matter of determining the correct wattage rating. The CB manufacturer usually states a wattage figure in the rig's instruction manual—generally about 50 watts for tube rigs, less than half that for transistor units. Once you find this figure, check the converter listings. There are two power ratings for each: continuous and intermittent.

To get the most inexpensive converter of proper capacity, select one on the basis of its intermittent rating. This should take care of the transmitter, which draws heaviest power but operates only for short intervals.

And if you're the kind who likes the conveniences of home on the road, just unplug the CB rig. The converter also will power an electric shaver, mixer and small power tools, not to mention your electric toothbrush.



LONG NOSE AND
DIAGONAL PLIERS

look to
Xcelite for
the best in
pliers & snips, too

CHAIN NOSE ELECTRICIAN'S
PLIERS



RADIO AND TV PLIERS



COMBINATION
SLIP JOINT PLIERS



NEEDLE NOSE PLIERS



SIDE CUTTING PLIERS



TRANSVERSE
CUTTING PLIERS



UTILITY PLIERS



ELECTRONIC SNIPS



Same professional quality as famous Xcelite screw drivers and nutdrivers. Forged alloy steel construction. Precision machined. Scientifically proportioned. Variety of sizes. All available with permanent, plastic coated Cushion Grip handles for extra working comfort (except slip joint models).

XCELITE

XCELITE INC. • 16 BANK ST., ORCHARD PARK, N. Y.
Send Catalog Sheet N664 on pliers and snips.

name _____
address _____
city _____ state & zone _____

Common Sense About CB Antennas

Continued from page 31

footer. Efficiency, however, is reduced somewhat. And deciding just where to put that loading coil is anything but easy.

In the base-loaded whip the coil, located at the bottom, is most satisfactory mechanically. It sways least and keeps signals constant, though it also tends to concentrate radiation at the low end. Raise the coil up to the tip of the whip and radiation improves, but sway and possible damage also are increased.

One obvious compromise between the two extremes is the center-loaded whip. And still another bid for the best of both worlds is the continuously loaded whip, where the coil is distributed, in spiral fashion, over the entire whip length. Only drawback here is that the wire must be wound on a relatively rigid form—fiberglass, say—and thus is less resilient.

Which mobile antenna is best? Though there are no major differences in relative performance, there is a rule-of-thumb worth following: the more whip length and the less loading coil, the better. And if you're willing to plant even a short, loaded whip in the center of the car roof, chances are performance will be excellent. It even can beat the full-length 9-footer since the car roof makes an efficient, uniform ground-plane.

Oddballs. Beyond the ground-plane, collinear and whip lies the exotic realm of the oddball antenna. But most really aren't as different as they seem. Instead, they're more like round and straight pretzels; the dough's the same, the application different.

Take the recent Squalo, for example. It's a squared-off dipole lying on its side. Since it is horizontally polarized, it reduces much noise interference, which tends to travel vertically. Thing is, the Squalo won't work well with other CB stations unless they, too, have horizontal antennas.

Also on the oddball front are the combined horizontal/vertical jobs which give you a choice of two polarizations; vertical for all-round communications, horizontal for point-to-point. These have been joined by the so-called phased antennas where two collinears are installed. This arrangement permits the operator to switch-select his coverage pattern at will.

Whether you choose a conventional or oddball antenna, be prepared to play the usual juggling game. As we have seen, several features—gain, physical construction, mounting style—tend to conflict with one another and only you can decide the cut of the compromise. Study the manufacturer's literature for each of these details. Apply a heavy dose of common sense—without the delusion of split-hair differences in specs—and you'll come up with the *best* antenna for you.

Finally, don't overlook the fact that antennas must perform as well mechanically as they do electrically. With wind and rain beating down on the antenna structure, a few more dollars shelled out for high-quality construction frequently can pay off handsomely.

Our Friendly Secret Police

Continued from page 95

least two of the four ARRL frequency-measuring tests each year. (These tests are run by the League's own station, W1AW, on the low ends of the 80-, 40- and 20-meter ham bands.)

OO's measure specific transmitted signals and submit their measurements to the ARRL. An independent frequency-measuring laboratory also measures the transmitted signals and OO results are compared with laboratory figures. OO's who fail to measure up to standards lose their appointments.

Except for postcards and record-keeping forms furnished by the ARRL, OO's receive no supplies or equipment from outside sources. They use their own receivers, scopes, frequency meters and antenna systems. They also obviously must contribute a lot of operating time to monitoring and sending notices.

And lest it sound as though bum signals mean bum hams, it should be pointed out that even the experts foul up sometimes. W1JNV recalls sending a notice for key clicks to a Canadian station and later learning it was being operated by an inspector for the Canadian Department of Transport, which is comparable to our FCC.

When the inspector wrote back, his letter told a familiar story. He had thought all along, of course, that his signal was clean. But when he took a good look at it on a scope, sure enough, there were the spikes.

Radio's Impossible Impasse

Continued from page 62

the movement of large amounts of air (and thus can be made small enough to be used in tiny transistor sets). The same engineers already have created tuning devices less than 1/4 in. in size—infinately smaller than American engineers thought possible only a decade ago.

"What would you do with a radio in the eraser of a lead pencil if we did make it?" asks one manufacturer. "How many people would have practical use for anything that small? And would they be willing to pay for an item which is a very expensive novelty?"

Answer is that Americans seem quite prepared to pay for any type of radio which strikes their fancy. During the past year, however, some manufacturers concede, the industry was so busy competing at the profitless level of \$9.95 for six-transistor midgets and five-tube AC/DC sets that the public slipped one-up on everybody simply by not giving a damn.

The Listener

Continued from page 81

The Rare Ones . . . Every SWL has heard HCJB in Quito, Ecuador. Its potent signal penetrates into all corners of this continent and logging it requires no skill. Question is, why do so many listeners stop there and fail to go after more difficult Ecuadorian stations?

At the provincial capital of Ibarra, for example, there's HCDF1, La Voz del Norte, on 5897 kc. This one programs mostly authentic Ecuadorian music and any folk-music fan of the international variety is certain to find it of real interest. But music-programming notwithstanding, La Voz del Norte is DX; HCJB is not. Shocked?

Similarly, most listeners have no trouble hearing the O.R.T.F. relay station at Brazzaville, Congo Republic. Reason is that it transmits on numerous frequencies with plenty of watts. But how many SWL's have logged the Brazzaville government's own R. Congo on 4845?

Same thinking can be applied to strong-lunged R. Japan (run by the government-owned N.H.K.) as opposed to Japan's com-

mercially-owned N.S.B. (3925, 3945, 6055 and 9595 kc). Or the Korean Broadcasting System's Voice of Free Korea as opposed to The Voice of the United Nations Command on 9415 kc and other channels.

By this time our point should be clear. The number of countries verified by a DXer isn't the only test of his prowess. And the saddest thing about the countries game is that it often is pure statistics, not prowess, that's being counted.

But statistically—and we do live in an age of statistics—countries possibly are the only practical way of rating DXers. Just the same, it would be nice if someone could invent a replacement for the DX numbers game.

The Rarest DX Of All

Continued from page 89

ered rare *because* of the weird QSL's they offer. Venezuela certainly isn't any great shakes on the ham bands, but any amateur might consider YV5BFN's card a worthy addition to his collection. Matter of fact, many amateurs take pride in issuing unusual cards, some of which EI wouldn't dare print.

Offbeat QSL's are considerably rarer in other radio services. And it is for this reason (and others) that a rarity called RADIKA makes such an inviting target. For the record, RADIKA is a BCB station at Paramaribo, Surinam. Sometimes received in North America around 0400 EST, the station verifies with a distinctive QSL featuring a three-armed gal perched atop the antenna.

To make the logging a little more distinctive, the station transmits primarily in Hindi and verifies only once in a while. But then, Hindi lingo from a once-in-a-blue-moon station is the stuff the rarest DX is made of.

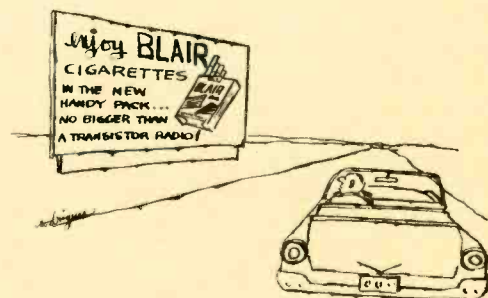



Electro-Toot School

GERMANY—West Germany, that is—has a way with trains that puts most other nations into rear-of-the-coach seats back around the caboose somewhere. For as any traveler on Europe's trains well knows, Germany's railroads easily rate among the world's best.

Excellent equipment and split-second scheduling both figure in explaining why railroads carry some 45% of inter-city passenger traffic in Germany as opposed to 3% in the U.S. And the German Federal Railroad's newly opened electro-toot school ranks as still another effort to insure that Germany's railroads maintain their enviable reputation.

Because all railway lines in West Germany are being electrified, the Railroad decided a school was needed to help engineers bone up on the inner workings of electric locomotives. And a school it now has, complete with life-size, electrified mock-ups of the very locomotives engineers are to drive. (Our photo shows a portion of the school, with an exploded view of an engine in the background.)

Located at Munich, Bavaria, the school boasts most every electronic teaching aide known. And its record already is nearly as outstanding as the railway it serves.

—H. F. Kutschbach

TV Call Box

Continued from page 92

Connect the lead from lug 1 on RY1 to the other lug on the TV set's speaker without disturbing the existing wiring to the speaker. Run the cable out of the rear of the TV set, put the back on and you're ready to go.

By the way, the connections to any other speaker circuit, whether it be in a table radio, short-wave receiver, or CB transceiver are the same.

After the system is installed, give it one more check. Set S1 to *talk*. This should kill the TV sound and when you speak into the control unit you should hear your voice from the TV set. You control the volume of your voice with R2.

Set S1 to *listen*. You should be able to hear the TV sound at the control unit and be able to control its volume with R1. To shut the system down, set S1 to *off*.

Budget Ham Station

Continued from page 69

restored, it takes a while for the receiver to settle down again.)

The 500 doesn't have this problem because in the standby mode the detector is grounded and B+ is not removed from any part of the circuit. Because the receiver does not have AVC, a strong station can cause overload and the gain has to be reduced manually with the RF gain control.

Since the 400 and 500 are companion units, we wish antenna switching had been provided. But you can replace the mode switch with a double-pole type and use the extra set of contacts to control an antenna changeover relay.

Since the transmitter and receiver are the same size, they can be made into a very attractive portable station by simply bolting one unit on top of the other. Then put a handle on the top unit and you've got a complete station that easily can be carried (20 pounds) wherever you go.

After a couple of satisfying QSO's, we realized that in terms of its low cost and outstanding performance, the 400/500 combination makes an excellent first station.

The Dream That Won't Die

Continued from page 28

propel the rotors and keep the vehicle flying.

When the pencil pushers really got to work, though, they found that the gas-turbine idea wasn't as hot as they had thought. Getting enough power up to the helicopter would be no problem. Catch was that there was no good way to scoop that power out of the air and convert it into usable form once it got to the helicopter. The first idea—turning it into heat and using that heat to drive a turbine—was far too inefficient to be practical.

The answer came from a group of scientists at Purdue University. A professor of electrical engineering, E.M. Sabbagh, had set up an array of point-contact silicon diodes and sprayed them with microwave energy. Sabbagh found that the solid-state devices soaked up power from the air like sponges.

In the summer of 1963 Raytheon wired together a flock of the diodes, mounted an electric motor on top and hooked a helicopter rotor to the motor. The gadget flew under its own power—beamed from the ground—on July 1, 1964.

To be sure, the Raytheon helicopter is a relatively crude affair. Then, too, it's not completely free-flying but relies on a guide wire to hold it over the transmitting antenna. But automatic guidance controls that would apply correction when it begins to drift out of the beam could be built. (A similar system holds the beam-riding Nike missile on course.) And though the world's first radio-powered vehicle may be crude, it has proved its point: the old dream of wireless power transmission yet may come true.

One catch still is cost. Copper wire remains the cheapest way to transmit power; radio transmission is practical only where its great advantages outweigh the equally great expense. Raytheon has done some figuring and concluded that anyone wanting to operate a large microwave-powered flying platform at 10,000 feet for ten years would have to pay about \$25 an hour. A system operating at 50,000 feet—and able to cover considerably more area—would run \$50.

While that sounds like a lot of money, it's almost insignificant when compared with operating costs of the present airborne electronic sky stations it could replace. Radar

[Continued on page 115]

FOR SPEEDY SERVICE

1102171 647 98 24 0664

T M BROWN

5936 23rd PARKWAY

WASHINGTON, D. C. 20031

WE'RE LOST WITHOUT THIS LABEL

Well, not really lost—but we can do things faster for you if you send along the ADDRESS LABEL from your magazine any time you write to us about your subscription.

CHANGE OF ADDRESS

If you're moving, please let us know six weeks before changing your address. Better still, attach the magazine address label to this form, and print your new address here.

name

street

city

state zip

attach
label
here

ELECTRONICS ILLUSTRATED Sub. Dept., Greenwich, Conn. 06830

\$215,000 NOVEL AWARD STILL OPEN



Writers, there is still time to submit your manuscript for the International Novel Award offered jointly by Putnam's, McCall's Magazine, Fawcett World Library and Embassy Pictures. More than \$215,000 in prize money will be awarded for the best original, unpublished novel in the English language plus:

- First publication in McCall's Magazine
- A motion picture contract with Embassy Pictures Corporation
- Book publication by G. P. Putnam's Sons
- Paperback reprint publication by Fawcett World Library

Deadline:

All submissions must be received not later than July 1, 1965 and must be accompanied by an official entry form. For complete prospectus and entry form write:

International Novel Award
G. P. Putnam's Sons
200 Madison Ave., N. Y. 10016

ELECTRONICS ILLUSTRATED

Classified Ads

Your advertisement can reach this mail-buying audience for only 50¢ per word . . . payable in advance (Check or M.O. please) . . . minimum 10 words. Closing dates are the 20th of 4th preceding month i.e. copy for the November issue must be in our office by July 20th. Mail to ELECTRONICS ILLUSTRATED, 67 West 44th St., New York 36, N. Y.

• • • FOR SALE

JEES — \$62.50, TRANSMITTERS — \$6.18, Typewriters—\$4.15, Walkie-Talkies, Oscilloscopes, Multimeters. Typical Government Surplus Prices. Exciting Details Free. Enterprises, Box 402-PS3, Jamaica 30, New York.

GOVERNMENT SURPLUS. How and Where to Buy in Your Area. Send \$1.00. E.I. Surplus Information, Headquarters Bldg., Washington 6, D. C.

JAPAN & HONG Kong Electronics Distributors. Products, components, supplies. 50 firms—just \$1.00. Ippano Kaisha Ltd., Box 6266, Spokane, Washington 99207.

CANADIANS—GIANT Surplus Bargain Packed Catalogs. Electronics, Hi-Fi Shortwave Amateur Citizens Radio. Rush \$1.00 (Refunded). ETCO, Dept. EI, Box 741, Montreal.

CONVERT ANY television to sensitive, big-screen oscilloscope. Only minor changes required. No electronic experience necessary. Illustrated plans, \$2.00. Relco-A19, Box 10563, Houston 18, Texas.

NEW SUPERSENSITIVE transistor locators detect buried gold, silver, coins. Kits, assembled models. \$19.95 up. Underwater models available. Free catalog. Relco-A19, Box 10563, Houston 18, Texas.

INVESTIGATORS, FREE Brochure, latest subminiature electronic surveillance equipment. Ace Electronics, 11500-X NW 7th Ave., Miami, Florida. 33168.

AMAZING NEW electronic miracle transforms your TV room into a Stereophonic Theatrel \$12.95. Free details and Free Gift! Consolidated Acoustics, 1302E Washington, Hoboken, New Jersey.

FREE! GIANT bargain catalog on transistors, diodes, rectifiers, components, valuable parts, equipment. Poly Paks, P.O. Box 942E1, Lynnfield, Mass.

TRANSISTORS: 7 FOR \$1.00 Quality, general purpose, TO-5 case. T&L Sales, Box 17, Derry Village, N. H.

• • • EDUCATION & INSTRUCTION

MONEY BACK Guarantee—C.I.S.T.—The World Wide Institute of Home Study—34 global centres—260 courses—Engineering, Electronic, Academic and Commercial—send for your Free 100 page copy of "Career Opportunities" today—No salesman will call. C.I.S.T., 632 Garden City Building, 263 Adelaide St. W., Toronto, Canada.

ENGINEERS, DESIGNERS, Draftsmen, Students, Engineers Handbook Perfect Pocket Reference 192 Pages Needed Information, \$2.00 Deluxe Bound, \$1.00 Paperback. Editronics, Box 204B, Essex, Conn. 06426

ELECTRONICS CAREER—F.C.C. License Training. Correspondence, or resident classes. Free details. Write: Dept. 8, Grantham Schools, 1505 N. Western, Hollywood, Calif. 90027.

• • • BUSINESS OPPORTUNITIES

EARN BIG Money! Learn Electric Appliance Repairing at home in your spare time. How to use Christy Electronic Trouble Tracer to make repairs. Make \$5-6 per hour in kitchen or basement. Pay later. Send for Free Book. Christy Trades School, 3214 W. Lawrence Ave., Dept. A-1013, Chicago 60625.

HIGH WEEKLY Earnings! Address—mail letters featuring real merchandise. Get \$10 with every order—keep \$8 profit. Supplies furnished. Free particulars. Modern Merchandising, Box 357, Oceanside, New York.

INVESTIGATE ACCIDENTS. Earn \$750 to \$1,100 monthly. Men urgently needed. Car furnished. Expenses paid. No selling. No college education necessary. Pick own job location. Investigate full time. Or earn \$8.44 hour spare time. Write for Free Literature. No obligation. Universal, CEE-7, 6801 Hillcrest, Dallas 5, Texas.

VENDING MACHINES—No selling. Operate a route of coin machines and earn high profits. 32-page catalog free! Parkway Machine Corp., 715E1 Ensor St., Baltimore 2, Md.

\$50 PER 1000 POSSIBLE. Addressing 1000 envelopes. Longhand-typewriter. Home—spare time. Free particulars. General Enterprises, Box 303, Island Park, New York.

• • • EMPLOYMENT OPPORTUNITIES

PRINTING - ADVERTISING SALESMEN. Excellent moneymaking sideline selling Decalomania Name Plates. Advertising Specialties. Sign letters, Automobile initials. Free Samples. "Ralco"—EI, Box L, Boston 19, Mass.

• • • BUILD IT-DO IT YOURSELF

AUTOMATIC WASHER Repair Manuals on Norge, Hamilton, General Electric, Hotpoint, RCA Whirlpool, Kenmore, Westinghouse, Frigidaire, Kelvinator, \$2.50 ppd each. Major Appliance, Dept. J, 13106 Caine Avenue, Cleveland, Ohio 44105.

"ULTRA MINIATURE Transmitter" under 2" long, Plans — \$2.00. Electronics, Dept.-A, Box 262, Peter Stuyvesant Station, New York, N. Y. 10009

PROFESSIONAL ELECTRONICS Projects—Organs, Timers, Computers, etc.—\$1 up. Catalog, 25¢, refundable. Parks, Box 25565, Seattle, 98125.

• • • TAPE RECORDERS

LEARN WHILE Asleep with your recorder, phonograph or amazing new "Electronic Educator" endless tape recorder. Details free. Sleep-Learning Research Association, Box 24-EI, Olympia, Washington.

TAPE RECORDERS Hi-Fi Components. Sleep Learning Equipment, tapes. Unusual values. Free Catalog. Dressner, 1523 Jericho Tpke., New Hyde Park-4, N. Y.

RENT STEREO Tapes—over 2500 different—all major labels—free brochure. Stereo-Parti, 1616-AY Terrace Way, Santa Rosa, California.

• • • RADIO & TV

BEFORE YOU Buy Receiving Tubes, Transistors, Diodes, Electronic Components & Accessories . . . send for your Giant Free Zalytron Current Catalog, featuring Standard Brand Tubes: RCA, GE, etc.—all Brand New Premium Quality Individually Boxed, One Year Guarantee—all at Biggest Discounts in America! We serve professional servicemen, hobbyists, experimenters, engineers, technicians. Why Pay More? Zalytron Tube Corp., 469-L Jericho Turnpike, Mineola, N. Y.

DIAGRAMS FOR repairing radios \$1.00. Television \$2.50. Give make model. Diagram Service, Box 1151E1, Manchester, Conn. 06042.

McGEE RADIO Company. Big 1965 176 Page Catalog Sent Free. America's Best Values, Hi-Fi—Amplifiers—Speakers—Electronic Parts. 1901 McGee Street, Dept. EI, Kansas City, Missouri.

FREE ELECTRONICS Catalog. Tremendous Bargains. Electrolabs, Department C-567AE, Hewlett, New York 11557.

NEW MAGNETIC Device—Engineers inventors experimenters hobbyists, latest theory in basic magnetism. Create new products by experimenting with the Magnetic Ladder Acceleration Solenoid using direct current. Plans (\$1.00). Jesse Costa, Box 26, Waquoit, Mass. 02570.

TV TUNERS rebuilt and aligned per manufacturers specification. Only \$9.50. Any make UHF or VHF. We ship COD. Ninety day written guarantee. Ship complete with tubes or write for free mailing kit and dealer brochure. JW Electronics, Box 51K, Bloomington, Indiana.

\$1.00 DELIVERS PLASTIC Packets for 60 QSL's. Tepadco, Browne St., Gallatin, Tennessee.

15 DISTANCE ONE-TUBE Plans — 25¢. "One Tube Handbook"—50¢. Includes Data sheets, catalog, Laboratories, 1131-K Yalota, Redwood City, California.

RADIO & T.V. Tubes—33¢. Free List. Cornell, 4213-15 University, San Diego, Calif. 92105.

• • • INVENTIONS & INVENTORS

INVENTORS! WE will develop, sell your idea or invention, patented or unpatented. Our national manufacturer-clients are urgently seeking new items for highest outright cash sale or royalties. Financial assistance available. 10 years proven performance. For Free information write Dept. 59, Wall Street Invention Brokerage, 79 Wall Street, New York 5, N. Y.

INVENTORS! HIGHEST cash sale or royalties for your inventions. Patented-Unpatented. Urgent demand from our client manufacturers. Financial Assistance available. Write Dept. 45, United Invention Brokerage, 78 Wall Street, New York 5, N. Y.

• • • STAMPS & COINS

LINCOLNS: 25 DIFFERENT "S" Mint \$2.00. 30 Different \$3.50. John Finneran, 22166 North 6th St., Castro Valley, California.

• • • MUSIC

DISCOUNT RECORDS—All Labels—Free List—Write Cliff House, Box 42-D, Utica, N. Y.

• • • ROCKETS

ROCKETS: IDEAL for miniature transmitter tests. New illustrated catalog 25¢. Single and multistage kits, cones, engines, launchers, trackers, technical information, etc. Fast service. Estes Industries, Penrose 13, Colorado.

• • • PERSONAL

ELECTRONIC EXPERIMENTERS' Club. Projects, Bargains, Fun. Join Now! Information, Box 5332-C, Inglewood, Calif. 90310

SECRET ADDRESS. Remailing 25¢ or \$3.00 monthly. Haley & Son, Box S, Imola, Calif.

• • • MISCELLANEOUS

WINEMAKERS—MAKE Strongest Brews Yourself! Booklet of Formulas, \$2.00. (Supplies, Hydrometers, Equipment Headquarters.) Research Enterprises, 29-85 Samoset Road, Woburn, Mass.

TREASURE, GOLD, Silver, Relics. Find them with new 1965 models. Free information. Rayscope, Dept. 7-L, Box 715, North Hollywood, California.

HYPNOTIZE SECRETLY, cleverly, one glance . . . or money-back. \$2. Elton's, Box 18223-E2, Indianapolis, Indiana, 46218.

Continued from page 113

patrol planes that cruise the Atlantic, for example, cost at least ten times as much per hour. So, too, do the educational TV broadcasting planes that currently hover over the Midwest.

Also worth noting is the fact that airborne electronic stations aren't the only place where microwave power transmission might come in handy. Earth satellites now struggle along with heavy batteries and unwieldy solar cells for electric power. They could save in both weight and complexity by tapping their power from ground-originated beams.

Back in the early days of satellites, one Pentagon official suggested that the problem of supplying electric power to earth-circling vehicles could be solved with an exceptionally long extension cord. He meant it as a joke. But now, science has turned the joke into reality. The long cord—wireless transmission—finally is here.

Continued from page 73

Frankly, the first year or so's worth of four-track tapes left me cold. They didn't sound as good as the old two-track releases and they also came through with all sorts of problems—including complete drop-out in some instances.

But today's tapes definitely are a new breed. They have much more high-frequency sparkle than anyone would have expected of the four-track system not too long ago. And when you make a direct comparison of tape and disc on slambang orchestral music, there's no denying that the tape almost always sounds less strained. There's no comparison at all, of course, when you come to a loud *finale*, since a tape shows none of the end-of-side distortion that often plagues records.

This isn't to say that records aren't superb at their best. Nor is it to suggest that the disc is any less strong as a commercial proposition. But it is good to see pre-recorded tapes starting to fulfill their real promise.

YOUR TICKET

... to the best in hobby electronics is a subscription to EI. Whether you're a ham, CBer, SWL, audio buff, experimenter or simply have a general interest in electronics, you are sure to find the finest, most up-to-date and the most interesting feature articles and construction projects in EI. To make sure you don't miss a single issue, subscribe now! Fill out the coupon and mail it today!

10
issues
for
only
\$2.98

ELECTRONICS ILLUSTRATED
Circulation Department
Fawcett Building
Greenwich, Connecticut 06830

7-65

Here's my ticket. Please cash me in for the next 10 issues of ELECTRONICS ILLUSTRATED.

- I enclose \$2.98 Bill me later
 New order Re-order

NAME

ADDRESS

CITY..... STATE..... ZIP.....

lots of guts!

The inside counts. And e.c.i. makes it count most with 23 channel operation . . . triple conversion . . . transistor power supply . . . PA system . . . chrome cabinets. From the copper plated chassis to final inspection, these rigs deliver the performance you demand. Dollar for dollar, they've got the quality and the price that gives you the most for the least . . . 2 way radios from \$109.50. And at this price that takes guts! See the Courier 1M, Courier 23, Courier 12, 30B Business Band Radio, Fleet Courier and Port-A-Lab. At your dealer. Or use the coupon.

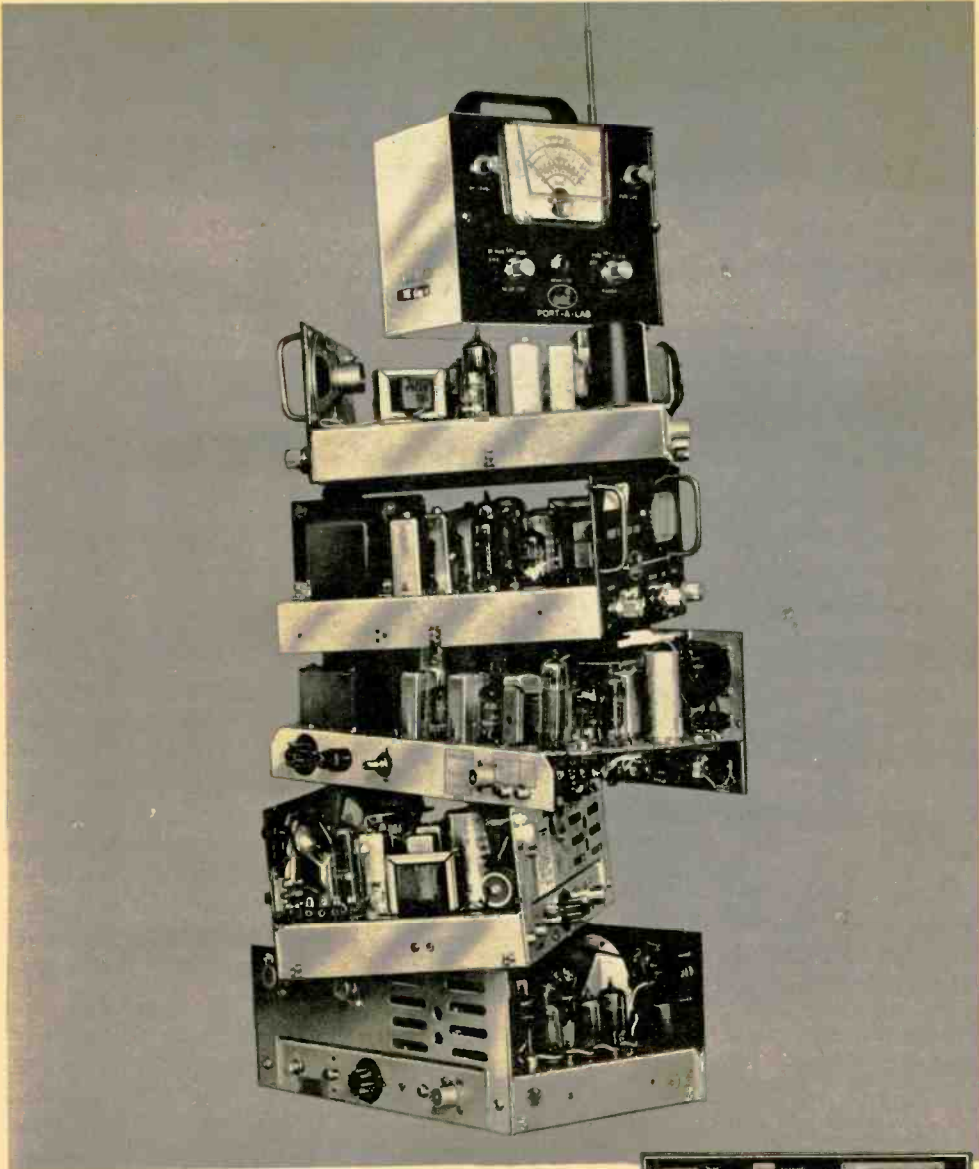

Name

Address

City State



electronics communications, inc. 56 hamilton ave., dept.E17, white plains, n. y.

Protect your future through the New CREI Program in Space Electronics

SPACE DATA SYSTEMS—Includes multi-channel recording, analog to digital conversion systems, data acquisition and processing.

SPACECRAFT TRACKING AND CONTROL—Includes such areas as orbit calculation and prediction, inertial guidance, electromagnetic wave generation, space surveillance and environment.

AEROSPACE RADAR ENGINEERING—Includes surveillance radar, antennas, receivers, components and microwave equipment used in space applications.

■ The first extension programs developed specifically to help men in electronics apply their experience to the space effort.

■ Content developed to meet employment requirements as determined by government and private organizations in the space field. Text material prepared in leading space-oriented organizations.

CREI also offers specialized education in these important areas of electronics: **Automation, Industrial, Nuclear, Servomechanisms, Computers, Radar, Communications, Aeronautical, Navigational and Television.**

You are eligible for these programs if you work in electronics and have a high school education.

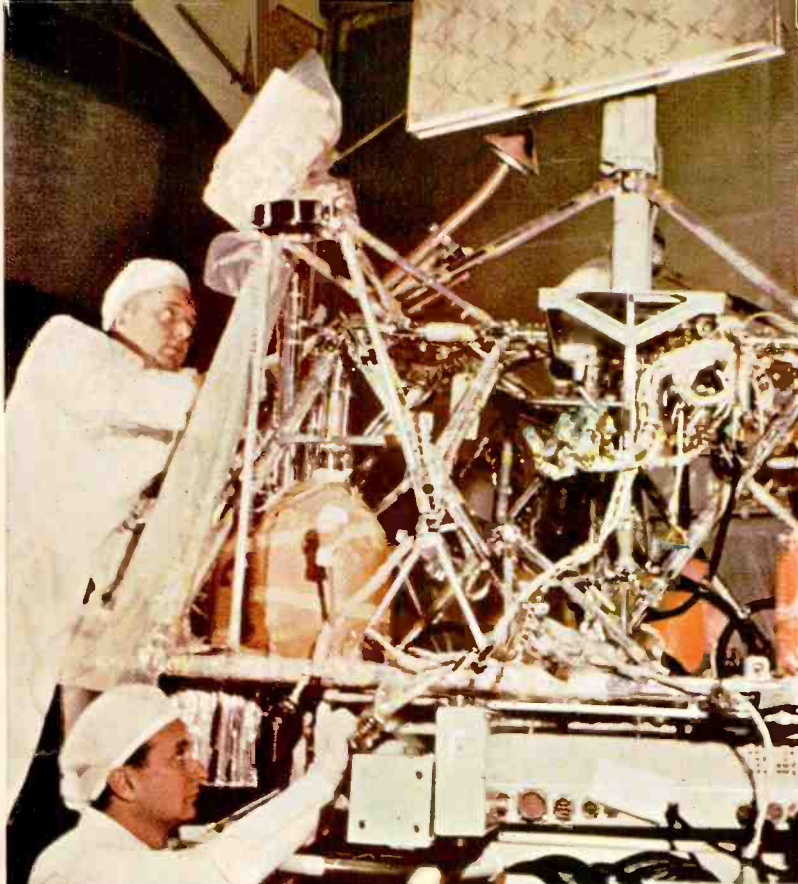

Will the space age end your career in electronics? Or will it open up new opportunities for you? What happens depends on whether or not you supplement your education in electronics with the new knowledge needed to make you a valuable employee today. The new CREI Program in Space Electronics offers you the up-to-date knowledge employers want and need.

FREE BOOK GIVES FULL INFORMATION ON CREI PROGRAMS.

For your copy, mail postpaid card or write: CREI, Dept. 1707-C, 3224 16th St., N.W., Washington, D.C. 20010

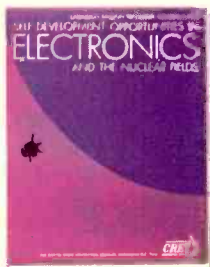

FILL OUT AND AIR MAIL TODAY—NO POSTAGE REQUIRED

THE CAPITOL RADIO ENGINEERING INSTITUTE

Founded 1927 Accredited Member of the National Home Study Council

Dept. 1707-C, 3224 Sixteenth St., N. W.
Washington, D.C. 20010

Please send me FREE book describing CREI Home Study Programs including new Programs in Space Electronics. I am employed in electronics and have a high school education.

Name _____ Age _____

Address _____

City _____ State _____ Zip Code _____

Employed by _____

Type of present work _____

www.americanradiohistory.com

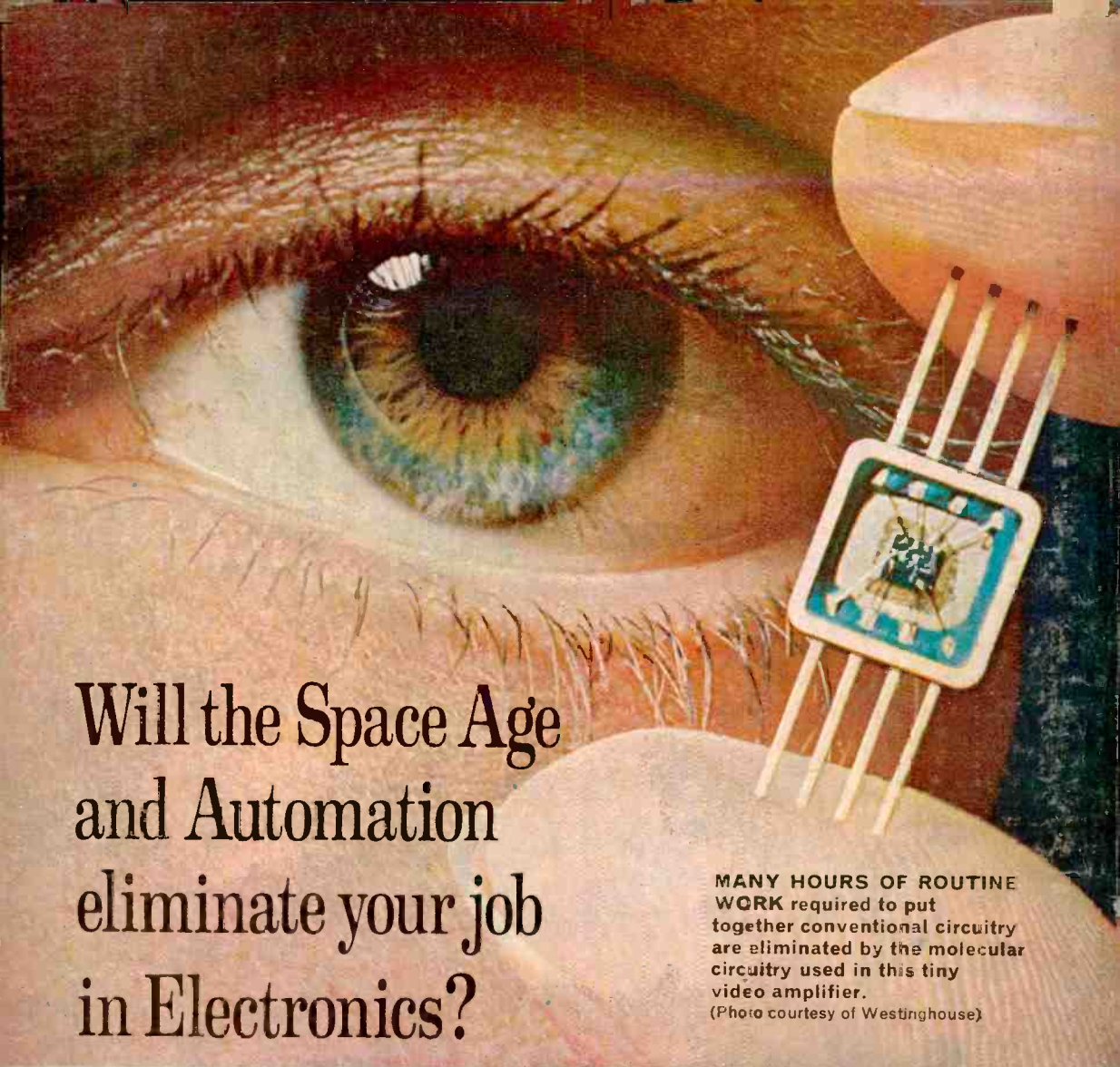

Will the Space Age and Automation eliminate your job in Electronics?

MANY HOURS OF ROUTINE WORK required to put together conventional circuitry are eliminated by the molecular circuitry used in this tiny video amplifier.
(Photo courtesy of Westinghouse)

FIRST CLASS
Permit No. 288-R
Washington, D.C.

BUSINESS REPLY MAIL
NO POSTAGE STAMP NECESSARY IF MAILED IN THE UNITED STATES

VIA AIR MAIL

Postage will be paid by
CREI

The Capitol Radio Engineering Institute
3224 Sixteenth Street, N.W.
Washington, D.C. 20010



YOUR JOB IS IN DANGER if you work on the routine level where new automated manufacturing techniques are rapidly replacing men. And your job is in danger if you haven't learned enough about new developments in electronics to be of real value to your employer in the space age.



CREI