

Build a BLOCKBUSTER R/C TRANSMITTER—Most Powerful Yet!

# ELECTRONICS ILLUSTRATED®

By the Publishers of MECHANIX ILLUSTRATED

MARCH • 35c

For the First Time Anywhere!  
Two Construction Projects  
Using this Microminiature

**INTEGRATED  
CIRCUIT!** →

- ✓ IC Broadcast Radio
- ✓ IC Square-Wave Generator

## THE CASE OF THE CODELESS HAMS

ICE ALARM TELLS YOU WHEN ROAD IS DANGEROUS

TRANSMIT YOUR VOICE ON A LIGHT BEAM

BUILD A MINI-CLIPPER TO BOOST CB TALK POWER

BEST HAM STATIONS FOR \$100 TO \$1,000

EI's OFFICIAL COUNTRIES LIST FOR DXers

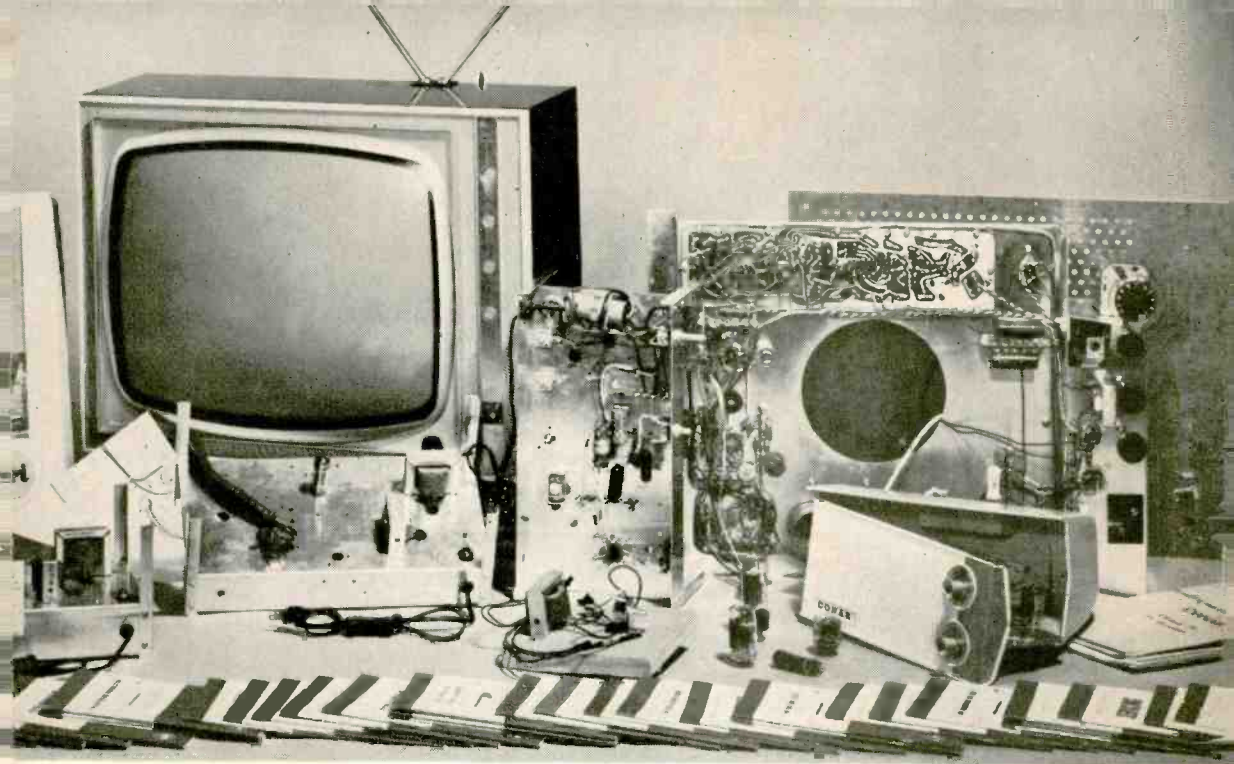

COMPARE. You'll find—as have tens of thousands of NRI graduates—that NRI training gives you more value. From the delivery of your first lessons in the remarkable NRI Achievement Kit we send you on enrolling, to “bite size” easily-read texts carefully programmed with custom-designed training kits . . . NRI can't be beat. Text for text, kit for kit, dollar for dollar—your best home-study buy is unquestionably NRI. (And NRI training costs you less than one semester's tuition at most colleges.)

### New Achievement Kit Starts You Fast

The day we receive your enrollment application we mail out your new NRI Achievement Kit. This attractive starter kit is an outstanding, logical way to help you get an easier, faster start in the training of your choice. It is the first of a number of special training aids developed in the NRI laboratories to make your adventure into Electronics exciting, meaningful. What's

## NOW 10 WAYS to Train at Home with the Leader

1. **TELEVISION-RADIO SERVICING**—Learn to fix black-and-white and color sets, AM-FM radios, stereo hi-fi, etc. A profitable field for part or full-time business of your own.
2. **COMPLETE COMMUNICATIONS\***—Teaches and gives actual practice in operation, service, maintenance of AM, FM, and TV broadcasting stations. Also covers marine, aviation, mobile radio, facsimile, microwave, radar.
3. **INDUSTRIAL-MILITARY ELECTRONICS**—From basic principles to computers. A comprehensive training plan that starts with fundamentals, then covers servos, telemetry, multiplexing, phase circuitry, other subjects.
4. **FCC LICENSE\***—Specifically designed to prepare you for First Class FCC Radiotelephone License exams. You

begin with Electronic fundamentals, advance to required subjects covering equipment, procedures.

5. **MATH FOR ELECTRONICS**—A brief course for engineers and technicians who need a quick review of math used in industry, communications, government jobs. Short-cut formulas, digital number systems, much more.
6. **BASIC ELECTRONICS**—Concise course in modern Electronic terminology and components. Practical, useful information to help you understand the field, give you some technical knowledge of Radio-TV, Electronics.
7. **AVIATION COMMUNICATIONS\***—Prepares you to install, maintain, service aircraft equipment like direction finders, ranges, markers, Loran, Shoran, Radar, landing systems. Prepares you for

in it? Your first group of lesson texts; a rich, vinyl desk folder to hold your material; the industry's most complete Radio-TV Electronics Dictionary; valuable reference texts; lesson answer sheets; envelopes; pencils; pen; engineer's ruler; even postage. No other school has anything like it.

### Build, Discover with NRI Equipment

Electronics comes alive with NRI training kits. What better way to learn than by *doing*? NRI pioneered and perfected the “home lab” technique of training at home in spare time. You get your hands on actual parts to build, experiment, explore, discover. NRI invites comparison with training equipment offered by any other school. Begin *now* this exciting program of practical learning. Whatever your need . . . whatever your education . . . there's an NRI instruction plan for you, at low tuition rates. Get all the facts. Fill in and mail the postage-free card today. NATIONAL RADIO INSTITUTE, Electronics Division, Washington, D. C. 20016

FCC License exams.

8. **MOBILE COMMUNICATIONS\***—Learn to install, maintain mobile equipment and associated base stations. Covers transmitters and receivers used by police, fire departments, taxi companies, etc. Prepares for FCC exams.
9. **MARINE COMMUNICATIONS\***—Covers transmitters, direction finders, depth indicators, Radar, Sonar, other equipment used on commercial ships and pleasure boats. Prepares you for FCC License exams.
10. **ELECTRONICS FOR AUTOMATION**—Not for beginners, but for men with some fundamental knowledge of Electronics who want an understanding of Automation. Process control, ultrasonics, telemetering and remote control, etc.

\*NOTE: You must pass your FCC License exams (any Communications course) or NRI refunds in full the tuition you have paid.



**The Oldest and Largest  
School of its Kind  
in America**



**WHERE YOU TRAIN IS AS IMPORTANT  
AS YOUR DECISION TO TRAIN**

# At NRI you are backed by 50 Years of leadership in home-study training for Electronics • Automation • TV • Radio



**J. E. Smith,  
Founder—1914.**

Fifty years ago, a school teacher named James E. Smith started giving extra instruction to four of his students in the "mysterious" new field of radio. From that small beginning, National Radio Institute has grown to be America's largest home-study school in the many fields of Electronics. Nearly three-quarters of a million students have enrolled over the years. This vast experience is behind NRI's

meaningful, interesting, easy-to-understand methods of training; methods that make Electronics a practical subject for almost anyone to learn no matter how much or how little formal education he has.

But experience is only the *base* upon which NRI is built. Today there is a staff of more than 150 dedicated people working with you as a "class" of one, keeping training material up-to-the-minute, providing consultation services as you train, advising you about new developments in Electronics, even helping you with job placement when you're ready. Ask men whose judgment you respect about NRI training. And send for the catalog we offer. Read about opportunities in Electronics, about new developments, about NRI itself and the variety of training plans open to you at reasonable cost. Mail the postage-free card today.

## **JOIN MEN LIKE THESE— TRAIN FOR SUCCESS WITH NRI**

"I went into my own business six months after finishing the NRI Radio-TV Servicing Course. It makes my family of six a good living. We repair any TV or Radio. I would not take anything for my training with NRI. It is the finest."

**DON HOUSE, Lubbock, Texas**



"Many thanks to NRI for the Electronics training I received. I hold a first class FCC License and am employed as a studio and master control engineer/technician with KXJB-TV."

**RONALD L. WOOD, Fargo, N.D.**

"I am a Senior Engineering Aide at Litton Systems, in charge of checkout of magnetic recording devices for our computers. Without the help of NRI I would probably still be working in a factory at a lower standard of living."

**DAVID F. CONRAD, Reseda, Calif.**



"NRI training enabled me to land a very good job as Electronic Technician with the Post Office Dept. I also have a very profitable spare-time business fixing Radios and TV."

**NORMAN RALSTON,  
Cincinnati, Ohio**

# ELECTRONICS ILLUSTRATED

MARCH, 1965

A Fawcett Publication

Vol. 8, No. 2

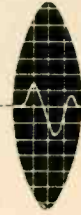

## Special Section: Integrated Circuits

Integrated Circuits for Hobbyists! .....	Fred B. Maynard, 11Q0846	29
Square-Wave Generator .....	Fred B. Maynard	31
Broadcast Radio .....	Harry Kolbe	34

## General Features

Swap Shop .....		24
Electronics and Black Gold .....	A. D. Jackson	55
New Look in Servicing .....	Paul Daniels	68
Robot Rembrandt .....		91
The Alhambra Affair .....	Don Carter	101
Electronic Scouts .....		117
Over and Out .....		121

## Construction Projects

Blockbuster R/C Transmitter .....	Howard G. McEntee	40
Enlarging Exposure Meter .....	Bert Mann	48
Talk on a Light Beam .....	Edward Lininger	64
Driver's Ice Alarm .....	Steven E. Summer	73
Kit Report: Knight-Kit Exposure Meter .....		98

## Radio: CB • Amateur • SWL

A Ham Station for \$100 to \$1,000 .....	Paul Hertzberg, K2DUX	45
The Listener .....	C. M. Stanbury II	51
EI's Official Countries List .....		52
Rack Your Ham Station .....		58
Logging Illegal DX .....	Alex Bower	70
Notes From EI's DX Club .....		76
CQ de Tape .....	Herb Friedman, W2ZLF	77
Ham Shack .....	Robert Hertzberg, W2DJJ	83
CB Mini-Clipper .....	Herb Friedman, KB19457	84
The Case of the Codeless Hams .....	Alex Karlin	95
CB Corner: CB's Secret Weapon .....	Len Buckwalter, KBA4480	103

## Audio & Hi-Fi

Hi-Fi Today .....	John Milder	54
Gurgle, Chuckle, Oink—Yeah! Yeah! Yeah! .....	Ken Gilmore	80

## Theory & Practice

Beginners Page: The Power Transformer .....	H. B. Morris	90
Optimum Oscillators .....	Al Toler	92
How to Wire Coax Connectors .....	Fred J. Whiteman	99

## Regular Departments

Feedback From Our Readers .....		6
Electronics in the News .....		10
Broadsides .....		16
Electronic Marketplace .....		19
Good Reading .....	Tim Cartwright	72
Subscription Blank .....		112

Audit Bureau of Circulations



MEMBERSHIPS



Magazine Publishers Association, Inc.



COVER — Kodachrome by  
Daniel Robert Rubin



# A New Electronics Slide Rule with Self-Training Course

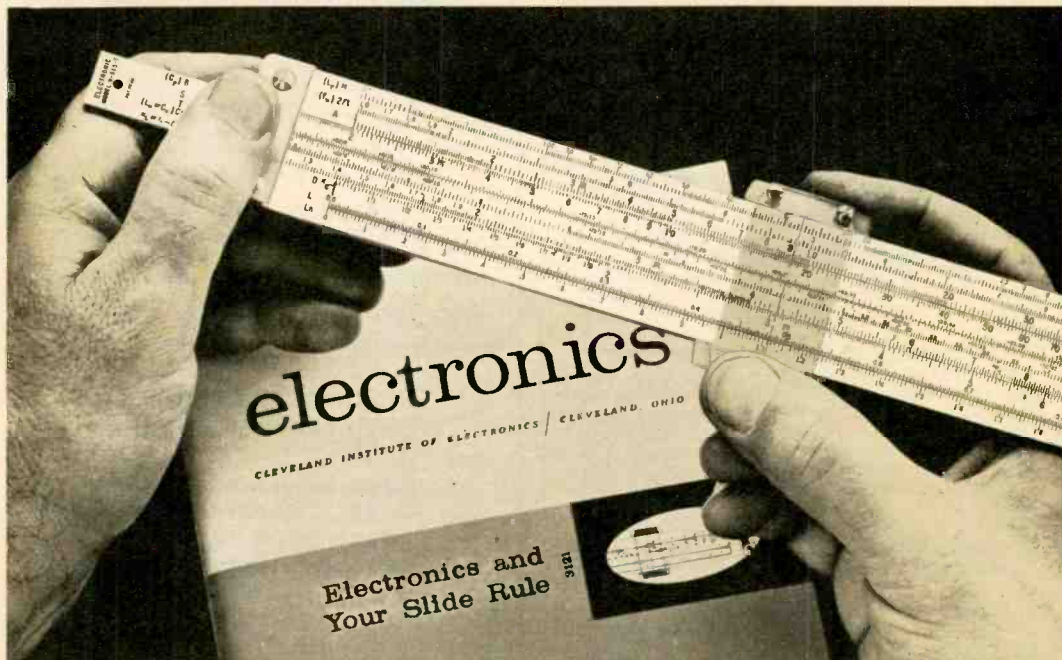

## Why didn't someone think of this before?

Here's a great *new* way to solve electronic problems accurately . . . easily. The Cleveland Institute Electronics Slide Rule is the only rule designed specifically for the exacting requirements of electronics computation. It comes complete with an illustrated Self-Training Course consisting of four lessons . . . each with a short quiz you can send in for grading and consultation by CIE's expert instructors. With this personal guidance, you'll soon be solving complex electronics problems in seconds while others still struggle along with pad and pencil.

Here's what Mr. Joseph J. DeFrance, Head of the Electrical Technology Dept., New York City Community College, has to say about it:

"I was very intrigued by the 'quickie' electronics problem

solutions. It is an ingenious technique. The special scales should be of decided value to any technician, engineer, or student. The CIE slide rule is a natural."

See for yourself. You will learn how to use special scales to solve problems dealing with reactance, resonance, inductance, AC and DC circuitry, etc. And, as an added bonus, you can use this high-quality rule for conventional computation, too.

This all-metal Slide Rule is a full 10" long and is made to our rigid specifications by a leading manufacturer of measuring instruments. Slide Rule, Self-Training Course *and* handsome top-grain leather carrying case . . . all yours for just \$14.95. Cleveland Institute of Electronics, 1776 E. 17th St., Department EI-103, Cleveland, Ohio 44114.

### SATISFACTION Warranty

The Electronics Slide Rule with Self-Training Course is available only from Cleveland Institute of Electronics, and is covered by CIE's exclusive "Satisfaction Warranty." Order it now . . . use it for ten full days. Then, if you're *not* completely satisfied, you may return the Slide Rule with Self-Training Course and CIE will refund full payment.

**SEND COUPON TODAY**

**to: Cleveland Institute  
of Electronics**

1776 East 17th St., Dept. EI-103 • Cleveland, Ohio 44114

Please send me your Electronics Slide Rule with Self-Training Course and top-grain leather carrying case. (If not fully satisfied after 10-day trial, CIE will refund payment.)

Name \_\_\_\_\_ (Please Print)

Address \_\_\_\_\_ County \_\_\_\_\_

City \_\_\_\_\_ State \_\_\_\_\_ Zip \_\_\_\_\_

Send descriptive literature only . . . no obligation.

# ELECTRO\*STUDY!

A NEW WAY TO HIGH PAY IN ELECTRONICS

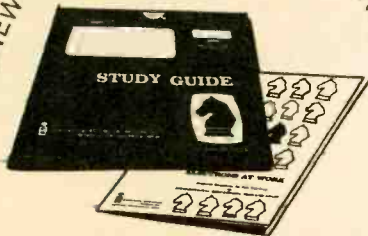

Now YOU can get the basic knowledge you need to break into the high-pay electronics field. You can teach yourself the 16 vital areas of electronics knowledge at home, in your spare time, with ELECTRO \* STUDY, a new method that makes learning a snap. Each unit comes with simply written textbook AND a programed Study Guide with hundreds of questions and answers on the text. Study the text, answer the questions. Tough points seem easy. You really learn your stuff!

Here are the 16 units, each a detailed study:

- E1 Electrons at Work
- E2 Electric Circuits and Ohm's Law
- E3 Magnetism, Electromagnetism—Wiring, Soldering
- E4 Theory of Alternating Currents
- E5 Direct-Current Networks
- E6 Inductance and Capacitance
- E7 Transformers in Radio and Electronics
- E8 Motors and Generators in Electronics
- E9 Resonant Circuits
- E10 Radio Communications Fundamentals
- E11 Vacuum Tube Fundamentals
- E12 Batteries and Electronic Power Supplies
- E13 Audio Frequency Amplifiers
- E14 R-F Circuits
- E15 Transistors and Their Applications
- E16 Superheterodyne Receivers

Order one ELECTRO \* STUDY unit or several. But do it now. Take advantage of the special introductory price of \$4.95 each. And a FREE bonus if you order now: a handsome vinyl case for each Study Guide.

CLIP COUPON HERE—YOU'RE ON YOUR WAY!



## INTERNATIONAL EDUCATIONAL SERVICES

Box 804, Scranton, Penna. 18515

- Send me, postpaid, the ELECTRO \* STUDY units circled below, at \$4.95 each. I enclose (check or money order) for \_\_\_\_\_ to cover full amount.
  - Please send circled items COD. I will pay postage.
- 15-day money-back guarantee if not satisfied.**

E1	E2	E3	E4	E5	E6	E7	E8
E9	E10	E11	E12	E13	E14	E15	E16

Name \_\_\_\_\_

Address \_\_\_\_\_

City \_\_\_\_\_

State \_\_\_\_\_ Zip Code \_\_\_\_\_

# ELECTRONICS ILLUSTRATED

By the Publishers of MECHANIX ILLUSTRATED

editor **ROBERT G. BEASON**  
 managing editor **Robert D. Freed**  
 feature editor **Richard A. Flanagan**  
 art editor **Lou Rubsamen**  
 editorial associate **William C. Fuller**  
 production editor **Rosanne Walsh**  
 advertising mgr. **John F. Webster**  
 eastern adv. mgr. **Don Daily**

## CONTRIBUTING EDITORS

amateur radio **Robert Hertzberg, W2DJJ**  
 citizens band **Len Buckwalter, KBA4480**  
 swl-dx **C. M. Stanbury II**  
 special projects **Herb Friedman, W2ZLF/KBI9457**  
 audio **Harry Kolbe**  
 audio **John Milder**  
 audio **David Muirhead**

## EXECUTIVE STAFF

vice president **Ralph Daigh**  
 art director **Al Allard**  
 associate art director **Ralph Mattison**  
 advertising director **Mortimer Berkowitz, Jr.**  
 production director **George H. Carl**

## ADDRESSES

Editorial and Advertising Offices: 67 West 44th St., New York, N.Y. 10036. Subscriptions: Change of address Form 3579 to Subscription Dept., Fawcett Bldg., Greenwich, Conn. 06830.

ELECTRONICS ILLUSTRATED is published bi-monthly by Fawcett Publications, Inc., Fawcett Place, Greenwich, Conn. W. H. Fawcett, Jr., President; Gordon Fawcett, Secretary and Treasurer; Roger Fawcett, General Manager; Roscoe K. Fawcett, Circulation Director; Donald P. Hanson, Assistant General Manager.

Second-class postage paid at Greenwich, Conn., and at additional mailing offices.

Subscription price \$4 for 12 issues in U.S. and possessions and Canada. All other countries \$6 for 12 issues. Foreign subscriptions and sales should be remitted by International Money Order in U.S. funds payable at Greenwich, Conn.

Printed in U.S.A. Copyright © 1965 by Fawcett Publications, Inc. Permission hereby granted to quote from this issue of this magazine on radio or television provided a total of not more than 1,000 words is quoted and credit is given to the title of the magazine and issue, as well as the statement, copyright 1965 by Fawcett Publications, Inc.



# AMERICAN BASIC SCIENCE CLUB'S ELECTRONICS LAB and RADIO COURSE



All the Equipment for 65 Exciting Projects, Including  
3-Tube Short Wave Radio, DC Power Supply,  
Microphone and Audio Amplifier, Signal Tracer—only

**\$17<sup>80</sup>**  
COMPLETE  
LAB AND  
COURSE

Get it All in One Complete Shipment —  
or Divided into these 4 Monthly Kits

TROUBLE SHOOTING WITH THE SIGNAL TRACER

## YOU GET A VALUABLE ELECTRONICS LAB

Containing parts by RCA, MALLORY, PYRAMID, GE, CENTRALAB, STACKPOLE, TRIM, CINCH and other reliable manufacturers. Retail value of parts alone is MORE THAN **25 DOLLARS**

## PLUS A COMPLETE ELECTRONICS COURSE

You REALLY LEARN ELECTRONICS. The progressive "learn by doing" American Basic Science Club system is the EASIEST, MOST THOROUGH and MOST EXCITING way to a solid background in electronics. Basic enough for beginners . . . rewarding enough for experts. NOWHERE ELSE is a course of this scope available at this LOW PRICE!

### ENTHUSIASTIC MEMBERS WRITE:

"basic principles unforgettably learned" . . .

It is only after having completed the experiments in your kits that I can say I have truly and unforgettably learned the basic principles of electronics. JOHN R. KANIA, 2 Berkeley Ave., Yonkers 5, N. Y.

"your kits are interesting and rewarding" . . .

I am an electronics student in the Air Force and find your kits interesting and rewarding. We have not covered anything in the school that you have not covered in the kits. JOHN G. DILL, Keesler Air Force Base, Biloxi, Miss.

"for ahead of friend taking another course" . . .

A friend of mine is taking a correspondence course in electronics, and I have learned more from your first two kits than he has in twenty lessons. RAY P. BILODEAU, 139 Exchange St., Leominster, Mass.

"the number of concepts presented is amazing" . . .

Your kits offer a range of experiments usually performed only in the better high school and college laboratories. The number of concepts presented, and the clarity and concreteness of their development is amazing. R. M. HELM, Professor of Physics, East Carolina College, Greenville, N. C.

### 1st KIT — DC AND AC CIRCUITS

Equipment for 26 Projects Including:

- Electro-scope • Electromagnetic Relay • Galvanometer
- AC Buzzer • Magnetizer and Demagnetizer • Solenoid
- Coin Tossing • Safety AC Power Supply with Isolation Transformer.

- Subjects Covered:
- Electron Theory
  - DC and AC
  - Electro-Chemistry
  - Transformer Principles
  - Inductance

FREE with 1st Kit — Surprise "Mystery Box"

### 2nd KIT — RESISTANCE, CAPACITANCE AND RECTIFICATION

Equipment for 18 Projects Including:

- Strobe Light - variable pulse Neon Lamp "freezes" the motion of vibrating or rotating objects and checks RPM
- Thermocouple • Wheatstone Bridge (measures resistance)
- Extinction Voltmeter • DC Power Supply (Transformer, Vacuum Tube Rectifier and 20-20 mfd. Capacitor Filter Circuit.)

- Subjects Covered:
- Ohm's Law
  - Rectification
  - Resistance
  - Neon Glow Tubes
  - Capacitance
  - Filter Circuits

FREE with 2nd Kit — Electric Soldering Iron

### 3rd KIT — AMPLIFIERS AND OSCILLATORS

Equipment for 14 Projects Including:

- Two Stage Amplifier • Capacitance Burglar Alarm
- Proximity Detector • Variable Frequency Ripple Tank Wave Generator (Produces standing waves, nodal lines, etc. Invaluable in understanding wave theory) • Code Practice Oscillator.

- Subjects Covered:
- Vacuum Tube Amplifiers
  - Radio Theory and Wave Length
  - Wave Theory
  - Oscillator Circuits

FREE with 3rd Kit — "Steps to a Ham License" Manual

### 4th KIT — AUDIO AMPLIFICATION AND RADIO

Equipment for 7 Projects Including:

- Short Wave and Broadcast Radios (3-tube regenerative. Uses 115V AC house current. Complete with Headset) • Carbon Microphone and Two Stage Audio Amplifier • Radio Transmitter • Signal Tracer and Continuity Tester (valuable trouble-shooting tools).

- Subjects Covered:
- Audio Amplifiers
  - Radio Theory
  - Regen. Circuits
  - Tuning Circuits
  - Signal Tracing

FREE with 4th Kit — Radio-TV Service Manual

ALL FOUR KITS IN ONE SHIPMENT ONLY **\$17<sup>80</sup>** POSTPAID

OR—YOU CAN GET THE FOUR KITS, ONE A MONTH

SEND **\$2<sup>00</sup>** WITH PAY **\$3<sup>95</sup>** PLUS COD POSTAGE  
ONLY COUPON ONLY ON RECEIPT OF EACH KIT

ALL SHIPMENTS ON 10 DAY APPROVAL.  
YOUR SATISFACTION OR YOUR MONEY BACK.

WE KNOW YOU WILL BE **AMAZED AND DELIGHTED.**

USE THIS "NO RISK" COUPON FOR EITHER PAID IN FULL OR MONTHLY PLAN

AMERICAN BASIC SCIENCE CLUB, Inc., 501 E. Crockett, San Antonio 6, Texas

Send me ABSClub's Electronics Lab in four kits — one a month. I enclose \$2.00 and will pay \$3.95 plus COD Postage on arrival of each kit. I understand that all kits will be on 10 day approval with full refund guaranteed and also that I may cancel unshipped kits at any time without obligation.

Send me ABSClub's Electronics Lab (all four kits) in one shipment. I enclose \$17.80 full payment, postage paid to me. I understand that this will be on a 10 day approval with full refund guaranteed.

NAME .....

ADDRESS .....

CITY and STATE .....

# FEEDBACK

## from our readers



Write to: Letters Editor, Electronics Illustrated, 67 West 44th Street,

New York, N.Y. 10036

### ● MATCHMAKERS

I would imagine that you get some odd characters together who exchange some rather odd things in the new Swap Shop department you have started. But don't get me wrong. I'm all for it and I'd bet that most of the rest of your readers are, too.



Swap Shop strikes one as the closest thing we've had to a real electronics grab-bag since the days when Bobby Baker got wind of hi-fi.

Paul Martinson  
Chicago, Ill.

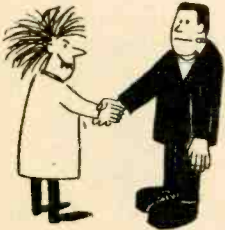

### ● SILENT SINGER?

After suffering several times the frustrating experience of waiting for a DX station to identify, only to have a blast of QRM drown out the signal, I finally discovered the heart of my problem—a next door neighbor's sewing machine! I have heard of cures for birdies from TV sets, but what do you do for the birdies that like to sew?

Thomas Siolek  
Brooklyn, N.Y.

*That's life, Tom. As she sews, so shall ye weep.*

### ● TYPO

You have an error in your description of our FS-23 CB transceiver in the November '64 EI. The correct price is \$299.55.

Sonar Radio Corp.  
Brooklyn, N.Y.

### ● GOOD PINCH

I enjoyed reading your article, HOW TO PINCH PENNIES ON PARTS, in the November '64 EI. Very interesting. In passing, I would like to mention our new WRL catalog, which is an annual publication and has been considered a good source for ham and CB equipment and parts for nearly 30 years.

Larry B. Meyerson, W0WOX  
World Radio Laboratories  
Council Bluffs, Iowa

*To get a copy, EI readers should write to World Radio Labs, 3415 W. Broadway, Council Bluffs, Iowa 51504. Okay, Larry?*

### ● ONE MAN'S MEAT

You people ought to give instructions on how to build a machine to supply the punch the jokes in your stories aint got (AMATEUR RADIO CONFIDENTIAL, Jan. '65 EI). Untold story, my foot. You should of left it untold.

Pete Mann  
New York, N.Y.

### ● TOUGH STUFF

I can tell you something that hasn't happened to home-study electronics (LOOK WHAT'S HAPPENED TO HOME STUDY ELECTRONICS, Jan. '65 EI) and that's an attention-getter to make you keep your mind on what you're supposed to be studying. Did you ever try to watch TV and study electronics at the same time?

Don Boyle  
Chicago, Ill.

*What's TV?*

*[Continued on page 8]*





# Profits That Lie Hidden in America's Mountain of Broken Electrical Appliances

By J. M. Smith President, National Radio Institute



And I mean profits for you — no matter who you are, where you live, or what you are doing now. Do you realize that there are over 400 million electrical appliances in the homes of America today? So it's no wonder that men who know how to service them properly are making \$3 to \$5 an hour — in spare time or full time! I'd like to send you a Free Book telling how you can quickly and easily get into this profitable field.

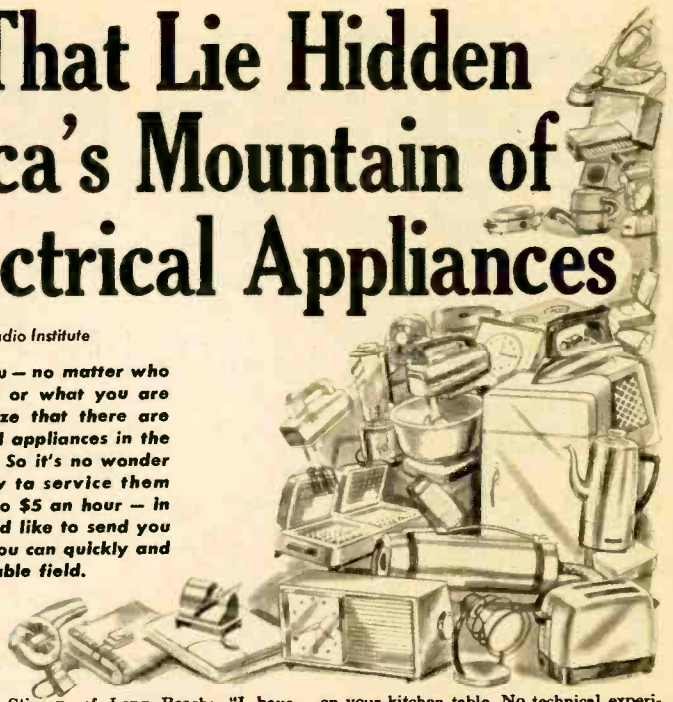

THE COMING OF THE AUTO created a multi-million dollar service industry, the auto repair business. Now the same thing is happening in the electrical appliance field. But with this important difference: anybody with a few simple tools can get started in appliance repair work. No big investment or expensive equipment is needed.

The appliance repair business is booming — because the sale of appliances is booming. One thing naturally follows the other. In addition to the 400,000,000 appliances already sold, this year alone will see sales of 76 million new appliances. For example, 4,750,000 new coffee makers, almost 2,000,000 new room air conditioners, 1,425,000 new clothes dryers. A nice steady income awaits the man who can service appliances like these. And I want to tell you why that man can be you — even if you don't know a volt from an ampere now.

### A Few Examples of What I Mean

Now here's a report from Earl Reid, of Thompson, Ohio: "In one month I took in approximately \$648 of which \$510 was clear. I work only part time." And, to take a big jump out to California, here's one from

J. G. Stinson, of Long Beach: "I have opened up a small repair shop. At present I am operating the shop on a spare time basis — but the way business is growing it will be a very short time before I will devote my full time to it."

Don't worry about how little you may now know about repair work. What John D. Pettis, of Bradley, Illinois wrote to me is this: "I had practically no knowledge of any kind of repair work. Now I am busy almost all my spare time and my day off — and have more and more repair work coming in all along. I have my shop in my basement."

### We Tell You Everything You Need to Know

If you'd like to get started in this fascinating, profitable, rapidly growing field — let us give you the home training you need. Here's an excellent opportunity to build up "a business of your own" without big investment — open up an appliance repair shop, become independent. Or you may prefer to keep your present job, turn your spare time into extra money.

You can handle this work anywhere — in a corner of your basement or garage, even

on your kitchen table. No technical experience, or higher education is necessary. We'll train you at home, in your spare time, using methods proven successful for over 45 years. We start from scratch — tell you in plain English, and show you in clear pictures — everything you need to know. And, you will be glad to know, your training will cost you less than 20¢ a day.

### FREE BOOK and Sample Lesson

I think that our 24-page Free Book will open your eyes to a whole world of new opportunities and how you can "cash in" on America's "Electrical Appliance Boom."

I'll also send you a Free Sample Lesson. It shows how simple and clearly illustrated our instruction is — how it can quickly prepare you for a profitable future in this big field. Just mail coupon, letter, or postcard to me: Mr. J. M. Smith, President, National Radio Institute, Dept. 504-035 Washington 16, D.C. (No obligation, of course — and no salesman will call on you.)

### EARN WHILE YOU LEARN with this APPLIANCE TESTER

— Yours at No Extra Charge



Your NRI Course comes complete with all the parts to assemble a sturdy, portable Appliance Tester that helps you earn while you learn. Easy-to-follow manual tells how to assemble and use the Tester right away. Locate faulty cords, short circuits, poor connections, etc. in a jiffy; find defects in house wiring, measure electricity used by appliances; many other uses.

With this Tester you save time and make money by doing jobs quicker, making sure appliances operate correctly after repairs.

### MAIL THIS FOR FREE BOOK and SAMPLE LESSON

Mr. J. M. Smith, President  
NATIONAL RADIO INSTITUTE  
Dept. 504-035, Washington 16, D.C.

Tell me how I can "cash in" on the "Electrical Appliance Boom." Send me your illustrated FREE BOOK that outlines the whole NRI Course, tells what opportunities are open to me, answers my questions, describes success of other students, and much more. Also send me the FREE SAMPLE LESSON so I can see how clear and easy your instructions are. I am particularly interested in:

Spare Time Earnings  Business of My Own  Better Job

I understand there is no obligation on my part; and no salesman will call on me.

Name.....

Address.....

City..... Zone..... State.....

Accredited Member National Home Study Council

send for New **FREE**  
**CRYSTAL CATALOG** . . . with New  
**TRANSISTOR OSCILLATOR CIRCUITS**

**Citizen Band Class "D" Crystals**

**CITIZEN BAND CLASS "D" CRYSTALS**  
 3rd overtone — .005% tolerance — to meet all FCC requirements. Hermetically sealed HC6/U holders. 1/2" pin spacing. .050 pins. (Add 15c per crystal for .093 pins).

**\$2.95**  
 EACH

All 23 channels frequencies in stock: 26.965, 26.975, 26.985, 27.005, 27.015, 27.025, 27.035, 27.055, 27.065, 27.075, 27.085, 27.105, 27.115, 27.125, 27.135, 27.155, 27.165, 27.175, 27.185, 27.205, 27.215, 27.225, 27.255.

Matched crystal sets for ALL CB units (Specify equipment make and model numbers) \$5.90 per set

**CRYSTALS IN HC6/U HOLDERS**

**SEALED OVERTONE** .486 pin spacing — .050 diameter — .005% tolerance  
 15 to 30 MC .....\$3.85 — 30 to 40 MC .....\$4.10 — 40 MC to 65 MC .....\$4.50 — 65 MC to 100 MC .....\$6.00 ea.

**FUNDAMENTAL FREQ. SEALED** From 1601 KC to 2000 KC \$5.00; from 2001 KC to 2500 KC \$4.00; 2501 KC to 5000 KC \$3.50; 5001 KC to 7000 KC \$3.90; 7001 KC to 10,000 KC \$3.25.

**RADIO CONTROL** Specify frequency. .05 pins spaced 1/2" (Add 15c for .093 pins). \$2.95 ea.



**QUARTZ CRYSTALS FOR EVERY SERVICE**

All crystals made from Grade "A" imported quartz—ground and etched to exact frequencies. Unconditionally guaranteed! Supplied in:

- |   |  |
|---|--|
| <b>FT-243 holders</b><br>Pin spacing 1/2"<br>Pin diameter .093  | <b>MC-7 holders</b><br>Pin spacing 3/4"<br>Pin diameter .125 |
| <b>CRIA/AR holders</b><br>Pin spacing 1/2"<br>Pin diameter .125 | <b>FT-171 holders</b><br>Pin spacing 3/4"<br>Banana pins     |

**MADE TO ORDER CRYSTALS . . . Specify holder wanted**  
 1001 KC to 1600 KC: .005% tolerance .....\$4.50 ea.  
 1601 KC to 2000 KC: .005% tolerance .....\$3.55 ea.  
 2001 KC to 2500 KC: .005% tolerance .....\$2.75 ea.  
 2501 KC to 9000 KC: .005% tolerance .....\$2.50 ea.  
 9001 KC to 11,000 KC: .005% tolerance .....\$3.00 ea.

**Amateur, Novice, Technician Band Crystals**

.01% Tolerance . . . \$1.50 ea. — 80 meters (3701-3749 KC)  
 40 meters (7152-7198 KC), 15 meters (7034-7082 KC), 6 meters (8335-8650 KC) within 1 KC  
 FT-241 Lattice Crystals in all frequencies from 370 KC to 540 KC (all except 465 KC and 500 KC) .....\$1.25 ea.  
 Pin spacing 1/2" Pin diameter .093  
 Matched pairs — 15 cycles \$2.50 per pair  
 200 KC Crystals, \$2.00 ea.; 465 KC Crystals, \$1.25 ea.; 500 KC Crystals, \$1.25 ea.; 100 KC Frequency Standard Crystals in HC18/U holders \$4.50 ea.; Socket for FT-243 Crystal 15c ea.; Dual Socket for FT-243 Crystals, 15c ea.; Sockets for MC-7 and FT-171 Crystals 25c ea.; Ceramic Socket for HC6/U Crystals 20c ea.

**3 PLANTS TO SERVE YOU BETTER  
 ORDER FROM CLOSER PLANT  
 TEXAS CRYSTALS**

DEPT. E-35  
 1000 Crystal Drive  
 FORT MYERS, FLORIDA  
 Phone 813 WE 6-2109

Division of



AND  
 4117 W. Jefferson Blvd.  
 LOS ANGELES, CALIF.  
 Phone 213-731-2258

**FEEDBACK**

Continued from page 6

● **YUP, BY GEORGE**

In that nice, extremely simple circuit for your chicken-corn-fox game (OLD RID-DLE, NEW GAME, Nov. '64 EI), I think you managed to make a wiring error. The lead shown connected to the lower left lug on S3 should be connected to the lower right lug. I won't say anything more.

George Granger  
 York, Me.

*All small favors are appreciated, George.*

● **SOAP OPERA**

I am the harried housewife of a hubby whose hobby is electronics. Ironically this seems to have taken the charge out of our marriage (which took place in D.C.). Before your magazine started him building hier fi's, remoter controls and sundry, we were building a family. What I want to know, is: can a girl from a little mining town in the West find happiness as the wife of a . . .

Judith M.  
 Cleveland, Ohio

*Somebody's pulling somebody's . . .*

● **RABID ROBOT**

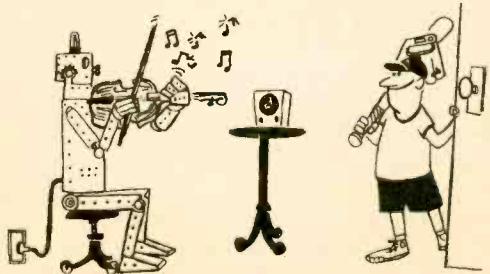

Randy, my robot, has been gathering dust for years but now he's gainfully employed at long last. I'd tried him on my violin practicing before but he had no sense of timing. Your metronome (MODULAR METRONOME, Jan. '65 EI) proved everything Randy needed.

J.P.C.  
 New Orleans, La.

Everything?





# 5,000 FIRMS HAVE EMPLOYED DeVRY TECH GRADUATES...

There Must be a Reason!

## READ WHAT A FEW OF THESE FIRMS SAY ABOUT DeVRY GRADUATES

A National Research Laboratory, Illinois: "One of the more important features of DeVry graduates is their up-to-date knowledge of new developments. A DeVry man made highest score on our own test."

Ontario Computer Manufacturers: "The on-the-job performance of your graduates is of the highest calibre . . . they have been a valuable asset to our rapidly growing production team."

A Space-Missile Company, California: "Our company has probably employed a greater number of your graduates than any company doing similar work. We have never had an unsatisfactory employee from DeVry."

## Employment Service

With many employers so enthusiastic about DeVry Tech graduates, it's no wonder our Employment Service can help our graduates get started — and keep them going; for this service continues.

*Let Us Prepare You at Home or In  
One of Our Two Big Resident Schools  
for a Profitable Career in*

# ELECTRONICS

Across the continent, leading employers of personnel trained in electronics write to tell us that DeVry training is "Tops." Read a few of the opinions at left. Better still, get the full story of DeVry for yourself. The two free booklets pictured below tell of many marvelous opportunities for trained men in electronics: the great variety of jobs, from research, production, operation, maintenance and servicing of electronic equipment — to a neighborhood TV-radio sales and service business of your own. They'll tell you too, how DeVry has prepared men for good jobs with outstanding firms: on practical, "brass-tacks" problems with actual electronic equipment. Here's good news: you don't need advanced training or previous technical experience — if you can fix an electric iron or splice a connection, and follow simple directions, you may be able to prepare with DeVry's help for real money in a field that offers the opportunity of your lifetime.

FREE BOOKLETS  
ON ELECTRONICS AS  
A CAREER AND HOW  
YOU MAY PREPARE  
FOR IT



### DeVRY TECHNICAL INSTITUTE

4141 Belmont Ave., Chicago, Ill. 60641, Dept. E1-3-V

Please give me your two free booklets, "Pocket Guide to Real Earnings" and "Electronics in Space Travel"; also include details on how to prepare for a career in Electronics. I am interested in the following opportunity fields: check one or more:

- |  |   |
|--|---|
| <input type="checkbox"/> Space & Missile Electronics | <input type="checkbox"/> Communications         |
| <input type="checkbox"/> Television & Radio          | <input type="checkbox"/> Computers              |
| <input type="checkbox"/> Microwaves                  | <input type="checkbox"/> Industrial Electronics |
| <input type="checkbox"/> Automation Electronics      | <input type="checkbox"/> Broadcasting           |
| <input type="checkbox"/> Radar                       | <input type="checkbox"/> Electronic Control     |

NAME \_\_\_\_\_ AGE \_\_\_\_\_  
ADDRESS \_\_\_\_\_ APT. \_\_\_\_\_  
CITY \_\_\_\_\_ ZONE \_\_\_\_\_ STATE \_\_\_\_\_

Check here if you are under 16 years of age.  
Canadian residents: Write DeVry Tech of Canada, Ltd.  
2095 970 Lawrence Avenue West, Toronto 29, Ontario

## DeVry Technical Institute

Chicago • Toronto

## PULSING PLASTIC . . .

There was a time when anyone who argued that plastics could be made to conduct would have been suspect as a nut. But a plastic that conducts is just what is being held in the photo by a scientist at GE's Research Lab. The new material will require some additional research before it becomes available commercially but the groundwork seems to have been completed. And so, some day you may be reading about chassis that are hand-plasticized, and the hand-wired claim will be old-fashioned.



...electronics in the news

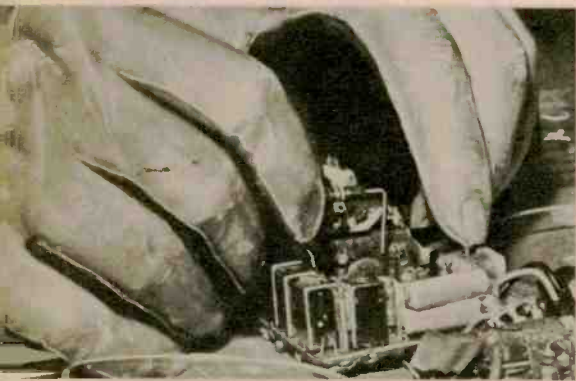

**Skinless Grip . . .** Handling modern electronic components demands a mighty light touch, and a dirt-, dust- and moisture-free one at that. One answer to the problem is some nifty mitts that well might be considered the counterpart of the rubber gloves surgeons wear. Developed by Plasticsmith, Inc., the gloves permit workers to retain the sensitivity of touch required for maximum manual dexterity. Simultaneously, they provide a barrier against moisture, dust and grit, not to mention chemicals and solvents. With such gloves available in a variety of special weights and materials, it looks as though electronics labs now can hold their own against most any hospital.

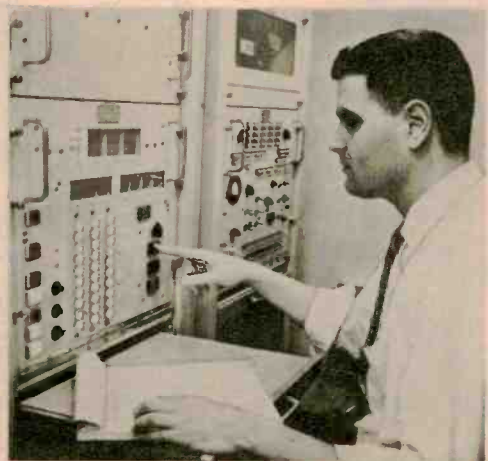

**Robot Doc . . .** Getting ready to give the U.S. Air Force's airborne equipment a head-to-toe checkup is this new digital diagnostician. A veritable electronic medic, the device can make up to 1,000 tests a second, tell an attendant what ails a complex system and even diagnose its own ills. Heart of the installation is a digital computer which draws from a memorized repertoire of more than 500 different instructions. Sperry, the manufacturer, says that the MSM-42 also can be adapted for use in large repair installations or on automated production lines.



# You probably thought top quality electronic test instruments were too expensive...didn't you?

*Well, they're not when you build them with money-saving RCA kits*

You've known right along that you can save money on electronic test instruments by building from kits.

But you may have shied away from kits because you thought they involved complicated calibration or adjustment problems. Forget it!

RCA kits are inexpensive, of course, but they're also easy to build. Build them right and they'll give you the best performance you can buy in their price range.

What's better about RCA test instrument kits?

**Ease of assembly is one thing.** Parts are clearly identified. Each assembly diagram appears on the same page as the step-by-step instructions for that section of assembly. There's no need to refer back constantly to other pages, which consumes time and increases the chance of error.

**Ease of alignment is another thing.** Each kit contains complete instructions for accurate calibration or alignment of the instrument. Where necessary, precision calibrating resistors are provided for this purpose.

**What does it mean?** It means that with RCA kits you can get a professional V-O-M or VTVM for as little as \$29.95\*. Or you can get a good oscilloscope (one of the most useful—but normally one of the most expensive—test instruments) for only \$79.50\*

Specialized instruments such as an AC VTVM or an RF Signal Generator, are also available as kits for far less than they would cost otherwise. In every case, RCA kits, when completed, are identical with RCA factory assembled instruments.

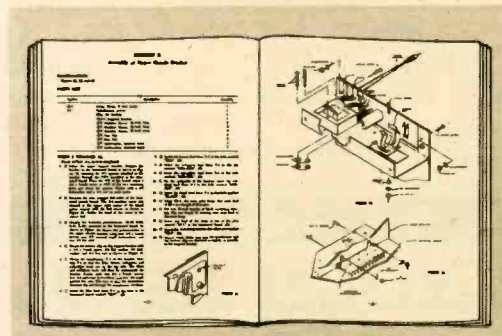

Each sub-assembly is described in a separate section with illustrations applying to that sub-assembly available at a glance. No cross referencing necessary.

## LOOK WHAT'S AVAILABLE TO YOU IN KIT FORM:

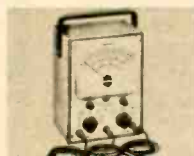

RCA VOLTOHMYST®. The most popular VTVM on the market. WR-77E(K). Kit price: \$29.95\*



RCA SENIOR VOLTOHMYST. A professional VTVM. WV-98C(K). Kit price: \$57.95\*



RCA VOLT-OHM-MILLIAMMETER. One of most useful instruments. WV-38A(K). Kit price: \$29.95\*



RCA 3-INCH OSCILLOSCOPE. Compact, lightweight, portable. WO-33A(K). Kit price: \$79.95\*



RCA HIGH-SENSITIVITY AC VTVM. Doubles as audio pre-amplifier. WV-76A(K). Kit price: \$57.95\*



RCA RF SIGNAL GENERATOR. For audio and TV servicing. WR-50A(K). Kit price: \$39.95\*



RCA TV BIAS SUPPLY. For RF, IF alignment in TV sets. WG-307B(K). Kit price: \$11.95\*

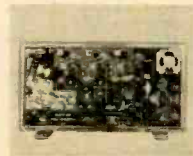

RCA TRANSISTOR-RADIO DYNAMIC DEMONSTRATOR. For schools. WE-93A(K). Kit price: \$39.95\*

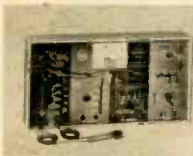

RCA V-O-M DYNAMIC DEMONSTRATOR. A working V-O-M. WE-95A(K). Kit price: \$37.95\*

See them all—and get full technical specifications for each—at your local Authorized RCA Test Equipment Distributor. Or write for information to: Commercial Engineering, Section C134W, RCA ELECTRONIC COMPONENTS AND DEVICES, HARRISON, N. J.

\*Optional Distributor Resale Price. All prices are subject to change without notice. Prices may be higher in Alaska, Hawaii and the West.



The Most Trusted Name in Electronics

RCA ELECTRONIC COMPONENTS AND DEVICES, HARRISON, N.J.

...electronics in the news

**Musical Modulator** . . . Slower than a wink, the world's largest electronic tuning fork oscillates a mere two times per second.



Though the pretty miss in our photo seems to be having trouble synchronizing her winks and blinkens, there's little cause for concern. The gadget is a model of other units made by Bulova to chop laser beams.

**Super Solid-Stater** . . . Looming above the man in our photo is one of three gigantic rectifiers now in operation for Project Haystack. Developed by Energy Systems, Inc., the rectifiers contain a total of 4,608 solid-

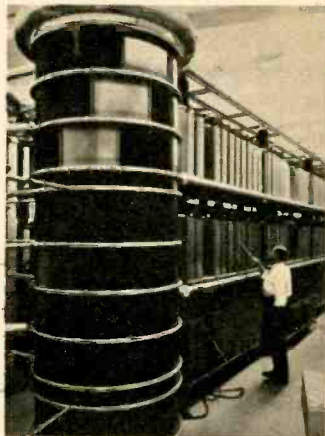

state diodes and will be used to fire up a 1-million-watt transmitter in the Haystack Facility. MIT Lincoln Laboratory currently is operating the Haystack Facility for the U.S. Air Force.

## YOUR NEW COPY IS WAITING



**FREE!** For fun and pride in assembly, for long years of pleasure and performance, for new adventures in creative electronics mail the coupon below and get Conar's brand new catalog of quality do-it-yourself and assembled kits and equipment. Read about items from TV set kits to transistor radios . . . from VTVM's to scopes . . . from tube testers to tools. And every item in the Conar catalog is backed by a no-nonsense, no-loopholes, money-back guarantee! See for yourself why Conar, a division of National Radio Institute, is about the fastest growing entry in the quality kit and equipment business.

# CONAR

MAIL THIS COUPON NOW

CONAR

CE5C

3939 Wisconsin Ave., Washington 16, D.C.

Please send me your new catalog.

Name \_\_\_\_\_

Address \_\_\_\_\_

City \_\_\_\_\_ State \_\_\_\_\_ Z-Code \_\_\_\_\_



# BUILD YOUR OWN RADIO

Reg. U. S.  
Pat. Off.

CIRCUITS AT HOME ONLY  
with the Deluxe \$26.95  
PROGRESSIVE RADIO "EDU-KIT"®

A Practical Home Radio Course

## Now Includes

- ★ 12 RECEIVERS
- ★ 3 TRANSMITTERS
- ★ SQ. WAVE GENERATOR
- ★ SIGNAL TRACER
- ★ AMPLIFIER
- ★ SIGNAL INJECTOR
- ★ CODE OSCILLATOR

- ★ No Knowledge of Radio Necessary
- ★ No Additional Parts or Tools Needed
- ★ EXCELLENT BACKGROUND FOR TV
- ★ SCHOOL INQUIRIES INVITED
- ★ Sold in 79 Countries



Training Electronics Technicians Since 1946

**YOU DON'T HAVE TO SPEND  
HUNDREDS OF DOLLARS FOR A RADIO COURSE**

The "Edu-Kit" offers you an outstanding PRACTICAL HOME RADIO COURSE at a rock-bottom price. Our Kit is designed to train Radio & Electronics Technicians, making use of the most modern methods of home training. You will learn radio theory, construction practice and servicing. THIS IS A COMPLETE RADIO COURSE IN EVERY DETAIL.

You will learn how to build radios, using regular schematics; how to wire and solder in a professional manner; how to service radios. You will work with the standard type of punched metal chassis as well as the latest development of Printed Circuit chassis.

You will learn the basic principles of radio. You will construct, study and work with RF and AF amplifiers and oscillators, detectors, rectifiers, test equipment. You will learn and practice code, using the Progressive Code Oscillator. You will learn and practice trouble-shooting using the Progressive Signal Tracer, Progressive Signal Injector, Progressive Dynamic Radio & Electronics Tester, Square Wave Generator and the accompanying instructional material.

You will receive training for the Novice, Technician and General Classes of F.C.C. Radio Amateur Licenses. You will build Receiver, Transmitter, Square Wave Generator, Code Oscillator, Signal Tracer and Signal Injector circuits, and learn how to operate them. You will receive an interesting hobby, a well paying career, Hi-Fi and Electronics.

Absolutely no previous knowledge of radio or science is required. The "Edu-Kit" is the product of many years of teaching and engineering experience. The "Edu-Kit" will provide you with a basic education in Electronics and Radio, worth many times the low price you pay. The Signal Tracer alone is worth more than the price of the Kit.

## THE KIT FOR EVERYONE

You do not need the slightest background in radio or science. Whether you are interested in Radio & Electronics because you want an interesting hobby, a well paying business or a job with a future, you will find the "Edu-Kit" a worth-while investment. Many thousands of individuals of all

ages and backgrounds have successfully used the "Edu-Kit" in more than 79 countries of the world. The "Edu-Kit" has been carefully designed, step by step, so that you cannot make a mistake! The "Edu-Kit" allows you to teach yourself at your own rate. No instructor is necessary.

## PROGRESSIVE TEACHING METHOD

The Progressive Radio "Edu-Kit" is the foremost educational radio kit in the world, and is universally accepted as the standard in the field of electronics training. The "Edu-Kit" uses the modern educational principle of "Learn by Doing." Therefore you construct, learn schematics, study theory, practice trouble-shooting—all in a closely integrated program designed to provide an easily-learned, thorough and interesting background in radio.

You begin by examining the various radio parts of the "Edu-Kit." You then learn the function, theory and wiring of these parts. Then you build a simple radio. With this first set you will enjoy listening to regular broadcast stations, learn more advanced theory and trouble-shooting. Then you build a more advanced radio, learn more advanced theory and techniques. Gradually, in a progressive manner, and at your own rate, you will find yourself constructing more advanced multi-tube radio circuits, and doing work like a professional Radio Technician.

Included in the "Edu-Kit" course are Receiver, Transmitter, Code Oscillator, Signal Tracer, Square Wave Generator and Signal Injector circuits. These are not unprofessional "breadboard" experiments, but genuine radio circuits, constructed by means of professional wiring and soldering on metal chassis, plus the new method of radio construction known as "Printed Circuitry." These circuits operate on your regular AC or DC house current.

## THE "EDU-KIT" IS COMPLETE

You will receive all parts and instructions necessary to build twenty different radio and electronics circuits, each guaranteed to operate. Our Kits contain tubes, tube sockets, variable, electrolytic, mica, ceramic and paper dielectric condensers, resistors, tie strips, coils, hardware, tubing, punched metal chassis, Instruction Manuals, hook-up wire, solder, selenium rectifiers, volume controls and switches, etc.

In addition you receive Printed Circuit materials, including Printed Circuit chassis, special tube sockets, hardware and instructions. You also receive a useful set of tools, a professional electric soldering iron, and a self-powered Dynamic Radio and Electronics Tester. The "Edu-Kit" also includes Code Instructions and the Progressive Code Oscillator, in addition to FCC Radio Amateur License training. You will also receive lessons for servicing with the Progressive Signal Tracer and the Progressive Signal Injector, a High Fidelity Guide and a Quiz Book. You receive Membership in Radio-TV Club, Free Consultation Service, Certificate of Merit and Discount Privileges. You receive all parts, tools, instructions, etc. Everything is yours to keep.

## PRINTED CIRCUITRY

At no increase in price, the "Edu-Kit" now includes Printed Circuitry. You build a Printed Circuit Signal Injector, a unique servicing instrument that can detect many Radio and TV troubles. This revolutionary new technique of radio construction is now becoming popular in commercial radio and TV sets.

A Printed Circuit is a special insulated chassis on which has been deposited a conducting material which takes the place of wiring. The various parts are merely plugged in and soldered to terminals.

Printed Circuitry is the basis of modern Automation Electronics. A knowledge of this subject is a necessity today for anyone interested in Electronics.

## UNCONDITIONAL MONEY-BACK GUARANTEE

ORDER FROM AD — RECEIVE FREE BONUS  
RADIO & TV PARTS JACKPOT WORTH \$15

- Send "Edu-Kit" Postpaid. I enclose full payment of \$26.95.
- Send "Edu-Kit" C.O.D. I will pay \$26.95 plus postage.
- Rush me FREE descriptive literature concerning "Edu-Kit."

Name \_\_\_\_\_

Address \_\_\_\_\_

## PROGRESSIVE "EDU-KITS" INC.

(ATT: S. GOODMAN, M.S. IN ED. PRES.)  
1186 Broadway Dept. 562AE, Hewlett, N. Y.

...electronics in the news

**Instant Repair . . .** Though it looks like a conventional ophthalmoscope, this compact device is designed to spot-tell damaged



eyes with an intense beam of laser light. Heart of the instrument is a ruby rod which is pumped to produce bursts of deep red light. A prototype is in use at the famed Mayo Clinic in Rochester, Minn.

**Parabola Plus . . .** Parabolas may be easy to draw with thread, pins and graph paper, but producing a true parabola to serve as an antenna reflector is a mule of a different molecular structure. Yet the Marconi Company has done just that, forming a surface that departs only 0.03 in. r.m.s. from true paraboloid. Our photo shows one of the antennas on test at the company's testing ground near Chelmsford, Eng.



Results of the tests have led Marconi engineers to conclude that the new resin bonded glass fiber reflectors achieve front-to-back ratios in excess of 65db at frequencies as high as 4,000 mc. Result is that transmitters used with such antennas should radiate practically all of their power in the forward direction.

LARGE, SELECT STOCK! DEPENDABLE, FAST SERVICE!

- Every tube tested in our own laboratory for mutual conductance and life test.
- We guarantee FREE replacement for one year of any tube purchased from us which fails to function efficiently under any or all operating conditions. Prompt refunds on any defective merchandise.
- Advertised tubes not necessarily new, but may be electrically perfect factory seconds or used tubes—each clearly so marked.

024	6AB4	3BZ7	6K7	6W6GT	7F8	12BY7
1A7GT	6AC7	6C4	6K8	7H7	7H7	12CA5
1B3GT	6AF4	6C5	6L7	8X4	8X5	12J5
1H4C	6AG5	6C6	6N7	8X8	707	12M7
1H5GT	6AG7	6CB6	6Q7	5Y6C	7X7/XXFM	12L6
1L4	6AH4GT	6CD6G	654	7A4/XXL	7Y4	12Q7
1L6	6AH6	6CF6	7A5	7Z4	7Z4	12SA7
1N5GT	6AL5	6CG7	6S47	7A6	12A8	12SC7
1Q5GT	6AL7					12SK7
1R5	6AM8					12SN7GT
1S5	6AN8					12SQ7
1T4	6AQ5					12S97
1U4	6AQ6					12W6GT
1U5	6A07GT					12X4
1V2	6AR5					12Z3
1X2	6AS5					14A7
2A3	6AT6					12B7
2AF4	6AT8					14B5
3BC5	6AL4GT					1407
3B6	6AUSGT					19
3B8	6AU6					19AU4GT
3C86	6AUB8					19B6G
3CF6	6AV5GT					19J6
3C56	6AV6					19T8
3L4	6AW8					2A4
3Q4	6AX4GT					25AV5
354	6AX5GT					25BQ6
3V4	6BA					25DN6
4B07A	6BA6					25L6GT
4B27	6BC5					25W4GT
5A58	6BC8					25Z5
5A78	6BD6					25Z6
5A8	6BE6					
5AW4	6BF5					
5B7	6BF6					
5J6	6BG6G					
5B8	6BH6					
5U4G	6BJ6					
5U8	6BK5					
5V4G	6BM7					
5V5GT	6BL7GT					
5X3	6BN6					
5Y3GT	6BQ6GT					
5V4G	6B07					
6A7	5BY5G					
6A8	6BZ6					

Jan Surolo Tubes  
**37¢ ea.**  
**\$35**  
 for  
**ANY TUBE LISTED**  
 PER HUNDRED ASSTD

6CL6	6SC7	7A7	12AQ5	26
6CM6	6SF5	7A8	12AT6	35A5
6CN7	6SF7	7B4	12AT7	35A5
6CN7	6SJ7	7B5	12A06	35C5
6BH6	6CS6	6SK7	12A07	35L6GT
6BJ6	6CU6	6T4	12A08	35Y4
6BK5	6DE6	6SN7GT	12A07	35Y4
6DQ6	6DQ6	6S07	12AX4GT	35Z5GT
6BL7GT	6F6	6S57	12AX7	37
6BN6	6H6	6T4	12AZ7	39/44
6J4	6J4	6T8	12B4	42
6J5	6J5	6U8	12B6	43
6J7	6J7	6V6	12B7	45
6K6GT	6K6GT	6W4GT	12BE6	50A5
				50B5
				50C5
				50L6GT
				50X6

New at MICRO!  
 25-WATT POWER  
 TRANSISTORS

Your Choice **79¢ ea.** 3 for **\$2**

2N155	2N297	2N1136
2N156	2N301	2N1136A
2N157	2N301A	2N1136B
2N158	2N307	2N1137
2N158A	2N307A	2N1137A
2N158B	2N325	2N1137B
2N176	2N350	2N1138/A/B
2N178	2N350A	2N1245
2N179	2N351	2N1246
2N234	2N351A	2N1291
2N234A	2N352	2N1293
2N235	2N353	2N1297
2N235A	2N376	2SB25
2N235B	2N376A	2SB26
2N236	2N386	AR5
2N236A	2N387	AR6
2N236B	2N399	AR8
2N242	2N400	AR9
2N250	2N401	DS503
2N251	2N554	DS520
2N255	2N555	ET-6
2N255A	2N589	CT1124
2N256	2N1014	CT1124B
2N256A	2N1022	MN25
2N257	2N1033	MN29
2N268	2N1038	SYL-109
2N268A	2N1039	WTVPwr25
2N285	2N1040	WTVPwr12
2N285A	2N1041	WTVPwr6
2N296	2N1046	WTV99Pwr
		WTV199Pwr

EXTRA SPECIALS:  
 6/12 volt VIB 89¢  
 6/12 volt New VIB \$1.49  
 50 watt 25K Sprague Resistors 30¢

**MICRO**  
 SINCE 1957  
**EVERY**  
**DEAL**  
**A FAIR**  
**DEAL**

Not Connected With Any Other Mail Order Tube Co.  
 ALL TUBES SENT POST-AGE PAID. Please send 35¢ handling for orders under \$5. Send 25¢ dep. on C.O.D. orders. Send approx. postage on Canadian and foreign orders.

**MICRO**  
 ELECTRON TUBE CO.  
 P.O. Box 55 Park Sta. Paterson 3, N. J.  
 WRITE DEPT. E-13 FOR OUR FREE COMPLETE LIST OF TUBES & SPECIAL PURPOSE TUBES





## Build the Fisher KX-200 StrataKit and own a \$250 stereo control- amplifier for \$169.50.

It's almost absurdly easy. You need no experience whatsoever. The superbly detailed kit construction manual prepared by Fisher StrataKit engineers tells you absolutely everything you need to know to build this magnificent 80-watt stereo control-amplifier. The language is simple; the diagrams are huge and crystal-clear; the exclusive StrataKit method itself is uniquely 'beginner-proof.'



You build your StrataKit in ingeniously simplified stages (Strata). Each stage corresponds to a separate fold-out page in the instruction manual. Each stage is built from a separate, clearly identified packet of parts (StrataPack). The major parts come already mounted on the extra-heavy-gauge steel chassis. Wires are precut for every stage—which means every page. All work can be checked stage-by-stage and page-by-page, before proceeding to the next stage. There is no possibility of last-minute 'surprises.'



When you have built the Fisher KX-200, you are the owner of one of the world's finest amplifiers, easily worth \$250.00. Its 80-watt (IHF) stereo power amplifier section will drive the least efficient speakers at extremely low distortion. Its preamplifier section provides a virtually unlimited range of input and control facilities. It even incorporates exclusive features like a laboratory-type d'Arsonval bias/balance meter and a power-derived third-speaker output with separate volume control.

All this is yours in a kit priced at \$169.50. The Fisher KX-100, a 50-watt stereo control-amplifier kit of advanced design, costs only \$129.50. (Walnut cabinet for either model, \$24.95; metal cabinet, \$15.95.)

*"I personally guarantee that any Fisher StrataKit you assemble, as directed, will be fully equal in performance and reliability to its laboratory-wired prototype."*



*Avery Fisher*  
Founder and President  
Fisher Radio Corporation



### FREE! \$1.00 VALUE!

Send for *The Kit Builder's Manual*, an illustrated guide to high fidelity kit construction, complete with detailed specifications of all Fisher StrataKits.

Fisher Radio Corporation  
21-40 44th Drive  
Long Island City, N. Y. 11101

Name \_\_\_\_\_

Address \_\_\_\_\_

City \_\_\_\_\_

State \_\_\_\_\_

The  
Kit Builder's  
Manual

213

OVERSEAS RESIDENTS PLEASE WRITE TO FISHER RADIO INTERNATIONAL, INC., LONG ISLAND CITY, N. Y. 11101. CANADIAN RESIDENTS WRITE TO TRITEL ASSOCIATES, LTD., WILLOWDALE, ONT.

# BROADSIDES

Pamphlets, booklets, flyers, application notes and bulletins available free or at low cost.

For hobbyists who want to find out more about **negative-resistance diodes**, a four-page brochure gives theory of operation as well as descriptions of 24 circuits using the devices. Request your free copy of bulletin E-505 from ITT Semiconductors Inc., 500 Broadway, Lawrence, Mass. 01840.

When it comes to selecting hi-fi/stereo speakers and earphones, Jensen's new 24-page catalog may be right down your alley. The booklet offers useful hints for choosing a system to fit your needs and even includes data on designing your own enclosures. Ask for catalog 165-K from the Jensen Mfg. Co., 6601 S. Laramie Ave., Chicago, Ill. 60638.

Anyone who wants to learn more about **thermistors** and their uses should get ahold of Capsule Thermistor Course #9. Copies are available from Fenwal Electronics, Inc.,

63 Fountain St., Framingham, Mass. 01701.

Knowing as much as you can about **magnetic tape** is about the only way to select the exact tape you need. Bulletin RS-64-18 describes over twenty of tape's electromagnetic and physical properties in some six pages. A copy can be yours for the asking from Reeves Soundcraft, Great Pasture Rd., Danbury, Conn. 06810.

Going portable can be easy with the right battery. And bulletin GEA-7678 gives electrical ratings and physical dimensions for seven types of **nickel-cadmium batteries**. Ask for your copy from General Electric Co., 1 River Rd., Schenectady, N.Y. 12305.

Dozens of **electronic projects** are listed in a 28-page catalog from Parks Lab. Grouped according to degree of difficulty and design type (i.e., vacuum-tube, solid-state or electro-mechanical), the projects described can be built from the circuit diagrams, parts lists and notes the company will supply. Prices for such literature range from \$1 up, depending on the complexity of the project. Catalog No. 8 itself costs 25 cents (refunded with your first order) and can be obtained from the Henry Francis Parks Laboratory, Box 1665, Seattle, Wash. 98125.

TV-RADIO Servicemen or Beginners . . .

## Send for *Coyne's* 7-Volume Job-Training Set on 14-day **FREE TRIAL!**



The First Practical TV-RADIO-ELECTRONICS Shop Library!

Like Having An Electronics Expert Right At Your Side!

Answers ALL Servicing Problems QUICKLY . . .  
Makes You Worth More On The Job!

Put money-making, time-saving TV-RADIO-ELECTRONICS know-how at your fingertips—examine Coyne's all-new 7-Volume TV-RADIO-ELECTRONICS Reference Set for 14 days at our expense! Shows you the way to easier TV-Radio repair—time saving, practical working knowledge that helps you get the BIG money! How to install, service and align ALL radio and TV sets, even color-TV, UHF, FM and transistorized equipment. New photo-instruction shows you what makes equipment "tick." No complicated math or theory—just practical facts you can put to use immediately right in the shop, or for ready reference at home. Over 3000 pages; 1200 diagrams, 10,000 facts!

**SEND NO MONEY!** Just mail coupon for 7-Volume TV-Radio Set on 14-Day FREE TRIAL! We'll include the FREE BOOK below. If you keep the set, pay only \$5 in 14 days and \$4 per month until \$32.95 plus postage is paid. Cash price only \$29.95. Or return set at our expense in 14 days and owe nothing. Either way, the FREE BOOK is yours to keep. Offer limited, so act NOW!

### "LEARNED MORE FROM THEM THAN FROM 5 YEARS WORK!"

"Learned more from your first two volumes than from 5 years work."  
—Guy Bliss, New York

"Sweet set for either the serviceman or the beginner. Every service bench should have one."  
—Malvin Masbruch, Iowa

### FREE DIAGRAM BOOK!

We'll send you this big book, "150 Radio-Television Picture Patterns and Diagrams Explained" ABSOLUTELY FREE just for examining Coyne's 7-Volume Shop Library on 14-day FREE TRIAL! Shows how to cut servicing time by reading picture-patterns, plus schematic diagrams for many TV and radio sets. Yours FREE whether you keep the 7-Volume Set or not! Mail coupon TODAY!



**VOL. 1—EVERYTHING ON TV-RADIO PRINCIPLES!** 300 pages of practical explanations; hundreds of illustrations.

**VOL. 2 EVERYTHING ON TV-RADIO FM RECEIVERS;** 403 pages; fully illustrated.

**VOL. 3—EVERYTHING ON TV-RADIO CIRCUITS!** 336 pages; hundreds of illustrations, circuit diagrams.

**VOL. 4—EVERYTHING ON SERVICING INSTRUMENTS!** How they work, how to use them. 352 pages; illustrated.

**VOL. 5—EVERYTHING ON TV TROUBLESHOOTING!** Covers all types of sets. 437 pages; illustrations, diagrams.

**VOL. 6—TV CYCLOPEDIA!** Quick and concise answers to TV problems in alphabetical order, including UHF, Color TV and Transistors; 840 pages.

**VOL. 7—TRANSISTOR CIRCUIT HANDBOOK!** Practical Reference covering Transistor Applications; over 200 Circuit Diagrams; 410 pages.

BOOKS HAVE BRIGHT, VINYL CLOTH WASHABLE COVERS

### FREE BOOK—FREE TRIAL COUPON!

**COYNE SCHOOL PUBLICATIONS**

1455 W. Congress Parkway, Dept. 35-EI, Chicago 7, Ill.

Yes! Send me COYNE'S 7-Volume Applied Practical TV-RADIO-ELECTRONICS Set for 14-Days FREE TRIAL per offer. Include "Patterns & Diagrams" book FREE!

Name ..... Age .....

Address .....

City ..... Zone ..... State .....

Check here if you are sending \$29.95 in full payment. Same 2 Week Money Back Guarantee applies.

*Coyne*

SCHOOL PUBLICATIONS INC.

1455 W. Congress Parkway, Dept. 35-EI, Chicago 7, Illinois



# Choose Your Tailor-Made Course in N.T.S. "PROJECT METHOD" ELECTRONICS!

Now! N.T.S. — one of America's oldest leading home-study and resident technical schools — offers you **GREATER CAREER OPPORTUNITIES IN ELECTRONICS**. N.T.S. "Project Method" home training lessons are shop-tested in the Resident School in Los Angeles. The Schools' practical methods, plus more than 60 years of experience, have helped thousands of students all over the world to successful careers. Choose your field and prepare now for a secure future with one of 8 N.T.S. Electronics Courses designed to fit your own particular needs.



**SEE OTHER SIDE**

## 1 ELECTRONICS-TV-RADIO-SERVICING & COMMUNICATIONS

A basic course thoroughly covering fundamentals of electronics, radio, TV servicing and communications.

## 2 MASTER COURSE IN ELECTRONICS-TV-RADIO, PLUS ADVANCED TV & INDUSTRIAL ELECTRONICS

This course covers everything included in Course No. 1 plus Automation and every phase of the Electronics industry.

## 3 FCC LICENSE

Preparation for this government license essential for interesting jobs in radar, radio, television, communications, guided missiles, many others. Upon completion of this course, if you do not pass the FCC exam for a 1st Class Commercial Radiotelephone License your tuition will be refunded.

## 4 RADIO SERVICING (AM-FM-Transistors)

Train for radio sales and service with dealer or distributor.

## 5 TELEVISION SERVICING (Including Color)

Covers installation, adjustment, repair and servicing of black and white and color television . . . prepares you for your own sales and service business.

## 6 STEREO, HI-FI AND SOUND SYSTEMS

A growing field. Prepares you to build, install and service modern sound equipment for home or industry.

## 7 BASIC ELECTRONICS

Gives you the fundamentals you must know to build on for a future Electronics career. Also offers an excellent background for Salesmen, Purchasing Agents, and others in Electronics.

## 8 ELECTRONICS MATH

Simple easy-to-follow instructions in the specialized math you need in many electronics jobs.

### HIGH SCHOOL AT HOME

Learn easily. New modern method. National offers accredited high school programs for men and women. Take only subjects you need. Study at your own pace. Latest approved textbooks — yours to keep — everything included at one low tuition. Check High School box in coupon for information.

### CLASSROOM TRAINING AT LOS ANGELES

You can take classroom training in our famous Resident School at Los Angeles in Sunny Southern California. N.T.S. is the oldest and largest school of its kind. Associate in Science Degree also offered in our Resident Program. Check Resident School box in coupon for full details.



**NATIONAL TECHNICAL SCHOOLS**  
WORLD-WIDE TRAINING SINCE 1905

Send Postcard for Free Book & Sample Lesson.

**CUT OUT & MAIL TODAY. NO POSTAGE NECESSARY.**

Please Rush **FREE** Electronics "Opportunity Book" and sample lesson on course checked below:

- |   |   |
|---|---|
| <input type="checkbox"/> Electronics-TV-Radio Servicing & Communications                            | <input type="checkbox"/> Television Servicing (Including Color) |
| <input type="checkbox"/> Master Course in Electronics-TV-Radio Advanced TV & Industrial Electronics | <input type="checkbox"/> Stereo, Hi-Fi and Sound Systems        |
| <input type="checkbox"/> FCC License  | <input type="checkbox"/> Basic Electronics                      |
| <input type="checkbox"/> Radio Servicing (AM-FM-Transistors)  | <input type="checkbox"/> Electronics Math                       |

Dept. 213-25



Name \_\_\_\_\_ Age \_\_\_\_\_

Address \_\_\_\_\_

City \_\_\_\_\_

State \_\_\_\_\_ Zip \_\_\_\_\_

- Check here for High School Department Catalog only.  
 Check here if interested **ONLY** in Classroom training at L.A.



You can install and maintain electronic circuitry in missiles and rockets . . . specialize in microwaves, radar, and sonar, or succeed in your own business.



You can succeed in TV-Radio Communications . . . prepare for F.C.C. License, service advanced satellites for industry and defense.

# TAKE THE QUICK WAY TO HIGHER PAY, LIFELONG BENEFITS, WITH N.T.S. HOME TRAINING!

N.T.S. "Project Method" Courses can help you get

a new and better job — or move up to higher pay in your present one. You work on practical job projects, learn to use shop manuals and schematics. Your N.T.S. training is individual. You proceed at your own pace.

## BENEFIT NOW AND ALL YOUR LIFE WITH N.T.S. HOME TRAINING

The personal guidance you receive during your training can be very helpful to your progress. Many N.T.S. students are able to earn more money within a few months. You can pick and choose your career. Work in industry or go into business for yourself. Your services will always be in demand wherever you go — and you can pick your spot!

N.T.S. Graduate Advisory Service can help you answer technical questions in establishing your own business and in countless other ways after you've completed your training.

Most courses include Equipment Kits. THERE ARE NO KIT DEPOSITS. Everything included in your low tuition.



**CLIP & MAIL POSTAGE FREE CARD TODAY FOR FREE BOOK AND SAMPLE LESSON**

in Field of Your Choice. You enroll by mail under N.T.S. "No Obligation" Plan. We have No Salesmen; This means lower tuition for you.

See other side of this card for description of all courses.

FIRST CLASS  
Permit No. 3087  
Los Angeles, Calif.

**BUSINESS REPLY MAIL**

No Postage Stamp Necessary If Mailed in the United States

—POSTAGE WILL BE PAID BY—

**NATIONAL TECHNICAL SCHOOLS**

WORLD-WIDE TRAINING SINCE 1905

4000 South Figueroa Street  
Los Angeles, California 90037



Accredited Member  
National Home Study Council



**NATIONAL TECHNICAL SCHOOLS**  
WORLD-WIDE TRAINING SINCE 1905  
4000 So. Figueroa  
Los Angeles, California 90037



## ELECTRONIC MARKETPLACE



**HIGH FLIER** . . . In the air or on the ground, this three-band transistor portable is all it takes to keep in tune with



weather reports, aircraft and control towers or standard broadcast stations. Tuning VHF (108-136 mc), LF (200-400 kc), as well as the BCB, the Scot Air is powered by eight flashlight batteries housed in a leakproof compartment. \$89.95, less batteries. Scot Air, Inc., 6451 Main St., Morton Grove, Ill. 60053.

**Even Steven** . . . More power with no more watts is the promise of Galaxy's compression amplifier, adaptable to SSB and AM transmitters alike. Microphone outputs up to 10



mv are amplified 10db, while strong peaks up to 1.8 V are compressed 20db. Result is greater voice power and increased transmitter range. The unit is powered by a 9-V battery. \$24.95. Galaxy Electronics, 10 S. 34th St., Council Bluffs, Iowa 51501.

# HAS POWER, WILL TRAVEL

## NEW CADRE C-75 2-WAY CB RADIO

For business use, the all-transistor Model C-75 packs the power (1.5 watts) and has the portable convenience for operation anywhere. • Delivers clear, reliable communications up to 5 miles or more. • Sensitive receiver brings in signals in poor reception areas. • 2 crystal-controlled channels for perfect contact. • Completely portable (less than 2 lbs.) offers many hours of operation from penlite cells (8 hour nickel-cadmium rechargeable battery supply also available).

**NEW CADRE C-60**—powerful, hand-held full fledged 100 milliwatt 2-way radio with many of the features found in the C-75. For business use, it delivers clear reliable communications up to 3 miles. 2 crystal-controlled channels • Sensitive superhet receiver • powerful transmitter (70 MW output to antenna) many hours of operation from standard penlite cells or rechargeable nickel-cadmium batteries • no license needed. See Cadre CB 2-way radios at your distributor.



**CADRE INDUSTRIES CORP.**  
COMMERCIAL PRODUCT DIVISION, ENDICOTT, NEW YORK

# BIG MONEY IN THE 4 CORNERS of THE WORLD

IN  
TELEVISION  
ELECTRONICS  
RADAR  
SONAR



## CHRISTY'S MOST COMPLETE COURSE!

Christy's complete course covers every phase of this exciting new subject. You get comprehensive training, starting with your first lesson. You learn Radar, Sonar, Television (Color TV tool), Radio and Electronics in CTS's COMPLETE course.

Christy Shop Method Home Training makes you a more valuable and desirable technician, assures you of more money, faster progress and greater success. Practical step-by-step training makes everything interesting and easy to learn.

## 19 Training Kits Sent

you learn in months what used to take years to learn.

## 3 Free Books

give you complete information as to how you too can get started in this fascinating new field.

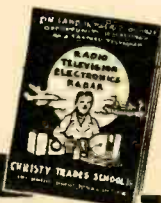

## MAIL COUPON

CHRISTY TRADES SCHOOL Dept. T-2613  
3214 West Lawrence Ave., Chicago Ill. 60625

Send me without cost or obligation two FREE lessons,  
new 24 page illustrated book and Pay Later Form.

Name \_\_\_\_\_ Age \_\_\_\_\_

Address \_\_\_\_\_

City \_\_\_\_\_ Zone \_\_\_\_\_ State \_\_\_\_\_

# MARKETPLACE

**Home-Base TV . . .** No more can you blame the networks for dull TV programs. Wire the Model TV-110 camera to your television set, and the picture on the screen is one you yourself are responsible for. The transistor-



ized CCTV rig operates on standard 117 VAC and is small enough to be carried most anywhere. It offers a 4-mc frequency response and a composite video output of 1 V PEP. \$299.98. Olson Electronics, Inc., 260 S. Forge St., Akron, Ohio 44308.

**Signal Crazy . . .** Just about any signal you'd want for servicing can be yours with the Model 1500 signal generator. Seven overlapping bands cover the range from 115 kc



to 110 mc and you can convert the generator's sine-wave RF output to 400-cycle AM at the flick of a switch. Housed in a metal case, the 1500 is line-isolated and thus safe to use with any type of equipment. \$37.50. Mercury Electronics Corp., 111 Roosevelt Ave., Mineola, N.Y. 11501.



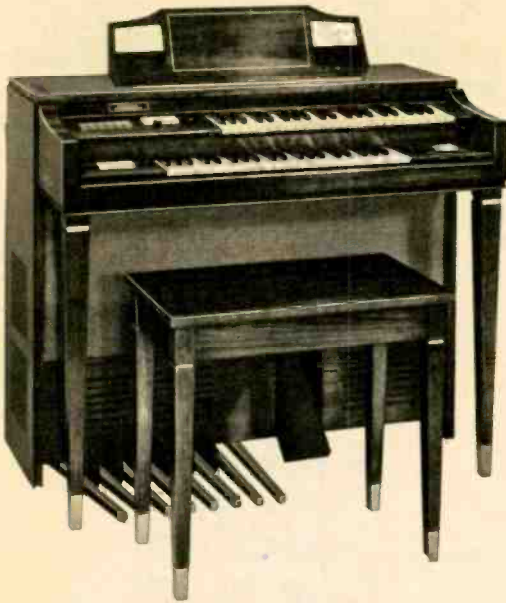

# World's Best Buy In Electronic Organs!

GD-983

**\$849<sup>00</sup>**

including bench  
\$125 dn.,  
as low as \$27 mo.

**Full Features...  
No Extras To Buy...  
Saves Hundreds of Dollars  
New Heathkit/Thomas  
"Coronado" Transistor Organ!**

### Every Organ Feature You've Ever Dreamed Of!

- 17 beautiful organ voices ... Diapason 16' & 8', Bass Clarinet 16', Trumpet 16', English Horn 8', Violin 8', Oboe 8', Bourdon 16', Flute 8', Flute D'Amour 4', Quint 5-1/3', Saxophone 8', French Horn 8', Cello 8', and Chimes — all at the simple touch of a tab!
- Two full-size 44-note keyboards • Built-in 2-speed rotating Leslie plus 2-12" Main speakers • 28 notes of chimes • 13-note heel & toe pedal board, range C thru C • New Stereo chorus for exciting "stereo" effects • Color-tone attack, repeat & sustain percussion ... the only organ to give you all 3
- Treble accent tab • Reverb • Manual balance • Pedal volume • Expression pedal • Headset outlet for private play • All-transistor 75-watt EIA peak music power amplifier • Transistor tone generators ... warranted for 5 years • Pre-tuned Tone generator ... for easily tuning organ, no special "ear" needed
- Luxurious Hardwood Cabinet & bench ... hand-crafted with walnut finish.

**No Extras, Nothing More To Buy!** Everything you need for complete playing versatility is included. There are no speakers, amplifiers, no other "hidden necessities" to add as with other organ kits. It's *all* there at *one* price ... even the bench!

**Saves Hundreds Of Dollars!** Save more than \$400 over the factory assembled version. And you could pay as much as \$1000 more for other brands, and still *not* enjoy as many features!

**It's Truly A Professional Organist's Dream With A Beginner's Simplicity!** And yet, you don't have to be an electronic wizard to build it, nor a professional organist to play it. Famous Heath "Engi-nuity" has reduced assembly to simple steps that require *no* special talents, tools or knowledge. And the famous Thomas "Musical Fun Book" is included to start you playing many favorites fast! A special recorded 48-lesson course is also available that lets you learn at your leisure ... regular \$50 value, only \$19.95!

**Pay As You Play!** Only \$125 dn., as little as \$27 a month. Get *free* catalog for full details — now!

*Kit GD-983, organ & matching bench, 290 lbs. ... \$125 dn., as low as \$27 mo. .... \$849.00*

### WORLD'S LOWEST COST 2 MANUAL ORGAN HEATHKIT/THOMAS "LARGO"



- 10 true organ voices • Variable Repeat Percussion • Two 37-note keyboards • 20-watt peak power amplifier • 13-note heel & toe bass pedals • Walnut cabinet

*Kit GD-232A, organ only,  
158 lbs. .... \$349.95*

#### HEAR IT YOURSELF!



Convince yourself by sending for a 7", 33 1/3 demonstration record! Order No. GDA-983-2 for Deluxe GD-983 organ, GDA-232-5 for low-cost GD-232A organ. Each record 50c. Do it now!



**HEATH COMPANY, Dept. 39-3**

Benton Harbor, Michigan 49023

In Canada: Daystrom, Ltd., Cooksville, Ontario

Enclosed is \$ \_\_\_\_\_ Please send model \_\_\_\_\_

Please send Free 1965 Heathkit Catalog.

Name \_\_\_\_\_

Address \_\_\_\_\_ (Please Print)

City \_\_\_\_\_ State \_\_\_\_\_ Zip \_\_\_\_\_

Prices & specifications subject to change without notice. CL-197R

# You earn your FCC First Class License

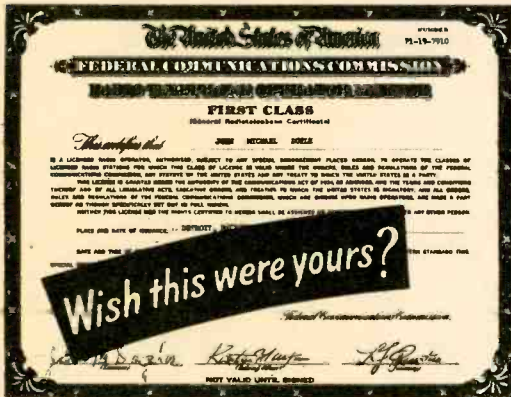

## or your money back!

### THERE'S A WORLD OF OPPORTUNITY FOR THE MAN WITH AN FCC LICENSE

All it takes is a few spare hours a week and NRI's FCC License Course to open the way to increased opportunities in Communications. With an FCC License, you're ready to operate, service and install transmitting equipment used in aviation, broadcasting, marine, mobile and Citizens-Band communications.

What does it take? Men with absolutely no training or experience in Electronics complete the course in 10 months. A Technician or man with some background can easily cut that time in half. And because NRI has a greater enrollment than any other school of its type, training costs you less than comparable courses offered by other schools. Further, **YOU MUST PASS your FCC exams or NRI refunds your tuition in full.**

Get full details today about NRI FCC License Course plus 9 other home-study instruction plans offered by NRI, oldest and largest school of its kind. Mail coupon for free catalog. There's no obligation. No salesman will call. NATIONAL RADIO INSTITUTE, Washington, D.C.

### MAIL NOW for FREE CATALOG



NATIONAL RADIO INSTITUTE  
Electronics Division  
Washington, D. C. 20016 20-035

Please send me complete information on FCC License Training and other NRI courses, as checked below. (No salesman will call.)

- |  |   |
|--|---|
| <input type="checkbox"/> FCC License             | <input type="checkbox"/> Radio-TV Servicing         |
| <input type="checkbox"/> Complete Communications | <input type="checkbox"/> Industrial Electronics     |
| <input type="checkbox"/> Aviation Communications | <input type="checkbox"/> Electronics for Automation |
| <input type="checkbox"/> Marine Communications   | <input type="checkbox"/> Basic Electronics          |
| <input type="checkbox"/> Mobile Communications   | <input type="checkbox"/> Math for Electronics       |

Name \_\_\_\_\_ Age \_\_\_\_\_  
PLEASE PRINT

Address \_\_\_\_\_

City \_\_\_\_\_ State \_\_\_\_\_ Zip \_\_\_\_\_

ACCREDITED MEMBER NATIONAL HOME STUDY COUNCIL

# MARKETPLACE

**Multibutton Multimeter . . .** Push-button switching and a double-jeweled meter movement are two reasons why the MPB-420 is a multimeter with a difference. The 6 x 4 1/4 x



2 in. VOM measures AC and DC voltages to 1,000 V; DC currents to 250 ma.; resistances to 10 megs; decibels from -10 to +62. Test leads and batteries are supplied. \$23.95. Inter-Tech Instruments Corp., 125-08 84th Ave., Kew Gardens, N.Y. 11415.

**Tri-Tipper . . .** Resistors, heavy wires or copper pipes are all the same to the new Model 450 soldering gun. Because of its special design, the gun delivers heats from 25



to 450 watts, depending on which of three tips you've chosen. The gun also features a focused spotlight to illuminate the work area. \$13.95. Wen Products, Inc., 5810 Northwest Hwy., Chicago, Ill. 60631.



# Regardless of what you pay for other Color TV

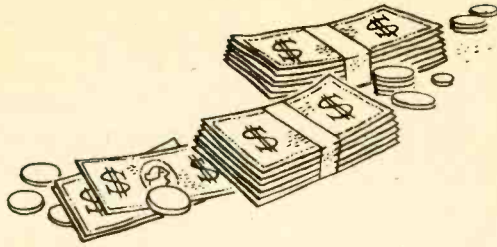

it can't perform as well as this one...

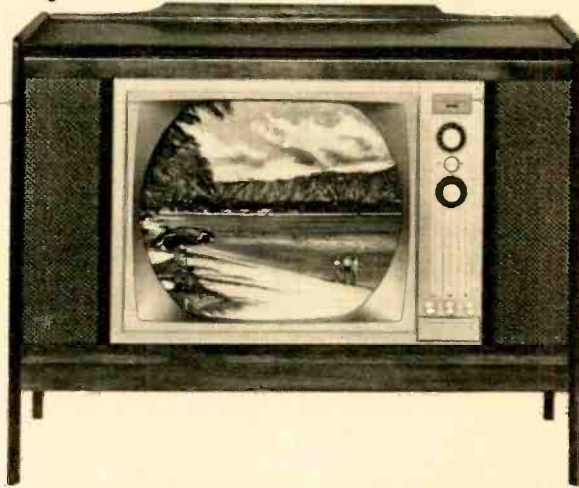

and yet a Heathkit set costs as little as \$399!

**Exclusive Heath Features For Unequalled Performance!** That's right. No matter how many of your hard-earned dollars you pay for another brand of color TV, *none* can equal the performance of the Heathkit All-Channel, High Fidelity 21" Color TV! Why? *All* color sets require minor periodic adjustments to maintain peak picture performance. The Heathkit GR-53A is the *only* set with a "built-in service center" that provides facilities for perfect picture adjustments. Heath's simple-to-follow instructions and detailed color photos show you exactly what to look for and how to achieve it . . . quickly, easily! You become the expert! Results? Beautiful, true-to-life color pictures day in and day out . . . and *no* costly color TV service calls for simple picture alignment.

But don't take our word for it. See the special articles on the Heathkit GR-53A in the May issue of *Popular Electronics*, June issue of *Radio-TV Experimenter*, February issue of *Popular Mechanics*, April issue of *Science & Mechanics*, and the August issue of *Radio-Electronics*.

Then tear out the coupon and order yours now!  
 Kit GR-53A, chassis, tubes, mask, VHF & UHF tuners, mounting kit, speaker, 127 lbs. . . . . \$399.00

## THE ONLY COLOR TV YOU CAN INSTALL 3 WAYS!

1. In Heathkit walnut-finished hardboard cabinet (Illustr. opposite), Model GRA-53-6, 52 lbs. . . . \$49.00
2. In Heathkit Deluxe Walnut Cabinet (Illustr. above), Model GRA-53-7, 85 lbs. . . . . \$115.00
3. In a wall, bookshelf, or custom cabinet!

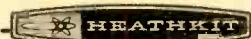

**HEATH COMPANY, Dept. 39-3**  
 Benton Harbor, Michigan 49023  
 Enclosed is \$\_\_\_\_\_, plus shipping.  
 Please send Model(s)\_\_\_\_\_  
 Please send FREE 1965 Heathkit Catalog.

Name \_\_\_\_\_  
 (Please Print)

Address \_\_\_\_\_

City \_\_\_\_\_ State \_\_\_\_\_ Zip \_\_\_\_\_

Prices & specifications subject to change without notice. CL-193R



LEARN

# ELECTRONICS

TELEVISION

ELECTRICITY

Two Year  
Electronics  
Engineering  
Technology Program



## COYNE ELECTRONICS INSTITUTE

Founded  
1899

on a quarter of a million dollars worth of equipment for top salaries and an Exciting Career. Special finance plans. Part time employment service while in school. Also Free graduate employment service.



Use this coupon to get our FREE BOOK  
"YOUR OPPORTUNITIES IN ELECTRONICS"

COYNE ELECTRONICS INSTITUTE, Dept. of Electronics 35-A  
1501 W. Congress Parkway, Chicago, Illinois 60607

Name \_\_\_\_\_ Age \_\_\_\_\_

Address \_\_\_\_\_ Phone \_\_\_\_\_

City \_\_\_\_\_ Zone \_\_\_\_\_ State \_\_\_\_\_

*Unlike most other schools, we do not employ salesman*

**Build It Yourself TV Camera Kit  
Here It Is! — Offered For The  
First Time From England!**

### “BEUKIT”

The first fully transistorized TV CAMERA KIT

It is so simple to make BECAUSE:

- Comprehensive step by step fully illustrated instruction book, including basic Camera Theory.
- Wideband Video Amplifier with only one tuned inductor. No signal generator or special test equipment required.
- Unique printed circuit board with each component clearly marked.
- Single Unit Scanning and Focus Assembly, including Target connector.

These are the Star features to ensure good pictures from your DO-IT-YOURSELF TV CAMERA.

**YOU CAN USE YOUR OWN TV  
TO MONITOR TV CAMERA**

We will offer you in the very near future a low priced VIDEO TAPE RECORDER KIT.

**BEUKIT COMPLETE WITH VIDICON \$251.90  
ASSEMBLED — \$295.00**

Lens purchased with Kit \$39.50 extra.

For full information write to: Dept. B

**P. A. F. ENTERPRISES**

32 EAST 22nd STREET, BAYONNE, N. J. 07002

Distributor for Beulah Electronics, England.

We also carry 3 completed models of Video Cameras — Plus a full line of Video lenses and accessories. Subject to price change.

All Shipments F.O.B., Bayonne, N. J.

## ELECTRONIC SWAP SHOP

EI's Swap Shop provides a way for readers to obtain equipment they want in exchange for items they no longer have use for. Notices must be from individuals, not commercial concerns. Entries must include your name and address as well as a description of what you now have and what you would like in exchange. Address: EI's Swap Shop, ELECTRONICS ILLUSTRATED, 67 West 44th Street, New York, New York 10036.

HEATH GW-52 CB Walkie-Talkie. Will exchange for older 5-watt unit. David Dube, 905 Ivy, McAllen, Tex 78501.

HALLICRAFTERS S-120 receiver, other items. Will trade for tape recorder. Hector Belardo, 232 W. 21st St., New York, N.Y. 10011.

CADRE C-75 CB transceiver. Will swap for battery eliminator. Douglas Faunt Jr., Box 1835, Columbia, S.C. 29202.

RCA Volt-Ohmyst, Vibroplex Champion key. Need Heathkit HW-30 transceiver. Stuart Kravitz, 1233 Robbins St., Philadelphia, Pa. 19111.

OLD TUBES: 6A7's, 45's, 80's, others. Want test equipment. Henry O'Connor, 616 Goulding St., Winnipeg 10, Man.

OSCILLOSCOPE with 1-in. CRT. Will trade for VTVM or VHF receiver. Dave Erickson, 82 Pacific Ave., San Bruno, Calif. 94066.

MINNEAPOLIS-HONEYWELL 24-channel recorder, other items. Want FM tuner, CB or ham equipment. John M. Hicks, 1136 Margray St., Pittsburgh, Pa. 15207.

KNIGHT T-50 transmitter, other equipment. Make swap offer. William Ringleben, 305 E. Elm St., Hazleton, Pa. 18201.

RADIO PHYSICS COURSE by Ghirardi, dated 1932. Will trade for 4-section, 365-mmf variable capacitor (not miniature). Jakob DeHaan, 5814 Sagewood Dr., Murray, Utah. 84647.

BC-654 TRANSCIVER, other surplus items. Will swap for ham gear. Tom Woods, 6203 Jessamine St., Apt. 209, Houston, Tex. 77000.

VENUS R/C transmitter, other equipment. Need ham gear. Alan S. Owens, 1859 Country Club Rd., Ann Arbor, Mich. 48105.

TWO-METER TRANSMITTER, other ham gear. Make swap offer. Jim Strayhorn, 290 Fraser St., Smyrna, Ga. 30080.

EUROPEAN TUBES with sockets. Want tube tester. Jack Silverberg, 737A De L'epée Ave., Montreal 8, Que.

HAM TRANSMITTER, home brew. Will trade for CB transceiver. Robert E. France, 16247 Denley St., Hacienda Hts., Calif. 91745.

EICO 368 TV-FM sweep and marker generator and 315 signal generator. Make swap offer. Robert J. Bloete, 2236 29th St. S.W., Calgary, Alta.

AIRCRAFT TRANSMITTER, less tubes and power supply. Will exchange for two CB walkie-talkies. C. Olsen, 3240 Metropolitan Way, Salt Lake City, Utah. 84109.

EICO HFT-94 AM tuner. Will swap for square/sine-wave generator. Mack Owen, 206 Barron Ave., Thomaston, Ga. 30286.

HEATH RF signal generator. Want signal tracer, wide-band scope or color-bar generator. Floy J. Fein, Box 72, Hopedale, Ill. 61747.

WURLITZER piano accordion, other items. Want Hallicrafters or National SW receiver. William Wozniak, Sr., 5315 Daley Pl., Gary, Ind. 46403.

CB PREAMPLIFIER. Will swap for transistor preamp or radio handbook. Don Memberg, 678 W. Milton Ave., Rahway, N.J. 07065.

OLD TUBES: 26's, 71A's, others. Make swap offer. Ira Stoler, 729 Ave. T, Brooklyn, N.Y. 11223.

HEATHKIT HW-30 transceiver. Will trade for Knight-Kit KG-250 amplifier. Ronald L. Sutherland, Rte. 3, Windsor, Mo. 65360.

TELEPHONE DIALS and handsets with coil cords. Will swap for pocket transistor radios. Willis G. Chesnut, 1220 W. 22nd, Kearney, Neb. 68847.

HALLICRAFTERS SX-99 receiver. Will exchange for Hallicrafters SX-28 receiver. Robert Willis, Box 230, Kentucky Wesleyan College, Owensboro, Ky. 43201.

HEATH GD-1B grid-dip oscillator, Sencore TDC-22

[Continued on page 26]



# How To Get 4 New CB Features At The Same Low Price...



## Buy The New Heathkit® MW-34... Only \$89.95!

4 New Advanced Features For Greater Operating Convenience! That's the new Heathkit MW-34 Citizen's Band Transceiver. Boasts 5 crystal-controlled transmit & receive channels with a new front-panel crystal socket to allow quick, easy changing of one transmit crystal *without* the fuss of removing the cabinet! Utilizes variable receiver tuning with another new feature—a spotting switch—for receive function. The spotting switch turns on the transmitter oscillator without going on the air, thus generating a signal for tuning the receiver to exactly the same transmit frequency.

In addition, a TVI filter is incorporated to minimize interference with TV sets. And a new calibrated "S" meter automatically shifts from transmitter to receiver to indicate strength of received signals or relative power output during transmit.

**Ideal For Boat, Home & Car!** The MW-34's compact size, 3-way power supply (6 & 12 v. DC, 117 v. AC) and gimbal mounting bracket allow installation just about anywhere . . . under your car's dash, on top of your boat's instrument panel, or anywhere in your home. And you enjoy the convenience of variable receiver tuning with vernier action and lighted dial to receive all 23 channels . . . superhet receiver with RF stage for sensitive, long-distance reception . . . adjustable squelch to silence receiver during standby . . . automatic noise limiter to reduce electrical ignition interference . . . efficient transmitter circuit for extra-range transmissions. Attractively styled in rust-resistant black & white metal cabinet . . . matches Heathkit marine gear.

**Quick & Easy To Assemble!** With new Heathkit 2-color step-by-step instructions. Requires no special talents, background or tools. Kit includes push-to-talk microphone for ease of operation, AC & DC power cord, and crystals for one channel (specify frequency). Get the most for your money . . . more performance, more savings . . . get the new Heathkit MW-34. Tear out the coupon & order yours now!

Kit MW-34, 16 lbs. . . . . \$89.95



**FREE CATALOG**

See these and over 250 other exciting Heathkits available in easy-to-build kit form. Save 50% or more by doing the easy assembly yourself. Send for your Free Catalog today!

HEATHKIT

**HEATH COMPANY, Dept. 39-3**  
Benton Harbor, Michigan 49023

Enclosed is \$89.95, plus postage.  
Please send kit MW-34 CB Transceiver.

Please send Free 1965 Heathkit Catalog.

Name \_\_\_\_\_ (Please Print)

Address \_\_\_\_\_

City \_\_\_\_\_ State \_\_\_\_\_ Zip \_\_\_\_\_

Prices & specifications subject to change without notice. GX-136

# POCKETFUL OF POWER

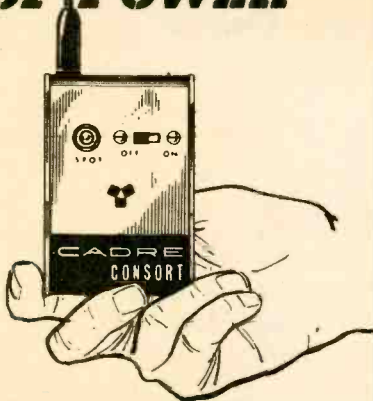

## NEW CADRE CONSORT FM WIRELESS MICROPHONE

A complete, portable, wireless PA system when used with FM radio. Zero in the Consort on an open channel in the FM band with a special pushbutton tone signal—and talk. You've got a wireless short range FM transmitter effective up to 200 feet from the FM radio. 101 applications: public address, broadcasting, musical instrument pickup, etc. \$44.95

**CADRE INDUSTRIES CORP.**  
COMMERCIAL PRODUCT DIVISION □ ENDICOTT, N. Y.

# FREE GIANT NEW 1965 CATALOG

## BURSTEIN-APPLEBEE CO.

Dept. 118, 1012 McGee St., Kansas City 6, Mo.

Rush me FREE 1965 B-A Catalog

Name .....

Address .....

City .....

State .....

SEND FOR IT TODAY

FREE

# ELECTRONIC SWAP SHOP

Continued from page 24

transistor checker. Want audio sine- or square-wave generator. Jay Smith, 5452 W. Augusta Blvd., Chicago, Ill. 60651.

KNIGHT Star Roamer receiver. Will trade for Lafayette HE-80 or Knight R-55A receiver. Thomas Kooch, Carolyn Dr., Jefferson City, Tenn. 37760.

HEATH HD-20 transistorized crystal calibrator. Will exchange for tube crystal calibrator. Lee R. Gruber, 4316 Hegner Ave., Deer Park, Ohio. 45236.

SILVERTONE combination wire recorder and record player. Will swap for a 30-50 mc SW receiver or 3-tube phono amplifier. Ralph J. Monson, Rte. 1, Box 484, Lancaster, Va. 22503.

TUBES: 5964's and 2033's. Will trade for transistors, diodes, relays, etc. Jeffrey Hickey, 266 Harmony Dr., Massapequa Pk., N.Y. 11762.

HEATHKIT SG-9 RF signal generator, hi-fi components. Would like hi-fi/stereo and audio test equipment. George Ritscher, CRM 1, Box 4258, Chanute AFB, Ill. 61867.

HALLICRAFTERS S-107 receiver, also 3-6 mc receiver. Will trade for CB transceiver. Marty Kugelman, 2084 E. 5th St., Brooklyn, N.Y. 11223.

ATWATER KENT model 55c radio. Will swap for ham or CB gear. Abe Schwartz, 153 Boerum St., Brooklyn, N.Y. 11206.

NEPTUNE Outboard Motor. Want Hallicrafters S-85 receiver or equivalent. Robert Bielek, 20524 Alameda Pkwy., Warrensville Twp., Ohio. 44128.

BC-603 RECEIVERS, power supply. Will exchange for stereo record changer. John Trombly, 32 Pages Court, Billerica, Mass. 01821.

DAVID BOGEN two-band receiver. Will swap for all-band antenna. Steve Gray, 1811 Superior, Wyandotte, Mich. 48192.

CB CRYSTALS for channels 2, 7, 18, 21. Want crystals for channels 10, 12, 13, 14. Harry R. Beck, 2700 Fleetwood Ave., Baltimore, Md. 21214.

RADIO-CONTROL equipment. Need test equipment. Jerome M. Dunlevy, 924 Belmont Rd., Grand Forks, N. Dak. 58201.

VIBROPLEX KEY, carrying case. Will trade for VHF receiver or Sony CB-106 transceiver. Wayne Hughes, 2541 Modoc Rd., Apt. 6, Santa Barbara, Calif. 93100.

NATIONAL electric Hawaiian guitar. Want CB base or mobile unit. Don Ramsey, 508 Edmond Dr., Dyer, Ind. 46311.

BC-696 RECEIVER. Will trade for Tesla-coil transformer. Stephen Weatherspoon, Rte. 2, Centerville, Tenn. 37033.

CLEGG 6-Meter Transceiver, Sony 464CS four-track stereo tape deck, other equipment. Will swap for either Viking Ranger II transmitter or Hammarlund HQ-110 receiver. Michael Bender, 61 Millrock Rd., New Paltz, N.Y. 12561.

BC-348-Q SW RECEIVER. Will exchange for CB transceiver. Chris Ross, 151 W. Hopson St., Bad Axe, Mich. 48413.

KNIGHT T-50 ham transmitter. Want CB or test equipment. L. D. Bunch, Rte. 2, Wilder, Idaho 83676.

KNIGHT R-100A communications receiver. Will trade for CB transceiver or test equipment. Dave Sprague, 1075 Stewart, Reno, Nev. 89502.

KEYSTONE 8mm movie projector. Will swap for CB transceiver or test equipment. Henry Marbach, 2 Overlook Rd., White Plains, N.Y. 10605.

KNIGHT Space Spanner with case, Heath MW-33 CB transceiver, other items. Want ham or SWL gear. Harold H. Blesy, 1918 W. Wolfram St., Chicago, Ill. 60657.

HALLICRAFTERS S-119 SW receiver. Want Novice transmitter. Carl S. Nutty, 1634 Georgia, Connersville, Ind. 47331.

HALLICRAFTERS SX-140 receiver. Will swap for CB transceiver or walkie-talkies. L. R. Scott, Rte. 3, Box 343, Saraland, Ala. 36571.

DEVRY 5-in. oscilloscope. Would like flyback tester, CRT checker or intercom. Darian Gray, Box 51, Cambridge, N.Y. 12816.

KNIGHT-KIT T-60 transmitter. Will trade for Heath HW-30 transceiver or 152-174 mc FM receiver. Charles S. Reavis, Box 79, Palmer Hall, Muncie, Ind. 47306.



“Until just recently, I have been somewhat skeptical about low-priced transistor amplifiers. However, after testing and listening to the Heath AA-22, I feel it is time to revise my opinion.”

JULIAN D. HIRSCH, *Hi Fi/Stereo Review*, Nov. '64

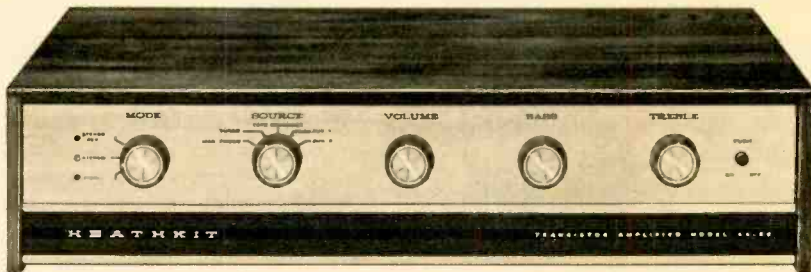

## Heathkit® 40-Watt Transistor Stereo Amplifier . . . \$99.95

**Mr. Hirsch Went On To Say:** “This remarkable amplifier can easily hold its own against any amplifier — tube or transistor — anywhere near its price range. It is the embodiment of the so-called ‘transistor sound’ — clean, sharply defined and transparent. It has the unrestrained effortless quality that is sometimes found in very powerful tube amplifiers, or in certain transistor amplifiers. The AA-22 is almost unique among amplifiers at or near its price, since it delivers more than its rated power over the entire range from 20 to 20,000 cps . . . The power response curve of this amplifier is one of the flattest I have ever measured . . . Its RIAA phono equalization was one of the most precise I have ever measured . . . Intermodulation distortion was about 0.5% up to 10 watts, and only 1% at 38 watts per channel, with both channels driven . . . The hum and noise of the amplifier were inaudible . . . *Hi Fi/Stereo Review's* kit builder reports that the AA-22 was above average in ‘buildability’ . . . In testing the AA-22, I most appreciated not having to handle it with kid gloves. I operated it at full power for long periods, and frequently overdrove it mercilessly, without damage to

the transistors, and with no change in its performance measurements. One of the best things about the Heath AA-22 is its price, \$99.95 in kit form, complete with cabinet.”

**About All We Can Add** is that the AA-22 has complete controls; 5 stereo inputs to handle mag. phono, stereo-mono tuners, tape recorders, & 2 auxiliary sources; 4, 8 & 16 ohm speaker outputs; plus tape recorder outputs. It weighs in at 23 lbs. for shipping, and it's delivered direct to your door.

**Oh, Yes, One More Thing!** There's a matching AM/FM/FM Stereo tuner that performs just as well for the same price.

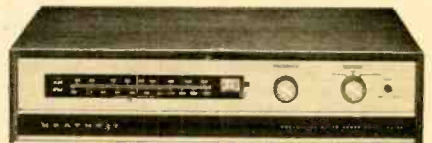

Kit AJ-33A, matching tuner, 17 lbs. . . . . \$99.95



### FREE 1965 CATALOG!

See these and over 250 other exciting Heathkits available in easy-to-build kit form. Save 50% or more by doing the easy assembly yourself! Send for your free catalog today!

HEATH COMPANY, Dept. 39-3  
Benton Harbor, Michigan 49023

In Canada: Daysram, Ltd., Cooksville, Ontario

Enclosed is \$ \_\_\_\_\_, plus shipping.

Please send Kit(s)

Please send Free 1965 Heathkit Catalog.

Name \_\_\_\_\_ (Please Print)

Address \_\_\_\_\_

City \_\_\_\_\_ State \_\_\_\_\_ Zip \_\_\_\_\_

Prices & specifications subject to change without notice. HF-179R



# EICO

# BEST VALUES IN KITS and wired equipment



### 3566 SOLID STATE FM MPX AUTOMATIC STEREO TUNER/AMPLIFIER.

Finest all-transistor kit value, equal to \$500-600 class instruments. Kit comes with pre-wired and prealigned RF, IF & MPX circuit boards plus transistor sockets. Outstanding 2 UV IHF sensitivity, automatic FM stereo-mono switching, muting, 40 db FM stereo separation. Total 66 watts IHF music power, only \$229.95 semi-kit (recommended to beginners!); optional walnut cabinet \$14.95—also \$349.95 factory wired including cabinet.

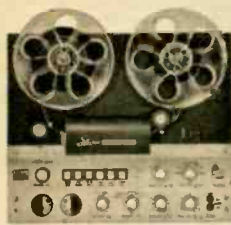

### RP 100 SOLID STATE 4-TRACK STEREO TAPE DECK

Top professional quality—independent record and play—transistor electronics—used by industry in computer and communications systems • 3-motor drive including hysteresis synchronous capstan motor • 3 high-performance heads • Kit only \$299.95. Wired \$450.



**2536 FM MPX STEREO TUNER/AMPLIFIER** Superb FM stereo-MPX tuner, plus a 36-watt stereo amplifier. "In tuning ease, general handling, and sound quality... leaves little to be desired." HIRCH-HOUCK LABS in ELECTRONICS WORLD. Kit only \$154.95. Wired \$209.95.



**ST 70-WATT INTEGRATED STEREO AMPLIFIER** Best buy of highest ranked stereo amplifiers according to independent testing. Kit \$99.95. Wired \$149.95. **ST40 40-WATT INTEGRATED STEREO AMPLIFIER.** Kit \$79.95. Wired \$129.95.

**HF-90A FM TUNER.** Pre wired and aligned FM, front end. Most popular FM tuner kit ever made. "Without question an extraordinary value." American Record Guide.



Kit \$44.95. Wired \$69.95. **HF-12A 12-WATT MONO AMPLIFIER.** 18 watts IHF power. "Packs a bigger wallop than is apparent from the specifications." POPULAR ELECTRONICS. Kit \$39.95. Wired \$59.95.



### 435 DC WIDEBAND 3" SCOPE

Sensational performance in a compact 15-lb. package. Flat-face 3-inch CRT with V and H trace expansion. Flat from DC to 4.5 Mc/s, useful to above 10 Mc/s. Zener diode calibrator. Equal to scopes costing many times more. Kit only \$99.95. Wired \$149.95.

**324 RF Signal Generator** Covers 150 Kc/s to 435 Mc/± 1.5% frequency accuracy. Internal 0-50% 400-cycle modulation. Kit \$28.95. Wired \$39.95.



### 232 PEAK-TO-PEAK VTVM

For color and B&W TV servicing, experimenters and laboratories. 7 non-skip ranges on every function. Measures AC peak-to-peak and RMS as well as DC. Response 30 Cps to 3 Mc/s with HVP probe. Kit \$29.95. Wired \$49.95.



### 369 SWEEP/POST INJECTION MARKER GENERATOR

For the "pro" service engineer, experimenters and laboratories. For aligning TV, FM and communications receivers. Sweeps cover 3-220 Mc/s. Markers cover 2-225 Mc/s. Kit \$89.95. Wired \$139.95.

**667 TUBE/TRANSISTOR TESTER** Dynamic conductance tube tester • 14 combinations of 3 plate and 3 screen voltages and 3 ranges of grid voltage • Interelement leakage readings in ohms. Checks all new tube types



• Two step transistor test • Kit \$79.95, wired \$129.95. Model 628 Emission tube tester • Checks all new tube types • Kit \$44.95, wired \$59.95. Model CRU—adapts 667 or 628 for testing B&W & Color TV picture tubes. Wired \$9.95.

**EICO** EICO Electronic Instrument Co., Inc.  
131-01 39th Avenue, Flushing, N.Y. 11352

Send new 1965 catalog featuring more than 230 EICO Products.

Name \_\_\_\_\_

Address \_\_\_\_\_

City \_\_\_\_\_ Zone \_\_\_\_\_ State \_\_\_\_\_



EI-2





ELECTRONICS  
ILLUSTRATED

MARCH 1965

**And Now...**

# INTEGRATED CIRCUITS FOR HOBBYISTS!

*Those space-age wonders no longer are limited to computers and satellites  
—and we present the world's first two build-it-yourself projects to prove it!*

By **FRED B. MAYNARD, 11Q0846**

Motorola Semiconductor Products, Inc.

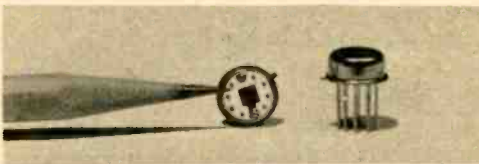
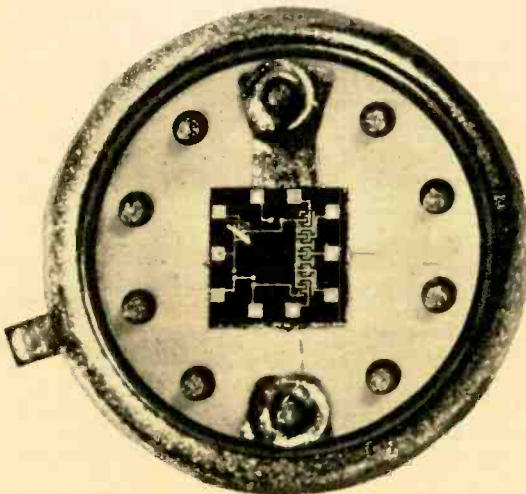

Fig. 1—A typical Motorola integrated circuit is shown actual size above. The diameter of the cover is about 5/16 inch. The chip in the center, which is shown in greater detail below, is about 1/10-inch square. In the MC356G IC we use, the chip contains six transistors and eight resistors.



**A** NEW electronics technology has taken shape in the last two or three years, centering on the concept of extreme miniaturization and the development of the integrated circuit. The IC is fast becoming as important to electronics as was the introduction of the vacuum tube and the transistor. Integrated circuits make it possible to reduce the size and weight of electronic equipment to the proportions of a gnat and, in the long run, they will reduce equipment prices to a drastic degree.

IC prices already have fallen to the point where hobbyists now can afford to use them for experimental projects. Ten different inexpensive Motorola IC's are on the market and are available from electronics parts distributors. The cheapest is \$2.45 for a quantity of one.

Almost all of them are in the logic class. That is, they are special circuits designed to build up logic systems of all kinds. An example of such a system is a high-speed digital computer which may contain thousands of IC's.

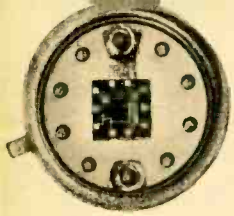
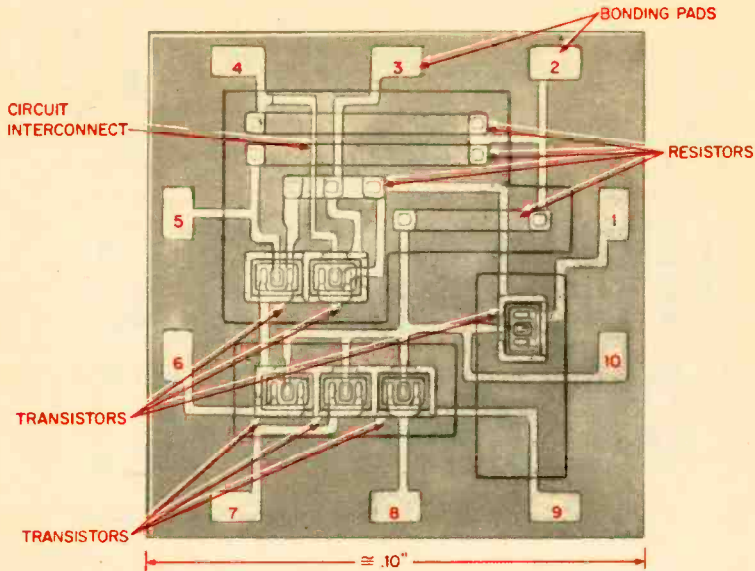

Fig 2—Take a chip like the one shown in Fig. 1, put it under a microscope and you will see all the components of the IC. This is the MC356G, the complete schematic of which is shown in black in Fig. 4.



To get another idea of how IC's can save space, consider an ordinary five-tube AC/DC radio. It contains about six basic circuits composed of 20 to 30 components.

Take a look at Fig. 1. The top photo shows the actual size of open and enclosed IC's. The enlargement below shows greater detail of the IC chip and its mounting. Now, take a look at Fig. 2, a detailed enlargement of the \$3.55 IC we use in our projects. Though not much larger than the head of a match, this 1/10-inch square contains eight transistors and four resistors.

And this isn't the limit to the number of parts that can be put on a single chip. The day soon will be here when one or two IC's will constitute a complete radio that is equivalent in performance to that five-tube AC/DC job.

How is an IC made? It all starts out with a conventional schematic of a circuit. An example of this is the schematic of a Motorola MC356G three-input logic gate shown in black in Fig. 4 (this is the IC we use in our square-wave generator and radio).

In the next step all the components in the schematic are rearranged mechanically so that connections can be made to them from the pins on the header. The photo at the bottom of Fig. 1 gives you a clearer idea of this. (Not all leads are connected to the chip.) The rearrangement of the components in the schematic of Fig. 4 is shown in Fig. 2.

Actually, this mechanical layout of components starts out as a drawing about 2 feet

square. Next, a series of large masks, or overlays, are made. The masks and overlays are then optically reduced in size for use in the manufacturing steps that include etching, diffusion, metallization and oxidation.

The IC chip, which is about 6/1,000 of an inch thick, is then cut from a larger sheet and mounted on what is called a header. Short wires are connected from the header pins to the circuit elements on the chip. Lastly, the IC is sealed hermetically and subjected to several tests.

The finished IC may contain several transistors, resistors, diodes, zener diodes and capacitors. The finished unit is shown at the top, right in Fig. 1 and is somewhat smaller than a TO-5-size transistor.

Let's get to the square-wave generator project now to see what one of these mighty midgets can do. After that we'll build a broadcast radio.

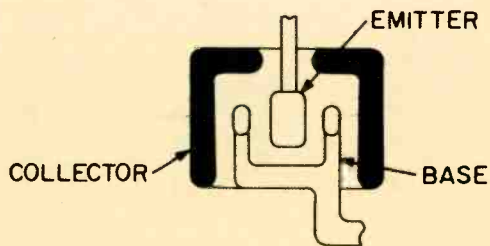
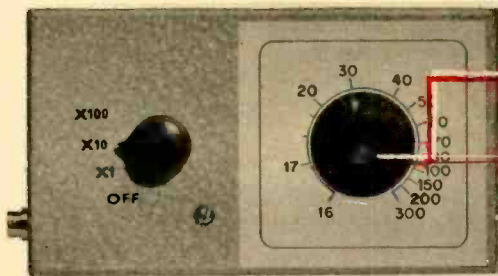

Fig. 3—Enlarged drawing of one of the transistors in Fig. 2 shows arrangement of the elements.





# IC SQUARE-WAVE GENERATOR

**T**HE circuit in Fig. 4 shows a square-wave generator that is useful for audio testing, as a musical-tone generator or as a code-practice oscillator. The black schematic is of the MC356G IC. The schematic in color is what we added to make the generator. The frequency range is about 16 cps to 30 kc. Peak-to-peak output is about 0.8 V.

But first, let's examine the MC356G IC which is shown in black in Fig. 4. The circuit contains three paralleled input transistors, Q1, Q2 and Q3; a common-emitter amplifier stage, Q4; and two output emitter-followers, Q5 and Q6. The IC was designed for OR-NOR logic functions, but it easily can be converted into an amplifier.

Now look at Fig. 5, a simplified schematic (black) showing only those parts of the MC356G IC that are used for the square-wave generator. Notice that we use only transistors Q1, Q4 and Q6. Q1 is an emitter-follower which drives the emitter of Q4 through unbypassed common-emitter coupling resistor  $R_e$ . Q4 is a grounded-base voltage amplifier stage which provides amplification across its collector load resistor,  $R_{C2}$ . Q6, an emitter-follower, is driven directly from the collector of Q4.

The positive-feedback loop which produces oscillation is composed of either C2, C3 or C4; R1 and R2. The bases of Q1 and Q4 are biased at an intermediate level with respect to the positive and negative power supply levels.

Positive feedback, which produces oscillation, is obtained in this circuit in much the same manner as in more conventional transistor and vacuum-tube amplifiers. In this circuit, the input and output happen to be in phase. Let's see why.

Look at the circuit shown in black in Fig. 5 as a straight amplifier. A positive-going signal at the base of transistor Q1 produces a positive-going signal at its emitter. Since Q1's emitter is connected directly to Q4's emitter, the signal at Q4's emitter also will be positive-going. Now, a positive-going signal at Q4's emitter is equivalent to a negative-going signal at its base, which is at AC ground. And if you apply a negative-going signal to the base of a transistor in a common-emitter configuration, the signal at the collector will be inverted, or positive-going. Therefore, the positive-going signal at Q4's emitter produces a positive-going signal at Q4's collector. Still with us? Okay, let's go on.

The positive-going signal at Q4's collector is direct-coupled to the base of Q6. Since Q6 is an emitter-follower, the signal at its emitter will be positive-going—just as it was at the base of Q1. The signal at pin 4 of Q6, the emitter, is fed back through either C2, C3 or C4 and C1 to the base of Q1. This positive feedback sustains oscillation.

When power is applied to the circuit, either C2, C3, or C4 (depending on which is selected by S1) begins to charge. The charging path is from the positive side of B1 through R1, R2, C2, C3 or C4,  $R_o$ ,  $R_e$ , R4 and ground. When the voltage on Q1's base reaches a certain level, Q1 switches on very rapidly and conducts heavily. Because of the fast response time of Q1 and Q4, and what is called a toggle effect that occurs in the conductance state, a complete square wave is produced, C2, C3 or C4 discharges and the cycle repeats.

The oscillation frequency of the circuit is controlled by R1 and either C2, C3 or C4. However, the frequency is also affected somewhat by shunt resistance within the IC. And

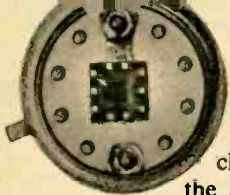

because of interaction between components on the chip, there will be a slight tilt to the square wave. However, this is not serious for routine servicing of audio equipment.

Variable resistor R1 controls the basic frequency of oscillation. Capacitors C2, C3 and C4 are decade multipliers of the fundamental oscillation frequency. That is, set S1 to the  $\times 1$  position and you will generate a fundamental frequency. Set S1 to  $\times 10$  and the output frequency will be multiplied by 10.

### Construction

You can use just about any layout and cabinet you want for the generator. Placement of parts isn't critical and performance

won't be affected if you build your model differently from ours.

Our model, as you can see in Figs. 5 and 6, is built in a  $5\frac{1}{4} \times 3 \times 2\frac{1}{8}$ -inch Minibox. We mounted the IC socket and R6 on a small piece of perforated board and used flea clips for tie points. Note in the pictorial that we used two selected parallel-connected capacitors for C3. Reason for this was so the capacitance C3 would be exactly  $1/10$  the capacitance of C4. If the values C2, C3 and C4 are not related to each other by an exact multiple of 10, decading will not be accurate. That is, if S1 is set to  $\times 1$  and R1 set for say 100 cps, setting switch S1 to  $\times 10$  may not produce an output that is exactly 1,000 cps. The closer the values of C2, C3 and C4 to what we specify, the greater the accuracy.

### PARTS LIST

B1—Five 1.5-volt penlite cells  
 C1—25 mf, 25 V electrolytic capacitor  
 C2—.05 mf, 75 V or higher ceramic disc capacitor  
 C3—.5 mf, 75 V or higher ceramic disc capacitor  
 C4—5 mf, 12 V electrolytic capacitor  
 C5—50 mf, 15 V electrolytic capacitor  
 IC—Motorola integrated circuit type MC356G.  
 Allied Radio Industrial catalog No. 650, pg. 15.  
 \$3.55 plus postage.  
 J1—Phono jack  
 R1—15,000-ohm potentiometer  
 R2—200 ohm,  $\frac{1}{2}$  watt, 5% resistor

R3—56,000 ohm,  $\frac{1}{2}$  watt, 10% resistor  
 R4—4,700 ohm,  $\frac{1}{2}$  watt, 10% resistor  
 R5—1,000 ohm,  $\frac{1}{2}$  watt, 10% resistor  
 R6—5,000 ohm, subminiature variable resistor (Lafayette 99 G 6143)  
 S1—Two-pole, five-position rotary switch (Lafayette 99 G 6164)  
 Misc.—Integrated-circuit socket: Cinch-Jones 10-ICS (Allied Industrial Catalog Stock No. 40 H 195. 65¢ plus postage),  $5\frac{1}{4} \times 3 \times 2\frac{1}{8}$ -inch Minibox, battery holder, perforated board, flea clips

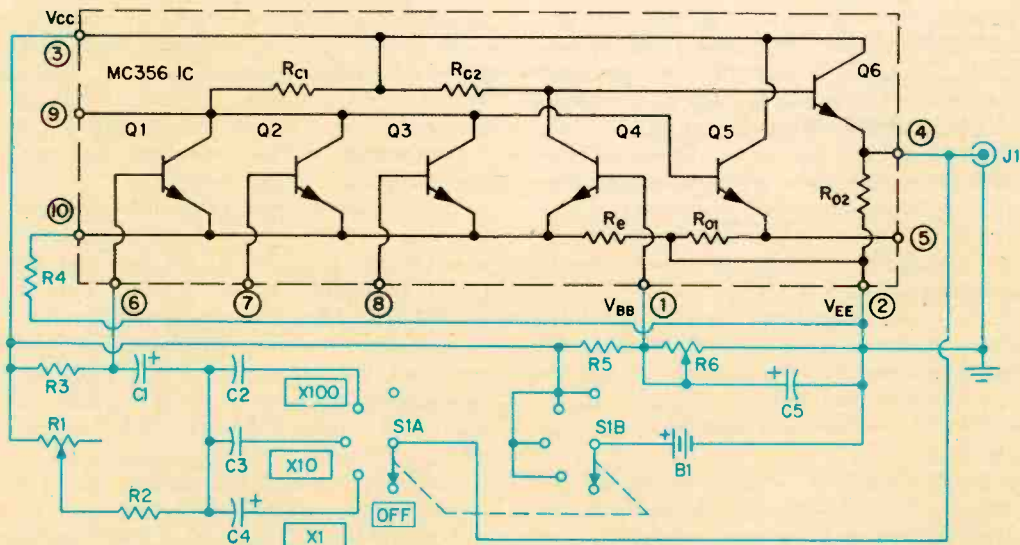

Fig. 4—The schematic in black is of the MC356G IC. The schematic in color is what we added to make a square-wave generator out of the unit. Q1, Q2 and Q3 are parallel-connected input transistors and are all emitter-coupled to transistor Q4. Transistors Q5 and Q6 are the IC's output emitter-followers.



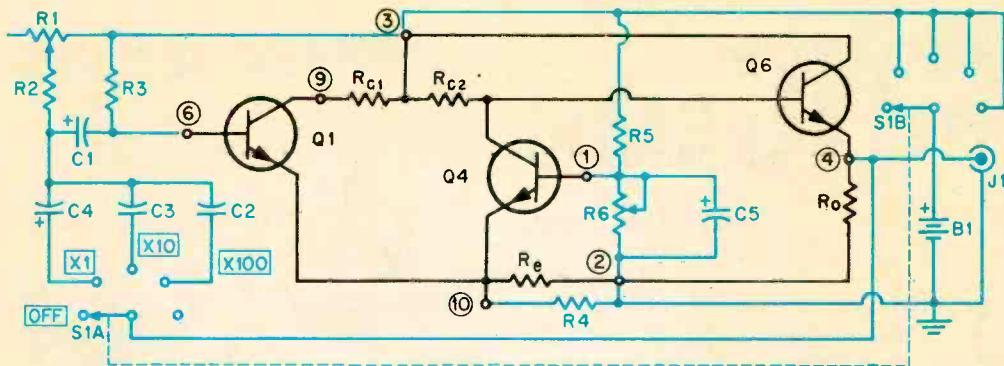
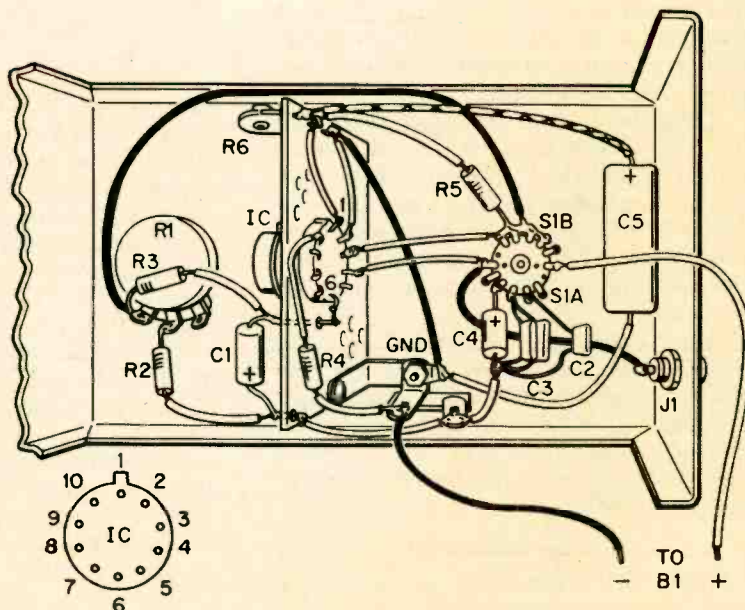

Fig. 5—Only the elements of the IC we used for the square-wave generator are shown (black) above. Charging path for capacitors in R-C timing circuit is from B1 through R1; R2; C2, C3 or C4; R0; R<sub>e</sub> and R4 to ground. Positive feeding back path is from emitter of Q4 back through C2, C3, or C4 to the base of Q1. Construction is easy in the size box we specify. Mount the IC socket on a piece of perforated board as shown. Five penlite batteries are mounted in holders on rear of Minibox.



### Calibration

After the wiring has been checked, turn on power. Observe the waveform with S1 set to  $\times 10$  and R1 set to mid position. Then adjust R6 until the square wave is perfectly symmetrical. That is, the width of the upper or lower portion of the waveform should be the same as the distance between two upper or lower waveforms.

The waveform should have perfectly vertical sides and will have small amount of tilt at the top and the bottom. That is, the top of the square wave will gradually slope down to the right. One of the best ways to calibrate the generator's dial is with a calibrated oscillator and an oscilloscope. The technique requires that you feed the output of our oscillator to the scope's vertical input and the output of the other oscillator to the scope's horizontal input. Then, by using Lissa-

jous patterns, it's easy to determine when both oscillators' frequencies are the same.

Or, you can feed the oscillator's output to an earphone or amplifier and compare the tone with different notes on a piano or organ.

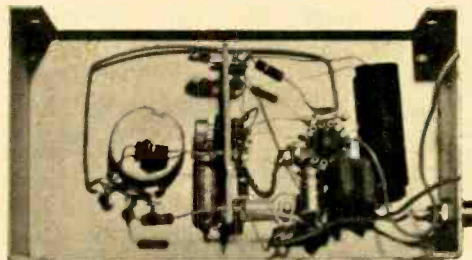
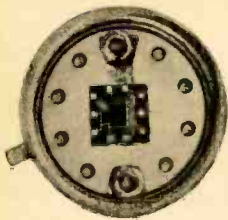

Fig. 6—We allowed ourselves plenty of room but you could build the generator in a smaller cabinet.



# IC RADIO

By HARRY KOLBE

**A**LTHOUGH the Motorola MC356G integrated circuit is designed primarily for use in computers, it also is possible to build a broadcast radio with the component. The project is an interesting one and lends itself well to the advanced hobbyist/experimenter who likes to modify circuits to improve their performance.

There are problems in designing and building a radio with an IC. The headaches are caused by the close proximity of the transistors and resistors on the IC chip. This unavoidable togetherness produces undesirable leakage paths between circuit elements that are operating at both radio and audio frequencies.

After several experimental designs, we hit upon one that has a decent amount of sensitivity, selectivity and audio output. Compromises had to be made, of course. But the finished product does work and offers you the opportunity to dig into the circuit to soup things up a little.

## How the Radio Works

Take a look at Fig. 7. The part of the schematic in black is the portion of the IC we used for the radio. The section of the schematic in color is what we added. Circled numbers identify the IC pins to which external connections are made.

The signals picked up by the ferrite loopstick antenna (L2) are tuned by variable capacitor C2. The loopstick we used will pick up enough signal for satisfactory reception if you live in a strong-signal area. However, if signals are weak, connect a long-wire antenna to J1 to improve reception.

If the antenna is too long, the signal fed to transistor Q4 will be excessive and Q4 will be overloaded. This will cause crossmodulation and will result in the stations being spread out over wide sections of the dial. If this happens try shorter antennas for best, or compromise, performance.

The selected signal is then fed to the base of transistor Q4. Resistors R2 and R3 estab-

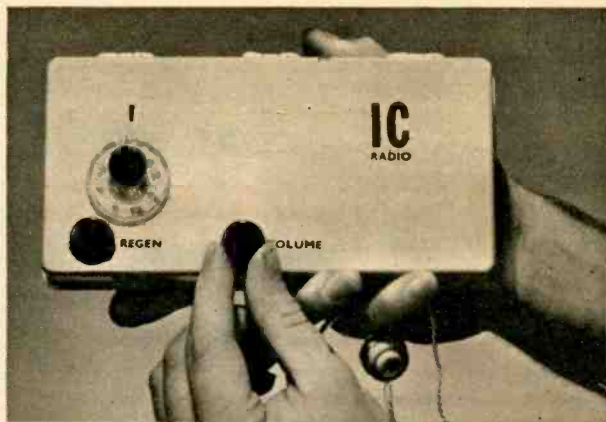

lish Q4's bias. Resistor RC2 (approximately 300 ohms) is Q4's collector resistor and is part of the integrated circuit. The signal is amplified by Q4 and direct coupled to transistor Q6. Transistor Q6 is an emitter-follower (unavoidably), therefore the signal at its built-in emitter resistor (RO2, pin 4) is not amplified.

The RF signal at pin 4 is fed to a voltage-doubler detector consisting of diodes D1 and D2. The RF signal is also fed back through C3 and regeneration control R1 to tickler coil L1 to produce added gain and selectivity. L1 is wound over one end of the ferrite loopstick as shown in Fig. 9.

The audio signal produced by diodes D1 and D2 is fed back to Q4 which operates as a reflexed amplifier. That is, Q4 is both an RF and AF amplifier. The audio signal is now amplified by Q4 and direct coupled to Q6, which is also a reflexed stage.

Audio at Q6's emitter is coupled by RF choke L3 to volume control R4. The audio signal then goes through C6 to the base of audio amplifier Q3. Resistors R5 and R6 establish Q3's bias. Resistor RC1 is Q3's collector resistor and is part of the IC. Capacitor C7 bypasses stray RF on the IC chip to ground.

The amplified audio at Q3's collector is direct coupled to the base of transistor Q5—also an emitter follower. Capacitors C8 and C10 bypass stray RF to ground. The audio output at Q5's emitter (pin 5) is coupled by C9 to phone jack J2.

## Construction

Even though the IC contains four of the transistors and resistors that are used in the  
[Continued on page 38]



Clip coupon—and take your first big step to real success! I.C.S., Scranton, Penna. 18515

Accredited Member,  
National Home Study Council

# INTERNATIONAL CORRESPONDENCE SCHOOLS **ICS** 75th YEAR

Box 456, Scranton, Penna. 18515

(In Hawaii: P. O. Box 418, Honolulu. In Canada: I. C. S. Canadian, Ltd., Montreal.)

Without cost or obligation, rush me "HOW to SUCCEED," the opportunity booklet about the field I have indicated below, and a sample lesson.

New! Special Package for Women!

Name of the course in which you are interested \_\_\_\_\_

Mr. \_\_\_\_\_

Miss \_\_\_\_\_

Mrs. \_\_\_\_\_

City \_\_\_\_\_

Occupation \_\_\_\_\_

Age \_\_\_\_\_

Address \_\_\_\_\_

State \_\_\_\_\_

Zip Code \_\_\_\_\_

Working Hours \_\_\_\_\_

A.M. to \_\_\_\_\_

P.M. \_\_\_\_\_

Employed by \_\_\_\_\_

Low rates to members of U. S. Armed Forces!  
Special training programs for industry

## Cast your ballot for a successful future!

# 253 I.C.S. COURSES



I.C.S. is the oldest, largest correspondence school. Over 200 courses. Business, industrial, engineering, academic, high school. One for you. Direct, job-related. Bedrock facts and theory plus

practical application. Complete lesson and answer service. No skimping. Diploma to graduates. Send for the 3 free booklets offered here and find out how I. C. S. can be your road to success.

**ACCOUNTING**  
Accounting for Business  
Programmers  
Cost Accounting  
C.P.A. Review  
Estate & Trust Accounting  
Executive Accounting  
Federal Tax  
General Accounting  
Industrial Accounting  
Legal Accounting  
Office Accounting  
Personal Income Tax & Social Security  
Practical Accounting  
Public Accounting  
Small Business Accounting  
Starting & Managing a Small Bookkeeping Service

**ARCHITECTURE AND BUILDING**  
Architectural Drawing & Designing  
Architecture  
Building Contractor  
Building Estimator  
Building Inspector  
Building Maintenance  
Carpenter-Building  
Carpentry & Millwork  
House Planning & Interior Design  
Mason  
Painting Contractor  
Reading Arch. Blueprints  
Review in Arch. Design & Practice  
Review of Mech. Systems in Buildings

**ART**  
Amateur Artist  
Commercial Art  
Commercial Cartooning  
Illustrating  
Interior Decorating  
Oil Painting for Pleasure  
Show Card & Sign Prod.  
Show Card Writing  
Sign Painting & Designing  
Sketching & Painting

**AUTOMOTIVE**  
Automatic Transmission Specialist  
Automobile Body Rebuilding & Refinishing  
Automobile Electrical Tech.  
Automobile Engine Tune-Up  
Automobile Technician  
Automotive Mechanic

Diesel-Gas Motor Vehicle Engines  
**BUSINESS**  
Advertising  
Basic Inventory Control  
Business Administration  
Business Management & Marketing  
Business Management & Production  
COBOL Programming  
Condensed Business  
Practice  
Industrial Psychology  
Managing a Small Store  
Marketing  
Modern Executive Management  
Office Management  
Programming for Digital Computers  
Programming the IBM 1401 Computer  
Purchasing Agent  
Retail Business Management  
Statistics and Finance Systems and Procedures Analysis

**CHEMICAL**  
Analytical Chemistry  
Chemical Engineering  
Chemical Engineering Unit Operations  
Chemical Laboratory Tech.  
Chemical Process Control Technician  
Chemical Process Operator  
Elements of Nuclear Energy  
General Chemistry  
Instrumental Laboratory Analysis

**CIVIL ENGINEERING**  
Civil Engineering  
Construction Engineering  
Highway Engineering  
Principles of Surveying  
Reading Highway Blueprints  
Reading Structural Blueprints  
Sanitary Engineering  
Sewage Plant Operator  
Structural Engineering  
Surveying and Mapping  
Water Works Operator

**DRAFTING**  
Aircraft Drafting  
Architectural Drafting  
Electrical Drafting

**Electrical Engineering**  
Drafting  
Electronic Drafting  
Introductory Mechanical Drafting  
Mechanical Drafting  
Pressure-Vessel and Tank Print Reading  
Sheet Metal Layout for Air Conditioning  
Structural Drafting  
**ELECTRICAL**  
Electric Motor Repairman  
Electrical Appliance Servicing  
Electrical Contractor  
Electrical Engineering (Power option of Electronic option)  
Electrical Engineering Tech.  
Electrical Instrument Tech.  
Industrial Electrical Tech.  
Industrial Telemetering  
Power Line Design and Construction  
Power Plant Operator (Hydro or Steam Option)  
Practical Electrician  
Practical Linemen  
Reading Electrical Blueprints

**ENGINEERING (PROFESSIONAL)**  
Chemical Civil  
Electrical Mechanical  
Industrial Management for Engineers

**ENGLISH AND WRITING**  
Belt Business Writing  
Introductory Technical Writing  
Modern Letter Writing  
Practical English  
Short Story Writing

**HIGH SCHOOL**  
High School Business  
High School College Prep. (Arts)  
High School College Prep. (Engineering & Science)  
High School General  
High School Mathematics  
High School Secretarial  
High School Vocational

**LANGUAGES**  
(Edited by Berlitz)  
French  
German

Italian  
Spanish  
**LEADERSHIP**  
Basic Supervision  
Industrial Foremanship  
Industrial Supervision  
Personality Development  
Personnel-Labor Relations Supervision  
**MATHEMATICS**  
Advanced Mathematics  
Mathematics and Mechanics for Engineering  
Mathematics and Physics for Engineering  
Mathematics & Physics for Technicians  
Modern Elementary Statistics

**MECHANICAL**  
Industrial Engineering  
Industrial Instrumentation  
Machine Design  
Mechanical Engineering  
Quality Control  
Safety Engineering Tech.  
Tool Design  
Value Analysis

**PETROLEUM**  
Natural Gas Production & Transmission  
Oil Field Technology  
Petroleum Production Engineering  
Petroleum Refinery Oper.  
Pipeline Engineering

**PLASTICS**  
Plastics Technician  
**PLUMBING, AIR CONDITIONING**  
Air Conditioning  
Air Conditioning Maint.  
Domestic Heating with Oil & Gas  
Domestic Refrigeration Gas Fitting  
Heating  
Heating & Air Conditioning with Drawing  
Plumbing  
Plumbing & Heating  
Plumbing & Heating Contractor  
Plumbing & Heating Estimator  
Practical Plumbing  
Refrigeration

Refrigeration & Air Conditioning  
Steam Fitting  
**PULP AND PAPER**  
Paper Machine Operator  
Paper Making  
Pulp Making  
Pulp & Paper Engineering  
Pulp & Paper Making Supervision  
**SALESMANSHIP**  
Creative Salesmanship  
Real Estate Salesmanship  
Sales Management  
Salesmanship & Sales Management  
**SECRETARIAL**  
Clerk-Typist  
Commercial  
Legal Secretary  
Medical Secretary  
Professional Secretary  
Shorthand  
Stenographic  
Typewriting

**SHOP PRACTICE**  
Drill Operator  
Foundry Practice  
Industrial Metallurgy  
Lathe Operator  
Machine Shop Inspection  
Machine Shop Practice & Toolmaking  
Metalurgical Engineering  
Technology  
Milling Machine Operator  
Patternmaking  
Practical Millwrighting  
Reading Shop Prints  
Rigging  
Tool Engineering Techn'gy  
Tool Grinder  
Toolmaking  
Turret Lathe Operator  
Welding Engineering Tech.  
Welding Processes

**STEAM AND DIESEL POWER**  
Boiler Inspector  
Industrial Building Engineer  
Power Plant Engineering  
Stationary Diesel Engines  
Stationary Fireman  
Stationary Steam Eng.

**TEXTILES**  
Carding and Spinning

Cotton Manufacturing  
Dyeing & Finishing  
Loom Fixing  
Spinning  
Textile Designing  
Textile Technology  
Textile Mill Supervisor  
Warping and Weaving  
Wool Manufacturing

**TRAFFIC**  
Motor Traffic Management  
Railway Rate Clerk  
Traffic Management

**TV-RADIO-ELECTRONICS**  
Communications Techn'ly  
Electronic Fundamentals  
Electronic Fundamentals (Programed)  
Electronic Fundamentals with Electr. Equip. Tr'n'g  
Electronic Instrumentation & Servo Fundamentals  
Electronic Principles for Automation  
Electronics and Applied Calculus

Electronics Technician  
First Class Radiotelephone License  
Fundamentals of Electronic Computers  
General Electronics  
General Electronics with Electronic Equip. Tr'n'g  
Hi-Fi Stereo and Sound Systems Servicing  
Industrial Electronics  
Industrial Electronics Engineering  
Industrial Electronics Technician  
Practical Radio-TV Eng'g  
Practical Telephony  
Principles of Radio-Electronic Telemetry  
Principles of Semiconductor-Transistor Circuits  
Radio Servicing with Radio Equipment Training  
Radio & TV Servicing  
Radio & TV Servicing with Radio Equip. Tr'n'g  
Second Class Radiotelephone License  
Sound Systems Specialist  
Telephone, Electronics and Radio Communications  
TV Receiver Servicing  
TV Technician

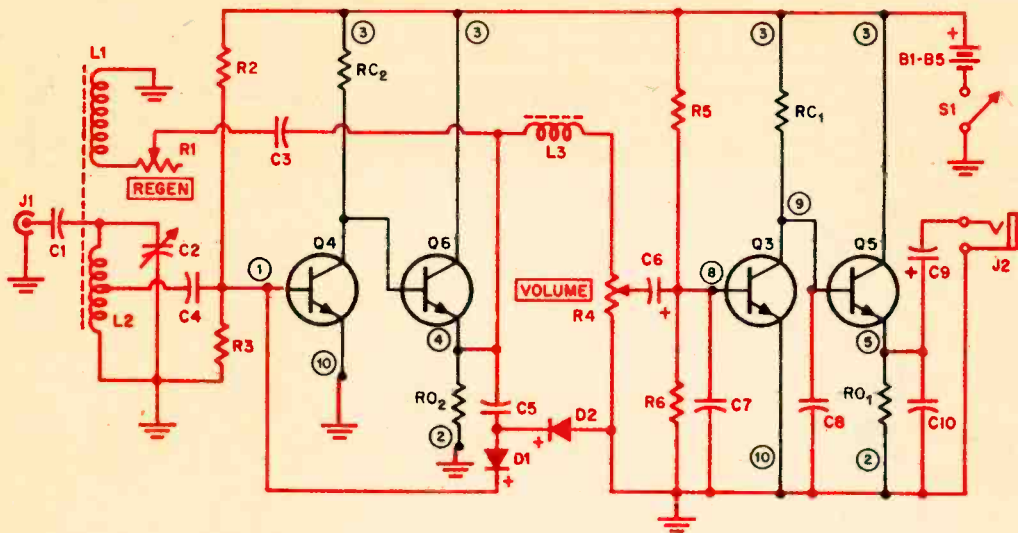

Fig. 7—Signals picked up by loopstick L2 are tuned by C2 and fed to Q4, which is direct coupled to Q6. RF is fed to voltage-doubler detector (D1, D2) and to regeneration coil L1. Audio from D1, D2 is fed back to Q4 where it is amplified and fed to Q6. Audio at Q6's emitter is amplified by Q3, Q5 to drive phones.

#### PARTS LIST

- B1-B5—1.5 volt, alkaline energizer penlite battery (5 reqd.)
- C1—10 mmf mica or ceramic disc capacitor
- C2—10-365 mmf miniature variable capacitor (Lafayette 99 G 6217)
- C3, C7, C8—.005 mf, 75 V ceramic disc capacitor
- C4—500 mmf, 75 V ceramic disc capacitor
- C5—100 mmf, 75 V ceramic disc capacitor
- C6—25 mf, 25 V electrolytic capacitor
- C9—100 mf, 6 V electrolytic capacitor
- C10—.001 mf, 75 V ceramic disc capacitor
- D1, D2—1N64 diode
- IC—Motorola integrated circuit. See square-wave generator parts list
- J1, J2—Miniature phone jack
- L1—5 turns No. 28 enameled wire wound over narrow winding on L2 (see text)
- L2—Ferrite tapped antenna coil (Lafayette 32 G 4105)
- L3—10 microhenry miniature RF choke
- R1—10,000 ohm miniature potentiometer (Lafayette 32 G 7356)
- R2—43,000 ohm, 1/2 watt, 5% resistor
- R3—15,000 ohm, 1/2 watt, 10% resistor
- R4—10,000 ohm, miniature potentiometer with switch (Lafayette 32 G 7364)
- R5—27,000 ohm, 1/2 watt, 10% resistor
- R6—4,700 ohm, 1/2 watt, 10% resistor
- S1—SPST switch on R4
- Misc.—Plastic box, perforated board, socket for integrated circuit (see square-wave generator parts list), hardware, 2,000-ohm ear-phones (Allied 86 S 083)

radio, it will not be possible to build the radio in a matchbox because of the standard size of other components. Our model is built in a plastic box whose dimensions are 7x3½x1½ inches. All components are

mounted on a piece of perforated board. Flea clips are used for tie points.

To be on the safe side, try to duplicate the layout we show (Fig. 9), especially around the loopstick antenna, tuning capacitor C2 and regeneration control R1. If these parts and wiring are shifted around and packed together too tightly, you may end up with uncontrollable oscillation. Gain of the input stage is fairly high and there is RF all over the place. Therefore, if after your radio is built there is oscillation that can't be stopped at any setting of R1, try relocating L2, C2 and R1.

Before winding L1, carefully examine the loopstick antenna. You'll notice two windings—one is about 3/16-inch wide and the other occupies the remaining space. It is the narrow winding over which you wind L1. Tickler winding L1 is five turns of No. 28 enameled wire wound tightly and evenly over the 3/16-inch wide winding of the loopstick. After the turns are wound, wrap them with tape to prevent them from unwinding. By the way, the tap on L2 that is connected to C4 is the twisted pair of wires at the extreme end of the loopstick. The wires from the loopstick are very delicate, so take care when handling them.

The IC socket can be mounted by bending its lugs outward, as shown in the pictorial, and soldering them to three or four flea clips.



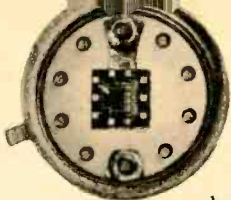

After the socket is installed, proceed with wiring.

The diode leads must be very short. For this reason it is necessary to hold them with pliers when soldering to prevent heat damage. All ground connections should be made to one point. Therefore, run a length of buss wire from one end of the board to the other, as shown.

Because of the high current consumption of the IC, it will not be possible to operate the radio from an ordinary 9-volt transistor-radio battery. These batteries just cannot supply the necessary current. Furthermore if they could, nine volts would be too much for the IC to handle. Best source of operating power is five penlite cells (alkaline energizer type) connected in series.

When everything is in place, double check your connections to the IC socket. It is possible to install the IC in any position in the socket. The correct way is with the tab on the IC case directly over the nib on the side of the socket.

When you're sure everything is in order, turn on power, advance regeneration control R1, and try to tune in a station. If the radio is dead, reverse the connections of the leads from tickler winding L1. You should now

near something. Tune the radio and adjust the regeneration control to a point where oscillation starts. Then back off for best sound.

If you can't get sufficient pickup with the loopstick we specify and find a long-wire antenna causes overloading, try a larger loopstick. A little experimentation with tickler coil L1, such as adding or removing turns will produce optimum regeneration.

The impedance of the phones must be high—at least 2,000 or 3,000 ohms for top performance. Low-impedance phones won't give you much volume. You could try a transistor output transformer to couple the output to a low-impedance phone.

Then again you could add a transistor and the radio will drive a speaker.

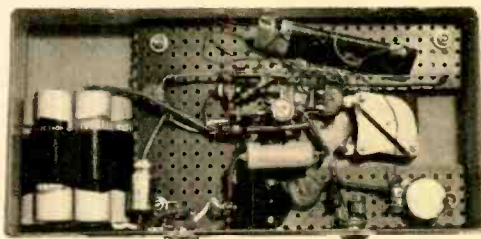

Fig. 8—Our layout was spacious but the wiring in the area around the IC's socket is very crowded.

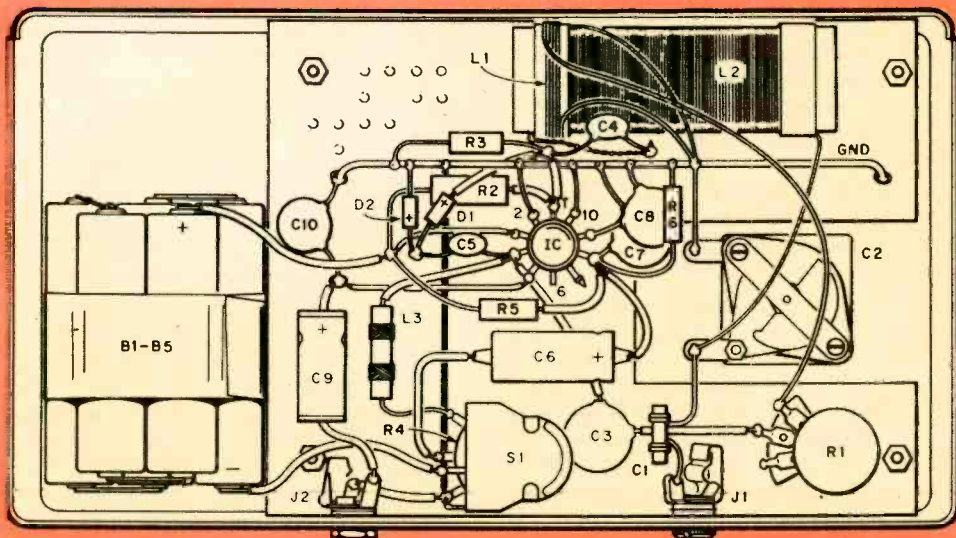
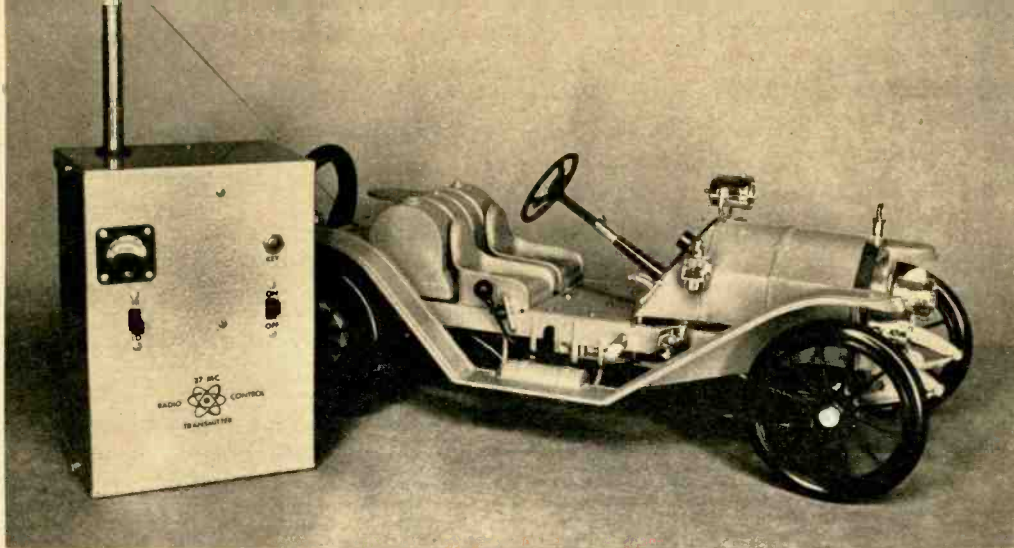

Fig. 9—The perforated board we built our model on is 5x3¼ inches. It is supported above the inside of the cabinet with spacers. Duplicate our layout and you will avoid undesirable oscillation problems.



# Blockbuster R/C Transmitter

By HOWARD G. McENTEE

**T**HE track is clear, the weather is good and they're off to a flying start. A lot of radio-controlled models are out there competing for first prize and this means the channels are going to be jammed. Unless your signal can get through the interference you're likely to lose contact with your model and end up being just an also-ran.

But with the Blockbuster in your hand you'll have control all the way, for this transmitter puts out a real blast of a signal. It's more powerful than all hobby rigs now on the market. Power input to the final is a whopping .9 watt. This means you can maintain contact with your model, even though the transmitter batteries begin to weaken or the receiver in the model (whether plane, car or boat) becomes a bit detuned.

The FCC normally requires that you have an R/C transmitter whose input power is greater than 100 mw checked by a licensed commercial operator if you have made any adjustments that will shift frequency or cause spurious radiation. But you can change the operating frequency of the Blockbuster without such a check. This is because the Blockbuster uses a commercially manufactured oscillator-amplifier which establishes the operating frequency. It is an International Crystal Mfg. Co. Model TRT-1A low-power transmitter. The rig is supplied with a close-

tolerance crystal (International Crystal type F-605:  $\pm .0025$  per cent) and with the oscillator factory tuned. Oscillator tuning should *not* be changed, but you can, and should, peak the amplifier stage of the TRT-1A to match it to the Blockbuster's driver stage (Q3).

Furthermore, you can operate on any of the six R/C channels (26.995, 27.045, 27.095, 27.145, 27.195 and 27.255 mc) merely by inserting another crystal. The crystal should be the type specified by International Crystal (F-605) for the unit. Oscillator tuning is broad enough so you won't have to retune for another crystal. But the following stages should be peaked when a channel change is made.

**The Circuit.** Because they are stable and efficient, common-base transistor configurations are used for both the driver (Q3) and the power amplifier (Q5). Q3 boosts the output from the TRT-1A module so it will drive Q5 to its maximum capability.

More drive from Q3 (its normal collector current is 20 ma) will put more power into the antenna, but it's tougher on the batteries. Transistor Q5 runs quite warm and a heat sink must be used on it.

Tone modulation is applied way upstream—to the TRT-1A module. Neither Q3 nor Q5 will draw current unless they are driven.



DRIVER BOARD

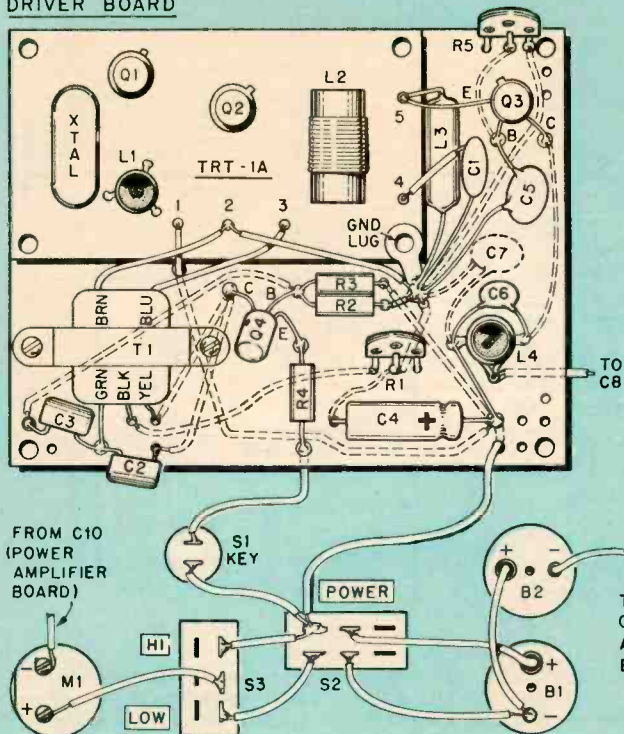

Fig. 1—Driver stage fits on a 3¼x-2¼-inch perforated board. Before mounting components on it, determine area that will be occupied by TRT-1A module. Proceed with wiring using 3/32-inch diameter brass eyelets or flea clips for the points. After all parts are installed, mount TRT-1A and make connections to it. Components and wiring shown in broken lines are on back of board. So as not to obscure parts, heat sink is not shown on Q3. Lead from the top on L4 goes back through shield plate to C8 on power amplifier board.

POWER-AMPLIFIER BOARD

Fig. 2—Duplicate parts layout on 2 3/16x3¼-inch power amplifier board for optimum performance. Note how L7 is positioned within L6. To be sure of good heat transfer between Q5's case and its heat sink, put a light coat of silicone grease on Q5's case. Components and wiring in broken lines are on back of board.

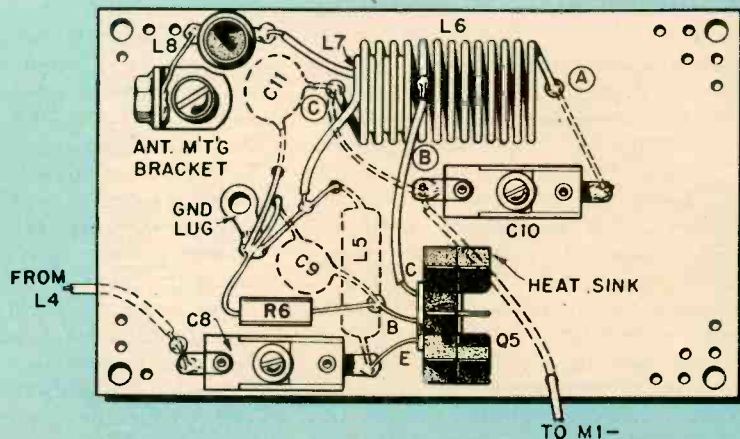
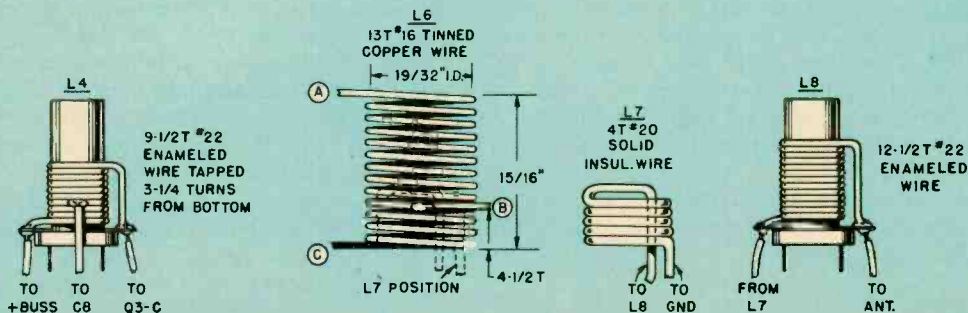

Fig. 3—Coil details. Coils L4 and L8 are wound on forms available from Ace Radio Control (see Parts List). The outside diameter of coil L7 should be slightly less than the inside diameter of coil L6.



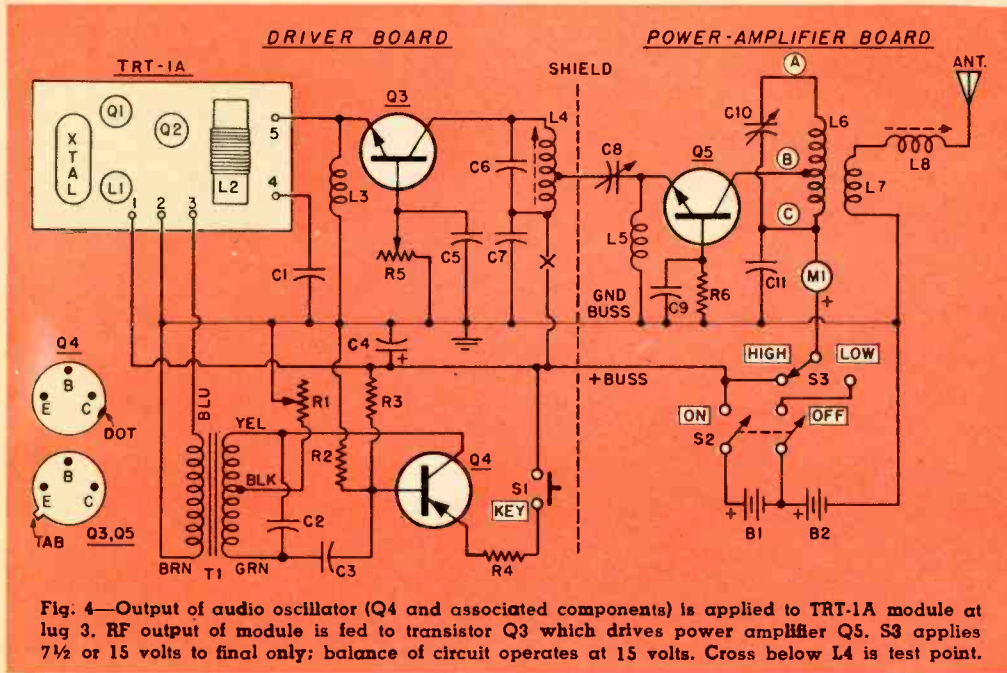

Fig. 4—Output of audio oscillator (Q4 and associated components) is applied to TRT-1A module at lug 3. RF output of module is fed to transistor Q3 which drives power amplifier Q5. S3 applies 7½ or 15 volts to final only; balance of circuit operates at 15 volts. Cross below L4 is test point.

## Blockbuster R/C Transmitter

Thus, when the output of the TRT-1A module is driven down to zero by audio modulation from Q4, these two transistors (Q3 and Q5) will not produce output during modulation dips. This is called downward modulation. Q5's collector current will drop during modulation and a field-strength meter will show lower output. However, the RF carrier amplitude doesn't drop—it rises a bit. A field-strength meter shows reduced output because we chop holes in the output at an audio-frequency rate.

The method of antenna coupling and loading is such that Q5's collector current will not go sky-high if the transmitter is operated with the antenna collapsed. High-Low switch S3 applies either 7½ or 15 volts to Q5. The lower voltage reduces the output for shop testing or short-range operation, and should *always* be used when the antenna is collapsed.

Before you order parts, keep in mind that this is not a project for the beginner. Construction and wiring are not that difficult, but for perfect tune-up and testing it is helpful to have at least a VTVM with an RF probe, an oscilloscope, and some type of frequency meter. A VOM is a necessity, of

course. We advise even the experienced builder to stick to the layout and parts shown. Changes might be all right—but we *know* our design and layout work.

**Construction.** Our construction should be duplicated to shield the power amplifier from the other circuits and prevent instability. Tuning is accomplished easily and there is plenty of room in the 3x5x7-inch Minibox for batteries (see Fig. 7). When collapsed, the antenna projects only 2½ inches above the top of the case.

The aluminum shield shown in Fig. 6 was tapped for the board mounting screws. However, you may use nuts and washers instead. The mounting hardware that comes with the TRT-1A module is used to hold it and the driver board to the shield plate. Details of how these are held together are also shown in Fig. 6. The power-amplifier board also is held to the shield plate with 2-56 screws.

Both the driver and power amplifier circuits are built on perforated phenolic board. we used 3/32-in. brass eyelets for tie points.

Cut the leads back from the upper left and lower right holes on the rear of the TRT-1A board to prevent shorts. Use fiber washers to space the board about 1/8-inch away from the driver chassis as in Fig. 6. The other two corners on the TRT-1A board are secured



### PARTS LIST

- B1, B2—7½-volt battery (Eveready 717 or equiv.)  
 C1, C5, C7, C9, C11—.01 mf. 75 V or higher ceramic disc capacitor  
 C2, C3—.1 mf, 75 V or higher mylar capacitor  
 C4—50 mf, 15 V electrolytic capacitor  
 C6—10 mmf, 500 V ceramic disc capacitor  
 C8—90-400 mmf midget trimmer capacitor (Allied 17 L 086 or equiv.)  
 C10—7-100 mmf midget trimmer capacitor (Allied 17 L 080 or equiv.)  
 L1, L2—On TRT-1A module  
 L3, L5—70-microhenry RF choke (Ace Radio Control, Box 301, Higginsville, Missouri. Stock No. 17A13)  
 L4—Coil: 9½ turns No. 22 enameled wire wound on Ace form No. 17A5 (See Fig. 3)  
 L6—Coil: 13 turns No. 16 tinned wire wound on 19/32-in. dia. form (See Fig. 3)  
 L7—Coil: 4 turns No. 20 solid insulated hook-up wire (See Fig. 3)  
 L8—Coil: 12½ turns No. 22 enameled wire wound on Ace form No. 17A5 (See Fig. 3)  
 M1—0-100 ma DC milliammeter  
 Q1, Q2—On TRT-1A module  
 Q3—2N696 transistor  
 Q4—2N2429 transistor (Amperex. Newark Electronics 21FX2679)  
 Q5—2N2194A transistor  
 Resistors: ½ watt, 10% unless otherwise indicated  
 R1, R5—1,000 ohm miniature potentiometer (Lafayette 99 G 6142)  
 R2—27,000 ohms R4—130 ohms, 5%  
 R3—4,700 ohms R6—120 ohms  
 S1—SPST pushbutton switch  
 S2—DPST slide switch S3—SPDT slide switch  
 T1—Transistor output transformer, primary and secondary 500 ohms, center tapped (Lafayette 33 G 8553)  
 TRT-1A—Transistorized transmitter (International Crystal Mfg. Co., Inc., 18 N. Lee, Oklahoma City, Okla. Catalog No. 200-129. \$12.50. Specify R/C frequency when ordering)  
 Misc.—Heat sink for Q3 (Newark Electronics 58F530), heat sink for Q5 (Newark 58F531), 3x5x7-inch Minibox, 12-section, 52-inch antenna (Lafayette 99 G 3008), battery plugs, perforated board, flea clips

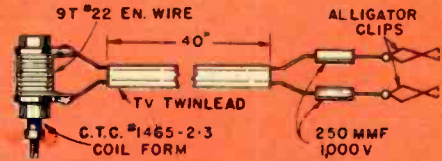

Fig. 5—To display modulation on scope, build this pickup probe which will couple RF near coil L6 to the vertical plates of scope.

with 2-56 screws and spacers, through the shield plate as shown in Fig. 6.

Note that all ground connections on both boards are made to lugs held under hex nuts on a 3-48x1½-inch-long headless screw which goes through both boards. This screw also is fastened firmly to the shield plate with a nut on each side.

Mount T1, L4, R1 and R5. R1 and R5 should be positioned so you can easily reach the screwdriver slot. Q3 is mounted by its leads only. Finish all wiring and make connections to the TRT-1A module.

Install a 1/16-inch-thick x ¾-inch-wide brass angle bracket for the antenna on the power-amplifier board. Solder the nut supplied with the antenna to the bracket as shown in Fig. 2.

Wind L4, L6, L7 and L8 as shown in Fig. 3 and install them. Put narrow strips of cellophane tape on L7 to hold the turns together tightly. The position of L7 within L6 is shown in Fig. 3. We do not show the heat sink on Q3 as it would obscure other parts.

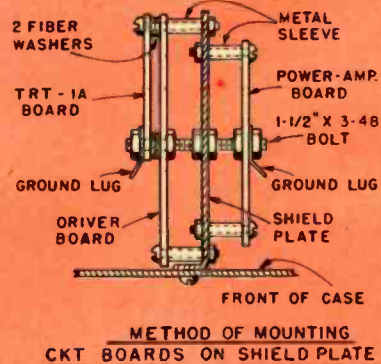
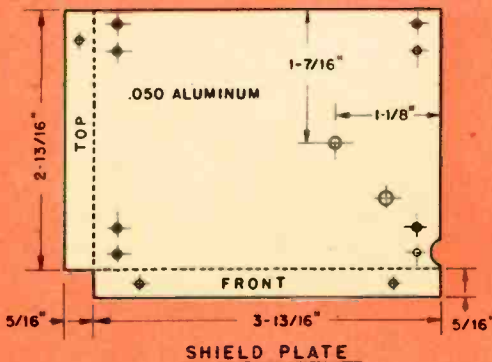
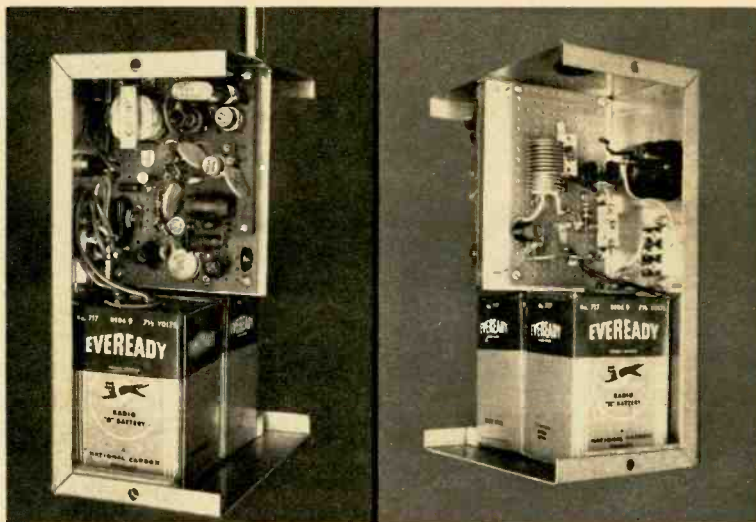

Fig. 6—Shield-plate dimensions and circuit-board mounting details. View of the shield plate is from driver-board side. The exact location and size of holes depends on individual construction.

Fig. 7—Photo at left shows driver board. Power-amplifier board, which is on other side of shield plate, is shown in photo at right. After boards are mounted determine where to drill hole in top of cabinet for antenna. Put grommet in hole so antenna doesn't touch the case.



## Blockbuster R/C Transmitter

**Tune Up.** Use only 9 to 12 volts for the first tests. Temporarily remove the antenna and pull coil L7 out of L6. Next, solder a 50-ohm, 1-watt resistor from the ground end (C) of L6 to a winding  $2\frac{1}{2}$  turns above. Then connect your VTVM's RF probe across the resistor. The core in coil L2 on the TRT-1A module should be close to the center of the winding. The core in L4 should be about halfway into the winding and C8 should be about  $\frac{1}{2}$  turn from maximum capacity. Set R5 to about half its resistance. Press pushbutton S1 and tune C10 for maximum indication on the VTVM. All adjustments interact to some extent, so go over them several times again until you have peak output. Q5's collector current should be between 40 and 60 ma.

Now set S3 to high (15V) and tune up everything again for maximum output. A meter temporarily connected in the point below L4 (on the schematic) marked X should indicate no more than 20 ma. If the current is higher, increase the resistance of R5. At this point Q5's collector current should be 60 ma. You should be putting from 0.5 to 0.6 watt into the 50-ohm load resistor. The total current drawn by the TRT-1A module should be less than 15 ma. None of the stages gives maximum output at minimum current (as is often the case with tube circuits). Therefore collector current isn't a reliable guide to tuning

or output. Meter M1 is an overload guide to warn you if Q5 is drawing too much current.

To check modulation, build the simple RF pickup probe shown in Fig. 5. The capacity of the twinlead across the coil tunes the pickup probe to 27 mc. Attach the clips directly to the vertical plates of your scope. Bring the coil near L6 and you'll be able to observe your modulation pattern. R1 should be adjusted so that you just start to get a bright narrow line between RF bursts.

For a final tune up, remove the 50-ohm resistor, insert the antenna and extend it to full length. Since the transmitter will normally be held with both hands, it's best to make final adjustments holding it this way (you'll need an assistant to do this). With L8 properly adjusted and correct coupling between L6 and L7, you should be able to load Q5 up to about the same collector current (60 ma) as you did with the resistor.

To check modulation with the antenna, run a foot of wire (connected to one of pickup probe coil lugs) close to the case or to the antenna. The former method is preferred so that antenna tuning won't be disturbed too much. Adjust the core in the pickup probe coil for highest scope pattern.

The TRT-1A module's frequency is certified only when the voltage is 15 volts  $\pm$  10%. The  $7\frac{1}{2}$  volt batteries we specify are the handiest size to use. They should give about 5 hours service (when used an hour a day) before their output drops to 12 volts. For better service, make up a pack of ten size C alkaline-energizer cells.



# A HAM STATION FOR

TURN PAGE 

*The easy way to select top equipment for your shack!  
You pick the price—we tell you what to buy.*

**G**UIDANCE is one thing many hobbyists need if they are to get over the hurdles and become licensed hams. Such advice may come from friends, relatives, clubs, books or magazines. But few are the radio amateurs who can say that they secured their tickets without hints from some source.

Broadly speaking, obtaining an amateur radio license and going on the air entails three big steps. First off, you must bone up on electronic theory, familiarize yourself with the regulations governing amateur radio and learn the code in preparation for the FCC exam. Next step is to take and pass the exam. This done, you must equip yourself with a receiver, a transmitter and the rest of the gear that goes to make up a ham shack.

Most would-be hams have guidance galore on steps one and two. Fact is, there are more good courses in electronic theory around than there are ham bands. As for the code, there are group-practice sessions and on-the-air code transmissions, not to mention a variety of recordings and how-to-learn-the-code books. In short, no one who really wants a ticket will find either the theory or the code all that difficult to master.

But what about the gear for that shack? There you have one hurdle almost no one bothers to guide you over. To be sure, you're well aware of what you need—in a general sense, at least. But when it comes to determining which transmitter and which receiver you should buy at a price you can afford—well, that's the place where hints are hard to find.

To help you over this hurdle, EI lists four complete ham stations in different price categories—\$100, \$250, \$500 and \$1,000. All you need do is determine how much you can afford to spend, then choose your station. Each of the four stations we show is complete and includes everything you need to set up a shack and go on the air. And the equipment in each station has been selected carefully to give you top value for your money.

An alternate unit is listed for each transmitter and receiver to allow you some options on the equipment you select. However, should you choose one of the alternates, some additional juggling may be required to keep the total price within the figure specified.

Ready to choose a ham station? Turn the page and take your pick.



By PAUL HERTZBERG  
K2DUX

March, 1965

45

# \$100



**TRANSMITTER: Ameco AC-1T (kit)**  
 Covers 80- and 40-meter amateur bands  
 Operates on CW only  
 Crystal-controlled  
 Pi-network output matches random-length antennas  
 TVI suppressed  
 Built-in AC power supply  
 Two tubes; 6V6 in final  
 Power input: 15 watts  
 Price: \$19.55

**Alternate: Knight-Kit T-60**

# \$250



**TRANSMITTER: Heathkit DX-60 (kit)**  
 Covers 80- through 10-meter amateur bands  
 Operates on CW or AM phone  
 Front-panel switch selects internal crystals or external VFO  
 Pi-network output matches 50- to 75-ohm antennas  
 Built-in low-pass filter  
 Grid-block keying  
 Front-panel meter  
 Five tubes; 6146 in final  
 Power input: 90 watts  
 Price: \$79.95

**Alternate: Knight-Kit T-150A**



**RECEIVER: Lafayette KT-320 (semi-kit)**  
 Tunes 550 kc to 30 mc  
 Calibrated bandsread on 80-, 40-, 20-, 15- and 10-meter amateur bands  
 S-meter  
 Q-multiplier and BFO  
 Automatic noise limiter  
 Illuminated slide-rule dial  
 Headphone jack  
 Nine tubes  
 Sensitivity: 1  $\mu$ v for 10db S/N ratio  
 Price: \$74.50

**Alternate: Lafayette HA-63**

**ACCESSORIES:**

Key (Lafayette 99G2554): 69¢  
 Antenna (wire, insulators, etc.): about \$2.50  
 Switch (SPDT switch for transferring antenna between receiver and transmitter): about 25¢  
 Speaker (Lafayette 99G2532): \$7.95



**RECEIVER: Heathkit HR-10 (kit)**  
 Tunes 80-, 40-, 20-, 15- and 10-meter amateur bands  
 Preassembled, prealigned tuning unit  
 Slide-rule dial  
 S-meter  
 Lattice-type crystal filter  
 Self-contained BFO  
 Jack for external 100-kc crystal calibrator  
 RF stage  
 Seven tubes  
 1  $\mu$ v sensitivity for 10db S/N ratio  
 Price: \$79.95

**Alternate: Knight-kit R-100A**

**ACCESSORIES:**

Key (Lafayette 99G2555): \$1.95  
 Microphone (Astatic JT-30): \$10.82  
 Antenna (Hy-Gain 4BDT): \$24.50  
 VFO (Lafayette 99G2501): \$34.50  
 Antenna Relay (Dow-Key DK60-G2C): \$15.65  
 Speaker (Heath AK-5): \$10.95



# \$500



**TRANSMITTER: Johnson Viking Ranger II (kit)**  
 Covers 160- through 6-meter amateur bands  
 Operates on CW or AM phone  
 Built-in VFO or crystal control  
 Pi-network output matches 50- to 500-ohm antennas  
 TVI suppressed  
 Calibrated bandspread  
 Grid-block keying  
 Fourteen tubes; 6146 in final  
 Power input: 65-75 watts  
 Price: \$249.50  
**Alternate: EICO 720K transmitter with 730K modulator and 722K VFO**



**RECEIVER: Lafayette HA-350**  
 Tunes 80- through 10-meter amateur bands, plus WWV (15 mc)  
 Single-knob tuning  
 S-meter  
 Automatic noise limiter  
 Double conversion  
 Tunable preselector  
 Crystal-controlled BFO  
 Voltage-regulated power supply  
 Twelve tubes  
 Provision for 100-kc crystal calibrator  
 Sensitivity: less than 1  $\mu\text{V}$  for 10db S/N ratio  
 Price: \$189.50  
**Alternate: Hammarlund HQ-110A**  
**ACCESSORIES:**  
 Key (Lafayette 99G2555): \$1.95  
 Microphone (Shure 520SL): \$24.46  
 Antenna Changeover Relay (Dow-Key DK60-G2C): \$15.65  
 Speaker (Lafayette 99G2532): \$7.95

# \$1,000



**TRANSMITTER: Hallicrafters HT-37**  
 Covers 80- through 10-meter amateur bands  
 Operates on CW, AM or SSB phone  
 High-stability VFO  
 Pi-network output matches 52-ohm antenna  
 Built-in VOX  
 Front-panel meter  
 Eighteen tubes; 6146's in final  
 Power output: 70-100 watts PEP on CW or SSB, 17-25 watts carrier on AM phone  
 Price: \$495  
**Alternate: Hammarlund HX-50**



**RECEIVER: Drake R-4**  
 Tunes 80- through 15-meter amateur bands, plus portion of 10-meter amateur band; accessory crystals available for other bands and frequencies  
 Gear-driven circular dial  
 S-meter  
 Passband tuning  
 Four selectivity bandwidths  
 Notch filter  
 Crystal lattice filter  
 Built-in 100-kc crystal calibrator  
 Sensitivity: less than 0.5  $\mu\text{V}$  for 10db S/N ratio  
 Price: \$379.95  
**Alternate: Hammarlund HQ-180A**  
**ACCESSORIES:**  
 Microphone (Astatic UG8-D104): \$33.05  
 Antenna (Mosley TA-33JR): \$71.52  
 Antenna Relay (Dow-Key DK60-G2C): \$15.65  
 Speaker (Drake MS-4): \$19.95

# ENLARGING EXPOSURE METER

By BERT MANN

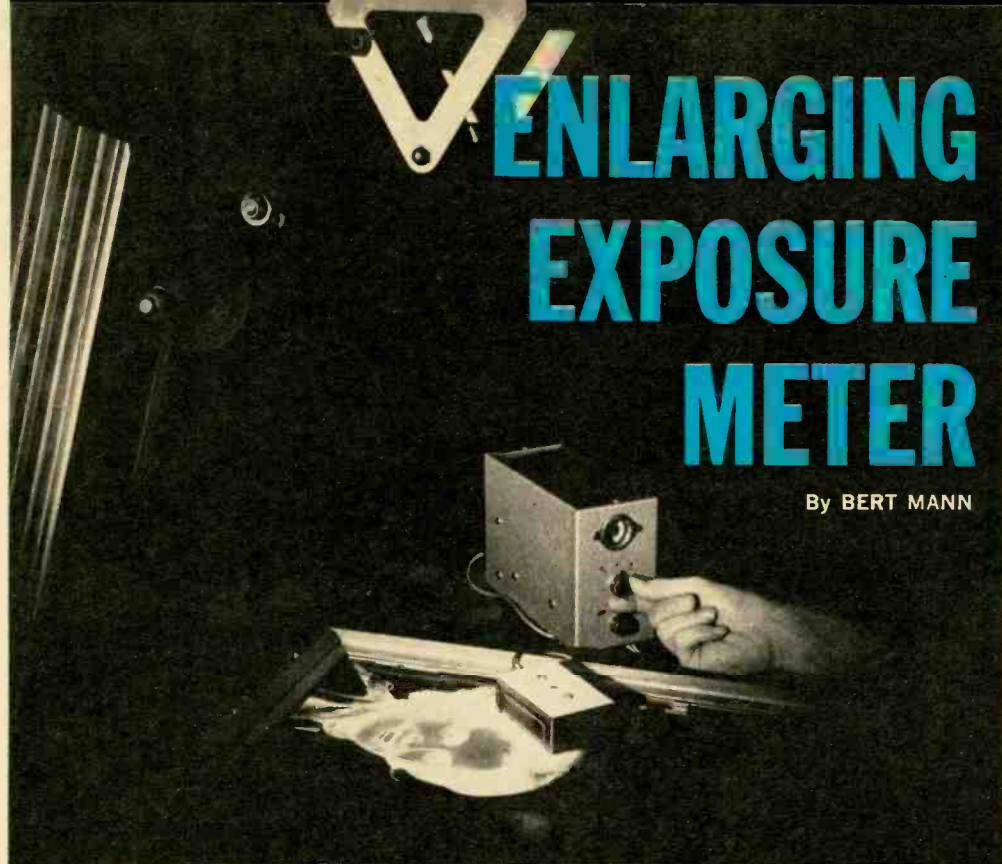

**W**HEN you stop to think about it, a lot of time spent making enlargements is non-productive. No one will argue that it is worth a great deal of effort to turn out a good print. But it is not worth the time and extra paper to run several tests to determine the correct exposure for, say, *each* wallet-size print of Uncle Herman's Atlantic City vacation. Since Uncle Herman shoots 36-exposure, 35-mm film—and no two exposures are alike—a lot of time and money could go down the drain.

With EI's Enlarging Exposure Meter you get the correct exposure the first time without making unnecessary tests. And best of all the exposure meter is fast. Once calibrated for each of your enlarging papers, calibration never has to be touched again.

Look how easy it is to make a perfect print the first time from any negative. After the negative and easel are in place you open the enlarger's diaphragm all the way. Then you put the photocell in the brightest area on the easel as we show above. The next operation is to stop down the enlarger's diaphragm until the meter's eye pops open, give a ten-second exposure and the job is done.

If you're wondering where the paper-grade control is (since so-called pro meters have one), forget it. You can learn quickly to determine whether to use a low, normal or high-contrast paper. The time needed to make a grade test for each print isn't worth the effort and cannot replace your own artistic skill. The only frill on our exposure meter is an adjustment which compensates for the different sensitivity of each enlarging paper you use. Since this adjustment also happens to be the calibrate control, another extra step is eliminated. The calibrate control lets you instantly pre-set the meter for whichever paper you use. If you prefer exposures other than 10 seconds you can pre-set the meter for any time between 5 and 20 seconds.

## Construction

Our meter is built in the main section of a 3x5x7-inch Minibox. The wiring is not critical and the parts may be rearranged to fit into a cabinet of a different size.



Take care when connecting T1. T1 is a special isolation transformer and is provided with a rubber-covered black line cord. These are the primary leads. The secondary leads are also black but they are *fabric* covered and are connected to the junction of J1 and R2, and to R1 and R4. Since T1's primary leads are long and come with a standard AC plug, the excess wire can be used for the meter's power cord.

Make certain that R3 has a logarithmic taper or the calibration will bunch up making adjustment difficult. Use a heat sink, such as an alligator clip, on the leads of D1 when

soldering them in place.

To insure accurate operation construct the pick-up probe *exactly* as follows: In the center of a 3¼x2½x1½-inch Minibox, carefully drill a ¼-inch diameter hole. Then spray the top of the box with white enamel paint. After the paint dries center PC1 under the hole and secure it in place with a 3/16-inch wide bracket cut from scrap aluminum. Tape the bracket so it doesn't short PC1's leads. *Warning.* If you use some other size cabinet, or drill a hole larger or smaller than ¼ inch, it may be impossible to calibrate the meter. While V1 can be mounted with a

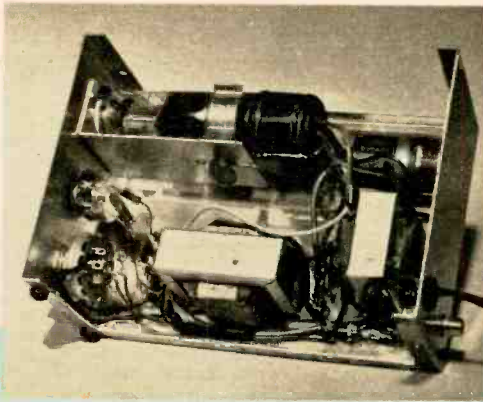

Mount the magic-eye tube as high as possible in the main section of the cabinet to allow room for potentiometer R3 and switch S1. Socket supplied with magic-eye tube mounting assembly comes with color-coded leads and R6. If you do not use assembly, connect R6 from pin 2 to pin 4. Watch the heat when soldering D1 or you'll damage it. To be safe, hold each lead with pliers when soldering. Black band on D1 is positive end.

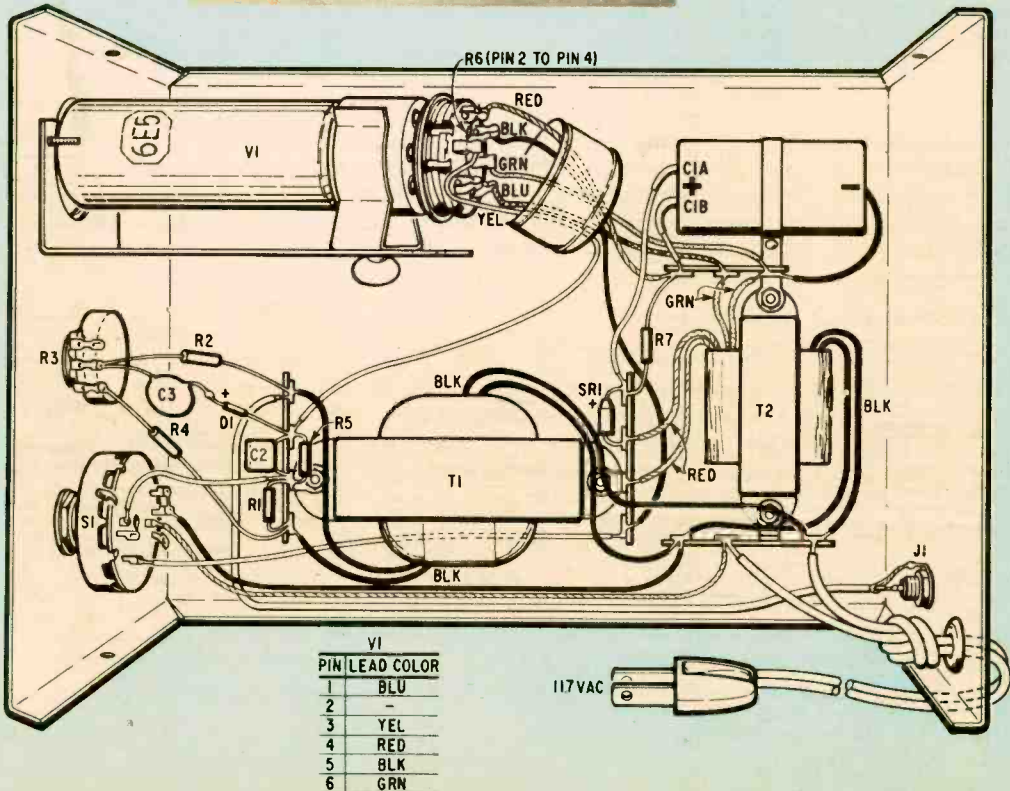

# ENLARGING EXPOSURE METER

Brightest light on PC1 from test negative lowers PC1's resistance. When R3 is adjusted so its resistance equals PC1's, bridge output at B is zero, eye opens. With other negatives, when you adjust diaphragm so eye opens it means light is same as it was with test negative and print will be perfect.

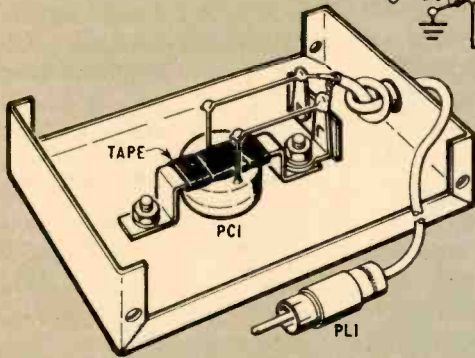

Exposure meter was designed around photocell specified in Parts List therefore do not use another type. The hole in cabinet above photocell must be 1/4-inch diameter and all edges of cabinet must be sealed against light with tape.

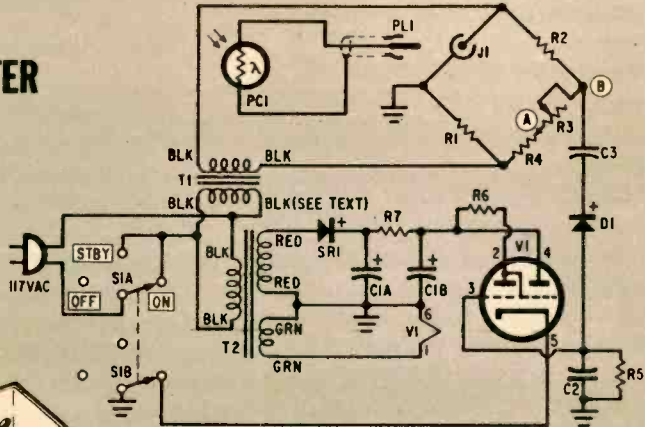

### PARTS LIST

- C1A, C1B—20/20 mf, 250 V electrolytic
- C2—1 mf, 75 V or higher capacitor
- C3—.02 mf, 500 V ceramic disc capacitor
- D1—1N34A diode J1—Phono Jack
- PC1—Cadmium sulphide photocell (Polaris MAJ-1 type LDR-C1. Allied Radio 7 E 565)
- PL1—Phono plug
- Resistors: 1/2 watt, 10%
- R1—560,000 ohms R2—62,000 ohms, 5%
- R3—250,000 ohm, log-taper potentiometer
- R4—2,700 ohms R5—2.2 megohms
- R6—1 megohm (see text) R7—470 ohms
- S1A, S1B—2-pole, 3-position non-shorting rotary switch (Mallory 3223J or equiv.)
- SR1—Silicon rectifier: minimum ratings, 100 ma; 400 PIV
- T1—Line isolation transformer (Lafayette 33 G 7502)
- T2—Power transformer: 125 V @ 15 ma, 6.3 V @ 0.6 A (Lafayette 33 G 3405 or equiv.)
- V1—6E5 tube (Socket, Amphenol CM-49)

home-brew bracket, a complete mounting assembly, including a pre-wired socket containing R6, is available from many electronic parts distributors. For convenience, use a thin microphone cable to connect PC1 to PL1.

### Calibration and Operation

Connect an ohmmeter across points A and B and rotate R3 until the meter indicates approximately 60,000 ohms. Connect the photocell plug to J1 and the meter is ready for calibration. First, turn on power by setting S1 to standby. The meter will be ready for operation but the magic-eye tube will not light.

Select a good, normal-density negative and make a perfect print with a 10-second exposure at an appropriate diaphragm setting. If you are satisfied with the print quality, place the pickup probe on the easel so that

its hole in the center of an area of maximum light (this is the spot which will come out dense black on the print). Turn off all safelights, set S1 to on (turning on V1's green target) and slowly adjust R3 in both directions until the shadow in V1 opens up fully. Put a mark on the panel opposite R3's knob pointer. This is the 10-second calibration for the particular paper you selected. If you use other papers, repeat this procedure for each of them.

For run of the mill enlargements the calibration will give you a good print almost every time following the procedure we explained at the beginning of this story. For high-quality enlargements where just a second or two change in exposure is needed for that extra effect, the meter will put you so close that the second print will be right-on-the-nose. The money you save on test enlargements will pay for the meter quickly.





**B**ACK SCRATCH . . . Something for nothing doesn't come anyone's way very often. And though membership in the R. Portugal DX Club supposedly

is free, there is a string or two attached. Matter of fact, R. Portugal's DX Club perhaps is more of a you-scratch-my-back-and-I'll-scratch-yours arrangement than anything else, as we soon will see.

Way EI understands it, R. Portugal already will have mailed out first copies of its free (?) monthly bulletin by the time this issue of EI reaches you. To join, a U.S. or Canadian SWL has to send five reception reports on *The Voice of the West*, a R. Portugal transmission beamed our way weekly on 6025 and 6185 kc. Other appropriate reports mailed off to Lisbon every succeeding two weeks will keep you in good standing.

In addition to its monthly bulletin, V. West will offer a (free) DX program on those Sundays following the second and fourth Fridays of each month. Times will be 2115 and 2315 EST, with the broadcasts featuring tape recordings from DX clubs round the world.

Explanation behind this interesting bit of mutual back-scratching is anybody's guess. But there's good reason to believe that R. Portugal is attempting to organize DXers primarily to sell the Lisbon line. Give a listen, and you'll find R. Portugal describing the U.N. as a "hybrid body supported at the expense of civilized nations." You'll also hear

some anti-U.S. diatribes, though these have been toned down noticeably since President Kennedy's assassination.

Listen to R. Portugal enough, however, and you likely will conclude that its primary assignment is an all-out anti-African crusade. Fact is, they've blasted every independent African nation *except* South Africa, a nation whose racial policies are notably rigidly colonial. Interesting, too, is the fact that R. Portugal has smeared all of Africa's Negro leaders except Moise Tshombe (of Katanga province fame).

Few SWL's would consider R. Portugal's views unbiased. For they only too obviously are designed to win support for Lisbon's own colonial policies in Angola and Mozambique. African independence, to R. Portugal, becomes Black Fascism, Communist conspiracy or most any other damaging epitaph it can come up with.

But whether R. Portugal's African views are right or wrong is of secondary importance to SWL's. The real issue is whether any SWBC station can gain a measure of control over SWLing by offering club membership, a DX bulletin or other special services free. At this point, we only can wait and see.

**Harmonic Hunting** . . . Though the Federal Communications Commission sets rigorous technical standards for stations under its jurisdiction, many BCB stations sneak through on frequencies the FCC clearly didn't assign. These frequencies are harmonics of the ones the FCC intended, and on

[Continued on page 110]



Unusual QSL card from R. Portugal is larger than most and mailed in a separate envelope. Printed in five colors, it highlights the role that nation played in discovering and exploring the once unknown portions of the globe. Reports should be sent to R. Portugal at Rua de Quelhas 2, Lisbon.



# DX CLUB

# OFFICIAL

ALL awards from EI's DX Club, with the exception of a broadcast-band certificate, are issued on the basis of the number of different countries from which a DXer holds QSL cards or letters. Since the important thing is the countries represented and not the sheer number of QSL's, the question of what is and is not a country becomes important.

To give DXers and short-wave listeners a definitive guide, we now present the EI DX Club's Official Countries List.

Because the Club gives credit for log en-

tries back to January 1, 1950, our Official Countries List includes all nations which have existed between that date and the present. Dates following certain countries indicate the period to, from or during which they may be counted.

The Club defines a country in DX rather than political terms because the list is meant as a guide for radio hobbyists, not a key to world politics.

The criteria used:

- 1) Any self-governing nation shall count as a country.

- A—
- Aden, Hadhramaut and Socotra Is.
  - Afghanistan
  - Aland (Ahvenanmaa) Is.
  - Alaska (including Aleutian Is.)
  - Albania
  - Aldabra (Seychelles) Is.
  - Algeria
  - American Phoenix Islands (including Canton and Enderbury Is.)
  - American Samoa Is.
  - Amsterdam and St. Paul Is.
  - Andaman and Nicobar Is.
  - Andorra
  - Angola
  - Annohon Is.
  - Antarctica
  - Antipodes and Bounty Is.
  - Argentina
  - Armenian S.S.R.
  - Ascension Is.
  - Asiatic R.S.F.S.R.
  - Asiatic Turkey
  - Auckland and Campbell Is.
  - Australia
  - Austria
  - Aves Is.
  - Azerbaijdzhan S.S.R.
  - Azores Is.

- B—
- Bahama Is.
  - Bahrain Is.
  - Bajo Nuevo Is.
  - Baker and Howland Is.
  - Balearic Is.
  - Barbados Is.
  - Basutoland
  - Bechuanaland
  - Belgian Congo (until 6/30/60)
  - Belgium
  - Bermuda Is.
  - Bhutan
  - Bolivia
  - Bonin and Volcano Is.
  - Bouvet Is.
  - Brazil
  - British Gilbert and Ellice Is.
  - British Guiana
  - British Honduras

- British North Borneo (before 9/16/63)
- British Phoenix Is.
- British Solomon Is.
- British Somaliland (before 6/30/60)
- British Togoland (before 3/6/57)
- Brunei
- Bulgaria
- Burma
- Burundi (after 7/1/62)
- Byelorussian S.S.R.

- C—
- Cambodia (after 11/9/53)
  - Cameroon
  - Canada
  - Canal Zone
  - Canary Is.
  - Cape Verde Is.
  - Cargados Carajos Is.
  - Caroline Is.
  - Cayman Is.
  - Cay Sal Is.
  - Celebes and Molucca Is.
  - Central African Rep. (after 8/13/60)
  - Ceuta and Melilla (Spanish Morocco)
  - Ceylon
  - Chad (after 8/11/60)
  - Chagos Is.
  - Channel Islands (Guernsey, etc.)
  - Chatham Is.
  - Chile
  - China
  - Christmas Is. (Indian Ocean)
  - Christmas, Fanning and Washington Is.
  - Clipperton Is.
  - Cocos (Keeling) Is.
  - Colombia
  - Comoro Is.
  - Congo Rep. (Brazzaville) (after 8/15/60)
  - Congo, Rep. of (Leopoldville) (after 6/30/60)
  - Cook Is.
  - Corn Is.
  - Corsica
  - Costa Rica
  - Crozet Is.
  - Cuba
  - Cyprus

- Czechoslovakia
- D—
- Dahomey (after 8/1/60)
  - Denmark
  - Dodecanese Is. (Rhodes)
  - Dominican Rep.
- E—
- East Germany
  - East Pakistan
  - Easter and Salay Gomez Is.
  - Ecuador
  - Egypt (6/18/53 to 2/1/58)
  - El Salvador
  - England
  - Eritrea (before 10/30/62)
  - Estonian S.S.R.
  - Ethiopia
  - European R.S.F.S.R.
  - European Turkey

- F—
- Faeroes Is.
  - Falkland Is.
  - Fernando de Noronha Is.
  - Fiji Is.
  - Finland
  - Formosa (Taiwan)
  - France
  - Franz Josef Land
  - French Equatorial Africa (before 8/15/60)
  - French Guiana
  - French India (before 10/31/54)
  - French Indo-China (before 7/20/54)
  - French Polynesia (Tahiti, etc.)
  - French Somaliland
  - French St. Martin and St. Barthelamy
  - French West Africa (before 8/6/60)

- G—
- Gabon (after 8/17/60)
  - Galapagos Is.
  - Gambia
  - Georgian S.S.R.
  - Ghana
  - Gibraltar

- Gilbert, Ellice and Ocean Is.
- Glorieuse Is.
- Goa, Damao and Diu (until 3/14/62)
- Greece
- Greenland
- Guadeloupe Is. (Fr.)
- Guadeloupe Is. (Mex.)
- Guam Is.
- Guantanamo Bay
- Guatemala
- Guinea (after 10/2/58)

- H—
- Haiti
  - Hawaiian Is.
  - Heard Is.
  - Honduras
  - Hong Kong
  - Hungary
- I—
- Iceland
  - Ifni
  - India
  - Indonesia
  - International Waters
  - Iran
  - Iraq
  - Ireland (Eire)
  - Isle of Man
  - Israel
  - Italian Somaliland (before 7/1/60)
  - Italy (including Sicily)
  - Ivory Coast (after 8/7/60)

- J—
- Jamaica
  - Jan Mayen Is.
  - Japan
  - Jarvis Is.
  - Johnston Is.
  - Jordan
  - Juan de Nova and Europa Is.
  - Juan Fernandez Is.

- K—
- Kaliningradsk
  - Kamran Is.



# COUNTRIES LIST

2) Colonized territory (possessions) shall count separately from the mother country.

3) Any colony administered separately from all other colonies of similar nationality shall be considered a separate country. For the purposes of this rule, the central colonial administration (the British Colonial Secretary, for example) shall not be considered as governing.

4) Any area under joint control of two or more self-governing nations, under UN control or under UN trusteeship shall count as a separate country.

5) Any territory separated from all other territory of like nationality by 100 miles of foreign territory or international waters shall count as a separate country.

6) Where a territory extends across continental

boundaries, it shall count as two separate countries.

7) The integral parts of Great Britain—England, Northern Ireland, Scotland, Wales—each shall count as a separate country.

8) Each Soviet Socialist Republic of the U.S.S.R. shall count as a separate country. Further, the Russian S.F.S.R. shall count as two countries. All other parts of the U.S.S.R. shall be considered as part of the Russian S.F.S.R. except where No. 5 applies.

9) Until territorial claims become clearer, Antarctica shall count as one country. In addition, the categories of International Waters and Outer Space each shall count as the equivalent of one country.

Karelo-Finnish S.S.R.  
(before 7/15/56)  
Katanga (7/1/60 to 1/15/63)  
Kazakh S.S.R.  
Kenya  
Kerguelen Is.  
Kermadec and Sunday Is.  
Kirghiz S.S.R.  
Kuwait  
Kuwait (Saudi Arabia Neutral Zone)

—L—

Laccadive and Amindivi Is.  
Laos (after 7/21/54)  
Latvian S.S.R.  
Lebanon  
Leeward Is.  
Liberia  
Libya  
Liechtenstein  
Line Is. (except Christmas, Fanning and Washington Is.)  
Lithuanian S.S.R.  
Lord Howe Is.  
Luxembourg

—M—

Macao Is.  
Macquarie Is.  
Madeira Is.  
Madagasy Rep. (Madagascar)  
Malawi (after 7/6/64)  
Malaya (7/11/57 to 9/16/63)  
Malaysia (after 9/16/63)  
Maldives Is.  
Mali (after 6/20/60)  
Malpelo Is.  
Malta Is.  
Manihiki (Danger) Is.  
Marcus Is.  
Mariana Is.  
Mariana Is. (Rota, Saipan, etc.)  
Marion and Prince Edward Is.  
Marquesas Is.  
Marshall Is.  
Martinique Is.  
Masqat and Oman  
Mauritania (after 11/28/60)  
Mauritius Is.  
Mexico  
Midway Is.  
Moldavian S.S.R.

Monaco  
Mongolia  
Morocco  
Mozambique

—N—

Nauru Is.  
Navassa Is.  
Nepal  
Netherlands (Holland)  
Netherlands Antilles (Aruba, Bonaire, Curacao)  
New Caledonia Is.  
New Hebrides Is.  
New Zealand  
Nicaragua  
Niger (after 8/3/60)  
Nigeria  
Niue Is.  
Norfolk Is.  
North Korea  
North Vietnam (after 7/21/54)  
North-East New Guinea Territory  
Northern Ireland  
Northern Rhodesia  
Norway  
Nyasaland (until 7/6/64)

—OP—

Outer Space  
Panama  
Papua Territory  
Paracel Is.  
Paraguay  
Pelagie and Pantelleria Is.  
Peru  
Philippines  
Pitcairn Is.  
Poland  
Portugal  
Portuguese Guinea  
Portuguese Timor Is.  
Puerto Rico

—QR—

Qatar  
Reunion Is.  
Revillagigedo Is.  
Rodriguez Is.  
Romania  
Roncador Cay and Seranna Bank  
Ruanda-Urundi (until 7/1/62)

Russian S.F.S.R.  
Rwanda (after 7/1/62)  
Ryukyu Is. (Okinawa)

—S—

Saarland (before 1/1/57)  
St. Helena Is.  
St. Pierre and Miquelon Is.  
San Andres and Providencia Is.  
San Marino  
Sao Tome and Principe Is.  
Sarawak (before 9/16/63)  
Sardinia Is.  
Saudi Arabia  
Scotland  
Senegal (after 6/20/60)  
Sierra Leone  
Sikkim  
Singapore (before 9/16/63)  
Sint Maarten (Dutch St. Martin), Saba and St. Eustatius Is.  
Socotra Is.  
Somalia (after 7/1/60)  
South Africa  
South Korea  
South Orkney Is.  
South Shetland Is.  
South Vietnam (after 7/21/54)  
Southern Rhodesia  
South-West Africa  
Spain  
Spanish Sahara (Rio Muni)  
Spanish Sahara (Rio de Oro)  
Spitsbergen (Svalbard) Is.  
Sudan  
Surinam (Dutch Guiana)  
Swan Is.  
Swaziland  
Sweden  
Switzerland  
Syria (before 2/1/58)  
Syrian Arab Republic (after 9/30/61)

—T—

Tadzhik S.S.R.  
Tanganyika (12/9/61 to 7/1/64)  
Tangier (before 10/28/56)  
Thailand  
Tibet  
Tinian Is.

Togo (after 4/27/60)  
Tokelau (Union) Is.  
Tonga (Friendly) Is.  
Trieste (before 10/5/54)  
Trindade and Martim Vaz Is.  
Trinidad and Tobago Is.  
Tristan da Cunha and Gough Is.  
Tromelin Is.  
Trucial Oman and Das Is.  
Tunisia (after 7/25/57)  
Turkey  
Turkmen S.S.R.  
Turks and Caicos Is.

—U—

Uganda  
Ukrainian S.S.R.  
United Arab Rep. (2/1/58 to 9/30/61)  
United Nations  
United Republic of Tanganyika and Zanzibar (after 7/1/64)  
Upper Volta (Voltaic Republic) (after 8/5/60)  
Uruguay  
Uzbek S.S.R.

—V—

Vatican State (City)  
Venezuela  
Vietnam (7/20/54 to 8/31/54)  
Virgin Is.  
United States of America  
Volcano and Bonin Is.

—W—

Wake Is.  
Wales  
Wallis and Futuna Is.  
West Berlin  
West Germany  
West Pakistan  
Western Samoa Is.  
Willis and Coringa Is.  
Windward Is.  
Wrangell Is.

—YZ—

Yemen (before 2/1/58, after 12/26/61)  
Yugoslavia  
Zanzibar (10/7/63 to 7/1/64)



- ✓ Ready rule for proper speaker placement
- ✓ Best bets for best stereo discs
- ✓ The case against those made-over mono's

**P**RACTICALLY every loudspeaker instruction sheet I've ever seen has stressed the importance of proper speaker placement. But that's about as far as the instructions seem to go.

"Experiment," the manufacturer says. But how? And where?

"Ah," says Mr. Manufacturer, "that's *your* worry."

And so it is. But, for all the dearth of solid information, there's no real mystery about the subject. True, it *does* take a little experimenting to determine where to put your speaker for best sound. The right spot, of course, is where its bass is full and rich without also sounding boomy, where all its highs blossom forth without sounding shrill. And, happily, there is a fairly easy rule to follow.

To put it as baldly as possible, the closer a speaker is moved toward intersecting room surfaces, the more bass there will

be in the overall sound. Why? Reason is that bass frequencies are non-directional and tend to be dissipated easily. Hang a speaker dead center in a room and it just may seem to have no bass at all. But move it toward floor, wall or ceiling, and that non-directional bass will become focused somewhat, making it much more audible.

**You'll get the greatest amount of bass** when you put a speaker at the junction of three surfaces—in a corner at the floor or ceiling. Next best place for bass is at the intersection of two surfaces—wall and wall, wall and ceiling or wall and floor. And so it goes until you move away from the various room surfaces to the dead-center position where bass seems weakest of all.

But why is bass the thing to talk about?

Answer: it's the vital factor in the all-important *balance* of a speaker's sound. When a speaker seems thin and strident it's usually because of missing bass. And when it sounds boomy, too much bottom ordinarily is the cause.

Use the intersecting surfaces-rule as a guide, though, and it's fairly easy to find the place where any speaker yields just the right proportion of bass for smooth sound. If the speaker's high end needs some touching up, you can fiddle either with the speaker's high-frequency level control or the treble control on your amplifier.

Occasionally, of course, tricky room acoustics can result in standing waves. And these potent phenomena may cause a speaker's bass to overwhelm you at one listening position and yet be almost non-existent at another.

Tearing your listening room apart and building a new

one is one way out of this dilemma, but there are easier solutions. I've found the most practical tack is to move a speaker around over a limited area (a foot or two often is enough) until the worst effects of standing waves occur at non-critical points in the room—the places where no one usually settles down to listen, anyway. You'll find it next-to-impossible to rid a room of standing waves, but tricks such as these can keep them under control.

**What about placement** for effective stereo? Well, this stacks up as a much overrated problem. To my mind, it's best to start with the minimum speaker separation that seems to give good stereo spread, then work outward from there to get the overall sonic bal-

*(Continued on page 115)*

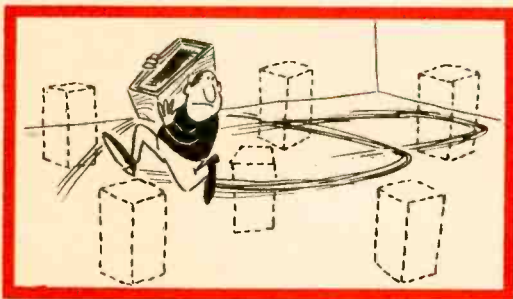



# ELECTRONICS AND BLACK GOLD

By A. D. JACKSON

"**E**LECTRONICS in the petroleum industry? It would be hard to find a place where electronics isn't used in the oil business today."

So says Dr. Gerald A. Harlow, supervisor of the Shell Development Co.'s analytical chemistry laboratory in Emeryville, Calif. And a tour through these modern laboratories, just off the eastern end of San Francisco's famed Bay bridge, quickly confirms the fact that electronics is immersed in oil. Matter of fact, electronics is all but instrumental to black gold—from finding the crude in the ground, to refining the finished products for the consumer.

One reason electronics has entered the oil business so substantially stems from the elusive nature of oil itself. As it happens, geologists feel there still may be twice as much oil in the U.S. as the 100 billion or so barrels discovered in the last century. Problems are to find it, then refine it. Electronics measures up to both tasks nicely.

"To help make up for the lower level of exploration activity and to find new ways to find oil more economically, the industry is making



## ELECTRONICS AND BLACK GOLD

increasing use of research and technology," observes Harold Gershinowitz, chairman of the Royal Dutch Shell Group Research Council in the Hague, Netherlands. And much of the research and technology he mentions are of an electronics nature.

Precisely what new tricks *has* electronics brought to the oil industry? Actually, there are so many it's difficult even to list them all. For one thing, more and more companies are using electronic devices—ultrasonic transducers—to pump vibrations into the earth—and thus learn more about the lay of the land (and oil) down there. This particularly is true when a firm is searching for a possible well off-shore.

In another instance, a company is feeding data gathered in actual drilling into computers for accurate recording and analysis. Other oil companies, using new data processing equipment, currently are reclassifying the reams of information they have gathered over the years.

Socony Mobil, for example, has poured seismographic data going back as far as 1938 into a new \$500,000 electronic monster. The machine spins its electronic gears, eventually converts the information into cross-sectional maps of rock layers. And just to prove you can't beat a robot, this computer actually projects the maps it has made onto a TV screen.

Other instances of electronics and black gold are legion. Texaco, for example, has opened the nation's first electronically controlled blending plant which automatically mixes over 40 different lubricants in half the time it took manual workers to do the job. A single control console directs the entire operation.

In another new development, an electronic data transmission system enables oil companies to control petroleum fields or pipelines remotely. Made by RCA, the system is designed to keep constant watch over widely-separated oil or gas wells or cross-country pipelines. It logs production data and reports

breakdowns, relaying instructions from a central control point.

One of the more interesting applications of electronics in the oil industry is in the solution of a decades-old problem—the loss of crude oil through cracks and holes in the casing. Though they may be thousands of feet in the ground, these leaks can be repaired readily simply by forcing cement into them under pressure. But until very recently, problem has been to locate the leaks and determine their nature.

The old way of finding defects and corrosion involved pulling the casing—perhaps a mile or more in length—back out of the ground. This obviously was expensive and time-consuming. Further, it meant the loss of the well's production during shutdown for inspection and repairs.

But today an electronic device conceived by Shell Development can sniff out defects in the pipe while it is in the ground, reporting findings to a recorder on the surface. Ferret-fast, the instrument inspects all sides of the pipe at a uniform rate of 1,800 feet per hour. And in an emergency it can move at twice that speed.

The probe tool is a pipe about eight feet long, looking something like a flagpole. A knob at the bottom acts as a weighted bumper, bringing the total weight of the tool to upwards of 500 lbs., so it readily will drop to the bottom of the well.

A second knob at the top houses an exciter coil which induces an electrical signal into the well casing. And in the middle is still a third knob, housing a pickup coil which receives the signals after they have passed through the length of casing between the coils.

In the narrow cylinder separating the coils is the down-hole electronic circuitry, all of which is transistorized. Working with this down-hole probe are the surface instruments, installed on a truck in standard 19-inch relay racks.

In operation, the electromagnetic probe is dropped to the bottom of the well. Next, with the instruments turned on, it is pulled back out of the pipe at the uniform rate of 6 inches per second. Simultaneously, a 60-cycle signal is fed down the cable from a generator on the surface. This is radiated by the exciter coil out to the casing walls, where it sets up eddy currents.

Because of these currents, the signal which



reaches the pickup coil not only is much weakened but also shifted in phase. This phase-shifted signal is greatly amplified and used to modulate a 3-kc carrier, which then travels back up the cable to the surface.

Since this same cable also carries the 60-cycle signal which goes down the hole, a high-pass filter and amplifier reject it, passing only the FM-modulated carrier. The signal then is demodulated and further stepped up by a tuned amplifier. Its time phase lag is determined by a phase meter, and the resulting signal fed to a pen recorder.

A typical pen recording of a length of pipe reveals every change in thickness. If, for example, a pipe had thinned for some reason at 4,000 feet, the recorder would indicate this. Or, if there were pitting at about 5,050 feet and again at 5,075 feet, the recorder would show this as well.

Though the device operates on a relatively simple principle, its importance shouldn't be

underestimated. For the long and the short of the matter is that oil companies now may obtain information on corrosion and other deterioration of well casings which previously was unavailable. And electronics has made it possible.

**Another important objective** of oil companies is to make oil wells as automatic as chemical plants and refineries already are. Here, too, electronics is in the picture. Fact is, new electronic devices automatically make well tests, transfer custody of crude oil and even pay the oil-field lessor.

First thing to understand in considering oil-field automation is the fact that most land from which crude oil is extracted is not owned by the oil company. The company merely leases rights to seek oil, and if successful, to remove it. This arrangement has an important bearing on how automation is achieved, as we shall see shortly.

*[Continued on page 118]*

**Specially designed TV camera enables engineers to inspect oil-well casings visually at depths up to one mile.**

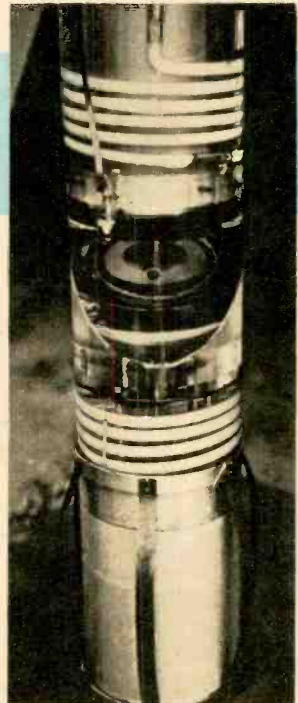

**Electron accelerator is big boon in chemical analyses. Machine stands two stories high.**

# RACK YOUR HAM STATION

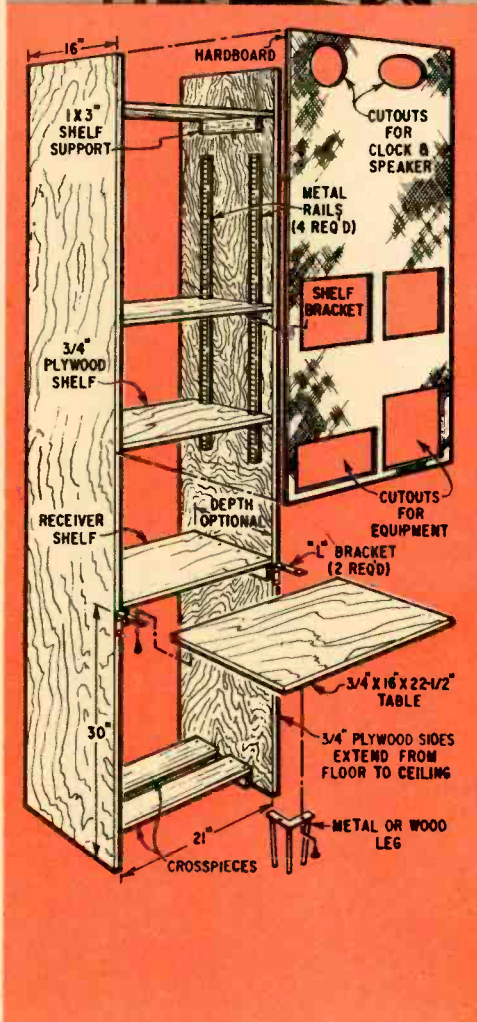

**P**ICTURE a ham in action and what do you see? Someone pounding brass, barking into a mike, maybe hunched over a bandspread dial? Could be, but that's movie stuff. Walk into a real shack and the ham probably is rassing with tangled wires in back of his rig. Or maybe he's pushing a new VFO onto a jammed-up table while a receiver slides off the other end.

The answer? Don't wreck it, rack it! And one way to rack it is with EI's 15-buck homebrew week-end special.

Our drawing and photos give the details, so we'll concern ourselves here with the basics. Start with a standard, 4x8-ft. sheet of  $\frac{3}{4}$ -in. plywood. Cut it into three long strips, each 16-in. wide and your rack is underway. Two strips become the uprights, the other is sawed up for shelves.

Next step is to fasten one upright against a convenient wall. (If the ceiling is less than 8 ft. high, trim the upright at the top. And if there's a baseboard along the wall bottom, use a wood shim at the top so the upright stands true and vertical.)

Note that three shelves, or crosspieces, are fastened permanently to give the rack rigidity. Two are near top and bottom, the other is the middle shelf which supports the receiver at about table height. The adjustable shelves use the metal rails and matching clips which are stocked in hardware stores. Each movable shelf is notched into its rail to prevent any front-to-back sliding.

A finished appearance can be achieved by using a large piece of hardboard as a front panel, marked and cut according to the equipment on the shelves.



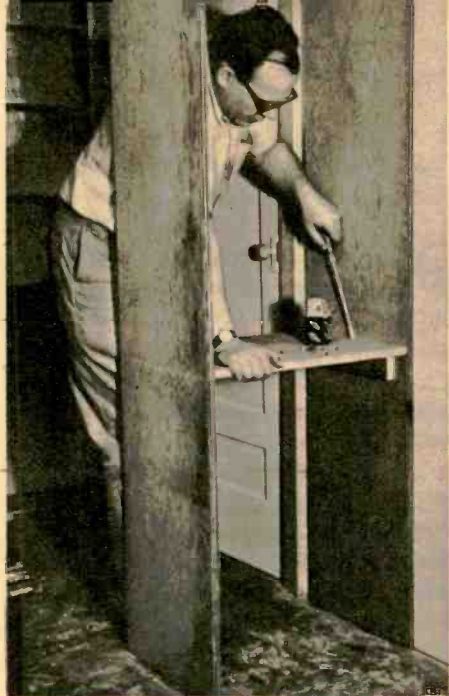

Easily modified or moved, El's wooden rack costs much less than commercial metal variety. Basic structure consists of two uprights made of  $\frac{3}{4}$ -in. plywood, cut to extend from floor to ceiling. Convenient depth is 16 in., but figure can be altered to meet your requirements.

Two crosspieces at bottom add rigidity. Top shelf and receiver shelf also are attached permanently.



Metal rails installed above receiver shelf accept clips which support additional shelves. Note that shelf ends have been notched for snug fit.



Rear of rack is open, leaving equipment and interconnecting cables within easy reach. AC outlets can be installed along rear of either upright.



Table directly in front of receiver is perfect for key or logbook. For two-tone rack, paint edges of table and crosspieces contrasting color.

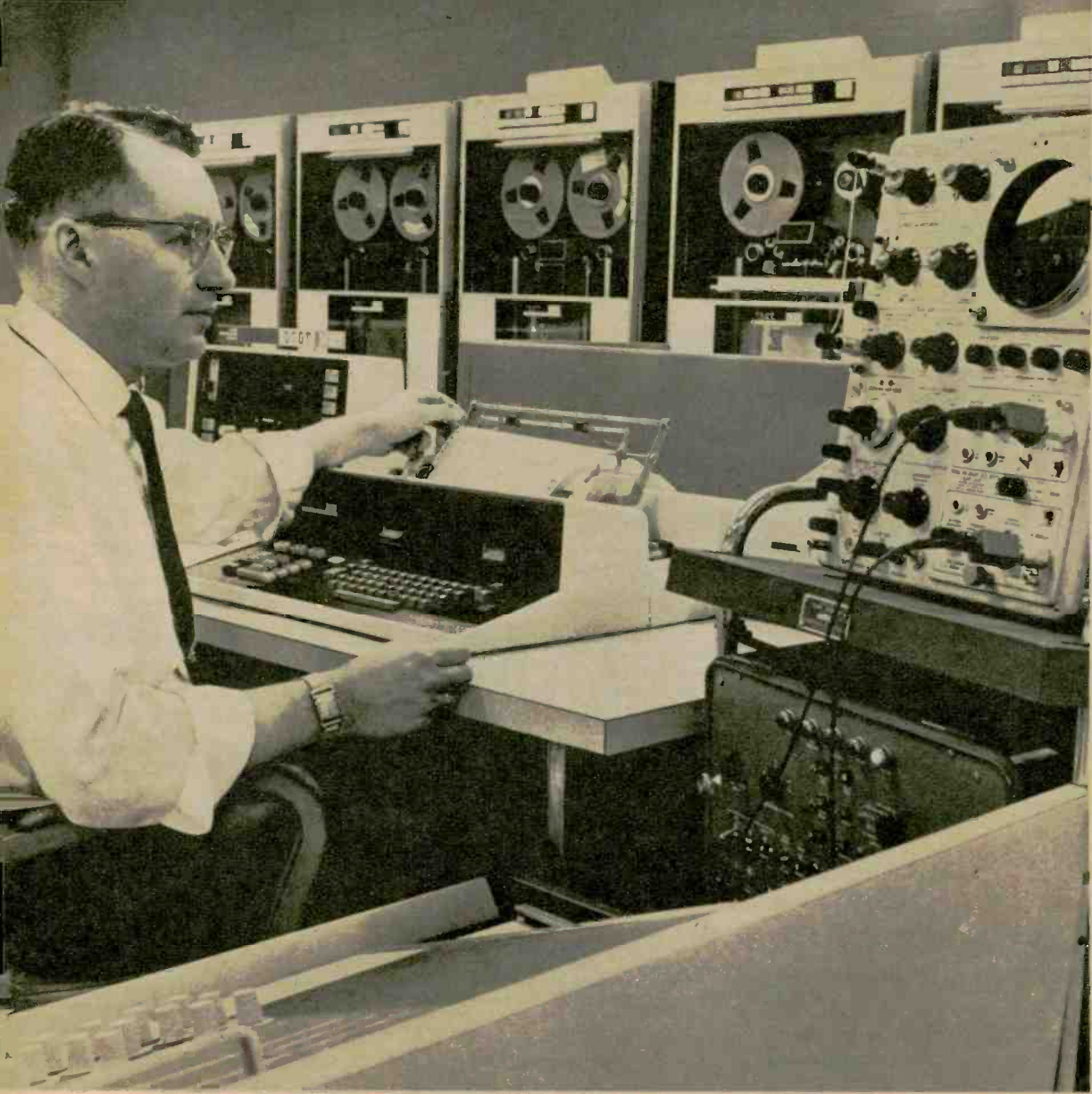

## Why Fred got a better job . . .

I laughed when Fred Williams, my old high school buddy and fellow worker, told me he was taking a Cleveland Institute Home Study course in electronics. But when our boss made him Senior Electronic Technician, it made me stop and think. Sure I'm glad Fred got the break . . . but why him . . . and not me? What's he got that I don't. There was only one answer . . . his Cleveland Institute Diploma and his First Class FCC License!

After congratulating Fred on his promotion, I asked him what gives. "I'm going to turn \$15 into \$15,000," he said. "My tuition at Cleveland Institute was only \$15 a month. But, my new job pays me \$15 a week more . . . that's \$780 more a year! In

twenty years . . . even if I don't get another penny increase . . . I will have earned \$15,600 more! It's that simple. I have a plan . . . and it works!"

What a return on his investment! Fred should have been elected most likely to succeed . . . he's on the right track. So am I *now*. I sent for my three *free* books a couple of months ago, and I'm well on my way to Fred's level. How about you? Will you be ready like Fred was when opportunity knocks? Take my advice and carefully read the important information on the opposite page. Then check your area of most interest on the postage-free reply card and drop it in the mail *today*. Find out how you can move up in electronics too.



# How You Can Succeed In Electronics

## . . . Select Your Future From Five Career Programs

### The "right" course for your career

Cleveland Institute offers not one, but five different and up-to-date Electronics Home Study Programs. Look them over. Pick the one that is "right" for you. Then mark your selection on the reply card and send it to us. In a few days you will have complete details . . . without obligation.

#### 1. Electronics Technology

A comprehensive program covering Automation, Communications, Computers, Industrial Controls, Television, Transistors, and preparation for a 1st Class FCC License.



#### 2. First Class FCC License

If you want a 1st Class FCC ticket *quickly*, this streamlined program will do the trick and enable you to maintain and service all types of transmitting equipment.



#### 3. Broadcast Engineering

Here's an excellent studio engineering program which will get you a 1st Class FCC License and teach you all about Program Transmission and Broadcast Transmitters.



#### 4. Electronic Communications

Mobile Radio, Microwave, and 2nd Class FCC preparation are just a few of the topics covered in this "compact" program . . . Carrier Telephony too, if you so desire.

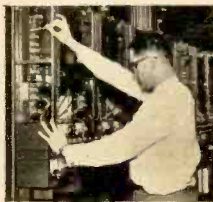

#### 5. Industrial Electronics & Automation

This exciting program includes many important subjects such as Computers, Electronic Heating and Welding, Industrial Controls, Servomechanisms, and Solid State Devices.



### An FCC License . . . or your money back!

In addition to providing you with comprehensive training in the area indicated, programs 1, 2, 3, and 4 will prepare you for a Commercial FCC License. In fact, we're so certain of their effectiveness, we make this *exclusive* offer:

The training programs described will prepare you for the FCC License specified. Should you fail to pass the FCC examination after completing the course, we will refund *all* tuition payments. You get an FCC License . . . or your money back!

### CIE's "AUTO-PROGRAMMED" method helps you learn faster and better

Cleveland Institute uses the new programmed learning approach. This "Auto-Programmed" method presents facts and concepts in small, easy-to-understand bits . . . reinforces them with clear explanations and examples. Students learn more thoroughly and faster through this modern, simplified method. You too will absorb . . . retain . . . advance at your own pace.

### Free nationwide job placement service . . . for life, for every CIE graduate

Once enrolled with CIE, you will get a bi-monthly listing of the many high-paying interesting jobs available with top companies throughout the country. Many Cleveland Institute students and graduates hold such jobs with leading companies like these: American Airlines, American Telephone and Telegraph, General Electric, General Telephone and Electronics, IBM, Motorola, North American Aviation, New York Central Railroad, Raytheon, RCA and Westinghouse.

### Electronics is a fast moving, dynamic industry . . . Cleveland Institute keeps you current

The Electron Bulletin is CIE's bi-monthly digest of new developments in the world's fastest growing industry. As a CIE student, you will get a free copy throughout your training to keep you up-to-date on Masers, Lasers, Solid State Devices, and other new inventions.



### Full accreditation . . . your assurance of competence and integrity

Cleveland Institute of Electronics is accredited by the Accrediting Commission of the National Home Study Council. You can be assured of competent electronics training by a staff of skilled electronics instructors.

**Your Future In Electronics Is  
Up To You. Make It A Brighter One.  
Mail Reply Card Today.**

# Cleveland Institute of Electronics

Dept. EI-56, 1776 E. 17th St., Cleveland 14, Ohio



# TALK ON A

*Someday you'll be able to afford laser*

BY EDWARD LININGER

**C**OMMUNICATIONS is a word you hear a lot these days. Instant, world-wide, broadcast, TV, amateur and Citizens Band are but a few of the terms that get linked to this word. And one of the newest methods of communication—though still in the laboratory stage of development — involves the laser.

Our novel method of communications permits you to talk on a beam of light. You might liken our talking flashlights to a poor-man's laser. Using ordinary flashlights, modular amplifiers and a few other standard electronic parts, this project enables you to talk over a distance of a couple of hundred feet. The beam of light is an electro-optical representation of your voice.

To appreciate how far man has come in his effort to communicate over distances, let's go back a few hundred years to see how things developed. Just plain shouting, drum beats and smoke signals were the early techniques. As time passed, Morse code and wires were used. It wasn't long thereafter that the telephone came along, only to be followed by radio.

But radio had a difference. It used what is known as a carrier, on which intelligence was superimposed. At first this carrier was amplitude-modulated. This is still the basis of most AM broadcasting. At the receiving end, the modulation on the RF carrier is converted back to audio.

Then came frequency modulation. With

this system, the RF carrier's amplitude remains constant but its frequency is varied. In either case there is always a carrier that has something done to it to get the message across.

It's the carrier concept that is important in our talking flashlights. In this case the carrier is a beam of light whose brilliance is varied. Just think of an ordinary flashlight beam as equivalent to the RF signal a transmitter puts out when intelligence is not being transmitted. Speak into a microphone and the RF carrier's amplitude will be varied. Speak into the talking-flashlight mike and you will see the intensity of the light beam vary.

Short-range, line-of-sight voice communication can now be yours for a lot less than those high-priced lasers you've heard about. A pair of our units can be assembled with standard parts for about \$30. You can use them to carry on conversations via a light beam in either daylight or darkness.

The voice-modulated light beam is virtually eavesdrop-proof (though it's unlikely a hobbyist would want a secret means of communication). The beam is directed to the other unit only and cannot be converted easily into audio by someone else.

In addition to being useful for experimental work and Science Fair projects, the talking flashlights can be used for house-to-house, construction-site and camping communications.

## How They Work

Take a look at the schematic and pictorial. The heart of the unit is a modular five-tran-



# LIGHT BEAM

communications, but in the meantime try flashlights.

sistor amplifier and a doctored-up transistor. The amplifier is used for both transmitting and receiving.

When you want to transmit, the signal from your microphone is fed to the amplifier, where it is boosted in strength to modulate, or vary, the intensity of the flashlight bulb. Input and output connections to the amplifier are switched by S1.

When receiving, modulated light from the transmitting unit is focused by an ordinary magnifying glass on photo transistor Q1. Q1 also provides the first stage of amplification. The amplifier boosts the signal from the transistor so it is large enough to drive a small speaker.

Transistor Q1 is a standard audio type that is modified so it will work as a photo transistor. It is made into a photo transistor simply by removing the paint from its glass case to expose the internal junctions.

To get a better idea of how the transistor can be used in this way, let's have a brief refresher on semiconductor theory.

Current carriers in a transistor can be caused to move by three types of energy—heat, electrical potential or light. Overheat an operating transistor and you see circuit operation go haywire mighty quickly. Apply an electrical signal to a transistor and current through it and the circuit will increase. (This, by the way, is the way in which most transistors are used.)

When a beam of light is focused on one of the PN junctions in a transistor, current will flow in about the same way it would if you applied a signal to the transistor's base.

An increase in light intensity causes an in-



crease in current from the transistor's emitter to collector. A decrease in light intensity on the internal elements of the transistor reduces the current flow from emitter to collector. When the intensity of the light beam on the transistor changes, the signal to the amplifier will change.

## Construction

The most important part of construction is optical. By this we mean that transistor Q1 must be mounted at a point where all light aimed at the lens will be concentrated on a single point—the transistor. This point is called the focal point of the lens. The diameter of our lens was 2 inches and its focal length was 4 inches. Therefore, we mounted Q1 exactly 4 inches behind the lens. A larger-diameter lens would gather more light and could be used; however, its greater focal length would require a longer box.

To find the focal length of your lens, aim the lens at a distant light bulb. Then focus the image of the bulb on a piece of paper until you have a minimum-size spot, then measure the distance from the lens to the paper. This distance is called the focal length and is the distance your transistor must be mounted behind the lens. Mount the transistors' socket on a bracket made from scrap aluminum. It's important to mount the transistor correctly. The red dot on the transistor's case must be turned away from the lens. By mounting the transistor this way, the

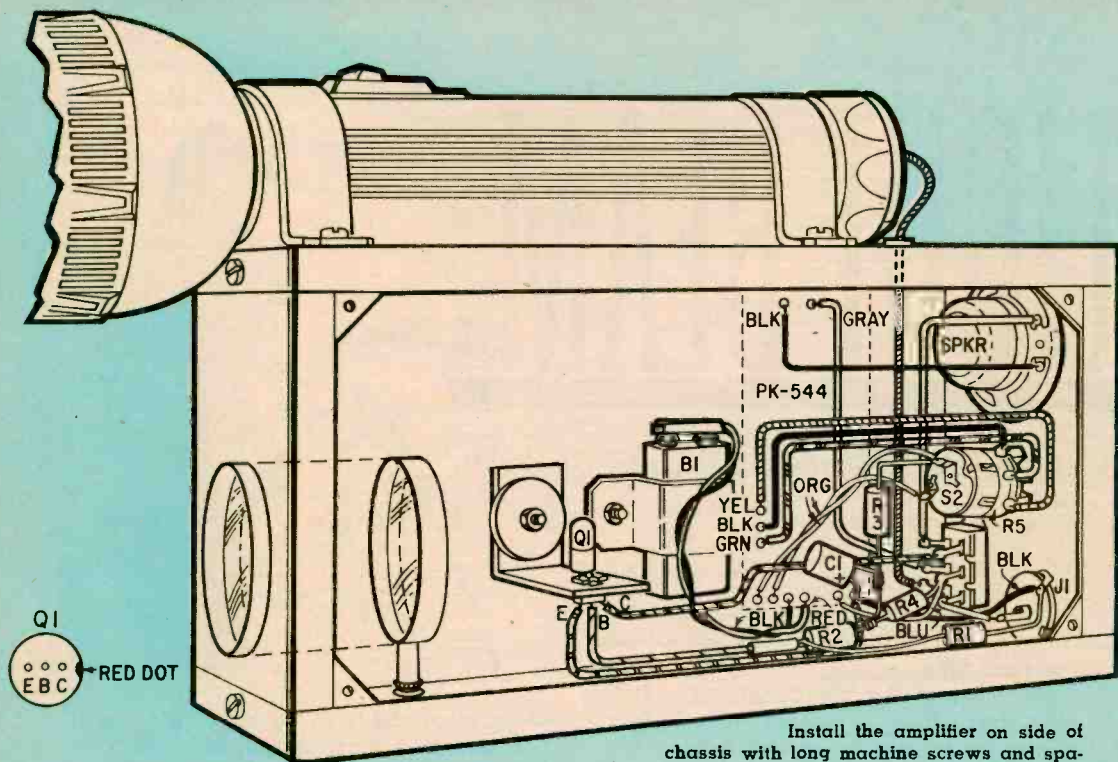

Install the amplifier on side of chassis with long machine screws and spacers. Q1's position depends on focal length of lens.

## TALK ON A LIGHT BEAM

more sensitive transistor junction will be facing the lens.

Once the transistor is mounted, mount all other parts in the rear of the cabinet as shown in the pictorial. Be sure to install the ampli-

fier with spacers so its back does not touch the cabinet.

Before mounting the flashlight install the PR-7 bulb (this type can be modulated more easily than other types). Drill a hole in the cap at the back of the flashlight and insulate the spring in the cap with tape or spaghetti so that it *does not* make contact with the battery. Place the batteries in the flashlight and solder a piece of wire to the back of the

Do not mount the amplifier until you have determined where Q1 will be located. Because our lens had a 4-inch focal length, Q1 was mounted in such a position that there was plenty of space for amplifier and other parts. If your lens has longer focal length it may be necessary to install amplifier in upper part of cabinet.

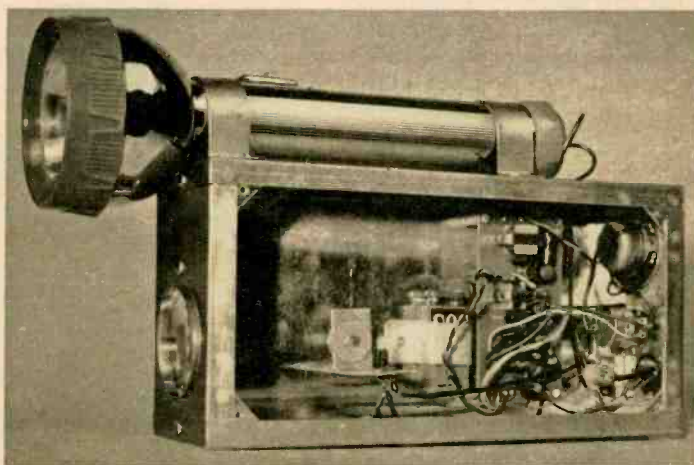



last battery. Pull the wire through the cap and connect it to S1. Mount the flashlight on the cabinet so that its metal case makes good electrical contact with the cabinet.

Then mount the volume control, microphone jack, switch S1, the lens and the speaker. Connect the wires and components going to these parts, then install the bias resistors following the layout in the pictorial. Use stranded wire to Q1's socket.

You can use almost any low-impedance carbon microphone. Lots of them are available on the surplus market and they don't cost much. If their resistance is in the vicinity of 30 to 100 ohms they'll work. One possible source is mentioned in the Parts List. If you have a pair of old telephones lying around, the carbon mike in the mouthpiece will be fine.

### Test and Adjustment

Focus the image of a light bulb about 15 feet away on Q1. Adjust the position of Q1 so the image of the bulb is sharp. With S1

in the receive position, turn the volume control up. There should be a loud hum, indicating that the receive function is working. Then push S1 to the transmit position and speak into the mike. The flashlight bulb intensity should change and the volume control should be able to affect the change.

### Operation

Make your first test with the units separated about 20 feet. When operation is satisfactory, increase your distance. As you increase separation the position of both units will become more critical. You may find it necessary to mount both units on inexpensive camera tripods so perfect aim can be maintained.

When you use the flashlights outdoors, it will be helpful to shield the lenses from bright light. A simple way to do this is with hoods made from tin cans painted dull black.

And if you plan to carry on long conversations use alkaline energizer batteries in the flashlights.

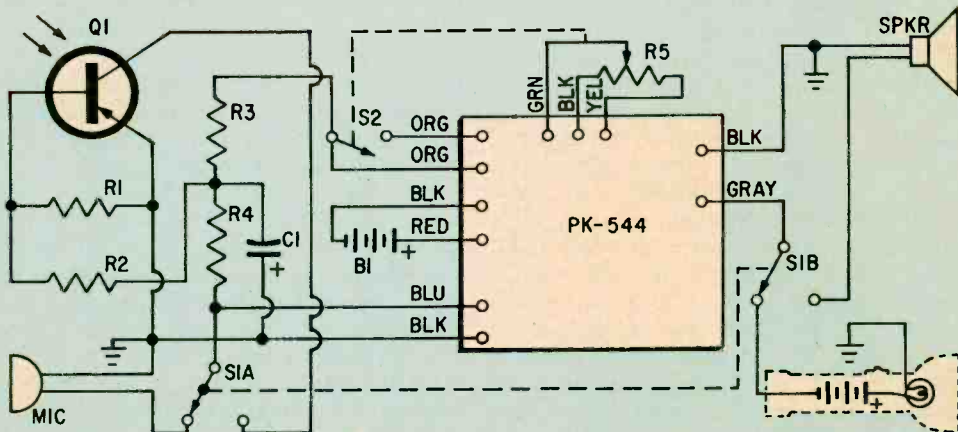

When S1 is in transmit (as shown), mike is connected to amplifier input and amplifier output is connected in series with flashlight to ground. Light beam brilliance is modulated by amplified mike signal. Since black battery lead is connected internally to top orange lead. DC is applied to carbon mike through R3, R4.

B1—9-volt battery

C1—20 mf, 15 V electrolytic capacitor

J1—Phono connector

MIC—Carbon microphone: 30-100-ohms impedance (McGee Radio Co., 1901 McGee St., Kansas City 8, Mo. Stock No. MCS-2841. 79¢ plus postage.)

PK-544—Modular amplifier (Lafayette 99 G 9037)

#### PARTS LIST

Q1—2N279 transistor

(Amperex)

R1, R4—10,000 ohm, ½ watt, 10% resistor

R2—270,000 ohm, ½ watt, 10% resistor

R3—68,000 ohm, ½ watt, 10% resistor

R5 — 10,000-ohm, audio-taper potentiometer with SPST

switch.

S1—DPDT slide or toggle switch

S2—SPST switch on R5

SPKR—2-inch, 8-10-ohm speaker

Misc. — 10x5x3-inch aluminum chassis (Premier ACH-401). 10x5-inch aluminum chassis bottom plate (Premier ABP-401), flashlight bulb: 3.7 V, 300 ma, (GE PR-7 or equiv.), 3-cell flashlight

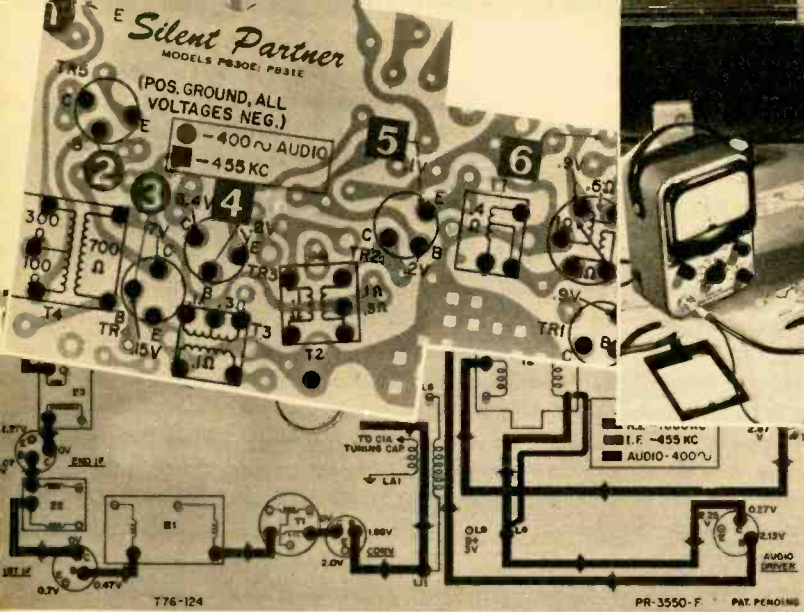

**NEW**

**YEARS AGO**—in the days before science fiction became science non-fiction—some prophets were predicting that radios would become so simple and inexpensive that servicing would be no more. If a set stopped working for some reason or other, its owner would just throw it away and get another. At most, he might pull out the “works” module and plug in a low-cost replacement.

But predicting is an inexact science, and in this case it was way off the mark. Radios have become dirt-cheap, all right (we put a \$2.98 transistor portable through its paces just the other day). But servicing is still very much with us.

What people think of a product often depends on how easily and cheaply it can be repaired. This means that it's good business for a manufacturer to devise a shortcut or two for servicing his radios or TV sets. And that's exactly what some have done.

These shortcuts understandably are of big interest to servicemen. But they're a boon to hobbyists, as well. For they make it downright easy for most any electronics-minded person to service his own sets—not to mention those of his friends and neighbors.

As you're probably aware, most transistor radios include a printed-circuit board, and it's no picnic to try to trace a signal through one. Yet this must be done when the cause of the trouble can't be uncovered immediately. One

easy answer to this problem is a card of the same shape and size as the printed circuit board itself (see photos above).

The card fits over the back of the radio neatly (after the rear cover has been removed, of course). What's more, the various test point holes on the card fall over specific terminals, solder joints and conductors on the printed circuit board. Marked right on the card in three colors (blue for RF, red for IF and green for AF) is the path that the signal takes from the antenna to the speaker.

But that's only the beginning. The card gives the correct voltage that should appear at each test point, shows the proper lead orientation for each transistor and is, in effect, a simplified schematic diagram of the receiver. Special color coding even tells you what kind of signal to feed in at any point on the board (1600 kc for RF, 455 kc for IF and 400 cycles for audio) when you want to do some signal tracing.

How does all this work to help fix a radio? Say we have a transistor portable for which a card is available, and that the radio suffers from low volume. We've checked the batteries and battery contacts, the antenna and various other components for loose connections. We next slip the card over the back of the radio and check the voltages at the various transistor leads through the holes in the card.

If we get an incorrect reading at one



Typical of the many new aides for speedy transistor servicing is General Electric's Silent Partner (at right). It features color-coded cards which can be dropped right over the printed-circuit board in a transistor portable. Once a card has been put in place, finding the defective stage or component in a faulty circuit usually is as quick as 1, 2, 3.



# LOOK IN SERVICING

lead, reference to the Voltage Reading Interpretation Chart furnished with the card will tell us what's probably the cause. It could be a bad transistor or maybe a resistor; replace the part and the radio works again.

Things also are looking up for TV repairs in much the same way. The printed circuits in TV sets are no simpler than those in transistor portables (that's the understatement of the year). But hold on—there's a whole series of colored diagrams for various models of TV chassis (see photos at lower right). They show signal flow in the same fashion that the cards depict signal flow for the little portables.

What you get is a master schematic

diagram, color-coded so you know precisely where you are at any given spot. It also shows proper waveforms and correct voltages and resistances for critical points all through the circuit. Along with this diagram comes other valuable servicing information—including a number of colored charts, outlining the audio and video circuits, the vertical and horizontal sync circuits and so on.

Armed with this battery of data, even a neophyte ought to be able to make a sizable stab at fixing a TV set. But personal portable or TV, it all boils down to the same thing. And that's what we call a new look in servicing.

—Paul Daniels

Figuring out what's where on a TV set's printed-circuit board is a tough, time-consuming chore if the only thing you have to go by is the schematic itself. But schematics and pictorials are keyed on TVD's Colorgrams to make a serviceman's task that much easier. You mightn't guess it, but both diagrams shown here represent the same portion of the circuit.

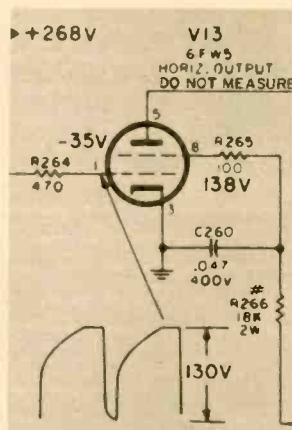
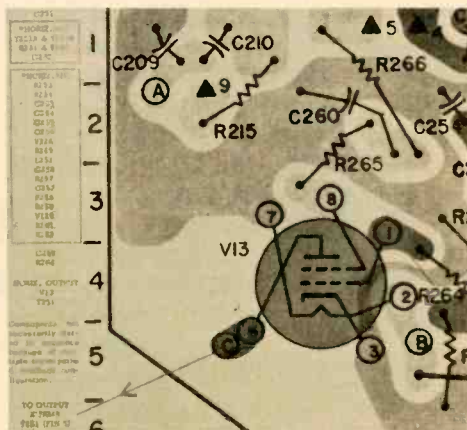

**M**OST anyone who's tried living in an anarchy probably would agree that laws are nice to have around. Radio broadcasters more or less unanimously are sold on laws, too, for the simple reason that the spectrum would be chaos without them. Matter of fact, most broadcasters toe the legal line so closely that logging anything illegal is almost as rare as an unsolicited QSL. But some broadcasters *do* go a little farther afield.

The law—international law, that is, stemming from an organization called the International Telecommunications Union—says that all international SW broadcasting is supposed to take place within the limits of 12 specific bands (our chart lists these bands and shows the frequencies concerned). Yet certain SWBC stations continue to broadcast outside frequency allocations. Doing so just plain ain't cricket, of course. It's also a menace to international communications and in some instances dangerous to public safety. But those offband SW stations sure make for some prize DX.

**First for a look** at the dangerous side. Two prime examples of offband SWBC outlets are R. Chiclayo and R. Huaraz, both in

Peru. Drifting back and forth from 5500 to 5700 kc, the two at various times have lighted on 5559.5, a North Atlantic aeronautical channel. With communications on this route often a ticklish matter and with the present low sunspot count producing world-wide reception on these frequencies, such interference conceivably could cause a disaster at any time.

In a similar vein, utility services often are plagued by offband broadcasters. The Ontario Department of Lands & Forests, for example, legally transmits in the 4500-4600 kc range. But drifting Ecuadorian SWBC outlets quite *illegally* give the Lands & Forests people plenty to worry about. It doesn't happen often but once is enough to spell serious trouble.

Now none of the broadcast stations we've mentioned so far has the slightest interest in long-range coverage. Their unconventional activities are due largely to lax government administration (both Peru and Ecuador belong to that International Telecommunications Union we brought up earlier, but you'd never know it).

Also part of the picture are the stations'

# LOGGING

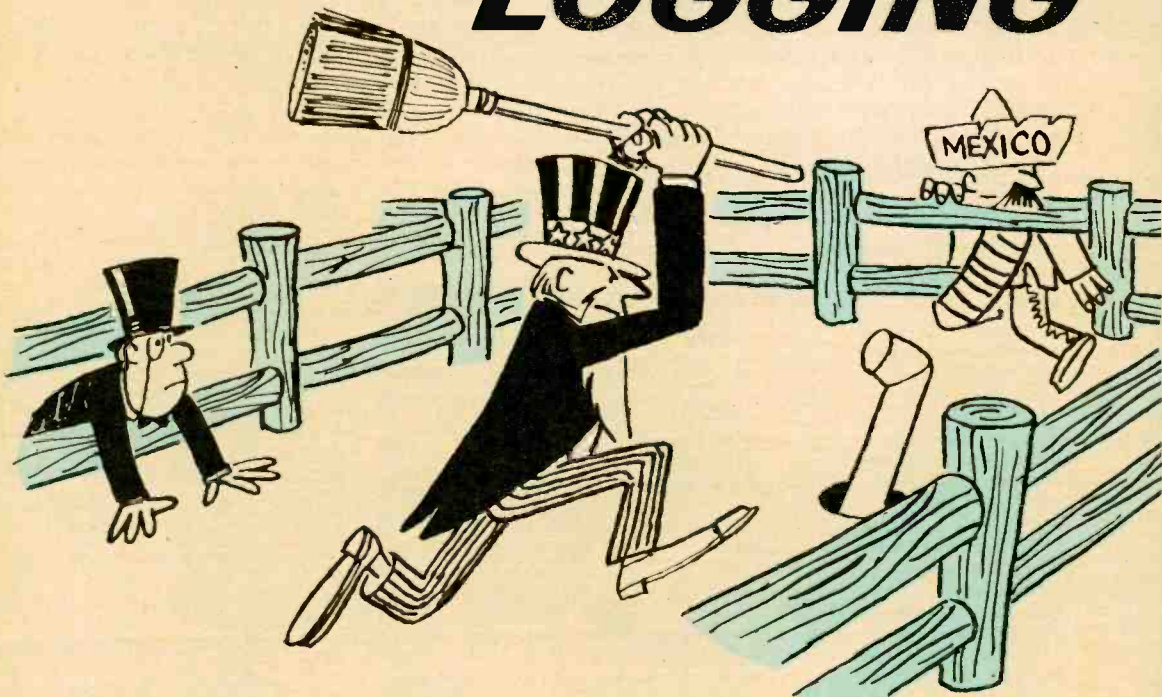



own sloppy technical standards. Transmitter frequencies obviously are not crystal-controlled. And in many instances stations are allowed to use any channel they choose, since getting their own message across seems far more important than adhering to any mere international agreement.

In another category, we have small nations or small broadcasters which must obtain international coverage with a minimum number of transmitters. And, for this set, it clearly is tempting to move off the QRM-ridden SWBC bands.

As a case in point, consider R. Caribe (now R. Santo Domingo). When this station first came on the air, it used 9485 kc which, believe it or not, happens to be a telephone channel for the neighboring Radio Corporation of Puerto Rico. Another offbander is Kol Israel on 9009 kc, a Royal Canadian Air Force frequency. Others in this same pasture are R. South Africa and R. Nacional España, both of which can be found on unorthodox frequencies.

Reason such examples abound is because little pressure is brought against them. Fact is, some major broadcasting organizations

have been known to pull similar tricks. The Communists, for example, frequently use off-band channels, and it seemingly makes no difference whether the broadcaster is Moscow, Peking, Budapest or Prague.

Even that much-respected giant among broadcasters, the British Broadcasting Corporation, has been known to revert to offband tactics. One of the BBC's favorite frequencies is 9410, which happens to fall within a few kilocycles of the AT&T station at White Plains, N.Y. True, the British beam this particular transmitter to Africa, but it nonetheless puts a strong signal into North America.

Another BBC channel is 12040 kc, beamed to South America and smack in the middle of what is supposed to be busy radioteletype territory. Still another offbander is All India R. on 9870 kc—a U.S. military channel. Question is, so long as the BBC and AIR do it, how can we expect small fry like R. Huaraz to stop?

Getting down to the meat of the matter, this whole business of offband SWBC stations really shows several sides. Fixed circuits of international telephone variety are

*[Continued on page 119]*

# **ILLEGAL DX**

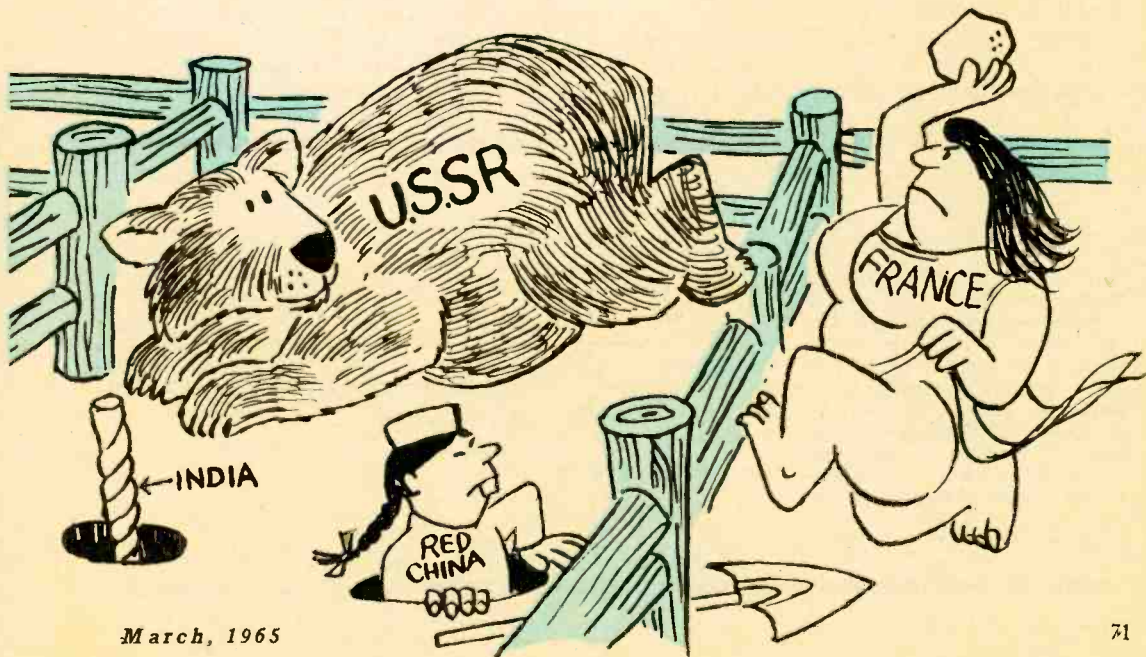

March, 1965

71



By Tim Cartwright

# GOOD READING

**THE ENCYCLOPEDIA OF HIGH FIDELITY.** Six volumes. Edited by John Borwick. Focal Press, New York and London. \$9.50 per volume, \$49 the set

One could talk about this unique British encyclopedia in a general sort of way, of course, but we've chosen another approach. Most readers probably will be more interested in one or two volumes rather than the whole premium-priced set, so it makes more sense to cover each of the six entries individually. Here we go, then, on the chance that you may find one or more of them up your particular alley.

## ACOUSTICS. By G.W. Mackenzie

The subject being what it is, you might expect this volume to be the most textbookish and technical of the lot. But it isn't. Instead, it poses a readable and thoroughly practical explanation of the nature of sound and its reproduction. Theoretical principles are there all right, as are such important matters as recording-studio practices and miking techniques. In short, this definitely is a volume worth dipping into.

## DISC RECORDING AND REPRODUCTION. By P.J. Guy

There's a good deal of solid and interesting information in this volume but a lot of frustrating omissions as well. The slighting of

stereo is one real shortcoming. So, too, is a lack of recognition of what's been happening on this side of the Atlantic for the past few years.

Both flaws join, for instance, in providing not even a few-word description of the moving-magnet stereo pickup, the overwhelming favorite on these shores. Similarly, nothing is said about rumble and acoustic feedback in stereo record-playing, nothing about such lately-interesting subjects as vertical cutting and playback angles.

Give this volume an A for effort and an F for frustration.

## TAPE RECORDING AND REPRODUCTION. By A.A. McWilliams

There's no complaint about the lack of specific stereo coverage here. And the fact that there is little material aimed at the home recordist doesn't detract much, either. Matter of fact, the amount of information here that you almost can't find elsewhere makes the few omissions seem trivial in comparison. This one certainly is worth looking over.

## RADIO RECEIPTION. By H. Henderson

Here, again, we have the problem of slighted stereo (a final chapter on multiplexing is all we get). And here, too, is obvious confusion about who the potential reader

[Continued on page 109]

Ears are the thing in hi-fi, and they range from tin to golden. But precisely what takes place in the human hearing system remains a subject for experts. And even they don't know for sure, since the process is curiously complex. Our illustration, taken from the book on acoustics discussed above, shows a much simplified diagram of the human ear.

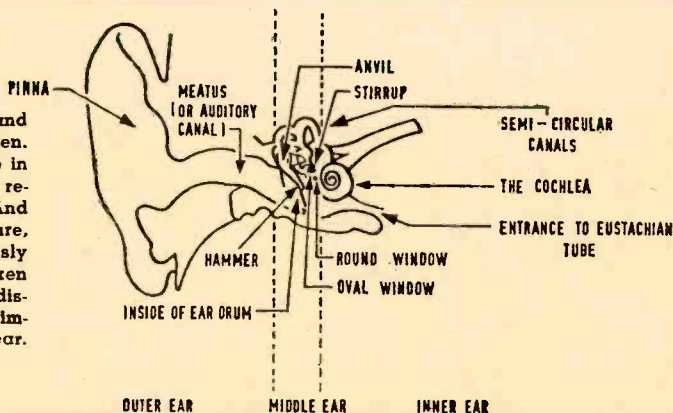



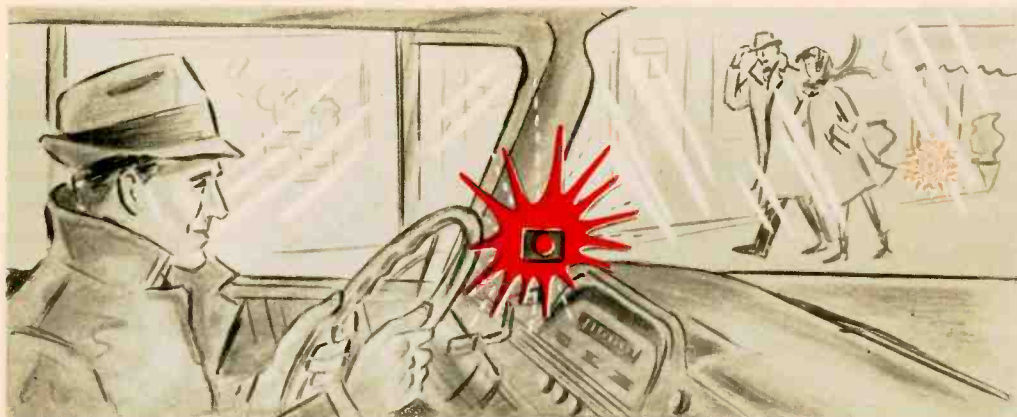

# DRIVER'S ICE ALARM

*This low-cost ounce of prevention tells you when the road is dangerous.*

By STEVEN E. SUMMER

**T**HE late-afternoon winter sun is bright, the road is clean and inside the car you are warm and comfortable. You can see there's no snow on the road but what you don't realize is that some snow has been melting, and the water flowing onto the road is starting to freeze. Run into one of these patches of ice and you may be in for a bad skidding accident—or worse.

But with our Ice Alarm in your car you'll be forewarned of dangerous road conditions. When the air temperature falls to 36° F., the Alarm's warning light starts flashing. At 32° the light stays on.

Because it is difficult to measure the temperature of the road directly, the Alarm measures the temperature of the air just

above the surface. And approximately 2 feet above the road the temperature could be as much as 4° higher when the air is windy and humid. On a wet road, on which ice won't form until the temperature drops below 32° (with the air dry and calm, ice may form when air temperature is as high as 36°), the Alarm will start flashing. When the alarm light is on constantly, road conditions are becoming pretty bad, though you ordinarily might not realize it from inside the car. This inability to judge road conditions from several feet away causes hundreds of accidents each year. The Ice Alarm solves the problem by doing the judging for you.

Basically an electronic thermostat, the Alarm uses a transistor (mounted on the

The near photo shows how Alarm's probe is installed in car's grille. Be sure wire going back to unit in car doesn't come in contact with hot parts of engine. Photo far right shows installation of warning lamp under dash. Alarm box should not be mounted on firewall as heat may affect performance.

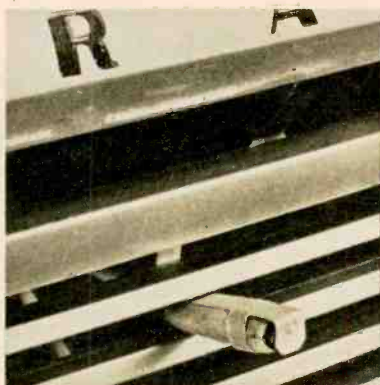

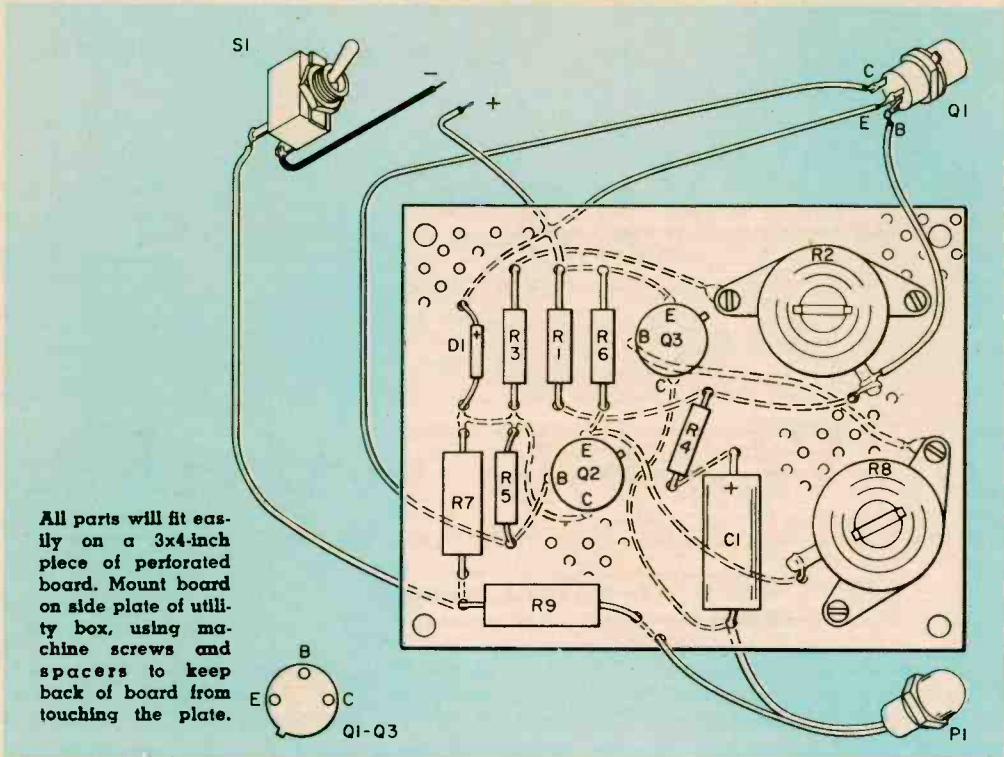

## DRIVER'S ICE ALARM

grille in the front of the car) as a temperature sensor. Response is fast and the Alarm can be calibrated easily and accurately.

**Construction.** Mount all parts except D1 on a 3x4-inch piece of perforated board as shown in the pictorial. (Wiring on the back of the board is shown with dotted lines.) Mount the two transistor sockets on the board by pushing their pins through the holes and bending them flat on the back of the board. Connect all other parts, using spaghetti on bare leads. Now install D1, using a heat sink on its leads and a low-temperature iron. Be sure D1's polarity is correct.

The perforated board will fit in a 4x4x2-inch aluminum utility box. After the case has been drilled, insert grommets in the cable holes, mount switch S1 and a six-lug terminal strip. Mount the board on one of the case's side plates with machine screws and spacers.

Make a bracket for pilot lamp P1 from a piece of 1x3-inch scrap aluminum. Drill mounting holes in the bracket so it can be mounted under the dash or near the windshield. Solder a transistor socket on the end

of the three-conductor probe cable, making sure the emitter, base and collector connections are correct.

Don't try parts substitutions. However, if your car has a 6-volt electrical system, use the alternates specified in the Parts List for D1, R7 and R9.

**Calibration.** Fill two glasses with water

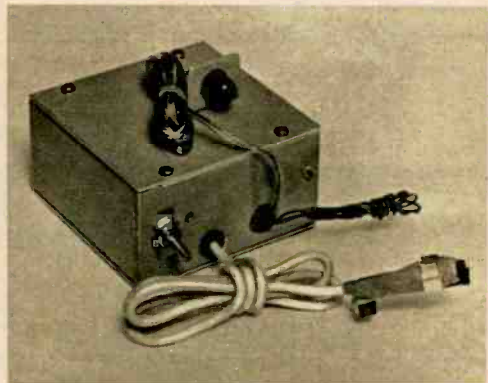

Completed Ice Alarm ready for installation. Note how the probe is constructed and that only its tip is exposed. Shield should be 1/8-in. away from tip.



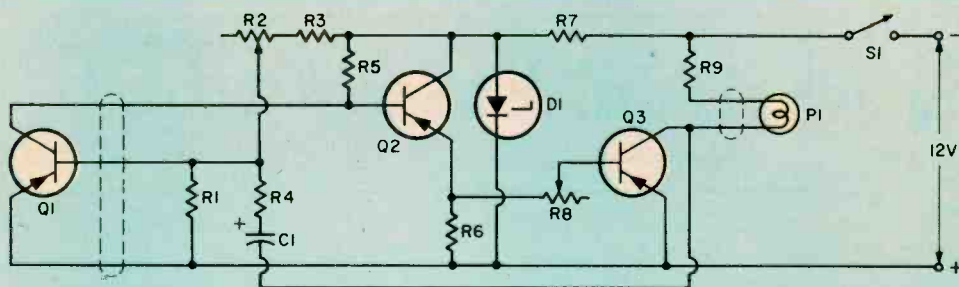

Q1's collector current changes with temperature. Current change is coupled by Q2 to Q3 to change its bias. At 36°, Q3 is forward-biased so it conducts. P1 flashes because positive feedback (R4, C1) causes oscillation. At 32° oscillation stops and P1 stays on. Zener diode D1 provides voltage regulation. R2 and R8 compensate for transistor differences and are used to calibrate the unit.

#### PARTS LIST

- |   |   |   |
|---|---|---|
| C1—20 mf, 12 V electrolytic capacitor                                 | R4—6,800 ohm, ½ watt resistor   | R9—150 ohm, 1 watt, 10% resistor (12 V); 27 ohm, ½ watt 10% (6 V)   |
| D1—1N753 zener diode (12 V) or 1N1520A (6 V)                          | R5—15,000 ohm, ½ watt resistor  | S1—SPST switch  |
| P1—Pilot lamp; 6 V, 40 ma (GE No. 345)                                | R6—1,000 ohm, ½ watt resistor   | Misc.—4x4x2-inch aluminum utility box (Premier AC-442), Insul-X rubber tool dip, 3-conductor cable, pilot lamp holder (Dialco 101-5030-971), perforated phenolic board, terminal strips |
| Q1-Q3—2N508 transistor  | R7—200 ohm, 1 watt, 5% resistor (12 V); 15 ohm, 1 watt 5% (6 V)             |   |
| R1—10 ohm, ½ watt resistor  | R8—1,500 ohm, 2 watt, wire-wound flange mount potentiometer (Clarostat U39) |   |
| R2—250 ohm, 2 watt, wire-wound flange mount rheostat (Mallory FL-250) |   |   |
| R3—220 ohm, ½ watt resistor   |   |   |

and ice cubes. Put one glass of water in the refrigerator and let the ice in the other glass melt. Wait another minute or two and the water temperature should be approximately 36°. (A thermometer can be used to check temperature but high accuracy is not required here.) Now dip the top of Q1's case into the glass of ice water that has been kept in the

refrigerator (32°) and wait a second. Adjust R2 until P1 lights constantly but is just on the verge of flashing. Next, put the top of Q1 into the other glass of water (36°) in which the ice has melted. Wait a few moments and adjust R8 so P1 goes out but still is on the verge of flashing.

Repeat this process two or three times until the settings remain the same. Better results may be obtained by switching the transistors around. Determine (with a transistor tester that measures DC beta) which transistor has the highest beta and use it for Q2. Use the other transistor for Q3. Don't switch transistors again or calibration will change.

After calibration, put several coats of a rubber tool-insulation compound, such as Insul-X, on Q1 and its socket to waterproof and shockproof the probe. When the compound has dried, cut away some rubber from the tip to expose just the top of Q1. If you don't do this, the Alarm will not respond to temperature changes quickly. The metal shield in front of the probe protects Q1 from the direct force of the wind, which could affect accuracy. Mount the alarm's case under the dash and connect the power cable.

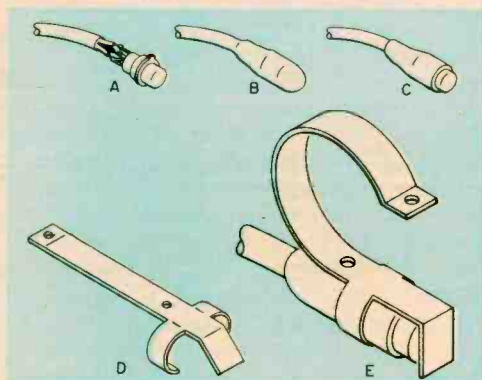

Coat all of bare probe (A) with the insulating compound, as in B, then remove compound from tip (C). Construction of probe shield is shown in D and E.

# Notes from EI's DX CLUB

WE suspect our ham readers are cursing the BBC these days. True, the Commies have been beaming SWBC transmissions (and we mean *beaming*) into NA on 40 meters for years. And, ITU treaty or no, there doesn't seem much anyone can do about it.

But now the British Broadcasting Corporation not only is pulling the same trick on 40 meters (7130 kc at 1800-2230 EST), but on 75 as well (3952.5 kc at 1900-2145). They would appear to be doing so without violating that treaty since they list their target as the "Atlantic Islands." Nuts.

Jim Howard has moved from Kansas City to Cleveland for the season, bringing reports of his (and our) favorite mystery station right along with him. This one sends the letter L almost continuously in Morse, occasionally tossing in short cryptographic messages. First heard on 6047, the weirdie now appears on 9520 kc from time to time. We once queried the FCC on the station. They know it exists, all right, but that's all the Commission would tell us.

La Voix de Laos has appeared suddenly with a potent signal on 7340 kc, where it first was noted by California EIDXer H. L. Chadbourne at 0715 EST sign-off. Just one catch—we don't know yet whether this is the real Laotian-government station or a Chinese Communist ringer.

Our ace Maryland member, Hank Holbrook, is back in the news again and he gets better all the time. In his latest venture he got Peking to verify reception of its regional broadcast station at Chekiang, China, on 2475 kc. That's 120 meters.

Dave Bennett (British Columbia) has bagged the U.S. Navy's station NME on Eniwetok atoll (Marshall Islands). West Coast DXers should watch for this one around 4930 kc.

One call which made our ham members flip is YF1HUKE, heard around the upper edge of 20 meters. This sounds like an Indonesian (or Martian) but probably is a pirate.

R. Hong Kong has been getting into the West Coast around 0545 PST on 3940 kc when the ham QRM seems to drop off. Remember that this country and Brunei are the only two British territories in SE Asia that *didn't* join the Malaysian Federation.

Trans World R., Bonaire, Netherlands Antilles, must have set some sort of record in the number of reports it received during its initial tests on the SW bands. Frequencies now include 5955, 6170, 9600, 9705, 9755, 11855, 15240 and 15295 kc. Even BCB DXers weren't forgotten, since there's also a powerful (500 kw) transmitter on 800 kc.

The New Guinea territorial government is planning two new broadcast stations for 120 meters. They'll be VL9BR (2340 kc) at Rabaul and VL9CG (2410) at Gereka, so keep both ears open.

R. Equatorial (4926 kc), Bata, Spanish Guinea, is being received as far west as the Mississippi River. Sign-off weekdays is between 1700 and 1715, but this piece of true DX is around til 1800 on Saturdays.

Propagation: The record-breaking BCB DX of the past several months should begin to taper off with the arrival of spring. However, just as the number of medium-wave stations that can be logged will drop off noticeably, FM- and TV-DX will pick up toward the end of the period because of a seasonal increase in sporadic-E activity.

Of the various SWBC bands, 15, 17 and 21 mc all will be usable throughout the daylight hours. Both 9 and 11 mc should start coming through in the late afternoon. And, in the evening and nighttime. 6, 7 and 9 mc will be best for DX.





**An endless loop of taped CQ's is an easy way to keep a fresh fist.**

By HERB FRIEDMAN, W2ZLF

**L**ISTENING to a pile-up of stations answering a *short CQ* is one of the greatest satisfactions a ham can get. On the other hand, the surest way to have the wind taken out of your sails is to pound out CQ's for hours before even one reply comes back. Unfortunately, there are too many of those days when your wrist gets so tired from CQing that it hardly lasts through one contact.

All this will be a thing of the past when you use our CQ Sender to do the CQing. You just sit back and relax while your tape recorder sends an automatic CQ—time after time if necessary.

The Sender is a device which enables a pre-recorded tape to key the transmitter. You record a CQ on a tape loop once. Then, when the tape is played, it keys the transmitter automatically.

The Sender consists of two units: a code-practice oscillator, which is used to record the tape, and a keyer. The CPO is like most any other unit of its type, except it has an audio-output jack. This is used to feed the mike input of a tape recorder. (If you have a CPO, just connect a jack to its speaker leads

and you can dispense with our CPO.)

The keyer, which is connected to the recorder's speaker-output jack, contains a relay (and a few other parts) that is controlled by the recorder's output signal. A transformer in the keyer steps up the recorder's output voltage to operate relay RY1. Every time the recorder plays a tone burst, RY1 closes and the transmitter is keyed, just as if you'd pressed a conventional telegraph key. Insensitive to RF pickup, the keyer can be placed behind the transmitter and located several feet from the tape recorder.

#### Construction

The CPO can be built in the main section of a 3x4x5-inch Minibox. Parts layout isn't critical but component values are—particularly Q1 and T1. The CPO may not work if a substitution is made for Q1 and T1. Jack J1 should mate with your present key plug and J2 should match the tape recorder's patch-cord plug.

The CPO's frequency is about 400 cps. By changing the value of C1 (and only C1) the pitch can be raised or lowered.

Don't worry about layout. It isn't critical and any you choose will work. Do not try substitutions for T1 or Q1 since CPO was designed around these parts. It will be a lot easier if you mount C1, R1, R2 and Q1 on the terminal strip before putting the terminal strip in the cabinet. And go easy on the heat when soldering Q1. Though it is not apparent in the pictorial, the cabinet serves as the ground return for J1, J2 and the center (ground) lug on the terminal strip.

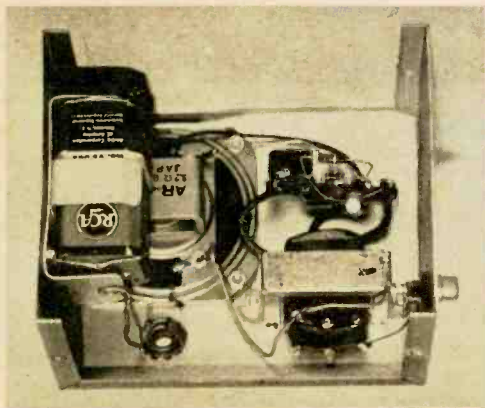
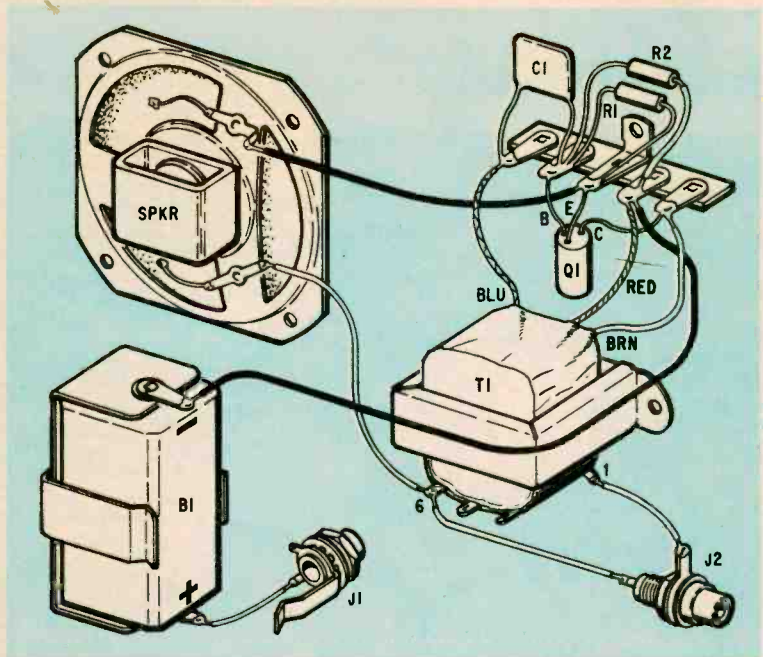

**PARTS LIST**

- B1—6-volt battery (Burgess Z4 or equiv.)
- C1—.2 mf, 75 V (or higher) capacitor
- J1—Phone jack
- J2:J5—Phono jack (see text)
- Q1—2N217 transistor
- R1—4,700 ohm, 1/2 watt resistor
- R2—27,000 ohm, 1/2 watt resistor
- RY1—SPDT relay, 2,500-ohm coil. (Potter and Brumfield GB5D or equiv.)
- SPKR—2 1/4 inch, 3.2-ohm speaker
- SR1,SR2—Silicon diode: minimum ratings; 100 PIV, 50 ma
- T1,T2—Universal output transformer (Lafayette 33 G 7505)
- Misc.—2 1/4 x 2 1/4 x 5-inch and 3 x 4 x 5-inch Mini-boxes, terminal strips, battery holder

Schematic of the CPO. Oscillator's frequency is approximately 400 cps, but it can be lowered or raised by changing the value of C1. Increasing the capacitance of C1 lowers the pitch. Use a smaller-value capacitor for C1 and the pitch will rise.

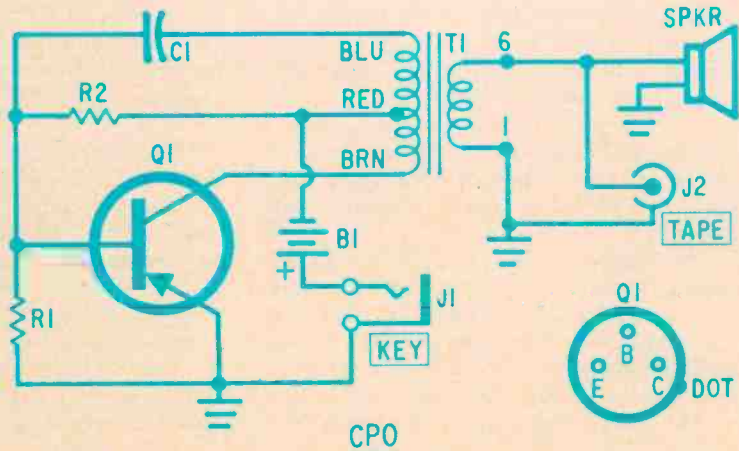



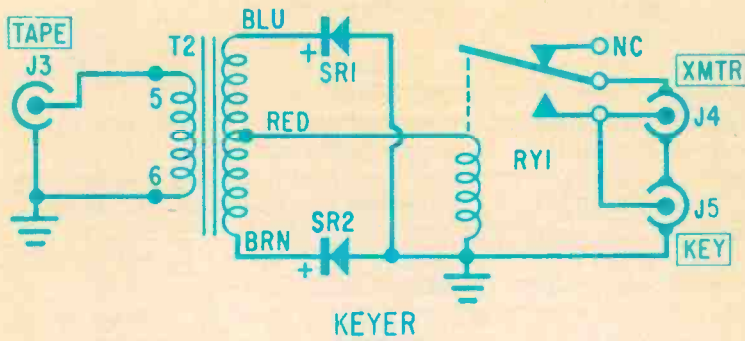

Schematic of keyer. Signal from recorder is stepped up by T2 and rectified by SR1, SR2. DC energizes relay RY1, causing its contacts to close and key transmitter. Your key, plugged into J5, will key the transmitter instantly.

## CQ de Tape

Do not try to increase the speaker's output level. Component values have been selected so the output level at J2 is approximately that of a microphone. The speaker level is about equal to normal receiver output level.

The keyer is built in the main section of a 2¼x2¼x5-inch Minibox. Do not substitute for T2 and RY1. Diodes SR1 and SR2 can be any silicon diode rated at 100 PIV or higher. Jack J4 connects RY1's contacts to your transmitter's key jack. Jack J5, which is connected in parallel with RY1's contacts, becomes your new key jack.

### Using the Sender

First thing to do is make a tape loop of CQ's. To determine how much tape is required you'll need to know the time it takes to send a complete CQ. (CQ CQ CQ de—then your call three times). For example, if it takes 20 seconds and you can record at a speed of 1½ inches per second, you'll need 37½ inches of tape (20 seconds multiplied by 1.875). A tape speed of 3¾ ips will require 75 inches of tape. To be on the safe

side, add another inch or two. Splice the ends of the tape together and you're ready to record.

Connect your key to J1 and connect the CPO's output at J2 to the recorder's mike input. Hold the key down and adjust the recorder's level control until the recording level indicator shows normal. Start the recorder and send a complete CQ in the same time (or less) you first clocked yourself at. When the master tape is completed, disconnect the CPO.

Connect the keyer input jack (J3) to the recorder's speaker output and connect J4 temporarily to the CPO key jack (J1). Play the tape and adjust the recorder's playback level control so RY1 follows the code accurately. You will hear the keying from the CPO and will know when the level is correct. Note the correct output level setting and disconnect the CPO.

Connect J4 to the transmitter's key jack and plug your key into J5. When the tape is played the transmitter will be keyed. Whenever you feel enough CQ's have been sent, just stop the tape and hit the already-connected key to add the K (go ahead). It isn't necessary to disconnect the recorder—it's always ready for instant use.



To record CQ on a tape, use the setup above. To use tape to send CQ, use the setup shown below.

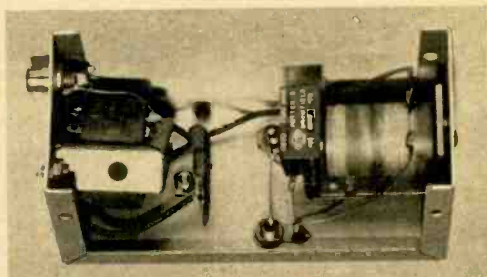
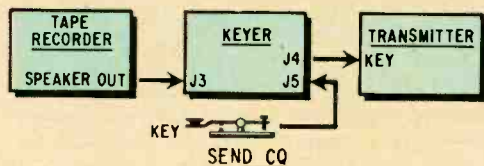

All of the components in the keyer will fit easily in the main section of a 2¼x2¼x5-inch Minibox.

By **KEN GILMORE**. One day a few years ago a young rock-'n'-roll recording star named Johnny Sardo made a guest appearance on TV. Idiot-box watchers across the nation saw Johnny step into the limelight and, for all they knew, start to sing. Only something went wrong. The words coming out didn't match the movement of Johnny's lips.

Such goofs are rare on TV. But lip sync—make-believe singing while a record produces the actual sound—isn't. Fact is, many rock-'n'-roll record idols never sing on television, radio or in person. When called on to perform, they play their records and do a lip-sync act for cameras or audience, just as Johnny hoped to do in this instance.

know him. And they throw in enough gurgles, chuckles and oinks to delight the ears of any scream-ager.

Does our would-be vocalist have an unpleasant nasal twang? Filter it out. Weak on the low end? Beef it up. Thin and flat? Add echo. Switch in a gadget called a Pultec to accentuate or diminish bass, treble or mid-range. Call on a Graphic—another control—to exaggerate or attenuate a specific frequency and thus clear up mistakes nature may have made in creating the voice. Disguise the voice completely. Create a new sound, a selling sound that didn't exist before.

Record the song over and over again. If he can't sing it all the way through, record



# GURGLE CHUCKLE OINK

The reason is simply that many voices on records nowadays don't exist in real life. They are manufactured products, skillfully fabricated in a recording studio. The basic ingredients are a little singing and a lot of electronic manipulation.

Sitting before an array of dials, knobs, controls and meters as complex as those in a DC-8 cockpit, the recording industry's professional voicemakers go to work. They shape and alter the basic sounds squeezed from a singer until even his own mother wouldn't

it in bits and pieces—a bar here, a phrase there. Is his pitch shaky? His rhythm weak? Somewhere on the tape he got this note right, that rhythm on the beat. Find the good pieces, snip them out, splice them together. The result may not be music, but it sends adrenalin pulsing through the teen-age bloodstream. And it sells records.

Even the orchestra on modern-day records isn't what it seems. Listen to a stereo disc and you'll hear strings on the left, brasses on the right, singer out front. But look in on



the creation of a new record and you're in for a surprise.

Typical session might take place in a gymnasium-size recording studio in mid-Manhattan. Sitting around the room are a half dozen small groups of musicians—a couple of trumpets in the far corner, a drummer in another corner partially hidden by a screen, a guitar in the near center of the room and small clumps of saxophones, strings and trombones scattered here and there.

Bundles of cables snake across the floor to the microphones placed in front of each group. On one side of the studio sits a closet-size box with a glass window. Inside the box

studio has nothing to do with where they appear on the record.

When the session is over each track is changed, manipulated, altered. A big echo on the right track makes three trumpets sound like ten. And jacked-up bass gives a beat solid enough to wobble a brick wall.

Though the gimmicked disc reached its present high state of development only a few years ago, the foundations were laid back in the 1930's. When London's famed Ambrose Orchestra rented a huge, empty ballroom for a recording session, it got more than it had bargained for. But the boomy sound on the discs it made wowed the customers. (Any bathroom baritone knows the principle.)



# YEAH! YEAH! YEAH!

is the vocalist with his own microphone. Sure, he may bleat like a lamb in real life. But the voicemakers with their million-dollar manipulation machinery can make him roar like a lion on the disc.

As large reels turn silently on three-track tape recorders, the singer's voice is recorded on the center track. The signal from the strings is piped to the left track, the brassy to the right. Other instruments are distributed according to plans made before the session began. Their actual position in the

A short time later, Columbia Records discovered Liederkrantz Hall, a cavernous studio in New York. Benny Goodman loved the big sound his band made there and Andre Kostelanetz gleefully noted that ten fiddles sounded like 20.

In 1937 it suddenly dawned on recording engineers that you don't have to have a studio as echoey as a locker room to get an echo on the disc. Horace Heidt, recording a snappy number called Little Sir Echo, put a singer in a men's room and gave him a pair of head-

phones and a mike. When he sang, his voice had the same kind of sound that makes any man into a Caruso in the shower.

This gave recording experts an idea. They put a loudspeaker on one side of the men's room, a microphone on the other. As a record was being made, they piped the sound into the men's room. The booming echo that resulted was picked up by the microphone, then piped back to the recording machine, where it was mixed with the regular signal.

From that time on, most popular records have been made with generous doses of echo. Fortunately, most companies have regular echo chambers now and no longer use the men's room. But it remained for a guitarist named Les Paul to teach the world a few more recording tricks.

When the first tape recorders appeared in the 1940's, Paul was fascinated. He bought one and started experimenting. One of his early innovations was an extra playback head attached to the machine an inch or so behind the recording head. During the recording he piped some of the signal being picked up by the extra playback head into the recording channel. The result was a sort of shimmering sound—as though the music were coming from underwater. But tape reverb, as it came to be known, was just the beginning.

Paul also began overdubbing. He'd record one guitar part, then play it back and simultaneously use it to record a second part on another tape machine. Back and forth the recording would go from one machine to another, with Paul adding a new guitar part each time. A few passes and he sounded like a

## **GURGLE CHUCKLE OINK YEAH! YEAH! YEAH!**

roomful of guitars. Then he did the same thing with his wife's voice and parlayed one voice and one guitar into a hall full of instruments and a female chorus.

Elvis Presley gave the manipulated sound its next big boost. Though the voice was Presley's all right, his use of tape reverb gave his discs a vibrant, frantic effect. By this time all stops were out. Record buyers were glomming frantically onto new sounds. And the record companies were scratching just as frantically to supply them. Voices created in the studio leaped into the top ten. New sounds, no matter how unmusical, soared into stardom.

The Chipmunk records, made by overdubbing the words of a songwriter named Ross Bagdasarian at twice the normal speed, sold by the tens of millions. A disc called *Beep, Beep*, a purported race between a Cadillac and a Rambler, poured forth horn sounds that sent many a younger music lover (?) into ecstasy. One of the biggest hits was an Australian classic called *Tie Me Kangaroo Down, Sport*. Its popularity, explained disc jockey Scott Muni of New York's WABC, was due to "something on the record that sounds like a bathroom plunger."

Today, record companies have become expert alchemists, adroit at turning tin-throated sparrows into golden-tongued nightingales. With millions of dollars worth of complex electronic equipment and legions of engineers who can play the knobs and dials as they would an organ, they create sounds at will.

Since the sound that eventually appears on the disc frequently resembles nothing in real life, the vocal equipment which nature gave the prospective star couldn't be less important. If the voice makers think they've got someone with star quality (translation: he'll look sexy to teen-age girls), they couldn't care less if his music-making ability is roughly comparable to that of a rusty hinge.

Go back to a fall evening a few years ago. George Avakian, who produces pop records for Warner Brothers, was watching 77 Sunset Strip. Kookie Byrnes, one of the program's regulars, came on.

"I was struck by a sudden inspiration," recalls Avakian. "He should make rock-'n'-roll records. I was sure that kids would like [Continued on page 109]"



# THE HAM SHACK

BY ROBERT HERTZBERG W2DJJ

**T**ECH TICKETS . . . Seems we stirred up a hornet's nest with a recent comment in this column about the uselessness of the Technician license — uselessness in our opinion, that is. Many Techs took our views as a personal insult. Others admitted that for a mere 8 more words per minute they

could be Generals—with the same call letters and with unlimited instead of severely restricted operating rights.

A few even went so far as to say that they know of Techs who actually use some of the General bands. To do so is illegal, of course, but it isn't much of a trick. After all, distinguishing Tech calls from General calls is plain impossible under the present setup.

"I suppose you'll be attacking Novices next," postcards one Tech. Not at all. The Novice ticket serves a very useful purpose and its holders have distinctive calls. What many hams seem to overlook is that the Novice license runs only one year, cannot be renewed and cannot be obtained for a second time at some later date.

**Tempus Fugits . . .** From the looks of the Quarter Century Wireless Association's roster, you might argue that hams are getting older and remaining in the game longer. Open only to hams who have held tickets without

a break for 25 years or more, the QCWA now has a membership of more than 4,000. And that's not all: 76 of these OM's (literally) have been licensed for a full 50 years!

On second thought, maybe that *old* terminology isn't as literal as it seems. Most of the fellows remain almost as young and full of pep as they were back in 1912. One, incidentally, even sports a call that's mighty close to home—W2DJ. Not W2DJJ . . . W2DJ. Don't know the gentleman concerned, but it's a safe bet that there's a difference of a few years between us!

**Ham Stamp . . .** Exchanging QSL's with stations round the world has given many hams the secondary hobby of philately. And anyone with an eye for stamps will be glad to learn of a new one soon to roll from the presses. A commemorative stamp honoring the first half-century of ham licensing, it should be available by the time this issue of EI appears.

**Commerce Crazy . . .** Sometimes a ham here and there slips up and plain forgets our reason for being. Fact is, our hobby is *amateur* radio and we're dedicated to public service—like saving lives during emergencies and phone-patching an overseas GI to his wife back home.

But one thing we're *not* in is the commercial communications business. Just the same, 20 meters saw two flagrant abuses of our operating privileges just the other day.

[Continued on page 114]



A shack's a shack in anyone's language, but here's a custom console that's sleek enough to be at home most anywhere in the house. Our guess is that the op at the controls wishes this setup belonged to him, though we'd also wager that George Baily, W2KH, and former president of the ARRL, has a pretty good rig of his own. Called the Nova-K, the console is distributed by Harrison Radio of New York City.

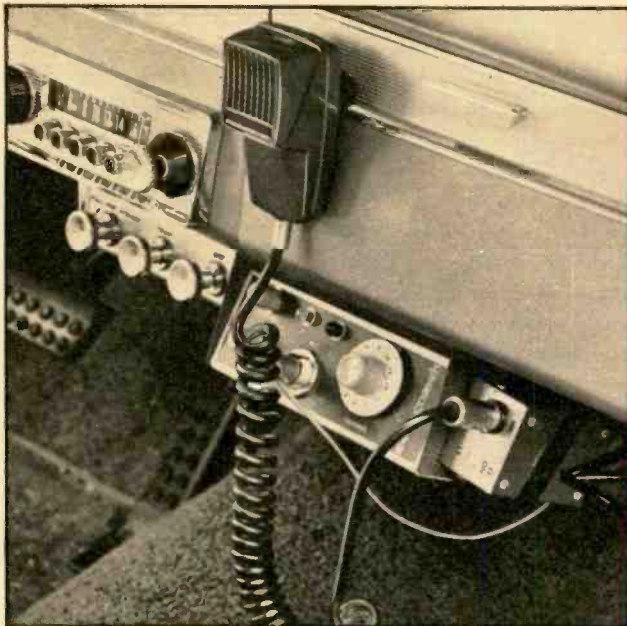

# CB MINI CLIPPER

By HERB FRIEDMAN, KBI9457

*It's small in size and small in cost but it does big things for your range.*

**N**OT much larger than a pack of cigarettes, easy to install as a new crystal, almost certain to save you up to \$200, yet the gadget costs only about \$10. What is it? EI's CB Mini-Clipper, an all-transistor miniature clipper.

How can the Mini-C put all this dough in your wallet? Simple. Big thing in *expensive* CB transceivers these days is some sort of modulation booster which extends transmitting range. But plug the Mini-C into your budget transceiver, plug your mike in the Mini-C and your signal will be right up there with those from \$200-to-\$300 rigs. You can forget about spending all that money for a new transceiver and you'll never be drowned out by a channel hog again.

The Mini-C is connected between your mike and transceiver, as we indicated. It contains its own battery; therefore, power connections or modifications to the transceiver are not required. Since the current drain is low, the battery will last about six months in normal service. The unit is palm-size and can be tucked conveniently behind the transceiver. Or you can attach a small magnet to the Mini-C's case and hang it on the side of the transceiver.

The Mini-C's clipping level is automatic. That is, it's always able to produce maximum

clipping. There is no possibility of too little or too much clipping.

### How it Works

The mike gain of CB rigs is preset for a normal or average voice level. This means that only a *loud*, or above average, voice level (peak) will produce 100 per cent modulation. If your voice has only an occasional peak, the *average* modulation level could be down around 10 per cent—and that doesn't give you much of a signal.

With this sort of down-in-the-basement modulation you'll end up getting mighty sad reports from contacts since their ears respond to average modulation and not the peaks.

For a modulating signal to be called excellent, its amplitude must remain constant, no matter what the level of your voice. How is a signal like this produced? By clipping the peaks, both high and low speech levels will effectively end up being almost equal in amplitude. Add a little gain to this evened-off modulating signal and you'll be able to produce uniformly high modulation whether you shout or whisper.

The effect at the receiving end is a solid wall of sound that seems to be coming from a transmitter of much higher power.

Though the Mini-C is transistorized it has



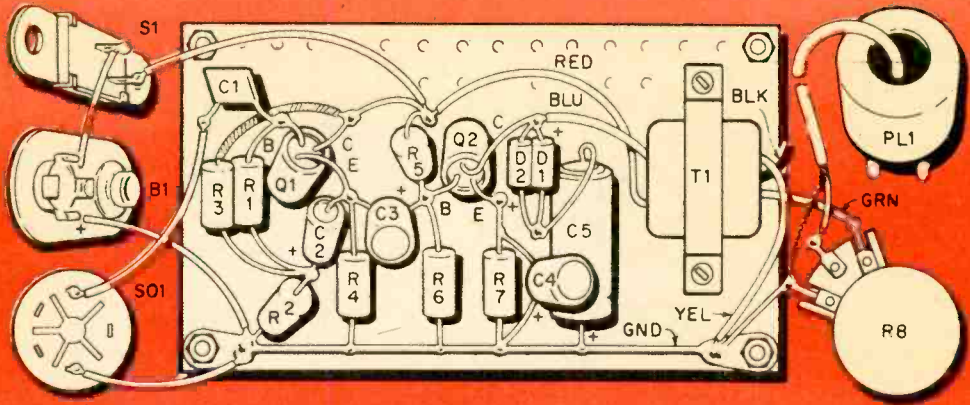

Follow this pictorial carefully and you won't have trouble in squeezing all the parts on the board. Transistors are shown upside down so you can identify leads. Ground buss at bottom must make contact with cabinet through mounting screw.

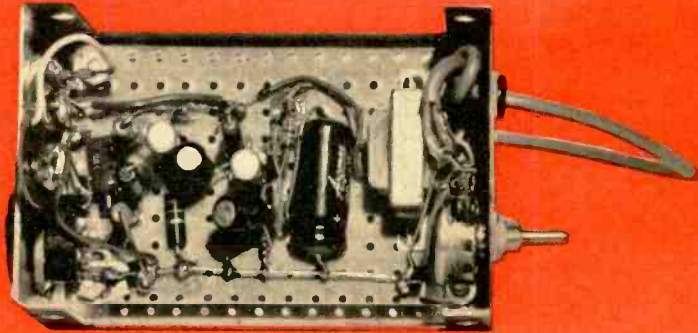

Mount level control R8 (right), input socket SO1 and switch S1 (left) in cabinet before installing parts on board. Then determine where to mount the transformer and all other parts so that the completely wired board can be installed easily in the cabinet.

an input impedance of nearly 2 megohms, which means any crystal or ceramic mike can be plugged in. It won't change the mike's frequency characteristics.

To avoid the problem of a high noise level caused by the added preamplification, the Mini-C uses low-noise transistors. You won't hear a roaring background hiss.

### Construction

Our Mini-C is built on a 2x3-inch piece of perforated board which is mounted in the main section of a 3¼x2½x1½-inch mini-box. Space is at a premium so we suggest you use a slightly larger cabinet if you don't have experience at construction in cramped quarters. Since space is limited, lay out the cabinet-mounted components with the board

mounted temporarily in position. Use as much of the board as possible, taking care that components don't prevent the cabinet cover from being slipped into place.

Special precautions are not required when wiring the board. Follow our pictorial and, as we indicate, mount the components shown standing on end in just that way or you'll run out of space before the board is wired. Flea clips are used for tie points.

T1's mounting holes are small and the transformer frame will be damaged easily if you attempt to enlarge them. Mount T1 with #2 or #3 machine screws.

The leads on Q1, Q2, C1, D1 and D2 must be short so make certain you use a heat sink, such as an alligator clip, on each lead when soldering it. Transistors Q1 and Q2 are spe-

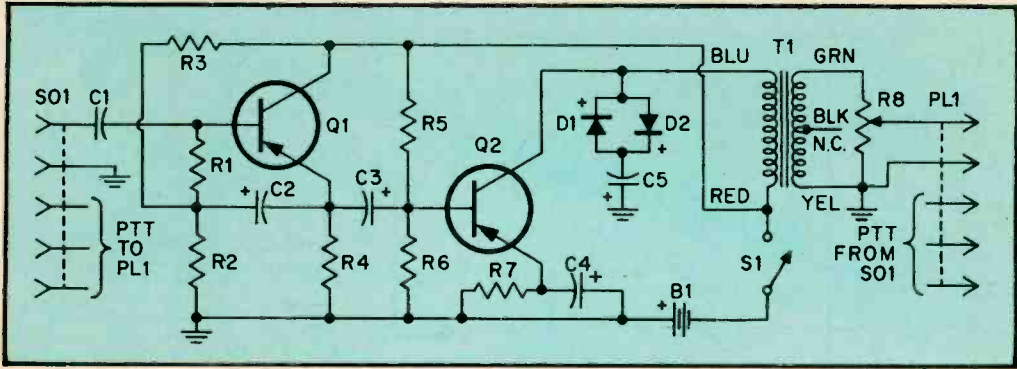

Because transistor Q1 is a bootstrapped emitter-follower, Mini-Clipper's input impedance is on the order of 2 megohms. Signal is amplified by Q2 and coupled to transceiver input by T1. Output level is adjusted by R8. Diode D2 clips positive-going peaks at Q2's collector. Diode D1 clips the negative-going peaks.

cial low-noise transistors. Do not substitute general-purpose transistors for them or you will have a noisy signal.

To prevent the back of the flea clips (they extend through the perforated board) from touching the cabinet, place a quarter-inch stack of washers or a spacer under each of the board's corner mounting screws.

Mike socket SO1 must mate with your existing mike plug. And output lug PL1 must be the same type as your mike plug. Since push-to-talk (PTT) circuitry varies from transceiver to transceiver we don't show PTT lead connections. Simply connect the PTT leads from SO1 to PL1 as required. Power switch S1 must be the miniature type specified. There isn't room for a standard slide or toggle switch.

Battery B1 should be mounted in the U-section of the Minibox directly over the components on the board. If an insulated battery connector isn't used, or if you solder directly to the battery terminals, cover the end of the battery with electrical tape.

### Using the Mini-Clipper

The Mini-C's output level is adjustable and slightly higher than the normal mike output level. This is necessary to boost the average level of the clipped modulating signal. It also is useful for giving an extra boost to those rigs normally a little shy on modulation. Since there is extra gain, it could be possible to overmodulate the transmitter. We suggest the Mini-C be adjusted by using a modulation indicator. Any of the CB modulation indicators in past issues of EI will do the job (BIG-I CB MODULATION MONITOR, July '64; IN-LINE MODULATION MONI-

### PARTS LIST

- B1—9 V battery
- Capacitors: 6 VDC or higher unless otherwise indicated
- C1—.01 mf
- C2—4 mf electrolytic
- C3, C4—10 mf electrolytic
- C5—100 mf, 15 V electrolytic
- D1, D2—1N34A diode
- PL1—Plug to match mike socket on CB transceiver
- Q1, Q2—2N220 transistor (RCA)
- Resistors: ½ watt, 10% unless otherwise indicated
- R1, R4—47,000 ohms
- R2, R3—100,000 ohms
- R5—150,000 ohms
- R6—10,000 ohms
- R7—220 ohms
- R8—5,000-ohm miniature potentiometer (Lafayette 32 G 7355 or equiv.)
- S1—Miniature slide switch (Lafayette 99 G 6189 or equiv.)
- SO1—Socket to match mike plug
- T1—Transistor driver transformer; primary impedance: 10,000 ohms, secondary impedance: 2,000 ohms center tapped (Lafayette 33 G 8505)

TOR, Nov. '64).

Connect your mike to SO1 and plug PL1 into the transceiver. Turn level control R8 fully counterclockwise and set S1 to on. While holding the mike in normal position and speaking in your normal voice, adjust R8 until the transmitter modulation is 85 per cent on average voice peaks. One hundred per cent modulation will now be produced on intermittent peaks.

Once the correct setting for R8 is determined we suggest you tape the knob in position to prevent changing its setting.

Once R8 is adjusted, raising your voice will not increase the modulation above 100 per cent; should your voice level fall off, the modulation level will hold at about 85 per cent.



# Master Electronics faster with RCA Home Training

NEW, EASY WAY TO BEGIN WITH "AUTOTEXT" PROGRAMMED INSTRUCTION  
HERE'S WHAT YOU GET!

**40** fascinating  
THEORY LESSONS.



Here are all the basic principles of radio and electronics in easy-to-understand language, fully illustrated!

**40** exciting  
EXPERIMENT LESSONS.



Each contains hundreds of absorbing, experiments and construction techniques to help you learn easier!

**40** complete  
SERVICE PRACTICES.



Filled with practical, time-saving, money-saving servicing tips to use throughout your training!

PLUS ALL THIS AT NO EXTRA COST...

**15 KITS!**

to build a Multimeter, AM Receiver and Signal Generator. Kits contain new parts for experiments, integrated so as to demonstrate what you learn in the lessons and to help you develop technical skills. Each kit is fun to put together! Compare what RCA gives you with any other school!



### MULTIMETER

A sensitive precision measuring instrument you build and use on the job. Big 4½" meter with 50 micro-amp meter movement. 20,000 ohms-per-volt sensitivity d-c, 6,667 a-c.



### AM RECEIVER

Have the satisfaction of building your own AM radio with this high quality 6-tube superheterodyne set. Big 5" speaker, fine tone!



### SIGNAL GENERATOR

A "must" for aligning and trouble-shooting receivers. Build it for your own use. 170 KC to 50 MC fundamental frequencies for all radio and TV work.

Begin your training the faster, easier way with new "Autotext" programmed instruction. You learn almost automatically—and go on to advanced training sooner than you ever thought possible! Practical work with the very first lesson. Liberal Tuition Plan. Pay only as you learn. No long term contracts to sign! No monthly installments required!

Complete selection of Home Training Courses to choose from: TV Servicing • Color TV • Transistors • Communications Electronics • FCC License Preparation • Mobile Communications • Automation Electronics • Digital Techniques • Nuclear Instrumentation • Automatic Controls • Industrial Applications • Drafting • Computer Programming.

### CLASSROOM TRAINING ALSO AVAILABLE

RCA Institutes Resident School in New York City offers training that will prepare you to work in rewarding positions in fields such as automation, communications, television, computers, and other industrial and advanced electronic applications. You are eligible even if you haven't completed high school. Check Classroom training and information will be rushed to you.

**Send postcard for free illustrated book today!**  
**Specify home training or classroom training!**

**RCA INSTITUTES, INC.,** Dept. EI-35  
350 West 4th St., New York 14, N. Y.



**THE MOST TRUSTED NAME  
IN ELECTRONICS**

# The Power Transformer

**J**UST about everywhere there's AC you'll find a power transformer stepping the voltage up or down. It's a simple job to wind your own transformer on a large carriage bolt to see and get the feel of transformer action. To keep our experiment shock-free, we use a 6.3 volt filament transformer as a source of operating voltage.

For the primary, wind 500 turns of No. 28 enameled wire in even layers as shown. The beginning lead of the secondary, which is wound on top of the primary, is called the *com* or common lead. Wind 250 turns, bring out a 6-inch loop for *tap 1*, wind 250 more turns, bring out a loop for *tap 2*, then wind 500 more turns for *tap 3*. Connect the primary leads to the secondary of the filament transformer and you're ready to go.

You can make measurements with a 0-10 V AC voltmeter (or a 0-1 ma DC milliammeter by adding the diode and resistor as shown). Plug in the filament transformer and measure the primary voltage at A and B. It should be about 6 volts. Now read the secondary voltage across the *com* and *tap 1* leads. It should be about 2 to 3 volts. This shows that voltage has been stepped down. And the amount of step-down is equal to the ratio of primary and secondary turns. Since the secondary we used has half the number of primary turns, the voltage is half.

Move the meter to *tap 2* and the voltage will be about the

same as the primary voltage because the turns ratio is one to one. Connect the meter to *tap 3* and the voltage will be twice the primary voltage because the secondary has twice the number of primary turns. Secondary voltages are not always in proportion to the ratio of turns because of poor magnetic coupling between the primary and secondary.

Transformer action takes place because current changes in the primary create an expanding and collapsing magnetic field. As lines of this field cut across the secondary windings, they induce a current in them. The carriage bolt, however, is not efficient enough to transfer all the energy. To improve the coupling, lay a screwdriver flat against the secondary. Now angle the screwdriver so its tip touches one end of the bolt. The voltage should increase because of the improved coupling. Another transformer loss occurs

because the magnetic field induces current in the bolt and this just produces heat. Commercial transformer cores are made of iron laminations which provide a good path for the magnetic lines of force but resist current flow.

The transformer's turns ratio also changes current but in the opposite way. If a 6-volt primary is rated at 1 amp, the available current in a secondary with twice the number of turns will be .5 A. Stepping down the voltage will increase the current and vice versa.

—H. B. Morris

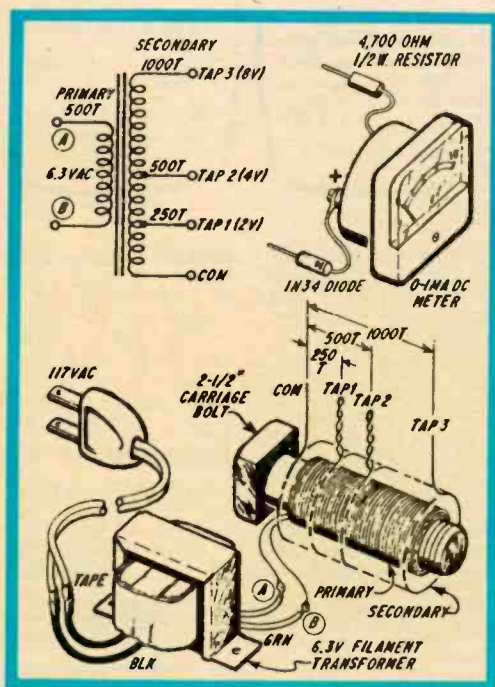



# ROBOT Rembrandt

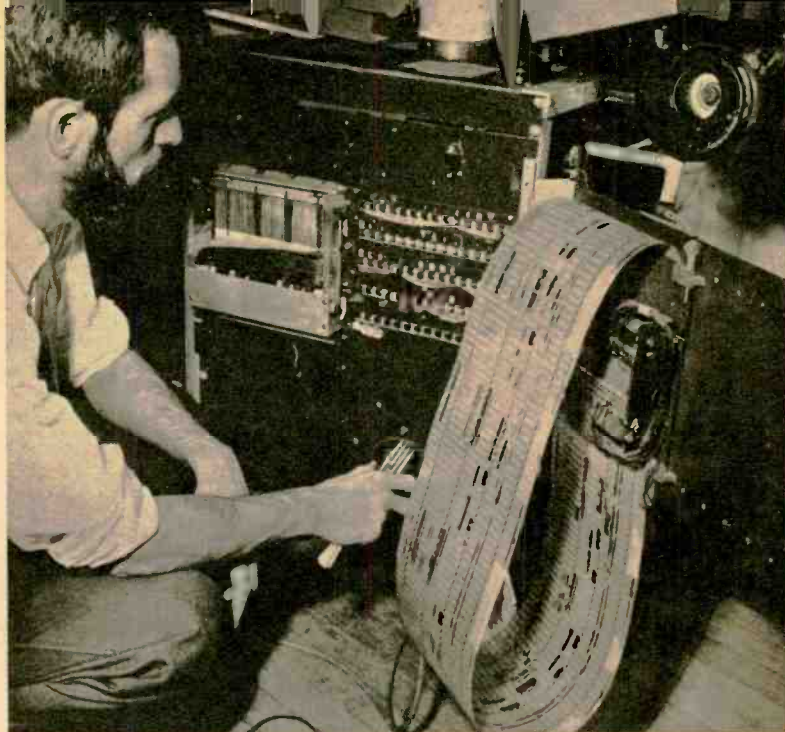

**I**F NEW YORK INVENTOR Raymond N. Auger has his say, automation may one day mark the end for abstract artists. Enterprising as a gang of kids on an Easter-egg hunt, Mr. Auger's Robot Rembrandt has painted hundreds of abstracts, some gratifyingly good, all with ample color and no two alike. It all began when Mr. Auger developed an intricate gadget he couldn't sell—an arm that was supposed to stuff toothpaste into tubes. Undaunted, the inventor set about to bring automation to abstract art. A little something called creativity soon produced a Robot Rembrandt that's as esthetic as environmental variables and controlled probability can make it. No, the Robot hasn't had an exhibition just yet. But when it does, there's good chance it will ask some computer-composer friend if it doesn't want to schedule a premiere of electronic music for the same occasion.



Toothpaste-tube stuffer turned painter, the Robot Rembrandt produced the novel abstract painting shown below. Plastic tapes resembling arty IBM cards serve as its brain food.



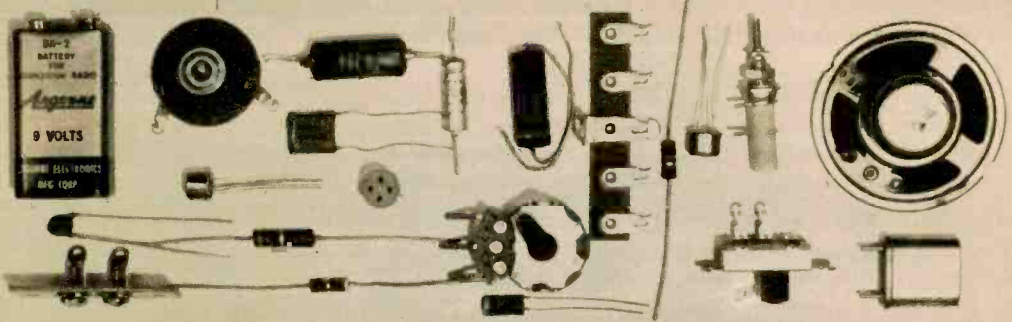

# OPTIMUM OSCILLATORS

*You name the frequency and these simple design tips tell you how to get it.*

By AL TOLER

**T**HINK back a few years. How many times would you have given your grandma's toothbrush to have a source of AF or RF that's as handy as AC at a wall outlet? You know the situation. You get an idea for a project or have to do some troubleshooting and need an RF or AF signal. You don't own a signal generator, therefore the only alternative is to try to make one with a quick lash-up of parts.

But what kind of a circuit are you going to use? Looking through back issues of EI for a suitable oscillator would take a lot of time. Most likely its frequency won't be just what you need anyway.

The answer—knowing how to design your own oscillator. Forget about slide rules, high-power mathematics or advanced engineering. We have an easy way of designing simple AF and RF oscillators.

We know these circuits work because they have been used successfully in the following EI projects: AN EASY-TO-BUILD SIDEBAND ADAPTOR FOR YOUR CB RECEIVER, May, '63; A MODULATED CRYSTAL CALIBRATOR, Sept., '63; 6-IN-1 CB SERVICE SET and WANT TO BE A JUNIOR HAM?, March, '64.

There's nothing really unique about these circuits. The AF oscillator is right out of a Government electronics handbook and the RF oscillator is used by several manufacturers of ham and CB equipment. Both cir-

cuits can be built with junk-box parts.

**The Audio Oscillator.** The AF oscillator (Figs. 2 and 3) has a frequency range of about 100 to 15,000 cps. Additional specifications are shown in the table in Fig. 1. While the circuit works best with a 2N586 transistor, any general-purpose transistor, such as a 2N217 will do the job, though the distortion may be slightly higher. Because the distortion is high compared to the specs of a stereo amplifier, you shouldn't use this oscillator for making amplifier-performance measurements anyway. A more practical application of the AF oscillator is the STEREO BALANCER (Nov. '63 EI) which just provides a steady 1,000-cps signal of reasonably low distortion.

What determines the frequency of the oscillator in Fig. 3? The parallel-resonant circuit consisting of L1/C2,C3. Since C3 must be one tenth the capacitance of C2 in this circuit, C3's reactance is ten times C2's. Therefore C2 is essentially out of the circuit

AUDIO OSCILLATOR			
Supply Voltage	Supply Current (ma)	E-out (rms)	Total Harmonic Distortion
6	1.1	0.13	1.8%
9-13.5	6.5	0.3	2.8%
22	11.0	0.54	2.6%

Fig. 1—Specifications of the AF oscillator.



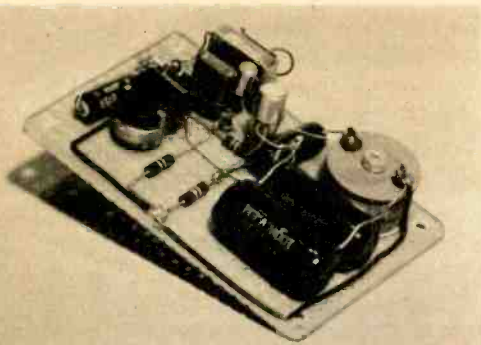

Fig. 2—1,000 cps audio oscillator (lower right). Output is fed to one-transistor power amplifier (upper left) which can drive speaker. Schematic of oscillator is shown at the right.

in terms of determining frequency. The frequency, therefore, is determined by L1 and C3.

Let's now take a look at the formula for the resonant frequency of a tuned circuit which is:  $f_r = 1 / (2\pi\sqrt{LC})$ .  $f_r$  is the resonant frequency in cycles per second, L is inductance in henries and C is capacitance in farads. Since L and C are multiplied, you can see there will be infinite number of values for them that will produce the same answer. That is, L can be large and C can be small, or vice versa, and you'll come up with the same answer.

So where do you start? To tie things down we prepared the table in Fig. 4 which shows values for L and C for some commonly-needed frequencies.

A very useful tool to have handy for determining values of L and C for these and other frequencies is a Shure reactance slide rule. With this rule you merely set the frequency opposite an arrow, then read off combinations of L and C. The rule is available from Allied Radio and other distributors for \$1.00 plus postage. Allied's stock No. is 37 K 950.

Let's take a practical example by building a 2,000-cps oscillator. From the table in Fig. 4 you can see that a choke whose inductance is between 47 and 125 millihenries can be used. A 56-mh choke would be a good choice because it costs less than a dollar. Next thing to do is use the resonant-frequency formula to determine the value of C3. By rearranging the terms of the formula we find that

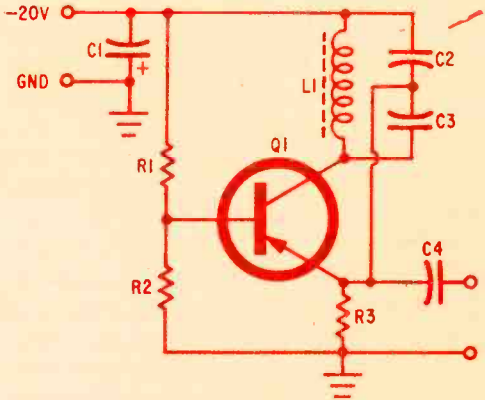

Fig. 3—Audio oscillator is Colpitts type. Feedback is from collector to emitter through the capacitor voltage divider (C2, C3). Frequency is reasonably independent of the supply voltage.

$C3 = 1 / (6.28f_r)^2 L1$ . When we put 2,000 cps and 0.056 henries in the formula we come up with .114 mf. Since this isn't a standard value, use two .05 mf capacitors in parallel or a .15 mf capacitor. A .15 mf capacitor is close enough if the frequency doesn't have to be right on the nose. C2 must be ten times C3's value or 1.15 mf. (Use a 1.5 mf capacitor.)

On the other hand if you prefer to use standard-size capacitors use the following formula to calculate the value of L:

$$L1 = 1 / (6.28f_r)^2 C3$$

For a 2,000 cps oscillator using .2 mf and 2 mf capacitors, for C3 and C2 respectively, the formula tells us to use about a 30-mh choke. Or, you could use an adjustable inductor, such as a Miller No. 9007 which has a range of 25 to 150 mh.

Note that the output signal is taken across R3, a 4,700-ohm resistor. While the signal amplitude at the collector is substantially higher, it also is much more distorted (30

AUDIO OSCILLATOR			
F (cps)	C3 (mf)	C2 (mf)	L1
100	.5	5.0	5 hy
500	.02	.2	5 hy
1,000	.2	2.0	125 mh
5,000	.02	.2	47 mh
10,000	.01	.1	27 mh
15,000	.005	.05	22 mh

Fig. 4—L/C values vs frequency—AF oscillator.

# OPTIMUM OSCILLATORS

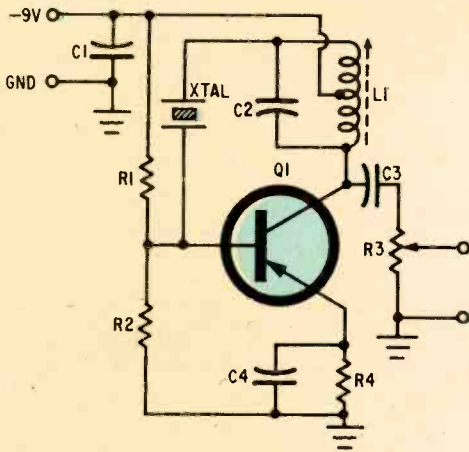

Fig. 5—RF oscillator is modified Hartley. Crystal in feedback path increases frequency stability. Crystal impedance rises at frequencies above and below its series-resonant frequency.

per cent or more).

Any device connected to the oscillator must not upset the emitter-circuit impedance. Therefore the load must be at least ten times larger than R3, or 47,000 ohms. If you are going to feed the oscillator's output into a 25,000-ohm potentiometer, you'll have to connect a 22,000-ohm resistor in series with the output and the pot. Other parts values are as follows: C1—50 mf, C4—1 mf, R1, R2—10,000 ohms.

The RF Oscillator shown in Figs. 5 and 6 will work with either fundamental or overtone crystals to 54 mc. The part values (R1—270,000 ohms, R2—33,000 ohms, C1, C4—.01 mf, C3—1-3 mmf) have been selected so that the circuit will work with an RCA 2N274 transistor. For 27 mc operation, C2 should be a 47 mmf silver-mica capacitor.

Emitter resistor R4 is 680 ohms to limit the collector current to about 1 ma. If R4 is reduced to 47 ohms, the input power (collector current times collector voltage) can be raised to almost 100 milliwatts. But even with a 680-ohm resistor, the oscillator (with a 5- to 12-inch length of wire connected to Q1's collector) will radiate an S9 signal into a receiver two feet away. If you

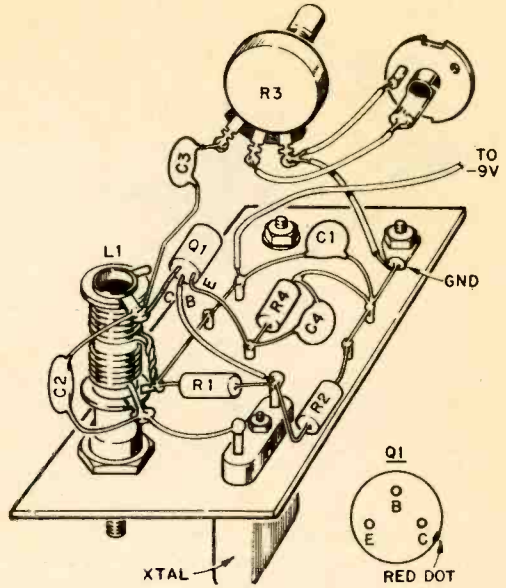

Fig. 6—Suggested layout for RF oscillator on perforated phenolic board. Start winding L1 at collar end, pull out wire midway to form loop (tap), twist it and continue to wind in same direction.

need a strong signal to troubleshoot a receiver that has lost all its sensitivity, connect the oscillator's output through a 50,000-ohm potentiometer (R3) directly to the receiver's antenna terminals.

Overtone crystals may not produce the frequency stamped on their cases. For example, a 27-mc third-overtone crystal will produce an output frequency slightly higher than 27 mc. However, by adjusting L1's slug, you can change the frequency somewhat. Resonance is not limited to only one very precise slug setting. Adjusting the slug will "rubber" (change slightly) the output fre-

[Continued on page 111]

RF OSCILLATOR		
F (mc)	C2 (mmf)	L1 (μh)
3.5	47	36.0
7.0	47	9.0
14.0	47	2.3
21.0	47	1.0
27.0	47	0.6
28.0	47	0.55
50.0	25	0.36

Fig. 7—L/C values vs frequency—RF oscillator.



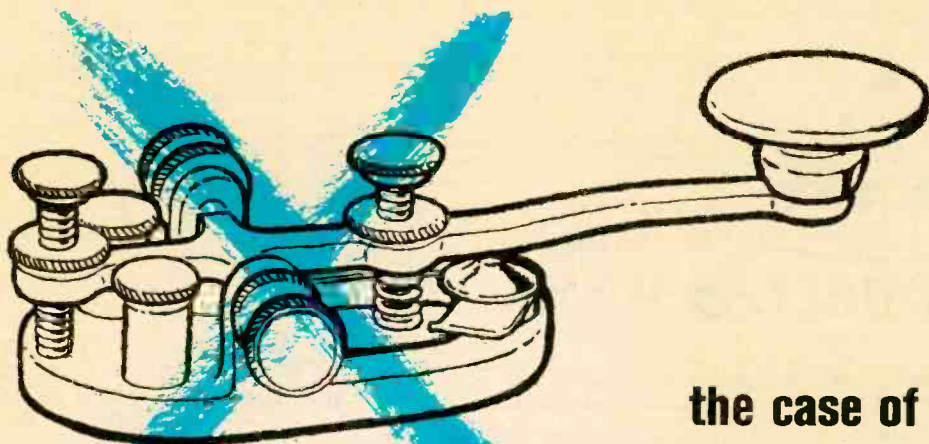

## the case of the **CODELESS HAMS**

By ALEX KARLIN

**T**HE BIGGEST battle in many a decade quietly is shaping up on the ham/CB scene these days. We say quietly, because a good many hams and CBers scarcely are aware it exists. But exist it does. And it concerns what might be called codeless hams.

One view common among radio enthusiasts holds that a large proportion of Citizens Band licensees (and many ordinary citizens as well) would like to become amateur radio operators. And hams they would be, were it not for that little stickler called the code. As things now stand, every ham in the United States must satisfy the Federal Communications Commission that he can send and receive the International Morse Code.

For years there have been grumblings (mostly from non-hams) about these code requirements. Argument is that they are outmoded, oppressive, unrealistic and constitute an unfair barrier to the many thousands of potential ham operators. Through it all the FCC steadfastly has held its ground, requiring a 13-word-per-minute code proficiency of all General Class operators, a 5-wpm proficiency of all Novices and Technicians.

The situation has intensified in the past few years, however. Even a passing acquaintance with the goings-on in most areas of the Citizens Band bears out the they-want-to-be-hams contention. And no one doubts the existence of a vital interest in ham radio by non-hams.

For these reasons, a new radio band and a new type of radio amateur would seem entirely within the scheme of things. The band would be open to all varieties of ham-type, non-substantive communications. There would be no code requirement for obtaining a license. So far as an examination is concerned, would-be licensees might be required to answer only a few technical questions (or none) and a few questions about operating procedures. Or there might be no exam at all. Almost the only requirement would be the filing of an application.

In some ways, of course, the Citizens Band already has become a codeless ham band. Trouble is, those who make like codeless hams are violating the rules. What is needed, say some, is a real codeless band to legalize these activities somewhere else in the spectrum.

As the foregoing indicates, no single and unified concept of the proposed new band exists. There are many proponents but each seems to have slightly different ideas about what the new breed of radio hobbyist should have or should want. This divergence of opinions is by no means the main barrier between wish and fulfillment, however. Matter of fact, it is one of the lesser problems.

**Foremost among the hurdles** to be cleared is the lack of any known interest on the part of the Federal Communications Commission to create such a band. Second is the problem of where to find room in an extremely

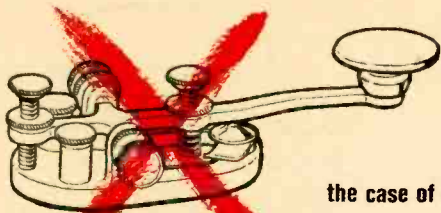

the case of the

## CODELESS HAMS

crowded spectrum to put a codeless ham band. There simply are no open spaces at any reasonable frequency to slip a new group of hobbyists into.

Farther down the list of troubles is the Geneva Radio Regulations of 1959 (to which the United States is a party). These regulations forbid the operation of amateur stations below 144 mc unless the operator is able to send and receive code.

Add to these problems the fact that, virtually to a man, currently licensed hams and their main organization, the American Radio Relay League, now are opposed to the general concept. And they are certain to fire broadsides at any concrete proposal that is made to the FCC.

The battle, however, already has started. Fact is, many of the 700,000 users of the giant CB service already are attempting to obtain at least a portion of what is now the 10-meter ham band. Simultaneously, of course, the amateurs of the nation are counterattacking. Recalling how CBers were awarded the old 11-meter ham band after the hams supposedly had abandoned it, they have begun an intensive campaign to pep up activity on 10 meters. And they have good reason, since there's no denying that tired old 10 has fallen into relative disuse during the past few years and the current low-sun-spot cycle.

Though there have been complaints and more complaints about that code requirement, first formal petition to the FCC seems to have been presented by the International Crystal Mfg. Co. of Oklahoma City, Okla., back in February 1963.

A leading manufacturer of CB and ham radio equipment, International Crystal asked that the FCC create a hobby-class ham license which would permit crystal-controlled 10-watt transmitters to be operated with amplitude modulation on 17 channels within the confines of the 10-meter amateur band.

There also was a request for six frequencies upon which unmodulated code could be transmitted.

No exam was to be given by the FCC to allow operation in this service. The operators would be allowed to contact any ham station (even Generals), and the only equipment allowed would be of commercial manufacture and type-approved by the FCC. International Crystal, while presumably considering the obvious commercial potential of such a new service, also stated that this class of ham license would "start a large group pursuing electronics as a possible livelihood and create a technical pool of interest to the nation."

**The FCC didn't agree.** It not only rejected International's proposal, but also turned down several other proposals which would have allowed Technician Class hams (who *do* have code abilities) to operate on 10 meters. Further, the FCC continued to tighten the vise on CBers who pursued ham-type operations on the existing CB channels.

Two CB clubs next entered the picture. One, the National Association for Citizen Band Radio (NACBR) had, at least at the time its petition was filed, only one member—the president of the group. The NACBR chieftain, who is owner of a commercial radio station in Rochester, N.Y., said in effect that code was an outmoded form of radio communication that should have been buried with the steam automobile. NACBR asked that the FCC do away with code tests and turn the 10-meter band over to the CB service.

The American Citizens Band Association, the second group, has had a short but stormy history, already having irritated many FCC officials through virulent attacks in its publications. In this instance, ACBA also asked for the 10-meter ham band, but on slightly different grounds.

The CBers of America had a *right* to hobby-type communications, ACBA argued. And, in view of the fact that the FCC seemingly had played into the hands of CB's so-called commercial users in its handling of the existing 11-meter band, the non-commercial ops had been left without a band. Therefore, the hobbyists deserved the 10-meter band so they could grow and multiply in their own right.

Amateurs, meanwhile, getting wind of such proposals, silently have gone to bat to save 10. Evidence is a Save-10 program, a con-



centrated attempt to repopulate the dormant 10-meter band with hams. And to top it all off, the ARRL, oldest of the existing ham organizations, put its own Save-10 petition into the FCC. In doing so, it brought up a little-publicized point which could prove to be the cat some canaries hadn't bargained for.

The thing which most everyone seems to have overlooked is international laws and agreements. As it happens, most of the nations of the world sit down round a table every now and again to slice up the radio spectrum like a pie. Certain frequency bands are given to broadcast services, some to aeronautical services, still others to police, maritime, international telephone and telegraph services and so on. Hams also get their slices, though some feel they receive little more than the crumbs at the end of the meal.

But more than just serving pieces of pie, the nations also agree on just how each slice of pie is to be eaten. In other words, they agree on certain operating and licensing rules so that the various stations in each category reasonably will be standardized regardless of their nationality.

Most recent of these international radio conferences took place in Geneva, Switzerland, during 1959. At that time, the nations agreed on a restriction regarding the operation of ham stations on frequencies below 144 megacycles. It states that the operators must exhibit to their respective governments that they can send code by hand key and receive same by ear—i.e., without the aid of automatic decoding equipment. (No speed requirements are mentioned in the Geneva rules, by the way. This little matter is left strictly up to the individual governments involved.)

Since the U.S. is a party to the Geneva regulations, it accordingly must honor them. Therefore, regardless of the wishes, desires or opinions of FCC officials, CBers, hams, manufacturers or Mr. John Q. Citizen himself, the U.S. cannot permit ham stations to

operate within the confines of the internationally agreed-upon 10-meter band unless the operators have demonstrated that they can send and receive code.

Next time the nations will sit down to re-carve the pie will be late in 1967 or, possibly, 1968. And the question is whether the American delegation will go to bat for codeless hams. Answer is anybody's guess, though it seems possible that the U.S. representatives could be talked into getting a change in the no-code-below-144-mc rule. At best, this would put a codeless band several years away, but tomorrow is better than never.

For in spite of the heavy enemy lineup staring it in the face, a codeless ham band seems likely to materialize. To be sure, many radio hobbyists, hams and otherwise, believe it will not. But we don't agree. We feel that there *will* be such a band at some time in the future, though not necessarily soon.

At the bottom of our reasoning lie two factors. The Citizens Band has demonstrated graphically that hundreds of thousands of Americans want the right to carry on the type of communications envisioned in the codeless ham band concept. Secondly, CB showed equipment manufacturers that a new and popular radio service can mean a new market for their products—in terms of millions of dollars of new income. Another new market that could equal CB in potential is an alluring prospect to any company in the field.

The FCC and the rest of the government—in theory, at least—are in Washington to administer the people's money and the people's laws and the people's airwaves according to the desires of the citizens. This being the case, it seems unlikely that the FCC would ignore several hundred thousand voters and an industry representing billions of dollars. Instead, the agency can be counted on to give the now-formless group a fair hearing and, if possible, accommodate its desires.

To our way of thinking, 10 meters might

[Continued on page 111]

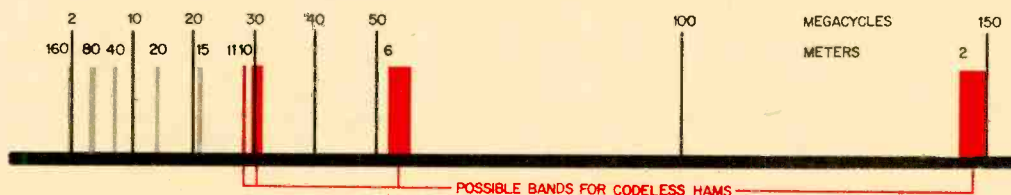

Our chart shows major amateur bands and also indicates the four that conceivably could go codeless. Placing codeless hams on any of these bands (save two meters) would necessitate a treaty revision.

KNIGHT-KIT KG-275

*build-it-yourself*  
**EXPOSURE METER**



**A**LLIED RADIO'S Knight Electronics division has stolen a march on both electronic and photographic competitors by bringing out the first exposure meter in kit form.

The KG-275 is the new cadmium-sulphide type of meter in which a photosensitive CDS cell controls the flow of current from a mercury battery through a meter movement according to the amount of light falling on the cell. The more light, the more current and the higher the meter reading.

Knight's kit meter contains exactly 49 parts, including a dozen electronic components. Electrical and mechanical assembly are easy and straightforward. Our builder took 80 minutes to complete construction and encountered no problems.

List price of the KG-275 is \$15.88. In features and accuracy, the unit equals or surpasses factory-assembled models costing \$50 or more. Some half-dozen low-cost CDS meters presently are on the market, ranging in price from \$10.95 to \$22.95, but none offers all the features of the KG-275.

We tested the Knight product for accuracy on a photometric bench, using a master light source calibrated by the U.S. Bureau of Standards, and found its readings fell within prescribed limits in all ranges. This was particularly noteworthy in view of the fact that the CDS cell and meter movement must necessarily be economy models to make possible the \$15.88 price tag.

The meter has light-measuring abilities to burn, giving accurate readings at light levels well below those any camera bug can use. The argument in favor of such unused abilities is that the meter is not likely to become obsolescent in the foreseeable future, even with phenomenal increases in film speeds.

Besides giving normal reflected-light readings, the KG-275 has a diffuser permitting measurement of incident light. There are two

light - level ranges, the lower one reading from .014 to 28 foot-candles, the higher range running from 28 to 28,000 f-c. The color-coded computer's scales are large and easy to read. Shutter-speeds range from 1/4,000 sec. to 30 min. The f-stop range is from .5 to 64. For cameras with the EV-LVS exposure system, the range is from -12 to +22. Movie readings range from 4 to 128 frames per second. The meter is calibrated for films with an ASA rating of 6 to 12,000 (or degrees ASA from 1° to 12°). Its light-acceptance angle is a normal 50°.

The battery-test button requires care or it hangs up. The meter pivot base is merely cemented to the coil assembly. However, vibration tests indicated the joint can stand up under hard usage.

Considering its price, features and accuracy, the KG-275 for the time being enjoys the distinction of being in a class by itself.



Interior of wired meter shows computer back at lower right and meter terminals at upper right.



# how to wire

By FRED J. WHITEMAN



# COAX CONNECTORS

**P**UTTING a new plug on a lamp is duck soup. But installing connectors on shielded audio or coax cable is an entirely different story. Do a quick and sloppy job and you'll regret it. One tiny piece of shielding in the wrong place or a broken conductor, and everything will be dead as a doornail. It doesn't take much time to do the job correctly the first time. But it could take hours to track down a short or intermittent later on.

Despite coax's wide use, many hams, CBers and audiophiles haven't acquired the touch for installing connectors on coax easily and correctly. These tips should keep you from losing your temper in the future.

First, let's get our terminology straight. (The diagram at the upper left of the next page shows the construction of typical coax such as RG8/U or RG58/U.) A solid or stranded inner *conductor* is surrounded by an insulating *dielectric*. This in turn is covered with a woven outer *braid* (often referred to as the shield) which is enclosed by a *jacket*.

Audio and microphone cables sometimes use spirally wound rather than woven shield. Some shielded cable may not have an outer jacket.

**Phono plugs** (top, center diagram, next page) are probably the most popular connectors for hi-fi equipment. And they are being used more and more with low-power communications equipment. First thing to do is *dress* the cable as shown in the diagram on the next page and the photo below.

Measure one inch back from the end of the cable, then cut through the jacket all the way around the wire. Be very careful not to cut into the shield. Then make a lengthwise cut to remove the plastic jacket. Again, be careful you don't cut into the shield.

Sometimes the shield is woven loosely so that it can be pushed back. Or, it may be possible to open a hole in the weave of the shield and pull out the conductor and the

**Phono plug cable preparation.** One inch from end of cable, cut through the jacket around the circumference being careful not to cut the shield. Then make a second lengthwise slit to remove the jacket.

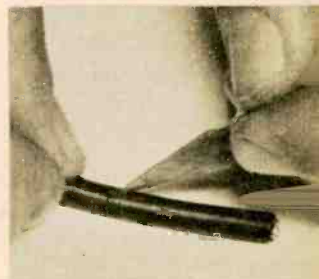

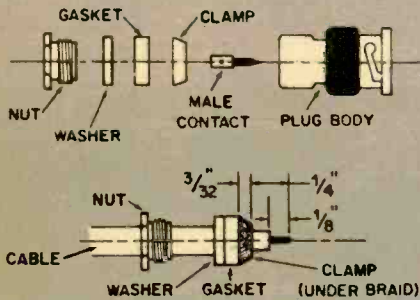
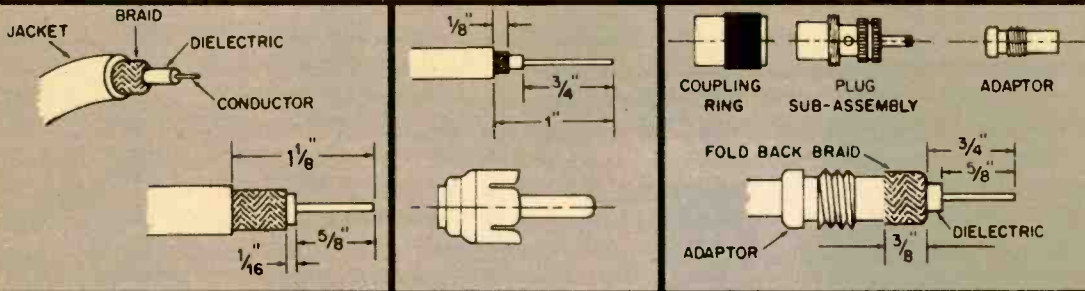

When using UG175/U or UG176/U adaptors (top, right diagram) for smaller-diameter coax such as RG58/U and RG59/U, remove  $\frac{3}{4}$  inch of jacket. Slide coupling ring and adaptor on cable. Position adaptor at end of jacket, spread shield over body of the adaptor and trim it to  $\frac{3}{8}$  in. back on adaptor. Strip  $\frac{3}{8}$  in. of conductor and tin it. Screw plug sub-assembly on adaptor and solder shield to shell through solder holes. Solder the conductor to the center contact of the plug and scrape off any residue on the outside of the contact. Then screw coupling ring on the plug sub-assembly to finish the job.

## COAX CONNECTORS

dielectric. In either case, cut the shield so it extends only about  $\frac{1}{8}$  inch beyond the jacket, being careful not to cut into the dielectric. Now, cut through the dielectric  $\frac{3}{4}$  inch back from the end and pull off the dielectric.

Tin the conductor and insert it in the prong of the phono plug, wedging the plug shoulder between the dielectric and the shield. Solder the conductor in the center prong and solder the shield all around the shoulder. Trim the conductor flush with the end of the center prong and scrape off the flux.

The PL-259 UHF plug is the most commonly used connector for ham and CB equipment; it mates with the SO-239 chassis receptacle. When installing it on heavier coax, such as RG8/U, only the coupling ring and the plug sub-assembly are required (top, right diagram above). Remove  $\frac{1}{8}$  inch of the jacket, strip  $\frac{5}{8}$  inch of conductor and trim the braid back  $\frac{1}{16}$  inch from the remaining dielectric. Slide the coupling ring on the cable and tin the exposed conductor and shield. Screw the plug sub-assembly on the cable and solder it to the shield through the solder holes. Solder the conductor to the center contact and screw the coupling ring

on the plug sub-assembly as shown above.

When smaller-diameter coax is used, you must use an adaptor (top, right diagram). Use the UG175/U adaptor for RG58/U cable and the UG176/U adaptor for RG59/U cable. The caption under the diagrams explains how the adaptors are installed.

**BNC Connectors.** The quick-release BNC-type RF connector is often found on commercial and military equipment. It is used with RG58/U and RG59/U coax and is sometimes the most difficult to install since it comes in six parts (lower left diagram).

Remove  $\frac{1}{4}$  inch of the coax's jacket. Position the clamp at the edge of the jacket and fan, or spread, the shield back over it. Trim off the shield so it just covers the clamp. Remove  $\frac{1}{8}$  inch dielectric and tin the conductor. Slip the contact in place, butting it against the dielectric and solder it to the conductor. Now, push this assembly into the plug body as far as it will go.

Next, slide the nut into the plug body and screw it tight, holding the cable and shell rigid and rotating the nut. And after the job is done always check the coax for continuity and shorts before you use it. This takes only a few minutes time with an ohmmeter, but can save you a lot of head scratching later on. All it takes is a single strand of stray shield to ruin the whole job. ⚡



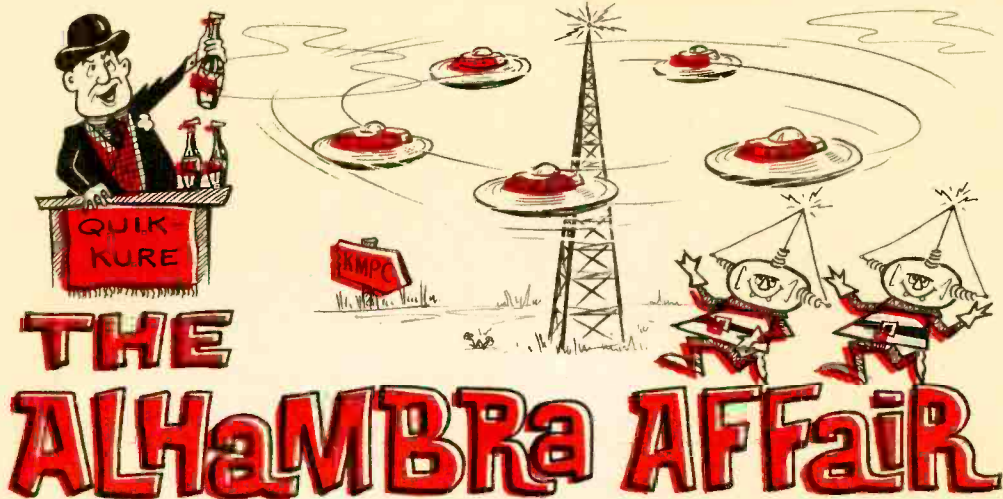

By DON CARTER

A FEW YEARS back when a man named A Newton Minow was chairman of the Federal Communications Commission, you heard a lot about public interest, convenience, necessity and that sort of thing. Mr. Minow doesn't happen to be with the FCC anymore, but he certainly let you know the way the FCC saw things in the short time he was around.

"Vast wasteland" was the stamp he put on the American TV industry in that famous speech of his back in 1961, and the industry has yet to forget it.

"I do not accept the idea that the present overall programming is aimed accurately at the public taste," Mr. Minow said at one point. There also was much talk at the time about how the airwaves belonged to the people and how stations held their licenses only by *proving* they served the public. And it was said that license renewals for broadcasters would not be an automatic, rubber-stamp affair. Instead, stations would have to demonstrate that they deserved to hang onto their tickets.

In these recent times no one has heard of much difficulty for commercial licensees seeking renewals. But that was not always the case. Mr. Minow didn't originate the serve-the-public-or-shut-down idea. Almost 30 years ago, when the FCC was brand new, the Commissioners seemed to have the same concept.

In those days they even tried to do something about the way they felt the public should be served and the result was the little-celebrated Alhambra Affair. The case didn't

cause much of a stir at the time and now is almost forgotten, but it doesn't deserve extinction because the Alhambra Affair was a noteworthy chapter in America's radio annals.

The year was 1935. Only a few months before, Congress had created the FCC in its Communications Act of 1934 to regulate radio in the "public interest, convenience and necessity." In California in that Depression year a group bearing the name of the Alhambra Electronic Institute went into the business of practicing medicine without, as the authorities later said, proper licensing. In order to sell its services, Alhambra bought time on some local broadcast stations, chief of which was KMPC, the Station of the Stars, operating in Beverly Hills. Alhambra eventually came to its justified end but not before both it and KMPC had been the subjects of thousands of words of testimony and the objects of more investigations than they desired.

When the incident started, the FCC was still in creepers and had just reached the end of its initial clean-up campaign to rid the air of what it considered undersirable or unethical programs. Its crusade already had driven Norman Baker and John (Doc) Brinkley to regions south of the border. Once before in its clean-up the FCC had hit the Los Angeles area. The victim that time was Dr. Bob Shuler and his station which, in the words of a Shuler disciple named Dan Gilbert, had "dared denounce Al Smith, the 'rum and Romanism' candidate for President." But that's a tale for another time.

As it happened, the Alhambra Electronic

## THE ALHAMBRA AFFAIR

Institute was a group of chiropractors offering diagnosis of any ailment via that "new marvel instrument," the "Electron-O-Meter." Clearly a miracle machine (if we are to believe the advertiser's claims), the device was heralded as a godsend no listener well could afford to pass up. Hear the announcer now, as he proclaims the wonders of this 1935 panacea:

**"Ladies and gentlemen—Here is good news for all people who are sick or in ill health. The Alhambra Electronic Institute has installed the latest Scientific Invention—the Electron-O-Meter—a machine that shows you definitely the cause of your illness, the condition of your internal organs, the severity of the ailment, and how to correct the faulty condition.**

**". . . (This instrument) . . . is causing a sensation here before us in Southern California, for this reason, it shows you visually the underlying and basic cause of your ailment. Many of you have spent many dollars trying to regain your health and today you are at a loss to know what is causing your ailment. You say to yourself, 'If I knew what was causing my sickness, I certainly would regain health.'**

**"All right, you would, and here is your opportunity, that is for ten people, we are authorized to make appointments for ten people at this time for this examination. Now this examination usually costs \$10.00, but for these ten people it is going to be given to them for just \$1.00 and that is the total cost without any obligation. The only thing we ask of you is that you make a definite appointment right now."**

So much for the Electron-O-Meter. Miracle machine or no, it really didn't carry much weight in the affair. For Alhambra's chief of staff soon found himself arrested, tried and convicted of violating the California State Medical Act. At about this same time, KMPC's license came up for renewal.

The thing the FCC had to decide was whether the station had been operating in the public interest, convenience and necessity. As we said earlier, licenses are granted on this basis and "past conduct of the applicant" must be considered at renewal time.

Since the whole Alhambra Affair would suggest that public interest might not have been served, the FCC seemingly found itself faced with the unique possibility of affixing the mark of extinction on two stations in the

same area during a period of less than two years. Hearings were held but there was no ax. Instead, while condemning KMPC's promotion of the Alhambra scheme, the FCC renewed the Station of the Stars' license in light of its "general program service."

After renewal, the station was sold, its management changed and this could have been the end of the affair—but wasn't. Almost simultaneously, Alhambra reorganized and went back in business as the Basic Science Institute. Its operation was essentially unchanged. And once again it was allowed to purchase time on the same station. Worse still, Basic Science was only one of two such pseudo-institutes whose commercials KMPC carried. The Samaritan Institute, specializing in a 48-hour cure for alcoholism, also was touted. Later the courts held that its staff, too, was engaging in the practice of medicine without a license.

On September 28, 1937, against this backdrop, W.H. Kindig of Hollywood filed for a construction permit from the FCC which in effect would have given him all the facilities of the Beverly Hills broadcaster. An examiner's hearing was set for December 8 to coincide with still another renewal of the Station of the Stars' license.

But Kindig never showed up. His application was denied as in default and the examiner recommended that the existing license be renewed. But before this recommendation could be carried out, Washington got wind of the Basic Science (Alhambra) and Samaritan deals. Result was that a full FCC hearing was set for January.

Though substantially the same hoax had been perpetrated twice via the same station (with an intervening warning from the FCC), KMPC's officials said they had done nothing wrong. And the FCC eventually decided in the station's favor, noting that KMPC was under new management, that both Basic Science and Samaritan had been dropped as

*[Continued on page 111]*

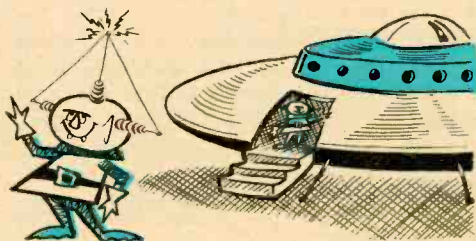





# LAFAYETTE RADIO ELECTRONICS

# FREE!

1965 CATALOG No. 650

Over 500 Pages! *Featuring Everything in Electronics for*  
**HOME • INDUSTRY • LABORATORY**

from the "World's Hi-Fi & Electronics Center"

- Stereo Hi-Fi—All Famous Brands Plus Lafayette's Own Top-Rated Components
- Citizens Band—Transceivers, Walkie-Talkies and Accessories
- Tape Recorders • Ham Gear
- Test Equipment
- Radios, TV's, and Accessories
- P.A. Equipment; Intercoms
- Cameras; Optical Goods
- Marine Equipment; Auto Accessories
- Musical Instruments; Tools; Books and MUCH MORE



**BUY ON TIME—**  
Use Lafayette's famous Easy-Pay Credit plan . . . up to 24 Months to Pay

See the Largest Selection in Our 44-Year History



199.50

New LR-800 70-Watt Complete AM-FM Stereo Multiplex Receiver features a tuned nuvistor "front-end" and an FM "Stereo-Search" multiplex indicator. Excellent sensitivity, frequency response, and low distortion specs. Imported, 99-0005WX.



93.95

New LT-325 AM/FM Multiplex Tuner combines simplicity, flexibility, and superb styling. 20-Tube performance provides a great variety of features, including a new audible tone "Stereo Search System." Imported, 99-0001WX.



59.95

Model RK-142 Deluxe Portable Tape Recorder perfect for the home, school, or office. Records and plays 1/2 track monaural at two speeds. With dynamic microphone, connecting cables and empty 7" reel. Imported. 99-1512WX.

**HEADQUARTERS  
FOR THE HI-FI  
ENTHUSIAST**

## THE WIDELY ACCLAIMED LAFAYETTE RK-137A TAPE RECORDER



FEATURING **4** —TRACK STEREO PLAYBACK\*  
—TRACK MONAURAL RECORD  
PLAYBACK

**89.50**

99-1511WX

\*adaptable-to stereo playback

**MAKES REELS UP TO 7"**

With Electronic Track Selector Switch, VU Recording Level Meter and Pause Switch For Instant Editing

Includes Lightweight carrying case, dynamic microphone, output cable, 7 inch empty tape reel.

- Two Speeds—3 3/4 & 7 1/2 ips
- Pause Lever Provides Instant Stop for Editing
- Record—Erase Safety Switch
- Fast, Rugged Shift Lever Control
- Extension Speaker Jack
- High Impedance Monitoring Jack
- VU Meter Recording Level Indicator
- Electronic Track Selector Switch
- Specially Designed Heavy-Duty 6x4" PM Speaker
- Separate Erase and Record Heads. Imported.

Mail The Coupon TODAY For Your FREE LAFAYETTE 1965 Catalog



# LAFAYETTE is HEADQUARTERS

## For CB and AMATEUR EQUIPMENT



64<sup>50</sup>

Deluxe Model HA-63 Shortwave Receiver is an excellent choice for the beginning shortwave listener or novice amateur. Covers 550 KC to 30mc in 4 bands and features electrical bandspread on all frequencies. 7 Tube circuitry gives outstanding selectivity and sensitivity. Imported. 99-2534WX



22<sup>95</sup>

"Explor-Air"™ 4-band short wave receiver kit—an ideal way of introducing yourself or your children to the fascinating world of electronics and shortwave listening. Detailed step-by-step instruction book makes this kit a pleasure to build. 19-0905. Cabinet available for 2.85. 19-0906



59<sup>95</sup>

Three New Deluxe Lafayette Receivers for monitoring police, fire department, aircraft, civil defense, or commercial communications. 10-Tube performance features high sensitivity, variable squelch, and fully tuned RF stage. Imported. Model HA-50 30-50Mc 99-2525WX Model HA-55 108-136Mc 99-2527WX Model HA-52 152-174Mc 99-2526WX



25<sup>95</sup>

The New Model HA-115 audio compressor amplifier instantly and automatically increases the "talking power" of your citizens band transceiver by increasing the average modulation of the transmitter section. Works with all popular CB units. 42-0117.



25<sup>95</sup>

2 for 49.95

HE-29C 9-Transistor Walkie-Talkie provides two-way communications up to 1.5 miles. Powered by six penlight batteries with life expectancy of 55 hours. An AC power supply is also available. Specify channel. Imported. 99-3020CL.



19<sup>95</sup>

2 for 38.75

Model HA-85 6-Transistor "Walkie-Talkie" transmits and receives up to 1 mile. Ideal for sports, boating, construction and recreation. Complete with leather case, earphone, batteries, and crystals for the channel of your choice. Imported. 99-3013CL.



9<sup>88</sup>

2 for 18.88

The HA-70A—a wired pocket-size 3-transistor walkie-talkie with countless exciting short range applications. Complete with crystal, carrying case, and 9-volt battery. Imported. 99-3011L.



6<sup>95</sup>

Lafayette Stainless Steel CB Mobile Antenna—an outstanding buy with outstanding features. Chrome plated swivel ball mount base permits mounting on any surface. Lug terminals for easy hook-up to coaxial cable. Imported. 99-3034WX.

## EXCLUSIVE LAFAYETTE WIRED TEST EQUIPMENT



9<sup>95</sup>

New! 20,000 Ohms-Per-Volt Multitester at Lafayette's low, low price. Has every needed range for testing appliances, radio, etc.: 40 microampere meter movement and 1% precision resistor for accurate readings. Imported. 99-5008. Pigskin carrying case available for 1.75. 99-5009.



26<sup>95</sup>

Lafayette VTVM with all the ranges and accuracy you need for audio, radio and TV applications. Giant 6½" full-view meter accurately measures AC peak-to-peak, AC RMS, DC voltage, and resistance. Leather case and accessory RF probe available. 38-0101



19<sup>95</sup>

Lafayette Tube Checker packed with features

at a price you can afford. Accurately checks over 1600 tubes including new compactrons and nuvistors. Handy, easy to read slide out tube chart. Imported. 99-5011.

## SEND TODAY FOR YOUR FREE 1965 CATALOG

LAFAYETTE RADIO ELECTRONICS  
Mail Order and L. I. Sales Center

111 Jericho Turnpike, Syosset, L. I., New York

New York, N. Y. 100 Sixth Ave.  
Brooklyn, N. Y. 2265 Bedford Ave.

New! New York City Store!  
71 West 45th St.

Jamaica, N. Y. 165-08 Liberty Ave.  
Bronx, N. Y. 542 E. Fordham Rd.

Scarsdale, N. Y. 691 Central (Park) Ave.  
Paramus, N. J. 182 Route 17

Newark, N. J. 24 Central Ave.  
Plainfield, N. J. 139 W. 2 St.  
Boston, Mass. 584 Commonwealth Ave.  
Natick, Mass. 1400 Worcester St.

LAFAYETTE RADIO ELECTRONICS

Dept. EIC-5 P.O. Box 10  
Syosset, L.I., N.Y. 11791

- Send me the FREE 1965 Lafayette Catalog 650 enclosed; send me (Prices do not include shipping charges).

Name \_\_\_\_\_

Address \_\_\_\_\_

City \_\_\_\_\_

State \_\_\_\_\_

Zip \_\_\_\_\_



# LAFAYETTE ...Headquarters For Citizens Band Equipment

## NEW! LAFAYETTE 23-CHANNEL CRYSTAL-CONTROLLED DUAL CONVERSION 5-WATT CB TRANSCEIVER WITH ADVANCED "RANGE-BOOST" CIRCUIT

- 13 Tubes, 8 Diodes
- Low Noise Nuvistor RF & Mixer
- 5 Double-tuned IF Transformers

Model HB-400 **169<sup>50</sup>**  
Only

■ Frequency Synthesis For 23 Channel Crystal Controlled Transmit & Receive ■ No Extra Crystals Needed ■ Dual Conversion Receiver with 3/10  $\mu$ V Sensitivity ■ Delta Tuning ■ Variable Squelch, Variable Noise Limiter ■ Illuminated "S" and RF Output Meter ■ Push-to-Talk Ceramic Mike ■ "Range-Boost" provides high average Modulation—increases Effective Range ■ Built-in Dual Power Supply, 117VAC, 12VDC ■ "Vari-Tilt" Mobile Bracket For Easy Installation ■ Plug-in Facilities for Lafayette Selective Call Unit ■ Compact, 12"Wx10"Dx5"H.



## NEW! LAFAYETTE ALL-TRANSISTOR DUAL CONVERSION 5-WATT CB TRANSCEIVER FEATURING AUTHENTIC MECHANICAL FILTER



- 100% Solid-State . . . Full 5-Watt Performance!
- 9 Rugged Silicon Mesa Transistors Used in Critical Areas
- Small, Compact—Only 3" High!
- Low Battery Drain—Less Than 350 ma on Receive, 850 ma on Transmit!

MODEL HB-500 **139<sup>50</sup>**  
Only

■ 12 Crystal-Controlled Transmit & Receive Positions ■ 23 Channel Tunable Receiver with Spotting Switch ■ 15 Transistors, 5 diodes with Printed Circuit Construction ■ Dual Conversion Receiver with 5/10  $\mu$ V Sensitivity ■ Mechanical Filter For Razor-Sharp Selectivity ■ Variable Squelch, Automatic Noise Limiter, "S" meter ■ Dependable Sealed Relay Switching ■ Fits Anywhere—Only 1 1/4"Wx6 1/4"Dx3"H ■ For 12VDC (optional 117VAC Solid State power Supply available) ■ Supplied With Crystals for Channel 12, special Mobile bracket, Push-to-Talk Dynamic Mike and Mobile power cable.

## NEW! LAFAYETTE DELUXE 8-CHANNEL DUAL CONVERSION 5-WATT CB TRANSCEIVER SUCCESSOR TO THE FAMOUS LAFAYETTE HE-20C

Model HB-200 **109<sup>50</sup>**  
ONLY

■ 9 Tubes plus 3 Silicon Diodes plus 2 Crystal Diodes for 17-Tube Performance ■ Super Sensitivity—1 Microvolt or Less ■ 8 Crystal Receive Positions plus 8 Crystal Transmit Positions plus 23-Channel Tunable Receive ■ Push-to-Talk Microphone ■ Dependable Relay Switching ■ Illuminated Meter with 3-Position Switch ■ Adjustable Squelch and Automatic Noise Limiter ■ Spotting Switch ■ Built-in 117 Volt AC Power Supply with 12 Volt DC Mobile Transistorized Power Supply ■ Plug-in facilities for Lafayette Selective Call Unit ■ With Bracket Handle, Push-to-Talk Ceramic Mike, Pair of Transmit and Receive Crystals for Channel 15 plus Crystal for Dual Conversion.



**FREE!** Lafayette 516—Pg. 1965 Catalog No. 650. Write:  
Lafayette Radio Electronics Corp., Dept. EIC-5, P.O. Box 10, Syosset, L. I., N. Y. 11791



Continued from page 72

might be. The volume begins with a treatment of basic AC and DC theory that an engineer won't need, then goes on to circuit descriptions that the interested layman won't find exciting. All in all, this entry is a real disappointment.

**AMPLIFIERS.** By H. Lewis York

The problem here is spelled t-r-a-n-s-i-s-t-o-r. All but ten pages in this 250-page volume deal with vacuum-tube theory (or valve theory, as the English author would have it). And most of the information—highly technical at that—is sadly dated for the people most likely to use it.

Still another problem is that stereo amplification is given short shrift. Matter of fact, most of the circuit descriptions are of the mono designs made possible in 1956-58 by tubes like the EL34 and EL84. Result is that there just isn't much here to be excited about.

**LOUDSPEAKERS.** By E.F. Jordan

This is the most thorough coverage of speaker theory and practice we've seen in really comprehensible form, and it deserves reference-shelf space alongside Edgar Villchur's Handbook of Sound Reproduction.

The language isn't the layman's by any stretch of the imagination but the information is almost endless. Subject matter runs all the way from an esoteric discussion of speaker Q to the relation of speaker efficiency and listening-room size to necessary amplifier power. Recommended for audiophiles and speaker designers alike.

**103 SIMPLE TRANSISTOR PROJECTS.**

By Tom Kneitel. John F. Rider, New York. 120 pages. \$2.75

To come back home, here's an electronic cookbook full of recipes for an evening's or week end's entertainment. The projects, ranging from what may be the world's smallest receiver to a reasonably good square-wave generator, are interesting and fairly simple to tackle.

Though you won't pick up much information on transistors as such, you will find more interesting things to do with them than most of us would be able to dream up in a month of Sundays. All illustrations, by the way, are schematics, and all seem quite clear and accurate.

Continued from page 82

his talk and his looks, especially the way he had of looking out of the corner of his eye."

It turned out that Kookie couldn't carry a tune, much less evidence rhythm, range or pitch. But no matter. A girl named Connie Stevens was written into the script of the TV show to build up her stock with teen-agers. And a song was written in which she could do most of the singing while Kookie injected comments once in a while. Then the voice-makers went to work on Kookie.

To keep things simple, his singing participation was limited to six bars. His part was recorded again and again. His voice was given the full treatment—echo, filters, boosts—to make it sound as pleasing as possible. The record, called Kookie, Kookie (Lend Me Your Comb), was the nation's top hit in the Variety poll in three weeks.

Kookie isn't the only voiceless wonder around. A couple of years ago a Philadelphia record executive named Bob Marcucci spotted a 14-year-old named Fabian Forte on the street. Marcucci decided then and there that Fabian would be a recording star.

Though the first two singing teachers gave up without trying after they heard Fabian groan a few bars, a third agreed to take the job. He helped some. But his pupil still couldn't sing on key or do much else quite so radical.

Then Fabian did a guest spot on the Dick Clark TV show. His appearance (as Marcucci had known it would) set teen-age passions afire. Fabian spent every holiday and weekend—he still was in high school at the time—making personal appearances. And, thanks to some hefty beefing, his recordings soon were hitting the top ten regularly.

Where does the rage for phony voices leave the singers who really sing—the Sinatras, the Tormes, the Staffords? Their records, of course, contain only music and no crazy sounds, so they can't hope to compete with singing chipmunks, bathroom plungers and the electronically manufactured voices of teen-age idols.

Nevertheless, it's a hopeful sign that they continue to sell at all. For despite the current state of popular music, they perhaps prove that an ability to sing isn't necessarily fatal in the record business.

Continued from page 51

# ONE MILLION\*

## ITEMS CAN BE BUILT WITH CORDOVER MODULES

ALL MODULES ARE TRULY SOLID STATE, PERMANENTLY ENCASED IN A ROCK HARD, ICE CUBE SIZE PLASTIC NUGGET, AMERICAN MADE.



### TRANSISTORIZED CODE OSCILLATOR MODULE

Produces same tone as normal Morse Code transmissions. Will drive any size PM speaker at a pleasant room level volume. Ready to connect to telegraph key. **98¢ ea.** CODE CPO-4

### PUBLIC ADDRESS AMPLIFIER MODULE For Carbon Mike

Complete and ready for operation when connected to carbon mike, battery and speaker. Will drive up to a 15" speaker at enough volume to carry several hundred yards. **1.98 ea.** CODE PAA-2



**PUBLIC ADDRESS AMPLIFIER MODULE High Gain for Crystal or Dynamic Mike**  
Needs only a mike, speaker and 6 Volt battery, and your public address system is "on the air". Will drive any size speaker or trumpet. **3.50 ea.** CODE PA-9



**PHONOGRAPH AMPLIFIER MODULE**  
Powered by 6 Volt battery, it will take output of crystal phono cartridge and drive any 8 Ohm PM speaker to far above average volume. Has only 4 leads to be connected (per instructions) to your speaker and phono cartridge. **3.50 ea.** CODE PH-7



**TELEPHONE AMPLIFIER MODULE**  
Ready to amplify telephone conversations. Simply connect to speaker, battery and telephone pick-up coil. Permits group listening to any phone conversation. **3.50 ea.** CODE TA-9

**INTERCOM MODULE**  
Fully wired, ready for instant use. Connect to 2 speakers, battery and switch, and the system is complete. **3.50 ea.** CODE IC-9



**CB MIKE PREAMPLIFIER MODULE**  
Preamplifier which will increase CB modulation to optimum for more dependable transmissions. Drawing less than 1 milliamperes permits powering by any 1 1/2 Volt battery. **3.50 ea.** CODE MP-7

**EXPERIMENTERS SEMI-CONDUCTOR 38 Piece ASSORTMENT**  
2—Power transistors—to 3 case; 20—Germanium Diodes (General Purpose); 4 Each—PNP and NPN Transistors (General Purpose); 4—Silicon Rectifiers, Stud Mount, 2 Amp 200 PIV; 4—Zener Diodes, 3/4 Watt. Assorted Voltages 00 clearly marked **CODE EXP-38 3 kit**



\* WELL . . . SO WE EXAGGERATE A BIT!

CLIP OUT HERE AND MAIL TO:

GEM ELECTRONICS  PLEASE SEND  
Technical Industrial Park FREE CATALOGUE  
Plainview, Long Island, N.Y.

Please send items checked below:

CPO-4  PAA-2  PA-9  PH-7  
 TA-9  IC-9  MP-7  EXP-38

Enclosed is check or M.O. for \$ \_\_\_\_\_

Name \_\_\_\_\_

Address \_\_\_\_\_

City \_\_\_\_\_ State \_\_\_\_\_ Zone \_\_\_\_\_

occasions they can be logged at amazing distances. Given these circumstances, a station which normally is just a routine catch becomes a prize addition to your log.

Most BCB harmonics are heard between 1600 and 3200 kc, though such signals have been bagged as high as 49 meters. However, because low power (we trust) and low frequencies usually are involved, this is strictly a nighttime DX field.

To start, check the second multiples of the so-called graveyard channels. For the record, these multiples work out as 2460, 2480, 2680, 2800, 2900 and 2980 kc. Since myriads of U.S. stations operate on the fundamentals of these frequencies, evening BCB DX on these spots ordinarily is just plain impossible. But hunt for those second harmonics, and you just might find a few punching through around sunset or perhaps a little before.

With a little ingenuity, you should be able to verify about half your harmonic loggings. And about 50 per cent of those stations that do QSL not only will appreciate your report but will say so, too. When reporting, never state that you picked up a harmonic as such. But clearly indicate the frequency you heard by underlining it, putting it in red or some such thing. Needless to say, you never should pass off harmonic reception as an ordinary BCB logging—not unless you want to join the cheat club.

**Those Rumor Mongers . . .** Speaking of cheats, it seems that hoaxing is one of the more popular DX sports these days. Fraudulent reception reports are one thing, but making up fictitious news about non-existent stations is as bad if not worse. And this is especially true when such info gets passed throughout the DX world.

Way it happens, the original report usually is sent to a station with an SWDX program (R. Sweden is one) where reporters aren't known by reputation and where one man's word is as good as the next. Once broadcast, the story frequently is picked up on all five continents and reprinted in numerous DX publications—depending on just how sharp their editors are (or aren't).

Probably the most glaring recent example of what we're talking about was the Yemeni

[Continued on page 112]



## Optimum Oscillators

Continued from page 94

quency—the maximum shift being a few kc.

We can't pin down L1's exact specifications because of the frequency and the parts layout (we suggest the layout in Fig. 6). The RF section of EI's 6-IN-1 CB SERVICE SET is a good example of where this 27 mc oscillator is used. Coil L1 is wound of No. 22 enameled wire on a Cambridge Thermionic slug-tuned coil form No. 1534-2-2. For the exact coil construction details, refer to the 6-IN-1 CB SERVICE SET and the Junior Ham Station stories.

For further information about designing and winding RF coils for other frequencies, refer to the Radio Amateur's Handbook (ARRL). A grid-dip oscillator also comes in handy—you just cut-and-try until the GDO dips at the frequency you want.

When the slug is completely out of the form, the circuit will not oscillate and Q1's collector current will be about 500 microamperes. As the slug is turned into the form, the collector current will rise to a maximum of about 2 ma, indicating oscillation.

Unlike the AF oscillator, the RF oscillator won't work above and below the design frequency if other components and voltage are off value. And be sure to mount the oscillator in a metal cabinet to avoid direct signal radiation.

While we don't claim these oscillators will work for everyone in every application, they do meet the need for something that can be thrown together quickly, even on a breadboard.

## CB Corner

Continued from page 103

erate *simultaneously* from one antenna just isn't practical.

For one thing, mismatch would waste signals on receive. Worse yet, the transmitter of one rig would feed power into the other receiver, possibly burning out some delicate coils.

Even so, there is a way to work out a two-on-one-antenna setup. Wire up a coax switch and you can switch one antenna manually between two or more sets with practically no loss or danger at all. Look one up in the catalogs; they're made by B&W.

## The Alhambra Affair

Continued from page 102

advertisers and that "a satisfactory public service is now being furnished."

The Station of the Stars again had managed to stay on the air. This "satisfactory public service" included, among other things, a lecture series on metaphysics, sponsored by the Royal Order of Tibet—George Adamski, lecturer.

For the record, Adamski's activities didn't stop with metaphysics. On November 20, 1952, somewhere near the height of America's flying-saucer bugbear, Professor Adamski claimed to have met and communicated with a Venutian in the California desert.

KMPC still is on the air today, a highly respected and successful broadcaster with some 37 years of continuous operation behind it. The station has many distinctions, among them a couple it no doubt would like to forget. Not only is it one of the few stations ever called on the FCC's carpet on the public-interest angle, but KMPC has the distinction of having been there twice.

## Codeless Hams

Continued from page 97

be the best place to put our codeless hams. We have heard of at least one proposal that would open 2 meters to codeless hams, but we do not believe this would be the most practical thing to do. Favoring this proposal, of course, is the fact that no treaty revisions would be required to make this band available to codeless hams.

Trouble is, the way things seem to be moving for CB, the current 11-meter band very well could be locked up tight as far as hobby-type operations are concerned. Should this happen, CBers would be left with millions of dollars worth of useless equipment. A better idea would be making part of 11 meters or part of 10 meters into a codeless ham band. Old CB equipment then would be usable as-is on 11 meters or it could be retuned easily for use on 10.

But regardless of where codeless hams eventually are put, the fact that they will exist seems reasonably certain. For now that the ball has started rolling, the big question is *when*—not *if*.

## The Listener

Continued from page 110

Cave bit. As originally carried by the Swiss Broadcasting Corporation, this tale went as follows:

"Yemeni Royalists are to begin transmissions shortly in French and English. At present the Royalists have available a 5-kw transmitter in a bullet-proof cave. The frequency is somewhere in the 41-meter band."

Now this sounds a trifle unbelievable even to a novice, assuming he gives it a little thought. After all, if that cave were bullet-proof, it also might be short-wave proof, too.

Just the same, one prominent NA SW editor got hold of this story, deleted the cave angle and made the thing sound quite legitimate. Why? Well, we won't even guess. But we are certain that many North American DX clubs could do with sharper blue pencils. In fact, if they don't start making a real effort to weed out hoaxes and dubious news tidbits, things soon may be as bad as they currently are in European DX circles.

As things stand, the only SWBC station EI knows for sure to be in Yemen is operated by the government at Sanah. Frequency varies from 5950 to 5985 kc, and DXers should try for it before 1700 EST.

**Difficult Reports . . .** Preparing reception reports can be a problem, especially for many programs transmitted by stations in Asia and North Africa. These broadcasts simply don't fit into any of the normal categories—news, classical music and so on. A good example is Radio Baghdad's transmission on 6155 kc beginning about 2130 or 2200 EST. This program is a mixture of chanting, talking and singing.

You *could* use a tape recorder, of course, but some stations won't take the time to monitor tapes. A better solution simply is to send the station a blow-by-blow account of what you heard during the broadcast. If there was chanting at a certain time, say so. If there was talking by a man, put that down. This certainly doesn't make for a spectacular report, but it can get the job done. ●

# GET ACQUAINTED OFFER!

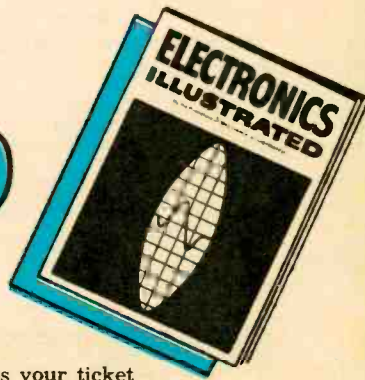

ELECTRONICS ILLUSTRATED  
Circulation Department  
Fawcett Building  
Greenwich, Connecticut 06830

3-65

**YES!** I want to take advantage of your special get-acquainted offer. Please enter my subscription right away.

- I enclose \$2.98       Bill me later  
 New order               Re-order

NAME .....

ADDRESS .....

CITY..... STATE..... ZIP.....

The coupon below is your ticket to the very best in hobby electronics—issue after issue of feature articles and construction projects certain to interest every electronic hobbyist, be he ham, CBer, SWL, hi-fi buff or general experimenter. Why not take advantage of this easy way to subscribe? Just fill in the coupon and drop it in the mail.

**10 issues  
for  
only \$2.98**



**MADE IN U.S.A.**

for Lifetime Service  
and Performance

# Buy Quality with Confidence—Compare! SOCKET WRENCH OUTFIT COMBINATION (2 Sets in 1) 1/4"-3/8" SQUARE DRIVE

EVERY PIECE MIRROR CHROME PLATED

**SATISFACTION  
GUARANTEED  
OR  
MONEY BACK**

**GUARANTEE**  
Unconditionally guaran-  
teed against defects  
in workmanship  
and material

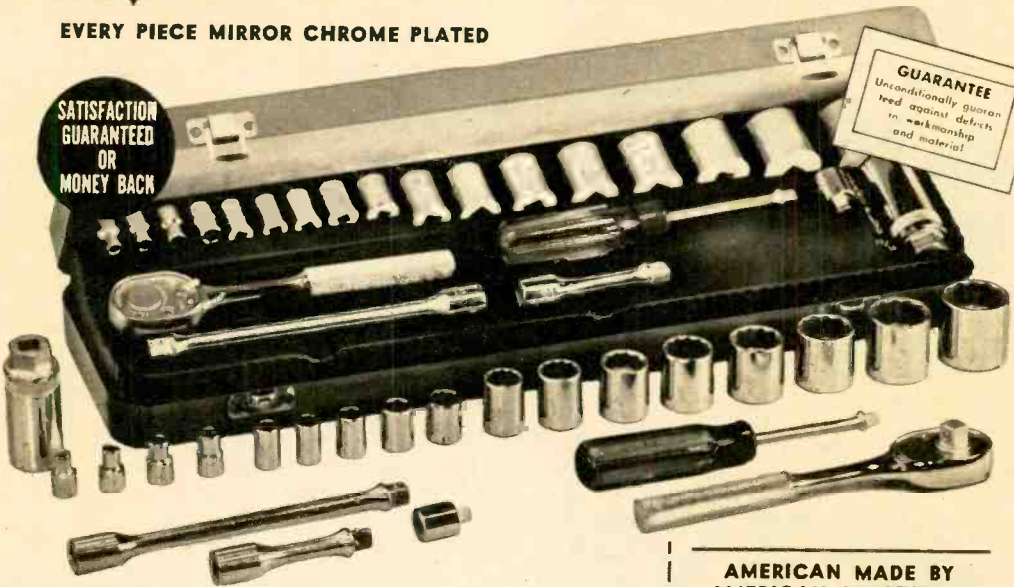

FOR CAR REPAIR



FOR HOME USE



FOR THE FARM

## MADE AND GUARANTEED BY THE WORLD'S LARGEST MANUFACTURER OF MECHANICS HAND TOOLS

Sizes range to 1-inch. Two sets in one promote a wide range of work. Will handle all nut and bolt sizes from 3/16" to 1". For radio, television, appliances, automobiles, motor boats, lawn mowers, farm maintenance, and thousands of other uses. Mirror-chromed steel sockets and attachments precision hardened for extra strength. Spark plug socket is neoprene lined to prevent plug cracking and dropping.

All fully guaranteed against defects in material and workmanship

**FILL IN COUPON AND MAIL TODAY!**

**AMERICAN MADE BY  
AMERICAN CRAFTSMEN**

## ONLY \$15.95

Including custom-fitted steel Tool Box  
If Each Piece Purchased Individually You Would Pay \$26.22!

### COMPLETE 24-PC. OUTFIT CONTAINS:

- |                              |                                   |
|------------------------------|-----------------------------------|
| 1/4" DRIVE ITEMS             | 6" Extension                      |
| Nine 6 point sockets         | Reversible Ratchet                |
| 3/16" to 1/2" Spinner Handle | 3/8" DRIVE Spark Plug Socket      |
| 3/8" DRIVE ITEMS             | 3/8" to 1/2" Adaptor              |
| Eight 12 point sockets       | 9/16" to 1" Fitted Steel Tool Box |
| 3" Extension                 |                                   |

HAMILTON HOUSE, DEPT. 13L-3, COS COB, CONN. 06807

I am enclosing \$15.95. Please send a complete 24-piece Socket Wrench Outfit and be sure to include the Custom-Fitted Steel Tool Box. It is understood that I must be completely satisfied or I will obtain an immediate refund. Enclosed find \$ .....

NAME .....

ADDRESS .....

CITY ..... STATE ..... ZIP .....

# Olson

\* **FREE**

\*  
Fill in coupon for a 'FREE One Year Subscription to OLSON ELECTRONICS' Fantastic Value Packed Catalog—Unheard of **LOW, LOW PRICES** on Brand Name Speakers, Changers, Tubes, Tools, Stereo Amps, Tuners, CB, and other Values. Credit plan available.

NAME \_\_\_\_\_  
ADDRESS \_\_\_\_\_  
CITY \_\_\_\_\_ ZONE \_\_\_\_\_ STATE \_\_\_\_\_

If you have a friend interested in electronics send his name and address for a FREE subscription also.

**OLSON ELECTRONICS**  
INCORPORATED

350 S. Forge Street Akron, Ohio 44308

## WANT A JOB? PART TIME— FULL TIME?

**No Boss! No Experience!**

**No Capital! Your Own Hours!**

### WHAT A JOB ! ! ! !

And yet selling subscriptions to **ELECTRONICS ILLUSTRATED** and other leading publications is just like being in business for yourself.

But no business requires less capital, stock and space. The time you devote and the money you make is up to you. You need no experience to earn steady profits and you keep a cash commission on every sale. You operate in your own community by phone or personal calls. You will be authorized to sell new and renewal subscriptions along with special offers made by the publishers. You'll be amazed at the number of people wanting to take advantage of the convenience, service and savings you can offer them.

To get started immediately—send us your name (on a postal card) requesting *free* supplies and selling materials.

**Write to:** Subscription Dept. DE  
**ELECTRONICS ILLUSTRATED**  
Fawcett Bldg., Greenwich, Conn. 06830

## The Ham Shack

Continued from page 83

In one case, a chap in Italy had a long talk with a confrere in California about the resale and shipment of some animals to a zoo out there, with much detail about peanuts and other food for the beasts en route. And then there was the lad in Florida who spent ten minutes discussing a shipment of merchandise with a salesman in a New York store. Not good, fellers, not good.

**Free Plug . . .** Don't fret if you didn't get to the New York World's Fair this year. Come next year, and you still can see the sights and operate station K2US in the Coca Cola Building. Better yet, as a bonus, you can sit in at the ham station in the lobby of Manhattan's Hotel Rutledge, 30th Street and Lexington Avenue. Manager Stan Doben even is willing to give you a cut in the regular room rates—if you show your ticket when you register. Good deal, eh?

**Boomerang . . .** Funny how some complaints to the FCC about amateur interference bounce back to the complainant. Latest case we've heard about involved a beef to the Commission's San Francisco office. Seems radio and TV reception in an Oakland apartment house was being blanketed.

Interesting thing here is that "blanketed" proved the perfect word. The trouble eventually was traced to a defective thermostat in an electric blanket owned by . . . guess who? The complainant, natch! —

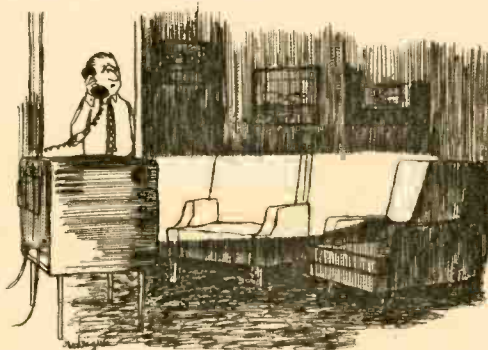

"It's about that picture-brightener you put in. . ."



*Continued from page 54*

ance you want. And don't worry about that famous hole-in-the-middle business. If your speakers are in phase and if the high-frequency dispersion is all it should be, extra-wide separation of speakers won't produce exaggerated stereo.

Oh, just one more thing. Try to get as healthy a distance as possible between you and your speakers. The farther away you get from any speaker, the less like a mechanical contraption—and the more like music—it usually will sound.

A couple of columns back I talked about the sudden flood of fine-sounding speakers now found around the \$50 notch. But to reassure anybody who's itching to spend a year's pay on audio gear, let me announce that the newest speaker I've heard weighs in at a cool \$1690.

For that trifling consideration you get the Acoustech Ten. No squeak-easy this. It is comprised of a matched pair of full-range electrostatic speakers, each with two built-in solid-state amplifiers (one for each end of the frequency range). Like the Sigma Transcendent and the KLH Model Nine, the new Acoustech is tall, slim and room-dividerish in appearance. Sound good?

Setting up a spanking-new stereo rig for a non-technical friend of mine the other day, I was asked which record companies make the best-sounding stereo records. Now there's a tricky question — particularly since the sound of an individual disc may be affected by anything from the temperature of a recording studio to what the engineer had for breakfast.

Nevertheless, some companies rate high marks for consistently good recordings. To my way of thinking, the most dependable of the big outfits is London. Their orchestral discs truly are outstanding, always seeming to sound rich, spacious and detailed, all at once. I'd put Deutsche Grammophon next, mainly because their discs sound almost as though they were pressed on silk instead of vinyl. Among the smaller independents, I'd give the palm to Vanguard, Elektra and Connoisseur Society (those 45-rpm LP's). Anyone want to argue?

*[Continued on page 116]*

## SOLDERING TIPS FOR HI-FI KIT BUILDERS

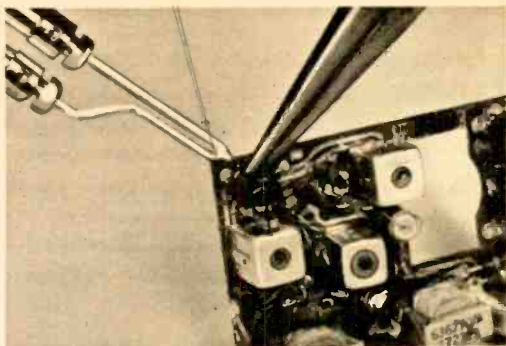

### AVOID TOO MUCH HEAT

High heat can damage components. Use low heat for soldering, and a pair of long-nose pliers to hold the wire. Pliers act as a heat sink and prevent overheating.



### USE A DUAL HEAT GUN

A Weller Dual Heat Gun has 2 trigger positions. One provides low heat for electronic connections; the other gives high heat when needed. You switch instantly to the right temperature for the job.

The greatest time-saver in hi-fi kit building is a Weller Dual Heat Gun. Tip heats instantly . . . no waiting. Spotlight illuminates your work. Long reach tip gets into tight spots and permits soldering with pinpoint accuracy.

A Weller "Expert" Kit includes 100/140 watt dual heat gun, 3 soldering tips, tip-changing wrench, flux brush, soldering aid and solder, in a plastic carrying case. Model 8200PK—\$8.95 list. Weller Electric Corp., Easton, Pa.

# Weller®

WORLD LEADER IN SOLDERING TECHNOLOGY





## Electronic Scouts

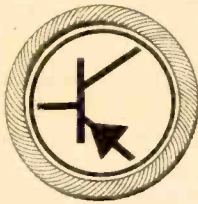

**M**OST EVERYONE knows about the Merit Badges that Boy Scouts can earn. But one thing the Boy Scouts of America seemingly hasn't known about is electronics, and non-Scouters only can wonder why.

Way things stood, a Scout could try for a Merit Badge in everything from agriculture to zoology—everything, that is, save electronics. But with the addition of electronics as one of the 106 Merit-Badge subjects, the Scouts appear fully to have entered the Twentieth Century at long last.

Each would-be Merit-Badge earner must satisfy his counselor that he successfully can meet the published requirements for a specific Badge before it will be granted. In the case of the new Electronics Merit Badge, the applicant must

1. (a) Show how to read a schematic diagram.
- (b) Draw a simple circuit and label all components using correct schematic symbols.
- (c) Explain the purpose of the components in the circuit.
2. (a) Explain the proper method of soldering and unsoldering electronic parts.
- (b) Wire the circuit drawn in Requirement 1 on a chassis or breadboard.
- (c) Explain to the counselor how to avoid heat damage to the components.
3. Do one of the following:
  - (a) Remote-control application: Explain how an electronic circuit can be used for remote control. Suggested circuits: use of an electric eye in opening doors; use of a switch and relay with a transistor circuit to control a model-train system; use of a transmitter to control the flight of a model plane; use of a simple audio oscillator in a toy electronic organ. The device must be built.
  - (b) Electronic-brain application: Explain the binary number system. Make up and work out five problems in addition and subtraction. Convert the binary to the decimal system. Build a simple flip-flop circuit, using either transistors or tubes. Demonstrate the circuit to the counselor.
4. Discuss the job opportunities in the field of electronics.

# COLOR CODED NUTDRIVER SETS

no fumbling...  
you reach for  
the right one  
every time!



No. 17  
HANDY  
BENCH STAND

- 7 Most-used sizes —  $\frac{3}{16}$ " thru  $\frac{3}{8}$ " • High carbon steel, polished and plated • Precision fit case-hardened sockets
- Shockproof plastic handles (UL) • Large, readable size indexes

No. 127  
SPACE-SAVING  
WALL RACK  
(Lockable)

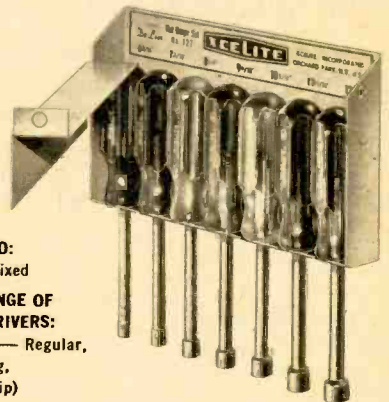

**OTHER SETS, TOO:**  
hollow-shaft or mixed

**PLUS A FULL RANGE OF  
SEPARATE NUTDRIVERS:**  
 $\frac{3}{32}$ " thru  $\frac{3}{4}$ " — Regular,  
Stubby, Extra-long,  
Midget (Pocket clip)

available through leading electronic distributors

# XCELITE®

XCELITE INC. • 16 BANK ST., ORCHARD PARK, N. Y.  
Send free literature on nutdriver sets.

name \_\_\_\_\_

address \_\_\_\_\_

city \_\_\_\_\_

state & zone \_\_\_\_\_

Continued from page 57

# DYNAKIT high fidelity



SCA-35  
stereo amplifier—\$99.95

For the cost-conscious perfectionist

- AMPLIFIERS • TUNERS
- PREAMPLIFIERS

Write for detailed specifications  
and impartial test reports

DYNACO INC., 3912 Powelton Ave., Phila. 4, Pa.  
 Please send specifications and test reports to:  
 Name .....  
 Address .....  
 City ..... State.....

## FOR SPEEDY SERVICE

1102171 647 98 24 0664  
 T M BROWN  
 5936 23rd PARKWAY  
 WASHINGTON, D. C. 20031

## WE'RE LOST WITHOUT THIS LABEL

Well, not really lost — but we can do things faster for you if you send along the ADDRESS LABEL from your magazine any time you write to us about your subscription.

### CHANGE OF ADDRESS

If you're moving, please let us know six weeks before changing your address. Better still, attach the magazine address label to this form, and print your new address here.

name \_\_\_\_\_  
 street \_\_\_\_\_  
 city \_\_\_\_\_ state \_\_\_\_\_ zip \_\_\_\_\_

attach  
label  
here

ELECTRONICS ILLUSTRATED Sub. Dept., Greenwich, Conn. 06830

The next thing to bear in mind is that the crude coming out of the ground contains not only oil, but natural gas and water as well. It is a fairly easy matter to separate the gas and the liquid right at the site, but the oil company also wants to know just how much water there is in the crude it buys.

With the installations currently in use, the desired information is gathered electronically, stored at the site until needed, then sent to the central station on request. There it is read out automatically on a teletypewriter.

The automatic well tester is called a cut recorder. This device simply records the amount of water in the crude, using electrostatic principles. The dielectric constant of the oil goes up with the addition of water, and this is measured by a phase null indicator.

When the central station wants information on the well in question, it interrogates the cut recorder by wire, and the answer comes back to the station by wire. At the central station the data is fed into a computer, which in turn actuates a teletypewriter for printing the figures.

In the custody transfer system, the computer also totals the amount of oil going from leases into a pipeline (which is a common carrier, like a railroad tank car or a sea-going tanker). The computer pro-rates the payment among the various leases, depending upon the figures derived from the automatic well tests. The computer actually writes the checks, thus making every aspect of the extraction process completely automatic.

Even the laboratories of many an oil company house a strange complex of electronic instrumentation, mostly for some aspect of analytical chemistry.

Nucleonic techniques also are used widely in the petroleum industry. At Shell Development, for example, there are both electron and deuteron accelerators, used for the creation of radioactive particles. Along with these we find the instruments common to nuclear work, such as scalars, counters and rate meters.

In short, as we already have noted, there is almost no end to electronics in the oil industry. Few ever would guess it, but electronics' role in black gold is staggering. And it's growing bigger day by day.



## Logging Illegal DX

Continued from page 71

set up on a brute-force basis and don't suffer much from the odd offband broadcaster.

But services relying on mobile transmitters—aeronautical, marine and land mobile—obviously are of an entirely different nature.

A skeptic might predict nothing will be done about this situation until it does cause a disaster. Only then would real international pressure be put on the offending nations to cease offband operations and behave as proper citizens. And even if such an event did occur, it's doubtful that the Commies, to mention only one group, would end all illegal broadcasting.

Meanwhile, of course, DXers can take advantage of this bit of international free-for-all'ing by trying for some of the offband broadcasters. Assuming a QSL is the goal, it's best to submit a routine report (but with the frequency clearly indicated) on the chance that the station will reply. If lucky, you will find yourself with a gem of sorts—a quirky kind of QSL bearing an offband frequency, much as a misprinted stamp might contain an erroneous figure or letter.

And even if a particular station chooses to ignore your report, there's no need to be dismayed. After all, once you know the exact frequencies where all SWBCing is supposed to take place, logging illegal DX becomes relatively easy. It'll take some careful digging, but you'll be surprised at just how much abundance in the not-so-free spaces between the legal SWBC bands. —Alex Bower

THE SHORT-WAVE BROADCAST BANDS		
DESIGNATION	FREQUENCIES (kc)	REMARKS
120 meters	2300-2495	Tropics only
90 meters	3200-3400	Tropics only
75 meters	3900-4000	Africa, Asia, Europe and W. Pacific only
60 meters	4750-5060	Tropics only
49 meters	5950-6200	
41 meters	7100-7300	Africa, Asia, Europe and W. Pacific only
31 meters	9500-9775	
25 meters	11700-11975	
19 meters	15100-15450	
16 meters	17700-17900	
13 meters	21450-21750	
11 meters	25600-26100	

## need reliable service data?

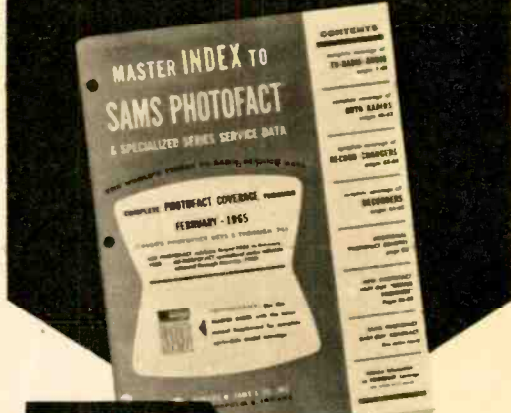

**FREE** SEND TODAY FOR YOUR VALUABLE

## INDEX to PHOTOFACT®

your instant handy guide to the  
WORLD'S FINEST ELECTRONIC SERVICE DATA

covers over 58,000 listings of:

- TV Receivers
- Home & Auto Radios
- Hi-Fi & Phonos
- Tape Recorders
- CB Radios
- Record Changers

Send today for this valuable 78-page guide covering virtually every model of home-entertainment electronic equipment produced since 1946! Helps you locate the proper PHOTOFACT Folder to quickly solve any service problem in any model. Available from your local Parts Distributor, PHOTOFACT provides everything needed for quick, effective repairs in complete, uniform style: Famous Standard Notation Schematics packed with the service details you need; Full Photo Coverage of all chassis views; Complete Replacement Parts Lists; Tube Placement Diagrams; Adjustment Instructions; CircuitTrace® for printed boards; Disassembly Instructions; Dial Cord Diagrams; Changer and Recorder "Exploded Views"—plus dozens of other great features. Send coupon for your FREE copy of the latest PHOTOFACT Index to the service data you need!

MAIL COUPON TODAY!

**HOWARD W. SAMS & CO., INC.**

Dept. EIF-3  
4300 W. 62nd St., Indianapolis, Ind. 46206

Send me FREE Photofact Index to Service Data for over 58,000 listings

Name \_\_\_\_\_

Address \_\_\_\_\_

City \_\_\_\_\_ Zone \_\_\_\_\_ State \_\_\_\_\_

# ELECTRONICS ILLUSTRATED

## Classified Ads

Your advertisement can reach this mail-buying audience for only 50¢ per word . . . payable in advance (Check or M.O. please) . . . minimum 10 words. Closing dates are the 20th of 4th preceding month i.e. copy for the July issue must be in our office by March 20th. Mail to ELECTRONICS ILLUSTRATED, 67 West 44th St., New York 36, N. Y.

### • • • FOR SALE

**JEEPS**—\$62.50, **TRANSMITTERS**—\$6.18, Typewriters—\$4.15, Walkie-Talkies, Oscilloscopes, Multimeters. Typical Government Surplus Prices. Exciting Details Free. Enterprises, Box 402-P51, Jamaica 30, New York.

**JAPAN & HONG Kong Electronics Directory.** Products, components, supplies. 50 firms—just \$1.00. Ippano Kaisha Ltd., Box 6266, Spokane, Washington 99207.

**INVESTIGATORS, FREE Brochure,** latest subminiature electronic surveillance equipment. Ace Electronics, 11500-X NW 7th Ave., Miami 50, Florida.

**NEW SUPERSENSITIVE transistor locators** detect buried gold, silver, coins. Kits, assembled models. \$19.95 up. Underwater models available. Free catalog. Relco-A19, Box 10563, Houston 18, Texas.

**CONVERT ANY television** to sensitive, big-screen oscilloscope. Only minor changes required. No electronic experience necessary. Illustrated plans, \$2.00. Relco-A19, Box 10563, Houston 18, Texas.

**CANADIANS—GIANT Surplus Bargain Packed Catalogs.** Electronics, Hi-Fi Shortwave Amateur Citizens Radio. Rush \$1.00 (Refunded). ETCO, Dept. EI, Box 741, Montreal.

**GOVERNMENT SURPLUS.** How and Where to Buy in Your Area. Send \$1.00. E.I. Surplus Information, Headquarters Bldg., Washington 6, D. C.

### • • • BUSINESS OPPORTUNITIES

**BIG MONEY—Operate your own fix-it shop.** Service all household appliances: irons, fans, refrigerators, automatic washer-dryers, etc. Know how they work, what goes wrong, and how to fix them. Learn how to do house wiring, commercial wiring, rewind motors of all sizes, sharpen mowers, skates, saws. How to get business, buy spare parts wholesale. What to charge for your work. Free Book. Christy Trades School Inc., Dept. A-813, 3214 W. Lawrence Ave., Chicago, Ill. 60625

**VENDING MACHINES—No selling.** Operate a route of coin machines and earn high profits. 32-page catalog free! Parkway Machine Corp., 715E1 Ensor St., Baltimore 2, Md.

**HIGH WEEKLY Earnings!** Address—mail letters featuring real merchandise. Get \$10 with every order—keep \$8 profit. Supplies furnished. Free particulars. Modern Merchandising, Box 357, Oceanside, New York.

**INVESTIGATE ACCIDENTS.** Earn \$750 to \$1,100 monthly. Men urgently needed. Car furnished. Expenses paid. No selling. No college education necessary. Pick own job location. Investigate full time. Or earn \$8.44 hour spare time. Write for Free Literature. No obligation. Universal, CEE-3, 6801 Hillcrest, Dallas 5, Texas.

**\$50 PER 1000 POSSIBLE.** Addressing 1000 envelopes. Longhand-typewriter. Home—spare time. Free particulars. General Enterprises, Box 303, Island Park, New York.

**FREE REPORT:** "609 Unusual, Successful Businesses." Box 122-ELB, Wheeling, Illinois.

### • • • EMPLOYMENT OPPORTUNITIES

**PRINTING - ADVERTISING SALESMEN.** Excellent money-making sideline selling Decalcomania Name Plates. Advertising Specialties. Sign Letters, Automobile initials. Free Samples. "Ralco"—EI, Box L, Boston 19, Mass.

### • • • EDUCATION & INSTRUCTION

**MONEY BACK Guarantee—C.I.S.T.—The World Wide Institute of Home Study**—34 global centres—260 courses—Engineering, Electronic, Academic and Commercial—send for your Free 100 page copy of "Career Opportunities" today—No salesman will call. C.I.S.T., 626 Garden City Building, 263 Adelaide St. W., Toronto, Canada.

**ELECTRONICS CAREER—F.C.C. License Training.** Correspondence, or resident classes. Free details. Write: Dept. 8, Grantham Schools, 1505 N. Western, Hollywood, Calif. 90027.

### • • • BUILD IT-DO IT YOURSELF

**AUTOMATIC WASHER Repair Manuals** on Norge, Hamilton, General Electric, Hotpoint, RCA Whirlpool, Kenmore, Westinghouse, Frigidaire, Kelvinator, \$2.25 ppd each. Major Appliance, 13106 Caine Avenue, Cleveland, Ohio 44105.

**PROFESSIONAL ELECTRONIC Projects—Organs, Timers, Computers, etc.,—\$1 up.** Catalog #8 Free. Parks, Box 1665, Seattle, Wash. 98125

### • • • TAPE RECORDERS

**LEARN WHILE Asleep** with your recorder, phonograph or amazing new "Electronic Educator" endless tape recorder. Details free. Sleep-Learning Research Association, Box 24-EI, Olympia, Washington.

**TAPE RECORDERS Hi-Fi Components.** Sleep Learning Equipment, tapes. Unusual values. Free Catalog. Dressner, 1523 Jericho Tpke., New Hyde Park-4, N. Y.

**RENT STEREO Tapes—over 2500 different**—all major labels—free brochure. Stereo-Parti, 1616-AY Terrace Way, Santa Rosa, California.

**FREE! TAPE Recording Handbook.** Sarkes Tarzian's Galaxie tape. Pofe, 1716-EL Northfield, Muncie, Indiana.

### • • • RADIO & TV

**BEFORE YOU Buy** Receiving Tubes, Test Equipment, Hi-Fi Components, Kits, Parts, etc. . . . send for your Giant Free Zalytron Current Catalog, featuring Standard Brand Tubes: RCA, GE, etc.—all Brand New Premium Quality Individually Boxed, One Year Guarantee—all at Biggest Discounts in America! We serve professional servicemen, hobbyists, experimenters, engineers, technicians. Why Pay More? Zalytron Tube Corp., 469-L Jericho Turnpike, Mineola, N. Y.

**TV TUNERS** rebuilt and aligned per manufacturers specification. Only \$9.50. Any make UHF or VHF. We ship COD. Ninety day written guarantee. Ship complete with tubes or write for free mailing kit and dealer brochure. JW Electronics, Box 51K, Bloomington, Indiana.

**FREE ELECTRONICS Catalog,** Tremendous Bargains. Electrolabs, Department C-563AE, Hewlett, New York 11557.

**McGEE RADIO Company.** Big 1965 176 Page Catalog Sent Free. America's Best Values, Hi-Fi—Amplifiers—Speakers—Electronic Parts. 1911 McGee Street, Dept. EI, Kansas City 8, Missouri.

**SUPER CRYSTAL Set Plans—30¢.** Charley's Shop, Box 11-E, Skidway Lake, Mich. 48756

**RADIO & T.V. Tubes—33¢.** Free List. Cornell, 4213-15 University, San Diego, Calif. 92105.

**FREE SPRING Catalog!** Bargains galore, that's what's in store! We'll send you latest 8-page flyer listing semiconductors, parts and paks, including giant \$1 special sale. Poly Paks, P.O. Box 942E1, So. Lynnfield, Mass.

**15 DISTANCE ONE-TUBE Plans—25¢;** One-tube Handbook—50¢. Includes Transistor experiments, a catalog. Laboratories, 1131-K Valota, Redwood City, California.

**DIAGRAMS FOR repairing radios \$1.00.** Television \$2.50. Give make model. Diagram Service, Box 1151E1, Manchester, Conn. 06042.

**\$1.00 DELIVERS PLASTIC Packets for 60 QSL's.** Teapabco, Browne St., Gallatin, Tennessee.

### • • • INVENTIONS & INVENTORS

**INVENTORS! WE** will develop, sell your idea or invention, patented or unpatented. Our national manufacturer-clients are urgently seeking new items for highest outright cash sale or royalties. Financial assistance available. 10 years proven performance. For Free information write Dept. 59, Wall Street Invention Brokerage, 79 Wall Street, New York 5, N. Y.

**INVENTIONS—PATENTS—New Ideas—**Etc. Do your's have market? We will make preliminary determination free. Central Trust Company, 4344 East Indian School Road, Suite 4 EI, Phoenix, Arizona 85018.

### • • • DETECTIVES

**DETECTIVES—EXPERIENCE Unnecessary.** Detective Opportunities. Write, Wagner, B-125 West 86th, New York 24.

### • • • MUSIC

**ACCORDIONS, GUITARS, Band Instruments!** Save 1/2. Famous makes, free home trial. Easy terms. Trades. Free discount catalogs. Mention instrument. International Music Mart, Dept. EL-35, 5535 Belmont, Chicago, 41

**DISCOUNT RECORDS—All Labels—Free List—Write Cliff House, Box 42-D, Utica, N. Y.**

### • • • ROCKETS

**ROCKETS: IDEAL** for miniature transmitter tests. New illustrated catalog 25¢. Single and multistage kits, cones, engines, launchers, trackers, technical information, etc. Fast service. Estes Industries, Penrose 13, Colorado.

### • • • MISCELLANEOUS

**FREE SONG "Hit" Copy** to you, five friends. Send names, addresses: Nurdyke Songs, 6000-31 Sunset, Hollywood, California 90028.

**TREASURE, GOLD, Silver, Relics.** Find them with new 1965 models. Free information. Rayscope, Dept. 3-L, Box 715, North Hollywood, California.

**RAY GUN—Want to build a Laser?** You can build one for about \$100. Complete blueprints and directions, \$9.95. M. J. Research Co., Dept. EL, 7110 Cedar, Shawnee Mission, Kansas.

**WINEMAKERS—MAKE Strongest Brews Yourself!** Booklet of Formulas, \$2.00. (Supplies, Hydrometers, Equipment Headquarters.) Research Enterprises, 29-B5 Samoset Road, Woburn, Mass.

**ANSWERS TO Questions** in transistor theory. 10¢ per answer. Answers #15, 4513 Clara St., Bell, Calif.



# OVER AND OUT

BY *Rodrigues*



"She wants to know if phase shift in the inverter could be causing acoustic feedback."

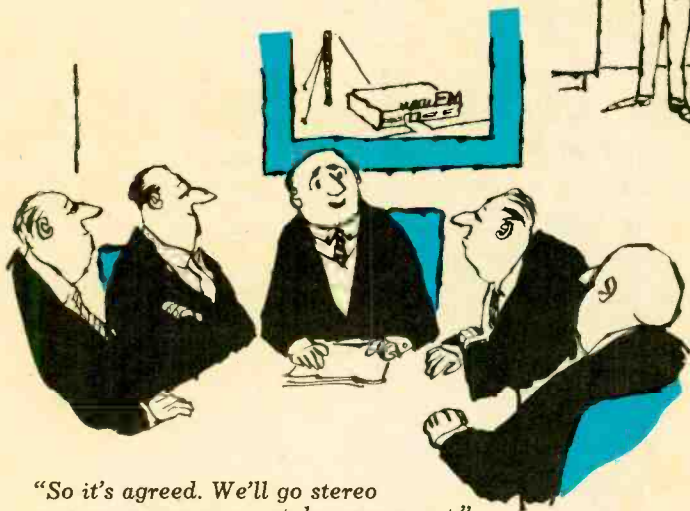

"So it's agreed. We'll go stereo as soon as our mono stylus wears out."



"We're having a little stereo trouble. Will somebody please call and tell me whether my voice is coming from the right or left speaker?"

"Yes, sir, that's JUST what you need for these records. A de-multiplexer stylus."

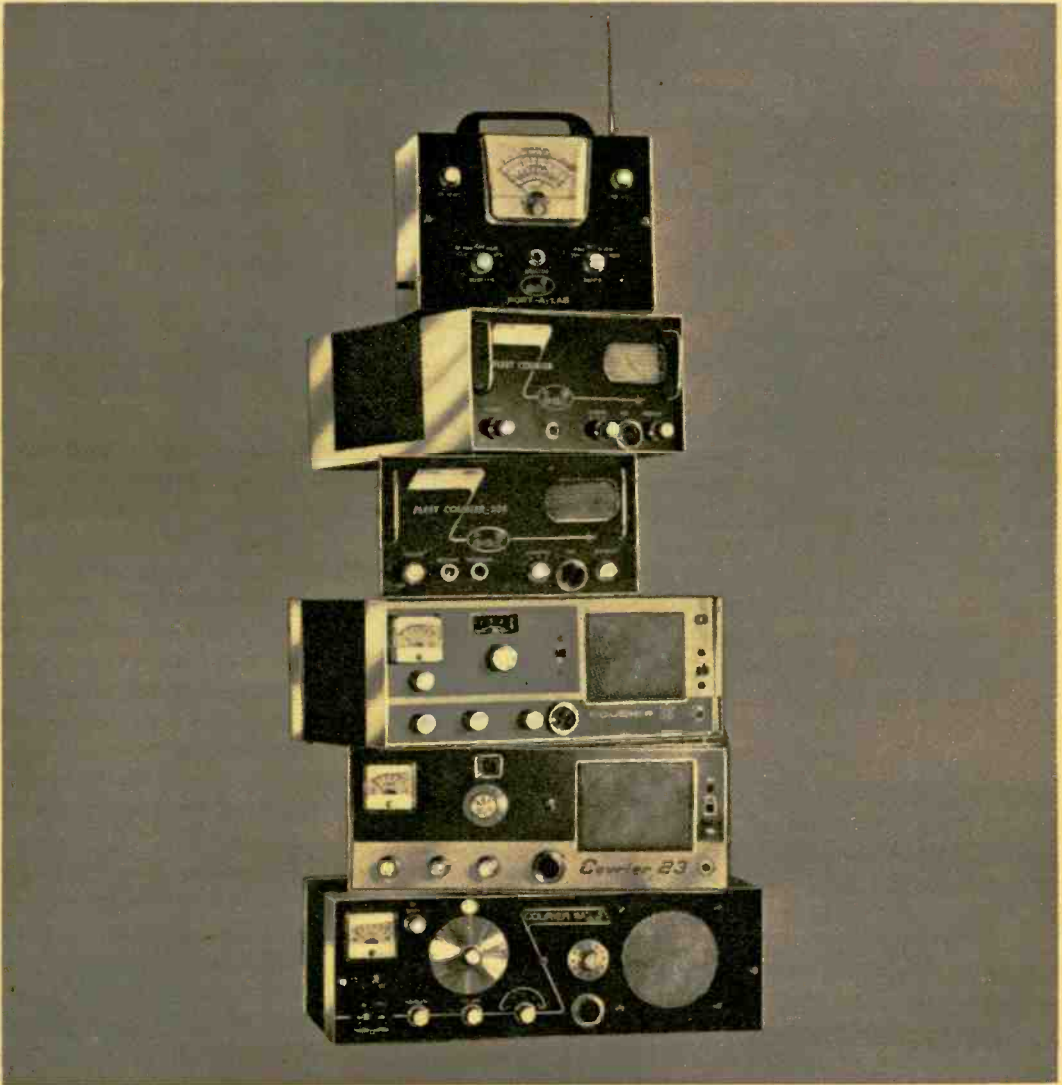

## REALLY STACKED!

From top to bottom. . . Port-A-Lab, Fleet Courier 30B Business Band Radio, Courier 12, Courier 23 and Courier 1M. All loaded with famous e.c.i. quality features that make us the leader. You name it, e.c.i. rigs have the built-in plus features

you demand . . . 23 channel operation, triple conversion, transistor power supply, PA system, chrome cabinet. Compare. We'll stack 'em up against any rig, so will you. e.c.i. 2 way radios are from \$109.50. See your dealer or use the coupon.

Name .....

Address .....

City ..... State .....



**electronics communications, inc.**  
56 hamilton ave., dept. EI 1, white plains, n. y.



**PROJECT APOLLO LUNAR ORBIT RENDEZVOUS MISSION**

The Lunar Excursion Module of NASA's Project Apollo will carry two men from lunar orbit to the moon's surface and, after brief exploration, back to the mother craft for return to earth.

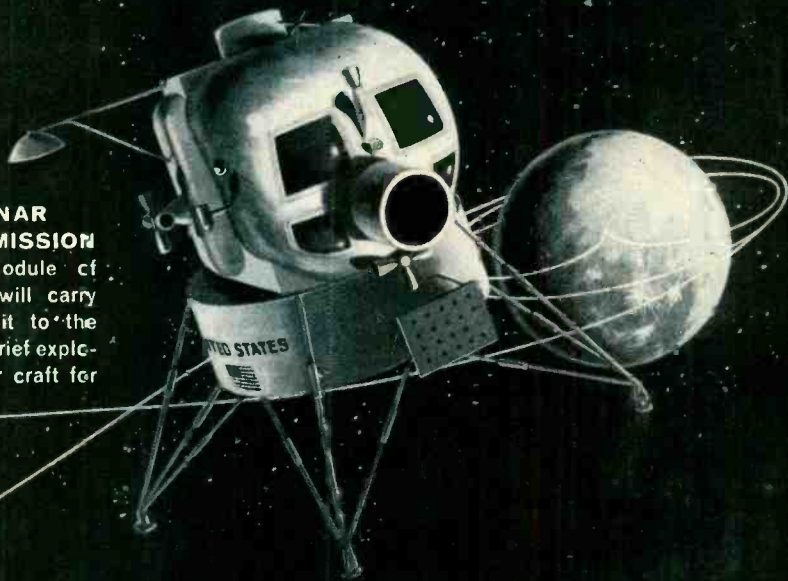

# Has the Space Age outdated your knowledge of Electronics?

TURN PAGE  
FOR ANSWER



For **FREE BOOK**  
and complete  
information about  
**CREI Programs**,  
mail postpaid  
air mail card  
today.

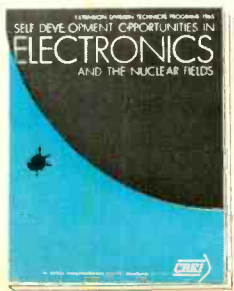

First Class

Permit No. 288-R

Washington, D. C.

**BUSINESS REPLY MAIL**

NO POSTAGE STAMP NECESSARY IF MAILED IN UNITED STATES

**VIA AIR MAIL**

Postage will be paid by



**THE CAPITOL RADIO ENGINEERING INSTITUTE**

3224 Sixteenth Street, N.W.

Washington, D. C. 20010



# Protect your future through the New CREI Program in Space Electronics

For a career in space electronics you must acquire considerable new knowledge—knowledge that just didn't exist when you studied electronics. And, because developments in space electronics are quickly applied to other areas of electronics, knowledge of space electronics is an asset to a man in any field of electronics.

You can protect your future through the new CREI Program in Space Electronics which offers you up-to-date knowledge of these specialties:

**SPACE DATA SYSTEMS**—Includes analog and digital computers, information theory, data acquisition and processing.

**SPACE TRACKING SYSTEMS**—Includes microelectronics, space propagation, masers, lasers, infrared techniques.

**SPACE GUIDANCE & CONTROL**—Includes inertial navigation, space radar, star tracker systems, tracking networks.

- The first extension programs developed specifically to help men in electronics apply their experience to the space effort.
- Content developed to meet employment requirements as determined by consulting government and private organizations in the space field.
- Text material prepared in leading space-oriented organizations.

CREI also offers specialized education in these important areas of electronics: Communications, Aeronautical and Navigational, Television, Automation and Industrial, Nuclear, Servomechanisms and Computers. You are eligible for these programs if you work in electronics and have a high school education.

**FREE BOOK GIVES FULL INFORMATION ON CREI PROGRAMS.** For your copy, mail postpaid card or write: CREI, Dept. 1703-C, 3224 Sixteenth Street, N. W., Washington, D. C. 20010

What happens to transistors in the Van Allen Belt? How are vacuum tubes used in space? Why can't regular lubricants be used on moving parts in a spacecraft? To what extent has the space effort changed reliability standards?

These and other questions reflect the changes taking place with space applications of electronics. Project Apollo and other missions in the space effort are rapidly outdated conventional concepts

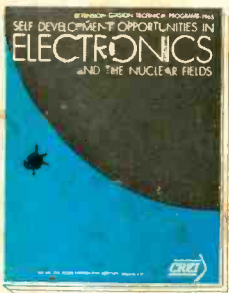

## The Capitol Radio Engineering Institute

Dept. 1703-C, 3224 Sixteenth St., N. W.  
Washington 10, D. C.

Founded 1927, Accredited Member of the National Home Study Council

Please send me FREE book describing CREI Home Study Programs including new Program in Space Electronics. I am employed in electronics and have a high school education.

For **FREE BOOK** and complete information about **CREI Programs**, mail postpaid air mail card **today.**

Name \_\_\_\_\_ Age \_\_\_\_\_

Address \_\_\_\_\_

City \_\_\_\_\_ State \_\_\_\_\_ Zip Code \_\_\_\_\_

Employed by \_\_\_\_\_

Type of present work \_\_\_\_\_