

Short-Wave Listener's Guide to Communist Propaganda Broadcasts

# ELECTRONICS ILLUSTRATED

By the Publishers of MECHANIX ILLUSTRATED

MAY • 35¢

**BUILD:**

**N-C BATTERY CHARGER**

**CB DIP METER**

**TAPE LOAD BOX**

**PTT RELAY FOR CB**

**FET SIGNAL TRACER**

**AUDIO GENERATOR**

**COMPLETE PLANS for  
Remote-Control Transmitter  
and Receiver for  
Model Cars, Boats, Planes**



ADDRESS 643 980012 1161  
WILLIAM B DUNLAP  
1803 AUGUST DR  
SILVER SPRING MD

# RS OF LEADERSHIP for Radio-Television



## SPECIAL CUSTOM DESIGNED TRAINING EQUIPMENT INCLUDED

Since NRI pioneered equipment units to provide ACTUAL ON-THE-JOB EXPERIENCE in home training, NRI instructors have invested many thousands of man hours in testing, changing, retesting, improving NRI equipment to simplify and speed training. Unlike other schools "stock" or "standard" equipment is not good enough. NRI equipment is custom designed EXCLUSIVELY FOR TRAINING. It demonstrates theories, circuit action, defects; you get experience in operation, maintenance, trouble shooting.

## These Men Trained for Success with NRI—YOU CAN, TOO



"I want to thank NRI for making it all possible," says Robert L. L'Heureux of Needham, Mass., who sought our job consultant's advice in making job applications and is now an Assistant Field Engineer in the DATAmatic Div. of Minneapolis-Honeywell, working on data processing systems.

His own full-time Radio-TV Servicing shop has brought steadily rising income to Harlin C. Robertson of Oroville, Calif. In addition to employing a full-time technician, two NRI men work for him part-time. He remarks about NRI training, "I think it's tops."



Even before finishing his NRI training, Thomas F. Favaloro, Shelburne, N.Y., obtained a position with Technical Appliance Corp. Now he is foreman in charge of government and communications divisions. He writes, "As far as I am concerned, NRI training is responsible for my whole future."

"I can recommend the NRI course to anyone who has a desire to get ahead," says Gerald L. Roberts, of Champaign, Ill., whose communications training helped him become an Electronic technician at the Coordinated Science Laboratory, U. of Illinois, working on Naval research projects.



**NATIONAL RADIO INSTITUTE**  
Oldest and largest school of its kind



## Choose From NRI'S Specialized Instruction Plans

### 1 Television-Radio Servicing

Learn to fix black-and-white and color sets, AM-FM radios, stereo hi-fi, etc. A profitable field for part or full-time business of your own.

### 2 Industrial-Military Electronics

Learn Principles, Practices, Maintenance of Electronics equipment. Covers computers, servos, telemetry, multiplexing, other subjects.

### 3 Complete Communications

A comprehensive program for careers in broadcasting or mobile, marine, aviation communications. Learn to operate, maintain transmitting equipment. Prepares for FCC license.

### 4 FCC License

Prepares you quickly for First Class license exams. Every communications station must have licensed operators. Also valuable for Service Technicians.

### 5 Math for Electronics

A short-course of carefully prepared texts going from basic arithmetic to graphs and electronic formulas. Quick, complete, low in cost.

### 6 Basic Electronics

Abbreviated, 26-lesson course covering Automation-Electronics, TV Radio language, components, principles. Ideal for salesmen, hobbyists, others.

### 7 Electronics for Automation

For the man with a knowledge of basic electronics who wants to prepare for a career in process control, ultrasonics, telemetering and remote control, electromechanical measurement, others.

### 8 Aviation Communications

For the man who wants a career in and around planes. Covers direction finders, ranges, markers, loran, shoran, radar, landing system transmitters. Prepares for FCC license.

### 9 Marine Communications

Learn to operate, repair transmitters, direction finders, depth indicators, radar, other Electronic equipment used on commercial and pleasure boats. A growing, profitable field. Prepares for your FCC license.

### 10 Mobile Communications

Learn to install, operate, maintain mobile equipment and associated base stations as used by police, fire departments, taxi companies, etc. Prepares for FCC license.

## SEND FOR THESE TWO NEW BOOKS

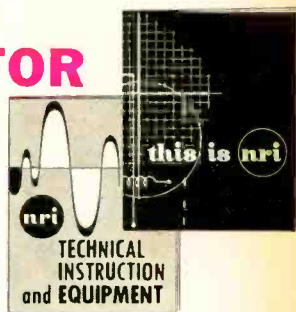

Read the story of NRI's 50 years of pioneering and leadership in training men at home for careers in Electronics. Read about NRI's philosophy of training; its reputation among leaders of the Electronics industry; read about our specialized instruction plans and see pictures of equipment you get. Whatever your age or status, the continuing increase in career opportunities in the ever-growing, ever-changing Electronics industry should interest you. Mail the postage-free form today.

A MESSAGE TO ELECTRONIC BUFFS—

# DON'T JOIN THE ARMY UNLESS



**unless** you want to build a career in Electronics. The sky's the limit in this field, if you have the right training. The Army is the place to get that training. And the Army will keep you trained as you move up to positions of increasing responsibility.

**unless** you want your future to be automation-proof. No matter how far automation goes, men with electronics training will still be in demand in tomorrow's Army.

**unless** you want premium pay for doing work that you'll enjoy. As you advance in grade and increase your skill, you can earn from \$50-100 extra per month in proficiency pay.

**unless** you want to travel... adventure...and responsibility. Army electronics specialists are stationed in many countries throughout the Free World. Doing work that is exciting, stimulating, and vital to everyone's safety.

**unless** you care enough about your Country to serve it.

If that sounds like just what the doctor ordered, talk to your Army Recruiter soon. And ask him about Army electronics training.

If you're good enough to get in...a proud future can be yours in the new action

# Army

# ELECTRONICS ILLUSTRATED

MAY 1964

A Fawcett Publication

Vol. 7, No. 3

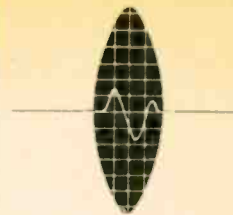

## General Features

Meet the Istors .....	Robert K. Re	38
Half-Pint Antenna Lab .....		80
Super-Cold Super-Magnets .....	Robert S. Bush	106

## Special Construction Projects

Electronic Name Dropper .....	Fred Maynard	51
R/C Transmitter and Receiver .....	Howard McEntee	53
FET Signal Tracer .....	John Potter Shields	63
Nickel-Cad Charger .....	Bert Mann	72
Seat Belts AOK! .....	Hal Bergida	110

## Radio: CB • Amateur • SWL

Inside Radio Moscow .....	Alex Bower	29
Outside Radio Moscow—Way Out! .....	Don Carter	32
Lightning Arrester .....	Howard S. Pyle, W7OE	34
CB Corner .....	Len Buckwalter, KBA4480	44
Radio at 100 Billion Cycles .....	Saunders Harris	45
Ham-CB Compressor Limiter .....	Herb Friedman, W2ZLF	47
The Listener .....	C. M. Stanbury II	62
Ham Slangage .....	Bill Walker, K2RUK	68
How to Switch to PTT for CB .....	David Walker	70
CB Dipper .....	Len Buckwalter	82
Radio + Radar = Rescue .....	Alan D. Haas	94
CB's Silent Sentinels .....	Len Buckwalter	96
Ham Shack .....	Robert Hertzberg, W2DJJ	101
Prize Shacks .....		102

## Audio & Hi-Fi

Hi-Fi Today .....	John Milder	33
Kit Report: Stereo Preamp .....		42
Headphone Hi-Fi .....	Ivan Berger	74
Tape Fan's Load Box .....	Lawrence Glenn	88
6 X Audio Generator .....	Herb Friedman	90

## Theory & Practice

Kit Report: Vacuum-Tube Volt-Milliammeter .....		50
What's a Q-Multiplier, Anyway? .....		78
Beginner's Page .....	H. B. Morris	100

## Regular Departments

Feedback from Our Readers .....		6
Broadsides .....		12
Electronics in the News .....		14
Electronic Marketplace .....		22
EI at Large .....		79
Good Reading .....	Tim Cartwright	87
Subscription Blank .....		117

Audit Bureau of Circulations



MEMBERSHIPS



Magazine Publishers Association, Inc.



COVER — Color transparent by John Capotosfo.

# Profits That Lie Hidden in America's Mountain of Broken Electrical Appliances

By J. M. Smith President, National Radio Institute



And I mean profits for you — no matter who you are, where you live, or what you are doing now. Do you realize that there are over 400 million electrical appliances in the homes of America today? So it's no wonder that men who know how to service them properly are making \$3 to \$5 an hour — in spare time or full time! I'd like to send you a Free Book telling how you can quickly and easily get into this profitable field.

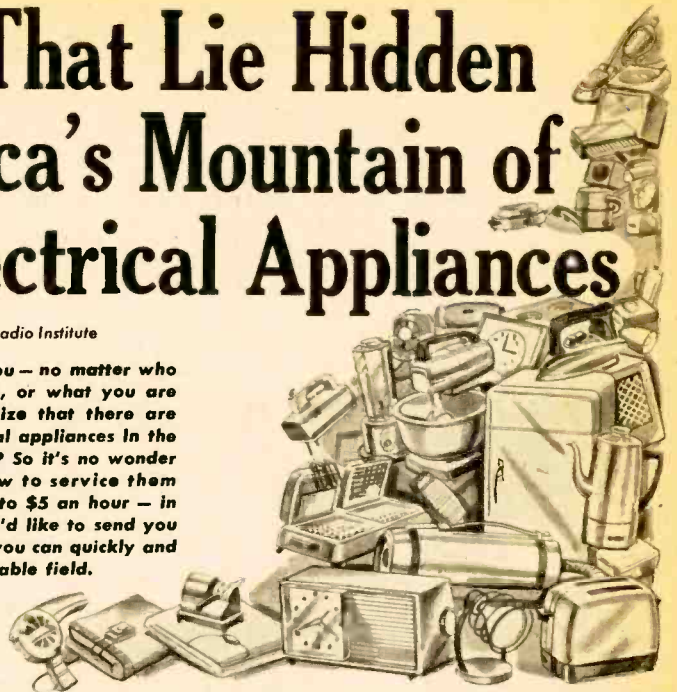

THE COMING OF THE AUTO created a multi-million dollar service industry, the auto repair business. Now the same thing is happening in the electrical appliance field. But with this important difference: anybody with a few simple tools can get started in appliance repair work. No big investment or expensive equipment is needed.

The appliance repair business is booming — because the sale of appliances is booming. One thing naturally follows the other. In addition to the 400,000,000 appliances already sold, this year alone will see sales of 76 million new appliances. For example, 4,750,000 new coffee makers, almost 2,000,000 new room air conditioners, 1,425,000 new clothes dryers. A nice steady income awaits the man who can service appliances like these. And I want to tell you why that man can be you — even if you don't know a volt from an ampere now.

### A Few Examples of What I Mean

Now here's a report from Earl Reid, of Thompson, Ohio: "In one month I took in approximately \$648 of which \$510 was clear. I work only part time." And, to take a big jump out to California, here's one from

J. G. Stinson, of Long Beach: "I have opened up a small repair shop. At present I am operating the shop on a spare time basis — but the way business is growing it will be a very short time before I will devote my full time to it."

Don't worry about how little you may now know about repair work. What John D. Pettis, of Bradley, Illinois wrote to me is this: "I had practically no knowledge of any kind of repair work. Now I am busy almost all my spare time and my day off — and have more and more repair work coming in all along. I have my shop in my basement."

### We Tell You Everything You Need to Know

If you'd like to get started in this fascinating, profitable, rapidly growing field — let us give you the home training you need. Here's an excellent opportunity to build up "a business of your own" without big investment — open up an appliance repair shop, become independent. Or you may prefer to keep your present job, turn your spare time into extra money.

You can handle this work anywhere — in a corner of your basement or garage. even

on your kitchen table. No technical experience, or higher education is necessary. We'll train you at home, in your spare time, using methods proven successful for over 45 years. We start from scratch — tell you in plain English, and show you in clear pictures — everything you need to know. And, you will be glad to know, your training will cost you less than 20¢ a day.

### FREE BOOK and Sample Lesson

I think that our 24-page Free Book will open your eyes to a whole world of new opportunities and how you can "cash in" on America's "Electrical Appliance Boom."

I'll also send you a Free Sample Lesson. It shows how simple and clearly illustrated our instruction is — how it can quickly prepare you for a profitable future in this big field. Just mail coupon, letter, or postcard to me: Mr. J. M. Smith, President, National Radio Institute, Dept. KE4, Washington 16, D.C. (No obligation, of course — and no salesman will call on you.)

### EARN WHILE YOU LEARN with this APPLIANCE TESTER

— Yours at No Extra Charge

Your NRI Course comes complete with all the parts to assemble a sturdy, portable Appliance Tester that helps you earn while you learn. Easy-to-follow manual tells how to assemble and use the Tester right away. Locate faulty cords, short circuits, poor connections, etc. in a jiffy; find defects in house wiring, measure electricity used by appliances; many other uses.

With this Tester you save time and make money by doing jobs quicker, making sure appliances operate correctly after repairs.



### MAIL THIS FOR FREE BOOK and SAMPLE LESSON

Mr. J. M. Smith, President  
NATIONAL RADIO INSTITUTE  
Dept. KE4, Washington 16, D.C.

Tell me how I can "cash in" on the "Electrical Appliance Boom." Send me your illustrated FREE BOOK that outlines the whole NRI Course, tells what opportunities are open to me, answers my questions, describes success of other students, and much more. Also send me the FREE SAMPLE LESSON so I can see how clear and easy your instructions are. I am particularly interested in:

Spare Time Earnings  Business of My Own  Better Job

I understand there is no obligation on my part, and no salesman will call on me.

Name .....  
Address .....  
City ..... Zone ..... State .....

Accredited Member National Home Study Council



## Citizen Band Class "D" Crystals

### CITIZEN BAND CLASS "D" CRYSTALS

3rd overtone — .005% tolerance — to meet all FCC requirements. Hermetically sealed HC6/U holders. 1/2" pin spacing. .050 pins. (Add 15c per crystal for .093 pins). **\$2.95 EACH**

All 23 channels frequencies in stock: 26.965, 26.975, 26.985, 27.005, 27.015, 27.025, 27.035, 27.055, 27.065, 27.075, 27.085, 27.105, 27.115, 27.125, 27.135, 27.155, 27.165, 27.175, 27.185, 27.205, 27.215, 27.225, 27.255.

Matched crystal sets for ALL CB units (Specify equipment make and model numbers) **\$5.90 per set**

### CRYSTALS IN HC6/U HOLDERS

**SEALED OVERTONE** 486 pin spacing — .050 diameter — .005% tolerance  
 15 to 30 MC ..... \$3.85 — 30 to 40 MC .....  
 \$4.10 — 40 MC to 65 MC ..... **\$4.50** —  
 65 MC to 100 MC ..... **\$6.00 ea.**

**FUNDAMENTAL FREQ. SEALED** From 1601 KC to 2000 KC **\$5.00**; from 2001 KC to 2500 KC **\$4.00**; 2501 KC to 5000 KC **\$3.50**; 5001 KC to 7000 KC **\$3.90**; 7001 KC to 10,000 KC **\$3.25**.

**RADIO CONTROL** Specify frequency, .05 pins spaced 1/2" (Add 15c for .093 pins). **\$2.95 ea.**



## QUARTZ CRYSTALS FOR EVERY SERVICE

All crystals made from Grade "A" imported quartz—ground and etched to exact frequencies. Unconditionally guaranteed! Supplied in:

**FT-243 holders** MC-7 holders  
 Pin spacing 1/2" Pin spacing 3/4"  
 Pin diameter .093 Pin diameter .125

**CRIA/AR holders** **FT-171 holders**  
 Pin spacing 1/2" Pin spacing 3/4"  
 Pin diameter .125 Banana pins

**MADE TO ORDER CRYSTALS . . . Specify holder wanted**  
 1001 KC to 1600 KC: .005% tolerance ..... **\$4.50 ea.**  
 1601 KC to 2000 KC: .005% tolerance ..... **\$3.55 ea.**  
 2001 KC to 2500 KC: .005% tolerance ..... **\$2.75 ea.**  
 2501 KC to 9000 KC: .005% tolerance ..... **\$2.50 ea.**  
 9001 KC to 11,000 KC: .005% tolerance ..... **\$3.00 ea.**

### Amateur, Novice, Technician Band Crystals

.01% Tolerance . . . **\$1.50 ea.** — 80 meters (3701-3749 KC)  
 40 meters (7152-7198 KC), 15 meters (7034-7082 KC), 6 meters (8335-8650 KC) within 1 KC

**FT-241 Lattice Crystals** in all frequencies from 370 KC to 540 KC (all except 455 KC and 500 KC) ..... **\$1.25 ea.**

Pin spacing 1/2" Pin diameter .093  
 Matched pairs — 15 cycles **\$2.50 per pair**

200 KC Crystals, **\$2.00 ea.**; 455 KC Crystals, **\$1.25 ea.**; 500 KC Crystals, **\$1.25 ea.**; 100 KC Frequency Standard Crystals in HC6/U holders **\$4.50 ea.** Socket for FT-243 Crystal **15c ea.**;

Dual Socket for FT-243 Crystals, **15c ea.**; Sockets for MC-7 and FT-171 Crystals **25c ea.**; Ceramic Socket for HC6/U Crystals **20c ea.**

## NEW TWX SERVICE—48 HR. SHIPMENT

3 PLANTS TO SERVE YOU BETTER

ORDER FROM CLOSER PLANT



**TEXAS CRYSTALS**  
 DEPT. E-54  
 1000 Crystal Drive  
 FORT MYERS, FLORIDA  
 Phone 813 WE 6-2109  
 TWX 813-334-2630

Division of



AND  
 4117 W. Jefferson Blvd.  
 LOS ANGELES, CALIF.  
 Phone 213-731-2258  
 TWX 213-737-1315

# ELECTRONICS ILLUSTRATED

By the Publishers of MECHANIX ILLUSTRATED

editor **ROBERT G. BEASON**  
 feature editor **Richard A. Flanagan**  
 technical editor **Robert D. Freed**  
 art editor **Lou Rubsamen**  
 editorial associate **Kevin Murphy**  
 production editor **Rosanne Walsh**  
 advertising mgr. **John F. Webster**  
 eastern adv. mgr. **Don Daily**

### CONTRIBUTING EDITORS

amateur radio **Robert Hertzberg, W2DJJ**  
 citizens band **Len Buckwalter, KBA4480**  
 swl-dx **C. M. Stanbury II**  
 special projects **Herb Friedman, W2ZLF/2W6045**  
 medical electronics **R. A. Markoff, M.D.**  
 audio **Harry Kolbe**  
 audio **John Milder**  
 audio **David Muirhead**

### EXECUTIVE STAFF

editorial director **Ralph Daigh**  
 advertising director **Mortimer Berkowitz, Jr.**  
 art director **Al Allard**  
 associate art director **Ralph Mattison**  
 production director **George H. Carl**

### ADDRESSES

Editorial and Advertising Offices: 67 West 44th St., New York, N.Y. 10036. Subscriptions: Change of address Form 3579 to Subscription Dept., Fawcett Bldg., Greenwich, Conn. 06830.

ELECTRONICS ILLUSTRATED is published bi-monthly by Fawcett Publications, Inc., Fawcett Place, Greenwich, Conn. W. H. Fawcett, Jr., President; Gordon Fawcett, Secretary and Treasurer; Roger Fawcett, General Manager; Roscoe K. Fawcett, Circulation Director; Donald P. Hanson, Assistant General Manager.

Second-class postage paid at Greenwich, Conn., and at additional mailing offices.

Subscription price \$4 for 12 issues in U.S. and possessions and Canada. All other countries \$6 for 12 issues. Foreign subscriptions and sales should be remitted by International Money Order in U.S. funds payable at Greenwich, Conn.

Printed in U.S.A. Copyright © 1964 by Fawcett Publications, Inc. Permission hereby granted to quote from this issue of this magazine on radio or television provided a total of not more than 1,000 words is quoted and credit is given to the title of the magazine and issue, as well as the statement, copyright 1964 by Fawcett Publications, Inc.

# How to pass a genius



All of us can't be geniuses. But any ordinarily talented mortal can be a success—and that's more than some geniuses are.

Now, as in *Æsop's* time, the race doesn't always go to the one who potentially is the swiftest. The *trained* man has no trouble in passing the genius who hasn't improved his talents.

In good times and bad times, in every technical and business field, the *trained* man is worth a dozen untrained ones, no matter how gifted.

The International Correspondence Schools can't make you into a genius. For more than 67 years, however, I. C. S. has been helping its students to become *trained, successful leaders*—and it can do the same for you.

Mark your special interest on the coupon. Don't be like the unsuccessful genius who wastes his life in dreaming of what he intends to do. *Act now!*

Clip coupon here—and take your first big step to real success! I. C. S., Scranton, Penna. 18515

Accredited Member  
National Home Study Council

## INTERNATIONAL CORRESPONDENCE SCHOOLS

Box E8483C, Scranton, Penna. 18515

(In Hawaii: P. O. Box 418, Honolulu. In Canada: I. C. S. Canadian, Ltd., Montreal.)

Without cost or obligation, rush me **FREE Success Kit**, with 3 valuable booklets: (1) How to Succeed; (2) opportunity booklet without the field I've checked below; (3) sample I.C.S. lesson.

### ARCHITECTURE and BUILDING TRADES

- Air Conditioning
- Architecture
- Arch. Drawing
- Building Contractor
- Carpentry & Millwork
- House Planning
- Painting
- Plumbing & Heating

### ART and DESIGN

- Commercial Art
- Interior Decorating
- Magazine Illustrating
- Show Card & Sign
- Painting
- Sketching and Painting

### AUTOMOTIVE

- Auto Body Rebuilding
- Auto Electric Technician
- Automobile Mechanic
- Engine (Gas & Diesel)
- Engine Tune-Up
- Transmission Specialist

### AVIATION

- Aero Engineering
- Aircraft Drafting
- Aircraft Mechanic

### BUSINESS

- Accounting
- Cost Accounting
- Public Accounting
- Bus. Administration
- Executive Training
- Mgmt. Accounting
- Marketing
- Personnel-Labor Relations
- Programming for Digital Computers
- Purchasing Agent
- Real Estate
- Salesmanship
- Sales Mgmt.
- Small Business Mgmt.
- Traffic Mgmt.

### CHEMICAL

- Analytical Chemistry
- Chem. Engineering
- General Chemistry
- Lab. Technician

- Nuclear Energy
- Plastics
- Pulp, Paper

### CIVIL ENGINEERING

- Civil Engineering
- Highway Blueprints
- Highway Engineering
- Structural Blueprints
- Sanitary Engineering
- Structural Engineering
- Surveying & Mapping

### DRAFTING

- Architectural
- Drafting Technology
- Electrical and Electronic
- Mechanical

### ELECTRICAL

- Elec. Appliance Servicing
- Electrical Engineering
- Elec. Motor Repairman
- Industrial Telemetering
- Instrument Technician
- Practical Electrician
- Practical Lineman

### ELECTRONICS

- Automation
- Basic Electronics
- Electronic Computers
- Electronics Technician
- Hi-Fi Stereo and Sound Systems
- Industrial Electronics

### ENGINEERING (Professional)

- Chemical
- Civil
- Electrical
- Mechanical

### ENGLISH and WRITING

- Better Business Writing
- Introductory Technical Writing
- Short Story Writing
- Practical English

### HIGH SCHOOL (Diploma)

- High School General
- High School Math
- High School Secretarial

- High School Vocational
- College Preparatory

### LANGUAGES

- (Edited by Berlitz)
- French
- German
- Italian
- Spanish

### MECHANICAL and SHOP

- Gas and Electric Welding
- Industrial Engineering
- Industrial Instrumentation
- Machine Design
- Machine Shop Practice
- Mechanical Engineering
- Reading Shop Blueprints
- Tool Design
- Toolmaking
- Safety Engineering

### SECRETARIAL

- Clerk-Typist
- Professional Secretary

- Shorthand
- Stenographic
- Typist

### STEAM and DIESEL POWER

- Boiler Inspector
- Power Plant Engineering
- Stationary Diesel Engineering
- Steam Engineering

### SUPERVISION

- Foremanship—Suprv'n
- Personnel—Lab. Rel'n's

### TV-RADIO

- Radio and TV Servicing
- Radio-Telephone License
- TV Technician
- Practical Radio-TV Engineering

### MISCELLANEOUS

- Textile
- Other (please specify)

Name \_\_\_\_\_ Age \_\_\_\_\_ Sex \_\_\_\_\_  
 Home Address \_\_\_\_\_  
 City \_\_\_\_\_ Zone \_\_\_\_\_ State \_\_\_\_\_  
 Occupation \_\_\_\_\_  
 Employed by \_\_\_\_\_ Working Hours \_\_\_\_\_  
 Special low rates to members of U. S. Armed Forces!

# FEEDBACK

# from our readers

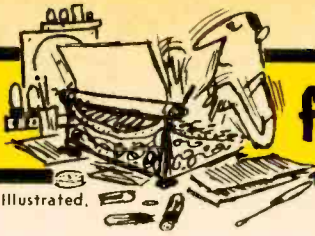

Write to: Letters Editor, Electronics Illustrated,

67 West 44th Street, New York, N. Y. 10036

## ● ELSIE SPOTTER

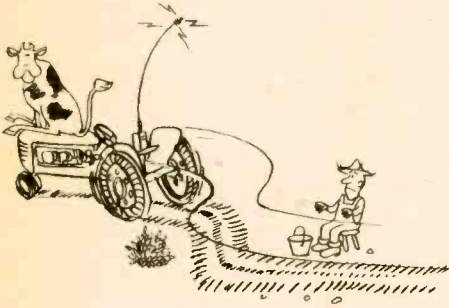

Would you please supply information on any inexpensive electronic device that could be bought or built to steer a tractor or other farm machine down a row of fruit trees or crops? I have in mind something that would sense clear space for perhaps 40 feet ahead and steer the machine along the clear, open path. If the device senses an obstacle perhaps 10 feet ahead, it would stop the machine or sound a warning.

Joseph Bednarz  
Ojai, Calif.

*We don't know of any cheap automated tractors, Joe—let alone one that's radar-equipped, R/C operated, complete with cow-catcher . . . and still on the inexpensive side. Radar happens to be anything but cheap, though a British firm called Tractors Ltd. was experimenting with a radio-controlled farm tractor some years back. Why don't you hire a driver and let obstacles like Elsie look out for themselves?*

## ● PARTY TAP

I am the owner of a Bell & Howell tape recorder which I use mostly at neighborhood parties. I merely place the recorder in a hidden corner and let the party go on. When the party is about halfway through, I let the guests in on the secret. At first everyone looks shocked, but the tapes usually add a lot of fun and laughter to the party.

Mary Brown  
Dallas, Tex.

Gee.

## ● SHOCKED

Would like to experiment in using house wiring for a TV antenna. Please advise what information and parts I will need.

Lewis J. Schucht  
Lewistown, Pa.

*Parts you don't need. Information you do. Play safe and forget all about it. Or maybe start by using the battery cable as an antenna for your car radio. The results would be the same.*

## ● ALLEY SPANNER

I am proposing an amendment to Part 15 of the FCC Rules that would allow an operator to use an antenna up to 200 feet in length.

N.W.  
Rutherford, N.J.

*Give some people an inch and they'll try for a mile. How come, N.W., that you're 5,080 feet short?*

## ● CQ CQ DE BABY

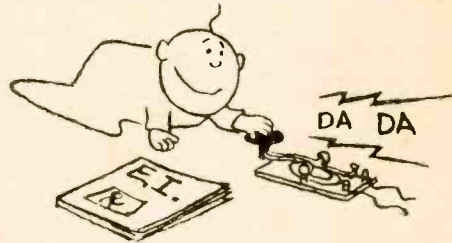

WANT TO BE A JUNIOR HAM? (March EI) has set me thinking about my eight-month-old son Peter. I want him to take an interest in electronics and I've read how infants can pick up foreign languages in no time flat. Seems to me it should be pretty easy to teach Pete the code if I start before he gets much older. Any ideas on how I can get him going?

Dennis Kearns  
Fallbrook, Calif.

*Better put Pete on Part 15 phone for the next few years. Them that can't read might send, all right, but it would make for tough reading for pops.*

[Continued on page 8]



# From Parts...

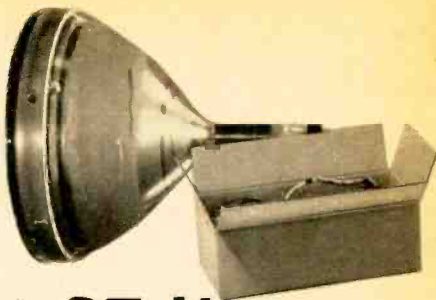
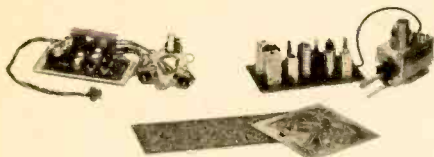

## To Picture In Just 25 Hours



### Heathkit High Fidelity Color TV For As Low As \$349

25 hours of relaxing fun! That's all! And you've built the *new* Heathkit High Fidelity 21" Color TV with the finest color circuitry, components, and performance possible today. Goes together quickly, easily. *No* special skills or knowledge required! And you enjoy quality features and "true-to-life" color pictures comparable to units costing \$600 or more!

**Compare These Heathkit Features With Others!** 27 tube, 8-diode circuit with optional UHF • High definition RCA 70° 21" color tube with anti-glare, bonded-face safety glass • Degaussing coil & built-in dot generator for perfect picture adjustments • Automatic Color Control • Gated Automatic Gain Control for peak performance • 24,000 volt regulated picture power • Hi-Fi sound with outputs for speaker and hi-fi amp • Deluxe Nuvistor tuner with "push-to-tune" fine tuning for individual channels • 3-Stage high gain video I.F. • Line thermistor for longer tube life and thermal circuit breaker for component protection • All critical circuits factory built & tested • Can be custom mounted (requires GRA-53-3 mounting kit) or installed in handsome walnut finish hardboard cabinet • One year warranty on picture tube, 90 days on parts.

**Learn Color TV Theory—Save on Maintenance Costs!** The Heathkit instruction manual contains circuit diagrams, alignment, and theory sections so you can easily make necessary adjustments with confidence.

**Enjoy The Beauty Of Color TV** with the added fun and satisfaction of a Heathkit! Order now!

- Kit GR-53, chassis & tubes, 118 lbs. . . . . \$349.00
- GRA-53-1, walnut hardboard cabinet, 70 lbs. . . . \$49.00
- GRA-53-3, custom mounting kit, 10 lbs. . . . . \$4.00
- GRA-53-2, UHF Converter, 3 lbs. . . . . \$20.00



**FREE 1964 HEATHKIT CATALOG**  
Gives full description and specifications of Color TV, plus over 250 others in Test, Amateur Radio, Hi-Fi, Marine, Educational fields! Send for your Free copy now!



**HEATH COMPANY** 39-5-2  
Benton Harbor, Mich. 49023

Enclosed is \$ \_\_\_\_\_, plus shipping. Please send model (s) \_\_\_\_\_

Please send my Free 1964 Heathkit Catalog.

Name \_\_\_\_\_

Address \_\_\_\_\_

City \_\_\_\_\_ State \_\_\_\_\_ Zip \_\_\_\_\_

CL-166R

solid  
state  
reliability...



## Cadre (CB Transceivers)

Solid state circuitry means that Cadre CB receivers can be bounced over rough roads in mobile installations; and can take plenty of rough use at base stations and in portable field use.

Solid state circuitry means that Cadre transceivers draw about as much power as an electric clock. Not only do auto or marine batteries last longer, but when batteries get low, Cadre solid state transceivers operate where others might not.

Reliability is only one reason why Cadre solid state CB transceivers are your best buy. Performance is another part of the story—plenty of transmission punch on 5 crystal controlled channels—long distance reception with the dual conversion superhet receiver. And unwanted noise and adjacent channels are effectively suppressed.

**FOUR POWERFUL SOLID STATE 5-WATT, 5 CHANNEL MODELS** for every possible application—base station, mobile, field. New Cadre 510-A—AC/DC 23 channel manual tuning \$219.95. Cadre 515 same as 510-A less manual tuning \$199.95. Cadre 520 DC only with battery cable and mounting kit. For mobile and portable use from 12 volt batteries \$187.50. Cadre 525 model 520 in portable pack carrying case with built-in battery/power supply, recharger, AC cord and telescoping antenna for complete field portability. \$269.95.

**FULL POWER, 1.5 WATT HAND HELD RECEIVER CADRE C-75** Solid-state throughout. Two crystal controlled channels. Sensitive receiver, powerful transmitter with one watt output to the antenna. \$109.95. Recharger and set of (2) nickel-cadmium batteries. \$31.85. Cartridge for (9) penlite cells. \$2.95.

**CADRE INDUSTRIES CORP. COMMERCIAL PRODUCT DIV.**  ENDICOTT, NEW YORK  AREA CODE 607, 748-3373. Canada: Tri-Tel Assoc., Ltd., 81 Sheppard Ave. W., Willowdale, Ont. Export: Morhan Export, 458 B'way, N. Y. 13, New York.

## FEEDBACK

Continued from page 6

### ● TEN CENTS A CALL

I read how a beginning SWL could receive a monitor certificate and call letters by sending 10¢. I have just bought a receiver and enjoy short-wave listening very much. I enclose the 10¢.

Robert Gore, Jr.  
Robbins, Ill.

*You're barking up the wrong tree, Robert. EI's DX Club gives Awards; it doesn't sell certificates. And we believe an Award has to be earned. You'll find information on EI's DX Club, as well as an official application form, in our January issue. Meanwhile, your dime is being returned. As we've said, all of EI's DX Awards are free—if you can qualify.*

### ● TEACHER TAPER

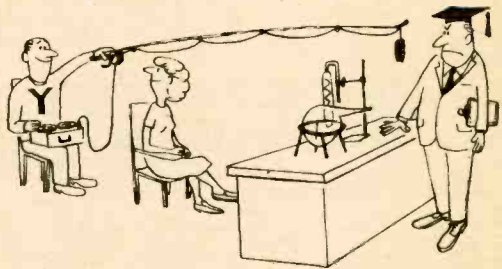

You recently had a comprehensive report about tape recorders (**SO YOU'RE GOING TO BUY A TAPE RECORDER**, Jan. EI) which I found interesting. Right now, I'm kind of worried about whether I can get through college, and I wonder if I couldn't use one of those transistor tape recorders so I could get a complete transcription of my lectures without having to write my arm off.

David Gladhill  
Detroit, Mich.

*We hate to disillusion you, but a tape recorder would pick up more chair scrapes, coughs and giggles than lecture. Unless you can talk your prof into letting you suspend a mike directly in front of him, you'd likely end up with pure classroom cacophony and no professorial pearls. Ever try short-hand?*

[Continued on page 10]

# Here's your only "middleman"...



## when you buy a Heathkit®!

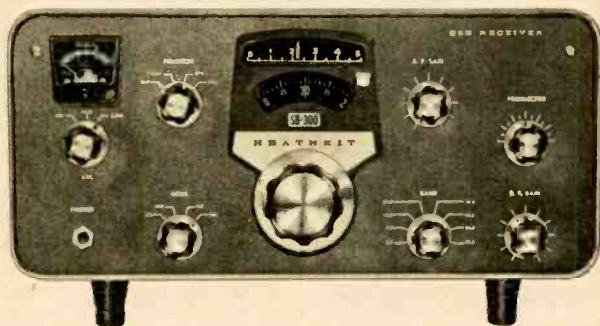

Just a few postage stamps from Uncle Sam is all it takes to move your Heathkit from factory to you. There's no one in between . . . no distributor . . . no dealer. This means that you put your money in the product, not its distribution. It means better quality and performance at lower cost.

And there are other advantages! Free consultation services and personal assistance in the selection, construction, and use of any Heathkit . . . original replacement parts, factory repair and fast, to-your-door delivery.

Add the 50% savings of "do-it-yourself" and you'll see why Heathkit equipment is your best buy in electronic kits!

**A superb Example of Heathkit Quality . . . The New SB-300 SSB Amateur Receiver . . . Only \$265.00\***

**Check these Features!**

- Professional styling & features at 60% savings!
- Complete coverage of 80 through 10 meter amateur bands with all crystals furnished, plus provision for VHF converters
- Prebuilt, calibrated linear master oscillator (LMO)
- 25 KC per tuning knob revolution offers bandspread equal to 10 feet per megacycle
- Built-in crystal calibrator
- 2.1 KC crystal bandpass filter
- Stability of 100 CPS after initial warmup
- Wiring harness & two heavy-duty circuit boards for easy assembly.

**Check these Specifications!**

**Frequency range (megacycles):** 3.5 to 4.0, 7.0 to 7.5, 14.0 to 14.5, 21.0 to 21.5, 28.0 to 28.5, 28.5 to 29.0, 29.0 to 29.5, 29.5 to 30. **Intermediate frequency:** 3.395 megacycles. **Frequency stability:** 100 cps after warmup. **Visual dial accuracy:** Within 200 cps on all bands. **Electrical dial accuracy:** Within 400 cps on all bands. **Backlash:** No more than 50 cps. **Sensitivity:** Less than 1 microvolt for 15 db signal plus noise-to-noise ratio for SSB operation. **Modes of operation:** Switch selected: LSB, USB, CW, AM. **Selectivity:** SSB: 2.1 kc at 6 db down, 5.0 kc at 60 db down (crystal filter supplied). AM: 3.75 kc at 6 db down, 10 kc at 60 db down (crystal filter available as accessory). **CW:** 400 cps at 6 db down, 2.5 kc at 60 db down (crystal filter available as accessory). **Spurious response:** Image and IF rejection better than 50 db. **Internal spurious signals** below equivalent antenna input of 1 microvolt. **Audio response:** SSB: 350 to 2450 cps nominal at 6 db. AM: 200 to 3500 cps

nominal at 6 db. **CW:** 800 to 1200 cps nominal at 6 db. **Antenna input impedance:** 50 ohms nominal. **Muting:** Open external ground at Mute socket. **Crystal calibrator:** 100 kc crystal,  $\pm .005\%$ . **Front panel controls:** Main tuning dial; function switch; mode switch; AGC switch; band switch; AF gain control; RF gain control; pre-selector; phone jack. **Rear apron connections:** Accessory power plug; HF antenna; VHF #1 antenna; VHF #2 antenna; mute; spare; anti-trip; 500 ohm; 8 ohm speaker; line cord socket; heterodyne oscillator output; LMO output; BFO output; VHF converter switch. **Tube complement:** (1) 6BZ6 RF amplifier; (1) 6AU6 Heterodyne mixer; (1) 6AB4 Heterodyne oscillator; (1) 6AU6 LMO osc.; (1) 6AU6 LMO mixer; (2) 6BA6 IF amplifier; (1) 6AU6 Crystal calibrator; (1) 6HF6 1st audio, audio output; (1) 6AS11 Product detector, BFO, BFO amplifier. **Power supply:** Transformer operated with silicon diode rectifiers. **Power requirements:** 120 volts AC, 50/60 cps, 50 watts. **Dimensions:** 14 1/2" W x 6 1/2" H x 13 1/2" D.



**FREE CATALOG**

Send for your Free copy today! Fully describes over 250 exciting Heathkits at savings of 50% or more! Choose from the world's largest selection of quality instruments in easy-to-assemble kit form!



**HEATH COMPANY**  
Benton Harbor, Mich. 49023

39-5-3

Please send free 1964 Heathkit Catalog.

Name \_\_\_\_\_

Address \_\_\_\_\_

City \_\_\_\_\_ State \_\_\_\_\_ Zip \_\_\_\_\_

AM-135R

# FEEDBACK

Continued from page 8

## ● SATISFIED

I very much enjoyed reading about the new stereo tape recorder that uses tape cartridges and plays them automatically (TAPES YOU NEVER TOUCH, Jan. EI). I went out and purchased one of these machines after I read about it in EI, and I fully agree that it is little short of phenomenal. Playing tapes on the machine is every bit as easy as playing records on a record changer.

R. Rothenberg  
New York, N.Y.

Since you already own one, you're probably aware that there have been some price changes, as well as some additions to the line, since our story was published. The Revere tape-cartridge system now sells for \$399. In addition, the company is offering a play-only version of the machine for \$329, a play/record deck version for \$339 and a play-only deck for \$269.

## ● FOWL FOR FIDEL



I recently saw your story, CASTRO SPEAKS . . . TO US (Mar. EI). As a Cuban, let me tell you that Castro has spoken to us Cubans many times, but who can believe a man like him? And, anyway, who cares whether he speaks to us or the Martians or anybody else? For my money, Castro is a power-hungry Russian puppet. The nicest thing anybody could do for him is to put him to work back where he came from—plucking chickens in Oriente Province.

Roberto Diaz  
New York, N.Y.

## WONDERSHAFT Marine C/B Antennas

... handsome and rugged

These all fiberglass antennas, made by the pioneer manufacturers of *Shakespeare* glass fiber fishing rods, require no ground plates for installation . . . never corrode . . . give maximum performance. This exclusive Columbia Products construction combines material and process to produce antennas thoroughly at home in a marine environment. Your boat will wear a **WONDERSHAFT** proudly!

Style 72-1 unit includes 2-section antenna with chrome plated bronze, free standing, fold-down deck mount; PL 259 UHF connector and feed-through fitting for bulkhead or deck thickness of up to 1".

Style 176-1 unit includes 2-section antenna with chrome plated base, fold-down brass and insulated stand-off bracket; female UHF connector.

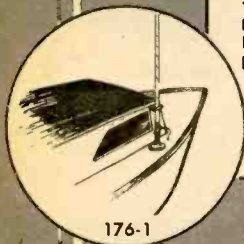

176-1

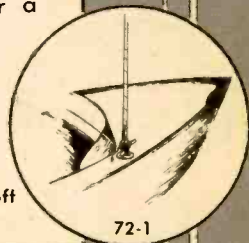

72-1



COLUMBIA PRODUCTS COMPANY

Subsidiary of *Shakespeare* Company  
COLUMBIA, SOUTH CAROLINA

Complete line of **WONDERSHAFT** 2-3 mc radio-telephone antennas available through leading radio-telephone manufacturers.

# What in the world is going on?



## With Heathkit SWL receivers - you know!



You're there when it happens... with just the touch of the tuning knob on your Heathkit Shortwave Listener's Radio! Enjoy on-the-spot news and sporting events from Tokyo, England, France, Germany, Moscow... anywhere! Tune in fascinating amateur radio broadcasts, or listen to your favorite programs on popular AM stations! Take your pick! You know "what in the world is going on" with a Heathkit SWL radio!

### Heathkit Shortwave Listener's Radio ... Fun to build, a top performer!

- Covers standard broadcast and 3 shortwave bands—550 KC to 30 MC • Large, easy-to-read illuminated slide-rule dial • Complete controls for full operating convenience • Built-in speaker and tuning "S" meter • Simple circuit board construction for "beginner" building.

Kit GR-91... 14 lbs. .... \$39.95

**SPECIFICATIONS**—Frequency range: 550 kc to 30 mc in four bands. Short wave, broadcast bands clearly marked on dial. Controls: General coverage tuning, Bandspread tuning, Antenna trimmer, Bandswitch, Noise Limiter—ON/OFF, phone-Standby-CW switch, BFO control, Audio Gain, AC-ON/OFF, Headphone jack, Q-multiplier input jack. Power requirements: 105-125 V 50/60 cycles AC, 30 watts. Dimensions: 12 1/2" W x 5 1/2" H x 8 1/2" D.

### Heathkit All-Transistor Portable Shortwave Receiver... Now Only \$95

- Deluxe ten-transistor, six-diode circuit • Covers standard broadcast and shortwave bands—550 KC to 32 MC • Ceramic IF transmitters for fixed aligned band pass • Telescoping 50' whip antenna—built-in tuning meter • Sturdy one-piece metal cabinet with carrying handle • Operates anywhere with built-in battery power supply.

Kit GC-1A... 18 lbs... Was \$109.95.. Now... \$95.00  
Assembled GCW-1A... 20 lbs. Was \$193.50.....  
Now..... \$165.00

**SPECIFICATIONS**—IF Frequency: 455 kc. Frequency coverage: 550 kc to 32 mc in 5 bands with calibrated bandspread scales (oscillator tuning) for 80, 40, 20, 15 and 10 meter amateur bands and 11 meter citizens band. Selectivity: 3 kc wide at 6 db down. Sensitivity: 10 uv broadcast band, 2 uv short wave bands for 10 db signal-to-noise ratio. Output: 400 milliwatts max. Battery life: up to 400 hours normal intermittent service using 8 standard size "C" cells. Dimensions: 6 1/2" H. x 12" W. x 10" D.



#### FREE 1964 HEATHKIT CATALOG

See these and over 250 other exciting Heathkits available in easy-to-build kit form. Save 50% or more by doing the easy assembly yourself! Send for your free catalog today!



**HEATH COMPANY**  
Benton Harbor, Mich. 49023

39-5-4

Enclosed is \$ \_\_\_\_\_, plus postage. Please send model (s) \_\_\_\_\_

Please send my Free 1964 Heathkit Catalog.

Name \_\_\_\_\_

Address \_\_\_\_\_

City \_\_\_\_\_ State \_\_\_\_\_ Zip \_\_\_\_\_

GX-125

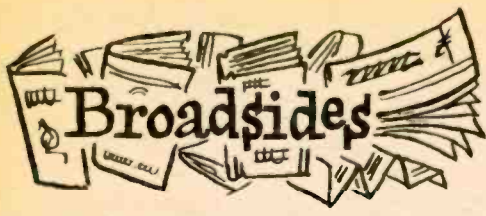

Pamphlets, booklets, flyers, application notes and bulletins available free or at low cost.

Beginners in electronics are plagued by many unanswered questions, and **Getting Started in Electronics** is designed to provide most of the answers. Its 112 pages cover the field from electron theory to modern-day semiconductors and even include a section on construction tips. For your copy, send 50 cents to Allied Radio Corp., 100 N. Western Ave., Chicago, Ill. 60680.

Catalog No. 15 by Littlefuse offers a six-page bonus on Fuseology—basic principles and operation of fuses. And, in the regular catalog portion, you'll find photos, schematics and operating characteristics for more than 400 circuit protection devices. The catalog is free from the Littlefuse Literature Dept., 1865 Miner St., Des Plaines, Ill. 60016.

The TF-01 emitter bypass Transfilter described in Clevite bulletin 94-20 is designed to replace the conventional emitter bypass capacitor in transistorized IF-amplifier circuits. For a free copy of the bulletin, write the Piezoelectric Div., Clevite Corp., 232 Forbes Rd., Bedford, Ohio. 44014.

A complete Silicon Rectifier Reference Chart lists approximately 500 rectifier types with current ratings from 50 ma to 40 amps. A free copy is yours for the asking from National Transistor, 500 Broadway, Lawrence, Mass. 01840.

Schematic diagrams and service information for many radios and TV sets now are available. The material costs 50 cents for most radios, 75 cents for most TV sets. Be sure to mention make and model number when you write Supreme Publications, 1760 Balsam Rd., Highland Park, Ill. 60035.

**OUR NEW TYPES.** Many of the feature articles and construction projects in this issue of EI have been set in new typefaces. Each of the various faces was chosen with a great deal of care to make EI easier to read than ever before. We like them, and we hope you'll like them, too.

**LARGE, SELECT STOCK! DEPENDABLE, FAST SERVICE!**

- Every tube tested in our own laboratory for mutual conductance and life test.
- We guarantee FREE replacement for one year of any tube purchased from us which fails to function efficiently under any of all operating conditions. Prompt refunds on any defective merchandise.
- Advertised tubes not necessarily new, but may be electrically perfect factory seconds or used tubes—each clearly so marked.

0Z4	6AB4	5BZ7	6K7	6WGCT	7E8	12BY7
1A7CT	6AC7	6C4	6K8	6X4	7H7	12CA5
1B3CT	6AF4	6C5	6L7	6X5	7N7	12J5
1H4G	6AC5	6C6	6N7	6X8	7Q7	12M7
1M5CT	6AH4CT	6CB6	6Q7	6Y6G	7X7/XXFM	12NL6
1L4	6AM6	6CD6G	6S4	7A4/XXL	7Y4	12Q7
1L6	6AK5	6CF6	6SBGT	7A5	7Z4	12SA7
1NSCT	6AL7	6CC7	6SA7	7AG	12A8	12SC7
1Q5CT	6AL7					12SJ7
1R5	6AM8					12SK7
1S5	6AN8					12SN7GT
1T4	6AQ5					12SQ7
1U4	6AQ6					12SV6GT
1U5	6AQ7GT					12SW6GT
1V2	6AR5					12X4
1X2	6AS5					12Z3
2A3	6AT6					14A7/
2AF4	6AT8					12B7
3BC5	6AU4GT					14B6
3BN6	6AUSGT					14Q7
3BZ6	6AU6					19
3CB6	6AU8					19A4GT
3CF6	6AV5GT					19B6GCT
3C96	6AV6					19J6
3L4	6AW8					19T8
3Q4	6AX4GT					24A
3S4	6AX5GT					28AV5
3V4	6BB					25BQ6
4BQ7A	6BA6					25DN6
4BZ7	6BC5					25L6GT
5A58	6BC8					25W6GT
5AT8	6BD6					25Z3
5AV8	6BE6					25Z6
5AW4	6BF5					26
5BK7	6BG6					35A5
5J6	6BG6G					35B5
5T8	6BM6					35C5
5U4G	6BJ6					35L6GT
5U9	6BK5					35W4
5V4C	6BK7					35Y4
5V6GT	6BL7GT					35Z5GT
5X9	6BN6					37
5Y3GT	6BQ6GT					39/44
5Y4G	6BQ7					42
6A7	6BZ6					43
6A8						45

Jan Surplus Tubes  
**37¢ ea.**  
**\$35**  
 for HUNDRED ANY TUBE LISTED PER HUNDRED ASSTD

6CL6	6SC7	7A7	12AQ5	26
6CM6	6SF5	7AB	12AT6	35A5
6CM7	6SF7	7BA	12AT7	35B5
6C7	6S7	7B5	12AUG	35C5
6C8	6C56	7B6	12AUG	35L6GT
6C9	6CUC	7B7	12AV6	35W4
6C9G	6CUC	7B8	12AV7	35Y4
6C9G	6CUC	7B9	12AV7	35Z5GT
6C9G	6CUC	7C4	12AX4GT	37
6C9G	6CUC	7C5	12AX7	39/44
6C9G	6CUC	7C6	12AZ7	42
6C9G	6CUC	7C7	12B7	43
6C9G	6CUC	7C8	12BA6	45
6C9G	6CUC	7E6	12BA7	50A5
6C9G	6CUC	7E7	12BA8	50B5
6C9G	6CUC	7F7	12BE6	50C5
			12BF6	50L6GT
			12BH7	50X6
			12BQ6	
			12BR7	

**SPECIAL PURPOSE and INDUSTRIAL TUBES**

AT SPECIAL SAVINGS!

Type	Price	Type	Price
0A2	\$.60	872A	\$6.95
0A3	.70	884	.80
0A4	.75	885	.75
0B2	.45	954	.20
0B3	.65	955	.30
0C3	.50	957	.30
0D3	.40	2050	.90
2D21	.55	2051	.90
2E26	1.95	5643	.75
4X150A		5654	.75
New	18.00	5686	1.50
5R4GY	1.95	5687	.75
6J4WA	1.15	5703	1.50
218	8.00	5725	.90
304TL	35.00	5726	.40
416B	18.95	5751	.90
5J29	.50	5763	.80
750TL	32.00	5814A	.75
807	1.00	5879	.90
811A	New	5881	1.95
815	2.50	6146	2.45
829B	7.00	6159	2.75
832	3.00	6201	1.00
832A	5.50	6900	1.95
866A	2.95		

EXTRA SPECIALS:  
 6/12 volt VIB 89¢  
 6/12 volt New VIB \$1.49  
 50 watt 25K Sprague Resistors 30¢

**MICRO**  
 SINCE 1957  
**EVERY DEAL A FAIR DEAL**

Not Connected With Any Other Mail Order Tube Co.  
 ALL TUBES SENT POST-AGE PAID. Please send 35c handling for orders under \$5. Send 25¢ dep. on C.O.D. orders. Send approx. postage on Canadian and foreign orders.

**MICRO**  
 ELECTRON TUBE CO.

P.O. Box 55 Park Sta.  
 Paterson 3, N. J.

WRITE DEPT. E-15 FOR OUR FREE COMPLETE LIST OF TUBES & SPECIAL PURPOSE TUBES

# His...

# Hers...

# Jr.'s...

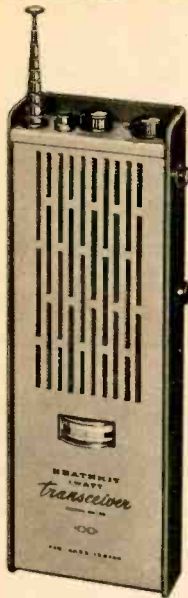

## There's a Heathkit® Walkie-Talkie for Every Use!

**Everyone Can Use A Heathkit Walkie-Talkie!** Dad for hunting & fishing; Mom for keeping tabs on the youngsters; and Junior for playing an endless number of exciting games! Check all 3 units! There's a Heathkit for every family member, every budget!

**For Dad . . . Powerful 1-Watt Walkie-Talkie!** Lightweight, compact! Operates up to 3 miles between units—even greater distances with Class D 5-watt CB units! Features \$20 rechargeable battery • 10 transistor, 2-diode circuit • crystal-controlled transmit & receive • adjustable squelch • automatic noise limiter • transformer-type charger for recharging from 117 VAC or 12 V. car battery. Includes shoulder strap, hand strap, power cords, earphone, FCC license pack and crystals for one channel (specify). Rustproof aluminum cabinet. Easy-to-build. Order yours now!

*Kit GW-52, 4 lbs., \$74.95. Kit, pair, \$139.95.*

**For Mom . . . Deluxe 9-Transistor Walkie-Talkie!** Requires no license, tests, or age limit! 1 to 3 mile inter-unit operation; 10 miles with Class D CB units! Features crystal controlled transmitter and superhet receiver • built-in squelch & automatic noise limiter • RF amplifier • antenna jack • 2-tone green aluminum case. Portable—battery powered! Simple to operate, simple to build! Crystals supplied for one channel (specify). Less battery.

*Kit GW-21, 3 lbs., \$44.95. Wired \$71.95. Kit pair, \$84.95. Wired pair, \$136.50*

**For Junior . . . Low-Cost 4-Transistor Walkie-Talkie!** Pocket-size—easy-to-use, easy-to-build! No license, tests, or age limit required! Operates up to a mile between units—up to 75 hours on built-in 9-volt battery. Crystal-controlled transmitter—super regenerative receiver. Includes instructions & crystals for one channel (specify). Less battery. Order Now!

*Kit GW-31, 2 lbs., \$19.95. Pair, \$35.00.*



### FREE 1964 HEATHKIT CATALOG

See these and over 250 other exciting Heathkits available in easy-to-build kit form. Save 50% or more by doing the easy assembly yourself! Send for your free catalog today!



### HEATH COMPANY

39-5-1

Benton Harbor, Michigan 49023

Enclosed is \$\_\_\_\_\_ plus postage. Please send model(s)\_\_\_\_\_

Please send my Free 1964 Heathkit Catalog.

Name \_\_\_\_\_

Address \_\_\_\_\_

City \_\_\_\_\_ State \_\_\_\_\_ Zip \_\_\_\_\_

GX-127

## ..electronics in the news

**EAGLE EYE** . . . It takes a skilled craftsman to repair a watch, but count on one even more highly skilled to put together that Dick Tracy wrist-watch radio you're always hearing about. The watchmaker in our photo, Edmund E. Malecki, still does some watch fixing, but his chief job is assembling micro-miniature components at the Army's Electronics R & D Labs at Fort Monmouth, N.J. Here, Mr. Malecki makes with tweezers and eye-pieces to add a wafer-like diode to a micromodule already crammed with nearly a dozen other components.



**An Adding Phone?** . . . Nope. That gadget is the Bell System's new Touch-Tone telephone that's a lot faster on the draw than current dial phones. Already offered as an optional extra in two cities, the new phones are expected to be common as corn flakes come 1974. As you can see from our photo, ten buttons replace the dial we're used to. Push the right sequence of buttons and your number has been touched—not dialed. And every time you push a button a pleasant-sounding tone supplies you with audible proof that a particular number has been touched.

**Causeway's Caretaker** . . . When the road ahead looks like it leads only to the Sargasso Sea—if there—it takes faith to venture onward. But the world's longest causeway, spanning 24 miles of Lake Pontchartrain near New Orleans, is just such a foreboding-looking road. Add the likelihood of fog and you'll understand why modern engineering had to give motorists a reassuring hand. The pole-mounted device in our photo is one of the Raytheon radars and marine radiotelephones which have been installed at the two bascule bridges, eight miles out from each shore, where ships cross the roadway. Let a disabled vessel dangerously close and a radar warning brings the Coast Guard on the run.





# BUILD 20 RADIO

CIRCUITS AT HOME  
with the New  
PROGRESSIVE RADIO "EDU-KIT"®  
A Practical Home Radio Course

only  
**\$26.95**



Reg. U.S.  
Pat. Off.

- Now Includes**
- \* 12 RECEIVERS
  - \* 3 TRANSMITTERS
  - \* SQ. WAVE GENERATOR
  - \* SIGNAL TRACER
  - \* AMPLIFIER
  - \* SIGNAL INJECTOR
  - \* CODE OSCILLATOR
- \* No Knowledge of Radio Necessary
  - \* No Additional Parts or Tools Needed
  - \* EXCELLENT BACKGROUND FOR TV
  - \* **SCHOOL INQUIRIES INVITED**
  - \* Sold in 79 Countries

**YOU DON'T HAVE TO SPEND  
HUNDREDS OF DOLLARS FOR A RADIO COURSE**

The "Edu-Kit" offers you an outstanding PRACTICAL HOME RADIO COURSE at a rock-bottom price. Our Kit is designed to train Radio & Electronics Technicians, making use of the most modern methods of home training. You will learn radio theory, construction practice and servicing. THIS IS A COMPLETE RADIO COURSE IN EVERY DETAIL. You will learn how to build radios, using regular schematics; how to wire and solder in a professional manner; how to service radios. You will work with the standard type of punched metal chassis as well as the latest development of Printed Circuit chassis. You will learn the basic principles of radio. You will construct, study and work with RF and AF amplifiers and oscillators, detectors, rectifiers, test equipment. You will learn and practice code, using the Progressive Code Oscillator. You will learn and practice trouble-shooting, using the Progressive Signal Tracer, Progressive Signal Injector, Progressive Dynamic Radio & Electronics Tester, Square Wave Generator and the accompanying instructional material.

You will receive training for the Novice, Technician and General Classes of F.C.C. Radio Amateur Licenses. You will build 20 Receiver, Transmitter, Square Wave Generator, Code Oscillator, Signal Tracer and Signal Injector circuits, and learn how to operate them. You will receive an excellent background for television, Hi-Fi and Electronics.

Absolutely no previous knowledge of radio or science is required. The "Edu-Kit" is the product of many years of teaching and engineering experience. The "Edu-Kit" will provide you with basic education in Electronics and Radio, worth many times the complete price of \$26.95. The Signal Tracer alone is worth more than the price of the entire kit.

## THE KIT FOR EVERYONE

You do not need the slightest background in radio or science. Whether you are interested in Radio & Electronics because you want an interesting hobby, a well paying business or a job with a future, you will find the "Edu-Kit" a worth-while investment. Many thousands of individuals of all

ages and backgrounds have successfully used the "Edu-Kit" in more than 79 countries of the world. The "Edu-Kit" has been carefully designed, step by step, so that you cannot make a mistake. The "Edu-Kit" allows you to teach yourself at your own rate. No instructor is necessary.

## PROGRESSIVE TEACHING METHOD

The Progressive Radio "Edu-Kit" is the foremost educational radio kit in the world, and is universally accepted as the standard in the field of electronics training. The "Edu-Kit" uses the modern educational principle of "Learn by Doing." Therefore you construct, learn schematics, study theory, practice trouble-shooting—all in a closely integrated program designed to provide an easily-learned, thorough and interesting background in radio. You begin by examining the various radio parts of the "Edu-Kit." You then learn the function, theory and wiring of these parts. Then you build a simple radio. With this first set you will enjoy listening to regular broadcast stations, learn theory, practice testing and trouble-shooting. Then you build a more advanced radio, learn more advanced theory and techniques. Gradually, in a progressive manner, and at your own rate, you will find yourself constructing more advanced multi-tube radio circuits, and doing work like a professional Radio Technician.

Included in the "Edu-Kit" course are twenty Receiver, Transmitter, Code Oscillator, Signal Tracer, Square Wave Generator and Signal Injector circuits. These are not unprofessional "breadboard" experiments, but genuine radio circuits, constructed by means of professional wiring and soldering on metal chassis, plus the new method of radio construction known as "Printed Circuitry." These circuits operate on your regular AC or DC house current.

## THE "EDU-KIT" IS COMPLETE

You will receive all parts and instructions necessary to build 20 different radio and electronics circuits, each guaranteed to operate. Our Kits contain tubes, tube sockets, variable, electrolytic, mica, ceramic and paper dielectric condensers, resistors, tie strips, hardware, tubing, punched metal chassis, Instruction Manuals, hook-up wire, solder, selenium rectifiers, coils, volume controls and switches, etc.

In addition, you receive Printed Circuit materials, including Printed Circuit chassis, special tube sockets, hardware and instructions. You also receive a useful set of tools, a professional electric soldering iron, and a self-powered Dynamic Radio and Electronics Tester. The "Edu-Kit" also includes Code Instructions and the Progressive Code Oscillator, in addition to F.C.C.-type Questions and Answers for Radio Amateur License training. You will also receive lessons for servicing with the Progressive Signal Tracer and the Progressive Signal Injector, a High Fidelity Guide and a Quiz Book. You receive Membership in Radio-TV Club, Free Consultation Service, Certificate of Merit and Discount Privileges. You receive all parts, tools, instructions, etc. Everything is yours to keep.

## PRINTED CIRCUITRY

At no increase in price, the "Edu-Kit" now includes Printed Circuitry. You build a Printed Circuit Signal Injector, a unique servicing instrument that can detect many Radio and TV troubles. This revolutionary new technique of radio construction is now becoming popular in commercial radio and TV sets. A Printed Circuit is a special insulated chassis on which has been deposited a conducting material which takes the place of wiring. The various parts are merely plugged in and soldered to terminals.

Printed Circuitry is the basis of modern Automation Electronics. A knowledge of this subject is a necessity today for anyone interested in Electronics.

**UNCONDITIONAL MONEY-BACK GUARANTEE**  
**ORDER DIRECT FROM AD—RECEIVE FREE BONUS**  
**RESISTOR AND CONDENSER KITS WORTH \$7**

- Send "Edu-Kit" postpaid. I enclose full payment of \$26.95.
- Send "Edu-Kit" C.O.D. I will pay \$26.95 plus postage.
- Rush me FREE descriptive literature concerning "Edu-Kit."

Name .....

Address .....

**PROGRESSIVE "EDU-KITS" INC.**  
1186 Broadway, Dept. 553 AE, Hewlett, N. Y.

Training Electronics Technicians Since 1946

## FREE EXTRAS

- SET OF TOOLS
- SOLDERING IRON
- ELECTRONICS TESTER
- ALIGNMENT TOOL
- WRENCH SET
- VALUABLE DISCOUNT CARD
- CERTIFICATE OF MERIT
- TESTER INSTRUCTION MANUAL
- HIGH FIDELITY GUIDE & QUIZZES
- TELEVISION BOOK & RADIO TROUBLE-SHOOTING BOOK
- MEMBERSHIP IN RADIO-TV CLUB: CONSULTATION SERVICE, A FCC AMATEUR LICENSE TRAINING
- PRINTED CIRCUITRY

## SERVICING LESSONS

You will learn trouble-shooting and servicing in a progressive manner. You will practice repairs on the sets that you construct. You will learn symptoms and causes of trouble in home, portable and car radios. You will learn how to use the professional Signal Tracer, the unique Signal Injector and the dynamic Radio & Electronics Tester. While you are learning in this practical way, you will be able to do many a repair job for your friends and neighbors, and charge fees which will far exceed the price of the "Edu-Kit." Our Consultation Service will help you with any technical problems you may have.

## FROM OUR MAIL BAG

J. Statatits, of 25 Poplar Pl., Waterbury, Conn., writes: "I have repaired several sets for my friends, and made money. The 'Edu-Kit' paid for itself. I was ready to spend \$240 for a Course, but I found your ad and sent for your Kit."

Ben Valerio, P. O. Box 21, Magna, Utah: "The Edu-Kits are wonderful. Here I am sending you the questions and also the answers for them. I have been in Radio for the last seven years, but like to work with Radio Kits, and like to build Radio Testing Equipment. I enjoyed every minute I worked with the different kits; the Signal Tracer works fine. Also like to let you know that I feel proud of becoming a member of your Radio-TV Club."

Robert L. Shuff, 1534 Monroe Ave., Huntington, W. Va.: "Thought I would drop you a few lines to say that I received my Edu-Kit, and was really amazed that such a bargain can be had at such a low price. I have already started repairing radios and phonographs. My friends were really surprised to see me get into the swing of it so quickly. The Troubleshooting Tester that comes with the Kit is really swell, and finds the trouble, if there is any, to be found."

Get Your First Class Commercial

# F.C.C. LICENSE QUICKLY!

Career opportunities in communications electronics are almost unlimited. Prepare now. Let Grantham train you — by correspondence, or by classroom and laboratory instruction. Get your *first class commercial* F.C.C. license in as little as 2 months, or at a slower pace if you prefer. Then, continue in more-advanced electronics training if you wish. Diploma awarded. Our catalog gives full details.

Learn how our training can prepare you for your F.C.C. license (and for advanced electronics work); write or telephone the School at any one of the teaching divisions listed below, and ask for "Catalog #48." It will be mailed to you free of charge. There is no obligation on your part, and no salesman will call on you. Make your own decision — enroll if and when you wish.

### Grantham School of Electronics

1505 N. Western Ave., Los Angeles, Calif. 90027  
(Phone: HO 9-7878)

9320 Long Beach Bl., South Gate, Calif. 90280  
(Phone: 564-3421)

12732 Garden Grove Bl., Garden Grove, Calif. 92640  
(Phone: 530-0795)

408 Marion Street, Seattle, Wash. 98104  
(Phone: MA 2-7227)

3123 Gillham Road, Kansas City, Mo. 64109  
(Phone: JE 1-6320)

821 19th Street, NW, Washington, D.C. 20006  
(Phone: ST 3-3614)

NOW IN PAPERBACK

## Silent Spring Rachel Carson

ANOTHER HISTORY-  
MAKING BESTSELLER FROM



On Sale Wherever Paperbacks Are Sold—  
only 75c

...electronics in the news

Lookout! . . . You're about to be crushed by a dictating machine! But Sheila Turnbull really isn't worried as she demonstrates the dramatic difference in size and styling between old (1888) and new dictators. If that



50-lb. antique reminds you of a foot-operated sewing machine, it's probably because it worked on much the same principle. Fully transistorized, the compact, all-electronic model which rates her undivided attention was demonstrated recently in New York. Its weight? A mere 6 lbs.

**Baby Talk . . .** The white whale in our photo may be a baby, but this hasn't stopped him from uttering all kinds of melodious grunts and squeals for the benefit of distant ears. Thanks to a special, super-sensitive underwater microphone, scientists at AFC's underwater lab in Paramus, N.J., have been able to tune in on a wide variety of weird



submarine noises, including those made by Mr. Whale himself. Thing is, they're having a whale of a time figuring out exactly what the kid is talking about.

**NOW!**  
at a price  
you can afford!

# MAKE MORE MONEY in ELECTRONICS TELEVISION-RADIO

**BETTER...MORE COMPLETE...LOWER COST...  
WITH NATIONAL SCHOOLS SHOP-METHOD  
HOME TRAINING!**

**BETTER...** Training that is proved and tested in Resident School shops and laboratories, by a School that is the **OLDEST** and **LARGEST** of its kind in the world.

**MORE COMPLETE...** You learn **ALL PHASES** of *Television-Radio-Electronics*.

**LOWER COST...** Other schools make several courses out of the material in our **ONE MASTER COURSE**... and you pay more for less training than you get in our course at **ONE LOW TUITION!**



Prepare  
for your  
**F.C.C. LICENSE**

- Be prepared for secure future in
- INDUSTRIAL ELECTRONICS
  - COMPUTERS
  - GUIDED MISSILE SYSTEMS
  - ELECTRONIC CONTROLS
- or go into . . .
- COLOR TV REPAIR
  - HI-FI AND SOUND SYSTEMS
  - BROADCASTING STUDIOS
  - INSTALLATION

**TOP PAY... UNLIMITED OPPORTUNITIES  
LIFETIME SECURITY CAN BE YOURS!**

You are needed in the Television, Radio, and Electronics industry! Trained technicians are in growing demand at excellent pay—in **ALL PHASES**, including Servicing, Manufacturing, Broadcasting and Communications, Automation, Radar, Government Missile Projects.

**NATIONAL SCHOOLS SHOP-METHOD HOME TRAINING**, with newly added lessons and equipment, trains you in your spare time at home, for these unlimited opportunities, including many technical jobs leading to supervisory positions.

**YOU LEARN BY BUILDING EQUIPMENT WITH KITS AND PARTS WE SEND YOU.** Your National Schools course includes thorough Practical training—**YOU LEARN BY DOING!** We send you complete standard equipment of professional quality for building various experimental and test units. You advance step by step, perform more than 100 experiments, and you build a complete TV set from the ground up that is yours to keep! A big, new TV picture tube is included at no extra charge.

**EARN AS YOU LEARN.** We'll show you how. Many students pay for their course—and more, while studying.

**GET THE BENEFIT OF OUR  
OVER 55 YEARS EXPERIENCE**

APPROVED FOR  
GI TRAINING



**NATIONAL TECHNICAL SCHOOLS**  
World-Wide Training Since 1905  
Write to Dept. R4Y-44  
4000 So. Figueroa Street  
Los Angeles, California 90037

**YOU GET...**

- 19 Big Kits—**YOURS TO KEEP!**
- Friendly Instruction and Guidance
- Job Placement Service
- Unlimited Consultation
- Diploma—Recognized by Industry
- **EVERYTHING YOU NEED FOR SUCCESS!**

**IMPORTANT  
SEE OTHER SIDE**

**THESE TWO FREE  
BOOKS TELL HOW**

**SEND FOR FREE FULLY-ILLUSTRATED BOOK AND ACTUAL LESSON TODAY.** Your own copy of "Your Future in Electronics-Television-Radio" will be mailed to you at once. No salesman will call; there is no obligation. Cut out card along dotted line, fill in and mail today! **NO POSTAGE NECESSARY.**

**CUT OUT AND MAIL THIS CARD TODAY**

Yes, I want to make more money in Electronics-TV-Radio. Send me your **FREE** Fully-Illustrated Opportunity Book and Actual Lesson today.

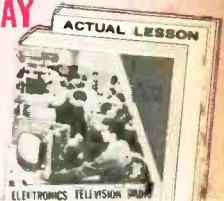

**RUSH TODAY—NO POSTAGE NECESSARY**

Name \_\_\_\_\_ Age \_\_\_\_\_

Address \_\_\_\_\_

City \_\_\_\_\_ Zone \_\_\_\_\_ State \_\_\_\_\_

Check here if interested only in Resident Training at Los Angeles. **R4Y-44**  
Veterans: Give date of discharge \_\_\_\_\_

**NO SALESMAN WILL CALL; NO OBLIGATION ON YOUR PART**

# DON'T BE HALF-TRAINED

## Be a MASTER TECHNICIAN in ELECTRONICS-TV-RADIO

Only N.T.S. offers you ALL 8 PHASES in ONE MASTER COURSE

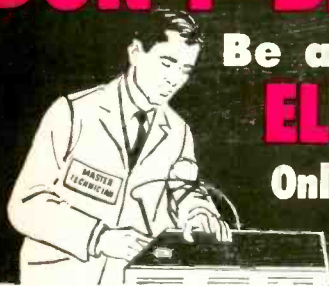

### SUCCESS IS THEIRS; IT CAN BE YOURS TOO!



I cannot praise N.T.S. enough. I've just graduated and already I have started repairing radios and servicing TV's ... At 53, I'm starting a new life and my diploma from National Technical Schools is my proudest possession.

William E. Eckenrod

As field director of Berean Mission Inc., I have complete charge of our radio work.



With the expert advice and training I am receiving from you I can do my own repairs on our recorders and P.A. systems, besides keeping our radios going. My training from N.T.S. helps keep us on the air. I feel privileged to be a member of such a fine institution.

Rev. Enoch P. Sanford



Thanks to N.T.S. I have a business of my own right in my home. I have paid for all my equipment with money earned servicing TV sets. Yes, N.T.S. gave me my start in television.

Louis A. Tabat

I have a TV-Radio shop in Yorkville, Illinois, about 4 miles from my home, and it has been going real good. I started part-time but I got so much work that I am doing it full-time. Thanks to National Technical Schools.



Alvin Sperra

### ALL 8 PHASES IN ONE MASTER COURSE

**PHASE 1 TELEVISION INCLUDING COLOR TV**  
90% of homes have at least one set. Color TV is becoming more popular daily. TV Stations grow in number, need technicians. Maintenance and repair offer big opportunities.

**PHASE 5 FCC LICENSE PREPARATION**  
FCC License holders have a wide range of top jobs open to them. FCC License now a requirement for most Communication jobs.

**PHASE 2 RADIO-AM & FM**  
Radios in homes, cars, schools, all need expert upkeep. Stations expand as FM becomes popular. Now transistors boom entire field.

**PHASE 6 RADAR AND MICROWAVES**  
These are the communications systems of the future, already used in tracking and contacting satellites.

**PHASE 3 INDUSTRIAL ELECTRONICS**  
Computers, Data-Processing machines, Electronic Controls, Guided Missile Systems are new fields where Electronics play a vital role.

**PHASE 7 AUTOMATION & COMPUTERS**  
Automation and Computer electronics are the new tools of industry and commerce. Skilled Technicians in these fields are in great demand at top pay.

**PHASE 4 SOUND SYSTEMS**  
New popularity of Hi-Fi. Stereo, as well as industrial sound systems and business intercoms make this a highly specialized and important field.

**PHASE 8 BROADCASTING & COMMUNICATIONS**  
In the entertainment industry, or in commerce, communications and broadcasting have great importance. Installation and maintenance of equipment requires trained technician know-how.

SEE OTHER SIDE

### FIRST CLASS

Permit No. 3087

Los Angeles, Calif.

### BUSINESS REPLY MAIL

NO POSTAGE STAMP NECESSARY IF MAILED IN THE UNITED STATES

— POSTAGE WILL BE PAID BY —

**NATIONAL TECHNICAL SCHOOLS**

WORLD-WIDE TRAINING SINCE 1905

4000 So. Figueroa Street

Los Angeles, California 90037

### RESIDENT TRAINING AT LOS ANGELES

If you wish to take your training in our famous Resident School in Los Angeles—the oldest and largest school of its kind in the world—check special box in coupon.



Approved for GI Training

**NATIONAL TECHNICAL SCHOOLS**

WORLD-WIDE TRAINING SINCE 1905

Address correspondence to Dept. R4Y-44  
4000 So. Figueroa Street

Los Angeles, California 90037

National Technical Schools also offers Complete Home Study Training Programs in Auto Mechanics & Diesel, Air Conditioning, Refrigeration-Electrical Appliances, and Home Appliances Repair. For information and FREE BOOK write the School, Dept. RDC, stating course desired.

## ...electronics in the news



### Totem Pole . . .

This 11-kw UHF power klystron soon may be gracing the countryside atop TV transmitting towers, invoking the powers of UHF television to bring you a wider choice of channels. First UHF power klystron to use permanent magnets for beam

focusing, the YK1001 also uses air rather than water for cooling. Amperex, its manufacturer, thinks the new klystron will help simplify design of UHF TV transmitters. Furthermore, its life expectancy—about 10,000 hours—promises to give it something of a totem pole's longevity.

**Fast Secrets . . .** The short-wave bands may carry secret, high-quality voice transmissions in the form of digits, once General Telephone & Electronics' high-speed data system is installed at key points around the globe. Transmitting 2,400 bits of information a



second, the new system doubles the traditional digital transmission rate and improves voice quality substantially at the same time. Scrambling devices convert the voice into digits, code the digits, then decode and reconvert the digits into voice at the receiving end.

## To kit builders who go through THICK and THIN



to get the best . . .



## SEND FOR THE THIN!

You don't judge a book by its cover. Nor by the number of pages. If you're looking for weight, don't bother with the Conar catalog. But if you're looking for quality electronic kits that are backed by a *no-loopholes guarantee*, you'll want to study our careful selection of do-it-yourself and assembled units. There's something for everyone:

V set kits to transistor radios, VTVM's to scopes, tube testers to tools. For years of pleasurable performance, for fun and pride in assembly, mail coupon below. Discover why Conar, a division of the National Radio Institute, is the fastest growing entry in the kit and equipment **CONAR** business.

MAIL NOW

CONAR

3939 Wisconsin Ave., Washington 16, D.C.

Please send me your catalog.

BE4C

Name \_\_\_\_\_

Address \_\_\_\_\_

City \_\_\_\_\_ Zone \_\_\_\_\_ State \_\_\_\_\_

**NO MATTER WHAT YOUR JOB IS TODAY**

**There's BIG MONEY to be Made In COLOR TELEVISION!**

**DUE TO SHORTAGE OF TRAINED MEN**



Get into fast-growing field! Learn **COLOR TV** servicing at home in spare time. Many *earn cash* while training! Move ahead to a better job, a business of your own!

**Get 20 Valuable Kits to Build 21" TV Set and Test Instruments!**

Become expert the fast, easy way . . . by working on actual TV problems. Your training includes 20 valuable kits of parts and tools, yours to keep. Build a complete 21" TV set, tube tester, and electronic voltmeter as part of your training.

**HERE'S HOW TO GET STARTED:  
MAIL COUPON TODAY FOR**

**FREE BOOKLET!**

Commercial Trades Institute  
1400 Greenleaf Ave., Chicago, Illinois 60626

Dept. T-11

Rush my **FREE** booklet (without cost or obligation) on C.T.I. training for job opportunities in television-electronics—including **COLOR TV** servicing.

NAME \_\_\_\_\_

ADDRESS \_\_\_\_\_

CITY \_\_\_\_\_ ZONE \_\_\_\_\_ STATE \_\_\_\_\_



Accredited Member National Home Study Council

**NEW - - by KUHN  
AM/FM VHF RECEIVER**

Covers 26-54 and 108-174 MC in six calibrated bands with excellent sensitivity. Ideal for rapid scanning for CB, Amateur, Aircraft, or FM Police, Fire, etc. signals with controllable selectivity.

353-A  
**\$48.70**



**AIRCRAFT • POLICE • FIRE**



348A  
Complete  
**\$34.95**

315-B  
5-54 MC  
**\$17.95**  
115-160 MC  
**\$18.95**



Transistorized, directly tuneable converter. Powered with self-contained mercury cell. Excellent sensitivity and stability. Designed for car, home or portable receivers.

Converts home or car radios to receive Fire, Police, Aircraft, CB, SW, etc. Exceptional sensitivity on High and Low Bands. High Band type adjusts to bracket 115-160 MC. Low Band type should be ordered for 33-47 MC, 40-52MC, 26-30 MC, 9-12 MC, etc. May be adapted for transistorized car radios.

Order today or send for free catalog on full line of converters and receivers for every application.



20 GLENWOOD  
CINCINNATI 17,  
OHIO

**...electronics in the news**

**Faithful Fido . . .** Dogs may be known for their devoted dedication, but GE's Commander 2-way radio isn't far behind. A battery-operated VHF FM portable, the Commander stands ready



to serve its master most anywhere. It puts out about 1 watt of RF and its chrome handle doubles as a desk stand when its batteries are being recharged.

**Down We Go . . .** The interconnected maze of transistors, resistors and other electronic components you see here eventually will be reduced to a complete circuit no bigger than a match-head. In this instance, the 24-inch glass

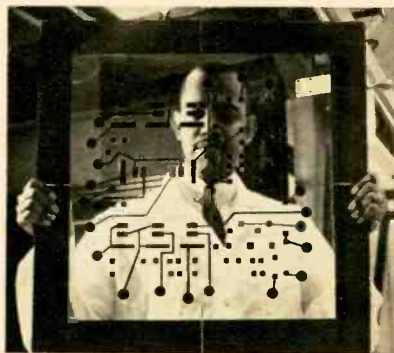

masking plate will undergo a photographic reduction of some 200 times, then be installed in an airborne computer. Engineer Donald Elam says that the fine art of molecular electronics is all in a day's work at Westinghouse.

Exclusive with **RCA** ...

# **AUTOTEXT<sup>®</sup>**

## **new, faster, easier way toward a career in electronics**

**EXCLUSIVE WITH RCA.** "AUTOTEXT," developed by RCA and introduced by RCA Institutes, Inc., is a system of programmed instruction, accurately planned so that as you read a series of statements, questions, and answers, you learn almost without realizing it! It's fast! It's easy! It's fun!

**NEW TREND IN EDUCATION!** Programmed instruction has been proved with thousands of students. People who have had trouble with conventional home training methods in the past can now master the fundamentals of electronics almost automatically!

**PROVE IT TO YOURSELF NOW!** An interest or inclination in electronics is all you need. RCA "AUTOTEXT" will help you do the rest. And the future is unlimited; the jobs are available! The important thing is to get started now!

**COMPLETE COURSE AVAILABLE.** RCA Institutes now offers you a complete Home Training Course ("Introduction to Electronics") using the "AUTOTEXT" method. You get a complete set of theory lessons, service practice lessons, experiment lessons, and all the kits you need. You'll learn faster with less effort!

### **FREE OFFER!**

We'll send you complete information on the amazing new RCA "Autotext", along with a FREE SAMPLE of a Home Training lesson to prove to you how easy it is to learn this new way. Check "Autotext", and information will be rushed to you.

**Complete selection of Home Training Courses, in addition to "AUTOTEXT" Introduction to Electronics.**

- Electronic Fundamentals (also available in Spanish)
- Electronic Drafting
- TV Servicing
- Automation Electronics
- Color TV Servicing
- Transistors
- Communications Electronics
- Industrial Electronics
- FCC License Preparation
- Automatic Controls
- Mobile Communications
- Nuclear Instrumentation
- Computer Programming
- Digital Techniques

#### **● LIBERAL TUITION PLAN FOR ALL HOME TRAINING COURSES**

This plan affords you the most economical possible method of home study training. You pay for lessons only as you order them. If, for any reason you wish to interrupt your training, you can do so and not owe one cent. No other obligations! No installment payments required.

#### **● YOU GET PRIME QUALITY EQUIPMENT**

All kits furnished with home training courses are complete in every respect and the equipment is top grade. You keep all the equipment furnished to you for actual use on the job, and you never have to take apart one piece to build another!

Licensed by the New York State Department of Education. Approved for Veterans.

**Classroom Training Available in New York City, and Cherry Hill (near Camden) New Jersey.**

**Send postcard for free illustrated book today! Specify home training or classroom training!**

**RCA INSTITUTES, INC.** Dept. EI-54  
A Service of Radio Corporation of America  
350 West 4th St., New York, N. Y. 10014



**THE MOST TRUSTED NAME IN ELECTRONICS**

## TWO GREAT NEW RECEIVERS FROM NATIONAL...



**NC-121** This handsome, feature-packed general coverage receiver is a natural for the amateur, short-wave listener, and hi-fi enthusiast. Features full coverage from 550 KC to 30 MC, large illuminated signal strength meter, noise-limiter, SSB/CW features, and peaking Q-multiplier for optimum selectivity. National's exclusive Tuner Output allows use of the NC-121 with hi-fi equipment. \$129.95. With walnut case (NC-121W) \$149.95

**NC-77X** An exceptional value for the novice radio amateur or beginning short-wave listener, the NC-77X is a full coverage superheterodyne all-band receiver with electrical bandspread on all frequencies. Transformer-operated circuitry for safety, increased sensitivity, and low noise. Giant easy-to-read dial has standard AM Broadcast, Marine, Aircraft, Citizen's Band, CD, WWV, amateur and foreign short-wave bands clearly marked. \$69.95. With walnut case (NC-77XW) \$89.95

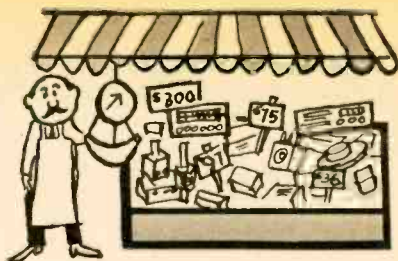

## Electronic Marketplace



**ALL GREEK . . .** Though the seven speakers in the Sigma hi-fi series carry a Greek letter as a name, you don't have to be from Athens to appreciate the quality of their sound. High-power handling capability and low distortion are claimed in these 8- and 12-inchers, which feature high-energy ceramic magnets. In addition, a special suspension system permits free cone movement, resulting in good bass response. And, to round out the picture, low-crossover (2,000 cps) tweeters do well with highs and mid-range sound. \$16.50 to \$69.50. Jensen Mfg. Co., 6601 S. Laramie Ave., Chicago, Ill. 60638.

**Tough Telephone . . .** The somewhat less than jet-smooth rides of Jeeps, tractors, forklifts and boats are no problem for the VS-2 industrial radiotelephone. With a high vibration-service rating and a moisture- and shock-proof mike cartridge, the rugged VS-2 is a

must for sportsman or foreman. What's more, the versatile unit is capable of operating from 117 VAC or 12 VDC. Mike, crystals for one channel and a 117-V cord are included with the rig. \$139.95. General Radiotelephone Co., Burbank, Calif. 10260.



must for sportsman or foreman. What's more, the versatile unit is capable of operating from 117 VAC or 12 VDC. Mike, crystals for one channel and a 117-V cord are included with the rig. \$139.95. General Radiotelephone Co., Burbank, Calif. 10260.

**NATIONAL RADIO  
COMPANY, INC.**  
37 Washington Street  
Melrose, Mass. 02176

Rush Me Free Your Complete Guide To  
National Receivers! DEPT E1-564

Name \_\_\_\_\_  
Address \_\_\_\_\_  
City \_\_\_\_\_ State \_\_\_\_\_



studying antenna system in Tri-State's electronics lab

## B.S. degree in 36 months

Small professionally-oriented college. Four-quarter year permits completion of B. S. degree in three years. Summer attendance optional. **Engineering:** Electrical (electronics or power option), Mechanical, Civil, Chemical, Aeronautical. **Business Administration:** Accounting, General Business, Motor Transport Administration. One-year Drafting-Design Certificate program. Graduate placement outstanding. Founded 1884. Rich heritage. Excellent faculty. Small classes. Well-equipped labs. New library. Residence halls. Pleasant community. Attractive 200-acre campus. Modest costs. Enter Mar., June, Sept., Jan. For Catalog and View Book, write J. A. McCarthy, Director of Admissions.



**TRI-STATE COLLEGE**

4815 College Avenue • Angola, Indiana



In any CB application...you'll  
outperform 'em all with a  
**M E S S E N G E R**

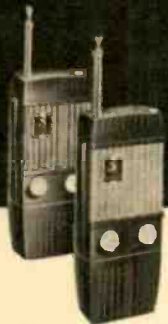

**Personal  
Messenger**

Compact, hand-held 100 mill watt or 1½ watt models! Rugged and reliable — 11 transistors, 4 diodes. Twice the sensitivity and 40% more range than similar units with conventional circuitry — more output than similar units with same rated inputs!

- Cat. No. 242-101  
100 milliwatts.....\$109.50 Net
- Cat. No. 242-102  
1½ watts.....\$129.50 Net



**Messenger and Messenger Two**

For mobile or base stations. High efficiency design makes full use of maximum allowable legal power. Excellent receiver sensitivity and selectivity. Automatic "squelch" control. 5 crystal controlled channels on the "Messenger" and 10 crystal controlled channels plus a tunable receiver on the "Messenger Two."

- M E S S E N G E R**
- Cat. No. 242-127  
115 Volts AC/ 6 Volts DC...\$109.95 Net
  - Cat. No. 242-128  
115 Volts AC/12 Volts DC...\$109.95 Net

- M E S S E N G E R T W O**
- Cat. No. 242-162  
115 Volts AC/ 6 Volts DC...\$169.95 Net
  - Cat. No. 242-163  
115 Volts AC/12 Volts DC...\$169.95 Net

*New!*

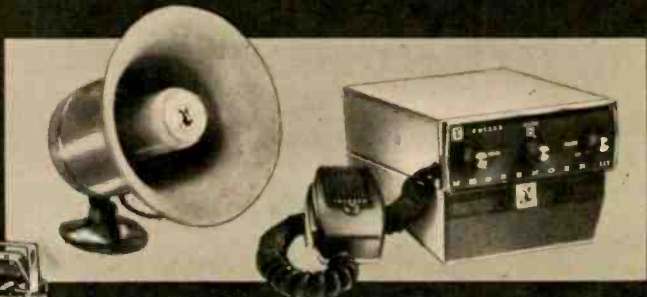

**M E S S E N G E R I I I**

The "Messenger III" offers everything you ever wanted in a CB transceiver... compact size, a husky signal, extreme sensitivity, razor-sharp selectivity — and complete flexibility for base station, mobile, public address, or battery powered portable use! Double conversion receiver — set-and-forget "Volume" and "Squelch" controls — 11 channel coverage — "Tone Alert" Selective Calling System available as accessory.

- Cat. No. 242-150 12 Volts DC Messenger III.....\$189.95 Net
- Cat. No. 250-823 117 Volt AC Power Supply.....\$ 29.95 Net

**WRITE TODAY**  
for full details  
SEE YOUR DEALER/DISTRIBUTOR  
AND ASK FOR A DEMONSTRATION



**E. F. JOHNSON COMPANY**  
2211 TENTH AVE. S.W. • WASECA, MINNESOTA

LEARN

# ELECTRONICS

TELEVISION

ELECTRICITY

Train in the  
new shop-labs of  
the world famous



## COYNE ELECTRONICS INSTITUTE

on a quarter of a million dollars worth of equipment for a Big Pay Job and an Exciting Career. Special finance plans. Part time employment service while in school. Also Free graduate employment service.



Use this coupon to get our FREE BOOK  
"YOUR OPPORTUNITIES IN ELECTRONICS"

COYNE ELECTRONICS INSTITUTE, Dept. of Electronics 54-A  
1501 W. Congress Parkway, Chicago, Illinois 60607

Name \_\_\_\_\_ Age \_\_\_\_\_

Address \_\_\_\_\_ Phone \_\_\_\_\_

City \_\_\_\_\_ Zone \_\_\_\_\_ State \_\_\_\_\_

*Unlike most other schools, we do not employ salesman*

## DYNAKIT high fidelity



SCA-35  
stereo amplifier—\$99.95

For the cost-conscious perfectionist

- AMPLIFIERS • TUNERS
- PREAMPLIFIERS

Write for detailed specifications  
and impartial test reports

DYNACO INC., 3912 Powelton Ave., Phila. 4, Pa.  
Please send specifications and test reports to:

Name \_\_\_\_\_

Address \_\_\_\_\_

City \_\_\_\_\_ State \_\_\_\_\_

ET-564

## Marketplace

**Cordless VTVM** . . . Combining the overload protection feature of the VTVM and the portability of the VOM,



this transistorized AC/DC multimeter is an unusually versatile instrument for experimenters and engineers alike. It is powered by self-contained flashlight cells and draws a small amount of current. The kit is priced at \$64.50; wired, \$89.50. DeVry Technical Institute, Chicago, Ill.

**11-Inch TV** . . . An 11-inch picture tube with 60 square inches of viewing area is a lot of TV in a portable package. The



personal portable plugs into the 117 VAC outlet anywhere you'd like it. Complete with dipole antenna and ear-phone jack, the set takes up slightly more space than a telephone book. Prices run from \$99.95 to \$109.95. General Electric, Syracuse, N. Y.

# Marketplace

**Convertible . . .** A new split-and-hinged design on Atlee's Military Type A tube shield makes it possible to remove the

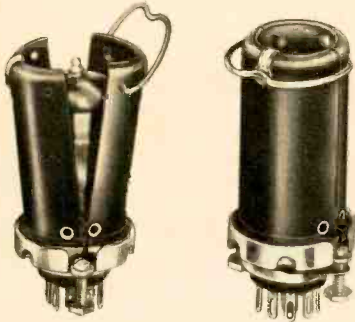

shield without taking the tube from its socket. A metal snapping keeps the shield in place and a hinge swings open at the base for instant removal. A flexible beryllium copper material inside the shield provides a firm glove-like grip for maximum heat dissipation. Atlee Corp., Winchester, Mass.

**Combo . . .** H. H. Scott took the performance of their 350 FM stereo tuner, combined it with the power of their 299



stereo amplifier and came up with the 340B stereo tuner/amplifier—one compact unit that does double duty. The 70-watt unit has automatic stereo-to-mono switching, a tuning meter, a powered third channel for connecting an optional speaker or a three-channel system and complete tape-monitoring facilities. Also included is an earphone jack and a signal light that indicates when the tuner is receiving stereo. Attractive styling and slide-rule tuning complement the front panel. The 340B carries a \$399.95 price tag. H. H. Scott, Inc., Maynard, Mass.

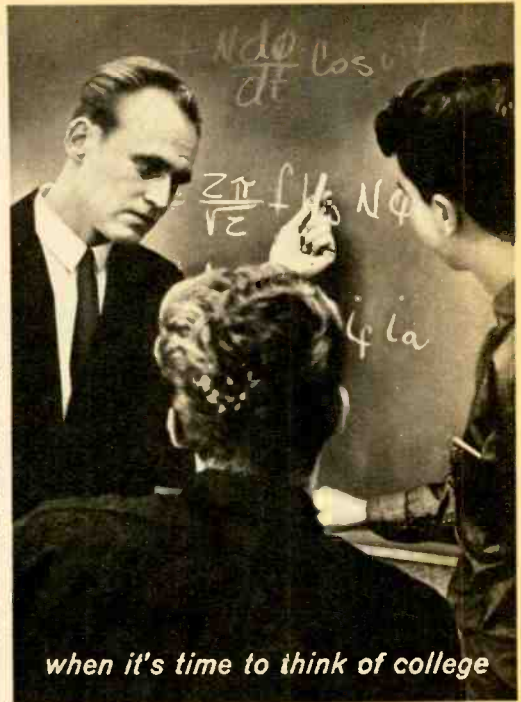

*when it's time to think of college*

## inquire about Electronics at MSOE

Planning your space age engineering education now, will enhance your career later. Find out about MSOE programs in Electronics, Computers, and Electrical Engineering.

Obtain all the facts about courses leading to 4-year Bachelor of Science and 2-year Associate in Applied Science degrees. Find out about MSOE scholarships, financial aids, job placement opportunities, and other services.

Assure yourself of a bright future in the exciting field of space age engineering and technology. Write for your Free "Career" booklet which will tell you about educational advantages at MSOE.



# MSOE

MILWAUKEE SCHOOL OF ENGINEERING

MS-217

Dept. E1-564, 1025 N. Milwaukee St. Milwaukee, Wisconsin 53201

Tell me about a career through residence study:

- Electronics field       Mechanical field  
 2-years or  4-years

Name.....Age.....

Address.....

City, State.....

# BIG MONEY

IN THE **4** CORNERS OF THE WORLD!

in TELEVISION, RADIO, ELECTRONICS, RADAR, SONAR

**ONLY CHRISTY OFFERS COMPLETE TRAINING!**

Investigate the Christy Complete Course. Why be satisfied with less? CTS Shop Method, Home Training makes learning easy. You learn by working with actual equipment. You receive Comprehensive training from the start. Can **EARN AS YOU LEARN**. You become qualified to open your own Electronics Repair business or to gain high pay as a TV, Radio, Electronics, etc., Technician.

**19 TRAINING KITS INCLUDED!** You receive a Multi-Tester, Oscillator, Signal Tracer, Oscilloscope, Signal Generator, Electronic Timer, Regenerative Radio, 24" TV set (optional) and other valuable testing equipment. **FREE BOOK** and **TWO FREE LESSONS** yours for the asking! No obligation.

**CHRISTY TRADES SCHOOL**  
Dept. T-2413, 3214 W. Lawrence Ave.  
Chicago, Illinois 60625



SEND for 3 FREE BOOKS



CHRISTY TRADES SCHOOL, Dept. T-2413  
3214 W. Lawrence Ave., Chicago, Illinois 60625  
Please send me the 3 FREE BOOKS and Special Form for PAYING LATER from EARNINGS MADE WHILE LEARNING.

NAME ..... AGE .....

ADDRESS .....

CITY ..... ZONE ..... STATE .....



LOOK FOR



A BRAND NAME IS A MAKER'S REPUTATION

Brand Names Foundation, Inc.

**FREE... SCOTT CUSTOM STEREO GUIDE**



New 24-page 1964 Custom Stereo Guide packed with photos, descriptions, and specifications of all Scott tuners, amplifiers, tuner/amplifiers, speakers, and kits. Also... articles and pictures on decorating your home with stereo, selecting a tuner and amplifier, and how FM multiplex stereo works. Send for your copy today.

Rush me the new 1964 Scott Guide to Custom Stereo. 130-05

Name.....

Address.....

City..... Zone..... State.....

H.H. Scott, Inc.  
111 Powdermill Road  
Maynard, Massachusetts



EXPORT: Morhan Exporting Corp., 450 Broadway, N. Y. C.  
CANADA: Atlas Radio Corp., 50 Wingold Avenue, Toronto

## Marketplace

**RF Galore . . .** The TE-20A RF signal generator is worth its weight (only 8 lbs.) in inexpensive versatility. It offers a choice of six frequency ranges: 120-320 kc, 320-1000 kc, 1-3.2 mc, 3.2-11 mc, 11-38 mc and 37-130



mc. And you can choose from three different outputs: 400-cps audio and either modulated or unmodulated RF. \$27.95, factory-wired and calibrated. Lafayette Radio Electronics Corp., 111 Jericho Tpke., Syosset, L.I., N.Y. 83550.

**All in One . . .** The Classic stereo FM receiver combines a quality stereo tuner and a complete 36-watt stereo amplifier/preamplifier on one compact chassis. The amplifier's frequency response remains within 1db between 15 and 40,000 cps and the preamp has inputs for phono, tuner and tape auxiliary. Separate bass and treble controls, a blend control and a tape monitor switch offer maximum flexibility, while high styling is achieved with an extruded aluminum, brushed-silver top and a pale gold bottom. \$154.95, kit; \$229.95, factory-wired. Eico, 33-00 Northern Blvd., Long Island City, N.Y. 48301.

# Marketplace

**Four-Bander . . .** The NC-77X four-band communications receiver covers the range from 540 kc to 31 mc. Electrical bandspread makes for easy tuning, while a power transformer eliminates shock hazards. The set fea-



tures a built-in 5-in. speaker plus a head-telephone jack. Though a wrinkle-finish steel cabinet is standard, hand-rubbed walnut is available for those willing to fork over an additional \$20. \$69.95 and \$89.95. National Radio Co., 37 Washington St., Melrose, Mass. 45050.

**Xtals Everywhere . . .** Looking for crystal control? You've got it in the HB-222, a 23-channel CB transceiver with crystal-controlled transmit and receive plus tunable receive. The dual-conversion receiver uses



1650- and 262-kc IF's for excellent selectivity and sports a sensitivity of better than 1 microvolt. The transmitter features PTT relay switching and a noise-cancelling ceramic microphone. Ten tubes, three diodes; 117 VAC and 12 VDC. \$159.50. Lafayette Radio Electronics Corp., 111 Jericho Tpke., Syosset, L.I., N.Y. 83550.

hayden and rider books

FREE

THE HAYDEN BOOK COMPANIES  
1964

Describes more than 250 John F. Rider and Hayden books covering all vital areas of electronics • electricity • computers • transistors • kit building • radio & TV servicing • hi-fi • amateur radio • CB

## Read these new Rider Books

**PRACTICAL OSCILLOSCOPE HANDBOOK** by Rufus P. Turner. Up-to-date guidebook of interest to anyone who uses an oscilloscope for servicing, lab or hobby. Step-by-step directions with each operation illustrated show you how to use your scope in almost any application. #339, 2 vols. paper, \$5.90; #339-H, cloth, \$6.95.

**UNDERSTANDING DIGITAL COMPUTERS** by Ronald M. Benrey—Excellent first step if you want to get to know your way around digital computers and understand their operation. #319 paper, \$3.75; #319-H cloth, \$5.45.

Today, visit your electronics parts distributor or bookstore. Use coupon below to order or get your free 1964 catalog.

ORDER TODAY—10-DAY GUARANTEE

**JOHN F. RIDER, PUBLISHER, INC.**

A division of Hayden Publishing Co., Inc.  
116 West 14th Street, New York, N.Y. 10011

Please send ( ) copies for free 10-day examination. Within 10-days of receipt, I shall remit payment plus postage, or return books without obligation.

**PRACTICAL OSCILLOSCOPE HANDBOOK**  
 2 vols. paper, \$5.90;  cloth, \$6.95

**UNDERSTANDING DIGITAL COMPUTERS**  
 paper, \$3.75;  cloth, \$5.45

Name \_\_\_\_\_

Address \_\_\_\_\_

City \_\_\_\_\_ Zone \_\_\_\_\_ State \_\_\_\_\_

Payment enclosed. We pay postage.

Free 72-page catalog of RIDER BOOKS.

## BEST BUYS IN STEREO AND MONO HI-FI

Stereo/  
mono  
4-track  
tape  
deck  
3 motors  
#2400  
Semikit  
(transport assembled & tested)  
\$199.95; Wired \$269.95



Stereo FM Multiplex Tuner ST97  
Kit \$99.95\* Wired \$149.95\*



70-Watt Integrated  
Stereo Amplifier ST70  
Kit \$99.95 Wired \$149.95



FM-AM Stereo Tuner ST96  
Kit \$89.95\* Wired \$129.95\*

40-Watt Integrated  
Stereo Amplifier ST40  
Kit \$79.95 Wired \$129.95



New Classic Series  
36-Watt FM-Multiplex  
Stereo Receiver 2536  
Kit \$154.95\* Wired \$209.95\*



New Classic Series  
FM-Multiplex Stereo Tuner 2200  
Kit \$92.50\*; Wired \$119.95\*

New  
Classic  
Series



36-Watt Stereo Amplifier 2036  
Kit \$79.95; Wired \$109.95  
50W-2050 K. \$92.50; W. \$129.95  
80W-2080 K. \$112.50; W. \$159.95



Stereo  
Power  
Amplifiers

Kit Wired

70W HF87A: \$74.95 \$114.95  
100W HF89A: \$99.50 \$139.50

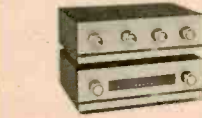

12-Watt Mono Amp. HF-12A  
K. \$39.95; W. \$59.95; Incl. Metal Cover  
FM Tuner HF-90A K. \$44.95\*; W. \$69.95\*



2-way system 6 1/2" woofer. HFS-10.  
W. \$29.95 + 2-way system 8" woofer  
HFS-8. W. \$44.95 + 3-way system 10"  
woofer HFS-6. K. \$59.95; W. \$89.95

## BEST BUYS IN CITIZENS TRANSCEIVERS, HAM GEAR, RADIOS

Dual Conversion CB Trans-  
ceiver 777. Kit \$119.95;  
W. \$189.95.



770 Series  
CB Trans-  
ceivers  
from Kit  
\$79.95;  
Wired  
\$109.95



Transmitters from \$59.95  
90 watt CW transmitter #720  
Kit \$89.95. Wired \$129.95

Hand held  
Citizens Band  
Transceiver #740  
incl.  
rechargeable  
battery & charger.  
Kit \$54.95.  
Wired \$79.95.



## BEST BUYS IN TEST EQUIPMENT

Peak-To-Peak  
VTVM #232  
& Uni-Probe®  
(U.S. Pat.)  
Kit \$29.95  
Wired \$49.95



VTVM #222  
Kit \$27.95 Wired \$42.95

General  
Purpose  
3" Scope #430.  
Kit \$65.95; Wired \$99.95



DC-5 MC  
5" Scope #460  
Kit \$89.95  
Wired \$129.50



General Purpose 5" Scope #427  
Kit \$69.95 Wired \$109.95

Dynamic  
Conductance  
Tube &  
Transistor  
Tester.  
#667 Kit  
\$79.95;  
Wired  
\$129.95.



Tube Tester #628  
Kit \$44.95; Wired \$59.95

RF Signal  
Generator  
#324  
Kit \$28.95  
Wired \$39.95



V-O-M  
1000  
ohms  
volt  
#536  
Kit  
\$14.95;  
Wired  
\$18.95  
20,000 ohms volt  
#565. Kit \$24.95;  
Wired \$29.95



Extra Low  
Ripple 6- &  
12V Battery.  
Eliminator  
& Charger.  
#1064  
Kit \$45.95;  
Wired \$54.95  
#1050. Kit \$29.95; Wired \$38.95.  
#1060 for transistor equip.  
Kit \$39.95; Wired \$49.95



TV-FM  
Sweep &  
Post Injec-  
tion Marker  
Generator #369  
Kit \$89.95; Wired \$139.95



Deluxe Multi-Signal  
Tracer #147-A  
Kit \$29.95; Wired \$44.95



# NEW EICO® KITS FOR 1964

A line-up of the best buys in stereo hi-fi, tape recorders, test equipment, CB & ham gear. You can save up to 50% by building them yourself, or buy them factory-wired and still have the best values available. More than 230 Eico products to choose from.



EICO ELECTRONIC INSTRUMENT CO., INC.  
131-01 39th Avenue, Flushing, N. Y. 11352

Send 1964 Catalog. EI-5

Name.....  
Address.....  
City..... Zone..... State.....  
Add 5% in the West \*Incl. F.E.T.



By ALEX BOWER

**E**VERY AMERICAN has heard of Radio Moscow. More importantly, every short-wave listener with even a smidgin of curiosity has monitored its broadcasts time and again. And why not? As the official voice of one of the world's two great powers, Radio Moscow deserves a listen.

To put it another way, anyone with a keen interest in the incredible political and ideological complexities of the Cold War ought to give Radio Moscow an ear. Tuning out Radio Moscow is something like hiding your head in the sand, ostrich style. For in Radio Moscow lies the key to better understanding of the elusive giant that is the U.S.S.R.

But what do you personally know about Russia's North American service? Whom is it aimed at? How does it operate? And how do the Russians justify the many millions of rubles it costs?

**Two Audiences.** Actually, it takes only a few hours of listening to determine how Radio Moscow views its American audience. The Soviets obviously divide us into two categories. First, there are listeners of a technical bent, DXers included. Listeners of this variety come from every walk of life and possess widely varying degrees of education. But few converts to Communism can be expected

from this group. Regardless of how many QSL's Mrs. Eugenia Stepanova and her staff may send, this group (fortunately for us) is far more interested in the cards themselves than in Communism.

The second category of listeners consists of college students, intellectuals and others interested primarily in gaining "culture" and information from short-wave listening. Moscow fights hard for a corner of this market. In fact, the musical portion of Radio Moscow's programming consists principally of classical selections aimed at this group. Accompanying interviews with artists and students are calculated to lend a personal, hands-across-the-Curtain touch.

At other times, folk songs are presented with an eye toward these same intellectuals. And, more often than not, the lyrics have overtones that are distinctly political. For example, a program of songs might include such "pacifist" offerings as Ain't Gonna Study War No More, Peace in the Valley and so on.

**Subtle Tactics.** As you've probably gathered by now, the nature of its target audience is such that Radio Moscow seldom lies—outright. With well-educated listeners, a direct misstatement of fact simply

Sovfoto

## INSIDE RADIO MOSCOW

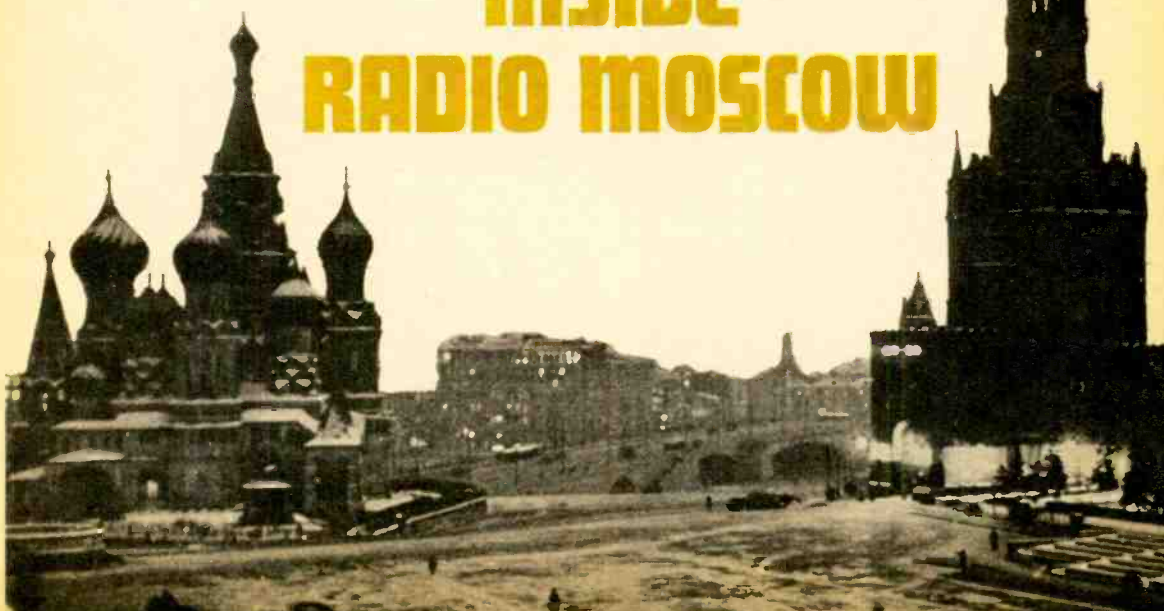

## INSIDE RADIO MOSCOW

would not get by. Radio Moscow's exposé of the now deposed Trujillo and conditions in his Dominican Republic is a case in point. The program presented the truth in every respect. The facts could well have been lifted from some legitimate American publication.

But what was not mentioned was perhaps of even greater importance—significant by its absence. Never did Radio Moscow acknowledge that Washington was instrumental in Trujillo's expulsion from the Organization of American States. In fact, the expulsion itself was quietly ignored.

And therein lies Radio Moscow's No. 1 weapon: selection. For while Moscow may take every possible precaution to insure that it tells the truth, it seldom tells the whole truth. Instead, it selects . . . from news events, background material and—most frequently of all—from statements by persons of note.

So clever is Radio Moscow that anyone who makes a public statement may find himself part of a Soviet propaganda broadcast. And this goes for even the President. Or per-

haps we should say *especially* the President. Typical was a short commentary of some months back which spoke of declining American prestige and quoted liberally from the late President Kennedy's campaign speeches.

Still another of Radio Moscow's many tricks is to quote without fully identifying the source. For example, pro-Castro statements from the "former foreign minister of Guatemala" proved to have come from a member of the Red regime which briefly controlled this republic. Naturally, nary an hour passes without at least one quote from Comrade Khrushchev. But, while monotonous and a weakness in their attack, this kind of bear-hugging undoubtedly is necessitated by the political facts of life in the U.S.S.R.

**The Big Aim.** When you come right down to it, Radio Moscow has but one reason for being: to sell the U.S.S.R. and the Soviet way of life. In addition to its main theme—progress—Radio Moscow goes out of its way to cite an even greater abstraction: freedom.

At times, such efforts may be based on nothing more tenable than the fact that the Soviet Union today is producing more electricity. Again, the material facts probably

Sovfoto

Sovfoto



Warehouse-like building at left houses main studios of Radio Moscow in the Soviet capital, though programs originate from points throughout the Soviet Union. Even stations which identify themselves as "Radio Moscow" often are located elsewhere, as you can see from the table at right. Since women are found in all walks of Soviet life, don't be surprised to hear plenty of women announcers in your hours with Radio Moscow.



are accurate. Living conditions in most of Russia's republics *have* improved since the 1917 revolution. But freedom is considerably more difficult to pin down. And it most certainly has little to do with the statistics of electrical production.

**The Problems.** Despite advanced technical know-how, Radio Moscow still faces a tremendous natural geographic barrier in its efforts to beam its propaganda to the four corners of the world. Proximity to the polar zone and the accompanying auroral absorption of radio signals pose a highly difficult problem

for Moscow's technicians. With the sole exception of Finland, transmissions from Russia to North America pass more completely through this region than those from any other European nation.

By and large, Radio Moscow relies on the shotgun method to overcome both absorption and interference from other stations. Generally, its engineers pick the best two or three bands and load them with transmitters. Due to the problems involved, signals often are weak at best and sometimes subject to heavy

*[Continued on page 114]*

### SHORT-WAVE LISTENER'S GUIDE TO RUSSIAN PROPAGANDA BROADCASTS

FREQ. (KC)	IDENTIFICATION	NOTES (Times in EST)
6070	R. Moscow	English to East Coast at 2000-2200; probably from Bulgaria
6140	R. Moscow	English to East Coast at 1700-1800, 2100-2200, 2230-0100
6160	R. Moscow	English to West Coast at 0630-0830, Sundays only
6170	R. Moscow	English to East Coast at 2100-2200
7130	R. Moscow	English to East Coast at 1700-1800, 1830-1930, 2000-2200, 2230-0100
7150	R. Moscow	English to Europe and East Coast at 1700-1800, 1830-1930, 2000-2200, 0000-0100
7170	R. Moscow	English to East Coast at 1700-1800, 2230-0100
7180	R. Kiev	English to North America at 2100-2130
7190	R. Kiev	English to North America at 2100-2130, 2300-2330
7200	R. Moscow	English to West Coast at 0630-0830, Sundays only; to East Coast at 1700-1800, 2100-2200, 0000-0100
7250	R. Moscow	English to West Coast at 2200-0230; probably from Siberia
7270	R. Moscow	English to West Coast at 0630-0830, Sundays only; probably from Siberia
7280	R. Kiev	English to North America at 2300-2330
7280	R. Moscow	English to Far East at 0300
7290	R. Kiev	English to North America at 2100-2130
7290	R. Moscow	English to East Coast at 1700-1800, 0000-0100; probably uses Kiev transmitter
7310	R. Kiev	English to North America at 2100-2130, 2300-2330
7380	R. Moscow	English to East Coast at 1700-1800, 1830-1930, 2000-2200, 2230-0100
9540	R. Moscow	English to West Coast at 2200-0230; and at 0630-0830, Sundays only
9540	R. Yerevan	English to North America at 1520-1530, Saturdays and Sundays only
9570	R. Moscow	English to East Coast at 1830-1930, 2000-2200; probably from Rumania
9600	R. Tashkent	English to North America at 0700 and 0900
9620	R. Moscow	English to East Coast at 1700-1800, 1830-1930, 2000-2400
9640	R. Moscow	English to West Coast at 2200-0230; probably from Siberia
9650	R. Moscow	English to East Coast at 1830-1930, 2000-2200
9730	R. Moscow	English to West Coast at 2200-0230; probably from Siberia
11890	R. Moscow	English to Europe at 1400
11925	R. Tashkent	English to North America at 0700 and 0900
15140	R. Moscow	English to West Coast at 2200-0230, to Far East at 0300-1000; probably from Siberia
15150	R. Moscow	English to Africa at 1000 and 1300

# OUTSIDE Radio Moscow

## ...WAY OUT!

By DON CARTER

*Castro's radio shenanigans were detailed in our last issue, R. Moscow's in the preceding article. Here's the scoop on the two non-Soviet Reds.*

### ► Radio Peking

With the Red China-Russia split a hard reality, Radio Peking no longer can be regarded as a mere satellite of Radio Moscow. Today, this Asian broadcasting giant has assigned itself the double task of fighting both the free world and the "revisionist" policies of Russia's Premier Khrushchev.

Taking their cue directly from Karl Marx, the Red Chinese are militant atheists. Yet Radio Peking's campaign against Moscow can only be described as "theological." (Radio Peking itself even makes mention of its "sacred duty.")

Following Marxist-Leninist principles, Peking's broadcasts openly renounce Moscow's supposed policy of peaceful coexistence in favor of small wars "when necessary." Some Red Chinese spokesmen even have termed the "foul practice of collaboration with the United States imperialists" an "unprecedented shame." In Radio Peking's view, world peace is impossible without world Communism.

Though Radio Moscow is no weakling, Radio Peking is well equipped to offer stiff competition. It boasts a bevy of high-powered transmitters beamed to all parts of the world. And it employs at least two widely separated transmitter sites to cope with varying ionospheric conditions.

One British source goes so far as to credit Peking with a relay station in the West African republic of Guinea. However, best guess is that this story is a hoax. Even when Peking carries Radio Tirana's North American service, it is forced to use a transmitter on the Chinese mainland.

Radio Peking probably experiences its greatest difficulty in getting a good signal into the eastern half of North America. However,

English is beamed to this area at 2000-2200 EST with signal strength ranging from pretty good to just plain lousy. Listeners in the West usually enjoy excellent reception, with English scheduled at 1900-2100 PST.

As for frequencies, Radio Peking seems to delight in off-band operation. Winter favorites are 7480, 9457, 9480 and 9945 kc. During the summer months, 15,040 and 15,090 frequently are used.

In event you're thinking of going after a Red Chinese QSL, it's well to be forewarned. Radio Peking never has been especially friendly toward DXers. In fact, Peking once would verify only those transmissions specifically intended for the listener's particular geographic region.

Things are somewhat better now. But Peking still would prefer to send out program schedules, oriental-style post cards and copies of their anti-Russian editorials rather than the kind of QSL most DXers prefer. Maybe it's all something Mr. Karl Marx ordered.

### ► Radio Tirana

Tiny little Albania, the other Communist country outside the Soviet bloc, possesses only two short-wave transmitters even barely capable of international coverage. To get its North American service into the U.S., the program is taped, flown to China and then transmitted by Radio Peking at 1930-1955 EST. This broadcast ordinarily is on 9475 kc, with 11,945 kc used during the summer months.

While these transmissions are entirely in Albanian, Radio Tirana does have an English-language broadcast for Europe emanating from Albania itself. It's aired at 1730 and occasionally heard by North American DXers on approximately 7090 kc.



- ✓ *New way to bypass output transformers*
- ✓ *What ceramic cartridges offer the golden ear*
- ✓ *Better tapes for better listening*

**E**LECTROSTATIC SPEAKERS have been around for years now, but a new version I heard recently puts them back in the news. Reason: it's a superlative performer. Made in Canada, the Sigma is a full-range electrostatic. And, much like the KLH Model 9, it's tall, slim and room-dividerish in appearance, as our photo reveals.

At \$690 per stereo pair, this speaker ought to sound excellent. It does. Thanks to some 48 sq. ft. of radiating area, it loafingly fills a room with sound. And its bass response (largely a function of radiating area in an electrostatic) is good.

What sets the Sigma apart from most of today's electrostatics, though, is the fact that it's meant to be connected directly to the output tube plates. In this way, the Sigma effectively bypasses the output transformers that can limit amplifier sound quality. And this trick may help explain why the Sigma

is one of the best-sounding speakers I've heard to date.

To go from one end of the hi-fi chain to the other (and from cost-no-object to low-priced equipment), it's long been an article of hi-fi faith that only magnetic cartridges are capable of really top-flight performance for golden-eared audiophiles. But there is no cause to accept this proposition without question. In fact, there's no reason that the ceramic pickup *has* to be a crude device.

Most ceramics have a peaky ceramic sound mainly because the elements inside them are fairly large. And these elements have to be big in order to produce a healthy output when they are flexed and twisted by the movements of an attached stylus.

But hold on—high output may be a necessity for cartridges in phonographs, but it isn't for the kind to be used in quality hi-fi systems. Drop this objective, and the ceramic might be able to produce good sound—maybe excellent sound. Get its generating elements as small—or as low in effective mass—as those in today's magnetic cartridges and the only further requirement might be the careful design needed to make a good cartridge of any kind.

To find out what's what with current ceramics, I sent away for three units I had reason to believe might sound more than respectable. One of them, the Decca Deram, is a cartridge only recently imported from England, where it has been getting rave notices in the hi-fi press. The second, the Weathers LDM, comes from a manufacturer whose mono cartridge—the famous FM unit—was a fussy but unbeatable product for playing mono LP's. The third, the Sonotone Velocitone Mark IV, is the top-of-the-line cartridge by a long-time manufacturer of ceramics.

I've listened to all three for the past couple of months—in direct comparison with each other and with the best magnetics (costing up to \$75) now on the market. The verdict? Favorable. Yes, there are differences between

[Continued on page 116]



Sigma's TL33 electrostatic speaker stands 68 in. high. Its panels are 15 in. wide, 1-3/16 in. deep.

# Spark-Plug *Lightning* Arrester

**S**MALL consolation the cliché that lightning never strikes twice in the same place. All it takes is one good blast the first time to finish off your antenna system, receiver, transmitter or maybe even your home. While you can't change nature's ways, you can take steps to protect your equipment and perhaps your life, too, by providing a good electrical path to ground for the bolt out-of-the-blue when it strikes *your* antenna.

The answer to the problem is a lightning arrester. Many electronic parts distributors list lightning arresters in their catalogs for about 50¢ and up. While many of these are good for radio and TV receivers, most are practically worthless for amateur radio transmitters. For a few cents more you can build your own arrester that will work with any antenna—radio, TV or ham transmitter.

Our lightning arrester couldn't be simpler to make. It consists of a 25¢ electrical utility box, an automobile spark plug and a ceramic feed-thru insulator. You can put it together in a matter of minutes and installation won't be much more work. Start by punching out the hole in the top and bottom of the utility box. Mount the feed-thru insulator in the top, making sure there is a tight seal so moisture won't get in. In the bottom hole mount the spark plug, using a large hex nut to secure it in place.

Connect a heavy piece of buss wire from the bottom of the feed-thru insulator to the top of the spark plug, as shown in the photo, and you're done. Since the box should be mounted outdoors near the antenna transmission line, use a gasket between the box and its cover plate to keep out moisture.

Run a heavy wire from the box to a good ground, such as a heavy copper rod deeply imbedded in the earth, or a cold water pipe. Connect the transmission line to the top of the feed-thru insulator. If you use two-line feeders, build two arresters and connect one to each leg of the line.

If you use coaxial cable for your feed line, the Cush Craft Model LAC-1 Blitz Bug is the lightning arrester to get hold of. Its installation is as simple as plugging in a new tube. You simply disconnect the coax at the rear of your transmitter, plug the transmission line into the Blitz Bug and plug the other end of the unit in the transmitter's antenna connector. There is a large screw on the side of the unit for the ground wire. The Blitz Bug is equipped with type 83 connectors. There is no insertion loss and equipment performance and SWR will not be affected all the way up to 500 mc.

It's available from Allied Radio, Newark Electronics and other electronics parts distributors for \$3.95 plus postage. Allied's stock No. is 89 S 044; Newark's stock No. is 92F096.

Next time a lightning bolt is looking for the easiest way to ground around your home you won't have to worry if it's headed for your antenna. A lightning arrester will make the bolt bypass your valuable gear and put it in the ground where it belongs.—Howard S. Pyle, W7OE

A conventional automobile spark plug installed in a surface-mount utility box makes an excellent lightning arrester for the ham station. Two arresters can be used on two-line feeders—one on each leg of the line. The box should be mounted outdoors and cork or rubber gaskets should be put between the box and the cover plate.

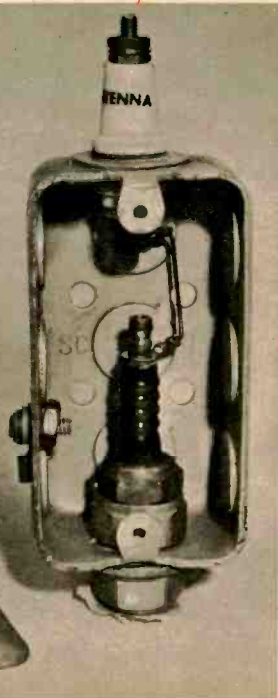

# At \$114<sup>75</sup>\*

## YOUR BEST BUY IN C-B RADIO

### THE FAMOUS RCA

# MARK VIII

#### 27-Mc CITIZENS BAND 2-WAY RADIOPHONE

UP TO 9 FIXED, CRYSTAL-CONTROLLED TRANSMIT-AND-RECEIVE CHANNELS. PLUS ALL-COMMAND TUNABLE RECEIVER.

CONVENIENT ACCESS TO CRYSTALS FOR QUICK CHANGING.

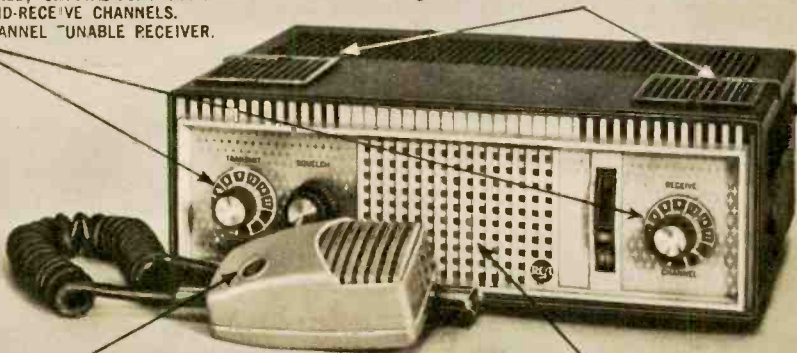

PUSH-TO-TALK CERAMIC MICROPHONE with coiled cord.

EXCELLENT VOICE REPRODUCTION—high intelligibility.

EXCELLENT TRANSMITTER MODULATION CHARACTERISTICS

IMPROVED AUTOMATIC NOISE LIMITER reduces effects of ignition and similar interference.

COMPACT AND LIGHTWEIGHT 3½" high, 9 pounds. Fits easily under any auto dashboard.

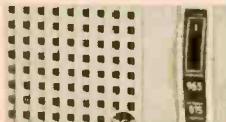

Continuously tunable receiver picks up any of the 23 C-B channels. Tunes either by channel number or frequency.



Illuminated working channel. Pilot lamps behind the fixed-channel dials show the channels being worked.



Separate mobile power supply. (Optional) 6- or 12-volt, for car or boat. All units contain AC power supply.



Channel-marker kit. Select channels best for your area, then mark them with the self-adhering labels included.

**NEW LOW PRICE** **\$114<sup>75</sup>\***

AC Unit

Optional DC Power Supply (6- or 12-volt) **\$19<sup>95</sup>\***

\*Optional List Price



**The Most Trusted Name in Electronics**

Get all the Facts Before You Buy.  
Mail Coupon Today. Paste on 4c Post-Card.

RCA ELECTRONIC COMPONENTS AND DEVICES,  
Commercial Engineering Dept. E-134-R  
415 South Fifth Street, Harrison, N. J.

Please send more information on the RCA Mark VIII C-B Radiophone

Name \_\_\_\_\_

Address \_\_\_\_\_

City \_\_\_\_\_ Zone \_\_\_\_\_ State \_\_\_\_\_



MEMISTOR

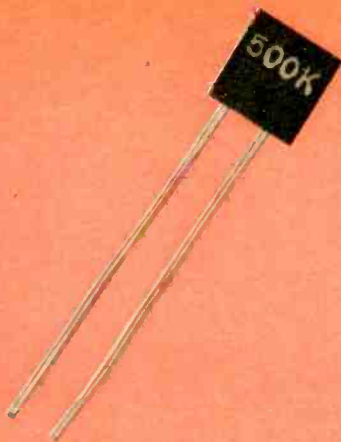

SQUARISTOR



CHRONISTOR

**T**HE SUFFIX *istor* is much like the suffix *ist*. Both usually have something to do with an agent—one who does or makes a practice of doing something or other. Not all the *istors* in the large family discussed here make a practice of doing quite what their names suggest. After all, a *transistor* hardly makes a practice of trans-ing. But a *resistor* does resist current flow, just as a *Surgistor* does something to do with surges.

A few years ago the only *istor* that was likely to come to mind was the resistor. But the clan now has spread all through electronics and is destined to continue to grow and multiply. The electronic hobbyist may never come face to face with the rarer *istors* but he at least should know what they are when he reads about them.

The brief descriptions we give are followed in some cases by the name of a manufacturer when the product is enough of a commercial reality to be marketable. Ready? Then let's meet the *istors*!

**BINISTOR.** A silicon tetrode which possesses many of the characteristics of the familiar flip-flop circuit. It basically is a bistable, negative-resistance device, with a fourth lead—the injector—brought out to act as a latching electrode. The Binistor differs from the thyatron in that its base retains control of conduction at all times. Present Binistors operate at frequencies as high as 100 kc in binary and ring counters, shift registers and memory circuits. Transitron Electronic Corp., Wakefield, Mass.

**BOLOMISTOR.** A non-rectifying, heat-sensing device and square-law microwave detector. Shaped like a 1N23 crystal diode, the Bolomistor operates by RF excitation of the carriers in the semiconductor to generate a Seebeck voltage proportional to the RF power. Fast or faster than comparable point-contact detectors, the device

## meet the

*An electronic hobbyist who doesn't kindergarten. But some istors are rare*

has no barrier capacitance. It is particularly useful in burn-out resistant radio detectors, devices for measuring peak-pulse power, countermeasures, beacons and telemetry. It also is used as a video detector (30-12,000 mc) and as a power monitor. MSI Electronics, Richmond Hill, N.Y.

**CALORIMISTOR.** A thermoelectric semiconductor of the bismuth telluride class, used as an insertion-type microwave wattmeter. Placed in series with a waveguide transmission line to measure power flow, the unit has a range from 2.5 to 3000 watts CW. It is used in measuring CW, AM and FM transmissions, giving an output derived from sampling a small amount of the incident RF power. The direct-reading meter can measure power to 12.4 gc with a 5-second time constant and an insertion loss less than 0.1%. The Calorimistor requires no external power supply. MSI Electronics, Richmond Hill, N.Y.

**CHARGISTOR.** An experimental, high-resistivity pnp germanium amplifier that has been operated at up to 200 volts. It is similar to a vacuum tube in that it can be assembled with several elements which control current flow. Made in triode, tetrode and pentode form, it finds application in switching, amplifying and oscillator circuits where there are high-voltage requirements. Specifically, Chargistors may be used as magnetic-core drivers for computers and as power deflection tubes in TV sets. IBM.



RAYSISTOR



TRIGISTOR



MISTOR

# ISTORS

know a resistor or a transistor when he sees one is slated for another year in or specialized enough to stump even the experts.

By ROBERT K. RE

**CHRONISTOR.** A fuse-size elapsed-time indicator, recording time up to 10,000 hours. In effect, the device is a miniature electroplating bath containing anode and cathode electrodes of copper and an electrolyte. In operation, the unit is connected in parallel with the device to be timed. When a DC voltage is applied, electroplating proceeds, tending to make the anode shorter and the cathode longer. If, for instance, you want to know how long a battery has been in operation, you connect the cell across the power input terminals of the battery load. Whenever the switch is turned on, voltage is applied to the cell and its resistor and time begins to be computed. Bergen Laboratories, Paterson, N.J.

**CRYOSISTOR.** A germanium field-effect controlled cryogenic switch which finds applications as a thyatron, bistable element, pulse amplifier or logic gate.

**DYNISTOR.** A two-terminal bistable switching component. Its principles of operation are similar to those of four-layer or breakdown diodes.

**FERRISTOR.** Trade name for a ferrite-core ferresoanant magnetic amplifier. It is designed for high-speed applications.

**FIELD-EFFECT VARISTOR.** A semiconductor with a constant-current feature, making it suitable for use as a current limiter, pulse shaper and interstage coupling component.

**FILMISTOR.** A high-precision, encapsulated, deposited-carbon resistor. The device will operate at full rated wattage at a temperature of 70 C; standard tolerance is 1%. Particularly well suited for use in computer circuitry or within packaged modules where high stability and tolerance are desirable. Sprague Electric Co., North Adams, Mass.

**FRIGISTOR.** A tiny, solid-state thermoelectric cooling device which can cool semiconductors, make ice, condition air, etc. Needco Frigistors, Montreal, Que.

**GAUSSISTOR.** An electronic valve that operates at extremely low temperatures. Consisting of a strip of magneto-restrictive material in the magnetic circuit gap of an inductor, it performs the functions of oscillation and amplification.

**GYRISTOR.** An ideal or perfect component concept thought up and used hypothetically only by analysis engineers to simplify circuit-design studies.

**KRYPISTOR.** A constant-current resistor or gate, essentially a high-voltage/low-current device. Leeson Corp., Warwick, R.I.

**MADISTOR.** A magnetically-controlled cryogenic semiconductor that uses the effects of a magnetic field on an injection plasma. The plasma is formed by injecting minority carriers into an indium-antimony semiconductor from the forward-biased junction, controlling the position

# meet the ISTORS



## STRAINISTOR

of the plasma by small magnetic fields. The action takes place only at extremely low temperatures. However, an experimental eight-position stepping switch has been made that is based on the Madistor principle.

**MEMISTOR.** A resistor with a memory. Basically a plating cell, it contains a resistive substrate, an electrolytic bath and a source electrode. DC on the source controls the substrate's resistance; an AC voltage senses this resistance, which varies with the amount the Memistor has learned. Used in learning machines, such as Stanford University's Adaline, and as pulse counters, relays and variable-gain elements. Memistor Corp., Mt. View, Calif.

**MISTOR.** A thin-film, magnetic-flux-sensitive resistor. A solid-state device featuring high impedance, low noise and fast response, the unit offers a resistance which increases directly with the strength of a magnetic field. Useful as magnetic flux measurement devices, magnetic field probes and contactless potentiometers. American Aerospace Controls, Farmingdale, N.Y.

**NEGISTOR.** A negative-resistance component, with a stable, linear, negative-resistance curve somewhat similar to that of a tunnel diode. Used in oscillators, filters, multivibrators and control circuits. Circuitdyne Corp., Laguna Beach, Calif.

**NESISTOR.** A solid-state unit with a wide range of linear negative resistance. Similar in principle and operation to a field-effect transistor, it is made much like an alloy-junction transistor.

**NEURISTOR.** A device for simulating a lossless transmission line or a human neuron (which permit signals to travel at a constant speed without attenuation and, once fired, they have a finite recovery time). The Neuristor has been produced experimentally, using resistors, capacitors and negative-resistance devices. Stanford Research Institute has perfected a tiny silicon Neuristor that works well; RCA has used special

glass rods (lasering fibers) to perform Neuristor logic functions optically.

**NUVISTOR.** A tiny ceramic and metal vacuum tube available in seven different single- and double-ended types. The single-ended units are either diodes or triodes composed of a ceramic base wafer, a 50% nickel/50% iron shell and molybdenum leads. The double-ended type is similar in construction, but with added ceramic at the top. The double-ended UHF triode permits low feedback capacitance which appreciably extends the frequency range. An important application is in the RF stage of a VHF tuner, where the Nuvistor achieves low noise—reportedly the lowest noise in VHF up to 200 mc. Other uses include low-noise hybrid equipment, in conjunction with transistors to allow impedance matching and low power drain. RCA.

**OSCILLISTOR.** A semiconductor device which produces frequencies up to 10 mc without the use of L-C components. Unit works on electron-hole plasma principles, requires no magnetic or electrical fields. RCA.

**PERSISTOR.** An experimental cryogenic computer element. A switching element and an inductor are formed in a parallel bimetallic loop. At temperatures near absolute zero superconductivity causes a current to persist so that, when triggered by a current pulse, an output voltage is obtained across the inductor.

**RAYSISTOR.** A light-operated switch with no moving parts. Enclosed in an opaque tube are a light source and photocell. When the light source is on, the photocell's resistance drops, allowing current to flow in the external circuit. Used in photochoppers, AGC circuits, SSB receivers, regulated power supplies and remote control units. Raytheon.

**SENSISTOR.** A silicon thermistor with a positive temperature coefficient. Used as temperature compensating and sensing devices, Sensistors find wide application in amplifiers, power supplies.



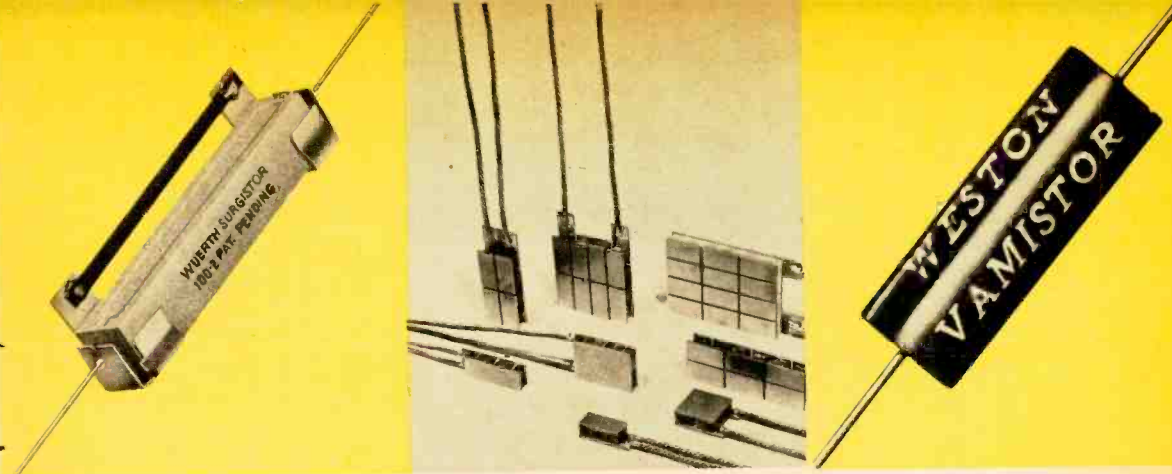

**SURGISTOR**

**FRIGISTOR**

**VAMISTOR**

servos, computers and telemetering equipment. Texas Instruments, Dallas, Tex.

**SQUARISTOR.** A miniature, high-precision (0.01%) wirewound resistor of internal weld construction. Single-ended in design, the unit is available in resistance values to 1.2 megohms. Applications are in etched boards of analog summing computers, precision voltage dividers and analog-digital converters where high packing density is desirable. General Resistance, Bronx, N.Y.

**STABISTOR.** A semiconductor diode, useful as a low-voltage regulator. Somewhat like a zener diode, the Stabistor differs in that it regulates voltage in its forward-conducting region. Transitron, Inc., Wakefield, Mass.

**STRAINISTOR.** A linear, strain-sensitive element with negligible hysteresis and low resistance. Century Electronics & Instruments, Tulsa, Okla.

**SURGISTOR.** A resistive time-delay that limits input voltage to about 25% of nominal value until a bimetallic strip shorts out a resistor, (about 10 seconds). Used in TV sets, hi-fi equipment and car radios to extend tube life and protect other components, such as capacitors, rectifiers and pilot lamps. Two basic types are available: one for 117 volts and up to 1,500 watts; another for 6-10 volts and up to 5 amps. Wuerth Products Corp., Hollywood, Fla.

**THERMISTOR.** A temperature-sensitive resistor whose resistance decreases with increasing temperature. Useful for measuring and controlling temperatures, measuring power, controlling current surges and producing time delays. A semiconductor, it is made of ceramic-like material from metallic oxides. Fenwal Electronics, Framingham, Mass.

**THYRISTOR.** A high-speed, germanium switching transistor having a fourth lead (an injector) for controlling conduction. Somewhat

similar to both the Binistor and the Tristor.

**TRIGISTOR.** An all-silicon, alloy-diffused pnpn SCR that functions like a triggered bistable multivibrator. It features base (or gate) turnoff which allows single terminal control and thereby approximates flip-flop action. There are two classes of Trigestors. Logic Trigestors operate at currents down to 1 ma over a temperature range from -65 to 125 C; their main application is in standby power systems, such as those used in satellites, where power conservation is a premium need. High-current Trigestors can operate at up to 400 ma DC and, therefore, are suitable for replacing or driving relays. Solid State Products, Salem, Mass.

**TRINISTOR.** A three-terminal, bistable switching component, essentially a high-powered SCR handling up to 150 amps. Westinghouse.

**TWISTOR.** A memory element made by twisting a strip of magnetic material around a wire. The wire is composed of a nickel-iron alloy which has a rectangular hysteresis loop. Simultaneous current pulses in the wires magnetize the material—thus storing information.

**VAMISTOR.** A precision (0.05%) metal film resistor. The resistive film is obtained from an alloy of the nickel-chrome family. Resistance is adjusted to value with an optimum spiral, thereby distributing the heating effect over the entire available surface. Weston Instruments & Electronics, Newark, N.J.

**VARISTOR.** A voltage-sensitive resistor whose resistance changes instantly to a lower value when the applied voltage exceeds the normal range. It is made from electrical-grade silicon carbide, milled and mixed with a suitable ceramic binder. Unaffected by pressure or vibration, the device has essentially equal non-linear characteristics for both polarities. Useful to suppress arcs and limit the inductive kick voltage in relays, motors and other equipment. General Electric.



Dynakit PAS-3

# STEREO PREAMP

**I**NTEGRATED stereo amplifiers are so abundant these days you get the feeling that preamps have gone the way of the dodo. But they really haven't, and there are good reasons why. Preamps allow flexibility in the physical arrangement of stereo system components and eliminate hum problems that sometimes occur with integrated amplifiers. Furthermore, using a separate preamp and power amplifier allows you to choose the best of two worlds when building your system.

The Dynakit PAS-3 stereo preamp deservedly has been ranked high. Its specs are excellent, construction is simple with two pre-wired printed-circuit boards, and the \$69.95 price (\$109.95 assembled) is reasonable in relation to the PAS-3's features.

The PAS-3 measures 4x13x8 inches and has eight front-panel controls. They are an input-selector switch, dual volume control, blend switch, balance control, and separate bass and treble controls for each channel. Four slide switches are used for tape monitor, loudness, scratch filter and AC power.

There are three low-level inputs per channel for magnetic cartridge, tape head and a special input for a microphone, etc. Of the four high-level inputs per channel, one is for an AM tuner, another is for an FM tuner, one is for the output of a tape preamp and the fourth can be used for TV sound. On the rear panel there are two switched and two unswitched AC outlets. One important feature of the PAS-3 is that none of the inputs

can be overloaded by most program sources.

Construction is broken down into five steps: front-panel mechanical assembly and wiring; installation of the printed circuit boards on the main chassis and wiring to the boards; back-panel mechanical assembly and wiring; selector-switch wiring, and final interconnections between components and assemblies.

The construction manual is clear and we found no errors. Dyna supplies a large pictorial to be cut out and propped up in front of you for easy reference during construction. There are excellent photos of the completed front-panel assembly and main chassis wiring.

FREQUENCY RESPONSE		
Frequency (cps)	Channel A (db)	Channel B (db)
5	-0.5	-0.65
10	0.0	0.0
50	+0.25	0.0
100	+0.25	0.0
1,000	0.0	0.0
5,000	0.0	0.0
10,000	0.0	0.0
20,000	-0.25	-0.25
40,000	-0.75	-0.75
50,000	-1.25	-1.50

Input: high level; 0db reference: 1,000 cps @ 1.5-volt output; controls: off/flat.

INPUT SENSITIVITY *		
Input	Channel A	Channel B
Tape head	3.2 MV	3.6 MV
Phono (mag)	1.6 MV	1.8 MV
FM-AM	0.2 V	0.21 V
FM-MPX	0.2 V	0.21 V
Spare (high level)	0.2 V	0.21 V

\* 1,000 cps for 1.5-volt output; volume control at maximum; controls: off/flat.

By using these in conjunction with the pictorial, component wiring and lead placement are simplified. And there are no tight, hard-to-work-in corners. Our construction time was about ten hours.

Though the output is direct rather than through a cathode follower, the output impedance is lower than might be expected—a nominal 1,000 ohms—because of a feedback loop. This creates one minor problem in that the input impedance of the power amplifier being fed by the preamp will affect the preamp's feedback loop. The solution is a power amplifier with an input impedance of at least 500,000 ohms. A lower impedance will cause low-frequency loss.

Unlike the earlier Dyna mono preamp, which got its power from the amplifier, the PAS-3 has a complete power supply that furnishes well-filtered B+, as well as DC for the filaments of the four 12AX7's.

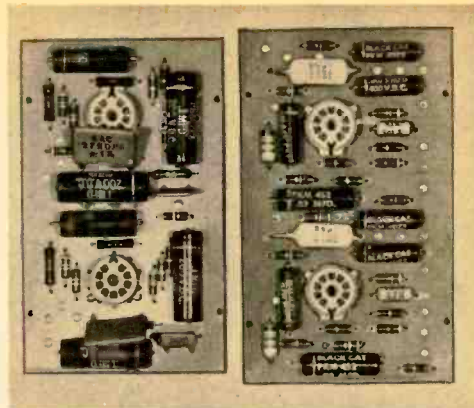

Dual phono and tape-head preamp (left) and tone-control boards (right) are supplied prewired.

The first 12AX7 in each of the identical channels provides gain for the low-level inputs. The second 12AX7 furnishes additional gain and has the tone controls in its feedback loop.

Our tests indicated that the PAS-3 provides high-quality listening, and its specs stood up. The figures in the table show that the response is flat within .25db from 10 to 20,000 cps. Response was down .5db at 5 cps on channel A and down .65db on channel B. The response was down .75db on both channels at 40,000 cps. The variation between channels was no more than .25db. Hum, noise and distortion were too low to be measured.

With a price of \$69.95, superb specs and a construction time of ten hours, the Dyna PAS-3 deserves a *best buy* label.

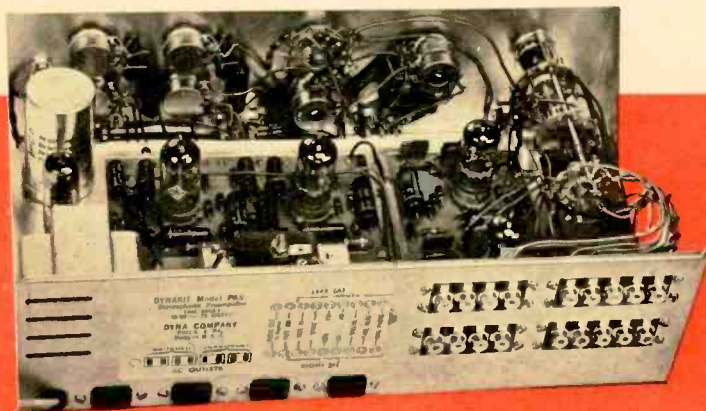

Inside of completed PAS-3. Tone controls are at upper left side of front panel. To the right is blend switch and below it is balance control. Volume control is to the right and selector switch is at extreme right. Tone control printed-circuit board is at left, preamp circuit board is at the right.



## CB CORNER

BY LEN  
BUCKWALTER  
KBA4480

# what to do at an ACCIDENT

**H**ELP . . . That's the one thing every CBER most wants to give when he's first on the scene of an accident. And any club worth its salt has drilled its members on roadside emergency procedures—from calling an ambulance to rendering first aid. But how about adding a few more solid points to your rescue technique? They're culled from the often grim experience of state trooper Dwight Carlson, whose beat is the Connecticut highways. Speaking to a CB club audience (see photo), he pointed out some rare gems any CBER will do well to remember, should he stumble upon an accident.

**Pliers.** Fire is a big hazard in a car wreck. A pair of common slip-joint pliers enables you to cut one cable from the battery. Loss of battery power kills the danger of a hot, shorted wire igniting the car.

**Fire extinguisher.** Is the wreck aflame? No need to carry a bulky, expensive extinguisher. Fight fire with one of the new dry-powder units. They're small and effective.

**Flares.** Important for channeling traffic around the scene are ever-helpful flares. But

some people are not aware how easily flares can start new fires in spilled gasoline (frequently found at a wreck).

**Other tips.** When you get on the CB rig to summon help, don't identify the accident location with a vague, "We're three miles north of Route 5 . . ." Trooper Carlson talks from sad experience: "Most people simply can't judge mileage accurately enough." The result: help arrives too late.

Be exact. Give the nearest intersection, landmark or business establishment. Citing even telephone poles can help. Often spaced 150 to 200 feet apart, they can be used to gauge your distance in feet from a nearby landmark. Police or an ambulance otherwise might search aimlessly on a dark night, wasting precious minutes.

Trooper Carlson's final comment: "Never turn your back on oncoming traffic."

**Generators.** Is a standard generator husky enough to handle the power drawn by a mobile CB rig? This question frequently has filtered into this department. We've even heard CBERs claim that a big, high-charge generator can boost RF output. Before you go out and buy a super-wattage generator or replace your present one with an alternator (like those on many new cars), however, consider these facts.

The most power-hungry CB rig uses about the same or slightly more electricity than a car's regular AM broadcast set. The figure is about 50 watts. Transistorized sets, CB or AM, draw about half that amount. And if you compare generators on Fords or Cadillacs, you'll come up with a capacity of more than 400 watts in each case. This easily takes care of any CB rig.

But some tinkerers have discovered that they can raise the output of the generator by readjusting the voltage regulator. This increases the supply voltage to the CB rig and may produce slightly more output. The price, however, is extremely high. Added voltage

[Continued on page 111]



Connecticut state trooper Carlson shows members of Danbury, Conn.'s Marc V CB Club how to use a flare. Club president Bud Collischonn is at right.

# RADIO AT

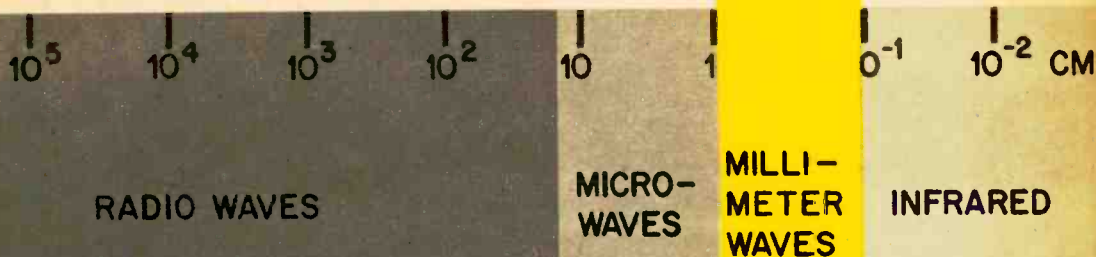

## 100 BILLION CYCLES

**F**REQUENCIES are what the electromagnetic spectrum is made of, and most of those frequencies have been put to good use. But scientists and engineers still are struggling with one band that's proven a tough nut if ever there was one. That portion of the spectrum lies at about 100 billion cycles in the never-never land between infrared, which sits just beneath the visible-light portion of the spectrum, and microwaves, the region of short-short radio waves.

This millimeter band (so called because the waves are less than a centimeter in length and thus are measured in millimeters) has turned out to need a whale of a nutcracker, yet researchers round the world are hard at it. Why? Mainly, it's because with all those cycles around, the MM band offers an astounding number of channels—the normal concept of a channel being a band of frequencies that's from a few kilocycles to a few megacycles wide. The MM band has room for more channels than you'll find in the entire radio-television-radar range combined. A single channel up there can be wide enough to carry 100,000 telephone conversations or 100 TV programs simultaneously. And you'd still have more unused channels than a St. Bernard has fleas.

**Half Radio, Half Light.** What are waves like at frequencies in the billions of cycles? As you might guess from their place in the spectrum, they're sort of half-radio, half-light waves with some of the qualities of each. Matter of fact, the usual measurement up here is wavelength rather than frequencies because even with gigacycles (1,000 megacycles) the numbers are too large to handle easily. Because of the many cycles that are jammed into such a small space in the spectrum, obtaining wide bandwidth is easy and this offers, for instance, several advantages for precision radar. The Japanese already have a plan to use millimeter-wavelength radar to detect local rainstorms and typhoons. The high directivity is especially attractive for military applications since it's all but impossible for an enemy to pick up the signal, let alone jam it. In our own moisture-laden atmosphere, millimeter waves act much like light waves in a dense fog. They get through, but only to a point. However, this too can be an advantage. Choose the right power and frequency and you pretty much can guarantee that the signal will *not* be received beyond a given spot on the map. Out in space, millimeter waves again possess many of the qualities of light waves—so much so, in fact, that they promise to be an

excellent means of communication between space ships, rockets and other such craft.

In actual fact, millimeter waves are nothing particularly new on the scene, nor is the move toward higher frequencies at all unique. Long ago as 1895, scientists were producing waves at wavelengths that were shorter than short—0.6mm, to be exact. And over the years radio has moved higher and higher in frequency in a kind of little-by-little, year-by-year fashion that had all the earmarks of an inevitable progression. Only yesterday, it seems, radio amateurs were fooling around with shorter and shorter wavelengths, eventually to discover that these so-called useless frequencies made possible round-the-world communications. More recently, FM and even TV have moved upward because new developments and greater engineering know-how made operation at higher frequencies feasible.

But the big reason for this ever-upward shift in frequencies lies in the nature of the electromagnetic spectrum, as we've already hinted. The shorter the wavelength, the more channels you have at your disposal. Make those wavelengths short enough—say on the order of a millimeter or two, and you'll have channels to burn.

**Half Wild, Half Tame.** But if the millimeter wave's advantages seem all but overwhelming, so too are the problems in producing and controlling one. For how do you generate radio waves at 100 billion cycles? Tubes can't do it—not the ordinary kind, anyway. Transistors can't do it. Matter of fact, any component with wires or leads of any sort is likely to have too much self-inductance and self-capacitance to do the job. Worse yet, prices of the kinds of specialized equipment that will turn the trick are sky-high. And the efficiency of the same costly gear tends to be about that of a peanut whistle.

All sorts of possibilities have been tried, with varying degrees of success. First in the field were gas-discharge oscillators, but they proved far too unstable and too noisy for practical use. So engineers moved on to miniaturized cavity oscillators, backward-wave oscillators, masers and lasers, parametric amplifiers, nonlinear RLC and ferromagnetic devices, relativistic electron sources and other weirdies. None has been unquali- [Continued on page 117]

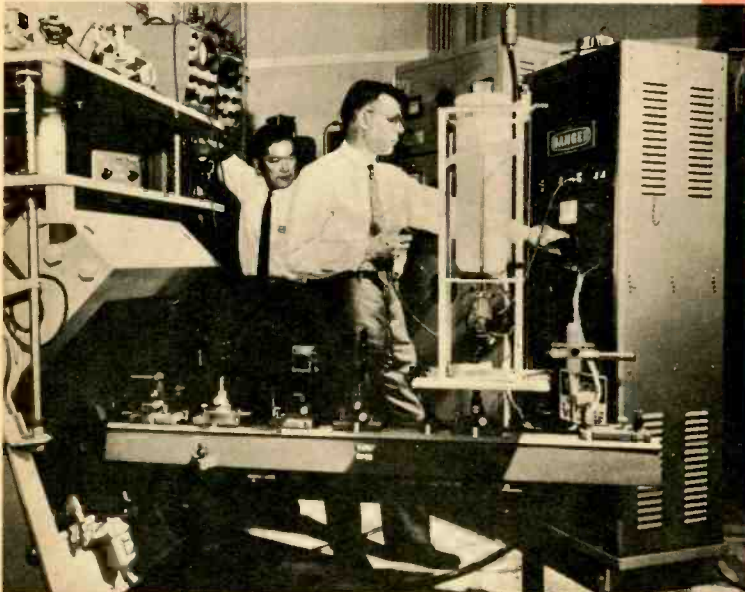

Laser-pumped maser developed by Hughes Aircraft is one answer to problem of producing waves in the millimeter region. Still in the experimental stages, set-up uses light from a synthetic ruby to generate radiation in another ruby crystal at a much lower frequency.

# Ham-CB

By HERB FRIEDMAN

W2ZLF

## COMPRESSOR (LIMITER)

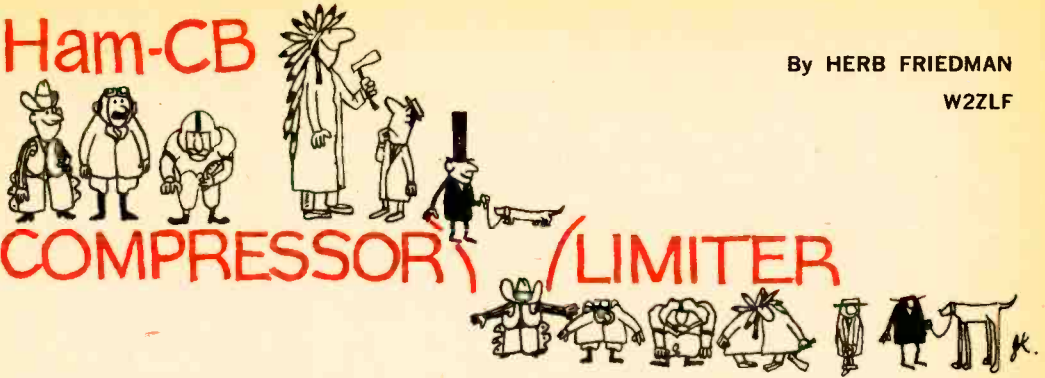

*Bellow or whisper—this accessory keeps your modulation level the same.*

IT'S always a letdown to be told that your voice sounds weak and unintelligible when your modulation meter has been hitting the 100-per-cent mark. The explanation is simple: the meter is indicating 100 per cent on modulation *peaks*. Your *average* power is some 10db less, which is equivalent to 30 per cent modulation. The reason for disappointing reports from contacts is that their ears respond to *average* modulation power, not the peaks that your meter shows.

And if you speak quietly or back away from the mike your modulation heads right for the basement. Getting out a really solid signal requires that every word you speak modulate the transmitter close to 100 per cent.

The best modulating signal is one whose amplitude remains constant, regardless of changes in the level of your voice. El's Compressor-Limiter turns your speech into just such a signal. The Compressor-Limiter clips speech peaks that would cause over-modulation, boosts the level of your voice when you speak quietly and reduces the level of the modulating signal when you shout.

By reducing your voice's dynamic range (the difference in level between a shout and a whisper) you increase your rig's talk power and produce a signal that sounds as though it's coming from a transmitter of much higher power.

The compression gain is extra high, enabling you to produce *full compression*, even when you whisper or use a low-output mike. Although transistorized, the Compressor-Limiter has about a 3-megohm input impedance so you can connect a crystal or ceramic mike to its input.

And there's plenty of extra gain to pro-

duce 100 per cent modulation even if your transmitter is shy on mike gain. The Compressor-Limiter is self-contained and does not require special connections or modifications to your transceiver or transmitter. Best of all, with careful shopping you can bring in this project for under \$10.

### Construction

We simplified construction by building the entire circuit on a piece of 4x6½-inch perforated board. Flea clips are used for tie points and to insure rigidity (especially important for mobile operation). Construction has been simplified further by running ground and —9 VDC buss wires at the top and bottom of the perforated board.

Before mounting T1, cut its black lead short. After selecting T1's mounting position.



A useful accessory for hams and CBers, the Compressor-Limiter will fit in a 3x5x7-inch Minibox.

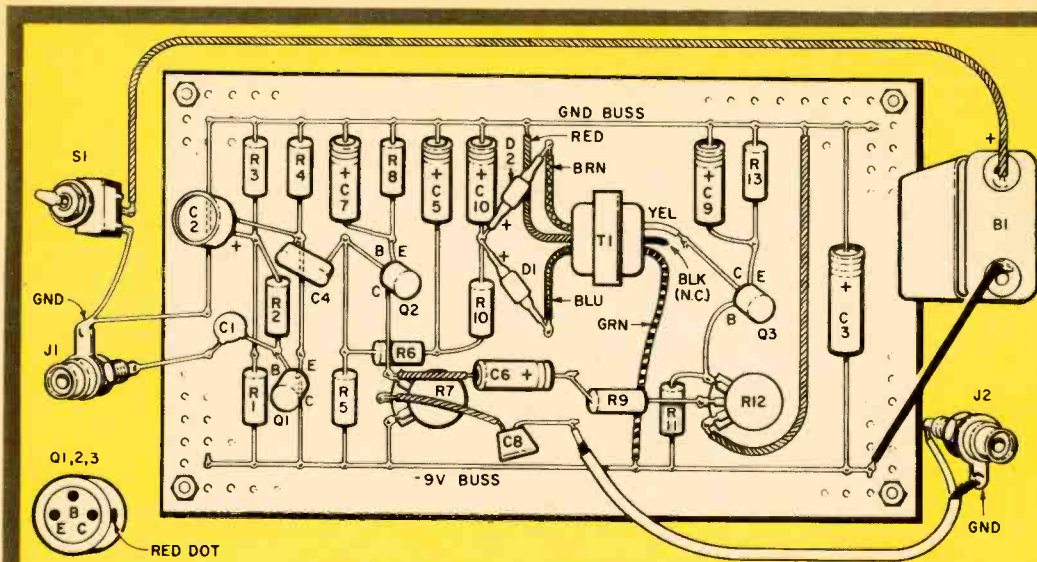

There's plenty of space to spare on circuit board in author's model, but a smaller board and box could be used if you want a more compact unit. Locate the holes in the cabinet for R7 and R12 after they have been mounted on the perforated board. Ground the braid on the shielded wire from C8 to J2 at J2 only.

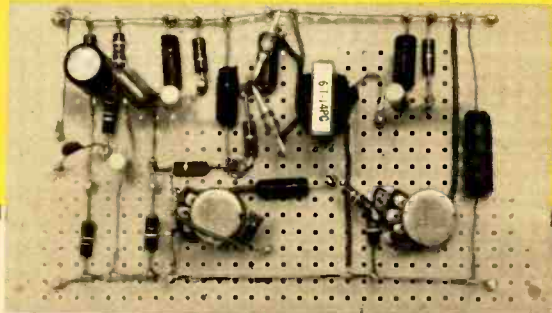

## COMPRESSOR-LIMITER

use a #30 bit to drill a hole centered between two existing holes in the board. Using a small screwdriver or knife, chip away the phenolic between the new hole and the perforations on each side. T1's mounting tabs will fit in these slots. Pass the tabs through the slots and fold them toward each other on the underside of the board.

Compression control R12 and volume control R7 should be miniature types or the board will be crowded and wiring will be tight. Transistors Q1, Q2 and Q3 should be 2N217's or their equivalent (2N109's). Do not use general-purpose replacements or low-cost specials. This rule applies to T1 and all other components. Do not use different parts values.

When connecting the diodes and transistors, keep in mind that the leads are extra-short and use a heat sink when soldering them.

The perforated board mounts easily in the

main section of 3x5x7-inch Minibox. To avoid shorting the back of the flea clips, place quarter-inch grommets between the board and the Minibox at each corner. Mount the battery on the side of the cabinet with a bracket made of scrap aluminum or tin. Since R12's and R7's shafts extend through the front of the Minibox, do not cut them until the board has been mounted.

If the Compressor-Limiter is to be used with a transceiver or transmitter that has manual T-R switching, J1 and J2 can be standard phone or phono jacks. If your rig is equipped with a push-to-talk (PTT) mike, J1 and J2 should mate with the mike plug. The PTT control wires should be connected directly from J1 to J2. Use shielded wire to connect output jack J2 to C8 and note that the shield is connected to ground at the J2 end only. If you normally speak loudly or your mike has a high output, eliminate C7 to reduce the gain.



## Operation

To adjust the Compressor-Limiter properly you'll need a modulation meter (See MODULATION METER FOR CB, March '63 EI). Connect the Compressor-Limiter to your transmitter and set R12 and R7 full counterclockwise. Speaking in a normal voice, rotate R7 until the transmitter is modulated 100 per cent. Continue speaking and advance R12 until the modulation falls to 50 per cent (this amounts to 6db compression). Then advance R7 again until the modulation is 100 per cent. (In use you will have a tendency to raise your voice and the compression will be about 10db or more.)

Once R12 has been set, a ceiling is established on the modulation level. If you raise your voice or move in on the mike, limiting will take place and the modulation level will rise only slightly. If you lower your voice, compression is reduced and modulation will be maintained at a high level.

Do not attempt to use excessive compression. If R12 is advanced too far, your voice's characteristic will be compressed so greatly that only a few gurgles will get through.

The frequency response of the Com-

pressor-Limiter is tailored to suppress low frequencies so your voice will have a crisp quality. For comfortable listening at the receiving end, you should use a good-quality mike that has a flat frequency-response curve.

## PARTS LIST

- B1—9-volt battery
- Capacitors: 10 VDC or higher
- C1—.1 mf ceramic disc
- C2—30 mf electrolytic
- C3—50 mf electrolytic
- C4—.25 mf ceramic disc
- C5,C7,C9,C10—10 mf electrolytic
- C6—1 mf electrolytic
- C8—.001 mf ceramic disc
- D1,D2—1N34A diode
- J1,J2—Phone connectors (see text)
- Q1,Q2,Q3—2N217 transistor (RCA)
- Resistors: 1/2-watt, 10% unless otherwise indicated
- R1,R3,R5,R11—100,000 ohms
- R2,R4—47,000 ohms
- R6—5,600 ohms
- R7—10,000-ohm, miniature audio-taper pot.
- R8,R10—1,000 ohms
- R9—20,000 ohms
- R12—5,000-ohm, miniature audio-taper pot.
- R13—100 ohms
- S1—SPST toggle switch
- T1—Transistor interstage transformer (Allied Radio Industrial catalog stock No. 62G378. \$2.63 plus postage.)
- Misc.—3x5x7-inch Minibox, perforated board, flea clips

Q1, a bootstrapped emitter-follower amplifier, provides a high-impedance input for crystal or ceramic mikes. Input signal is amplified by Q2, part of whose output is fed to Q3, the control amplifier. Q3's (T1's) output is rectified by D1, D2 and filtered by C5, C10 and R10. Resultant DC controls Q2's bias, changing its gain. As input level rises, bias reduces Q2's gain and vice versa.

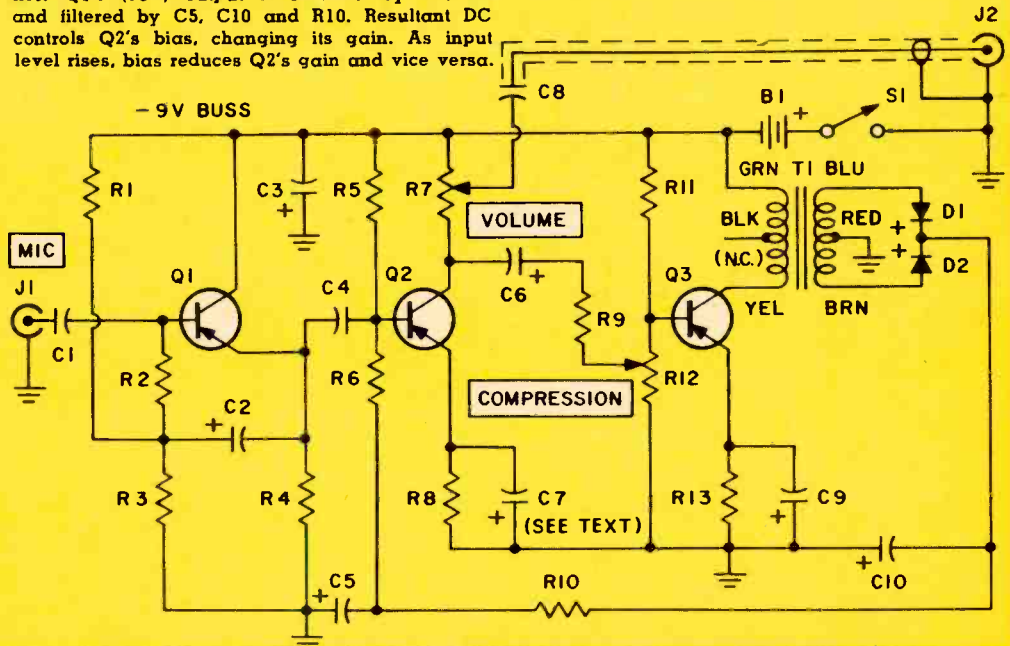

KIT

**EI**  
**REPORT**

**T**HE VTVM long has been the *incomplete* right hand of the electronics experimenter. What was missing, of course, was its ability to measure current, which no VTVM possessed. This meant an additional cash outlay for a VOM.

But Hallicrafters, an old name in the communications-equipment field, recently changed the picture when it included a multi-range milliammeter circuit in its new VTVM, the Model HM-1 (\$29.95, kit; \$59.95, wired).

The HM-1 basically is the same as any other VTVM. It has an 11-megohm DC and 1-megohm AC input impedance; seven AC and  $\pm$  DC ranges from 1.5 to 1,500 volts; seven ohmmeter ranges to 1,000 megohms

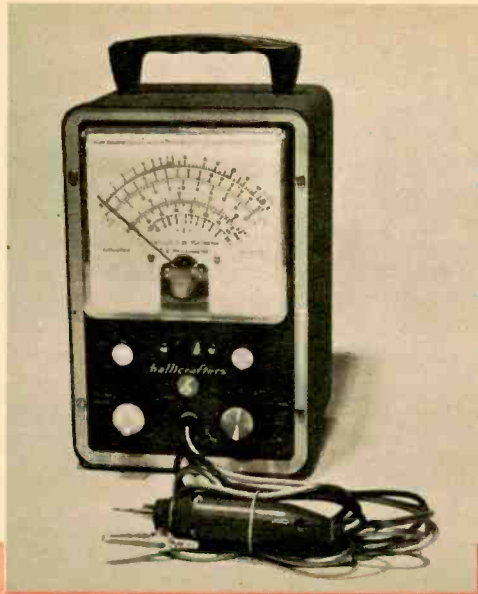

**Hallicrafters HM-1**

**Vacuum-Tube Volt-Milliammeter**

and a zero-center meter scale (illuminated) for FM detector alignment. The big difference is the milliammeter function with six ranges from 1.5 to 500 ma.

And the milliammeter circuit is completely independent of the VTVM. Separate test jacks having no connection to the VTVM's test leads are used for current measurements. This means the milliammeter section can be connected in one circuit—for example, the B+—when the VTVM is connected to another circuit.

When you set the function switch to measure voltage or resistance, the milliammeter jacks are shorted automatically. A switch mounted in the single probe selects either the DC or AC-ohms mode.

The HM-1 meets the specified 3 per cent DC and 5 per cent AC full-scale accuracy. Decoding accuracy is excellent. A voltage read full scale will read the same on the next higher range, even though the needle is now at the bottom of the scale.

The peak-to-peak scale calibration is accurate for sine-wave voltages only and is not valid for complex-waveform (square waves) measurement. This fact is not made clear in the instruction manual.

Construction time is about seven hours, but the instrument will not be ready for use after

the last connection is completed. The tubes first must be aged for 60 hours by leaving the power on. Unless the tubes are aged the zero-adjustment drift, which normally is negligible, becomes severe.

Two unusual assembly aids, which also reduce the possibility of a wiring error, are cone-type tube sockets and terminal strips. Instead of the usual tab and hole, the sockets and terminal strips have a small metal cone with a built-in spring clip which grasps each lead firmly. When all leads are in place, the entire cone assembly is soldered. It's a unique and convenient approach.

Hallicrafters recommends that a quarter inch of insulation be removed from each lead that is connected to a cone. But connections will be easier to make if you strip a half-inch of insulation from the wire. To further simplify construction, the terminal strips and tube sockets are pre-mounted on the chassis.

The construction manual includes large, clear pictorials on the same page as the wiring instructions. Construction steps are arranged logically.

All in all, the Hallicrafters HM-1 vacuum-tube volt-milliammeter has everything you'd expect a good VTVM to have—plus the additional convenience of a built-in milliammeter.

**M**ANY people say a little booze is the best way to start a tea party swinging. Could be, but we guarantee that anyone who wears our Electronic Name Dropper to a social will find himself in the midst of a crowd in less time than it takes to pour a double Scotch on the rocks.

So if you're the shy type and have trouble asking names, just tuck our Name Dropper in your pocket and wait for spectacular results. The gadget costs about \$8 to build, and that's economical in terms of Arthur Murray dance lessons or Charles Atlas muscles.

The Name Dropper has other uses, too. At conventions, where look-alike name tags are standard, it gives you a chance to be different. It can be made to supply flashing numbers for the front of your house, or it can become a warning light when you're stuck on the road at night.

### Construction

The Name Dropper can be built in a  $5\frac{1}{4} \times 3 \times 2\frac{1}{8}$ -inch Minibox. Since this is the thinnest box on the market that will accommodate all the parts, cut its thickness down to about  $1\frac{1}{4}$  inches with a hacksaw so it will fit comfortably into your jacket or trouser pocket. In the bottom of the case mount a Keystone Model 182 battery holder for the four penlight batteries.

Directly above the battery holder mount C1 and hold it in place with a heavy wire soldered to one of the holder's lugs. Mount T1 in the upper right corner of the case and mount Q1 upside down in the upper left corner. Switch S1 should be mounted in the top. The hole through which the wires to the Nite-Lite pass should have a grommet.

Cut the lugs off a Sylvania Panelescent Nite-Lite so they are about  $\frac{1}{8}$ -inch long and solder a pair of twisted leads to the nubs. To one of the nubs solder a piece of stiff wire shaped like a clip. This will hold the Nite-Lite in your lapel pocket. Be sure to tape the exposed nubs and clip. The 500 volts they carry could give you a man-size jolt that would be dangerous.

### Operation

The oscillator circuit produces a strong pulse about every half second, using the parts values specified. This short pulse is stepped up by T1 to about 500 volts. The pulse is fed to the Nite-Lite, causing it to flash much more brightly than it would when plugged into an AC outlet. However, the flash duration



# ELECTRONIC NAME DROPPER

By  
FRED MAYNARD

*You come on strong at  
convention or party and  
no one forgets your name ...  
if you're properly equipped!*

# NAME DROPPER

is short and the *average power* delivered to the Nite-Lite is about the same in both cases.

By reducing the value of R1, the flashing speed can be increased. In fact if R1 is reduced in value sufficiently, the Nite-Lite stays on all the time. R2 controls the length of time the Nite-Lite is on. By changing R2's value you can increase or decrease the on-time independently of the flashing speed.

Don't worry about a squeak in the transformer. It is normal and is caused by the heavy surge of current through the primary. The sound comes from loose transformer laminations. As a matter of fact, the squeaking adds another attention-gathering feature to the gadget.

We found the best batteries to use are penlight-size alkaline energizers. They cost more than ordinary flashlight batteries but they produce a brighter flash and last longer. If you want to keep the size down, use smaller mercury batteries but keep the operating voltage around 5 to 7 volts.

You can letter the Nite-Lite with India ink or transfer-letter decals. The decals are available in a wide assortment of sizes at art supply stores. To protect the letters, spray the face of the Nite-Lite with clear lacquer.

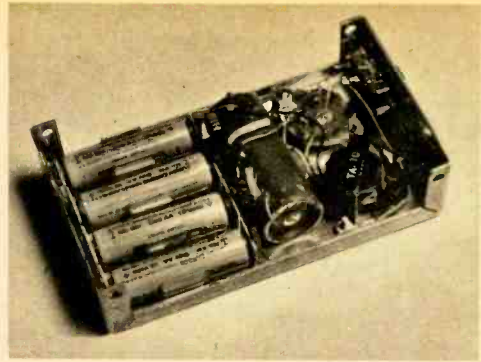

Our model was built in a standard 5¼x3x2½-inch Minibox, which was cut down so the thickness was reduced to 1¼ inches. The case will easily fit into your jacket pocket with relative comfort.

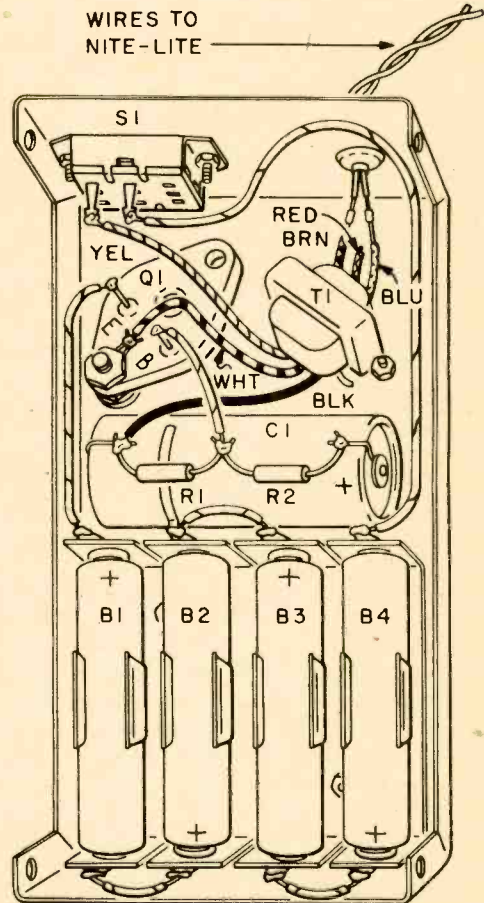

## PARTS LIST

- B1-B4—1.5-volt alkaline-energizer penlight battery
- C1—1,000 mf. 6 V electrolytic capacitor
- Q1—2N176, 2N554 or 2N669 transistor
- R1—2,700-ohm, ½-watt resistor (see text)
- R2—56-ohm, ½-watt resistor (see text)
- S1—SPST slide switch
- T1—Transistor output transformer (Stancor TA-10)

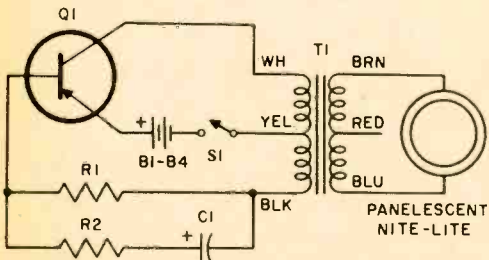

When S1 is closed Q1 conducts, producing heavy current in primary of T1, which is stepped up to fire Nite-Lite. Current also charges C1, which then cuts off Q1, causing the Nite-Lite to go off.

There's plenty of space in Minibox for uncrowded layout. C1 is held in place by heavy wire soldered to lug on battery holder. Q1 is mounted upside down with machine screw through the case.

# Complete plans for R/C TRANSMITTER AND RECEIVER

By HOWARD G. McENTEE

**W**HY BE CONTENT to sit back and dream of owning and driving a flashy sports car, restored antique or an ocean-going yacht when you can drive your own (a model, of course) for a fraction of the cost of the insurance on the real thing? Fact of the matter is, building and installing radio-control equipment in a model car or boat isn't as big a job as you'd think. We have outfitted a toy truck but you can use the R/C equipment to control most any model car, boat or short-range plane.

The R/C equipment is designed for compound steering. That is, press the button on the transmitter once and the truck's wheels will turn right and stay there as long as you hold the button. Release the button and the wheels re-

turn to their straight-ahead position. Push the button twice and the wheels turn to the left and stay there until the button is released.

The transmitter's input power is limited to 100 milliwatts but since the receiver is extremely sensitive, you can control the truck for quite a distance. And because of the transmitter's 100 mw power rating, it operates license-free on Citizens Band channel 23.

### Modifying the Truck.

Since we could not find a low-cost car with steerable front wheels, we bought a non-steerable truck made by Tonka Toys (Mound, Minn.) and modified it. The truck is about 13 inches long, 5½ inches wide and has 2 ⅜-inch diameter wheels. It is



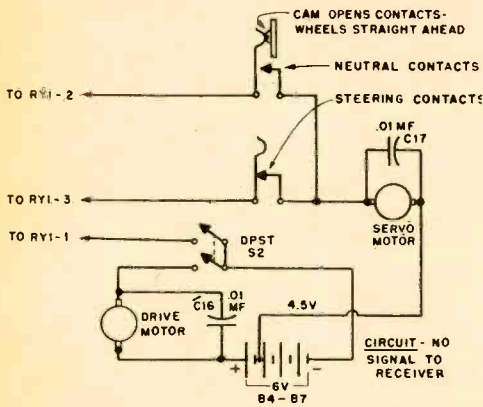

Fig. 1—Schematic of steering and drive circuits in truck. Neutral and steering contacts are shown with the wheels in their straight-ahead position.

made of relatively heavy steel and cost us about \$5 at a discount house.

First thing to do is remove the whitewall side of the front wheels. Since 6-32 round-head screws will be used for the new axles, install bushings made of 5/32-inch inside-diameter brass tubing inside the axle hole of each wheel. The tubing first should be expanded with a #29 drill. If it is too loose in the wheel, wrap a couple of layers of cellophane tape around it.

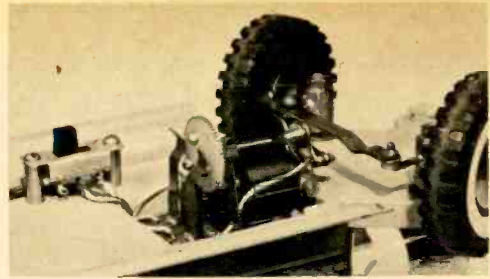

Fig. 3—Steering servo. Note screws added to plastic gear. Neutral contacts are at left and steering contacts are at right. Switch (S2) at left controls power to servo and drive motors.

To add the new steering mechanism, we cut off the front portion of the steel chassis, removed the cab and hood assemblies and added a plywood chassis as shown in Figs. 2 and 8. The plywood must be cut as shown in Fig. 2 to allow the wheels to swivel. A section must be removed in the center of the plywood for the steering servo. And cut a 3 3/8 x 6-inch piece of plywood to fit in the back of the truck. This piece and the larger plywood chassis are held together by two wood screws, with the metal truck frame sandwiched between them. A strip of metal should be attached to the front of the wood chassis to hold the cab in place.

The steering knuckles (Fig. 4A) are made of 5/8-inch lengths of 1/2-inch-diameter brass rod and are mounted on the plywood chassis with 8-32 screws. Drill a hole through them with a #12 drill for the 8-32 mounting screws. The axles should be installed on the

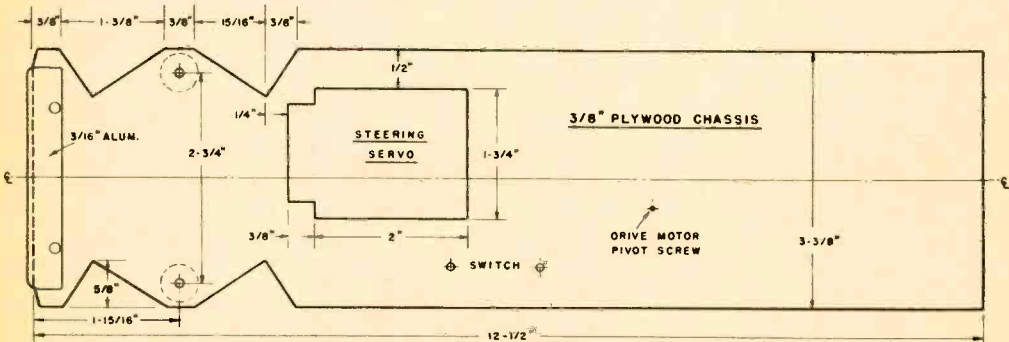

Fig. 2—For a Sportsman truck, cut a chassis out of 3/8-inch plywood to these dimensions. Rear wheels and axle are not altered. Front of truck is removed and new steering assembly built on this chassis.

steering knuckles so the front of the car is the same height as it was originally.

Drill the axle holes with a #35 bit and tap them for 6-32 screws; don't tap all the way through. Round-head steel screws serve as axles and should be forced into the partially-threaded holes. Before mounting the axles, attach the steering arms, which are made of 3/32-inch music wire. The wire should be heated red hot to anneal it before bending.

Drill a #42 hole in the steering knuckles for the steering arms and solder them in place. Note that the arm holes are at a slight inward angle to make for straighter steering. Assemble the wheels, axles and steering knuckles (use washers on both sides of the wheels, top and bottom of knuckles) and add grease.

The steering mechanism is built around a Mighty-Midget servo motor. First add three 2-56 round-head machine screws to the large gear on the servo, as in Fig. 7, left. Solder a crank to the pulley at the opposite end of the countershaft as in Fig. 7, right, making sure it lines up with the cam screws, as in Fig. 7, left.

Attach two identical sets of contacts (Fig. 7, center) made of 1/64-inch thick spring bronze to a phenolic base, as shown. Attach the contact strips to the base plate with brass eyelets. When the cam gear is turned, check to see that the screw heads don't touch the wrong contact strips and that the latter don't touch the motor armature shaft.

Fig. 4—Tie rod (B and C) is a piece of 1/4x1/32-inch brass strip. Kink enables you to adjust length so wheels will be parallel. Steering link, made from 1/16-inch annealed piano wire, is connected to small angle bracket at right side (C).

STEERING SET-UP

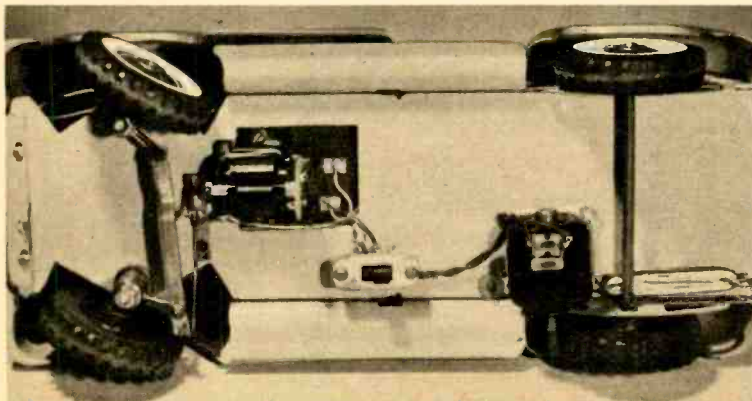
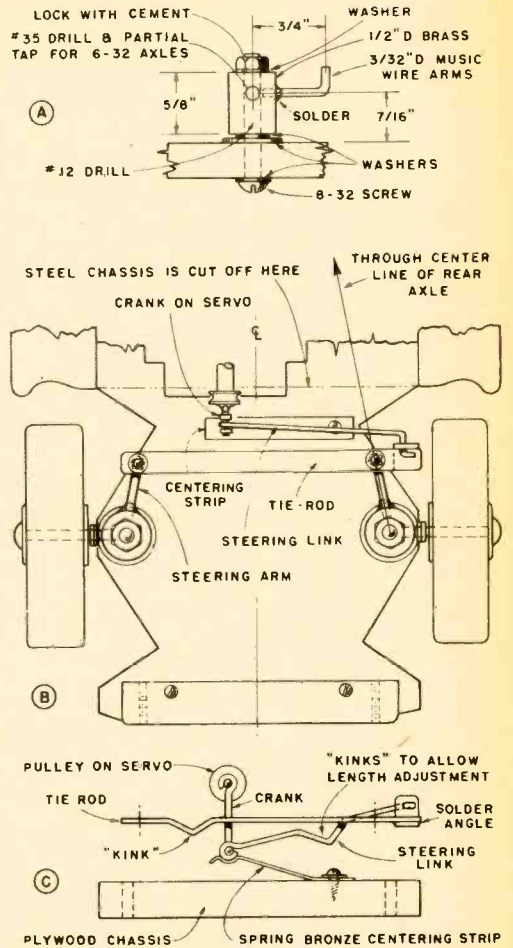

Fig. 5—Note that the front of the Sportsman truck was completely removed just behind the front wheels. Wood chassis is slipped in place under rear axle, which is not touched. Shaft of drive motor is held firmly against rear tire by rubber bands in the lower right corner.

# R/C

The #3 (steering) contacts (Fig. 7, center) should open about 1/32-inch when touched by either of the cam screws closest to the gear hub. The #2 (neutral) contacts should open 1/32-inch when touched by the screw near the gear rim. The screws should be cut short so they don't protrude beyond the back of the gear. Final servo and steering adjustments will be made after the truck is finished and running. Install a drag strip (Fig. 7, right) of the same spring material as used for contacts to press against the rear of the servo-motor gear.

The steering servo is mounted on the underside of the metal chassis in an opening in the plywood chassis. When the servo is in place, bend the steering link and attach it to the tie rod. When the wheels are straight ahead, the servo crank should be near the chassis and contacts #2 (neutral) should be held open by the outer cam-screw head. Lastly, add a centering strip, Fig. 4C, to return the wheels to their straight-ahead position after a turn.

The drive motor pivots on one small wood screw (Fig. 6) while a second screw keeps

Fig. 6—Drive motor turns either rear wheel by friction contact. Motor shaft is extended with a piece of 3/32-inch ID brass tubing so it will extend to outer edge of wheel. Solder extension to shaft and slip piece of rubber tubing over it.

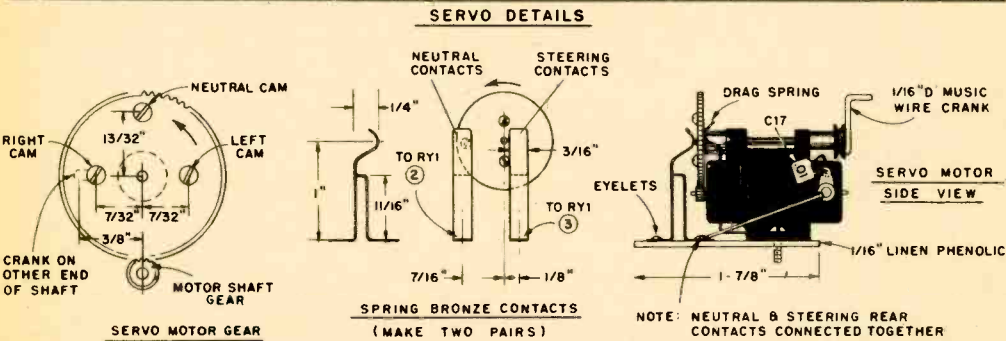
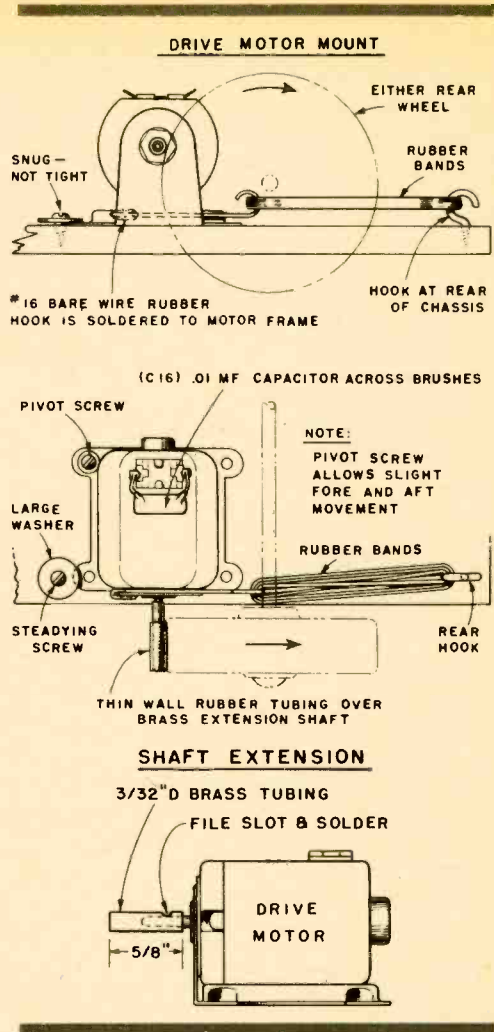

Fig. 7—Servo motor comes equipped with plastic gear (left) on which screws must be mounted exactly where shown. Neutral and steering contacts (center) are mounted with servo motor on separate piece of phenolic board. Dimensions are critical and must be observed carefully. Music-wire crank is 7/16 x 1/4 inch.



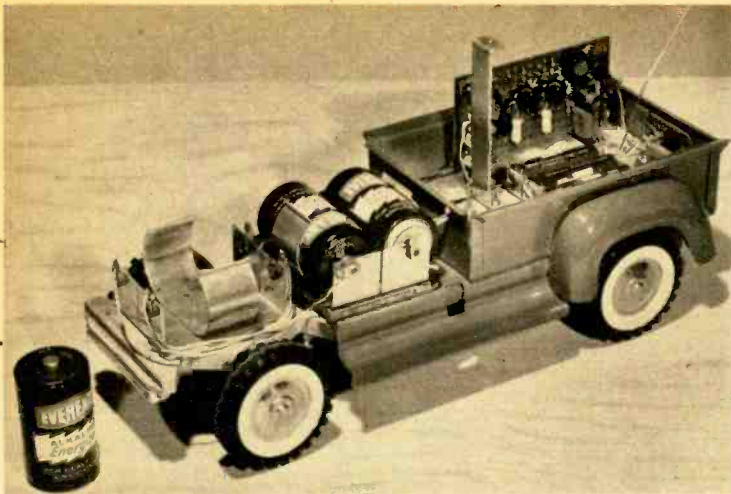

Fig. 8—Ready to go—after the batteries and the cab and rear cover are installed. Receiver is mounted vertically in rear of truck. Top is screwed to added vertical bracket so truck can be lifted.

it in position. The latter is not tightened—just made snug—so the motor can slide back and forth. Tensioning rubber bands are attached to a hook soldered to the motor frame.

**Receiver Construction.** Mount all receiver parts on a piece of 3/8 x 2-inch perforated phenolic board as shown in Fig. 11. Force T1's tabs through two filed slots, bend them over, then mount all other parts. Transistor leads should be about 1/4-inch long and heat-sunk when soldered.

Last part to go on the board is RY1, which will first have to be adjusted as in Fig. 10, center. Connect RY1's coil in series with a 50-100 ma meter, a variable resistor of more than 200 ohms and a 3- or 4½-volt battery. Before connecting the battery, bend down the lower spring tab to increase spring tension. With the battery connected and about 40 ma going through the coil, make sure the armature does not touch the relay's core (you should see a little light between the core and armature). If they touch, bend up the contact arm slightly. You probably will have to increase the contact gaps, too. The adjustment isn't critical but the relay should be set to pull in at about 15 ma and to drop out at 10 ma.

Mount and connect the relay, attach C14 and C15 to its terminals and connect the battery leads and antenna lead to the board. To tune up the receiver you will need the transmitter, so let's get to its construction and

Fig. 9—Receiver schematic. Q1 is superregenerative detector. Sensitivity is high but tuning is broad so it is possible to pick up signals on adjacent channels. Signal is further amplified by Q2-Q5. When signal is fed to Q5, it conducts, causing RY1 to close and steering servo to turn.

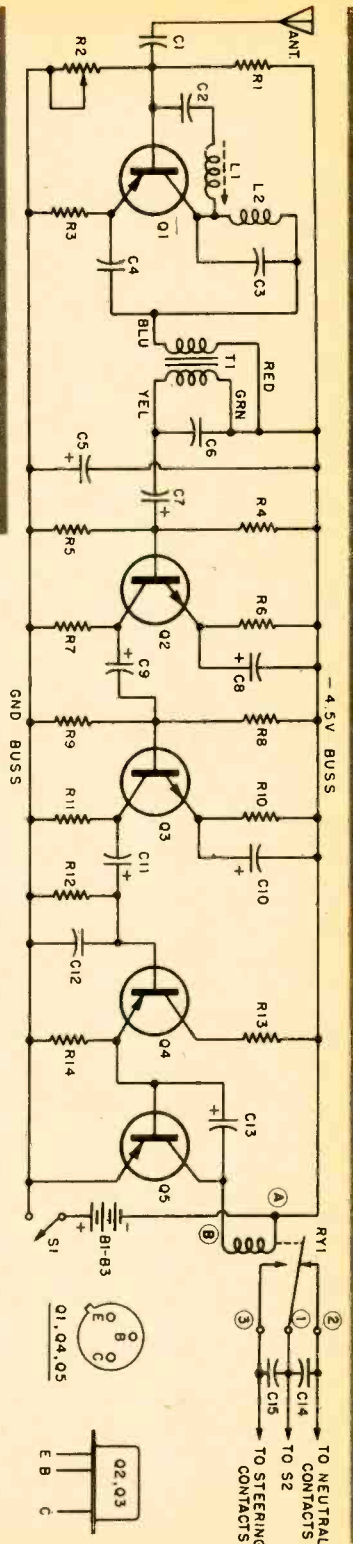

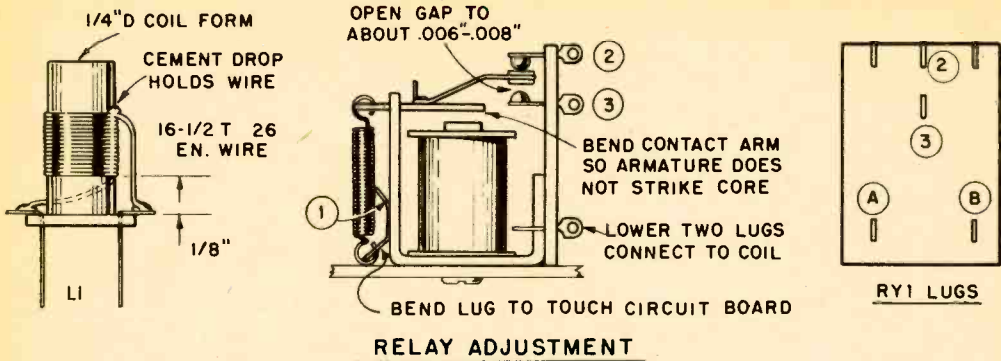

**RELAY ADJUSTMENT**

Fig. 10—L1 consists of 16½ turns of #26 enameled wire wound on ¼-inch diameter form (see Parts List). RY1's contact arm must be bent so when RY1 is energized with 40 ma current, the armature will not strike the core. When adjusted properly, the relay should pull in at about 15 ma and drop out at about 10 ma.

**R/C**

return to receiver tune-up later.

**Transmitter Construction.**

Since it was not possible to obtain a commercially-made box of the size we wanted for the transmitter, we cut a 4x5x6-inch Minibox to 1⅞-inch thickness.

All parts are mounted on a 4⅞x5¾-inch piece of perforated phenolic board as shown

in Figs. 13 and 14. Insert 3/32-inch diameter eyelets for the leads of all components. Small screws hold the crystal socket, transformer T2 and the antenna bracket in place. T1 and L3 are held in place by bending their lugs under the board.

Pushbutton switch S1 is mounted as shown in Fig. 13 because it is easier to reach it there with your thumb. S2 is held to the board by putting its lugs through slots in the

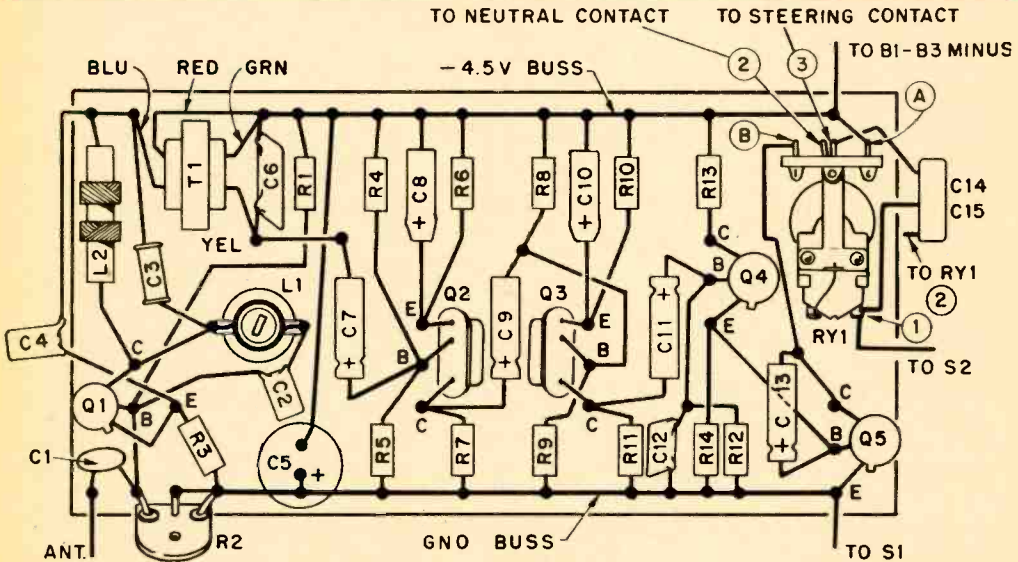

Fig. 11—Receiver will fit on a 3⅞x2-inch piece of perforated board. Run buss wires along top and bottom and use spaghetti on wires that cross. Brass eyelets should be used for tie points. They take up less space than flea clips. Holes for mounting brackets are bored between R10 and R13, and C3 and L1.

RECEIVER AND TRUCK PARTS LIST

B1-B3—1.5-volt penlight batteries  
 B4-B7—1.5-volt alkaline energizer  
 D-size batteries  
 Capacitors: All ceramic disc, 75 V or higher unless otherwise indicated.  
 C1—2 mmf C2—500 mmf  
 C3—10 mmf C4, C14-C17—.01 mf  
 C5—100 mf, 6 V electrolytic  
 C6—.2 mf  
 C7, C9, C11—2 mf, 6 V electrolytic  
 C8, C10—30 mf, 6 V electrolytic  
 C12—.005 mf  
 C13—1 mf, 6 V electrolytic

L1—Choke (See Fig. 10)  
 L2—50 microhenry RF choke  
 Q1—GE-M100 transistor (GE)  
 Q2, Q3—2N1694 transistor (GE)  
 Q4, Q5—2N404 transistor (GE)  
 Resistors: 1/10 watt unless otherwise indicated. (Lafayette RS-250)  
 R1—51,000 ohms  
 R2—50,000-ohm miniature potentiometer (Lafayette VC-60)  
 R3—2,000 ohms  
 R4, R8—11,000 ohms  
 R5, R9—68,000 ohms

R6, R10—1,100 ohms  
 R7, R11, R12—6,200 ohms  
 R13—33 ohms R14—820 ohms  
 RY1—100 ohm Gem Miniature relay (Ace)  
 S1—SPST slide switch  
 S2—DPST slide switch  
 T1—Transistor audio transformer (Lafayette TR-98)  
 Misc.—Drive Motor (Lafayette F-405), Servo motor (Mighty Midget, Ace)

board and meter M1 is cemented to the board. Three screws and spacers and S1 and S2 hold the board 5/16-inch away from the case. The buss strip is made of shim brass as it makes a better RF ground than would a piece of wire.

**Transmitter Tune-Up.** With the transmitter mounted in the case and the antenna extended, connect a 0-25 ma meter in series with B1. Remove the crystal from its socket and turn on S2. You should get an indica-

tion of about 2 ma. Insert the crystal and screw T1's core all the way in. Then turn the core counterclockwise slowly. At one point the current should jump suddenly. Turn the core another full turn in the same direction.

Turn the core of L3 so it is about 2/3 out of the winding. Grasp the case firmly with one hand and turn C8 with a plastic alignment tool. The meter indication will fall several ma at some point during C8's adjustment.

Fig. 12—Transmitter schematic. Crystal-controlled oscillator Q1 drives power amplifier Q2. L3 is a loading coil which makes the short whip antenna look like a quarter wave at 27 mc, causing more power to be radiated. Q3 is AF oscillator and modulator. We found transmitter was able to put 35 mw into a 50-ohm dummy load, indicating an output efficiency of about 35 to 40 percent. Tank coil L2 is below center of schematic.

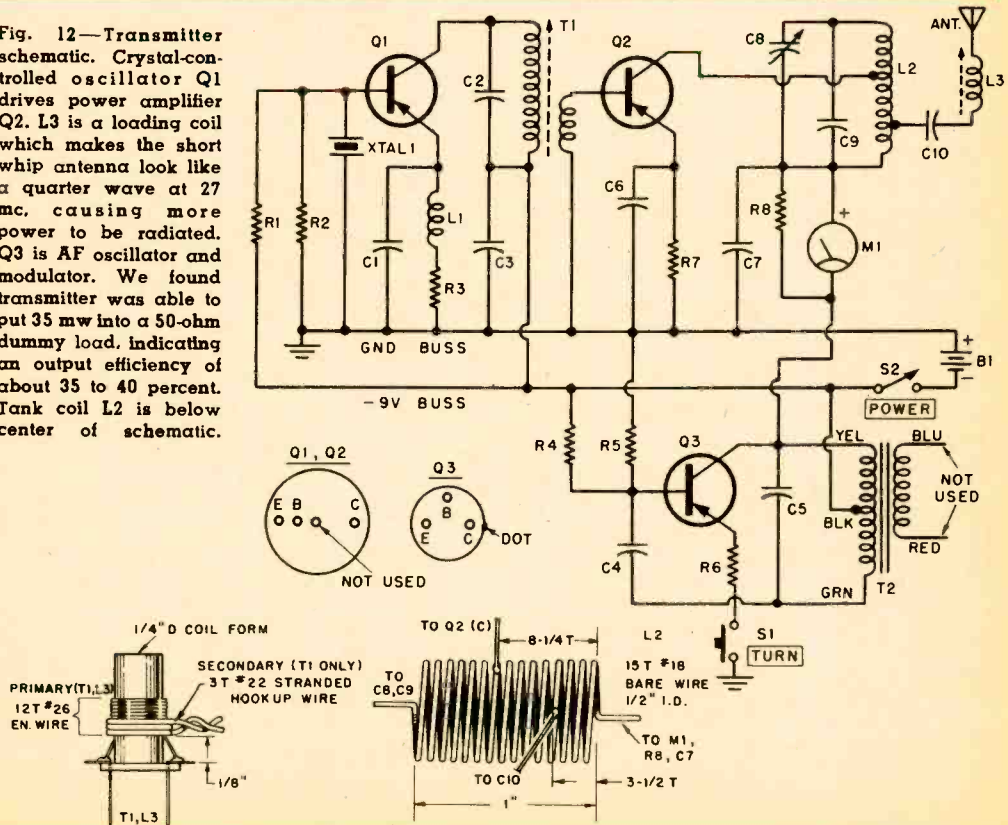

## TRANSMITTER PARTS LIST

B1—9-volt battery (Eveready #266)  
 C1—100 mmf ceramic disc capacitor  
 C2, C9—10 mmf disc capacitor  
 C3, C6, C7—.01 mf disc capacitor  
 C4—.25 mf ceramic disc capacitor  
 C5—.1 mf ceramic disc capacitor  
 C8—440 mmf trimmer capacitor (ARCO 422)  
 C10—500 mmf disc capacitor  
 L1—22 microhenry RF choke (ACE)  
 L2—Tank coil. See Fig. 12  
 L3—Loading coil (wound on Ace SPC-2 form. See Fig. 12)

M1—Miniature tuning meter (Lafayette TM-18)  
 Q1, Q2—2N2207 transistor (Amperex)  
 Q3—2N2428 transistor  
 Resistors: ½-watt 10% unless otherwise indicated  
 R1—10,000 ohms R2—1,000 ohms  
 R3—560 ohms R4—8,200 ohms  
 R5—2,200 ohms R6, R7—47 ohms  
 R8—6.8 ohms  
 S1—SPST pushbutton switch  
 S2—SPST slide switch

T1—Transformer (wound on Ace SPC-2 form. See Fig. 12)  
 T2—Transistor transformer (Lafayette AR-173)  
 XTAL 1—27.255 mc (Channel 23 transmit) CB crystal (Lafayette MS-786)  
 Misc.—Crystal socket, #26 enameled and #18 bare wire, 3/32-inch eyelets (Ace Radio Control, Box 301, Higginville, Mo.), Antenna (Lafayette F-343)

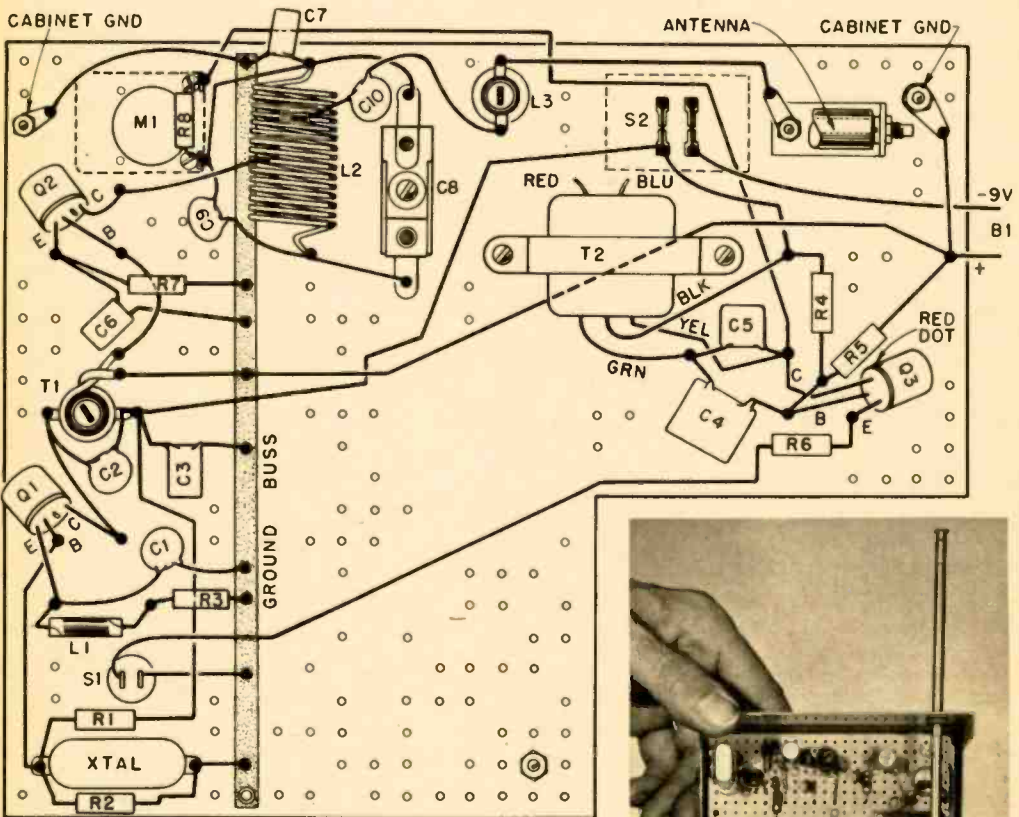
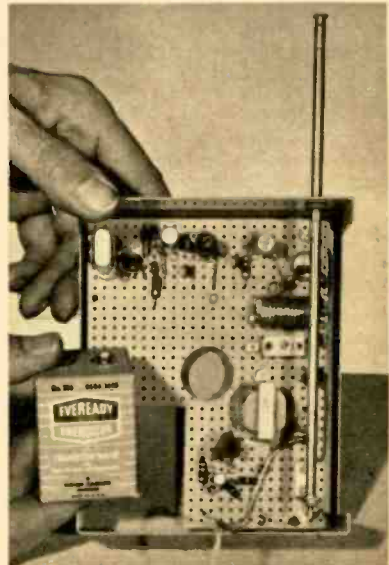

Fig. 13—Transmitter is built on a 4½x5¾-inch piece of perforated board. Cutout in corner is for battery. Antenna fits through grommeted hole in top. Position it so it clears adjustment slots in L3 and C8. Keep board 5/16 inch above inside of cabinet by putting spacers under mounting screws.

Fig. 14—Transmitter mounted in case. Drill holes in U-section of Minibox over L3 and C8 so you can make a final tune-up with the cover in place. Be careful ground lug above the meter doesn't come in contact with the meter case.



Oscillator Q1 draws between 2 and 3 ma and Q2 draws 8-9 ma when loaded properly. If the meter falls much below 11 ma, L3 should be readjusted. Turn the core a half turn into the winding and adjust C8 again. Do not retune L3. Just shift its core a small amount at a time and tune C8 until the meter indicates at least 11 ma.

You can do a better job of tune-up by inserting a meter between Q3's collector and M1. On our transmitter M1 indicated about 9 ma when the pointer was opposite the last scale marker. (M1's pointer goes backwards, since it really is an S-meter.)

The tuning of C8 and L3 will be a little different when the back of the case is in place. Therefore, drill small holes over these parts so they can be touched up when the cover is in place.

If you set the transmitter on a non-metallic table, the current to Q2 will drop to about 5 ma. This is quite normal as the final is not loaded unless you hold the case—or set it on a metal surface. When the antenna is collapsed, Q2's current will rise to about 8 ma or so—again, quite normal and nothing to worry about.

**Receiver Tune-Up.** Now that you have a working transmitter, let's get back to tuning up the receiver. Set R2 to its maximum-resistance position. Put an 18-inch antenna on the receiver and connect a 4½-volt battery with a 50 or 100 ma meter in series with one lead. (The meter should be a low-resistance moving-coil type.) There should be an indication of about 5 ma. Reduce the resistance of R2. The current should rise gradually. Continue to adjust R2 so the current *without* an input signal is about 10 ma.

If you don't have a milliammeter, hook a 5-volt DC voltmeter across RY1's coil terminals. Adjust R2 for an indication of about .5 V. Collapse the transmitter antenna, turn on its power and press *turn* push button S1. Now, turn L1's slug until the meter reading rises to about 45 ma (or 4V if you are using a voltmeter across RY1's coil).

If you have difficulty tuning the receiver with the transmitter close by, back away until the meter indication drops and retune L1 for a peak. Incidentally, don't try to save money by connecting the receiver to the motor-drive batteries.

**Final Adjustments.** Mount the receiver in the back of the truck with two angle brackets and install a 10-inch piece of music

CERTIFICATE OF COMPLIANCE WITH FEDERAL COMMUNICATIONS  
COMMISSION REGULATIONS, PART 15, PARAGRAPH 205

ELECTRONICS ILLUSTRATED certifies that this low-power transmitting device can be expected to comply with the requirements of Paragraph 15.205 of the FCC Regulations under the following conditions:

- (a) When this device is assembled with components of the specified values and according to the diagrams and instructions published in this magazine.
- (b) When used for the purpose and in the manner indicated in the instructions.
- (c) When operated on a frequency of 27.255 megacycles and using an antenna limited to a single element not more than 5 feet long.

*Robert J. Beason*

ELECTRONICS ILLUSTRATED, New York, N. Y.

dated: January 13, 1964

I hereby certify that I have assembled and adjusted this device in strict accordance with the above.

Owner's signature .....

Date .....

Cut out this certificate, sign it and paste it on back of transmitter before operating the truck.

wire for an antenna (Fig. 8).

Mount two dual holders for D-size flashlight cells under the cab and hood. Any D cells could be used but we recommend alkaline energizers since the current drain is fairly heavy. Note in Fig. 1 that all four batteries drive the truck motor but only three operate the steering servo.

Since the completed car weighs about 6 lbs. it will run only on fairly smooth surfaces. Don't try it on rugs or rough driveways. The weight on the front wheels will prevent the steering servo from turning the wheels unless the truck is moving.

With the receiver off and the steering servo in neutral, check to see that the truck runs in a fairly straight line on a smooth surface. Now, turn on the receiver and transmitter and try a few turns. At first, chances are the truck will either refuse to turn at all, or the steering servo will cycle; that is, the front wheels will wobble as though they had a bad case of shimmy. If the wheels refuse to turn—and you are sure the relay is operating and power is getting to the servo motor (try it with the front wheels off the floor)—either the servo drag strip or the centering strip or both are under too much tension. Try reducing the tension a bit. If the servo cycles and refuses to stop, *increase* drag strip tension. If the wheels respond to your signals fairly well but occasionally go through a steering cycle when you haven't pushed the transmitter button, increase centering-strip tension. ●



# THE LISTENER

SWL-DX NOTES

BY C. M. STANBURY II

**SWAN ISLAND** . . . By now just about every DXer has heard of Swan Island down in the Caribbean. Question is, what's the best way to bag this rare catch? And, once you've heard it, how do you go about getting a QSL? Fortunately, there are at least two ways of accomplishing the feat.

DXers lucky enough to own a long-wave receiver certainly should try for radio beacon SWA on 407 kc. With 50,000 watts behind it, this is one of the world's most powerful beacons and it often breaks through the QRM for brief periods. To prove your reception, time the SWA identification to the second as well as the period of silence between transmissions. This done, send off your report to Technician in Charge, Swan Island Radio Beacon, c/o U.S. Weather Bureau, Tampa, Fla.

Swan Island also can be logged on SW when aircraft passing over it contact a control station there. Swan happens to be a reporting point between New Orleans and Panama on aircraft Route F (Foxtrot). During daylight hours the frequency is 10,021.5 kc; at night, both 2952 and 5619 kc are used. Since the 2952 frequency actually is medium-wave, logging that one can well be considered especially fine DX.

Inasmuch as Swan Island lies between reporting points F5 and F6, a southbound aircraft will report as it passes over point F5. At that time, its pilot will estimate when he expects to be over Swan. This will tell you when to listen hardest. For northbound flights, point F6 can serve a similar purpose.

Having followed the flight until it passes over Swan Island, you then should be in a position to write down everything you hear. Reports go to the Communications Supervisor (name of airline), New Orleans International Airport, New Orleans, La. By the way, flights calling themselves *Clipper* belong to Pan American.

**Radio Italiana** . . . A pertinent and accurate quote included with an SW newscast can provide important information for the SWL. But too often those quotes which find favor with SW broadcasters are just so much

cold air—political platitudes, hackneyed patriotic cliches and plugs for lifeless cultural exchanges. We really don't know who is champ in the dull quotes department, but Radio Italiana (RAI) certainly must be a contender. It's not unusual for 75% of an RAI newscast to be long-winded blurbs from various government leaders in Rome.

Of course, RAI's strength in this field can be explained in part by the political situation in Rome. Of all nations in NATO, Italy has one of the most unstable governments. No party ever seems to have a majority; coalitions are the order of the day. Policies constantly shift between moderate and leftist.

With this backdrop, a *patient* listener comparing these dull quotes from month to month will be able to keep tabs on one of America's more important allies. Assuming you do qualify as a patient listener, Radio Italiana has English for North America at 1930-1950 and 2205-2225 on 5960 and 9570 kc.

[Continued on page 112]



Radio Italiana speaks to the world from this building, which houses its Foreign Broadcasting Department. Letters from listeners are welcomed; the address is RAI, Via Del Babuino 9, Rome.

**W**HEN troubleshooting a radio or amplifier, the fastest way to locate a defective stage is with a signal tracer. Thanks to this useful device, it's a simple matter to work back, stage by stage, until you pinpoint the location of the trouble. EI's FET Signal Tracer—a tracer with a difference—will earn its keep in service work in an extremely short time.

Because it's transistorized, our tracer is small and will fit neatly into a corner of your service kit. But, unlike

# FET SIGNAL TRACER



Chase signals  
the new way

with a field-effect  
transistor, whose  
two-million-ohm  
input impedance

banishes the problem of  
circuit loading.

most transistorized devices, our FET Signal Tracer has an input impedance that's way up there—on the order of 2 megohms.

Secret of the high input impedance—and of those mysterious letters *FET* in our tracer's name—is a relatively new electronic component called the field-effect transistor. The initial letters in the term, of course, read *FET*. Our tracer has an *FET* in its input stage, making it useful for checking any kind of circuit—even those using vacuum

By  
JOHN  
POTTER  
SHIELDS

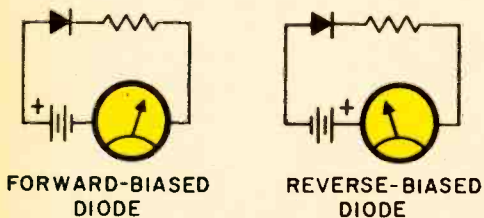
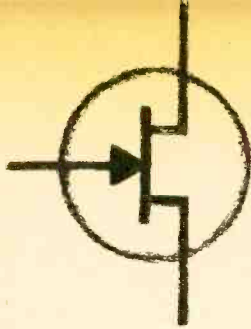

Fig. 1—Positive anode (left) forward biases diode; circuit resistance is low. Negative anode (right) reverse-biases the diode; circuit resistance is high.

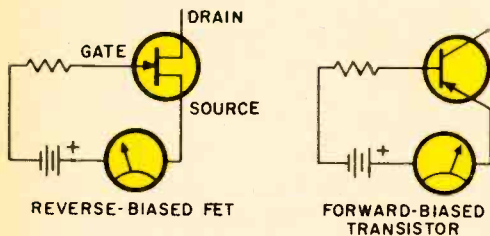

Fig. 2—FET source-gate junction is always reverse-biased so input impedance is high. Forward-biased transistor has a low input impedance.

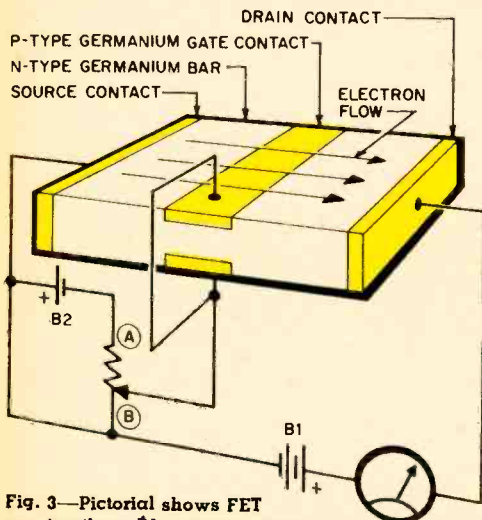

Fig. 3—Pictorial shows FET construction. B1 causes electrons to flow from source contact through N-type germanium bar to drain contact. Potentiometer applies bias voltage from B2 to gate to control flow.

tubes—without loading problems.

Since the field-effect transistor is the most important and interesting part of the tracer, let's take a look at it first. We'll get to construction later.

First, take a look at Fig. 3. It is a pictorial representation of an FET in a simple circuit. The FET consists of a bar of N-type germanium which has been doped with an impurity to give it free electrons, just like the germanium in regular transistors.

At each end of the bar are electrical contacts. The contact at one end is called the *source* because it supplies electrons. It is analogous to the emitter in an ordinary transistor and the cathode in a tube.

The contact at the other end of the bar is called the *drain*, because it collects electrons from the source. It is analogous to the collector in an ordinary transistor and the plate in a tube.

In the center, on the top and bottom of the germanium bar, are pieces of P-type germanium. They form PN junctions with the bar—like the PN base-emitter junction in an ordinary transistor. The P-type sections are connected to form what is called the *gate*. The gate controls the number of electrons that go from the source to the drain and is analogous to the base in an ordinary transistor and the grid in a tube. Source, gate, drain—these are the elements in the FET.

### How The FET Works

In Fig. 3 we will assume that the wiper arm on the potentiometer is at point B. Because the gate now is connected directly to the positive terminal of B2, it is at the same potential as the source. Under this condition, the bar appears as a simple resistance between source and drain. Since the whole bar acts like a resistor, any point along its length is more positive than any second point nearer the source because of the way B1 is connected. Keep this in mind, since we will refer to it again later.

Electrons supplied by B1 to the source will now flow through the bar to the positive drain. The gate has no effect yet. The amount of current depends on the dimensions of the bar and the amount of the impurity added to it.

As the slider on the potentiometer is moved from point B to point A, the gate becomes negative with respect to the source. Because of the polarity of B2, the PN junction be-



tween the gate and the bar is said to be reverse-biased (gate negative, bar positive).

To see more clearly what we mean by forward and reverse bias, look now at Fig. 1. The diode at the left is *forward*-biased because its anode (P-type germanium) is positive with respect to its cathode (N-type germanium). The diode at the right is reverse-biased because its anode is negative and its cathode is positive.

Now, here's why the FET has a high input impedance. Look at Fig. 1. When a diode is reverse-biased, only a small leakage current flows in the circuit. And when little current flows in a circuit, it means the circuit resistance is high. When the diode is forward-biased, the current is high. This means the circuit resistance is low.

Since an "N-channel" FET's source-gate junction is *always* reverse-biased (source positive, gate negative) as in Fig. 2, the current is low. And for the same reason given for the reverse-biased diode in Fig. 1, the resistance of the source-gate (or input) circuit is high.

In a practical circuit an input signal replaces B2. In conventional transistors, the base-emitter circuit is always forward-biased (Fig. 2) and a heavy current flows. This is why the input impedance of conventional transistors is low.

### How The FET Amplifies

Take a look at Fig. 4 and recall what we said before about the N-type germanium bar acting like a resistance.

To amplify, we must be able to control a flow of electrons. In an FET application, when the wiper arm of the potentiometer is just above point B, the gate gets free electrons from the negative terminal of B2. (The free

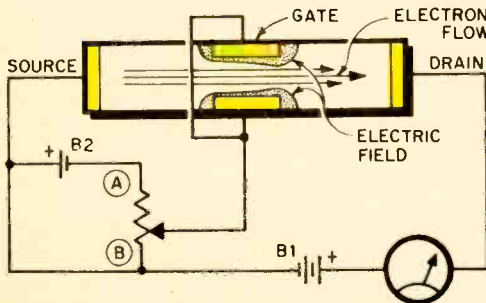

Fig. 4—Apply negative voltage from B2 to gate and size of space-charge region (dots) increases, narrowing channel through which electrons flow.

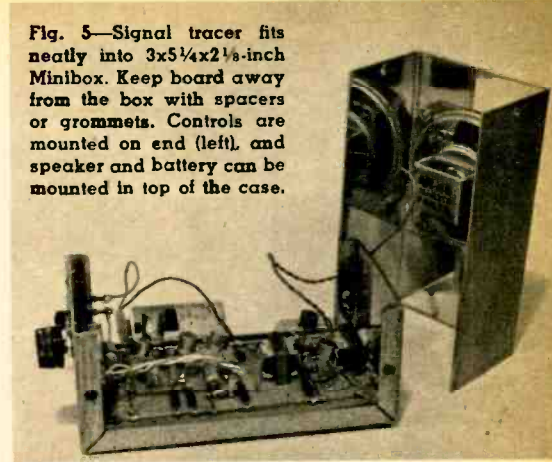

Fig. 5—Signal tracer fits neatly into 3x5¼x2½-inch Minibox. Keep board away from the box with spacers or grommets. Controls are mounted on end (left), and speaker and battery can be mounted in top of the case.

electrons are the dots just below and above the gate in Fig. 4.) These free electrons diffuse into the bar and their concentration is greater at the right end of the gate. This is because the bar gets progressively more positive as you go from left to right and, therefore, attracts more electrons from the right side of the gate. The free electrons form what is called an electric field (hence the name *field-effect*) or a space-charge region. This region narrows the channel in the bar through which the electrons pass when going from source to drain. The greater the negative voltage from B2, the narrower the channel and the fewer the electrons that can pass.

When the wiper arm is moved closer to A on the potentiometer the gate gets even more free electrons around it. This causes the space-charge region to increase in size, as in Fig. 5, further limiting the number of electrons that can get from source to drain.

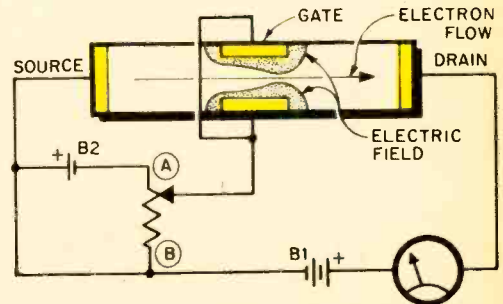

Fig. 6—When potentiometer is at A, highly negative voltage from B2 increases size of space-charge region, which stops the flow of electrons.

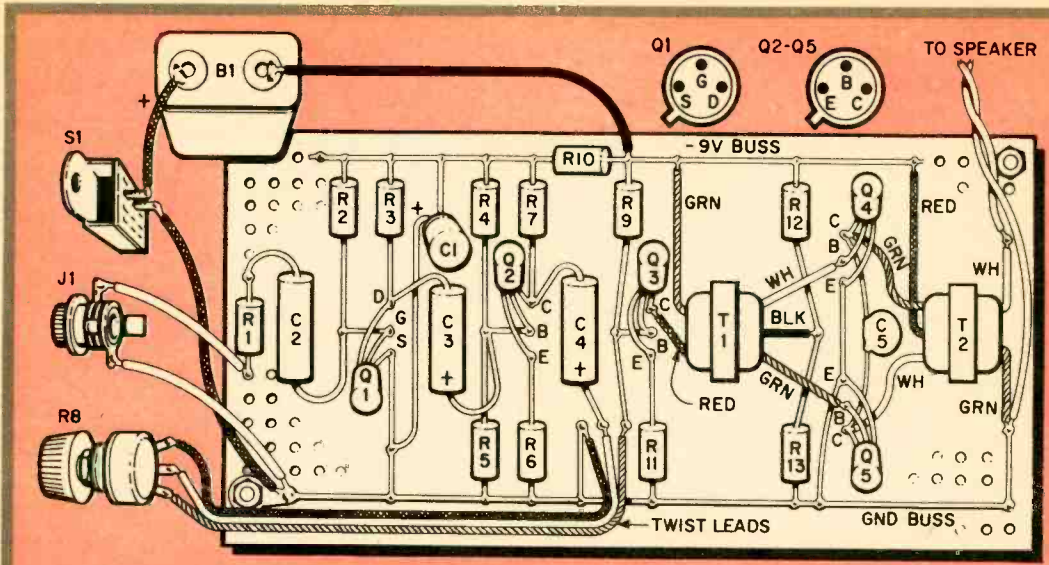

Fig. 7—All parts fit on 2½x5-inch perforated board. Heat-sink the transistor leads when soldering.

Fig. 8—Inside view of tracer. Maximum peak-to-peak input voltage is 2 VAC, 200 VDC. Adding circuit in Fig. 11 at the left side between input jack J1 and power switch S1 increases maximum input voltage to 200 peak-to-peak VAC, 2,000 VDC. Tracer also can be used as amplifier for record player or as a booster for small pocket transistor radios.

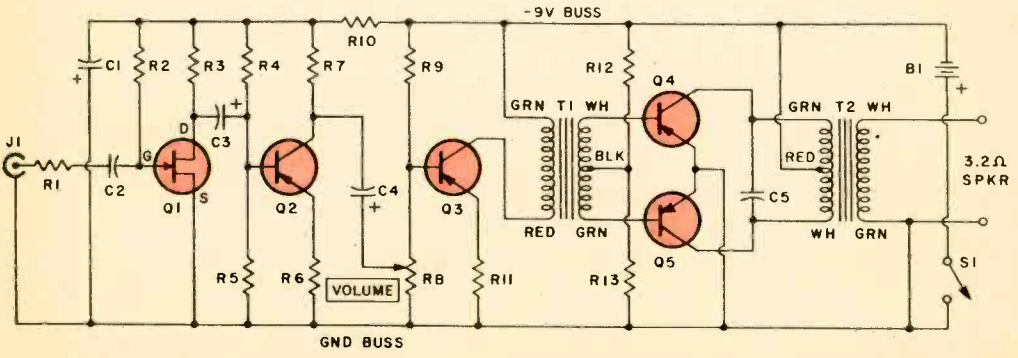
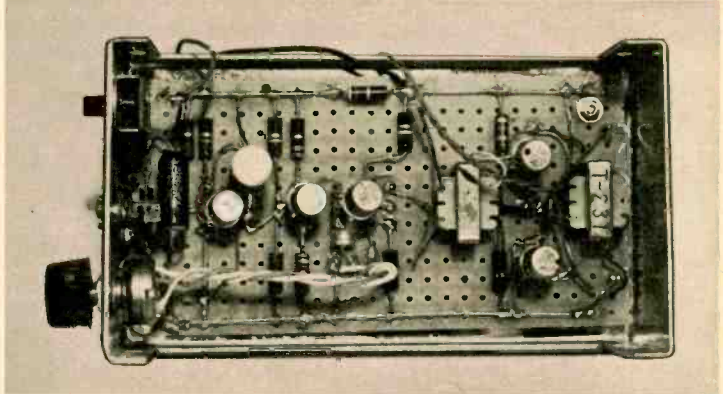

Fig. 9—Q1's output is taken from drain. Tracer's gain is 37db; response is 3db down at 500 cps, 29 kc.

### PARTS LIST

- B1—9-volt battery  
 C1—100 mf, 15 V electrolytic capacitor  
 C2—1 mf, 75 V or higher ceramic disc capacitor  
 C3,C4—20 mf, 15 V electrolytic capacitor  
 C5—6,800 mmf, 75 V ceramic disc capacitor  
 C6—470 mmf, 600 V ceramic disc capacitor  
 D1—1N34A diode J1—Miniature phono jack  
 PL1—Miniature phone plug  
 Q1—Texas Instruments T1X880 FET  
 (Available for \$3.05 plus postage from Newark Electronics Corp., 223 West Madison St., Chicago, Illinois 60606. Special stock No. 22F5150)  
 Q2-Q5—2N1273 transistor (Texas Instruments)  
 Resistors: 1/2-watt, 10%  
 R1—1 megohm R2—2.2 megohms  
 R3—18,000 ohms R4,R17—220,000 ohms  
 R5—8,200 ohms R6—390 ohms  
 R7—3,300 ohms  
 R8—10,000-ohm audio-taper potentiometer  
 R9—150,000 ohms R10—470 ohms  
 R11,R13—69 ohms R12—1,800 ohms  
 R14,R15—150,000 ohm, 1/10-watt resistor  
 R16—22 megohms  
 S1—SPST slide switch S2—SPDT slide switch  
 T1—Transistor driver transformer: 10,000-ohm primary, 2,000-ohm secondary (Lafayette TR-98)  
 T2—Transistor output transformer: 500-ohm primary, 3.2-ohm secondary (Lafayette TR-99)

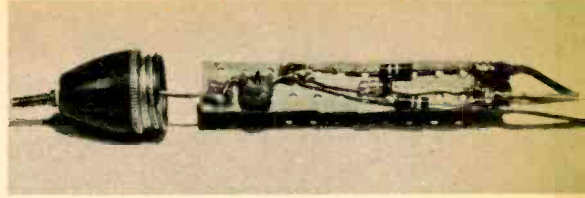
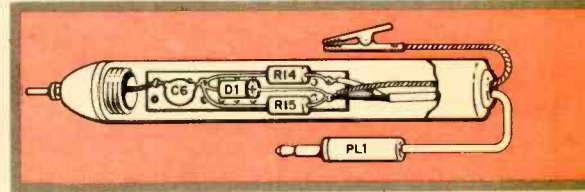

Fig. 10—RF probe can be built on small piece of perforated board but must be housed in metal case. D1's leads are short so watch the heat when soldering in place. Maximum voltages which can be applied to probe are 40-peak-to-peak RF volts and 600 VDC. R14 and R15 are 1/10-watt resistors.



If the wiper on the potentiometer is moved all the way to A, we reach what is called the pinch-off voltage and the channel in the bar is sealed. No electrons can now get to the drain.

So you see how a small voltage in the source-gate circuit can control a large current in the source-drain circuit. And now we have amplification. Replace the meter with a load, B2 with an input signal, and we have a practical amplifying device. Let's put the FET to work in our signal tracer.

Figure 9 is the schematic of the FET signal tracer. Signals applied to input jack J1 are fed through isolating resistor R1 and DC-blocking capacitor C2 to the gate of FET Q1. Though not apparent, Q1 is connected as a source-follower, analogous to a transistor emitter-follower. Since Q1, an N-channel

FET, is designed to operate with a positive voltage on the drain, Q1 is turned over in the circuit. (The source and drain of a FET can be interchanged.) That is, we are using the drain as the source and vice versa.

The amplified signal at Q1's source (really the drain) is coupled by C3 to the base of Q2. The signal is amplified further by Q3 and applied to driver transformer T1, which feeds Q4 and Q5. Q4 and Q5 are coupled by T2 to a 3.2-ohm speaker. Output power exceeds 200 milliwatts.

The tracer is built on a 2½x5-inch piece of perforated board and mounted in a 2½x5¼x3-inch Minibox. Additional construction details are covered in the captions.

The RF probe is built in a metal penlight case which serves as a shield. The tip is a miniature banana plug (Olson HW-35).

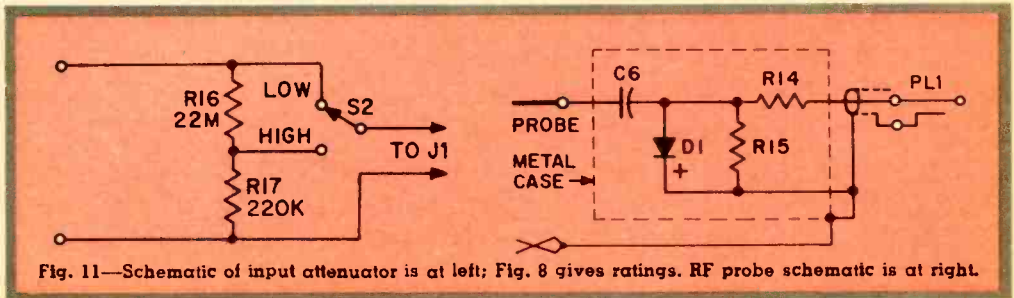

Fig. 11—Schematic of input attenuator is at left; Fig. 8 gives ratings. RF probe schematic is at right.

# HAM SLANGUAGE

**Stumped by terms oh-so-familiar to seasoned amateurs? This dictionary of ham lingo includes a few expressions that even old-timers may not know.**

**By Bill Walker, K2RUK**

**all-band wonder.** Semi-derogatory description of an antenna that's supposedly able to give equal performance on all bands—but usually doesn't.

**armchair copy.** Clear, static-free signals—which you can sit back, relax and listen to.

**BCI.** Interference to broadcast receivers in the vicinity of a ham transmitter.

**big jump.** DX contact which obviously is the result of two or more skips (e.g.: New York to Australia, the long way around).

**big pond.** Atlantic or Pacific Ocean.

**big switch.** The station master power switch.

**birdies.** False signals in a receiver due to interference or poor design.

**bottle, bulb.** Vacuum tube, generally applied to high-power transmitting types.

**brass pounder.** Morse code operator, especially one who spends long hours handling "traffic."

**bucket of bolts.** Deprecating remark made by an operator when congratulated on a good quality signal. Usually he's running a first-rate rig, but won't admit it.

**buckshot.** Noise produced over the band by an over-modulated signal. Also called "splatter."

**bug.** Transmitting key which sends dots and dashes automatically.

**California kilowatt.** A transmitter running more than the legal 1,000 watts (usually hidden in the attic).

**cans.** Earphones.

**chirp.** Change in pitch of code due to poor regulation of transmitter power supply.

**DX hound.** Amateur who specializes in making distant contacts.

**ether blaster.** Rig that *sounds* powerful. An expression used chiefly by newcomers to ham radio.

**eyeball QSO.** (que-so).  
Face-to-face contact.

**final final.** A transmission made after a ham supposedly already has made his final transmission.

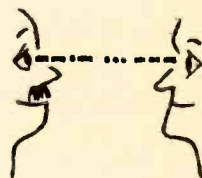

**fine business.** Acknowledgment or agreement.

**fist.** Ability to transmit code. Clean, sharp code comes from a "gud fist."

**gallon.** One thousand watts of power; 1 kw; all the law allows for conventional AM transmitters.

**garbage.** The noise resulting from too many hams trying to work the same frequency at the same time.

**gold-plated special.** A piece of super-de luxe equipment, which is supposedly unsurpassable.

**ham fest.** Annual picnic or dinner held by most ham clubs.

**handle.** A person's given name.

**harmonic.** A child of a ham.

**hash.** Atmospheric. Static crashes and sizzling from a receiver caused by electricity in the atmosphere.

**hi.** Ham laughter.

**ITV.** Interference from a TV set that causes "birdies" in a ham receiver.

**junior op(erator).** A child of a ham.

**junk box.** Mythical receptacle for odds-and-ends of electronic components.

**knows his stuff.** Said of someone who appears to be an expert because he speaks in double-talk. Rarely used when you get to know him. Rarely, if ever, said of a true expert.

**land line.** Telephone.

**lid.** A sloppy operator or one who horses around on the air. Also a TV set particularly susceptible to "TVI."

**mickey mike.** Microfarad; a unit of capacity.

**mickey-mickey mike.** Micro-microfarad or picofarad; a unit of capacity.

**modulate the pillow.** Go to bed.

**monkey chatter.** Sound of signals from a single-sideband phone station. Also called "Donald Duck."

**mud.** "Garbage" and "hash" together. Signals are indistinguishable unless they can be "pulled out of the mud."

**no strain, no pain.** Said of reception that is clear and free of interference.

**Old Man, OM.** Terms of address between hams.

**one-eyed monster.** TV set.

**outboard.** Accessory or attachment to main receiver or transmitter.

**peanut whistle.** Very low-powered transmitter, usually under ten watts.

**pink ticket.** Notice from FCC of a violation of regulations. Also known as a "QSL from the FCC."

**pinning the meter.** Refers to powerful signal that causes receiver S-meter to read at or near full scale.

**QR Mary (QRM).** Interference caused by other hams, car ignitions, etc.

**QR Nancy (QRN).** Interference caused by atmospherics.

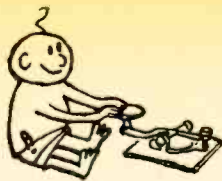

**rag chew.** Engage in lengthy conversations.

**ratty.** Spoken word for initials RTTY, radio teletype.

**read the mail.** Listen in on other stations.

**rock bound.** Crystal-controlled transmitter.

**roundtable.** Simultaneous contact by more than two hams.

**run it barefoot.** Operate a transmitter at low power without a linear amplifier.

**rush-box.** A superregenerative receiver.

**shack.** That part of an operator's home devoted to his radio equipment.

**sideswiper.** A telegraph key which operates from side to side rather than up and down.

**silent key.** Deceased ham.

**sked.** Schedule.

**skip.** The path which signals take as they leave an antenna, bounce off the ionosphere and reach a far-away ham.

**sky hook.** Antenna.

**solid.** Transmission received perfectly with no "holes."

**Tennessee Valley Indians (TVI).** Interference to television sets in the vicinity of a ham transmitter.

**tie the ribbons.** Finish the contact; make the final remarks.

**traffic.** Messages.

**whizzing rettsynitch.** Symbol of the Wouff Hong, so despicable that no one could look at it; those who did were permanently trans-fixed.

**Wouff Hong.** ARRL's secret society, now disbanded.

**XYL.** Former young lady; married woman; ♀ ham's wife.

**YL.** Young lady; unmarried woman.

**73.** Best regards; used when signing off.

**88.** Love and kisses

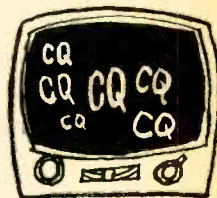

# How to SWITCH TO PTT

*Converting your old mobile rig to PTT will be like growing that third arm you've wanted for so long.*

By DAVID WALKER



**F**IGURE it out—it takes a three-handed Martian to operate a mobile Citizens Band rig if it's not equipped with a push-to-talk (PTT) mike. One hand holds the mike, the other hand presses the T-R switch, while the third hand holds the steering wheel.

At least seven early CB transceivers did not provide the convenience of a PTT mike. If you own one of these sets you can convert it to PTT operation for about \$10 and a few hours of time: EICO 760,761 and 762; Lafayette HE-15; Heath CB-1; ULS TR-800 and Knight-Kit C-11. The modification described here is the same for all.

First step is to find a spot for the relay on the top of the transceiver chassis. Locate the relay where it won't hit the rig's cover and mount it with an 8-32 screw. Install a large rubber grommet in a 1/2-inch diameter hole to protect the leads going from the relay to the underside of the chassis.

To prevent errors when transferring leads from the existing T-R switch to the relay lugs, we've worked out a step-by-step procedure. Although circuits differ from one CB transceiver to the next, the system will work for all. First, examine the drawing at the top left of the next page. This is what the T-R switch looks like from the rear. Notice that it is divided into four sections and that there

are three lugs in each one of the sections.

Compare this with the arrangement of the relay lugs, which also are divided into four groups with three lugs each. The lugs in each section (for both relay and switch) are identified REC (receive), COM (common) and XMIT (transmit). The job is to transfer the three leads from each switch section to the relay lugs.

Twelve wires are involved so there's a good chance of making an error unless you are careful. However, as you complete each section, check the set's operation. With the rig turned on and the T-R switch in receive, you should hear signals. To check the transmit position, flip the T-R switch to transmit and push the relay armature down with the tip of a pencil. If operation is normal, proceed to the next switch section.

If the leads from the switch are too short to reach to the relay lugs, extend them with similar wire and tape the solder connection. If shielded leads are too short, replace them with shielded phono wire. It is necessary to ground shielded leads at only one end—under the chassis, not at the relay. If the wires that run from the receiver input and transmitter output coils to the switch are shielded, bare or spaghetti-covered, extend them to the re-

*[Continued on page 112]*

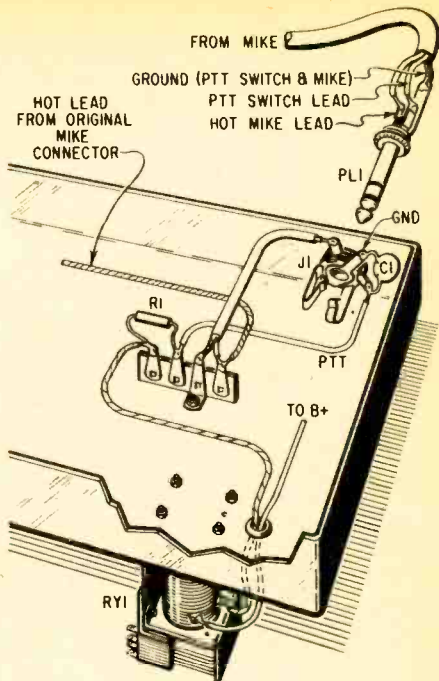
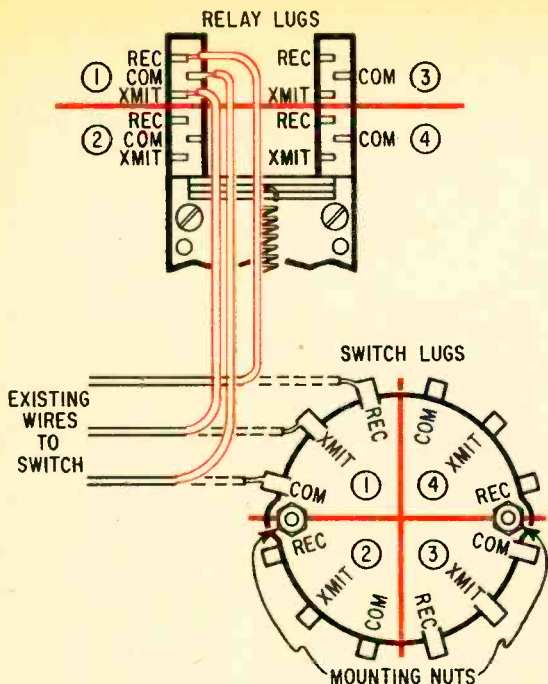

Orient the original T-R switch by its assembly nuts, and imagine water to be divided into four sectors. Then transfer wires from one sector at a time to lugs on relay, which are shown above divided into four groups, each having three lugs.

in a clear corner underneath the chassis mount a terminal strip near the new jack (mounted in original T-R switch hole). Run hot lead from original mike connector to terminal strip and complete other wiring shown here and in schematic.

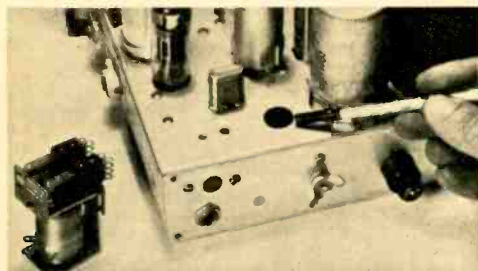

EICO Models 760, 761 and 762 have an empty corner on the rear of the chassis where relay can be mounted. Watch shavings when drilling holes.

#### PARTS LIST

- C1—02-mf, 500-V ceramic disc capacitor
- J1—3-conductor phone jack
- PL1—3-conductor, metal-shell phone plug
- R1—15,000-ohm, 2-watt resistor
- RY1—Relay: 4PDT, 10,000-ohm coil (Potter & Brumfield Type GB17D, Lafayette stock No. 3RY-291)
- Misc.—Grommet, 8-32 screw, shielded phono wire, 5-lug terminal strip, PTT mike (Lafayette M-243 or equiv.)

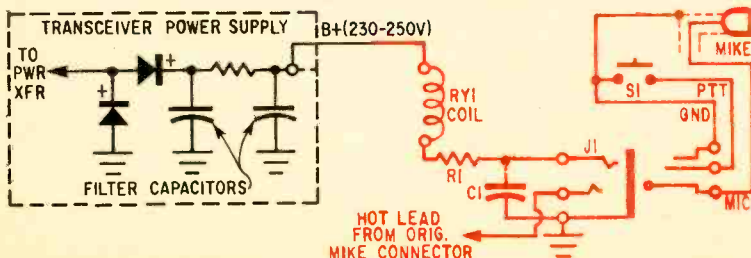

Partial schematic of transceiver power supply within dotted line shows where you get B+ for RY1's coil. Check contacts on mike plug with ohmmeter. Resistance should be low between PTT lead and the connector shell when the PTT button is pressed.

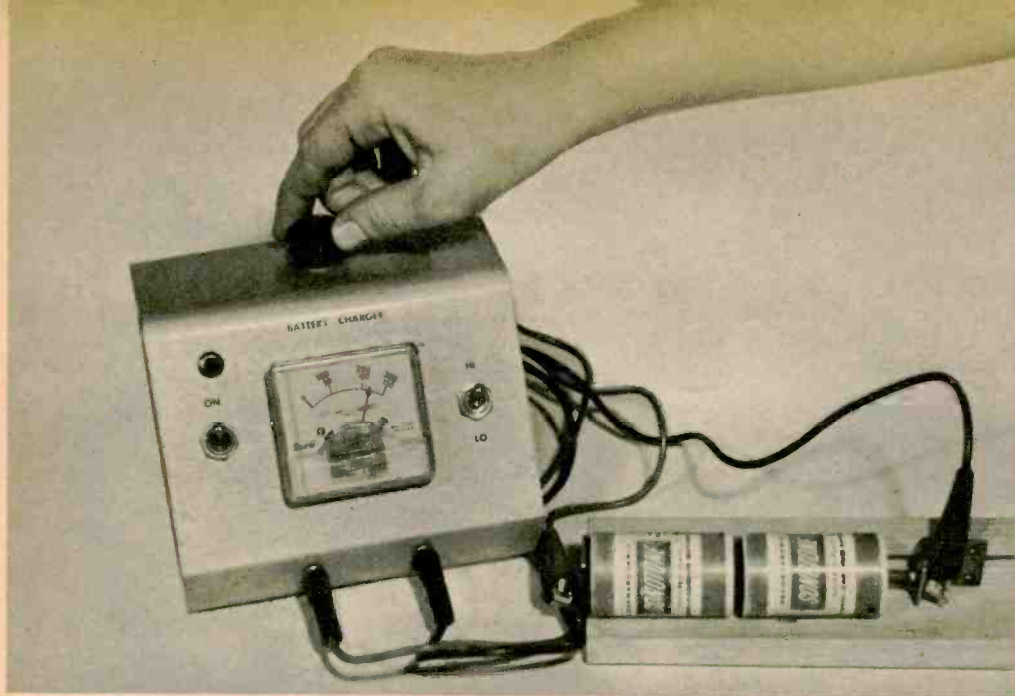

# NICKEL-CAD CHARGER

*Put life back into any type N-C battery with this budget project.*

By BERT MANN

**R**ECHARGEABLE nickel-cadmium batteries are being used more and more in everything from walkie-talkies to power tools. No doubt you've noticed the trend and by now must have considered putting N-C's in equipment that now use throw-away batteries. While the initial cost of N-C batteries is not excessive, the problem often is the charger since each size battery has different charging requirements.

EL's charger can handle virtually any experimenter-size N-C battery because its charging current can be varied from 20 to 300 ma. And the circuit can be modified to provide up to 1 ampere.

**Construction.** Mount charging-current control R2 on the top of a 6 3/16-inch-wide sloping-panel utility cabinet to keep its heat

away from the meter's plastic case. While a 25-watt rheostat is not required (10 watts will do) the type specified costs little.

Filter capacitor C1 is not normally used in an N-C charger. However, to use a low-cost meter, C1 is necessary. The value specified for C1 provides a *minimum* charging current of 40 ma for a single 1.2-volt battery. If you have an N-C battery which requires less than 40 ma, change C1 to 50 mf. The

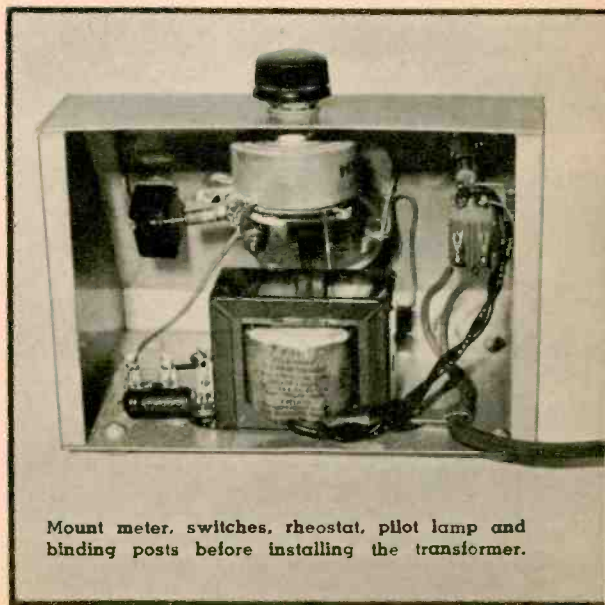

Mount meter, switches, rheostat, pilot lamp and binding posts before installing the transformer.

*Electronics Illustrated*



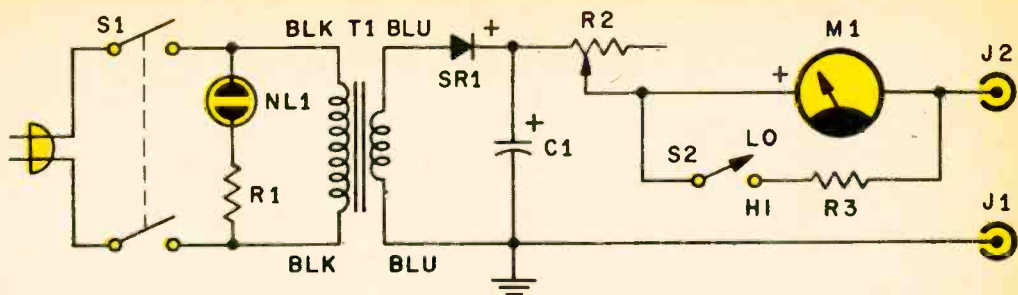

If you want a charging current up to 1 ampere, connect another 500 ma diode in parallel with SR1.

#### PARTS LIST

C1—100 mf, 15 V electrolytic capacitor (see text)  
 J1, J2—5-way binding posts  
 M1—Shurite 150 ma DC milliammeter (no substitution)  
 NL1—NE-2 neon lamp

R1—100,000-ohm, 1/2-watt resistor  
 R2—250-ohm, 25-watt rheostat (Olson Electronics VC-260 49¢ plus postage)  
 R3—4.7-ohm, 1-watt resistor

S1—DPST toggle switch  
 S2—SPST toggle switch  
 SR1—Silicon diode, 50 PIV @ 500 ma or higher  
 T1—12.6-volt filament transformer (Olson T-304)

smaller capacitance produces a lower output voltage, which reduces the charging current to about 20 ma.

For a charging current greater than 150 ma, shunt resistor R3 is used to increase the meter's range to 300 ma. For a 1-ampere charging current, wind a 0.83-ohm resistor for R3 and calibrate the dial accordingly, or use a 1-amp meter.

The battery holder is made from two pieces

of wood approximately 12 inches long, with a slot cut in one almost the full length. Attach a piece of copper or aluminum to one end, as shown in the photo on the first page, for the positive battery terminal. Form a piece of metal into an L-bracket. Pass a screw through the bracket and the slot and secure it with a thumb nut to permit the bracket to be moved along the length of the holder. A

*[Continued on page 113]*

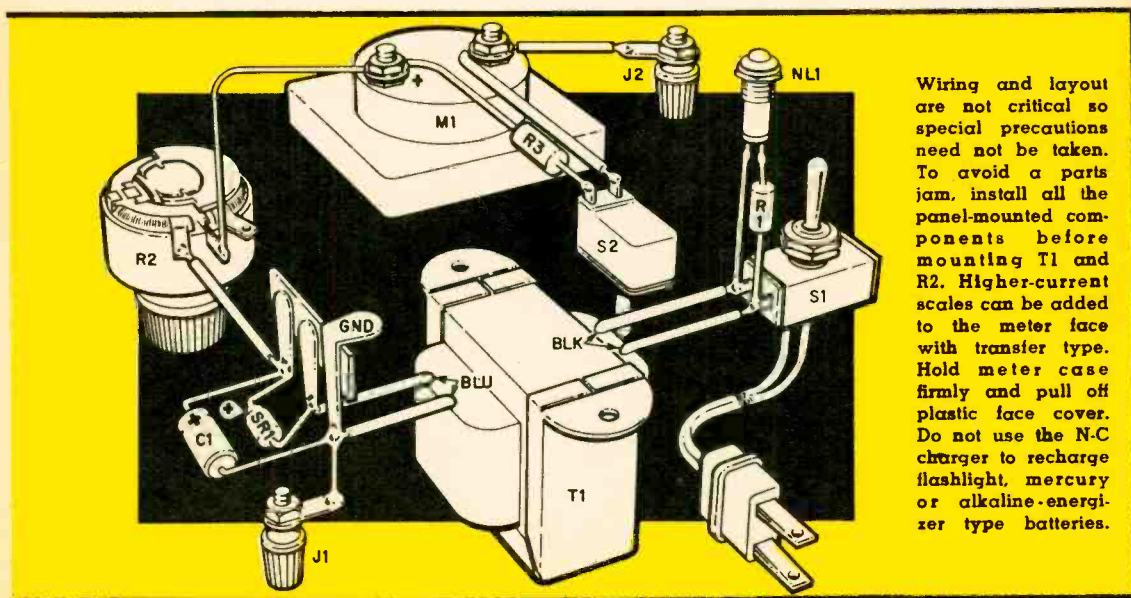

Wiring and layout are not critical so special precautions need not be taken. To avoid a parts jam, install all the panel-mounted components before mounting T1 and R2. Higher-current scales can be added to the meter face with transfer type. Hold meter case firmly and pull off plastic face cover. Do not use the N-C charger to recharge flashlight, mercury or alkaline-energizer type batteries.



# HEADPHONE HI-FI

*Most of us know headphones as the spidery black cans without which no ham or SWL listening post is complete. Invaluable as they are, headphones of this variety are unattractive, uncomfortable and worn of necessity rather than choice. For the audio buff, their frequency response, peaked for greatest intelligibility of the human voice, is totally inadequate. But a new breed of headphones—sleek, soft and stereophonic—is invading the nation's living rooms. And they offer the audiophile a whole new kind of listening enjoyment. Its name? Headphone hi-fi.*

By IVAN BERGER

*Electronics Illustrated*

**M**ODERN stereo headphones had their beginnings in the broadcast industry. And it was all quite simple—in the early days, at least. Broadcasters needed hi-fi reproducers to monitor their signals. Headphones filled the bill. Matter of fact, they were about the only device broadcasters could use. For headphones, by their very nature, precluded any chance of the program being fed back into open microphones.

It wasn't long, however, before studio headphones came to look unlike anything the world had seen. Since broadcast personnel might be required to wear headphones for hours at a time, larger earpieces were added, to surround the ear instead of crushing it. And soft pads, often fabric-covered, led to both a better fit and a tighter seal.

Still other improvements brought greater fidelity, always paramount in the minds of designers. How else could studio technicians judge program quality adequately? In short, headphone development was on its way toward today's excellent models, many of which provide the equivalent of a full-size concert hall in a space about the size of a couple of tea cups.

**Bouquets.** Though modern hi-fi headphones are basically miniature speakers, they can produce far more bass than their size would lead you to believe. A speaker needs a large area or a long throw to reproduce low frequencies, but a headphone needs neither. After all, it has to move only a few cubic inches of air between its diaphragm and the inner ear. A speaker, in contrast, must drive a whole roomful.

Even those headphones capable of producing the fullest bass will sound tinny when held away from the ear. You might say they're almost like tweeters, but full-range and in close. For, like tweeters, these transducers are so small and light that they have precious little inertia. And, again like tweeters, their high-frequency and transient response is likely to be excellent.

Hi-fi headphones have shown themselves to possess several other advantages for the dedicated music listener. Because they promote concentration by shutting out such distractions as children, neighbors and Dr. Kildare, headphones bring you into far more intimate contact with the music. In fact, they enable you to follow every nuance and subtle melodic line more closely than ever before, especially in stereo.

Because they require less power, headphones can be used with smaller, less expensive amplifiers. Further, the amplifiers can operate at lower levels, where many exhibit far less distortion. Headphones also eliminate problems associated with listening-room acoustics. Standing waves, treble reflection or absorption by hard or soft surfaces and like problems disappear. The sound, in short, is strictly between the phones and your ears.

**Brickbats.** But some of these advantages have matching drawbacks. Because they shut out the world so well, headphones also shut out telephones, doorbells and calls to dinner. And the wearer, unable to hear his own voice, just may roar like the bull of Bashan when he thinks he is speaking at a whisper.

If every nuance of the music comes through, so, too, does every crackle of a noisy resistor, every buzz, whistle, hiss or tick that might be swallowed up and ignored in a larger space. The bird-like appetite for power brings its problems. Too much power can burn out phones. Worse yet, hum and noise are far more prominent at the low amplifier levels which phones require. Engineers would say the signal-to-noise ratio suffers.

Another factor on the debit side is that headphones restrict the wearer physically. Their weight, the dangling cord, the pressure on the ears (no matter how slight) take their toll. And some cushions grow clammy on

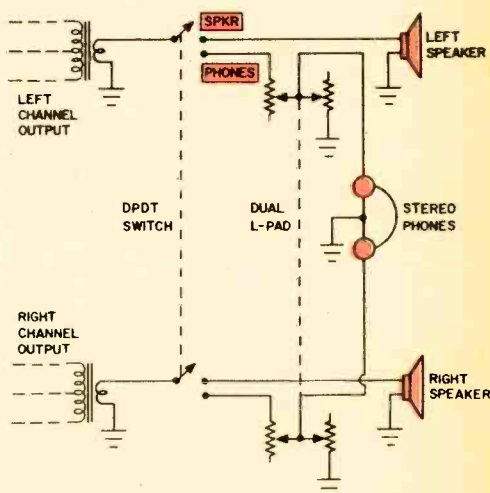

Hooking up headphones isn't complicated, but all impedances must match. Circuit above is for adding phones to a stereo power amplifier; dual L-pad can be a Lafayette VC-49 (8 ohms) or VC-50 (16 ohms).

# HEADPHONE HI-FI

heavy, humid days.

Probably the softest spot in the entire headphone armor is directionality — or the lack of it. Music, after all, is supposed to be of a directional nature. It has to come

from somewhere. And, whether you dig up enough dough for seats that are front-row center or make-do with bargain-balcony back-breakers, you're going to hear an orchestra playing from a particular spot—the front of the concert hall.

But in headphone hi-fi, the sound doesn't seem to come from any direction; it's simply everywhere. And it remains everywhere, regardless of where you sit or how you turn your head. The orchestra, in other words, no longer is where common sense tells you it ought to be. It's strapped to your ears, and it goes everywhere you go.

**Sea of Sound.** Pros and cons aside, it was stereo that brought the headphone boom. For in headphone stereo, the listener finds himself afloat in a vast, sparkling sea of music in which he is able to comprehend the total structure—almost literally—from the inside out. The sound is spectacular and, like most things spectacular, unrealistic. Modern stereo recordings are made with little cross-feed between channels to allow for blending of the two signals in the listening room. Headphones segregate the channels, heightening the effect beyond realism. If you like it, fine. If not, there are two solutions.

The first is nothing more than simple blending, mixing a bit of the left channel into the right and vice versa. This can be done either with your preamplifier's blend (separation) control or by means of a simple network you can build yourself. The end effect is to draw the sound in closer to your head. You're still swimming; it's just that the pool has shrunk.

The second solution is to add a device such as the Jensen CC-1 Space Perspective control center. This imparts a slight time delay and a frequency-selective phase shift to the blended signals, approximating the various effects stereo signals are prone to in a listening room.

**Hooking Them Up.** Connecting stereo headphones is easy. Most phones are packed with a three-conductor jack and a resistive network which acts as a pad. This lessens the

danger of over-driving, while allowing you, the listener, to bring up the signal above the amplifier's hum level.

Most headphone manufacturers also offer optional junction boxes. These frequently contain switches to turn speakers on and off, volume or balance controls to govern headset level and so on. In some cases, they even include fuses to protect the phones.

For those who wish to avoid an amplifier entirely, most headphones are available in high-impedance versions. These models can be driven directly from the output of a pre-amp, tuner or tape deck. Transformers also are available to match low-impedance lines; these include the peanut-size AKG U-50 transformer (two needed for stereo); the Koss T-1 junction box, with transformers for both channels and jacks for two pairs of phones; and the compact R-Columbia #80 converter plug, which contains two matching transformers in a compact brass barrel (there's a stereophone plug at one end, a stereophone jack at the other).

But any hobbyist willing to give a little time and effort can hook up headphones without such accessories. The basic wherewithal are a double-pole, double-throw switch and a stereo L-pad. Connect them as shown in our diagram and you're ready for headphone hi-fi. Though this hookup is quite adequate for most installations, the imaginative do-it-yourselfer can add such refinements as fuses and extra phone jacks.

When shopping for phones, listen carefully to several, preferably while playing a record you already are familiar with. It might even be worth your while to bring a favorite record along to your dealer's, just to be on the safe side. Like speakers, every headphone has its own personality. But with headphones you don't have to compensate for the differences between showroom acoustics and those in your home. The sound you hear in the headphones is *their* sound, though the associated equipment always is in the picture.

EI assembled a Test Panel to check out 19 different stereo headphones. The panel's findings are shown at right. As is the case with virtually all sound reproducing equipment, judging headphones tends to be subjective. Thus, various members of our panel disagreed on the quality of specific phones. However, an average of the grades assigned to the headphones tested clearly indicates the consensus of the panel. ●

## HOW EI's TEST PANEL RATED 19 POPULAR STEREO HEADPHONES

Rank	Make	Model	Rating <sup>1</sup>	Range	Price	Weight	Comments <sup>2</sup>
1	AKG	K50	78.6	60-100	\$23.50	3.8 oz.	"Lightest." "Easily adjustable." "Most efficient." "Must press on ears for fullest bass."
2	Lafayette	F-767	74.6	60-80	11.88	10.5 oz.	"Very comfortable." "Good over-all sound." "Hot." "Hissy, but balance good." "Excellent seal."
3	David Clark	100	74.5	54-100	39.50	13 oz.	
4	Koss	PRO-4	70.2	50-80	44.10	18.5 oz.	"Heavy." "Ear pressure hurts my jaw." "Low efficiency." "Very comfortable, good seal."
5	Roanwell	100700	68.2	40-100	37.50	11 oz.	"Earphones may hurt, but sound fairly good." "Just a little too tight around the ears." "Excellent, uncolored reproduction." "Cushion material gets sweaty."
6	Telex	ST-10	66.0	54-66	24.40	9.5 oz.	"Good tone."
7	Permoflux	HDB-16/16	65.8	60-100	40.00	17 oz.	"Sound you can live with." "Uncomfortable with glasses." "Bright, but fine definition."
8	Permoflux	BDHS-28	65.3	60-86	45.00	17 oz.	"Should have more padding." "Clamped too hard." "Too bassy."
9	Superex	ST-M	64.7	60-90	29.95	15.5 oz.	"High frequency control useful to eliminate scratch, hiss." "Too heavy." "Low on bass."
10	Sharpe	HA-8	62.3	60-86	24.50	13 oz.	"Good for extended listening, but lowest bass lacking."
11	Telex	HDP-53A	61.7	60-86	27.95	12.5 oz.	"Irregular ear-seal." "Fairly good sound, comfortable." "Clammy."
12	Koss	SP-3	61.5	20-80	24.95	13 oz.	"Too hollow." "Bright." "Muddy." "Bass too heavy, muddies entire range."
13	Pioneer	SE-1	60.7	40-86	19.95	12 oz.	"Very hollow sounding." "Not bad, but definitely hard on cheekbones." "Very comfortable."
14	Permoflux	BHL-16	60.2	40-100	31.50	16 oz.	"Not enough bass." "A must, regardless of cost." "Entirely too bright—a 'demonstration' sound." "Cushions are too stiff."
15	Superex	ST-S	59.6	60-80	24.95	12.5 oz.	"Well constructed." "No presence." "Hissy."
16	Sharpe	HA-10	55.6	40-80	43.50	14.5 oz.	"Jazzy, but weak on bass." "Somewhat uncomfortable." "Very comfortable, good seal." "Bright and sassy, clean sound."
17	Jensen	HS-1	55.6	40-80	24.95	14 oz.	"Hangs too heavily, too hot." "Poor fitting." "Too loose, clammy."
18	Olson	PH-46	51.3	40-70	12.97	15 oz.	"Hollow, but moderately clean." "Good overall." "Far from living realism." "Stiff cushion."
19	Knight	KN-845	50.0	10-80	19.95	13 oz.	"Distortion, muddy." "Earpiece too hard." "Muffled, but still hissy."

### NOTES:

1. This figure is an average of the Test Panel's ratings for ear comfort; headband comfort; treble, mid-range and bass response and overall sound. Panelists used a zero-to-100 rating system.
2. These figures are the minimum and maximum ratings given by members of the Test Panel for "overall sound." Panelists used a zero-to-100 rating system, as in preceding column.
3. Comments by all Test Panel members have been included here, so some may be contradictory.

# What's a **Q**-Multiplier, anyway?

**S**IMPLE—a device that multiplies  $Q$ ! But what is this thing called  $Q$ ? And how can  $Q$  be multiplied? Fact is, the concept of  $Q$  is not easily explained, but it's easy as pie to demonstrate. To get to know Mr.  $Q$ , what say we go over a simple experiment?

To conduct our experiment, we first connect a capacitor in parallel with a coil to form a parallel-resonant circuit. Next, we connect this circuit in series with an AC milliammeter to a signal generator. When we vary the generator's frequency and plot frequency vs current, *voilà*—the curve looks like the dotted line here except that it is turned upside down. The vertical center line ( $f_r$ ) corresponds to the circuit's resonant frequency, which is determined by the values of the capacitor and coil. The shape of the curve depends on the ratio of the coil's DC resistance to its reactance.

And now we have  $Q$ —the coil's reactance divided by its resistance—another way of expressing the shape of the curve. If the resistance of the coil is high compared to its reactance,  $Q$  is low and the curve is both broad and low. Conversely, if the coil's DC resistance is low,  $Q$  is high and the curve is both narrow and high: low  $Q$ , low curve; high  $Q$ , high curve.

Now let's put  $Q$  to use. Your CB rig's

IF transformers, with their small built-in capacitors, are parallel-resonant circuits, too. The width of their response curve, or their  $Q$ , has a pronounced effect on the receiver's selectivity. A low  $Q$  results in adjacent-channel interference. A high  $Q$  reduces adjacent-channel interference. The hard way to improve the  $Q$  of a receiver's IF's would be to rip them out and install new ones with high- $Q$  coils. But a  $Q$ -multiplier does the job much more easily.

Take a look at the schematic of a  $Q$ -multiplier at the right. This circuit could be an oscillator; it's not allowed to oscillate, though.

If sensitivity control  $R_5$  is set to its maximum-resistance position, the circuit's gain is too low for the circuit to break into oscillation. Turn  $R_5$  the other way and the gain of the circuit rises. Just before you reach the point of oscillation, the *apparent*  $Q$  of the

whole circuit (looking in at  $J_1$ ) goes sky high. In operation,  $R_5$  is always kept below this critical point, depending on the degree of selectivity you want the receiver to have.

Connect the  $Q$ -multiplier to the IF strip at the plate of the mixer tube, and the overall  $Q$  of the IF strip becomes predominantly that of the  $Q$ -multiplier.

The  $Q$ -multiplier we have discussed simulates a *parallel-resonant* circuit.

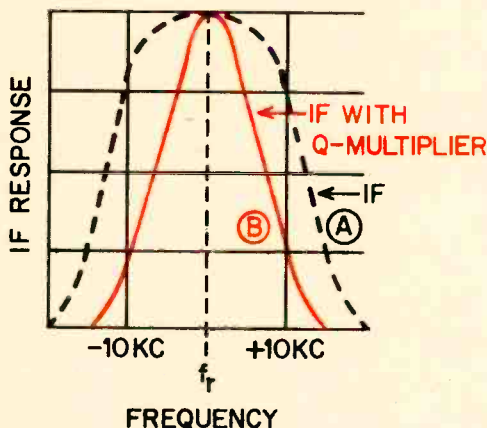

Receiver IF selectivity curves without (A) and with (B) a  $Q$ -multiplier. Upside down the curves represent the impedance of a low- $Q$  (A) and high- $Q$  (B) parallel-resonant circuit versus frequency.

But a Q-multiplier also can be designed to simulate a *series-resonant* circuit. This type of Q-multiplier, when connected to a receiver, will insert a narrow vertical notch in the receiver's selectivity curve without changing the curve's shape. By changing the Q-multiplier's operating frequency the notch can be located anywhere in the receiver's selectivity curve (IF pass-band). The notch's width is changed by varying the amount of the Q-multiplier's regeneration.

What does a series-resonant Q-multiplier get you? It attenuates or "notches out" an interfering signal without degrading the signal you want to hear. This feature is mighty useful when you're trying to listen to a weak signal and there is a strong signal just a few kilocycles away. By centering the notch right over the interfering signal, you effectively remove it.

Q-multipliers can be adjusted to pro-

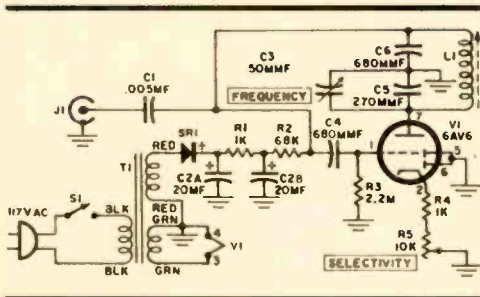

duce sharp peaking or notching. For phone reception use just a slight amount of peaking or speech will be almost completely unintelligible. When there is a heterodyne, use the notch to remove it.

Considering that you can build a home-brew (see HIKE THAT Q, March '64 EI) or kit Q-multiplier for \$20 or less, there's no reason for you to suffer with ten layers of QRM.

While you're waiting to trade up to a high-priced receiver that has greater selectivity, you can use an outboard Q-multiplier. Connecting it to most rigs isn't a big undertaking.

And you'll be surprised at how it will turn a budget job into a big leaguer in performance.



## The Crack in the Wall

IT'S a true story—the one about the surgeon who carried one of those pocket-size paging devices into the operating room. The thing suddenly went off with a strident tone and the doc dropped his scalpel. Then, after he finally got hold of the nearest phone, he found out the call wasn't for him, after all. Couple of doctor friends of ours swear by the tale.

Not long ago we had our own bit of infighting with a telephone-extension device. Only this one was different. The old-fashioned type just beeped to tell you there was a call for you. Then you rang the operator. The beeper we got introduced to, it was said, amounted to a real wireless extension of Mr. Bell's brainchild. If you get a call and happen to have this little wonder in your pocket, you simply take it out and start talking. A really mobile telephone. And it is designed to work up to 25 miles from home base—that being the instrument on your night table, or perhaps in your workshop, as the phone company would like to imagine.

The call inviting us to come and see the gadget—no larger than a pack of cigarettes—rattled in on our old-fashioned office phone from The Chromalloy Corp., down in lower Manhattan. We made our way to the storied canyons of Wall Street and were met at the door by a gentleman who happened to be wearing one of his company's products in his pocket. While we were asking some preliminary questions (and getting cryptic answers with words like *duplexing* dropped in), we heard a buzzing ring-tone. In a flash the chap pulled up the gadget's whip antenna, pressed a button and answered the phone—which happened to be a hundred feet or so away. Impressive.

We next investigated the equipment hooked to the telephone itself. The handset had been removed and placed in a box-like holder resembling one of those telephone voice amplifiers. A small arm extended from the mystery box to hold down the two buttons on the phone that normally are depressed by the handset.

[Continued on page 113]

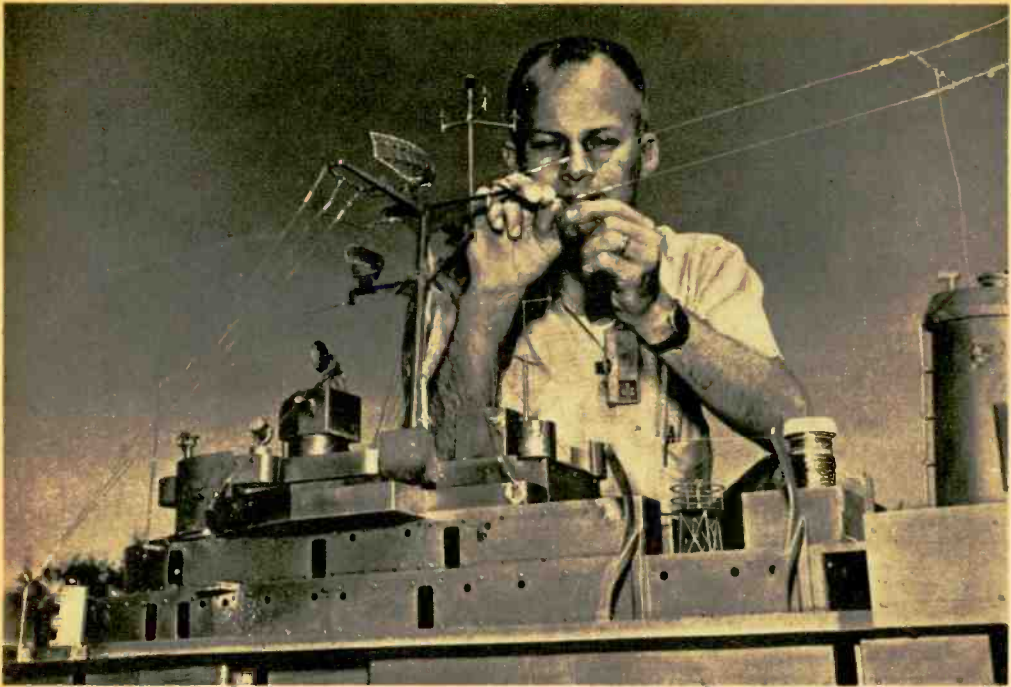

## HALF-PINT ANTENNA LAB

**T**HE BOYS down the block would have a sailor's picnic in San Diego—if they like ships, that is. For a Lilliputian lab in that sunny city offers everything from a cruiser to a carrier, all meticulously constructed to 1/48 scale and built to sail a lead-coated, asphalt ocean. Thing is, the ships were made for bigger boys. They're part of the U. S. Navy's Electronics Laboratory, and they're playing an important role in the Navy's continuous testing of ship-board antenna systems.

Since it was impossible to test ship-board antennas unless the vessels actually were on the high seas, the Navy decided to duplicate these conditions as closely as possible in a highly workable, scaled-down version. And this they did, in what looks like an immense outdoor playground.

The lead coating gives the lab's 160-ft. diameter ocean a conductivity very much like that of sea water. As a result, it affects radio waves in much the

same way that sea water does. And, since the ships are mounted on a 22-ft. diameter turntable, they easily can be rotated to check out most any antenna pickup pattern.

During an actual experiment, each model antenna is connected to a remote receiver, and its response to specially calibrated transmissions is charted in a monitoring room. As the turntable rotates, signal strength is recorded for each orientation of the ship. In this way, obtaining antenna response patterns for a given frequency takes only a few seconds. And modifications to an antenna take only a few seconds, too.

Though the models cost some \$5,000 to \$10,000 apiece, the Navy feels they're well worth it. Experimentation with the toy fleet already has led to scores of improvements. Someday, the Lilliputian lab may help the Navy clear up still another problem: how to unfailingly detect missiles fired from points thousands of miles away.





Accuracy is uppermost in the minds of the men who design these scale model ships, since accuracy of the models has much to do with the accuracy of the final data obtained. Ships cost up to \$10,000 each.



Modifying a shipboard antenna used to be an expensive, time-consuming operation, but the Navy's antenna lab makes it easy as 1, 2, 3. A few seconds and a soldering iron are all it takes these days.



Technician Leo P. Wilbert sits at the control console of the half-pint antenna lab. Model ship in man-made ocean rests on a revolving turntable, enabling pickup patterns to be charted for most any angle.

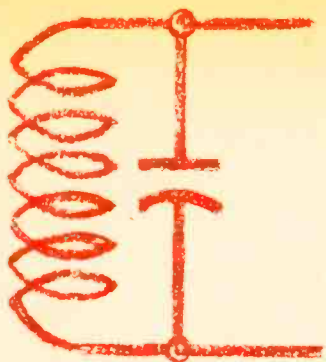

# DIPPER

*Without doubt the most useful station accessory for receiver, transmitter and antenna-system tune-ups.*

By LEN BUCKWALTER, KBA4480

ANY CBer who knows his S numbers will tell you that a grid-dip meter (GDM), or dipper, is one of the handiest accessories to have around for getting top performance from a Citizens Band transceiver and antenna.

A first cousin to the vacuum-tube GDM, EI's CB Dipper is transistorized so it doesn't have the word *grid* in its name. But it performs the same basic functions—tuned-circuit checker, signal generator and field-strength meter. At the flick of a switch, the Dipper will either *give you* an RF signal or *tell you* the relative strength of an existing one. The Dipper can be used to check RF and IF stages in a receiver and to tune up and troubleshoot a transmitter or antenna system. (See HOW TO USE THE GRID-DIP OSCILLATOR, Sept. '63 EI.)

If you wonder what the word *dip* means, it refers to the meter's behavior during certain tests. Suppose you want to determine whether a tuned circuit in a transceiver is resonant within the CB band. Set switch S1 to *OSC* and bring the Dipper near the coil. If the coil is all right—not shorted or otherwise defective—the meter needle will dip or fall to the low end of M1's scale as tuning control C1 is turned. The reason for the dip is that the coil being checked absorbs energy from oscillator coil L1. A dip won't occur unless the resonant frequency of the circuit being checked is the same as the frequency of the signal from the Dipper.

To determine whether an RF signal is present when checking a transmitter or tuning an antenna, set S1 to *REC*. This converts the Dipper to a field-strength meter by disabling the oscillator (Q1) and feeding the received signal to diode detector D1 and meter amplifier Q2. Construction details are covered in the captions.

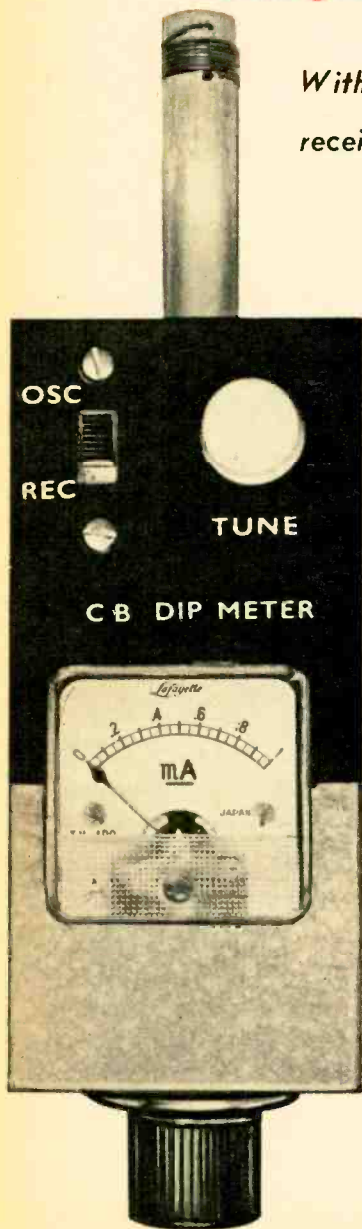

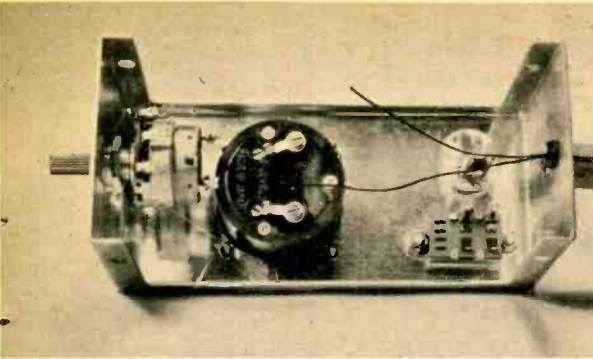

Before mounting parts on circuit board, mount R4, M1, S1 and C1 in main section of a 2 1/4 x 2 1/4 x 5-inch Minibox. The 3 3/4 x 2-inch piece of perforated board (with cutout for C1) is held in place by meter terminal screws. Heavy buss wire from case of R4 to meter terminal holds the battery in place.

When S1 is set to REC, Q1 is disabled, signal from L1 is demodulated by D1 and Dipper will function as a field-strength meter.

### PARTS LIST

- B1—9-volt battery
- C1—2.3-14.2 mmf miniature variable capacitor (E. F. Johnson 160-007, Allied Industrial catalog No. 13 L 760. \$1 plus postage.)
- C2—2-30 mmf trimmer capacitor
- C3, C6—.01 mf ceramic disc capacitor
- C4—7.5 mmf ceramic disc capacitor
- C5—30 mmf ceramic disc capacitor
- D1—1N34A diode
- L1—Coil, 9 turns No. 26 enameled wire on 1/2-inch-diameter dowel (see text)
- M1—0-1 ma DC milliammeter
- Q1—2N371 transistor
- Q2—GE-2 transistor (General Electric)
- R1, R5—22,000-ohm, 1/2-watt, 10% resistor
- R2, R3—3,300-ohm, 1/2-watt, 10% resistor
- R4—500,000-ohm potentiometer
- S1—SPST slide switch
- S2—SPST switch on R4
- Misc.—2 1/4 x 2 1/4 x 5-inch Minibox, 2 x 3 3/4-inch piece of perforated board, knobs, grommets

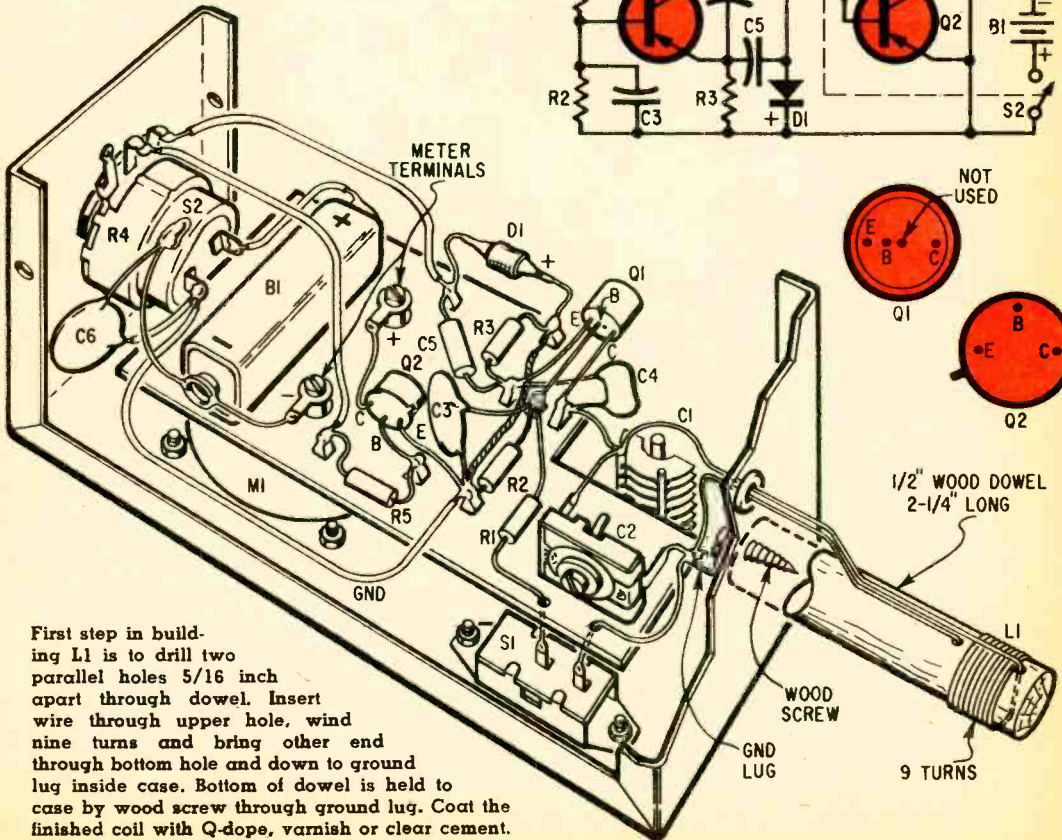
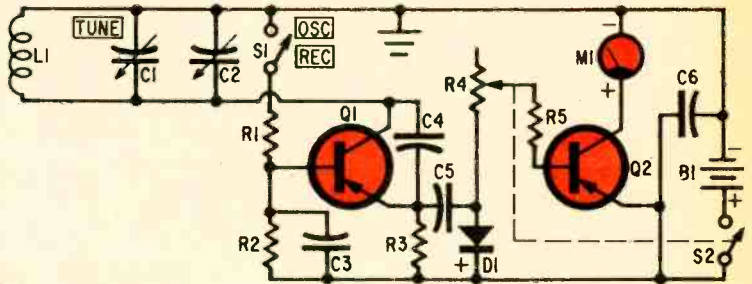

First step in building L1 is to drill two parallel holes 5/16 inch apart through dowel. Insert wire through upper hole, wind nine turns and bring other end through bottom hole and down to ground lug inside case. Bottom of dowel is held to case by wood screw through ground lug. Coat the finished coil with Q-dope, varnish or clear cement.

# DIPPER

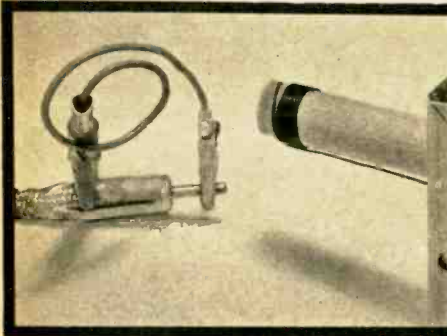
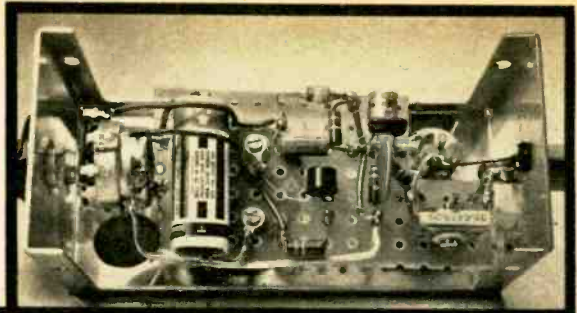

After M1, C1, S1, R4 and dowel have been installed in case, solder two leads to S1, then fit perforated board over M1's contact lugs. Leads from S1 pass through holes in board. Using flea clips for the points, install all other parts on the board.

To check the resonance of your antenna's feed line, form a small loop with heavy hookup wire and install an alligator clip on each end. Connect one clip to the shield and the other to the hot lead. Bring L1 within one or two inches of loop and tune for dip.

## Tuning Up the Dipper

With the Minibox cover in place, set S1 to *OSC* and then turn control R4 until the meter indicates full scale. If the Dipper is working properly, touching coil L1 should cause the needle to drop sharply. Set S1 to *REC*: the meter needle should fall almost to zero, regardless of R4's setting.

Set S1 to *OSC* and turn tuning control C1 so its plates are half meshed. Now tune your CB receiver to channel 5 or 6. With a *non-metallic* alignment tool, slowly turn the screw on trimmer capacitor C2. At one point in C2's adjustment you'll hear a strong hiss that quiets receiver noise and causes the S-meter needle to rise. When you tune the CB receiver from channel 1 to 23, you should be able to follow along with C1. To spread the Citizens Band over 180 degrees of rotation of C1, carefully remove one movable plate at a time from C1 until the signals spread out. In our model we removed six of the eight plates. Each time you remove a plate, check the tuning of the Dipper by tuning the receiver across the band.

This modification to C1 makes the Dipper's tuning range somewhat broader than the 23-channel range of the receiver. Channels 1 to 23 can now be covered in less than a half turn of C1. It is perfectly normal for the Dipper's signal to be heard in the receiver

twice during one complete rotation of C1.

## Using the Dipper

When using the unit as a dipper, set S1 to *OSC* and adjust R4 for any convenient meter indication about half to three-quarters up M1's scale. Actual scale position is unimportant, but one precaution should be taken when S1 is in the *REC* position. Since the meter is quite sensitive and can be driven off scale when you're too near a 5-watt transmitter, set the needle near the low end or middle of the scale with R4.

When making dip checks, turn off the CB rig. To determine if a coil in the set is resonant in the band, set S1 to *OSC*. Bring coil L1 near the coil to be checked and turn C1 for a dip. In general, the most pronounced dip will occur when the two coils are lined up end to end about a half-inch apart. To check an antenna for proper resonance, clip a two-turn coil to the antenna plug, as shown in the photo, and turn C1 for a dip.

Put S1 in the *OSC* position when the Dipper is to be used as a signal generator. To align a CB receiver, just place the Dipper a few feet away from the antenna jack on the transceiver.

When S1 is in the *REC* position, the Dipper becomes a field-strength meter. Tune in

[Continued on page 117]



# GOOD READING

By Tim Cartwright

**A HISTORY OF ELECTRICITY.** By Edward Tatnall Canby. Hawthorn Books, New York. 111 pages. \$5.95

Here is a book many people will want to buy, even though they may know its subject matter backwards and forwards. To my mind, the book, which was printed (beautifully) in Switzerland, is a delight because of its superb production and outstanding illustrations. Our illustration, taken from the book, is but one example. And Mr. Canby's easy, informal dealings with the history of electricity may well provide many laymen with the kind of introduction to electrical theory they've long been looking for.

As it should, the book begins with the story of how men tried to cope with and understand an invisible, intangible force in nature thousands of years ago. Gradually, of course, they learned to explain and classify its mysterious workings, as the book recalls. In time, this understanding enabled men to harness electricity and led to the applications we know today.

This book recounts all, in a style that is easy, free-flowing and anything but stuffy. If later additions to Hawthorn's New Illustrated Library of Science are as good as this volume, the series promises to be excellent fare for anyone who is interested in learning more of the world around him.

**BASIC ELECTRONIC TEST INSTRUMENTS.** By Rufus P. Turner. Holt, Rinehart and Winston, New York. 297 pages. \$8.95

This is no ABC's of . . . book intended to introduce the workings of test instruments, but a comprehensive coverage of the subject.

True, its professorial style makes for hard going at some points. But the book probably is the best overall reference now available on the subject and it can be consulted for information left out of many more popular books. Tables and illustrations are both comprehensive and clear.

**SCIENCE PROJECTS IN ELECTRONICS.** By Edward M. Noll. Howard W. Sams & Bobbs-Merrill, New York & Indianapolis. 144 pages. \$2.95

The problem with most learn-by-doing books about electronics is that their projects either are too rudimentary (you can read them and learn as much as you would by doing the experiments) or not educational (you wind up with a useful gadget, but one you don't understand very well).

This book succeeds in steering a nice middle course. Most of the projects are simple but interesting and instructive. And the completed gadgets—an audio oscillator, a wireless microphone and a record player, to name three—are items you actually can do something with.

**MAGNETIC RECORDING FOR THE HOBBYIST.** By Arthur Zuckerman. Howard W. Sams & Bobbs-Merrill, New York & Indianapolis. 128 pages. \$2.50

Though there are millions of tape machines in homes

across the country, few people get all the use and pleasure out of tape that they might. This book covers just about everything you can do with a recorder. In fact, it offers good, down-to-earth advice on most every tape stunt from making movie and slide-show sound tracks to supplying your own sound ef-

*(Continued on page 114)*

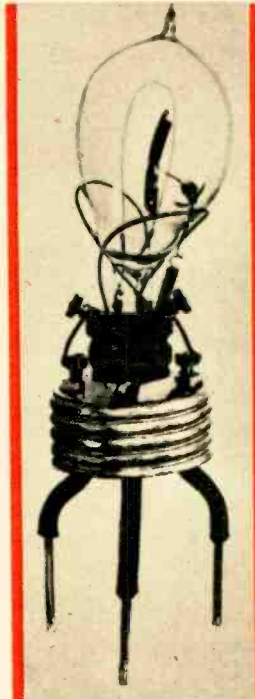

Everyone has heard of the Edison Effect, but few people have any idea of what that early vacuum tube might have looked like. Plate connection was taken from side.

# Tape Fan's Load Box

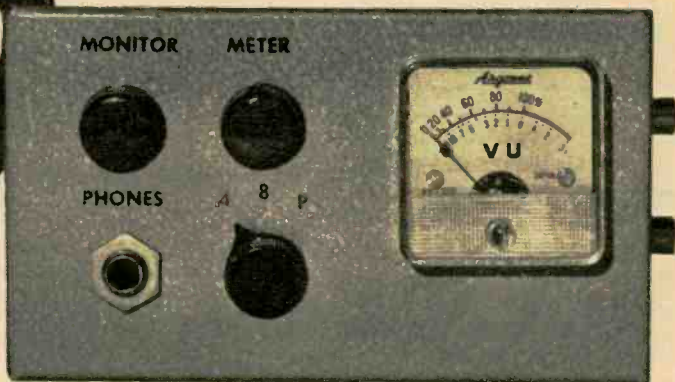
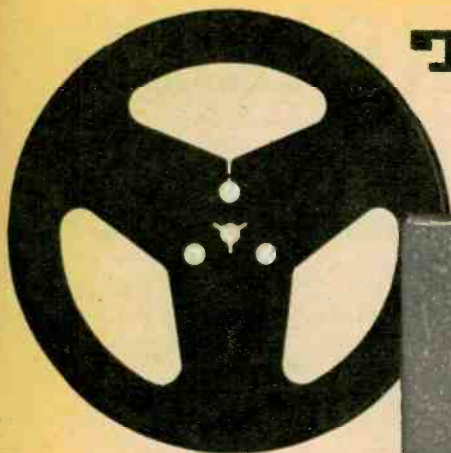

By  
**LAWRENCE GLENN**

**Q**UIKKEST way to turn success into disappointment when dubbing tapes and records or making off-the-air recordings is to have a rat's-nest of interconnecting cables and unprofessional level changes. But connect our Tape Fan's Load Box to a budget tape recorder and you'll have signal control that's as tight as you'd get with an expensive semi-professional tape recorder.

The load box enables you to record the right way from the speaker output of another tape recorder, radio or amplifier by substituting a resistive load for the disconnected speaker. And while the recording is in process you'll be able to monitor the signal level on the built-in VU meter or with a pair of headphones.

**Construction.** Our load box was built in the main section of a 5¼x3x2½-inch Minibox. The layout of parts and wiring are not critical so make any changes you want. The 1½-inch hole for M1 can be cut with a standard chassis punch.

R1, a 3-ohm, 10-watt wirewound resistor is the load for 3.2- or 4-ohm program-source outputs. The load for 6- or 8-ohm outputs is R2, a 7.5-ohm, 10-watt wirewound resistor. If you require a 16-ohm load, connect a 16-ohm resistor to one of S1's unused lugs.

Load resistors are directly below VU meter. One side of meter and resistors connect to ground lug under meter mounting screw at left. Switch used for S1 in our model has extra pole (six lugs at top) which isn't used. Straightforward wiring should not give you any problems.

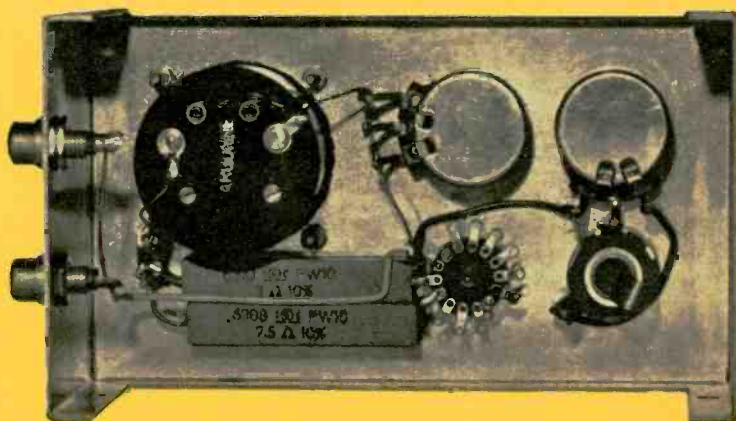

### PARTS LIST

- R1—3-ohm, 10-watt resistor  
(IRC PW-10, Allied 1 MM 190)
- R2—7.5-ohm, 10-watt resistor  
(Same IRC and Allied Nos.)
- R3—2,500-ohm, audio-taper  
pot
- R4—100,000-ohm, linear-taper  
pot
- M1—VU meter (Lafayette  
TM-10)
- S1—2-pole, 5-position rotary  
switch (Lafayette SW-78)
- J1, J2—Phono jack
- J3—Phone jack

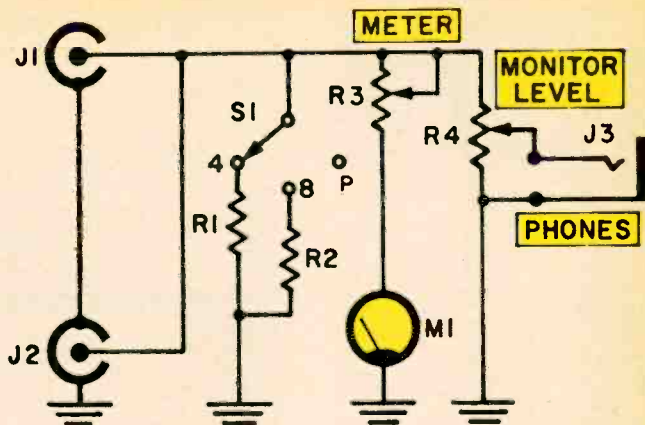

If speaker is not disconnected when patch cord is plugged into program source, set S1 to P to disconnect load resistors. If program-source impedance and phones are 8 ohms, set S1 to P otherwise load on amplifier will be incorrect.

**Using the Load Box.** Remember that you really make the best recordings and dubbings when the signal is taken from the voltage-amplifier output of a tape recorder or radio. Only when there is no such output should the signal be taken from the speaker terminals.

Connect the speaker output of the program source to J1 and connect the low-gain input on the tape recorder to J2. Set S1 to match the impedance of the speaker in the program source. If the speaker is *not* disconnected when you plug in your patch cord, set S1 to position P.

Adjust the gain control on the recorder for maximum recording level, indicated by the neon lamp or magic-eye tube. Then adjust R3 so M1 indicates zero VU, or 100 per cent, on program-level peaks. To maintain a constant recording level always adjust the level control at the program source so M1 indicates zero VU on peaks.

To monitor the recording, plug high-impedance headphones in J3 and adjust the phone volume with R4. If the impedance of the phones is 6-8 ohms, you still can use them for monitoring without loading the program source's output by keeping R4 below three-quarters clockwise rotation (the volume probably will be low but still useful).

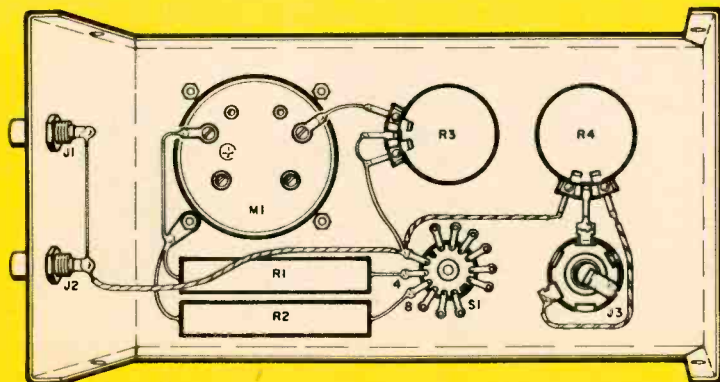

You can use the load box to terminate the output of your hi-fi amplifier when you want to listen with high-impedance phones. Connect J1 or J2, instead of speaker, to amplifier's output. Set S1 for correct load resistance and forget about phones' impedance not matching impedance of amplifier.



*Two tubes give you 20-200,000 cycles in fixed steps at low distortion.*

By **HERB FRIEDMAN, W2ZLF** **T**HE audio generator never could win a popularity poll. On lists of recommended test equipment it always is destined for the bottom. Yet the poor-relation beeper does have a great many uses and it's an absolute *must* for the audio experimenter. You simply can't make meaningful gain and frequency-response measurements on a hi-fi amplifier or system by ear. An audio generator is required.

EI's 6X Audio Generator is designed for maximum usefulness to the audio experimenter and just might—because of its low cost—add a little to the instrument's popularity. You can build the 6X for about \$25. To minimize calibration problems, the generator was built to produce 24 switch-selected frequencies from 20 cycles to 200 kc. It has basic frequencies of 20, 30, 50, 75, 100 and 150 cps that are multiplied by 10, 100 and 1,000.

The generator is to be used with high-input impedance circuits commonly found in hi-fi equipment. A variable output-level control and a stepped attenuator provide output voltages of 3, 0.3, .03, and 0.003 rms volts at less than 0.4 per cent distortion. If you set up the generator to provide a 1-volt maximum output, distortion will be less than .25%.

A VU meter in the output circuit permits you to make precise changes in the output voltage for amplifier gain and response checks.

**Construction.** While 5 per cent capacitors give adequate performance at low cost, trimming or paralleling them, as we'll explain later, will result in still lower distortion and an output level that is almost constant at all frequencies.

The normal output-voltage variation with 5 per cent capacitors is  $\pm 2.5$ db. Five per

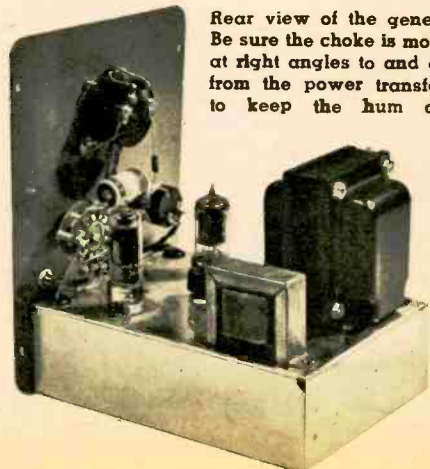

Rear view of the generator. Be sure the choke is mounted at right angles to and away from the power transformer to keep the hum down.



Generator schematic. Oscillator is a Wien bridge whose fundamental frequencies are selected by S2. Frequencies are multiplied by S1. For 1- or 3-volt outputs at J1 an external calibrating meter is not required; unit is self-calibrating. That is, you merely set R20 to its lowest-resistance position and adjust R9 for an indication of 100 per cent on M1. The value of R21 determines whether the meter indicates 100 per cent at a 1- or 3-volt output. Optional output at J2 is 10 V at less than .25% distortion.

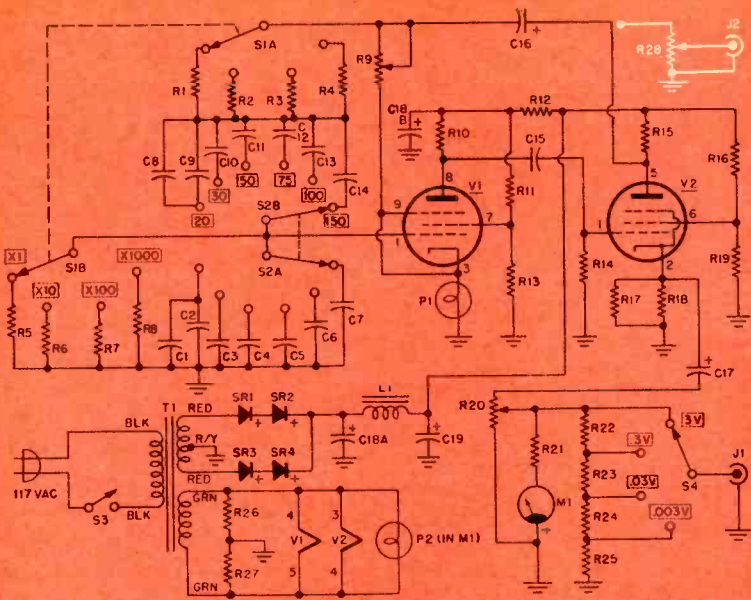

**PARTS LIST**

**Capacitors:** Silver mica, Arco type DM-15 unless otherwise indicated.

- C1, C8—360 mmf
- C2, C9—24 mmf
- C3, C10—250 mmf
- C4, C11—150 mmf
- C5, C12—91 mmf
- C6, C13—68 mmf
- C7, C14—39 mmf
- C15—22 mf, 400 V tubular
- C16—8 mf, 450 V electrolytic
- C17—25 mf, 25 V electrolytic
- C18A, C18B—Dual 20 mf, 450 V electrolytic
- C19—20 mf, 450 V electrolytic
- J1, J2—Phono jack (see text)
- L1—Choke: 8.5 henries, 50 ma (Allied Radio 62 G 136)
- M1—VU meter (Allied Radio type 38, \$5.95 plus postage. Not listed in catalog.)

P1—110-volt, 3-watt candelabra lamp type 3S6 (see text)

**Resistors:** 1/2-watt, 10% unless otherwise indicated.

- R1, R5—20 megohms, 1%
- R2, R6—2 megohms, 1%
- R3, R7—200,000 ohms, 1%
- R4, R8—20,000 ohms, 1%
- R9—5,000-ohm, linear-taper pot
- R10—47,000 ohms
- R11—100,000 ohms
- R12—10,000 ohms
- R13—68,000 ohms
- R14—470,000 ohms
- R15—7,000 ohms, 10 watts
- R16—10,000 ohms, 1 watt
- R17, R18—820 ohms, 1 watt
- R19—27,000 ohms
- R20—20,000-ohm, linear-taper pot
- R21—See text

- R22—4,700 ohms, 5%
- R23—470 ohms, 5%
- R24—47 ohms, 5%
- R25—4.7 ohms, 5%
- R26, R27—68 ohms
- R28—100,000-ohm, audio-taper pot
- S1, S2—2-pole, 6-position rotary switch (Mallory 3226J)
- S3—Switch on R20
- S4—Single-pole, 5-position rotary switch (see text)
- SR1-SR4—Silicon diode, 750 ma, 400 PIV (Allied Radio 39 A 912-D)
- T1—Power transformer: 460 V center tapped @ 50 ma, 6.3 V @ 2.5 A (Allied Radio 61 G 461)
- V1—5879 tube V2—6AR5 tube

cent capacitors also provide relatively good frequency accuracy. For example, the 1-kc output of our model actually runs to about 950 cps and 15 kc is about 14.5 kc. For more exact frequencies, the capacitors can be trimmed using an external frequency reference and an oscilloscope. Above 20 kc, accuracy falls off somewhat. For example, 20 cycles does not multiply to 200 kc. Instead, the output is about 180 kc—quite acceptable for hobby-experimenter work.

Our model is built on a 7x5x2-inch chassis.

Don't use a chassis ground for one side of the filament circuit. Make twisted pairs of the two filament leads from each tube and also of the leads to the VU meter lamps. Be sure to run the leads to the VU meter lamps as shown in the pictorial.

Output-attenuator switch S4 has extra lugs which were used as tie points, but a terminal strip can be used instead.

Frequency-multiplier resistors R1-R8 must be 1 per centers. However, if R1 and R5 are not readily available in this tolerance,

# AUDIO GENERATOR



Underside of the chassis is tight, so start by wiring switches and terminal strips near tubes. Use our layout and you should have no problems.

5 per cent resistors will do a satisfactory job.

You can build the generator to produce any output frequency you need by adding to or changing the basic-frequency positions on S2, substituting other capacitors for the values we have indicated.

If you require 800 or 8,000 cps, for instance, provide a position on S2 for 80 cps. S1 will multiply this to 800, 8,000 or 80,000 cps. To add a frequency, add two capacitors of the same value, one to S2A and one to S2B. The capacitor value in micromicrofarads can be determined with this formula:  $C = (7950/F) - 13$ . F is the frequency in cps you want and C represents capacitance. For example, the capacitor value for 80 cps is  $C = (7950/80) - 13$ , which comes out to 86.3 mmf. Since 86.3 mmf isn't a standard value, use the closest *smaller* value or, better yet, parallel two capacitors to obtain 85 mmf.

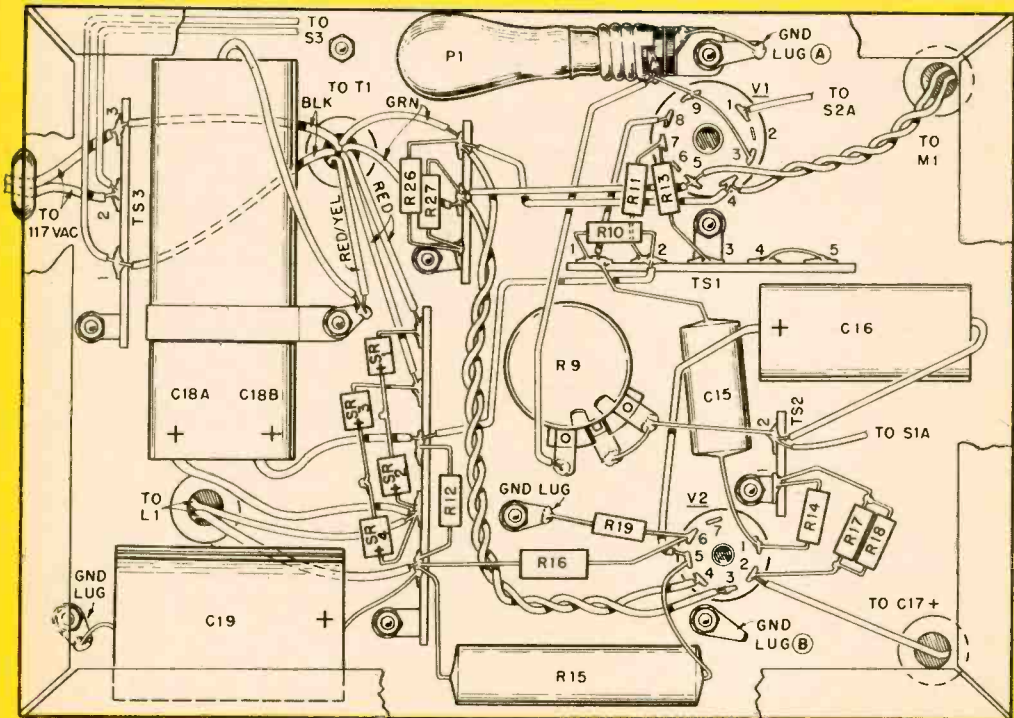

Underside of chassis is shown here. The selector switches on front panel appear at right. Attach panel to chassis (our cabinet and panel are Bud WA-1540) and wire the switches and filaments first.

(Our formula departs from the standard formula since it takes into account the distributed capacity of the wiring and tube capacity of 13 mmf. Failure to allow for these values would result in frequencies below those desired.)

Matching the capacitors for S2A and S2B not only results in exact frequency, it gives nearly constant output voltage at all frequencies. But for greatest frequency accuracy, select a pair of capacitors about 5 mmf below the required value. Then, comparing the generator's output frequency against a known frequency, parallel the capacitors with 1 or 2 mmf capacitors until you get the exact frequency. Simultaneously look for maximum output voltage. While you may hit a combination that gives the desired frequency, adding one or two more trimming capacitors might give more output voltage.

If you don't require exact frequencies but want a constant output voltage, matching is much easier. Connect a capacitor of the required value to S2A and connect a capacitor

5 to 10 mmf smaller to S2B. Then parallel the S2B capacitor with small capacitors until maximum output is obtained. Matching may be required only for frequencies above 50cps. For experimenter use, the output and frequency characteristics obtained without matching are quite adequate.

For 100 per cent (0 VU) indication on M1 at a 3-volt maximum output, R21 should be 15,000 ohms. For the same meter indication at a 1-volt output, R21 should be 1,000 ohms.

P1 is part of the Wien-bridge oscillator feedback circuit and you must not make a substitution for it. While the type specified in our Parts List may not be available from electronic parts distributors, you should be able to pick it up at a hardware store.

**Checkout and Adjustment.** Regardless of whether you want the generator to provide a 1- or 3-volt output at 100 per cent indication on M1, set R20 full clockwise for maximum output. If you use the high-voltage out-

[Continued on page 115]

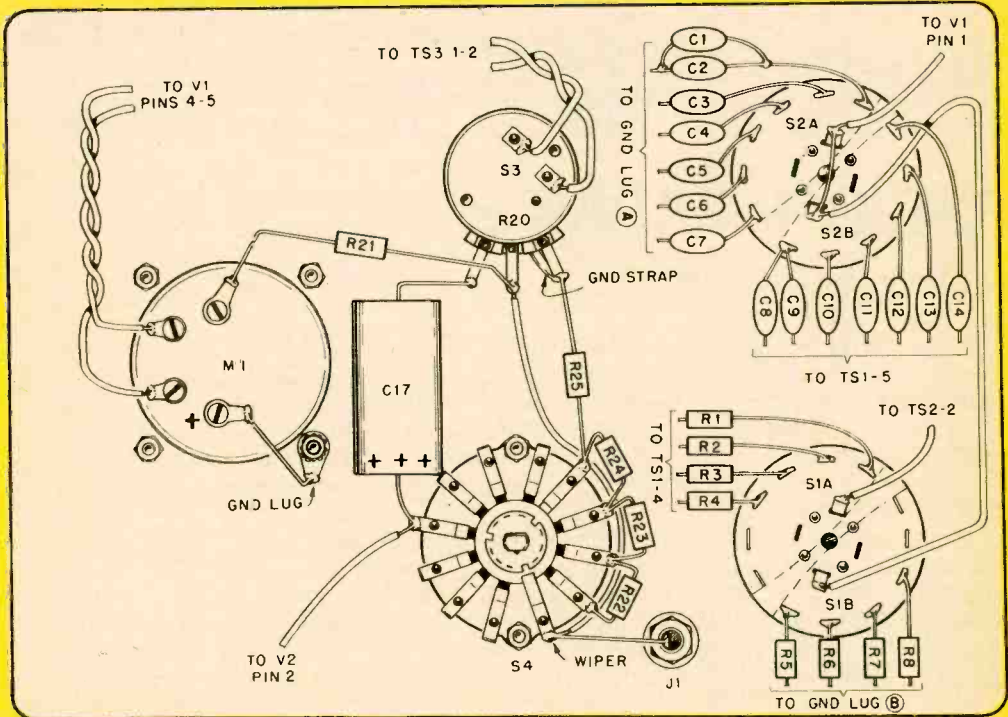

Lead placement both under and above the chassis is critical and should be followed as closely as possible. Connect all capacitors and resistors from S1 and S2 to the specific tie points indicated.



# RADIO + RADAR = RESCUE

By Alan D. Haas

**S**MALL SHIPS floundering off the New York/New Jersey coasts these days are apt to be plucked from disaster by a unique Coast Guard rescue operation directed by a single man. Equipped to the hilt with radio and radar equipment, the Coast Guard's 82-foot patrol craft No. 82307 stands ready to rush to the aid of small fishing and pleasure boats. And Lt. Lawrence O. Hamilton, the ship's skipper, can oversee and direct virtually any type of search and rescue operation right from the wheelhouse.

Prime feature of CG 82307 is the unique arrangement and location of its control panel. Specially designed for small-craft rescue work, the 82307 places an automatic direction finder, a range finder, a two-way radio, a radar scope and other electronic gear at the skipper's fingertips. Though normally accompanied by a crew of eight, Lt. Hamilton is in constant personal control of all operations and can make instantaneous life-and-death decisions without leaving the helm.

To be sure, life isn't all work and no play aboard 82307. FM radio, television and a central heating/air-conditioning system help provide the comforts of home, and most housewives would envy the craft's all-electric galley. But duty comes first for the little boat. And, thanks to the 82307's duty-oriented design, radio and radar almost always add up to one thing: rescue. ●



A wide range of electronic equipment and an intercom for communicating with others on board give the 82307's skipper every modern aid to rapid rescue. Since it's less than 100-ft. long, boat is assigned a number instead of a name.



On shore, radio operators stand by in a round-the-clock watch, ready to relay distress calls from pleasure craft and fishing vessels anywhere in the New York/New Jersey coastal waters. Modern as the little rescue ship itself, the shoreside installation includes a teletype for speedy communication with other Coast Guard monitoring stations in the immediate area. Main Coast Guard center on shore is located on Sandy Hook, the tip of land which lies in front of entrance to New York Harbor.

By **LEN BUCKWALTER, KBA4480** Remember the war between the Turkey Call and the Q-Bird? About two years ago these add-on gadgets—CB's first call systems—filled the band with noise reminiscent of a gargling banshee. As tone generators, they achieved their mission, all right. They attracted attention. Trouble was, they weren't selective and sounded in everyone's receiver.

As the novelty wore off (and the law became known), these primitive devices joined the kiwi, whooping crane and other nearly extinct birds. But today some dozen manufacturers offer true selective tone call for most CB transceivers. Add one to your rig and all stations not in your system are dropped electronically out of earshot. Only signals you want to hear can trigger your receiver.

Before looking at various systems, let's see what tone call is *not*. For one thing, it can't give you the privacy of a landline telephone. Other stations still can eavesdrop on your communications. And it won't clear a channel of interference when you're about to transmit.

You might say that tone call performs like a receiver's regular squelch, but with one important difference: a carrier on your channel can't awaken your receiver unless it is modulated with the correct tone information. If you wish to hear all traffic, just flick a switch and everything returns to normal.

It's not difficult to see who benefits from tone call. Take an office where CB is used to dispatch trucks. No longer need a business-like atmosphere be shattered with such miscellany as, "I just blew a resistor . . . is that

# CB's SILENT

*Any CBer fed up with the meaningless babble on the band will*

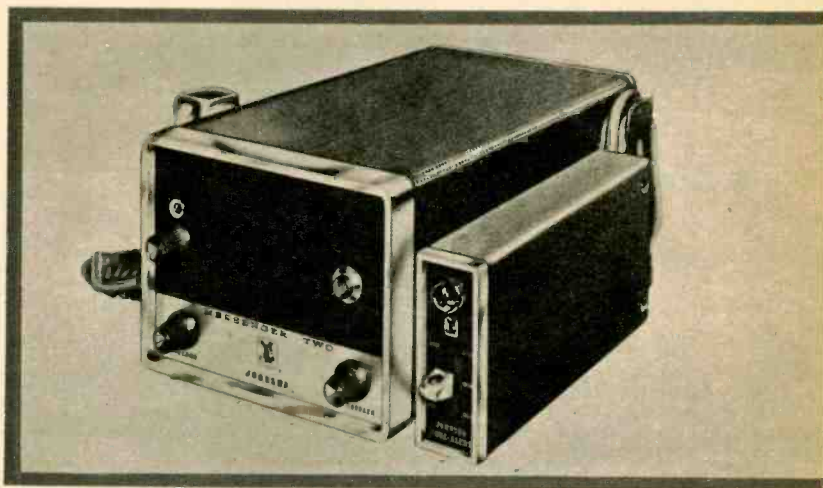
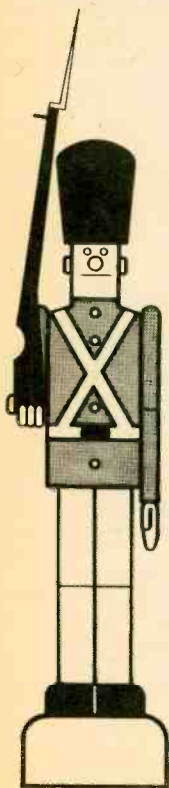

Tone-Alert by Johnson mounts on side of transceiver, plugs into company's Messenger 202 or Messenger Two without further wiring. \$59.95.

a big fat 10-4?" And personal users of CB, tired of "reading the mail," can continuously monitor a channel for hours in blissful silence.

There are advantages on the transmit side, too. A control station in a large CB network can use tone to activate only certain stations in particular groups (one code for cars, another for trucks, let's say).

**How It Works.** Unlike those early birds, the tone in today's systems isn't one you can hear. According to law, to transmit such a tone would be broadcasting encoded intelligence—a sort of Morse—and this is taboo. The tone must be confined to *control* purposes in order to agree with CB rules.

With few exceptions, most current tone-call devices employ a resonant-reed relay. It operates on the same principle as a tuning fork. When the reed—a thin sliver of metal—is set into motion, it vibrates at one frequency with great precision. A typical rate might be 200 cps, though the frequency may lie anywhere in the audio range, depending on the reed's physical size. One or more of these steel fingers is mounted atop an electromagnet, which provides the energy to drive the reed.

When the rig is on selective receive, all the audio energy on the channel—tone, voice, static—is fed to the coil, where it is converted to magnetic fields. If the varying field attracts the reed at the same rate as its resonant frequency, the reed swings repeatedly and strikes a fixed contact. (This contact can't handle much current, so its action usually operates a larger relay.) In this fashion, only those stations capable of transmitting the correct tone can trigger the receiver into action. This section of the tone-call

# SENTINELS

*take to the new selective-calls quicker than a duck to water.*



GW-42 transceiver kit by Heath has built-in tone call. Tone selector switch is at top right of front panel, with call button immediately above. \$119.95.

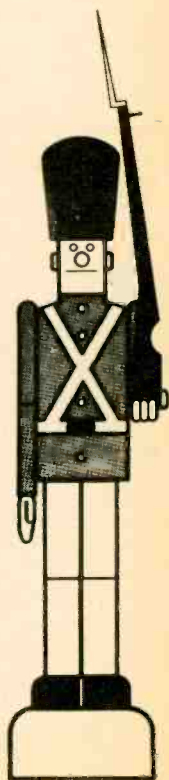



# CB's SILENT SENTINELS



circuit customarily is known as the *decoder*.

The actual warning to the CB operator that the correct signal has arrived can occur in any one of three ways: most important is activation of the speaker. In this case, you actually are summoned by the voice of the caller. Another technique is the sounding of an optional bell or buzzer. Finally, there's the call light on the panel of some devices. It stays on to indicate that one of your stations made an attempt to contact you. In any case, you never hear the reed's tone.

A second section of the tone-call system is the *coder*, which functions in the transmit mode. The most popular technique for generating the tone makes use of the same reed that functions during receive. In some models, a surge of current is fed to the reed-relay coil when the operator presses a call button. The resulting magnetic field shocks the reed into vibration at its natural frequency. Reed movement dies out quickly, but the signal lasts long enough to modulate the transmitter with a short tone burst. Other systems cause the reed to control an audio oscillator if a long-duration tone is needed.

**What's Available.** Emerging from these basic arrangements are the refinements and variations found in today's models. In the Heathkit *GW-42*, there are four reeds, each tuned to a different frequency. The operator can switch-select any one or monitor all si-

**Poly-Call by Polytronics** attaches to Model N transceiver, requires no circuit changes. \$59.95.

multaneously. The *Johnson Tone Alert* makes available any one of 37 possible tone frequencies. Relays are the plug-in type and can be changed readily if another station in your area is using your tone frequency.

A rare departure from the usual reed relay shows up in the *Poly-Call* adaptor by Polytronics. This company decided to avoid any mechanical components and process the tones through high-efficiency tuned circuits.

The models mentioned above typify the one-tone system. More recently, manufacturers have turned to the simultaneous two-tone system to reduce the chance of falsing or improper response. Heterodynes during crowded-band or skip conditions have been known to fool a one-tone decoder.

Late-model units of two-tone design include the *Lafayette Priva-Com*, the *Hallcrafters HA-12* and the *Sonar-Call*. In these systems, a four-reed relay is used. Two reeds, however, are de-activated by slipping pieces of plastic tubing over them. If the user wishes to change the code he merely shifts the plastic tubes around. There are six different two-tone possibilities with the reed relay supplied.

**Installation.** Adding tone call to your rig

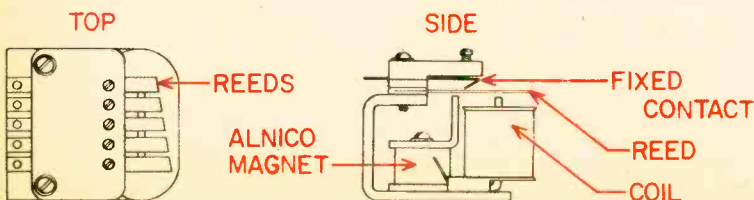

Four-reed relay by Bramco forms heart of many tone-call units. Reed vibrates whenever coil's magnetic field varies at reed's resonant frequency.





Priva-Com by Lafayette fits most CB rigs, uses no tubes or transistors. \$32.50 each, \$62.50 the pair.



HA-12 by Hallicrafters incorporates a call light, plugs into company's CB-3A transceiver. \$79.95.

is easy if you purchase an adaptor offered by the set's manufacturer. A socket on the back of the transceiver chassis usually is prewired for the purpose. The job entails mounting the accessory alongside the rig and plugging in the connector. In nearly all cases the manufacturer provides step-by-step wiring instructions for making his adaptor work with most other-make transceivers.

Whether a particular unit can work with your set is chiefly a question of supply voltages. The safest choice, when no adaptor is made for your set, is to choose from among the two-tone devices. They contain no tubes or transistors. The basic requirements are that your rig have a push-to-talk button on the microphone and a source of B+ voltage ranging from 200 to 300 volts. This last requirement is met if the transceiver is not fully transistorized. (Designers now are at work on units to match all-transistor rigs.)

Adding a socket to a set not already prewired isn't a difficult job, but it definitely calls for some electronic skill. It shouldn't be attempted unless you're able to read a schematic and pick out such circuit points as the input to the mike preamp, the right source of B+ voltage and the proper connections on the output transformer. Some instruction manuals give data for several popular transceivers, but even these demand some technical proficiency on the part of the installer.

**Operation.** No matter which tone-call unit you use, chances are that its operation is accomplished with a three-position switch marked with words like *Standby*, *Normal* and *Call*. The *Standby* position is for selective

receiving. No signals except those bearing correct tone information will activate the speaker. When the speaker is triggered, it remains on long enough for you to hear the voice of the calling station. The call can be answered once you have flipped the switch to *Normal*, since this restores the rig to conventional operation.

To initiate a call to other units in your system, the switch is depressed from *Standby* to *Normal*. This is a necessary step to comply with FCC regulations; in the *Normal* mode you can check the channel for other stations before transmitting. If it's clear, the switch then is depressed to *Call* and held down for three or four seconds. (The tone burst itself may last only a few thousandths of a second.)

When the *Call* switch is released, a spring-return automatically throws the selector back to *Normal*.

Incidentally, these one- and two-tone systems likely will prevail for some time to come. True, you could use some sort of telephone dial and assign a number to each and every CBER in your area. But this arrangement would be impractical for at least three reasons. Such complex digital pulsers are hard to handle during mobile operations. They tend to be confused by the proliferation of ignition-noise pulses encountered on 27 mc. And they cost upwards of \$300.

The simpler systems we have just described can provide hundreds of possible tone-codes for a given area. And there's no denying that they're a good many S-units easier on the pocketbook. —



# The Diode

**W**IDELY used in electronic equipment from computers all the way down to transistor portables, diodes do the important job of rectifying—passing current in one direction only. And our last experiment here will show that diodes also can avalanche—the basis of operation of other special-purpose diodes.

Connect a 6-volt pilot lamp (No. 44 or 47) in series with a 9-volt battery and a general-purpose diode, such as a 1N34, as shown below. (If your diode is not marked with an arrowhead-bar symbol, the bar alone at one end is the cathode.) The glowing lamp proves that when connected this way the diode permits current to flow in the circuit.

If you reverse the connection of the diode in the circuit, the bulb will not light because current does not flow from the battery through the diode and lamp, back to the battery.

The diode's internal construction explains its one-way action. A diode consists of two pieces of germanium in contact with each other. During the manufacturing process each piece has impurities added to it which cause the germanium to become rich in current carriers. The piece (marked N in our drawing) that is to be the cathode ends up with free electrons. The current carriers in the anode (marked P in the drawing) are called holes and have a positive charge.

Connected as shown at the lower left of the drawing (A), the positive terminal of the battery will repel the holes, pushing them to where the germanium layers meet—at the junction. The battery's negative terminal repels the electrons in the cathode, pushing them also toward the junction.

The result is that the holes and electrons combine (since their charges are opposite) at the junction and create an electrical bridge that permits the passage of current through the bulb. Stated another way, the resistance of the diode is lowered and it is said to be forward-biased. When the diode is connected in reverse (B), the battery terminals attract the holes and electrons, pulling them away

from the junction. The holes and electrons don't combine and current does not flow.

If the battery is replaced by an alternating current, the diode will pass current only on the half of the cycle when the anode is positive. This is the most common use for a diode—as a rectifier to convert AC to DC.

Let's take a look now at the avalanche effect. Connect the diode so the bulb *does not* light and hold the diode over a flame. In a minute or so the bulb should light. Let the diode cool and the bulb will go off. Though the diode is reverse-biased, heat energy temporarily breaks down its normal structure, allowing a large current to flow in the *reverse* direction.

Ordinary diodes can't withstand high reverse current for long, but special construction makes possible what's called the zener diode. Widely used as a voltage regulator, it avalanches safely whenever circuit voltages rise beyond normal. The resulting current flow automatically brings the voltage back to normal.

—H. B. Morris

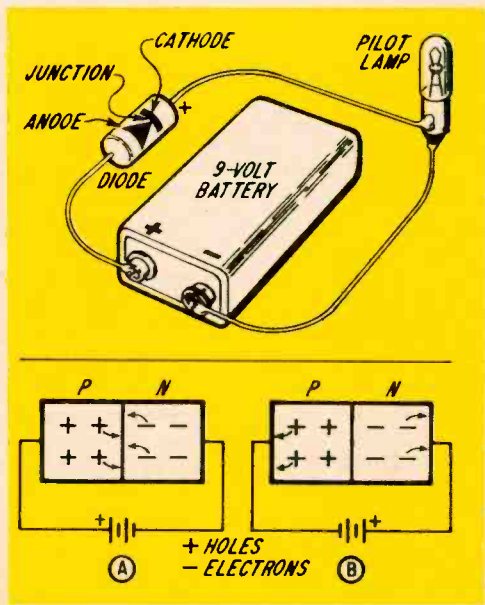



# THE HAM SHACK

BY ROBERT  
HERTZBERG  
W2DJJ

**R**X BY DX... Another heart-warming chapter in amateur radio's long history of public service was written recently by hams more than 3,000 miles apart. It began when Dr. Gino Antonucci, I1AG1, of Genoa, Italy, transmitted a frantic appeal on 20-meter

SSB for a rare drug needed for an ill patient. The person involved was his own son.

Dr. Antonucci's call first was heard by Nicholas Marrone, K2RVQ, of Franklin Square, N.Y. When Nick found he couldn't raise Italy, he passed the word to Selden Pinero, WA2WPP, of nearby Baldwin, N.Y. Selden managed to contact I1DFD, a station in Vincenza operated by Jerry Lehman and Duke Russell, American hams stationed with the U.S. military there.

They, in turn, got through to Gino, checked out all details, then reported back to WA2WPP. Selden immediately phoned a pharmacist friend, Michael R. DeMarco of Kew Gardens Hills, N.Y., who shipped \$165 worth of the medicine by air to Genoa. It arrived in time to save the boy's life.

**Stat-ic . . .** Common complaint heard over



Selden Pinero, WA2WPP, is proud of his shack and even more proud of the role it played in offering Rx by DX. WA2WPP operates both phone and CW.

the air is that many photostating firms refuse to make copies of ham licenses, explaining that federal law forbids same. Tain't so! Paragraph 12.25 of Part 12, FCC Rules and Regulations, specifically states: "No recognition shall be accorded to any photocopy of an operator license; *however, nothing in this section shall be construed to prohibit the photocopying for other purposes of any amateur radio operator license.*" (The italics are our own.)

After we showed Part 12 to a local photostater, to prove that he had been misinformed on the matter, he copied not only our ticket but the entire FCC page. He said: "Thanks for bringing this in. I've turned down a lot of business from hams. Charge for your stat? Compliments of the house."

**Time to Change?** . . . Hams screaming against the ARRL's incentive licensing proposals may well be fighting the inevitable. As FCC regulations now stand, an amateur who obtained his ticket ten or 50 years ago—and who hasn't cracked an electronics book since—can buy a modern kilowatt rig and blast holes in any or all of a dozen bands.

You have only to tune around a bit to learn how appallingly ignorant some of these chaps are of basic operating practices, much less of technical matters. In fact, we have heard men openly admit that they didn't know what type of microphone they were using, didn't know how to replace a dial light, didn't know the meaning of QRX, didn't know how to relate GMT to local time.

Also overlooked by some hams is the hard fact that incentive licensing existed for 20 years (1932 to 1952) and worked well. Why the noise against it now?

**Free Plug . . .** "Since learning the code as a Boy Scout, my son has become interested in amateur radio," writes Joel Bachner, of Floral Park, L.I., N.Y. "Can you suggest a good starting book for him?"

So glad you asked, Joel! Your letter gives us an opportunity to plug a book titled *So You Want To Be a Ham!*, published by Howard W. Sams & Co. of Indianapolis, and sold by amateur suppliers and book stores. We'll let you guess as to who is the author. The price is \$2.95 a copy. We use the royalties to buy new gear for our shack.

[Continued on page 111]



HAM

Llangefni, Isle of Anglesey, North Wales, U.K., may sound like code from an atom-sub harbor, but it's actually home base for George Preuss, GW7796. Though his shack is a modest one and comprised largely of surplus equipment, George is one of the top DXers in Wales, with 192 countries confirmed. And, far from content with being a first-rate ham, George also is translator of German for the International Short Wave League.

## PRIZE SHACKS

A LOT of time, though not necessarily a lot of money, goes into every neat and attractive shack, whether it belongs to a ham, a CBer or an SWL. Each of the three shacks pictured here is outstanding for its orderliness and appearance, and this is the reason each has won its owner a \$20 prize. A careful study of these photos may uncover some ideas you can make use of in your own shack. But whether you pick up ideas or not, we are certain you will join with EI in bestowing a hearty congratulations on the respective owners of each shack for a job well done.

Airman 2nd Class Sidney J. Dixe tunes the short-wave bands from Dow AFB way up in Bangor, Me. Sid has logged 31 countries as well as all of the 50 states. And, as if this weren't enough, he also devotes at least an hour a day monitoring emergency frequencies. Equipment at Sid's prize-winning shack includes two receivers, a preselector, a tape recorder and a home-brew power supply, with many of the items arrayed on a home-made desk.

SWL



CB

This prize-winning CB shack is the proud possession of George W. Heflin, 5Q1206. A free-lance photographer in Fredericksburg, Va., George snapped this picture himself, which explains why the photo reveals plenty of equipment but nothing of George. The impressive collection of QSL's shows George to be an active card-exchanger. And the gear, which includes two Hallcrafters communications receivers, hints at still another of 5Q1206's interests: ever-popular SWLing.

# How You Can Succeed In Electronics

## ... Select Your Future From Five Career Programs

### The "right" course for your career

Cleveland Institute offers not one, but five different and up-to-date Electronics Home Study Programs. Look them over. Pick the one that is "right" for you. Then mark your selection on the reply card and send it to us. In a few days you will have complete details . . . without obligation.

#### 1. Electronics Technology

A comprehensive program covering Automation, Communications, Computers, Industrial Controls, Television, Transistors, and preparation for a 1st Class FCC License.



#### 2. First Class FCC License

If you want a 1st Class FCC ticket *quickly*, this streamlined program will do the trick and enable you to maintain and service all types of transmitting equipment.



#### 3. Broadcast Engineering

Here's an excellent studio engineering program which will get you a 1st Class FCC License and teach you all about Program Transmission and Broadcast Transmitters.



#### 4. Electronic Communications

Mobile Radio, Microwave, and 2nd Class FCC preparation are just a few of the topics covered in this "compact" program . . . Carrier Telephony too, if you so desire.



#### 5. Industrial Electronics & Automation

This exciting program includes many important subjects such as Computers, Electronic Heating and Welding, Industrial Controls, Servomechanisms, and Solid State Devices.



### An FCC License . . . or your money back!

In addition to providing you with comprehensive training in the area indicated, programs 1, 2, 3, and 4 will prepare you for a Commercial FCC License. In fact, we're so certain of their effectiveness, we make this *exclusive* offer:

The training programs described will prepare you for the FCC License specified. Should you fail to pass the FCC examination after completing the course, we will refund *all* tuition payments. You get an FCC License . . . or your money back!

### Cleveland Institute's new "Check-Point Plan" helps you learn faster and better

Cleveland Institute uses the new programmed learning approach. This "Check-Point Plan" presents facts and concepts in small, easy-to-understand bits . . . reinforces them with clear explanations and examples. Students learn more thoroughly and faster through this modern, simplified method. You too will absorb . . . retain . . . advance *at your own pace*.

### Job placement service . . . another CIE extra to help you get ahead in electronics

Once enrolled with CIE, you will get a bi-monthly listing of the many high-paying interesting jobs available with top companies throughout the country. Many Cleveland Institute students and graduates hold such jobs with leading companies like these: American Airlines, American Telephone and Telegraph, General Electric, General Telephone and Electronics, IBM, Motorola, North American Aviation, New York Central Railroad, Raytheon, RCA and Westinghouse.

### Electronics is a fast moving, dynamic industry . . . Cleveland Institute keeps you current

The Electron Bulletin is CIE's bi-monthly digest of new developments in the world's fastest growing industry. As a CIE student, you will get a free copy throughout your training to keep you up-to-date on Masers, Lasers, Solid State Devices, and other new inventions.



### Full accreditation . . . your assurance of competence and integrity

Cleveland Institute of Electronics is accredited by the Accrediting Commission of the National Home Study Council. You can be assured of competent electronics training by a staff of skilled electronics instructors.

**Your Future In Electronics Is  
Up To You. Make It A Brighter One.  
Mail Reply Card Today.**

# Cleveland Institute of Electronics

Dept. EI-51, 1776 E. 17th St., Cleveland 14, Ohio

# SUPER-COLD



**D**UTCH tulips may be known the world over, but some other Dutch products don't enjoy quite the same following. In the case of Holland's Mr. K. Kamerlingh Onnes, a physicist of no meager mien, you can chalk the lack of fame up to plain bad luck.

As it happens, Onnes was the Dutch physicist who introduced the modern world to super-cold way back in 1908. A few years later, Onnes stumbled upon something called superconductivity that should have been the discovery of a lifetime. It was—and then again it wasn't.

Before Onnes made his experiments, the scientific world was well aware that metals exhibited less and less resistance as temperature was lowered. But no one dreamed that all resistance would disappear. Zero resistance? Impossible! Even if you brought a metal down to absolute zero (-459.6 F), which is as cold as cold can get, it still would have a finite resistance. Or so the theory went, at any rate.

**The Helium Pot.** But Onnes was to prove his fellow scientists wrong. Once he had successfully liquefied helium in 1908, Onnes was able to lower metals into the super-cold world near absolute zero. And he discovered that metals not only display decreasing resistance as temperatures are lowered; they eventually reach a point where every ohm of resistance vanishes. Build a coil of wire in a pot of liquid helium, reasoned Onnes, hook it up to a battery to set the electrons in

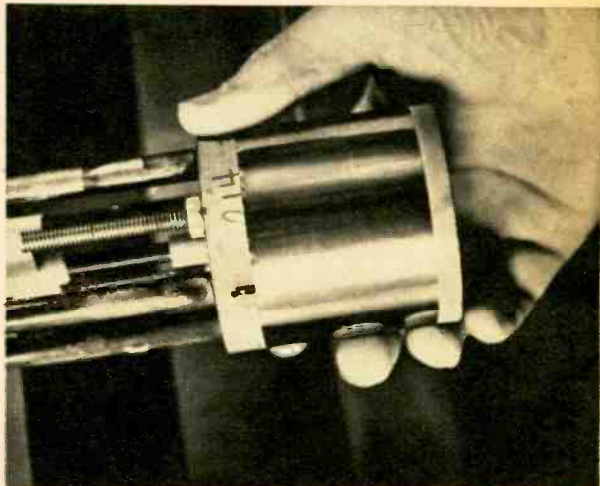

Superconducting solenoid wound with 600 ft. of niobium-tin conductor produces up to 100,000 gauss.



Helium rises in smoke-like fashion as super-magnet is withdrawn from super-cold, liquid-helium bath.



# SUPER-MAGNETS

*Science got itself sidetracked—not once but twice—in the 50-odd years it took to prove fully that magnets love the cold.*

By ROBERT S. BUSH

motion, and you'd have an electromagnet that would go on operating forever.

An enthusiastic Onnes brought news of his great discovery to the Third International Congress of Refrigeration in Chicago in 1913. Superconductivity, he proudly told the assembled throng, could well result in "intense magnetic fields" produced by "coils without iron cores."

But shortly after the meeting, Onnes chanced upon still another discovery that was to make him eat his words. True, metals do lose all resistance at certain extremely low temperatures. They do become superconductive, in other words. And, in theory at least, they should remain so as long as they are kept at the right degree of sub-zero super-cold.

The sad fact of the matter is that they didn't—for Onnes, anyway. Any sizable magnetic field seemed to destroy the very superconductivity that was the crux of Onnes' entire argument. In short, as soon as Onnes put his beauty to work, she turned into a hag.

**Magic Wand.** Onnes never succeeded in achieving anything other than an Ugly Duckling; he lacked the magic wand. But two other Dutch scientists almost found that wand during the early 1930's.

Working at the same University of Leiden where Onnes had conducted his experiments, W. J. de Haas and J. Voogd did further research. But superconducting magnets again missed becoming a reality, just as that magic wand was all but within reach. Hindsight puts the blame on an assistant, who made a

miscalculation in some of his computations. But whatever the cause, one thing's for sure: super conducting magnets remained in the future.

Today, however, supercon magnets are very much a reality. Subsequent studies have revealed that certain alloys—niobium-tin and niobium-zirconium are among the most promising—will *remain* superconducting in an intense magnetic field. Once established, current in today's super-cold, super-magnets can flow forever, even though the circuit is connected to no power source whatever.

Thing is, the coil must be rigidly maintained at the proper super-cold temperatures it requires. This could be a problem, but put the super conducting coil in a kind of vacuum bottle called a Dewar, and the task is as good as done. Meanwhile, the external enclosure can enjoy normal room temperatures, same as most any other magnet.

**Simplicity Plus.** Not long ago, a group of physics teachers watched a scientist from International Business Machines make an extremely powerful magnet from the simplest of components. The experiment realized the very predictions Onnes had made some 50 years before. For just as Onnes had forecast, scientist Richard L. Garwin was able to form an unbelievably intense magnetic field simply by combining two dry cells, a small coil of wire and an ordinary thermos bottle.

To appreciate the importance of the demonstration, consider the conventional equivalent of this super-powerful vacuum-bottle magnet. The hard facts: this pint-size super-

magnet was the equal of an ordinary electro-magnet drawing 100,000 watts of power and requiring some 1,000 gallons of water an hour to keep it cool.

Secret of the super-magnet, of course, lay in the contents of the vacuum bottle itself. As you already may have guessed, the bottle contained liquid helium at a temperature of some -450 F. The dry cells were connected to the coil briefly, but only to set up a current. Once the cells were disconnected, current continued to flow indefinitely, so long as the temperature wasn't allowed to rise. In this experimental setup, the magnet operated for about two hours before the liquid helium in the bottle evaporated. When this happened, of course, the temperature rose, restoring the normal resistance of the coil.

#### The Road Ahead.

Such experiments as this are concrete proof that Onnes was on the right track decades ago. But they also point toward what is to come, when super-cold super-magnets enter into such promising developments as thermonuclear power, frictionless bearings and interplanetary propulsion systems. These and other exciting accomplishments all could make use of the same doughnut-size, super-strength magnets, operating at super-cold temperatures and consuming less energy than a gnat in a stall.

Much of the ground work already has been completed. For example, niobium-tin, one of the preferred superconducting alloys, happens to be so brittle that it's practically impossible to draw it into a wire. But technicians at Bell Laboratories solve this problem by

placing a powdered mixture of the two metals in a slender tube of niobium. The tube then is hammered and drawn into wire, wound into a solenoid and heated to 1000 C. The particles fuse into the desired substance.

RCA employs a slightly different attack, but it ends up with niobium-tin wire just the same. RCA relies on a chemical transfer technique to produce its niobium-tin metal string. The process calls for reducing

chlorides of niobium and tin at high temperatures, then depositing them on a base material.

#### Magnet Race.

Now that scientists have gained the technical know-how to produce core-less super-magnets, it shouldn't be surprising to learn that an international superconducting race already is under way. One major breakthrough occurred only a few months ago when scientists at General Electric demonstrated a super-cold super-magnet with a field of more than 100,000 gauss (a horseshoe magnet averages 1,000 gauss).

One of the most exciting things about the new GE device is the fact that it requires only a tiny fraction of the power ordinary magnets

need. To achieve the phenomenal force of 100,000 gauss, the GE scientists used nothing more than six ordinary automobile storage batteries as a power source. In contrast, the only comparable magnetic fields ever created by conventional means required some two million watts of electric power.

With much of the hard struggle behind them, scientists look forward to the day when super-cold super-magnets may find ready application in [Continued on page 112]

## SUPER-COLD SUPER-MAGNETS

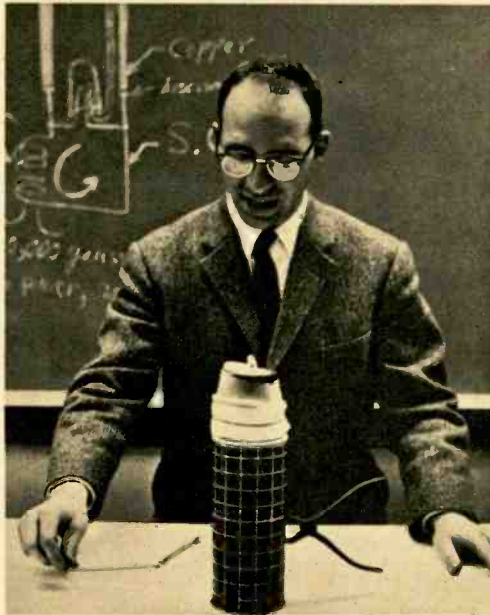

Two dry cells, connected momentarily, provide all the current this ultra-powerful magnet ever needs.



# IMAGINE EXPLORING A WORLD OF DIAMONDS, EMERALDS, RUBIES, SAPPHIRES AND 21 OTHER EXOTIC GEMS!

250 carats of precious and semi-precious gems make up just one part of this educational and unusual gift idea.

**Fascinating New Hobby Will Thrill The Entire Family!**



Can you match the precious gems with their native countries?

Precious Gem	Country
Diamond	Ceylon
Sapphire	Colombia
Ruby	Brazil
Emerald	Africa
Precious Topaz	Burma

YOU ALSO GET 20 SEMI-PRECIOUS GEMS.

Jade	Beryl
Opal	Rose Quartz
Amethyst	Quartz
Garnet	Tourmaline
Tigereye	Agate
Labradorite	Amazonite
Petrified Wood	Fluorite
Obsidian	Epidote
Turquoise	Sodalite
Peridot	Rhodocrosite

It is exciting to look at a gem and know everything about it. To know how to identify it—how to tell the perfect from the imperfect. Learn all about the countries of origin. Learn how the gems are mined. Learn the many valuable uses. In short, you will have enough information to know any gem inside out.

All of this knowledge is yours when you develop an interest in collecting gems. It's a fascinating hobby for every age group. For youngsters, their interest may later develop into more serious studies of the Natural Sciences. For you, it becomes a stimulating experience and in a very short time, you will design and make your own jewelry at your own price.

Here, at last, is a kit for those with inquisitive minds—for those who like to ask questions, for those who are curious and for those who are looking to develop a new interest. Working with the famed International Gem Corporation, we have selected 250 Carats of genuine precious and semi-precious gems. *Diamond from Africa, Sapphire from Burma, Ruby from Ceylon, Emerald from Colombia, Precious Topaz from Brazil.* These are the five precious gems in the kit. Every bit as glamorous and as colorful are the twenty semi-precious gems collected from countries all over the world. Although some of the names may not be familiar to you, the gems are all being used today in rings, charms, necklaces, etc. You will recognize them when you see them.

Remember. These are not just chips or tiny stones. Every gem is a good large size, perfect for scientific and display purposes. Some weigh as much as 20 Carats.

Now, do not be misled. Although every gem is absolutely authentic and genuine, they are in rough form, neither cut nor polished, which gives them an unusual beauty of their own. They are not perfect. Experienced eyes will be able to detect the flaws of Nature. Perhaps someday your hobby will develop to the point where you have a perfect, flawless collection which will be worth thousands of dollars.

## BONUS: FREE 10 CARAT JADE NUGGET

Every kit includes a finished and a polished 10 Carat genuine Jade nugget. Jade, with all the romance and mystery of the Far East, is said to bring good fortune to those who possess it. Use this magnificent nugget for pocket or purse. 10 Carat Jade nugget is yours to keep even if you decide to return the kit. There are no strings attached. The nugget is yours, absolutely free, and we hope it will bring good fortune to you.

With each kit comes a booklet which tells you how to identify the gems, tells you about the countries of origin and all the other details you need to know. Along with the gems, the kit includes a Mounting Board, a Jeweler's Tweezers, a powerful Magnifying Glass, a special Glue and two special Bonus Offers. After the gem has been studied and identified, it is placed on a Mounting Board in the space designated for it. Who will be the first in your home to make the correct identifications? The entire family can take part and you will spend many evenings gaining knowledge while you are having fun. Educational and unusual, the kit contains everything to start you or your youngster on a fascinating study of the universe of gems.

*The International Gem Kit* can be purchased only by mail and only from Hamilton House. We hope to have enough kits to satisfy everyone but, just in case, we suggest you order now. Specially priced at \$4.95 and that includes everything.

A complete and unqualified guarantee goes with each kit. It must be everything we say it is or you get every cent refunded immediately. *And you keep the beautiful, polished, good luck 10 Carat genuine Jade Nugget with our compliments.*

**Bonus:** Every gem in your kit can be made into a piece of jewelry. Identify and select your favorite and write the name on the special certificate enclosed with your kit. For only \$2.50 you will receive the same gem from our collection, mounted on a Sterling Silver circular charm for pendant, bracelet or keychain.

Copyright Hamilton House, 1964

**HAMILTON HOUSE Dept. CE-5**

**P. O. Box 77, Cos Cob, Conn.**

Please rush to me.....complete International Gem kits at \$4.95 (2 for \$9.00). Each kit includes all of the following, making up 250 Carats, and all gems are genuine: A. 5 different precious gems; B. 20 different semi-precious gems; C. Magnifying glass; D. Jeweler's tweezers; E. Mounting glue; F. Mounting board; G. Instruction booklet; H. Special charm or keychain certificate; I. 10 Carat Jade nugget (mine to keep). Enclosed find \$..... (No C.O.D.'s or Canadian orders.) For Air Mail, add 75¢.

Name .....

Address .....

City..... Zone..... State.....



# SEAT BELTS AOK!

**N**EARLY every car owner realizes that seat belts can mean the difference between life or death in an accident. Yet many drivers admit that even though they have seat belts in their car they're not used all the time. Our system reminds you in three ways to *fasten that belt*.

If at least one seat belt isn't fastened when you turn on the ignition switch, a buzzer will sound and a sign on the dash will light—and, you won't be able to start the engine. Fasten the belt and the buzzer and sign lamps go off and you'll be able to drive off in safety.

The mounting of the microswitch and a spring-steel wire on the belt buckle is a simple job. The relay, pilot lamps and buzzer are installed easily under the dash. The diagrams and caption below cover the details.—*Hal Bergida.*

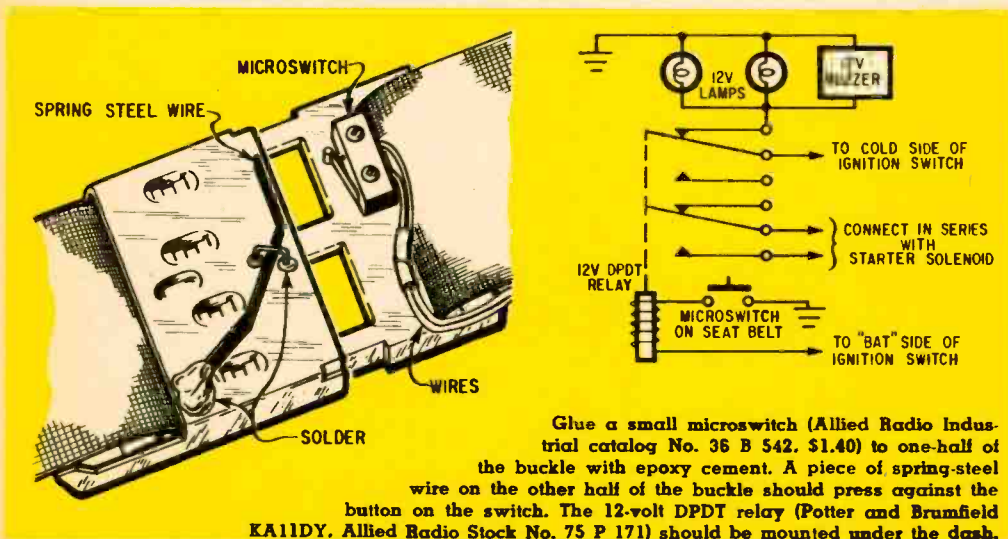

## CB Corner

Continued from page 44

applied to the rig reduces tube and component life (and overcharges the battery or causes the generator to "throw solder"). Normal voltage to the rig, when the car engine is at a fast idle, is somewhere between 14 and 15 volts. This is true for a 12-volt car; the figure is reduced by one-half for a 6-volt system.

One tip to squeeze the most range from your rig is never to transmit while the car engine is turning over at a slow and normal idling speed. Unless the car is equipped with an alternator, the supply voltage drops to that of the battery (6 or 12 volts). By holding down the gas pedal for a fast idle, the generator delivers several more volts (needed to charge the battery) and the rig's output rises.

News . . . of your CB operations, or your club's, is welcomed by this column. Let us hear about jamborees, technical problems or questions and like subjects. Items (and

photos, too) should be sent to CB Corner, Electronics Illustrated, 67 West 44th St., New York, N.Y. 10036.

## The Ham Shack

Continued from page 101

**Redundant . . .** Oddest operating report of the month, overheard on 15 meters: "Read you fine, old man. No QRM or interference on your signal."

**Time Saver . . .** One of the handiest shack accessories we've seen in a long time is W9IOP's Second Op. About 11 inches in diameter and made of heavy cardboard, it looks like a circular slide rule. Around the periphery on both sides are all the ham call prefixes. Turn the inner circle index to any of 'em, and three little cutouts on the face will give you the relevant great circle bearing, time differential, postage rates and location. The Second Op costs a buck and is obtainable from Larry LeKashman at Electro-Voice, Inc., Buchanan, Mich. 49107.

# Mosley

TRAP  
MASTER

MODEL TA-33  
for 10, 15 and 20 meters.

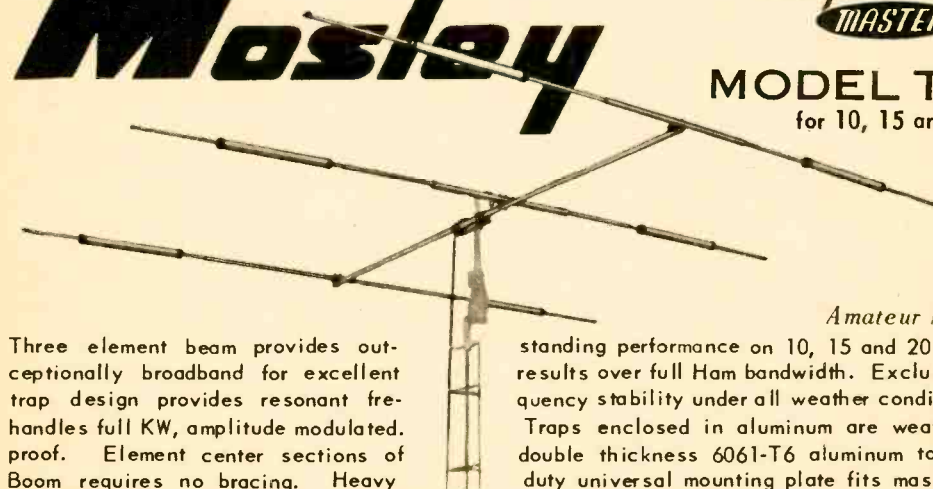

Three element beam provides exceptionally broadband for excellent trap design provides resonant fre-handles full KW, amplitude modulated. proof. Element center sections of Boom requires no bracing. Heavy OD. Feed with one coax line. RG-8/U is recommended.

**SPECIFICATIONS and DATA:** Forward gain is 8 db. Front-to-back is 25 db. SWR is 1.1/1 or less, at resonant frequencies. Maximum element length is 28 feet. Boom length is 14 feet. Turning radius is 15.5 feet. Assembled weight is 40 pounds. Wind surface area is 5.7 square feet. Wind load is 114 pounds. Shipping weight is 53 pounds.

Amateur Net \$104.75

standing performance on 10, 15 and 20 meters. Excellent results over full Ham bandwidth. Exclusive MOSLEY frequency stability under all weather conditions. Easily Traps enclosed in aluminum are weather and dirt double thickness 6061-T6 aluminum to reduce sag. duty universal mounting plate fits masts up to 1½"

MOSLEY Electronics Inc.,

4610 N. Lindbergh Blvd.,

Bridgeton, Mo., 63044.

## The Listener

Continued from page 62

**Notes from EI's DX Club . . .** For you who are anxious to try for a ten-country award from our DX Club, we here present a list of ten countries that should make the task easy. All are heard easily throughout the U.S. and all carry numerous English-language broadcasts. Better yet, all will verify promptly if reports are sent via airmail. All times are EST and frequencies are those on which you're most likely to bag your quarry. The list:

- AUSTRALIA—R. Australia, Melbourne (11,710 kc, mornings; 9600 kc, 1200-1400)
- CANADA—R. Canada, Montreal (11,720 kc, afternoons; 9590 kc, evenings)
- COSTA RICA—TIFC, Faro del Caribe, Apt. 2710, San Jose (9645 kc, evenings)
- DENMARK—R. Denmark, Copenhagen (15,165 kc, afternoons)
- ECUADOR—HCJB, Cas. 691, Quito (9745 and 11,910 kc; 6050 kc, evenings)
- JAPAN—N.H.K., Tokyo (11,705 and 11,780 kc, 1830-1930)
- NETHERLANDS—R. Nederland, Hilversum (9585 kc, evenings)
- NEW ZEALAND—R. New Zealand, Wellington (9540 kc, after midnight)
- SWEDEN—Stockholm (11,705 kc, afternoons)
- SWITZERLAND—S.B.C., Berne (6165, 9535 and 9665 kc, 2030-2215)

In the event you're unable to pick up one of these stations, there's always our own Voice of America. For the record, all VOA reports should go to the Voice of America, Washington, D.C. 20025.

Since our Third Award Period will end

April 30, 1964, there's not much time left to get in under the wire. However, if you already have nearly enough QSL's in your collection to qualify for an Award, you may be able to obtain the additional ones you need in the time remaining. You'll find instructions on how to apply for your Award as well as an application form in the January 1964 issue of EI (p. 79).

Good DXing! —

## Switch to PTT

Continued from page 70

lay with shielded phono wire. Be sure to ground the shield near the point where the wires connect to the coils.

After all leads are transferred, remove the old switch from the panel and install the new mike connector in the same hole.

RY1's coil is energized by B+ from the power supply. To find the B+ point, look at the set's schematic and at ours. Our schematic shows two silicon diodes, a filter resistor and output filter capacitor. Physically, the tie-in point should be on a lug of the output filter capacitor.

In the conversion shown here, a new mike equipped with a push button replaced the old, buttonless mike. If your mike can be opened, install a spring-return slide or push-button switch to energize the relay and a three-conductor mike cable. One wire inside a shield is for the mike connection, the other is for the relay. —

## Super-Cold Super-Magnets

Continued from page 108

research laboratories, in fusion power and magneto-hydrodynamic generators, in electron-beam microscopes and in special microwave devices including masers.

Perhaps the most optimistic view comes from Dr. Guy Suits, who's director of research at GE. To his way of thinking, superconductivity may "revive the long-held hope that the phenomenon of zero electrical resistance can be used economically in the generation, transmission and application of bulk electric power." Naturally, he cautions, such applications still are highly speculative. But then, so too were Mr. Onnes' ideas back at the University of Leiden only 50-odd years ago. —

Continued from page 79

More questions brought us the information that the transmitter-receiver in this base unit normally remains in the transmit mode. When a call comes through on the land line, the transmitter beeps a signal to your shirt pocket. You then press the button on your wireless extension and this signal flips up the handset buttons. After that, it's conversation as usual, except that you must press a push-to-talk button each time you want to speak. When you're through, your phone is hung up automatically when the person on the other end puts his handset back in the cradle. That's the end of it.

Then, just before leaving, we noticed a cable of about half-inch diameter. It came out of that mystery box, snaked across the floor and disappeared through a mouse-size crack in the wall. Visions of relay racks full of equipment on the other side of the wall began to plague us. We asked about the cable.

"Oh, that?" the Chromalloy man said. "Why, that goes to a small power supply, that's all. In production models it will be built into the unit you see with the telephone."

That seemed a likely answer, though we never got the privilege of seeing what was through the crack. "Thanks," we said, and left.

But it still bothers us sometimes. What was on the other end of that cable?—R.D.F.

### Nickel-Cad Charger

Continued from page 73

compression spring fastened to the L-bracket will hold the batteries in place. Further construction details are covered in the captions.

**Using the Charger.** Connect J2 and J1 to the positive and negative battery terminals, respectively. Set R2 to maximum resistance (full counterclockwise) and set S2 for the appropriate meter range. Turn on AC power and rotate R2 until M1 indicates the correct charging current. The current generally is specified on the battery, as is the charging time—usually 14 to 16 hours.

If the charging current and time are not specified on the battery, the manufacturer will supply the information on request.

## LATEST SAMS BOOKS FOR EVERYONE IN ELECTRONICS



### USE THIS HANDY ORDER FORM

- Science Projects in Electronics.** Learn basic electronics principles by actually building fascinating projects. You begin with a demonstration of how to use the VOM, and progress to more advanced projects, so you gain an easy understanding of modern electronics systems. Order **SPJ-1**, only **\$2.95**
- Hi-Fi Projects for the Hobbyist.** Improve your present hi-fi or stereo system at minimum cost. Easy-to-build projects include: Rumble filter; noise filter; hi-gain antenna; transistorized microphone pre-amp; record player; tape recorder; FM tuner, etc. Order **HFF-1**, only **\$2.50**
- CB Radio Construction Projects.** Complete details for building valuable CB devices, such as S-meter, portable antenna, pocket monitor receiver, selective call system, field strength meter, modulation monitor, SWR meter, remote listening unit, etc. Order **CBG-1**, only **\$2.50**
- Science Projects in Electricity.** Uniquely planned science projects easily teach the facts about electric current flow; electrical units, terms, and circuits; magnetism; DC & AC; inductors & transformers; capacitors, etc. Order **SPE-1**, only **\$2.95**
- Transistor Ignition Systems Handbook.** Clearly explains the principles, installation and tuning up of these new transistor ignition systems which are revolutionizing the auto industry. Order **IGS-1**, only **\$2.50**
- Amateur Radio Construction Projects.** Shows how to build 40-80 meter band novice transmitter, 30-watt 15, 40, 80 meter transmitter, balun antenna matching unit, crystal-controlled converters, etc. Full building instructions. Order **ARP-1**, only **\$2.50**
- Science Projects in Electricity/Electronics.** Demonstrates basic principles of electricity and electronics through the construction of fascinating projects that are not only instructive but useful. Ideal for self-learning or as science class project guide. Order **SPN-1**, only **\$2.95**
- Computer Circuit Projects You Can Build.** Starting with a simple flip-flop circuit, this book details the construction of 13 basic analog and digital computer-circuit projects. You not only learn computer circuitry but build useful devices as well. Order **BOC-1**, only **\$2.95**
- How to Read Schematic Diagrams.** **RSD-1**..... **\$1.50**
- Radio Receiver Servicing.** **RS-2**..... **2.95**
- Modern Dictionary of Electronics.** **DIC-2**..... **6.95**
- TV Servicing Guide.** **SGS-1**..... **2.00**
- Handbook of Electronic Tables & Formulas.** **HTF-2**... **3.95**
- Electronic Experiments & Projects.** **ESE-1**..... **2.50**
- Tube Substitution Handbook.** **TUB-7**..... **1.50**
- 101 Ways to Use Your VOM & VTVM**..... **2.00**
- Understanding Transformers & Colls.** **TAC-1**..... **1.95**
- Howard W. Sams & Co., Inc. Famous ABC's Books**
- Electronics Drafting.** **DRA-1**..... **1.95**     **Transistors.** **TRA-1**..... **1.25**
- Electronic Test Equipment.** **STE-1**..... **1.95**     **Electronic Organs.** **ECO-1**..... **1.95**
- Electronics.** **ELW-1**..... **1.95**     **Lasers & Masers.** **LAL-1**..... **1.95**
- Short-Wave Listening.** **SWL-1**..... **1.95**     **Computers**..... **1.95**

### HOWARD W. SAMS & CO., INC.

Order from any Electronic Parts Distributor or mail to Howard W. Sams & Co., Inc., Dept. EI-5, 4300 W. 62nd St., Indianapolis 6, Ind.

Send books checked above. \$ \_\_\_\_\_ enclosed.

Send FREE Booklist.     Send Photofact Index.

Name \_\_\_\_\_

Address \_\_\_\_\_

City \_\_\_\_\_ Zone \_\_\_\_\_ State \_\_\_\_\_

IN CANADA: A. C. Simmonds & Sons, Ltd., Toronto 7

## Good Reading

Continued from page 87

fects for a home-produced melodrama.

While the author explains specialized types of recorders and how you may want to make use of them, his book won't tell you how to choose the best recorder for some particular purpose. But it will introduce you to countless ways to enjoy tape more fully, which is precisely what the author set out to do.

### **M**OTOROLA HIGH-SPEED SWITCHING TRANSISTOR HANDBOOK.

Edited by William D. Roehr. Motorola Semiconductor Products, Box 995, Phoenix, Ariz. 346 pages. \$2.50

Aimed at engineers rather than hobbyists, this volume is jam-packed with information on the switching characteristics of transistors, with more detailed charts and tables than any transistor designer's handbook I've seen. If you are involved with transistor design beyond the hobby stage, here is an excellent, economical reference to keep handy.

**H**I-FI PROJECTS FOR THE HOBBYIST. By Leonard Feldman. Howard W. Sams & Bobbs-Merrill, New York & Indianapolis. 128 pages. \$2.50

Current hi-fi equipment comes loaded with enough knobs and what-not to wire up the family dog for sound. But price tags often are loaded, too, and there is good argument for taking some basic (or older) equipment and adding the frills yourself—the ones you want and can afford.

This book offers a number of good and easy-to-build projects for making a hi-fi system more versatile. Some go slightly astray: if you have to add a tuning eye to an FM tuner, chances are that the original tuner is just too rudimentary to give you good reception.

But many others—rumble and scratch filters, a stereo FM adaptor, a multiple-speaker switch and a high-gain FM antenna—are decidedly worthwhile. And all of the projects are well thought out. Thanks to such considerate extras as how to design and etch your own printed circuit boards, most of them promise to be unlaborious fun.

And make note of . . .

**COLOR TV SERVICING MADE EASY.**

By Wayne Lemons and Carl Babcoke. Sams. 192 pages. \$2.95

**DICTIONARY OF MODERN ACRONYMS AND ABBREVIATIONS.** By Milton Goldstein. Sams. 158 pages. \$4.95

**ABC'S OF BOOLEAN ALGEBRA.** By Alan Lytel. Sams. 112 pages. \$1.95

**ELEMENTS OF TRANSISTOR TECHNOLOGY.** By Robert G. Middleton. Sams. 288 pages. \$6.95

**UNDERSTANDING AND USING THE SLIDE RULE.** Sams. 96 pages. \$1.95

## Inside Radio Moscow

Continued from page 31

interference. But at least one transmitter probably will get through.

While unconfirmed, most experienced short-wave listeners have an idea that Radio Moscow employs many different sites for its transmitters in hopes of finding a crack through the auroral shield. Our table lists all known frequencies utilized by Radio Moscow. But you'll note that the Russians maintain a separate service for the Pacific coast on different frequencies and at a later hour.

**The Answer.** Now that you have more than casual acquaintance with the Soviet radio propaganda machine, at least as directed toward Americans, you probably are about to ask a question. Why bother with Radio Moscow? Why wouldn't it be best just to ignore the whole mess, turning the dial a little faster every time you chance to hit upon one of Moscow's many frequencies?

Well, as far as entertainment goes, you certainly wouldn't be missing much. But what happens when you stumble across a true Leftist? It won't do merely to call him a liar. Chances are, his facts have been selected as carefully as Radio Moscow's. They will prove to be quite accurate.

No, there is only one way to fight. Know Soviet arguments in advance, then get those facts which put the picture back in focus. By all means, listen to Radio Moscow. But strive for the truth and the whole truth and nothing but the truth. The Voice of America, the BBC, local news services, books and magazines are good antidotes. And, coupled with a level head, all are potent medicine for that powerful short-wave voice from the other side of the Iron Curtain.

## 6X Audio Generator

Continued from page 93

put at J2 or you don't build in the VU meter, temporarily connect an AC VTVM across R18 and follow the 1-volt output procedure. Set S2 to 100 and S1 to X10 for a 1,000 cps output.

Set R9 to mid-position and turn on AC power. Allow five minutes for warmup, then adjust R9 for a reading of 100 per cent on M1. If you don't use M1 or you use the output at J2, adjust R9 for 1-volt rms on the VTVM. The calibration for a 3V output is the same. Don't adjust R9 to get more than 3 volts out of the generator or the distortion will increase.

If you have set up the generator for a 1-volt output, make certain it starts on all frequencies. Beginning with 20 cps, switch through all frequencies. At each frequency, the output voltage should bounce, then stabilize. If there is no output at a particular frequency or if the output voltage pulsates, the two capacitors for that frequency have too great a mismatch and they must be trimmed. A 5-mmf capacitor usually will do the job. Connect it across each capacitor until the generator starts.

Capacitor mismatch also can be caused by the distributed capacity of the wiring. At low frequencies where capacitor values are high, this won't be a problem. From 20 to 50 cps (and multiples thereof) the output will be fairly constant. Matching may only be required above 50 cps. For experimenter use, the generator's performance without matching is more than adequate.

This is the way the generator is used: if you've set it up for a maximum output of 3 volts and need a 3-volt output at a particular frequency, set S4 to 3V. Then adjust R20 so M1 indicates 100 per cent. The output voltage is now exactly 3 volts. Turn R20 to reduce the output by 3, 6, or 10db. In other words, R20 is used to produce the same output voltage regardless of the frequency you've selected.

If, when you switch to a high frequency, the output voltage falls, adjust R20 to bring M1 back to 100 per cent, or whatever level you want. If you've set up the generator so its maximum output is 1 volt, the positions on S4 will now correspond to 1, .1, .01 and .001 volts.

# now there are 3 time & tool-saving double duty sets

New PS88 all-screwdriver set rounds out Xcelite's popular, compact convertible tool set line. Handy midgets do double duty when slipped into remarkable hollow "piggyback" torque amplifier handle which provides the grip, reach and power of standard drivers. Each set in a slim, trim, see-thru plastic pocket case, also usable as bench stand.

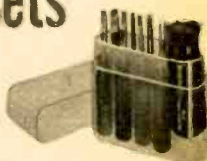

**PS88**  
5 slot tip,  
3 Phillips  
screwdrivers

### PS7

2 slot tip,  
2 Phillips  
screwdrivers,  
2 nutdrivers



**PS120**  
10 color  
coded nutdrivers



# XCELITE

XCELITE INC. • 16 BANK ST., ORCHARD PARK, N. Y.  
Please send free literature N563.

name \_\_\_\_\_

address \_\_\_\_\_

city \_\_\_\_\_

state & zone \_\_\_\_\_

Continued from page 33

these units and the best magnetics. But the differences are subtle, to say the least. And it's safe to say that all three are as kind to records as any magnetic. In other words, the ceramic no longer has to be a heavy-tracking, uncompliant destroyer of record grooves.

**Getting down to cases**, each of the three new ceramics has a recognizable sound of its own (and so, too, do even the best magnetics). The Decca and the Sonotone both are a bit on the bright side; the Weathers has a mellow overall quality. All three have low moving mass. The Weathers and the Sonotone also have ultra-high compliance. This means that all will track well at 2 grams in a good arm. Matter of fact, the Weathers will track at one gram in its own arm if the record is immaculately clean.

The Decca, of an ingenious design with a heavy-looking but actually ultra-light stylus bar, delivers well-defined sound even on the loudest and most complex musical material. And it seems to have no trouble with passages that cause annoying break-up in some magnetics.

The Weathers, sent to me pre-installed in the company's turntable/arm combination, was inclined to pick up dirt on its stylus at its pre-set tracking force of one gram. With a Dust Bug set up to clean records as the Weathers played them, though, the LDM handled tough passages beautifully. It delivered smooth sound throughout its range, with bass that was particularly impressive.

The Sonotone, deliberately designed with rolloff above 17,000 cps to avoid unnecessary resonances from the vinyl material of discs, also sounded clean. Regardless of what you think of this ultrasonic rolloff, the fact remains that the Sonotone's sound is fully as good as the company claims. It, too, will handle complex passages without breakup.

**But what does the new breed of ceramics offer in direct comparison with magnetics?** Well, the answer varies in these three examples. For anyone whose amp/preamp combination is less than the best, all three offer not only good but hum-free sound. Even when connected to a low-level magnetic phono input, they don't permit induced hum.

Both the Decca and the Sonotone also can be connected to a high-level input to eliminate hum from an economy amplifier's pre-

amp stage; their output, while less than half the figure for cruder ceramics, is adequate enough to enable them to bypass preamp circuitry. And, with both the Decca and the Sonotone, price is a potent factor. They're 20 bucks each.

The Weathers LDM is a slightly special case. It is designed only for preamp inputs and its price-tag reads \$39.50. Then, too, it obviously is meant for mounting in a Weathers arm; it takes skill and patience to get this cartridge into a standard arm. To balance these factors, however, there is excellent sound, ultra-low tracking force and no possibility of induced hum.

All in all, these three manufacturers can take a bow for proving that ceramic sound doesn't have to be second rate. Their new ceramics sound as good as the majority of magnetics (and, in the case of the Sonotone and the Decca, at half the price).

**Without much fanfare**, the makers of magnetic tape have been busy improving their product. And, chances are, you'll be able to hear the results on your own recorder before long. To my way of thinking, the biggest breakthrough is the 3M Company's new higher-output tape. Designed mainly for studio use, it offers a tremendous jump (4-6db, that is) in signal-to-noise ratio. And it purportedly does so without added print-through problems.

I don't know what the new tape's designation will be when it's offered for home use. But I've heard what it can do for studio recordings. And I know it's bound to make a hit with perfectionists who despise tape hiss almost as much as the sound of chalk squeaking across a blackboard.

Still another new tape is Soundcraft's Golden Tone. I haven't had a chance to try it out yet, but it promises to rival the Scotch high-output tape right down the line. Both products are something to watch for, since both will be worth their premium price to a lot of home recordists.

Also meriting mention is the line of tape Eastman Kodak is making. The news here, in addition to superb sound quality, is a triacetate backing which Kodak calls Durol. Much stronger than standard acetate, Durol will take quite a bit of abuse. And when it reaches the point of no return, it breaks cleanly instead of stretching—thus taking care of one of the few complaints leveled against polyester tapes. ●



# ANY WAY YOU LOOK AT IT!

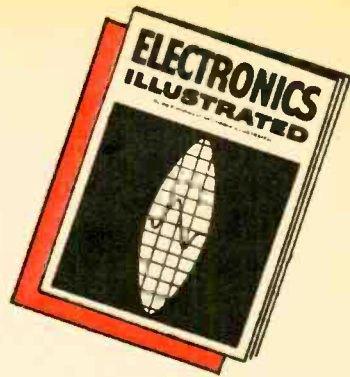

There's only one magazine—**ELECTRONICS ILLUSTRATED**—that's the best for all electronic hobbyists. And there's only one way to make sure you don't miss a single feature-packed issue of EI... by subscribing *now!* Take advantage of our special get-acquainted subscription offer—six issues of EI for only \$1.98. Fill in the coupon and mail it today!

ELECTRONICS ILLUSTRATED  
Circulation Department  
Fawcett Building  
Greenwich, Connecticut

5-64

**YES!** I want to take advantage of your special get-acquainted offer. Please enter my subscription right away.

- I enclose \$1.98  
 New order

- Bill me later  
 Re-order

NAME.....

ADDRESS.....

CITY.....ZONE.....STATE.....

**6 issues for only \$1.98**

## Radio At 100 Billion Cycles

*Continued from page 46*

fiedly successful as yet but recent developments suggest that a true breakthrough may be just around the corner. For example, Sperry recently produced two backward-wave oscillators weighing only 7 lbs. apiece and no larger than a pair of healthy power transformers. The catch: power output is only 45 milliwatts, sometimes less. Again, Sylvania has developed a battery-powered portable millimeter radio system. The drawback: ground range is a mere half-mile. Still another firm, RCA, is experimenting with a beam-plasma amplifier that might supply tens of watts at frequencies up to 100 million mc (or 100,000 gc, if you prefer). Problem: it has yet to be perfected.

In short, scientists still haven't succeeded in getting millimeter waves completely under control. But when they do, they will have cracked the last nut in the spectrum—the strange region where frequencies reach billions of cycles and radio is almost light.

—Saunders Harris

## CB Dipper

*Continued from page 84*

(with C1) a signal from your transmitter or antenna and adjust the transmitter's final or the antenna for a peak indication on M1. Adjust R4 for any convenient indication on M1 and tune C1 for highest indication.

To calibrate the Dipper to known frequencies, first set the continuous-tuning dial on a CB receiver to the desired channel. Then adjust C1 until you hear the Dipper's signal in the speaker, or for a peak indication on the S-meter. Mark the channel opposite C1's pointer. Greater accuracy can be achieved if the receiver is set on a crystal-controlled receive channel.

To service a receiver that is inoperative, tune in a signal from the transmitter on the Dipper with S1 in *REC.* Without touching the Dipper's tuning knob, set S1 to *OSC* and you'll have a known-frequency signal that's the same frequency as the transmitter's for trouble shooting the receiver. You can now use the signal from the Dipper to peak the receiver's RF and IF stages.

# ELECTRONICS ILLUSTRATED

## Classified Ads

Your advertisement can reach this mail-buying audience for only 50¢ per word . . . payable in advance (Check or M.O. please) . . . minimum 10 words. Closing dates are the 20th of 4th preceding month i.e. copy for the September issue must be in our office by May 20th. Mail to ELECTRONICS ILLUSTRATED, 67 West 44th St., New York 36, N. Y. Word count: Zone number free. Figure one word: Name of state (New Jersey), name of city (New York); sets of characters as in key (14-D); also abbreviations as 35MM, 8x10, D.C., A.C.

### SAVE MONEY • ORDER BY MAIL

#### • • • FOR SALE

**EXCELLENT BUYS** on Tubes and equipment all listed in the "Green Sheet." Send .25¢ for your copy today. Cash paid for unused tubes. Write: Barry Electronics Corp., 512 Broadway, Dept. E1, NYC 12, NY.

**CONVERT ANY** television to sensitive, big-screen oscilloscope. Only minor changes required. No electronic experience necessary. Illustrated plans, \$2.00. Relco-A19, Box 10563, Houston 18, Texas.

**CANADIANS—GIANT** Surplus Bargain Packed Catalogs. Electronics, Hi-Fi Shortwave Amateur Citizens Radio. Rush \$1.00 (Refunded). ETCO, Dept. E1, Box 741, Montreal.

**INVESTIGATORS, WRITE** for free brochure on latest subminiature electronic listening devices. Dept.-5X, Ace Electronics, 11500 NW 7th Ave., Miami 50, Florida.

**TRANSISTORIZED PRODUCTS** Importers Catalog, \$1.00, Intercontinental, C.P.O. 1717, Tokyo, Japan.

**GOVERNMENT SURPLUS.** How and Where to Buy in Your Area. Send \$1.00. E.I. Surplus Information, Headquarters Bldg., Washington 6, D. C.

**CB TRANSMITTERS** \$6.00. Other bargains, catalog 10¢. Vanguard, 190-48—99th Ave., Hollis, N. Y. 11423.

**ELECTRONIC PARTS** Catalog; lowest prices anywhere. Free. Knapp's, 3174-8th Ave., Largo, Florida.

**SENSATIONAL NEW** transistor treasure finders locate buried gold, silver, coins. Kits, assembled models from \$19.95. Free catalog. Relco-A19, Box 10563, Houston 18, Texas.

**MAGNET WIRE,** Small Lots. Prather Bant Co., 19105 Allen, Melvindale, Michigan.

#### • • • BUSINESS OPPORTUNITIES

**MAKE \$25-\$50 WEEKLY** clipping newspaper items for publishers. Some clippings worth \$5.00 each. Particulars free. National, Box 718, Long Beach, New York.

**\$100 WEEKLY POSSIBLE.** Address-Mail letters featuring real merchandise. Get \$10 orders in every mail—keep \$8 profit. Everything furnished. Details free. National Plans, Box 718, Long Beach, New York.

**MAKE \$100.00 FAST** sewing, assembling our products. Materials supplied! FMN, DeFuniak Springs 15, Florida.

**VENDING MACHINES—**No selling. Operate a route of coin machines and earn high profits. 32-page catalog free! Parkway Machine Corp., 715E1 Ensor St., Baltimore 2, Md.

#### • • • EMPLOYMENT OPPORTUNITIES

**PRINTING - ADVERTISING SALESMEN.** Excellent moneymaking sideline selling Decalcomania Name Plates. Advertising Specialties. Sign letters, Automobile initials. Free Samples. "Ralco"—E1, Box L, Boston 19, Mass.

#### • • • EDUCATION & INSTRUCTION

**UNIT MEASURE,** Intro \$1. Landsite E, 12167 Gay Rio Ter, Lakeside, Calif. 92040.

#### • • • BUILD IT YOURSELF

**PROFESSIONAL ELECTRONIC** Projects—Organs, Timers, Computers, etc.—\$1 up. Catalog Free. Parks, Box 1665, Seattle, Wash. 98125

#### • • • TAPE RECORDERS

**LEARN WHILE ASLEEP** with your recorder, phonograph or amazing new "Electronic Educator" endless tape recorder. Details free. Sleep-Learning Research Association, Box 24-E1, Olympia, Washington.

**TAPE RECORDERS** Hi-Fi Components. Sleep Learning Equipment, tapes. Unusual values. Free Catalog. Dressner, 1523 Jericho Tpke., New Hyde Park-4, N. Y.

**RENT STEREO Tapes—**over 2500 different—all major labels—free brochure. Stereo-Parti, 1616-AY Terrace Way, Santa Rosa, California.

#### • • • RADIO & TV

**15 DISTANCE ONE-TUBE** Plans — 25¢; One-tube Handbook — 50¢. Includes Transistor experiments, catalog. Laboratories, 1131-K Valota, Redwood City, California.

**DIAGRAMS FOR** repairing radios \$1.00. Television \$2.50. Give make model. Diagram Service Box 1151E1, Manchester, Conn. 06042.

**TELEFIXIT.** ALLTIME Bestseller Nontechnical TV Repair Book With Famous Troubleshooting Charts. 60¢ Postpaid. 2 For \$1.00. Telefixit, Box 714, Manhasset 2, New York.

**BEFORE YOU Buy** Receiving Tubes, Test Equipment, Hi-Fi Components, Kits, Parts, etc. . . . send for your Giant Free Zalytron Current Catalog, featuring Standard Brand Tubes: RCA, GE, etc.—all Brand New Premium Quality Individually Boxed, One Year Guarantee—all at Biggest Discounts in America! We serve professional servicemen, hobbyists, experimenters, engineers, technicians. Why Pay More? Zalytron Tube Corp., 461 Jericho Turnpike, Mineola, N. Y.

**TV TUNERS** rebuilt and aligned per manufacturers specification. Only \$9.50. Any make UHF or VHF. We ship COD. Ninety day written guarantee. Ship complete with tubes or write for free mailing kit and dealer brochure. JW Electronics, Box 51X, Bloomington, Indiana.

**TEST INSTRUMENTS,** ham gear, radios. Free catalog. Tattershall Manufacturing Co., Hamilton, Mo.

**RADIO & T.V. Tubes—**33¢. Free List. Cornell, P. O. Box 5412, San Diego, California. 92105.

#### • • • INVENTIONS & INVENTORS

**PATENT SEARCHES,** \$6.00! Free "Invention Record"/Information. Miss Hayward, 1029 Vermont, Washington 5, D. C.

#### • • • DETECTIVES

**DETECTIVE PROFESSION.** Easy home study plan. Lapel pin, certificate, future. Free information. Professional Investigators, 2759CJ-W, Broadway, Los Angeles 41, California.

#### • • • MISCELLANEOUS

**WINEMAKERS — STRONGEST** Formulas! Wonderful Flavor! Complete Instructions, \$2.00 Postpaid. (Supplies, Hydrometers Price List Included!). Research Enterprises, 29-85 Samoset Road, Woburn, Mass.

**TREASURE, GOLD, Silver, Relics.** Find them with new 1964 models. Free information. Raytron, Dept. 5-L, Box 715, North Hollywood, California.

**"WINEMAKING" HOBBYISTS** rare, hard-to-find Recipes. Send \$1.00. Supply, Hydrometer Catalog with Order. Interstate Products, Box 1-YC2, Pelham, New Hampshire.

**HYPNOTIZE** quickly, effortlessly, or refund! \$2.00. Request free catalog. Hypnomode, Box 244-PM, Cedarburg, Wisconsin.

## ANTICIPATION

He's contemplating the strategy of a summer's day...  
a shallow stream... a supple rod... a smooth cast.

Each pool... each bank becomes a new test of his  
artistry and ingenuity.

What tapered leader?... What sized hook?... Will it  
be Royal Coachman or Whirling Dun... Brown Spider  
or Gray Hackle?

Within these pages he finds information and prod-  
ucts that enlarge his desires... enhance his prowess.

His fulfillment depends upon experience...  
tenacity... knowledge...

... and he reads this magazine, just as you do.

**MPA** MAGAZINES / YOUR WORLD OF IDEAS AND PRODUCTS!



# RAD-TEL'S

QUALITY

# BRAND NEW TUBE SALE!

LOW, LOW PRICES--COMPARE

UP TO **75%** OFF\*

\*Manufacturers Suggested List Price

## ONE YEAR GUARANTEE

RAD-TEL WILL REPLACE ANY TUBE THAT DOES NOT GIVE EFFICIENT PERFORMANCE FOR 1 YEAR FROM DATE OF PURCHASE.

## ONE DAY SERVICE OVER 500 TYPES IN STOCK

ORDER TYPES NOT LISTED

• **FREE!** Send For New Tube & Parts Catalog •  
• **FREE!** Send For Trouble Shooting Guide •



### TUBE SUBSTITUTION BOOK

**\$1.25**  
No. 193

- Over 11,000 direct tube substitutes
- Only all-inclusive directory of electron tube equivalents:
  - For USA electron tubes
  - Substitutes for foreign tubes
  - Picture tubes, newer models
  - Picture tubes, older models
  - transistor replacements
  - Army-Navy, V.T. substitutes



### CHEATER CORD

Easy to work on set while panel is off.  
6 ft., No. 154..... **29¢ ea.** Lots of 3—**25¢ ea.**



## RAD-TEL TUBE CO. TV, RADIO AND HI-FI

DEPT. EI 55 CHAMBERS STREET, NEWARK, NEW JERSEY 07105

TERMS 25% deposit must accompany all orders, balance C.O.D. Orders under \$5 add \$1 handling charge plus postage. Orders over \$5 plus postage Approx. 8 tubes per 1 lb. Subject to prior sale. No C.O.D.s outside continental USA.

Fast, Dependable service — Setting direct by mail for over 16 years

RAD-TEL Tube Co.

Dept. EI

55 Chambers Street

Newark, New Jersey 07105

Total Tubes \$ \_\_\_\_\_  
Total Part(s) \$ \_\_\_\_\_  
Postage \$ \_\_\_\_\_  
Grand Total \$ \_\_\_\_\_

ENCLOSED IS \$ \_\_\_\_\_ Please rush order.

SEND: — TUBE SUBSTITUTION BOOK, No. 193 @ 1.25 EACH

— Cheater Cord 29¢ ea. Lots of 3— 25¢ ea. #154

Orders under \$5.00 - Add \$1.00 handling charge - plus postage.

**FREE!**

- Send FREE Tube and Parts Catalog
- Send FREE Trouble Shooting Guide

NAME \_\_\_\_\_

ADDRESS \_\_\_\_\_

CITY \_\_\_\_\_

ZONE \_\_\_\_\_

STATE \_\_\_\_\_

### EACH TUBE ATTRACTIVELY BOXED & BRANDED RAD-TEL

Qty.	Type	Price	Qty.	Type	Price	Qty.	Type	Price	Qty.	Type	Price
—	024	.79	—	6AU8	.87	—	6K6	.83	—	12CU5	.58
—	1AX2	.82	—	6AV6	.41	—	6X4	.52	—	12CUG	1.06
—	1B3	.79	—	6AW6	.90	—	6SA7GT	.99	—	12CX6	.54
—	1DN5	.55	—	6AX4	.66	—	6SN7	1.02	—	12D4	.69
—	1E3	.79	—	6AX5	.74	—	6S17	.88	—	12D8	.83
—	1J3	.79	—	6BA6	.50	—	6SK7GT	.95	—	12DL8	.88
—	1K3	.79	—	6BC5	.81	—	6SL7GT	.65	—	12DQ6	1.04
—	1R5	.77	—	6BC8	1.04	—	6SN7	.65	—	12D57	.84
—	1S5	.75	—	6BE6	5.55	—	6SQ7GT	.94	—	12DT5	.76
—	1T4	.72	—	6BF5	.90	—	6T4	.93	—	12DT7	.79
—	1U5	.65	—	6BF6	.44	—	6T8	.85	—	12DT8	.78
—	1X2B	.82	—	6BG6	1.70	—	6U8	.83	—	12DW8	.89
—	2AF4	.96	—	6BH8	.98	—	6V6GT	.54	—	12DX6	.62
—	3AL5	.46	—	6BJ6	.65	—	6W4	.61	—	12E05	.62
—	3AU6	.54	—	6BJ7	.79	—	6W6	.71	—	12E66	.82
—	3AV6	.42	—	6BK7	.85	—	6X4	.41	—	12EK6	.62
—	3BC5	.63	—	6BL7	1.09	—	6X8	.80	—	12EL6	.50
—	3BN6	.75	—	6BN6	.74	—	7A8	.68	—	12EF6	.57
—	3BU8	.78	—	6BQ6	1.12	—	7AU7	.65	—	12F8	.66
—	3BY6	.58	—	6BQ7	1.00	—	7EY6	.75	—	12FA6	.79

—	3BZ6	.56	—	6BU8	.70	—	7Y4	.69	—	12FM6	.50
—	3CB6	.56	—	6BX7	1.11	—	8AU8	.90	—	12FR8	.97
—	3CS6	.58	—	6BZ6	.55	—	8AW8	.93	—	12FX8	.90
—	3DG4	.85	—	6BZ7	1.03	—	8BQ5	.60	—	12GC6	1.06
—	3DK6	.60	—	6C4	.48	—	8C7	.63	—	12J8	.84
—	3DT6	.54	—	6CB6	.55	—	8CM7	.70	—	12K5	.75
—	3GK5	.98	—	6CD6	1.51	—	8CN7	.97	—	12L6	.73
—	3Q4	.63	—	6C7	.81	—	8CS7	.74	—	12SF7	.69
—	3S4	.75	—	6C8	.80	—	8EB8	.94	—	12SK7GT	.95
—	3V4	.63	—	6CM7	.79	—	8F47	.56	—	12SL7	.80
—	4BQ7	1.01	—	6CQ8	.69	—	9CL8	.79	—	12SN7	.67
—	4CS6	.61	—	6CN7	.70	—	11CY7	.75	—	12SQ7GT	.91
—	4DT6	.55	—	6CQ8	.92	—	12A4	.60	—	12U7	.62
—	4GM6	.60	—	6CR6	.60	—	12AB5	.60	—	12VC	.63
—	5AM8	.79	—	6CS6	.57	—	12AC8	.55	—	12W6	.71
—	5AN8	.90	—	6CS7	.69	—	12AD6	.57	—	12X4	.47

### RAD-TEL TUBE CO. NOT AFFILIATED WITH ANY OTHER MAIL ORDER TUBE COMPANY

—	5AQ5	.54	—	6CU5	.58	—	12AE6	.50	—	17AX4	.67
—	5AT8	.83	—	6CU6	1.08	—	12AE7	.94	—	17DQ6	1.06
—	5BK7	.86	—	6CY5	.70	—	12AF3	.73	—	18FW6	.49
—	5BQ7	1.01	—	6CY7	.71	—	12AF6	.67	—	18FX6	.53
—	5BR8	.83	—	6DA4	.68	—	12AJ6	.62	—	18FY6	.50
—	5CG8	.81	—	6DE6	.61	—	12AL5	.47	—	19AU4	.87
—	5CL8	.76	—	6DG6	.62	—	12AL8	.95	—	19BG6	1.39
—	5CQ8	.84	—	6DJ8	1.21	—	12AQ5	.60	—	19EA8	.79
—	5EAB	.80	—	6DK6	.59	—	12AT6	.50	—	19T8	.85
—	5EU8	.80	—	6DN6	1.55	—	12AT7	.76	—	21EX6	1.49
—	5J6	.72	—	6DR6	1.10	—	12AU6	.51	—	25AX4	.70
—	5T8	.86	—	6DT5	.91	—	12AU7	.61	—	25C5	.53
—	5U4	.60	—	6DT6	.53	—	12AV6	.41	—	25CA5	.99
—	5U8	.84	—	6DT8	.94	—	12AV7	.82	—	25CD6	1.52
—	5V6	.56	—	6EA8	.79	—	12AX4	.67	—	25CUG	1.11
—	5X8	.82	—	6EB5	.73	—	12AX7	.63	—	25DN6	1.42

—	5Y3	.46	—	6EB8	.84	—	12AY7	1.44	—	25EH5	.55
—	6AB4	.46	—	6EM5	.77	—	12AZ7	.86	—	25L6	.57
—	6AC7	.96	—	6EM7	.82	—	12B4	.68	—	25W4	.68
—	6AF4	1.01	—	6EU8	.79	—	12BD6	.50	—	32ET5	.55
—	6AQ5	.70	—	6EV5	.75	—	12BE6	.53	—	35C5	.51
—	6AH4	.81	—	6EW6	.57	—	12BF6	.60	—	35L6	.60
—	6AH6	1.10	—	6EY6	.75	—	12BH7	.77	—	35W4	.42
—	6AK5	.95	—	6F67	.69	—	12BK5	1.00	—	35Z5	.60
—	6AL5	.47	—	6FV8	.79	—	12BL6	.56	—	36AM3	.36
—	6AM8	.78	—	6GH8	.80	—	12BQ6	1.16	—	50B5	.69
—	6AQ5	.93	—	6GK5	.61	—	12BR7	.74	—	50C5	.53
—	6AS5	.60	—	6GK6	.79	—	12BV7	.76	—	50EH5	.55
—	6AT6	.49	—	6GN8	.94	—	12BV7	.77	—	50L6	.61
—	6AT8	.88	—	6H6	.58	—	12BZ7	.86	—	70L7	.97
—	6AU4	.85	—	6J5GT	.51	—	12CN5	.56	—	117Z3	.85
—	6AU6	.52	—	6J6	.71	—	12CR6	.67	—	807	.75

**NEW! DIFFERENT!**

**EXCITING!**

**Men 17-55...Prepare**

**Now for a Real Job in  
Space and Missile  
Electronics**

**NO ADVANCED  
EDUCATION  
REQUIRED!**

To help you **EARN GOOD MONEY** later in industry, DeVry's modern training provides a thorough grounding in basics . . . then develops your skill. Thus, there is no need for advanced education or previous technical experience at the start. Whether you prepare in your spare time at home or in our well-equipped Laboratories, DeVry helps you become a well-trained technician, ready for a real career in Electronics.

**BUILD  
AND KEEP  
VALUABLE  
EQUIPMENT!**



You build the 5-inch streamlined commercial type oscilloscope and the transistorized, portable meter above. This test equipment is similar in every way to the latest design used on today's jobs — with function grouped controls and meter scales color-keyed to the panel markings. And you keep this valuable equipment; you'll use it both in your training and on the job.



**FROM RADIO TO ROCKET ELECTRONICS**

Front Pages have been full of stories about "Men in Orbit" and "Outer Space Race." With headlines about Vanguards, count-downs, launching pads, the miracles of **ELECTRONICS IN SPACE** are exciting the Free World.

But there is **BIG NEWS** on the "Help Wanted" pages too! The Space Age has touched off another wave of opportunity for trained men in Electronics jobs ranging all the way from Radio and Television to Communications, Radar, Broadcasting, Automation, Industrial Electronics, Missile Work, etc. Yes, "Electronics" today spells **OPPORTUNITY IN CAPITAL LETTERS**.

"What does that mean to me?" you ask. Just check yourself. Are you 17-55? Are you handy with simple tools? Can you follow step-by-step instructions? Are you ambitious enough to invest a few hours of your spare time each week?

If your answer is "Yes," then when you are trained Electronics may be your path to better living, money, excitement, more security, future. Here's more good news: you don't need to leave home or quit your present job—to prepare for many of the opportunities Electronics offers. DeVry's **SPARE TIME** program is an answer!

**CONTINUOUS EMPLOYMENT and COUNSELING SERVICE**

DeVry's 33 years in Electronics training has won us wide and respected contact with many key placement people in the industry. Thus, when you become a DeVry graduate you are, from then on, entitled to our highly effective Counseling and Employment Service.

**DRAFT AGE?** If you are subject to military service, we have valuable information for you.

**TURN PAGE FOR MORE FACTS...**

**MAIL POSTAGE-FREE CARD NOW!**

**DeVRY TECHNICAL INSTITUTE**  
4141 Belmont Ave., Chicago, Illinois 60641, Dept. EI-5-U

Please give me your two free booklets, "Pocket Guide to Real Earnings" and "Electronics in Space Travel"; also include details on how to prepare for a career in Electronics. I am interested in the following opportunity fields (check one or more):

- Space & Missile Electronics
- Television and Radio
- Microwaves
- Radar
- Automation Electronics
- Communications
- Computers
- Broadcasting
- Industrial Electronics
- Electronic Control

Name \_\_\_\_\_ Age \_\_\_\_\_

Address \_\_\_\_\_ Apt. \_\_\_\_\_

City \_\_\_\_\_ Zone \_\_\_\_\_ State \_\_\_\_\_

Check here if you are under 16 years of age.  
Canadian residents: Write DeVry Tech of Canada, Ltd.  
970 Lawrence Avenue West, Toronto 19, Ontario

**2 FREE  
BOOKLETS**

**GIVE YOU FACTS ON HOW  
YOU MAY GET STARTED!**

# WHETHER IT'S RADIO-TV OR MISSILE ELECTRONICS...

## Get Your Training From DeVry! PREPARE FOR A VARIETY OF GOOD JOBS

Hundreds and hundreds of companies in the vast Electronics industry are on the lookout for trained technicians. They seek men to help build, test, install and service a wide variety of Electronic devices. To men with skill in Electronics, these firms offer GOOD-PAYING JOB OPPORTUNITIES, such as those shown below . . . and others.

What's more, the trained man can start his OWN BUSINESS in Electronics, when he has all the advantages of preparing the DeVry way.

Why not see for yourself how YOU may get ready with DeVry's help to enter and prosper in Electronics . . . one of history's fastest-moving fields! Mail the coupon now.

### WHAT SOME DeVRY TECH GRADUATES ARE DOING

Edward Hahn, Illinois, was a laborer. Now he is an Electronic Senior Engineer with the Martin Company, a large producer of missiles.  
Dale L. Gawthorpe, Illinois, left a clerk's job to take the DeVry program. He is now enjoying his work with automatic pilot equipment at Sperry Phoenix Company.  
Charles Morishita, Oregon, worked as a farmer before taking DeVry's training. Now he builds and tests equipment at Lockheed's Space and Missile Division.  
Gerald R. Borner, Washington, has found his DeVry training a valuable aid on his job as Radar Technician in Boeing Airplane Company's Aero Space Division.

### A FEW OF THE MANY JOB OPPORTUNITIES!

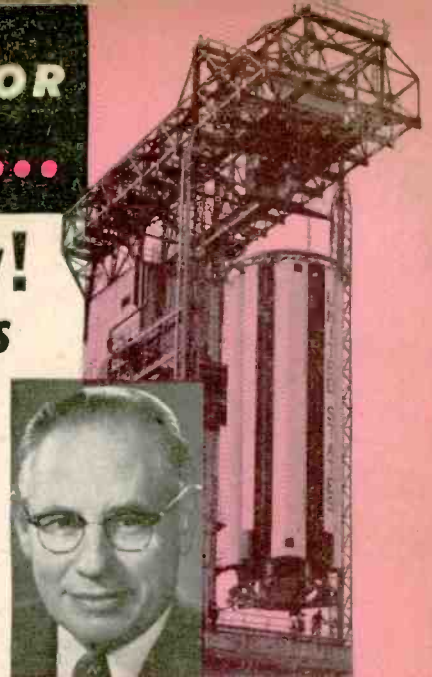
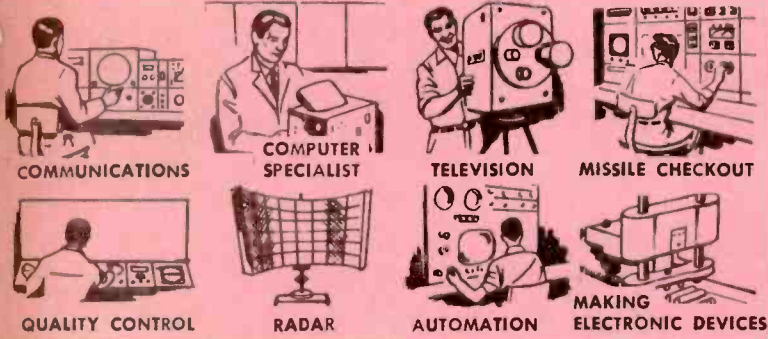

### DEVRY TECH PRESIDENT VISITS MISSILE BASE

DeVry's president, Mr. T. J. Lafeber, accorded a special invitation to inspect a famous missile facility, was deeply impressed with the role of Electronics in the national defense.



A RARE VIEW! This inside view of a ballistic missile is seldom seen by a civilian. It's a sight that greatly impressed Mr. Lafeber.



ELECTRONICS — THE HEART OF THE MISSILE! The wiring in missile devices soon comes clear to a DeVry Tech man because he learns basic circuits by use of the "Electro-Lab", a training method that helps speed up learning.

Postage Will be Paid by Addressee

No Postage Stamp Necessary If Mailed in the United States

**BUSINESS REPLY MAIL**  
First Class Permit No. 4148, Chicago, Ill.

**DeVry Tech**  
4141 Belmont Avenue  
Chicago, Illinois 60641

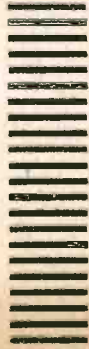

**DON'T DELAY MAIL TODAY!**