

WIN \$20 FOR A PHOTO OF YOUR CB · HAM · SWL SHACK!

# ELECTRONICS ILLUSTRATED

By the Publishers of MECHANIX ILLUSTRATED

SEPTEMBER • 354

**Complete in This Issue!**

## A BASIC TRANSISTOR COURSE

Plus **6** Transistor Projects:

**FM Signal Booster**

**Square-Wave Adaptor**

**Radio Direction-Finder**

**Stereo Microphone Mixer**

**Voice-Control (VOX) for CB or HAMS**

**Super-Sensitive Field-Strength Meter**

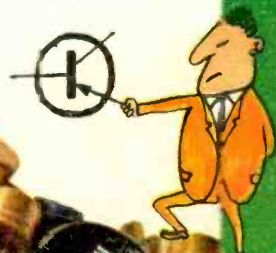



# Prepare Now For The Higher Rewards The Electronics Age Offers You

There is an immediate and growing need for trained technicians in Industrial-Military Electronics, Radio-TV Servicing and Communications. Better than average jobs with high pay, interesting work, bright futures await you in the fast growing industry of the 1960's. Join thousands of NRI graduates now benefiting from career opportunities in this Electronic Age.

## Training Equipment Included



NRI "learn-by-practice" training is the time-proved way to higher earnings and advancement. Except for FCC License

course, all NRI courses include—at extra cost—special training equipment to give shop and laboratory experience in your own home. Makes NRI training come to life in an easy-to-grasp, interesting manner. Take the advice of job counselors, investigate Electronics if you are dissatisfied with your present job or pay, or you want to prepare for military service.



## Oldest and Largest School

For nearly 50 years NRI has featured Electronics training at reasonable cost because it is the oldest, largest home-study school of its kind. Take the first step to a new career now. Mail postage-free card. National Radio Institute, Washington 16, D. C.



## Industrial ELECTRONICS

The NRI course in Electronics—Principles, Practices, Maintenance prepares you for a career as an Electronic Technician in industry, business, government, the military. Computers, telemetry, automation, missiles, rockets all employ the same basic Electronic principles . . . and that is what this NRI course stresses with illustrated lessons, special training equipment.



## Commercial FCC LICENSE

You must have an FCC License if you want to operate or service transmitting equipment used in TV and Radio Broadcasting, aviation, marine, microwave, facsimile or mobile communications. Even a service Technician needs an FCC License today to work on C-Band Radio equipment. From Simple Circuits to Broadcast Operation, this new NRI course trains you quickly to take Government exams.



## TV-Radio COMMUNICATIONS

In NRI's Communications course you get *actual experience* as NRI trains you for your choice of Communications fields. Commercial methods and techniques of Radio-TV Broadcasting; teletype; facsimile; microwave; radar; mobile and marine radio; navigation devices; multiplexing are some of the subjects covered. You work with special training equipment.



## Radio and TV SERVICING

NRI's time-tested course in Servicing not only trains you to fix radios, TV sets, hi-fi, etc., but also shows you how to earn spare-time money starting soon after enrolling. Fast growth in number of sets means money-making opportunities for you in your own spare-time or full-time business, or working for someone else. Special training equipment at no extra cost. Mail postcard.

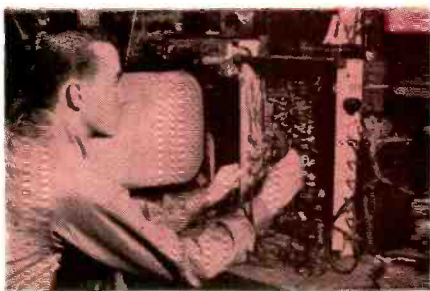

*First* new concept in citizen's band equipment  
in two years! . . . Heathkit 4-Position Selective-Call kit



*an exclusive with  
Heath, this inexpensive  
unit converts your  
CB station from  
"party line" confusion  
to "private line" calling  
convenience*

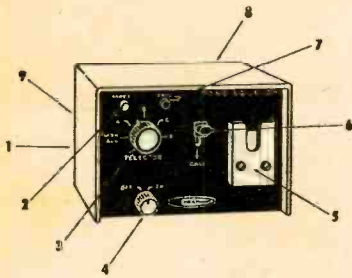

**FEATURES**

(1) squelch time-delay control, (2) power indicator, (3) tone selector switch (4 tones plus "monitor all" position), (4) tone squelch "defeat" switch for normal operation (5) "HFR-to-operate" microphone bracket, (6) "call" lever (7) "call" indicator, (8) external alarm contacts to signal received call, (9) input and output level controls.

Here's welcome news for the serious user of Citizen's Band two-way radio. Heath's new Selective-Call Kit with tone squelch makes it possible for you to enjoy the calm of a CB station that is completely silent, yet ever alert for a personal call . . . makes it possible for you to call your choice of four specific units in your system at the touch of a button.

Using a unique new method, Heath's Selective-Call Kit features an *exclusive* 4-position rotary selected resonant-reed relay which responds only to calls transmitted by similarly equipped units using the same tone frequency. Upon receipt of the proper tone, your unit will automatically "come to life" permitting you to hear the call letters transmitted . . . you reply by merely lifting the microphone and acknowledging. At all other times, your station is peacefully quiet, allowing you to perform your job without one ear "cocked", for this unit does your listening for you.

To call another unit, just select the correct one of four tone frequencies, press the lever, and the called station will be waiting for you. Nothing could be simpler or more convenient. A "defeat" switch allows normal transceiver operation at any time. Equip all your CB units now with this economical new advance in communication ease . . . instructions included for installation with most popular CB transceivers using PTT.

**Kit GD-12A (AC), no money down, \$5 mo. \$33.95; Kit GD-12D (DC) \$37.95**



**GW-11** 3-channel transceiver from \$89.95



**GW-12** Single channel all crystal controlled transceiver from \$39.95



**GW-21** Low Cost "Wattle-Talker" from \$24.95



**GW-21** Superhet "Wattle-Talker" from \$44.95



**HEATH COMPANY**  
Benton Harbor 39, Michigan

Ordering instructions: Fill out the order blank. Include charges for parcel post according to weights shown. Express orders shipped delivery charges collect. All prices F. O. B. Benton Harbor, Mich. A 20% deposit is required on all C.O.D. orders. Prices subject to change without notice. Dealer and export prices slightly higher.

Enclosed is \$ \_\_\_\_\_; send \_\_\_\_\_

Name \_\_\_\_\_

Address \_\_\_\_\_

City \_\_\_\_\_ Zone \_\_\_\_\_ State \_\_\_\_\_



# ELECTRONICS ILLUSTRATED

September 1962

A Fawcett Publication

Vol. 5, No. 5

ROBERT G. BEASON Editor  
 Larry Klein Technical Editor  
 Murray Cooper Art Editor  
 Linda R. Grossman Editorial Assistant

## Special Section

Basic Transistor Circuits ..... Milton S. Kiver 29

## Special Transistor Projects

All-Purpose Voice-Controlled Relay (VOX) ..... Herb Friedman, 2W6045 56  
 Stereo Mike Mixer ..... Harry Kolbe 66  
 FM Signal Booster ..... Ed Liminger 72  
 A Square-Wave Adaptor ..... Dan Horowitz 84  
 Super-Sensitive Field-Strength Meter ..... Herb Friedman 89  
 A Do-It-Yourself Radio Direction-Finder ..... Len Buckwalter, 1W5733 92

## General Features

What is Electricity? An Expert's Definition ..... Jacob Millman, PhD 40  
 Machines That Read ..... Ken Gilmore 46  
 First Flying Radioman ..... 50  
 The Engine With the Magnetic Squeeze ..... 54  
 A Ransom From Rentals ..... James Joseph 70  
 The Tape Club Story ..... Alan J. Broder 75  
 Prize Shacks ..... 88  
 There's a Fuel Cell in Your Future ..... Saunder Harris 106

## Radio: CB • Amateur • SWL

The Listener ..... C. M. Stanbury II 42  
 CB Corner: EI Attends a National Convention ..... Len Buckwalter 43  
 An Oldtimer's Advice to Novices ..... Howard S. Pyle, W7OE 52  
 Ham Shack ..... Robert Hertzberg, W2DJJ 62  
 Latin America: Red-Hot DX ..... C. M. Stanbury II 63  
 Tuning SSB With BFO ..... Nicholas Rosa, W1NOA 91  
 CB Servicing Made Easy III ..... Herb Friedman 99  
 New In CB ..... 114

## Audio & Hi-Fi

Hi-Fi Record Guide ..... Warren DeMotte 80  
 Kit Report: A 100-Watt Stereo Power Amplifier ..... 81  
 Hi-Fi Clinic: Ultra-Linearity ..... 104

## Theory & Practice

Beginner's Page: Electromagnetism Made Easy ..... Len Buckwalter 51  
 Shock-Free Continuity Checker ..... Dave Gordon 74  
 Tech Editor's Test Bench: The Useful Square Wave ..... Larry Klein 86  
 Kit Report: Two Power Supplies ..... 110

## Regular Departments

Feedback From Our Readers ..... 4  
 BroadSides ..... 10  
 Electronics in the News ..... 12  
 Electronic Marketplace ..... 20  
 Good Reading ..... John Milder 98

CONTRIBUTING EDITORS  
 Robert Hertzberg, W2DJJ  
 Amateur Radio  
 Len Buckwalter, 1W5733  
 Citizens Band  
 C. M. Stanbury II  
 SWL-DX

Herb Friedman, W2ZLF/2W6045  
 Special Projects  
 Richard A. Markoff, M.D.  
 Medical Electronics  
 Harry Kolbe  
 John Milder  
 David Muirhead  
 Audio

ADVERTISING  
 John F. Webster  
 Advertising Manager  
 EXECUTIVE STAFF

Ralph Daigh  
 Editorial Director  
 James Boynton  
 Advertising Director  
 Al Allard  
 Art Director  
 Ralph Mattison  
 Associate Art Director  
 George H. Carl  
 Production Director  
 Larry Eisinger  
 Editor-in-Chief  
 Phyllis Bendremer  
 Production Editor  
 Benita Rockwood  
 Asst. Production Editor

### ADDRESSES

Editorial and Advertising Offices:  
 67 West 44th St., New York 36,  
 N.Y. Subscriptions: Change of  
 address Form 3579 to Subscription  
 Dept., Fawcett Bldg., Green-  
 wich, Conn.

ELECTRONICS ILLUSTRATED is  
 published bi-monthly by Fawcett  
 Publications, Inc., Fawcett Place,  
 Greenwich, Conn. W. H. Fawcett,  
 Jr., President; Gordon Fawcett,  
 Secretary and Treasurer; Roger  
 Fawcett, General Manager; Roscoe  
 K. Fawcett, Circulation Director;  
 Donald P. Hanson, Assistant Gen-  
 eral Manager.

Second-class postage paid at  
 Greenwich, Conn., and at addi-  
 tional mailing offices.

Subscription Price \$4 for 12 is-  
 sues in U.S. and possessions and  
 Canada. All other countries \$6 for  
 12 issues. Foreign subscriptions  
 and sales should be remitted by  
 International Money Order in U.S.  
 funds payable at Greenwich, Conn.

Printed in U.S.A. Copyright 1962  
 by Fawcett Publications, Inc.  
 Permission hereby granted to  
 quote from this issue or television  
 magazine on radio or television  
 provided a total of not more than  
 1,000 words is quoted and credit  
 is given to the title of the maga-  
 zine and issue, as well as the  
 statement, copyright 1962 by  
 Fawcett Publications, Inc.

### MEMBERSHIPS

Audit Bureau of Circulations



Magazine Publishers Association, Inc.



COVER—Ektachrome by Grayson  
 Tewksbury, 1/8 sec. at f-16, yellow  
 gel. Transistors by Semitronics  
 Corp. Art by Murray Cooper.



# JOIN MEN LIKE THESE

## Who Now Make **BIG PROFITS** From

### America's Electric Appliance Boom!

Here's a report on six of NRI's typical successful graduates who earn \$3 to \$5 and more an hour — spare time or full time — enjoying their work as qualified Appliance Service Technicians...\*

#### Make \$3 to \$5 an Hour... FIXING Electric Appliances!

**STOP AND THINK** for a minute about YOUR present job and future. Are YOU making enough money? Are you happy in your work? Can you bank on a steady income, good times or bad?

Now you can have the answer to these money and job worries, once and for all. Get in "on the ground floor" of a booming industry — Servicing Electrical Appliances. The coming of the auto created a multi-million dollar service industry, the auto repair business. Now it's happening in the electric appliance field. But with this important difference: anybody with a few simple tools can get started in it!

#### Why the Boom in Appliances Means Money in Your Pocket

In addition to the 400 MILLION appliances already in use, this year alone will see sales of 76 million new appliances! For example, 4,750,000 coffee makers, 2,000,000 room air conditioners, 1,425,000 clothes dryers. A nice income awaits the man who can service such appliances. That man can be you! Even if you don't know a volt from an ampere now, you can soon be making \$3 to \$5 an hour in your spare time.

The NRI training in Servicing Electric Appliances is thorough — right from the basic fundamentals about electricity. And your training will cost less than 20¢ a day.

#### Your Skill Always in Demand — "Set Up Shop" Anywhere

People need their appliances fixed in good times or bad. Once word gets around that you are trained to service them properly, you'll have plenty of work.

You need only the few basic tools that you may already have — and an Appliance Tester which we provide at no extra charge. You can work in a corner of your basement or garage. If you like, you can open your own shop. And you can save money by fixing your own appliances. Mail coupon for Free Book telling how you can "cash in" on the big opportunities that are waiting for the man who knows how!

#### FREE BOOK and SAMPLE LESSON

Our 24-page Free Book tells about America's "Electric Appliance Boom" — how we train you to "cash in" on it. Free Sample Lesson shows how simple our instruction is — how it can quickly prepare you for a profitable future. Mail coupon to: *National Radio Institute, Dept. KJ2, Washington 16, D. C.* (No obligation — and no salesman will call on you.)



#### Earn While You Learn With this Precision Appliance Tester — Yours At No Extra Charge!

Along with the NRI course in Electric Appliance Repair you receive — without extra charge — this precision Appliance Tester, in kit form, which enables you to locate short circuits, faulty cords and poor connections, check fuses and circuit breakers. Test for open circuits, check thermostats, line voltages, wattage drain, take resistance measurements. This instrument helps you track down trouble in every appliance from table lamps to room air conditioners — and make up to \$8 an hour doing it!



**EARL G. REID, RFD 1, Thompson, Ohio** reports that he took in \$648 in one month, of which \$510 was clear — and he was only working part-time!

**JAMES CARTER, 872 Franklin St., Rocky Mount, Va.** states some of the single lessons in the course are worth the entire cost — now owns and operates the *Pixit Shop* in his own home town.



**NRI Graduate CHESTER M. SIEMS, 2326 Corbin St., Melvindale, Mich.** tells that he saved big money just keeping his own major electric appliances in repair. Says he would recommend the course to anyone.

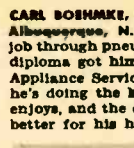

**CARL BOSHKKE, 636 Grove N.E., Albuquerque, N. Mex.,** lost his job through pneumonia. His NRI diploma got him a job with an Appliance Service Center where he's doing the kind of work he enjoys, and the climate is much better for his health.



**FRANK S. NETTMAY, 827 M. 7th St., Vincennes, Ind.** gets all the spare-time appliance repair work he can handle from hardware store where he has a regular job.



Now that **ERNEST B. FARRAR, RFD 1, Mountain Home, Ark.** has retired at age 67, he has opened his own Appliance Repair Service.

\* Letters on file

#### MAIL NOW FOR FREE BOOKLET AND SAMPLE LESSON

Mr. J. M. Smith, President  
NATIONAL RADIO INSTITUTE  
Dept. KJ2, Washington 16, D. C.

Please send me Free Book about NRI Electrical Appliance Repair training program and a free Sample Lesson. I am particularly interested in:

- Spare time earnings  Business of my own  Better job  
I understand there is no obligation on my part; and no salesman will call.

Name.....

Address.....

City..... Zone..... State.....

Accredited Member National Home Study Council



# FEEDBACK

# from our readers



## • All Quiet

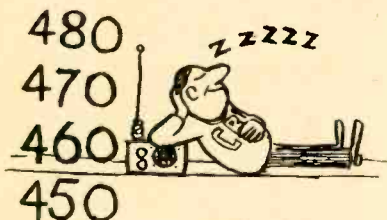

All the Citizens Band activities you hear about are on the 27-megacycle frequency. What's happening on that other Citizens Band, up at 462 mc?

Herb Morris  
Miami, Fla.

*Nothing.*

## • Hint

Your all-CB issue (May '62 EI) was great and a big help to CBers. You also had an all-SWL issue. Now it's only fair that you have all-ham and all-hi-fi issues with articles, projects, etc.

I have one comment. You didn't tell which CB channels are unofficially set aside for various uses . . . marine, travel, CD and others. The list would have been helpful.

Devoted Reader

*Thanks for the compliments, Devoted. We did not list those unofficial channel designations because there are no national patterns. They vary widely from community to community, and rightly so. The FCC has told us it believes such channel reservations should be strictly local in scope in order to make the CB service as useful as possible to as many as possible. Channel assignments on a grand scale would have the effect of limiting the number of channels for general business and personal communications. We must agree. By common practice and agreement, however, some assignments are widely accepted.*

## • Rocket Rattling

Your article on FLYWEIGHT TRANSMITTER FOR MODEL ROCKETS (May '62 EI) is just what I've been waiting for. I hope you have more articles on amateur rocket instrumentation.

Eric Alchowiak  
Rochester, N. Y.

*We will.*

Bravo for your article on the model rocket transmitter. It's the most effective I've used to date. One suggestion. With low-velocity rockets the acceleration isn't enough to affect the antenna but when you get into high-efficiency missiles (mach 3 or so), the antenna becomes twisted. The solution is to mount it in a downward direction flush with the instrument housing.

Also, around mach 4 the components of a vertically mounted transmitter can be cut off as neatly as if snipped with clippers. The answer is to mount it horizontally or in latex rubber.

Bob Vernon  
Los Angeles

## • A Penny Saved

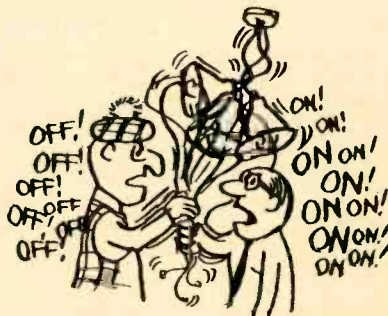

I've always heard it is cheaper to let the lights in a home burn rather than turn them on and off every five minutes. I wish you would clear this up because

[Continued on page 6]



men  
17-55

**JOB OPPORTUNITIES!  
EXCITEMENT!  
MONEY!**

All this  
can be  
Yours as a trained

# Electronics TECHNICIAN

**OVER 6,000 FIRMS HAVE EMPLOYED  
DeVRY TECH GRADUATES!**

Thousands of companies in the United States and Canada who have employed DeVry Tech men prove two most important facts: (1) Electronics is one of the biggest, fastest growing opportunity fields of our time; and (2) DeVry Tech graduates are "WANTED" MEN.

Whether DeVry Tech prepares you in spare time at home or in its modern Chicago or Toronto Laboratories, your training is designed to get you ready to meet the exacting standards of industry. You get practical training that not only helps to fit you for a job or a service shop of your own—but also gives you a foundation for a career that can be profitable the rest of your life.

You work over 300 learn-by-doing experiments at home, using DeVry Tech's exclusive Electro-Lab method. You build and KEEP valuable equipment. With another DeVry Tech exclusive, you have the benefit of training movies that you can show over and over until basic points are crystal clear. Special texts guide you every step of the way as well.

### HOW DeVRY TECH CAN "BLUEPRINT" YOUR CAREER!

DeVry's faculty not only know how to teach Electronics, but they also understand men. They most likely know the type of problems you face. From this staff you get help, advice and understanding. It is this "human" side of DeVry's program that has caused many of our graduates to say: "DeVry Tech not only trains you for a job, they actually help you blueprint a profitable future!"

### NO ADVANCED EDUCATION NEEDED!

Why don't you write for FREE FACTS today? Learn how you TODAY can be a member of the great fraternity of DeVry Tech graduates across the continent . . . men who were properly trained, encouraged, appreciated and understood! SEND IN COUPON NOW!

#### EFFECTIVE EMPLOYMENT SERVICE

DeVry Tech's effective Employment Service is available to all graduates without additional cost.

**2 FREE BOOKLETS  
Send Coupon TODAY!**

"One of North America's Foremost Electronics Training Centers"



Accredited Member of  
National Home Study Council

**DeVRY TECHNICAL  
INSTITUTE**  
CHICAGO • TORONTO



TELEVISION



COMPUTERS



MICRO-WAVES



RADAR



BROADCASTING

LET DeVRY HELP  
YOU PREPARE  
AND BLUEPRINT  
A SOLID  
CAREER IN  
THIS  
FAST-GROWING  
FIELD!



#### DeVRY TECHNICAL INSTITUTE

4141 Belmont Ave., Chicago 41, Ill., Dept. EI-9-5

Please give me your 2 FREE BOOKLETS, "Pocket Guide to Real Earnings" and "Electronics in Space Travel;" also include details on how to prepare for a career in one or more branches of Electronics.

Name \_\_\_\_\_ Age \_\_\_\_\_

Street \_\_\_\_\_ PLEASE PRINT Apt. \_\_\_\_\_

City \_\_\_\_\_ Zone \_\_\_\_\_ State \_\_\_\_\_

Check here if you face military service.

2075 Canadian residents address: DeVry Tech of Canada, Ltd.  
770 Lawrence Avenue West, Toronto, Ontario

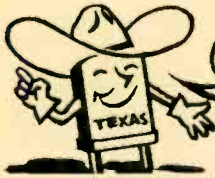

Send for NEW  
FREE CATALOG #962  
with oscillator  
circuits

## Citizen Band Class "D" Crystals

### CITIZEN BAND CLASS "D" CRYSTALS

3rd overtone — .005% tolerance — to meet all FCC requirements. Hermetically sealed HC6/U holders. 1/2" pin spacing. .050 pins. (Add 15c per crystal for .093 pins).

**\$2.95**  
EACH

All 22 megacycle frequencies in stock: 26.965, 26.975, 26.985, 27.005, 27.015, 27.025, 27.035, 27.055, 27.065, 27.075, 27.085, 27.105, 27.115, 27.125, 27.135, 27.155, 27.165, 27.175, 27.185, 27.205, 27.215, 27.225.

Matched crystal sets for ALL CB units (Specify equipment make and model numbers) **\$5.90 per set**

### CRYSTALS IN HC6/U HOLDERS

<b>SEALED OVERTONE</b>	.486 pin spacing — .050 diameter — .005% tolerance	
	15 to 30 MC	\$3.85 ea.
	30 to 45 MC	\$4.10 ea.
	45 to 60 MC	\$4.50 ea.

<b>FUNDAMENTAL FREQ. SEALED</b>	From 1400 KC to 2000 KC	
	.005% tolerance	\$5.00 ea.
	From 2000 KC to 10,000 KC, any frequency, .005% tolerance	\$3.50 ea.

<b>RADIO CONTROL</b>	Specify frequency. .05 pins spaced 1/2" (Add 15c for .093 pins).	\$2.95 ea.
----------------------	--	------------



### QUARTZ CRYSTALS FOR EVERY SERVICE

All crystals made from Grade "A" imported quartz—ground and etched to exact frequencies. Unconditionally guaranteed! Supplied in:

<b>FT-243 holders</b>	<b>MC-7 holders</b>
Pin spacing 1/2"	Pin spacing 3/4"
Pin diameter .093	Pin diameter .125

<b>CRIA/AR holders</b>	<b>FT-171 holders</b>
Pin spacing 1/2"	Pin spacing 3/4"
Pin diameter .125	Banana pins

<b>MADE TO ORDER CRYSTALS</b>	Specify holder wanted
1001 KC to 1600 KC: .005% tolerance	\$4.50 ea.
1601 KC to 2500 KC: .005% tolerance	\$2.75 ea.
2501 KC to 9000 KC: .005% tolerance	\$2.50 ea.
9001 KC to 11,000 KC: .005% tolerance	\$3.00 ea.

### Amateur, Novice, Technician Band Crystals

.01% Tolerance \$1.50 ea. — 80 meters (3701-3749 KC) 40 meters (7152-7198 KC), 15 meters (7034-7082 KC), 6 meters (8335-8650 KC) within 1 KC

FT-241 Lattice Crystals in all frequencies from 370 KC to 540 KC (oll except 455 KC and 500 KC) .50c ea. Pin spacing 1/2" Pin diameter .093

Matched pairs — 15 cycles \$2.50 per pair  
200 KC Crystals, \$2.00 ea.; 455 KC Crystals, \$1.25 ea.; 500 KC Crystals, \$1.25 ea.; 100 KC Frequency Standard Crystals in HC6/U holders \$4.50 ea.; Socket for FT-243 Crystal 15c ea.; Dual Socket for FT-243 Crystals, 15c ea.; Sockets for MC-7 and FT-171 Crystals 25c ea.; Ceramic Socket for HC6/U Crystals 20c ea.

**ENGINEERING SAMPLES** and small quantities for prototypes now made at either Chicago or Fort Myers plants with 24 hour service. IN CHICAGO, PHONE Gladstone 3-3555

**IF YOUR PARTS DEALER DOESN'T STOCK** Texas Crystals, order direct and send us his name.

**TERMS:** All items subject to prior sale and change of price without notice. All crystal orders must be accompanied by check, money order or cash with payment in full.

RUSH YOUR ORDER NOW TO

# TEXAS CRYSTALS

1000 Crystal Drive, Fort Myers, Florida

Dept. E-92

Phone WE 6-2100

FOR SHIPMENT VIA FIRST CLASS MAIL AT NO EXTRA COST ATTACH THIS ADVT. TO YOUR ORDER!

# FEEDBACK

Continued from page 4

my boss follows behind me and turns off every 150-watt light he sees on.

R.B.

Louisville, Ky.

*Sorry, R.B., but what you heard is not correct. Turning lights on and off frequently will shorten bulb life (and run up your light bulb bill) but leaving them on will run up your power bill even more . . . unless you have an exceptionally kind power company at the other end of your lines.*

## • Club Man

I would like to form an Electronic Experimenters Club in the Chicago area. I believe there must be many experimenters around here who would like to get together and exchange ideas and meet people with like interests.

James T. Bates

5241 W. 23rd Place  
Cicero 50, Ill.

*Anyone interested in being a charter EEC member, drop James a note.*

## • An Antique



I've recently come in contact with a Collins 18-5 Xmitter-Rcvr, an old war surplus rig. I have been unable to get a schematic for it, not even from Collins. I'm wondering whether anyone in your audience could help me.

John Adamson, K4CGU

Box 312

Key Largo, Fla.

Happy hunting! 🍀



# PICK YOUR OWN SUCCESS STORY FROM THIS PAGE

These are the true stories of people who seemed trapped in routine, low-pay shabby jobs. Handicapped by lack of proper training, they couldn't get the things they wanted out of life—more money, a job they liked, security and happiness.

They are a small sample of the thousands of men and women—young and old—who turn to I. C. S. for help. Their will-to-learn plus I. C. S. training have changed the course of their lives.

Are you discouraged with your job and pay and feel you can't improve yourself because of lack of specialized education? Well, these men and women were in the same boat. With I. C. S. training, one of these success stories could be about you.

I. C. S. is the oldest and largest correspondence school. 250 courses. Business, industrial, engineering, academic, high school. One for you. Direct, job-related. Bedrock facts and theory plus practical application. Complete lesson and answer service. No skimping. Diploma to graduates.

For Real Job Security—Get an I. C. S. Diploma!

I. C. S., Scranton 15, Penna.

Accredited Member,  
National Home Study Council



Wins \$3000 contest—"After my I. C. S. courses I secured a new position," says Mr. Cecil Rhodes. "My income has more than doubled and I recently won a \$3000 sales contest."



From clerk to Assistant Estimator, thanks to I.C.S. "Any way you look at it," writes Mrs. Edna James, "the time and money one spends for I. C. S. Courses will be repaid a thousandfold."



"As a college graduate, I found I.C.S. very valuable." Robert Lee took the I. C. S. Course in Advertising, is now Promotion Manager for a large corporation. "I. C. S. got me started on the way up," he says.



Reports 20% increase in salary! Gregory C. Johns says, "I. C. S. training gave me unlimited opportunity! I have completed one course, and am now enrolled in Practical Plumbing."

**3 FREE BOOKLETS**—a 36-page pocket-size guide to advancement, a gold mine of tips on "How to Succeed." Also a big catalog outlining opportunities in your field of interest and a sample I.C.S. lesson.

## INTERNATIONAL CORRESPONDENCE SCHOOLS



BOX J4390H. SCRANTON 15, PENNA.

(In Hawaii, reply P.O. Box 418, Honolulu)

(Partial list of courses)

Without cost or obligation, send me "HOW TO SUCCEED" and the opportunity booklet about the field BEFORE which I have marked X (plus sample lesson):

### ARCHITECTURE and BUILDING CONSTRUCTION

- Air Conditioning
- Architecture
- Arch. Drawing and Designing
- Building Contractor
- Building Estimator
- Carpenter Builder
- Carpentry and Millwork
- Heating
- Painting Contractor
- Plumbing
- Reading Arch. Blueprints

### ART

- Commercial Art
- Magazine Illus.
- Sign Painting and Design'g
- Sketching and Painting

### AUTOMOTIVE

- Automobile
- Auto Body Rebuilding and Refinishing
- Auto Engine Tuneup
- Auto Electrical Technician
- Diesel Engines

### AVIATION

- Aero-Engineering Technology
- Aviation Engine Mech.
- Reading Aircraft Blueprints

### BUSINESS

- Accounting
- Advertising
- Bookkeeping and Cost Accounting
- Business Administration
- Business Management
- Clerk Typist
- Creative Salesmanship
- Managing a Small Business
- Professional Secretary
- Public Accounting
- Purchasing Agent
- Real Estate Salesmanship
- Salesmanship and Management
- Traffic Management
- CHEMICAL
- Analytical Chemistry
- Chemical Engineering
- Chem. Lab. Technician
- General Chemistry

- Oil Field Technology
- Pulp and Paper Making

### CIVIL ENGINEERING

- Civil Engineering
- Construction Engineering
- Highway Engineering
- Professional Engineer (Civil)
- Reading Struc. Blueprints
- Sanitary Engineer
- Sewage Plant Operator
- Structural Engineering
- Surveying and Mapping
- Water Works Operator

### DRAFTING

- Aircraft Drafting
- Architectural Drafting
- Drafting & Machine Design
- Electrical Drafting
- Electrical Engineer Drafting
- Industrial Piping Drafting
- Mechanical Drafting
- Sheet Metal Drafting

### ELECTRICAL

- Electrical Appliance Servicing
- Electrical Engineering

- Electric Motor Repairman
- Elec. Eng. Technician
- Elec. Light and Power
- Practical Electrician
- Practical Lineman
- Professional Engineer

### HIGH SCHOOL

- Good English
- High School Diploma
- High School General
- H. S. College Prep.
- (Eng'g & Science)
- High School Math
- High School Science
- Short Story Writing

### LEADERSHIP

- Industrial Foremanship
- Industrial Supervision
- Personnel-Labor Relations
- Supervision

### MECHANICAL and SHOP

- Diesel Engines
- Gas-Elec. Welding
- Heating and Air Conditioning
- Industrial Engineering
- Industrial Instrumentation

- Industrial Safety
- Machine Shop Practice
- Mechanical Engineering
- Plumbing and Heating
- Professional Engineer
- Quality Control
- Reading Shop Blueprints
- Refrigeration and Air Conditioning
- Tool Design
- Tool Making
- RADIO, TELEVISION
- General Electronics Tech.
- Industrial Electronics
- Practical Radio-TV Eng'g
- Radio-TV Servicing
- TV Technician

### RAILROAD

- General Railroad

### STEAM and DIESEL POWER

- Combustion Engineering
- Power Plant Engineer
- Stationary Diesel Eng'r.
- Stationary Steam Engines

### TEXTILE

- General

Name \_\_\_\_\_ Age \_\_\_\_\_ Home Address \_\_\_\_\_  
 City \_\_\_\_\_ Zone \_\_\_\_\_ State \_\_\_\_\_ Working Hours \_\_\_\_\_ A.M. to P.M. \_\_\_\_\_  
 Occupation \_\_\_\_\_

Canadian residents send coupon to International Correspondence Schools, Canadian, Ltd., Montreal, Canada. . . . Special low monthly tuition rates to members of the U. S. Armed Forces.

# BECOME A RADIO

## Build 10-20 Radio and Electronic Circuits at Home

### ALL GUARANTEED TO WORK!

#### YOU DON'T HAVE TO SPEND HUNDREDS OF DOLLARS FOR A RADIO COURSE

The "Edu-Kit" offers you an outstanding **PRactical HOME RADIO COURSE** at a rock-bottom price. Our Kit is designed to train Radio & Electronics Technicians, making use of the most modern methods of home training. You will learn radio theory, construction practice and servicing. **THIS IS A COMPLETE RADIO COURSE IN EVERY DETAIL.** You will learn how to build radios, using regular schematics; how to wire and solder in a professional manner; how to service radios. You will work with the standard type of punched metal chassis as well as the latest development of Printed Circuit chassis.

You will learn the basic principles of radio. You will construct, study and work with RF and AF amplifiers and oscillators, detectors, rectifiers, test equipment. You will learn and practice code, using the Progressive Code Oscillator. You will learn and practice trouble-shooting, using the Progressive Signal Tracer, Progressive Signal Injector, Progressive Dynamic Radio & Electronics Tester, Square Wave Generator and the accompanying instructional material.

You will receive training for the Novice, Technician and General Classes of F.C.C. Radio Amateur Licenses. You will build Receiver, Transmitter, Square Wave Generator, Code Oscillator, Signal Tracer and Signal Injector circuits, and learn how to operate them. You will receive an excellent background for television, Hi-Fi and Electronics.

Absolutely no previous knowledge of radio or science is required. The "Edu-Kit" is the product of many years of teaching and engineering experience. The "Edu-Kit" will provide you with a basic education in Electronics and Radio, worth many times the small price you pay. The Signal Tracer alone is worth more than the price of the entire Kit.

#### THE KIT FOR EVERYONE

You do not need the slightest background in radio or science. Whether you are interested in Radio & Electronics because you want an interesting hobby, a well paying business or a job with a future, you will find the "Edu-Kit" a worth-while investment. Many thousands of individuals of all

ages and backgrounds have successfully used the "Edu-Kit" in more than 79 countries of the world. The "Edu-Kit" has been carefully designed, step by step, so that you cannot make a mistake. The "Edu-Kit" allows you to teach yourself at your own rate. No instructor is necessary.

#### PROGRESSIVE TEACHING METHOD

The Progressive Radio "Edu-Kit" is the foremost educational radio kit in the world, and is universally accepted as the standard in the field of electronics training. The "Edu-Kit" uses the modern educational principle of "Learn by Doing." Therefore you construct, learn schematics, study theory, practice trouble-shooting—all in a closely integrated program designed to provide an easily-learned, thorough and interesting background in radio.

You begin by examining the various radio parts of the "Edu-Kit." You then learn the function, theory and wiring of these parts. Then you build a simple radio. With this first set you will enjoy listening to regular broadcast stations, learn theory, practice testing and trouble-shooting. Then you build a more advanced radio, learn more advanced theory and techniques. Gradually, in a progressive manner, and at your own rate, you will find yourself constructing more advanced multi-tube radio circuits, and doing work like a professional Radio Technician.

Included in the "Edu-Kit" course are Receiver, Transmitter, Code Oscillator, Signal Tracer, Square Wave Generator and Signal Injector circuits. These are not unprofessional "breadboard" experiments, but genuine radio circuits, constructed by means of professional wiring and soldering on metal chassis, plus the new method of radio construction known as "Printed Circuitry." These circuits operate on your regular AC or DC house current.

#### THE "EDU-KIT" IS COMPLETE

You will receive all parts and instructions necessary to build several different radio and electronics circuits, each guaranteed to operate. Our Kits contain tubes, tube sockets, variable, electrolytic, mica, ceramic and paper dielectric condensers, resistors, tie strips, hardware, tubing, punched metal chassis, Instruction Manuals, hook-up wire, solder, selenium rectifiers, volume controls and switches, etc.

In addition, you receive Printed Circuit materials, including Printed Circuit chassis, special tube sockets, hardware and instructions. You also receive a useful set of tools, a professional electric soldering iron, and a self-powered Dynamic Radio and Electronics Tester. The "Edu-Kit" also includes Code Instructions and the Progressive Code Oscillator, in addition to F.C.C.-type Questions and Answers for Radio Amateur License training. You will also receive lessons for servicing with the Progressive Signal Tracer and the Progressive Signal Injector, a High Fidelity Guide and a Quiz Book. You receive Membership in Radio-TV Club, Free Consultation Service, Certificate of Merit and Discount Privileges. You receive all parts, tools, instructions, etc. Everything is yours to keep.

#### SERVICING LESSONS

You will learn trouble-shooting and servicing in a progressive manner. You will practice repairs on the sets that you construct. You will learn symptoms and causes of trouble in home, portable and car radios. You will learn how to use the professional Signal Tracer, the unique Signal Injector and the dynamic Radio & Electronics Tester. While you are learning in this practical way, you will be able to do many a repair job for your friends and neighbors, and charge fees which will far exceed the price of the "Edu-Kit." Our Consultation Service will help you with any technical problems you may have.

J. Statitis, of 25 Poplar Pl., Waterbury, Conn., writes: "I have repaired several sets for my friends, and made money. The "Edu-Kit" paid for itself, I was ready to spend \$240 for a Course, but I found your ad and sent for your Kit."

#### FROM OUR MAIL BAG

Ben Valerio, P. O. Box 21, Magna, Utah: "The Edu-Kits are wonderful. Here I am sending you the questions and also the answers for them. I have been in Radio for the last seven years, but like to work with Radio Kits, and like to build Radio Testing Equipment. I enjoyed every minute I worked with the different kits; the Signal Tracer works fine. Also like to let you know that I feel proud of becoming a member of your Radio-TV Club."

Robert L. Shuff, 1534 Monroe Ave., Huntington, W. Va.: "Thought I would drop you a few lines to say that I received my Edu-Kit, and was really amazed that such a bargain can be had at such a low price. I have already started repairing radios and phonographs. My friends were really surprised to see me get into the swing of it so quickly. The Trouble-shooting Tester that comes with the Kit is really swell, and finds the trouble, if there is any to be found."

#### Choose From These Popular

##### "Edu-Kit" Models

- #10A: 10 Circuits \$14.95
- #15A: 15 Circuits \$19.95
- #16A: 16 Circuits (includes Printed Circuitry) \$22.95
- #20A: 20 Circuits (includes Printed Circuitry and 4 Advanced Circuits) \$26.95

# NOW! TRAIN AT HOME IN RADIO AND ELECTRONICS

ORDER DIRECT FROM AD . . . . USE COUPON ON NEXT PAGE

## RECEIVE FREE BONUS RESISTOR AND CONDENSER KITS



# TECHNICIAN for only \$14<sup>95</sup> UP

## THE NEW IMPROVED DELUXE

# Progressive Radio "Edu-Kit"<sup>®</sup> is now ready



Reg. U. S.  
Pat. Off.

NOW INCLUDES

- ★ RECEIVERS
- ★ TRANSMITTERS
- ★ SQ. WAVE GENERATOR
- ★ AMPLIFIER
- ★ SIGNAL TRACER
- ★ SIGNAL INJECTOR
- ★ CODE OSCILLATOR

PRACTICAL  
HOME  
RADIO  
COURSE

only  
\$14<sup>95</sup>  
UP

TRAINING ELECTRONICS  
TECHNICIANS SINCE 1946

SCHOOL INQUIRIES INVITED

## FREE EXTRAS

- SET OF TOOLS
- SOLDERING IRON
- ELECTRONICS TESTER
- PLIERS-CUTTERS
- ALIGNMENT TOOL
- WRENCH SET
- VALUABLE DISCOUNT CARD
- CERTIFICATE OF MERIT
- TESTER INSTRUCTION MANUAL
- HIGH FIDELITY GUJDE • QUIZZES
- TELEVISION BOOK • RADIO TROUBLE-SHOOTING BOOK
- MEMBERSHIP IN RADIO-TV CLUB: CONSULTATION SERVICE • FCC AMATEUR LICENSE TRAINING
- PRINTED CIRCUITRY

### Unconditional Money-Back Guarantee

The Progressive Radio "Edu-Kit" has been sold to many thousands of individuals, schools and organizations, public and private, throughout the world. It is recognized internationally as the ideal radio course.

By popular demand, the Progressive Radio "Edu-Kit" is now available in Spanish as well as English.

It is understood and agreed that should the Progressive Radio "Edu-Kit" be returned to Progressive "Edu-Kits" Inc. for any reason whatever, the purchase price will be refunded in full, without quibble or question, and without delay.

The high recognition which Progressive "Edu-Kits" Inc. has earned through its many years of service to the public is due to its unconditional insistence upon the maintenance of perfect engineering, the highest instructional standards, and 100% adherence to its Unconditional Money-Back Guarantee. As a result, we do not have a single dissatisfied customer throughout the entire world.

*You Will Find That The Progressive  
Radio "Edu-Kit" Is Perfect*

- • • FOR anyone who wishes to learn more about radio construction, theory and servicing.
- • • FOR anyone who is looking for an interesting hobby.
- • • FOR anyone who would like to learn radio but does not have time to attend regular school hours.
- • • FOR anyone who wants to start studying for a high-paying radio job.
- • • FOR anyone who wishes to start in Television.

Please RUSH my Progressive Radio "Edu-Kit" to me.  
BE SURE TO INCLUDE all the FREE EXTRAS and BONUS RESISTOR and CONDENSER KITS WORTH \$7.00.

MODEL desired \_\_\_\_\_ Price \_\_\_\_\_

- Send "Edu-Kit" postpaid. I enclose remittance in full.
- Send "Edu-Kit" C.O.D. I will pay postage.
- Send me FREE additional information describing "Edu-Kits."

Name \_\_\_\_\_

Address \_\_\_\_\_

**PROGRESSIVE "EDU-KITS" INC.**

1186 Broadway, Dept. 543AE, Hewlett, N. Y.

**WORTH \$7.00**

# FREE CAREER BOOKLET



To guide you to a  
successful future in

## ELECTRONICS RADIO-TV COMPUTERS ELECTRICAL ENGINEERING

This interesting pictorial booklet tells you how you can prepare for a dynamic career as an Electrical Engineer or Engineering Technician in many exciting, growing fields:

**MISSILES • AVIONICS • AUTOMATION  
SALES • DEVELOPMENT  
ELECTRICAL POWER • ROCKETRY  
RADAR • RESEARCH**

Get all the facts about job opportunities, length of study, courses offered, degrees you can earn, scholarships, part-time work — as well as pictures of the Milwaukee School of Engineering's educational and recreational facilities. No obligation — it's yours free.

### MILWAUKEE SCHOOL OF ENGINEERING

#### MAIL COUPON TODAY!

Milwaukee School of Engineering  
Dept. EI-962, 1025 N. Milwaukee St., Milwaukee, Wis.  
Please send FREE "Your Career" booklet  
I'm interested in  
 Electronics     Radio-TV     Computers  
 Electrical Engineering     Mechanical Engineering

Name \_\_\_\_\_ Age \_\_\_\_\_

Address \_\_\_\_\_

City \_\_\_\_\_ Zone \_\_\_\_\_ State \_\_\_\_\_

I'm eligible for veterans education benefits.  
Discharge date \_\_\_\_\_ MS-117

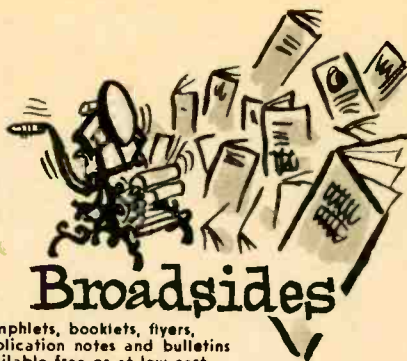

Pamphlets, booklets, flyers,  
application notes and bulletins  
available free or at low cost.

**How to Make Quality Recordings at Home** is a booklet that gives tips on improving your tape recording techniques, selecting the right tape and editing the end result. Send 10¢ for postage and handling to Triton Electronics, Inc., 62-05 30th Ave., Woodside 77, N. Y.

Whether you're a technician or a hobbyist in the radio field, **Practical Radio Mathematics** probably would be helpful to you. This 32-page pamphlet covers the mathematics of resistors, coils, decibels, and the other terms and components of radio. Available for 25¢ from Supreme Publications, 1760 Balsam Rd., Highland Park, Ill.

A **technical book list**, issued by Howard W. Sams & Co., tells you about various volumes on TV, radio, hi-fi, computers, etc. For a free copy, write to the publisher's Technical Book Div., 2201 E. 46th St., Indianapolis 6, Ind.

**Edwards Language Laboratory** is a pamphlet that describes the principles and function of electronic teaching machines used in foreign language courses. The booklet illustrates the various applications of the Edwards line of robot teachers. For a free copy, write to the company in Norwalk, Conn.

**Subliminal Weightlessness** sounds like the title of a wordy treatise on the space age. To the contrary, most of the words have been replaced by light, science-spoofing cartoons. For a free chuckle or two, write to Audio Devices, 444 Madison Ave., New York 22, N. Y.

Sylvania's wafer-thin **Panelescent Lighting Design** is described in **New Freedom of Lighting Design**. Included are the lighting and electrical characteristics of the lamp and hints on its application. Free copies may be obtained from Sylvania, 60 Boston St., Salem, Mass.



# Train in New Coyne Shop-Labs for Today's Top OPPORTUNITY FIELDS!



Instructor helping students check the wiring and trace the circuits of television receivers.

This modern fire-proof building which is occupied entirely by Coyne, houses the NEW COYNE SHOP-LABS.

Instructor explaining operation and testing of a large Motor Generator.

## TELEVISION-RADIO ELECTRONICS

Here at COYNE you're trained for Testing, Trouble-Shooting and Servicing on AM and FM Radio, Auto Radio, Television, Color TV, etc. Thousands of COYNE trained men in good jobs or own well paying TV-Radio businesses.

## ELECTRICITY ELECTRONICS

Big opportunities everywhere—city, town and country, in Power Plant Work, Motors, Industrial Electronics, Armature Winding, Home and Factory Wiring, Appliances, Refrigeration, Maintenance, Illumination, etc.

## OLDEST AND BEST EQUIPPED SCHOOL OF ITS KIND IN THE U. S.

Send Coupon or Write for

### FREE BOOK

"GUIDE to CAREERS" Whether you prefer Electricity—Television—Radio or Combined Electronics Training this book describes all training offered.

Information comes by mail and no salesman will call.



### WE TRAIN YOU IN CHICAGO

Our famous Practical-Technical method gives you practical experience on a massive outlay of equipment—over a quarter of a million dollars worth—plus necessary technical training right here in the NEW COYNE Shop-Labs.

*Training in Refrigeration and Electric Appliances can be included.*

**Training offered to VETERANS and NON-VETS alike**

#### START NOW—PAY LATER

Enroll now, pay most of tuition after Graduation. Part time employment help for students. Lifetime employment service to Graduates. Starting dates, every six weeks.

B. W. COOKE, JR., President

**COYNE ELECTRICAL SCHOOL**

FOUNDED 1899

CHARTERED AS AN EDUCATIONAL INSTITUTION NOT FOR PROFIT  
1501 W. Congress Parkway, CHICAGO, Dept. 62-A

ELECTRICITY • RADIO • TELEVISION • REFRIGERATION • ELECTRONICS

September, 1962

To get Free Book and information, mail this Coupon in envelope or Paste on Postal Card, or write to address below.

COYNE ELECTRICAL SCHOOL, Dept. 62-A  
1501 W. Congress Pkwy., Chicago 7, Ill.

At no obligation to me send FREE book "Guide to Careers" and details of all the training you offer. However, I am especially interested in:

ELECTRICITY  TELEVISION  BOTH FIELDS

Name \_\_\_\_\_

Address \_\_\_\_\_

City \_\_\_\_\_ State \_\_\_\_\_

(I understand no Salesman will call.)

## electronics in the news



**Three-Second Sun . . .** An incredibly fast-heating furnace, able to produce 5,000-degree-F temperatures in three seconds, has been developed by Baird-Atomic, Inc., Cambridge, Mass. Science teachers and researchers are expected to use the Kopito Furnace, which produces sun-hot temperatures safely in the open.

The heart of the unit is a strip of low-resistance graphite cloth made by the National Carbon Co. Electric current from a step-down transformer is conducted to the cloth through water-cooled carbon rollers. The specimen to be heated sits on the graphite strip.

In effect, the furnace is a large version of a soldering gun. It pulls 30 amps at 110 volts.

Within seconds after the furnace has been shut off, it cools down to room temperature.

**Night Sight . . .** Engineers in RCA's Photo Tube Department have come up with a cascaded image photo tube designed to operate at light levels that are pitch darkness to the naked eye. The cascading intensifies the light seen by the tube by a factor of 100,000.

Astronomy, nuclear science and the Army have found wide applications for the new orthicon tube (which resembles the tube in a TV camera). The tube can record the image of a star many light years away in a hundredth the time required for the usual photographic exposure, and it also can photograph atomic particles with one-microsecond exposures. The Army has used the tube in a closed-circuit television setup to record nighttime amphibious operations.



**The Vast Moneyland . . .** Television, which already brings you murder, mayhem and madness, can now fix it so you don't have to go to your broker's to find out what's happening on Wall Street. You can make your daily million right at your desk if you have a Telequote II rig handy. It's an instantaneous quotation service devised by the Teleregister Corp. of Stamford, Conn. The viewing screen shows you stock, bond and commodity prices as they are flashed to brokerage offices by a computer in New York City. The system also may be adapted to duplicate

current ticker and news tapes.

In essence, Telequote is a closed-circuit television receiver having four channels, each of which carries the prices on any group of 24 issues. A keyboard control unit selects channels and stocks.

**Fast Start . . .** The transistor gets the thanks for giving us instant warm-ups of electronic equipment, while the average electron tube has been left in the dust with a warm-up of 10 to 25 seconds. Engineers in General Electric's Tube Department have made a start toward cutting the delay with an experimental heater-type tube



# GET YOUR First Class Commercial F.C.C. LICENSE IN 12 WEEKS!

## Is the course proven?

A high percentage of our fulltime resident students get their 1st class licenses within 12 weeks from the time they start the course. Intensive FCC license training is our specialty — not just a sideline.

## Is the course complete?

The Grantham course covers all the required subject matter completely. Even though it is planned primarily to lead directly to a first class FCC license, it does this by TEACHING you electronics.

## Is the course "padded"?

The streamlined Grantham course is designed specifically to prepare you to pass certain FCC examinations. All of the instruction is presented with the FCC examinations in mind. If your main objective is an FCC license and a thorough understanding of basic electronics, you want a course that is right to the point — not a course which is "padded" to extend the length of time you're in school. The study of higher mathematics or receiver repair work is fine if your plans for the future include them, but they are not necessary to obtain an FCC license.

## Is it a "coaching service"?

Some schools and individuals offer a "coaching service" in FCC license preparation. The weakness of the "coaching service" method is that it presumes the student already has a knowledge of technical radio. On the other hand, the Grantham course "begins at the beginning" and progresses in logical order from one point to another. Every subject is covered simply and in detail. The emphasis is on making the subject easy to understand. With each lesson, you receive an FCC type test so you can discover daily just which points you do not understand and clear them up as you go along.

For further details concerning F. C. C. licenses and our training, send for our FREE booklet

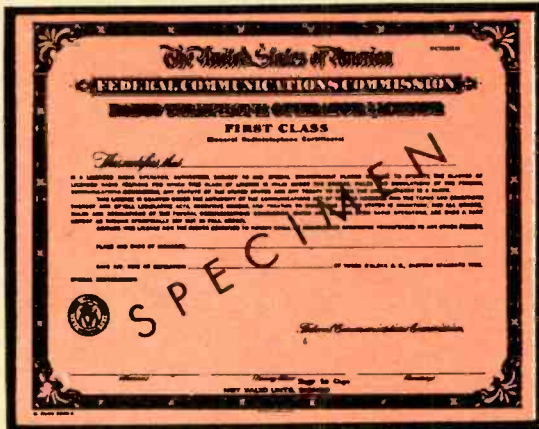

## Is the school accredited?

Accreditation by the National Home Study Council is your assurance of quality and high standards. Grantham is accredited.

## Is it a "memory course"?

No doubt you've heard rumors about "memory courses" and "cram courses" offering "all the exact FCC questions." Ask anyone who has an FCC license if the necessary material can be memorized. Even if you had the exact exam questions and answers, it would be much more difficult to memorize this "meaningless" material than to learn to understand the subject. Choose the school that teaches you to thoroughly understand — choose Grantham School of Electronics.

**THE GRANTHAM FCC License Course in Communications Electronics is available by CORRESPONDENCE or in RESIDENT classes.**

## Grantham Schools

1505 N. Western Ave.  
Los Angeles 27, Calif.  
(Phone: HO 7-7727)

408 Marion Street  
Seattle 4, Wash.  
(Phone: MA 2-7227)

3123 Gillham Road  
Kansas City 9, Mo.  
(Phone: JE 1-6320)

821-19th Street, N.W.  
Washington 8, D. C.  
(Phone: ST 3-3614)

### FIRST CLASS F.C.C. LICENSE IN 12 WEEKS

Grantham resident schools are located in four major cities — classes in F. C. C. license preparation are offered at all locations. New day classes begin every three months, and new evening classes begin four times a year.

MAIL COUPON NOW — NO SALESMAN WILL CALL →

Accredited by the National Home Study Council



(Mail in envelope or poste on postal card)

To: GRANTHAM SCHOOL OF ELECTRONICS  
NATIONAL HEADQUARTERS OFFICE  
1505 N. Western Ave., Hollywood 27, Calif.

Gentlemen:

Please send me your free booklet telling how I can get my commercial F.C.C. license quickly. I understand there is no obligation and no salesman will call.

Name \_\_\_\_\_ Age \_\_\_\_\_

Address \_\_\_\_\_

City \_\_\_\_\_ State \_\_\_\_\_

I am interested in:

Home Study,  Resident Classes

28-P

**...electronics in the news**

that gets going in 1.3 seconds. Two techniques are employed: the heater is bonded to the cathode (although kept electrically isolated) to provide heat transfer by conduction instead of radiation, as is normal, and a ballast resistor is hooked in series with the heater, resulting in a relatively high initial shot of current. The new heater-cathode structure is expected to have greater physical strength than conventional models and will operate at a lower temperature.

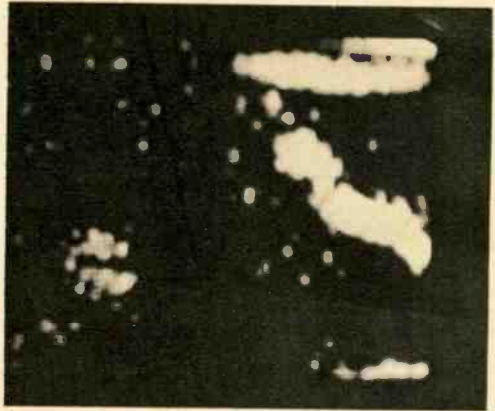

the high-temperature areas of a fire. Such microwave-frequency energy penetrates smoke where energy in the visible light spectrum is stopped cold. Space-General's camera, carried in a plane, can shoot the ground from as high as 10,000 feet. The system was tried out in the recent Los Angeles blazes which destroyed so much property. Our photo shows a radiometer scan photo. The white spots are the hot points in the fire, which covers the whole area.

**Electronic Fire-Finder . . .** Thick smoke too often hampers the work of firemen because it obscures the center of a large blaze, particularly a forest fire. But an electronic camera that sees the hot spots right through the smoke has been designed by the Space-General Corp., Glendale, Calif. The rig, called a scanning microwave radiometer, records high-frequency radio waves emitted by

# LEARN

electronics theory this easy way.  
No previous technical knowledge required.

# BUILD

the finest professional quality TV Set  
on a practical "pay-as-you-wire" plan.

# SAVE

up to 1/2 on cost of equivalent  
educational course plus TV set.

**Build the Transvision "Professional" TV Kit** described below and get this complete course of study for **\$7.95** (available only to Transvision Kit builders.)

*Requires no previous technical knowledge. Prepared by experts in teaching novices about electronics.*

**YOU LEARN:** About block diagrams... How to read and follow electronic circuits... How to use basic measuring instruments... Theory and operation of basic electronic circuits... How to service TV, Radio, and other types of electronic equipment.



Prices range from \$119 to \$199.



**The Transvision "Professional" TV Kit**  
Choice of 19", 23", or 27" Picture Tube... Easy "Pay as You Wire" Terms... Only \$15 for the Starting Package.



A few of the **Professional Quality Features of Transvision TV Kits:**

- Choice of push-pull 10-watt audio or output to your Hi-Fi System . . . D.C. restoration . . . Ultra linear sweep circuits . . . New Standard Coil Model PKO Automatic Tuner . . . Super-sensitivity for fringe areas . . . Complete line of Accessories for Custom Installations.

**ASSEMBLY MANUAL—\$2.00**  
See how easy it is to assemble the Transvision Kit. Cost of Manual refunded on purchase of Kit.

**START NOW — MAIL THIS COUPON**

TRANSVISION Electronics, Inc. Grey Oaks Ave., Yonkers, N.Y. Dept. EI-9

Send Free 12-page Catalog.  Enclosed is \$2 for Assembly Instructions so that I might see how easy it is to assemble the Transvision Kit. I understand that this will be refunded if I purchase a kit.

Enclosed is \$15 for the Starting Package. I understand that I can buy packages one at a time as I wire. (Models range from \$119 to \$199.)

Name..... Address.....  
City..... Zone..... State.....

U.S. Armed Services and over 4000 schools and colleges have selected Transvision Receivers for educational television.



**Grey Oaks Ave.  
Yonkers, N.Y.  
Y05-6900**



**want to  
double  
your pay?**

**Move Ahead  
in  
ELECTRONICS**

*Get All  
3 Free!*



**Get This Handy Pocket  
Electronics Data Guide  
Free...**

Puts all the commonly used conversion factors, formulas, tables, and color codes at your fingertips. Yours absolutely free if you mail the coupon today. No further obligation!

**TO GET THIS FREE GIFT,  
MAIL COUPON TODAY!**

**FIND OUT** how the FCC license helps you get a better job or increase your pay on your present job



**MAIL COUPON TODAY**

**Cleveland Institute of Electronics**

Cleveland Institute of Electronics  
Desk EI-41, 1776 E. 17th St., Cleveland 14, Ohio

Please send Free Career Information prepared to help me get ahead in Electronics. I have had training or experience in Electronics as indicated below:

- |   |   |
|---|---|
| <input type="checkbox"/> Military           | <input type="checkbox"/> Broadcasting       |
| <input type="checkbox"/> Radio TV Servicing | <input type="checkbox"/> Home Experimenting |
| <input type="checkbox"/> Manufacturing      | <input type="checkbox"/> Telephone Company  |
| <input type="checkbox"/> Amateur Radio      | <input type="checkbox"/> Other .....        |

**Your FCC License  
Or Your Money Back**

Completion of the Master Course (both Sections) will prepare you for a First Class Commercial Radio Telephone License with a Radar Endorsement. Should you fail to pass the FCC examination for this license after successfully completing the Master Course, you will receive a full refund of all tuition payments. This guarantee is valid for the entire period of your enrollment agreement.

**Cleveland Institute Announces  
A New and Dynamic Technician Training Program in Computers, Servo Mechanisms, Magnetic Amplifiers, and Others.**

Other advanced fields covered include Basic Math, A. C. Circuit Analysis, Pulse Circuitry, Color TV, Radar, Advanced Measuring Techniques, Industrial Electronics, Instrumentation, Automation, Radio Telemetry. Send for information today.

**Accredited by the  
National Home Study Council**

In what kind of work are you now engaged?

In what branch of Electronics are you interested?

Name ..... Age .....

Address .....

City ..... Zone ..... State .....

EI-41

ON LAND IN THE AIR and ON THE SEA

# BIG MONEY!

awaits  
**TRAINED  
TECHNICIANS**  
in  
**TELEVISION-RADIO-  
ELECTRONICS-RADAR**

**EARN AS YOU  
LEARN!**

Get CHRISTY's Complete Course. Why be satisfied with less? CTS Shop Method. Home Training makes learning easy. You receive Comprehensive training from the start. **EARN AS YOU LEARN!** You become qualified to open your own Electronics Repair business or to gain high pay as a TV, Radio, Electronics Technician.

**19 TRAINING KITS INCLUDED!**  
Multi-Tester, Oscillator, Signal Tracer, Oscilloscope, Signal Generator, Electronic Timer, Regenerative Radio, 24" TV set (Optional) and other valuable equipment sent. Send today for 3 **FREE BOOKS**. No obligation.



**CHRISTY TRADES SCHOOL, Dept. T-1913**  
3214 W. Lawrence Ave., Chicago 25

Send me 3 Free Books and Special Form for **PAYING LATER** from **EARNINGS MADE WHILE LEARNING.**

NAME \_\_\_\_\_ Age \_\_\_\_\_

ADDRESS \_\_\_\_\_

CITY \_\_\_\_\_ Zone \_\_\_\_\_ STATE \_\_\_\_\_

**...electronics in the news**

**On Again, Off Again . . .** A new outdoor lampholder has a built-in photoelectric switch that turns the lamp on at nightfall and off at daybreak. The switch, housed in aluminum, can handle one floodlight up to 150 watts or as many as three standard lamp fixtures. The Bryant Electric Co. of Bridgeport, Conn., the manufacturers, expect home-

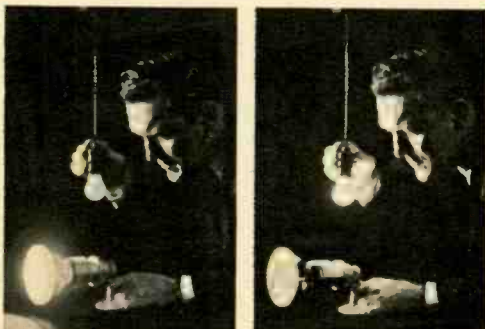

owners and outdoor advertisers to make use of the unit. Our photos show a floodlamp blazing away in semi-darkness at

left but turned off at right when the overhead bulb goes on.

**Lethal Light . . .** The death ray, a favorite subject of science-fiction writers for long years, is on the verge of graduating into fact with the demonstration of a laser light beam that can burn holes through stainless steel sheets and break balloons in mid-air. Our photo sequence, made in the Raytheon laboratory at Lexington, Mass., shows an LH-3 pulsed laser doing its dirty work on a balloon.

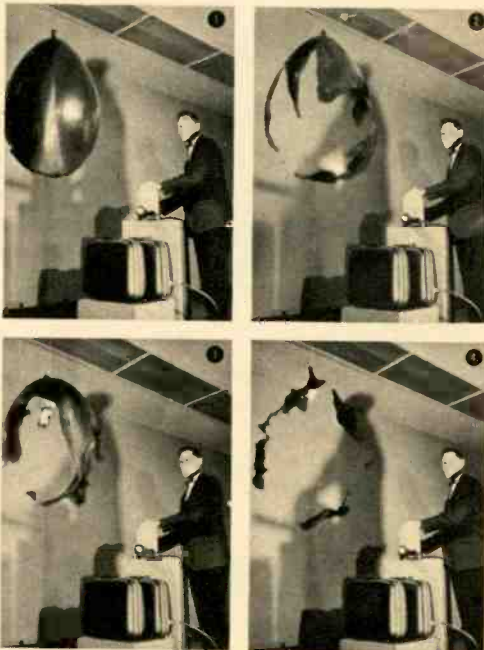

A laser's destructive capability is based on the fact that the beam of coherent (in-phase) light it emits is several million times brighter than sunlight.

The Defense Department is awarding contracts for experimentation with lasers as a death-ray weapon. In the meantime, the laser is being put to peaceful use in communications, medicine and biology.

**Chatterbox . . .** Voice communications, teletype messages and even computer-type data can be transmitted simultaneously over a new radio communications system called RACEP, Martin Marrietta Corporation's acronym for



# THE ONE AND ONLY *knight-kit*® "SPAN MASTER®!"



**WORLD-WIDE 4-BAND SHORT WAVE RECEIVER KIT**

ONLY  
**\$25.95**

**SEND NO MONEY**

only \$5 per month

You can hear *everything* on the fun-to-build "Span Master"—far and away the leader in its class for radio coverage, sensitive performance and value. Continuous tuning from 540 kc to 30 mc lets you hear ships, planes, direct broadcasts from Moscow, Berlin, Rome, London, Paris; tunes the 160, 80, 40, 20, 15 and 10-meter Ham bands—plus powerful local AM reception and dozens of other exciting broadcast services.

Bandspread dial and fine regeneration make tuning an easy pleasure. Has headphone terminals and speaker cut-out switch for private listening. Super-sensitive circuit. Easy to assemble from step-by-step instruction manual—includes list of foreign stations and international Morse code. Pyroxylin-covered cabinet with perforated white baffle and satin-chrome control panel. Complete with all parts, tubes, wire and solder. Size, 6¼ x 14 x 6¾". For 110-125 v., 60 cycle AC. Shpg. wt., 8 lbs.

83 YX 258BD "Span Master" Kit, only **\$25.95**  
83 Y 100. Outdoor Antenna Kit ..... **\$ 1.03**  
59 Y 110. Dual Headset ..... **\$ 2.08**

**Satisfaction guaranteed or your money back!**

**ALLIED RADIO**  
**KNIGHT ELECTRONICS DIVISION**

September, 1962

**GREAT TO BUILD!  
GREAT TO OWN!**  
packed with endless  
listening thrills



Tune world capitals direct



Hear ships at sea

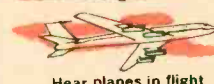

Hear planes in flight



Tune all your favorite local AM programs

- Tunes Shortwave and Broadcast Bands continuously from 540 kc to 30 mc
- Bandspread Control for easy, enjoyable shortwave tuning
- Sensitive Regenerative Circuit for world-wide radio reception
- Built-in Speaker plus headphone terminals for privacy listening
- Transformer Powered for maximum circuit performance
- Handsome modern styling—includes wood cabinet

**SEND NO MONEY**  
order today!

**ALLIED RADIO**

100 N. Western Ave., Chicago 80, Ill.

Ship me the following:

- "Span Master" 4-Band Receiver Kit 83 YX 258BD  
 Antenna Kit 83 Y 100       Dual Headset 59 Y 110  
 Ship No Money Down on Allied's Credit Fund Plan

Name \_\_\_\_\_  
PLEASE PRINT

Address \_\_\_\_\_

City \_\_\_\_\_ Zone \_\_\_\_\_ State \_\_\_\_\_

## ...electronics in the news

Random Access and Correlation for Extended Performance. The system ac-



commodates as many as 70 data and/or voice signals at one time with relatively simple equipment. A command feature permits one station to turn the others on and give them a message whether they are manned or not.

The system uses a pulse-modulation technique wherein sound is broken into millionth-of-a-second fragments and then combined at random over a wide frequency band. The receiver rearranges these data bits in their original order and reproduces voice or other messages. The transmitted signals are just hash to conventional receivers and are virtually impervious to interception or jamming. Our photo shows the whole works: a young chap on the TT, a pretty girl on the phone—and a RACEP unit.

**New Alloy . . .** General Electric has developed a new filament wire that combines tungsten—the element used in untold millions of tubes since 1930—with the rare metal rhenium, which costs more than gold. The alloy is stronger than tungsten alone and is expected to give longer life to tubes. A high electrical resistance enables a tungsten-

### GET YOUR FIRST CLASS F.C.C. LICENSE IN HOLLYWOOD IN SIX WEEKS!

We are specialists in F.C.C. license preparation—we do nothing else. We prepare you for your first class commercial license in six weeks, through intensive full-time teaching and coaching. Our classes are small and meet for 8 hours a day, with maximum personal instruction by a superior teacher. One low tuition covers everything until your F.C.C. license is secured. Write for free details.

**Pathfinder School, Dept. P-28**  
Suite 216  
5504 Hollywood Blvd., Hollywood 28, Calif.

### LEARN MATHEMATICS

Today, to get ahead as a technical man, you must understand basic mathematics — logarithms, slide rule, algebraic notation and laws, various equations, progressions and series, etc. Grantham School has just recently developed an unusual home study course which can bring you up to date in these subjects. Don't let inadequacy in math hold you back. Write today.

**GRANTHAM SCHOOLS, INC., Dept. 280P**  
1505 N. Western Ave. Los Angeles 27, Calif.



rhenium filament to heat faster and also protects against those damaging initial surges.

In addition to its use in tubes, the wire is found in new GE flash bulbs.



# The Same School That Originated The RTS BUSINESS PLAN

**...NOW**  
Proudly  
Presents...

## A SPECIAL COMPACT COURSE COVERING ALL THREE PHASES OF **ELECTRONICS**

**BASIC • INTERMEDIATE • ADVANCED**

The Entire Course Is Made Up Of The Following:

- 25 LESSONS COVERING BASIC AND INTERMEDIATE ELECTRONICS
- 9 EQUIPMENT KITS COMPLETE WITH TUBES AND BATTERIES
- SOLDERING IRON
- 25 LESSONS COVERING THESE ADVANCED ELECTRONIC SUBJECTS:

Thyratron Tubes • Semiconductors • Electronic Symbols and Drawings • Voltage-Regulators • Electronic-Timers • Control Systems • X-Rays • Photoelectric Devices • Dielectric Heating • Geiger Counters • Pulse Circuitry • Clippers and Limiters • Multivibrators • Electronic Counters • Radar • Magnetic Amplifiers • Analog-Computers • DC Amplifiers • Digital Computers • Storage Systems • Input and Output Devices • Servomechanisms • Telemetering

- 60 EXAMINATIONS
- UNLIMITED CONSULTATION SERVICE
- KIT MANUALS
- DIPLOMA UPON GRADUATION

AND MUCH MORE ...

DESIGNED FOR THE BUSY MAN OF TODAY

This is MODERN training for the MODERN man. You'll find no "horse and buggy" methods here. Every page of this streamlined course is devoted to important Electronics principles and practical projects. You'll be amazed how fast you grasp Basic Electronics the RTS way. RTS has combined modern THEORY and PRACTICE to make this the finest training program of its kind available!

**SATISFIES NOVICE, TECHNICIAN OR HOBBYIST**

Whether you're new to Electronics or an old "pro," chances are you'll find this to be the ideal course for you. The novice will appreciate the completeness of the training. It starts with the most basic considerations, covering each important point thoroughly, yet concisely. The technician will enjoy the practical review of fundamentals and profit from the 25 advanced subjects covered.

**RTS GIVES YOU "TOP MILEAGE" FOR YOUR TRAINING DOLLAR**

The price quoted below buys EVERYTHING — there are no extras to pay for. RTS has gone "all out" to give you the best training value in America. Why pay hundreds of dollars for training such as we offer when it's available for this LOW PRICE? If you can find a better training bargain ... BUY IT!

**CAN BE COMPLETED IN MONTHS INSTEAD OF YEARS**

Some students will complete this course with "Jet-Like" speed but we allow up to two years if your circumstances require it. You study at your own rate. You are ENCOURAGED but not pushed. You'll find the lessons professionally written. LET US SEND YOU ONE OF THESE LESSONS ALONG WITH YOUR CAREER BOOKLET SO YOU CAN SEE FOR YOURSELF. NO OBLIGATION!

\* TERMS ALSO AVAILABLE AS LITTLE AS

\$500 DOWN \$500 PER MONTH

**SAVE TIME — SEND \$5.00 WITH COUPON**

YOUR FIRST LESSONS AND KIT WILL BE RUSHED TO YOU THE SAME DAY THEY ARE RECEIVED!

COMPLETE COST ...  
INCLUDES ALL KITS, TUBES, BATTERIES, ETC.  
**\$125.00\***

RTS Membership in The Association of Home Study Schools is your assurance of Reliability, Integrity and Quality of Training.



**RTS ELECTRONICS DIVISION**  
815 E. ROSECRANS AVENUE  
LOS ANGELES 59, CALIFORNIA

Est. 1922



**Rush Coupon**

**NO SALESMAN WILL CALL!**

**DON'T LOSE OUT — FIND OUT!**

**RTS ELECTRONICS DIVISION Dept. E1-92**

815 E. ROSECRANS AVENUE LOS ANGELES 59, CALIFORNIA

Rush me full information by return mail. (Please Print)

Name \_\_\_\_\_ Age \_\_\_\_\_

Address \_\_\_\_\_

City \_\_\_\_\_ Zone \_\_\_\_\_ State \_\_\_\_\_

**ENROLL ME NOW**  **SEND MORE FACTS**

**ATR PRODUCTS FOR MODERN LIVING**



**ATR PLUG-IN TYPE PORTABLE INVERTERS\***  
A. C. Household Electricity Anywhere . . . in your car, boat or plane.

**MODELS**  
6-RMF (6 volts) 60 to 80 watts. Shipping weight 12 lbs. **DEALER NET PRICE . . . . . \$33.00**  
12T-RME (12 volts) 90 to 125 watts. Shipping weight 12 lbs. **DEALER NET PRICE . . . . . \$33.00**  
\*Additional Models Available

Operates Standard A.C.  
 ● Record Players  
 ● Dictating Machines  
 ● Small Radios  
 ● Electric Shavers  
 ● Heating Pads, etc.

Airplane Style Overhead Mounting under Cab Roof

**ATR TRUCK-BOAT-AUTO KARADIO** NO PRINTED CIRCUITRY



Excellent Tone, Volume, and Sensitivity! Compact, yet powerful. Fits all trucks, station wagons, most cars and boats. Just drill a 5/8 inch hole in roof and suspend the one-piece unit (serial, chassis and speaker) in minutes. Watertight mounting assembly holds antenna upright. Yoke-type bracket lets you tilt radio to any angle.

Extra-sensitive radio has 6 tubes (2 double-purpose), over-size Alnico 5 PM speaker for full, rich tone. Big, easy-to-read illuminated dial. Fingertip tuning control. Volume and tone controls. 33-in. stainless steel antenna. Neutral gray-tan enameled metal cabinet, 7 x 6 1/2 x 4 in. high over-all. Shipping weight 10 1/2 lbs.

Model TR-1279—12A for 12V Dealer Net Price. . . . . \$41.95  
 Model TR-1279—6A for 6V Dealer Net Price. . . . . \$41.95

See your Electronic Parts Distributor Write Factory for Free Literature . . .

**ATR ELECTRONICS, INC.**  
Formerly American Television & Radio Co.  
Quality Products Since 1931  
ST. PAUL 1, MINNESOTA—U.S.A.

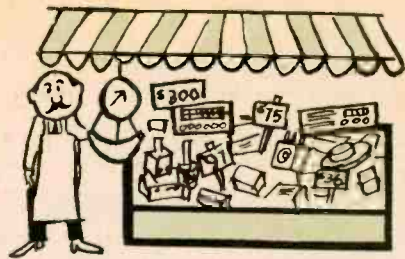

## Electronic Marketplace

Audio Furniture . . . A new line of hi-fi cabinets gives you the option of placing your speakers well inboard (see photo) or moving them off the shelves for greater separation. The cabinets nat-



urally come without the tuner, amplifier, speakers, etc., consisting of two uprights with long shelves at top and bottom, a short equipment shelf and a back panel. The price is \$69.50. Audio Originals, Indianapolis 25, Ind.

**Kit in a Cabinet . . .** Amplifier and tuner kits in Harman-Kardon's Award Series are coming out in a cabinet-type package new to the field. The package (see photo) looks a little like a cross between a child's chemistry set and a refrigera-

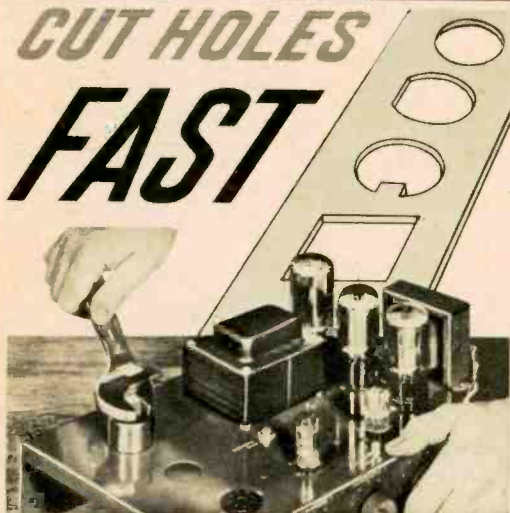

## GREENLEE CHASSIS PUNCHES

Make accurate, finished holes in 1 1/2 minutes or less in metal, hard rubber and plastics. No tedious sawing or filing — a few turns of the wrench does the job. All standard sizes . . . round, square, key, or "D" shapes for sockets, switches, meters, etc. At your electronic parts dealer. Literature on request.

**GREENLEE TOOL CO.**   
2028 Columbia Ave., Rockford, Illinois



# Down-to-Earth Training

## AT ROCK-BOTTOM COST! For Better Radio-Electronic-Electrical Jobs . . . For Servicing any TV or Radio Set Ever Built!

These giant, world-famous books bring you remarkably complete, easily understandable home study training at sensible prices. Pictures, diagrams and charts help make even the most complicated subject perfectly clear. No lessons to wait for. No unnecessary training expense. You learn fast! You learn right!

# HR&W's BIG 6

## ELECTRONICS TRAINING LIBRARY

### Get Your Basic Training From These 2 Practical Books

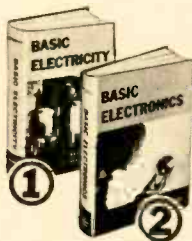

**BASIC ELECTRICITY.** Fundamental electrical principles are the basis of all electronics—and this 396-page manual gives you a complete working knowledge of all of them! Covers everything from electromagnetism to phone principles, wiring, circuits, illumination, reactance, impedance, power factor, instruments, controls, measurements, all types of components and equipment. Price \$7.50 separately.

**BASIC ELECTRONICS.** This new 389-page Guide takes up where Basic Electricity leaves off. Shows how electrical principles are applied in electronics and gives you a sound grasp of electronic theory, methods, circuits and equipment. Over 375 illustrations clearly explain details. The ideal basic training for any kind of work in TV, radio, communications, hi-fi, industrial electronics and related fields. Price \$7.75 separately.

Save \$1.75! See Basic Training Money-Saving Offer in Coupon!

### THESE 2 GREAT GHIRARDI BOOKS Train You for Radio-TV Servicing!

**RADIO AND TV CIRCUITRY AND OPERATION.** You can repair ANY radio, TV, or other electronic equipment lots easier, faster and better when you really understand circuits and know just how and why each one works. That's exactly the kind of training you get from Ghirardi's 669-page Radio and TV Circuitry and Operation Handbook. Gives a complete understanding of modern circuits. Shows what troubles to look for, and how to eliminate useless testing in servicing them. Brings you the above-average training that takes the guesswork out of troubleshooting and fits you for the best paid service jobs. 417 illustrations. Price \$9.00 but SEE THE MONEY SAVING OFFER!

**RADIO AND TV TROUBLESHOOTING AND REPAIR.** Ghirardi's Radio and TV Troubleshooting and Repair is a complete 822-page Guide to professional service methods. For beginners, this giant book with its 417 clear illustrations is an easily understood course in locating trouble fast and fixing them right. For experienced men, it is ideal for developing better methods and finding fast answers to puzzling problems. Covers troubleshooting by all methods including "static" and "dynamic" signal tracing types. Step-by-step charts demonstrate exactly how to proceed. A big TV section is a down-to-earth guide to all phases of TV troubleshooting and service. Price \$10.00 separately. See money-saving offer in coupon!



### Fix Radios and TV's in a Jiffy! GET THESE 2 EASY-TO-FOLLOW HANDBOOKS



**HANDBOOK OF TV TROUBLES.** This remarkable new 302-page Handbook helps you track down practically any TV trouble from the symptoms it produces in the set itself. Just turn to the index, look up the trouble symptoms of the set you want to fix—"snow"—poor detail—sync trouble—sound trouble—or any of the many others. Then Handbook shows you how to make adjustments or parts replacements. Outlines time-saving short cuts.

Explains puzzling details. Eliminates guesswork and useless testing. More than 150 TV trouble test pattern, wave form and circuit illustrations explain test results, details and procedures so you can hardly fail to understand. Price \$7.50.



**RADIO TROUBLESHOOTER'S HANDBOOK.** Just look up that troublesome old radio you want to fix. Four times out of five, this giant, 744-page Handbook tells what is causing the trouble, shows how to fix it. Cuts service time in half. Eliminates useless testing. Even beginners can easily fix old sets which might otherwise be thrown away for lack of service information. Gives trouble symptoms and their remedies for over 4,800 specific models of old home, auto radios and record changers made between 1925 and 1942—Atwater Kent, Belmont, Bosch, Brunswick, Clarion, Crosley, Emerson, Fada, G-E, Majestic, Motorola, Philco, RCA, Silvertone, Spanton, Stromberg, and dozens more. Has hundreds of pages of old tube and component data, service short cuts, etc. Price \$10.00.

The "cream" of most modern troubleshooting techniques—fully and clearly explained to make repair work simple and easy!

### TRY ANY BOOK 10 DAYS FREE!

Dept. PR-92,  
HOLT, RINEHART and WINSTON, Inc.  
P.O. Box 2234, Grand Central Station  
New York 17, N.Y.

Send books indicated for 10-day FREE EXAMINATION. In 10 days, I will remit price indicated plus postage, or return books postpaid and owe nothing. (SAVE! Send cash with order and we pay postage. Same 10-day return privilege with money promptly refunded.)

Check here for BASIC TRAINING COMBINATION of Basic Electricity and Basic Electronics. Send both big books at only \$13.50 for the two plus postage. Regular price \$15.25. You save \$1.75 (709493)

Check here for SERVICE TRAINING COMBINATION of Radio & TV Circuitry & Operation and Radio & TV Troubleshooting & Repair. Send both big books at only \$17.00 for the two plus postage. Regular price \$19.00. You save \$2.00. (709006)

Check here to order individual books

<input type="checkbox"/> Basic Electricity (#708859)	.....\$ 7.50
<input type="checkbox"/> Basic Electronics (#709378)	.....\$ 7.75
<input type="checkbox"/> Radio & TV Circuitry and Operation (#708214)	.....\$ 9.00
<input type="checkbox"/> Radio & TV Troubleshooting and Repair (#708578)	.....\$10.00
<input type="checkbox"/> Handbook of TV Troubles (#708453)	.....\$ 7.50
<input type="checkbox"/> Radio Troubleshooter's Handbook (#708297)	.....\$10.00

NAME .....

ADDRESS .....

CITY, ZONE, STATE .....

OUTSIDE U.S.A.—Add 50¢ to price of each book. Cash with order only.  
(Above offer expires March 30, 1963)

# Marketplace

tor. You set it on your workbench and swing open two doors. Mounted on shelves in the left door are the capacitors, tubes and switches. In the right door are slides holding the small parts. Behind the large photo in the center are the transformers and chassis. Little plastic posts hold the knobs on the front panel (top). H-K calls the package a tool box. It is made out of cardboard. You're supposed to work in front of the cabinet and then close it between wiring sessions. The big picture evidently is to remind you of what you'll have when you get done. Shown here is H-K's 50-watt integrated stereo amplifier, listing at \$119.95. A 30-watt job is available for about \$80. Harman-Kardon, Inc., Plainview, N. Y.

**Stronger Stereo . . .** One of the gremlins plaguing stereo FM is its reduced range as compared with monophonic broadcasts. The FMX Range Extender is intended to be a gremlin-killer, eliminat-

ing background noise and drift while souping up the signal with a gain of 20 db (making a healthy monster out of a weak, fringe-area signal). The one-tube broad-band amplifier plugs into a 117-volt outlet and operates anywhere

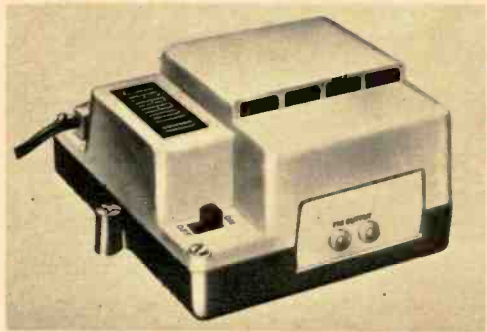

along the download between antenna and tuner. It requires no tuning and consumes no more juice than your electric clock. It also can feed as many as four receivers at once. A 6DJ8 frame grid tube insures stable performance for continuous use. About \$30. Jerrold Electronics Corp., Philadelphia, Pa.

## Special GET-ACQUAINTED OFFER

6 issues of  
**ELECTRONICS ILLUSTRATED**  
for only **\$1.98**



Read the electronics hobby magazine that gives you authoritative feature and construction articles on:

- Citizens Band Radio
  - Short-Wave Listening
  - Electronics Theory
  - Amateur Radio
  - Audio & Hi-Fi
  - Kit Building
- And many other exciting subjects!

**YES,** I want to take advantage of your special get-acquainted offer. Please enter my subscription right away.

- I enclose \$1.98       Bill me  
 New order             Re-order

NAME .....

ADDRESS .....

CITY ..... ZONE ..... STATE .....

Mail to: Electronics Illustrated  
Circulation Department  
Fawcett Bldg., Greenwich, Conn.



# Marketplace

All in One . . . EMC's 212 transistor analyzer is a compact unit that performs tests on transistors that used to require several instruments. It does its work both in-circuit and out.

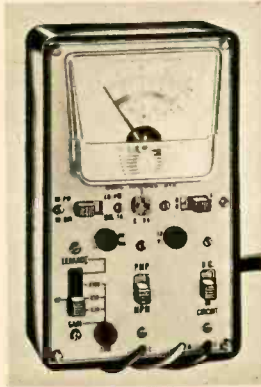

The analyzer's meter registers DC current gain (*beta*) in three ranges to 200, checks leakage, and reads current drain on an 80-ma. scale. Battery voltage can be checked on a 12-volt range. The unit can be used to signal-trace in AF, IF or RF circuits and check diodes. It also makes an oscillator check on transistors as AC current amplifiers. \$13.50 in kit form, \$18.50 wired. Electronic Measurements Corp., New York 12, N. Y.

Supressikitt SK-1. It consists of five bypass capacitors and a supply of shielded wire, all of which is designed to short-circuit random radio-frequency energy to ground (the car's chassis, as a rule). Supressikitt also is usable on marine engines. About \$20. Sprague Products Co., North Adams, Mass.

Kill That Noise . . . It may not have occurred to you before you installed that mobile CB or ham rig that a car's ignition system is a broad-band transmitter of undesirable noises. So you need a suppression kit. The newest one is what the Sprague people have named



Supressikitt SK-1. It consists of five bypass capacitors and a supply of shielded wire, all of which is designed to short-circuit random radio-frequency energy to ground (the car's chassis, as a rule). Supressikitt also is usable on marine engines. About \$20. Sprague Products Co., North Adams, Mass.

TV-RADIO Servicemen or Beginners . . .

Send for *Coyne's*  
7-Volume Job-Training Set  
on 7-Day **FREE TRIAL!**



The First  
Practical  
TV-RADIO-  
ELECTRONICS  
Shop  
Library!

Answers ALL Servicing Problems QUICKLY . . .  
Makes You Worth More On The Job!

Put money-making, time-saving TV-RADIO-ELECTRONICS know-how at your fingertips—examine Coyne's all-new 7-Volume TV-RADIO-ELECTRONICS Reference Set for 7 days at our expense! Shows you the way to easier TV-Radio repair—time saving, practical working knowledge that helps you get the BIG money! How to install, service and align ALL radio and TV sets, even color-TV, UHF, FM and transistorized equipment. New photo-instruction shows you what makes equipment "tick." No complicated math or theory—Just practical facts you can put to use immediately right in the shop, or for ready reference at home. Over 3000 pages; 1200 diagrams; 10,000 facts!

**SEND NO MONEY!** Just mail coupon for 7-Volume TV-Radio Set on 7-Day FREE TRIAL! We'll include the FREE BOOK below. If you keep the set, pay only \$3 in 7 days and \$3 per month until \$27.25 plus postage is paid. Cash price only \$24.95. Or return set at our expense in 7 days and owe nothing. Either way, the FREE BOOK is yours to keep. Offer limited, so act NOW!

"LEARNED MORE FROM THEM  
THAN FROM 5 YEARS WORK!"

"Learned more from your first two volumes than from 5 years work."

—Guy Bliss, New York

"Swell set for either the serviceman or the beginner. Every service bench should have one."—Melvin Masbruch, Iowa.

**FREE DIAGRAM BOOK!**

We'll send you this big book, "150 Radio-Television Picture Patterns and Diagrams Explained," ABSOLUTELY FREE just for examining Coyne's 7-Volume Shop Library on 7-Day FREE TRIAL! Shows how to cut servicing time by reading picture-patterns, plus schematic diagrams for many TV and radio sets. Yours FREE whether you keep the 7-Volume Set or not! Mail coupon TODAY!



Like Having An Electronics Expert Right At Your Side!

**VOL. 1—EVERYTHING ON TV-RADIO PRINCIPLES!** 300 pages of practical explanation; hundreds of illustrations.

**VOL. 2—EVERYTHING ON TV-RADIO-FM RECEIVERS!** 403 pages; fully illustrated.

**VOL. 3—EVERYTHING ON TV-RADIO CIRCUITS!** 336 pages; hundreds of illustrations, circuit diagrams.

**VOL. 4—EVERYTHING ON SERVICING INSTRUMENTS!** How they work, how to use them. 368 pages; illustrated.

**VOL. 5—EVERYTHING ON TV TROUBLESHOOTING!** Covers all types of sets. 437 pages; illustrations, diagrams.

**VOL. 6—TV CYCLOPEDIA!** Quick and concise answers to TV problems in alphabetical order, including UHF, Color TV and Transistors; 868 pages.

**VOL. 7—TRANSISTOR CIRCUIT HANDBOOK!** Practical Reference covering Transistor Applications; over 200 Circuit Diagrams; 410 pages.

BOOKS HAVE BRIGHT, VINYL CLOTH WASHABLE COVERS

**FREE BOOK—FREE TRIAL COUPON!**

Educational Book Publishing Division  
**COYNE ELECTRICAL SCHOOL**  
1455 W. Congress Parkway, Dept. 92-E1 Chicago 7, Ill.

Yes! Send me COYNE'S 7-Volume Applied Practical TV-RADIO-ELECTRONICS Set for 7-Days FREE TRIAL per offer. Include "Patterns & Diagrams" book FREE!

Name . . . . . Age . . . . .

Address . . . . .

City . . . . . Zone . . . . . State . . . . .

Check here if you want Set sent C.O.D. Coyne pays postage on C.O.D. and cash orders. 7-Day Money-Back Guarantee.

*Coyne*

Educational Book Publishing Division  
**ELECTRICAL SCHOOL**  
1455 W. Congress Parkway Dept. 92-E1, Chicago 7, Illinois

## Build your own superb **SCOTT KITS!**



**HAVE  
FUN...  
SAVE  
MONEY**

Have fun... save money... build the best! Now you can get world-famous Scott stereo components in kit form. Think of it... you can build the fabulous new LT-110 FM Multiplex Stereo Tuner... your choice of two complete stereo amplifiers, or a preamp and separate power amp... all from H. H. Scott!

Write today. Find out about these exciting Scott kits.

**Choice of 3 Booklets  
FREE**

**H. H. SCOTT**

H. H. Scott, Inc. 111 Powdermill Road, Maynard, Mass. Dept. 130-09

Send me the booklets checked below:

20-page "Guide to Custom Stereo"  Complete technical information on kits  16-page booklet explaining FM Stereo

Name \_\_\_\_\_

Address \_\_\_\_\_

City \_\_\_\_\_

Zone \_\_\_\_\_

State \_\_\_\_\_

Export: Morhan Exporting Corp., 458 Broadway, N.Y.C.

## Marketplace

**Speaker of Many Parts . . .** The hi-fi hobbyist finally has a chance to build his own speaker with a Realistic kit that contains all the needed parts—magnet, voice coil, spider, basket, cone, etc. An eight-page instruction manual describes

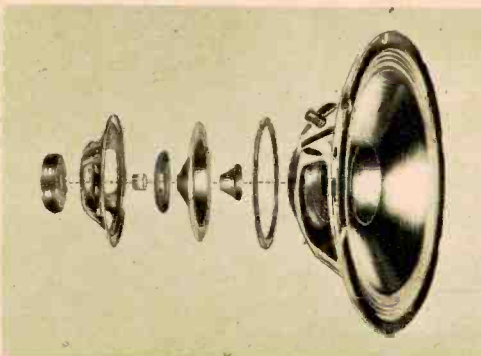

the function of each part and tells how to install it. The speaker kit is available in two sizes: 8 inches, with a power rating of 15 watts, and 12 inches at 20 watts. Blueprints for enclosures are in-

cluded. Prices are \$15.95 and \$19.95. Radio Shack Corp., Boston 17, Mass.

**Signal Squirter . . .** A new 12-element beam antenna has a name as imposing as its appearance: the Co-Planar Dipole Type Log Periodic. Originally developed for Air Force global communications, the antenna can now be had for amateur and commercial applications. It covers 13 through 30 mc with a forward gain of 8.7 db and can handle a couple of kilowatts with ease. The price is on the imposing side, too: \$495. A heavy duty rotating system is available for coupling with the Log Periodic. Hy-Gain Antenna Products, Lincoln, Neb.

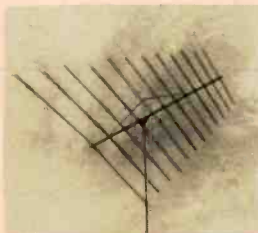

**TV Challenge . . .** Want to try your hand at a *real* kit project? Then take on Conar's Custom Seventy, a TV kit that gives you everything down to the last nut and bolt (and solder). You supply the soldering iron, screwdriver, pliers, cutters and a willingness to follow de-



tailed instructions. The tuner is pre-assembled and it, as well as four IF stages, are pre-aligned. The 19-inch rig uses high-gain, multi-purpose tubes. The price is \$135. Conar Div., National Radio Institute, Washington 16, D. C.



**NOW!**  
at a price  
you can afford!

# MAKE MORE MONEY in ELECTRONICS TELEVISION-RADIO

**BETTER...MORE COMPLETE...LOWER COST...  
WITH NATIONAL SCHOOLS SHOP-METHOD  
HOME TRAINING!**

**BETTER...** Training that is proved and tested in Resident School shops and laboratories, by a School that is the **OLDEST and LARGEST** of its kind in the world.

**MORE COMPLETE...** You learn **ALL PHASES** of *Television-Radio-Electronics*.

**LOWER COST...** Other schools make several courses out of the material in our **ONE MASTER COURSE**. . . and you pay more for less training than you get in *our course* at **ONE LOW TUITION!**



These  
**two FREE** books will  
show you how!

## TOP PAY... UNLIMITED OPPORTUNITIES LIFETIME SECURITY CAN BE YOURS!

You are needed in the Television, Radio, and Electronics industry! Trained technicians are in growing demand at excellent pay—in **ALL PHASES**, including Servicing, Manufacturing, Broadcasting and Communications, Automation, Radar, Government Missile Projects.

**NATIONAL SCHOOLS SHOP-METHOD HOME TRAINING**, with newly added lessons and equipment, trains you in your spare time at home, for these unlimited opportunities, including many technical jobs leading to supervisory positions.

**YOU LEARN BY BUILDING EQUIPMENT WITH KITS AND PARTS WE SEND YOU.** Your National Schools course includes thorough Practical training—**YOU LEARN BY DOING!** We send you complete standard equipment of professional quality for building various experimental and test units. You advance step by step, perform more than 100 experiments, and you build a complete TV set from the ground up that is yours to keep! A big, new TV picture tube is included at no extra charge.

**EARN AS YOU LEARN.** We'll show you how. Many students pay for their course—and more, while studying.

**GET THE BENEFIT OF OUR  
OVER 50 YEARS EXPERIENCE**

APPROVED FOR  
GI TRAINING



ACCREDITED  
MEMBER



**NATIONAL SCHOOLS**  
World-Wide Training Since 1905  
Write to Dept. R4Y-82  
4000 So. Figueroa Street  
Los Angeles 37, California

## YOU GET...

- 19 Big Kits—**YOURS TO KEEP!**
- Friendly Instruction and Guidance
- Job Placement Service
- Unlimited Consultation
- Diploma—Recognized by Industry
- **EVERYTHING YOU NEED FOR SUCCESS!**

**IMPORTANT  
SEE OTHER SIDE**

You get all information  
by mail. You make  
your own decision... at  
home. **NO SALESMAN  
WILL CALL**

**SEND FOR FREE FULLY-  
ILLUSTRATED BOOK AND  
ACTUAL LESSON TODAY.**  
Your own copy of "Your  
Future In Electronics-Tele-  
vision-Radio" will be mailed  
to you at once. No salesman  
will call; there is no obliga-  
tion. Cut out card along dot-  
ted lines, fill in and rush  
air-mail today!  
**NO POSTAGE NECESSARY.**

## CUT OUT AND MAIL THIS CARD TODAY

Yes, I want to make more money in Electronics-  
TV-Radio. Send me your **FREE** Fully-illustrated  
Opportunity Book and Actual Lesson today.

**RUSH AIR MAIL—NO POSTAGE NECESSARY**

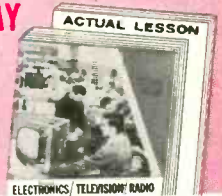

Name \_\_\_\_\_ Age \_\_\_\_\_

Address \_\_\_\_\_

City \_\_\_\_\_ Zone \_\_\_\_\_ State \_\_\_\_\_

Check here if interested only in Resident Training at Los Angeles. R4Y-82  
Veterans: Give date of discharge \_\_\_\_\_

**NO SALESMAN WILL CALL; NO OBLIGATION ON YOUR PART**

# DON'T BE HALF-TRAINED

## Be a MASTER TECHNICIAN in **ELECTRONICS-TV-RADIO**

Only N.T.S. offers you **ALL 8 PHASES** in  
**ONE MASTER COURSE**



### SUCCESS IS THEIRS; IT CAN BE YOURS TOO!



When I enrolled with N.T.S. last November, I was trained as a Seismograph

Observer. I was promoted to that job on May 1st of this year. With your school and my practical work in the field, my superiors recognized that I was capable of handling the job of Seismograph Recording. My superiors highly praise your school. The day I enrolled started me off to success.

Edgar Wesatzke

As field director of Berean Mission Inc., I have complete charge of our radio work.

With the expert advice and training I am receiving from you I can do my own repairs on our recorders and P.A. systems, besides keeping our radios going. My training from N.T.S. helps keep us on the air. I feel privileged to be a member of such a fine institution.

Rev. Enoch P. Sanford



Thanks to N.T.S. I have a business of my own right in my home. I am still in the Air Force but I have paid for all my equipment with money earned servicing TV sets. Yes, N.T.S. gave me my start in television.

Louis A. Tabat

I have a TV-Radio shop in Yorkville, Illinois, about 4 miles from my home, and it has been going real good. I started part-time but I got so much work that I am doing it full-time. Thanks to National Technical Schools.

Alvin Spera



### ALL 8 PHASES IN ONE MASTER COURSE

**PHASE 1  
TELEVISION**  
INCLUDING COLOR TV  
90% of homes have at least one set. Color TV is becoming more popular daily. TV Stations grow in number, need technicians. Maintenance and repair offer big opportunities.

**PHASE 5  
FCC LICENSE PREPARATION**  
FCC License holders have a wide range of top jobs open to them. FCC License now a requirement for most Communication jobs.

**PHASE 2  
RADIO—AM & FM**  
Radios in homes, cars, schools, all need expert upkeep. Stations expand as FM becomes popular. Now transistors boom entire field.

**PHASE 6  
RADAR AND MICROWAVES**  
These are the communications systems of the future, already used in tracking and controlling satellites.

**PHASE 3  
ELECTRONICS**  
Computers, Data-Processing machines, Electronic Controls, Guided Missile Systems are new fields where Electronics play a vital role.

**PHASE 7  
AUTOMATION & COMPUTERS**  
Automation and Computer electronics are the new tools of industry and commerce. Skilled Technicians in these fields are in great demand at top pay.

**PHASE 4  
SOUND SYSTEMS**  
New popularity of Hi-Fi-Stereo, as well as industrial sound systems and business intercoms make this a highly specialized and important field.

**PHASE 8  
BROADCASTING & COMMUNICATIONS**  
In the entertainment industry, or in commerce, communications and broadcasting have great importance. Installation and maintenance of equipment requires trained technician know-how.

SEE OTHER SIDE

**BUSINESS REPLY MAIL**  
NO POSTAGE STAMP NECESSARY IF MAILED IN THE UNITED STATES

FIRST CLASS

Permit No. 3087

Los Angeles, Calif.

VIA AIR MAIL

— POSTAGE WILL BE PAID BY —

**NATIONAL TECHNICAL SCHOOLS**

WORLD-WIDE TRAINING SINCE 1905

4000 So. Figueroa Street  
Los Angeles 37, California

RESIDENT TRAINING  
AT LOS ANGELES

If you wish to take your training in our famous Resident School in Los Angeles—the oldest and largest school of its kind in the world—check special box in coupon.



Approved for GI Training

**NATIONAL TECHNICAL SCHOOLS**  
WORLD-WIDE TRAINING SINCE 1905

Address correspondence to Dept. R4Y-82  
4000 So. Figueroa Street  
Los Angeles 37, California

National Technical Schools also offers complete Home Study Training Programs in Auto Mechanics & Diesel, and Air Conditioning, Refrigeration-Electrical Appliances. For information and Free Book write the School, Department RDC, stating course desired.



# Marketplace

**Packaged Power . . .** You usually think of a lead-acid battery as being a pretty messy thing that may eat holes in your clothes. But Exide has a new light-weight, sealed battery that can't spill and needs a minimum of attention during its expected seven-year life. The maker claims it can withstand

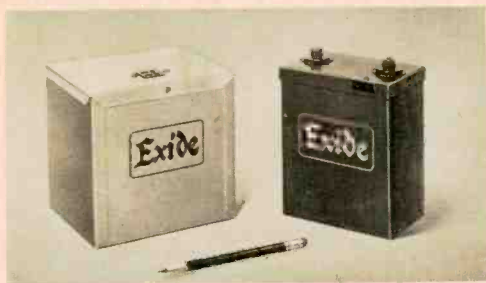

shock and vibration and may be operated at any angle. Complete with a built-in charger, the battery's cost per watt-hour is lower than the cadmium types, Exide says. The new cordless

tools and appliances are expected to use the battery. Our photo shows the 12-volt (left) and 6-volt (right) models. Electric Storage Battery Co., Philadelphia, Pa.

**Sprung Spring . . .** A tiny, forked cup and a tension spring inside it make up the Omni-Grip, a handy connector that can hold as many as eight component leads in a breadboard circuit. A screw

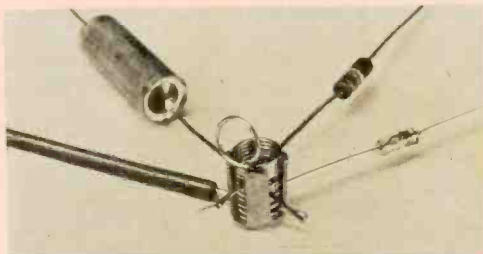

mounts the miniature connector, which measures  $\frac{5}{16} \times \frac{9}{16}$  inches. A pull on the spring's top loop opens the coils enough to admit a lead. The cup's fingers prevent the wires from twisting out of place. Cosmic Voice, Inc., Box 11, Jackson, Mich.

# MICRO

ELECTRON TUBE

FABULOUS LOW PRICES!

LARGE, SELECT STOCKS!

DEPENDABLE, FAST SERVICE!

# 37

¢ ea.

FOR any TUBE LISTED

\$35 PER HUNDRED ASSTD.

Jan Surplus Tubes!

# MICRO

ELECTRON TUBE CO. Dept. EI-9, P. O. Box 55 Park Sta., Paterson 3, N. J.

- Each and every tube is tested in our own laboratory for mutual conductance and life test.
- We guarantee FREE replacement for one year of any tube purchased from us which fails to function efficiently under any or all operating conditions. Prompt refunds are made on any defective merchandise.
- The advertised tubes are not necessarily new, but may be electrically perfect factory seconds or used tubes—each is clearly so marked.

6AQ5	6X8	6BN6	6SF8	7E4	198C6C
1A7ET	6Y30Y	6BJ6	6SF7	12A8	1916
1B2BT	6Y40	6BN5	6S17	12AQ5	1978
1N40Y	6A7	6BK7	6S27	12AT5	24A
1L4	6AB6	6BL7GT	6S17GT	12AU7	25AV8
1L6	6AC7	6BN6	6SN7GT	12AV6	25DNG
1NB6T	6AF4	6BQ6GT	6SQ7	12AU7	25L6GT
10B7	6AG5	6BQ7	6SS7	12AX4GT	25W4GT
1B8	6AG7	6BYS6	6T4	12AX7	25Z6
15A	6AH6T	6BZ6	6T6	12AZ7	26
174	6AM6	6BZ7	6T8	12B6	38A5
1U4	6AK5	6C4	6U6	12BA7	39A4
1U5	6AL5	6C5	6V6	12BE6	39/44
1V2	6AL7	6C6	6W4GT	12B7	42
2A3	6AM6	6C8	6W6GT	12B8	43
2AF4	6AN6	6C8B	6W6GT	12C6	50A5
30C5	6AO6	6C9G	6X4	12C6B	50B5
3BN6	6AG7BT	6C16	6X6	12C7	50C5
3BZ6	6AB6	6C16	6X6	12C8	50L6GT
3C90	6AB6	6C16	6X6	12C8B	50R5
3CF6	6AB6	6C16	6X6	12C9	50R5
3C54	6AB6	6C16	6X6	12CA8	50R5
3L4	6AB6	6C16	6X6	12CA8	50R5
394	6AB6	6C16	6X6	12CA8	50R5
354	6AB6	6C16	6X6	12CA8	50R5
3V4	6AB6	6C16	6X6	12CA8	50R5
48Q7A	6AV6GT	6H6	6T6	12CA8	50R5
48Z7	6AV6	6J4	6T6	12CA8	50R5
5A55	6AV6	6J4	6T6	12CA8	50R5
5AT8	6AX4GT	6J7	6T6	12CA8	50R5
5AV8	6AX4GT	6J7	6T6	12CA8	50R5
5AWA	6B7	6K6GT	6T7	12CA8	50R5
5BK7	6B6	6K7	6T6	12CA8	50R5
5J6	6B6	6K7	6T6	12CA8	50R5
5T6	6B6	6K7	6T6	12CA8	50R5
5U-6	6B6	6K7	6T6	12CA8	50R5
5U8	6B6	6K7	6T6	12CA8	50R5
5V46	6B6	6K7	6T6	12CA8	50R5
5V6T	6B6	6K7	6T6	12CA8	50R5
	6B6	6K7	6T6	12CA8	50R5

## BEST BUYS IN STEREO AND MONO HI-FI

New Transistorized Stereo/Mono 4-Track Tape Deck RP100 Semikit (electronics in kit form) \$299.95 Wired \$399.95



New FM-AM Stereo Tuner ST96 Kit \$89.95 Wired \$129.95 Incl. FET



New 70-Watt Integrated Stereo Amplifier ST70 Kit \$99.95 Wired \$149.95



New 40-Watt Integrated Stereo Amplifier ST40 Kit \$79.95 Wired \$129.95



28W Integrated Stereo Amplifier HF81 Kit \$69.95 Wired \$109.95

FM Tuner HFT90 Kit \$39.95 Wired \$65.95 Incl. FET Metal Cover \$3.95



AM Tuner HFT94 Incl. FET Kit \$39.95 Wired \$65.95



Stereo Preamplifier HF85 Kit \$39.95 Wired \$64.95

Stereo Power Amplifiers



	Kit	Wired
100W HF89:	\$99.50	\$139.50
70W HF87:	\$74.95	\$114.95
28W HF86:	\$43.95	\$ 74.95



NEW FM-Multiplex Autodaptor MX99 Kit \$39.95 Wired \$64.95 Cover Optional, \$2.95 (Patents Pending)



Bookshelf Speaker System HFS1 Kit \$39.95 Wired \$47.95

## BEST BUYS IN CITIZENS TRANSCEIVERS, HAM GEAR, RADIOS

Citizens Band Transceivers from Kit \$59.95 Wired \$89.95



New 60W CW Transmitter #723 Kit \$49.95 Wired \$79.95

NEW Walkie-Talkie Citizens Band Transceiver #740 Kit \$54.95. Wired \$79.95. Complete with rechargeable battery & charger.



## BEST BUYS IN TEST EQUIPMENT

New Metered Variable AC Auto-Transformer Bench Supplies Model 1073 (3 amps) Kit \$35.95 Wired \$47.95 Model 1078 (7 1/2 amps) Kit \$42.95 Wired \$54.95



Peak-To-Peak VTVM #232 & Uni-Probe® Pat. #2,790,051 Kit \$29.95 Wired \$49.95



VTVM #221 Kit \$25.95 Wired \$39.95

DC-5 MC 5" Scope #460 Kit \$79.95 Wired \$129.50



5" Push-Pull Scope #425 Kit \$44.95 Wired \$79.95

Tube Tester #625 Kit \$34.95 Wired \$49.95



RF Signal Generator #324 Kit \$26.95 Wired \$39.95



1000 Ohms/Volt V-O-M #536 Kit \$12.90 Wired \$16.90



6- & 12V Battery Eliminator & Charger #1050 Kit \$29.95 Wired \$38.95



Extra-filtered-for transistor equip. #1060 Kit \$38.95 Wired \$47.95

NEW AC Volt-Watt Meter #260 Kit \$49.95 Wired \$79.95



Multi-Signal Tracer #145A Kit \$19.95 Wired \$28.95



# EICO

## EXCELLENCE IN CREATIVE ELECTRONICS

Over 2 MILLION EICO instruments in use throughout the world. Compare, take them home — right "off the shelf" — from 1500 neighborhood dealers, most of whom offer budget terms.



EICO, 3300 N. Blvd., L.I.C. 1, N.Y. EI-9  
 Send free Catalog describing over 106 top-quality products, free Stereo HI-FI Guide, free Short Course for Novice License, name of nearest EICO dealer.  Send new 36-page GUIDEBOOK TO HI-FI for which I enclose 25¢ for postage & handling.

Name \_\_\_\_\_  
 Address \_\_\_\_\_  
 City \_\_\_\_\_ Zone \_\_\_\_\_ State \_\_\_\_\_  
 Add 5% in the West





# **BASIC**

# TRANSISTOR

## **CIRCUITS**

### **PART I**

*We take a look at the inner workings of a crystal diode for clues to transistor operation. Comparisons are made among the basic tube and transistor configurations and their biasing requirements.*

### **PART II**

*What happens to the phase of a signal going through an amplifier? The question has practical significance since it determines whether a common-collector, common-emitter or common-base mode best suits a circuit.*

### **PART III**

*Transistor amplifiers have three types of gain. With tubes, it's usually voltage gain that counts. But transistors are current-operated devices, so current and power gains are most important.*

**F**ROM pocket radios to computers, the transistor and its semiconductor relations are taking over a host of jobs previously reserved for the vacuum tube. A working understanding of these mighty midgets is as important to today's electronics enthusiast as his soldering iron or Ohm's Law. One of the best ways to become familiar with an electronic circuit or component is to put it through its paces in a variety of test setups. This is the approach EI takes in its basic transistor course.

**By  
Milton S.  
Kiver**



Before dealing with the transistor, it would be a good idea to take a look at exactly how a diode works. A diode is made up of two crystals, a positive type (P) and a negative type (N) joined together. The P crystal serves as the anode and the N as the cathode. Fig. 1 shows a diode for two conditions of applied polarity. When the negative side of the battery is connected to the diode's anode and the positive to the cathode you have a situation known as reverse bias (A). Without getting into the matter of majority or minority current carriers, let it suffice to say that in the reverse bias condition current flow is minimized. In the forward bias condition (B), current flow is encouraged.

Under reverse bias, the diode exhibits a high resistance, known as the *back* resistance of the diode. You can check it out with an ohmmeter and any diode, such as a 1N34A. Simply place the ohmmeter leads across the diode and take a reading. Now reverse the ohmmeter leads and the reading will differ considerably. It is the polarity of the battery in your ohmmeter that determines whether the diode is biased forward or reverse.

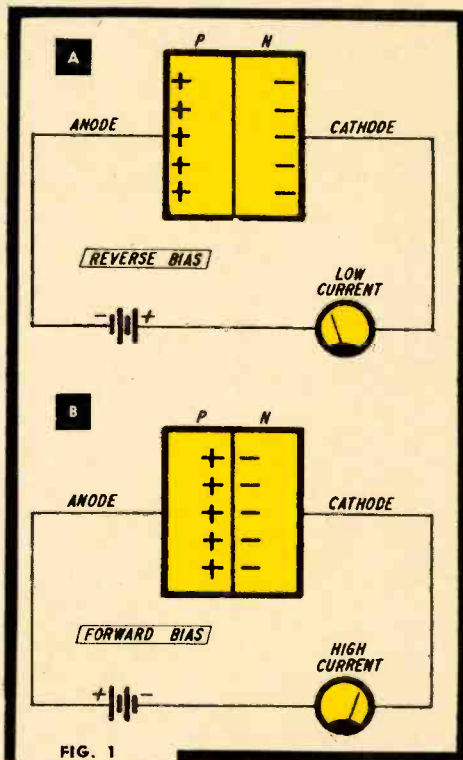

FIG. 1

### Transistors vs Tubes

All common transistors are three-terminal, three-element devices. Unlike the two-element diode, the transistor consists of a three-layer sandwich of P and N semiconductor materials. NPN transistors have two layers of negative material sandwiching one of positive; PNP's have the opposite.

The interactions of the layers in a transistor can be compared to the functions of the three elements in an electron tube (see Fig. 2). The emitter is comparable to the cathode, the base to the control grid and the collector to the plate. In both devices a flow of current originates at the first element, is regulated or

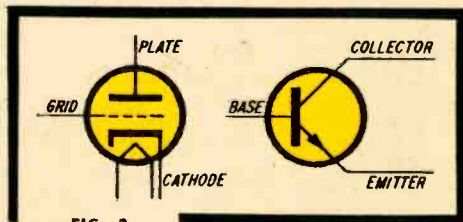

FIG. 2



controlled by the second and is received or collected by the third.

In a tube and in an NPN transistor the charges that travel from cathode to plate or from emitter to collector are electrons. In a PNP transistor, however, positive charges called holes are the carriers of electricity. This difference has little practical significance because PNP and NPN transistors in a circuit function the same way except that opposite polarity DC bias voltages are required.

### On The Bias

If you've done any work with transistors, you're aware that they are biased differently than vacuum tubes. In tubes, the control grid is usually given a negative voltage with respect to the cathode (reverse bias) which tends to repel electrons coming toward it from the cathode. By varying this negative voltage, we can control the number of electrons attracted toward the positively charged (forward-biased) plate.

In the NPN transistor, a forward bias voltage is set up between emitter and base, while a reverse bias is established between collector and base, as in Fig. 3. The negative potential of battery B1

repels the electrons from the N-type emitter, while the positive potential at the base attracts them. Resistor R1 sets the bias level and, therefore, establishes the amount of current flowing from emitter to base.

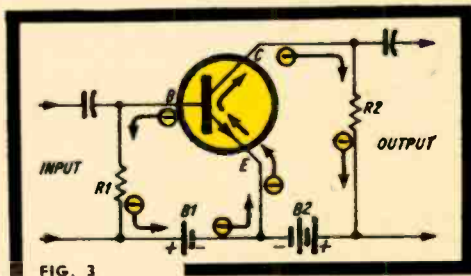

FIG. 3

Now let's look at the emitter-collector (EC) circuit. We take another battery (B2) and connect its negative terminal to the emitter and its positive terminal through R2 to the collector. Now the positive biased collector attracts the electrons from the base-emitter (BE) junction. However, the number of electrons that can enter the collector is determined by the current flow through the base-emitter junction. Without going into the complexities of semiconductor physics, let it suffice to say that the current flow in the base-emitter circuit controls the current in the emitter-collector junction. And since a small current variation in the BE circuit causes a much larger variation in the EC circuit, we have amplification.

The PNP transistor works in the same way as the NPN type discussed above. There is a difference in the hole and electron flow but, as we mentioned, the only practical distinction is in the bias polarities. It's easy to remember: the PNP transistor operates with a positive voltage on its emitter with respect to the collector and base; the NPN transistor operates with a negative voltage on its emitter.

### Three Ways to Amplify

Vacuum tubes can be used in three distinct circuit configurations: grounded cathode, grounded grid and grounded plate, as shown in Fig. 4. A similar division exists among transistors. The

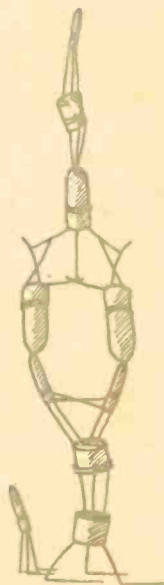

common-base (CB), common-emitter (CE) and common-collector (CC) types are shown in Fig. 5. A standard CE amplifier using a PNP transistor is shown in Fig. 6. (NOTE: all resistors shown are 1/2-watt, 10% except R8, which is 2 watts. All capacitors are electrolytic, 10 volts or higher rating.) The input signal is applied to the base and the output is obtained at the collector. In the equivalent vacuum-tube amplifier the input signal is fed to the grid and the output obtained at the plate.

Note that unlike our previous theoretical example, in the practical circuit of Fig. 6 a single battery (B1) supplies bias voltage to both the base and collector. At the input, the base connects into the voltage divider formed by R1 and R2 across battery B1. This places a bias voltage on the base (with reference to the emitter) of about 1/10 the battery voltage.

Another resistor, R3, has been placed in the emitter lead. With

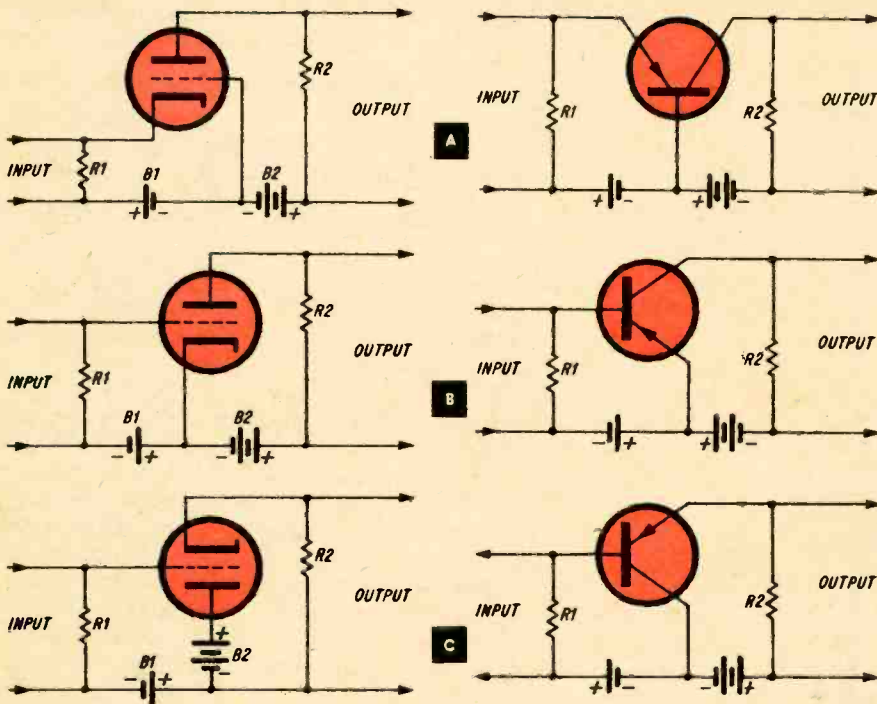

FIG. 4

FIG. 5

Three basic tube configurations and their transistor equivalents. Batteries are used to indicate polarity of the voltages applied to the elements. Note that the terms "common" and "grounded" are used interchangeably, although no grounds are shown in the schematics. The ground in each case can be placed at the junction of the two batteries.

**A** Grounded grid and grounded (or common-base) amplifiers. The tube version is encountered in RF front-ends and in cathode-coupled phase inverters. The common-base transistor circuit usually serves in oscillators.

**B** The grounded cathode tube and grounded (common) emitter transistor configurations are the standard workhorses found in conventional single or multi-stage amplifiers.

**C** The common-plate (better known as the cathode-follower) and the common-collector (or emitter-follower) generally serve to match a high impedance at their input to a low impedance at their output.



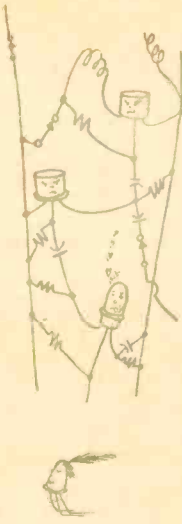

current flowing through the transistor, a voltage develops across R3 which makes the emitter negative with respect to R3's lead going to B1+. The total base-emitter voltage is thus equal to the voltage across R2, minus the voltage across R3. The two voltages buck each other, but the voltage across R2 is always larger; otherwise, no current would flow.

It is also necessary to provide a negative voltage (reverse bias) between collector and base. This is accomplished in Fig. 6 by connecting one end of resistor R4 to the negative terminal of the battery.

Note that the negative voltage at the collector is far higher than the voltage the divider permits at the base. This establishes the reverse bias between these two elements.

In Part II we will examine the three basic circuits from the point of view of two of their significant operating qualities—input and output phase and amplification.

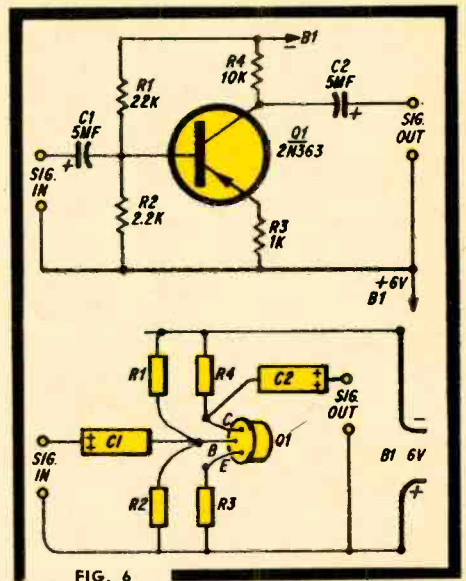

FIG. 6

## PART TWO

The phase change (or lack of it) that takes place when a signal travels through an amplifier stage is important when dealing with phase inverters and oscillators.

### Phase Flipping

The standard common-emitter, like the standard amplifier tube circuit, reverses the phase of any signal passing through it. We can demonstrate this in a simple experiment using the circuit of Fig. 6. Connect a volt-meter or VOM set for a low DC voltage range with its negative lead to the collector and its positive to ground (B1+). The meter will read between 2 and 4 volts.

As a signal source we will use a 1.5-volt flashlight battery with a

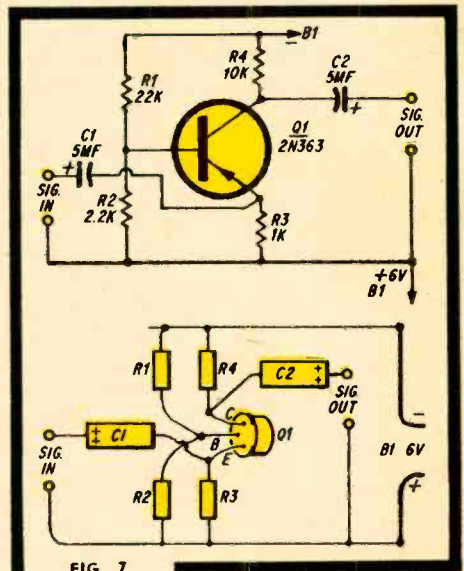

FIG. 7



4-inch piece of wire soldered to each terminal. Momentarily connect the positive battery lead to the base of Q1 and the negative lead to the common-ground (B1+). Note that the meter (which is reading the *negative* collector voltage) rises two or three volts. In other words, the collector went *more* negative. If we reverse the situation and connect the positive terminal of the battery to ground and the negative terminal to Q1's base, the meter reading falls: the collector goes more positive (or less negative).

We see, therefore, that a positive input signal produces a more negative collector voltage. This 180° signal phase change is characteristic of the common-emitter amplifier.

There are two remaining transistor amplifier arrangements, common-base and common-collector. We'll examine the common-base arrangement (Fig. 7) first.

In a CB amplifier, the input signal is fed to the emitter and the output signal obtained from the collector. As with the other circuits, the name for this arrangement stems from the fact that one element (in this case the base) is common to both the input and output circuits. Note that the CB circuit is equivalent to the grounded-grid vacuum-tube amplifier configuration, such as is used in phase inverters and RF amplifiers.

To determine what happens to the phase of a signal we'll use the circuit shown in Fig. 7. Connect the negative lead of the voltmeter to Q1's collector and the positive lead to common-ground (B1+). With the circuit in operation, the voltmeter will indicate 2-3 volts.

As before, we'll use the battery as a signal source. With the negative lead of the flashlight battery on the common ground (B1+), touch the positive lead to Q1's emitter and observe the meter needle. It will fall below scale and if you switch the meter leads you'll find that you have a reading of over 1 volt. In other words, a positive voltage signal at the input (emitter) of the common-base amplifier causes a corresponding positive signal at its output (collector).

As a double check, we can connect the battery with its positive terminal to ground and the negative lead to the input terminal (emitter). Note how the meter rises about 3 volts from its previous reading—indicating, as we would expect, that the voltage at the collector has gone more negative.

Now let's check the common-collector circuit of Fig. 8. Since the CC is the transistor analog of the vacuum-tube cathode-follower, it is frequently referred to as the emitter-follower. Like the CE amplifier in Fig. 6, the input signal is applied to the base. However, the collector doesn't feed a load resistor. It is connected directly to the battery. Signal output is obtained

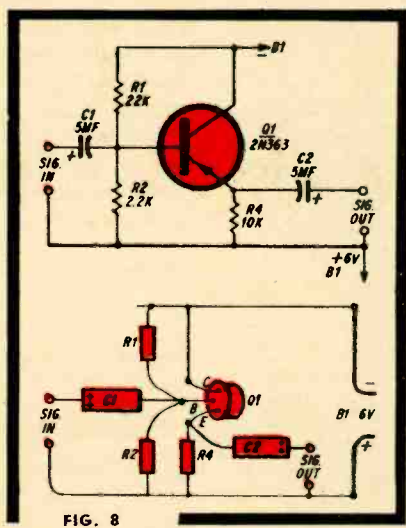

FIG. 8



at the emitter, clinching the resemblance to the cathode-follower.

We can check the phase shift from input to output in the following way. With the circuit wired as shown in Fig. 8, place a voltmeter across R4 with the positive lead to ground (B1+). Less than 1 volt should be read.

Now connect the test battery with its negative lead to ground (B1+) and its positive lead to Q1's base. The meter falls to slightly *below* zero. Reversing the battery and placing the negative lead on the base of the transistor causes the voltage to rise about 1.5 volts. In other words, a negative signal at the input of a CC circuit caused an *increase* in the negative voltage at its output terminal. And, conversely, a positive voltage causes a *decrease* in negative voltage. This means that there is *no* phase reversal as a signal passes through the circuit, which is exactly the case with a vacuum-tube cathode-follower.

## PART THREE

A key characteristic of an amplifier is its gain. In transistor amplifiers, we have three types of gain to consider. Most familiar (from vacuum-tube amplifiers) is voltage gain—the ratio of the output voltage of a stage to its input voltage.

Secondly, there is current gain—the ratio of output current to the input current. Finally, there is power gain—the ratio of output power to input power.

### Amplification: E and/or I

Since transistors are primarily current-operated devices, current and power gain are most important. Transistors usually are employed as power amplifiers, even when used in the RF stages of a radio or TV receiver. Vacuum-tube amplifiers, on the other hand, usually are voltage amplifiers and their power gain becomes important only when a power-operated device such as a loudspeaker is to be driven.

There are times when transistor voltage amplification is important (for example, when a transistor drives a TV picture tube); however, if a transistor drives another transistor or a speaker, it must provide power—not voltage. Remember, in any circuit power equals voltage  $\times$  current ( $W=EI$ ) or the square of the current  $\times$  the circuit's resistance ( $W=I^2R$ ). This means that any transistor with a high current gain usually has a high power gain. That is why such emphasis is placed on the current gain of a transistor stage.

In the experiments below we will first measure voltage gain and then check the individual current gains of the three basic amplifier configurations. From these two characteristics, we will be able to calculate their respective power gains.

**Voltage Gain.** For the experiments, we will use the transistor circuits of Figs. 6, 7 and 8. In each case, a small 6.3-volt filament transformer serves as the signal source, using the circuit shown in Fig. 9. The AC input signal is kept small in order not to overdrive the transistor. An oscilloscope will be used to view the transistor output.

The general procedure for each amplifier circuit is the same. We'll use the circuit of Fig. 6 and apply the AC signal voltage at the input of the stage. The oscilloscope is connected across

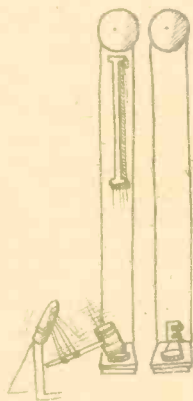

the output terminals. Start with zero AC input and gradually increase the signal (by rotating potentiometer R6) until the waveform of the oscilloscope screen starts to lose its sine-wave shape and distort. Then, back off R6 until the distortion disappears. Note the height of the pattern by measuring it with a ruler or using the ruled mask over the scope screen. Then, without touching anything else, place the input leads of the scope across the input voltage and measure the height of the sine-wave appearing on the screen. By dividing the

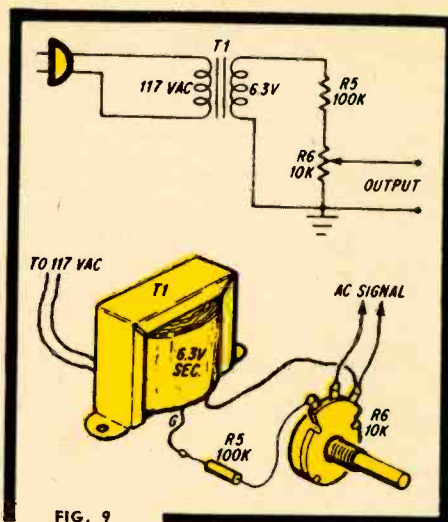

FIG. 9

input voltage reading into the output voltage reading, the voltage gain of the amplifier stage can be computed quickly. Check each set of measurements several times to make certain the correct figures are obtained.

Of the three circuits, it will be found that the CB amplifier has the largest voltage gain, while the common collector has the smallest. In fact, the voltage gain of the CC amplifier is somewhat less than 1—which means that you actually get less signal voltage out than you put in. In the CE and CB arrangements, a fairly sizeable voltage gain will be obtained.

### Finding the Beta

Now we'll measure the current gains of each amplifier type, starting with the common-emitter circuit of Fig. 10. In the CE mode, current gain is referred to as *beta*. Actually there are two current gains to deal with—AC and DC. A small-signal AC *beta* test is made on low- and medium-power transistors. The large-signal DC *beta* test is for high-power transistors. Low-power transistors designed for switching are exceptions to this rule, since the DC *beta* test best simulates their actual operating conditions.

**DC Beta.** When dealing with DC current gain, as we will be in the experiment below, the gain is determined with the formula:

$$\text{beta} = \frac{\text{collector current}}{\text{base current}}$$

To set up the experiment, adjust R7 (Fig. 10) to 50,000 ohms as measured by an ohmmeter. The resistance in the base-emitter circuit (R7 plus R4) then totals 60,000 ohms. The 1,000 ohms of R3 can be disregarded since it is negligible in comparison to the other figures.

With a 6-volt power supply and 60,000 ohms in the base-emitter circuit there is .1 ma of current flow. Now measure the voltage across R4 (say it's about 1.5 volts) and divide it by R4's resistance (470). This gives you about .003 amps (3 ma) as the collector





current. If we now divide this 3 ma collector current by the .1 ma base current, we have the DC current gain for the stage—30. It's as simple as that!

With the 2N363 transistor, current gain of anywhere from 15 to 40 can be expected. As a check, we can set R7/R4 for a total of 40,000 ohms. Now .15 ma is flowing in the base circuit. If you calculate the collector output current as above, you'll find that the current gain has remained the same. This will be true over a moderately wide range of input current.

**AC Beta.** The AC current gain test gives a better idea of what we may expect of a transistor under operating conditions. The AC beta describes the amount that a small change in base current ( $I_b$ ) is reflected by a change in collector current ( $I_c$ ). Expressed as a formula:

$$\text{AC beta} = \frac{I_c \text{ change}}{I_b \text{ change}}$$

The circuit of Fig. 10 will serve also for AC beta checks. As a start, we have the figures obtained in the DC beta measurement—.1 ma base current and 3 ma collector current.

Now set the R4/R7 combination to provide a total base circuit resistance of 30,000 ohms. With the 6 volts of B1, this produces a base circuit current of .2 ma ( $I = E/R$ ). This represents a change in base current ( $I_b$ ) of .1 ma from the previous value. This figure goes in the denominator of the equation.

For the  $I_c$  change figure needed for the numerator, we measure the voltage across R8 and divide it by R8's resistance. This gives the new  $I_c$ . The difference between this value of collector current and the previous DC beta value is placed in the numerator. Work out the equation and the answer is the AC beta value for the specific 2N363 transistor you used in the circuit of Fig. 10. (For other circuit arrangements, the transistor, may have slightly different values of AC and DC beta. In normal operation, however, all will be fairly close together.) If one checks out, the other will too.

### Analyzing the Alpha

Let's turn to the current gain of the common-base circuit shown in Fig. 11. In the common-base configuration, the symbol *alpha* is used for current gain. *Alpha* expresses the ratio of collector current ( $I_c$ ) to emitter current ( $I_e$ ) or

$$\alpha = \frac{I_c}{I_e}$$

**Common Base Gain.** First, adjust R2/R4 to a total value of 6,000 ohms for a current flow of about 1 ma in the base-emitter circuit. If you measure the voltage

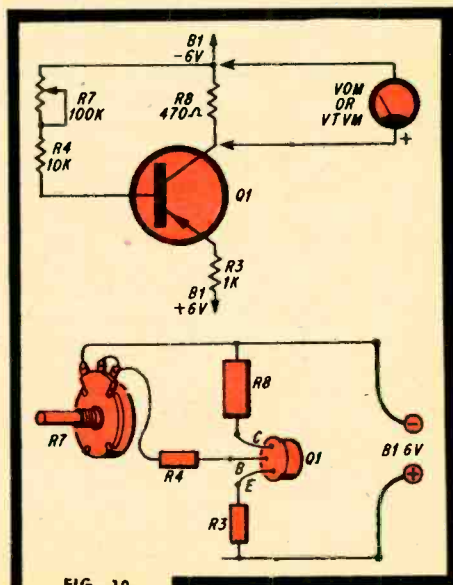

FIG. 10

across R8 and divide it by 470 (ohms) you'll find a collector current of between .9 and .95 ma. In spite of the fact that the common-base amplifier provides the best voltage gain, its current gain is less than 1. This means there's a current loss between input and output.

As with the previous circuits checked, stage amplification can be approached from both DC and AC gain. The AC *alpha* is measured in much the same way as with the previous circuits. The formula is:

$$\text{AC } \alpha = \frac{I_c \text{ change}}{I_e \text{ change}}$$

Note the currents in the emitter and collector circuits from the DC check. Now reduce the emitter current by increasing the resistance of R4 and note the corresponding change in collector current. Subtract the new figures from the old ones, insert them in the above equation—and you have the AC *alpha*.

If you're wondering what the relationship is between *alpha* and *beta* (other than the fact that they follow each other in the Greek alphabet), it's expressed in the formula:

$$\beta = \frac{\alpha}{1 - \alpha}$$

**Common-Collector Gain.** Fig. 12 shows how a common-collector circuit's current gain is checked, using the same techniques that served us for the other circuits. The R4/R7 combination is adjusted for a total resistance of 60,000 ohms. (We can ignore R8.) Measure the voltage across R8 and divide this value by 470 (ohms) to arrive at the current flowing in the emitter circuit. As in the common-emitter arrangement, a fairly high current gain is obtained.

Now let's review our findings. We saw that the common-emitter and common-collector circuits have about the same current gain, whereas the common-base arrangement produces a current gain of less than 1. If we combine this information with the voltage-gain data determined earlier, we can determine the relative power gain of the three configurations.

In the CE stage, the voltage and current gain were both good. When these two quantities are multiplied together ( $W=EI$ ) excellent power gain will result. In the CB amplifier, the voltage gain was good, but the current gain low. Its power gain, therefore, is less than that of the common-emitter. Finally, in the common-collector circuit, we found a voltage gain of less than 1, but a good current gain. Here again, we see that the power gain of a CC amplifier is not as high as that of the common-emitter

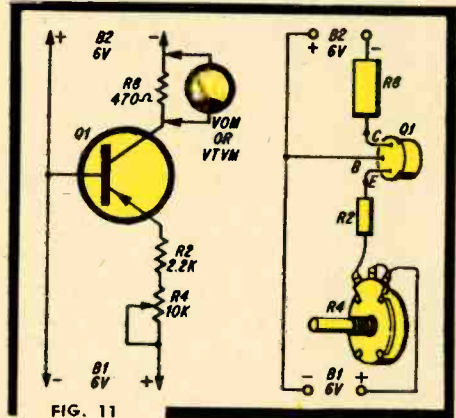

FIG. 11



amplifier. Actually, the CC's gain is the lowest of the three types.

Because the common-emitter arrangement has the best combination of current and power gain it is the type most frequently used.

The common-base arrangement is an excellent choice for oscillator circuits because the input and output phase are the same. By simply feeding a small amount of output voltage back to the input, oscillation can be obtained.

Finally, the common collector is useful as an impedance matching device because, like the tube cathode follower, it has a high input impedance and a low output impedance.

For those interested in pursuing transistors and transistor circuitry further, scores of books and pamphlets are available from libraries, bookstores, parts distributors or publishers. Here is a selection of these publications:

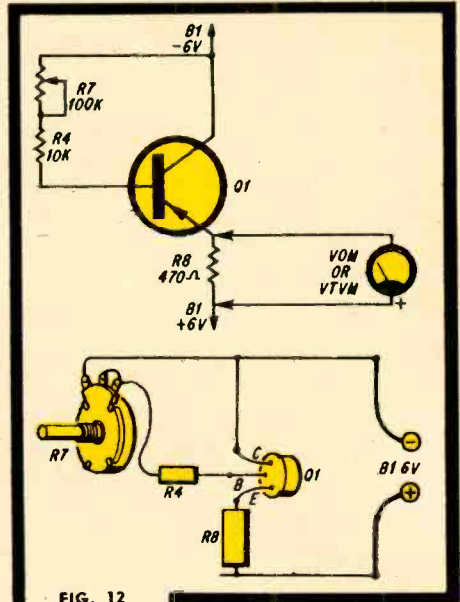

FIG. 12

**Basic Theory and Application of Transistors.**

U.S. Govt. Printing Office, Washington 25, D.C. \$1.25

**Facts on Transistors.** By Walter J. Cerveny.

Hickok Electrical Instrument Co., 10532 Dupont Ave., Cleveland, Ohio. \$1  
**Power Transistor Handbook.** Motorola Semiconductor Div., Phoenix, Ariz.

**Semiconductor Devices.** By Rufus P. Turner.

Holt, Rinehart & Winston, Inc., 383 Madison Ave., New York, N. Y. \$7.50

**Transistor Circuit Handbook.** By L. Garner.

Coyne Electrical School, 1455 W. Congress Parkway, Chicago 7, Ill. \$4.95

**Transistors in Radio and Television.** By Milton S. Kiver.

McGraw-Hill, 330 W. 42nd St., New York, N. Y.

**Transistor Manual, 4th Ed.** General Electric Co., Syracuse 1, N. Y. \$1

**Transistor Physics and Circuits.** By Robert L. Riddle, Marlin P. Ristenbatt.  
 Prentice Hall, Englewood Cliffs, N. J.

**Understanding Transistors.** By Milton S. Kiver. Allied Radio, Chicago, Ill. 50¢

**GERNSBACK LIBRARY, 154 W. 14th St., New York, N. Y.**

**Basic Transistor Course.** By Paul R. Kennian.

**Fundamentals of Semiconductors.** By M. B. Scroggie. \$2.95

**Transistor Circuits.** By Rufus P. Turner. \$2.75

**Transistor Techniques.** \$1.50

**Transistors.** \$1.95

**Transistors—Theory and Practice.** By Rufus P. Turner. \$2.95

**JOHN F. RIDER, INC., 116 W. 14th St., New York, N. Y.**

**Basic Transistors.** By Alexander Schure. \$3.95

**Fundamentals of Transistors, 2nd Ed.** By Leonard Krugman. \$3.50

**Fundamentals of Transistor Physics.** By Irving Gottlieb. \$3.90

**International Transistor Substitution Guidebook.** By Keats Pullen. \$1.50

**Principles of Transistor Circuits, 2nd Ed.** By S. W. Amos. \$3.90

**HOWARD W. SAMS & CO., Indianapolis, Ind.**

**ABC's of Transistors.** By George B. Mann. \$1.25

**Transistor Circuit Manual.** By Allan Lytel. \$4.95

**Transistor Substitution Handbook.** \$1.50

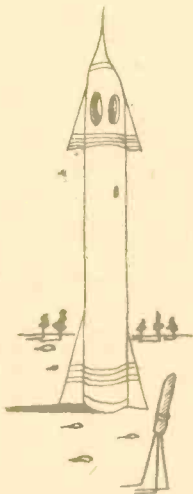

*an expert's*  
**DEFINITION** of

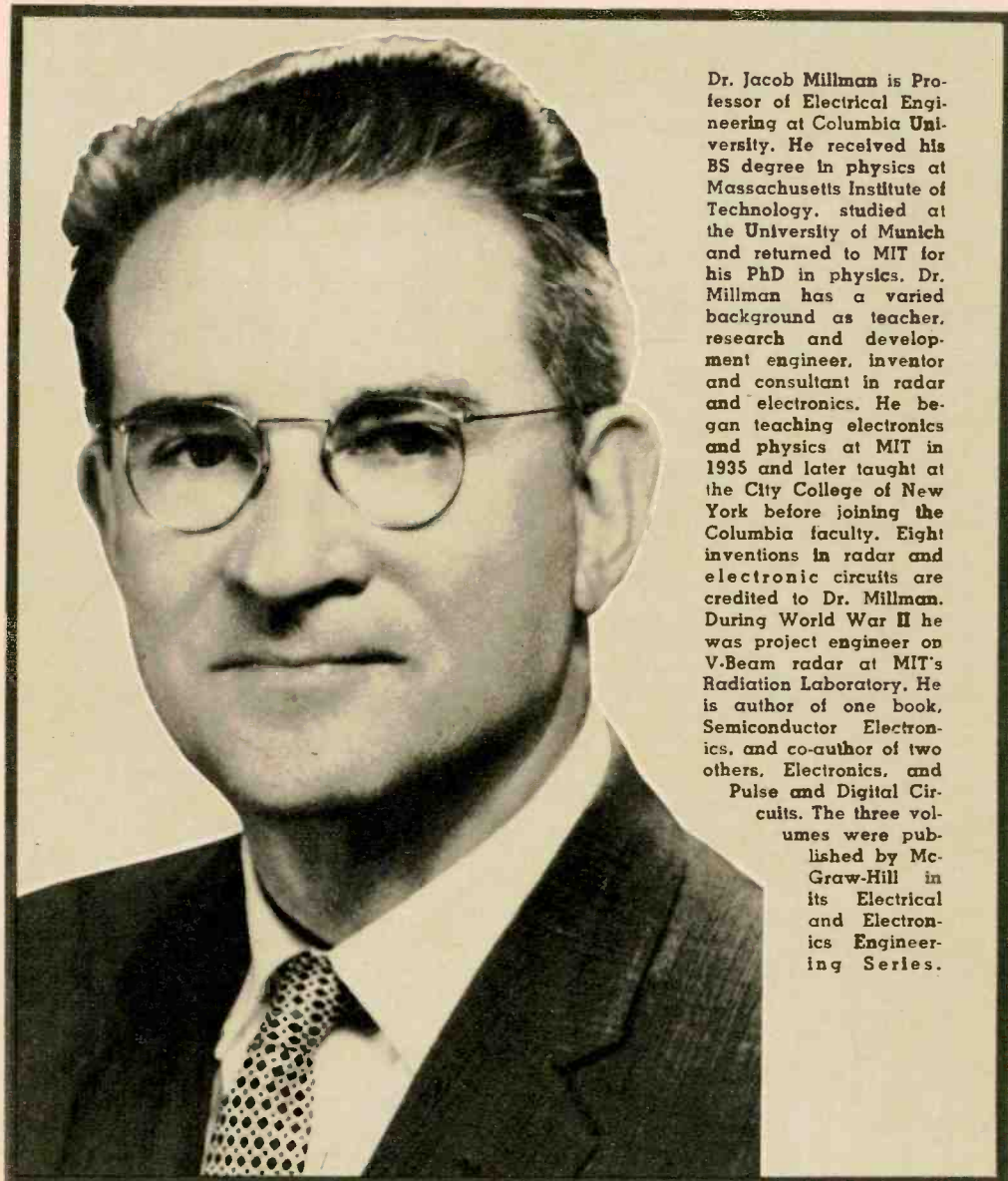

Dr. Jacob Millman is Professor of Electrical Engineering at Columbia University. He received his BS degree in physics at Massachusetts Institute of Technology, studied at the University of Munich and returned to MIT for his PhD in physics. Dr. Millman has a varied background as teacher, research and development engineer, inventor and consultant in radar and electronics. He began teaching electronics and physics at MIT in 1935 and later taught at the City College of New York before joining the Columbia faculty. Eight inventions in radar and electronic circuits are credited to Dr. Millman. During World War II he was project engineer on V-Beam radar at MIT's Radiation Laboratory. He is author of one book, *Semiconductor Electronics*, and co-author of two others, *Electronics*, and *Pulse and Digital Circuits*. The three volumes were published by McGraw-Hill in its *Electrical and Electronics Engineering Series*.



By Jacob Millman, PhD

# ELECTRICITY

**A** BRIEF exposition on the history of electrical science will be interesting and instructive, and will give us the answer to: "What is electricity?"

About 600 B.C. the Greeks made the observation that a piece of amber, when rubbed, acquired the ability to attract light objects to itself. William Gilbert (about 1600) introduced the word electricity from the Greek word meaning amber. It was found that other substances besides amber, when rubbed, also would exhibit this mysterious force of attraction. As a consequence, the phrase electrification by friction was born.

In the Sixteenth Century it was discovered that it also was possible to cause material to exert a repulsive force upon another electrified body. For example, let us rub two glass rods with silk and two ebonite rods with fur. We then find that the two glass rods repel each other, and the two ebonite rods likewise repel each other. But a glass rod is attracted to an ebonite rod. The conclusion that must be drawn is that the glass, as a result of the friction, has acquired a "substance" which is of a different type from that left on the ebonite rod. These substances have been given the names positive and negative electrical charges.

The above-described experiment is interpreted to mean that positive charges repel each other, negative charges repel each other. But a positive charge attracts a negative charge. Electric charge is thus seen to be a fundamental concept required by the existence of forces which are experimentally measurable.

In 1800 Volta produced a "pile" (we now call it a battery), consisting of zinc and copper plates separated by blotting paper moistened in brine. If a piece of wire was connected between the plates of this Voltaic cell, heat was produced in the wire. It was hypothesized that chemical energy was being used to cause a hitherto unknown "fluid" to flow through the wire. The friction or resistance to the flow was what was causing the wire to become hot. Could it be that this "fluid" was the same substance causing the static electrification of the glass or ebonite rods? Experimentation by many scientists finally gave an affirmative answer to this question. Charges were flowing in the wire, and the total charge passing through any cross section of the wire in one second was called the electric current.

It was not until 1897 that J. J. Thomson was able to prove that a current (in a discharge tube) consisted of a flow of isolated "corpuscles" carrying a negative charge, and these fundamental particles were called electrons. Further experiments have revealed that all matter consists of atoms and in each atom there is one or more electrons surrounding a core of positive charge called a nucleus. An atom which has lost an electron is called a positive ion.

In summary, electricity represents a quantity of charge, either electrons or ions. These may be at rest on the surface of a conductor or in motion, as in a current through a wire, a gas, a liquid, a semiconductor or a vacuum.

Dr. Millman's essay represents an expert answer to the question, "What is Electricity?"—posed in EI's Electricity Contest. It concludes the contest.



# THE LISTENER

SWL-DX NOTES

BY C. M. STANBURY II

**SIGNALS FROM SPACE.** . . After our experiences on the air during John Glenn's orbital flight in Friendship 7, and the other Mercury shots, it is apparent that a new field has opened for short-wave listeners in North America and elsewhere.

Col. Glenn used one main frequency in the short-wave spectrum—15016 kc. His transmissions could, at one time or another, be received throughout the continent. Reception beyond the line of sight (which took in a lot of territory because of his altitude) was spotty due to poor ionospheric and atmospheric conditions, but ground stations in Florida, Texas, California and Mexico put out potent signals.

And every suspense-filled word was in English!

Few knew the Glenn SW frequencies in advance. They are not made public for obvious reasons—somebody with no more official standing than being a taxpayer might try to contact the capsule and foul up communications completely. The Mercury short-wave frequencies are given simply as "between 4 and 26.5 mc," although the exact operating frequency of the UHF gear is announced by NASA (see HOW WE TALK TO THE ASTRONAUTS, March '62 EI).

Even though you don't know the frequency, extensive tuning while one of the capsules is on this side of the earth should produce results, since there will be a whole net on that frequency.

The 15016-kc frequency mentioned previously is a good bet to monitor, being a regular Air Force channel. Others that bear watching are 13826, 13215.5 and 11228 kc. On the day of a shoot you should start checking at least an hour before blast-off. Most ground stations heard here identify themselves as Cap Con.

**Confusion Reigns . . .** Though international broadcasting has its bright moments and makes its contribution to international understanding, the word that too often describes activities on the short-wave BC bands is *chaos*. You might throw in *confusion* for good measure.

Mother Nature, the jammers and unscrupulous operators create enough QRM to make life hectic for the DXer, but that's not all we have to contend with. There also are just plain accidents, caused by well-intentioned people. Consider the recent collision on 11895 kc of Radio Free Europe and Radiodiffusion du Senegal.

RFE is known and respected throughout the free world for its anti-Communist broadcasts. In recent years R. Senegal, transmitting from Dakar, has come to rank high among African transmitters as an excellent, objective station with no ax to grind (at least not a big one). In December of last year it was one of the few stations on the

[Continued on page 116]

**CHAOS ON THE SHORT WAVES.** Radio Senegal at Dakar (see QSL card) and Radio Free Europe have, by accident and because of Red jamming, come together on 11895 kc, burying Senegal for American listeners.

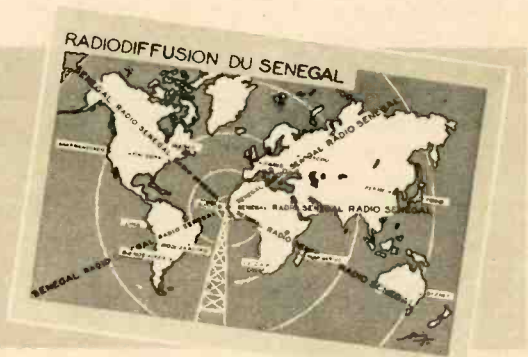





## CB CORNER

BY LEN  
BUCKWALTER  
1W6733

EI attends a

# NATIONAL CB CONVENTION



**I**T'S GETTING SO you can't tell the conventions without a score card. National Citizens Band conventions, that is. This year you'd use most of your fingers counting them up.

There has been some yelling and screaming about what is a true national convention and what isn't. We're of the opinion that any organization that can attract conventioners from a fair spread of states can call its get-together a national convention without getting its knuckles rapped with a dictionary.

One of the main underlying reasons for so many national CB

bashes is the great number of organizations that are trying to become the dominate voice of the Citizens Banders. One way to show your power would be a convention of World Series proportions. So far, we haven't seen one like that.

A few weeks ago this corner visited a convention held by the National Citizens Radio League at the Morrison Hotel in Chicago. It was a three-day affair and turned out to be a fairly large one, with some 4,000 people dropping in. It had all the trappings of a well-organized and professionally run convention and should have made NCRL's stock go up a few points with CBers.

More than 30 manu-



NCRL prexy Charles Greene (left) with Ivan H. Loucks, who administers CB radio for the FCC.

facturers exhibited their equipment, there was a goodly number of club presidents in attendance, and the Federal Communications Commission's top man on CB radio delivered a talk.

NCRL is a Chicago-based group that obviously is making a mammoth pitch



Polytronics booth had new frequency synthesis rig that gives you 23 channels on 12 crystals.

for nationwide recognition from its central location in 18-land (address: 6272 W. North Ave., Chicago). As we've said before, CB needs and should have a truly representative national organization serving its interests. It's too early to tell whether NCRL might be that organization.

NCRL was started when Charles Greene, now president, got together with two fellow employees at the Admiral Corp. The idea was hatched and three others then were invited to form the nucleus of NCRL, a corporation chartered by the State of Illinois. The group, who've picked up the moniker of the Big Six in some circles, is well-rounded, having backgrounds in electronics, business, sales and accounting. There is no question but that the Big Six spent a lot of time and money to make the convention a success.

Like most beginning organizations,

NCRL has its critics. The barbs were sharpest at a meeting of club presidents, who wanted to know whether the organization would be run democratically, when officers would be elected and how finances would be handled.

The last query turned out to be a small bomb when President Greene was unable to give an answer, going into a huddle with the Other Five instead. It appeared they simply had not decided about what was to become of dues money, for instance, that was paid into the corporation and who, if anyone, was going to reap the profits. The final answer was that dollars put into the organization by CBers would be held in a special account, while profits from exhibitions and conventions (such as this one) would go to Greene and his partners as being something apart from dues money.

All these details, said Greene, would be spelled out in a new constitution,

Heath's Al Tash holds new GW-12, superhet with transmit-receive crystal control; the price is \$39.95.



to be drawn up in a few months. He stressed the point that NCRL will grow and change according to the needs of CBers, or fail if it doesn't. The money in the special account and the offices of NCRL are to be placed at the members'



disposal, according to Greene.

Whether this proves a workable arrangement can be answered only by time. As Greene said during a taped interview we had with him, NCRL cannot hope to have a polished program overnight.



Browning proxy Gar Greene with module station, R-2700A receiver, matching 23/S-9 transmitter.

In general NCRL proposes to serve as the voice of CB by lobbying in Washington, to offer guidance to local clubs, and to aid clubs financially by conducting programs around the country that would turn a profit shared by the local groups.

The National Citizens Radio League, in its first announcements and releases, seems to be concentrating on the lobby angle. The rest of the program has not been spelled out in great detail to date but perhaps will be in the near future. Its biggest pitch now is simply for the support of Citizens Band licensees.

The exhibits by manufacturers were both entertaining and informative for Cbers, who had a field day twisting knobs and filling shopping bags with literature.

One significant trend we spotted concerns the way the equipment makers have started dividing their wares into

two groups. The first is for the Cber who wants a black box that transmits and receives. These stripped-down rigs give rugged, reliable performance at low cost. Although the chassis may hide advanced circuitry, it offers a minimum number of channels. The guy who goes for a black box, the companies say, is the all-business gent looking for equipment to do a specific job. Manufacturers are becoming convinced that the small industrial and commercial user may some day be the backbone of CB.

The second group of users naturally falls in the personal or non-business category—those looking for flexibility and features, and perhaps chrome trim.

Looking for gripes by manufacturers, we found the most popular beef to be with the Cber who doesn't read his instruction book before setting up his gear. "They just read the instructions to find out the errors they've already made!" said one.

Raytheon demonstrated a versatile handi-talkie that operates at either 1-watt or 100-mw level.



The speaker we mentioned earlier was Ivan H. Loucks, chief of the FCC's Land Transportation Division, who consequently is top man on CB. He gave an informative talk with wry touches of humor that went over well.

# MACHINES THAT READ

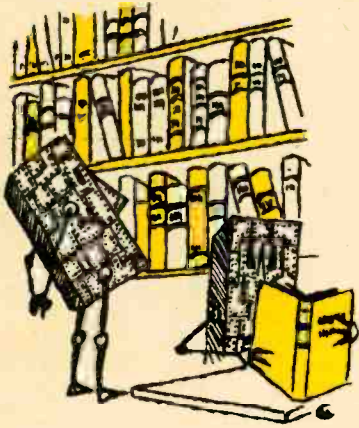

Type it, print it or pen it and there's a robot to tell you what you said.

By Ken Gilmore

**M**ACHINES have come a long way since the days when the best ones had nothing more to do than turn the paddlewheels of a steamboat. The smart machines now, after learning to add and subtract, are acquiring the ability to read. And it's not just numbers they're reading. They also recognize letters of the alphabet, whether typed, printed or written in longhand.

You've probably heard about the electronic monster that sits in a building just outside Washington, contentedly clucking to itself as it leafs through 10,000 letters an hour. It reads the addresses on typed envelopes and drops each one into the proper slot. This automated postal clerk is a prototype but its successful operation indicates it will soon be sorting part of the nation's mail on a full-time basis.

In New York's First National City Bank, a reading machine runs through cashed travelers checks at the rate of 100 a minute, reads the numbers and sorts them for processing. So sharp is the electronic scanning eye that it reads the information right through the rubber-stamp marks you see on cancelled checks.

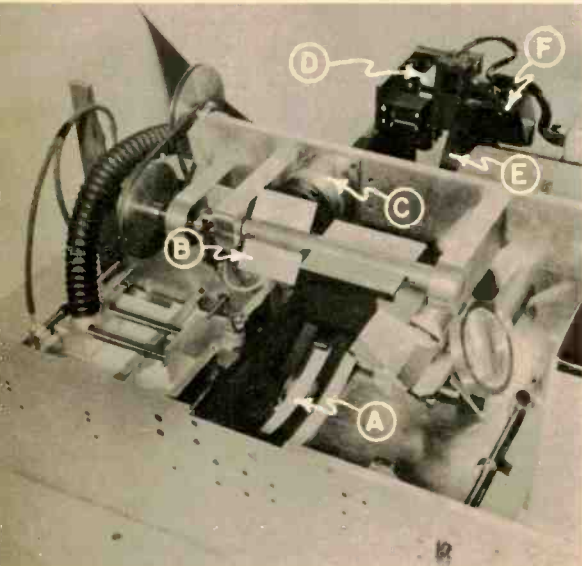

A robot reading: image of type (A) goes through mirror (B), lens (C), second mirror (D), scan disc (E) and finally into photomultiplier tube (F).

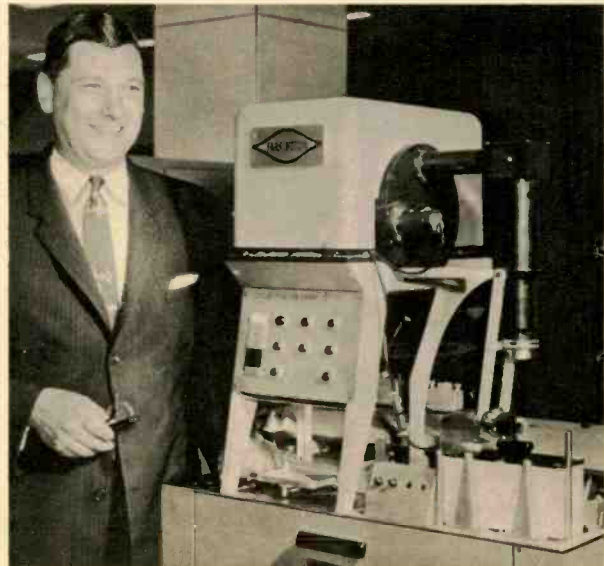

Leading reading-machine producer is Farrington Co., whose ex-president, William Tetrick, stands with a machine that reads cards stacked at right.



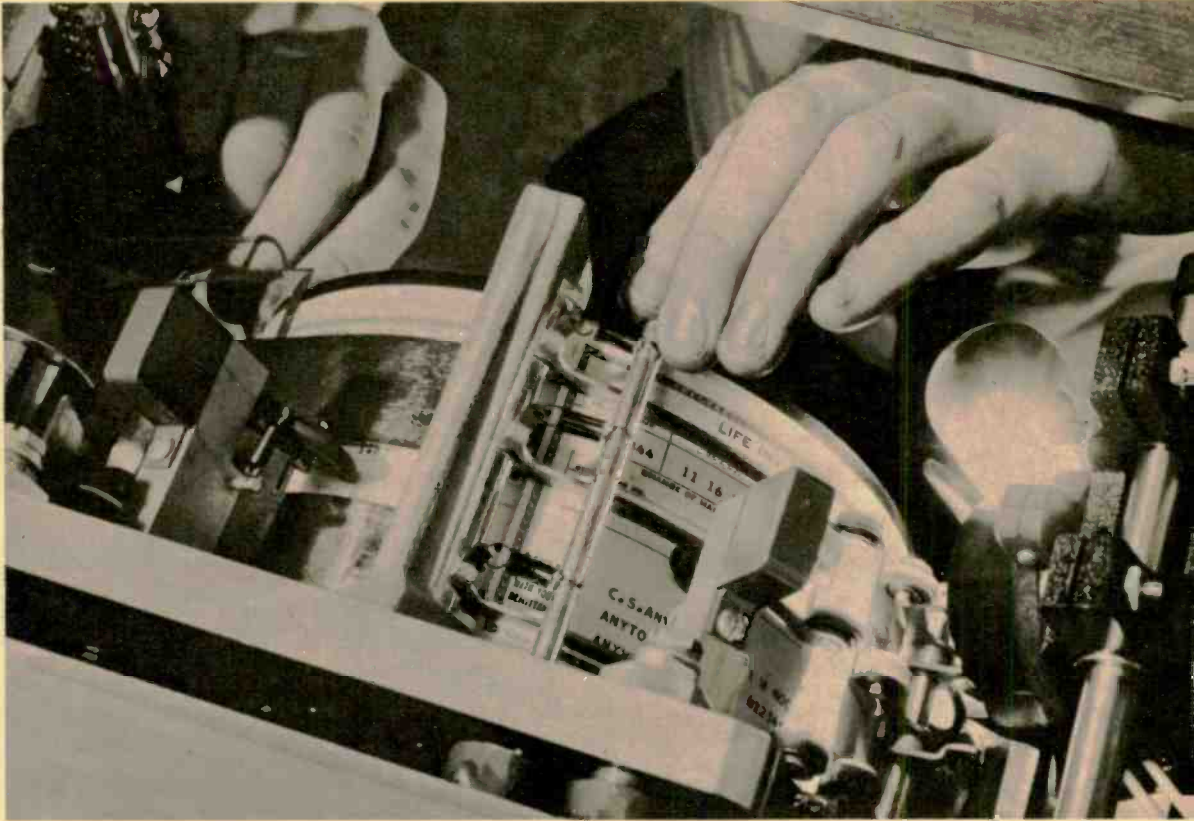

Reading station in IBM character reader which is reading insurance policies on spinning drum.

At an Air Force base in Rome, N. Y., technicians slip stacks of typewritten messages into an electronic scanner called The Eye. This robot reader glances across each line at 3,000 words a minute, reads what it sees and translates it into computer language. These signals go out over the Air Force's communications network and appear on teletype machines all over the country without a single airman lifting a finger.

These are just three of almost 100 optical scanners, or reading machines, now plowing through the mountains of paper work it takes to keep our society running. They're catching on rapidly at banks, insurance companies, oil firms and other businesses because they whiz through stacks of material at inhuman speeds, rarely make mistakes and work 24 hours a day with no time off.

The reading machine boom that is now picking up speed began in 1950, when the Department of Defense found itself buried in paper work. Its computers could handle the load, but there weren't enough punch operators to translate the information into punched cards for computers to read.

National Cash Register reader digests cash register tape.



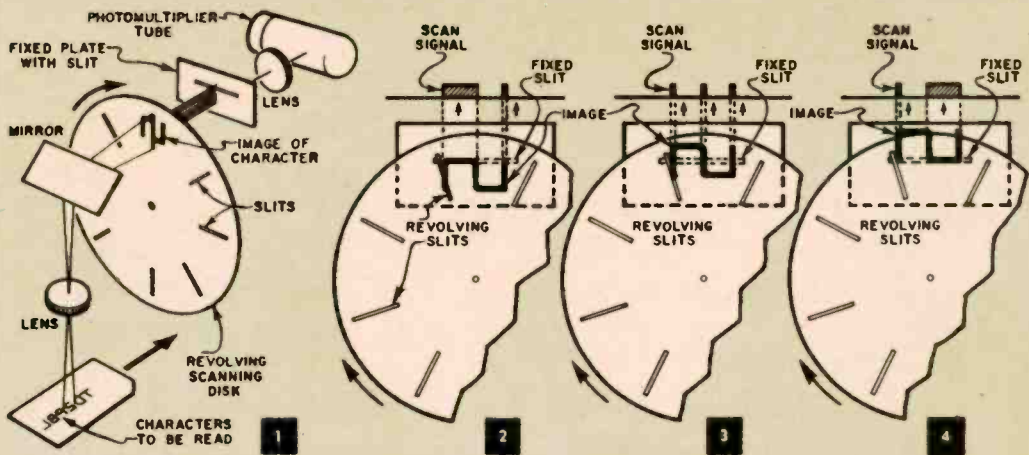

**HOW A MACHINE READS.** The device illustrated here scans characters mechanically with revolving disc. Fig. 1 shows characters to be read at lower left. Image of 2 is here focused on the scanning disc by lens and mirror. Fig. 2: as disc revolves one of its slits lets a slice of light from the 2 shine on a plate with fixed slit. Remaining pinpoint of light goes through a lens and hits a photomultiplier tube. As the moving slit makes a pass the tube generates the signal shown at the top. When the black part of a character is scanned, no light gets through; white part admits light. In Figs. 3 and 4 the character has moved and middle and lower edges are scanned. Actually, each

David Shepard, a 26-year-old engineer who worked for the department, decided to build a machine which could read the records and papers directly and feed the information to computers, eliminating card-punching.

During the war Shepard had studied to be a translator of Japanese, later becoming an engineer specializing in mathematics. He knew Japanese words are built on a number of long and short brush strokes in various positions, each of which means something. We usually think of the letters of our alphabet as single units. Shepard wondered whether they, like Japanese characters, could be analyzed on the basis of strokes.

Most others had tried to build reading machines which would match letters to be read with identical letters stored in a memory device. Trouble was, if a letter got tilted or out of line, no match could be found and any letter not printed perfectly was rejected.

Shepard's idea was a machine which would analyze each letter or number by

its characteristics and identify it from this information. The machine would ask itself, for example, whether a character had one, two or three crossbars. Top, bottom or middle? Was there a long or short vertical bar on the right? On the left? Shepard made up a chart of characteristics for each character (see Fig. 7).

The scanner Shepard envisioned (see Figs. 1-5) would look over a character and tell its logic-memory computer circuits something like this: "It has crossbars at top, bottom and middle; long vertical line on the right; no vertical line on the left." The computer could then search through its memory, find that these were the characteristics of a 3 and order that a 3 in computer language be sent to the machine's output.

Shepard set to work in his attic in Falls Church, Va., helped by a friend, Harvey Cook, Jr. One year later—in March 1951—they unveiled the world's first optical reader. Total cost, including labor: \$4,000. The first commercial



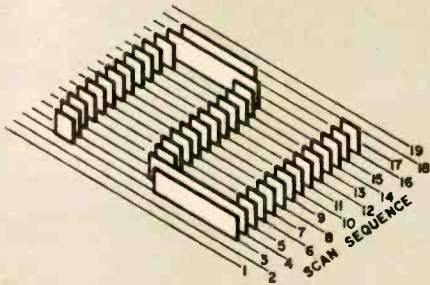

01234  
56789

012	
<b>HORIZONTAL</b>	
TOP	+ - +
MIDDLE	- - +
BOTTOM	+ + +
<b>SHORT VERTICAL</b>	
UPPER LEFT	-
LOWER LEFT	+
UPPER RIGHT	- +
LOWER RIGHT	- -
<b>LONG VERTICAL</b>	
LEFT	+ +
RIGHT	+

5

6

7

character is scanned 30 times or more, as shown in Fig. 5. A group of standard reading-machine characters is shown in Fig. 6. Stored in a reading machine's logic and memory devices is information of the type shown in Fig. 7, including the characteristics of each letter and number. A 2, for instance, is identified as having horizontal strokes at top, middle and bottom, etc. By comparing incoming signals with the information in its memory, a reading machine is able to recognize characters having standard shapes. It can then provide a direct readout or store the information on magnetic tape. Machines now being designed can read any type of printed characters or even neat longhand.

model went on the job in 1955, when a large book club faced a serious problem. Some 15,000,000 member cards had to be processed twice a year. By the time the workers needed for the job were hired, trained and had finished the task, it was almost time to start again. The operation was costly and inefficient. The club used its new Shepard machine to read its cards and feed the information to computers. Result: the twice-a-year job was done in three days.

The Shepard-Farrington method of machine-reading is one of two main methods for getting the job done. In the second system, mentioned previously, the image of a whole character is matched with cut-outs in a template. When a character and cut-out match exactly, a photocell is activated and that character's signal is produced.

Though all machines today require special characters for their reading operations, devices now in the laboratory stage will be able to read typed or printed characters of any size—and

even well-written longhand.

If you have a credit card from any one of a dozen oil companies, your charge slips are being read by machines. Many insurance companies use machines to scan premium stubs. Quarterly dividend checks from AT&T are scanned by machines, which later look at the cancelled check and record the fact that you've got your money. Utility bills, driver's licenses and car registration forms are coming under electronic scanners in increasing numbers.

In a few years all large companies will give their painful paper work to reading machines. Some day newspapers and magazines (such as EI) will be set in type by machines which scan typewritten manuscripts. The seers of the reading-machine field foresee the day when your groceries will simply slide under a supermarket scanner, which will read the labels and tote up the price. You'll have only one complaint with this robot: your groceries will still cost just as much.

E. N. Pickerill, now retired at 77, holds photo showing early biplane in flight with wireless rig aboard. He was the pilot of the plane.



# FIRST *Flying* RADIOMAN

**O**N August 4, 1910, a young wireless operator-pilot named E. N. Pickerill took off at Mineola on Long Island in a Wright Model B biplane, trailing two 200-foot wires and with a spark transmitter mounted behind his head. Operating a crude key on his control stick, Pickerill in an hour made history twice by sending the first wireless messages from a plane in flight to a receiver he had set up on the beach and to five ships at sea. It was quite a day for any man. Pickerill is now 77 and retired after working 46 years for RCA and its predecessors, including the American De Forest Co. and United Wireless Telegraph. He lives where his famous flight started—in Mineola.

Ground station which received Pickerill's first transmission from a plane in 1910 was in trunk.



Pickerill in 1908 as operator at WZ, the United Wireless station atop old Waldorf-Astoria Hotel.





## ELECTROMAGNETISM

### MADE EASY

**TRY THESE** half-dozen experiments and you'll find an electromagnet is more than a toy for picking up bits of metal. So important is electromagnetism that you'd search hard to find an electronic circuit that doesn't use it in some form. With the setup described here you can explore several of its interesting properties.

The carriage bolt shown is a hardware store item, the compass from a dime-store and the other components are available from electronic parts distributors. The 0-1 DC milliammeter is indispensable for electronic experiments and will be used frequently in this series.

You can get results with a single 1.5-volt penlite battery but several cells in series provide higher voltage and a stronger indication. To conserve battery life, connect the electromagnet only when a particular step is being performed.

The magnetic field of the electromagnet is generated by its windings of fine wire. About 1,600 turns are needed. The coil need not be wound evenly and it shouldn't take you more than ten minutes to complete the job.

Any wire carrying a flow of current has a magnetic field around it, but the coiled windings build it up by concentrating the energy. The bolt provides a convenient pathway for the mag-

netic lines of force to concentrate in.

You can start a magnetic mapping operation with some iron filings. Run a file over the end of the bolt or buy some filings at a local chemical supply house. Before the electromagnet is installed in its stand, lay it on its side on a wooden surface and hook it up. Over it place a sheet of paper. Sprinkle the iron filings evenly over the paper, tapping lightly as you sprinkle. The filings will arrange themselves in a revealing pattern. They will cluster at the ends of the bolt, indicating the strongest areas of magnetism—the magnetic poles. Between them the field grows weak and attracts fewer filings. Notice how the filings form curving lines between poles. These are *lines of force*, suggesting the path taken by the magnetic field from one pole to the other.

Are the two poles identical? With a small machine screw, feel the magnetic pull at each end of the bolt. The attraction is nearly equal, but the compass will reveal a key difference.

Place the electromagnet vertically for this step. If you hold the compass against the head of the bolt, one end of the needle will swing toward it. Move the compass to the other end of the bolt and the needle will swing around until its other end points to the bolt. This shows that the magnetic fields are not [Continued on page 119]

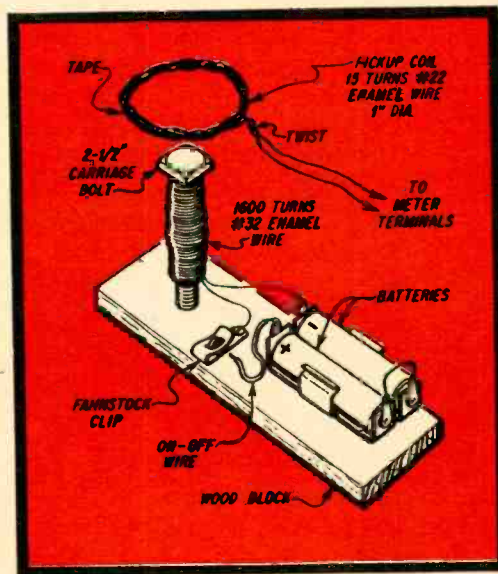



GIVES ADVICE TO NOVICES

"Keep it simple," a veteran ham tells beginners who are planning to set up their first amateur station.

By Howard S. Pyle, W7OE

EARLY in his study for the amateur license examination a beginner usually starts planning his station. After being on the air since 1908, my advice is—keep it simple! If you're not buying second-hand gear (which is a good way to get your rig cheaply), you're faced with a choice of new factory-wired equipment, kits or building your own. Of the three choices, kits are more practical today. They're economical, relatively easy to build and instructive.

But whatever you buy or build, I suggest you start with an inexpensive, simple station which requires some study and sweat to operate successfully. You'll learn more that way. The accompanying chart lists some of the better equipment buys for the novice, although it is by no means all-inclusive.

A good novice transmitter is particularly easy to assemble. It can be used

later in your General Class operations by adding modulation for voice (if it does not have this feature built in). Your power limit is 75 watts.

A modest receiver also can be built from a kit by a beginner, although the procedure is not as simple as putting together a transmitter.

As a novice, your station's accesso-

SIMPLE ANTENNAS FOR BEGINNERS

- A—Popular first antenna is end-fed long-wire of random length; 65-75 feet is best length.
- B—Windom is fed 14 per cent from center; the length shown is for operation on 80 meters.
- C—Center-fed antenna cut for 80 meters; it can serve also on 40, 20 and 10 meter bands.
- D—One-end antenna runs directly from single support to rig without conventional lead-in.
- E—Quarter-wavelength insulated vertical is tuned with a coil having variable-slide tap.



BUYING TIPS FOR NOVICES			
EQUIPMENT	DESCRIPTION	PRICE	COMPANY
<b>TRANSMITTERS</b>			
Ameco AC-1T	15 watts CW, no cabinet, kit.....	\$19.08	Ameco
Heathkit HX-11	50 watts CW, 80-10 meters, kit.....	43.50	Heath Co.
EICO Model 723	60 watts CW, 80-10 meters, kit.....	49.95	EICO
Knight-Kit T-60	60 watts, 80-6 meters, CW and phone, kit.....	49.95	Allied Radio
Viking Adventurer	50 watts CW, 80-10 meters, kit.....	54.95	E. F. Johnson
Globe Chief Deluxe	90 watts CW and phone, kit.....	59.95	Globe Electronics
Hallicrafters HT-40K	75 watts CW and phone, 80-6 meters, kit.....	89.95	Hallicrafters Co.
<b>RECEIVERS</b>			
Knight-Kit Space Spanner	40 and 20 meters, kit.....	14.95	Allied Radio
	cabinet	1.95	
Heathkit GR-91	80-10 meters, kit.....	36.95	Heath Co.
	cabinet	4.95	
Philmore CR-5AC	kit.....	49.95	Philmore Mfg. Co.
	cabinet	9.48	
National NC-60B	80-10 meters, wired.....	59.95	National Radio Co.
Lafayette KT-200	80-10 meters, kit.....	64.50	Lafayette Radio
	speaker	7.95	
Knight-Kit R-55	80-6 meters, ham bandspread, kit.....	67.50	Allied Radio
Hallicrafters S-120	80-10 meters, AC/DC operation, wired.....	69.95	Hallicrafters Co.
Gonset G-33	80-10 meters, ham bandspread, wired.....	69.95	Gonset Div.
Hallicrafters S-107	80-6 meters, wired.....	94.95	Hallicrafters Co.
Hallicrafters SX-140K	80-6 meters, CW-AM-SSB, ham bands only, kit.....	104.95	Hallicrafters Co.
Realistic GCR-6	80-10 meters, CW-AM-SSB, wired.....	99.50	Radio Shack
Heathkit GC-1A Mohican	80-10 meters, ham bandspread, kit.....	109.95	Heath Co.
<b>TRANSCIVER</b>			
Heathkit HW-30 Twoer	2-meter phone, portable, 5 watts.....	44.95	Heath Co.

ries are minor. A hand key (\$1 to \$5), a pair of headphones (about \$3) and one or more crystals is all you need. Get top-grade crystals because the best ones cost only about \$3 each. Other accessories, such as antenna tuners, standing wave ration meters and so on should not come until later.

Avoid elaborate antennas. Those shown in our diagram are good for beginners. The skyhooks cut for 80 meters (130 feet long) are particularly useful because they can be employed successfully on the even-harmonic frequencies—the 40-meter band and, after you have your General ticket, 20 and 10 meters.

Many novices prefer to use two antennas—one for receiving and the other for transmitting—rather than bothering with a transmit-receive switch. Use your best antenna for transmitting. Your receiving antenna could be nothing more than 25 to 30 feet of wire on the attic floor. Try to keep it a reasonable distance from and at right angles to the transmitting antenna to minimize pickup of your own signals. To prevent damage in the front end of your receiver, connect an NE-2 neon bulb across the antenna and ground terminals of the receiver. The bulb will ground your own signals but not the weaker ones from other hams.

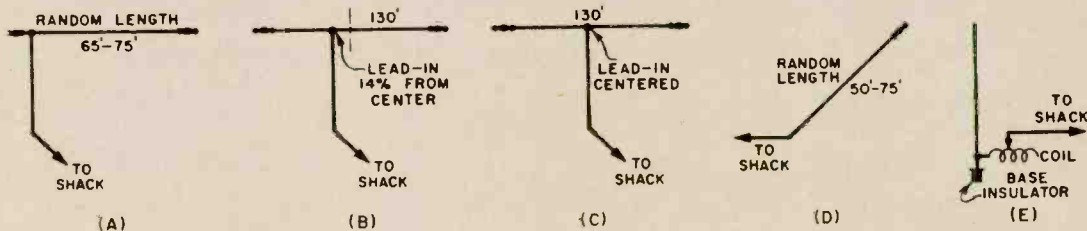

# SQUEEZE

## THE ENGINE WITH THE MAGNETIC

THE perfect engine that runs forever and requires no fuel hasn't yet been produced, but we're getting closer. Republic Aviation now is testing a little powerplant for outer space with such a minute appetite that it could cruise around amongst the stars for several years without dropping in at a celestial filling station.

The engine obtains its thrust from the magnetic pinching or squeezing of an inert gas such as nitrogen. A flyable model is expected to be ready for a shot into space this year.

Although producing only a tiny thrust, the engine could propel or steer huge spaceships through the heavens at fantastic speeds. In the near-vacuum of the wild blue yonder there is practically no resistance from air or gravity. Even a minute thrust can move huge weights.

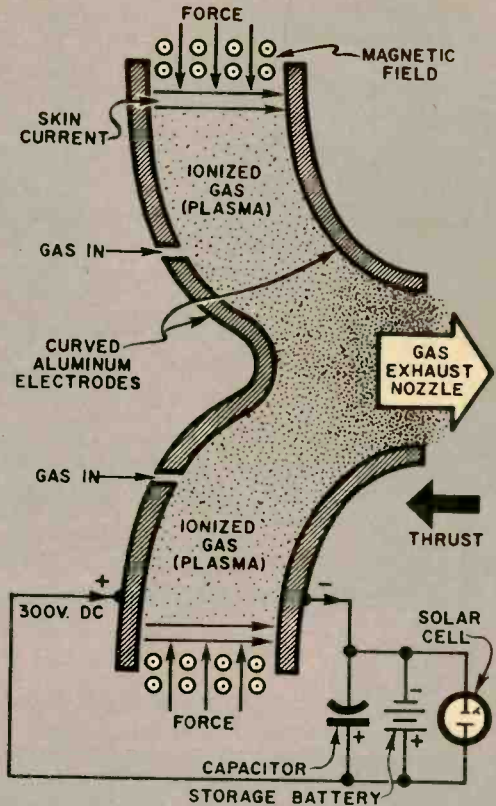

Technician below adjusts squeeze engine in test chamber. Diagram above explains its operation. Capacitors surround black nozzle at the right.

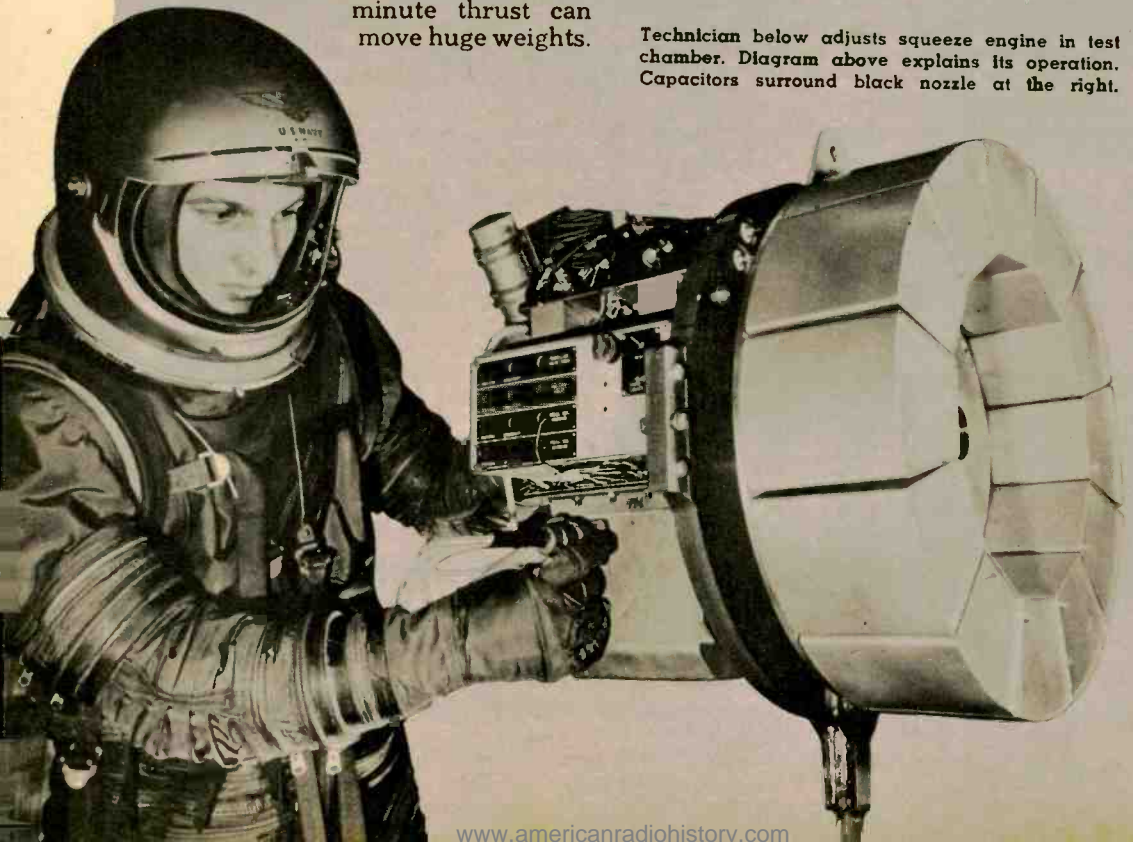



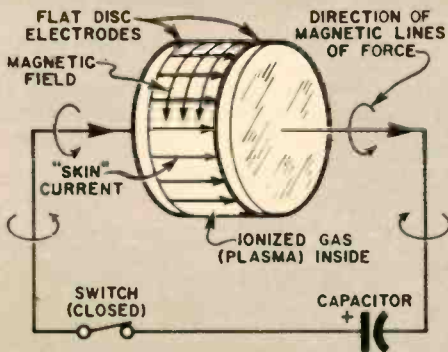

Simplified plasma-squeeze engine diagram shows the key role of "skin" current (see text).

Republic's squeeze engine carries a bottle of gas, which eventually would be exhausted. Its only other requirement, electricity, comes from a storage battery and can be replenished via a solar cell.

The operating principles of the squeeze engine are simple (see the diagrams on these pages). Two disc electrodes hold a quantity of gas between them. High voltage is applied to the electrodes (from the capacitors) and this ionizes (makes conductive) the gas, now called plasma.

Current begins to flow through the plasma. Because of what is called the "skin" current phenomenon, the current distribution is maximum around the edges of the discs, in effect making a sheath of current around the plasma.

As with any electric current, this sheath current has a magnetic field. In this case, it is *outside* the current sheath and pushes in on it (squeezes) from all sides. The ionized atoms of gas, being conductors, cannot penetrate this electromagnetic sheath and are squeezed together. If a hole is made in one of the discs, the gas flows out under pressure and produces a thrust in the opposite direction, according to Newton's Third Law of Motion. The hole, of course, becomes a nozzle.

If the process is repeated over and over, you have an engine that goes a long way on very little fuel.

## THE ENGINE WITH THE ION PUSH



**T**HE first full-size working model of an ion engine (see ENGINE OF TOMORROW, May '61 EI) was demonstrated a few weeks ago by the Hughes Aircraft Company. A thrust amounting to only a tenth of a pound is produced by the little powerplant, but that would be enough to move heavy loads in outer space.

Several different types of engines are being designed for the job of exploring space.

The Hughes engine vaporizes cesium to gain the required ions, which are accelerated to high speeds electromagnetically and expelled from a nozzle to produce thrust

An ionized atom stream from ion engine is viewed by technician through porthole.



*all-purpose*  
**VOICE  
 CONTROLLED  
 RELAY**

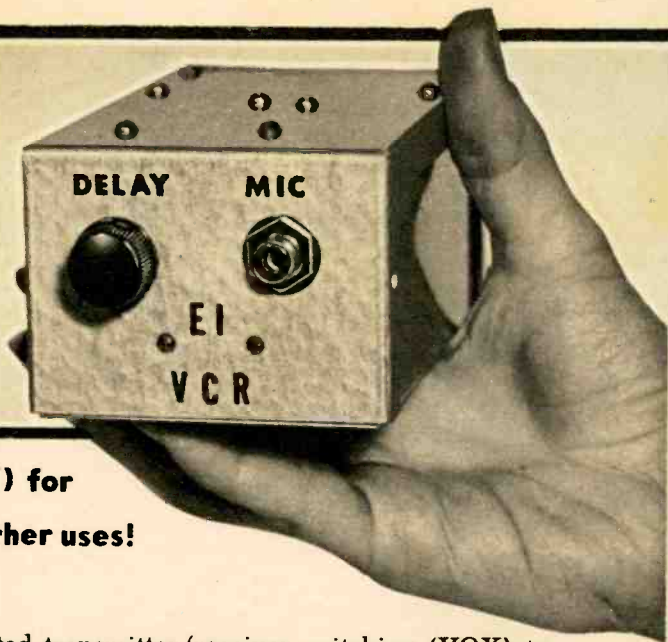

**Automatic T-R switcher (VOX) for ham or CB rigs has dozens of other uses!**

By Herb Friedman, 2W6045

**W**HEN YOU mention voice-operated transmitter/receiver switching (VOX) to a ham or CBer they invariably associate the term with high-priced rigs. That's unfortunate because VOX can give you wonderfully convenient automatic transmit-receive switching on even rock-bottom-price Citizens Band or ham equipment. The only requirement is that your equipment has (or you can add) the push-to-talk feature (see PUSH-TO-TALK CB SWITCHING, Jan. '62 EI). In addition, a voice-controlled relay can be used in a great many practical non-radio applications in

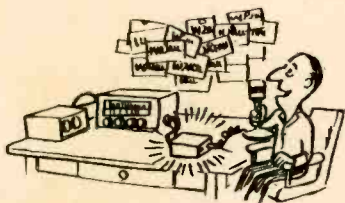

the home, shop or office.

Commercial units have a fairly steep price, but you can build EI's VOX for around \$15. You'll find it a highly sensitive unit with a wide latitude of adjustment. Besides automatically switching ham or CB gear, EI's VOX (or VCR for Voice-Controlled Relay) can:

- Switch mobile units when used in conjunction with EI's SAFE MOBILE MIKE (May '62 issue).
- Start a tape recorder at a party or elsewhere when someone is talking, and turn it off during silent periods.
- Start and stop a model train or other such equipment (when you say, "Full steam ahead," the train starts).
- Act as a baby-sitter to switch off your TV speaker (or anything else) when the child cries.
- Serve as a sound-sensitive burglar alarm.

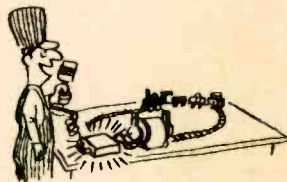

Resistors: 1/2 watt, 10% unless otherwise indicated  
 R1—Potentiometer, 5,000 ohms with DPST switch (S1)  
 R2—10 ohms  
 R3—27,000 ohms  
 R4—4,700 ohms  
 R5—1,000 ohms  
 R6—3,300 ohms  
 R7—100,000 ohms  
 Capacitors:  
 C1—50 mf @ 25 VDC miniature electrolytic  
 C2—500 mmf ceramic disc  
 D1, D2, D3—1N34A diode or equiv.  
 Q1, Q2—Transistors, high-gain NPN type (Semitron NA-30 or equiv.)  
 B1—6 v. battery (Burgess Z4 or equiv.)

**PARTS LIST**

B2—9 v. battery  
 RY1—Relay (Potter Brumfield type R55D, 6VDC)  
 J1—Jack for microphone  
 T1—Miniature transformer, 100,000 ohm pri./1,000 ohm sec. (Lafayette TR-97 or equiv.)  
 Amplifier—Lafayette PK-522  
 Misc.—Perforated board, flea clips, battery clamp, terminal strip, Minibox, etc.

A semiconductor kit containing the necessary diodes and transistors for the relay amplifier is available from Custom Electronics Co., 2929 Fulton St., Bklyn. 7, N. Y. Price is \$3.60 Postpaid.



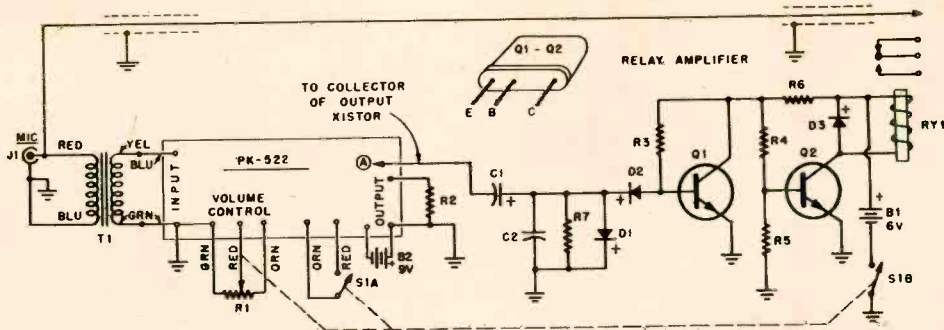

Schematic of relay amplifier shown with interconnections to preassembled amplifier.

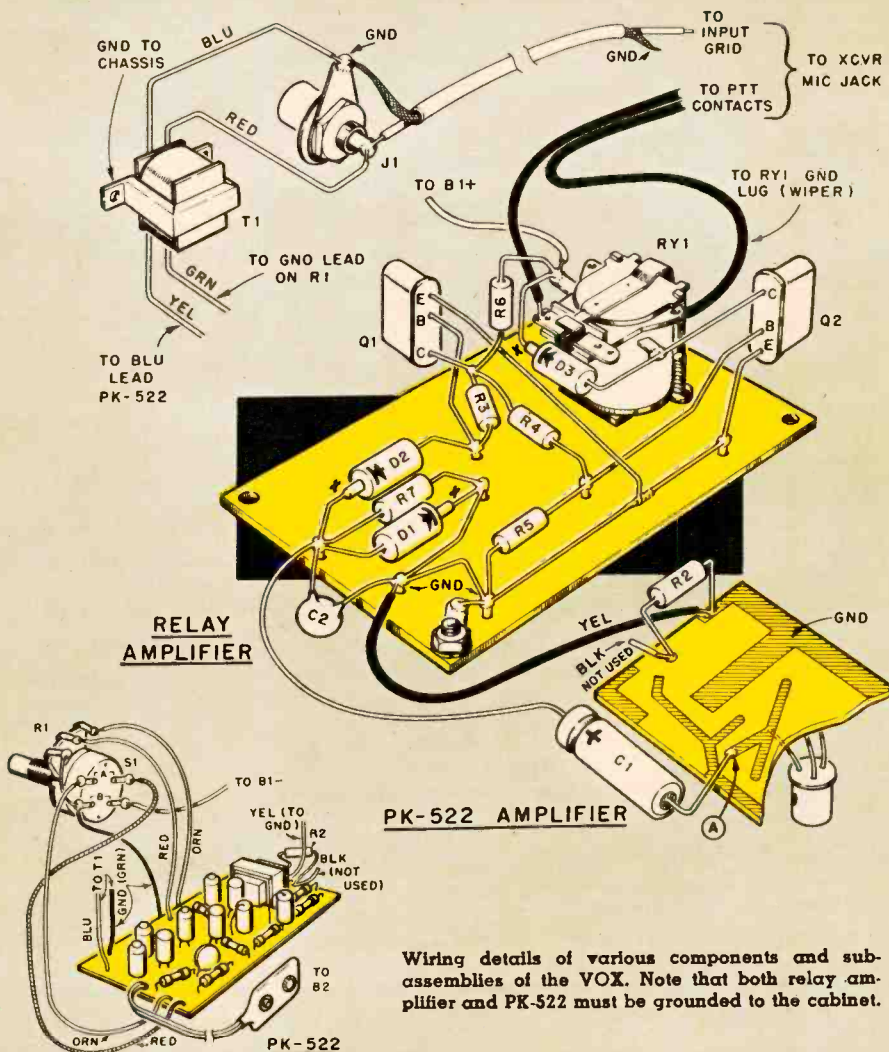

Wiring details of various components and sub-assemblies of the VOX. Note that both relay amplifier and PK-522 must be grounded to the cabinet.

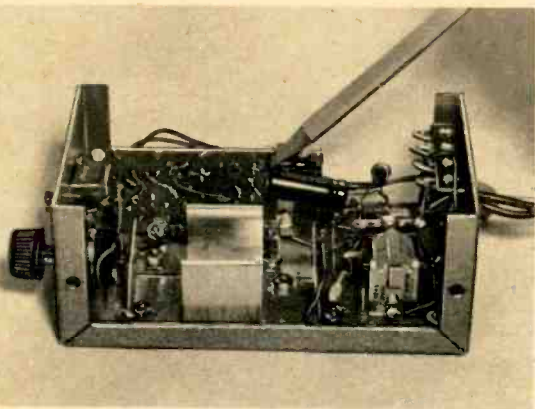

Completed unit. Electrolytic capacitor C1 which couples the PK-522 to relay amplifier is indicated.

You will be able to figure out many other applications, but that's a beginning.

Among the VOX's features are an adjustable sensitivity and a variable hold-in time delay. In normal operation when the relay closes it remains closed from one to three seconds after you stop talking, thus eliminating the relay chatter found in some VOXes.

EI's VOX consists of two units: a relay amplifier and an audio amplifier, both transistorized. The latter is a manufactured amplifier since its price (\$3.75) is less than it would cost you to build your own.

The unit shown is built in a  $5\frac{1}{4} \times 3 \times 2\frac{1}{8}$ -inch Minibox but if you lack experience in close-quarter wiring, a larger box and perforated board might be helpful. The relay amplifier is built on a  $1\frac{5}{8} \times 2\frac{5}{8}$ -inch section of perforated board with flea clip terminal points. Since relay RY1's frame is connected to the center wiper contact, the relay is mounted so its frame does not touch any other component or the cabinet. Note that the transistor and diode leads are short. Use a heat sink (such as an alligator clip) when soldering them.

Drill all the Minibox holes before installing the relay amplifier board or other components. Make certain the layout permits the cover to be slipped into place.

To avoid hum or RF pickup the leads to RY1 must be separate from the

shielded mike lead. Don't use one multi-conductor shielded cable. Run a separate shielded lead for the mike.

If you plan to use the VOX only in non-radio applications and have no need for a microphone signal output, eliminate T1. Connect the microphone directly to the amplifier's input. Or, if you want an integrated unit, a small ceramic or crystal microphone element can be mounted in the box.

Mount the relay amplifier board with a  $\frac{1}{4}$ -inch stand-off or a stack of washers between it and the Minibox.

The PK-522 amplifier is mounted in the Minibox by two L brackets. Clip the 522's black lead (the one near its transformer) short and connect the yellow lead to the relay amplifier's ground terminal. Connect R2 across the 522's output leads or solder it directly to the printed circuit board. Carefully solder C1's negative lead to the 522's printed circuit wiring at point A in the pictorial. This is the collector of the output transistor. Mount B1's holder and complete the wiring. The 9-volt battery, B2, is mounted on the Minibox cover directly above B1. Check for shorts before installing the batteries.

**Adjustment and Use.** Switching on the VOX will cause the relay to close momentarily, so always turn on the VOX before the associated equipment.

Place the microphone in its usual position.  
*[Continued on page 116]*

Another view of completed VOX. Physical arrangement of the two subassemblies is shown here.

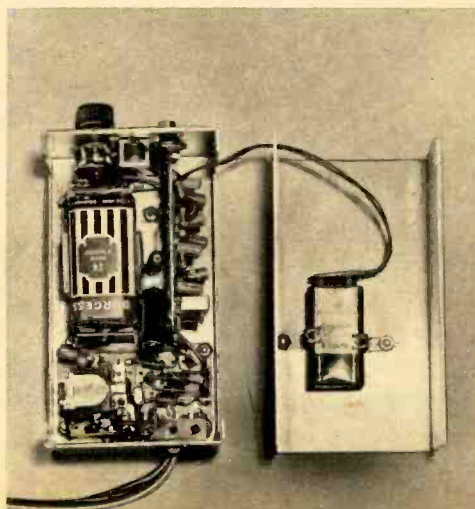



# 10,000 Things Electronic To Enjoy—10,000 Ways to Save in Famous **RADIO SHACK CORPORATION'S**

## Brand New 1963 Electronics Catalog



# FREE

## for You & 2 Friends Mail Card Today

### The Radio Shack Story

Radio Shack Corporation of Boston, Massachusetts is one of America's big 3 distributors of things electronic to the general public, industry, craftsmen and hobbyists. We offer a complete selection of precision built products by mail, through stores, and direct to manufacturers. Our exclusive REALISTIC® line of electronic products is famous nationwide for its high quality, dependable service and fine values. Our selection of national brand products is the largest in the country.

Radio Shack Corporation has been serving the nation since 1923—from the very beginning of the electronic age. This year over 2,000,000 people—music devotees, ham operators, amateurs and professionals—will shop from our catalog because they get the most value for every penny they spend on their favorite products . . . they will buy on the easiest terms, cash or credit . . . they are assured by our guarantee of getting the most satisfaction on every purchase. Radio Shack Corporation invites you and your friends to get your share of these savings and satisfaction by mailing the card opposite for your FREE catalog.

**284 pages  
over 10,000 items**

#### Partial List of Products in our New 1963 Catalog

- Amateur Radio
- Antennas
- Batteries
- Books
- Capacitors
- Controls
- Hi Fi
- Microphones
- Needles
- Phonographs
- Public Address
- Radios
- Resistors
- Tape Recorders
- Test Equipment
- Tools
- Transformers
- Transistors
- Tubes
- Wire

**NO MONEY DOWN CREDIT TERMS**  
Take up to 2 Years to Pay

# RADIO SHACK CORPORATION

BOSTON, MASSACHUSETTS  
America's Electronic Headquarters

**RADIO SHACK CORPORATION**

Dept. 62J8C

730 Commonwealth Ave., Boston 17, Mass.

Without obligation send me Free and Postpaid, your New Electronics Catalog plus every new issue for one full year.

Your name \_\_\_\_\_

Address \_\_\_\_\_

City, State \_\_\_\_\_

Name of a friend \_\_\_\_\_

62J8D

Address \_\_\_\_\_

City, State \_\_\_\_\_

Name of a friend \_\_\_\_\_

62J8E

Address \_\_\_\_\_

City, State \_\_\_\_\_

# THE HAM SHACK

BY ROBERT  
HERTZBERG  
W2DJJ

## THE BUG'S BITE... .

It's a fact: If you come down with any common malady the doctor probably can tell you exactly what will happen next. But there's no way of predicting the reaction when the ham bug grabs you. I've just witnessed a case involving a longtime acquaintance of mine, a man who has

been head of his own electronic manufacturing business almost 40 years. Amongst his products are some well-known pieces of ham gear, but the stuff used to be just so much hardware to him. No more.

Without warning my friend became entranced with the idea of talking via short wave to people in England and Africa and Brazil and who knows where else? Gripped by the hot hands of ham fever, he rushes off to a dealer and loads up his T'bird with a complete Collins single-sideband S-line, plus numerous accessories, all to the tune of about 2,000 bucks. What makes it even stranger is the fact that he doesn't know a dit from a dah.

The guy, probably wisely, doesn't go home with his loot but appears instead in my driveway, a slightly glassy look in his eyes. His recounting of his adventures staggers me but I hang on the ropes and come back with, "What about a license?"

"Yes, I know about the ticket," he says, "but I figure if I have the station I'll have to study hard and pass the test."

"What're you going to do in the meantime? That may take two months."

"I want you to keep it warm in your shack," he says evenly. "If I take it home I might be tempted to hook it up."

Restraining myself from grabbing the stuff and manhandling it into my shack, I reply coolly, "Sure. Always glad to help a guy in need."

Well, the chap worked hard and he really tried, but the butterflies got him when he showed up at the FCC office for the exam. I'd checked him out at 18 wpm on code but he flunked under fire.

My friend will try again, of course, but in the meantime, gents, you know why I have such a solid SSB signal on 10, 15 and 20 meters.

And maybe he could flunk just one more time without getting *too* discouraged.

**Just Call Him Doc . . .** Many physicians are active hams, finding the game a welcome relief from professional activities. It was fun, therefore, to eavesdrop on a phone conversation between W2MD and WA2RAU and to hear one of them addressed repeatedly as Doc.

"Well," I thought to myself, "at last the FCC has issued the right call to the right man."

But it was too good to be true. When they signed off it turned out to be WA2RAU and not W2MD who was the doctor! 📻



W2DJJ enjoying luxury of an expensive SSB rig that he's keeping warm while the real owner tries to pass his code test for a ticket. He uses TV set in the foreground to show absence of TVI, although his two antennas are less than 10 ft. apart. TV image was so bright even flash didn't kill it when photo was made.



Latin America...

# RED-HOT DX

By C. M. Stanbury II

ALL through North America short-wave signals from our Latin neighbors to the south are so plentiful that most DXers pass them by. And because they are in Spanish, few short-wave listeners, looking for an interesting program, pay them much heed.

The fact is, Spanish stations deserve more. Their programming compares favorably with many European stations, and for sheer excitement there's nothing quite like Central and South America. Where else can you find such a heavy schedule of political revolutions and such widespread economic changes? These historic events, as well as lesser day-to-day happenings, are covered by and reflected in Latin America's radio programs.

Atmospheric and ionospheric conditions are unusually kind to signals from south of the border, and these signals also are the only ones available here which have traveled parallel to the lines of the earth's magnetic field. The exact effect of this on short waves is still a moot point but it appears to aid propagation.

Latin America presents many contrasts, so far as the DXer is concerned, because it stretches

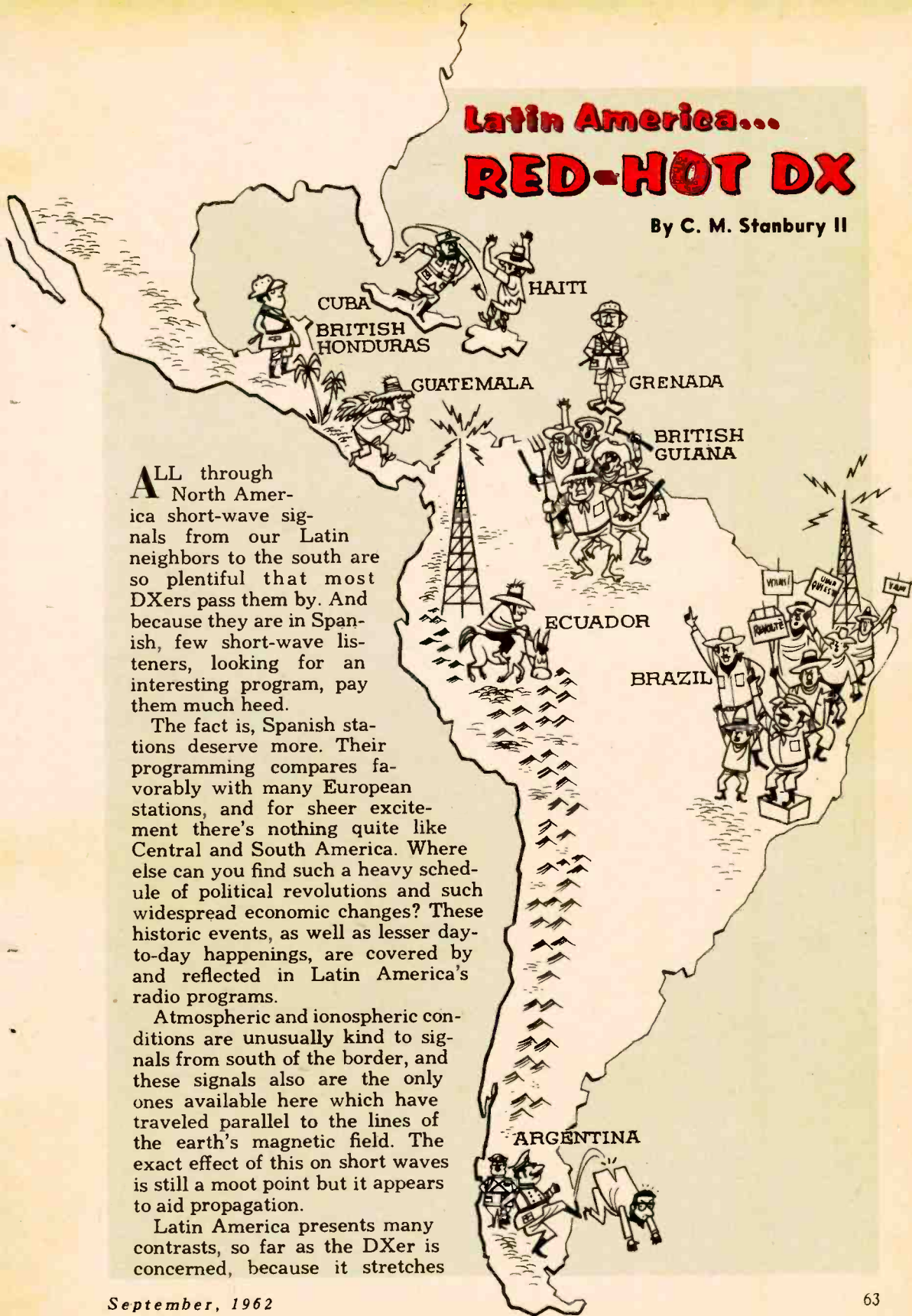

## DX GUIDE TO LATIN AMERICA

TIME (EST)	FREQUENCY (KC)	STATION CALL	LOCATION
0000-0100	9690	RAE (LRA32)	Buenos Aires, Argentina
0415	5981	R. Demerara, ZFY	Georgetown, Br. Guiana
1745	15085	Windward Is. BS	St. George's, Grenada
1800	3255	R. Demerara, ZFY	Georgetown, Br. Guiana
1800-2115	9815	Windward Is. BS	St. George's, Grenada
1830	17890	HCJB	Quito, Ecuador
	15115		(Exc. Mo, Sa)
1900	3300	BHBS	Belize, Br. Honduras
2120	4775	R. Dragao do Mar, ZYH29	Fortaleza, Brazil (Exc. Su)
2200	5990	R. Havana Cuba	Havana, Cuba
2200-2300	9690	RAE (LRA32)	Buenos Aires, Argentina
2300	5990	R. Nuevo Mundo, TGJA	Guatemala, Guatemala
	9745, 1915,	HCJB	Quito, Ecuador (Fr only)
	15115		
2315	9775 (Mo only),	4VEH	Cap Haitien, Haiti
	6135, 1035		



Towers of HCJB at Quito, Ecuador, stand on equator. Left: Colorful QSL's from Guatemala, Costa Rica stations.

for 6,000 miles (twice the distance across the Atlantic) from the U. S. border to Cape Horn. The formula for bringing in Cuba or Mexico naturally is not going to hold for Chile or Argentina.

Although the Latins offer rewarding transmissions, permitting you to keep track of revolutions, propaganda wars and even minor shooting wars, they have a drawback in that most of their programs are (naturally) in Spanish. There are many English-language transmissions from down south, of course, but your listening can be more rewarding if you crack the language barrier. First step is station identification. An SW catch is worthless unless its source is known.

Unlike North American stations, many Latins do not identify by call letters. Instead, they use a slogan such as Radio Nacional, La Voz de Colombia, etc. These are not difficult to pick out, even in an all-Spanish program. A second clue to identification is location. Though the speaker may be Spanish, you will have no difficulty distinguishing names like Caracas, Havana, Bogota and so on. The trick here is to learn a

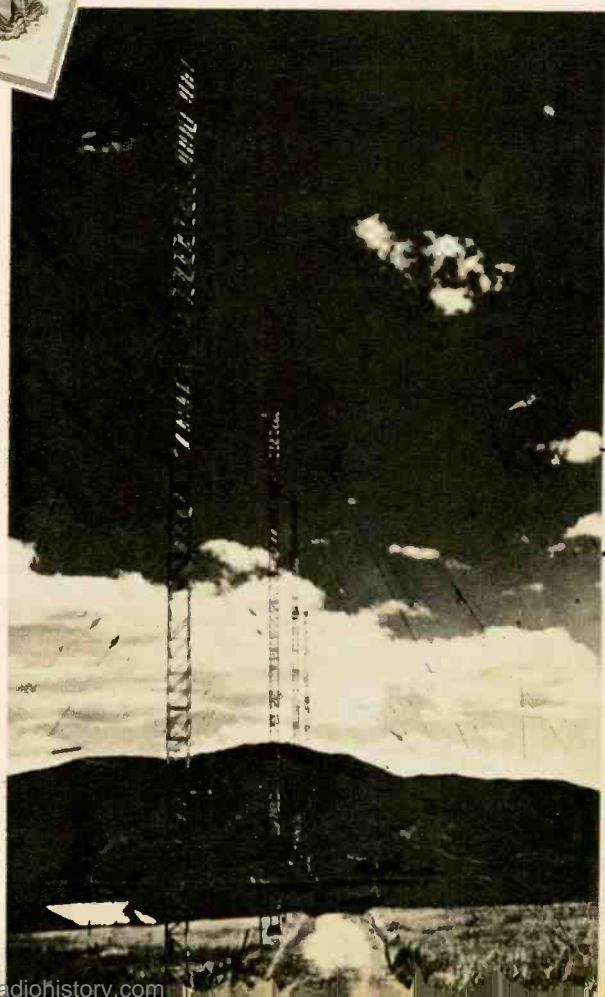





Many taped programs produced in U. S. are broadcast by Latin stations: tape above has just arrived.

little geography before listening. If you hear the word *Fortaleza*, for instance, you should know that you have Brazil. Such ID's often are preceded by a musical or gong signature.

Daytime reception of Latin America is pretty well limited to 19, 25 and 31 meters but at night the picture changes. Then you find them coming in on 49m (5950-6200 kc), 60m (4750-5060) and 90m (3200-3400). The high-frequency stations are still on after dark, of course, but for interesting reception you must tune the lower channels, too.

Interference can be a headache. Some channels are assigned to as many as five or six different stations. Thus, it becomes a matter of catching a station while it's on top. Generally speaking, Brazil (two hours ahead of EST) and lower South America are best around local sunset, with the Caribbean and Central America taking over later. After midnight most stations have signed off and those remaining are in the clear.

The 60m and 90m bands are different from any other SW frequencies. They

are classed as tropical, being assigned to broadcasters only near the equator. Elsewhere they are open to utilities and the military. Because of high absorption, distant reception is possible only at night, sunset and sunrise. In summer, when static is a major problem, the best time is around 6 p.m., local standard time. At that hour it's already dark in Latin America (which lies east of North America), while local static has not yet built up.

You'll find many missionary stations in Latin America. They can be rewarding (DX-wise) because most now include news and local-color programs in their schedules, which was not the case at one time.

In the British West Indies is a veritable hive of broadcasters (13 in all) who transmit primarily in English and provide first-rate entertainment features.

All political persuasions dot Latin America's map, from the staunch right (Argentina) through the middle-of-the-road (Organization of American States members) to the left (Cuba). —

# STEREO MIKE MIXER

For the home recording buff: a mixer plus VU meter that will handle four microphones per channel.

By Harry Kolbe, Contributing Editor

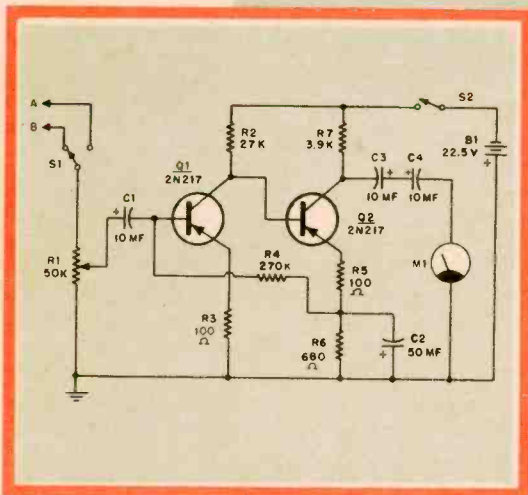

### MIXER PARTS LIST

- R1—240,000 ohms
- R2—91,000 ohms
- R3—330,000 ohms (original bias resistor)
- R4—33 ohms
- C1—2 mf, 15 v. electrolytic capacitor
- Mixer—Olson Radio RA-345; Lafayette PA-292

### VU METER PARTS LIST

- R1—50,000-ohm potentiometer
- R2—27,000 ohms
- R3—100 ohms
- R4—270,000 ohms
- C1, C3, C4—10 mf, 15 v.
- B1—Battery, 22.5 v.
- S1—SPDT
- Q1, Q2—RCA 2N217
- M1—VU Meter (Lafayette TM-10; Olson RA-345)
- R5—100 ohms
- R6—680 ohms
- R7—3,900 ohms
- C2—50 mf, 10 v.
- S2—SPST

Schematic of the two-transistor VU meter amplifier. Toggle switch S1 connects the meter to either the right or left channel.



**I**N THE past year or two, home tape recording has boomed in popularity. Relatively inexpensive stereo recorders are now available with quality approaching that of professional machines. Once the tape-recorder owner is bitten by the bug, he tries his hand at taping live performances. As he becomes proficient in the techniques, he realizes that he needs additional equipment to get professional-quality results.

The professional recording of a live situation may require the use of two or more microphones on each channel, or the mixing of other material into the program. Unfortunately, most stereo tape recorders can take only two inputs at a time. Professionals use a device called a mixer which is capable of accepting several different inputs and mixing them in any desired proportion into a single signal. Of course, a separate mixer is needed for each stereo channel.

The amateur can get the same kind of professional results with an ingenious low-cost transistorized mixer—one that can be built for under \$20. Each channel of this mixer can take up to four signals from microphones, tuners, phonographs, recorders, etc. The level on all four of the mixer inputs can be varied independently and combined into a single output. For example, you may be taping a stereo record and at some point you may want to fade in a microphone and fade out the phonograph to make an

announcement. With this mixer it's a cinch.

In addition to the mixing facilities of the unit, a VU meter is included so the output of *either* channel of the mixer may be monitored. Once the VU meter is calibrated, it will be possible to adjust the relative levels of any of the mixer inputs so the signal to the recorder is at the proper recording level.

The heart of the stereo mike mixer consists of a pair of commercial four-channel transistorized microphone mixers. We found that these mixers had frequency response that was down 3 db at 8.5 kc and a gain of little over 1.5 db. Although this is sufficient frequency response for the microphones supplied with the average inexpensive recorder, it was felt that some attempt should be made to improve the response characteristics of the mixer for those people who have purchased better quality microphones. By adding three resistors and a capacitor, it was possible to broaden the frequency response to a point where the mixer was down only 3 db at 18 kc at a slight sacrifice in gain. At the low end, the mixers are flat to below 20 cps.

A high-input-impedance, high-gain, two-transistor amplifier is used to drive the VU meter and its gain is high enough that even a microphone signal of a few millivolts gives full-scale meter deflection. The current drain is so low

VU meter board. Dotted lines represent wiring on reverse side. In board's center are meter terminals.

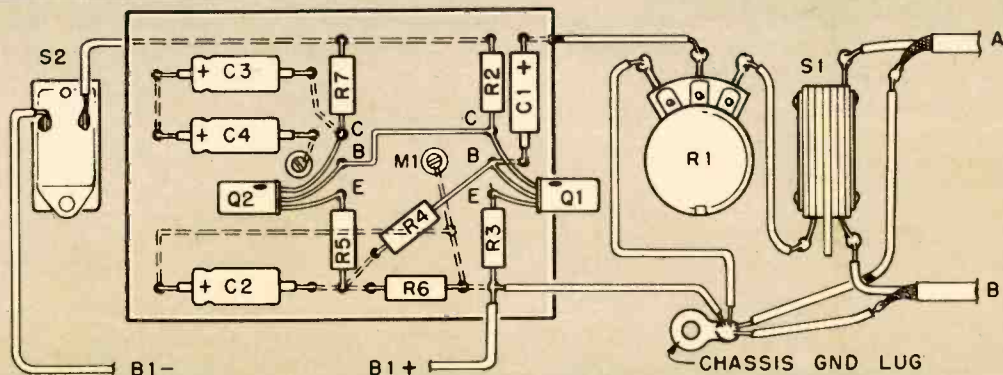

the battery will last almost its shelf life. The input of the VU meter amplifier is connected through an SPDT switch which permits the meter to be switched to the output of either channel.

**Modifying the Mixers.** A good starting point in the construction of the mike mixer is the modification of the mixer units. Remove the covers of the two mixers. Soldered to one level control is a four-terminal tie strip (see Fig. 3). Remove the 330,000-ohm (orange-orange-yellow) resistor (R3). In its place, connect R1, R2 and C1 as shown. Next, referring to the transistor lead marked with an X in Fig. 3, install a 33-ohm resistor (R4) as shown. Connect a 10½-inch length of shielded audio cable to the output jack of each mixer. The inner conductor connects to the center terminal of the jack, shielding to the ground side. This completes the electronic modification of the mixers.

The VU meter and amplifier are mounted in a 5 x 2¼ x 2¼-inch Mini-box. Drill the holes required for M1, R1, S1, S2 and the audio cables from the mixers. Install the cabinet mounting components.

The VU meter amplifier is built on a 2½ x 2-inch piece of perforated board. Mount the components by pushing leads through the board's holes. Solder the

connections on the reverse side as shown in the pictorial. Take care not to heat-damage the transistors. Mount the completed amplifier on the meter terminals and then make the appropriate connections between the amplifier and other components as shown.

The unit pictured was stacked by running bolts through the covers. If your setup requires a different arrangement, feel free to make modifications.

A word of caution: You may feel it's more efficient to operate the two mixers from a single 9-volt battery. Don't do it or you may run into a feedback problem due to the common power supply.

For maximum usefulness, the VU meter in the mixer should be calibrated to operate in conjunction with your recorder's level indicator. Although not shown in the author's prototype, use a pointer knob and scale on VU level control R1 to enable accurate re-setting. Make some test recordings with your usual microphone setup, and adjust R1 so that the average recording level falls on or about 0 db immediately before the recorder's indicator shows overload.

Note that the mixer's low output impedance enables long lines to be run between the mixer and recorder without noise pickup or high-frequency loss.

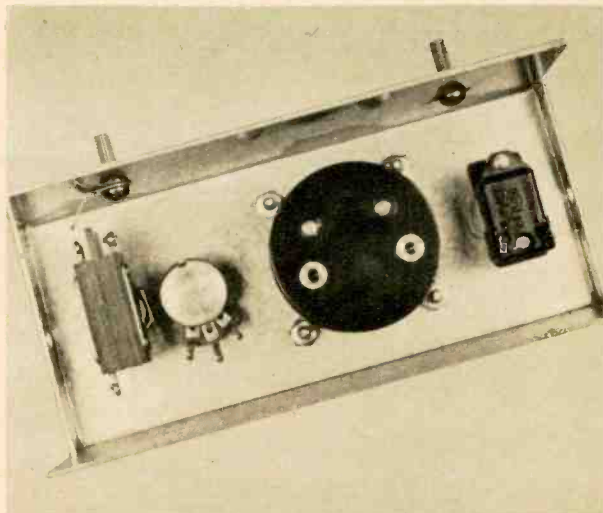
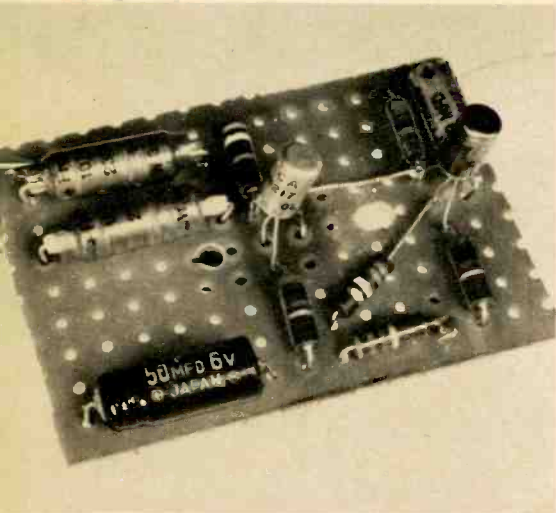

VU amplifier board subassembly is seen at left. Completed board is installed in cabinet (right) after the meter, two switches and potentiometer are mounted. The board is supported by the meter terminals.



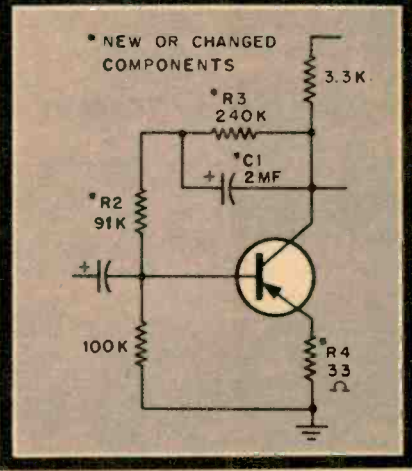
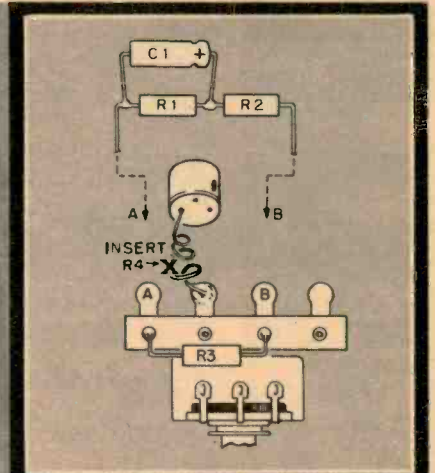
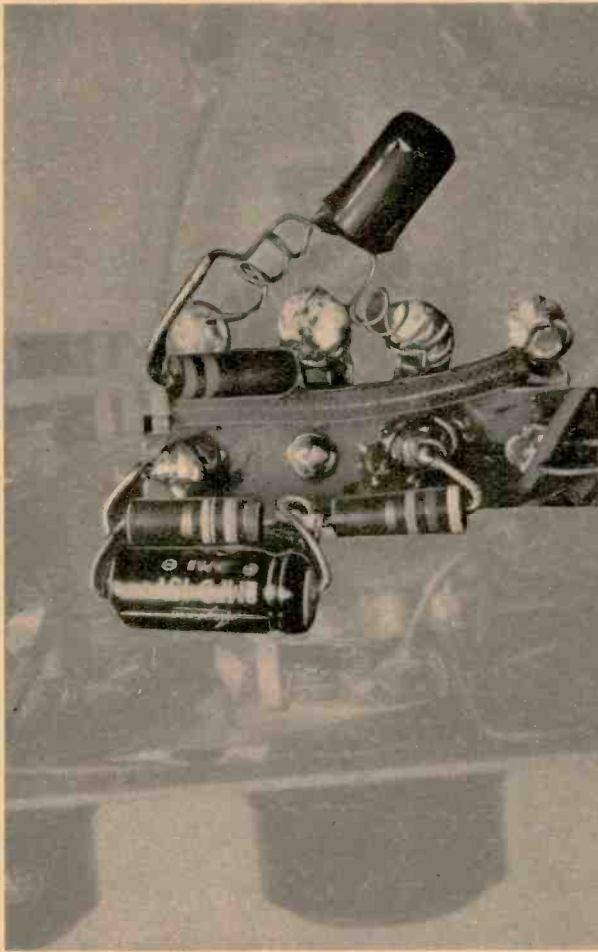

Details of feedback conversion made to commercial mike mixer to extend mixer's frequency response. Olson mixer is shown. Lafayette unit has same parts values, but different tie-strip arrangement.

Internal view of the completed VU meter amplifier. The bolts protruding from the case are used to hold the three units together when stacked as in photo at right. Any workable setup may be used.

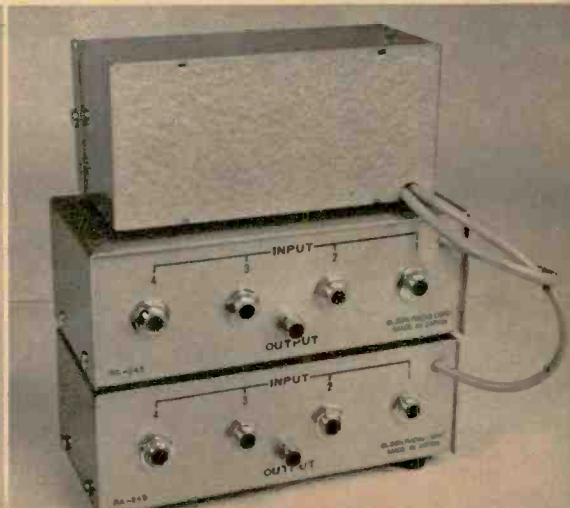
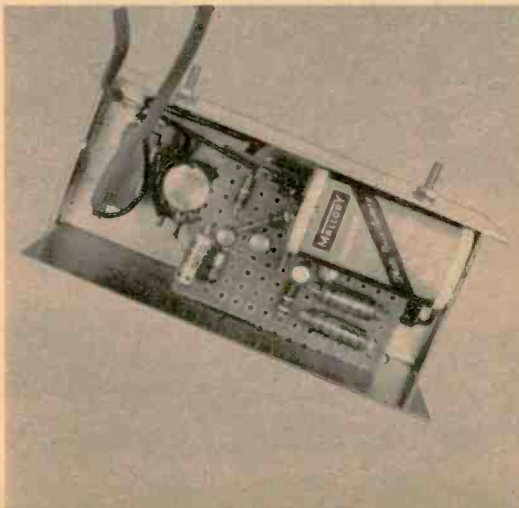

# A RANSOM FROM RENTALS

By James Joseph

**You own it...**

**Others use it...**

**Result: profits for you.**

1. Maurice Rosenthal, a Los Angeles electronic rent-all man, keeps his gear in bins.

2. Even highly specialized equipment is rentable; this is marker generator for TV.

3. Good mikes, amplifiers and two-way handi-talkie radios are among popular rent items.

4. Rosenthal brothers (left and center) have truck fleet to deliver rented equipment.

**WHAT IF** you wanted to get hold of a good oscilloscope just long enough to check out your hi-fi system? If you're stuck for an answer, you may have stumbled onto a lucrative opportunity—the electronic rental business.

The idea of renting out equipment to people who have a temporary need for it must go back into antiquity, but now there's something new—the rental store that handles nothing but *electronic* equipment. A few of these stores already are in operation and more are certain to come. The fact that there are few of them means the field is wide open for a man looking for an opportunity.

Though the initial investment in equipment to set up a rental service is not on the piggy-bank level, the money doesn't have to be *yours*. Lending institutions are always willing to invest in a promising business. But it *can* be done on a shoestring.





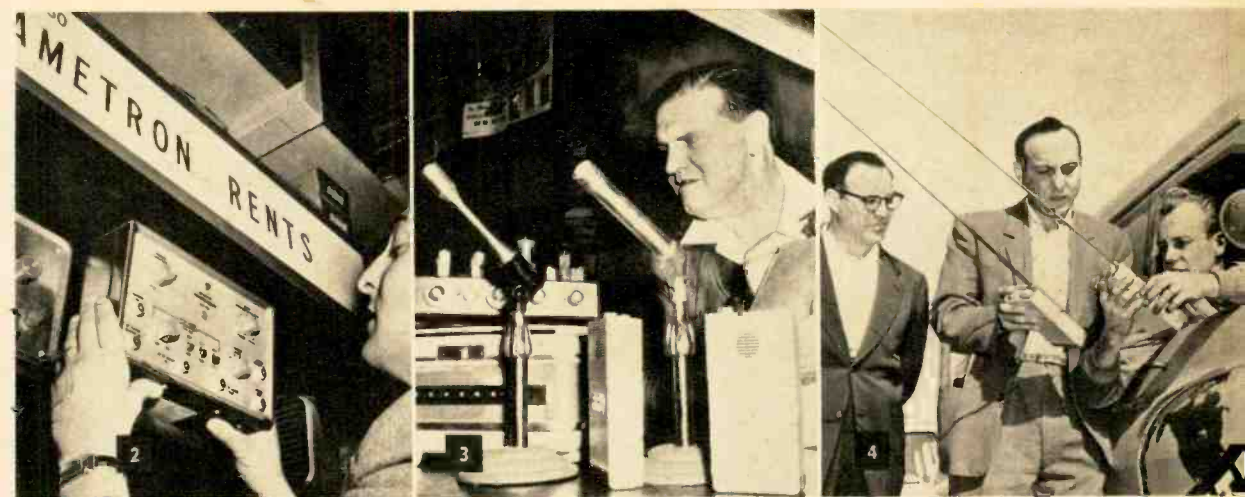

Maurice Rosenthal, who with his brother Mike runs Ametron Rents in Los Angeles, could tell you that.

Maurice was an electrical engineering student in frigid Alaska when the electronic rental idea struck him. He started by renting sound systems to Far North PX's, then moved south and in 1951 opened the doors of Ametron, specializing at first in portable TV receivers.

Nowadays Maurice and Mike will rent you almost anything, so long as it's electronic. And they have a profitable point to make: it's far easier to sell an electronic prospect on renting than talk him into buying.

At Ametron you can rent a \$225 console phonograph for \$15 a day, plunk down \$10 a day for a pair of transistorized handi-talkies (cost: \$320) or rent an entire sound system and a crew to run it for \$350 a day.

"And," says Maurice, who shelves more than 1,000 rentable items, "a renter's check becomes his down payment, should he decide to buy."

"We're still something of an oddity," the brothers say of their business. But the two are convinced that renting electronic gear is a golden career opportunity. How golden? Well, consider a transistorized wireless microphone that lists for \$650, costs the rental man \$445 and rents for \$25 a day. At worst, he may expect to recoup his investment in

a year (by renting the mike only 20 out of 365 days). Actually, he well may double or triple his investment. Comes the end of a year and he promptly sells the used mike for \$225.

Multiply returns like that by 1,000 rental items and you're headed for an enviable tax bracket.

Even in the electronic rental field you find specialists. Some stock nothing but medical equipment, others go for such construction-industrial gear as pipeline locators and spectrosopes.

The general rule about what to stock says you should have what your customers want. If you're in mining country, you need such prospecting aids as electronic ore-finders. Marine radios and direction-finders find renters in boating communities.

Among your customers you should expect local business firms, service clubs, industrial plants and such consumers as hams, Citizens Banders, hi-fi fans and general hobbyists. Ametron's business is about 50% industry, 25% consumer, 25% highly specialized. It stocks dictating and intercom systems, air purifiers, slide projectors, mikes, lecterns, prompters and page-turners, along with more common items for home experimenters.

Ametron and others have proved there is money to be made in renting electronic gear. It's an opportunity worth looking into.

transistorized

# FM BOOSTER

If stereo FM has put you in the fringe area, get back to hi-fi with an 18-db boost in signals.

By Ed Lininger, Amperex Electronic Corp.

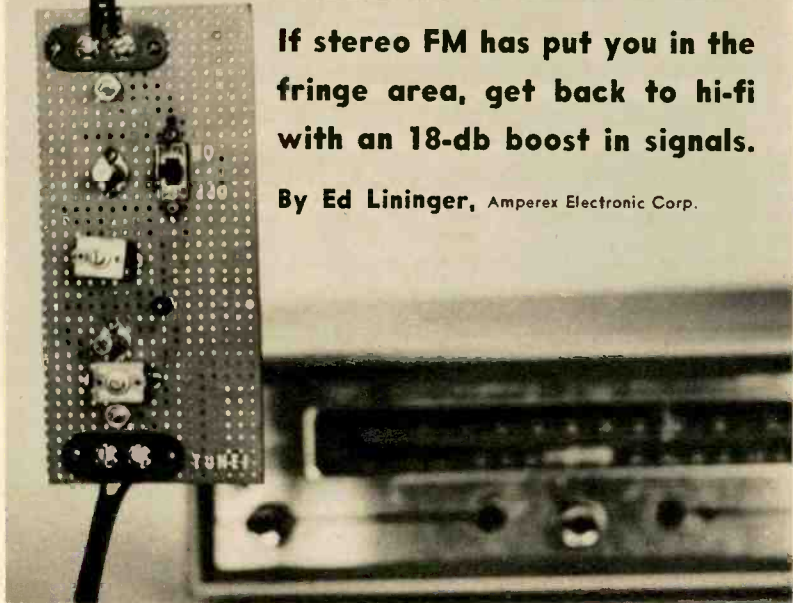

**S**TEREO FM broadcasting brought new problems, as well as new joys, to the ardent audiophile. FM tuners which had more than adequate sensitivity for standard FM broadcasts suddenly delivered noise and distortion when adapted for stereo. As EI has mentioned several times, the effective range of stereo broadcasts may be cut by a third in comparison to the signal strength of the equivalent mono broadcast. A better antenna usually helps, but if its installation presents difficulties for you, a booster may be the answer.

EI's transistorized FM Booster adds two RF stages to your tuner. Connected between the antenna and the tuner, the Booster's 18-db gain (and noise figure of better than -50 db) will bring in those once faint stations with excellent fidelity.

**Construction.** The prototype was built on a perforated Bakelite board, but the reader has the option of construction techniques. To eliminate hand capacity effects, the Booster board could be enclosed in a metal cabinet. For

clarity, the pictorial shows the leads somewhat longer than necessary. In practice, keep the leads as short as possible. The two coil forms shown (L2, L4) are modified by the addition of L1 and L5. These consist of 2½ turns of No. 28 enamel wire interwound between existing turns of

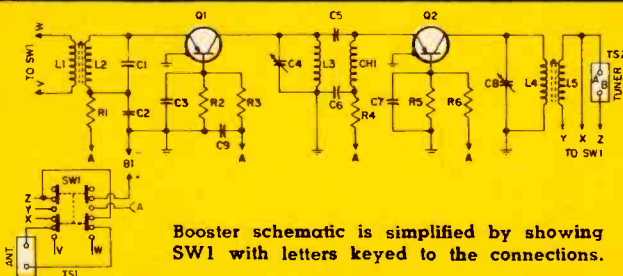

Booster schematic is simplified by showing SW1 with letters keyed to the connections.



input and output coils L2 and L4.

Inductance L3 consists of 2½ turns of No. 18 enameled wire wound on ⅜" rod with the turns spaced about the diameter of the wire. After winding, remove the rod and mount L3 directly to the terminal strip.

If you have difficulty obtaining the coil forms specified for L2 and L4, you can make two more coils like L3, except this time leave in the ⅜" diameter forms. Then wind L1 and L5 on the forms as before.

Choke CH1 consists of 30 turns of No. 28 enameled wire close wound on (and soldered to each lead of) a 1-megohm, 1-watt resistor.

Switch S1 both turns the booster on and off and switches the antenna from the input of the booster to the input of the FM set. A transistor radio 9-volt battery eliminator serves as B1.

**Adjustment and Operation.** For general use, tune in a weak station at the center of the dial and then switch on

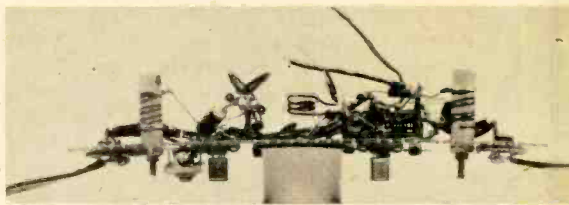

Profile of the Booster shows the relationship of the coil forms and the other major components.

the booster. Tune C4 and C8 for maximum response as indicated either by the tuner's tuning eye or meter. If it is not possible to peak C4 or C8 for maximum tuner response, its corresponding coil may not have sufficient inductance. You can vary the inductance by adjusting the coil cores. Note that the band-pass of the Booster is about 4 megacycles wide. This means that it would be best to use C4 and C8 to tune the Booster to the station you're most interested in receiving.

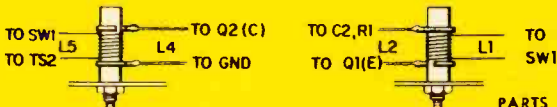
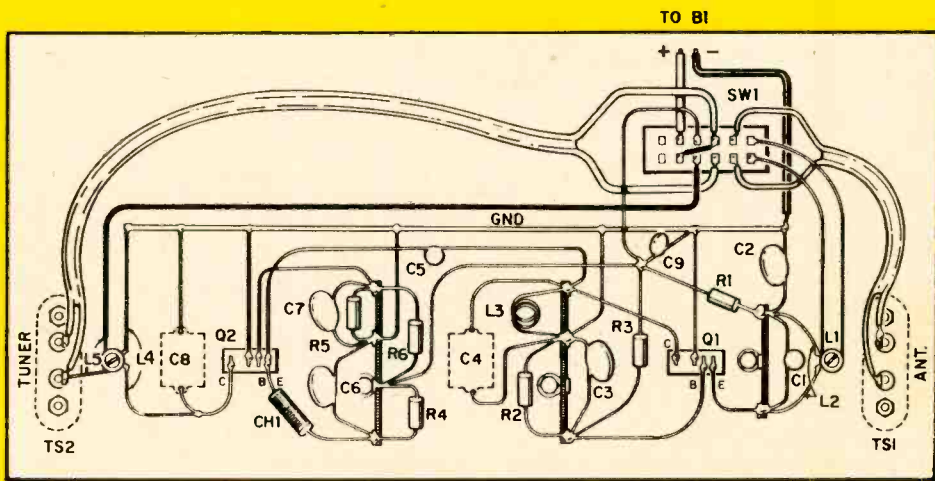

Pictorial of Booster shows parts drawn with long leads for clarity. In practice, keep the leads short.

**PARTS LIST**

- Resistors:** ½-watt, 10% unless otherwise indicated  
 R1, R4—560 ohms      R3, R6—1,500 ohms  
 R2, R5—6,800 ohms
- Capacitors:** low-voltage ceramic disc, unless otherwise indicated  
 C1—33 mmf      C4, C8—3-30 mmf trimmer  
 C2, C3, C6, C7—820 mmf      C5—3.3 mmf  
 C9—.002 mf
- CH1—30 turns #28 enamel wire wound on a 1-megohm, 1-watt resistor

- SW1—Four pole, double throw switch (Lafayette SW-91)  
 Q1, Q2—2N2089 transistors (Amperex)  
 L1, L4—coils, Cambridge Thermionic LS3-60 mc (see text)  
 B1—9 V. power supply (see text)  
 L2, L3, L5—see text  
 Misc.—terminal strips, lugs, transistor sockets, etc.
- A kit of the above parts (less power supply) is available from the Thermocare Co., 54 Buttern St., Bethpage, N. Y. Price is \$9 postpaid.

# SHOCK-FREE CONTINUITY CHECKER

**F**OR PRECISE measurement of resistance you need an ohmmeter. Usually, however, you're not interested in *exactly* how much resistance is present, but only whether there's continuity in the circuit or part under test.

A simple continuity checker that operates directly from the AC line can be constructed with less than a dollar's worth of parts. As shown in the diagram, a series resistance (150,000 ohms, ½ watt) in each probe limits the electrical current flow to a safe value. Simply plug the tester into any 117 VAC outlet and use both probes to check for continuity in tube filaments, flash bulbs, fuses, etc. Neons with built-in resistors don't need a 150K in series.

## Grounding and Leakage Check

With this simple tester you can check for leakage currents in appliances and find out whether they're safely grounded. Plug in the tester and touch the probe with the neon indicator to a water pipe, the screw holding the plate on an AC outlet or some other ground. In one position of the AC plug the neon lamp will light when the probe touches ground. When the plug is reversed in the wall socket, the neon will not light. This last plug position is the one to use for testing current leakage. Plug in the appliance under test (radio, TV, hi-fi, electric iron, etc.) and touch the lamp prod to its metal housing or chassis. Observe the brightness and then reverse the *appliance* plug and repeat the test.

If the neon lamp lights at full brilliance (as when the checker's probe tips are shorted together) the appliance should be checked for a short to the AC line or for low resistance between the AC line and chassis. If the lamp lights dimly, there's probably a normal degree of leakage. In that case, it may be a good idea to run a ground wire (ordinary lamp cord will do) between the appliance cabinet and the nearest ground. This may save you from a dangerous shock in the future. A three-wire line cord can be used on units that won't take a separate ground wire.

Note that most receivers and hi-fi amplifiers will show a definite amount of AC leakage. This is usually due to the bypass capacitor connected from the primary of the AC power transformer to chassis. Do not place a ground wire directly to the chassis of an AC/DC receiver, you may blow a fuse.—Dave Gordon

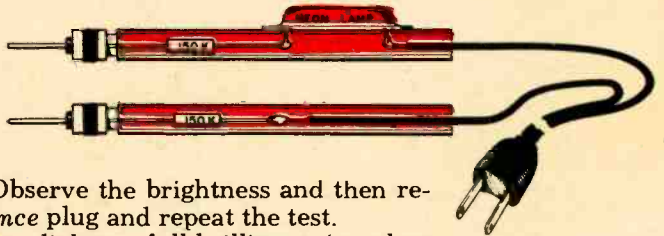



# the TAPE CLUB story

The romance of chatting with people in far away places makes for a boom in recording societies.

By Alan J. Broder



**A**MATEUR tape recording, once the province of hi-fi fans, has in a few years blossomed into something infinitely larger than a spare-time hobby. Today the world is covered with a net of magnetic tape carefully put together by amateur recordists, some of whom have close friendships with people in 25 or 30 countries. Any avocation that can make friends of a farmer in Kenya, an engineer in California and a student in India must be reckoned a force for international goodwill and understanding. The photographs above give some idea of the magnitude of this network, showing a tape club leader in Tokyo, a Bolivian recording at his office desk in La Paz, school children putting their voices on tape in Rarotonga, and a tape party on an Israeli kibbutz. In any activity as widespread as this one, there must be clearing-houses that put people in contact with each other and keep communications orderly. The clearing-house for recordists

A tape-correspondence fan gets audio letters from many lands; this one came from England.



is the tape club. Several hundred clubs are scattered about the near and far corners of the world.

Largest and probably best known is World Tape Pals, Inc., organized ten years ago in Dallas, Tex. WTP and its associated clubs have a combined membership of some 5,000 people who represent every major free nation on earth. Other large groups include the Voice-spondence Club (1,400 members in 32 countries), the Organ Music Enthusiasts (200), Catholic Tape Recorders International (200), Stereo International (150) and American Tape Exchange (150).

Although tape clubs are gaining popularity here, in England their history has been nothing short of fantastic. In six years they've gone from one club to more than 150.

Tape clubs come in two varieties—large international ones and smaller local groups. To see how an international club works, let's look at what happens when someone joins—in this case myself.

To join World Tape Pals, I filled out an application, giving my equipment and my general and specific interests. Then I received a roster listing every WTP member. Beside each person's name was a list of his interests. In addition to serious music devotees like myself, I found those who went for stamp-collecting, theater (amateur and professional), sports cars, handicrafts, antiques and a great many other sub-

After my name came out on the roster I began to receive (and send) written letters from other members in different parts of the world who wanted to exchange tapes. So it goes. Through clubs and mutual tape friends you acquire the names of others with interests similar to your own. Letters usually are exchanged and then tapes.

Most popular size audio letter is the "message" tape on a 3-inch reel. If you and your tape pal agree on a more extended exchange, you use 7-inch reels, or perhaps 5-inchers.

What do you get out of exchanging



The author and his elaborate tape layout of two Tapesonic recorders; preamps and controls below.





Typical meeting of local club—the N. Y. Tape Recording Society. The president is speaking.

tapes? Aside from giving you new friends all over the world, listening by tape is the next best thing to being there in person, and no other form of communication is quite as intimate as a tape recording.

As a music lover, I have visited all the great concert and opera halls of the world without leaving my home, and I now have taped concerts from England, South Africa, Australia, Spain, New Zealand and several cities in this country. I've known of marriages between people who first became acquainted via tape, war brides who keep in touch with their distant families and friends through tapes, and people who've learned a foreign language by exchanging tape with a citizen of another country.

When you make your first tape you probably will find the conversational approach easiest and most interesting. My first tape to a new correspondent (or tapespondent, as some call them) usually consists of some kind of musical introduction, taken from a record, another tape or recorded off the air. Then I describe myself, my city, work and hobbies and come to my particular interest of music, recording samples from various works and sometimes commenting on them. On future tapes, complete musical compositions or concerts may

be exchanged. Try to make your material as interesting as possible, even if your hobby is an all-talk one such as stamps or gardening.

Members of international clubs seldom meet face to face but in local clubs, serving in a social and informative role, they do get together every month or so in someone's home or (more likely) a public building. Usually there's a lot of informal chatting, and sometimes a member may play an especially entertaining tape he's made or received. Quite often there's a talk by a visiting

[Continued on page 112]

### POPULAR TAPE CLUBS

- Indiana Recording Club  
3612 Orchard Ave.  
Indianapolis, Ind.
- Organ Music Enthusiasts  
152 Clizbe Ave.  
Amsterdam, N. Y.
- Stereo International  
1067 Flatbush Ave.  
Brooklyn 26, N. Y.
- Union Mondial des Voix Francaises  
886 Bushwick Ave.  
Brooklyn 21, N. Y.
- New York Tape Recording Society  
1 West 64th St.  
New York, N. Y.
- American Tape Exchange  
Box 324  
Shrub Oak, N. Y.
- Catholic Tape Recorders of America  
International  
25 South Mount Vernon Ave.  
Uniontown, Pa.
- World Tape Pals, Inc.  
Box 9211  
Dallas 15, Tex.
- The Voicependence Club  
Noel, Virginia
- Australian Tape Recordists Assoc.  
Box 970H, GPO  
Adelaide,  
South Australia
- Club du Ruban Sonore  
Grosse Ile, Cte.  
Montmagny, Que.  
Canada
- Bilingual Recording Club of Canada  
1657 Gifford St.  
Montreal 34, Que.,  
Canada
- Magneto-Vox Club  
8140 10 Ieme Ave.  
Montreal 38, Que.  
Canada
- Tape Recorders Club  
123 Sutton Common Rd.  
Sutton, Surrey,  
England
- New Zealand Tape Recording Club  
39 Ponsonby Rd.  
Auckland, W.I.,  
New Zealand
- English Speaking Tape Respondents Assoc.  
Schoolhouse  
Whitson by Duns  
Berwickshire,  
Scotland

# HI-FI RECORD GUIDE

by Warren DeMotte



**T**HE BRILLIANT Russian pianist Sviatoslav Richter seems ubiquitous in the recording world: he's on no fewer than seven labels. For Angel (see cut) he plays Beethoven's Tempest Sonata and Schumann's C Major Fantasy with insight and warmth. For the new Philips line, he is joined by the London Symphony Orchestra, led by compatriot Kiril Kondrashin, in scintillating performances of the two Liszt Piano Concertos.

On RCA Victor, Charles Munch and the Boston Symphony Orchestra collaborate with him in a sinuous, subtle reading of Beethoven's First Piano Concerto, encoored with a lively reading of that composer's little-played Opus 54 Sonata. Lastly, Columbia has released another disc from the series of recitals he gave at Carnegie Hall in 1960, offering another Beethoven Sonata, Opus 10, No. 3, and a collection of Rachmaninoff Preludes, played with assurance and skill. Those four are his *new* discs.

Salome and Elektra, the two Richard Strauss operas that shocked audiences a half-century ago, comprise colorful fare, with opportunities for huge sonorities and subtle relationships be-

tween voices and orchestra. The London engineers and Georg Solti project Salome's theatrical effectiveness with imaginative engineering and conducting. Elektra is not nearly so successful a presentation. Its barbaric power is weakened by timid engineering and conducting that is deficient.

Two of the girls from the Metropolitan have a go at the pops repertoire, Patrice Munsel for the first time and Eileen Farrell for the third or fourth. Unpredictable is an accurate title for the former's disc; nobody would have predicted that a coloratura soprano could belt out rhythm numbers with the enthusiasm and power displayed here by the Munsel gal. Of course, where Farrell is concerned, we get what we expect, and that's a lot.

Belafonte's recordings are exciting entertainments and The Midnight Special is no exception. Each song is a special production, artificial and polished, to be sure, but made vital and artistic by personality and sensitivity and a tremendous amount of skill.

George Greeley does nice things on the piano with several of Gershwin's lovely songs. However, he was poorly advised to include truncated, unidiomatic renditions of the Rhapsody in Blue and An American in Paris. These two concert works demand concentration and integrity; they firmly resist the casual approach.

Folksong: U.S.A. is a gaudy title for a program that includes Nothin' Like a Dame from South Pacific and Little Bit O' Luck from My Fair Lady. The Robbinsdale Chorale sings with enthusiasm and precision, however, while the recording captures the sound of a large chorus with commendable clarity and spaciousness, particularly in the haunting Shenandoah.

Herbie Mann at the Village Gate offers only three numbers: Comin' Home Baby, Summertime and an amaz-

[Continued on page 116]





KIT  
**EI**  
REPORT

Lafayette KT-550  
100-WATT

## STEREO POWER AMPLIFIER

**A**LTHOUGH the trend is toward integrated stereo preamp-amplifiers, the audiophile with a taste for top equipment usually goes for a separate stereo preamp and dual power amplifier with 50 watts or more per channel.

How good are these 100-watt-plus monsters? Do they live up to their specifications? To find out, we checked out one of the big-power units, Lafayette's KT-550, which has a power rating of 50 watts per channel.

**Construction.** The KT-550's manual is well done, but if yours is numbered IM-185 (inside front cover), make sure that amendment sheet IM-186 is included.

Sub-assemblies and two printed circuit boards make wiring this kit a cinch. Because the silicon rectifier's thin pigtail leads tend to bend, mount them so they are spaced well away from the chassis or other components. If the uninsulated rectifiers accidentally contact a ground, you'll short out over 400 volts of B+.

Another area where it's a good idea to cross-check every connection is in the control panel wiring. Take it slow here because you are dealing with a multi-contact switch, an area of potential trouble in any kit. Expect to spend about twenty hours on the kit before checkout.

**Test results.** How well does the KT-550 check out? In a word—superbly. In fact, some of our findings were slightly better than Lafayette's figures.

With both channels driven, we found each channel capable of 50 watts output from 20 to 20,000 cps at only .5% harmonic distortion. Fifty watts per channel also is available before intermodulation distortion hits .5%, and 60 watts before it hits 1%.

At the 1-watt level, frequency response was flat within 1 db from 5 cps to 100 kc. To understand the

Closeup of bias/balance control panel. This amplifier is one of few with controls set from front.

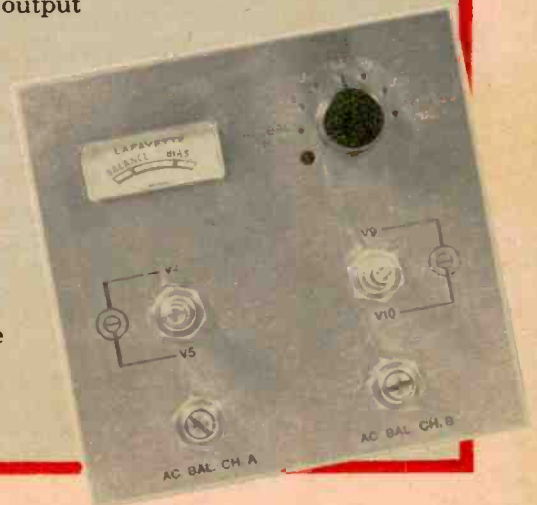

Underchassis view of completed amplifier. Two printed circuit boards are seen in upper section of chassis. Power supply subchassis in lower section has the filter cans and choke mounted on it.

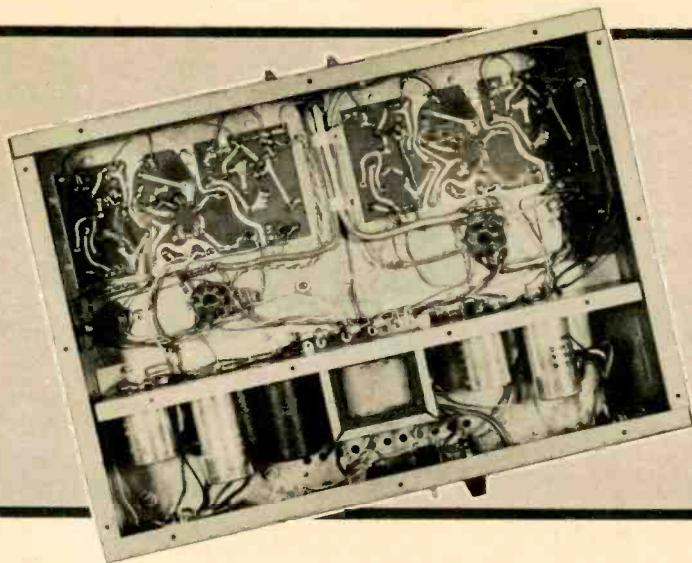

reason for this sub-to-ultrasonic frequency response (when the human ear itself doesn't cover the range), we'll have to look into the subject of *phase shift*, a seldom-mentioned but important factor in any amplifier. A signal is flipped  $180^\circ$  in phase every time it goes from grid to plate of a vacuum tube. In addition, the signal is shifted plus or minus some extra degrees by the inductance and capacity in the circuit.

If an amplifier has *non-linear* phase shift, which is  $10^\circ$  at one frequency,  $20^\circ$  at another and  $30^\circ$  at a still higher frequency, the harmonics of the frequencies being amplified will be shifted out of their proper relationship. This is known as *phase distortion*, and many authorities consider it responsible for the "it tests good, but doesn't sound right" problem. Phase distortion is fairly easy to test for, but hard to eliminate.

In order to minimize phase shift in the frequency range we can hear, the frequency response of an amplifier has to extend a decade plus an octave *above* and *below* the audible range. This means that for zero phase shift from 20 cps to 20 kc, an amplifier would have to be flat from 200 kc at the top down to 1 cps at the bottom end. Cost makes such a unit impractical but, as you can see from our figures, the KT-550 is one of the amplifiers that almost makes it.

The square-wave scope traces shown

on these pages were taken with 20 cps and 20 kc signals at the output of the KT-550. The amount of tilt on the tops and bottoms of the waveforms indicates phase shift or lack of it. The 20-cps wave indicates practically zero shift, while the 20-kc square wave indicates a trace of ringing and has about  $20^\circ$  phase shift—still a respectable figure at that frequency.

**Circuit Design.** Since the designer of the Lafayette amplifier attacked a problem (phase shift) not usually recognized as significant, new paths were blazed. The design goal is for widest possible bandwidth in each stage while minimizing and compensating for phase shift. This was achieved in an interesting way.

Until recently, amplifiers used a single feedback loop, usually from the secondary of the output transformer back to the cathode of the input tube. Phase shift problems within the amplifier limited feedback to about 20 db. The use of multiple (six) feedback loops in the KT-550 permits over 50 db of distortion-reducing negative feedback.

You can see the interrelations of the various factors. Wide bandwidth is needed to eliminate phase shift. When you get rid of phase shift, you eliminate phase distortion and can use high feedback without instability. And you need high levels of feedback both to extend



The twenty cycle square wave demonstrates excellent low-frequency response.

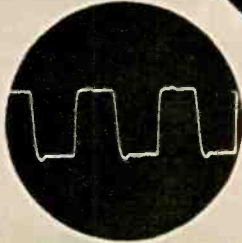

Twenty thousand cycle square wave testing high-frequency response.

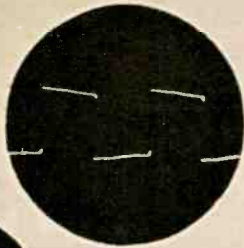

the frequency response (bandwidth) and to reduce harmonic and intermodulation distortion.

Let's look at the schematic of one channel of the KT-550. (Omitted are the metering circuit, bias and power supply.) We'll start at V1a, used in a standard pentode configuration, and trace the circuit to the output stage. Notice that a feedback loop is brought from the secondary of the output transformer to its cathode. The signal from the plate of V1a is fed to both V1b and V2.

V1b is a novel phase inverter. The tube has so much negative feedback around it (via R12, C3, C4) that gain is reduced to 1. However, since it is still functioning as an amplifier triode, it reverses the phase of the signal and feeds it to the grid of V3. Because of the heavy feedback around it, this type of phase inverter is virtually distortion-free and has excellent balance. While the signal from the phase inverter goes to V3, the non-inverted signal is fed directly from V1a to V2.

Drivers V2 and V3 (usually used as video amplifier tubes) feed a pair of push-pull 7027A pentodes operating in class AB1. The KT-550 is one of the first amplifiers to use this new tube. Operated conservatively, the 7027A is pushed to only about 80% of its maximum rating—which means a comparatively cool-running amplifier.

[Continued on page 117]

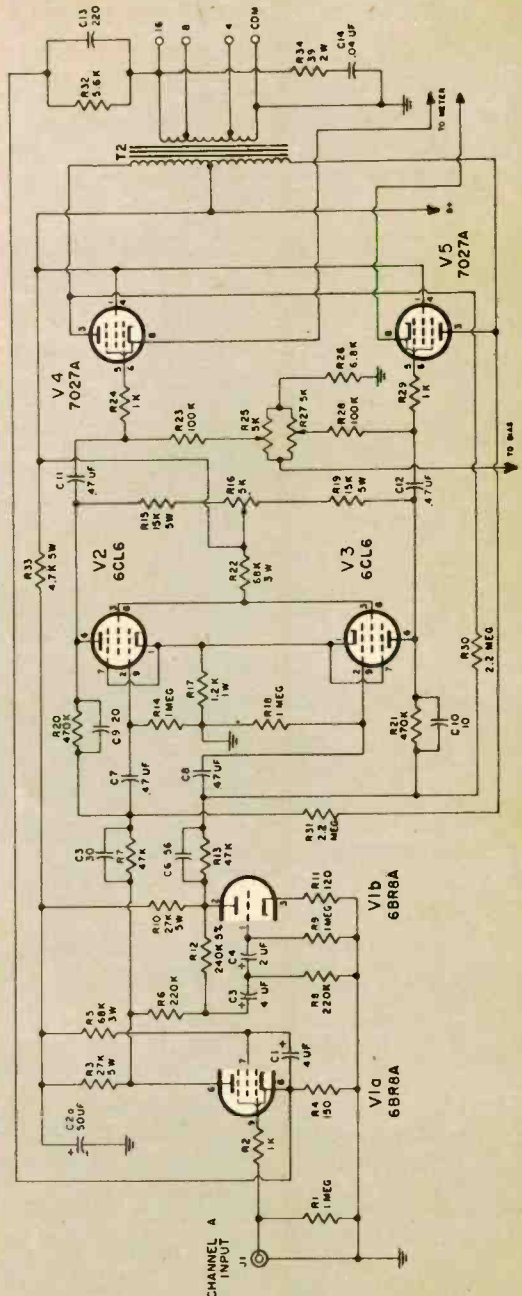

One channel of the KT-550. Note feedback loops from plate to grid of most stages. Power supply and metering circuits not shown.

# Square-Wave Adaptor



Transistorized trigger circuit changes any audio sine-wave signal into a fast rise-time square wave.

By Daniel Horowitz

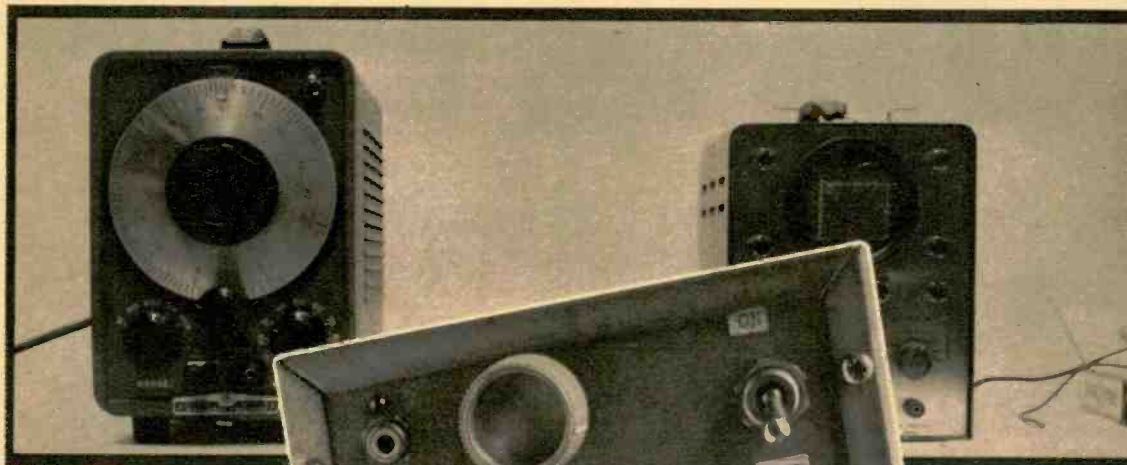

**I**F YOU own a sine-wave generator which does not have provision for square waves, you can add this exceptionally useful feature with a simple two-transistor adaptor. The compact, self-powered unit, when driven by a sine-wave generator, provides high-amplitude square waves with a good waveshape over the entire audio range. Construction cost is under six dollars.

Most build-it-yourself square-wave adaptors have been clipping circuits which simply chop the tops and bottoms off the incoming sine wave. Even those clippers with built-in amplification are unable to provide a high-quality square wave because of the inherent slope of the sine wave it has to work with. EI's adaptor operates on an entirely different principle. Here the incoming sine wave serves simply to trigger a transistorized Schmitt multivibrator circuit. It is the Schmitt trigger, flipping



## PARTS LIST

Resistors: 1/2 watt, 10% unless otherwise indicated

R1, R4, R7—2,200 ohms

R2—25,000-ohm potentiometer (linear)

R3—27,000 ohms

R5—1,500 ohms

R6—4,000 ohms

R8—2,000-ohm potentiometer (linear taper)

C1—150-680 mmf, trimmer capacitor

C2—25 mf, low-voltage capacitor

Q1, Q2—2N414 transistor

S1—Three-pole, double-throw toggle or slide switch

B1—9 V. battery

J1, J2—phono jacks

Misc.—Chassis (Minibox, 5"x2 1/4"x2 1/4"), 6-terminal barrier strip (for parts mounting)

Schmitt trigger circuit is flipped on and off by incoming signal. Three-pole switch S1 is shown in ON position. OFF position bypasses the adaptor circuit.

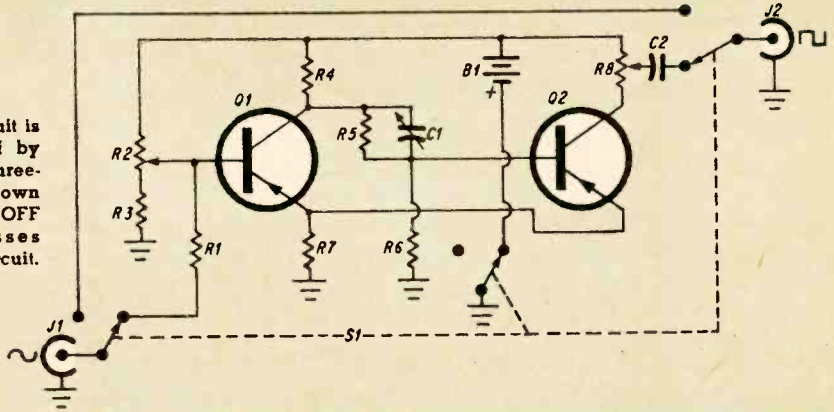

itself on and off in step with the sine wave as it goes from plus to minus, which provides the square wave.

The author's original model has the small parts mounted on a strip in the Minibox; however, almost any wiring technique will serve. The transistors (2N414) are inexpensive switching types with a high  $\alpha$  cutoff frequency. This makes possible sharp leading edges on the square wave.

**Adjustment and Operation.** Connect the output of your sine-wave generator to the adaptor's input jack (J1), using a shielded cable. Connect jack J2 to your oscilloscope. Obtain a pattern on the scope and then switch on the squarer. Turn level control R8 full clockwise for maximum output, then adjust symmetry control R2 until you get a pattern. Use the output control of the sine-wave generator together with R2 to get a square wave with its positive and negative portions of equal width. With a 10 kc sine-wave input, adjust trimmer C1 for the best waveshape. The squarer is now ready for use (see the TECH EDI-

TOR'S TEST BENCH in this issue).

Since the adaptor can be set (with R2) to provide square waves with non-symmetrical tops and bottoms, it is capable of some specialized testing techniques. See *101 Ways to Use Your Audio Test Equipment*, H. W. Sams & Co.

**Theory.** Transistors Q1 and Q2 are connected in a Schmitt trigger circuit, a form of emitter-coupled multivibrator. With no input signal, transistor Q1 is cut off and transistor Q2 is conducting. Bias to keep Q2 conducting is supplied by the voltage divider composed of resistors R4, R5 and R6.

When the input voltage to the base of transistor Q1 increases past its emitter bias voltage, Q1 is switched on and Q2 switched off. When the input signal to the base of Q1 goes down again, Q1 goes off and Q2 is switched on. Since the switching action is rapid, the waveform at Q2's collector is a square wave. Symmetry potentiometer R2 controls the bias voltage of Q1 and therefore sets the level of input at which the circuit switches. ●



TECH EDITOR'S  
TEST BENCH

## the useful SQUARE WAVE

IF YOU own a sine-wave generator as part of your test-bench equipment, you need not be reminded of its virtues. For audio experimentation, design or servicing, a sine-wave generator is mandatory.

Square waves, on the other hand, have their own special applications which supplement the standard sine-wave tests.

For example, let's say you wanted to run a fast frequency-response check on an amplifier, using a sine-wave generator. What you would do is feed in your sine wave at several spot frequencies—20, 100, 1,000, 5,000 and 10,000 cps, etc. You would keep tab on the input voltage from the generator and compare it with the output of the amplifier under test.

What you're doing is determining if the amplifier is amplifying all frequencies equally. For a professional approach, you would check even more frequencies and chart a curve on a sheet of five- or six-cycle semi-log graph paper. If the deviation (at a particular output power) is no more than  $\pm 3$  db, the amplifier is considered flat over the frequency range checked.

These are standard techniques and work well. But, as you may imagine, they can be a little tedious. Three quick square-wave frequency checks, however, will show not only the frequency response but also such important amplifier characteristics as transient response, phase shift and stability.

How is a square wave able to do this? Its special properties derive from the fact that a square waveform, if broken down, can be shown to be the sum of a

whole series of *sine* waves starting at the fundamental frequency (of the square wave) and including the third, fifth, seventh, ninth, etc., odd harmonics. Sending one square wave through an amplifier is, therefore, the equivalent of putting through a large number of sine-wave test frequencies simultaneously.

The trace displayed on the scope at the output of the amplifier provides a pretty good indication of how well the amplifier is able to handle the various portions of the frequency range that make up the square wave. As a rule of thumb, if a square wave of a given frequency comes out of the amplifier with the same waveform it had when it went in, we know the amplifier is essentially flat from about 1/10 to 10 times the fundamental square-wave frequency.

For example, if a 1,000-cps square wave goes through without visible distortion, the amplifier can be assumed flat from 100 to 10,000 cycles. You can see how square waves of only two or three frequencies can check an amplifier's response over the entire audio spectrum.

As I've mentioned, frequency response is not the only factor that square waves check. Arrayed on these pages are some oscilloscope trace photos I've made during various tests on amplifiers. The signal source for the tests was a Hewlett-Packard 200CD audio generator feeding the transistorized square-wave adaptor presented as a project in this issue. An RCA oscilloscope with a high-intensity CRT was used to display the waveforms.

There are certain points you should keep in mind when viewing a waveform display. The *number* and *height* of the

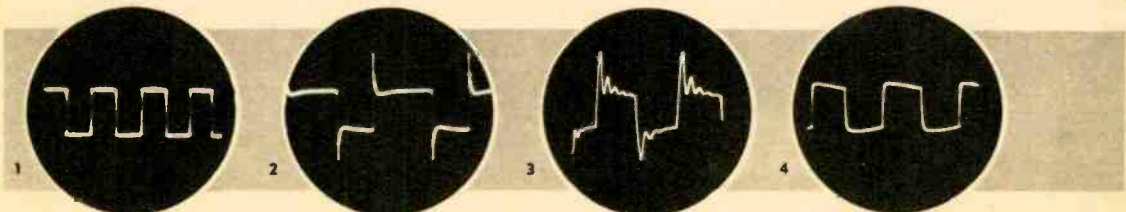



waves appearing on a scope face are determined not only by the voltage and frequency of the input signal, but also by the setting of the scope's sweep and gain controls. Traces therefore are not directly comparable. The fact that three or four cycles may appear in one trace and only two in another has no significance so far as interpretation is concerned. The wave *shape* is the important factor. And because of that, you must make certain that before and during the tests the test equipment isn't responsible for any distortion observed.

For example, if an oscilloscope does not have a wide bandwidth there is no point in trying to view a low- or high-frequency (10 cps, 100 kc) square wave. You will not be able to tell whether the amplifier or the scope is responsible for the distortion. Even when a scope does have adequate bandwidth, if its attenuator compensation capacitors are out of adjustment, visible high-frequency distortion will result. Let's take up the specifics of the waveforms shown below.

**Photo 1.** This is a 20-kc square wave test signal fed directly from the square-wave adaptor to the oscilloscope. Note that as we've mentioned, both the amplitude and width of the square wave are controllable by the scope and hence are not significant in the testing. Actually, the waveform in photo 1 is a rectangle, but for our purposes it is just as good as a square wave and can be turned into one by the scope's horizontal gain control.

**Photo 2.** This is a 1-kc square wave fed through an amplifier with the scope connected across a 16-ohm load resistor at the amplifier's output. Note the peak (or overshoot) on the leading edge and the almost invisible sides of the square wave. The peak indicates a boost in high-frequency response which caused instability. The slight jaggedness shows

a minor ringing or damped oscillation.

**Photo 3.** Here's the same amplifier, but with a 10-kc square wave fed in. The ringing is quite evident. In an amplifier such as the standard Williamson this fault is due to phase shift at the high-frequency end, which turns some of the negative feedback to positive. The problem usually can be minimized by installing a small-value capacitor across the feedback resistor to compensate for phase shift within the amplifier.

**Photo 4.** The slight rounding of the leading edge indicates a small loss of high frequencies at about ten times the fundamental frequency of the square wave; the tilt indicates leading phase shift at low frequencies. The amount of tilt shown is not significant and the generator itself may be responsible.

**Photo 5.** Note while the tops of these square waves are concave, the bottoms are convex. If the amplifier under test is push-pull, an unbalanced condition exists somewhere in the circuit. The particular amplifier tested here is an inexpensive, single-ended type (one output tube). A 50-cycle square wave used in this test demonstrates the poor low-frequency response of the amplifier. The downward tilt following the leading edge indicates both low-frequency attenuation and phase shift. If a higher frequency, such as a 1-kc square wave, was used for this test, the amplifier would pass the wave without too much distortion.

**Photo 6.** This is the output waveform of the same amplifier as above when fed a 10-kc square wave. The severe rounding off of the leading edge of the square wave indicates the amplifier's inability to reproduce frequencies of 10 kc and over. If this same effect were observed on a 1-kc square wave, it would indicate an almost total lack of high-frequency response.—Larry Klein

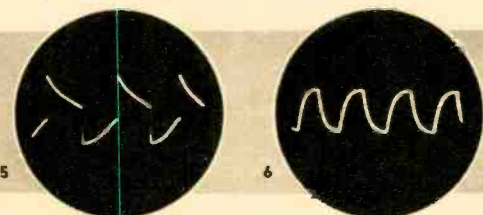

1. 20-kc test square wave.
2. High-frequency peaking.
3. Ringing due to amplifier instability.
4. Slight low-frequency phase shift.
5. Poor overall low-frequency response.
6. Extreme high-frequency loss.

# PRIZE SHACKS

**WIN \$20!** With this issue EI begins a new series of awards for Citizens Banders, amateurs and short-wave listeners. In each issue we will publish photographs of the most attractive or efficient-looking shack in those categories, along with the proprietor's name and a description of his equipment. To the owner of each Prize Shack will go a cash prize of \$20. If you are a CBer, ham or SWL fan we invite you to send us a picture of your shack. Unused photos will be returned. The address: EI Prize Shacks, 67 W. 44th St., New York 36, N. Y.

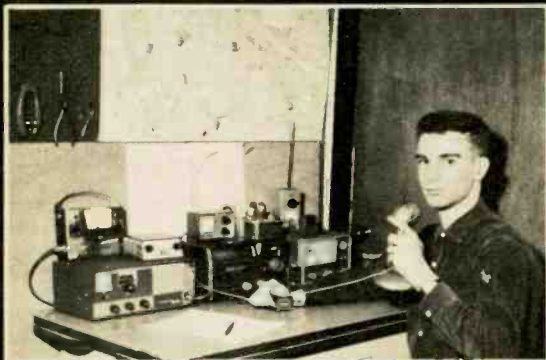

## CB

Our first Prize Shack in the Citizens Band category is owned by Charles (Red) Meyers, 2Q3459, Brooklyn, N. Y. Red has two transceivers—a Lafayette HE-20 and an EICO 761. He also has a short-wave receiver with converter for the public service band, a SECO antenna tester, field-strength meter and speech compressor. Red is 18, a high school student, and he helps dispatch equipment via CB for his father, who is an electrician.

## SWL

Short-wave listener Lavoyd Kuney of Detroit has verified 142 countries and holds a Century Award from EI's DX Club. He uses a Hallicrafters SX-100 receiver with a preselector. Lavoyd has a small forest of antennas, including a 29-foot vertical, a 20-meter folded dipole and a long-wire measuring 90 feet. He uses the tape recorder in the foreground to record his signals as proof of reception. His occupation is letter carrier.



## HAM

Proprietor of our Prize Ham Shack is Dr. Harold H. Riker, K2JHA, a general practitioner in Flushing, N. Y. He has a Collins single-sideband 75 A-4 receiver and 1-kilowatt KWS-1 transmitter, plus a 2-meter Gosset Communicator. His antennas are a three-element (10-15-20 meters) Mosley beam and a trap doublet for 40 and 80 meters. Other equipment includes a band scanner and wattmeter. Note the wall-full of QSL cards.



For CBers ...

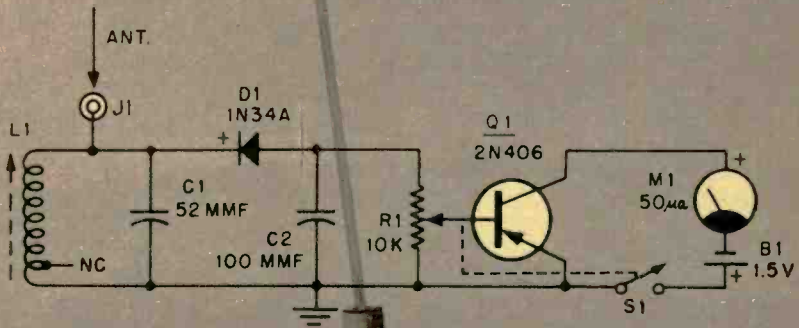

## a super-sensitive FIELD-STRENGTH METER

By Herb Friedman, 2W6045

**O**UR SUPER-SENSITIVE Field-Strength Meter is designed specifically for the Citizens Band new to electronic construction. No special wiring techniques are needed and the parts, including a stock coil, come to less than \$6.

EI's Amplified FS Meter—like any other field-strength meter—indicates the relative power output of your transmitter or antenna system, or both. But because of its high sensitivity, our instrument can be used where its production-line counterparts fail. It is particularly valuable when tuning antennas, especially beams, because it indicates directly whether your adjustments are correct.

For accurate indications, any FS meter should be located a considerable distance from the antenna (ten wavelengths is

recommended). Unfortunately, the output of a CB transceiver is insufficient to move the meter needle at any reasonable distance. But in the same location EI's amplified meter reads full scale.

**Construction.** The unit is built in a Minibox following the pictorial. Insulated antenna jack J1 is mounted in the center of the top panel. Transistor Q1 is specified as an RCA 2N406, but any low-cost *small signal* transistor may be used.

Wire in all the components, leaving diode D1 until last. When soldering D1, place an alligator clip on each of its leads to avoid heat damage.

Since miniature parts are used, work with a soldering iron that has a 25-50 watt rating.

The tap on L1's coil is not used and is soldered to the terminal strip just to tie it down. Don't cut the tap short since the wires are enameled and it may be difficult to solder them together.

Leads may be soldered directly to battery B1 or a battery holder, mounted on the box cover, can be used. Since there is no measurable leakage current and the meter at full scale draws only 50 microamperes, any small 1.5-volt cell will give long-term performance.

The antenna is made from a section of coat hanger approximately 10 inches long. Be certain to scrape off the paint before installing the section in the antenna plug.

**Adjustment.** Run out L1's slug approximately  $\frac{1}{4}$  inch. Turn gain control R1 halfway up. Holding the meter near an antenna or transmitter tuned to the center of the Citizens

Band (channel 9, 10 or 11), adjust L1's slug for maximum meter reading. As you peak L1, reduce the gain to avoid driving the meter off-scale.

#### Using the

FSM. Since the instrument is extremely sensitive, care must be taken to avoid overloading. Always start with the meter off, and advance R1 slowly until a half-scale reading is obtained. Once the meter is set for normal reading adjust the transmitter or antenna for maximum FRM response. This will insure optimum performance.

**Theory.** A standard-tuned circuit (L1, C1) picks up the RF signal and detector D1 rectifies it. The rectified RF (DC) is fed through gain control R1 to the base of a common-emitter amplifier and is amplified about 50 times.

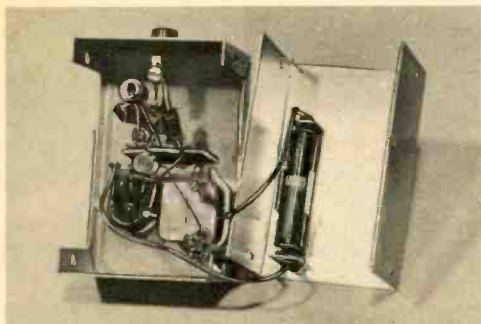
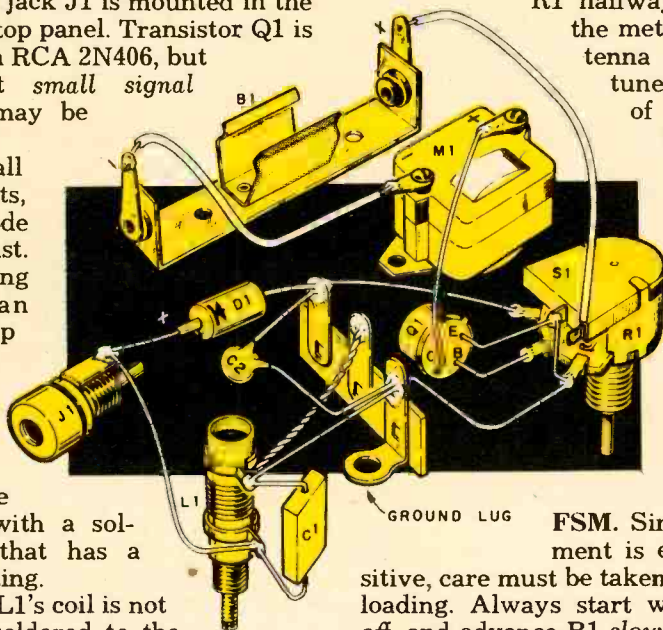

All wiring in the unit is point-to-point. Jack J1 is insulated from the metal cabinet.

#### PARTS LIST

- C1—52 mmf  $\pm 10\%$  low voltage mica or disc
- C2—100 mmf low voltage mica or disc
- R1/S1—10,000-ohm miniature potentiometer with switch
- D1—1N34A crystal diode
- L1—Tuning coil (Lafayette Radio HP62)
- B1—1.5 volt penlight cell
- Q1—2N406 transistor or the equiv.
- M1—Any 50 microamp meter movement. Type shown is an AM tuning meter
- J1—insulated banana jack and plug to match Cabinet—approx.  $1\frac{1}{2} \times 2 \times 3$  inches



## tuning SSB with BFO

**I**F YOU want to pick up single-sideband signals on the ham bands all you have to do is flip the switch on your receiver to SSB and begin tuning. That is, if your receiver came with a princely price tag and has this handy switch, it's all you have to do. But if you're a ham or short-wave listener with a more modest rig, bringing in SSB won't be quite so easy. It *can* be done, though. The secret lies in using your set's beat-frequency oscillator (BFO).

Unless your AM receiver is unusual, probably the first thing you should do in your SSB quest is to take off that dinky little knob on the variable BFO control and replace it with as large a knob as will fit on your rig conveniently. Why? Because a large knob's increased radius will permit fine adjustment of the control and a small knob does not. SSB requires a large amount of finesse in tuning the BFO control.

When you bump into an SSB signal it sounds like some kind of wild duck-talk. With BFO and automatic volume control (if your set has one) turned off, peak the signal as much as possible (this actually centers it in the intermediate-frequency pass band). You can tell when it's peaked by maximum readings on your S-meter or loudest audio. Turn the RF gain control to the minimum needed and the audio to wide open.

Now, with this unintelligible signal coming in, turn on the BFO and swing its variable control in either direction until the duck-talk is high-pitched. Then turn it slowly back so the audio comes down in pitch. Turning slowly and carefully on that large BFO knob, the duck-talk will suddenly become clear, intelligible speech.

The procedure may sound complicated, but after a couple of tries you'll find picking up SSB takes just a careful twist of the wrist. SSB stations can operate anywhere on the ham bands but by custom most of them congregate at the upper rim of the popular bands, and that's where to look for them.

A single-sideband signal actually is a regular AM signal stripped of one sideband and the carrier—leaving a single sideband, as the term implies. In order to recover the modulation in the signal, a receiver's detector needs the missing carrier. The output of your BFO provides it.—Nicholas Rosa, W1NOA

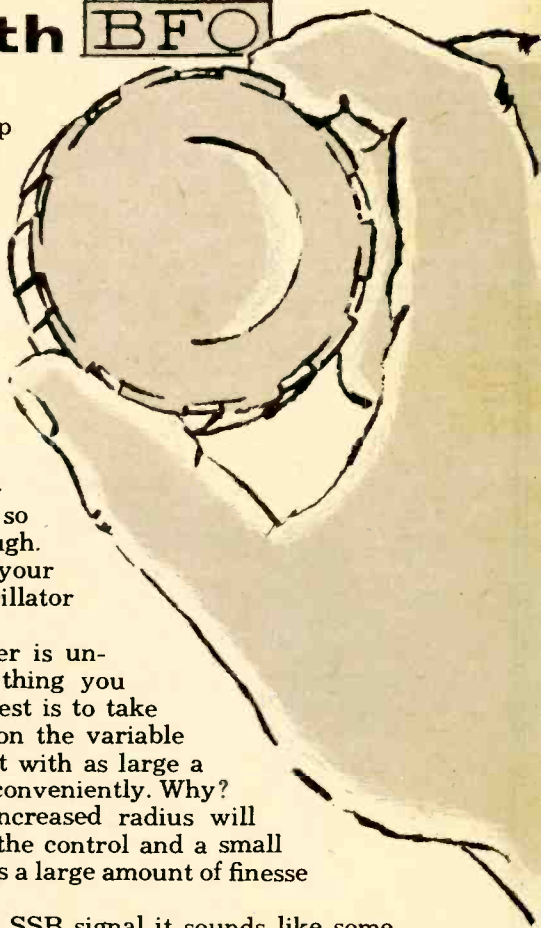

# *build your own* **Radio Direction Finder**



**Poor man's RDF requires only a transistor  
radio and EI's pocket-size adaptor.**

**By Len Buckwalter, Contributing Editor**



**N**EXT to a compass, a radio direction-finder is a boat-owner's best friend. By giving bearings on any radio transmitter in its frequency range, an RDF enables the Sunday skipper to determine both the direction of shore points and his distance from them.

With about \$10 worth of parts and a transistor portable radio, you can make your own radio direction-finder. And the radio will still do its usual job of furnishing music and news. The only modification to the set is the addition of a jack and two wires. The simple two-transistor RDF adaptor plugs into the jack.



You've probably noticed that transistor portables are sharply directional—as the set is rotated a station's apparent signal strength rises and falls. This is due to the loopstick antennas used in transistor portables. A loopstick responds best (produces loudest volume) when its side faces the transmitting tower. When either end points toward the station you get a null—the signal drops and background noise rises.

The signal changes affect the automatic volume control (AVC) voltage in the set. The RDF adaptor samples the AVC voltage and gives a reading on a meter. The two transistors serve as a meter amplifier and prevent the AVC from being loaded down.

**Construction.** The RDF adaptor is assembled in a standard Bakelite instrument case. Start by making the holes in the top panel for the meter control (R7), battery and switch. The battery holder is a clamp fastened to the panel with a single screw. Locate the hole for this screw at the center of the compass rose, which is cemented to the front panel. Choose a screw that's at least a half-inch long. After it is tightened in place with a nut (and holding the bat-

tery strap), use a file to smooth the screw threads above the top panel. This part of the screw later serves as an axle for rotating the radio.

The circuit board is wired separately, and when complete it is cemented to the rear of the meter. Two holes are drilled in the board so it can be slipped over the meter terminals.

**Preparing the Radio.** Because of the tight quarters inside the typical transistor portable, you may need a bit of ingenuity to mount miniature phone jack J1. Try to position J1 near the radio's volume control, but lead length is not critical. After thin, flexible wires have been soldered to J1 mount it on the case and locate the volume control and its five lugs. The two on the rear serve as the on-off switch. You want the two outer lugs of the control which are usually soldered directly to a printed-circuit board. If there is no room to connect wires directly to these lugs, solder to the printed circuit. You can hook the leads either way since polarity can be corrected later.

Check the position of the antenna loopstick in the radio. The loopstick usually lies parallel to one side of the

**PARTS LIST**

Resistors: 1/2-watt, 20% unless otherwise indicated  
 R1—47,000 ohms      R3—100 ohms  
 R2—1,800 ohms      R4,R5,R6—33,000 ohms  
 R7—10,000 ohm potentiometer  
 Q1—2N107 transistor  
 Q2—2N170 transistor  
 S1—SPST toggle switch

B1—9 V. battery  
 M1—0-50 DC microammeter, 1 1/2" or larger  
 J1—Miniature phone jack  
 PL1—Miniature phone plug  
 Misc.—Bakelite cabinet, 3 3/4" x 6 1/4", with panel; push-in terminal clips; battery clips; 1 3/4" x 3 1/4" perforated board; knob; hookup wire

Simple direct-coupled transistor circuit functions as DC amplifier to AVC signal tapped from radio.

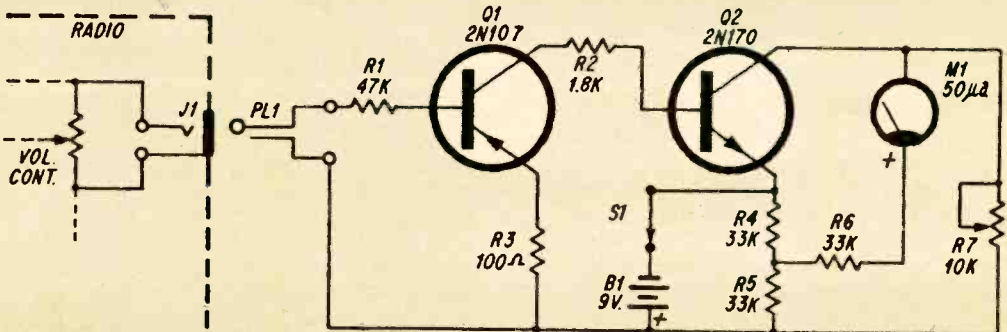

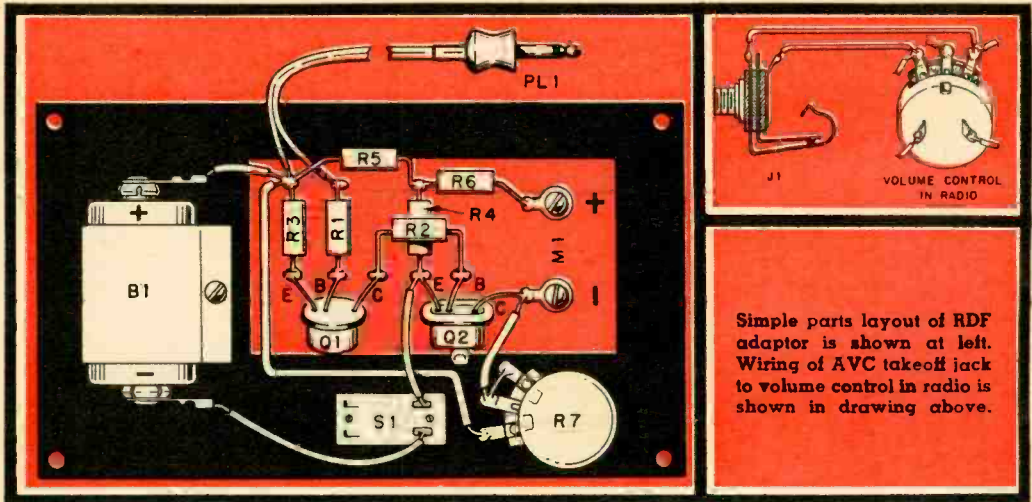

Simple parts layout of RDF adaptor is shown at left. Wiring of AVC takeoff jack to volume control in radio is shown in drawing above.

case. Make a mark along the edge of the case on this side and remember it as the *reference edge*.

**Checkout.** Plug the completed RDF adaptor into the transistor portable and turn on both. Tune in a station and adjust the radio's volume control to normal listening level. Now set R7 so the meter reads somewhere near center-scale. Dial across the broadcast band and see if the meter needle reacts to the signal strength—reading highest when nearby stations are heard. If the meter dips when a station is tuned in, reverse the leads of the connecting cable where they enter the RDF circuit board. Since the swing of the meter needle is influenced by the setting of the radio's volume control, simply turn up the radio's gain for a more positive indication.

Tune in a station, using the RDF meter as a tuning guide. Now, rotate the radio and notice the behavior of the needle. During one complete rotation it rises and falls twice. We're interested in the dip or null point (minimum reading on the dial) since it gives the most accurate indication. Either null may be used for direction-finding.

**Using the RDF.** You naturally need a compass on your boat in order to use a radio direction-finder. And you also need marine charts of your area, on which is noted the exact location of broadcast station transmitters (you draw in their locations). Such charts

are available from the U. S. Coast & Geodetic Survey, Washington 25, D. C. (coastal waters), and the Army Corps of Engineers (inland waters), and also from local map houses. You *could* use road maps but they are not as accurate.

To check out your RDF before taking it aboard, place one of the charts on a flat surface and give it a northerly orientation. The longitude lines on the map should be parallel with the needle of a pocket compass placed on top of the chart.

Tune in a station and place the *reference edge* of the radio—mentioned earlier—on the map so it cuts across the marked location of the station's trans-

[Continued on page 112]

Completed adaptor. Note that all wiring and components are installed on the rear of the front panel.

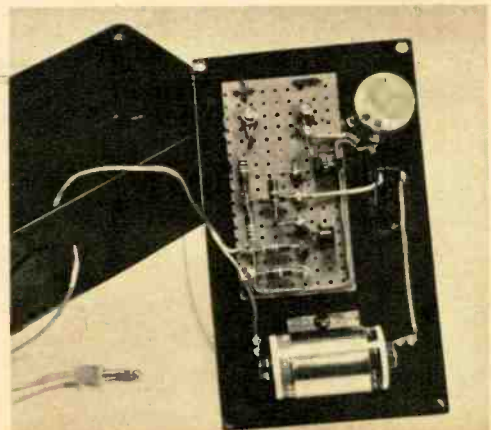



**Comprehensive courses in  
Electronic Fundamentals  
TV Servicing – Color TV –  
Electronics for  
Automation –  
Transistors**



**LET RCA TRAIN YOU AT HOME**

RCA Institutes, one of the leading technical institutes in the United States devoted exclusively to electronics, offers you the finest training-at-home. The very name "RCA" means dependability, integrity, and scientific advance. Practical work with your very first basic lesson. You build and keep prime quality equipment. Pay as you learn. No installment payments necessary. You pay for your next study group only when you order it. And remember, in electronics the more you know the higher you go. Licensed by the University of the State of New York.

Resident school courses in Los Angeles and New York City also offer college-level training in any field of electronics you may choose. Classes begin four times each year. Free Placement Service.

**SEND POSTAGE-PAID CARD TODAY  
FOR FREE ILLUSTRATED BOOK!**

Check Home Study or Resident School Box



**RCA INSTITUTES, INC.** A SERVICE OF RADIO CORPORATION OF AMERICA  
350 WEST FOURTH ST., NEW YORK 14, N. Y. • 610 S. MAIN ST., LOS ANGELES 14, CALIF.

The Most Trusted Name in Electronics

Dept. EI-92



# GOOD READING

By John Milder

**HOW TO BUILD ELECTRONIC EQUIPMENT.** By J. Richard Johnson. John F. Rider, New York. 288 pages. \$6.95

Nearly any electronic hobbyist, from

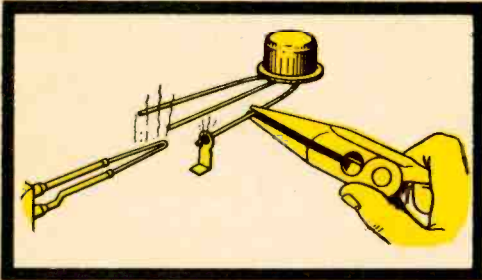

a kit-builder to those who design their own construction projects, can profit from this book. A comprehensive guide to electronic construction techniques, it outlines methods to use in tackling virtually anything. Particularly valuable is the book's emphasis on mechanics: tools, hardware, chassis layout and design, and other matters which the average hobbyist learns to deal with only through a painful process of trial and error. Illustrations are plentiful. The typical one shown above demonstrates how to solder in a transistor without heat damage.

**SINGLE-SIDEBAND CONSTRUCTION TECHNIQUES.** By Harry D. Hooton. Howard W. Sams & Bobbs-Merrill, New York & Indianapolis. 286 pages. \$6.95

Although they've been around more than 30 years, single-sideband techniques are still new to many hobbyists. Mr. Hooton's thorough handbook on SSB should be of value to amateur and professional alike. He has worked with SSB and other suppressed-carrier techniques some ten years. His book contains a good deal of new information, including new circuit designs and a limited number of construction projects.

**BASIC RADIO COURSE.** By John T. Frye. Gernsback Library, New York. 224 pages. \$4.10 soft cover, \$5.75 hard cover

This is a revised version of Mr. Frye's ten-year-old best seller. A glance will tell you why a new edition should do well. The author's clear, easy-going style can hardly be faulted. From the electron theory through resonant circuits and servicing techniques, Mr. Frye manages to be both informative and entertaining—an unusual feat in a basic text of any kind. The book is well organized and up to date, and has pertinent review questions after each chapter.

**FM MULTIPLEXING FOR STEREO.** By Leonard Feldman. Howard W. Sams & Bobbs-Merrill, New York & Indianapolis. 160 pages. \$2.50

The first book this reviewer has seen on the Zenith-GE stereo FM system, this volume seems to be aimed primarily at the technician and serviceman. The latter should find it particularly valuable. The three multiplex circuits you find in most tuners and adaptors are thoroughly explained, as is the test gear required by the new medium. The author, a designer of multiplex equipment, dwells at length on the critical alignment necessary for good separation in the receiver circuits. There is room, however, for much more detail on the equally critical subject of antennas.

And make note of . . .

**ELECTRONICS MATH SIMPLIFIED.** By Alan Andrews. Sams. 224 pages. \$4.95

**VACUUM TUBE CIRCUITS FOR THE ELECTRONIC EXPERIMENTER.** By Julian M. Sienkiewicz. Ziff-Davis. 176 pages. \$4.95

**101 MORE WAYS TO USE YOUR VOM AND VTVM.** By Robert G. Middleton. Sams. 128 pages. \$2.50



# CB Servicing Made Easy



## Part III

By Herb Friedman, 2W6045

*In this issue we conclude our CB servicing series by checking some typical transmitter circuits and their troubles.*

**POOR Transmitter Output; Receiver Operates.** Prepare the transmitter for testing by connecting either the visual RF indicator, a power meter or a dummy load to the antenna jack. Transmitters under test *always* should be terminated, but never by the antenna. There is no excuse for jamming a channel with your testing.

In any transmitter failure the crystal should be checked first; defective crystals are the prime cause of poor transmitter performance. Transmitter oscillators are checked in the same manner as receiver oscillators. However, a weak transmitting crystal usually fouls up transmitter operation far more than a bad receiving crystal upsets a receiver. Also, transmit crystals have a

Block diagram of a typical 5-watt Citizens Band transceiver.

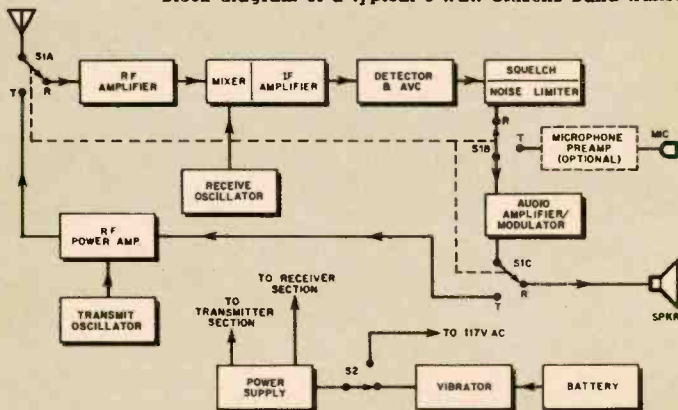

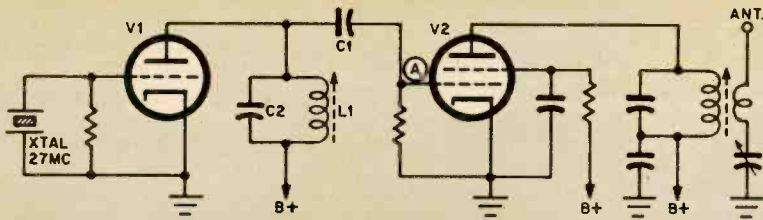

Fig. 1 Crystal oscillator and RF power output circuit found in many current transceivers.

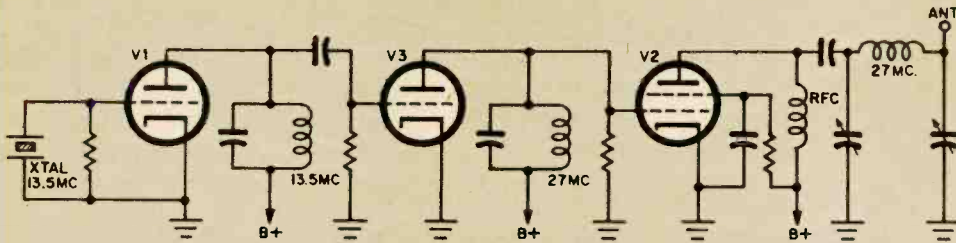

Fig. 2. Circuit used in many recent rigs. Crystal is cut to half-frequency and doubled.

higher percentage of failure because they usually work in a relatively high-power circuit. For a quick crystal check, simply replace a suspect crystal with one of known quality. As a general rule, the CBer should have one known-good crystal which he uses for test purposes only. (Many is the rig that has had a full set of weak crystals.)

If the crystals are all right, check for an RF signal (grid drive) at the RF power amplifier grid point A, V2 (Fig. 1). This will be shown by a negative grid voltage of about  $-15$  to  $-30$  VDC. If there is little or no negative voltage, oscillator coupling capacitor C1 may be open. A positive grid voltage on V2 indicates C1 is shorted or leaky.

Let's say that the crystal and C1 are okay, but the RF drive signal is still missing from the RF power amplifier grid. In that case, component aging may have detuned the oscillator plate circuit (L1-C2). A grid dip oscillator (GDO) is the best means for checking tuning (resonance). Place the GDO coil alongside the oscillator plate coil and tune the GDO through the 25- to 30-mc range. If the GDO dips, but not near 27 mc, it means the plate circuit is detuned. Consult the manufacturer's instructions for his recommended procedure in this

case. If the GDO does not dip, plate tuning capacitor C2 probably is defective.

If the oscillator is working (as evidenced by the presence of negative voltage) use the GDO as described above to check the plate circuit of power amplifier V2, Fig. 1.

While the transmitter circuit shown in Fig. 1 at one time was fairly standard, a variation shown in Fig. 2 is used in many late models. Usually the crystal is cut to half-frequency, 13.5 mc, with buffer doubler amplifier V3 doubling the crystal frequency to 27 mc. V3 also amplifies the signal, resulting in a more efficient transmitter having greater crystal stability since 13-mc crystals are more stable and rugged than overtone types. In some transmitters, the crystals are one-third frequency and use a tripling amplifier. In any event, the same troubleshooting techniques apply, the difference being an additional amplifier.

**Distorted or No Modulation; Receiver Operates.** Since the receiver is operative, the audio section common to the transmitter and receiver must be working; therefore, either the microphone preamplifier or the microphone itself is defective.



In order to check the *transmit* audio quality, some means of monitoring the audio must be provided. The simplest, though not the best, method is to connect one lead from a good-quality, high impedance (2,000 ohms or higher) headset to the chassis. The other lead is connected in series with a .05-mf, 600-VDC capacitor to the plate of modulator tube V1, Fig. 3. This arrangement enables you to judge whether the modulator is clean, but will not indicate the modulation percentage, which is as important as audio quality.

A CB transmitter tester such as the SECO 510 provides a power meter as well as a percentage modulation meter and an off-the-air audio detector. Since

the instrument's audio detector is an off-the-air signal you get a true picture of the transmitted signal.

The combination of an RF signal generator and transmitter tester lets you make direct modulation checks. Feed an *audio* signal from the generator into the transceiver's microphone input. Start the audio output control low and raise it gradually until the transmitter tester indicates 100% modulation. With a headset connected to the tester detector output, listen for a distorted signal. If the signal sounds good, the amplifier is all right and the microphone is defective. To double-check, have someone speak into the microphone and listen for distortion.

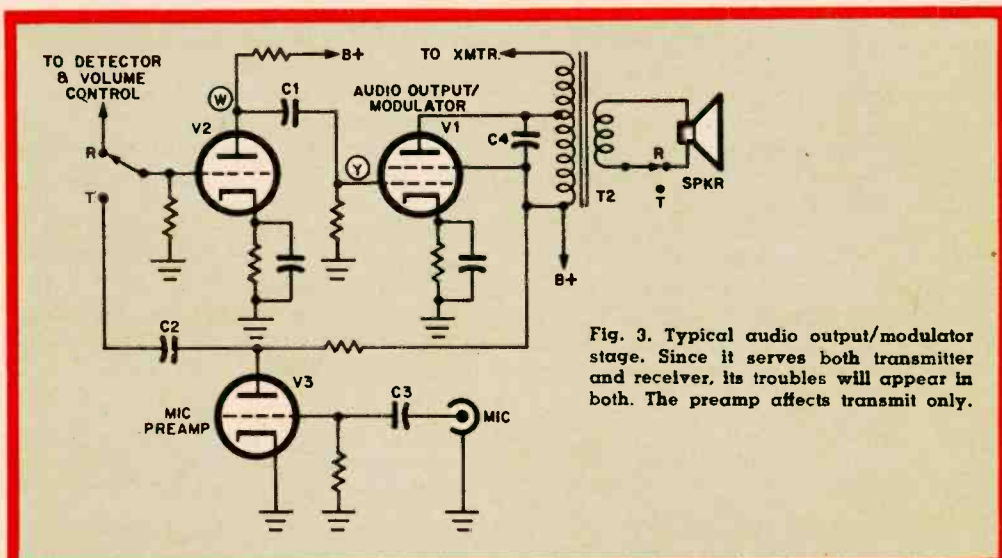

Fig. 3. Typical audio output/modulator stage. Since it serves both transmitter and receiver, its troubles will appear in both. The preamp affects transmit only.

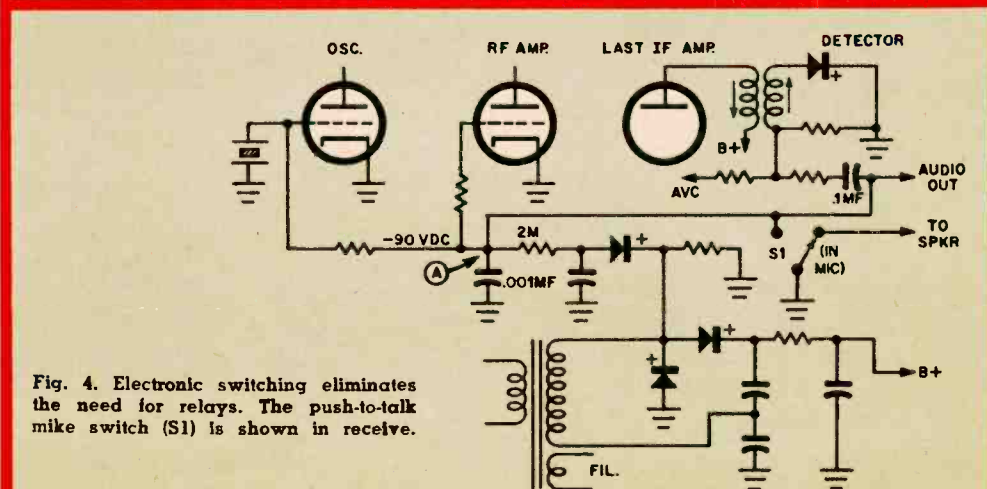

Fig. 4. Electronic switching eliminates the need for relays. The push-to-talk mike switch (S1) is shown in receive.



A specialized CB transmitter test set by Seco.

If the amplifier passes the audio signal test, but there is no response to the microphone, check for a shorted or broken mike cable. This is the major cause of microphone failure. Avoid connecting an ohmmeter directly across a ceramic or crystal mike element.

If the audio tone is distorted, the breakdown is in that part of the audio section used only for transmitting—the microphone preamplifier, V3, Fig. 3. Breakdown usually is due to a defective coupling capacitor, C2. With the transmitter *on*, check the voltage at the grid of V2; a positive voltage indicates C2 is shorted or leaky.

**Switching Problems.** Transceivers use multi-contact switches, relays, electronic or combined electronic-and-relay

switching to go from *receive* to *transmit*. If a switch is erratic, the problem probably is dirt. Spray the contacts with a contact cleaner and work the switch a few times. Do *not* attempt to squeeze the spring contacts together for more tension.

If a relay is the suspect, clean its contacts. In a pinch, dip a business card in carbon tet or contact cleaner and, holding the contacts down lightly, pull the card through the contacts. If available, use a contact cleaning kit which includes a contact burnisher. Do *not* file relay contacts.

Electronic switching is reliable and causes little trouble. Fig. 4 illustrates how it works. A rectifier diode is connected to the power transformer to produce a high negative voltage. This voltage biases the transmitter tubes to cut-off when the transceiver is on *receive*. When microphone *transmit* switch S1 is depressed, the negative voltage is grounded, permitting the transmitter to operate. S1 simultaneously grounds the audio signal from the detector and opens a speaker lead, thereby preventing acoustic feedback.

If electronic switching fails, first check for negative voltage at point A. If the voltage is correct, the trouble is most likely caused by dirty microphone switch contacts.



Percentage modulation and a number of other important factors can be checked directly with an instrument such as the CB transmitter tester.



# "A CREI Home Study Program helped me increase my salary by a factor of four (4)."

—Mearl Martin, Jr., SENIOR ENGINEER, Field Support Manager, Tektronix, Inc., Portland, Oregon



"I AM INDEED GRATEFUL TO CREI for my success," says Mearl Martin, Jr. "Since enrollment in a CREI Home Study Program in Electronic Engineering Technology, I have progressed from Junior Technician to licensed Senior Engineer. My present title is Field Support Manager and my salary has increased by a factor of four (4)."



DEMAND FOR CREI-PREPARED MEN today far exceeds the supply—and has for many years. CREI Home Study Programs, the product of 35 years' experience, include the latest advancements in the field. Here Martin discusses home study with company executive W. K. Dallas, V.P., Manager, Marketing Division, Tektronix, Inc.



WHEN YOU ENROLL in a CREI Home Study Program, you study courses to which a number of today's leading engineers and scientists have made substantial contributions. You are guided by qualified instructors. Robert Wruble, Group Manager (center) and Rollie Smith, (right) Field Training Manager at Tektronix, Inc., are shown here with Mearl Martin.



ASSURE A BETTER FUTURE and get more out of life with CREI Home Study. CREI alumnus Martin enjoys living in this comfortable home in Portland, Ore. CREI men are in such companies as Pan American Airways, Federal Electric Corp., The Martin Co., Northwest Telephone Co., Mackay Radio, Florida Power and Light, etc. This attests to the high calibre of CREI Programs.



YOUR WHOLE FAMILY BENEFITS when you achieve success through CREI Home Study. Here Martin relaxes with wife and family who share his success. Check the completeness of CREI Home Study Programs in Electronic Engineering Technology in our catalog, provided on request. For those who can attend, CREI maintains a Residence School in Washington, D.C.

**INDUSTRY-RECOGNIZED CREI HOME STUDY PROGRAMS PREPARE YOU FOR INCREASED RESPONSIBILITIES, HIGHER-PAYING POSITIONS IN ELECTRONICS.**

YOU CAN QUALIFY for a CREI Program if you have basic knowledge of radio or electronics and are a high school graduate or the equivalent. If you meet these qualifications, write for FREE 58-page book describing CREI Programs and career opportunities in advanced electronic engineering technology. Mail coupon or send your qualifications to: The Capitol Radio Engineering Institute, Dept. 1709-K, 3224 Sixteenth St., N. W., Washington 10, D. C.

Mail coupon today for FREE 58-page book

## THE CAPITOL RADIO ENGINEERING INSTITUTE

Founded 1927

Dept. 1709-K, 3224 Sixteenth St., N.W., Washington 10, D.C.

Please send me details of CREI Home Study Programs and Free Book, "Your Future in Electronics and Nuclear Engineering Technology." My qualifications are noted to obtain immediate service.

CHECK FIELD OF GREATEST INTEREST:  Electronic Engineering Technology  Nuclear Engineering Technology  Servo and Computer Engineering  Automation and Industrial Electronic Engineering Technology  Aero and Navigational Engineering Technology

Name \_\_\_\_\_ Age \_\_\_\_\_

Address \_\_\_\_\_

City \_\_\_\_\_ Zone \_\_\_\_\_ State \_\_\_\_\_

Employed by \_\_\_\_\_

Type of present work \_\_\_\_\_

Education: Years High School \_\_\_\_\_ Other \_\_\_\_\_

Electronics Experience \_\_\_\_\_

Check:  Home Study  Residence School  G.I. Bill

27

# ULTRA LINEARITY

PRO & CON



**A** NUMBER of high-power amplifiers marketed recently use straight pentode output tubes rather than an Ultra-Linear hookup in the output stage. Is the pentode circuit as good or are the manufacturers just trying to save money?

Charles Newman  
Brooklyn, N. Y.

The U-L output stage is excellent. But this does not mean it is the only, or even the best, circuit.

In the early days of high fidelity the usual high-quality amplifier used push-pull triodes in its output stage. A major drawback of triodes were their low power output. The conventional pentode output stage was capable of high output power, but also had high distortion and required a regulated power supply because of the large swing in current drain from a no-signal to a high-signal condition. A regulated power supply which could handle the job probably would cost as much as the rest of the amplifier.

The Ultra-Linear output circuit eliminated the need for a regulated power supply and produced almost as much power as straight pentode operation.

The development of the high-voltage silicon rectifier opened new doors for the audio design engineer. Due to its low voltage drop and high current capacity, the silicon rectifier contributes excellent regulation to any power supply. The availability of low-cost, stable power supplies plus the development of new output tubes is enabling pentode operation to come back into its own for hi-fi use.

## Tape Playback Problems

*When I record and play back tapes on my machine they sound good. However, when I lend the tapes to a friend and he plays them on his machine they lack*

*highs. To make things more complicated, the tapes my friend records and plays back on his machine sound fine. Is one of our machines defective?*

L. Karmin  
Philadelphia, Pa

If both machines use a single record/playback head the the mystery is easy to clear up. Each head's record/playback angle is consistent with respect to itself, but may not be correct with respect to the head on the other machine. This is why the tapes sound all right when played back on the machine they were recorded on, but do not reproduce well on another machine. Check the head azimuth alignment on both recorders.

## Low-Noise Preamp Tubes

*I own a preamplifier that uses four 12AX7's. What equivalent replacement of the 12AX7 will give me the lowest noise as the phono preamp tube?*

Herman Kraden  
Jacksonville, Fla.

Almost every tube manufacturer in the past several years has produced a version of the 12AX7 under numbers such as ECC83, 12AD7, 12AY7, 5721, 6681, 7494, etc. Since no one of these types seems consistently better than any other, trial and error is your best bet for selecting a quiet tube.

Set your preamp to *mag phono* and insert a shorting plug in the phono input. With your amplifier hooked up normally—but with the gain, bass and treble controls on full—try substituting new tubes for the preamp tube in each channel. After a one-minute warm-up, tap each tube. You should be able to select a tube with less noise simply by listening. Tubes that aren't quiet enough for the phono preamp stage usually will serve without difficulties in a tone control or later stage. ●



*Heathkit®  
puts  
professional  
quality  
into new  
low cost  
stereo tape  
recorder*

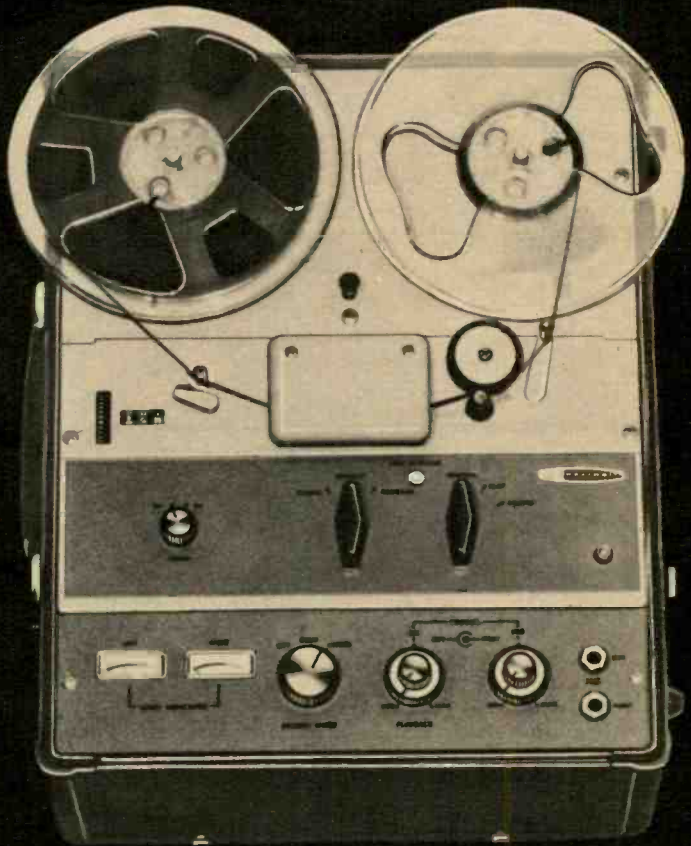

Here's the latest example of the Heath ability to give you more for less . . . the all new Heathkit 4-Track Stereo Tape Recorder. Its obvious quality yields professional results (less than .18% wow & flutter at 7½ ips). Its many extra features assure better, more convenient performance (see chart at right). Its fast, easy circuit board construction makes any tyro confident of technical excellence. Its versatility is remarkable . . . record and playback 4-track stereo tapes or playback 2-track monophonic tapes . . . use it as part of your stereo music system or as a portable. Choose your model now: the Model AD-12 provides the mechanism for playback of stereo or mono tapes (converts to a recorder later by adding the electronics) \$124.95; the model AD-22 includes both mechanism and electronics for stereo record and playback, \$179.95. Optional carrying case, \$37.50. Accessory ceramic microphones, \$9.95 ea.

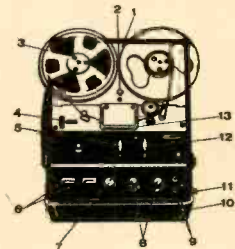

**FEATURES**

1. Die-Cast aluminum panel.
2. Speed change lever (7½ & 3½") 3. Seven inch reel capacity.
4. Three-digit counter.
5. Fast forward-rewind lever.
6. VU-type level meters.
7. Stereo /Mono record switch.
8. Mixing level controls (mic. & line).
9. Microphone inputs.
10. Cathode-follower output jacks.
11. Line inputs.
12. Record-playback lever.
13. 4-track record-playback and erase heads.



**HEATH COMPANY**  
Benton Harbor 39, Michigan

Ordering instructions: Fill out the order blank, include charges for parcel post according to weights shown. Express orders shipped delivery charges collect. All prices F. O. B. Benton Harbor, Mich. A 20% deposit is required on all C.O.D. orders. Prices subject to change without notice. Dealer and export prices slightly higher.

Enclosed is \$ \_\_\_\_\_; send \_\_\_\_\_

Name \_\_\_\_\_

Address \_\_\_\_\_

City \_\_\_\_\_ Zone \_\_\_\_\_ State \_\_\_\_\_

# there's a **FUEL CELL** in your future

Electricity to run your car, your tools and even your home may one day come from tiny gas generators.

By Saunder Harris

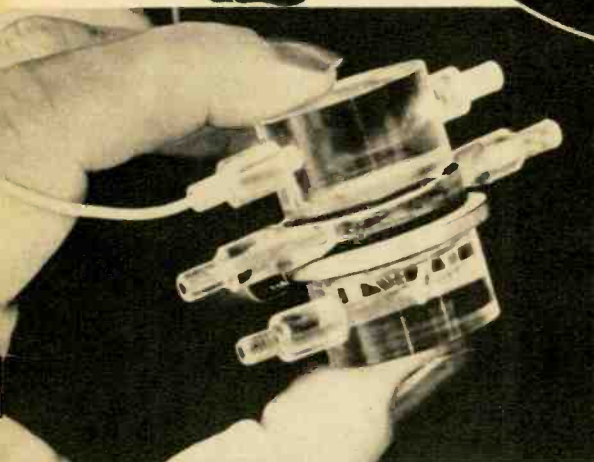
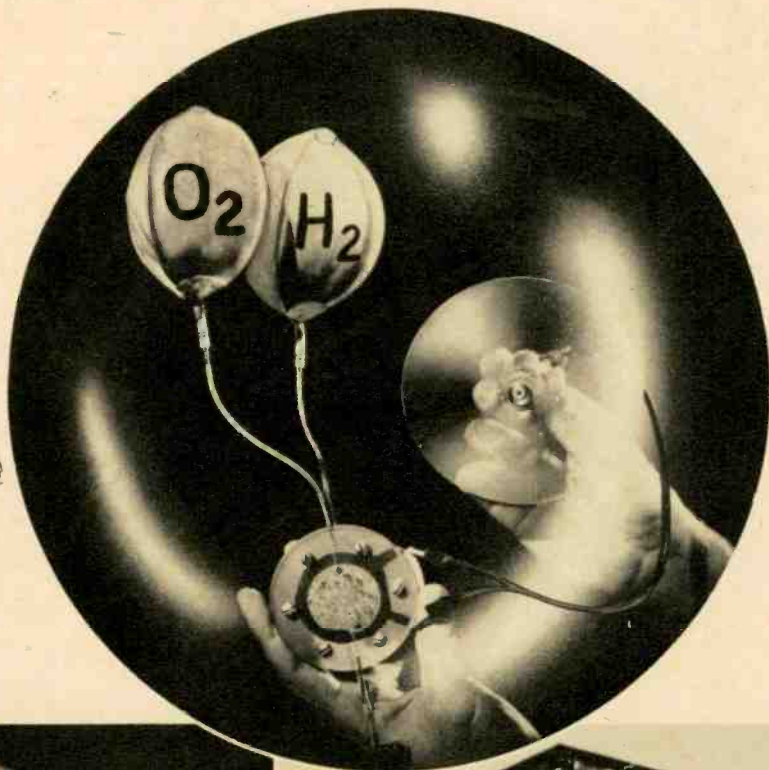

Miniature fuel cell by Hoffman Electronics uses sodium amalgam and chlorine to produce 3.3 volts.

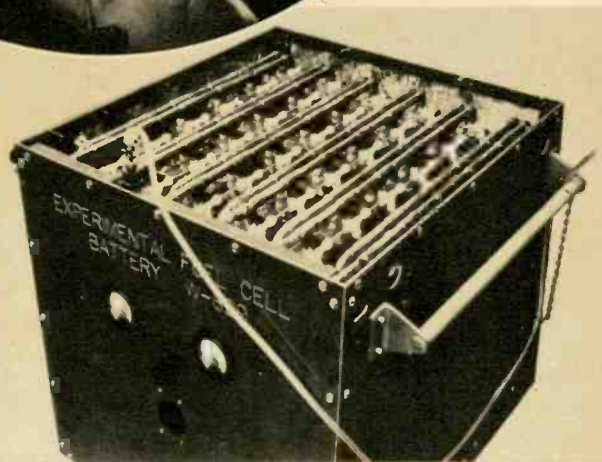

This massive experimental fuel cell built by the Union Carbide Corporation has 1-kilowatt rating.



**M**AYBE you've heard the one about the man who started cross-country in an electric car. Well, he didn't make it. Ran out of extension cord in Chicago.

That may be a limp joke, but in five years you might be able to head for distant parts in a shiny electric buggy and have every assurance of getting there. Your power would come from a small generator mounted on each wheel. They would be called fuel cells.

Though the term is new, the theory of fuel cells goes all the way back to 1839, the year Sir William Grove discovered that, when combined to form water, hydrogen and oxygen give off electrons.

After more than a century, we're trying to put Sir William's discovery to practical use by getting some work out of those electrons. Fuel cell research is eating up more than half the money spent today on developing exotic new sources of power—some \$28,000,000 a year on more than 60 projects.

Scores of experimental and demonstration cells have been built. Our lead photo shows a General Electric cell, powered by gas from two balloons, turning a fan. Thousands of students have built demonstration cells as science projects, a large fraction of them following instructions in a booklet distributed free by the Esso Research & Engineer-

ing Co. (Box 45, Linden, N. J.). To date, not a single fuel cell has passed beyond the research stage, but practical ones are near.

One immediate job for a fuel cell is to furnish power to orbiting satellites. Other cells in the future will drive submarines, operate Army field equipment, run remote weather stations and power floating sea instruments. These uses are remote to you and me, but we'll have our fuel cells, too. We'll see lawn mowers, power tools and even tractors drawing their energy from fuel cells. One day homes in remote areas may get all their power this way.

The purpose of any electric cell—wet battery, dry battery or fuel cell—is to pile electrons up on one of two electrodes. The cell then is hooked in a circuit and the electrons flow out to perform work, such as lighting a bulb. In a dry cell the electrons are piled up by action of chemicals contained in the battery.

In a fuel cell the chemicals are two gases—not stored in the cell but fed into it.

One is termed the fuel (hydrogen is the most common) and the other the oxidizer (oxygen). The process that takes place is combustion. Free electrons and water are produced. The electrons can be put to work. The water is waste (except in regenerative cells).

Two diagrams accompanying this article show what happens in the combustion process. In the simplest cell two hollow carbon electrodes are surrounded by a potassium hydroxide electrolyte. Hydrogen fed into one electrode passes through the electrode's carbon wall and in so doing releases an electron, becoming a hydrogen ion. The electron flows into an external circuit, while the ion moves through the electrolyte to the other electrode. Oxygen entering this electrode combines with the hydrogen and the returning electron to form water.

More exotic fuel cells work the same way but have variations in fuel and structure. Other fuels include bottled gas, alcohol, lithium, sodium, potassium and cesium; oxidizers run from oxygen to chlorine, bromine and iodine. Our

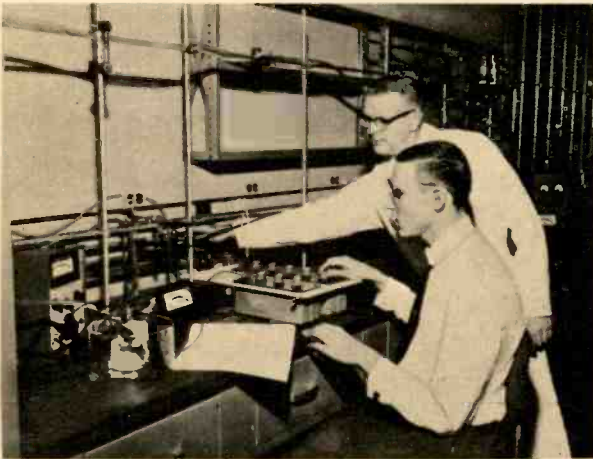

Young student (seated) built demonstration cell, using booklet supplied by Esso Research Company.

### FUEL CELL COMPARISON CHART

SYSTEM	FUEL/OXIDIZER	POWER OUTPUT
Hydrocarbon cells (med. & low temp.)	hydrogen/oxygen	.6-1. volts 50-1,000 amps per sq. ft.
Hydrocarbon cells (high temp.)	carbonaceous gas/air	.54-.96 volts 30-100 amps per sq. ft.
Regenerative cells	lithium hydride/air	.36 volts 450 amps per sq. ft.
Consumable electrode cells	sodium/oxygen	1.4 volts 100 amps per sq. ft.

Low-grade fuel cells have a potential as low as a half-volt, while one sodium-chlorine device produced 3.3 volts. Average is about 1 volt. To get higher voltages, you hook several cells in series. The amount of current produced depends on size

chart shows four types of cells, the most exotic being one with consumable electrodes. One electrode is made of zinc, sodium amalgam or magnesium; the active element in the other is oxygen or chlorine. In operation, the electrodes literally are eaten up.

A prime attraction of the fuel cell is its efficiency. Units with efficiencies of 70 to 80 per cent will be common, and the figure could easily run to 90 or above. The percentages mean that for every 100 units of chemical energy put into a fuel cell, you get as many as 90 units of electrical energy out. By comparison, conventional generators are less than 40 per cent efficient.

The fuel cell also has a simple design, noiseless operation, no fumes and no moving parts to break down. Its main drawback is the fuel. Pure hydrogen is extremely expensive, most of the other fuels more so.

—the surface area of the electrodes.

The Army has been experimenting with a fuel cell to power a portable radar set. It produces 200 watts of 24-volt direct current for 14 hours on one canister of fuel. Total weight is 30 pounds. By hooking enough individual cells together, almost unlimited power can be produced. The Navy has a 75-kilowatt unit. The only problem is size and weight.

A lightweight cell with high power naturally is the goal. The immediate prospect is a cell that produces 6 watts per pound or 200 watts per cubic foot.

One of the more interesting developments predicted is a marriage between fuel cells and solar cells. The latter would supply power during the day and at the same time decompose water into hydrogen and oxygen . . . which would be consumed during darkness by electricity-producing fuel cells.

In one simple fuel cell type hydrogen and oxygen produce electricity and water waste (see text).

In cell built by General Electric the same gases are employed but electrolyte is a solid membrane.

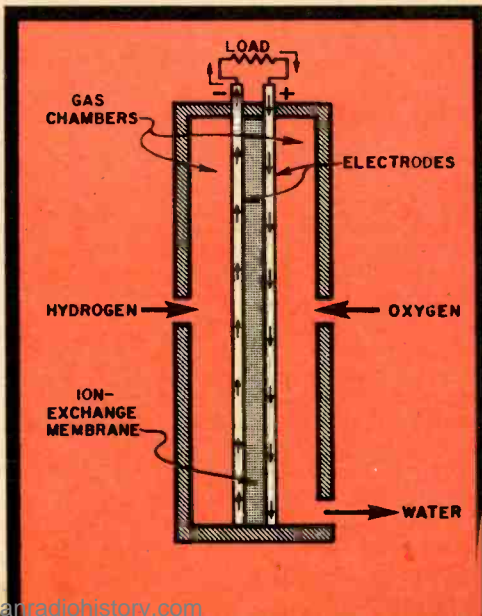
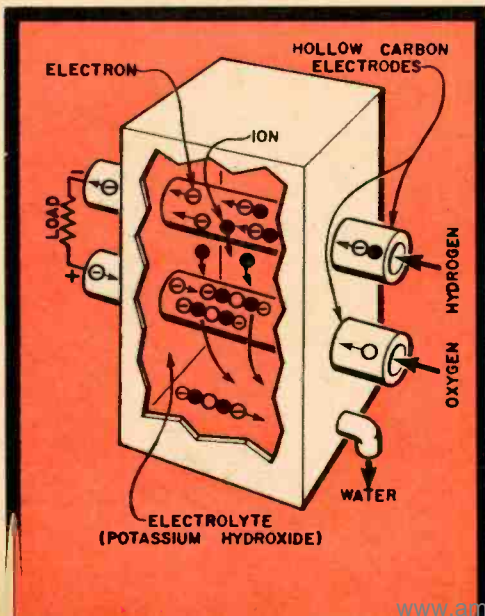



The Fisher KX-200 80-Watt Stereo Control-Amplifier StrataKit, \$169.50.\*



## It has four things that others haven't.

**1. StrataKit Construction.** Assembly by totally error-proof stages (strata). Each stage corresponds to a *separate* fold-out page in the Instruction Manual. Each stage is built from a *separate* transparent packet of parts. Major components come already mounted on the extra-heavy-gauge steel chassis. Wires are *pre-cut* for every stage—which means every page. Result: Absolutely equal success by the experienced kit builder or the completely unskilled novice!

**2. Built-In d'Arsonval Meter.** For laboratory-accurate adjustment of bias and balance. Assures peak performance from the start; permits 'touching up' for continued peak performance throughout the years, regardless of tube aging. No other single-chassis control-amplifier kit has this vital feature.

**3. Third-Speaker Output with Volume Control.** Blends the two stereo channel outputs to feed a third loudspeaker system—at *any* desired volume level. Ideal for center-channel stereo fill-in or for a mono extension speaker in another room of the home. A Fisher exclusive among control-amplifier kits.

**4. The Fisher Name.** No comment necessary.

USE THIS COUPON FOR FURTHER INFORMATION

Fisher Radio Corporation  
21-55 44th Drive, Long Island City 1, N. Y.

Please send me without charge the complete Fisher StrataKit catalogue.

NAME \_\_\_\_\_

ADDRESS \_\_\_\_\_

CITY \_\_\_\_\_

ZONE \_\_\_\_\_

STATE \_\_\_\_\_

21911



\*Walnut or Mahogany cabinet, \$24.95. Metal cabinet, \$15.95. Prices slightly higher in the Far West. Export: Fisher Radio International Inc., L.I.C., 1, N.Y. Canada: Tri-Tel Associates, Ltd., Willowdale, Ont.

KIT  
E.I.  
REPORT

# TWO POWER SUPPLIES

## for the test bench

**T**HE test-bench instruments most often forgotten in any list of useful equipment for the experimenter or technician are power supplies. Test-bench supplies can be divided into three basic categories: the variable AC type, the low-voltage, high-current DC supply and the high-voltage, low-current DC supply. The two kits we'll examine fall into the first two categories. Both kits are examples of EICO's new styling, which looks good on most anyone's test bench.

How easy are they to build? Actually both are mostly mechanical assembly

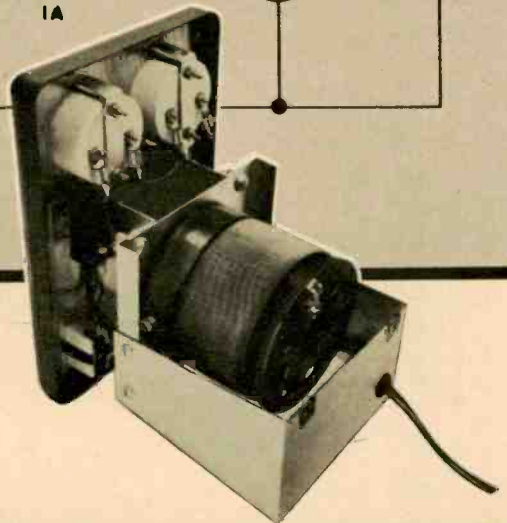
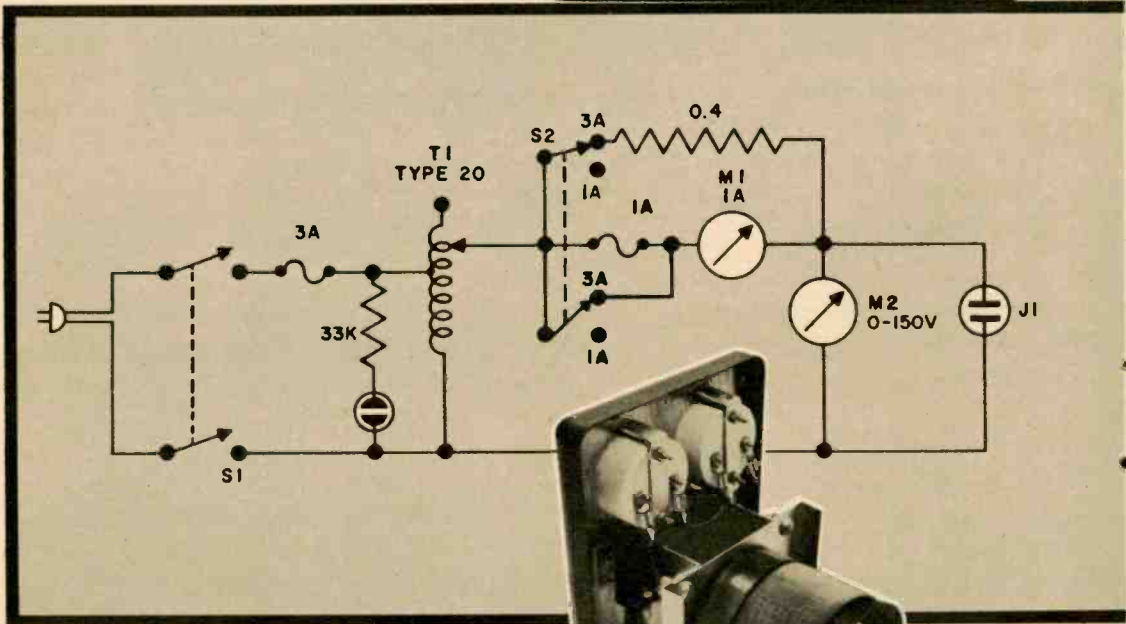
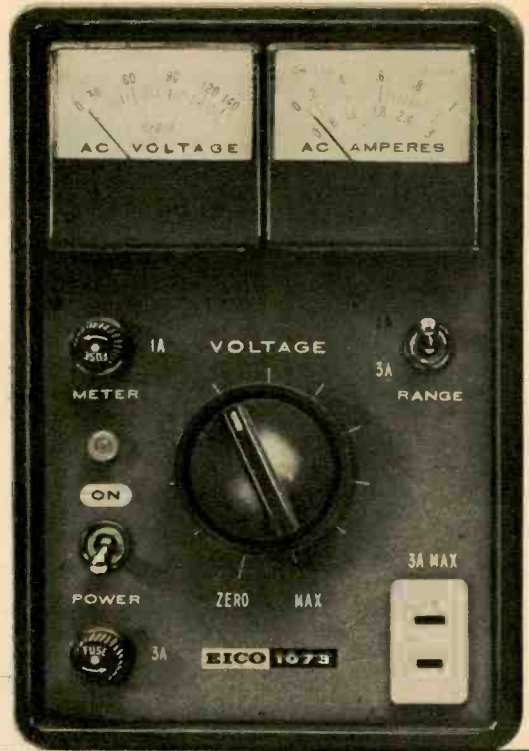

Variable auto-transformer T1 in the schematic is the large cylindrical object seen in the rear view of the 1073. The rest of the unit consists basically of the two meters and range switching.



The 1064 is somewhat more complex because of the need for rectification and filtering. Component K1 in the schematic is a thermal circuit breaker which can be seen bolted to rectifier CR1/CR2.

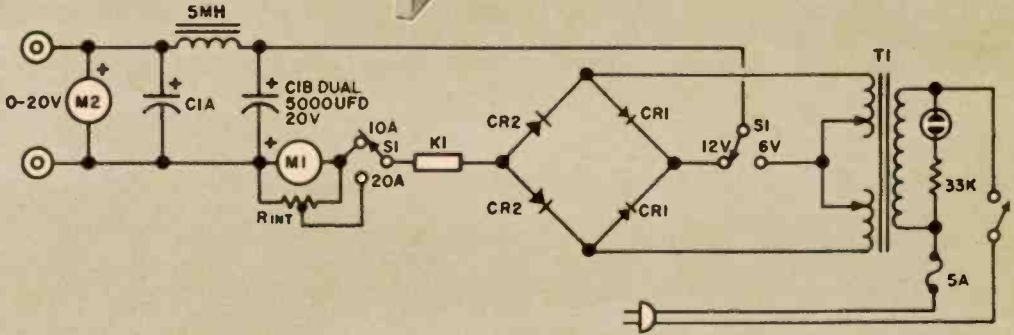
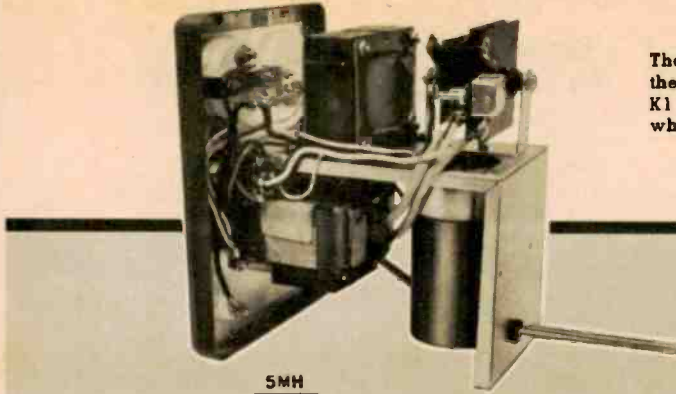

jobs and neither one should take more than an evening to complete. Let's look at the specifics of each.

**Variable AC Supply.** EICO's model 1073 uses a standard circuit incorporating a variable auto-transformer—T1 in the schematic. The sliding tap on the autoformer boosts or lowers the line voltage from 0 to 140 volts. Separate meters monitor voltage output and the current drain. Switching (S2) provides a choice of current meter ranges: 0 to 1 and 0 to 3 amperes. The voltmeter in the 1073 turned out to be surprisingly accurate. In fact, it can be used to check the upper AC ranges of your VOM or VTVM.

Although EICO doesn't mention it, connecting a simple half-wave rectifier diode and filter setup to the AC output of the instrument will provide high-voltage DC (to about 175 volts). Write EICO for further information. Note that the output of the unit is *not* isolated from the AC line, so precautions should be taken to avoid shock hazards when

[Continued on page 116]

## The Tape Club Story

Continued from page 79

expert on equipment or technique.

There are times when a local tape club receives a tape addressed to the membership as a whole. Recently I made such a tape for the Norwich (England) Gramophone Society. It was played as the program for one of their regular membership meetings.

In some less prosperous nations a local tape club is formed for the purpose of buying a recorder, which would be too expensive for any individual member. Then it is used by everyone in the group, and the club as a whole.

Both local and international clubs become involved in social service work. Typical projects are making tapes to entertain hospital patients and putting books on tape for the blind. World Tape Pals has congressional endorsement as part of our People to People Program, and it produces World Tapes for Education.

You can become an amateur recordist with an investment of about \$100 (\$50 more if you want to reproduce good music). It's not peanuts, but well below the ante needed to take up boating, ham radio or sports cars. There are tape recorders that cost less, of course, but for dependable equipment and usable tapes, this price bracket is the lowest advisable.

The most frequently used tape speed is 3¾-inches-per-second and half-track recording. You do, in the course of time, run into all speeds and track widths. The beginner should make sure his equipment can handle at least 3¾ and 7½ ips, and half- and quarter-track recording.

Tapes ordinarily are sent by regular mail. Shipping cartons to carry the reels can be purchased for a few cents.

What happens to the tapes you send and receive? If it is a reel you particularly value, you can arrange to have your tapespondent return it, and you send his back. It is usual, however, for him to keep your tape and you keep his, either erasing and recording again or putting the reel in your tape library.

## Radio Direction Finder

Continued from page 94

mitter. Now rotate the radio for a null on the meter. Using the reference edge as a guide, draw a line across the chart. The line will be parallel to the side of the loopstick and will cut through the transmitter's location. Take a null reading on a second station and draw its map line. The point at which the two lines intersect is your location. Readings on a third and fourth station will give you an even more accurate fix.

When mounting (or placing) the RDF adaptor in your boat, it is advisable to line up the north point on the compass rose with the bow, although you can use any orientation you desire.

The compass rose is a refinement which allows you to take a null reading directly in degrees with the radio on an axle at the center of the rose (this is the screw you previously filed smooth). A small hole drilled in the radio case engages the axle so the set can be rotated.

When you swing the radio around and obtain a null reading you merely read the compass rose bearing at the set's *reference edge*. That is the bearing of the station in relation to your boat's heading. A little problem develops here in that you get *two* null readings 180° apart. You don't know whether the station is off your port or your starboard side. To determine which is the correct side, you cruise ahead a few minutes, taking null readings as you go. The null will pass to stern on *one* side (as the station falls behind). The station is located on that side.

It is important to keep both adaptor and radio several feet from your compass. Permanent magnets in the speaker and meter disturb the compass needle. When taking readings, keep your hands away from the loopstick by holding the radio on the other side of the case. And take nulls on stations which lie in different directions, at least 30° apart.

You would be wise to practice often with your RDF to give you confidence when you get in a tight spot and really need it.



Clip this coupon for  
**FREE INFORMATION**

**ON YOUR  
FUTURE IN  
ELECTRONICS!  
NO OBLIGATION!**



**PROFITS FROM ELECTRONICS** contains valuable information on the many different profit opportunities for you in the exploding field of electronics... information that helps you pin-point exactly which area of electronics can be most profitable for you! **TO GET YOUR COPY, MAIL THE CAREER COUPON TODAY!**

**ELECTRONICS CAREER COUPON**

14092E

Please send me your FREE booklet "PROFITS FROM ELECTRONICS" and tell me how Central training can qualify ME for a high-pay career in Electronics.

Name..... Age.....

Address.....

City..... Zone.....

State..... County.....

I am interested in Home Study Training  
 I am interested in Resident Training

**CENTRAL TECHNICAL INSTITUTE**

1644 WYANDOTTE, KANSAS CITY 8, MO.  
Accredited Member National Home Study Council



# DISCOVER YOUR CAREER IN ELECTRONICS

**THERE'S A PLACE FOR YOU IN THE DYNAMIC, \$11,000,000,000 FIELD OF ELECTRONICS!**

Today—there are many exciting opportunities for you in Industrial Electronics, Automation, Radio, Color TV, Radio-TV Broadcasting, Communications Electronics, Radar, Missiles, Computers, Nuclear Energy, and many other areas. The electronics industry is growing so rapidly that **LAST YEAR, THERE WERE NOT ENOUGH TECHNICALLY-TRAINED PERSONNEL TO FILL ALL OF THE JOBS OPEN WITH ELECTRONICS COMPANIES!** With the electronics field expanding so FAST, every day you gain in starting your career training is **MONEY IN YOUR POCKET.** If you're interested in a rewarding, secure future in electronics—let Central Tech help you learn about the field. Mail the above CAREER COUPON TODAY! NO OBLIGATION!

**CENTRAL HAS THE FACILITIES AND THE EXPERIENCE TO TRAIN YOU FOR SUCCESS IN ELECTRONICS**



**AUTOMATION LAB** Central Tech's \$250,000 Data Processing Center contains a Remington-Rand UNIVAC computer system, a Bendix G-15 computer, and accessory data processing equipment. Students actually use this equipment in learning Electronic Computer Programming as well as Computer Technology.



**RADIO-TV BROADCAST LAB** This Studio Lab has three separate control rooms and is equipped with five modern TV cameras, a switching and control console, TV film projectors, recording console, FM transmitter, microphones, special lighting facilities and other accessory equipment.



**PRACTICAL ELECTRONICS LABS** The practical application of theory is an important part of Central's home study and resident curriculums. In Central's Practical Electronics Labs, students gain actual experience working with circuitry, components and test equipment.



**HOME STUDY** Students enrolled in Central Tech's excellent home study course have a double advantage. Central's highly qualified teaching staff employ the most modern lesson materials and personalized home instruction methods, together with a wide variety of Central's exclusive **INSTANT KITS®**. The experience gained by building these kits gives students a thorough knowledge of electronics assembly.

**CENTRAL TECH'S  
TRAINING EXPERIENCE  
INCLUDES THESE FIRSTS:**

- Central constructed and operated Station W9XAL, the **FIRST** Television Station west of Chicago to broadcast on a daily schedule.
- Central was granted one of the **FIRST THREE** High Fidelity commercial broadcast station permits issued by the Federal Communications Commission.
- Central Technical Institute was the **FIRST** civilian school in the United States selected by the U.S. Signal Corps to train radio operators and repairmen during W.W. II.
- Central Technical Institute was the **FIRST** Technical Institute in the United States to have a complete electronic computer system installed as a teaching aid.

**IF YOU'RE INTERESTED IN AN ELECTRONICS CAREER, LET CENTRAL TECH HELP YOU LEARN ABOUT THE MANY PROFITABLE OPPORTUNITIES IN THE FIELD. MAIL THE ABOVE CAREER COUPON TODAY!**

**Central Technical Institute**

1644 Wyandotte, Kansas City 8, Missouri

# new in CB

Shown here are pieces of Citizens Band equipment that have just reached the market and redesigned versions of some older models.



Cadre C-75 has power rating of 1.5 watts, uses printed-circuit modules. Two crystal channels. Batteries are recharging type.



Heath "black box" type transceiver has minimum controls and one crystal channel; GW-12 kit; \$39.95.



The Vocaline ED-27M Commaire offers crystal control on four transmit, one receive channel; price: \$189.50.



Radio Shack Realistic TRC-5 has five channels, delivers 2 watts RF power; one crystal receiver channel; \$69.95.



The SpeakEasy is an audio compressor by Communications, Inc. It is designed to increase average modulation and range of transmitter; price: \$34.75.



General MC-5 is seven-tube; six T and four R channels, 3.25 watts; \$199.95





Lafayette's revamped HE-15B has eight transmit channels, RF monitor meter jack; \$59.50.

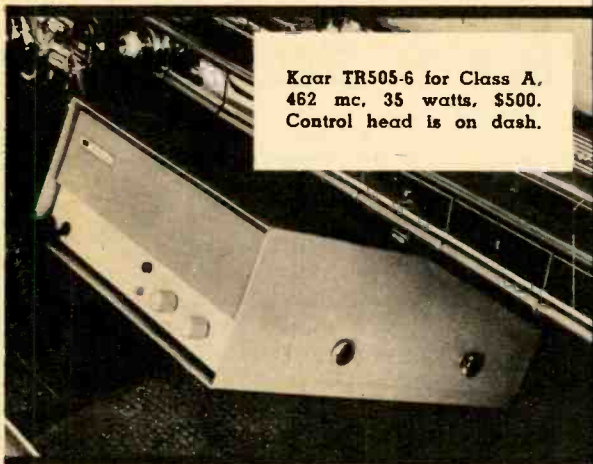

Kaar TR505-6 for Class A, 462 mc, 35 watts, \$500. Control head is on dash.



Lafayette's new version of the HE-20B has eight crystal T-R channels and S-meter; price: \$109.50.

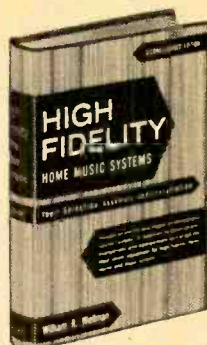
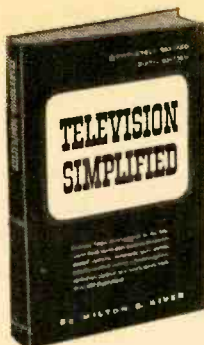

Completely revised, expanded, enlarged  
... the Sixth Edition of

## TELEVISION SIMPLIFIED

BY MILTON S. KIVER

The only manual in the field to offer in as compact and easy-to-follow a presentation:

- theory and analysis of various stages of a television receiver
- television transmitting
- servicing receivers.

New chapters, expanded discussions, latest advancements, newest techniques. Over 500 illustrations. An indispensable aid to all who want to understand the basic principles of television and their most recent applications. \$7.50

## The new, revised, Second Edition of HIGH FIDELITY

Home Music Systems

By William R. Wellman

Includes: • stereophonic sound systems • how to select proper equipment • diagrams with step-by-step instructions for "do-it-yourself" addicts • expanded discussion of tape recorders, amplifiers, and pre-amplifiers • suggestions for improving existing receivers • how to convert small table-type receivers for use as AM tuners • many other features.

Written for the layman who wants to understand the latest developments in hi-fi, without first studying for a degree in electronic engineering. \$6.50

### FREE EXAMINATION COUPON

D. Van Nostrand Company, Inc., Dept. T-E17  
120 Alexander Street, Princeton, New Jersey

Please send me:

\_\_\_ copies of Television Simplified @ \$7.50

\_\_\_ copies of High Fidelity: Home Music Systems @ \$6.50

Within 10 days I will remit purchase price, plus small delivery cost, or return book(s) and owe nothing.

Name .....

Address .....

City ..... Zone ..... State .....

SAVE! Remit with order and we pay delivery. Same return privilege guaranteed.

## Hi-Fi Record Guide

Continued from page 80

ing version of It Ain't Necessarily So that lasts for twenty minutes. It takes imagination and inventiveness to sustain interest in such extended renditions of songs, but the jazz flutist and his associates possess those virtues in considerable quantities—plus a few more like virtuosity, feeling and spontaneity. A fine jazz record.

Records discussed in this column, with monaural discs listed first and stereo versions just below:

Beethoven: Sonata; Schumann: Fantasy <i>Sviatoslav Richter</i>	Angel 35679 S-35679	\$4.98 5.98
Liszt: Piano Concertos <i>Richter-Kondrashin</i>	Philips 500.000 900.000	4.98 5.98
Beethoven: Piano Concerto No. 1 <i>Richter-Munch</i>	RCA Victor LM-2544 LSC-2544	4.98 5.98
Beethoven: Sonata; Rachmaninoff: Preludes <i>Richter</i>	Columbia ME-5725 (monaural only)	4.98
Strauss: Salome <i>Solti, Vienna Philharmonic</i>	London A-4247 OSA-1218	9.96 11.96
Strauss: Elektra <i>Boehm, Saxon State Orch. Deutsche Gram.</i>	18690/1 138690/1	11.96 13.96
Unpredictable <i>Patrice Munsel</i>	Philips 200.020 600.020	3.98 4.98
This Fling Called Love <i>Eileen Farrell</i>	Columbia CL-1739 CS-8539	3.98 4.98
The Midnight Special <i>Belafonte</i>	RCA Victor LPM-2449 LSP-2449	3.98 4.98
George Greeley Plays George Gershwin <i>George Greeley</i>	Warner Bros. W-1451 WS-1451	3.98 4.98
Folksong: U.S.A. <i>The Robbinsdale Chorale</i>	Audio Fidelity AFLP-1965 AFSD-5965	4.98 5.95
Herbie Mann at the Village Gate <i>Herbie Mann</i>	Atlantic 1380 S-1380	4.98 5.98

## Two Power Supplies

Continued from page 111

using the instrument as a power supply for AC/DC equipment.

**Battery Charger-Eliminator.** The model 1064's type of supply has been around a long time, and little need be said about its applications. As its name implies, the 1064 functions as both a storage battery charger and as a battery substitute for bench-testing auto radios. The important difference between this supply and less expensive or older models is in its filtering. The EICO has a full 10,000 mf of filter capacity in

an LC pi arrangement. Our checks showed the instrument's residual ripple to be low enough to permit its use with any transistorized device from the pocket portable to automobile hybrid receivers.

The kit went together in about three hours with a few minutes wasted for puzzling out two or three obscure points in the instruction manual. Referring to page 10C, step 2, be sure to scrape the enameled coating off the wires before attempting to solder them. And on page 11C, add (S1) to step 9. If you have trouble making the instrument's handles lie flat after assembly, bend the small knockout tab in the channel on the handle's underside. Aside from a few minor problems (which EICO has promised to take care of) both instruments are easy to build and have a professional appearance. And, most important, they do their jobs well.

## The Listener

Continued from page 42

Seething Continent to give a reliable account of the doings in Katanga.

Until the spring of 1962, Senegal's English-language newscasts, presented at 1540 EST, enjoyed a clear channel in Europe and North America. But during late March RFE, troubled by Communist jammers, moved around and came to rest on 11895 kc—Senegal's "clear channel." As a result, Dakar was buried.

Truth is, there aren't enough SWBC frequencies to go around, especially with a low sunspot count wrecking the upper bands. There's little hope of extending SWBC downward because the utility bands can't spare a kilocycle.

## Voice Controlled Relay

Continued from page 58

sition and speak in a normal voice. Slowly advance R1 until the relay closes; at this setting the VOX will open and close at approximately the word rate. Keep advancing R1 until the relay remains closed between words; at this



setting the relay will remain closed for approximately one second after you stop talking. If you desire a longer delay simply advance R1 more. R1 sets both the sensitivity and the holding delay.

If you use the VOX with a CB or ham rig, remember that sound from the speaker can trip the relay. If you run into this problem simply talk closer to the mike and reduce the sensitivity. In fact, it's a good idea to use minimum VOX sensitivity, for at full gain a single footstep on a wooden floor trips the relay. C1 controls the time delay, the specified value giving a range of one to three seconds. For longer delay, use a larger value; for shorter delay, a smaller one.

## Stereo Power Amplifier

Continued from page 83

A question may arise on the use of pentode-connected output tubes when the distributed-load or Ultra-Linear configuration is almost standard practice. Theoretically, pentodes are capable of providing low-distortion, 60-watt performance. However, until the advent of the 7027A there had been no tube which actually could do the job. In addition, pentode operation requires excellent regulation of the plate and screen voltages. The silicon diode rectifier solved that problem. In fact, with a moderately simple voltage-doubler power supply, there is a drop of only 4 or 5 volts in B+ at full amplifier output.

The Lafayette amplifier has one physical feature that our builder particularly liked. The bias adjust controls and a meter to determine optimum settings are centralized on a control panel (see photo). All bias and balance adjustments can be made easily without additional test equipment. In fact, the amplifier may be installed in a console with only the small brass control panel showing. As far as we know, this is the only basic amplifier available with this feature.

All factors, including laboratory and listening tests, establish the Lafayette KT-550 as one of the finest stereo basic amplifiers in its power class.



**EMC's  
UNBEATABLE  
VALUES!!!**

You get the most  
per measurement dollar!

All New precision instruments . . . satisfaction guaranteed! Best quality! By far the best value obtainable in wired or kit form!



with complete instruction manual, transistor listing and pair of test leads.

**EMC NEW MODEL 212 . . .  
TRANSISTOR ANALYZER . . .**  
Checks DC current gain in 3 ranges to 200. Tests for leakage. Checks all transistors as oscillators both in and out of circuit. Can be used to signal trace AF, IF or RF circuits. Checks condition of diodes. Tests battery voltage on 0-12 scale. Checks DC current drain on 0-80 ma scale. Supplied with complete instruction manual, transistor listing and pair of test leads.  
Model 212 . . . **\$18.50 Wired**  
Model 212 Kit . . . **\$13.50**



**EMC NEW MODEL 213  
TUBE TESTER . . .**  
Completely modern! Completely flexible! Completely new! Checks all the new 12 prong (Compactron), Nuvistor, Novar, and 10 prong tubes, in addition to octal, loctal, miniature, and 9 prong tubes. Tests each tube for shorts, leakages, intermittents, opens, as well as for quality. Each section of multi-purpose tube is checked separately. Magic eye, Voltage Regulator and HI-FI tubes are also tested. Unique switching arrangement makes the checker obsolescent proof. Supplementary tube listings supplied periodically at no cost to keep instrument up to date. It comes complete with instructions and tube charts in ring bound manual.

Model 213 (In bakelite case with strap) . . . **\$28.90 Wired**

Model 213 Kit . . . **\$18.90**

Model 213P (In wood carrying case) . . . **\$32.25 Wired**

Model 213 P Kit . . . **\$21.90**

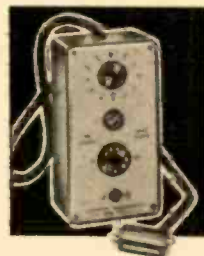

**EMC NEW MODEL SA  
SOCKET ADAPTOR . . .**  
Enables user to check 12 pin Compactron, Nuvistor, Novar and 10 pin tubes with any type tube tester including mutual conductance type.

Model SA . . . **\$9.45 Wired**

Model SA Kit . . . **\$4.95**

Yes, tell me more, send me **FREE** a detailed catalog of the Complete EMC Line. EL-9

NAME .....

STREET .....

CITY .....

STATE .....

**EMC** Electronic Measurements Corp.  
625 B'way, New York 12, N. Y.  
Ex. Dept., Pan-Mar Corp., 1270 B'way, New York 1, N. Y.

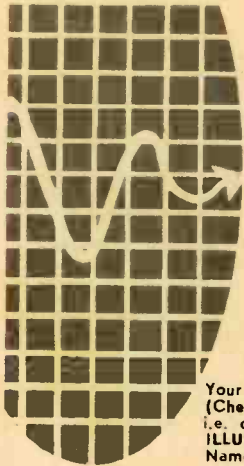

# ELECTRONICS ILLUSTRATED

## Classified Ads

Your advertisement can reach this mail-buying audience for only 50¢ per word . . . payable in advance (Check or M.O. please) . . . minimum 10 words. Closing dates are the 20th of 4th preceding month i.e. copy for the January issue must be in our office by September 20th. Mail to ELECTRONICS ILLUSTRATED, 67 West 44th St., New York 36, N. Y. Word count: Zone number free. Figure one word: Name of state (New Jersey), name of city (New York); sets of characters as in key (14-D); also abbreviations as 35MM, 8x10, D.C., A.C.

## SAVE MONEY • ORDER BY MAIL

### • • • FOR SALE

**EXCELLENT BUYS** on Tubes and equipment all listed in the "Green Sheet." Send .25¢ for your copy today. Cash paid for unused tubes. Write, Barry Electronics Corp., 512 Broadway, Dept. EI, NYC 12, NY.

**CONVERT ANY** television to sensitive, big screen oscilloscope. Only minor changes necessary. Plans \$1.95. Relco, Box 10563, Houston 18, Texas.

**FREE LIST.** Do-it-yourself circuits for building many economical miniaturized shop equipment items. Voice relays, signal generators, etc. Send, stamped addressed envelope, Dept-2E, 11500 NW 7th Ave., Miami 50, Florida.

**CB-QSL-SWL CARDS.** Samples 10¢. Include your personal picture on cards. No extra Cost. Signal, Adams County, Manchester, Ohio.

**GOVERNMENT SURPLUS.** How and Where to Buy in Your Area. Send \$1.00. E.I. Surplus Information, Headquarters Bldg., Washington 6, D. C.

**COMMUNICATIONS, TELETYPE,** unusual surplus bargains. Free Flyer, MDC, 923 W. Schiller, Phila. 40.

**ELECTRONIC SURPLUS Catalog,** 5,000 items. Send 10¢. Bill Slep Co., Drawer 178EI, Ellenton, Fla.

### • • • PRINTING, MULTIGRAPHING, MIMEOGRAPHING

**FREE CATALOG** Salesbooks, Snapper Forms, Printed Business Forms. Box 1, Bronx 72, NY.

### • • • BUSINESS OPPORTUNITIES

**VENDING MACHINES**—No selling. Operate a route of coin machines and earn high profits. 32-page catalog free! Parkway Machine Corp., Dept. 33, 715 Ensor St., Baltimore 2, Md.

**SECOND INCOME** From Oil Can End Your Toil! Free Book And Oilfield Maps! National Petroleum, PanAmerican Building-EI, Miami 32, Florida.

### • • • BUILD-IT-YOURSELF

**PROFESSIONAL ELECTRONIC** Projects—Organs, Timers, Computers, etc.—\$1 each. List free, Parks, Box 1665, Lake City, Seattle 55, Wash.

### • • • EMPLOYMENT OPPORTUNITIES

**PRINTING - ADVERTISING SALESMEN.** Excellent moneymaking sideline selling Decalomania Name Plates. Advertising Specialties. Sign letters, Automobile initials. Free Samples. "Ralco"-EI, Box L, Boston 19, Mass.

### • • • EDUCATION & INSTRUCTION

**TAKE BACHELOR'S** and Master's Degree correspondence courses from leading universities! Directory of 6,000 courses—\$2.00. College Research, North Highlands 4, California.

### • • • TAPE RECORDERS

**LEARN WHILE Asleep** with your recorder, phonograph or amazing new "Electronic Educator" endless tape recorder. Details free. Sleep-Learning Research Association, Box 24-EI, Olympia, Washington.

**HOBBIES GLOBAL** Tape Recording Exchange Hobby Club for all ages. Free Details. Write Mailway Co., 216 W. Jackson Blvd., Chicago 6, Illinois.

**TAPE RECORDERS Hi-Fi** Components. Sleep Learning Equipment, tapes. Unusual values. Free Catalog. Dressner, 1523Z Jericho Tpke., New Hyde Park, N. Y.

**RENT STEREO** Tapes—over 2500 different—all major labels—free catalog. Stereo-Parti, 811-AY Centinela Ave., Inglewood 3, California.

**SALE ITEMS**—Tapes—Recorders—Component Quotations. Bayla, Box 131E, Wantagh, N. Y.

### • • • RADIO & TV

**BEFORE YOU** Buy Receiving Tubes or Hi-Fi Components send now for your giant Free Zalytron current catalog—featuring nationally known Zalytron First Quality TV-Radio Tubes, Hi-Fi Stereo Systems, Kits Parts, etc. All priced to Save You Plenty—Why Pay More? Zalytron Tube Corp., 220-L West 42nd St., N.Y.C.

**FREE CONFIDENTIAL** electronic parts catalog—unbeatable prices. Knapp's, 3174-8th Ave. SW, Largo, Florida.

**DIAGRAMS**—FOR T.V. \$2., Radio \$1. Hieft Diagrams, Box 816, Laredo, Tex.

**DIAGRAMS FOR** Repairing Radios \$1.00, Television \$2.00. Give make, model. Diagram Service, Box 672EI, Hartford 1, Conn.

**SMALL SET** Builder's big information catalog with experiments—25¢, refundable. Laboratories, 1131-K Valota, Redwood City, California.

**DIAGRAMS: TV** \$1.25, Radio \$50. Baker Diagrams, 129 Cooper, Santa Ana, Calif.

### • • • ELECTRICAL SUPPLIES & EQUIPMENT

**GARAGE DOOR** Operator Kits—Edwards famous KR-50 kit. Easily assembled and installed. Available with or without remote car control. Thousands sold. Priced from \$59.95. Write for literature. Edward T. Fink Co., Inc., 284 Nepperhan Ave., Yonkers, N. Y., Dept. EI.

### • • • DETECTIVES

**DETECTIVE PROFESSION.** Easy home study plan. Lapel pin, certificate, future. Free information. Professional Investigators, Box 41197-CC, Los Angeles 41, Calif.

### • • • MUSIC

**PIANO TECHNIC** made easy, \$1.25. Walter Kazaks, 234 East 58th Street, New York 22.

### • • • PERSONAL

**INDEPENDENT THINKERS**—investigate Humanism! Free literature. American Humanist Association, Dept. EI, Yellow Springs, Ohio.

### • • • MISCELLANEOUS

**"HOMEBREW GUIDE"** Complete Illustrated Instruction Manual, \$1.00. Supply Catalog Included. CalBrew Supplies, Box 1005-A5, Seaside, California.

**"HOMEBREWING! . . . Beers . . . Wines."** Instruction Manual \$1 (guaranteed!). Crystal's, 28-BE14, Millburn, New Jersey.

**HYPNOTIZE UNNOTICED,** quickly, effortlessly, or refund! Thousands satisfied! \$2. Getro, Box 244, Cedarburg, Wisconsin.

**FREE COPIES** newspaper "Tax Land Sales." Grant Allen, 210E Fifth Ave., New York, N. Y.



## Beginner's Page

Continued from page 51

identical, but have directions. If the dark end of the compass needle (the north-seeking pole) is attracted to the bolt, that end of the bolt is the north pole. The opposite end is the south pole. (Remember the north pole position.)

If you reverse the battery connections you demonstrate what determines the pole positions of an electromagnet. It's the direction of current flow. All the results described above will reverse if the batteries are reversed.

A basic law of magnetism says like poles repel and unlike poles attract. If the north poles of two magnets were placed near each other, their magnetic fields would push them apart. The compass and electromagnet can illustrate this. It makes no difference that compass and electromagnet rely on different sources for their magnetism. The compass needle is simply a piece of *ferrous* (contains iron) metal that was magnetized in a strong magnetic field. It has the ability to store its acquired magnetism. The electromagnet has a core of soft iron (the bolt) which must have a flow of current to form its poles. Unlike the compass, the bolt loses most of its magnetism when current flow stops. It has low *retentivity*.

To experiment with attraction and repulsion, we'll take a closer look at the compass. You'll recall that the dark end of the needle was called a north-seeking pole because it always points to the magnetic north pole of the earth. But here we'll call it by its right name—a *south pole*. Sounds confusing at first but a little thought will tell you that it must be a south pole to point north (unlike poles attract). The term *north-seeking* is a matter of convenience when you're reading a compass for direction.

You can prove this point by placing the dark end of the compass needle near the south pole of the electromagnet (determined earlier). The needle will swing away. This is a case of two like poles repelling (both are south). The needle will continue to swing until the light end points to the electromagnet's

south pole. This end of the needle is a north magnetic pole and thus attracted by the south pole of the electromagnet.

The practical use of these principles? No electric motor could operate without magnetic attraction and repulsion.

Another area for experimentation with an electromagnet is *induction*. Not only can we demonstrate that a current flow produces magnetism, but we can show that a magnetic field can cause current flow in a coil if we add the meter and pickup coil to the previous setup.

If your meter has a zero-adjustment screw, turn the screw so the needle moves up the scale as far as it can go. This permits the needle to move right or left as current goes through. Connect the pickup coil to the meter and turn on the magnet. Now hold the pickup coil about two inches above the magnet and lower it quickly halfway down the body of the electromagnet. Do this a few times and watch what happens to the meter. The needle flicks to indicate a brief flow of current. Notice that the current is in one direction when you lower the pickup coil. When you start with the coil at the center and lift it the meter flicks in the opposite direction.

This demonstrates several aspects of induction. The magnetic field's *cutting* across the pickup coil sets up a current within the coil. (This is basically the operation of an electric generator.) Also, the direction of current flow, as indicated by the meter, depends on the direction of cutting.

Speed of cutting is another factor. Notice that if the pickup coil is moved slowly over the electromagnet, the amount of current generated is small. Place the pickup coil at about the center of the electromagnet and check what happens when you turn the electromagnet on and off. Note which direction the meter needle goes as you make and break contact. In this case the *magnetic field* is moving instead of the coil. The field builds up and collapses as you turn the electromagnet on and off.

If you'd like to make some discoveries on your own, try changing the size of the pickup coil and vary the distance of the compass from the electromagnet.

—Len Buckwalter —

# RAD-TEL



## WHY PAY MORE!

### RAD-TEL'S QUALITY BRAND NEW TUBES 1 YEAR GUARANTEE

TUBES FOR TV, RADIO, AND HI-FI

UP TO **75% OFF\***

**1-DAY  
SERVICE**



**OVER 500  
TYPES IN  
STOCK**

\*Manufacturers Suggested List Price

**FREE!** Send For New Tube & Parts Catalog & Trouble Shooting Guide

**CAM-DWELL DISTRIBUTOR POINT INDICATOR**  
FOR CARS, TRUCKS, ENGINES, ETC.



No. A2.....\$3.95

Now, anyone can set distributor points. It's done electronically and automatically. No other equipment needed, no outlet. You don't have to remove the distributor. Pocket-sized, precision-engineered, high quality testing instrument for use on cars, trucks, marine engines, industrial equipment, tractors, farm machinery and road equipment. It's accurate... It's portable... It's LOW priced!



**RAD-TEL TUBE CO.** TV, RADIO AND HI-FI

55 CHAMBERS STREET, NEWARK 5, NEW JERSEY

TERMS: 25% deposit must accompany all orders, balance COD. Orders under \$5: add \$1 handling charge plus postage. Orders over \$5: plus postage. Approx. 8 tubes per 1 lb. Subject to prior sale. No. COD's outside continental USA.

**EACH TUBE INDIVIDUALLY & ATTRACTIVELY  
BOXED & BRANDED RAD-TEL**

Qty. Type	Price	Qty. Type	Price	Qty. Type	Price	Qty. Type	Price
074	.79	6AU4	.82	6J6	.67	12CX6	.54
1AX2	.62	6AU6	.52	6K6	.63	12D4*	.69
1B3	.79	6AU7	.61	6C6	1.06	12DB5	.69
10N5	.55	6AU8	.87	6N7	.98	12DE8	.75
163	.79	6AV6	.41	6S4	.51	12DL8	.85
1J3	.79	6AW8	.90	6SA7GT	.76	12DQ6	1.04
1K3	.79	6AX4	.66	6S7GT	.41	12DS7	.79
1R5	.62	6AX5	.74	6SH7GT	.49	12DT5	.76
1S4	.59	6AX7	.64	6S17	.88	12DT7	.79
1S5	.51	6AX8	.92	6SK7GT	.74	12DT8	.79
1T4	.58	6BA6	.50	6SL7GT	.80	12DU7	1.01
1U4	.57	6BA8	.88	6SN7GT	.65	12DW8	.89
1U5	.50	6BC5	.61	6SQ7	.73	12DZ6	.56
1X2B	.82	6BC7	.94	6T4	.99	12E05	.69
2AF4	.96	6BC8	.97	6T8	.85	12EG6	.54
2BN4	.64	6BD5	1.25	6U8	.83	12EK6	.56
2EN5	.45	6BE6	.55	6V6GT	.54	12EL6	.50
3AL5	.42	6BF5	.90	6W4	.60	12EM6	.79
3AU6	.51	6BF6	.44	6W6	.71	12EN6	.78
3AV6	.41	6BG6	1.66	6X4	.39	12EZ6	.53
3B46	.51	6BH6	.65	6X5GT	.53	12F8	.66
3BC5	.54	6BH8	.87	6X8	.80	12FA6	.79
3BE6	.52	6BI6	.62	7A8	.68	12FM6	.43
3BN6	.76	6BJ7	.79	7AU7	.61	12FR8	.91
3BU8	.78	6BK7	.85	7B6	.69	12FX8	.85
3BY6	.55	6BL7	1.00	7EY8	.73	12GC6	1.06
3BZ5	.55	6BN4	.57	7F8	.90	12G8	.84
3CB6	.54	6BN6	.74	7N7	.90	12K5	.65
3CS6	.52	6BO6	1.05	7S7	1.01	12L6	.58
3DG4	.85	6BQ7	1.00	7Y4	.69	12SA7	.92
3DK6	.60	6BS8	.90	8AU8	.83	12SF7	.69
3DT6	.50	6BU8	.70	8AW8	.93	12SH7	.49
3Q4	.63	6BX7	1.02	8BQ5	.60	12SJ7	.67
3Q5	.80	6BY5	1.15	8CG7	.62	12SK7	.74

**RAD-TEL TUBE CO. NOT AFFILIATED WITH ANY  
OTHER MAIL ORDER TUBE COMPANY**

3S4	.61	6BY6	.54	9CM7	.68	12SL7	.80
3V4	.58	6BY8	.66	8C7	.97	12SM7	.67
4BQ7	1.01	6BZ6	.55	8C57	.74	12SQ7	.78
4BZ7	.96	6BZ7	1.01	8CX8	.93	12U7	.62
4BZ8	1.10	6BZ8	1.09	8E88	.94	12V6	.53
4CS6	.61	6C4	.43	8N7	.66	12W6	.69
4DT6	.55	6CB6	.55	9CL8	.79	12X4	.38
5AM8	.79	6CD6	1.42	11CY7	.75	17AX4	.67
5AN8	.86	6CE5	.57	12A4	.60	17BQ6	1.09
5AQ5	.52	6CF6	.64	12A85	.55	17DQ6	1.06
5AS8	.86	6CG7	.61	12AC6	.49	17W6	.70
5AT8	.80	6CG8	.77	12AD6	.57	18FW6	.49
5AV8	1.01	6CK4	.70	12AE6	.43	18FY6	.50
5BC8	.79	6CL8	.79	12AF7	.94	18FX6	.53
5BE8	.83	6CM6	.64	12AF3	.73	19AU4	.83
5BK7	.82	6CM7	.66	12AF6	.49	19BG6	1.39
5BQ7	.97	6CM8	.90	12AJ6	.46	19C8	1.14
5BR8	.79	6CN7	.65	12AL5	.45	19T8	.80
5BT8	.83	6CQ8	.84	12AL8	.95	21EX6	1.49
5CG8	.76	6CR6	.51	12AQ5	.60	25AV5	.83
5CL8	.76	6CS6	.57	12AT6	.43	25AX4	.70
5CM8	.90	6CS7	.69	12AT7	.76	25BK5	.91
5CQ8	.84	6CU5	.58	12AU6	.51	25BQ6	1.11
5CZ5	.72	6CU6	1.08	12AU7	.60	25C5	.53
5EA8	.80	6CV5	.70	12AV6	.41	25CA5	.59
5EU8	.80	6CV7	.71	12AV7	.75	25CD6	1.44
5J6	.68	6DA4	.68	12AX4	.67	25CU6	1.11
5T8	.81	6DB5	.69	12AX7	.63	25DN6	1.42
5U4	.60	6DB6	.51	12AY7	1.44	25E5	.55
5U8	.81	6DE6	.58	12AZ7	.86	25L6	.57
5V3	.90	6DGG	.59	12BA	.63	25W4	.68
5V6	.56	6DK6	.59	12BA7	.84	32ET5	.55
5X8	.78	6DN6	1.55	12BD6	.50	32L7	.90
5Y3	.46	6DQ6	1.10	12BE6	.53	35B5	.60
6AB6	1.20	6DT6	.53	12BF6	.44	35C5	.51
6AB4	.46	6DT8	.79	12BH7	.77	35L6	.57
6AC7	.96	6EA8	.79	12BK5	1.00	35W4	.42
6AF3	.73	6EB5	.72	12BL6	.56	35Z5	.60
6AF4	.97	6EB8	.94	12BQ6	1.06	36AM3	.36
6AG5	.88	6EM5	.76	12BR7	.74	50B5	.60
6AH4	.81	6EM7	.82	12BV7	.78	50C5	.53
6AH6	.99	6EUB	.79	12BY7	.77	50EH5	.55
6AK5	.95	6EW6	.57	12BZ7	.75	50L6	.61
6AL5	.47	6EY6	.75	12C5	.56	70L7	.97
6AM8	.78	6F5GT	.39	12C55	.56	70Z5	.69
6AQ5	.53	6FB7	.75	12CR6	.54	807	.70
6AR5	.55	6GG8	.80	12CU5	.58	117Z3	.81
6AS5	.60	6GG6	.79	12CV6	1.06		
6AS6	.80	6GN8	.94				
6AT6	.43	6H6	.58				
6AT8	.79	6J5GT	.51				

**BIG SAVINGS ON PARTS  
IN CATALOG**



# LAFAYETTE

# RADIO ELECTRONICS

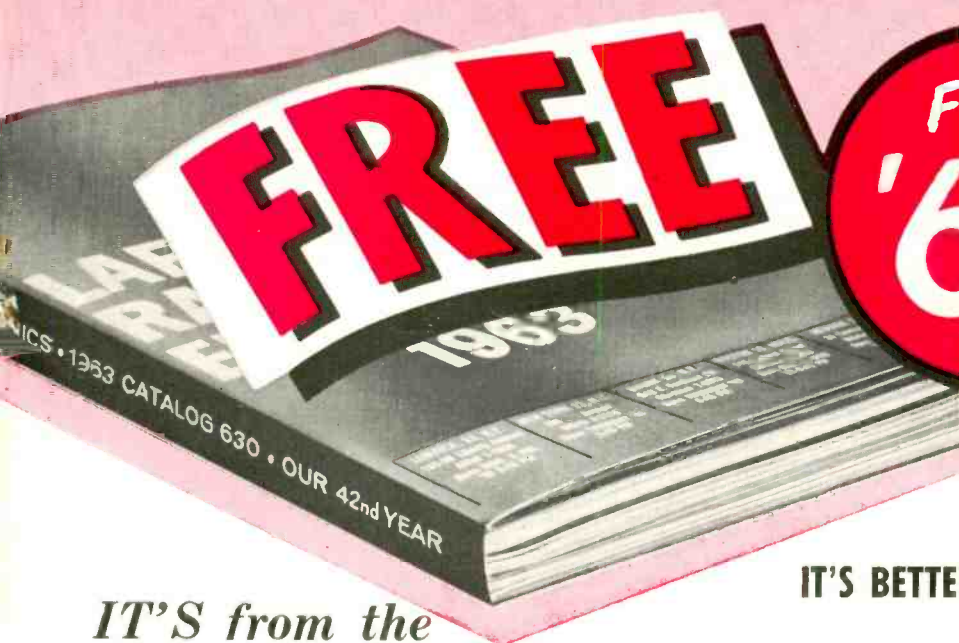

**IT'S NEW  
IT'S BIGGER  
IT'S BETTER THAN EVER**

*IT'S from the*

**"WORLD'S HI-FI & ELECTRONICS SHOPPING CENTER"**

Here it is . . . the exciting, all-new 1963 Lafayette catalog. 388 giant-sized pages . . . fully illustrated . . . over 50,000 different items . . . 2,000 different manufacturers . . . a complete selection for the Audiophile, Experimenter, Hobbyist, Technician, Engineer, Student, Dealer.

### CHECK THESE OUTSTANDING LAFAYETTE BENEFITS

**SATISFACTION GUARANTEED OR MONEY REFUNDED.** Buy it, try it at home with Lafayette's 30-day Free Home Trial. If not completely satisfied, the full purchase price will be refunded.



**NEW EASY PAY PLAN.** No money down, up to 24 months to pay.

**24 HOUR SERVICE.** Most orders fully processed within 24 hours after receipt.



**LARGEST STOCK SELECTION.** If it's in Electronics or Hi-Fi, it's in the Lafayette catalog—Citizens Band, Radio & TV Parts, Ham and Amateur Equipment, Test Equipment, P.A. Systems, Tape Recorders, and more.



**SPECIAL HI-FI SYSTEM PRICES.** Select a hi-fi music system and get Lafayette's special money-saving price.



**NEW LOWEST PRICES.** You always save more with Lafayette's low, low prices.

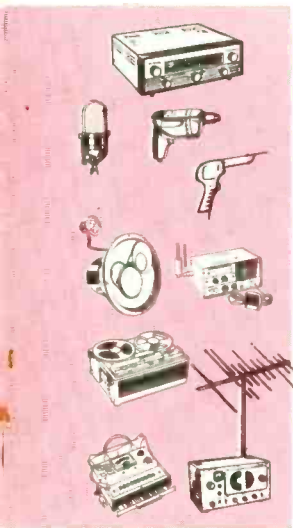

**MAIL THE COUPON TODAY FOR YOUR FREE 1963 LAFAYETTE ELECTRONICS CATALOG 630**

**LAFAYETTE RADIO  
MAIL ORDER & SALES CENTER**



**111 JERICO TURNPIKE  
SYOSSET, LONG ISLAND, NEW YORK**

**OTHER LOCATIONS**

JAMAICA, N. Y.  
NEW YORK, N. Y.  
BRONX, N. Y.

NEWARK, N. J.  
PLAINFIELD, N. J.  
PARAMUS, N. J.

BOSTON, MASS.

LAFAYETTE RADIO, DEPT. E112-2  
P. O. Box 10  
SYOSSET, L. I., N. Y.

Rush my FREE Lafayette 1963-Catalog 630

Name

Address

City  Zone  State



GET AMERICAN BASIC SCIENCE CLUB'S  
**New, Revised ELECTRONICS LAB**  
 All the Equipment for 65 Exciting Projects

plus a **BASIC RADIO COURSE** for only **\$17.80**

Available in One Complete Shipment or  
 Divided into 4 Monthly Kits as Shown

**TROUBLE SHOOTING WITH THE SIGNAL TRACER**

**YOU GET A VALUABLE  
 ELECTRONICS LAB**

Containing parts by RCA, MALLORY, PYRAMID,  
 GE, CENTRALAB, STACKPOLE, TRIM and other  
 reliable manufacturers. Retail value of parts  
 alone is **MORE THAN 25 DOLLARS**

**PLUS A COMPLETE  
 ELECTRONICS COURSE**

You REALLY LEARN ELECTRONICS. The  
 progressive "learn by doing" American  
 Basic Science Club system is the  
easiest, most thorough and most excit-  
ing way to a solid background in  
 electronics. Basic enough for beginners  
 ... rewarding enough for experts.  
 Nowhere else is a course of this scope  
 available at this **LOW PRICE!**

**ENTHUSIASTIC MEMBERS WRITE:**

"basic principles unforgettably  
 learned" . . .

It is only after having completed the experi-  
 ments in your kits that I can say I have truly  
 and unforgettably learned the basic principles  
 of electronics. JOHN R. KANIA, 2 Berkeley  
 Ave., Yonkers 5, N. Y.

"your kits are interesting and  
 rewarding" . . .

I am an electronics student in the Air Force  
 and find your kits interesting and rewarding.  
 We have not covered anything in the school  
 that you have not covered in the kits. JOHN  
 G. DILL, Keesler Air Force Base, Biloxi,  
 Miss.

"far ahead of friend taking  
 another course" . . .

A friend of mine is taking a correspondence  
 course in electronics, and I have learned more  
 from your first two kits than he has in  
 twenty lessons. RAY P. BILODEAU, 139  
 Exchange St., Leominster, Mass.

"the number of concepts presented  
 is amazing" . . .

Your kits offer a range of experiments  
 usually performed only in the better high  
 school and college laboratories. The number  
 of concepts presented, and the clarity and  
 concreteness of their development is amazing.  
 R. M. HELM, Professor of Physics, East  
 Carolina College, Greenville, N. C.

**KIT 1 — DC AND AC CIRCUITS**

Equip. for 26 Projects Including:  
 • Electroscopes • Electro Magnet  
 • Galvanometer • AC Buzzer •  
 Demagnetizer • Relay • Solenoid  
 Coin Tossing • Safety AC Power  
 Supply with Isolation Transformer

Subjects Covered Include:  
 • Magnetic Fields • Electron  
 Theory • Electric Charge • Direct  
 Current • Electro-Chemistry •  
 Alternating Current • Inductance  
 • Transformer Principles

**FREE with kit 1 — Surprise "Mystery Box"**

**KIT 2 — RESISTANCE, CAPACITANCE AND RECTIFICATION**

Equip. for 18 Projects Including:  
 • Strobe Light • Thermocouple  
 • Wheatstone Bridge • Voltmeter  
 • AC Rectifier • DC Power Supply

Subjects Covered Include:  
 • Ohm's Law • Power Formulas  
 • Rectification • Resistance •  
 Neon Glow Tubes • Capacitance  
 • Filter Circuits

**FREE with kit 2 — Electric Soldering Iron**

**KIT 3 — AMPLIFIERS AND OSCILLATORS**

Equip. for 14 Projects Including:  
 • Two Stage Amplifier • Capa-  
 citance Burglar Alarm • Prox-  
 imity Detector • High Speed Strobe  
 Light • Ripple Tank Wave Gen-  
 erator • Code Practice Oscillator

Subjects Covered Include:  
 • Vacuum Amplifier Tubes • Volt-  
 age Amplification • Oscillator  
 Circuits • Frequency and Wave  
 Length Sound Waves, Pitch and  
 Resonance

**FREE with kit 3 — "Steps to a Ham License" Manual**

**KIT 4 — AUDIO AMPLIFICATION AND RADIO**

Equip. for 7 Projects Including:  
 • Microphone and Audio Amplifier  
 • Broadcast Radio • Short Wave  
 Radio • Signal Tracer • Con-  
 tinuity Tester • Transmitter

Subjects Covered Include:  
 • Audio Amplifiers • Amplitude  
 Modulation • Radio Theory •  
 Regenerative Circuits • Tuning  
 Circuits

**FREE with kit 4 — Radio-TV Service Manual**

**ALL FOUR KITS IN ONE SHIPMENT ONLY \$17.80**  
 POSTPAID

**OR—YOU CAN GET THE FOUR KITS, ONE A MONTH**

SEND **\$2.00** WITH **PAY \$3.95** PLUS COD POSTAGE  
 ONLY COUPON ONLY ON RECEIPT OF EACH KIT

**ALL SHIPMENTS ON 10 DAY APPROVAL.  
 YOUR SATISFACTION OR YOUR MONEY BACK.**

**WE KNOW YOU WILL BE AMAZED AND DELIGHTED.**

USE THIS "NO RISK" COUPON FOR EITHER PAID IN FULL OR MONTHLY PLAN

—AMERICAN BASIC SCIENCE CLUB, Inc., 501 E. Crockett, San Antonio 6, Texas—

Send me ABSClub's Electronics Lab in four kits — one a month. I enclose \$2.00 and will pay \$3.95 plus COD Postage on arrival of each kit. I understand that all kits will be on 10 day approval with full refund guaranteed and also that I may cancel unshipped kits at any time.

Send me ABSClub's Electronics Lab (all four kits) in one shipment. I enclose \$17.80 full payment, postage paid to me. I understand that this will be on a 10 day approval with full refund guaranteed.

NAME .....

ADDRESS .....

CITY AND STATE .....