

**WHAT IS ELECTRICITY?**  
**\$100 CASH FOR THE BEST ANSWERS!** See page 35

# **ELECTRONICS ILLUSTRATED**

By the Publishers of **MECHANIX ILLUSTRATED**

JULY • 35¢



**OUR AMAZING  
NEW ROBOTS**

**BUILD AN FM TUNER**

404171 106 80 12 562  
ROBERT W HOOD  
1327 HEADWAYLEN DR  
MIAMI SBURG OHIO



# Training Kits at a Charge

*practical*—based on  
**ING** methods. Be-  
 tted lessons designed  
 or men without pre-  
 e—you get special  
 ive actual practice,  
 he things you study.  
 o keep without extra  
 e, you get all parts,  
 ture tube, to build  
 vacuum tube volt-  
 e. Read course de-  
 -PAGE CATALOG.  
 today.

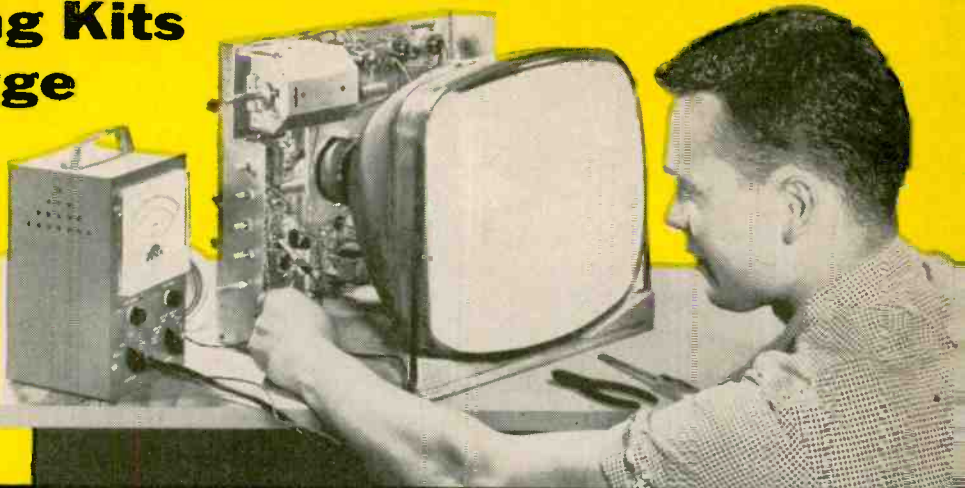

# START AND A BRIGHT FUTURE IN ELECTRONICS Radio Television IN YOUR SPARE TIME

## Fast Growing Field of Electronics Needs More Trained Technicians

New developments are creating more and more job opportunities for men with Electronics training, and these are better than average jobs. Take NRI training at home in your spare time. Hold your present job while training. Prepare now for a brighter future.

## Added Income in Spare Time Starting Soon

Soon after enrolling we show you how to earn extra money in spare time, repairing sets. Many use this extra money to pay for their NRI course, or buy things they normally couldn't afford. Some have found better paying jobs within a year. Others have started their own businesses.

## Train With the Leader—Get Started Fast

NRI is the oldest and largest school of its kind. For 45 years, NRI has featured the best training for beginners—for men without previous experience. Mail postage-free card for 64-page Catalog. Read success stories. See equipment you get. Find out about 60-day trial enrollment offer.

Convenient monthly terms. **ACT NOW.**

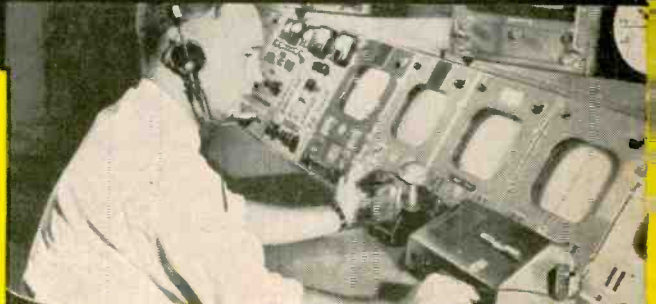

NRI Graduates help build, install, operate and service electronic equipment for the "Space Age" we live in—equipment used in offices, factories, the military. Others are inspectors, laboratory technicians, etc., or work with the Government and Armed Forces.



From Radio-TV Servicing and Broadcasting to missiles, NRI graduates share in the gigantic Electronics industry. Interesting jobs await you in studios, on ships and planes, in your own Radio-TV business. Mail coupon today.

**MAIL  
 CARD  
 NOW**

OLDEST & LARGEST HOME STUDY RADIO-TV SCHOOL  
**National Radio Institute**  
 WASHINGTON 16, D.C. ESTABLISHED 1914

## NRI PREPARES YOU FOR JOBS LIKE THESE

- Electronic Technician • Service Technician • Assistant Engineer
- Cameraman • Civil Service Specialist • Computer Technician
- Computer Programmer • Designer • Field Technician • Field Maintenance Man
- Plant Parts Inspector • Instrument Technician • Laboratory Technician
- Radio Operator • Transmitter Engineer • Airlines Technician



# LEARN *Electronics* FAST and RIGHT!

... at sensible prices!



*The most important training of all!*

## COMPLETE BASIC ELECTRONIC TRAINING

... written so you can really understand it!

### LEARN STEP BY STEP!

These two big, down-to-earth manuals help you train for a well paid career in ANY phase of Television-Radio, communications, hi-fi, industrial electronics, etc.—at only a small fraction of what you might expect to pay for such clear, complete training.

First, the 396-page **BASIC ELECTRICITY** Manual gives you a full working knowledge of the electrical theories, principles, components, instruments, measurements, etc. on which all Electronics is based. Then, the 389-page **BASIC ELECTRONICS** Manual teaches you just how these are applied in modern electronics.

Set-up diagrams, practical problem solutions, and over 700 pictures in the two manuals help make everything perfectly clear. Complicated electronic devices are vastly simplified by dividing them into 3 easily understandable groups. Nothing is omitted or condensed. Backed with this basic training you'll read technical articles, deal with circuits or equipment, and approach technical problems with a firm background of understanding. You'll be equipped with the **COMPLETE** basic training for many sorts of electrical-electronic specialization! 10-day Money-Back Guarantee. Either book \$6.25 separately or get both for only \$11.00!

**NOTE:** All 4 books are widely used in vocational schools and colleges — because of their remarkable completeness and clarity. They give you

the training you need — at far less than the price you'd pay if this same material were written in "lesson" form and sent to you as a "course."

## Complete training to help you REPAIR ANY TV or RADIO EVER MADE!

Let these two famous manuals teach you to handle all types of AM, FM, and TV service jobs by approved professional methods! Almost 1500 pages and over 800 clear pictures explain EVERY troubleshooting and repair procedure. No involved theory! You get straight-from-the-shoulder training that teaches you to do the best work in the shortest time. Each book is co-authored by A. A. Ghirardi whose electronic training guides have, for 25 years, been more widely used for military, school and home study training than any others of their type.



*Complete training for better TV-Radio service!*

**SAVE \$2.00!** Buy both of these giant service manuals for only \$17.00. See coupon.

**RADIO & TV RECEIVER CIRCUITRY & OPERATION**—This 669-page manual helps you repair TV's, radios and other electronic equipment easier, faster and better by familiarizing you fully with their circuits and how and why each one functions. First it gives you a complete understanding of modern circuits. Then it shows what troubles to look for and how to eliminate useless testing and guesswork in servicing them. It's the kind of training that fits you for the best-paid jobs! Price \$9.00 separately.

**RADIO & TV RECEIVER TROUBLESHOOTING & REPAIR**—This giant 822-page guide to professional methods with its 417 clear illustrations is a complete, clearly understandable course in locating all kinds of TV and radio troubles fast and fixing them right. Ideal for beginners. Helps experienced servicemen develop better methods and shortcuts or find fast answers to problems. Covers troubleshooting of all types. Step-by-step charts demonstrate what to look for and where. Big TV section covers all types of TV problems. Price \$10.00 separately.

## 10-DAY FREE EXAMINATION

Dept. PR-71, Technical Division  
Holt, Rinehart and Winston, Inc.,  
383 Madison Ave., New York 17, N. Y.

623900

Send following training manuals for 10-day FREE EXAMINATION. (U.S.A. customers only.) After 10 days, I will either remit price indicated (plus postage) or return books to you prepaid and owe nothing.

- BASIC ELECTRICITY**, Price \$6.25 No. 708859
- BASIC ELECTRONICS**, Price \$6.25 No. 708974
- MONEY-SAVING COMBINATION (1)**—Both of above Basic Training Books, \$11.00 for the two. (You save \$1.50) No. 709196
- Radio & TV CIRCUITRY AND OPERATION** (\$9.00) No. 708214
- Radio & TV TROUBLESHOOTING & REPAIR** (\$10.00) No. 708578
- MONEY-SAVING COMBINATION (2)**—Both of above Service Training Manuals for only \$17.00—you save \$2.00! No. 709006

**SAVE:** Send money with order and we pay postage. Same 10-day return privilege with money promptly refunded.

Name .....

Address .....

City, Zone, State .....

**OUTSIDE U.S.A.**—Add 50c to price of each book. Cash with order but 10-day return privilege with money refunded.

Above offers expire Feb. 28, 1962

# ELECTRONICS ILLUSTRATED

July, 1961

Vol. 4, No. 6

A Fawcett Publication

ROBERT G. BEASON ..... Editor  
 Larry Klein ..... Technical Editor  
 Robert D. Freed ..... Associate Editor  
 Murray Cooper ..... Art Editor  
 Lou Rubsamen ..... Art Associate  
 Elaine E. Sapoff, Editorial Assistant

In This Issue:

## Extra!

EI's Easy Cash Contest ..... 35

## Special Section: Summer Projects

Electronic Fish Lure ..... Forrest H. Frantz, Sr. 41  
 Flashing Electronic Taillight ..... Jack Allison 44  
 Camper Power Pack ..... Donald L. Stoner, W6TNS 46  
 Low-Cost Base Insulator ..... Howard S. Pyle, W7OE 49  
 Electronic Insect Killer ..... Harvey Pollack 50  
 Automobile Temperature Gauge ..... Harry Kolbe 53  
 Transistorized Fence Charger ..... C. Turner and J. Eimbinder 56  
 Step-Saver Appliance Alarm ..... Paul Harvey 59  
 Tag-Along Ham Rig ..... Howard S. Pyle 62

## By-Line Features

Ferrites: Mighty Midgets of Electronics ..... Ken Gilmore 36  
 Take Care of Your Tape ..... Norman Eisenberg 65  
 CB to Ham ..... Robert Hertzberg, W2DJJ 71  
 Our Amazing Robots ..... Lloyd Mallan 76  
 America's Own Marconi ..... Martha K. Gunther, W9HIX 89  
 How to DX Satellites ..... C. M. Stanbury II 94

## EI Projects

Build an FM Tuner for Your Car ..... Len Buckwalter, K10DH 29  
 TV Patterner ..... John Potter Shields 68  
 Commercial Killer ..... Virgil L. Parker 80

## EI Kit Report

EICO Transistor Radio ..... 85

## Short Features

They Said It Could Be Done! ..... 87  
 EE Topics ..... 96

## Departments

Feedback From Our Readers ..... 4  
 Electronics in the News ..... 12  
 Electronic Marketplace ..... 16  
 Good Reading ..... 40  
 Hi-Fi Doctor and Clinic ..... 74  
 Electronic Brain ..... 82  
 Ham Shack ..... 84

Ralph Dalsh ..... Editorial Director  
 James Boynton ..... Advertising Director  
 Al Allard ..... Art Director  
 Ralph Mattison ..... Associate Art Director  
 George H. Carl ..... Production Director  
 Larry Elisinger ..... Editor-in-Chief  
 Phyllis Bendremer ..... Production Editor  
 Benita Rockwood ..... Asst. Production Editor  
 John F. Webster ..... Advertising Manager

ELECTRONICS ILLUSTRATED is published bi-monthly by Fawcett Publications, Inc., Fawcett Place, Greenwich, Conn. W. H. Fawcett, Jr., President; Gordon Fawcett, Secretary and Treasurer; Roger Fawcett, General Manager; Roscoe K. Fawcett, Circulation Director; Donald P. Hanson, Assistant General Manager.

EDITORIAL AND ADVERTISING OFFICES: 67 West 44th Street, New York 36, N. Y.  
 ADDRESS ALL MAIL: Subscriptions, change of address, Form 3579 to Subscription Dept., Fawcett Bldg., Greenwich, Conn.; and all editorial and advertising to Fawcett Publications, Inc., 67 W. 44th St., New York 36, N. Y.

Second-class postage paid at Greenwich, Conn., and at additional mailing offices.  
 Subscription price \$4.00 for 12 issues in the U. S. and possessions and Canada. All other countries \$6.00 for 12 issues. Foreign subscriptions and sales should be remitted by International Money Order in U. S. funds payable at Greenwich, Conn.

Printed in U.S.A. Copyright 1961 by Fawcett Publications, Inc.  
 Permission hereby granted to quote from this issue of this magazine on radio or television provided a total of not more than 1,000 words is quoted and credit is given to the title of the magazine and issue, as well as the statement, copyright 1961, by Fawcett Publications, Inc.

Member of: Audit Bureau of Circulations  Magazine Publishers Association, Inc. 





**Has shop in basement — gets  
"more and more work all along"**

**I** HAD PRACTICALLY no knowledge of any kind of repair work. One day I saw the ad of NRI in a magazine and thought it would be a good way to make money in my spare time. Now I am busy almost all my spare time and my day off—and have more and more repair work coming in all along. I have my shop in the basement of my home."

—JOHN D. PETTIS,  
172 N. Fulton, Bradley, Illinois

# IF YOU'VE BEEN WANTING TO START "A LITTLE BUSINESS OF YOUR OWN" IN YOUR BASEMENT OR GARAGE

## CHECK the advantages of NRI training in Servicing Electrical Appliances

- STEADY DEMAND** for your services. Over 400 million appliances in U.S. — 6 million sold last year alone — mean shortage of trained appliance service men.
- NO ELABORATE EQUIPMENT NEEDED** — just simple hand tools, and Appliance Tester which we provide at no extra charge.
- START SMALL — GROW BIG.** You can start out in your own basement or garage, in spare time. Gradually expand until you open your own shop.
- NO NEED TO RISK YOUR SAVINGS.** Many businesses require a sizable investment. But here you can build up a following of customers *first*, then open a full-time shop if you wish to.
- EARN \$3 TO \$5 PER HOUR.** Fixing appliances is a high-paying skill because the demand for trained men is so great.
- ENJOY SEMI-RETIREMENT ON A GOOD INCOME.** When you're ready to retire, you can devote a few hours a day to this work. Live and work anywhere you please.
- NO PREVIOUS EXPERIENCE OR TRAINING NEEDED.** We tell you and show you everything you need to know, in plain English and clear pictures.

**I**F YOU'RE like so many men today, you've been "hankering" to start "a little home business of your own." In spare time at first, then maybe full-time later on. Something you'd enjoy — and that pays well. Something that fills an existing need in your neighborhood or town — that "sells itself," without any high pressure arguments — that doesn't take a big investment or elaborate equipment.

*This is it—Servicing Electrical Appliances!* Now is the perfect time to get into it. Sales of electrical appliances have skyrocketed. Look how **YEARLY SALES** have risen since 1950: Coffee Makers — from 900,000 to 4,750,000. Room Air Conditioners—from 200,000 to 1,800,000. Clothes Dryers—from 318,000 to 1,425,000. Floor Polishers — from 240,000 to 1,090,000. No wonder that men who know how to service appliances properly are making \$3 to \$5 an hour—in spare time or full time!

**Your Skill Always in Demand  
— "Set Up Shop" Anywhere**

People need their appliances fixed in good times or bad. Once word gets around that you are trained to service them, you'll have plenty of work.

Your training costs less than 20¢ a day. And you need only the few basic tools you may already have — and an Appliance

Tester which we provide at no extra charge. You can work anywhere—in a corner of your basement or garage, even on the kitchen table. If you like, you can open up your own shop, have others work for you. And you can save money by fixing your own appliances.

**FREE BOOK  
and Sample Lesson**

Our 24-page Free Book tells how you can "cash in" on America's "Electrical Appliance Boom"—the money our students are making, what they say about us.

Free Sample Lesson shows how simple and clearly illustrated our instruction is—how it can quickly prepare you for a profitable future in this big field. Mail coupon, letter, or postcard to: *National Radio Institute, Dept. KG1, Washington 16, D.C.* (No obligation — and no salesman will call on you.)



**EARN WHILE YOU LEARN**

with this  
**APPLIANCE  
TESTER**  
— Yours  
at No Extra  
Charge



Your NRI Course comes *complete* with all the parts to assemble a sturdy, portable Appliance Tester that helps you earn while you learn. Easy-to-follow manual tells how to assemble and use the Tester *right away*. Locate faulty cords, short circuits, poor connections, etc. in a jiffy; find defects in house wiring; measure electricity used by appliances; many other uses.

With this Tester you save time and make money by doing jobs quicker, making sure appliances operate correctly after repairs.

**NATIONAL RADIO INSTITUTE**  
Dept. KG1, Washington 16, D.C.

Please send me Free Book about your Electrical Appliance Repair Course and a free Sample Lesson. I am particularly interested in:

- Spare Time Earnings     Business of My Own     Better Job  
I understand there is no obligation on my part; and no salesman will call.

Name .....

Address .....

City ..... Zone ..... State .....

Accredited Member National Home Study Council



# FEEDBACK From Our Readers

## ● Mystic Cult?

Why does the electronics industry insist on holding to a mystic level? Why does it insist on using jargon that is beyond sensibility?

I believe electronics would be easier taught and understood if the mysteries were dropped and more accurate words were used. Blocking capacitor, filter condenser are confusing.

Let's name the parts for what they are and leave it like that.

Henry Boyce  
San Leandro, Calif.

You've got a good idea, Hank. A simpler language of electronics would be a blessing. Unfortunately, electronics has become an extremely complicated subject and the language merely reflects this fact. Simplifying that language is going to be a little difficult. Any volunteers?

## ● Hot Plans?



In reference to your article in the January EI about a plasma torch, I would appreciate any information on construction that you can supply. I would like to use the plasma torch in a high school science fair.

Could this equipment cause a complaint from the FCC?

D.B.  
Memphis, Tenn.

The FCC might not complain, but the fire department probably wouldn't be too happy. Plasma torches involve temperatures a little higher than those generated by Bunsen burners (like several thousand degrees). They're just not for amateurs. An A-bomb might be safer.

## ● Electrifying Development

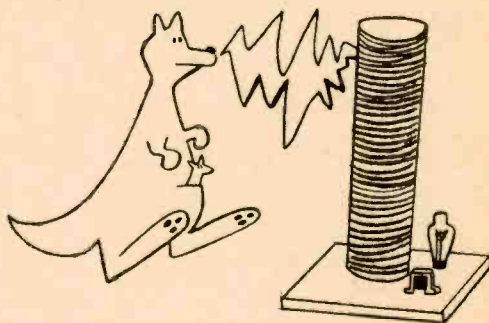

I have become interested in the work of Nikola Tesla ever since reading an article on his high-voltage coil in your fine publication (October '59 EI).

Since then I have constructed three progressively larger coils, the last having six-foot windings and nearly 5,000 turns. It discharges a beautiful 22-inch spark.

One receives the most unpleasant feeling when moving about as everything in the room throws a lusty spark when approached. A fluorescent tube held in the hand lights up at 30 feet.

W. R. Harris  
Christchurch,  
New Zealand

## ● Osteopathic Objection

Members of the American Osteopathic Association have asked us to write you regarding a reference in the



# Train in New Coyne Shop-Labs for Today's Top OPPORTUNITY FIELDS!

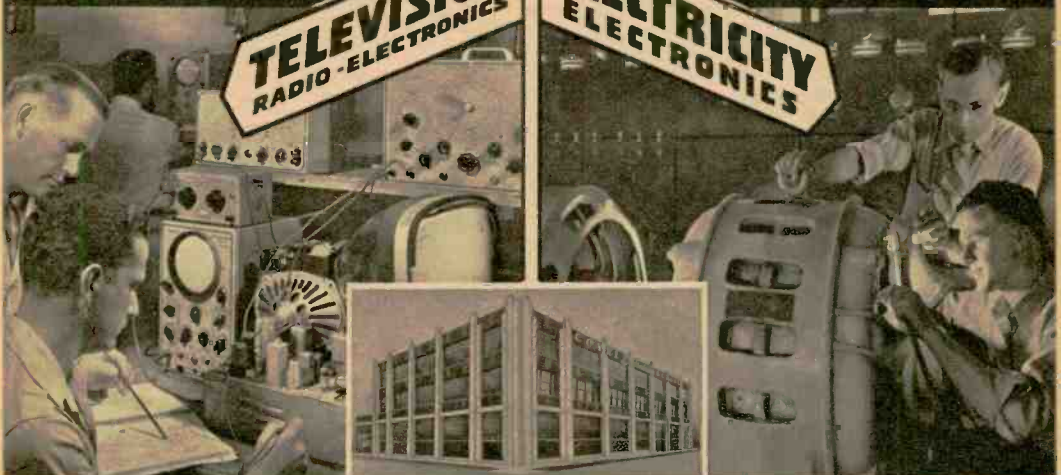

Instructor helping students check the wiring and trace the circuits of television receivers.

This modern fire-proof building which is occupied entirely by Coyne, houses the NEW COYNE SHOP-LABS.

Instructor explaining operation and testing of a large Motor Generator.

## TELEVISION-RADIO ELECTRONICS

Here at COYNE you're trained for Testing, Trouble-Shooting and Servicing on AM and FM Radio, Auto Radio, Television, Color TV, etc. Thousands of COYNE trained men in good jobs or own well paying TV-Radio businesses.

## ELECTRICITY ELECTRONICS

Big opportunities everywhere—city, town and country, in Power Plant Work, Motors, Industrial Electronics, Armature Winding, Home and Factory Wiring, Appliances, Refrigeration, Maintenance, Illumination, etc.

**OLDEST AND BEST  
EQUIPPED SCHOOL OF ITS  
KIND IN THE U. S.**

Send Coupon or Write for

## FREE BOOK

"GUIDE to CAREERS"  
Whether you prefer Electricity—Television—Radio or Combined Electronics Training this book describes all training offered.

Information comes by mail and no salesman will call.



To get Free Book and information, mail this Coupon in envelope or Paste on Postal Card, or write to address below.

## WE TRAIN YOU IN CHICAGO

Our famous Practical-Technical method gives you practical experience on a massive outlay of equipment—over a quarter of a million dollars worth—plus necessary technical training right here in the NEW COYNE Shop-Labs.

Training in Refrigeration and Electric Appliances can be included.

Training offered to **VETERANS** and **NON-VETS** alike

### START NOW—PAY LATER

Enroll now, pay most of tuition after Graduation. Part time employment help for students. Lifetime employment service to Graduates. Starting dates, every six weeks.

B. W. COOKE, JR., President

**COYNE**  
ELECTRICAL SCHOOL

FOUNDED 1899

CHARTERED AS AN EDUCATIONAL INSTITUTION NOT FOR PROFIT  
1501 W. Congress Parkway, CHICAGO, Dept. B1-8C

ELECTRICITY • RADIO • TELEVISION • REFRIGERATION • ELECTRONICS

COYNE ELECTRICAL SCHOOL, Dept. B1-8C  
1501 W. Congress Pkwy., Chicago 7, Ill.

At no obligation to me send FREE book "Guide to Careers" and details of all the training you offer. However, I am especially interested in:

ELECTRICITY  TELEVISION  BOTH FIELDS

Name \_\_\_\_\_

Address \_\_\_\_\_

City \_\_\_\_\_ State \_\_\_\_\_

(I understand no Salesman will call.)

July, 1961

# FEEDBACK

September '60 EI to "100 assorted chiropractors, osteopaths, naturopaths and auto mechanics."

This type of reference is not only derogatory and harmful to the osteopathic profession but also conveys the author's ignorance of the professional status and training of osteopathic physicians and surgeons. You . . . may not be fully aware of the complete service which osteopathic physicians and surgeons are rendering to 11 million patients in America.

L. E. Heffel

American Osteopathic Association  
Chicago, Ill.

*Our apologies to the osteopathic physicians and surgeons, and also to the chiropractors, naturopaths and auto mechanics. We seem to have assembled the wrong crowd.*

## ● Crystal Clear

As a subscriber to EI I am very pleased because in the January issue I found the answer to my prayers, plans for a Theremin. I built this item and to my amazement nothing happened. The article states that those who build them usually can't play them and vice versa, so it's pretty obvious that I'm musically inclined. Here is what I did that the author didn't:

I used a Halldorsen coil in place of the Miller coil. Article also said that the crystal may be surplus so I omitted it.

B.D.

Springville, Utah

*The word you're thinking of in connection with that crystal must be superfluous, which is exactly what the crystal is not. By surplus, we meant it may be obtained on the surplus market. Without it, the Theremin operates like a boat without a bottom. Also, this circuit is designed to use the Miller coil. If you want to use the Halldorsen, you'll have to redesign the whole thing.*

# MICRO

## ELECTRON TUBE

**INTRODUCES FOR THE FIRST TIME ANYWHERE A SELECT STOCK OF USED TUBES AT A FABULOUS LOW PRICE**

37
¢ ea.

\$35

PER HUNDRED ASSTD.

FOR any TUBE LISTED

Jan Surplus Tubes!

ALL TUBES SENT POSTAGE PAID

Please send 25¢ handling for orders under \$5. Send 25% deposit on C.O.D. orders. Send approximate postage on Canadian and foreign orders.

# MICRO

Dept. EI-7, P. O. Box 55 Park Sta., Paterson 3, N. J.

• Each and every tube is tested in our own laboratory for mutual conformance and life test.

• We guarantee FREE replacement for one year of any tube purchased from us which fails to function efficiently under any or all operating conditions. Prompt refunds are made on any defective merchandise.

• The advertised tubes are not necessarily new, but may be electrically perfect factory seconds or used tubes—each is clearly so marked.

0A2	6X8	6BM6	6SF6	7Z4	13BG6G
0Z6	6Y3GT	6B16	6B7	12A8	1916
1B3GT	5Y4Q	6B18	6B7	12AQ5	1918
1N4C	6A7	6B17	6B7	12AT5	2A4
1W9GT	6A8	6B17GT	6B17GT	12AT7	2A4V
1L4	6A8A	6B16	6B17GT	12AUG	25AV5
1L8	6A8C	6B16	6B17GT	6B17GT	25B06
1M8	6AF4	6B16	6B17GT	6B17GT	25B06
1W9GT	6AF4	6B16	6B17GT	6B17GT	25B06
1Q9GT	6A92	6B16	6B17GT	6B17GT	25B06
1R5	6A9T	6B16	6B17GT	6B17GT	25B06
1S5	6AN4GT	6B16	6B17GT	6B17GT	25B06
1Y6	6AN6	6B16	6B17GT	6B17GT	25B06
1U4	6AK5	6B16	6B17GT	6B17GT	25B06
1U8	6AL5	6B16	6B17GT	6B17GT	25B06
1V2	6AL7	6B16	6B17GT	6B17GT	25B06
1X2	6AN8	6B16	6B17GT	6B17GT	25B06
2A3	6A9S	6C76	6X4	12BA6	35A5
2AF4	6A9S	6C76	6X4	12BA7	35B5
3BC6	6A9S	6C76	6X4	12BA8	35C5
3B76	6A9S	6C76	6X4	12BA9	35D5
3BZ6	6A9S	6C76	6X4	12BA9GT	35E5
3C76	6A9S	6C76	6X4	12BA9GT	35F5
3C86	6A9S	6C76	6X4	12BA9GT	35G5
3C96	6A9S	6C76	6X4	12BA9GT	35H5
3L4	6A9S	6C76	6X4	12BA9GT	35I5
304	6A9S	6C76	6X4	12BA9GT	35J5
354	6A9S	6C76	6X4	12BA9GT	35K5
407A	6A9S	6C76	6X4	12BA9GT	35L5
4B7	6A9S	6C76	6X4	12BA9GT	35M5
5A5B	6A9S	6C76	6X4	12BA9GT	35N5
5AT4	6A9S	6C76	6X4	12BA9GT	35O5
5AV8	6A9S	6C76	6X4	12BA9GT	35P5
5AW4	6A9S	6C76	6X4	12BA9GT	35Q5
5B7	6A9S	6C76	6X4	12BA9GT	35R5
5J6	6A9S	6C76	6X4	12BA9GT	35S5
5T8	6A9S	6C76	6X4	12BA9GT	35T5
5U4G	6A9S	6C76	6X4	12BA9GT	35U5
5U6	6A9S	6C76	6X4	12BA9GT	35V5
5V4G	6A9S	6C76	6X4	12BA9GT	35W5
5V6GT	6A9S	6C76	6X4	12BA9GT	35X5
	6A9S	6C76	6X4	12BA9GT	35Y5
	6A9S	6C76	6X4	12BA9GT	35Z5
	6A9S	6C76	6X4	12BA9GT	35AA5
	6A9S	6C76	6X4	12BA9GT	35AB5
	6A9S	6C76	6X4	12BA9GT	35AC5
	6A9S	6C76	6X4	12BA9GT	35AD5
	6A9S	6C76	6X4	12BA9GT	35AE5
	6A9S	6C76	6X4	12BA9GT	35AF5
	6A9S	6C76	6X4	12BA9GT	35AG5
	6A9S	6C76	6X4	12BA9GT	35AH5
	6A9S	6C76	6X4	12BA9GT	35AI5
	6A9S	6C76	6X4	12BA9GT	35AJ5
	6A9S	6C76	6X4	12BA9GT	35AK5
	6A9S	6C76	6X4	12BA9GT	35AL5
	6A9S	6C76	6X4	12BA9GT	35AM5
	6A9S	6C76	6X4	12BA9GT	35AN5
	6A9S	6C76	6X4	12BA9GT	35AO5
	6A9S	6C76	6X4	12BA9GT	35AP5
	6A9S	6C76	6X4	12BA9GT	35AQ5
	6A9S	6C76	6X4	12BA9GT	35AR5
	6A9S	6C76	6X4	12BA9GT	35AS5
	6A9S	6C76	6X4	12BA9GT	35AT5
	6A9S	6C76	6X4	12BA9GT	35AU5
	6A9S	6C76	6X4	12BA9GT	35AV5
	6A9S	6C76	6X4	12BA9GT	35AW5
	6A9S	6C76	6X4	12BA9GT	35AX5
	6A9S	6C76	6X4	12BA9GT	35AY5
	6A9S	6C76	6X4	12BA9GT	35AZ5
	6A9S	6C76	6X4	12BA9GT	35BA5
	6A9S	6C76	6X4	12BA9GT	35BB5
	6A9S	6C76	6X4	12BA9GT	35BC5
	6A9S	6C76	6X4	12BA9GT	35BD5
	6A9S	6C76	6X4	12BA9GT	35BE5
	6A9S	6C76	6X4	12BA9GT	35BF5
	6A9S	6C76	6X4	12BA9GT	35BG5
	6A9S	6C76	6X4	12BA9GT	35BH5
	6A9S	6C76	6X4	12BA9GT	35BI5
	6A9S	6C76	6X4	12BA9GT	35BJ5
	6A9S	6C76	6X4	12BA9GT	35BK5
	6A9S	6C76	6X4	12BA9GT	35BL5
	6A9S	6C76	6X4	12BA9GT	35BM5
	6A9S	6C76	6X4	12BA9GT	35BN5
	6A9S	6C76	6X4	12BA9GT	35BO5
	6A9S	6C76	6X4	12BA9GT	35BP5
	6A9S	6C76	6X4	12BA9GT	35BQ5
	6A9S	6C76	6X4	12BA9GT	35BR5
	6A9S	6C76	6X4	12BA9GT	35BS5
	6A9S	6C76	6X4	12BA9GT	35BT5
	6A9S	6C76	6X4	12BA9GT	35BU5
	6A9S	6C76	6X4	12BA9GT	35BV5
	6A9S	6C76	6X4	12BA9GT	35BW5
	6A9S	6C76	6X4	12BA9GT	35BX5
	6A9S	6C76	6X4	12BA9GT	35BY5
	6A9S	6C76	6X4	12BA9GT	35BZ5
	6A9S	6C76	6X4	12BA9GT	35CA5
	6A9S	6C76	6X4	12BA9GT	35CB5
	6A9S	6C76	6X4	12BA9GT	35CC5
	6A9S	6C76	6X4	12BA9GT	35CD5
	6A9S	6C76	6X4	12BA9GT	35CE5
	6A9S	6C76	6X4	12BA9GT	35CF5
	6A9S	6C76	6X4	12BA9GT	35CG5
	6A9S	6C76	6X4	12BA9GT	35CH5
	6A9S	6C76	6X4	12BA9GT	35CI5
	6A9S	6C76	6X4	12BA9GT	35CJ5
	6A9S	6C76	6X4	12BA9GT	35CK5
	6A9S	6C76	6X4	12BA9GT	35CL5
	6A9S	6C76	6X4	12BA9GT	35CM5
	6A9S	6C76	6X4	12BA9GT	35CN5
	6A9S	6C76	6X4	12BA9GT	35CO5
	6A9S	6C76	6X4	12BA9GT	35CP5
	6A9S	6C76	6X4	12BA9GT	35CQ5
	6A9S	6C76	6X4	12BA9GT	35CR5
	6A9S	6C76	6X4	12BA9GT	35CS5
	6A9S	6C76	6X4	12BA9GT	35CT5
	6A9S	6C76	6X4	12BA9GT	35CU5
	6A9S	6C76	6X4	12BA9GT	35CV5
	6A9S	6C76	6X4	12BA9GT	35CW5
	6A9S	6C76	6X4	12BA9GT	35CX5
	6A9S	6C76	6X4	12BA9GT	35CY5
	6A9S	6C76	6X4	12BA9GT	35CZ5
	6A9S	6C76	6X4	12BA9GT	35DA5
	6A9S	6C76	6X4	12BA9GT	35DB5
	6A9S	6C76	6X4	12BA9GT	35DC5
	6A9S	6C76	6X4	12BA9GT	35DD5
	6A9S	6C76	6X4	12BA9GT	35DE5
	6A9S	6C76	6X4	12BA9GT	35DF5
	6A9S	6C76	6X4	12BA9GT	35DG5
	6A9S	6C76	6X4	12BA9GT	35DH5
	6A9S	6C76	6X4	12BA9GT	35DI5
	6A9S	6C76	6X4	12BA9GT	35DJ5
	6A9S	6C76	6X4	12BA9GT	35DK5
	6A9S	6C76	6X4	12BA9GT	35DL5
	6A9S	6C76	6X4	12BA9GT	35DM5
	6A9S	6C76	6X4	12BA9GT	35DN5
	6A9S	6C76	6X4	12BA9GT	35DO5
	6A9S	6C76	6X4	12BA9GT	35DP5
	6A9S	6C76	6X4	12BA9GT	35DQ5
	6A9S	6C76	6X4	12BA9GT	35DR5
	6A9S	6C76	6X4	12BA9GT	35DS5
	6A9S	6C76	6X4	12BA9GT	35DT5
	6A9S	6C76	6X4	12BA9GT	35DU5
	6A9S	6C76	6X4	12BA9GT	35DV5
	6A9S	6C76	6X4	12BA9GT	35DW5
	6A9S	6C76	6X4	12BA9GT	35DX5
	6A9S	6C76	6X4	12BA9GT	35DY5
	6A9S	6C76	6X4	12BA9GT	35DZ5
	6A9S	6C76	6X4	12BA9GT	35EA5
	6A9S	6C76	6X4	12BA9GT	35EB5
	6A9S	6C76	6X4	12BA9GT	35EC5
	6A9S	6C76	6X4	12BA9GT	35ED5
	6A9S	6C76	6X4	12BA9GT	35EE5
	6A9S	6C76	6X4	12BA9GT	35EF5
	6A9S	6C76	6X4	12BA9GT	35EG5
	6A9S	6C76	6X4	12BA9GT	35EH5
	6A9S	6C76	6X4	12BA9GT	35EI5
	6A9S	6C76	6X4	12BA9GT	35EJ5
	6A9S	6C76	6X4	12BA9GT	35EK5
	6A9S	6C76	6X4	12BA9GT	35EL5
	6A9S	6C76	6X4	12BA9GT	35EM5
	6A9S	6C76	6X4	12BA9GT	35EN5
	6A9S	6C76	6X4	12BA9GT	35EO5
	6A9S	6C76	6X4	12BA9GT	35EP5
	6A9S	6C76	6X4	12BA9GT	35EQ5
	6A9S	6C76	6X4	12BA9GT	35ER5
	6A9S	6C76	6X4	12BA9GT	35ES5
	6A9S	6C76	6X4	12BA9GT	35ET5
	6A9S	6C76	6X4	12BA9GT	35EU5
	6A9S	6C76	6X4	12BA9GT	35EV5
	6A9S	6C76	6X4	12BA9GT	35EW5
	6A9S	6C76	6X4	12BA9GT	35EX5
	6A9S	6C76	6X4	12BA9GT	35EY5
	6A9S	6			



# HOW WOULD YOU LIKE TO BREAK INTO ENGINEERING STARTING NEXT MONTH?

Your start in Engineering could mean higher pay, more interesting work, a real chance for advancement. Here's how to do it—fast!

A career in Engineering may be closer than you think, whatever your age or education or present job.

You know about the tremendous demand for engineers and technicians. But do you know how easy it is to get the training that will qualify you for this vital work, and how quickly you can advance?

## First Step Wins Job Consideration

The moment you enroll for a course in Engineering you're in a position to change your job. I. C. S. Engineering Courses, for example, start you off with Basic Mathematics and Drafting. Most employers are quick to accept men who start technical training.

## Your Advancement Is Rapid

Your interest, your determination, your willingness to spend free hours improving your-

self all work in your favor. But your mastery of engineering subjects is what wins you the biggest boosts.

The I. C. S. method makes it possible for you to learn while you earn, to qualify yourself for upgrading step by step—from Draftsman to Detail Designer to Engineering Technician to full-fledged Engineer. It's a plan fitted to your needs, with personalized instruction and guidance, and, if you like, regular progress reports to your employer.

## Mail Coupon for Free Books

If you are seriously interested in a fresh start in an opportunity-packed field, then mark and mail the coupon today. We'll send you *three* free books—(1) the 36-page career guide "How to Succeed," (2) Opportunity outlooks in your field of interest, (3) sample lesson (Math) demonstrating I. C. S. method.

Accredited Member,  
National Home Study Council

For Real Job Security—Get an I. C. S. Diploma! I. C. S., Scranton 15, Penna.

## INTERNATIONAL CORRESPONDENCE SCHOOLS



BOX 14057E, SCRANTON 15, PENNA.

(In Hawaii, reply P.O. Box 418, Honolulu)

(Partial list of courses)

Without cost or obligation, send me "HOW TO SUCCEED" and the opportunity booklet about the field BEFORE which I have marked X (plus sample lesson):

### ARCHITECTURE and BUILDING CONSTRUCTION

- Air Conditioning
- Architecture
- Arch. Drawing and Designing
- Building Contractor
- Building Estimator
- Carpenter Builder
- Carpentry and Millwork
- Heating
- Painting Contractor
- Plumbing
- Reading Arch. Blueprints

### ART

- Commercial Art
- Magazine Illus.
- Sign Painting and Design'g
- Sketching and Painting

### AUTOMOTIVE

- Automobile
- Auto Body Rebuilding and Refinishing
- Auto Engine Tuneup
- Auto Electrical Technician
- Diesel Engines

### AVIATION

- Aero-Engineering Technology
- Aviation Engine Mech.
- Reading Aircraft Blueprints

### BUSINESS

- Accounting
- Advertising
- Bookkeeping and Cost Accounting
- Business Administration
- Business Management
- Clerk Typist
- Creative Salesmanship
- Managing a Small Business
- Professional Secretary
- Public Accounting
- Purchasing Agent
- Real Estate Salesmanship
- Salesmanship
- Salesmanship and Management
- Traffic Management

### CHEMICAL

- Analytical Chemistry
- Chemical Engineering
- Chem. Lab. Technician
- General Chemistry

### CIVIL ENGINEERING

- Civil Engineering
- Construction Engineering
- Highway Engineering
- Professional Engineer (Civil)
- Reading Struc. Blueprints
- Sanitary Engineer
- Sewage Plant Operator
- Structural Engineering
- Surveying and Mapping
- Water Works Operator

### DRAFTING

- Aircraft Drafting
- Architectural Drafting
- Drafting & Machine Design
- Electrical Drafting
- Electrical Engineer Drafting
- Industrial Piping Drafting
- Mechanical Drafting
- Sheet Metal Drafting

### ELECTRICAL

- Electrical Appliance Servicing
- Electrical Engineering

### ELECTRIC MOTOR REPAIRMAN

- Elec. Ensr. Technician
- Elec. Light and Power
- Practical Electrician
- Practical Lineman
- Professional Engineer

### HIGH SCHOOL

- Good English
- High School Diploma
- High School General
- H. S. College Prep. (Eng'g & Science)
- High School Math
- High School Science
- Short Story Writing

### LEADERSHIP

- Industrial Foremanship
- Industrial Supervision
- Personnel-Labor Relations
- Supervision

### MECHANICAL and SHOP

- Diesel Engines
- Gas-Elec. Welding
- Heating and Air Conditioning
- Industrial Engineering
- Industrial Instrumentation

### INDUSTRIAL SAFETY

- Industrial Safety
- Machine Shop Practice
- Mechanical Engineering
- Plumbing and Heating
- Professional Engineer
- Quality Control
- Reading Shop Blueprints
- Refrigeration and Air Conditioning
- Tool Design
- Tool Making

### RADIO, TELEVISION

- General Electronics Tech.
- Industrial Electronics
- Practical Radio-TV Eng'g
- Radio-TV Servicing
- TV Technician

### RAILROAD

- General Railroad

### STEAM and DIESEL POWER

- Combustion Engineering
- Power Plant Engineer
- Stationary Diesel Engr.
- Stationary Steam Engines

### TEXTILE

- General

Name \_\_\_\_\_ Age \_\_\_\_\_ Home Address \_\_\_\_\_

City \_\_\_\_\_ Zone \_\_\_\_\_ State \_\_\_\_\_ Working Hours \_\_\_\_\_ A.M. to P.M. \_\_\_\_\_

Occupation \_\_\_\_\_ Canadian residents send coupon to International Correspondence Schools, Canadian, Ltd., Montreal, Canada. . . . Special low monthly tuition rates to members of the U. S. Armed Forces.



## CITIZEN BAND CLASS "D" CRYSTALS

All 22 Frequencies in Stock

3rd overtone. .005% tolerance—to meet all F C C requirements.

Hermetically sealed HC6/U holders. 1/2" pin spacing—.050 pins. (.093 pins available, add 15¢ per crystal!) **\$2.95 EACH**

The following Class "D" Citizen Band frequencies in stock (frequencies listed in megacycles): 26.965, 26.975, 26.985, 27.005, 27.015, 27.025, 27.035, 27.055, 27.065, 27.075, 27.085, 27.105, 27.115, 27.125, 27.135, 27.155, 27.165, 27.175, 27.185, 27.205, 27.215, 27.225.

Matched crystal sets for Globe, Gonset, Citi-Fone and Hallcrafters Units . . . \$5.90 per set. Specify equipment make.

### RADIO CONTROL CRYSTALS IN HC6/U HOLDERS

Specify frequency. 1/4" pin spacing . . . pin diameter .05 (.093 pin diameter, add 15¢) . . . \$2.95 ea.

### FUNDAMENTAL FREQ. SEALED CRYSTALS

in HC6/U holders  
From 1400 KC to 4000 KC. .005% Tolerance. . . . \$4.95 ea.  
From 4000 KC to 15,000 KC any frequency  
.005% Tolerance . . . . . \$3.50 ea.

### SEALED OVERTONE CRYSTALS

Supplied in metal HC6/U holders  
Pin spacing .486, diameter .050  
15 to 30 MC .005 Tolerance . . . . . \$3.85 ea.  
30 to 45 MC .005 Tolerance . . . . . \$4.10 ea.  
45 to 60 MC .005 Tolerance . . . . . \$4.50 ea.

## QUARTZ CRYSTALS FOR EVERY SERVICE

All crystals made from Grade "A" imported quartz—ground and etched to exact frequencies. Unconditionally guaranteed! Supplied in:

FT-243 holders Pin spacing 1/2" Pin diameter .093	MC-7 holders Pin spacing 3/4" Pin diameter .125	DC-34 holders Pin spacing 3/4" Pin diameter .150	FT-171 holders Pin spacing 3/4" Banana pins
---	---	--	---

### MADE TO ORDER CRYSTALS • SPECIFY HOLDER WANTED

1001 KC to 2600 KC:	
.01% Tolerance . . . \$2.00 ea.	.005% Tolerance . . . \$2.75 ea.
.005% Tolerance . . . . . \$2.50 ea.	
9001 KC to 11,000 KC:	
.005% Tolerance . . . . . \$3.00 ea.	

### Amateur, Novice, Technician Band Crystals

.01% Tolerance . . . \$1.50 ea.—80 meters (3701-3749 KC), 40 meters (7152-7198 KC), 15 meters (7034-7082 KC), 6 meters (8335-8650 KC) within 1 KC  
FT-241 Lattice Crystals in all frequencies from 370 KC to 540 KC (all except 455 KC and 500 KC) . . . . . 50¢ ea.  
Pin spacing 1/2" Pin diameter .093

Matched pairs ± 15 cycles \$2.50 per pair  
200 KC Crystals, \$2.00 ea.; 455 KC Crystals, \$1.50 ea.; 500 KC Crystals, \$1.50 ea.; 100 KC Frequency Standard Crystals in HC6/U holders \$4.50 ea.; Socket for FT-243 crystal 15¢ ea.; Dual socket for FT-243 crystals, 15¢ ea.; Sockets for MC-7 and FT-171 crystals 25¢ ea.; Ceramic socket for HC6/U crystals 20¢ ea.

Write for new free catalog #860 complete with oscillator circuits

### ASK YOUR PARTS DEALER FOR TEXAS CRYSTALS

See big red display . . . or order from our Florida plant.

NOW! Engineering samples and small quantities for prototypes now made either at Chicago or at Ft. Myers Plant. 24 Hour Service!

IN CHICAGO, PHONE GLADSTONE 3-3555

RUSH ORDER. Use coupon for 1st Class shipment

## TEXAS CRYSTALS

Dept. E-71, 1000 CRYSTAL DRIVE, FORT MYERS, FLORIDA  
For extra fast service, Phone WE 6-2100

ATTACH THIS COUPON TO YOUR ORDER FOR SHIPMENT VIA 1ST CLASS MAIL AT NO EXTRA COST

TERMS: All items subject to prior sale and change of price without notice. All crystal orders must be accompanied by check, cash or M.O. with PAYMENT IN FULL. NO COD'S. E-71

# FEEDBACK

## ● Useful Experiment

We are interested in the experimental program performed by your magazine on playback life of stereo records (November '59 EI) . . .

We have been planning a continuation of this study and your work will be a useful guide to us.

M. M. Lemcoe

Southwest Research Institute  
San Antonio, Tex.

## ● VOM Facts

Some place I read that a VOM should be 20,000 ohms per volt. What does this mean? Does it make for easier reading on the dial, or what? So many VOM's are 5,000 or 10,000 ohms/volt. Then another costs the same as the 20,000 ohms/volt instrument but does not say anything about this. What is the answer?

Gerald Leonardy  
Pascagoula, Miss.

*A detailed answer to that one, Jerry, could fill up several pages. Suffice it to say that a 20,000 ohms/volt instrument is more sensitive and doesn't load down the circuit under test. It is therefore usually more accurate than VOM's rated at 1000 ohms/volt. And the rating should be listed on the instrument.*

## ● Rx for EI

Continued articles inevitably end on opposite sides of the same page . . . and wonderful graphs and charts are presented back-to-back. Concluding articles separately might initially increase publication costs but (would lead to) greater circulation.

It would be a boon to subscribe to a periodical that broke a new issue at mid-month. Traditionally, we are all overwhelmed with new literature at the first of the month—and parched for three weeks thereafter.

Julius M. Tesi, M.D.  
Yorkville, Ohio

*Thanks for your comments. EI always attempts to end its construction articles*



# NEW knight-kits®

A PRODUCT OF ALLIED RADIO

## - simply great!



measures  
engine speed,  
0-8000 rpm



it's WIRELESS—  
just plug in  
and TALK!

### New Money-Saving Electronic Tachometer Kit

Most Accurate at this Low-Cost—Unaffected by Temperature

**ONLY \$19.95** Another KNIGHT-KIT first—a precision tachometer in money-saving, easy-to-build form. Helps you drive at your best engine speed efficiency, like the professionals. Temperature-compensated Zener diode regulator contributes to exceptional 5%-of-full-scale accuracy, regardless of voltage or temperature changes. Operates with 4, 6 or 8 cylinder automotive engines; simple 3-wire installation. Universal mount fits dash or steering column. Ideal also for high-powered outboard marine engines using primary ignition system from 2 cycle 2 cylinder and up. Big illuminated D'Arsonval meter; linear 0-8000 rpm scale; reference pointer may be preset to any desired speed. With cables, mounting hardware, wire and solder. Shpg. wt., 2 lbs.

**\$2 Down** 83 Y 944. Only \$2 Down. NET ..... \$19.95

### Deluxe Wireless Intercom Kit at Lowest Cost

Works Anywhere Without Wires—No Installation!

This easy-to-assemble intercom operates without installation or wiring—just plug into any AC or DC wall outlet for step-saving communication! Change locations easily—anywhere. Ideal for home, office or store. In the home, you can communicate with nursery, garage, basement or patio. In office or shop, provides time-saving communication. Will operate between adjacent buildings that are on same electric-company line transformer. Perfect for baby sitting. Features power-line noise silencing circuit for absolutely quiet "standby"; premium quality throughout. Has Talk-Listen switch, with lock-on feature for constant listening. Handsome cream-toned plastic cabinet, 9 x 5½ x 5½". Can be used in systems consisting of 2 or more units, as desired. Shpg. wt., 3½ lbs.

**ONLY \$18.95** 83 Y 941. NET. Each Station ..... \$18.95  
20 YX 272-2. Complete 2-Station System. NET ..... \$36.95

## BIG SAVINGS ON KITS in Allied's Summer Sale Book!



### KN-3000 AK Electrostatic Speaker System Kit

**Save \$25.00** Regularly \$99.50—Summer Sale price slashed to \$74.50! Finest high-compliance speaker system delivering absolutely fabulous sound. Includes 12" extra-low resonance woofer; two patented Arthur Janszen electrostatic tweeters; regularity power supply (pre-wired); hardwood premium quality sealed enclosure, Korina veneer panels for building sealed enclosure, acoustic panels (unfinished) for external surfaces; acoustic damping material. Assembled size, 14 x 26½ x 13". Response, 30-25000 cps. Capacity, 50 watts music waveform. Shpg. wt., 50 lbs.

35 DU 767. Only \$5 Down. NET ..... \$74.50

### C-27 Citizens Band Transceiver Kit with Press-to-Talk Microphone

**Save \$5.00** Combination regularly \$89.45—now reduced to \$84.45! Genuine dual-conversion superhet receiver for highest sensitivity and selectivity; 2-channel crystal-controlled full 5-watt transmitter. Features: Automatic noise limiter; continuously variable squelch control. With one transmitting crystal (channel 1-22—specify). Includes quality Press-to-Talk Microphone. Shpg. wt., 21 lbs.

20 YU 271-3. Only \$5 Down. NET ..... \$84.45



**FREE!** Send for the big bargain-packed Allied Summer Sale Book—save as never before on everything in Electronics!

Send for it!



ALLIED RADIO, Dept. 26-G1  
100 N. Western Ave., Chicago 80, Ill.

Please ship me the following:

- 83 Y 944 Tachometer Kit.  83 Y 941 Intercom Station.  
 35 DU 767 Speaker Kit.  20 YX 272-2 Intercom System.  
 20 YU 271-3 Transceiver with Mike. \$\_\_\_\_\_ enclosed  
 Send Free Allied Summer Sale Book No. 205

Name \_\_\_\_\_  
PRINT  
Address \_\_\_\_\_  
City \_\_\_\_\_ Zone \_\_\_\_\_ State \_\_\_\_\_

order from **ALLIED RADIO**

# FEEDBACK

in the front of the magazine so the written instructions are as close as possible to the schematics, pictorial drawings and Parts Lists. This is not always possible, of course. As for our publication date, it is in mid-month. EI is that little oasis in the middle of a big desert.

## ● *Lost Art?*

What has happened to radios? Years ago a fair set could reach out and bring in stations all over the country. Now you are lucky if you can pick up a station in the next county.

A short time after radio came out in 1920 I purchased a set by the name of Grebe that at the time was very good. With this set I could pick up Havana and California from this city nearly all the time. What is wrong with radios today?

A. J. Cornelius  
Pittsburgh, Pa.

*Some pretty wonderful things have happened to radio in the last four decades, Mr. Cornelius. And broadcast-band DXing can be more exciting than ever before. In the old days the average station's power was 500 watts. Today it is close to 50,000 watts. Along with the increased power has come an incredible increase in the number of stations. All this has led to problems. Strong signals are in the air, to be sure, but to receive them you need a good outside antenna and a selective receiver hooked to it. With so many stations crowding the band your set must have selectivity to separate one signal from the others.*

## ● *All a Matter of al*

I read your article in the March '61 issue titled UNDERGROUND RADIO IS NEWS AGAIN! Your reference to Development Engineering Corp. as a contributor to sub-surface communications experiments appears in error. This work is being conducted by Developmental Engineering Corp.

Charles E. Weller  
Developmental Engineering Corp.  
Washington, D. C.

*Sorry, Charlie. It was an accidental.*

## ● *Bright Point*

I have discovered something that may be of assistance to someone else. In tuning up my transmitter with a dummy load lamp (see A SHIELDED DUMMY LOAD, March '61 EI), I found that I couldn't be exactly sure of the best setting since the lamp glows brightly over a wide setting of the tank-coil. So I began using a photographic light meter, setting it on the most sensitive scale and placing it at a distance from the lamp that gives about half-scale readings. It works very well because reading the meter's dial is easier than trying to judge the brilliance of the lamp with the naked eye.

Frank Gilman, 1W6473  
Mars Hill, Me.

*Thanks for the tip.*

## ● *Oooops!*

In your article TUNE YOUR ANTENNA (February '61 EI) you say that if coaxial cable is chosen for the input line, the connector J1 may be omitted. Since J1 is the coax connector wouldn't TP1 be omitted instead?

The parts list calls for a Minibox CU-3008A, which is 7x5x3 inches. The coil, Illumitronic 1610T is ten inches long, however. How can a ten-inch coil fit in a seven-inch box? I think the correct box number is CU-3011. This box is 12x7x4.

Jeremy Clark, KN1QHA  
Pomfret, Conn.

*You're right. Thanks for writing.*

### IMPORTANT NOTICE TO SUBSCRIBERS

Effective with this issue, **ELECTRONICS ILLUSTRATED** will be published on a bi-monthly basis. No issue will be published for August. Your subscription will be extended and you will receive the number of copies to which your subscription entitles you.



**BECOME A RADIO TECHNICIAN For Only \$26.95**

# PROGRESSIVE RADIO

Reg. U. S. Pat. Off

**CIRCUITS AT HOME PRACTICAL only**  
**OR YOUR MONEY BACK! HOME \$26.95**  
**Progressive Radio "Edu-Kit"® RADIO COURSE**



**TRAINING ELECTRONICS TECHNICIANS SINCE 1946**

**Now Includes**

- ★ 12 RECEIVERS
- ★ 3 TRANSMITTERS
- ★ SQ. WAVE GENERATOR
- ★ SIGNAL TRACER
- ★ AMPLIFIER
- ★ SIGNAL INJECTOR
- ★ CODE OSCILLATOR

**SCHOOL INQUIRIES INVITED**

**Unconditional Money-Back Guarantee**  
is understood and agreed that should the Progressive Radio "Edu-Kit" be returned to Progressive "Edu-Kits" Inc. for any reason whatever, the purchase price will be refunded in full, without quibble or question, and without delay.  
The high recognition which Progressive "Edu-Kits" Inc. has earned through its many years of service to the public is due to its unconditional insistence upon the maintenance of perfect engineering, the highest instructional standards, and 100% adherence to its Unconditional Money-Back Guarantee. As a result, we do not have a single dissatisfied customer throughout the entire world.

**YOU DON'T HAVE TO SPEND HUNDREDS OF DOLLARS FOR A RADIO COURSE**

The "Edu-Kit" offers you an outstanding PRACTICAL HOME RADIO COURSE at a rock-bottom price. The Kit is designed to train Radio & Electronics Technicians, making use of the most modern methods of home training. You will learn radio theory, construction practice and servicing. THIS IS A COMPLETE RADIO COURSE IN EVERY DETAIL. You will learn how to build radios, using regular schematics; how to wire and solder in a professional manner; how to service radios. You will work with the standard type of punched metal chassis as well as the latest development of Printed Circuit chassis.

You will learn the basic principles of radio. You will construct, study and work with RF and AF amplifiers and oscillators and detectors, rectifiers, test equipment. You will learn and practice code, using the Progressive Code Oscillator. You will learn and practice trouble-shooting, using the Progressive Signal Tracer, Progressive Signal Injector, Progressive Dynamic Meter & Electronics Tester, Square Wave Generator and the accompanying instructional material.

You will receive training for the Novice, Technician and General Classes of F.C.C. Radio Amateur License, build 20 Receiver, Transmitter, Square Wave Generator, Code Oscillator, Signal Tracer and Signal Injector circuits, and learn how to operate them. You will receive an excellent background for television, Hi-Fi and Electronics.

Absolutely no previous knowledge of radio or science is required. The "Edu-Kit" is the product of many years of teaching and engineering experience. The "Edu-Kit" will provide you with a basic education in Electronics and Radio, worth many times the complete price of \$26.95. The Signal Tracer alone is worth more than the price of the entire Kit.

## THE KIT FOR EVERYONE

You do not need the slightest background in radio or science. Whether you are interested in Radio & Electronics because you want an interesting hobby, a well-paying business or a job with a future, you will find the "Edu-Kit" a worth-while investment. Many thousands of individuals of all

ages and backgrounds have successfully used the "Edu-Kit" in more than 79 countries of the world. The "Edu-Kit" has been carefully designed, step by step, so that you cannot make a mistake. The "Edu-Kit" allows you to teach yourself at your own rate. No instructor is necessary.

## PROGRESSIVE TEACHING METHOD

The Progressive Radio "Edu-Kit" is the foremost educational radio kit in the world, and is universally accepted as the standard in the field of electronic training. The "Edu-Kit" uses the modern educational principle of "Learn by Doing." Therefore you construct, learn schematics, study theory, practice trouble-shooting—all in a closely integrated program designed to provide an easily-learned, thorough and interesting background in radio.

You begin by examining the various radio parts of the "Edu-Kit." You then learn the function, theory and wiring of these parts. Then you build a simple radio. With this first set you will enjoy listening to regular broadcast stations, learn theory, practice testing and trouble-shooting. Then you build a more advanced radio, learn more advanced theory and techniques. Gradually, in a progressive manner, and at your own rate, you will find yourself constructing more advanced multi-tube radio circuits, and doing work like a professional radio Technician.

Included in the "Edu-Kit" course are twenty Receiver, Transmitter, Code Oscillator, Signal Tracer, Square Wave Generator and Signal Injector circuits. These are not unprofessional "breadboard" experiments, but genuine radio circuits, constructed by means of professional wiring and soldering on metal chassis, plus the new method of radio construction known as "Printed Circuitry." These circuits operate on your regular AC or DC house current.

## THE "EDU-KIT" IS COMPLETE

You will receive all parts and instructions necessary to build 20 different radio and electronics circuits, each guaranteed to operate. Our Kits contain tubes, tube sockets, variable, electrolytic, mica, ceramic and paper dielectric condensers, resistors, tie strips, coils, hardware, tubing, punched metal chassis, instructions Manuals, hook-up wire, solder, selenium rectifier, controls and switches, etc.

In addition, you receive Printed Circuit materials, including Printed Circuit chassis, special tube sockets, hardware and instructions. You also receive a useful set of tools, a professional electric soldering iron, and a self-powered Dynamic Radio and Electronics Tester. The "Edu-Kit" also includes Code Instructions and the Progressive Code Oscillator, in addition to F.C.C.-type Questions and Answers for Radio Amateur License training. You will also receive lessons for servicing with the Progressive Signal Tracer and the Progressive Signal Injector, a High Fidelity Guide and a Quiz Book. You receive Membership in Radio-TV Club, Free Consultation Service, Certificate of Merit and Discount Privileges. You receive all parts, tools, instructions, etc. Everything is yours to keep.

## PRINTED CIRCUITRY

At no increase in price, the "Edu-Kit" now includes Printed Circuitry. You build a Printed Circuit Signal Injector, a unique servicing instrument that can detect many Radio and TV troubles. This revolutionary new technique of radio construction is now becoming popular in commercial radio and TV sets.

A Printed Circuit is a special insulated chassis on which has been deposited a conducting material which takes the place of wiring. The various parts are merely plugged in and soldered to terminals.

Printed Circuitry is the basis of modern Automation Electronics. A knowledge of this subject is a necessity today for anyone interested in Electronics.

## ORDER DIRECT FROM AD—RECEIVE FREE BONUS RESISTOR AND CONDENSER KITS WORTH \$7

- Send "Edu-Kit" postpaid. I enclose full payment of \$26.95.
- Send "Edu-Kit" C.O.D. I will pay \$26.95 plus postage.
- Rush me FREE descriptive literature concerning "Edu-Kit."

Name \_\_\_\_\_  
Address \_\_\_\_\_

**PROGRESSIVE "EDU-KITS" INC.**  
1186 Broadway, Dept. 537AE, Hewlett, N. Y.

## FREE EXTRAS

- SET OF TOOLS
- SOLDERING IRON
- ELECTRONICS TESTER
- PLIERS-CUTTERS
- ALIGNMENT TOOL
- WRENCH SET
- VALUABLE DISCOUNT CARD
- CERTIFICATE OF MERIT
- TROUBLE-SHOOTING BOOK
- HIGH FIDELITY GUIDE & QUIZZES
- TELEVISION BOOK & RADIO
- MEMBERSHIP IN RADIO-TV CLUB
- CONSULTATION SERVICE & FCC AMATEUR LICENSE TRAINING
- PRINTED CIRCUITRY

## SERVICING LESSONS

You will learn trouble-shooting and servicing in a progressive manner. You will practice repairs on the sets that you construct. You will learn symptoms and causes of trouble in home, portable and car radios. You will learn how to use the professional Signal Tracer, the unique Signal Injector and the dynamic Radio & Electronics Tester. While you are learning in this practical way, you will be able to do many a repair job for your friends and neighbors, and charge fees which will far exceed the price of the "Edu-Kit." Our Consultation Service will help you with any technical problems you may have.

J. Stataitis, of 25 Poplar Pl., Waterbury, Conn., writes: "I have repaired several sets for my friends, and made money. The "Edu-Kit" paid for itself. I was ready to spend \$240 for a course, but I found your ad and sent for your Kit."

## FROM OUR MAIL BAG

Ben Valerio, P. O. Box 21, Magna, Utah: "The Edu-Kits are wonderful. Here I am sending you the questions and also the answers for them. I have been in Radio for the last seven years, but like to work with Radio Kits, and like to build Radio Testing Equipment. I enjoyed every minute I worked with the different kits; the Signal Tracer works fine. Also like to let you know that I feel proud of becoming a member of your Radio-TV Club."

Robert L. Shuff, 1534 Monroe Ave., Huntington, W. Va.: "Thought I would drop you a few lines to say that I received my Edu-Kit, and was really amazed that such a bargain can be had at such a low price. I have already started repairing radios and phonographs. My friends were really surprised to see me get into the swing of it so quickly. The Trouble-shooting Tester that comes with the Kit is really swell, and finds the trouble, if there is any to be found."

## ...electronics in the news

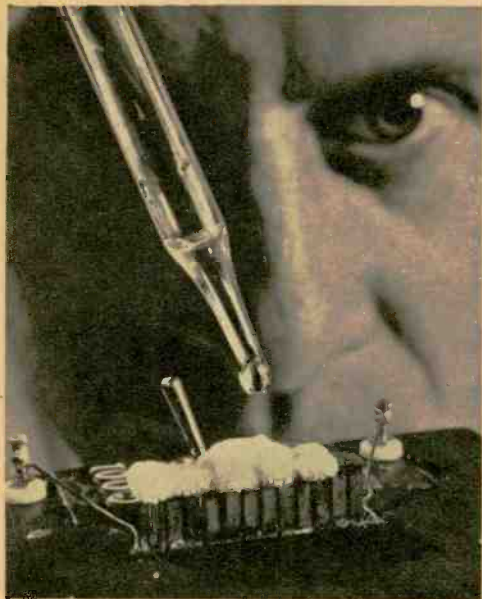

**Cold Spot . . .** A low-drain thermoelectric device which can freeze or boil a drop of water on the power of two flashlight batteries has been developed by Hughes Aircraft Co. The photo shows a scientist dropping water on the apparatus, about the size of a paper clip. It either heats or cools, depending on which way current is passed through it.

The principles of thermoelectricity have been around for more than 100 years but until now large amounts of current were required. The Hughes device reduces those requirements by 90 per cent. Chief of the Hughes contributions was a new technique for fabricating the two required semi-conductor materials.

The device could lead to a refrigerator with no moving parts but its real use probably will come later in temperature control inside spaceships.

**Maser Milestones . . .** Two developments in the light maser (or laser) are depicted in the photos below (see **LIGHT-AMPLIFIER BREAKTHROUGH**, January '61 EI). At right a scientist holds a continuously-operating optical gas maser announced by Bell Laboratories and at left is an operating light-beam radar employing a solid-state laser.

The Bell device, which operates on less power than a light bulb, is a tube containing neon and helium gases. The gases, highly excited, work together to produce a thin beam of coherent infrared light, capable of carrying a staggering number of telephone calls and television programs.

The Hughes Colidar (for Coherent Light Detection and Ranging) also emits a thin beam of light (the laser is in the circular transmitter at the top). The beam's



*Electronics Illustrated*



# Do you WISH you were EMPLOYED in ELECTRONICS?

## F.C.C. LICENSE—THE KEY TO BETTER JOBS

An F.C.C. commercial (not amateur) license is your ticket to higher pay and more interesting employment. This license is Federal Government evidence of your qualifications in electronics. Employers are eager to hire licensed technicians.

### WHICH LICENSE FOR WHICH JOB?

The THIRD CLASS radiotelephone license is of value primarily in that it qualifies you to take the second class examination. The scope of authority covered by a third class license is extremely limited.

The SECOND CLASS radiotelephone license qualifies you to install, maintain and operate most all radiotelephone equipment except commercial broadcast station equipment.

The FIRST CLASS radio telephone license qualifies you to install, maintain and operate every type of radiotelephone equipment (except amateur) including all radio and television stations in the United States, its territories and possessions. This is the highest class of radiotelephone license available.

### GRANTHAM TRAINING PREPARES YOU

The Grantham course covers the required subject matter completely. Even though it is planned primarily to lead directly to a first class FCC license, it does this by TEACHING you electronics. Some of the subjects covered in detail are: Basic Electricity for Beginners, Basic Mathematics, Ohm's and Kirchhoff's Laws, Alternating Current, Frequency and Wavelength, Inductance, Capacitance, Impedance, Resonance, Vacuum Tubes, Transistors, Basic Principles of Amplification, Classes of Amplifiers, Oscillators, Power Supplies, AM Transmitters and Receivers, FM Transmitters and Receivers, Antennas and Transmission Lines, Measuring Instruments, FCC Rules and Regulations, and extensive theory and mathematical calculations associated with all the above subjects explained simply and in detail.

### OUR GUARANTEE

If you should fail the F. C. C. exam after finishing our course, we guarantee to give additional training at NO ADDITIONAL COST. Read details in our free booklet.

Get  
Your First Class Commercial

# F.C.C. LICENSE QUICKLY!

Learn by Correspondence or in Resident Classes

Grantham training is offered by correspondence or in resident classes. Either way, we train you quickly and thoroughly---teach you a great deal of electronics and prepare you to pass the F. C. C. examination for a first class license. Get details now. Mail coupon below.

This booklet  
**FREE!**

This free booklet gives details of our training and explains what an F.C.C. license can do for your future. Send for your copy today.

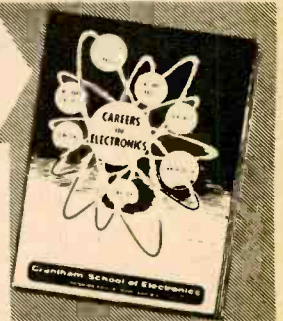

To get ahead in electronics—first, you need the proper training; then, you need "proof" of your knowledge. Your first class commercial F. C. C. license is a "diploma" in communications electronics, awarded by the U. S. Government when you pass certain examinations. This diploma is recognized by employers. Grantham School of Electronics specializes in preparing you to earn this diploma.

Grantham training is offered in resident classes or by correspondence. Our free booklet gives complete details. If you are interested in preparing for your F. C. C. license, mail the coupon below to the School's home office at 1505 N. Western Ave., Hollywood 27, California—the address given in the coupon—and our free booklet will be mailed to you promptly. No charge—no obligation.

## Grantham School of Electronics

HOLLYWOOD  
CALIF.

SEATTLE  
WASH.

KANSAS CITY  
MO.

WASHINGTON  
D. C.

RESIDENT CLASSES  
HELD IN FOUR CITIES

If you are interested in attending day or evening classes mail the coupon for free information to our home office in Hollywood, Calif.



(Mail in envelope or paste on postal card)

To: GRANTHAM SCHOOL OF ELECTRONICS  
1505 N. Western Ave., Hollywood, Calif.

Gentlemen:

Please send me your free booklet telling how I can get my commercial F.C.C. license quickly. I understand there is no obligation and no salesman will call.

Name \_\_\_\_\_ Age \_\_\_\_\_

Address \_\_\_\_\_

City \_\_\_\_\_ State \_\_\_\_\_

I am interested in:  Home Study,  Seattle classes

Hollywood classes,  Kansas City classes,  Washington-classes

MAIL COUPON NOW—NO SALESMAN WILL CALL →

18-K

reflection or echo from a distant object is then collected by the telescope, which appears as the large round circle at the bottom of the photo, and is fed to detection equipment. The operator is given a distance reading and other data. The beam of light—wavelength is 6,943 angstroms—intersects only about half a degree as it comes from the laser. When fed through a lens system, the beam-width is reduced to .0189 degree. Radio-frequency radar covers 2 degrees.

—o—

**Talking Gun** . . . An infrared beam, invisible to the naked eye, is the ammunition shot out of a strange new gun produced by Minneapolis-Honeywell (see photo). The gun is capable of transmitting a modulated infrared beam for full-voice communication. A similar gun aimed at the transmitting unit detects the beam, recovers the modulation and converts it back to sound, making possible two-way communications which are extremely hard to detect or jam.



The shape of these infrared transceivers was dictated by the need for extremely accurate aiming by the users. The guns are designed for use by police, firemen, in industrial security work and in some military applications where maximum secrecy is necessary. Hand-held guns have a range of about three miles and larger units 20 miles.

The M-H devices mark the beginning of commercial infrared communications. Most previous IR devices of this type have been purely experimental or toys.

## Signals From Space

**T**HE IONOSPHERE, which is so important to long-range radio communications, is in for a fairly thorough examination by the Ionosphere Beacon Satellite S-45, built for launching by the National Aeronautics and Space Administration.

Besides its scientific goals, the S-45 has a special interest for short-wave listeners since it transmits low-power signals on six frequencies (see our story on DXing satellites in this issue). One S-45 was launched some time ago and apparently went into orbit. However, its transmitting equipment did not operate. NASA has indicated it will keep trying until it has a successful one in orbit.

Little actually is known about the ionosphere, the ionized layer at the top of the earth's atmosphere, from 50 to several hundred miles up. The S-45 will enable scientists to study its hills and valleys, orbiting from 240 miles (perigee) to 1,600 miles (apogee) above the earth.

The 74-pound satellite looks something like two salad bowls cemented together rim-to-rim. Standing out from its circumference is a six-foot loop antenna. Only one transmitter, containing a crystal with a basic frequency of 1.00025 mc, is in the S-45. Its six transmitted frequencies will be harmonics. The frequencies are 20.005 mc, 40.01 mc, 41.01025 mc, 108.027 mc, 360.09 mc and 960.240 mc. Radiated power will range from 10 milliwatts at the highest frequency to 106 mw at 20.005 mc.

The launching vehicle is a Juno II rocket, a three-stage monster weighing in at 60 tons. Cape Canaveral is the launching site.

Several universities and other groups in the United States and New Zealand will monitor the signals and analyze them by various methods, such as change in polarization and Doppler shift. However, it has been made clear that the S-45's signals also are for the intended use of anyone in the world who has an interest in the ionosphere.

When in orbit, the satellite will be given an Explorer name. ●



**AT  
LAST!**

# RADIO-TV and ELECTRONICS TRAINING

**... AT A PRICE  
YOU CAN AFFORD!**



**\*21 INCH**  
Receiver Kit included

Yes, this great course costs far less than any training of its kind given by other major schools! Radio-Television Training School will train you for a good job in Television or Industrial Electronics — **AT HOME IN YOUR SPARE TIME.**

Think of it—a complete training program including over 120 lessons, Fourteen Big Radio-Television Kits, Complete Color-TV Instruction, Unlimited Consultation Service... **ALL at a really big saving to you.** How can we do this? Write to us today... and find out!

And what's more — you can (if you wish)

**OPEN YOUR OWN RTS-APPROVED AND FINANCED RADIO-TV SERVICE SHOP**

We Want Many More Shops This Year

This 39 year old training organization — called RTS, that's Radio-Television Training School — wants to establish a string of Radio-TV Repair Shops in principal cities throughout the U. S. So far, a great many such shops are **NOW IN BUSINESS AND PROSPERING.** We are helping and training ambitious men to become future owners and operators of these shops in all areas.

**FOR UNSKILLED  
INEXPERIENCED MEN ONLY —  
WE TRAIN YOU OUR WAY!**

We must insist that the men we sign up be trained in Radio-TV Repair, Merchandising and Sales by our training methods—because **WE KNOW** the requirements of the industry. Therefore, we will **TRAIN YOU**... we will show you how to earn **EXTRA CASH**, during the first month or two of your training period. **YOU KEEP YOUR PRESENT JOB. TRAINING TAKES PLACE IN YOUR OWN HOME, IN YOUR SPARE TIME!**



*you build these  
and other units*

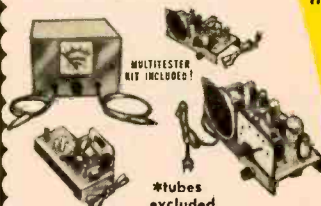

MULTIMETER KIT INCLUDED!

\*tubes excluded

## RADIO-TELEVISION TRAINING SCHOOL

815 EAST ROSECRANS AVENUE  
LOS ANGELES 59, CALIFORNIA

Est. 1922



**ACT  
NOW!**

Get your free book on the  
**FAMOUS RTS BUSINESS PLAN**

find out how you can open

**A REPAIR SHOP OF YOUR OWN**

We supply and finance your equipment

When you are ready and qualified to operate one of our RTS-Approved TV Repair Shops **WE WILL SUPPLY AND FINANCE EVERY BIT OF EQUIPMENT YOU NEED TO GET STARTED** plus an inventory of parts and supplies. In other words we will stake you

**AN OFFER NEVER MADE BEFORE BY ANY TRAINING ORGANIZATION.** Under the RTS Business Plan you receive:

1. An electric sign for the shop front.
2. Complete laboratory of test equipment.
3. Letterheads, calling cards, repair tickets, etc.
4. Basic inventory of tubes, parts, supplies.
5. Complete advertising and promotional material.
6. Plans for shop arrangement.
7. Instructions on how to go into business.
8. Continuous consultation and help.
9. The right to use RTS Seal of Approval, and the RTS Credo.
10. The right to use the Famous Trade Mark.



RTS' Membership in The Association of Home Study Schools is your assurance of Reliability, Integrity, and Quality of Training.

**ALL  
THESE  
FREE!**



**CUT OUT AND MAIL — TODAY!**

**RADIO-TELEVISION TRAINING SCHOOL**  
815 EAST ROSECRANS AVE Dept. E1-71  
LOS ANGELES 59, CALIFORNIA

SEND ME FREE — all of these big opportunity books — "Good Jobs in TV-Electronics," "A Repair Shop of Your Own" and "Sample Lesson." I am interested in:

- Radio-Television       Industrial Electronics (Automation)

Name \_\_\_\_\_ Age \_\_\_\_\_

Address \_\_\_\_\_

City & State \_\_\_\_\_

301

**Mail This Coupon Now — No Salesman Will Call**

**FREE** **ALLIED**  
SPECIAL MONEY-SAVING  
**ELECTRONIC SALE BOOK**



**SAVE** HUNDREDS OF BARGAINS!

SAVE MOST on Allied Summer Specials! Terrific closeouts on quality Stereo hi-fi systems and components, tape recorders, phono, records and tape. Top values in Allied's own KNIGHT® products and exciting build-your-own KNIGHT-KITS®. Hundreds of specials in radios, cameras, TV accessories, Citizens Band radio, amateur gear, P.A. systems, test instruments, tools and electronic parts. Dozens of new products. Write today!

**ONLY \$2 DOWN** on orders up to \$50; \$5 down up to \$200; \$10 down over \$200.

**FREE** SEND OR VALUE-PACKED SALE BOOK

**ALLIED RADIO**

ALLIED RADIO, Dept. 56-G1  
100 N. Western Ave., Chicago 80, Ill.  
 Send FREE Allied Sale Book No. 205

Name \_\_\_\_\_  
PRINT  
Address \_\_\_\_\_  
City \_\_\_\_\_ Zone \_\_\_\_\_ State \_\_\_\_\_

**QUICKLY CUT HOLES**  
in metal, plastics,  
hard rubber...



**GREENLEE CHASSIS PUNCHES**

Make smooth, accurate openings in 1 1/2 minutes or less ... for sockets, plugs, controls, meters, panel lights, etc. Easy to use ... simply turn with wrench. Many sizes and models. Write for literature.

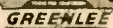

GREENLEE TOOL CO. 1915 Columbia Ave., Rockford, Illinois

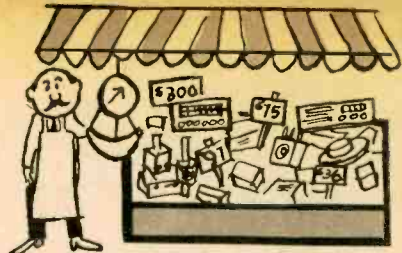

**Electronic Marketplace**

**LOW-PRICE OSCILLOSCOPE**

About the size of a telephone directory and priced around \$70, the new Waterman Primer-Scope Mark 1 is a buy for student-experimenters, hams, electronics servicemen and light industrial users. It is designed specifically for beginners, as well as for professional workers who don't require the advanced type of scope.



The Primer-Scope weighs less than six pounds, is 7 1/4 inches high, 3 1/2 inches wide and 11 1/4 inches long. It has a three-inch tube with an integral magnetic shield. Accompanying the instrument is a 75-page instruction book on basic scope technique.

Waterman Products Co., Inc., Philadelphia 25, Pa.

**CB Antenna** ... A new beam antenna for Citizens Band service has been put on the market by the Cubex Co. Cubex claims the Cubical Quad beam offers high performance for both transmitting and receiving, gain up to 10 db, high front-to-back ratio, light weight and





Accredited by the National Home Study Council

good training  
doesn't cost . . .  
it pays!

## An FCC License Or Your Money Back!

Completion of the Master Course (both Sections) will prepare you for a First Class Commercial Radio Telephone License with a Radar Endorsement. Should you fail to pass the FCC examination for this license after successfully completing the Master Course, you will receive a full refund of all tuition payments. This guarantee is valid for the entire period of your enrollment agreement.



### find out how . . .

1. You can handle the new electronic devices.
2. You can solve the problems that stump your fellow technicians.
3. Training is job insurance when employment is tough to find . . . and more money for you when times are good.

Get This Handy  
Pocket Electronics  
Data Guide  
**FREE . . .**

Puts all the commonly used conversion factors, formulas, tables and color codes at your fingertips. Yours absolutely free if you mail the coupon today. No further obligation!

### Cleveland Institute of Electronics

1776 E. 17th Street Desk EI-33 Cleveland 14, Ohio

July, 1961

# How To Get an

# FCC License (Commercial)



Get Your FCC  
License Quickly

### Increase Your Technical Knowledge

Get a government license plus an understanding of such electronic application as computers . . . industrial electronics . . . radar . . . communications . . . and many more.

### Not For Beginners

Please inquire only if you really want to get ahead and to add to what you have already learned in school, in the service, or on the job. Some previous schooling or experience in electronics, electricity, or related fields is necessary for success in Cleveland Institute programs.

### Get All Three

Booklets..

# Free



### Cleveland Institute of Electronics

1776 E. 17th Street, Desk EI-33, Cleveland 14, Ohio

Please send me Free Career Information Material prepared to help me get ahead in Electronics. I have had training or experience in Electronics as indicated below.

- |   |   |
|---|---|
| <input type="checkbox"/> Military           | <input type="checkbox"/> Broadcasting       |
| <input type="checkbox"/> Radio-TV Servicing | <input type="checkbox"/> Home Experimenting |
| <input type="checkbox"/> Manufacturing      | <input type="checkbox"/> Telephone Company  |
| <input type="checkbox"/> Amateur Radio      | <input type="checkbox"/> Other .....        |

In what kind of work  
are you now engaged?  
.....

In what branch of  
Electronics are you  
interested? .....

Name ..... Age.....

Address .....

City ..... Zone..... State .....

EI-33

**ENGINEERING  
SCIENCE  
MATH**

**DEGREE IN  
27 or 36 MOS.**



**B.S. degree — 36 mos. • B.E. degree — 27 mos.**

ACCELERATED YEAR-ROUND PROGRAM prepares for early employment in fields of SCIENCE AND ENGINEERING. Regular 4-year program for B.S. Degree completed in 36 months, special engineering degree program in 27. Classes start—June, July, Sept., January, March. **QUALITY EDUCATION.** Graduates employed from coast to coast. Government approved for veteran training. Students from 50 states, 40 countries. 20 buildings; dorms, gym. Campus. **SAVE TIME AND MONEY. EARN BOARD** while studying. Write for catalog and complete information.

**INDIANA TECHNICAL COLLEGE**

2471 East Washington Boulevard, Fort Wayne 2, Indiana  
Please send me free information on Bachelor's Degree Programs in Engineering and Science as checked below:

- |   |  |
|---|--|
| <input type="checkbox"/> Aeronautical Engineering | <input type="checkbox"/> Mechanical Engineering    |
| <input type="checkbox"/> Chemical Engineering     | <input type="checkbox"/> Metallurgical Engineering |
| <input type="checkbox"/> Civil Engineering        | <input type="checkbox"/> Physics                   |
| <input type="checkbox"/> Electrical Engineering   | <input type="checkbox"/> Chemistry                 |
| <input type="checkbox"/> Electronic Engineering   | <input type="checkbox"/> Mathematics               |

Name .....

Address .....

**BIGGEST DICTIONARY IN POCKET SIZE  
THE WORLD FAMOUS**

**WEBSTER'S  
NEW SCHOOL AND OFFICE  
DICTIONARY**

T433

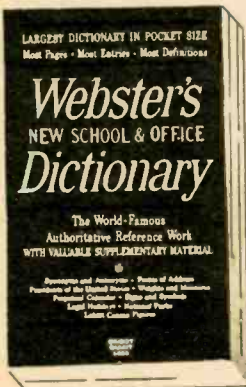

896 pages—More than 52,000 entries. Plus handy reference lists, charts and tables.

- Latest Census figures
  - Synonyms & Antonyms
- Signs & Symbols
- Weights & Measures
  - Perpetual Calendar

and other important supplementary material.

**IDEAL FOR CONTESTS AND CROSSWORD PUZZLES**

ONLY 75¢

**A CREST GIANT ON SALE WHEREVER PAPERBACKS ARE SOLD**

Buy this Crest Giant from your local newsdealer. If your dealer is sold out, send only 75¢ plus 10¢ for postage and handling to Crest Books, Fawcett Publications, Inc., Greenwich, Conn. If order is for five or more books, no postage or handling charge is necessary. Please order by number and title. No Canadian orders.

**ELECTRONICS  
ILLUSTRATED**



is your guide to the

**WONDERFUL  
WORLD OF  
ELECTRONICS**

Your leisure time is pleasure time if electronics is your hobby. Subscribe now to EI for exciting feature and construction articles on . . .

- Citizens Band Radio
- Amateur Radio
- Short-Wave Listening
- High-Fidelity
- New Products
- Kit Building
- Test Equipment

You get all this and much more in the complete magazine for electronics hobbyists!

YES, please enter my subscription to **ELECTRONICS ILLUSTRATED**

- I ENCLOSE \$2 FOR 6 ISSUES
- BILL ME LATER

NAME .....

ADDRESS .....

CITY..... ZONE.... STATE.....

Mail to: **ELECTRONICS ILLUSTRATED**  
Circulation Dept.  
Fawcett Bldg., Greenwich, Conn. EI-7



# Marketplace

small size. The standard CBQ with bamboo radial arms lists for \$39.50 and a

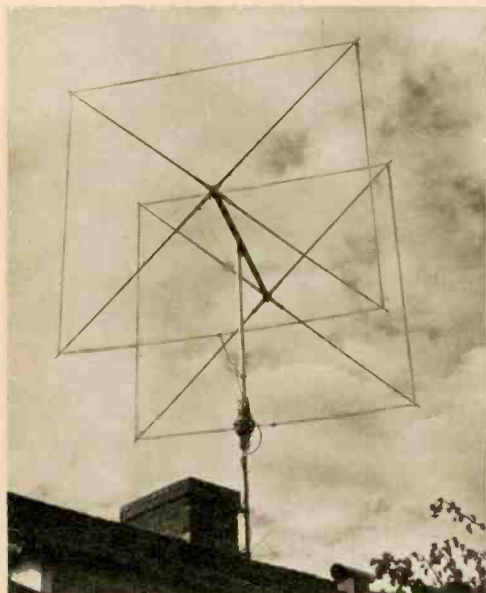

deluxe model with fiberglass arms is priced at \$64.50.

Cubex is at 3322 Tonia Ave., Altadena, Calif.



**Meter Magic . . .** As you turn the range switch of a new VOM called V O Matic 360, the correct scale clicks into view on the face. All 18 scales are direct-reading and do not require multiplica-



# RCA MARK VII RADIO-PHONE



**"TOP-OF-THE-LINE"  
CITIZENS' BAND  
2-WAY RADIO  
EQUIPMENT—  
GIVES YOU  
THE MOST!**

## PROVEN PERFORMER FOR BUSINESS OR PLEASURE

This quality equipment from the leader is a leader in performance . . . dependability. Operates from car, home, office, boat or truck. Terrific for business or pleasure two-way communications. Can be used at any location having 6 or 12 volt DC or standard 115 AC power source.

High reliability, stable reception, solid transmission. Provides four crystal controlled channels for both transmit and receive; also manual receiver tuning for all 23 channels. A tremendous value from the leader!

See your RCA Radio-Phone dealer. Or mail coupon.

**ONLY  
\$189<sup>95</sup>**

Manufacturer's  
Nationally Advertised Price



RADIO CORPORATION OF AMERICA  
Telecommunication Center  
Dept. X 411  
Meadow Lands, Pa.

Please send me FREE literature on the new RCA Mark VII Citizens' Band 2-Way Radio.

NAME \_\_\_\_\_

ADDRESS \_\_\_\_\_ PHONE \_\_\_\_\_

CITY \_\_\_\_\_ ZONE \_\_\_\_\_ STATE \_\_\_\_\_



The Most Trusted Name  
in Electronics

RADIO CORPORATION OF AMERICA

# voices from outer space...

**SPECIAL OFFER, 25¢**

## Dramatic Events Recorded First Time From Short Wave Radio!

President's voice from outer space... police capture of a gunman... radio contact with record altitude flight! Many other fascinating, historic events—ships, planes, foreign stations—all transcribed on a limited-edition recording, "The Amazing World of Short Wave Listening," narrated by world-famous newscaster Alex Dreier. If you're alert, adventuresome, send for this remarkable recording today!

As heard on Hallicrafters precision receivers, \$59.95 to \$395.00.



**Hallicrafters**

Department 35,  
Chicago 11, Ill.

Enclosed is 25¢. Please rush my copy of "The Amazing World of Short Wave Listening."

NAME \_\_\_\_\_

ADDRESS \_\_\_\_\_

CITY \_\_\_\_\_

STATE \_\_\_\_\_

# 10% OFF

## ON EVERY ORDER of \$10 or more

- One Day Service
- Individually Boxed
- All Tubes Unconditionally Guaranteed for 1 year

### ANY TUBE 41c

Partial Listing

0Z4	6AG7	6BQ6GTB/	6SQ7	12BY7A
1B3	6AG5	6CU6	6T8A	12SA7
1B5	6AL5	6BQ7	6U8A	12SK7
1S5	6AK5	6BZ7	6V6GT	12SQ7
1T4	6AN8	6C4	6W4GT	12X4
1U4	6AQ5A	6CB6	6W6GT	25L6GT
1U5	6AT6	6CD6	6X4	35C5
1X2B	6AU6	6CG7	6X5GT	36L6GT
3BZ6	6AW8A	6DQ6A	12AT6	35W4
3CB6	6AX4	6J6	12A7	35Z5GT
3S4	6BA6	6K6GT	12AV6	50A5
3V4	6BC5	6L6B	12AU7A	50B5
5U4GB	6BE6	6S4A	12AX7	50C5
5U8	6BG6	6K7	12BA6	50L6
5X8	6BK7B	6SN7GTB	12BE6	
5Y3GT	6BL7		12BH7A	

TERMS: No minimum order • Free postage on orders over \$5. 25% deposit required on C.O.D.'s. All tubes new and/or used.

Write Dept. E6 for Tube Mart's Complete Tube Listing.

## TUBE MART DISCOUNT HOUSE

Electronic Building, Paterson, N. J. • AR 4-4250

# Marketplace

tion or other interpretation. A knife-edge pointer against a mirrored background makes possible precise readings on current, voltage and resistance. The meter movement is protected against burnout and has a rating of 20,000 ohms per volt DC and 5,000 ohms/volt on AC. The ohms-adjust control includes a switch that automatically short-circuits the test leads for zero adjustment. Another built-in convenience is a polarity reversing switch. Price is about \$60.

B&K Manufacturing Co., 1801 W. Belle Plain Ave., Chicago 13, Ill.

What Is It? . . . That's the first question people ask when they catch a glimpse of a new Electro-Voice microphone. Some guess it's an air-cooled gun. The mike is listed as the Model 644 Sound Spot, its chief characteristic being extremely sharp directivity. It has to be aimed pretty much like a gun at the sound to be picked up.

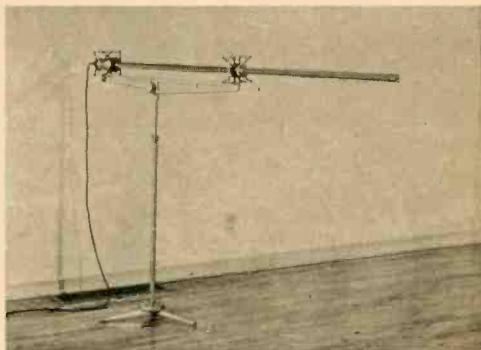

The Sound Spot permits great latitude in loudspeaker placement in public address systems, where feedback from loudspeakers often limits the usefulness of an installation. It solves some specialized recording problems, and professional eavesdroppers also may find it of interest since they have used shotgun mikes for years (although the trend now is toward small pickups placed close to the subject). Price of the Sound Spot is about \$110.

Electro-Voice, Inc., Buchanan, Mich.



# Marketplace

**Little Booster . . .** A pre-amplifier that fits inside the standard 14-pin base of an image orthicon TV tube has been developed by the Dage Division of Thompson Ramo Woolridge, Inc., Michigan City, Ind. Because the connecting leads

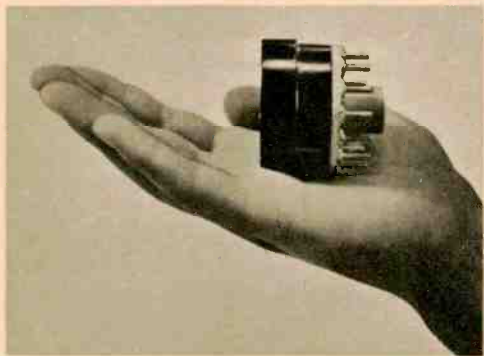

to the tube are less than an inch long, stray pick-up of unwanted video signals is greatly reduced. The transistorized amplifier is potted into the tube base.

**Electro-Chemical Meter . . .** A unique direct-reading ampere-hour meter, operating on electro-chemical rather than conventional electro-mechanical principles, has been developed by Curtis Instruments, Inc., Mount Kisco, N. Y. The meter is a glass tube two inches long

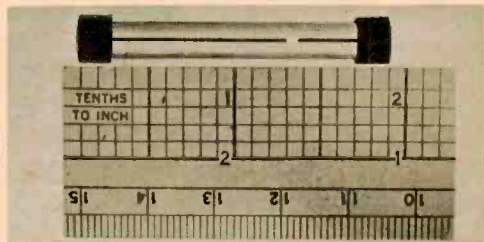

and a quarter of an inch in diameter. At first glance it looks like a burned-out fuse. When subjected to direct current, it undergoes chemical changes that cause the gap between the end caps to shift position. It is a simple matter to calibrate the device on the basis of current flow vs. elapsed time. The operation is reversible according to polarity,

**TV-RADIO Servicemen or Beginners . . .**

Send for *Coyne's*  
7-Volume Job-Training Set  
on 7-Day **FREE TRIAL!**



The First  
Practical  
TV-RADIO-  
ELECTRONICS  
Shop  
Library!

**Answers ALL Servicing Problems QUICKLY . . .  
Makes You Worth More On The Job!**

Put money-making, time-saving TV-RADIO-ELECTRONICS know-how at your fingertips—examine Coyne's all-new 7-Volume TV-RADIO-ELECTRONICS Reference Set for 7 days at our expense! Shows you the way to easier TV-RADIO repair—time saving, practical working knowledge that helps you get the BIG money! How to install, service and align ALL radio and TV sets, even color-TV, UHF, FM and transistorized equipment. New photo-instruction shows you what makes equipment "tick." No complicated math or theory—just practical facts you can put to use immediately right in the shop, or for ready reference at home. Over 3000 pages; 1200 diagrams; 10,000 facts!

**SEND NO MONEY!** Just mail coupon for 7-Volume TV-Radio Set on 7-Day FREE TRIAL! We'll include the FREE BOOK below. If you keep the set, pay only \$3 in 7 days and \$3 per month until \$27.25 plus postage is paid. Cash price only \$24.95. Or return set at our expense in 7 days and owe nothing. Either way, the FREE BOOK is yours to keep. Offer limited, so act NOW!

**"LEARNED MORE FROM THEM THAN FROM 5 YEARS WORK!"**

"Learned more from your first two volumes than from 5 years work."  
—Guy Bliss, New York  
"Swell set for either the serviceman or the beginner. Every serviceman should have one."  
—Melvin Masbruch, Iowa.

**FREE DIAGRAM BOOK!**

We'll send you this big book, "150 Radio-Television Picture Patterns and Diagrams Explained," ABSOLUTELY FREE just for examining Coyne's 7-Volume Shop Library on 7-Day FREE TRIAL! Shows how to cut servicing time by reading picture-patterns, plus schematic diagrams for many TV and radio sets. Yours FREE whether you keep the 7-Volume Set or not! Mail coupon TODAY!



**Like Having An Electronics Expert Right At Your Side!**

**VOL. 1—EVERYTHING ON TV-RADIO PRINCIPLES!** 300 pages of practical explanations; hundreds of illustrations.

**VOL. 2—EVERYTHING ON TV-RADIO-FM RECEIVERS;** 403 pages; fully illustrated.

**VOL. 3—EVERYTHING ON TV-RADIO CIRCUITS!** 336 pages; hundreds of illustrations, circuit diagrams.

**VOL. 4—EVERYTHING ON SERVICING INSTRUMENTS!** How they work, how to use them. 368 pages; illustrated.

**VOL. 5—EVERYTHING ON TV TROUBLESHOOTING!** Covers all types of sets. 437 pages; illustrations, diagrams.

**VOL. 6—TV CYCLOPEDIA!** Quick and concise answers to TV problems in alphabetical order, including UHF, Color TV and Transistors; 868 pages.

**VOL. 7—TRANSISTOR CIRCUIT HANDBOOK!** Practical Reference covering Transistor Applications; over 200 Circuit Diagrams; 410 pages.

**BOOKS HAVE BRIGHT, VINYL CLOTH WASHABLE COVERS**

**FREE BOOK—FREE TRIAL COUPON!**

Educational Book Publishing Division  
**COYNE ELECTRICAL SCHOOL**  
1455 W. Congress Parkway, Dept. 71-E1 Chicago 7, Ill.

Yes! Send me COYNE'S 7-Volume Applied Practical TV-RADIO-ELECTRONICS Set for 7-Days FREE TRIAL per offer. Include "Patterns & Diagrams" book FREE!

Name . . . . . Age . . . . .

Address . . . . .

City . . . . . Zone . . . . . State . . . . .

Check here if you want Set sent C.O.D. Coyne pays postage on C.O.D. and cash orders. 7-Day Money-Back Guarantee.

**Coyne**

Educational Book Publishing Division  
**ELECTRICAL SCHOOL**  
1455 W. Congress Parkway Dept. 71-E1, Chicago 7, Illinois

# 2 New easy-to-build KITS from H. H. Scott

Here are kits that make you a professional! Kits you can build that look and perform like factory units.  
• Kit-Pak box opens to work-table • All wires pre-cut, pre-stripped • All mechanical parts pre-riveted to chassis • Parts mounted on special Part-Charts in order you use them, simplifies and speeds assembly • Beautiful gold-finish panel harmonizes with H. H. Scott wired components.



### LT-10 FM TUNER KIT

Professional H. H. Scott Wide-Band tuner with pre-aligned, pre-mounted silver-plated front end. Uses Ez-A-Line alignment system... no special tools... entire alignment takes 15 minutes.  
**\$89.95\***



### LK-72 72 WATT STEREO AMPLIFIER KIT

Plenty of power for any speaker systems. Fabulous H. H. Scott features never before available in a kit: Separate bass and treble controls, center channel control, tape recorder monitor, many more.  
**\$149.95\***



## H. H. SCOTT

H. H. SCOTT Inc. 111 Powdermill Rd., Maynard, Mass. Dept. 130-07

Send me details on your new kits and stereomaster components for 1961.

Name \_\_\_\_\_

Address \_\_\_\_\_

City \_\_\_\_\_

State \_\_\_\_\_

\*Slightly higher west of Rockies. Accessory case extra.

Export: Telesco International Corp., 36 W. 40th St., N.Y.C.



studying antenna system in Tri-State's electronics lab

## double your income with degree . . . . .

A college education is a good investment! Important firms visit our campus to interview seniors. *They like Tri-State graduates!* Become an Electronics Engineer. **BACHELOR OF SCIENCE DEGREE IN 27 MONTHS** in Electrical (Electronics or Power major), Mechanical, Chemical, Aeronautical, Civil Engineering. **IN 36 MONTHS** a B.S. in Business Administration (General Business, Acctg., Motor Transport Mgt. majors). For earnest, capable, mature students. Enrollment limited. Small classes. More professional class hours. Campus. Well-equipped labs, modernized buildings, new dorms. *Modest costs.* Enter Sept., Jan., Mar., June. Write *J. A. McCarthy, Admissions,* for Catalog and "Your Career" Book.



## TRI-STATE COLLEGE

4871 College Avenue • Angola, Indiana

# Marketplace

giving a convenient reset feature.

The meter works on any DC voltage and requires only a series resistor to adjust the operating current to the desired time range. For normal applications the current is less than 100 microamperes and, therefore, imposes no appreciable drain on the power supply. The instrument is ideal as a battery life indicator or warning signal for such portable instruments as radios, tape recorders, hearing aids, medical devices and radiation detectors.



**Kernel Comparison . . .** American electronics manufacturers are showing the Japanese that they, too, can make sub-sub-miniature equipment. A new development in this direction is Micram, defined as "microminiature individual components reliable assembled modules" (the Japanese might be able to beat that, English-wise).

The photo shows a sample flip-flop

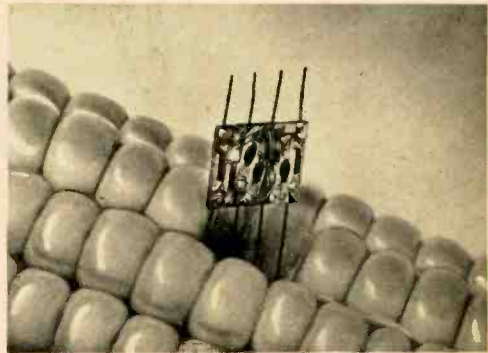

oscillator stuck into an ear of corn for size comparison.

Micram is a joint effort of seven companies: Cleveland Metal Specialties, Wilrite Products, Aerovox, Formica, Pacific Semi-Conductors, Raytheon and Sylvania.

The makers stress that these assemblies offer high reliability under adverse conditions, such as those encountered by space vehicles.





**THE  
A. E. S.**

*Gigolo*

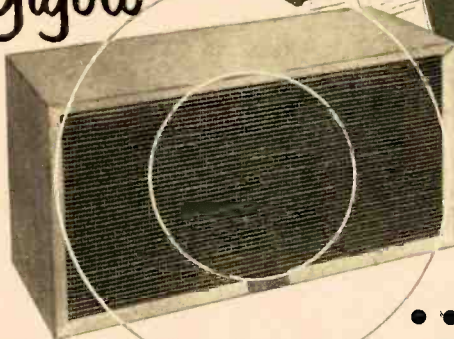

.....A  
**MIRACLE IN SOUND**

After two years of research and development, a speaker system we can offer to the public on a 100% MONEY BACK GUARANTEE. Compare the A. E. S. Gigolo, to any bookshelf speaker, regardless of price and if you do not feel that the Gigolo is the most outstanding unit you have heard, you may return it for a full purchase price refund.

Thousands of these gigolos are now in use all over the country. The acceptance has been unbelievable. Never before a sound so realistic to so many people in so many different homes! These are the facts that enable A.E.S. to make this bold offer.

Size —

24" wide, 12" high, 9 1/2" deep.

Power Handling Capacity —

The Gigolo is extremely flexible. May be used with small economy amplifiers of very low wattage, as well as with the highest power component amplifiers with satisfactory results.

Frequency Response —

The Gigolo will reproduce both high and low frequencies in excess of the requirements of even the most critical home listener.

Order now to insure prompt delivery

Price — \$15.00, F.O.B. factory  
Unfinished only

Price subject to change within thirty days  
of the issuance of this magazine

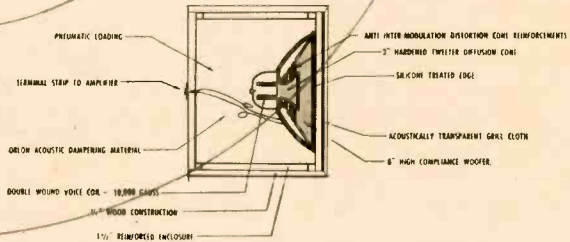

**ORDER BLANK**

A.E.S., Inc.  
3338 Payne Avenue, Cleveland, Ohio

Gentlemen please ship \_\_\_\_\_ GIGOLOS.

I understand these units are guaranteed and if I am not satisfied I may return for a full refund of sales price, \$15.00 each.

Name \_\_\_\_\_

Address \_\_\_\_\_

City and State \_\_\_\_\_

Enclosed find check \_\_\_\_\_ money order \_\_\_\_\_

# Marketplace

**Tools for Beginners . . .** Planning to give an electronic kit to a youngster just getting interested in radio, hi-fi and model control? A smart idea is to include a kit of basic tools, such as the Paco TK-6. This includes long-nose and



side-cutter pliers, wire stripper, two screwdrivers and soldering iron in a see-through case. Price is about \$10.

Paco Electronics Co., Inc., Glendale 27, N. Y.

**Alarming Development . . .** A thumb-size light-sensitive cadmium sulphide cell that is sensitive both on the top and sides is announced by the Amperex Electronic Corp., Hicksville, N. Y. Called the ORP50, it is hermetically

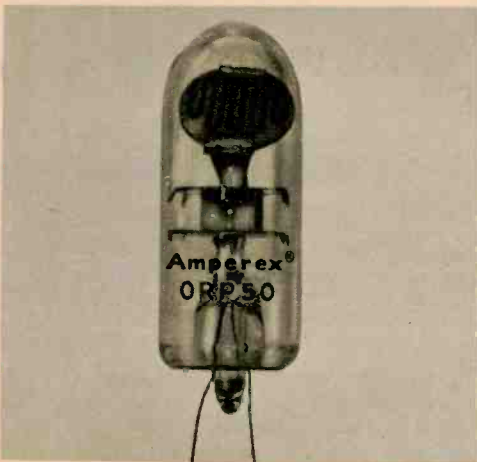

sealed and of strong construction. It can be used for such purposes as flame and fire warning, on-off switching by interrupted light beams, automatic counting and density control.

The ORP50 is about 5/8-inch in diameter and 1 1/2 inches long.

**TV-FM-System Kit . . .** A do-it-yourself home TV-FM system kit that can feed as many as four TV or FM receivers has been brought out by Blonder-Tongue Laboratories, Inc., Newark, N. J. The kit has a new type of indoor antenna. The antenna elements are imbedded in the cardboard con-



tainer of the kit. When the container is unfolded, it forms a flat sheet six feet long and 18 inches wide, which can be tacked down on the attic floor or put into a closet or crawl space or behind a sofa. The kit includes a four-set coupler, a roll of twin-lead and installation hardware. List price is about \$10.

**Room Divider Furniture . . .** A variety of combinations is possible with the Knight room-divider stereo system furniture offered by Allied Radio Corp., Chicago. The stereo furniture consists of supporting poles with pre-drilled holes, plus divider shelves and matching cabinets.

Matching accessories include a cabinet that can be used for record storage or for tuner, amplifier and record changer, and a speaker enclosure which is fastened to the supporting poles.

The units have an oiled walnut finish and the poles a satin brass finish. The



**NOW!**  
at a price  
you can afford!

# MAKE MORE MONEY in ELECTRONICS TELEVISION-RADIO

**BETTER...MORE COMPLETE...LOWER COST...  
WITH NATIONAL SCHOOLS SHOP-METHOD  
HOME TRAINING!**

**BETTER...** Training that is proved and tested in Resident School shops and laboratories, by a School that is the **OLDEST** and **LARGEST** of its kind in the world.

**MORE COMPLETE...** You learn **ALL PHASES** of *Television-Radio-Electronics*.

**LOWER COST...** Other schools make several courses out of the material in our **ONE MASTER COURSE**... and you pay more for less training than you get in our course at **ONE LOW TUITION!**

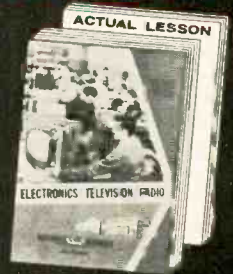

These  
**two FREE** books will  
show you how!

You get all information  
by mail... You make  
your own decision... at  
home! **NO SALESMAN  
WILL CALL**

## TOP PAY... UNLIMITED OPPORTUNITIES LIFETIME SECURITY CAN BE YOURS!

You are needed in the Television, Radio, and Electronics industry! Trained technicians are in growing demand at excellent pay—in **ALL PHASES**, including Servicing, Manufacturing, Broadcasting and Communications, Automation, Radar, Government Missile Projects.

**NATIONAL SCHOOLS SHOP-METHOD HOME TRAINING**, with newly added lessons and equipment, trains you in your spare time at home, for these unlimited opportunities, including many technical jobs leading to supervisory positions.

**YOU LEARN BY BUILDING EQUIPMENT WITH KITS AND PARTS WE SEND YOU.** Your National Schools course includes thorough Practical training—**YOU LEARN BY DOING!** We send you complete standard equipment of professional quality for building various experimental and test units. You advance step by step, more than 100 experiments, and you build a complete TV set from the ground up that is yours to keep! A big, new TV picture tube is included at no extra charge.

**EARN AS YOU LEARN.** We'll show you how. Many students pay for their course—and more, while studying.

**GET THE BENEFIT OF OUR  
OVER 50 YEARS EXPERIENCE**

APPROVED FOR  
GI TRAINING



ACCREDITED  
MEMBER



**NATIONAL TECHNICAL SCHOOLS**  
World-Wide Training Since 1905

Write to Dept. R4Y-61  
4000 So. Figueroa Street  
Los Angeles 37, California

## YOU GET...

- 19 Big Kits—**YOURS TO KEEP!**
- Friendly Instruction and Guidance
- Job Placement Service
- Unlimited Consultation
- Diploma—Recognized by Industry
- **EVERYTHING YOU NEED FOR SUCCESS!**

**RESIDENT TRAINING AT LOS ANGELES**  
If you wish to take your training in our famous Resident School in Los Angeles—the oldest and largest school of its kind in the world—check special box in coupon.

**SEND FOR FREE FULLY-ILLUSTRATED BOOK AND ACTUAL LESSON TODAY.**

Your own copy of "Your Future in Electronics-Television-Radio" will be mailed to you at once. No salesman will call; there is no obligation. Cut out card along dotted lines, fill in name and address, then mail today.

**NO  
POSTAGE  
NECESSARY**

FIRST CLASS  
Permit No. 3087  
Los Angeles, Calif.

**BUSINESS REPLY MAIL**  
NO POSTAGE STAMP NECESSARY IF MAILED IN THE UNITED STATES

— POSTAGE WILL BE PAID BY —

**NATIONAL TECHNICAL SCHOOLS**

WORLD-WIDE TRAINING SINCE 1905

4000 So. Figueroa Street  
Los Angeles 37, California

Dept. R4Y-61

Name \_\_\_\_\_  
Address \_\_\_\_\_  
City \_\_\_\_\_ Zone \_\_\_\_\_ State \_\_\_\_\_  
 Check if interested only in Resident Training at Los Angeles

# FAWCETT HOW-TO BOOKS

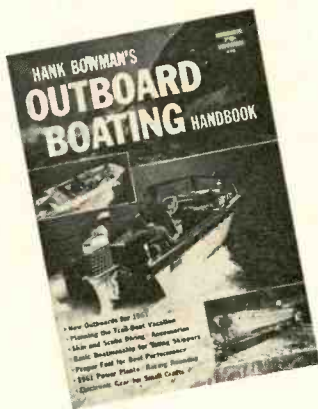
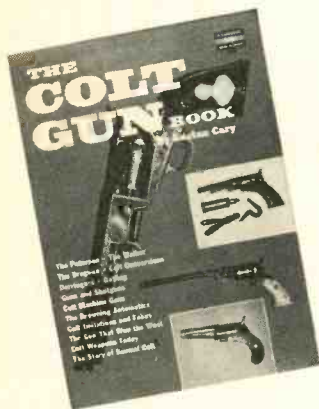

**THE COLT GUN BOOK** • Paterson, Walker, Dragoon, Gatling, etc., by gun authority, Lucian Cary. (No. 477)  
Also available in hard cover edition at \$2.50 per copy.

**BOWMAN'S OUTBOARD BOATING HANDBOOK** • 1961 outboards, racing, accessories, fuel, etc. (No. 476)

**ELECTRONICS HANDBOOK** • Radio controlled models, marine radio, test equipment, kits, careers, etc. (No. 475)

**TV REPAIR SIMPLIFIED** • Tube layout and service diagrams, over 100 trouble photos, detailed index. (No. 474)  
Also available in hard cover edition at \$2.50 per copy.

**FAMILY BOATING** • Compact cruisers, houseboats, motors, controls, catamarans, wind, towing, etc. (No. 473)  
Also available in hard cover edition at \$2.50 per copy.

**SALON PHOTOGRAPHY** • Portraits, glamor, special section; cameras, film, professional techniques. (No. 472)

**Borgeson's KARTING HANDBOOK** • Chassis design, engine care, souping, rebuilding, driving, etc. (No. 471)

**HOW TO BUILD 20 BOATS** • Detailed plans on runabouts, hydros; inboard, outboard, novelty boats. (No. 470)

**STEREO HI-FI HANDBOOK** • What stereo is, component specifications simplified, tapes, etc. (No. 469)

**MI ELECTRICAL REPAIRS YOU CAN MAKE** • Cords, plugs, wiring, fuses, circuit breakers, fixtures. (No. 468)

**HANDY MAN'S HOME MANUAL** • Finishing techniques, tools, plywood joining, indoor, outdoor projects. (No. 467)

**HOW TO BUILD IT** • Instructions, how-to photos for playground area, furniture, cabin trailer, etc. (No. 466)

**BEST HOT RODS** • Bonneville NHRA roundups, kart engines, compact souping, superchargers. (No. 465)

**ELECTRONIC IDEAS** • Electronic ignition analyzer, grid dip meter, kits, tools, TV tips, equipment. (No. 464)

**How To Be An Expert At SHOTGUN SHOOTING** • Trapshooting, skeet, sighting, body control, etc. (No. 463)

**HI-FI GUIDE** • New stereophonic, monaural components, kits, installations, enclosures, speakers. (No. 462)

**GOOD PHOTOGRAPHY** • Animals, children, glamor, portraits, nudes, water scenes, salon section. (No. 461)

**THE FIRST WAR PLANES** • First fighters, scouts, bombers, WW I aces, combat, U. S. squadrons. (No. 460)

**PLUMBING AND HEATING HANDBOOK** • Tools, techniques, materials, repairs, oil burners, pipes. (No. 459)

**PRIZE WINNING PHOTOGRAPHY** • National winners, portraits, children, nudes, glamor, salon section. (No. 458)

**HANDBOOK OF HOME IMPROVEMENTS** • Kitchens, attic, basement ideas, space-savers, patios. (No. 457)

**GOOD PHOTOGRAPHY'S 35MM HANDBOOK** • Motor cameras, darkroom, exposure meters, salon. (No. 456)

To order direct, send 75c per copy for regular edition or \$2.50 per copy for De Luxe edition to: FAWCETT BOOKS, Dept. EI-7, Greenwich, Conn. Add 10c per copy mailing charge for all books. Specify title and number. Canadian orders cannot be accepted.

A FAWCETT  
HOW-TO BOOK 75c

**AT YOUR LOCAL NEWSSTAND, LEADING DRUG STORE, SUPER MARKET, HARDWARE STORE AND BUILDING SUPPLY DEALER**



# Marketplace



poles are hollow, allowing concealment of connecting cables. A purchaser can obtain the furniture in modules to fit the space available, or buy a piece at a time as finances permit.



**New Depth Recorder . . .** Introduced by Apelco of San Francisco is priced in the small-boat range with a tag of \$285. Called the MR-200, the unit can sound down to 240 feet in two ranges and provides a permanent trace on moving graph paper. Besides depth, the instru-



ment indicates bottom conditions and locates underwater objects and schools of fish. The MR-200 comes with a transducer designed for through-hull mounting. It measures 6½ inches high, 12½ inches wide and 7¼ inches deep. It operates only on 12 volts DC and draws two amperes. ⚡

a wire-stripping notch

that **REALLY WORKS!**

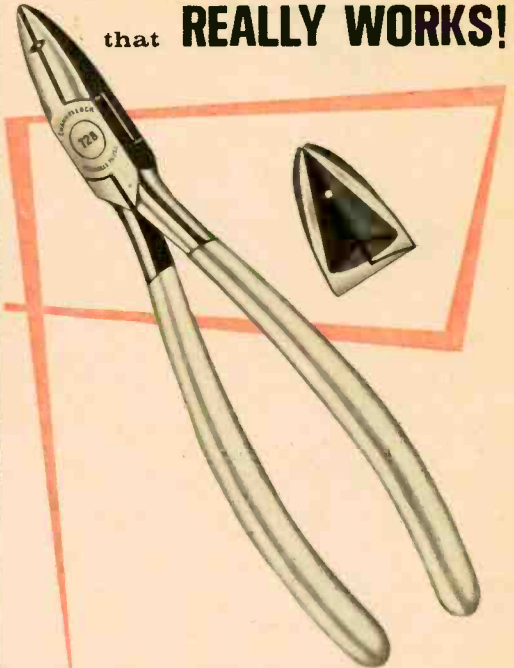

Specially Designed

**CHAN NEL LOCK**®

No. 728 Long-reach

**Diagonal Cutter**

You'll strip off plastic insulation quick as a wink—clean and smooth—with the patented wire-stripping notch of this CHANNELLOCK Diagonal Cutter. And you'll like the handy long reach . . . the precision-matched, hand honed cutting edges, too; A versatile cutter for electrical, radio, TV, Hi-Fi and all other types of electronics work. Comfortable, blue-plastic grips. Top quality, polished forged steel. Ask your tool supplier for a CHANNELLOCK No. 728 Diagonal Cutter. If he's out of them, ask him to order one for you.



Write for Catalog of Complete Line of Pliers

**CHAMPION DEARMENT TOOL COMPANY**  
Meadville 3, Pennsylvania

## BEST BUYS IN STEREO AND MONO HI-FI

New Stereo/Mono 4-Track Tape Deck RP100 Semikit (electronics in kit form) \$289.95 Wired \$395.00



New FM-AM Stereo Tuner ST96 Kit \$89.95 Wired \$129.95 Incl. FET



New 70-Watt Integrated Stereo Amplifier ST70 Kit \$94.95 Wired \$144.95



New 40-Watt Integrated Stereo Amplifier ST40 Kit \$79.95 Wired \$124.95

FM Tuner HFT90 Kit \$39.95 Wired \$65.95 Incl. FET Metal Cover \$3.95



28W Integrated Stereo Amplifier HF81 Kit \$69.95 Wired \$109.95



AM Tuner HFT94 Incl. FET Kit \$39.95 Wired \$65.95



Stereo Preamplifier HF85 Kit \$39.95 Wired \$64.95

Stereo Power Amplifiers Kit Wired  
100W HF89: \$99.50 \$139.50  
70W HF87: \$74.95 \$114.95  
28W HF86: \$43.95 \$ 74.95



Stereo/Mono Changer/Player 1007 with stereo cartridge and dual sapphire styli \$49.75



Bookshelf Speaker System HFS1 Kit \$39.95 Wired \$47.95



## BEST BUYS IN CITIZENS TRANSCEIVERS, HAM GEAR, RADIOS

Citizens Band Transceivers from Kit \$59.95 Wired \$89.95



New 60W CW Transmitter =723 Kit \$49.95 Wired \$79.95



Transistor Portable Radio R66 Kit \$29.95 Wired \$49.95 Incl. FET



## BEST BUYS IN TEST EQUIPMENT

New Metered Variable AC Bench Supplies Model 1073 (3 amps) Kit \$35.95 Wired \$47.95 Model 1078 (7 1/2 amps) Kit \$42.95 Wired \$54.95



Peak-To-Peak VTVM =232 & Uni-Probe® Pat. =2,790,051 Kit \$29.95 Wired \$49.95 VTVM =221 Kit \$25.95 Wired \$39.95



DC-5 MC 5" Scope =460 Kit \$79.95 Wired \$129.50 5" Push-Pull Scope =425 Kit \$44.95 Wired \$79.95



Tube Tester =625 Kit \$34.95 Wired \$49.95



RF Signal Generator =324 Kit \$26.95 Wired \$39.95



1000 Ohms/Volt V-O-M =536 Kit \$12.90 Wired \$14.90



6- & 12V Battery Eliminator & Charger =1050 Kit \$29.95 Wired \$38.95 Extra-filtered for transistor equip. =1060 Kit \$38.95 Wired \$47.95



R-C Bridge & R-C-L Comparator #950B Kit \$19.95 Wired \$29.95



Multi-Signal Tracer =145A Kit \$19.95 Wired \$28.95



# EXCELLENCE IN CREATIVE ELECTRONICS

Over 2 MILLION EICO instruments in use throughout the world. Compare, take them home — right "off the shelf" — from 1500 neighborhood dealers, most of whom offer budget terms.



EICO, 3300 N. Blvd., L.I.C. 1, N.Y. EI-7  
 Send free Catalog describing over 80 top-quality products, free Stereo Hi-Fi Guide, free Short Course for Novice License, name of nearest EICO dealer.  Send new 36-page GUIDEBOOK TO HI-FI for which I enclose 25¢ for postage & handling.

Name.....  
 Address.....  
 City..... Zone .. State.....  
 Add 5% in the West



*for your car:*

## **An FM Tuner**

**Hi-fi on the highway can be yours at low cost.**

**Tuner features a prealigned front-end and AFC.**

**By Len Buckwalter**

**C**OMPARED to the number of home-brew AM sets built by the hobbyist, FM sets run a poor second . . . and with good reason. FM tuners usually require skill and special equipment for good performance. But the unit described here enables the builder to neatly detour the problem with a packaged "front end"—a small subassembly that completely eliminates the headaches of critical wiring and alignment. The remainder of the tuner is relatively simple.

Tested under rigorous conditions by tuning in FM stations while driving along, this tuner proved capable of excellent performance. An AFC circuit kept the station zeroed in despite the voltage fluctuations from the car's generator. During the check-out, reception faltered only when the car was more than 40 miles from metropolitan FM stations.

The cost of parts is less than half that of a typical commercial unit selling for around \$80. Savings are realized by using the existing audio amplifier and speaker in the car's AM radio. In 6-volt cars, the AM radio can also furnish the necessary voltages; with 12-

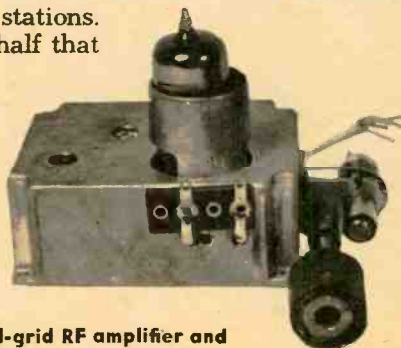

**Front-end uses dual triode as grounded-grid RF amplifier and autodyne converter. Text has details of tape-wound pulley.**

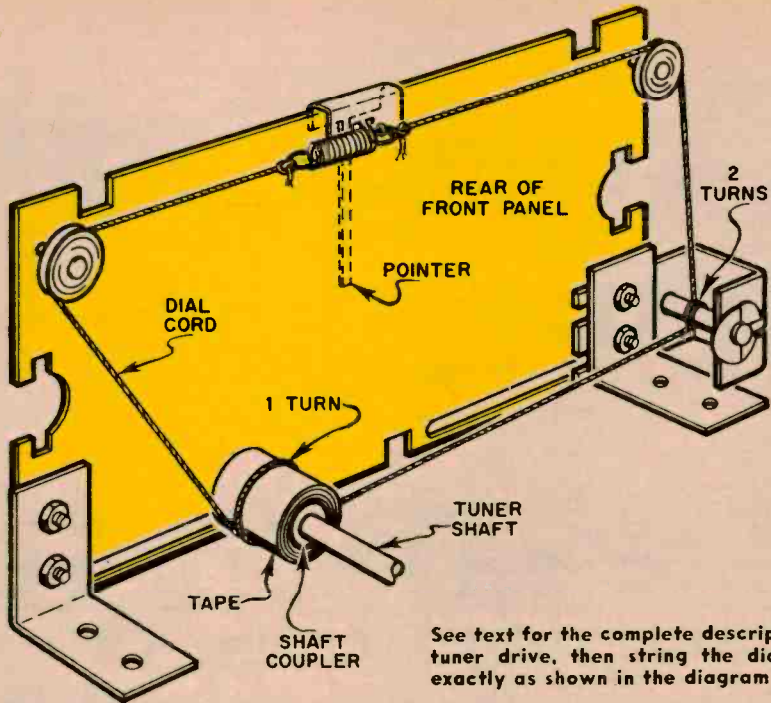

See text for the complete description of tuner drive, then string the dial cord exactly as shown in the diagram above.

Dial assembly is held in place with L-brackets. For lug clearance, mount tuning unit above chassis on four spacers.

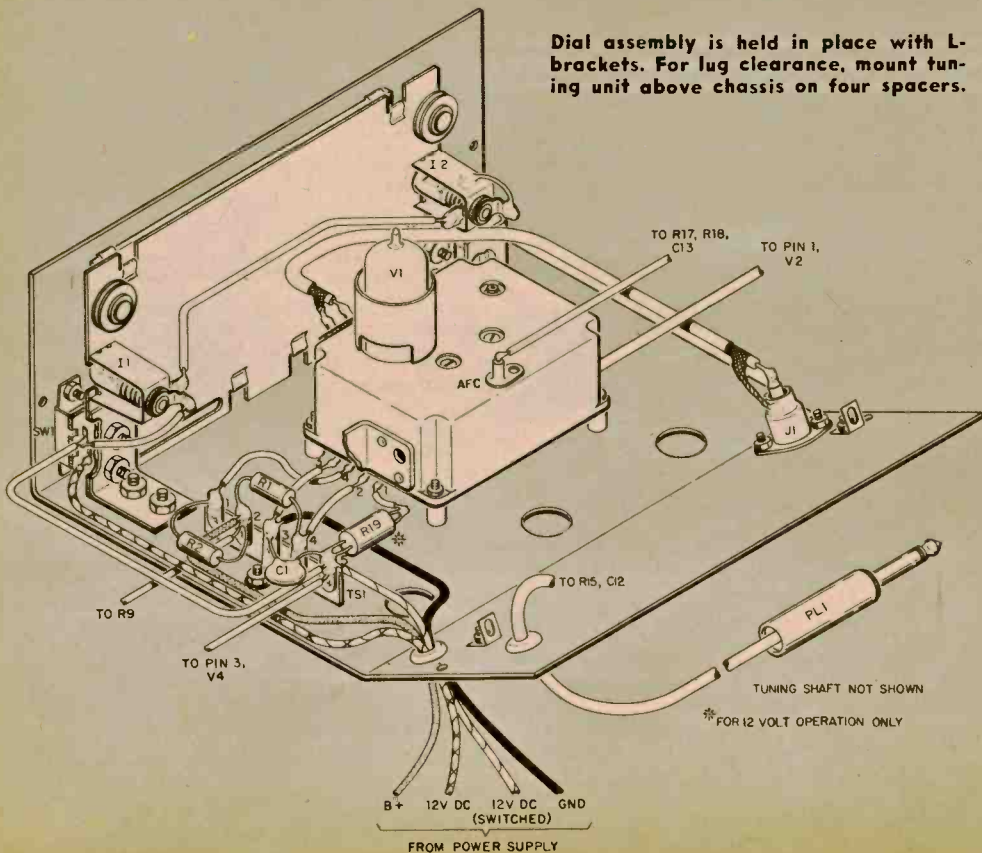



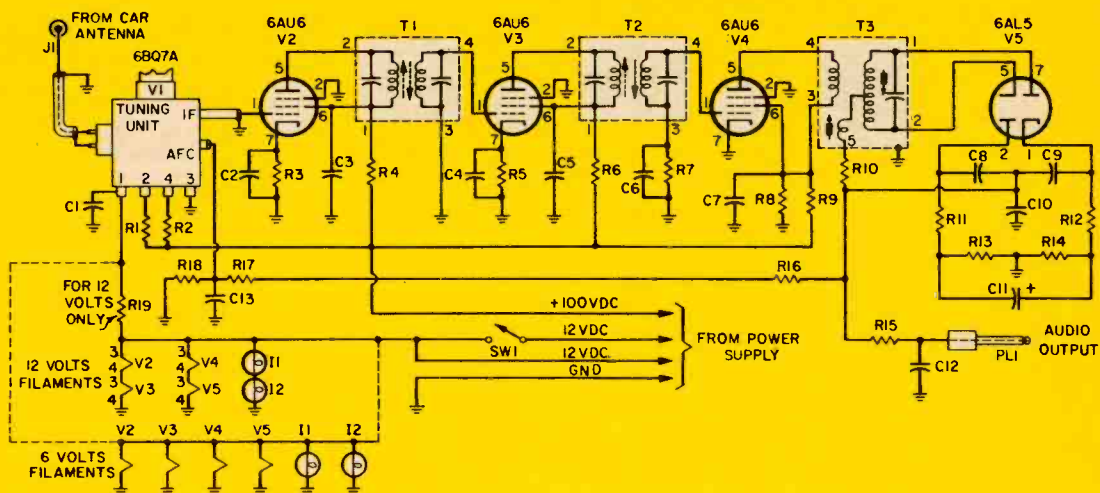

Schematic of tuner. Three IF stages are followed by ratio detector. Note filament hookup option.

#### PARTS LIST

Resistors: 1/2-watt unless otherwise indicated  
 R1—1000 ohms, 1 watt R8—15,000 ohms  
 R2—10,000 ohms, 1 watt R9—10,000 ohms  
 R3—68 ohms R11—1,500 ohms  
 R4, R6, R12—1000 ohms R13, R14—6,800 ohms  
 R5, R10—47 ohms R16—470,000 ohms  
 R7, R15—68,000 ohms R17, R18—100,000 ohms  
 R19—15 ohms; 5 watts (for 12-volt car radios only)  
 Capacitors: 600 or 1000-volt, ceramic disc unless otherwise indicated  
 C1—.01 mf  
 C2, C3, C4, C5, C7—.0047 mf  
 C6—47 mmf  
 C8, C9, C10—330 mmf  
 C11—10 mf, 25-volt electrolytic  
 C12—.001 mf  
 C13—.05 mf, 600-volt paper tubular  
 V1—6BQ7 tube  
 V2, V3, V4—6AU6 tube  
 V5—6AL5 tube  
 T1, T2—10.7 mc interstage transformer (Miller 1463)  
 T3—10.7 mc ratio detector transformer (Miller 1465)  
 I—FM tuning unit—Waller UT-345-AFC (Available for \$7.29 from Newark Electronics Corp., 223 W. Madison Street, Chicago 6, Ill. Page 389, catalog No. 71. Also available from Allied Radio Corp.)  
 J1—Antenna jack (Motorola Type or H. H. Smith No. 1207)

PL1—Standard phone plug  
 SW1—SPST toggle switch (reqd. for 12v operation only)  
 I1, I2—6-volt pilot lamps (#40) and matching sockets  
 Misc.—Four 7-pin tube sockets with center shield (Amphenol 147-905 or equiv.) one 5-lug terminal strip with center lug grounded; perforated Bakelite board, Minibox, 8"x6"x3 1/2" (Bud CU-2109A); FM Tuning dial assembly (Croname CRIC, available from Allied Radio); knob, phono cable; small L-brackets; 1/4" shaft coupler, closed-circuit jack, etc.

#### 12-Volt Power Supply

C14—10 mf, 25-volt electrolytic capacitor  
 C15—40 mf, 150-volt electrolytic capacitor  
 R20—50 ohm, 5-watt resistor  
 R21—680 ohm, 1-watt resistor  
 D1-D4—Silicon Diode rectifier (Sarkes-Tarjian M-500 or the equiv.)  
 Q1, Q2—2N307 transistor  
 T1—Transistor power transformer, Triad TY-685  
 Misc.—Two insulated binding posts; aluminum case, 2 1/8"x5 1/4"x3"; one 5-lug terminal strip, center lug rounded; two power transistor sockets; two diode holders (Littlefuse 099065)

volt car radios (which rarely use a high-voltage B-plus supply) a simple transistor supply is necessary.

#### Construction

The dial assembly is the first component to be mounted. Use the templates

and hardware supplied with the dial to mount it in the position shown. The bottom edge of this assembly should be firmly seated against the bottom of the tuner cabinet and held by L-brackets at both ends. Install the tuning knob bracket at the lower left edge.

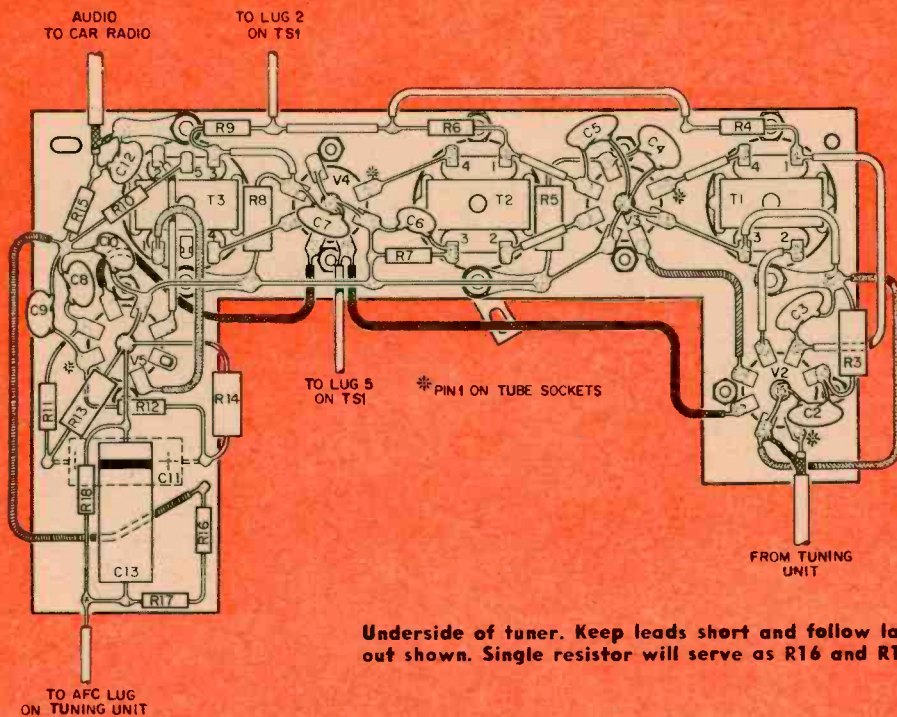

**Underside of tuner. Keep leads short and follow layout shown. Single resistor will serve as R16 and R17.**

The factory-wired and aligned front end is mounted next but before it is secured in place, a slight modification will have to be made to match its tuning to the frequency indicated by the pointer on the dial. Instead of the large tuning drum supplied with the dial assembly, a  $\frac{1}{4}$ " shaft coupler is fastened to the tuner shaft. Note its position in the illustrations—the coupler is slipped halfway onto the shaft so one of its set screws can be tightened. This permits the tuning unit to be mounted the correct distance from the rear of the dial plate. The coupler is then wrapped with approximately 21" of friction tape to bring its overall diameter to  $\frac{3}{4}$ ". Several dry runs should be made to see if the dial pointer is driven from one end of its travel to the other—while the tuning units' shaft rotates between its two stops. This can be done with the tuning unit outside the cabinet with the aid of the long dial cord supplied.

After this "gear" ratio is correct, solder four  $3\frac{1}{2}$ " insulated wires to the tuning unit's lugs (marked 3,4,2,1).

**Transistor power supply for 12-volt cars. Be sure the cases (C) of both transistors (not visible) are insulated from chassis.**

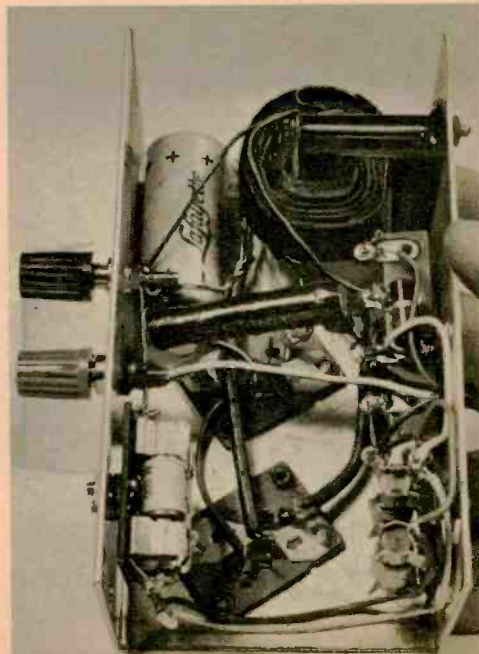



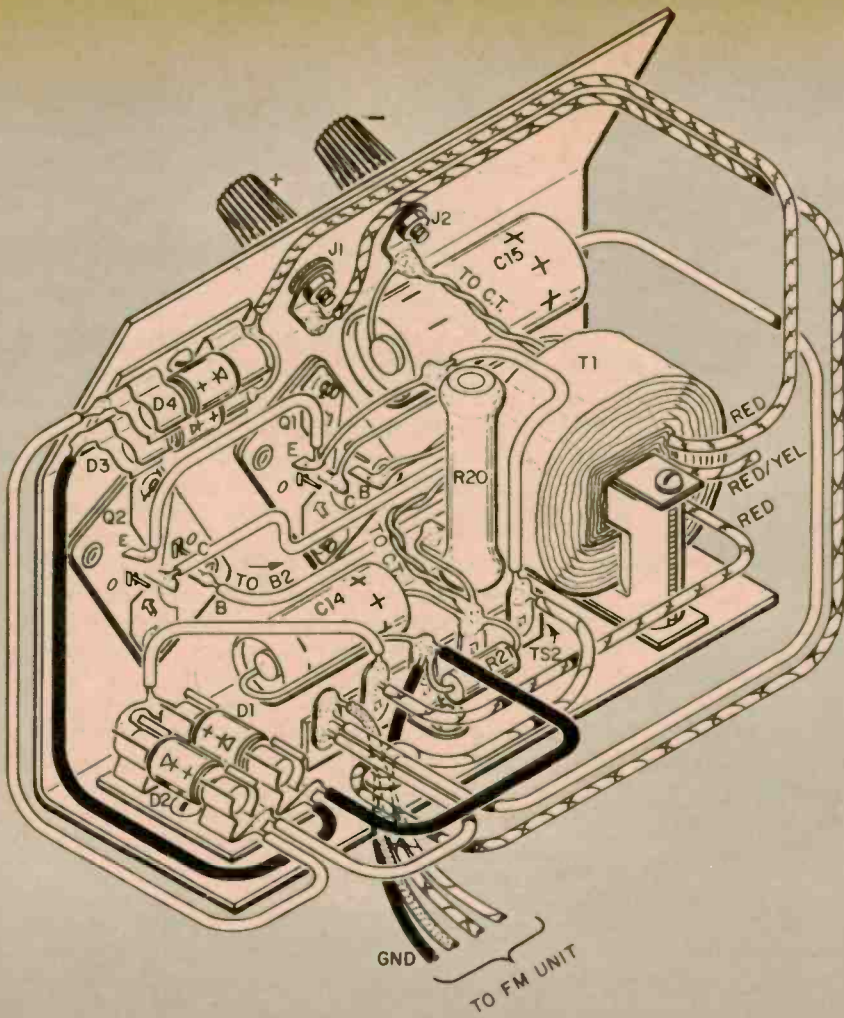

Power supply for 12-volt cars. Diode holders will short to case if attached flush. Space by threading nuts on mounting screws before installing.

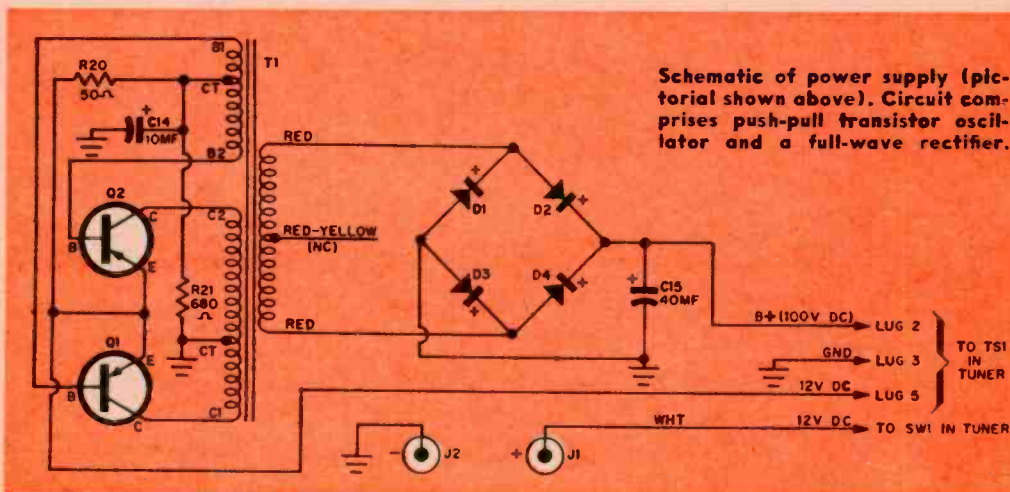

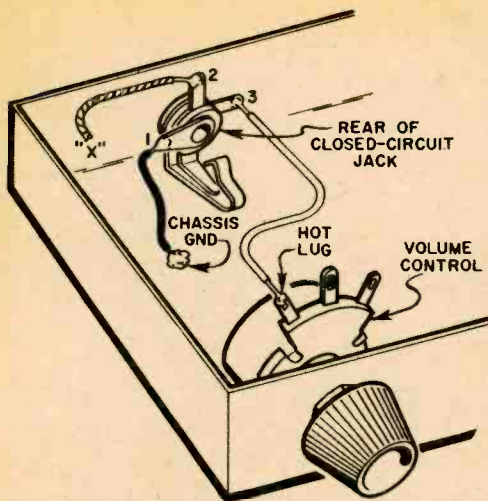

Audio jack added to car radio. Lead marked X originally went to the hot lug of control.

These will be connected later. Note that the bottom of the tuning unit must not touch the metal cabinet or its lugs will be shorted. Mount it in the following manner; drill four holes, insert long 4-40 screws from the outside of the metal cabinet and secure them in place with nuts. Thread another nut on each screw for several turns and place the tuning unit on them. These will be adjustment nuts for spacing the unit above the chassis. Check for lug clearance between the bottom of the tuning unit and the cabinet, then lock in place with four more nuts threaded onto the end of each 4-40 screw. The dial cord may now be strung.

The IF strip is wired on a piece of per-

forated board *before* installation. Start by cutting the board to  $6\frac{3}{4}'' \times 4''$ . Then, hold this piece in its mounting location and mark off a cutout which will permit its installation around the tuning unit, as shown.

After wiring, the finished board is mounted with three small angle brackets (Walsco #7570F). Note that brackets support the board at its two rear corners, while a third (flattened out) is held under one of T2's mounting screws and the screw on the tuning unit holding the "AFC" terminal. When the board is in place, the tops of the three IF transformers must not protrude over the top edge of the metal cabinet. *It is essential that the white shielded IF cable emerging from the tuning unit not be cut short* since its capacitance forms part of a tuned circuit. Three  $\frac{1}{2}''$  holes are drilled or punched in the bottom of the cabinet directly under each of the tuning holes of the three IF transformers for alignment accessibility. Five more holes are cut in the top cover to provide access to the top slugs of the IF's and for ventilation.

### Power Supplies

In some 12-volt hybrid car radios, the use of transistor stages and tubes which do not require more than 12 volts B-plus means that an external power supply must be used to energize the tuner. The cases of power transistors Q1, Q2 *must* be insulated from the metal case using a mounting kit or insulating washers and should be checked for shorts with an ohmmeter [Continued on page 100]

Optional switch could be combined with SW1 so power turn-on would effect antenna change.

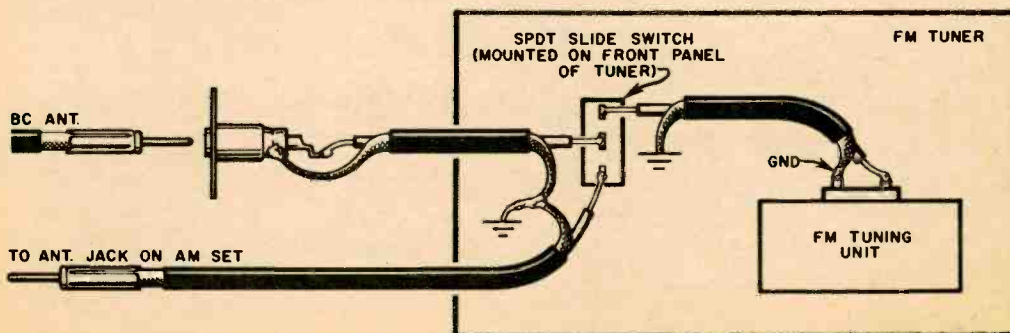



# \$100

## YOU CAN WIN...

# in EI's Easy Cash Contest

just answer this question...

## WHAT IS ELECTRICITY?

**H**ERE is your chance to pick up an easy \$100! Just answer this question: What is electricity? In each issue of **ELECTRONICS ILLUSTRATED** (beginning with the September '61 EI) the Editors will publish the best answer received and pay its author \$100. This is a continuing contest, not a one-time offer. If you don't win the first time you will have plenty of other chances! You may enter as many times as you wish.

It has been said that everyone knows what electricity does, but no one knows what it is. The dictionary calls it "one of the fundamental quantities of nature . . ." The encyclopedia speaks of a flow of electrons through a wire. There

is no one comprehensive theory that is universally accepted.

*Rules: Entries will be judged on aptness of thought, clarity of expression and originality. Entries must be typewritten and double-spaced and may be no longer than two pages of 8½ x 11-inch paper. Ideally, a definition should be short. Print your name and address on your envelope and the first page of your answer. One entry per envelope. EI's Editors are the judges. Entries will not be acknowledged or returned.*

*Prizes: \$100 will be paid the writer of the best definition. One winning definition will be published in each issue of EI. In case of ties, duplicate prizes will be awarded. Other entries of merit also may be published and will be paid for at the rate of \$10 each.*

Mail entries to: EI Electricity Contest, 67 W. 44th St., New York 36, N. Y.

# FERRITES... Mighty Midgets of Electronics

Computers, tiny radios, big-screen TV and other marvels owe everything to odd-acting crystals.

By Ken Gilmore



Reddish dust at left is the basic raw material for ferrites. Traces of metals are added to the dust. Photo above shows ferrite memory cores in computer; the four-wire hookup to cores makes it possible to interrogate the units individually.



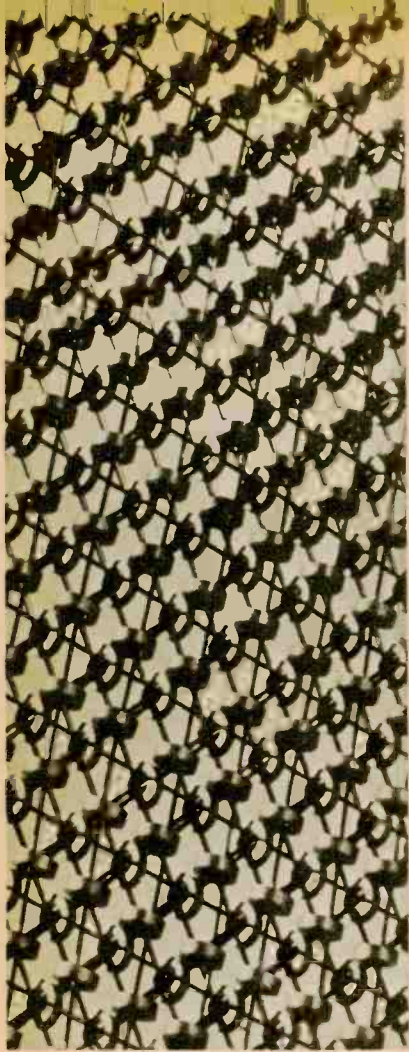

**F**OUR years ago the antenna in your bedside radio was a flat coil an eighth of an inch thick and as big as a sheet of writing paper. Today it is the size of a pencil or smaller and it does an even better job.

Not long ago it was said that TV tubes larger than 17 inches would never be practical. Today 27-inchers are not uncommon.

Scientists a decade ago had the major problems of computer circuitry worked out but the giant brains were not built because there were no practical memory units of reasonable size. Today has become the age of the computer because we are able to pack millions of memory cells into a few cubic feet.

All these remarkable advances, and hundreds of others ranging from day-after-tomorrow radar to improved motor car ignition systems, were made possible by the electronic wonder material of our time: ferrites.

Ferrites are nothing more than iron oxide—rust—with traces of such additives as zinc, nickel, manganese, magnesium and other substances. The word ferrite sometimes appears as an adjective (ferrite loopstick, ferrite stampings, etc.) but the plural form becomes a noun . . . ferrites. Though the terminology is a bit confusing, a ferrite is a tiny crystalline structure made up of the substances listed above.

To become useful, millions of ferrite crystals, which look like nothing more than reddish dust, are mixed into a special dough and stamped into intricate shapes by giant machines which exert tons of pressure and look like cookie cutters. After that the stampings are baked in kilns at high temperatures for a day or more. Out of the kiln come blackish bars, rods, rings, blocks and cylinders. The raw material looks pretty nondescript and so do the stampings, but their appearance

**Bell Labs ferreed is a ferrite-bar switch that is 1,000 times faster than models now used.**

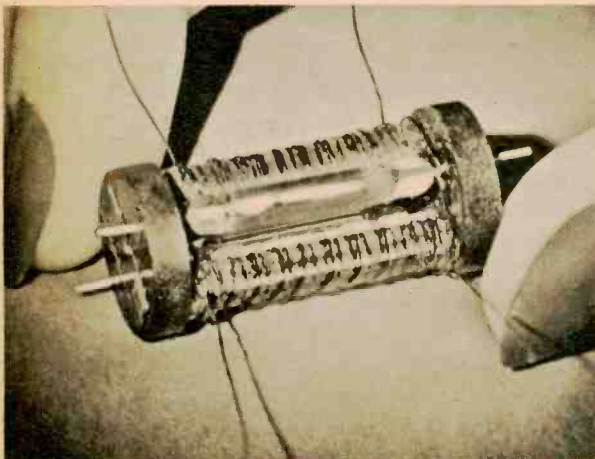

**Each of these ferrite doughnuts represents a single memory core for a modern computer.**





Sample ferrite stampings include TV yokes at upper left; C cores for flyback transformers at right; rod, strip are for radio antennas.



Tiny computer memory cores are counted with a paddle containing 400 holes. Worker scoops up cores, makes certain every hole is filled.

is deceiving. These electronic cookies are able to do a great many jobs that were simply impossible before they came along.

Ferrites perform their tricks because they combine two properties seldom found in one material. First, they are magnetic and can be magnetized and demagnetized like iron. And second, they are insulators. Unlike iron, they will not conduct electricity.

Why is this combination so important? Take the output transformer in your hi-fi amplifier. It, like many other electronic devices, works because it has the electrical property of inductance. Its inductance, and hence its efficiency, can be increased hundreds or thousands of times if it is wound on a core of magnetic material, usually iron. But the core creates its own problems.

The inductance, which does the transformer's useful work, unfortunately induces an eddy current in the iron core. This eddy absorbs power, cutting down efficiency and thus partially defeating the purpose of the core. At low frequencies the loss is small. But the higher the frequency, the higher the eddy current loss. Finally, the loss becomes so great that the transformer is useless.

To combat this problem, transformer designers split iron cores into thin, insulated sheets. This breaks up the con-

ducting path through which the eddy current can flow and raises the useful frequency limit of the transformer. But this is only a partial remedy. As the frequency rises, eddy currents begin to flow in the individual sheets.

But ferrites are magnetic materials which also are insulators. Consequently, they can serve as cores but no eddy currents can flow. Thus hundreds or thousands of new or improved electronic devices become possible.

The first child of the ferrites to gain wide acceptance came after World War II. Researchers had been intrigued with ferrites but they remained laboratory curiosities. Then along came television. Manufacturers shopped for a magnetic material to increase efficiency of the flyback transformer—the component which provides the high voltage for your TV picture tube. The flyback had to handle a lot of power and at the same time work efficiently at high frequency. A ferrite core did the trick.

About this time General Ceramics Corporation, which for almost 150 years had been making ceramic products from ash trays to bathroom fixtures, was looking for new fields to conquer. The choice was ferrites because ferrites and ceramics are first cousins—both are metallic oxides fired in a kiln.

Dr. Ernst Albers-Schoenberg, a lead-



Dr. Ernst Albers-Schoenberg, a leading authority on ferrites, developed memory cores for computers and played a major role in search for other uses for the material. He is holding tray of cores.

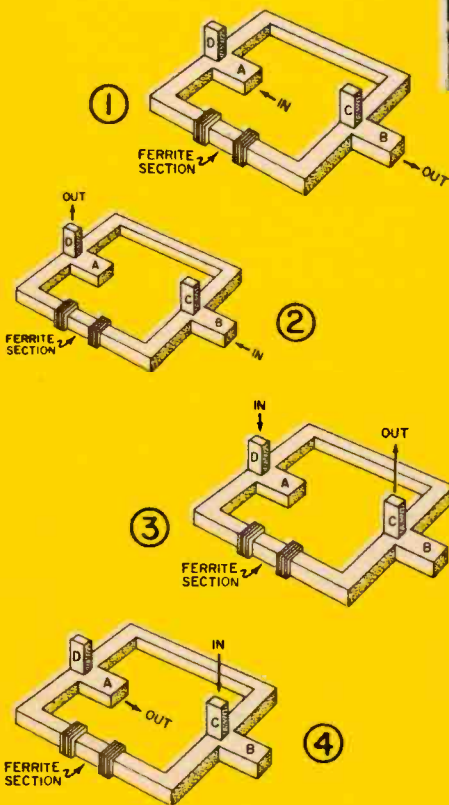
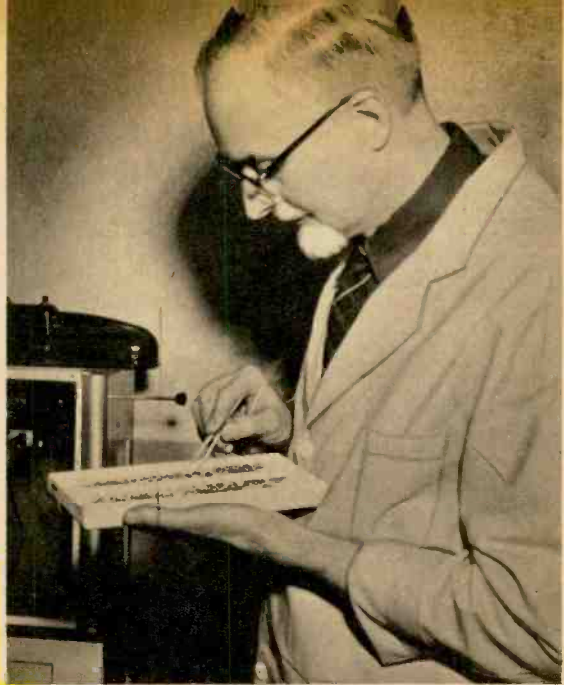

Ingenious ferrite circulator develops some strange phase relationships. Signal that goes in A comes out of B, but signal in B comes out of D rather than A. The diagrams show other possibilities. In radar work, transmitter is hooked to A, antenna to B, receiver to D. Transmitter pulses then cannot damage receiver but radar echoes are channeled to receiver, as they must be.

ing ferrite expert, was made GC's research director. He developed several types of ferrite material, but they caused no great excitement and went mostly to researchers. Then TV came on the scene and the staid old ceramics firm suddenly had back orders amounting to \$3,000,000. The biggest part of GC's facilities were turned into ferrite production. Other companies are now in the business but GC is the biggest.

By 1950 television was a fixture but the 17-inch tube seemed the practical limit. Even though the flyback was efficient, the coils into which its power was poured to do the beam sweeping just couldn't develop enough magnetic force to deflect the beam over a larger tube face. Again, ferrites to the rescue. An engineer at General Electric built a ferrite collar—or yoke, as it is now known—to fit over the deflection coils around the tube's neck, thus giving the system more magnetic strength. The result was the 21, 24 and 27-inch picture tube.

In 1953 MIT's Lincoln Laboratory designed a computer using electron tube memory cells which showed promise. But there were problems. The most difficult one was that tubes are subject to failure at a predictable rate. If you put 10,000 or so of them together you're likely to average a breakdown a day. Computers, to [Continued on page 97]

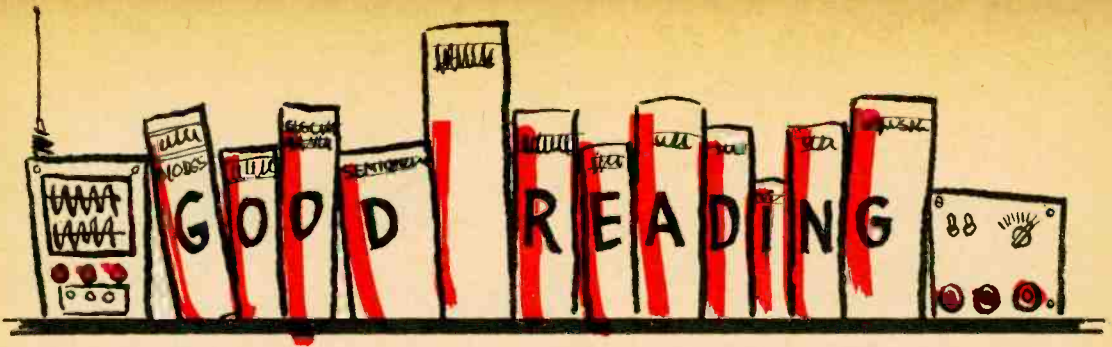

**H**OW TO READ SCHEMATIC DIAGRAMS. *By David Mark. John F. Rider, New York. 147 pages. \$3.50.*

While this book is not intended as a substitute for years of study and practical experience with electronic circuitry, it's a worthwhile acquisition for anyone who is beginning to feel his way in electronics. And there's more in it than the title implies. In addition to an explanation of symbols (including their variations from manufacturer to manufacturer) and their application in schematics, it provides short but accurate explanations of many kinds of circuits. Its only real shortcoming is the scanty coverage of transistor circuitry.

**B**ASIC ELECTRONIC TEST PROCEDURES. *By Rufus P. Turner. Rinehart & Co., New York. 316 pages. \$4.95.*

Here is a straightforward, step-by-step guide to electronic testing. The overall approach is distinctly in the textbook category, with summaries after each chapter and comprehensive review questions, but the style is clear and easily readable. Beginning with a section on the correct use of meters, the book proceeds in stages to explore measurement techniques for increasingly complex circuitry and finally outlines the applications and importance of test procedures in industrial and design processes.

**B**ASIC MATHEMATICS. *Volume 1. By Norman H. Crowhurst. John F. Rider, New York. 143 pages. \$3.90.*

If you've been promising yourself that you're going to review all that math that you glossed over or never understood, here is your chance, and you should make the most of it. Mr. Crowhurst asserts, with considerable justification,

that most of those who find mathematics a problem were simply never taught the right way to approach it. He is an outspoken opponent of rote learning, and considers memory no substitute for understanding. He feels instead that all math, from basic arithmetic on up, should mean something to the user. And, in line with his conviction that finger-counting is more helpful than mere memorizing, he begins the book by presenting various methods of counting. This, of course, is the new approach to math instruction, but Mr. Crowhurst doesn't indulge in unnecessary philosophizing. He is practical and the emphasis is on everyday matters that you can put your finger on. Four volumes are projected for this series, and if the next three are up to the standard of the first offering, chances are they will make calculus as easy as multiplication for the average reader . . . and perhaps as much fun as finger-counting.

**T**HE STORY OF STEREO: 1881 -. *By John Sunier. The Gernsback Library, New York. 160 pages. \$2.95.*

For hi-fi buffs, here is a comprehensive summary of the principles of stereo and their applications. As the title suggests, the approach is historical, tracing the phenomenon back to its first test at the Paris Exhibition of 1881. But despite the emphasis on stereo's history, this book makes for anything but dry reading. It's well written, and just about every aspect of stereo reproduction comes in for intelligent discussion. In addition to useful suggestions for achieving good stereo in the home, you'll find interesting and thorough coverage of its applications in films and broadcasting. All in all, it's a fine book for the audio novice or the veteran hi-fi addict. ♪



# Electronic Fish Lure

A fisherman's dream come true.  
Have fun, Sons of Izaak Walton.

By Forrest H. Frantz, Sr.

Special Section:  
24 Pages of  
**SUMMER  
PROJECTS**



**I**T is generally known that fish are attracted by light and sound. As a result, there have been a large variety of fish lures marketed to entice the denizens of the deep to the angler's hook.

However, most fish lures use expensive high-voltage batteries. This one employs a single 1.5-volt flashlight cell to operate both the light and the sound portion of the gadget. Only a buzzer, an inexpensive miniature output transformer (T1), and an alligator clip are required for construction of the unit which is then housed in a small waterproofed glass jar.

## Construction

First fasten a 4" length of wire to each of the buzzer screw terminals and run these leads through the back of the buzzer. Place a few fiber or metal washers between the battery holder and T1 and the back of the buzzer to make the holder and T1 flush with the back edge. Next fasten the battery holder in place over the buzzer mounting hole. Solder a lead from the frame to the screw and solder one

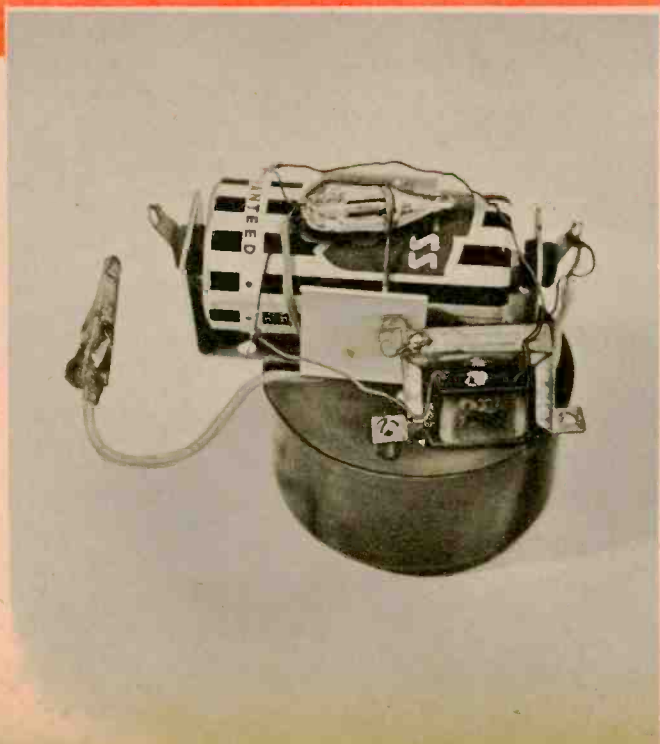
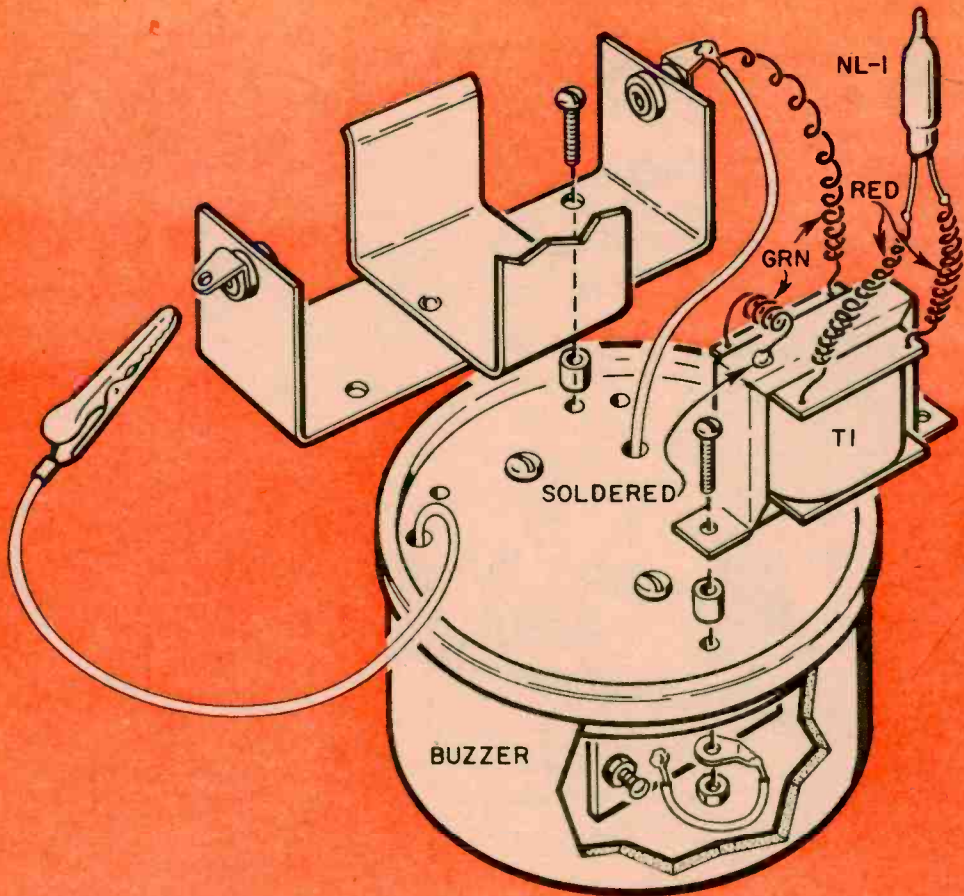

Place washers under transformer and battery holder for flush mount against edge of buzzer. Alligator clip connected to lug on battery holder starts unit.



of T1's green secondary leads to its frame. Solder the other green secondary lead and the lead from the buzzer coil terminal to the positive battery holder terminal. Solder the clip to the other buzzer lead which should be long enough to permit clipping to the negative battery terminal. Connect the red primary leads of T1 to the neon lamp. Fasten the neon lamp to the battery with a rubber band and place the battery in the holder.

If the buzzer sounds too loudly, you can weaken its signal by inserting a small value resistor at the point marked "X" in the schematic.

### Operation

To operate the lure, all you need do is connect the clip to the negative battery terminal and adjust the buzzer contact screw for a clear *high frequency* note. This adjustment may be somewhat critical and you may have to repeat it several times. Install the buzzer in the jar, fasten the lid, and lower the lure into the water on a line. If necessary, add weight to the jar, and use cellophane tape to hold the components and the weights in place.

A hook made of No. 14 copper wire may be soldered to the jar lid for attaching the line. Since a glass jar is used, it's a good idea to provide a similar hook on

the inside of the jar lid to permit tying a string to the battery holder. Then, if the jar is broken by accident when the lure is submerged, the contents will not be lost. If through some accident the jar does break, the electronic components should be dried by placing in the sun or an oven. If immersed in salt water, rinse in fresh water before drying.

This lure provides continuous sound and light. Those anglers who prefer periodic or intermittent sound and light can add an external remote on-off switch for operation from the boat. Leads will have to be added and brought out through waterproofed insulated terminals in the lid and given several coats of spar varnish. You could also install a mercury switch between the clip and buzzer and position it so the lure is normally on. Attach a string to the jar to tilt the unit to switch it off.

### How It Operates

The pulsating direct current that appears across the buzzer terminals is stepped up by the primary of T1. The high AC voltage across the secondary of T1 energizes the neon lamp. T1 connected in reverse steps up the voltage to almost 100 volts, sufficient to light the neon bulb. 

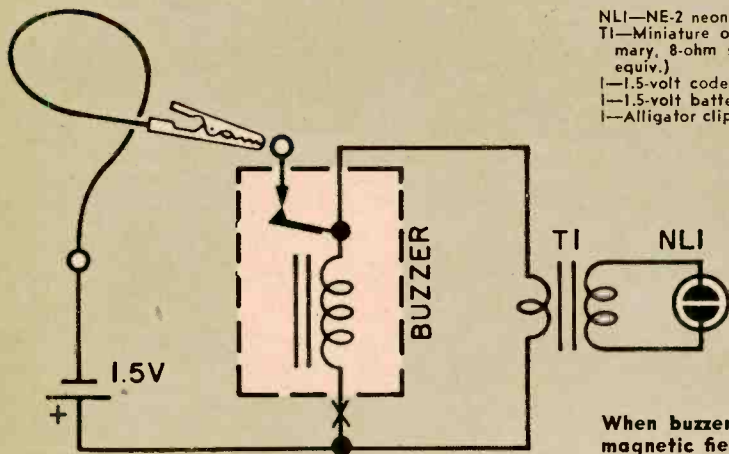

### PARTS LIST

- NLI—NE-2 neon lamp
- T1—Miniature output transformer; 2,000 ohm primary, 8-ohm secondary (Lafayette TR-93 or equiv.)
- I—1.5-volt code practice buzzer
- I—1.5-volt battery and matching holder
- I—Alligator clip

When buzzer contacts open, collapsing magnetic field in primary of T1 induces high voltage in secondary to light NLI. Add a resistor at X to weaken buzzer.

SUMMER  
PROJECT



## build a Flashing Electronic Taillight

By Jack Allison

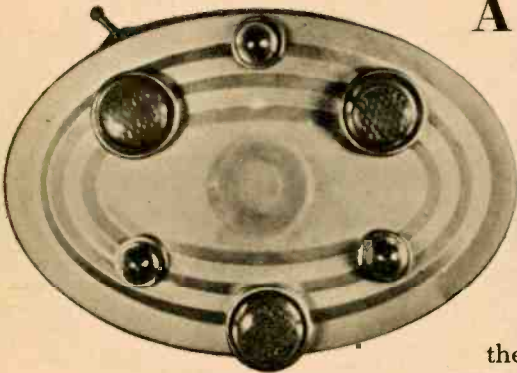

A sure-fire conversation starter and traffic stopper, this unusual gadget for your bike will add safety to your night trips and fun to any indoor gathering. The circuit is simple and easily constructed. The "chassis" can used by the author leaves plenty of room to work, but there's nothing to prevent you from building a smaller unit.

Construction is easy. Draw a circle on the can and drill holes on the circle for the reflectors and the neon lamps. Enlarge the holes with a reamer if necessary. You can use practically any neon lamp provided it does not have a built-in resistor. The larger the lamp, the greater the battery drain. The bulbs chosen are pushed through rubber grommets. (It will help if you moisten the bulbs first.) Pick the grommet that fits the bulb type you are using.

The pictorial shows the placement of parts. Make sure all connections are soldered well and that there are no shorts. Place tape over the battery terminals. As protection against moisture and vibration, drive small nails around the edge of the can into the wood back, then place a strip of tape around the edge of can. To prevent theft, attach taillight so you can remove it easily. ⚡



Components are soldered directly to the neon lamp bases. Spaghetti insulation should be used to avoid possible shorts.

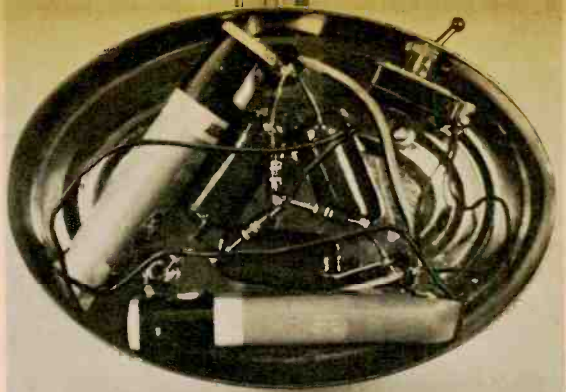

**PARTS LIST**

- C1, C2, C3—.25 mf, 200 volts (or higher) capacitors
- R1, R2, R3—220,000 ohms, 1/2 watt, 5% resistors
- NL1, NL2, NL3—NE-51 or NE-51H neon lamps (see text)
- SW1—SPST toggle switch
- B1, B2—45-volt batteries (four-22.5 volt batteries may be substituted)
- 3—Red reflectors
- 3—Rubber grommets to fit lamps
- 1—Tin can and fitted wood back
- Misc.—battery connectors, wire, etc.

It may be necessary to turn SW1 on and off a few times to start flasher. Neons are fragile and should be moistened so they can be fitted through grommets.

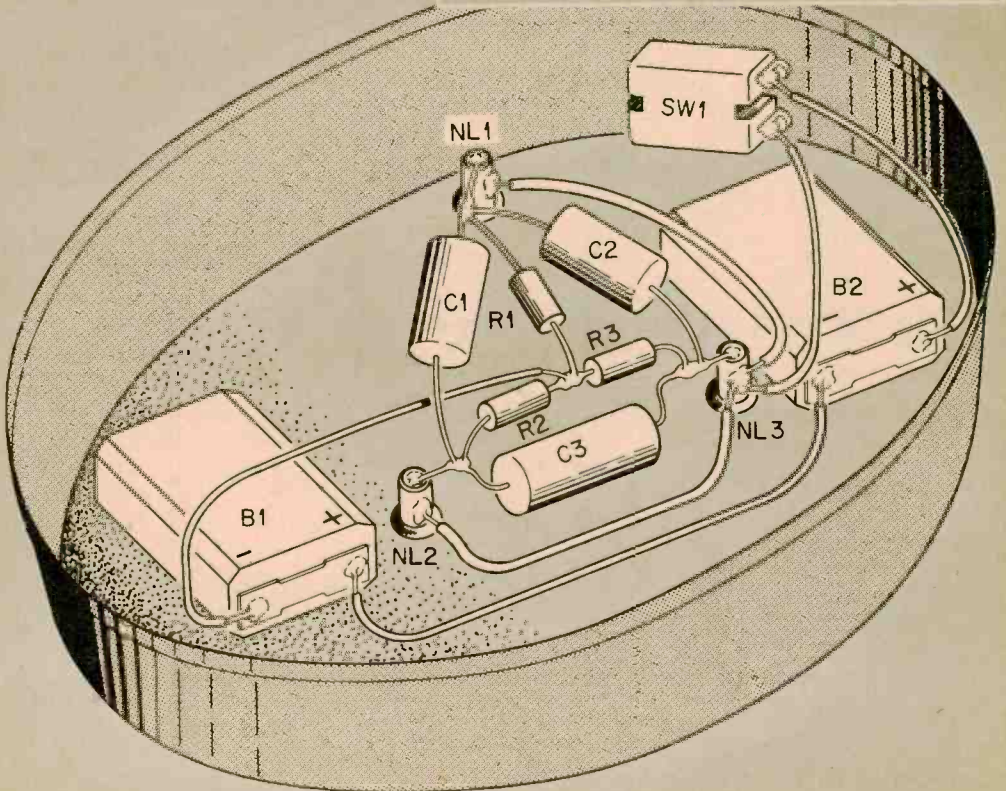
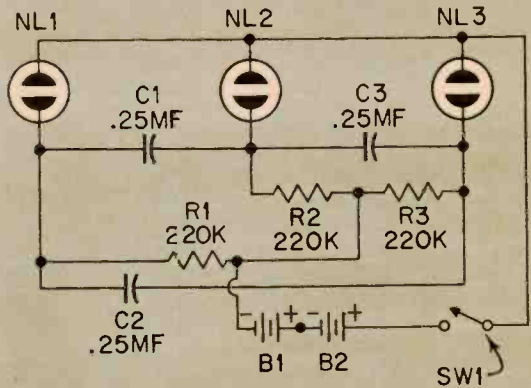



**SUMMER  
PROJECT**

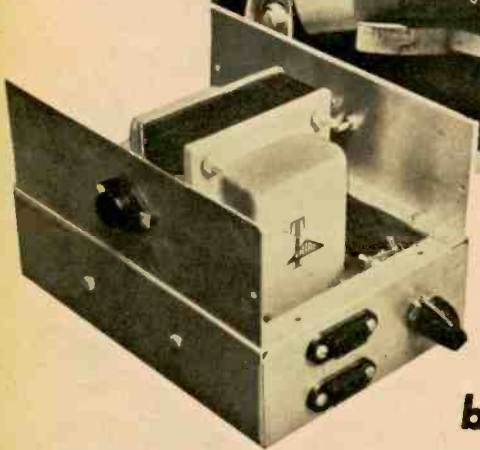

*build a transistorized*  
**Camper Power Pack**

**Provides 117-volts, 60-cycle AC from a 12-volt car battery  
to power a TV set or a tape recorder.**

**By Donald L. Stoner, W6TNS**

**F**RIDAY evening rolls around and mom, dad, and the kids hop in the pickup truck with the camper attachment and join hundreds of other similarly equipped trucks on the crowded highways. It's a typical scene, and the fad of "heading for the hills" is catching on all over the country. The portable home on wheels has everything, *including* the kitchen sink.

About the only thing you miss, miles from civilization, is that handy AC power outlet found in each room of your home. If you need power at some remote vacation spot you usually lug along a bulky engine-generator combination. For low power applications, such as electric razors, radios, lights,



or portable television receivers, the EI Camper Power Pack does a lot better job with much less weight and expense. The unit costs less than \$20 to build, too! To use the supply, all you need is 12-volt ignition system with a *negative* ground in your car or truck.

### Construction

The Pack is built on a 5" x 9" x 2" aluminum chassis with the components mounted inside. The transformer, positioned in the center of the chassis, "sits" on 1/4" thick spacers to prevent pinching the leads between its case and the chassis.

Note that transistors Q1 and Q2 are mounted on 2 1/4" x 7" pieces of aluminum. These cooling fins are necessary since the transistors handle large amounts of current and consequently get quite warm. The exact location of the transistor on the fin is unimportant, but they should be located near the center for best cooling.

Start the construction by mounting the battery terminals (the negative terminal is bolted to the chassis and one positive terminal is insulated from the chassis), fuse holder F1, SW1, and the terminal strips. Set the transformer in the center of the chassis so you can mark and drill the mounting holes. Make sure the transformer clears the back of the fuse holder. Next, drill the holes and mount the outlets (SO1, SO2) and SW2. Finish the drilling by constructing the fins and installing the transistors. Since the collectors are grounded, Q1 and Q2 can be bolted to the fins directly without insulators.

Start wiring the power pack by installing the resistors and capacitors on the side apron then wire the positive battery lead to F1, and the other fuse terminal to SW1. The two sections of SW1 are wired in parallel so it can handle the heavy current drawn from the battery. At least #14 wire should be used in this area.

All color-coded leads come from T1 which is mounted above the chassis on 1/4" long spacers. Sides of chassis are folded back for clarity.

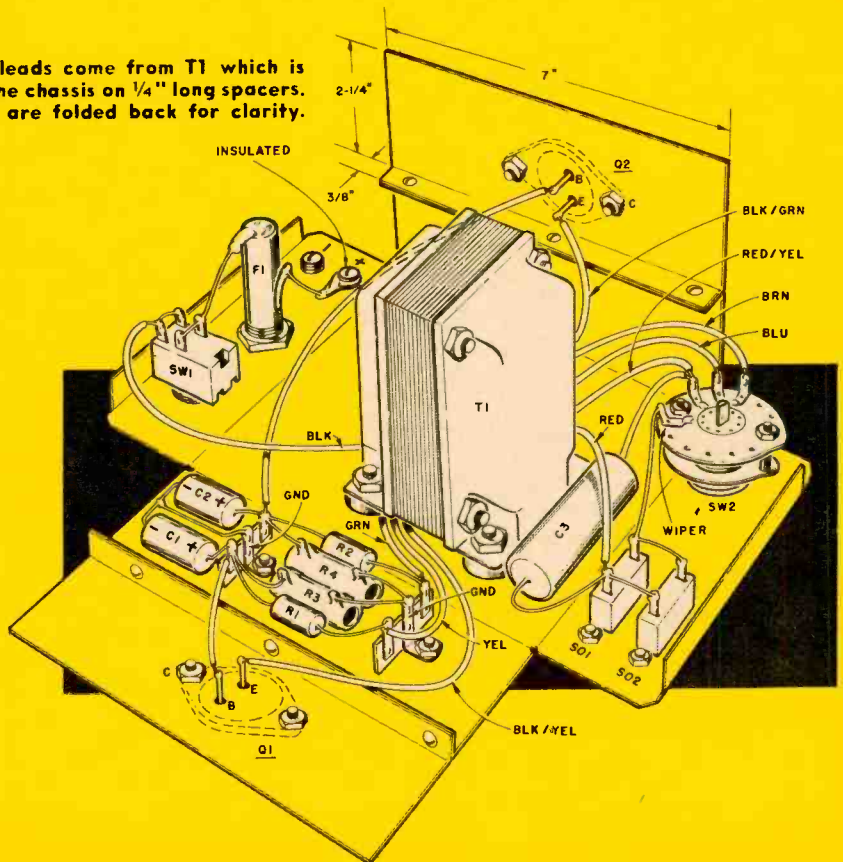

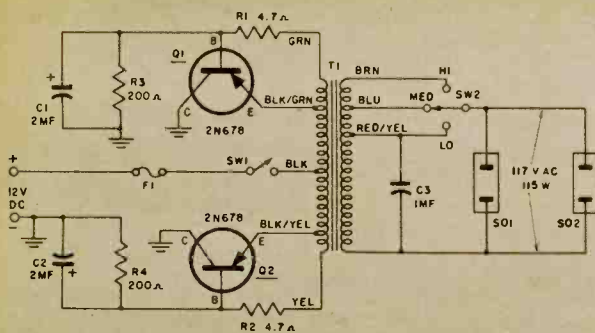

#### PARTS LIST

C1, C2—2 mf, 150-volt electrolytic capacitor  
 C3—1 mf, 200-volt paper tubular capacitor  
 F1—15-ampere fuse, and matching holder  
 R1, R2—4.7-ohm, 2-watt carbon resistor  
 R3, R4—200-watt wirewound resistor  
 SW1—DPST toggle switch  
 SW2—Single-pole, three-position rotary switch  
 (Centralab 1401 or equiv.)  
 T1—power converter transformer, 12.6 volts to 117  
 v. AC (Triad TY-75A)  
 Q1, Q2—2N678 transistors (Bendix)  
 SO1, SO2—117-volt AC, receptacles  
 Misc.—5"×9"×2", aluminum chassis, 2/4"×9" alu-  
 minium fins (see text) two 3-lug terminal strips,  
 four 1/4" long spacers, transistor sockets,  
 hdwe.

**Be sure input polarity is correct. SW2  
 adjusts the square-wave output voltage.**

Next install T1 and connect the wires to the components already installed. Finally complete the unit by attaching the fins to the chassis with 3 sheet metal screws and wire Q1 and Q2.

#### Testing The Power Pack

Make a dummy load by wiring a 100 watt lamp to an AC plug, and insert it in SO1 or SO2. Connect the supply to the car battery with heavy wire (#12, or better yet—#10). Make sure the negative terminal is connected to the car body and the positive lead is hooked to the "hot" lead of the battery. **WARNING:** *If you get these connections reversed you will immediately destroy the transistors, even before the fuse has a chance to blow!* Beware of incorrect connections, a new set of transistors will cost over six dollars! When you switch the pack on, it should make a growling noise and the bulb should light. If it doesn't, remove the power *immediately* and check the wiring.

#### Using the Supply

The power pack will deliver an absolute maximum of 115 watts, or 1 ampere at 115 volts. At full load the battery consumption is about 12 amperes. Fortunately the power supply has built-in protection. If you overload it heavily the circuit will "stall." When this occurs, the transistors will not be damaged, but will merely draw a small bias current (2 amperes, or so). It is the slight overload that you must be careful of. It will not be enough to stall the supply, but will cause overheating of the

transistors and might even destroy them.

When you use the supply, always make sure you know how much power the load consumes. For example, you can illuminate four 25-watt bulbs, a radio (35 watts or so) or a portable television receiver (approximately 85-100 watts).

In addition to observing your battery polarity and total power consumption, there is one other important caution. Never operate the power converter without a load of some sort. If the power is not absorbed in the secondary circuit (output), it could kick back and damage the transistors.

[Continued on page 101]

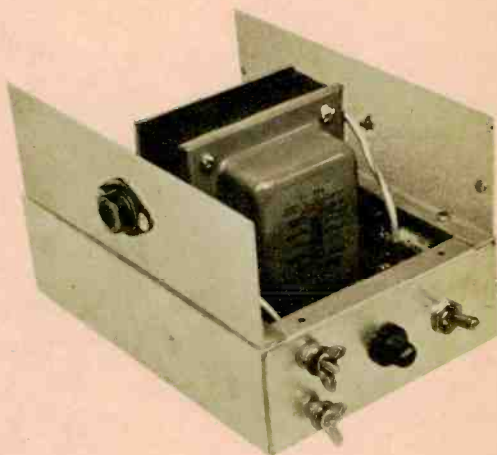

**Unit is built in an inverted chassis. Added side wings act as heat sinks for transistors.**



# Low-Cost Base Insulator



WHEN a ham decides to build himself an insulated-base vertical antenna of water pipe or conduit or irrigation piping he is often puzzled about what to use for a low-cost insulator. The best answer is petticoat insulators of the type used by telephone and power companies. They are made of bottle glass or brown porcelain and can support a sizable load if it is evenly distributed. Electrically, they will hold many times the legal output of a ham rig. Your local phone or power company can tell you how to get a couple of petticoats. While you're at it, pick up two offset mounting brackets. Bolt the bracket and insulator assembly to the base of your mast as shown in the drawing (a wooden plug keeps the mast from being crushed). The lower bolt serves as an RF connection. Best base size is about 12x14 inches and 6 inches thick.—Howard Pyle, W7OE

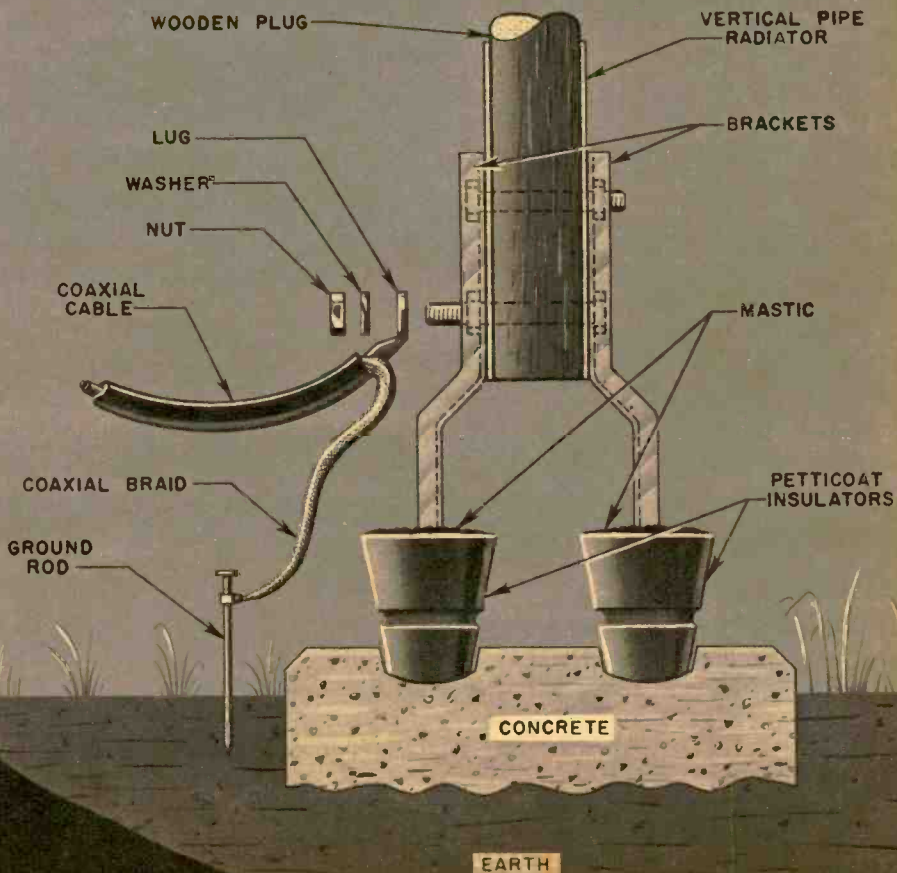

SUMMER  
PROJECT

## stop those patio parasites with EI's **Electronic Insect Killer**

By Harvey Pollack

**O**PEN terraces, patios, and porches—today's standards of relaxed suburban living—make ideal places to retire with one's guests after dinner—provided you don't mind sitting in the dark. Turn on the lights, and the flying insect invasion gets under way. Although the best remedy is full insect screening, you can relieve the situation substantially by using an electronic bug-killer lamp on your terrace.

The idea is to attract the bugs to the light and then flash them into the next world with a bolt of insect lightning! Of course a bug electrocutor must also be harmless to humans, big or small; hence, a rather tricky circuit is used. If the trap is touched with the fingers while the current is on, you feel the merest "pinprick" of electrical energy from a small charged capacitor.

### The Coil Trap

The lethal insect contacts are formed by two interlaced coils wound of No. 20 tinned,



bare copper wire. The coil form is made with two 4" dia. Masonite, plywood, or Bakelite discs notched about  $\frac{3}{8}$ " in from the circumference at six evenly spaced ( $60^\circ$  apart) spots. Cut a  $2\frac{1}{2}$ " diameter hole in one disc to allow easy lamp replacement and prepare the second disc with a center hole large enough to pass a standard electric-fixture receptacle. The receptacle should be of the porcelain or bakelite variety that unscrews in two parts. Using tin shears, cut six 4" x  $\frac{3}{8}$ " lengths of perforated bakelite right down the line of holes. By cutting through the hole centers, you will have a natural serrated-edge wire guide for coil winding. Next assemble the coil form by gluing the bakelite strips into the  $\frac{3}{8}$ " notches in

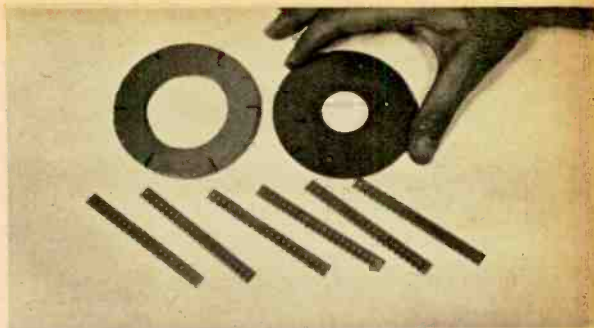

Discs form ends of coil in which ribs are glued. Larger hole must exceed bulb diameter.

the discs and allow the glue to dry thoroughly. Starting with the serration nearest to the disc that will hold the electric receptacle, wind one coil as tightly as possible without distorting the ribs, omitting every other serration as you proceed. After the ends of this coil are secured to prevent unravelling, wind the second coil in the previously omitted serrations, thus forming a pair of interlaced, disconnected coils. Some polystyrene coil dope or acetate household cement applied in small blobs on the serrations will help to hold the wire firmly in place. Now go on to the "shock-box."

#### PARTS LIST

- Resistors:  $\frac{1}{2}$ -watt, 10%  
 R1—100,000 ohms  
 R2—680,000 ohms  
 R3—2.2 megohms  
 R4—1 megohm  
 C1, C2—.25 mf, 600-volt paper tubular capacitor  
 C3—.0068 mf, 1200-volt molded paper capacitor  
 IL1—60-watt lamp and porcelain socket  
 NL1—NE-2 neon lamp  
 SR1, SR2—silicon diodes 750 ma, 600 peak inverse voltage (PIV) Texas instrument IN2071 or equiv.  
 T1—105/115/125-volt primary; 400-volt secondary photoflash transformer. Stancor P-6425  
 Misc.—30' No. 20 bare tinned copper wire, piece of perforated Bakelite board, 4" dia. Masonite or plywood disc, 3"x4"x $\frac{1}{8}$ " metal box (Bud CU-2105), grommets, terminal strips, hdwe. Length of line cord or piece of threaded brass electrical fixture tubing

#### The Power Supply

The 400-volt secondary of a small in-

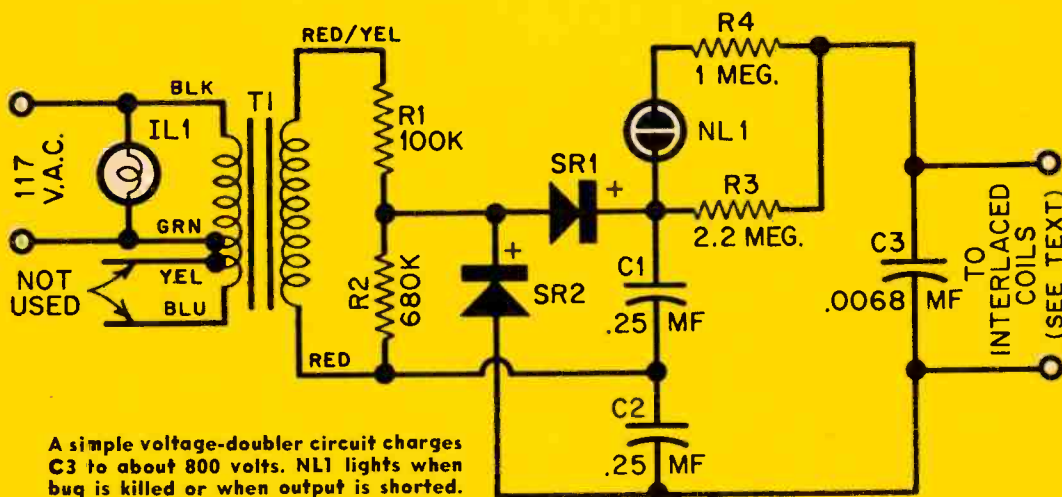

A simple voltage-doubler circuit charges C3 to about 800 volts. NL1 lights when bug is killed or when output is shorted.

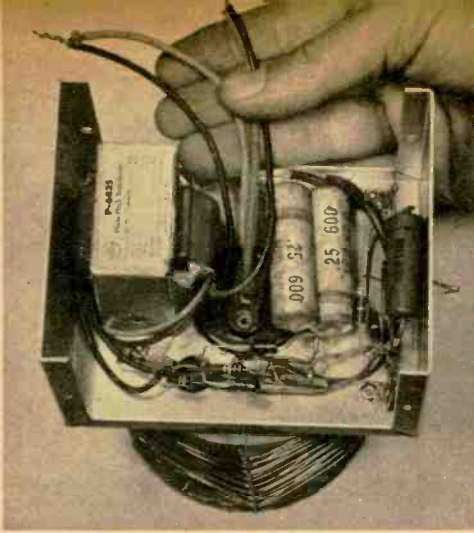

**Cramped quarters require construction care. Due to high voltage, parts should be isolated.**

expensive photo-flash transformer is connected, through a voltage divider comprising R1 and R2, to two silicon diodes (SR1 and SR2) arranged as a voltage doubler. (R1 and R2 prevent the peak secondary voltage from ex-

ceeding the peak inverse voltage rating of SR1 and SR2.)

SR1 and SR2 charge capacitors C1 and C2 and since C1 and C2 are in series, their combined voltage, applied to C3 through R2, is near 800 volts. This voltage is applied to the interlaced coils and has a lethal effect on insects. C3 is so small, however, that the energy content is too low to harm a human; also, note that the coils are isolated from the voltage doubler by a 2.2-megohm resistor (R3).

Neon lamp NL1 and R4 add an interesting feature. When an insect gets across adjacent trap wires, the current flowing through him develops sufficient voltage drop across R3 to light the neon lamp. One insect—one quick red flash! The reason for adding the neon indicator was not merely one of effect, however. Occasionally a bug sticks to the wires after being killed; should this happen the indicator will remain on. When the insect is removed with a soft brush, the [Continued on page 104]

**Avoid overheating SR1, SR2 during soldering and be certain that polarities are correct.**

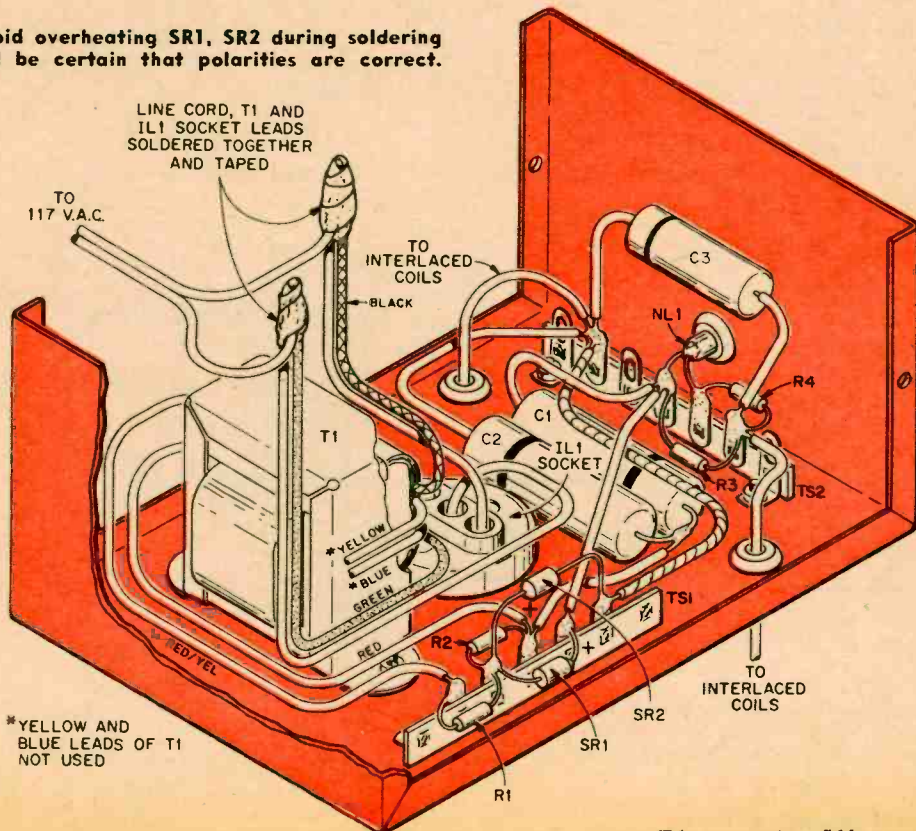





**SUMMER  
PROJECT**

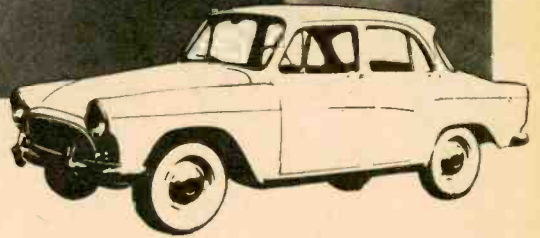
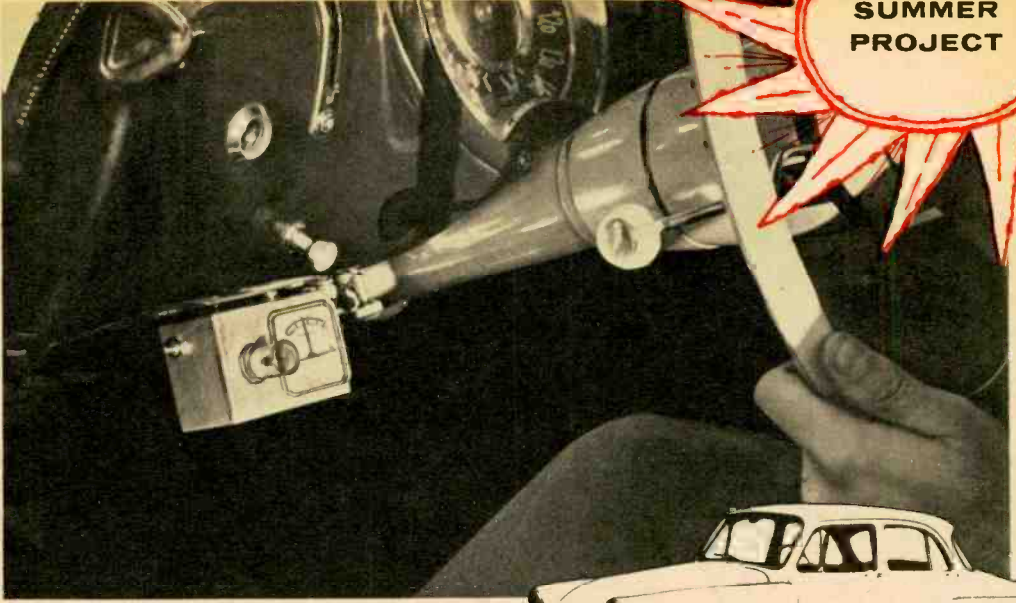

*add a*

# Temperature Gauge to Your Car

**Early warning from direct reading unit will prevent costly engine repairs due to overheating.**

**By Harry Kolbe**

**T**HERE I was merrily cruising along the New Jersey turnpike, when suddenly my engine began missing badly and I started to lose speed and coasted to a stop. On opening the hood, I was greeted by a blast of heat, smoke, and smoldering gaskets. Later, at the garage I was told that the engine was suffering from a ruined water pump, a burned-out piston and head gasket, a badly warped cylinder head, etc., etc. All due to overheating. Yet when I bought the car I was told that it would *never* overheat. In fact, the manufacturer hadn't even bothered to include a temperature gauge.

It's true, the car won't overheat if the cooling system is *functioning properly*. In my case, however the water pump gasket had ruptured and the water had drained out of the cooling system. A temperature gauge would have indicated that the engine was beginning to overheat and I would have been able to shut the engine off before any major damage was done.

For those who own cars that either have *no* temperature gauge or only a temperature warning light (warning lights can become loose in their sockets, or defective, and you would never know it), here are details on a

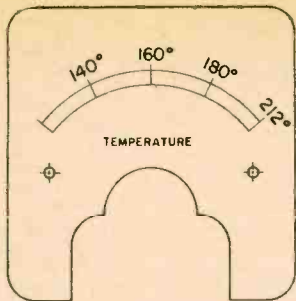

Cut out and glue over scale of M1.

- PARTS LIST**  
 R1—1000-ohm thermistor (Glennite 31TD2)  
 R2, R3—4,700 ohms, 1/2-watt resistor  
 R4—5,000 ohm miniature potentiometer  
 CR1—1N34 diode  
 M1—0-1 ma miniature meter  
 PL1—panel light (Dialco 4-1840 or equiv.)  
 I—3/4" x 2 1/8" x 1 1/8" Minibox  
 l—piece of copper tubing 1/4" O.D. x approx. 12" long

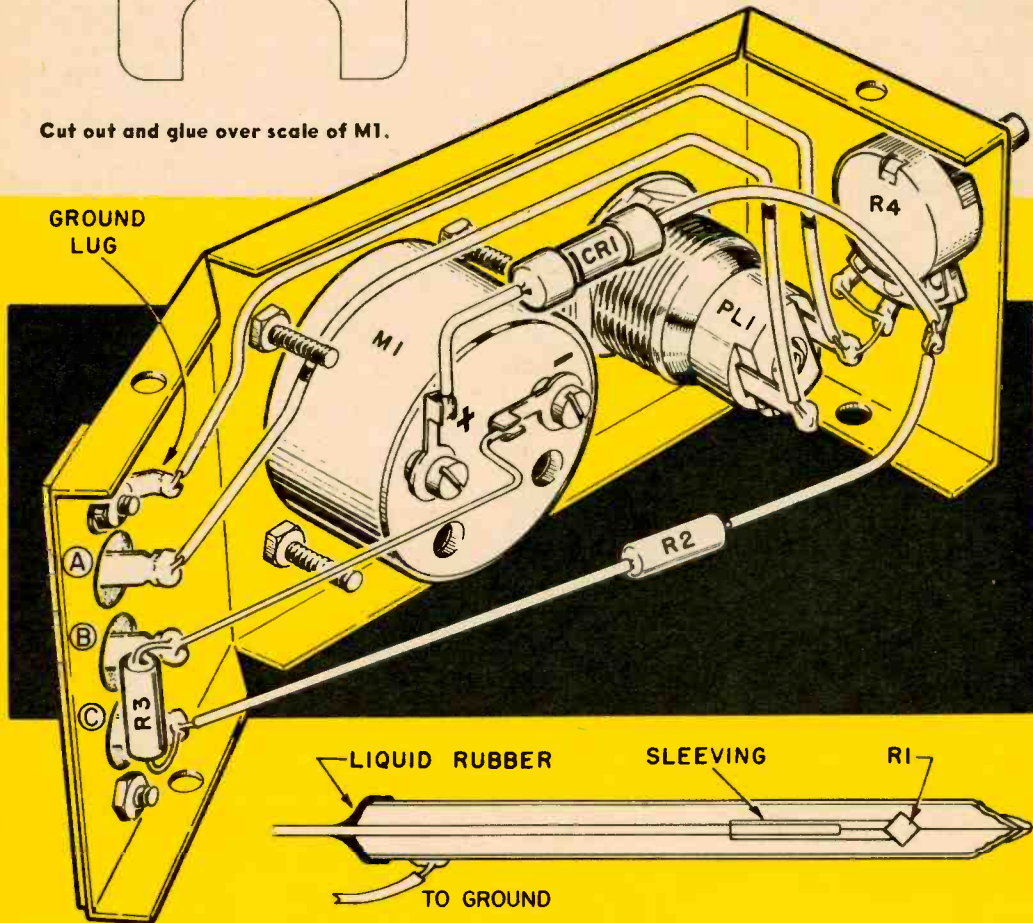

One thermistor (R1) lead goes to gauge, other into probe tip which is crimped and soldered.

highly accurate temperature gauge that can be built for under five dollars.

### Construction

The gauge consists of two separate assemblies: the probe, which is installed in the engine radiator, and the meter which is mounted on or under the dashboard.

In making the probe, one must first determine its length, which will vary depending on the car. Insert a ruler into the radiator and measure the distance between the top of the radiator element and the radiator housing. This measurement, plus 1 1/2", will be the probe length. Now cut a section of 3/8" outside-diameter copper tubing to the previously determined probe length. Cut



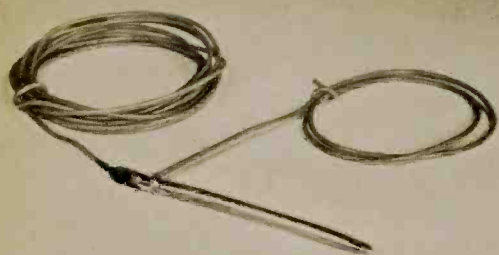

Probe ready for installation. Short coil of wire is for ground connection at chassis bolt.



Mount probe over water return inlet. Be sure hole is well sealed and wire is away from fan.

one lead of thermistor (R1) to  $\frac{1}{2}$ ". Solder this lead to a piece of rubber-insulated wire long enough to reach from the radiator to the dashboard. Slip a 2" length of sleeving over the wire so as to completely insulate the connection between the wire and the thermistor. Do not cut the other lead, but bend it forward so when the thermistor is inserted, the free end goes in first. Slide the thermistor down the tube until about 1" from the end. The free lead of the thermistor will extend about  $1\frac{1}{4}$ " beyond the end of the tube. Crimp the tube end with a pair of pliers, completely seal it with solder, and clip off the protruding thermistor lead. Solder a ground lead about  $\frac{1}{4}$ " down from the other end of the tube, and then seal the tube with liquid rubber.

The meter and associated circuitry are mounted in a  $3\frac{1}{4}$ " x  $2\frac{1}{8}$ " x  $1\frac{5}{8}$ " Minibox. In addition, a hooded panel light is installed to provide meter illumination for night driving.

### Calibration

Remove the plastic case from the meter, unscrew the two tiny bolts which hold the face plate, and slip out the face plate, *being careful not to damage the meter needle*. Cut out the new meter scale and cement it to the plate with rubber cement. Replace the new scale and plastic case front.

To calibrate the meter, connect it to the probe and a 12-VDC source. Immerse the thermistor end of the probe in boiling water and adjust the calibration pot (R4) so that the meter reads  $212^{\circ}$  (full scale). [Continued on page 101]

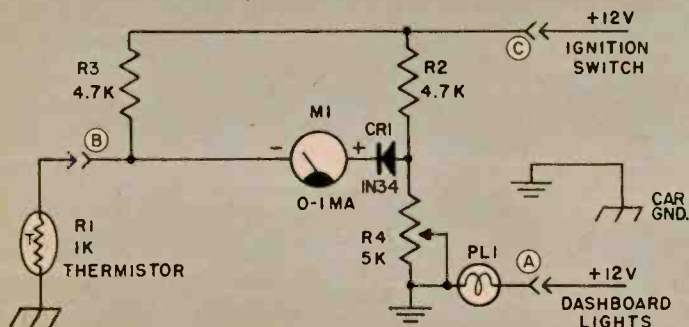

R4 of bridge circuit is adjusted so M1 deflects full scale when R1, in probe, is at exactly  $212^{\circ}$ .

SUMMER  
PROJECT

# build a transistorized Fence Charger

By C. Turner and  
J. Eimbinder

Radio Corporation of America

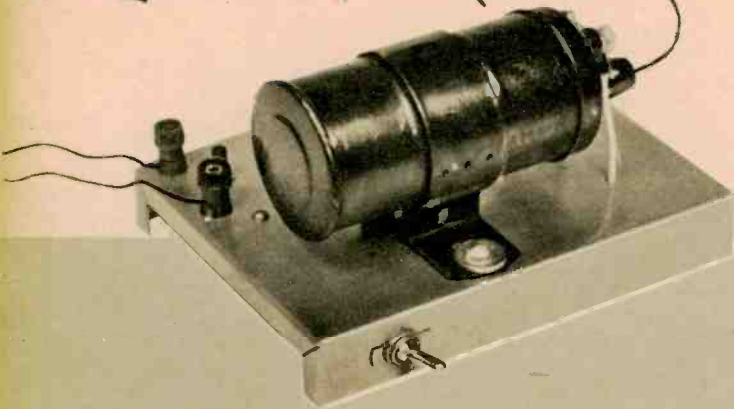
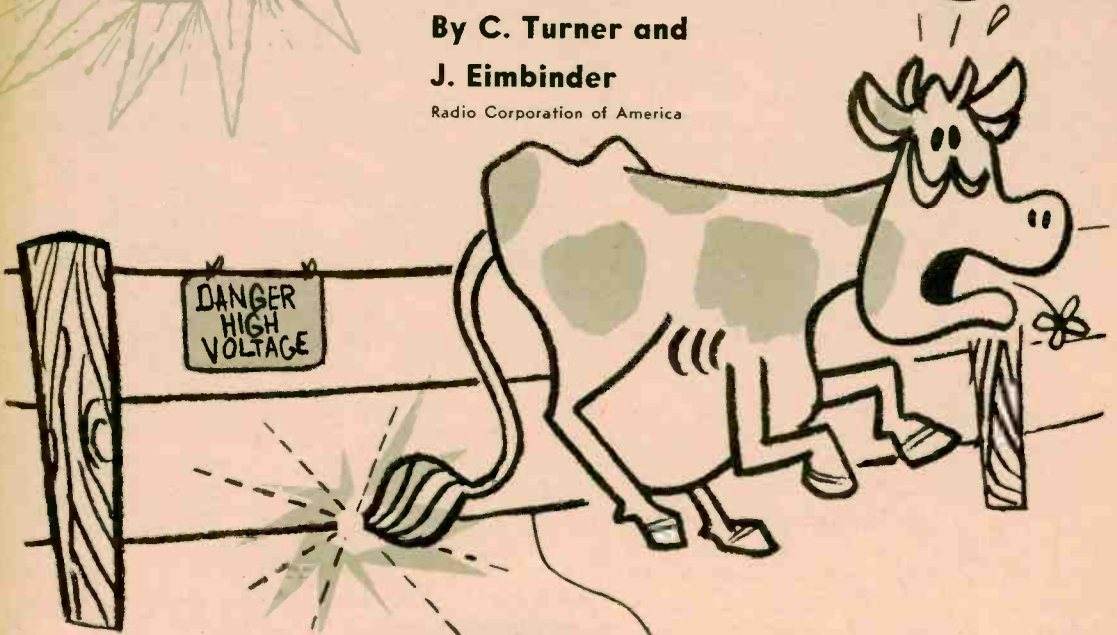

Q1-Q2 form multivibrator oscillator. Output, amplified by Q3 and driver Q4, is stepped up by T1.

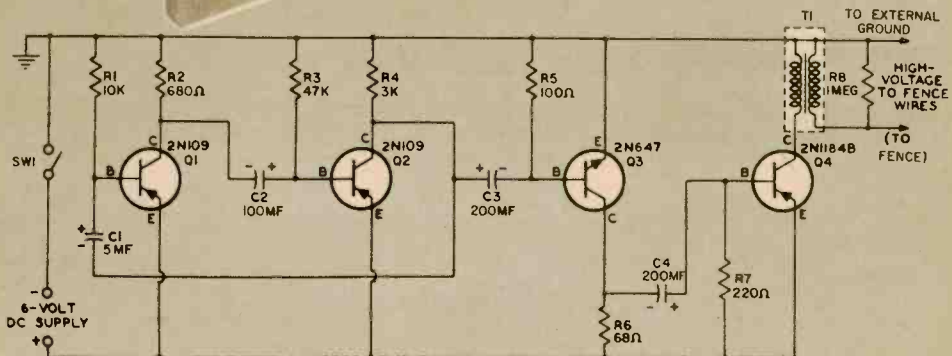



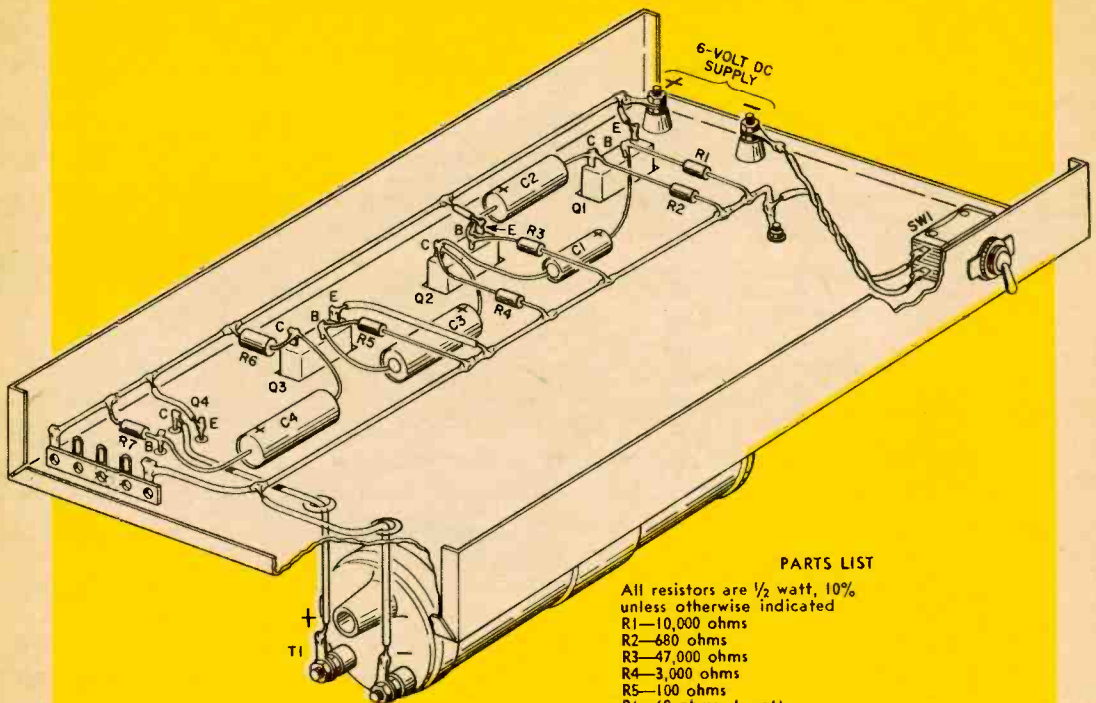

#### PARTS LIST

All resistors are 1/2 watt, 10% unless otherwise indicated  
 R1—10,000 ohms  
 R2—680 ohms  
 R3—47,000 ohms  
 R4—3,000 ohms  
 R5—100 ohms  
 R6—68 ohms, 1 watt  
 R7—220 ohms  
 R8—1 megohm  
 C1—5 mf, 6-volt electrolytic capacitor  
 C2—100 mf, 6-volt electrolytic capacitor  
 C3, C4—200 mf, 6-volt electrolytic capacitor  
 SW1—SPST switch  
 T1—6-volt automobile ignition coil  
 Q1, Q2—2N109 transistor  
 Q3—2N647 transistor  
 Q4—2N1184B transistor  
 Misc.—6-volt storage or "hot-shot" battery,  
 7"x6"x1" chassis, insulated binding posts,  
 transistor sockets, buss wire, hdwe.

Connect length of well-insulated wire from T1's high-voltage jack to fence. Observe T1's polarity markings. Chassis is grounded.

## Guaranteed to keep those gate crashers down on the farm.

**A**RE you one of EI's farmer-type readers, whose livestock believes that the grass is greener in the other fellow's field—and is willing to go right through the fence to get to it? If so, you've doubtlessly investigated the possibilities of the electrified fence. Its intention is not just to make the Jerseys bounce, but to save your fences and finances by training the animals to the idea that the fence area is *verboten*.

EI's fence charger is guaranteed not to sour the milk of the most sensitive bovine, since the high-voltage, low-current pulses it generates are harmless to man and beast. And if you already own a fence charger you'll appreciate the absence of trouble-prone mechanical moving parts in EI's all-transistor unit. Hooked up to a standard 6-volt storage battery, this highly efficient device requires nothing more than a fence (properly insulated) to get to work.

For the homeowner, this unit may prove the solution to dog vs. garbage can problems. Although the electric shock is not harmful, it acts as a deterrent to further contact.

Because humans as well as animals may come in contact with the fence,

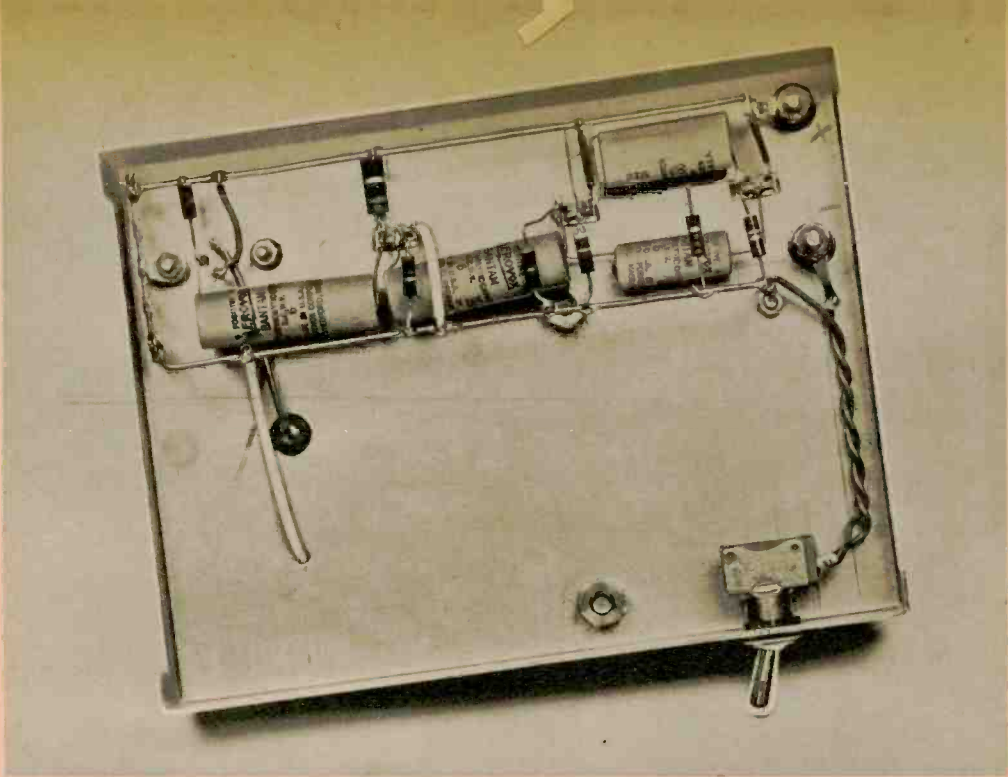

Both binding posts in upper right corner are insulated from chassis. Lower buss is common ground.

the average current for the electric-fence control circuit described in this article is at a relatively low 8 ma. In any case, the fence should be posted to warn of its shock hazard.

The transistorized circuit delivers a 500-microsecond-duration pulse of approximately 5000 volts every 1.25 seconds. Elimination of resistor R8 will increase the output voltage to 6000 volts; reduction of R8 to 100,000 ohms or 60,000 ohms will decrease the output voltage to 2,200 or 1,500 volts respectively.

### Circuit Description

Transistors Q1 and Q2 are connected in a multivibrator circuit which oscillates because of the feedback from the collector of Q2 to the base of Q1 via C1. The pulsed output of the multivibrator is fed to the NPN transistor (Q3) coupled to power output transistor Q4. The power pulses at the collector of Q4 are boosted by ignition coil transformer T1 to provide the high voltage.

### Installation

The charger and the storage or hot-

shot battery should be mounted in a waterproof box on or very near a fence post. The high voltage ground connection can be made by driving a 2'-3' length of bare pipe in the ground. The entire length of fence wire to which the charger is connected should be about  $\frac{2}{3}$  of the average height of the livestock and insulated from the fence posts.

Q4, at far left, is supplied with mounting instructions and uses the chassis as heat sink.

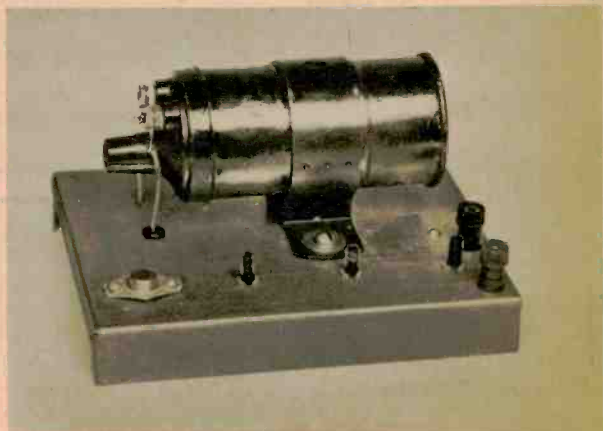



# Step-Saver Appliance Alarm

SUMMER  
PROJECT

Plug in this gadget and your washing machine  
will call you when its job is done.

By Paul Harvey

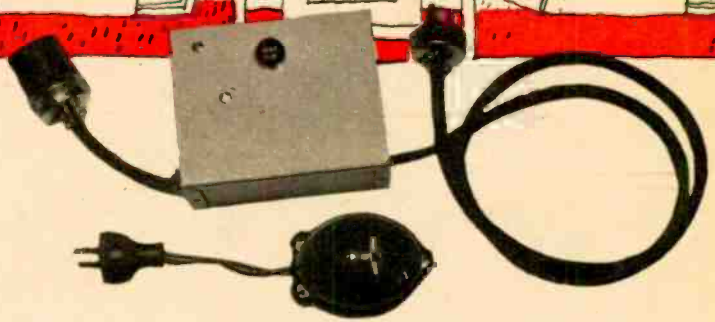
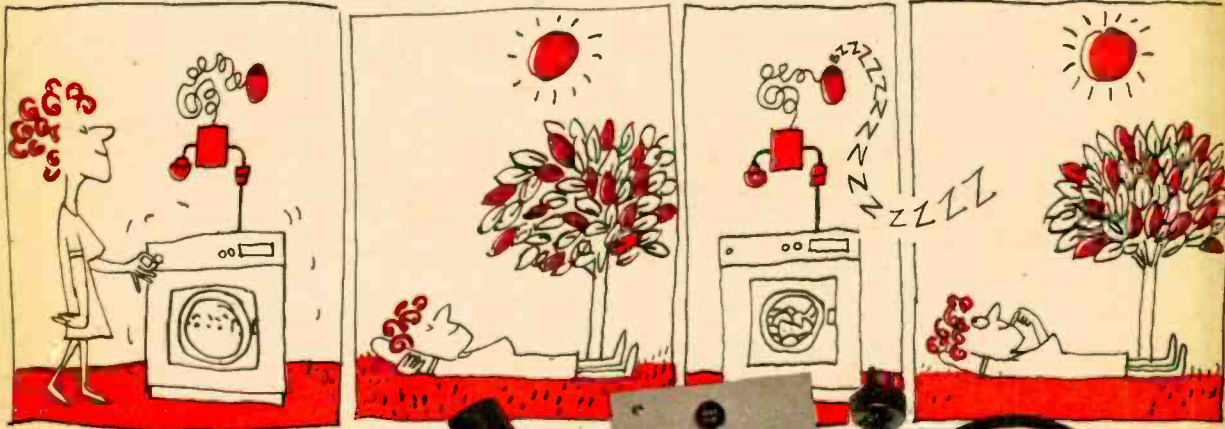

**H**ERE'S a signal device that obviates the need of running down to the basement to hear if the washing machine is still running. Its outstanding feature is that you need not tamper with the appliance wiring in any way. Merely plug the alarm into the AC receptacle and transfer the plug of the washer to the alarm. The alarm works equally well with a clothes dryer, dish washer, broiler, or any other heavy-current AC device that has a timed operation cycle.

When the cycle is complete, the alarm sets off a buzzer which sounds loudly for about 5 seconds and then shuts off, ready for the next cycle. You know, therefore, when the appliance is through with its job and is ready for the next one.

## Construction

Check the plug on your washer. Since 1957, most have been equipped with three-prong plugs for safety grounding. If this is the case, PL1 and SO2 must be three-contact connectors of the same type as on the appliance. If your appliance is older, it probably has a standard 2-prong AC plug. In that case, you must be sure the appliance is grounded to a cold water pipe or its equivalent by using a three-wire cable to PL1. Ground the third wire to the outlet box.

The alarm circuit uses thermal-current sensing. A 4" length of nichrome wire from an old heating coil or a re-

For clarity, RY2's octal socket is inverted and pin 4 is omitted. Heavier wires shown are No. 16.

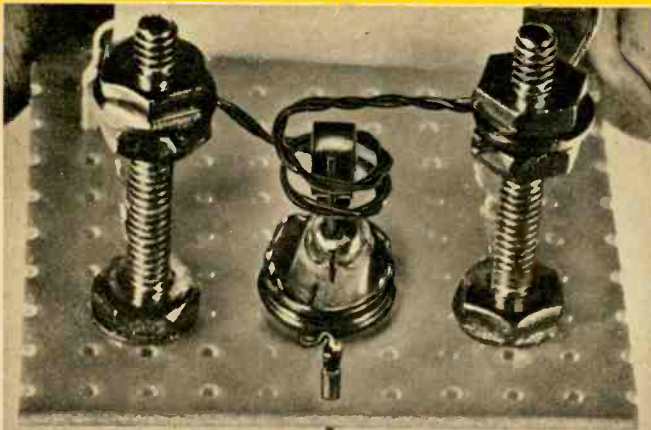
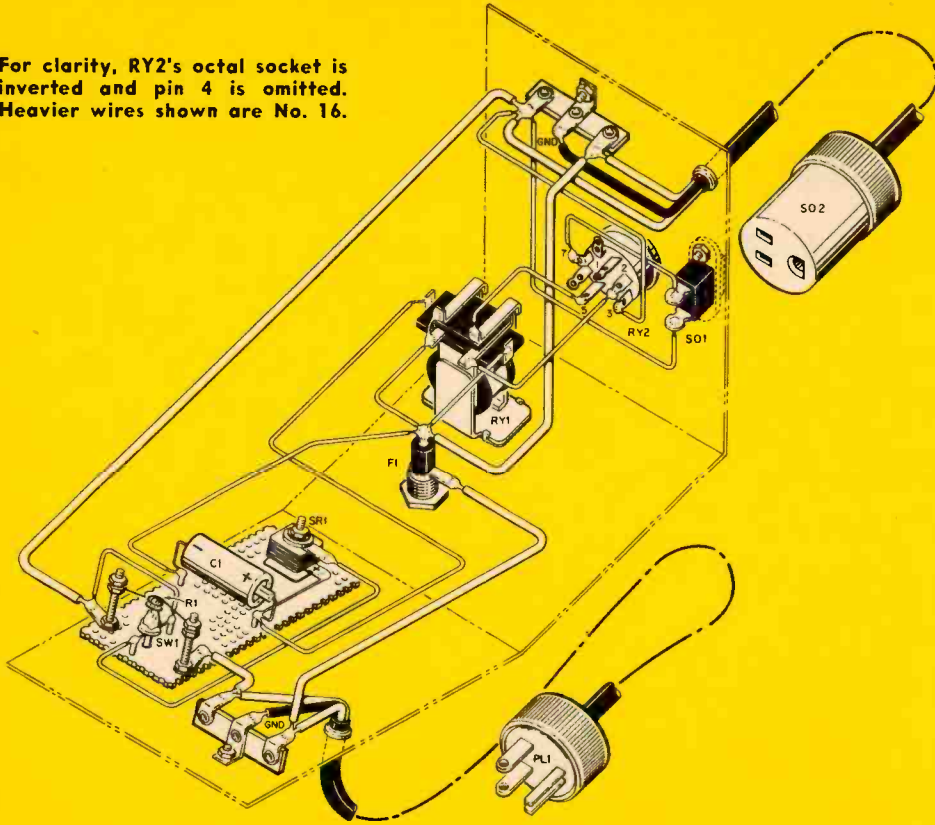

Thermal current-sensing element. Wire R1 gets hot and should be supported well above Bakelite base board. Center SW1 in R1.

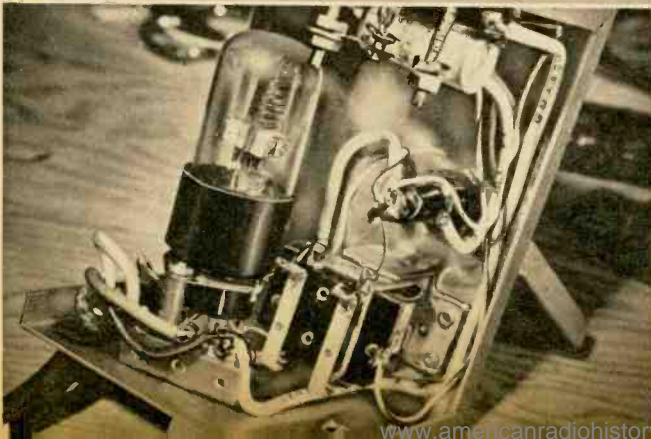

Note how RY1's socket is mounted on spacers above metal cabinets. Vent holes should be drilled in the cover for cooling of R1.



placement element is used to make heater resistor R1. Double the wire back on itself and twist tightly to form a 2" length of twisted lead. Form the twisted lead into a two-turn loop by wrapping it around a 1/4" drill. Now mount the coil on two 1 1/4" machine screws to hold it well away from the perforated base board.

Thermal switching action is accomplished by the bi-metallic strip taken from a fluorescent starter. Remove the starter from the metal case as shown and carefully break the glass from around the bi-metal starter element.

Using standard flea clips, mount the element in the center of the loop formed by R1.

DC relay RY1, selenium rectifier SR1, and capacitor C1 keep the make-break current of the fluorescent starter contacts low. Thermal time-delay relay RY2 has a closing time of 15 seconds and a re-cycling time of about 5 seconds. The re-cycling time controls the "on" period of the buzzer as follows: when the appliance is turned on, the 117-volt buzzer, which is plugged into S01, does



Starter used for SW1 is separated from base, soldered to flea clips, and centered in R1.

not sound because the contacts of RY2 are open. As the washing machine starts, its current flows through R1 which heats and causes bi-metallic strip SW1 to close. This in turn, energizes RY1. RY2 now heats, and its contacts close 15 seconds later. The buzzer remains off, however, because contact 1 on RY1 is now open. When the appliance goes off SW1 opens de-energizing RY1 whose contacts transfer and apply power to the buzzer through the closed contacts of RY2. RY2 cools and its contacts open five seconds later restoring the system to its ready-off condition.

#### PARTS LIST

- R1—Twisted heater-coil wire (see text)
- C1—4 mf, 150-volt electrolytic capacitor
- F1—10-amp, type 3AG slow-blow fuse and holder
- PL—3-wire heavy-duty AC plug
- RY1—Double-make, double-break relay. (Available for 95¢ plus postage from Edlie Electronics, Inc., 154 Greenwich St., New York 6, N. Y. Catalog No. BX1197)
- RY2—Thermal-delay relay (Amperite No. T15NO15)
- S01—Chassis-mount AC receptacle
- S02—3-wire heavy-duty AC receptacle
- SRI—65-ma selenium rectifier
- SW1—Bi-metal fluorescent starter (see text)
- 1—5"x4"x3" Minibox
- 1—Octal socket
- 2—1" long spacers
- 1—3/8" long spacer
- Misc.—Two 3-lug terminal strips, 2 1/2"x2" perforated Bakelite board, 117-volt AC buzzer (Lafayette EL-86 or equiv.), Length of No. 16 3-conductor rubber-covered wire, etc.

F1 should be large enough to carry current of the appliance. If RY1 is an AC relay, SRI and C1 can be eliminated.

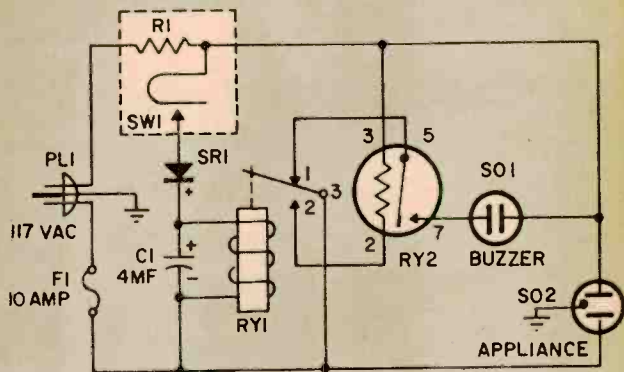

R1, SW1 HEATER-STARTER ASSY (SEE TEXT)

RY1, RY2, SW1 SHOWN IN DEENERGIZED (COLD) POSITION

WIRING FOR DOUBLE-MAKE DOUBLE-BREAK RELAY





**SUMMER  
PROJECT**

And don't forget to take the ham rig! Your whole station can tag along on a business or pleasure trip, putting you on the air from a hotel or motel room. You don't have to leave the air every time you leave your home!



## Tag-Along Ham Rig

The author has his CW gear set up and is ready to go on the air. Having equipment in the case makes for a fast start next morning.





## You get extra pleasure out of those vacation and business trips if you take your ham station along!

By Howard S. Pyle, W7OE

**W**HEN you hit the road this summer on vacation, or if you are required to travel often in your business, why don't you take along your ham station?

The idea may strike you as a little far out but I can tell you that it isn't. I've been taking my rig along for years!

A completely portable station fills a definite void for anyone on the road. Many hams simply leave the air when they leave home. Others have mobile gear in their cars, which is all right as long as you're in the car. But when you stop off at a motel or hotel you won't find much pleasure during the long evening if you sit huddled over the dash while your car is parked in a garage or out in front of your motel unit (with the engine idling on the high side to provide

the needed juice). Misery soon triumphs and in you go.

You can invest in one of the auto-home units but they are pretty expensive. A less expensive way to stay on the air away from home is to build yourself a carrying case for your home station and take it with you (if your equipment is anything like carrying size). With station in hand, you can simply plug into the nearest 117-volt outlet, drop into an easy chair and you're in business!

I first devised a carrying case for my ham gear during my many years of government service, when the XYL and I traveled practically all the time through 11 western states. We often wanted to check into our home area traffic net because that gave us a contact with our

Diagram gives general instructions for case but you determine dimensions to fit your own rig.

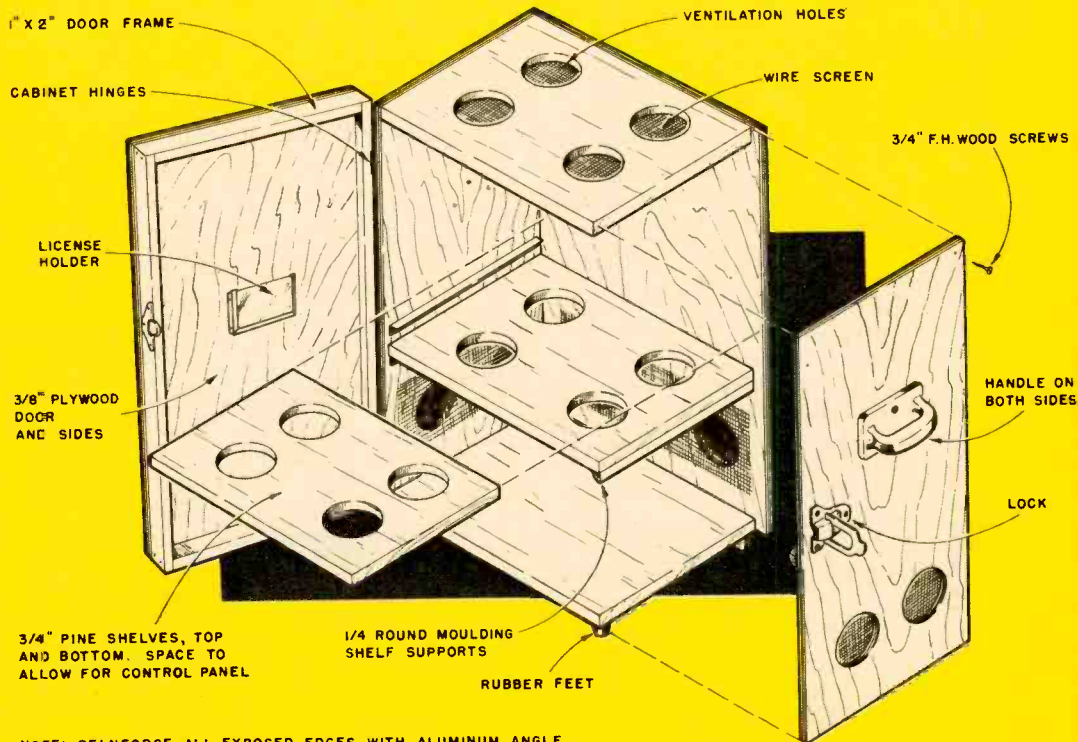



Control panel fits into space between Knight-Kit 50-watt CW transmitter and the National SW-54 receiver on the bottom. Note key and phones.

daughter and her family. At other times, I just wanted to be on the air on the popular amateur bands (the bug had bitten me hard).

At first, we attempted to carry loose pieces of gear around, but that didn't work because of the packing and handling problem. In the town where we happened to be at the time, I went out and had a carpenter make up a case for my transmitter, receiver and related gear. It was a

little expensive, but worth it. Since then, I've made up several cases to fit other gear that I've owned.

The instructions in this article for building a carrying case are necessarily pretty general. The case pictured was built for a 50-watt Knight-Kit CW transmitter and a National SW-54 receiver. But your equipment may differ, therefore, we aren't giving you dimensions. You'll have to figure those out yourself to fit your own components.

Only the most basic carpentry tools—a hand saw, square, hole saw or expansion bit, etc.—are needed for the job.

The best stock for the door, back and sides of the box, I have found, is  $\frac{3}{8}$ " plywood. This is light to carry but still strong and rigid. The shelving and top and bottom are  $\frac{3}{4}$ " pine. I used  $\frac{3}{4}$ " countersunk flat-head wood screws for the major assembly, and put quarter-rounds under the shelves to support them.

If you follow the general instructions shown in the drawing you shouldn't have any trouble.

At one time I was taking along both key and microphone, plus VFO and modulator. But I found those extra pieces just too much. Now I stick with crystals and straight CW, and I've found it strangely rewarding to be left without a mike. You keep up your speed if forced to use nothing but CW (and avoid perjuring yourself when you swear that you can do 13 wpm on your next FCC license application).

The control panel on my tag-along case is simplicity itself. I use a telephone-type lever antenna switch but a double-pole ceramic rotary will do as well. Other items on the panel are a jack-type fuse holder, a pilot jewel (for on-off power indication) and a power switch. The panel can be of Masonite, Bakelite or similar material.

On the back of my [Continued on page 104]

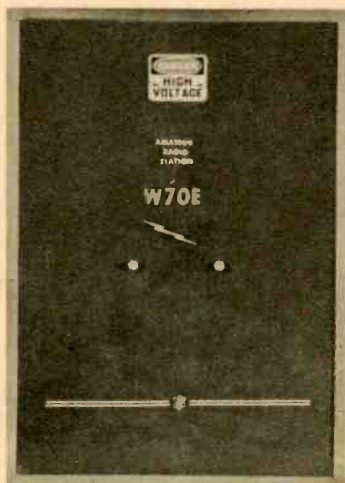

W7OE's case has his call letters and some other adornments on it. Make yours to fit your own taste.



# Take Care of Your Tape!

By Norman Eisenberg

**T**HE SUCCESSFUL and enjoyable use of tape recorders depends in large part on skillful handling of the tape. Even the best recorder is useless if it is given tape that has been mishandled by the owner.

Fortunately for the hobbyist, many accessories now on the market can help him care for his tapes and thus make recording and playback problems easier. Correctly used, these items make possible results that only a professional could have boasted a few years ago.

The first requirement of tape is that it be clean physically and electrically (magnetically). The former consideration involves dust, bits of tape coating, grease and the like picked up by the tape when used or handled. Obviously, the cleaner the recorder, the cleaner the tape run on it. So



Handy tape accessories shown here include white plastic leader tape at the top which can carry an identifying note, special cloth for cleaning tape at upper left, and stick-on label, at right, for the identification of tape reel.



Degaussers are designed to clean a tape electrically through the use of a strong magnetic field. Reel is put on spindle and rotated in case of the degaussers below, sold by (l. to r.) Olson, Microtran, Robins, Lafayette. Magneraser at left is unique in that it is simply held in the hand and moved over reel of tape.

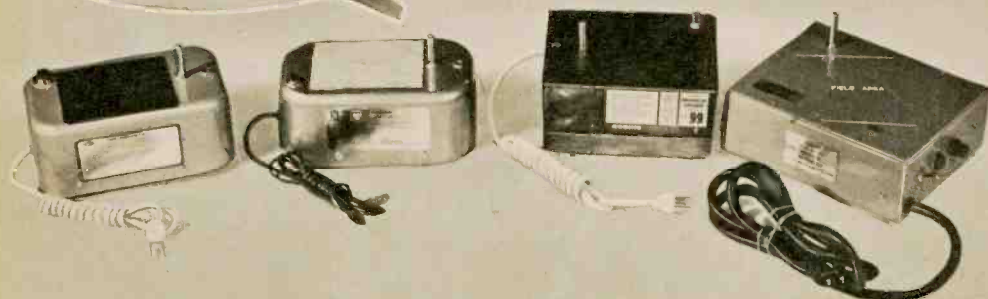

the equipment—heads, capstans, pressure pads, rollers—must be kept clean. The tape itself can be cleaned with a special cloth, such as the Jockey Cloth marketed by Robins Industries. This cloth is wiped across the tape as it unreels from the tape deck.

An electrically clean tape is one that has no audible signal, as from previous recordings. The erase head on a good machine can remove most of this sound,

**Special mailing boxes are handy for the tape correspondence fan, come in variety of sizes.**



but there are exceptions. Even top-quality heads have trouble with tape that has been too heavily recorded—overloaded with signal—or tape that has been stored too long. Fresh tape may have a residual noise level which shows up on your recordings as vague, annoying background noise.

Thorough magnetic cleansing can be done with a tape degausser, or bulk eraser. Such a device is simply a large electromagnet which sets up a strong field. A reel of tape, placed in the field, can be quickly restored to a neutral state. A reduction of as much as 6 db in residual noise has been claimed for degaussers, which in looks resemble small boxes with two holes on the top for different size reels. To use a degausser, you place the spindle in the proper hole, put on the reel, press the *on* button and rotate the reel a few times by hand.

Typical degaussers range in price from the \$12.50 Olson T-272 to the powerful, professional model 710 by Aerovox, listing at \$49.95. Audiotex and Robins offer \$33 models. The Microtran HD-11 sells for \$27.50. Lafayette's powerful and rugged ML-120



sells for \$18.95. The Magneraser by the Amplifier Corp. (\$18) is unique in that it is held in the hand and moved over the reel of tape.

Tape breakage once was a common problem. But stronger, more tensile tapes and improved braking and handling by recorders have helped a great deal, although it still can happen. When tape does snap, it must be spliced. Splicing, of course, is also a major part of editing tapes, in which sections are removed or re-arranged or new material is added. Indeed, ease of editing has helped make tape the master recording medium for professionals, as well as a source of fun for amateurs.

Tape can be spliced with a pair of scissors or a razor blade, but devices made expressly for this purpose do a neater, faster job, and do it easier. A good splice must be secure, the ends of the joined sections fitting together

snugly without overlap or exposed areas. And the splicing tape that joins the two sections must not project beyond the edges of the recording tape. In other words, a spliced tape should present to the recorder heads a surface almost as smooth as that of an unspliced tape. To accomplish this, it's an excellent idea to get some kind of tape splicer.

Many types of splicers are available but basically each has a means for holding the tape ends in place and a guide for cutting (and sometimes trimming) the splice. The most elaborate splicer is the Skila Model K-1 by the F. Reiter Co. Priced at \$69.75, it is a precise, automatic machine intended for professionals. Most hobbyists find lower-priced models suit their needs. Robins offers a choice of splicers from an industrial model at \$55 to a hobbyist model at \$1.75. [Continued on page 99]

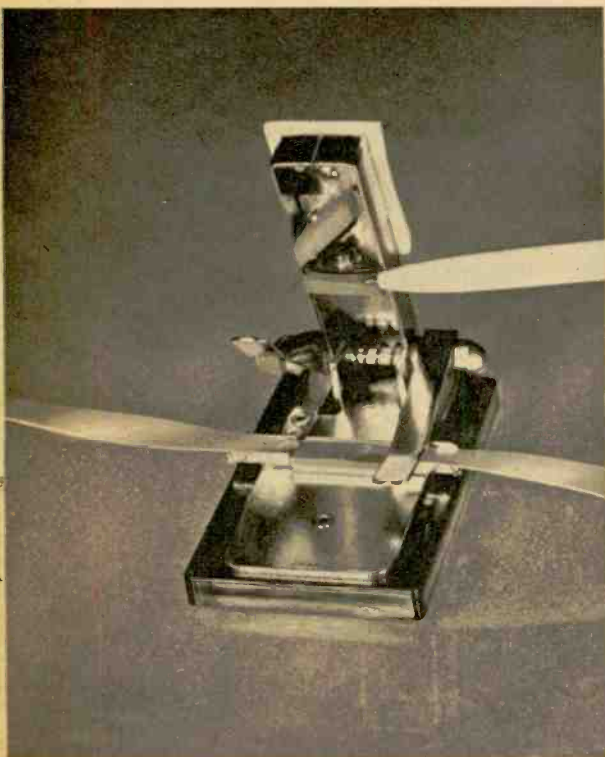

Hobbyist's tape splicer, the Rystl Sr., boasts three blades to perform miter and trim cuts. Pencil points to trim blade. Price is \$3.49.

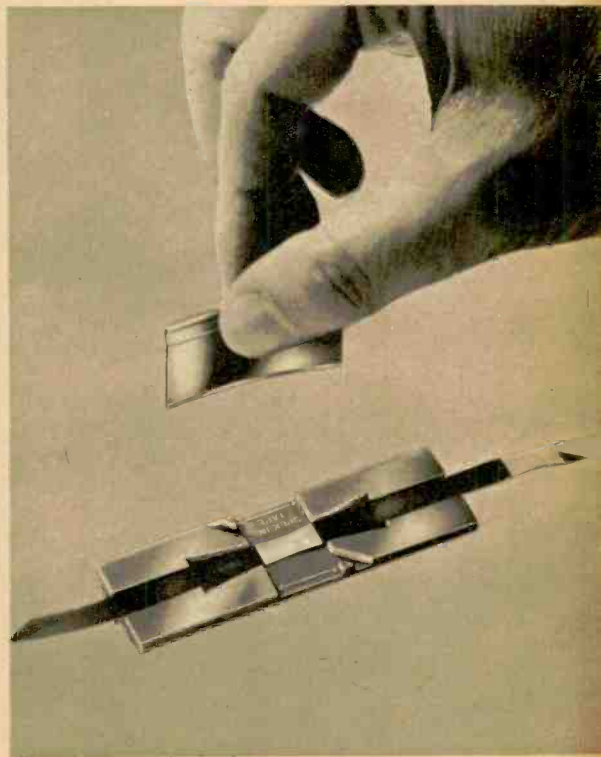

Most basic of all the tape splicers are the blade-and-block affairs. This Robins model has a curved cutting blade, sells for \$1.75.

# TV Patterner

One-tube unit generates test pattern for perfect height and linearity adjustments.

By John Potter Shields

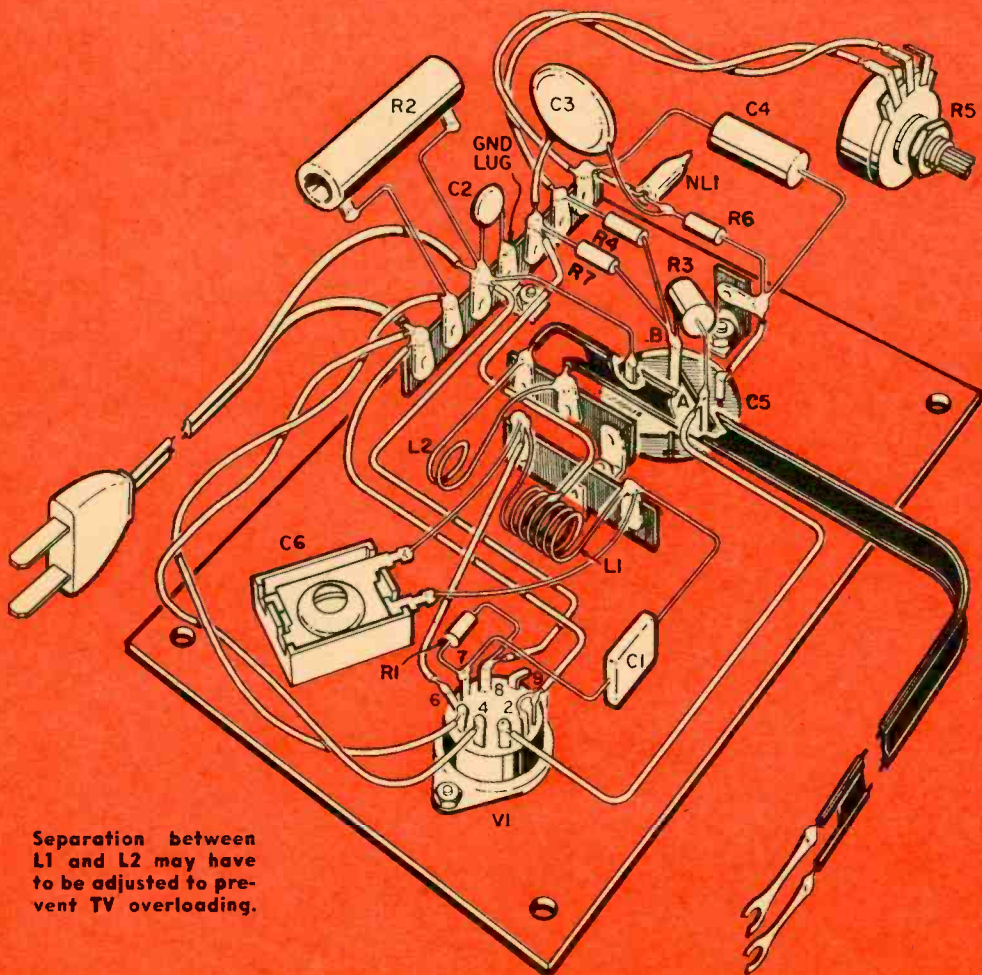

Separation between L1 and L2 may have to be adjusted to prevent TV overloading.



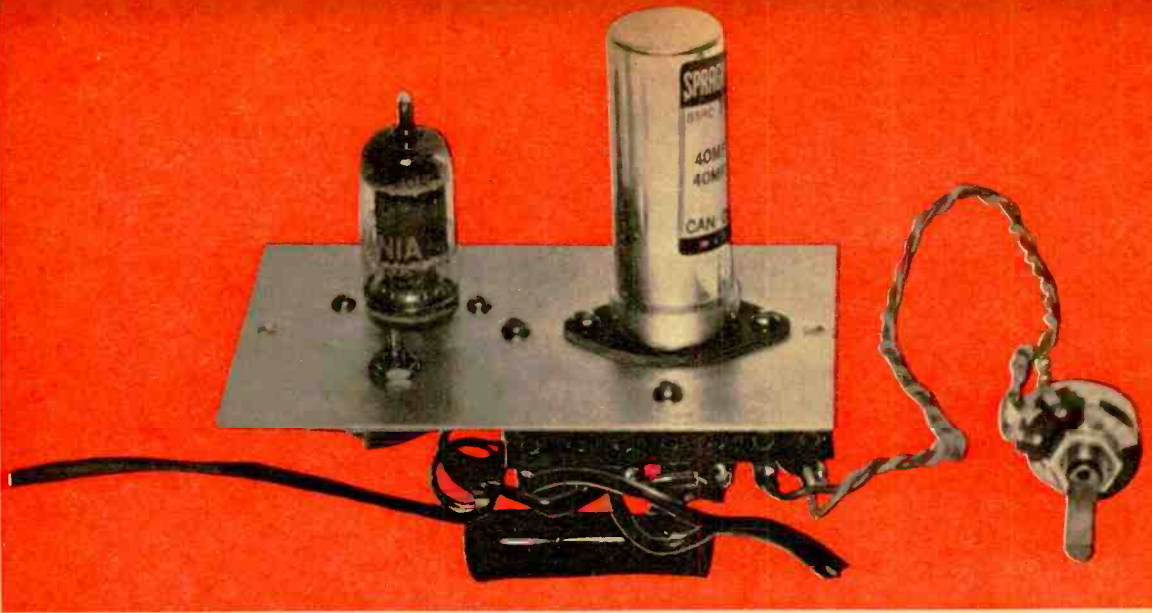

Can of C5 is connected directly to AC line and is "hot." A fiber mounting wafer isolates chassis.

**T**URN on your TV set and take a good look at the picture. Do the people on the screen suffer from over-long legs and squashed heads? And are the wheels on the old covered wagon a bit egg-shaped? If these troubles plague your TV, then you should build the TV Patterner.

The Patterner will provide an adjustable number of stationary horizontal lines on the face of your TV picture tube which enable you to accurately adjust your set for the best picture size and linearity. All you have to do is to connect the twin-lead from the Patterner to the antenna terminals of your set and adjust the vertical size and linearity controls until the picture fills the screen completely and the horizontal lines are evenly spaced as shown. The gadget also provides a variable frequency audio signal which can be used to adjust the sound section of the TV receiver. The Patterner is easy to build and even if all new parts are used, its price will be less than a ten-dollar bill.

### Construction

The author's Patterner is constructed on a piece of 4" x 6" sheet aluminum. No housing was used as the author's model was to be mounted with several other pieces of test gear in a larger cabinet. It would be best to mount the chassis

shown in some sort of insulated cabinet. Coils L1 and L2 are  $\frac{1}{2}$ " in diameter and are wound from #18 tinned copper wire. Both coils are supported by their leads from tie lug strips as shown.

### Adjustment

To use the Patterner, connect its twin-lead output cable to the antenna terminals of your TV receiver and switch the receiver's channel selector switch to any vacant channel between 1 and 7. Next, adjust C6 until the Patterner's signal appears as a number of horizontal lines on the face of the picture tube. Adjust R5 for the desired number of horizontal lines. It may be necessary to vary the spacing between L2 and L1, so as not to feed too strong a signal to the receiver which might cause overloading.

You will find that R5 will vary both the number of lines and the pitch of the audio signal. If more horizontal lines are desired, it is only necessary to decrease the value of capacitor C4. This will decrease the R-C time constant of the relaxation oscillator and raise its operating frequency.

### Circuit Operation

V1A is connected as a series-fed Hartley oscillator producing an RF signal whose frequency is set by C7 within

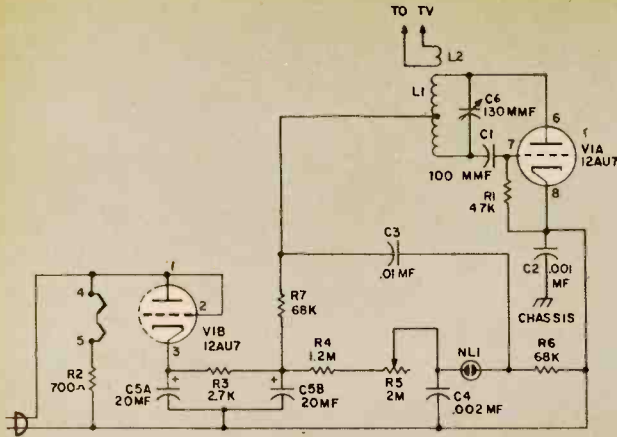

### PARTS LIST

- R1—47,000 ohms, 1/2 watt
- R2—700 ohms, 20-watt wirewound
- R3—2,700 ohms, 2-watt
- R4—2.2 megohms, 1/2 watt
- R5—5 megohm linear-taper potentiometer
- R6—100,000 ohms, 1/2 watt
- C1—100 mmf, 400-volt mica or disc
- C2—.001 mf, 400-volt mica or disc
- C3—.01 mf, 400-volt mica or disc
- C4—.002 mf, 400-volt mica or disc
- C5AB—Dual 20 mf @ 150-volt electrolytic (can type with insulating plate and sleeve)
- C6—Trimmer capacitor, 15-130 mmf (value not critical)
- L1—7 turns No. 18 tinned copper wire; 1/2" diameter
- L2—2 turns No. 18 tinned copper wire; 1/2" diameter spaced approximately 1/2" from L1
- V1A/B—12AU7 tube
- NL1—NE-2 neon lamp
- Misc.—9-pin tube socket, hdwe., 4"x6" piece of sheet aluminum, length of TV twin-lead, terminal strips

RF signal generated by VIA is pulse modulated by modified relaxation oscillator that includes NL1.

the range of lower TV channels. L2 is a pickup coil which couples the RF signal from L1, via the twin-lead, to the antenna terminals of the TV receiver.

The RF signal is pulse modulated by a modified relaxation oscillator consisting of R4, R5, R6, C4 and neon bulb NL1. When C4 charges to the firing voltage of NL1, NL1 "fires" and discharges C4 through series resistor R6 producing a sharp pulse across R6. This pulse is coupled by C3 to the oscillator side of R7, where it plate-modulates the oscillator. The modulating pulse frequency is varied by R5 to produce a frequency which is a multiple of 60 cycles. If this frequency is twice 60 cycles (120 cycles) two horizontal lines will appear on the picture tube face. If the frequency is three times 60 cycles (180 cycles) three lines will appear, etc. With the values given in the schematic, up to twelve lines can be produced. This number can be increased by changing C4 as was explained earlier.

This type of modulation also produces considerable frequency modulation of the carrier so that the signal can also be received by the sound section of the TV receiver. Varying R5 will vary the frequency of the audio output signal. By the way, the RF oscillator's harmonics can be received on an FM receiver which makes this a handy gadget for

occasionally troubleshooting an FM set.

The power supply is conventional, consisting of the second half of the 12AU7 (V1B), connected as a half-wave rectifier. The two heater sections of V1 are connected in series and supplied directly from the line through series dropping resistor R2. Since B-minus, common to one side of the AC line is not connected to the chassis, C2 is used to ground the chassis and RF signals to B-minus. However, the can of C5A/E is connected to one side of the line and will be hot. Cover it with an insulating sleeve or tape to prevent shocks.

**Underside view. If the patterner is built in metal box, drill ventilation holes around R2.**

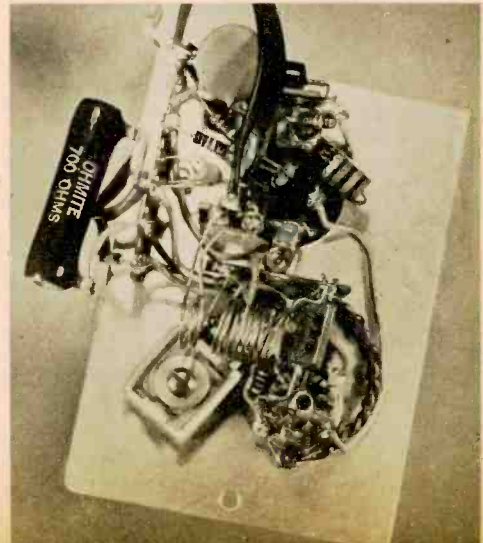



# CB To Ham

**Converting yourself and your equipment from the Citizens Band to the Amateur Service can be easy!**

**By Robert Hertzberg, W2DJJ**

**T**HERE are several reasons why a Citizens Band licensee might want to convert himself and his equipment to amateur radio operation.

If your true interest lies in the field of electronics or radio experimenting, the reason for the conversion is obvious. Any experimenting done on the CB bands is severely limited. Your frequencies are restricted, you cannot use more than five watts, you may not make adjustments in the transmitter itself and the FCC requires you to limit your communications to local stations. If you want to experiment you *must* become a ham. As a ham, you have an open choice of more than a dozen frequency bands, you can use any power up to 1,000 watts, you can build and experiment with equipment to your heart's content and you are free to talk with other hams anywhere in the world.

CB radio certainly has its attractions and it is a vital new link for necessary communications. But few would deny that a ham license gives you more prestige and makes you feel that you have accomplished more than does a CB ticket. Converting from CB to



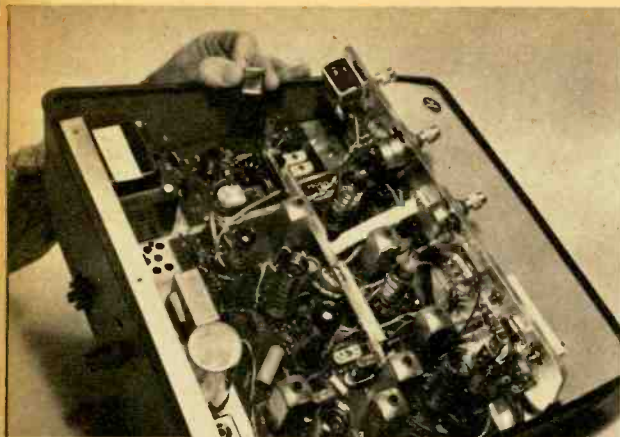

**Knight-Kit C-27 CB transceiver is a good unit to convert to ham use. Transmitter section requires new crystals, which merely plug in.**

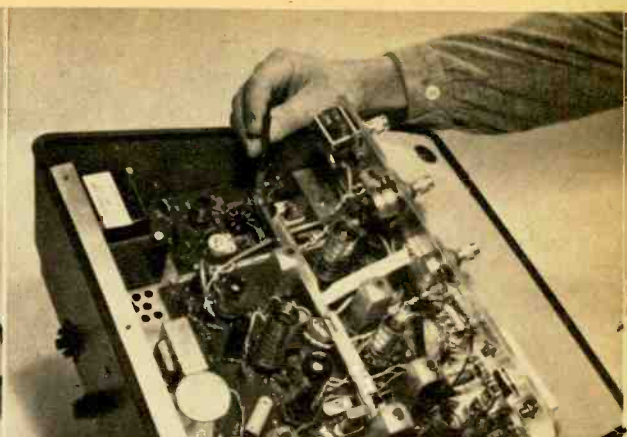

**Tuning coil slugs are shown being adjusted for maximum output on ham band. The receiver section also must be trimmed for 10-meter use.**

ham radio, then, can be a matter of self-improvement.

Or perhaps after getting into CB radio you have made a belated discovery that what you really wanted all along was ham radio.

Whatever your reasons, the switch from one service to the other need not be difficult for you. The ham license tests really are quite easy. Soon after learning this, you'll be busy practicing code (as the two youngsters are doing on the opening page of this article) and reading up on the FCC regulations.

But what about your CB equipment? If you decide not to continue with CB radio, can you salvage your rig for use on the ham bands? This article will attempt to give a general answer to that question. Let's see where you stand.

*Transmitters-Receivers.* Virtually all CB units are transceivers. That is, many of their circuit elements are used for both transmitting and receiving. The lower-price sets, the ones that are sold in the greatest number, employ receiving circuits of the super-regenerative type. While these are quite sensitive, they are also notoriously noisy and broad in tuning.

It is a sheer waste of time, energy and money to attempt to rework super-regens for ham purposes. If you have one in good condition, why not simply hold onto it? You might want to use it

again for Citizens Band operation. Of course, you may hold CB and ham licenses at the same time. The two activities have little to do with each other.

Far superior are the CB transceivers using super-heterodyne circuits in the receiving section. These are sensitive and, more importantly, much more selective than super-regens. You can make these sets operate in either the 6- or 10-meter amateur band by changing a few small components. This is an interesting, instructive and relatively simple undertaking if you have any background in electronics, which you must have acquired by now through your CB experience.

If you obtain the usual general-class ham license, probably the best idea is to revamp your CB set for the 10-meter band, which is effective for both local and DX communication. In most cases you will have to buy only one or two new quartz crystals (available by the bushel at low prices) and re-adjust a couple of minor controls.

As alternatives you can, of course, retain the CB equipment unchanged, sell it for cash or apply it against the purchase of ham gear. Super-het type transceivers have good turn-in value, and horse-trading is the usual order of the day in stores that handle both ham and CB merchandise.

*Antennas.* You're in luck here be-



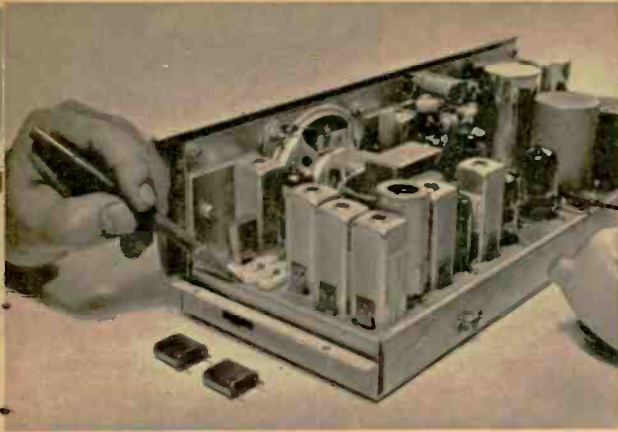

A Heathkit CW-10 does well on 10-meter band. Pencil points to three crystal sockets which can give you three transmitting frequencies.

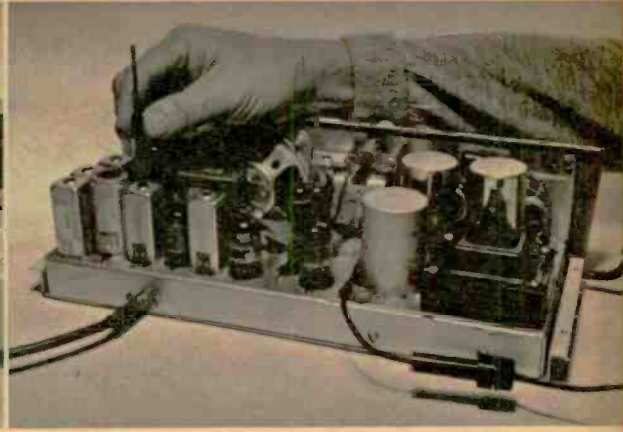

The tuning coils are inside shield cans in the Heath equipment. They can be reached easily with alignment tool for trimming to 10 meters.

cause the standard CB whip antenna needs only to be shortened a couple of inches to make it perk beautifully on the 10-meter band. To do this job properly you need a grid-dip meter, but you'll buy this anyway for many applications in your ham shack.

Perhaps you were an ambitious CBER and invested in a beam antenna and a rotator to move it around. You'll have to shorten the elements a bit and experiment with their spacing but this, too, is easy. You'll find a beam of enormous

advantage in ham communications. For transmitting, it provides a large increase in effective power by concentrating the radiated energy like a searchlight. For receiving, it works in reverse by gathering signals from one direction while attenuating those from other directions.

*Microphones, Power Supplies, etc.* All just as good for ham as for CB purposes!

At any event, a revamped CB set is only intermediate or stop-gap equipment in your ham program. You'll learn quickly that [Continued on page 108]

After you pursue ham radio a while you may have a beautiful shack full of equipment like W9IOP, who is Lawrence LeKashman, South Bend. He has two receivers and four transmitters.



# EI'S Hi-Fi Doctor . . . .

## Second Thoughts on Stereo—Part Three

LAST month I plugged for “bounced-off-the-wall stereo” as a solution—at least for the time being—to the problem of stereo speaker placement. I’d like to start off this time with a few more words on how to get the most out of your stereo speakers.

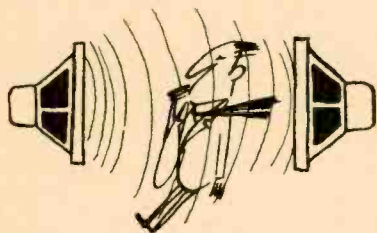

If you’ve ever complained that your stereo seems to have a “hole in the middle,” chances are you’ve put the blame on something beyond your control—like your wife, who insists on putting one speaker in the living room and the other in the back yard. But unless your stereo speakers are that far apart, I’d be tempted to bet the slim contents of my wallet that the real reason for that “hole” is that your speakers are out of phase. The thin-sounding stereo that issues from out-of-phase speakers is easy to confuse with the hole-in-the-middle effect, especially since the latter is now an honored part of stereo folklore. But it’s better and easier to put the blame where it belongs, and take time to phase your speakers, than to shell out hard-earned cash for extra speakers to fill a nonexistent hole.

Getting your speakers in phase is actually a double-barreled job. First there’s the simple but important matter of *acoustical* phasing. All this means is that you should take the time to locate both stereo speaker systems about the same distance from your usual listening spot, so that you get the sound from both at the same time. The further away you sit from your speakers, the less you have

to worry about their being *exactly* the same distance from your listening position. And as long as you don’t change your listening set-up, you have to worry only *once* about acoustical phasing.

Unfortunately, *electrical* phasing is something that stereo won’t allow you to “set and forget.” You have to *put* your speakers electrically in phase to start with, and then you have to *keep* them in phase.

The best way to phase your speakers initially is by listening to a *mono* record with your speakers close together. After a few minutes worth of listening, reverse the leads to *one* speaker and take another earful. The right connection will give both maximum bass and maximum volume. In fact, in-phase mono (with the speakers well spaced) sounds very much like stereo.

I suggest a *mono* record to phase your speakers for the same reason that I say you have to pay attention to *keeping* your speakers in phase. After three years of stereo disc production, *some* records still reach your dealer’s shelf with their two stereo channels out of phase. It’s an understandable matter, since there are plenty of chances for the channels to wander out of phase during the long process that starts with the setting up of the recording mikes.

If your stereo amplifier doesn’t have a switch for phase-reversal, it’s easy to install a DPDT switch in *one* speaker line to do the trick. Whenever things don’t sound “right,” phase-reversal is worth a try. Use the hookup below.

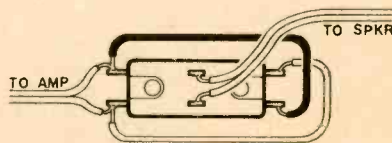

Next month I’ll suggest a short-cut to good stereo. ●



# and Clinic

## Hi-Fi Fusing

*My amplifier does not have a fuse built-in. Could you tell me the easiest way to install one?*

B. Newman  
Little Rock, Kansas

The simplest way to fuse your preamp is to change your line cord plug to a type that holds two fuses. There are several on the market which use a cartridge fuse in each side of the line.

Consult the manufacturer's specifications for the power consumption of your unit in order to determine the correct fuse size. As a rule of thumb, for each 25 watts of AC power consumed .25 amperes of current will flow. For example. If your amplifier consumes 75 watts of power you should use a  $\frac{3}{4}$  amp fuse.

## Adding Speakers

*To improve the sound from our radio, we added two additional speakers. We have been told that using a crossover or an L-pad would improve their sound. Can you tell us which to use?*

Alfred Nadeau  
Sanford, Maine

Neither is necessarily of any value in your case. A crossover is a frequency selective device. When used with a speaker system, its function is to send the correct range of frequencies to the appropriate speaker; the high frequencies to the tweeter, the lows to the woofer. The L-pad is used as a speaker volume control and it would only be of help to you if one speaker is louder than the other.

## How Much Power?

*How many speakers will my 15-watt amplifier drive?*

Arthur Horn  
Keene, N. H.

There are a number of factors that must be known before this question can be answered. First, how efficient are the speakers? Second, how much clean bass

**Hi-fi questions are all answered by mail.\* If of general interest they will appear in this column.**

do you want? If the speakers are of average efficiency and not too much bass is demanded a fifteen-watt amplifier could easily drive up to a dozen speakers. Driving a couple of efficient horn speakers, 15 watts could fill Carnegie Hall with sound. On the other hand, most 15-watt amplifiers would be at a loss to produce any deep bass from acoustic suspension type speakers such as the KLH or AR.

## Amplifier Buzz

*After about ten minutes of operation I notice a buzzing from my amplifier that I don't hear in my speaker system. What can I do to cure this?*

L. Herman  
Santa Clara, Calif.

This is a common problem that does not harm the amplifier and is not difficult to correct. What has happened is the laminations in your power transformer have loosened up and the sound you hear is the loose plates vibrating. While the transformer is still warm, tighten the long bolts through the laminations and tighten the nuts that hold the transformer to the chassis.

## Four-Track Stereo

*My stereo tape player is equipped with a two-track in-line playback head. Is there any way I can use this to play the new four-track stereo tapes?*

W. Martin  
New York, N. Y.

A two-track stereo head will reproduce all four tracks of the new stereo tapes at once, giving you a jumble of confused sounds. To play four-track tapes, you'll have to replace your playback head with a four-track type. 

---

\*Address inquiries to Hi-Fi Clinic, c/o Electronics Illustrated, 67 West 44th St., New York 36, N. Y. Please enclose a stamped self-addressed envelope for a prompt reply.

# Our Amazing New Robots

Talented mechanical men are being built for voyages where humans are yet afraid to go.

By Lloyd Mallan

WHEN the first man steps out of a spaceship on the moon or Mars or Venus he is likely to be greeted by another earthling who can tell him about conditions of soil and water and oxygen in his new surroundings. The creature at the foot of the ramp will be a robot, who no doubt will already be known as our electronic man on the moon.

Man is just now breaking free of his earthly bonds but he will not for a decade or more be ready for a journey even to the moon, our closest neighbor in space. Before he can go safely to another heavenly body we must learn much more about conditions existing at his destination and the requirements for survival there.

To obtain this information, we earthlings will land sensing devices on the surface. At first, these pieces of equipment probably will sit in one place and radio back data on temperature, radiation, gravity and perhaps chemical composition of the surface layer. Later and more sophisticated models will send back television images and will be capable of interrogation from the earth, and after that will come machines which will move about and carry out jobs at the command of men.

These mobile machines will be robots, designed for the specific job of exploring where man is yet afraid to tread.

As a matter of fact, all the sensing devices we send to other spatial bodies could be called robots because by definition the term applies to any machine which does



Trekking out of the Pacific after a scouting mission is the Navy's undersea robot, RUM.



RUM'S keeper is an engineer who views images from robot's TV eye and controls its hand.



Hughes Robot Mark II, also seen on EI cover, has long arms to handle radiation materials.

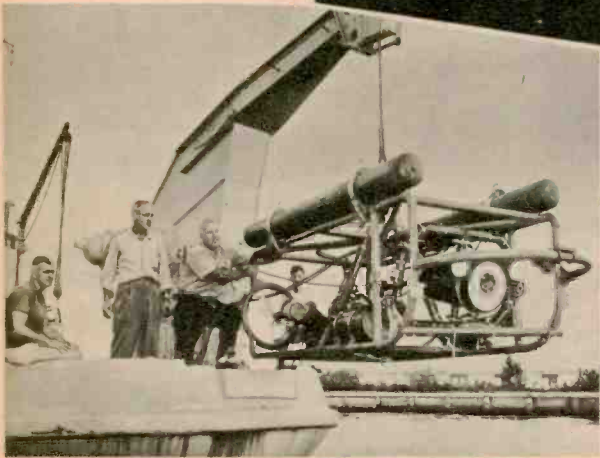
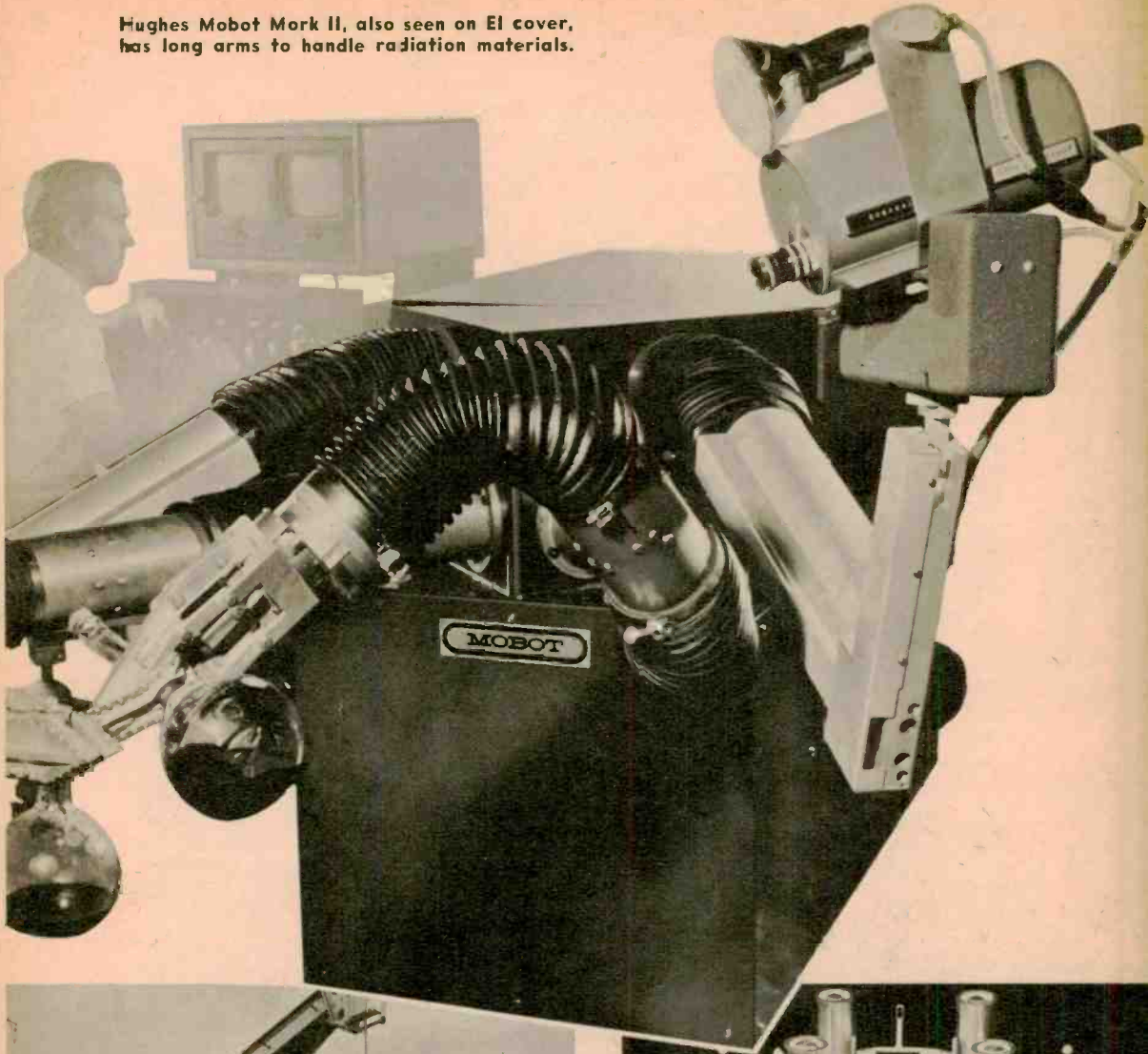

Mermut is mobile underwater, takes movie, still and TV photos, can have working arms.

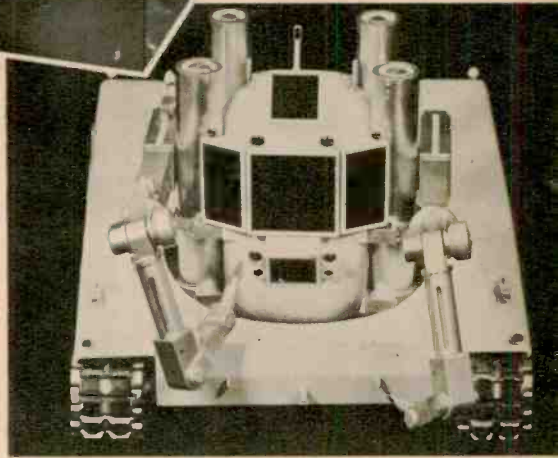

GE tractor robot assembles nuclear reactors, is run by well-protected man sitting inside.



Mechanical men out of fiction and the amateur workshops tend to look and act a little like the real thing, although human form and actions are illogical for machines. This is MM7, built by a Viennese engineer. It can pour a drink into a fragile glass without breaking it, also startles guests by polishing floors (left). Elaborate control panel runs the 6-foot robot.



Huge claw of Solaris, a one-eyed robot built by Vitro Laboratories, can clamp onto an object on the ocean floor and then lift as much as 7,500 lbs. to the surface. It is controlled from aboard ship by the operator above. Unit includes TV camera and lights at rear, two props for maneuvering, mechanical power unit in sphere. It operates at end of two cables, can go to 2,000 ft.



a man's work. Certainly, these pieces of equipment will be doing that. In fiction and the minds of boys a robot is a machine that looks and acts like a man, but in actual fact the amazing new robots now being designed and built bear little resemblance to their makers. In their specialized jobs, however, they are incredibly talented.

At least a dozen major companies are quietly researching, designing and building robots. Some of their progeny are operational, others are in prototype form and still more are in the planning stage. Robots now in existence could map the surface of the moon's hidden side, examine its crust, make geological probes below its surface and explore its mountain chains. We lack only the means of landing them there safely.

Scientists now foresee electronically controlled robots which will be able to build and operate satellite stations in outer space and then gather data and correlate the material for easy analysis

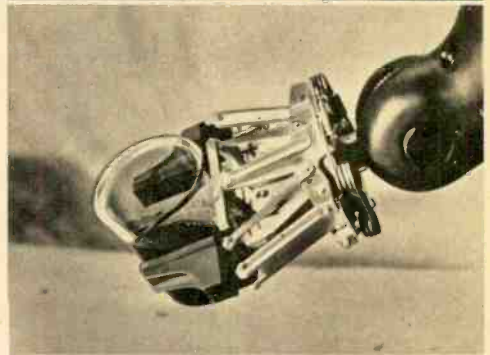

**Hand of Master-Slave Manipulator, used in radioactive rooms, is flexible, sensitive. It follows commands from human hand above.**

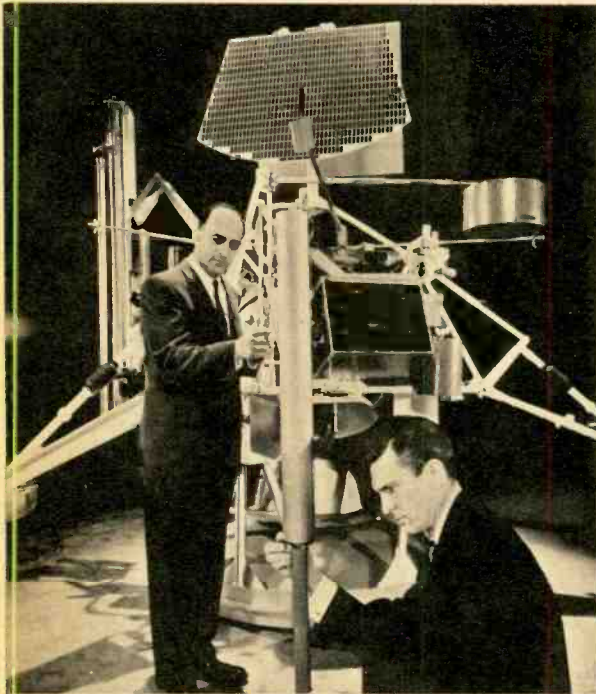

**NASA Surveyor is to land on moon, send back its findings. It has solar panel (top), TV cameras, probe, drill and special antenna.**

by humans. After exploring the moon and nearby planets, these mechanical men could be instructed to locate mineral deposits, mine them and refine the ore for the use of real men who arrive later.

Only a few years ago the robot was plodding along in its dreary work of handling radioactive substances in research laboratories. It was a job man could not perform, but the future was murky. Then opportunity beckoned.

"Now the big need is in outer space," says Ralph Mosher, equipment development engineer at General Electric, who built a robot called Handyman. "Handyman was designed for work in the hot shops but now we are working on new and different applications." Plainly, outer space has a job for Handyman.

Handyman was quite an advance in robotry when it became operational. Its arms and claws, controlled by a slave-unit, can be [Continued on page 110]

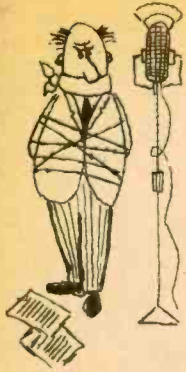

# Commercial Killer

The luxury of sponsor-free radio can be yours for less than three bucks. Could be used for TV too!

By Virgil L. Parker



**H**ERE'S good news for people who are plagued by radio commercials. This novel commercial killer was designed primarily for the car radio (though it can be used with any receiver) to eliminate frantic grabs at the volume or tuning knob when an advertiser gets overbearing.

By the push of a button the radio is silenced for a fixed length of time, at the end of which it comes back on automatically. A minimum of parts are required as use is made of the radio's AVC (automatic volume control) circuit as the suppression point.

## Theory

All radios have an AVC which controls the negative bias on the RF and IF amplifiers. If this bias is made sufficiently

Killer output goes to the AVC line in radio. Refer to the volume control to locate C4. It's at other side of a 2 or 3 megohm resistor and is about .05 mf.

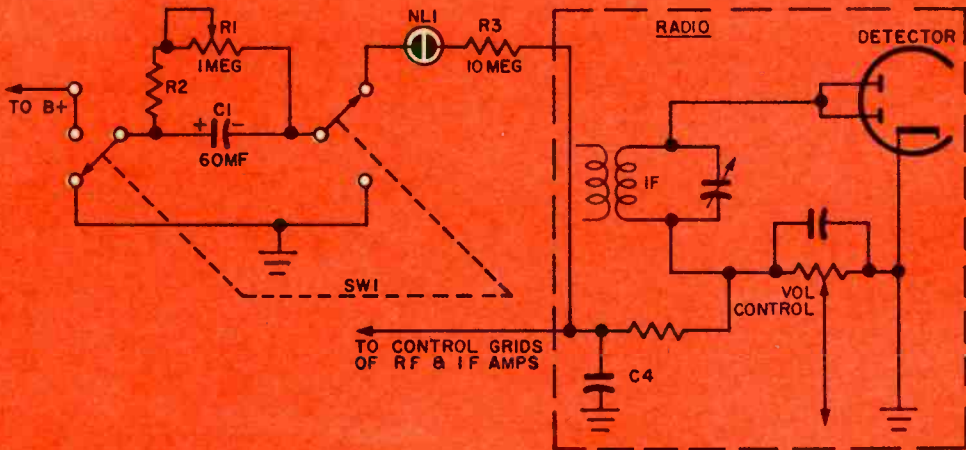



Parts arrangement for car-radio installation.  
For TV, the output could bias the audio stages.

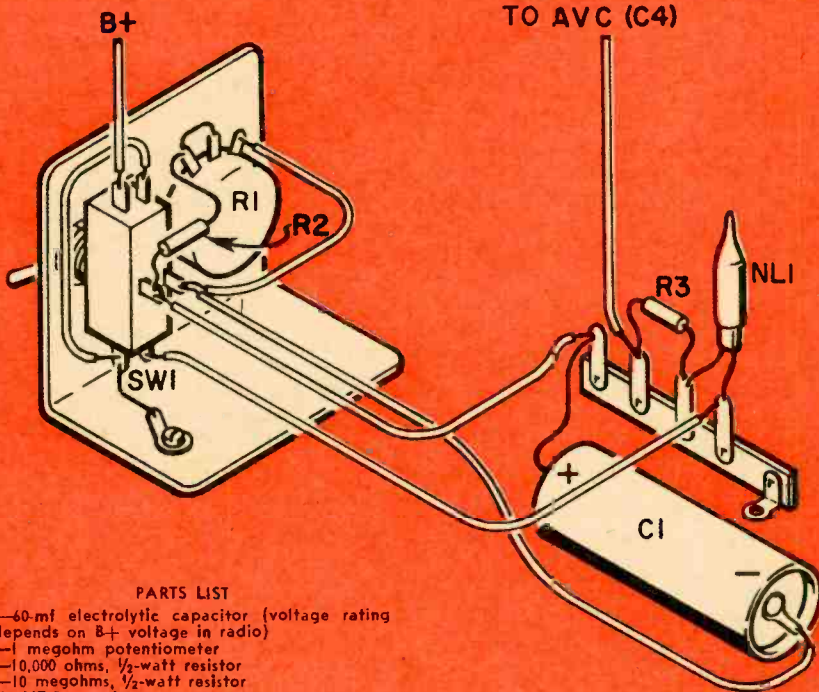

**PARTS LIST**

- C1—40-mf electrolytic capacitor (voltage rating depends on B+ voltage in radio)
- R1—1 megohm potentiometer
- R2—10,000 ohms, 1/2-watt resistor
- R3—10 megohms, 1/2-watt resistor
- NL1—NE-2 neon lamp
- SW1—DPDT momentary push-button switch or spring-return toggle switch
- Misc.—Solder lug terminal strip, knob mounting plate, hdwe., etc.

large, the tubes will be driven to cutoff and the receiver will be silenced. When SW1 (DPDT spring-return pushbutton switch) is depressed, C1 is charged to B+ potential. When SW1 is released, the positive terminal of C1 is grounded and the negative terminal is connected to the AVC line. Thus the application of a high negative voltage to the AVC line silences the radio.

The parts listed worked well with a 200-volt B+ supply and permitted adjustment of the dead time from a few seconds to one minute. If longer time is desired, or if the Commercial Killer is to be used with AC-DC receivers with lower B+ voltage, R1 or R2 should be made larger to lengthen the discharge time of C1. R2, a current limiting resistor, prevents damage to R1 when R1 is

adjusted to minimum resistance. Neon bulb NL1 acts as a switch to open the circuit abruptly when the voltage drops below its ionizing potential. This removes the high negative bias from the AVC line instantly and prevents distortion which would occur if the tubes were biased near cut-off. There are several points in the AVC circuit that the commercial killer could be tied to, however the high side of C4 (in a typical radio) was found to operate best. This capacitor is usually a .05 mf and can be located easily. For testing, SW1 should be held for five seconds to insure that C1 is fully charged.

**Construction**

Construction is simple. The terminal strip supporting [Continued on page 104]

# Electronic Brain

Have you any question on electronics? Send it in  
and the Electronic Brain will provide the answer.\*

## Determining Fuse Rating

In the December 1959 *Electronic Brain* you mention that a fuse may be installed in any equipment to protect its components. How does one determine what amperage this fuse should be able to carry?

Stanley Horn  
Miami Beach, Fla.

The very best way to determine required fuse size is to measure the current flowing in the AC input circuit by inserting an AC ammeter of 0-15 ampere range in series with one leg of the AC line. The fuse rating should then be 50% greater than the normal current. For example, if the current is found to be 3 amperes, the fuse should be  $3 + \frac{1}{2}(3) = 4.5$  amperes. A 5 ampere fuse is the closest commercially available value and would be quite satisfactory. If a wattmeter is available, the current requirements of the equipment may be obtained by dividing the wattage reading by the line voltage. Although this assumes unity power factor, the reading will still be approximately correct for all practical purposes.

Since manufacturers almost invariably state the input power requirements of their apparatus in their instruction booklets, you can use this literature to determine the fuse size from the rated power by the method given above. Finally, as a last resort, install the fuse holder and starting with a 1 ampere fuse (which may burn out), determine the *smallest* fuse size that remains operative over extended periods of use of the equipment. This means that you may waste one or two fuses, but it is a safe procedure.

## Filament Transformer Substitute

Can a universal output transformer be used as a filament transformer? I applied 117 volts AC to the primary of

one of these transformers and measured about 15 volts at the secondary.

James Wallace  
Appalachia, Va.

The voltage measured across the unloaded secondary may not be the same when the secondary is loaded. Since universal output transformers are seldom designed to provide more than 3 or 4 watts of audio, the secondary winding will not carry much more than 0.5 amperes. Loading the secondary will reduce the output voltage and may cause the transformer to overheat. The easiest way to determine if an output transformer will work as a filament transformer is to try it. If the voltage is within 5% of the tube rating, the transformer may be used provided that it does not overheat.

## Ham Antenna

I would like to become a ham but have been told that I would need a 50-foot long antenna. Since I am not permitted to use the roof, can I erect an antenna on a terrace nine stories up?

E. Berman  
Jackson Heights, N. Y.

You would need a 50-foot antenna only if you decided to operate on one of the lower frequency amateur bands. A 50-foot antenna folded to fit on a 12-foot terrace would be unsatisfactory. You should consider operating on the higher frequency bands where you will be able to use an antenna suited to your terrace.

For complete information on all aspects of amateur radio and license requirements, obtain a copy of the most recent edition of the ARRL handbook.

---

\*Write to Electronic Brain, *Electronics Illustrated*, 67 West 44th Street, New York 36, New York. Enclose a stamped, self-addressed envelope for a prompt reply.



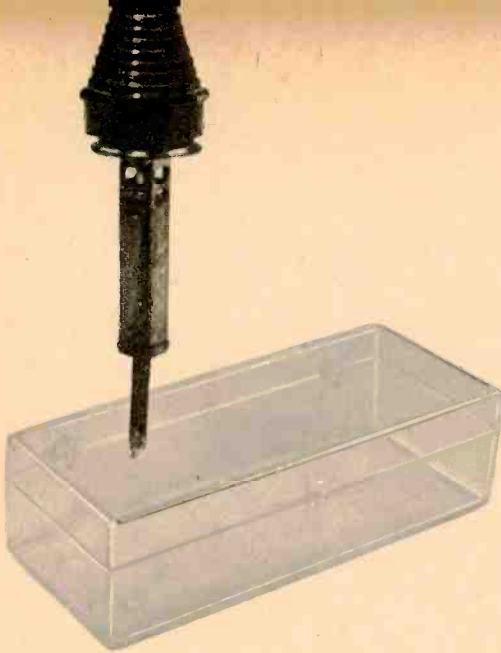

## El's Hot Tips

### Plastic Drilling

When a hole must be drilled into plastic, an indentation made with the tip of a hot iron at the spot will help start the drill. Holes in Bakelite can be drilled easily this way.



### Stopping Tip Corrosion

You can slow down or stop the corrosion of your iron or gun tip by coating it with aluminum solder. Its higher melting point keeps the tip brighter longer by reducing oxidation.

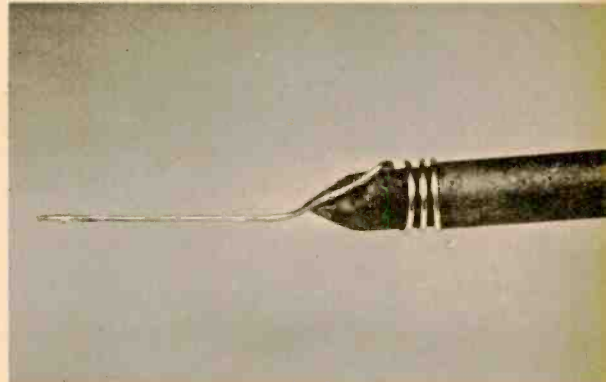

### Soldering in Cramped Quarters

Wrap about four turns of No. 14 tinned copper wire around the iron tip. Have the extension make good contact along the iron and flow solder in space between wire and the iron tip.

### Third Hand

Do you have a three-handed soldering job and no way to hold the work, iron, and solder at the same time? A vise might crack the iron. A good way is to use an empty metal tape dispenser.



# The Ham Shack



By Robert Hertzberg, W2DJJ

**FIFTH COLUMN** . . . From time to time we hear that the possession of a short-wave receiver by a Russian is frowned upon, to say the least. The Soviets obviously don't want their people listening to the rest of the world for fear they might learn what is happening outside the Iron Curtain. However, Soviet propagandists seemingly acknowledge the presence of many such receivers by jamming most international broadcasting frequencies (if there were no receivers jamming naturally would not be necessary).

It is, therefore, a surprise to hear Russian hams engaged in communication with other hams in many parts of the world, including the U. S. They talk excellent English, as well as several other languages, and in general are top operators. In fact, they are too good. And that's significant.

In view of the nature of the Soviet state, it seems a certainty that these hams are government agents of one kind

**These call letters belong to Ralph Thomas of Hawaii, winner of an Edison Award this year.**



or another. The equipment situation alone makes this evident. If basic short-wave receivers are contraband, what chance does an ordinary citizen have of obtaining a communications receiver, much less a powerful transmitter?

Maybe the Soviets have rediscovered a long-standing axiom in the military radio intelligence business: you can learn more from the enemy by letting his radio stations work in the clear than by jamming them. Just what they expect to get out of American hams is a question. They do well if they can even figure out what is said in a typical report:

"Say, you're sure pinning the S meter here in little old Squeedunk. S for sarsparilla, Q for quack, double E for easy does it, D for doughnuts, U for useless, N for nuts, K for kookie. Handle here is Mac, as in MacPherson. The QRMary is building up, and your QSB is bad, but I'm pulling you in fine business."

Ivan's boys no doubt get medals for decoding chatter like that . . . and they probably deserve them.

—○—

**Status Symbol, Cont'd.** In the previous Ham Shack I described the frustrations of new hams who try to obtain special call letters to match their initials. It can't be done. But there's an interesting reverse switch that's worth mentioning (see photo).

When the FCC gives you your call letters, check with the motor vehicle bureau of your state and determine whether it issues special plates bearing the call letters [*Continued on page 108*]



# El builds a Transistor Radio

El Kit  
Report

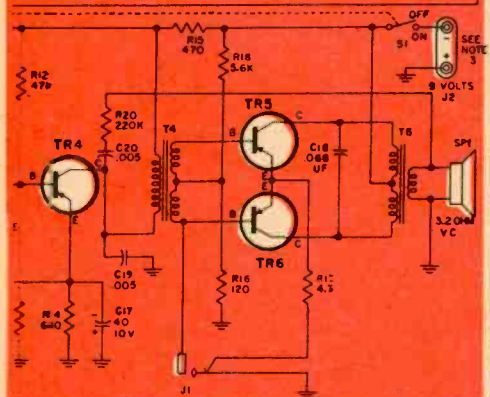
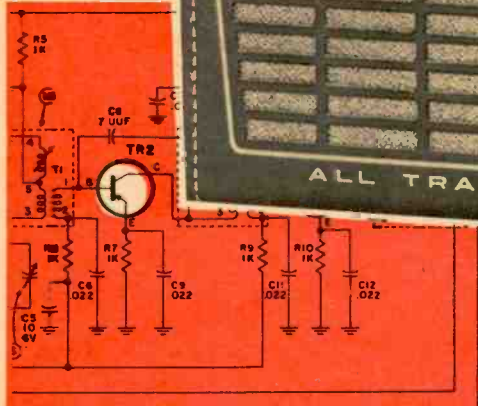

RESISTORS ARE EXPRESSED IN OHMS  
 (K IN MICROFARADS)  
 TRANSISTORS ARE 4 AND 2, 1, AND 3, RESPECTIVELY.  
 BATTERY OR EQUIVALENT (ALL BATTERIES CONFORMING TO N.E.C. #602 SPECIFICATION)  
 ALIGNMENT POINTS

WHETHER you're an old hand who simply enjoys putting together electronic equipment or a novice assembling your first kit, perhaps as a preliminary to building your own hi-fi, the EICO Model RA-6 portable radio has much to offer.

Among its features, this six-transistor superhet boasts a 4" x 6" speaker, a 250-milliwatt push-pull output stage, planetary-vernier fine tuning that makes catching those elusive marginal stations a cinch, a ferrite-antenna and a jack that eliminates output-stage current drain when an earphone is used.

We were very impressed with the performance of the completed kit, and found, for example, it brought in New York stations in Boston, Mass. The relatively large speaker provided

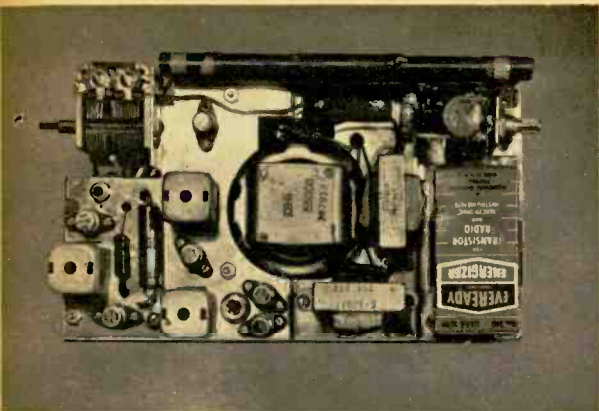

Rear view of chassis. Note large ferrite-rod antenna and the socket-mounted transistors.

good volume without excessive distortion, a problem many other portables have not licked.

Construction will not be too difficult for a novice. The instructions include exact descriptions, and in many cases pictures of all hardware. All electronic components are identified by number and color code. For those not familiar with electronic parts, in some instances a picture or drawing would make positive identification simpler, but careful attention to the descriptions will see you through.

This is not to say that there were no rough spots. In most cases these took the form of too many operations in the same step, confusing to the inexperienced, but not insurmountable. And at one point we were earnestly told to hold a lead wire with a pair of pliers while soldering it. Not aware of the approved techniques for this sort of thing we first tried, with pliers in one hand and soldering iron in the other, to hold the solder in our teeth. This method will prove effective only if you are bent on melting your fillings. We finally wrapped some solder around the forefinger of the hand holding the pliers, leaving several inches sticking out, and this worked fine.

After all the components were soldered in place, we were informed that, when installing the speaker, "If any component touches the frame of the speaker, dress the component closer to

the chassis and away from the speaker frame." Not forewarned of this possibility quite a few components touched the speaker frame, an occurrence apparently anticipated, for the instructions continued, "When pushing the components down away from the speaker frame . . ."

The only other area found troublesome was alignment. The IF transformers are prealigned at the factory. However, the oscillator and RF section are aligned by turning screws on the tuning capacitor. The instructions were inadequate for this phase. While warned that this adjustment was "critical" and that another screw adjustment ("for volume") was not, the directions left out a rather vital piece of information. The two screws must be jockeyed back and forth in conjunction with one another. That is, after locating a high-frequency station for the critical adjustment, the volume screw must be adjusted at several points to "follow" this station to its proper dial position.

In summing up, the EICO portable performed well, can be assembled with no special knowledge or training and compares well with any similar product in its price range. It is rugged, too. While pulling off a tuning knob in the latter stages of construction the chassis skidded off the work area and fell over three feet to the floor. We're happy to report that the radio continued to function perfectly! —Bruce Knowles

Sizable speaker provides excellent volume and tone. Case dimensions are 8½" x 4½" x 2¼".





# They Said It COULD Be Done!

**Two award-winning hams prove that long-distance communications are possible on high frequencies.**

**N**OT LONG AGO practically anyone knowledgeable in radio would have told you that the VHF and UHF frequencies were fine for short-range communications but just couldn't be used over long distances. In fact, those high frequencies already had been assigned line-of-sight limitations.

But two veteran hams couldn't believe that, and they set out to prove the theory wrong. The results of these experiments by Ralph E. Thomas, KH6UK, of Kahuku on the island of Oahu, Hawaii, and John T. Chambers, W6NLZ, Palos Verdes Estates, Calif., can be judged by the fact that the two men are co-winners

**Hawaiian ham shack of Ralph E. Thomas, KH6UK, sports a wealth of surplus and home-brew equipment. High-frequency antenna sits amid palms outside.**

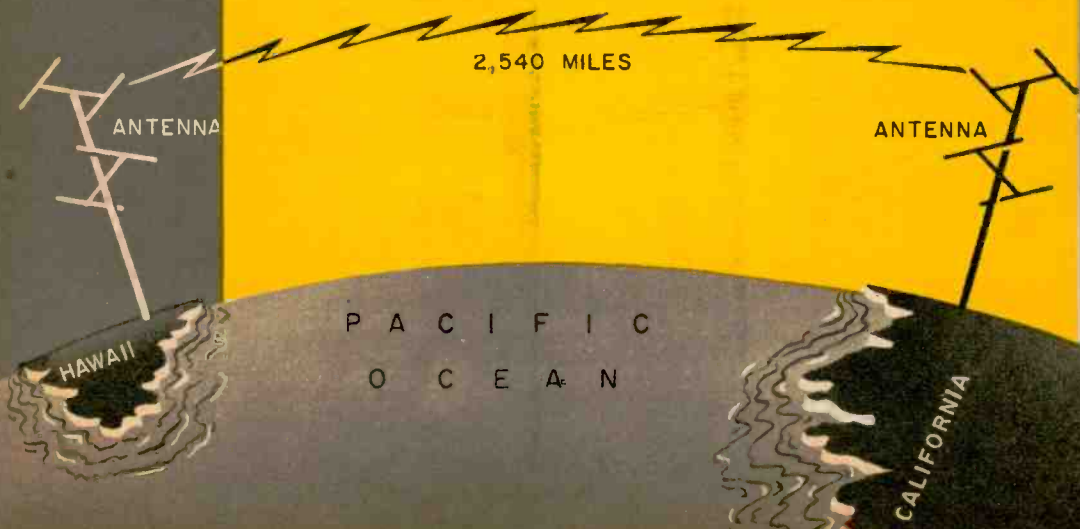

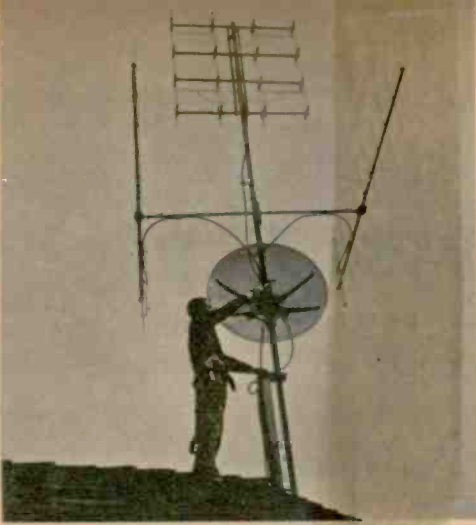

On Stateside end of the VHF-UHF link was John Chambers, W6NLZ, Palos Verdes Estates, Calif., shown here in his shack and adjusting his rooftop antenna, which includes experimental dish.

of the Edison Radio Amateur Award for the year.

The work involved, of course, was not quite as simple as it sounds. Thomas and Chambers experimented for four years before they achieved success. Included in the four years was one nine-month period of daily transmissions.

"It just took time and patience," says Thomas. "I guess you've got to be a nut to keep at something like that."

In presenting the Edison awards at a dinner in Washington, Federal Communications Commissioner Frederick W. Ford called the men "pioneers in the wilderness of radio wave propagation."

Using low-power equipment, mostly of military surplus and home-brew

origin, the Thomas-Chambers team first set a long-distance record on 144 megacycles, in the VHF range, over the 2,540-mile path between their homes. They later moved up to 220 mc, also a VHF frequency, and then jumped into the wilds of UHF at 432 mc. On July 20, 1960, the two made the historic first link at 432 mc. A faulty tube in the RF amplifier used by Thomas on the Hawaiian end prevented him from hearing Chambers, but his signals were received by Chambers in California.

The long-distance links on high frequencies were possible because of a phenomenon known as tropospheric ducting, which occurs mainly during the summer inversion season. The inversion of hot, dry air over damp air close to the ground changes the refractive index of the atmosphere at the point where the two air masses meet and makes UHF DXing possible.

During the experiments Chambers kept a weather eye on Los Angeles smog. When it clung thickly to the ground, he knew conditions were right for a DX attempt. In Hawaii, Thomas watched the evening sky for low clouds with flat tops as his signal for another attempt.

[Continued on page 111]

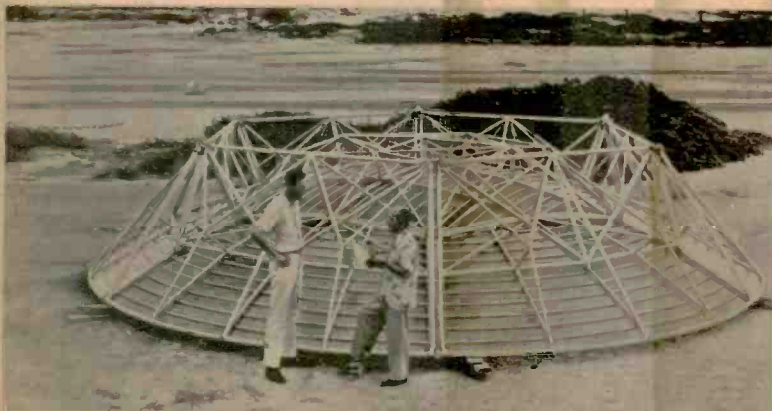

The shape of things to come is this giant parabolic antenna designed and built by Ralph Thomas for experiments at 1296 mc.



Inventor Nathan B. Stubblefield and his invention, now believed by many to be first radio. Photo was taken around the turn of the century. The large loop above modified telephone is thought to be the rig's antenna.

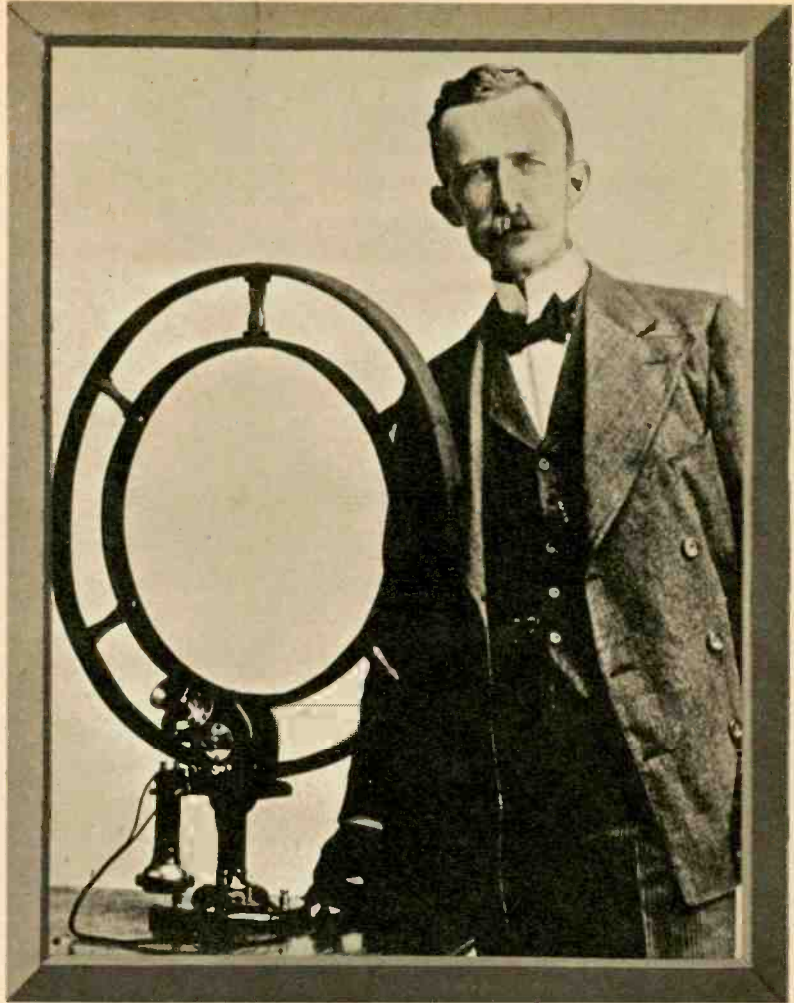

## America's Own Marconi

**Many now believe it was an obscure Kentuckian who achieved the first wireless transmission of voice.**

**By Martha K. Gunter, W9HIX**

**W**HO INVENTED radio? The answer for most people is Guglielmo Marconi, the Italian engineer who died in 1937. But there is a growing group of dissenters, and in one town in Kentucky virtually everybody from the dog catcher to the bank president will tell you the true father of radio was Nathan B. Stubblefield.

The town is Murray (pop. about 10,000), which calls itself the Birthplace of Radio because Stubblefield lived there until his death in 1928. To feed and clothe his family, Nathan Stubblefield raised and sold vegetables but most of his time was given over to experiments involving the telephone, and more particularly a telephone which



Stubblefield and his son Bernard with two pieces of his equipment. Note the rods driven into the ground in front of Bernard. The inventor never divulged the exact components of any of his equipment. Photograph probably dates from 1905.

operated without the benefit of wires.

Stubblefield lived on the edge of town in a little shack surrounded by an untrimmed hedge. Like a lot of inventors, he drew an elaborate curtain of secrecy over his experiments and automatically suspected that everyone wanted to steal his inventions. He kept a gun handy to discourage prowlers. Under such conditions it is not surprising that other Murray residents came to think of him as slightly mad. Children pointed at him when he appeared on the street and dogs barked at his heels.

According to all evidence at hand, Stubblefield did make some discoveries and inventions which would have been of value in their time. But because of his passion for secrecy and his failure to put his inventions to the use of others, his contribution to the world of science is virtually nil.

Stubblefield seems to have been experimenting with wireless transmissions before Marconi and some of his earlier probings in the field may have been contemporary with Bell's telephone experiments (Bell received his patent in 1876) and even the mathematical formulations pertaining to radio waves which were published in 1865 and 1873 by James Clerk Maxwell.

It is known that Stubblefield did achieve wireless transmission of the human voice in 1885. Marconi received his patent for a radio-telegraph device on June 2, 1896. It was not until 1888 that Heinrich Hertz demonstrated the existence of electromagnetic waves.

The only person Stubblefield allowed to be near [Continued on page 112]

Stubblefield on bank of the Potomac in 1902 receiving wireless telephone message from the central office some three-fourths mile away.





**Comprehensive courses in  
Electronic Fundamentals  
TV Servicing – Color TV –  
Electronics for  
Automation –  
Transistors**



**LET RCA TRAIN YOU AT HOME**

RCA Institutes, one of the leading technical institutes in the United States devoted exclusively to electronics, offers you the finest training-at-home. The very name "RCA" means dependability, integrity, and scientific advance. Practical work with your very first basic lesson. You build and keep prime quality equipment. Pay as you learn. No installment payments necessary. You pay for your next study group only when you order it. And remember, in electronics the more you know the higher you go. Licensed by the University of the State of New York.

Resident school courses in Los Angeles and New York City also offer college-level training in any field of electronics you may choose. Classes begin four times each year. Free Placement Service.

**SEND POSTAGE-PAID CARD TODAY  
FOR FREE ILLUSTRATED BOOK!**

Check Home Study or Resident School Box



**RCA INSTITUTES, INC.** A SERVICE OF RADIO CORPORATION OF AMERICA  
350 WEST FOURTH ST., NEW YORK 14, N. Y. • 610 S. MAIN ST., LOS ANGELES 14, CALIF

The Most Trusted Name in Electronics



# How to DX Satellites

**Biggest of all challenges for the SWLer is bringing in space signals, but it can be done!**

**By C. M. Stanbury II**

**A**RE YOU, as a short-wave listener, beginning to look around for something more challenging than bringing in London or Moscow or Hong Kong? If you're seeking more worlds to conquer, let me tell you about a real hair-curling DX challenge that is literally out of this world. I'm talking about signals from artificial earth satellites, sun satellites, moon probes, Venus shots and other assorted spaceships.

The mention of satellite DXing is enough to stop many people cold. Impossible, they say. But it *can* be done. I have

**Experimenter's satellite is S-45 Ionosphere Beacon (related to Explorers), built by the U. S. to transmit on six frequencies for the benefit of anyone anywhere interested in or studying phenomenon of ionospheric signals.**

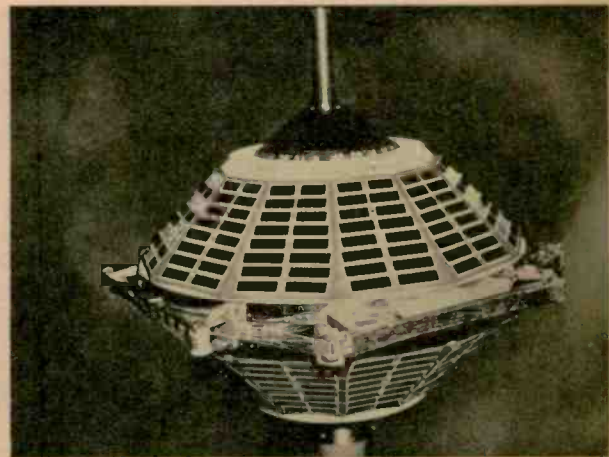

*Electronics Illustrated*



done it and I can tell you that the resulting QSL cards are worth the time and effort required.

DX catches usually are judged by four criteria: distance, power, accessibility of channel and ease of verification. Most bands qualify on at least one point. International broadcasters, for instance, have plenty of kilowatts and QSL faithfully. Even aeradios are often blessed with clear channels.

Earth satellites and the others, unfortunately, don't qualify consistently on any of the criteria. Your target is likely to be a great distance away (100,000 miles, for instance), power may amount to only a watt, the channels are offbeat and getting a QSL is like taking a five-spot away from Jack Benny. But satellites and spaceships truly represent the ultimate DX.

Let's take a look at the equipment required. Fortunately, many satellite radios operate on short-wave, between 19990 and 20005 kc. Sputnik I (20005) was heard by SWLers around the world with only one watt of power, and America's Explorer VIII put out a good signal on 19991.5 kc. Equipment is no problem so far as these satellites are concerned.

Amongst the VHF frequencies used for outer space work, 108 mc is the most popular. That is right atop the FM

broadcast band but in order to use an FM tuner you'll have to adapt it for AM reception, possibly using it as a converter in front of your short-wave receiver. In general the signal is tapped off just in front of the tuner's detector stage and fed to the short-wave set's antenna post. The SW receiver is then set to 10.7 mc, the standard FM Inter-

[Continued on page 103]

#### DX GUIDE TO SATELLITES

Frequencies (mc)	Used by
19.99-20.01	U.S.-U.S.S.R.
39.98-40.01	U.S.S.S.R.
54	U.S.
108-108.06	U.S.
162	U.S.
183.6	U.S.S.S.R.
216	U.S.
324	U.S.
922.8	U.S.S.S.R.
960.05	U.S.

#### SHORT-WAVE CHART

Frequency (kc)	Space Vehicle
19991.5	Explorer VII, VIII
19993	Lunik I, II, III
19995	Lunik I; U.S.S.R. Spaceships I, II, III, IV
19997	Lunik I, II
20003	Lunik II
20005	Sputnik I, II, III; Explorer VI

Two of author's coveted Russian QSL cards verify reception of signals from space vehicles. Card at right is standard Red QSL form. "Lunik III" note penned on other card (see circle) is a bit of irony. Russians kept Lunik III frequencies "secret" but faithfully QSLed, anyway.

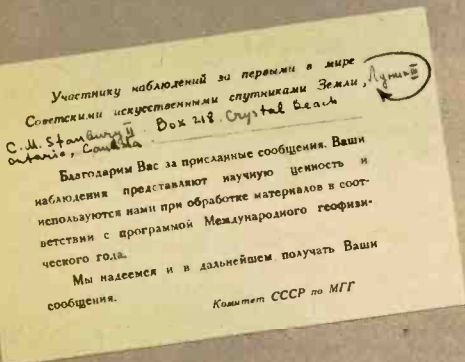



## New developments in electrical engineering.

**E**LECTRICAL engineers are expecting new secrets of matter to be revealed when Russia puts its 70 billion electron volt atom smasher into operation. An even bigger atom smasher is reported under construction in the U. S. Largest one now in use is rated at 30 BEV. The last sizable increase in power made possible the creation of anti-protons.

The first all-aluminum power transmission towers are now in use on a 218-mile line in Pennsylvania. The towers do not require paint and are said to be economically competitive with steel. So electric power transmission becomes another battleground in the steel-aluminum war.

*Mixing and blending such substances as cement and fertilizer may be taken over soon by a team of modern electronic marvels hooked together as a team—the digital control computer and the X-ray analyzer. The computer controls the mixing and the X-ray equipment tells the computer whether it is right. The job now is an art performed largely by human specialists.*

A new thyatron tube which is self-testing may be the bearer of good news for hams and CBers, or even television watchers. When the thyatron nears the end of its life, xenon and neon gases inside it produce a bright red light to tell maintenance men it's time for a change. If the development reaches consumer-type tubes it could eliminate a lot of pencil-tapping by home repairmen.

A General Electric engineer warned the Winter Meeting of the American Institute of Electrical Engineers of the danger of having Russian technical

papers translated by people who know Russian but have no engineering background. The choice of one wrong word may make a translation meaningless or misleading.

*AIEE's Edison Medal has been awarded to Dr. Harold S. Osborne, retired chief engineer of AT&T, for a long list of contributions to the art. Dr. Osborne has predicted that in the future everyone will be given a telephone number at birth and a little later will receive a gadget about the size of a pocket watch. This will be his telephone, which will have 3-D television to go with the voice. You will be able to call anyone on earth and see him while you're talking to him. Presumably a miniature curtain will cover the video lens when you step into the shower or leave the office early.*

Telemetry equipment will be used more and more in the pipe line industry, engineers predict. Telemetry makes quantity and flow control, formerly done manually by men who communicated via telephone, just a matter of pushing buttons or turning a dial.

Electronics, which has solved a great many problems for man, now may be called on to do a job that would dwarf most past accomplishments. The new assignment is to save the nation's railroads from rack and ruin, and even to put them in the black. A Westinghouse expert says sound financial health may be possible with a four-part electronics package: a better communications system, automation in the business office, centralized traffic control and conversion of diesel-electric locomotives to straight electrics. Big-city railroad commuters might dream of a fare reduction, but even electronics has its limitations. 



## Ferrites—Mighty Midgets

Continued from page 39

be really useful, must have hundreds of thousands of memory cells. That would mean tubes popping like firecrackers, faster than they could be replaced.

The answer to the problem was simply not to use tubes. Instead, Dr. Albers-Schoenberg developed a ferrite material which could be moulded into a doughnut a fraction of an inch in diameter. This tiny structure was able to serve as a computer memory cell because it could be magnetized in one direction or the other (yes or no) and then could produce this information a minute or a year later. Dr. Albers-Schoenberg and Lincoln Lab got together and history was made.

For a test, the lab built two computers, one using tubes, the other—the famous Whirlwind I—using ferrite memory cores. The giant brains, containing about 140,000 memory cells each, went into operation in August 1954. Six months later, Whirlwind had made two errors in millions of calculations. Its vacuum tube cousin had been down for repair over a third of the time. In addition, the ferrite memory proved to be faster and able to handle more work.

IBM, giant of the computer field, studied the results and switched to ferrite core memories. Today, although magnetic tapes and drums, photographic images, and other devices are being used in specialized applications, all large-scale, random-access computer memories use ferrite doughnuts. Some employ millions of cores.

There are other exciting gadgets made of this processed rust. Do you have a super-sonic remote control unit for your TV? When you press a button, this little wizard tells your TV set what to do with a series of sounds too high for you to hear. The TV set must not only pick up these sounds, but must discriminate between signals of several different frequencies. For this job, it uses five to ten ferrite filters which can tell a high squeak from a low one and thus know whether to change the channel or turn up the volume.

Within a few years you may have an automobile radio mounted in your car's trunk, thanks to ferrites. The radio now competes for space under the dash because you must turn the dial manually—and the capacitor or inductive tuner behind it—to change stations. But certain ferrite materials change their permeability, or magnetic properties, under the influence of electrical signals. This means that the

tuning section of your receiver could be varied electrically rather than mechanically. Your radio could thus be anywhere in the car with no difficulty.

Ferrites are helping make things smaller too. Some shirt-pocket transistor radios owe their small size in part to ferrite-core IF transformers the size of a sugar cube. Portable and bedside radio antennas are getting so small that a Dick Tracy wrist radio now seems a possibility.

Within a year or so you'll probably be able to do away with unsightly TV rabbit ears with the use of a new ferrite antenna which will be enclosed in the set and will do a better job. Several companies are reported near commercial production.

Electronic equipment of all kinds, from voltage converters for Citizens Band transceivers to recording heads on tape recorders, is being improved with ferrites. Scientists at Bell Labs recently dreamed up a gadget they call the ferreed. Basically, it is a tiny switch which operates a thousand times more rapidly than any present model. It may be routing your telephone calls before long. The ultra-high-speed switching is done, needless to say, by a versatile ferrite material.

Ferrite devices of another kind may help speed along your telephone calls. Engineers have found new ways to send hundreds or perhaps thousands of conversations over one microwave link or coax cable simultaneously. The only trick is to separate the signals at the other end. This electronic routing is a job for filters, and a newly developed ferrite "cup-core" may just fill the bill.

Ferrite microwave switches are doing away with many complex mechanical devices. For instance, a piece of ferrite material is put inside a waveguide—a pipe through which high-frequency signals flow. Normally, the waves go through the material just as though it were not there. But apply an electric current and it stops them cold.

Research in ferrites goes on, both to develop better basic materials and to find new ways to use them. Some of the developments promised by ferrite research include:

A better, non-flickering fluorescent light.

Power tools (electric drills and the like) which will weigh one-third as much as present models.

More efficient automotive and boat ignition and electrical systems which will be smaller, lighter, cheaper and more reliable.

Clearly, ferrites are destined to play a major role in our lives from here on.

## 150,000 RPM

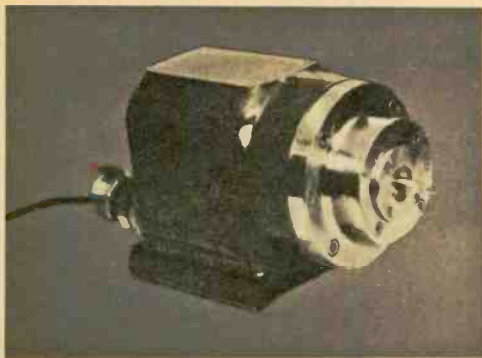

**A** NEW three-phase induction motor (above) built by Toshiba of Japan is capable of doing 150,000 rpm, a record in its class. The water-cooled unit operates on 300-380 volts at 2,500 cycles, requiring a special static inverter which has a silicon-controlled rectifier. It has a rating of about 270 hp. The motor will be used to turn high-speed lathes and grinders.

## Vertical Dial

**A** GERMAN inventor has patented a vertical-dial telephone which, among other things, stops the instrument's annoying habit of slipping side-wise when you dial with one hand. The vertical dial (you pull down) is a plastic tape which turns selector wheels inside.



## Electricity From Salt

**W**HAT does salt have to do with electricity? That was what scientists at the Honeywell Research Center got to wondering one day, and they didn't know the answer. Neither did anyone else. No one had ever done thorough research on the special characteristics of salt. So the wondering men at Honeywell launched a research program on common table salt (sodium chloride). They first took a fine-mesh platinum screen (see photo) and filled it full of salt. Then they heated the crystals until they melted. After that, they studied the infrared absorption qualities of salt (which gave them clues as to its structure). In answer to the question of what salt has to do with electricity, they found that man's most popular seasoning actually can be made to generate electric power. Even more interesting, solid-state salt is an insulator but when molten, the researchers found, it becomes a conductor, its resistance decreasing by as much as seven orders of magnitude. Thus salt may one day have a role in switching.





## Take Care Of Your Tape

Continued from page 67

All feature the Gibson Girl cut, so named because of the curves they make in the edge of the tape at the point of splice. Audiotex offers two models, one listing for \$9.95 that features the rounded cut, the other, priced at \$2.75, being a simple metal block-and-razor blade unit. Somewhat similar to the latter is the \$3.95 Bib offered by Ercona. Both have metal clamps that hold the tape in place during splicing. The Bib also has a vertical cutting groove as well as the usual miter groove. The vertical cut is useful for close, precise editing. Cousino's \$1.50 splicer resembles these two but has no holding clamps for the tape ends.

Other models include the \$8.92 Editall, the \$1.50 Rason Jiffy-Splice, the \$2.98 Rystl Tape Splicer Jr., the \$8.95 ORR Irish model SP-3 and splicers by Brand Products and the Olson Radio Corp., \$1.98 and \$1.49 respectively. Any of these splicers will do the job. The extra money you spend for the more expensive ones buys convenience and speed.

To join sections of recording tape securely, splicing tape should be used. This pressure-sensitive material is thin and strong and its adhesive material will not bleed beyond its edges and gum up the recorder. Splicing tape rolls are offered by Audiotex, Minnesota Mining & Manufacturing (Scotch), ORR (Irish), Reeves Soundcraft and Robins. You get several inches per penny.

Tape involves a lot of tape. From recording and splicing tape we move on to leader or timing tape, which is neither adhesive nor magnetic. It is a tough, flexible ribbon which may be spliced to the beginning and end of a recording tape, as well as at intervals in between. It serves as a convenient leader, making for easier threading and permitting you to use all the recording tape. Spliced between sections of tape, it serves as an interval marker for timing purposes or provides periods of silence. Some leader tapes have markings to permit a visual estimate of time or recorder speed. As an added convenience, you can write identifying data on leader tape to tell what is recorded on the reel.

Other identifying aids—for reels as well as sections—are labels that may be pressed on a tape reel and tabs for affixing to the tape itself at desired spots. Low-cost packets of these items are available from Audio Devices, Audiotex, Brady, Dactron,

Reeves and Robins. Audio Devices also offers colored recording tapes which, when spliced in standard tape, provide quick identification.

Little plastic clips that slip over the edge of a reel and hold the loose end of the tape in place are an aid in handling and storage. These are offered by Audiotex and Robins.

For the best storage of tapes, the serious hobbyist can buy metal cans, racks or drawer-tray units sold by Olson, Reeves, Robins and Sonoramic. These provide the proper environment for long storage and also catalog and identify a large collection.

Some tape recorders have an automatic electronic stop feature which shuts off the motor at the end of a reel or at any point desired. To trip this mechanism, the tape is fitted with stop tabs. Some machines also are designed to use foil stop tabs—little pieces of foil which can be stuck on the tape.

People who correspond by tape find mailing cartons offered by Audio Devices, MMM, ORR and Reeves especially useful. The cartons come in various sizes and cost a few cents each.

The newest tape accessory, yet one which serves a long-felt need, is the tape threader, which makes threading a tape from reel to reel easy and swift. The Robins Tape Threader, listing for \$1, is a metal grip with a tiny handle. It slips over the loose end of the tape and helps wind it on the take-up reel. The Tape Threading Leader by Audiotex (\$1.40) is a 24-inch strip of leader tape with a small foam rubber pill attached to one end. The leader is spliced to the recording tape and the pill slips into the slot on the take-up reel. The pill is strong enough to start the tape moving, yet pliable enough to slip out when the tape is rewound.

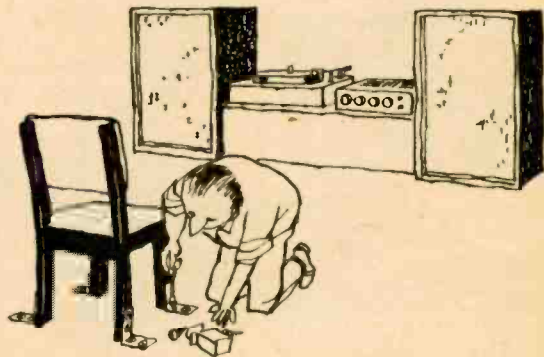

## Car FM Tuner

Continued from page 34

before being wired. Also, the two diode holders will short out if they are mounted flush against the case. Space them by threading nuts onto their mounting screws before pushing the holders onto these screws. For good heat dissipation of the completed power supply, the metal case should be mounted on a metal surface under the dashboard.

If the tuner is to be used in a 6-volt system, the power may be "stolen" from the AM radio. The difference in wiring the tuner for 6 volts is primarily in the filament circuit. This is illustrated in the schematic—one side of each filament goes to ground, rather than in series with the filament of another tube. The same is true for pilot lamps I1 and I2. Note that R19 (filament dropping resistor for V1) is not required for 6-volt operation; simply run a wire from lug 1 on the tuning unit to the 6-volt source.

The power pickup from the 6-volt supply in the AM radio is shown in a pictorial. However, since the high B-plus voltage from the car radio is usually 250 volts, a dropping resistor must be used to bring the voltage down to the 100 volts required by the tuner. The tuner draws about 35 ma, therefore the resistor needed to drop the extra 150 volts would be 4000 ohms at

**Top view of finished tuner shows IF strip held by bracket under screw on tuning unit.**

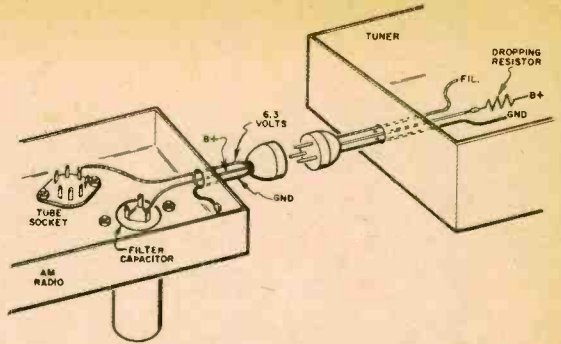

**Connections for obtaining power from 6-volt car radio. 6 volts is taken from filament pin and B+ from lug with highest voltage. Dropping resistor should be 10-watt wirewound.**

10 watts. For other voltages: resistance equals the voltage to be dropped, divided by the current (35 ma).

### Audio and Antenna Connections

The audio output of the tuner feeds into the high side of the volume control of the car radio. A closed-circuit jack, added to the car radio, is wired so that unplugging PL1 automatically restores AM operation. To find the correct lug of the volume control, remove the radio from its mount, take off its cover and apply power. (This can be done on the test bench if the builder has a 6 or 12 volt battery eliminator.) With the volume turned full up, touch each of the control's outside terminals. (Be careful not to touch any other exposed parts to avoid shock.) The lug which causes a loud hum in the speaker is the correct one.

The standard car radio antenna serves as an excellent FM antenna. Pull its plug from the jack on the AM radio and plug it into the FM tuner at J1. To change from FM to AM reception, the audio plug is removed from the AM set and the antenna re-inserted into the AM jack. If desired a switching system, as shown, may be added.

### Alignment

The FM tuning unit is pre-aligned at the factory and does not have to be touched. The rest of the tuner can be aligned by ear or with a VTVM. Since the IF transformers are also pre-set, only a slight "touch up" is necessary. Tune in a station and adjust the top and bottom slugs of T1, T2 and the bottom slug only of T3. At this time, adjust for maximum volume, not clarity. Next, set the top slug of T3 for least sound distortion. There is a possibility that the IF stages will go into oscillation and impart a

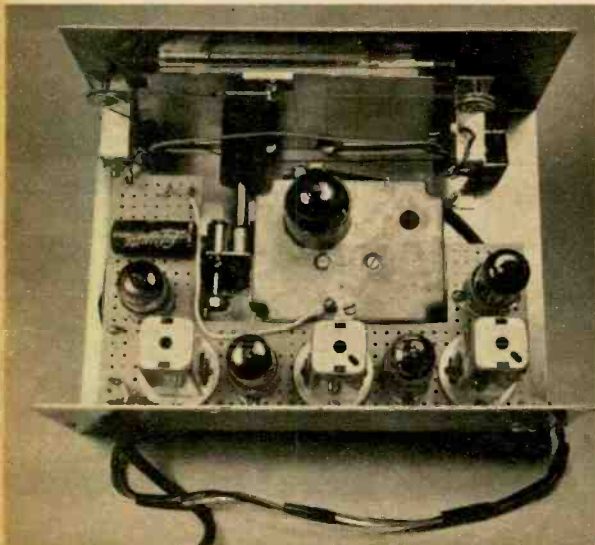



"mushy" quality to the sound. If so, detune T1 or T2 *slightly* until the sound is clear.

For VTVM alignment, tune in a station, set the meter range to 15-volts DC, and set the function to -DC. Ground one test lead and touch the ungrounded lead to the negative terminal of C11. Adjust the IF transformers, *except* for the top slug of T3, for maximum voltage. A typical reading on a moderately strong station will be about -5 to -8 volts. If the VTVM needle suddenly jumps to a high value, back off on the slug to kill the oscillation. The last step is to adjust the VTVM to its zero-center position on the lowest DC range and touch the ungrounded probe to the center lead of the audio cable (the junction of R15 and C12). Rotate the top slug of T3 for a zero voltage reading and alignment is complete.

One of the major limiting factors to the quality of the sound produced by the FM tuner is the speaker in the AM set. A remarkable improvement is possible with the installation of a rear-seat speaker. The type which includes a small tweeter is especially recommended—it will help to reproduce the wider audio range of FM.

## Temperature Gauge

*Continued from page 55*

### Installation

Drill a hole, large enough to accommodate the probe, over the water return inlet in the radiator. Insert the probe in the hole until it reaches the top of the radiator element then cement the probe in place with liquid or plastic steel. Be sure that the hole is completely sealed. Connect the probe's ground lead to the car chassis by placing it under a nearby chassis bolt. Run the center-probe wire back through the fire wall to the dashboard, keeping clear of the engine, fan, and ignition wiring. Mount the meter box on or under the dashboard with self-tapping screws. Use lock washers to ensure a good electrical connection between the box and the dashboard as the car body is the negative side of the 12-volt system. Connect the wire from the probe to the appropriate terminal on the meter box. Run wires from the ignition switch and the dashboard lights to the box.

**Complete plans for  
ION GENERATOR  
in September EI**

## Camper Power Pack

*Continued from page 48*

### Circuit Operation

Power from the battery (12 volts DC) is fed to the transformer center tap through F1 and SW1. When SW1 is closed, current starts to flow through both Q1 and Q2, but since they're not precisely alike, one transistor, let's say Q1, conducts more heavily than Q2. The current flows from the battery through the upper half of the primary of T1 and Q1 to ground causing a voltage drop across the primary. The polarity of this voltage is such that the base of Q1 is negative with respect to the emitter causing Q1 to conduct heavily. The voltage induced in the bottom half of the primary causes the base of Q2 to be driven positive and Q2 is therefore cut off. This process continues until the core of T1 saturates. At that time the induced primary voltage then falls to zero and the reverse voltage developed from the collapse of the magnetic field starts Q2 conducting.

The induced voltage in the top half of T1 now cuts off Q1 and Q2 conducts heavily until T1 saturates—and the process repeats. In effect the two transistors switch back and forth in 1/60th of a second providing a 60 cps alternation.

What does all this accomplish? Well, if you followed the explanation closely, you noticed current flows alternately in each half of the primary, just the same as alternating current. Thus the transformer can step these alternations up to 117 volts for powering appliances. If the transistors did not "chop up" the battery DC, the steady current would soon blow the fuse. Taps are provided on the secondary of the transformer to adjust the output voltage to 117-volts AC.

### IMPORTANT NOTICE TO SUBSCRIBERS

Effective with this issue, **ELECTRONICS ILLUSTRATED** will be published on a bi-monthly basis. No issue will be published for August. Your subscription will be extended and you will receive the number of copies to which your subscription entitles you.

# SHORT CIRCUITS

BY

*Rodriguez*

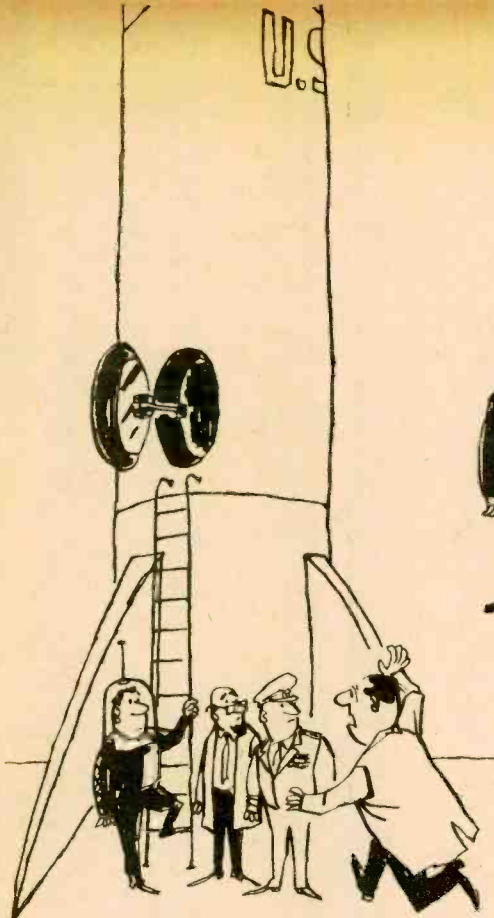

"Hold it! He flunked the code test!"

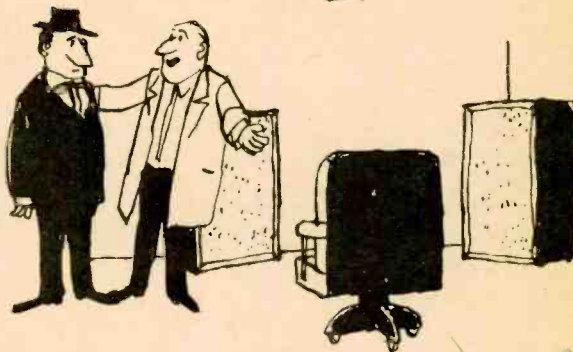

"Like I say, Congressman, it's an amazing satellite. Ever heard of stereo beeps?"

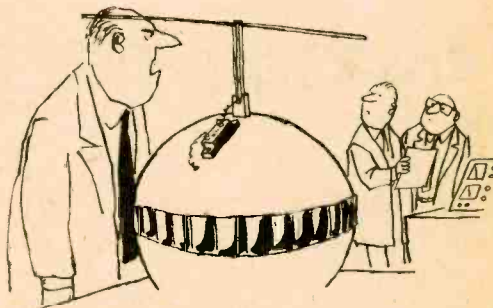

"Great idea, Simpson. But what are you going to ground it to?"

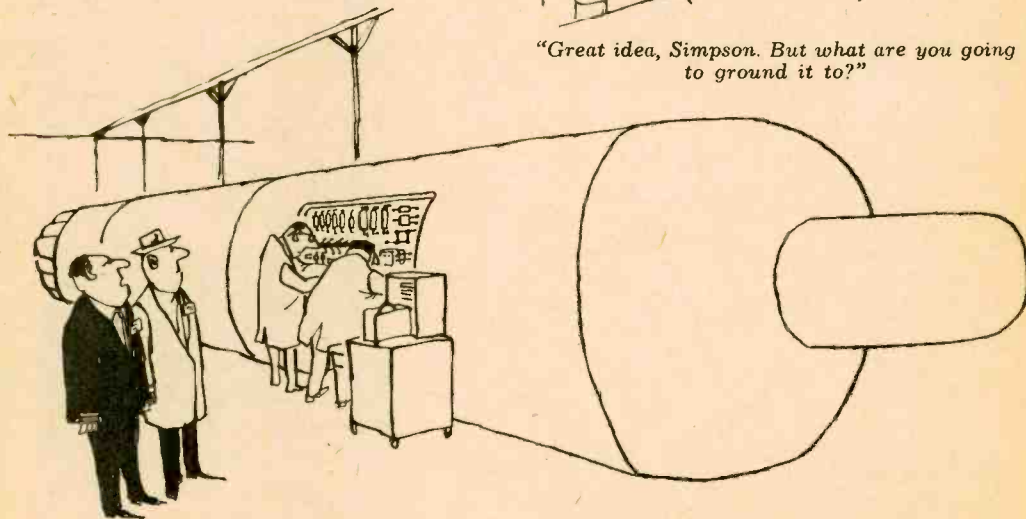

"Saved a lot of money here, Senator. Bought it in kit form, you know."



## How To DX Satellites

Continued from page 95

mediate Frequency (IF). Other types of converters are possible, of course.

A less active VHF band, but one easier to pull in, is 54 mc, on the upper edge of the 6-meter amateur band. Many receivers tune this band, and converters are available. The Transit (navigational) satellites use 54 mc.

The top band now used for space work is 900 mc, in the UHF range. Industrial communications equipment might be adapted for reception here but, frankly, these loggings would be beyond the capabilities of most such gear.

On whatever frequencies (below 300 mc) you work, it is advisable to use a crystal calibrator fitted with a 1-mc crystal. This accessory ranges in price between \$20 and \$30 but is well worth the price since exact tuning is a prime requisite for successful space monitoring.

The best short-wave receiver for space DXing is, of course, the communications type which is not only sensitive but selective. If your set lacks selectivity, a Q-multiplier would be a worthwhile investment. Your best bet for an antenna is a single wire, as long as possible so it will receive well in all directions. A directional array would provide more gain but it would be difficult to know which way to point it. Long wires have been used for DX reception beyond 150,000 miles (Lunik I).

How do you spot a signal from outer space? One clue is duration. Whether heard directly (line-of-sight) or via short-wave skip, reception from a fast-moving satellite should not last more than a few minutes. If it lasts even that long, turn on your BFO (beat frequency oscillator) and you'll hear a distinct frequency shift (Doppler effect) as the vehicle approaches, then recedes. In many instances reception lasts only a few seconds.

Satellites transmit no call letters and the simple beep pattern of Sputnik I has been replaced by more complicated and less distinctive signals.

The Soviets have put up many satellites transmitting in the short-wave ranges, so let's examine some Red signals. Three simple sound classifications are possible: (1) An irregular beep pattern with A1 modulation, requiring a BFO for reception (otherwise the signals produce a clicking sound). Be careful not to confuse this signal with radioteletype, which is sent more regularly during marker periods and at

higher speed during the handling of messages. (2) A high-speed pulse modulation producing a hiss. (3) An A2 modulation composed of two musical notes which sound simultaneously. This is Russia's most advanced signal and was used by the animal-bearing spaceship dubbed Arknik II.

To pick up a Red spaceship signal proceed this way: after a launching is announced, listen to Radio Moscow until frequencies are given. Then tune to one of them and wait (there is a lot of waiting in space DX). If your equipment is well warmed up and reasonably stable, monitoring on short-wave will require only patience and good ears. If it's unstable you'll have to tune periodically.

Send your signal reports, containing complete details, to: Secretary, Institute of Radiotechnics and Electronics, Academy of Sciences of Soviet Socialist Republics, Moscow—or to Mrs. Eugenia Stepanova, North American Service, Radio Moscow. In approximately two months you should receive a QSL card and/or a letter. While the card is highly decorative, it is of little value without the accompanying letter. The letter refers to your report as informative (rough translation) and thus at least implies confirmation.

The easiest American satellites to DX are the Explorers because they are at the low end of the outer-space short-wave band. They operate on 19991.5, down near the frequencies used so often by the Russians, and not far from a WWV frequency. The Explorer signals sound much like the Soviet signals just described, so care must be taken not to confuse them.

In the UHF ranges, 108 mc is used by so many spacecraft that identification becomes difficult and so does confirmation. Advanced communications systems can detect several different American space sounds, but most amateur rigs bring in only the satellite's carrier by using a beat frequency oscillator.

This signal also is like the Russian signal (1) we described earlier. At lower frequencies, these space signals tend to sound similar to radioteletype, as we have noted, and on UHF, the resemblance becomes even stronger. Certainly, there is a difference between satellite signals and RTT but you will have to hear both to know what it is. There is one shortcut to identification of U.S. satellites. Watch your local paper for times at which a given satellite is visible in your area and listen at those specific hours. Once you hear a U.S. space vehicle and tentatively identify it you're ready to go QSL hunting. Confirmations are harder

to get out of Washington than from Moscow, but they will be worded better. Reports should state which satellite you believe you heard, frequency, date, exact time and a description of the sound. Make the latter as detailed as possible. Then you can request verification in the form of a letter, or you may enclose a self-prepared QSL to be signed and mailed back to you.

Reports on Navy satellites go to the U.S. Naval Research Laboratories, Washington, D. C. Air Force space vehicles may be reported to U.S. Air Force Headquarters, Washington 25, D. C., but to receive a reply you'll definitely have to enclose a prepared card. Other reports may be sent to Director of Communications, Project . . . (name of satellite series, e.g., Project Tiros), c/o Office of Public Information, NASA, Room A-106, 1512 H Street N.W., Washington 25, D.C.

No one can promise you satellite QSL's. Each attempt is a hit-or-miss proposition. But outer-space QSL's are worth the time and effort required, and tomorrow they will be collector's items.

## Electronic Insect Killer

*Continued from page 52*

neon indicator lamp (NL1) will then go off.

There is nothing fussy about the construction of the shock-box. Be sure to observe rectifier polarity carefully; don't use the metal case as a common connection; be sure that AC wires don't touch the case anywhere; use rubber grommets when passing the wires from the coils to their respective terminals; and don't use parts with too low a voltage rating. The neon lamp is friction-fitted in a 1/4" i.d. rubber grommet fitted in a 3/8" dia. hole.

To install the bug killer in an overhead ceiling receptacle use a length of threaded brass tubing of the kind used in making table lamps. At one end of the tubing connect a commercial screw plug to replace the regular incandescent lamp in the ceiling fixture. The other end of the tubing is held to the case by a pair of large, flat nuts also available from the electrical fixture store. This way the trap hangs below the shock-box.

You may prefer to set the trap on a patio table. If so, the coils are uppermost and the "shock-box" case acts as a lamp base. Here, an ordinary 6-foot length of AC line cord is used to bring power to the equipment. Be sure to use grommets in all holes through which the AC-line cord passes.

## Commercial Killer

*Continued from page 81*

the electrolytic capacitor, resistor and neon bulb can be mounted on the outside of a car radio. The time control potentiometer and switch can be installed on a mounting plate under the dash. In any other receiver the parts should be mounted in vacant space inside the cabinet.

The parts listed are those used by the author, however most values are not critical and can be found in the standard junk box.

## Tag-Along Ham Rig

*Continued from page 64*

cabinet I have installed both a feed-through insulator and a coax connector, along with a ground bolt, which is simply a stove bolt with the head inside and two nuts on the outside. The top nut, of course, is used to hold on my ground wire lug.

Some time after completing the last case, I added a pair of phone jacks at the back, one for the key and the other for headphones. With these in place, I simply unplug the key and phones, stick them in a suitcase and away I go.

What about an antenna? I mounted a whip on the back of my case. It can be removed easily by turning one wing nut.

If you choose not to use a whip, there are many alternatives. Anything metallic will radiate! When I first started this operation from hotels and motels I used nearly anything in sight. Once I worked more than 1,300 miles on 33 watts, using a rusty barbed wire fence for an antenna. Other possible radiators include a wire thrown over a tree branch, the insulated guy wire on a utility pole, a metal rain gutter or fire escape ladders. In a hotel you can just drop a little wire out the window. Finding a suitable antenna is part of the pleasure!

At one time I used an eight-foot telescoping military whip, obtained on the surplus market for less than a dollar. I simply stood it in a corner (at an angle if the ceiling was low) and could usually do 800 to 1,000 miles. If it didn't load sufficiently to suit me, I simply hung an aluminum stew pan on the top and had a top-hat loader.

As you may have gathered by now, I've had a lot of fun taking my ham station along on trips. I think you will, too.



**For serious-minded men desiring higher income and status-**

CREI has developed a program of home study that is comparable in technological content to advanced residence courses in electronics. The program was developed hand-in-hand with leading companies and Government agencies contributing to the Nation's efforts in electronics, communications, missiles, and space exploration.

This CREI program in Electronics Engineering Technology may be completed in 2 to 4 years, depending on how much of your spare time you can devote to study. The courses are presented in easy-to-understand form. Our instructors will give you personal attention and assist you when you need help.

To qualify CREI graduates for advancement to key technical positions, CREI offers a complete program in electronics, including—

Automation • Instrumentation • Industrial Electronics  
Aeronautical Electronics • Guided Missiles • Radar  
Servo-mechanisms • Computers • Astronautics • Telemetering • Communications • Electronics Manufacturing • Field Engineering • Nuclear Engineering

# A COLLEGE-LEVEL EXTENSION PROGRAM IN ELECTRONICS

There is a drastic need in the electronics industry for well-educated engineers and technical personnel. Although the great majority of students find ample opportunity for advancement with their present companies, CREI maintains a Placement Bureau to assist graduates and advanced students in finding more desirable positions. For many years, the demand for CREI graduates and advanced students has far exceeded the supply.

A few of the private companies and government agencies whose officials approve CREI for their own personnel:

U. S. Navy (5,240 enrolled in extension program)

Army, Air Force, Marine Corps, Coast Guard

Columbia Broadcasting System

National Broadcasting Company

Federal Electric Corporation

Florida Power & Light

Pan American Airways

United Airlines

The Martin Company

All America Cable & Radio

Voice of America

... and many others

**QUALIFICATIONS FOR CREI.** You qualify if you have a high school diploma or equivalent, and if you have had basic electronic training and practical experience in electronics. Available to Veterans.

**CREI's Extension Division offers you a college-level home study program in electronics comparable in technological content to advanced residence courses.**

**Mail this coupon . . . today!**

## CAPITOL RADIO ENGINEERING INSTITUTE

ECPD Accredited Technical Institute Curricula • Founded 1927

Dept. 1707-N, 3224 16th St., N.W., Washington 10, D. C.

England: CREI London, Granville House,

132-135 Sloane Street, London S.W. 1, England

Please send me your course outline and FREE 56-Page Book

"Your Future In Electronics and Nuclear Engineering Technology"

... describing opportunities and CREI home study courses

in Advanced Engineering Technology.

- Radar, Servo and Computer Engineering Technology  
 Electronic Engineering Technology  
 Communications Engineering Technology  
 Television Engineering Technology  
 Aeronautical Electronic Engineering Technology  
 Automation and Industrial Electronics Engineering Technology  
 Nuclear Engineering Technology

Check field of greatest interest

Name \_\_\_\_\_ Age \_\_\_\_\_

Street \_\_\_\_\_

City \_\_\_\_\_ Zone \_\_\_\_\_ State \_\_\_\_\_

Check:  Home Study  Residence School  Korean Veteran



To obtain fast, immediate service and to avoid delay, it is necessary that the following information be filled in:

Employed by \_\_\_\_\_

Type of Present Work \_\_\_\_\_

Education: \_\_\_\_\_

Years of High School \_\_\_\_\_

Other \_\_\_\_\_

Electronics Experience \_\_\_\_\_

Only Heath offers  
Top Quality at the  
Lowest Price, and....



# NOW—we guarantee you

At your service . . .

## THE NEW HEATHKIT AUTOMATIC GARAGE DOOR OPENER!

Compare price, compare features, and you'll buy this latest Heathkit labor-saving wonder! Opens and closes all overhead track-type doors up to 8' high automatically! Garage light turns on when door is open, stays on for short period after door closes! Safety release device. Adjustable operating force! Tone-coded "hi-power" 6 or 12 v transmitter and special receiver prevents interference. Easy one-man assembly. All parts included, 65 lbs.

Kit GD-20 (mechanism, transmitter, receiver) . . . \$109.95  
 \$11 dn., \$10 mo. . . . .

Kit GOA-20-1 (extra transmitter) . . . \$2.50 dn., \$5 mo. . . . \$24.95



## BIG-BUY PORTABLE 4-TRACK STEREO TAPE RECORDER

All-in-one monophonic or 4-track stereo tape record and playback! Two tape control levers; individual tone balance and level controls; monitoring switch for listening while recording; "pause" button for editing; two "eyes" to check recording levels. Also functions as "hi-fi stereo center" for record players, etc., or to feed tape music to separate hi-fi system. Parts for all amplifiers and speakers included; turquoise and white cabinet and 3 3/4"-7 1/2" speed tape deck are assembled. Less mic.

Kit AD-40 . . . 49 lbs. . . \$18 dn., \$16 mo. . . . . \$179.95  
 Assembled ADW-40 . . . 49 lbs. . . \$30 dn., \$26 mo. . . . \$299.95



## NEW HIGH FIDELITY PA AMP.

Heath exclusive; 20 watt *hi-fi* rated PA amp. Two inputs; equalization switches; electrical mixing; sealed "pads"; tape recorder, line, and voice coil output. Plug-in, low-Z mic. Xformers separate. 24 lbs. Kit AA-31 . . .

\$6 dn., \$6 mo. . . . . \$59.95  
 Mic. Xformers. AN-11 \$11.95

## "LEGATO-COMPACT"

All Altec Lansing speakers! 2-12" hi-compliance woofers; exponential horn and driver; range 30-22,000 cps; assembled. 800 cps network. 30 watts program; 16 ohm Z. Assembled, finished cabinets; 32" x 19" d x 32 3/4" h 132 lbs.

Kit AS-21U, unfin. \$224.95  
 Kit AS-21W, wal. \$229.95  
 Kit AS-21M, mahog \$229.95



HEATH COMPANY Benton Harbor, Michigan

a subsidiary of  
**DAYSTROM, INCORPORATED**





Introducing a new styling concept in two popular Heathkit Stereo Units



Here's a handsome matching pair for your new Heathkit stereo system! Both have new louvered wrap-arounds of luggage-tan vinyl-clad steel with contrasting charcoal-grey front panels framed with polished aluminum bezels . . . a regal new look to Heath's medium-price stereo line.

### HEATHKIT AJ-11 AM/FM TUNER

Successor to the popular AJ-10, this new version features fly-wheel tuning, two "magic-eye" tuning indicators, adjustable FM automatic frequency control, AM "fidelity" switch for max. selectivity or fidelity, dependable 12 tube circuit, built-in power supply. 21 lbs.

Kit AJ-11 . . . \$7 dn., \$7 mo. . . . . **\$69.95**  
 Assembled AJW-11 . . . \$13 dn., \$11 mo. . . . . **\$129.95**

### HEATHKIT AA-151 28-WATT STEREO AMPLIFIER

Here's the popular SA-2 model all dressed up in brand-new styling. Delivers 28 hi-fi rated watts (14 per channel) for plenty of power. Has clutched volume controls, ganged tone controls, 4 dual inputs. 28 lbs.

Kit AA-151 . . . \$6 dn., \$6 mo. . . . . **\$59.95**  
 Assembled AAW-151 . . . \$12dn., \$11mo. . . . . **\$119.95**

*can build any Heathkit!*



#### IGNITION ANALYZER

Switch to primary, secondary, parade or superimposed patterns. See condition of plugs, points, wiring, coil & condenser. Plug-in ID-11 Timing Light available. 15lbs.

Kit IO-20 . . . \$9 dn. . . . . **\$89.95**  
 Assembled IOW-20 . . . **\$169.95**



#### NEW TELEPHONE AMPLIFIER!

Hands-free phone chats! Ideal for conferences, dictation, etc. Place handset on cradle, unit turns on, instantly ready! All-transistor; long-lasting battery power. Easy to build. Ivory color.

Kit GD-71 . . . 4 lbs. . . . **\$19.95**



#### LOW COST DEPTH SOUNDER

Best value in marine electronics. Detects fish, submerged objects, and bottom depth. Big 4 3/4" dial calibrated from 0-100'. 6-transistor circuit, battery powered. Corrosion & splash-resistant aluminum cab. Transducer included. 9 lbs.

Kit MI-10 \$7 dn., \$7 mo. **\$69.95**



#### LOW COST 3-BAND MARINE RDF

Deluxe features at minimum cost. Covers 200-400kc beacons, 550-1600 kc broadcast, 1700-3400 kc marine band. Loop and "sense" antennas eliminate double null. 9-transistor circuit, battery powered. Pre-assembled tuning unit.

Kit DF-3 12 lbs. \$10 dn. **\$99.95**

### You get guaranteed success with Heathkit!

Never before has a manufacturer of do-it-yourself kits guaranteed your success in completing a project. Heath does so and backs it up with an iron-clad, money-back guarantee! By making this guarantee, we hope to banish any doubt you may have about your ability to build a kit. How is such a guarantee possible? The careful planning that goes into the design of Heathkit equipment revolves around this paramount thought—anyone, regardless of background or experience, must be able to build any Heathkit. This same thought guides the writing of the detailed Heathkit assembly instructions with the world famous "check-by-step" system. These attributes plus the experience of a million customers attests to the fact that anyone can build a Heathkit. Order your favorite Heathkit today. Enjoy top quality equipment with savings of up to 50% and the satisfaction of doing it yourself. Get guaranteed success with Heathkit!

#### MONEY BACK GUARANTEE

The Heath Company *unconditionally guarantees* that you can build any Heathkit product and that it will perform in accordance with our published specifications, by simply following and completing our check-by-step instructions, or your purchase price will be cheerfully refunded.

### FREE Catalog!



Contains complete descriptions and specifications on all of the above new models plus more than 200 other famous Heathkit items. Send for your free copy, use the coupon below; see how you can enjoy top quality equipment with savings of up to 50% with Heathkit!

Ordering Instructions: Fill out the order blank. Include charges for parcel post according to weights shown. Express orders shipped delivery charges collect. All prices F.O.B. Benton Harbor, Mich. A 20% deposit is required on all C.O.D. orders. Prices subject to change without notice. Dealer and export prices slightly higher.

Please send the following items:

Item	Model No.	Price

Order direct by mail or see your Heathkit dealer.

Ship  Parcel Post  Express  C.O.D.  Best Way

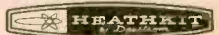

**HEATH COMPANY**  
 Benton Harbor 39, Michigan

PLEASE SEND MY FREE COPY OF THE 1961 HEATHKIT CATALOG

Name \_\_\_\_\_

Address \_\_\_\_\_

City \_\_\_\_\_ Zone \_\_\_\_\_ State \_\_\_\_\_

## Ham Shack

Continued from page 84

of hams who can show FCC tickets. At last count, more than 40 of the 50 states allowed hams this privilege, sometimes for an extra charge for making the plates (the labor costs usually are pretty low at those little stone-walled factories just up the river). You can be certain of one thing: nobody, but nobody, can use your call except you. So your tabs are quite distinctive.

—○—

**Queer Signals.** Puzzled by queer, wobbling signals that sound like CW but just don't quite come out in the form of dots and dashes? Rest easy. They're not from Mars or Venus but in all likelihood from hams who use radioteletype in preference to phone or radiotelegraph. The boys who play with RTT are almost a breed apart. They consider phone, even single sideband, too easy. They enjoy the challenging complexities of RTT, which has both electronic and mechanical problems.

—○—

**Monitor Your Keying.** After obtaining CW operating experience with straight keys many hams graduate to keys of the semi-automatic type . . . the bug or side-swiper. What too many of them neglect to acquire at the same time is a monitor of some kind that enables them to hear their own sending. The result is often such sloppy transmission that the advantages of the bug are lost. Hold the dot side closed just a trifle too long, and what you intended as I comes out S. The same negligence with H produces the number 5, which certainly can leave the guy on the other end a little confused.

—○—

**All Clear?** If you listen in on CW nets comprised of several stations on the same frequency, you may occasionally hear a terse signal that sounds like "IE." This is usually answered by "K" (for "go ahead") or "AS" (for "wait").

Actually, the signal is not IE but the letter C sent in American Morse, the former land-line telegraph code. While not official in any way, its recognized meaning among older operators is, "All clear? May I transmit?" It's a useful shortcut and makes for snappy operating.

**Mike Madness.** What is there about a microphone that turns otherwise sane and sensible citizens into chattering magpies? Maybe ham phone operation provides a much-needed outlet for henpecked husbands, or maybe many guys are just plain lonely. Given half a chance, some hams start reciting life histories before you can give them a signal report. Recently I clocked one chap who talked for seven solid minutes apparently without even catching his breath. And he was still going strong when I turned to another frequency.

It might be a good idea for all ham mikes to be adorned with a plain but legible sign reading, "Who cares?"

—○—

**Shocking Business.** A farmer-ham I know has lots of space, so he decided to string a 133-foot antenna for 80-meter operation. He secured one end well up in a tree and started reeling out the wire toward his house. Suddenly he found himself flat on the ground, dazed but conscious. At first he thought he'd been struck by a stray shot from the woods but when he recovered his senses he realized he'd been hit by something potentially much more dangerous: a static charge picked up by the antenna. Unwittingly, he had repeated Ben Franklin's famous experiment.

What misled him at first was the fact that the day was clear and bright. Heavy static usually precedes a storm and can be heard on radio receivers long before it builds up and becomes nature's most terrifying and violent manifestation, lightning. Obvious caution: when handling long, open antennas, keep them well grounded.

## CB To Ham

Continued from page 73

the basic building block of a ham station is a high-grade communications receiver. To this can be added converters for bands outside its normal frequency range. In most shacks the transmitter is entirely separate from the receiver. More likely, there are transmitters of several types.

Ham equipment costs more than CB gear. It should, because it is far more elaborate and does much more. Fortunately, it has long life and it pays for itself many times over in the enjoyment it furnishes its knob-happy owner.



# LAFAYETTE is America's Citizens Band Headquarters

Complete Portable Communications for Everyone



Ship to Shore



On the Farm



Construction Work

NO LICENSES, TESTS OR AGE LIMITS

HE-29



LAFAYETTE  
**9** TRANSISTOR  
CITIZENS  
BAND  
"WALKIE TALKIE"

**49.95**  
2.00 Down  
**2 for 96<sup>50</sup>**

PORTABLE—  
POCKET SIZE  
Only  
6 3/8" x 3 1/2" x 1 5/8"



- Completely Wired—Ready to Operate • Fully Transistorized—9 Transistors plus 1 Diode • Uses Inexpensive Penlight Batteries
- No License, Tests or Age Limits • Comes with Leather Carrying Case, Earphone, Antenna, Batteries and Crystals

As simple and easy to use as the telephone—and twice as handy. Receives and transmits up to 7 miles under favorable conditions, or 1.5 miles under average conditions. Weighs only 18-oz. and slips into your pocket. Push-to-talk button operates built-in speaker as sensitive microphone.

LAFAYETTE HE-20A  
DELUXE  
Citizens Band  
TRANSCEIVER

**109<sup>50</sup>** 5.00 Down



Made in U.S.A.

4 crystal-controlled transmit positions and 4 crystal-controlled receive positions. Tuneable superhet receiver covers all 23 assigned channels. Other highlights include dependable push-to-talk ceramic mike & relay, adjustable squelch control, automatic series gate noise limiter and illuminated dial.

Now With Added Deluxe Features—

- PI-Network for Greater Power Output • Calibrated "S" Meter
- 14 Tube Performance, 3 Diodes • Built-in 12 Volt Power Supply for Mobile Use • Complete with Matched Crystals for Channel 9

A highly efficient 2-way communications system operating over a distance of up to 20 miles or more depending on terrain. Features

LAFAYETTE HE-15A

Made in U.S.A.



ONLY  
**57<sup>50</sup>**  
5.00 Down

**SUPERHET**

Citizens Band TRANSCEIVER

- Completely Wired—Net A Kit • 5 Crystal-Controlled Transmitting Positions • Tuneable Receiver Over Full 23 Channels • High Output Crystal Microphone • Complete with Transmitting Crystal for Channel 9

A compact, precision transmitter and receiver covering up to a 20 mile or more radius, depending upon conditions. The HE-15A features an effective full-wave variable noise limiter, RF jack on front panel, planetary vernier tuning, 5-prong microphone jack for easy relay addition, and 12 tube performance from 4 dual-function tubes, 2 single-function tubes, 2 rectifiers.

HE-19 Telescoping Whip Antenna ..... Net 3.95  
HE-16 Power Supply for 12 Volts ..... Net 10.95  
HE-18 Power Supply for 6 Volts ..... Net 10.95

NOT A KIT

LAFAYETTE All-in-One  
CITIZENS BAND  
MOBILE ANTENNA

HE-800WX  
**6.95**

- Chrome Swivel Base • Stainless Steel Spring
- 102 1/2" Stainless Steel Whip for Optimum 11-Meter Performance

Chrome swivel ball mount base designed for mounting on any surface. Stainless steel spring holds rod in properly adjusted position and prevents rod damage from shocks and blows. Stainless steel whip for maximum resiliency and strength.



**NEW! LAFAYETTE**  
RADIO FIELD INDICATOR

- Continuously Indicates Transmitter Output • Rugged 200 ua Meter Movement • Requires No Electricity, Batteries or Transmitter Connection

Check the performance of marine, mobile or fixed transmitter. Features a 200 ua meter movement with variable sensitivity control. Earphones can be plugged in for an aural check of output. Antenna extends from 3/4" to 10 3/4". Magnet on bottom plate allows easy mounting on car dash or metal surfaces. Size, less antenna, 3 3/8", 2 3/4", 2"D.



TM-14  
**6.95**

**LAFAYETTE**  
**RADIO**

PLEASE INCLUDE SHIPPING CHARGES WITH ORDER

165-08 LIBERTY AVENUE, JAMAICA 33, N. Y. • OTHER LOCATIONS

NEW YORK, N. Y.  
100 6th Avenue

NEWARK, N. J.  
24 Central Avenue

BRONX, N. Y.  
542 E. Fordham Rd.

PARAMUS, N. J.  
182 Route 17

BOSTON, MASS.  
110 Federal Street

PLAINFIELD, N. J.  
139 W. 2nd Street



## Our Amazing New Robots

Continued from page 79

manipulated through ten essential motions. The bend of a wrist or elbow or the crook of a thumb can be simulated with almost human flexibility. Handyman is operated by a man who inserts his hands and arms into electronic controls that cause the fingers and arms of the robot to perform in identical manner.

Other robots may differ from Handyman to some extent but the basic concept remains the same. The vital ingredient is a man who issues instructions, either directly or through recorded data. The instructions are transmitted via cable or radio (or may be stored in the robot itself). At the receiving end is a machine supplied with power from another cable or from a self-contained source which could be nuclear. There is also a possibility of wireless transmission of the required power.

The robot, supplied with power and instructions, may contain some sort of sensing device, which could be a TV camera, a radiation counter or a magnetometer. Through these sensors, the robot gathers information and sends it back to the human operator.

Or, the robot may have grasping devices resembling human hands and arms. Following instructions, the robot can pick up and move objects just as a man might do. Some kind of feedback circuit usually is required to tell the operator how hard the claws or hands are gripping, or other information. Some robots are so sensitive that they can handle delicate glassware without breakage.

Whatever a robot's abilities, simple or complex, it must be able to perform tasks that a man cannot do for reasons of ability or environment. Otherwise, the mechanical man has no useful purpose.

Other advanced robots now amongst us or due for arrival soon include these:

*Unimate*, developed by the Consolidated Controls Corp. of Danbury, Conn. Unimate is a wireless robot which is given instructions before being sent off on an assignment.

"You just teach Unimate and send it off where you want it to go," says Consolidated's Charles Colt. "If you teach it right, it will go and perform the right job. It can be used to explore a planet or a mountain top. It can double as a stock clerk, machinist, miner or astronaut. You just take it by the hand and teach it the things you want it to do, then press a button and the

things stay in Unimate's brain of magnetic memory drums."

Unimate is a flexible machine with a longer reach than any human. It can sense its position magnetically and has a digital control system and digital memory. It can be taught work programs requiring 150 sequential commands. It can carry 25 pounds and has extra sets of specialized hands which it can change by itself.

*Mobot Mark II*, created by the Hughes Aircraft Co., probably is the best known of the new robots because of a barrage of publicity released by the company. *Mobot* (see EI's cover) is a remote-control handling machine with six-foot arms containing shoulders, elbows and wrists. Two television cameras mounted on rising, jointed tentacles serve as eyes. Microphones on the wrists serve as feedback mechanisms, allowing the operator to hear the hands at work. Except for the arms, *Mobot* looks like a big filing cabinet mounted on wheels. The cables connecting *Mobot* with its master carry more than 100 command channels and two TV channels. Although designed for work in radiation rooms, *Mobot* may be adapted to undersea or outer space tasks.

*Surveyor*, designed by Hughes for the National Aeronautics and Space Administration, is a probe vehicle to be soft-landed on the moon. It is equipped with a big retro-rocket and three vernier rockets to make the landing possible. *Surveyor* has a solar battery panel for power, a directional antenna, four TV cameras, a drill to dig into the moon's surface and instruments to analyze the resulting samples, a seismometer to record moon quakes and meteoritic impacts, a magnetometer to determine magnetic field, gravity instruments and radiation counters.

*RUM* (for Remote Underwater Manipulator), designed for the Navy by Scripps Institution, is a tractor-type vehicle which crawls into the ocean from the beach and can go down to 20,000 feet and as much as five miles from its control panel on shore. *RUM* has both TV and sonar equipment, mercury vapor lights and a working arm. Receiving instructions and power via cable from shore, it can observe the sea floor, collect samples and assemble and install deep-water oceanographic instruments at the bottom of the sea.

*Mermut*, designed by Vare Industries, Roselle, N. J., to explore the ocean depths. Many of the new robots are undersea machines built for exploration or to accomplish special underwater tasks. There also seem to be other long-range possibilities. The surface of Venus, for instance, is



largely covered by water. Mermut was built for the Navy. Project engineer Charles Krause says: "The Navy needed a device that could do things a diver couldn't, something that could submerge more deeply, see more clearly, have better endurance than a man and be able to tie a line around an object in deep water so it could be hauled to the surface."

Mermut sees via television, can operate motion picture and still cameras and descends to 20,000 feet. One version can splice an undersea telephone cable.

*Solaris*, developed by Vitro Laboratories, Silver Spring, Md. It also is an undersea robot which can descend or surface, move forward or backward, or hover. Its working hand is a giant claw.

*Beetle*, developed by General Electric. It has 15-foot arms and crawls on tractor-like treads. It will be used to inspect and overhaul "hot" equipment at atomic test sites. But it could also be used on the moon, which scientists believe is covered by thick layers of dust.

Thus the robots go, more talented and useful than ever before. And the future holds a still more important job for them. Says Dr. Fred Whipple, director of the Smithsonian Astrophysical Observatory:

"They can do the job at far less expense, weight and emotional concern than any man."

## They Said It Could Be Done

Continued from page 88

Both men have solid technical backgrounds and work at electronics professionally, yet continue to enjoy ham experimentation after long devotion to the hobby. Thomas, 57, is engineer-in-charge at RCA's Kahuku Point operation. He has been a ham 45 years. Chambers, 40, is a satellite communications project leader with Hughes Aircraft Co. He got his ticket in 1936.

The Edison Award was established by General Electric in 1952 in memory of Thomas A. Edison, probably the greatest experimenter of all time.

Thomas and Chambers don't intend to rest on their laurels. Even now they are planning a DX assault on 1296 mc, the next higher ham band, which at present is a no-man's land. Thomas, who won an American Radio Relay League award in 1955 for his work with meteor scatter, already has designed and built a 28-foot parabolic antenna for the new experiments.

—Robert Hertzberg, W2DJJ



# Remember!...

**EMC GUARANTEE** is that each instrument is by far the **BEST VALUE** obtainable in wired or kit form!

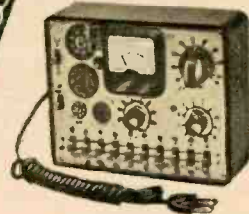

**EMC Model — 211 Tube Tester** — The smallest, lowest priced, domestic made tube tester on the market. It is completely flexible and obsolescent proof. It checks each section of multi-purpose tubes separately, checks all octal, octal, 9 prong and miniature tubes for shorts, leakages, opens, intermittents as well as for quality. Quality is indicated directly on a two color meter dial using the standard emission test. Comes complete with instructions and tube charts in ring bound manual. Size 6 3/4" x 5 1/4" x 2 1/4" deep. Shipping weight: 3 lbs.

Wired .....	\$22.90	Kit .....	\$14.90
CRT Picture Tube Adapter .....			\$ 4.50

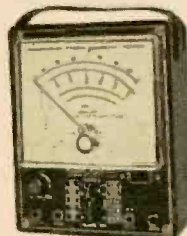

**EMC Model 109 — Voltmeter** — Features 20,000 OHMS volts DC sensitivity and 10,000 OHMS per volt AC sensitivity. Uses a 4 1/2, 40 microampere meter, with 3 AC current ranges, and 3 resistance ranges to 20 megohms. 5 DC and AC voltage ranges to 3000 volts and 3 DC current ranges; also 5 dB range.

Model 109 — With carrying strap, Weight 2 lbs. 5 ozs.: Size: 5 1/4" x 6 3/4" x 2 7/8" .....	\$26.95
Model 109K — Kit Form .....	19.25
Model HVT — 30,000 Volt Probe for Model 109 .....	7.95

Yes, tell me more, send me **FREE** a detailed catalog of the Complete EMC Line. EL-7

NAME .....

STREET .....

CITY ..... STATE .....

**EMC** Electronic Measurements Corp.  
625 B'way, New York 12, N. Y.  
Ex. Dept., Pan-Mar Corp., 1270 B'way, New York 1, N. Y.

## America's Own Marconi

Continued from page 90

him when he was experimenting was a son, Bernard, who was born around 1890. Sometimes, however, he did allow chosen individuals to view demonstrations of his apparatus and later even gave public exhibitions. After his 1885 experiment he one day ran into Duncan Holt, a Murray contractor who was as near a friend as he had, and exclaimed, "Duncan, I've done it. I've been able to talk without wires . . . all of 200 yards . . . and it'll work anywhere!" He still did not let Holt see the equipment, however. That honor was withheld until 1892, when Stubblefield allowed Dr. Rainey T. Wells, an attorney and prominent educator, to view his tangle of wires and telephones.

Dr. Wells later wrote:

"One day Stubblefield invited me to his farm for a demonstration of some kind of wireless outfit. Mind you, this was in the days when even telephones were rare. He had a shack about four feet square near his house, from which he took an ordinary telephone receiver such as we have today, but entirely without wires. Handing me this, he asked me to walk some distance away and listen. I had hardly reached my post which happened to be in an apple orchard, when I heard, 'Hello, Rainey,' come booming out of the receiver. I jumped a foot and said to myself: 'This fellow is fooling me. He has wires someplace.' I moved to the side about 20 feet but all the while he kept talking to me. I talked back and he answered me as a human voice sounds over a telephone today. But there were no wires."

Also in 1892 Stubblefield gave his first public demonstration on the town square in Murray. Hundreds of people watched as he set up one piece of equipment beside the courthouse and then another about 250 feet away. Those present noticed there were no connecting wires. Stubblefield spoke in low tones into one piece of equipment and his words came out of the other piece, distinct and clear. The crowd was astounded.

Few if anyone, realized what they had just seen and heard, however. In fact, the demonstration, plus such things as eerie wireless lights sometimes glimpsed in the trees outside Stubblefield's shack and weird voices that seemed to come from the air, only strengthened the suspicion of neighbors that they had a genuine nut in their midst.

Today, several sources credit Stubble-

field as the inventor of radio telephone. The World Almanac says he made the first radio broadcast in 1902. World History at a Glance by Joseph Reither of New York University declares him the inventor of the wireless telephone. Joseph Nathan Kane in his book, *Famous First Facts*, attributes two firsts to Stubblefield: the first radio broadcast and the first marine demonstration of wireless telephony.

The marine demonstration took place March 20, 1902, on the steam launch *Bartholdi* on the Potomac River near Washington. Stubblefield was able to transmit his voice from the launch to scientists on the bank as the craft chugged up the river.

Stubblefield said in an interview published March 21, 1902, in the *Washington Post*:

"My invention . . . is capable of sending simultaneous messages from a central distribution station over a very wide territory. For instance, anyone having a receiving instrument, which would consist merely of a telephone receiver and a few feet of wire, and a signaling gong could, upon being signaled by a transmitting station . . . be informed of weather news. My apparatus is capable of sending out a gong signal as well as voice messages. Eventually it will be used for the general transmission of news of every description.

"I have as yet devised no method whereby it can be used with privacy. Wherever there is a receiving station the signal and the message may be heard simultaneously. Eventually I, or someone, will discover a method of tuning the transmitting and receiving instruments so that each will answer only its mate.

"The system can be developed until messages by voice can be sent and heard all over the country, to Europe, all over the world."

What equipment did Stubblefield use? Probably no one will ever know exactly because the inventor never divulged his secrets. The *New York Sun* in 1930 described the gear of the then dead inventor in this manner:

"His transmitting apparatus was placed in a box four feet high and six inches in width. A coil of heavy wire was at one end and led to the ground. He [Stubblefield] made the startling statement that the earth's electrical waves furnished the power by which an ordinary telephone transmitter was operated. About a quarter of a mile away another box was fastened to a stump. There were wires leading to the ground and a pair of telephone receivers on top.



"Examination showed that the wires terminated in each case at steel rods topped with a ball of iron which was nickel-plated.

"Stubblefield claimed that the earth and all about it is charged with electrical power, part of which he was harnessing—and that in time spoken messages could be sent without wires thousands of miles.

"He admitted that he had developed radio-frequency current through a battery of his own arrangement, an earth battery, following which he devised a system of modulation and an adjustment for tuning. The detector was a receiving coil, tapped for adjusting inductance."

A modern assessment of Stubblefield's equipment doesn't divulge much more. He probably used a standard telephone receiver fitted for wireless reception. His transmitter, of his own design, probably contained, among other things, a ground battery cell system, an amplifier of some sort and some tuning coils. His use of rods driven into the ground suggests he may have stumbled onto underground radio (see UNDERGROUND RADIO IS NEWS AGAIN!, March '61 EI), although the iron balls atop his ground rods could have served as antennas.

Stubblefield made the 1902 trip to Washington in an attempt to obtain patents and he did receive one radiotelephone patent, No. 887357, on May 12, 1908.

Why didn't Stubblefield become known as the inventor of radio? No one can give an answer. Stubblefield was on the edge of fame after his demonstrations in 1902, but then he faded. His refusal to allow anyone to buy into his invention, giving him working capital, probably was a reason.

Some believe his invention was stolen while visiting Washington in 1912, since Stubblefield took it with him in a trunk when he left and no one saw him return with it. Whatever happened, Stubblefield returned home a disappointed and embittered man. Soon after, his house mysteriously burned and his family left him. He then moved into a crude, drafty hut lined with corn husks. Forgotten by the world, Stubblefield worked on in the hut until March 28, 1928, when he died of starvation and neglect.

Nathan B. Stubblefield's home town continues to back him as the inventor of radio and the local station honors him by having his initials in its call letters, WNBS. There is a monument to him on the Murray State College campus. But his ironic fate probably was spelled out at the time of his death. His passing was not even mentioned in news reports on the radio.

RESIDENT SCHOOL COURSES IN  
LOS ANGELES AND NEW YORK CITY

## START YOUR CAREER IN ELECTRONICS NOW AT RCA INSTITUTES...

Choose from this list

	Course	Qualifications	Length of Course
A	Advanced Electronic Technology (T-3)	High School grad, with Algebra, Physics or Science	Day 2¼ yrs. Eve. 6¾ yrs.
B	TV and General Electronics (V-7)	2 yrs. High School, with Algebra, Physics or Science	Day 1½ yrs. Eve. 4½ yrs.
C	Radio & TV Servicing (V-3)	2 yrs. High School, with Algebra, Physics or Science	Day 9 mos. Eve. 2¼ yrs.
D	Transistors	V-3 or equivalent	Eve. 3 mos.
E	Electronic Drafting (V-11 V-12)	2 yrs. High School, with Algebra, Physics or Science	Eve. Basic: 1 yr. Advanced: 2 yrs.
F	Color TV	V-3 or equivalent	Day 3 mos. Eve. 3 mos.
G	Audio-Hi Fidelity	V-3 or equivalent	Eve. 3 mos.
H	Video Tape	V-3 or equivalent	Eve. 3 mos.
I	Technical Writing (V-10)	V-3 or equivalent	Eve. 3-18 mos.
J	Computer Programming	High School grad	Day 6 weeks Eve. 24 weeks Sat. 30 weeks
K	Radio Code (V-4)	8th Grade	Eve. as desired
L	Preparatory Math & Physics (P-0)	1 yr. High School	Day 3 mos.
M	Preparatory Mathematics (P-0A)	1 yr. High School	Eve. 3 mos.

RCA Institutes is one of the largest technical institutes in the United States devoted exclusively to electronics. Coeducational Day and Evening classes. Free placement service. Applications now being accepted.



The Most Trusted Name  
in Electronics

RADIO CORPORATION OF AMERICA



Send to the school nearest you!

RCA Institutes, Inc. Dept. FIR 71  
350 West Fourth Street Pacific Electric Building  
New York 14, N. Y. 610 S. Main St., L.A. 14, Calif.

Please send me your FREE catalog. I am interested in the courses circled below.

A B C D E F G H I J K L M

Name \_\_\_\_\_ (please print)

Address \_\_\_\_\_

City \_\_\_\_\_ Zone \_\_\_\_\_ State \_\_\_\_\_

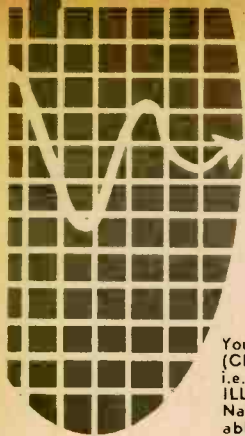

# ELECTRONICS ILLUSTRATED

## Classified Ads

Your advertisement can reach this mail-buying audience for only 50¢ per word . . . payable in advance (Check or M.O. please) . . . minimum 10 words. Closing dates are the 20th of 4th preceding month i.e. copy for the November issue must be in our office by July 20th. Mail to **ELECTRONICS ILLUSTRATED**, 67 West 44th St., New York 36, N. Y. Word count: Zone number free. Figure one word: Name of state (New Jersey), name of city (New York); sets of characters as in key (14-D); also abbreviations as 35MM, 8x10, D.C., A.C.

## SAVE MONEY • ORDER BY MAIL

### • • • FOR SALE

**BUY GOVERNMENT Surplus: Electronics;** Test Equipment; Oscilloscopes; Transceivers; Radiotelephones; Jeeps; Boats; Aircrafts; Misc.—Individuals can now buy direct from Govt.—Send for: "U. S. Depot Directory & Procedure" \$1.25. To: Brody Surplus, Box 425-EL, Nanuet, New York.

**EXCELLENT BUYS** on Tubes and equipment all listed in the "Green Sheet." Send .25¢ for your copy today. Cash paid for unused tubes. Write: Barry Electronics Corp., 512 Broadway, Dept. EI, NYC 12, N.Y.

**ANY TELEVISION** makes supersensitive big screen oscilloscope. Only minor changes required. Excellent for servicing, aligning TV. Complete plans \$3.00. Relco, Box 10563, Houston 18, Texas.

**FASCINATING GIFTS** direct to you from around the world. Information free. Bradford's, 1405 South St., Dept. 1, Leesburg, Florida.

### • • • BUSINESS OPPORTUNITIES

**VENDING MACHINES**—No selling. Operate a route of coin machines and earn high profits. 32-page catalog free! Parkway Machine Corp., Dept. 33, 715 Enor St., Baltimore 2, Md.

**GROW MUSHROOMS.** Cellar, shed and outdoors. Spare, full time, year round. We pay \$4.50 lb. dried. We have 29,000 customers. Free Book. Mushrooms, Dept. 315, 2954 Admiral Way, Seattle, Wash.

**EXCLUSIVE FRANCHISES.** Free Newsletter. Fred-A1, 535 Connaught Avenue, Halifax, Canada.

### • • • EMPLOYMENT OPPORTUNITIES

**PRINTING - ADVERTISING SALESMEN.** Excellent moneymaking sideline selling Decalcomania Name Plates. Advertising Specialties. Sign letters, Automobile initials. Free Samples. "Ralco"-EI, Box L, Boston 19, Mass.

### • • • EDUCATION & INSTRUCTION

**MEN-WOMEN NEEDED** for jobs in Electronics. Course used by top manufacturers. Special Reader's Electronics Illustrated—\$1.95. EFCO, Box 1158, Torrance, California.

**HIGHLY EFFECTIVE Home-Study Review** for FCC Commercial Phone Exams. Free Literature. Wallace Cook (EI-7), Box 10634, Jackson 9, Miss.

**ENGINEERING EDUCATION** for the Space Age. Northrop Institute of Technology is a privately endowed, nonprofit college of engineering offering a complete Bachelor of Science Degree Program and Two-Year accredited technical institute curricula. Students from 50 states, many foreign countries. Outstandingly successful graduates employed in aeronautics, electronics, and space technology. Write today for catalog—no obligation. Northrop Institute of Technology, 1116 West Arbor Vitae Street, Inglewood 1, California.

### • • • BUILD-IT-YOURSELF

**CATAMARAN.** A novel bipod mast is one of the outstanding features of King Kat, a 12-foot, all-plywood cat. The easy-to-follow-plans include large-scale drawings and full instructions for the amateur boatbuilder. Send \$3.00 to MI Reader Plan Service, Fawcett Place, Greenwich, Conn., and specify Plan No. B-230, King Kat.

**MI SPORTSTER.** Why envy the owner of a snazzy sports car? Build one yourself with these complete instructions and plans for less than \$500. To get your copy, send \$3.00 to **MECHANIX ILLUSTRATED** Plans Service, Greenwich, Conn. Specify Plan No. JH-19.

**SCIENCE PROJECT** Materials Hard To Get Items. Catalog 25¢. Wabash Instruments & Specialties, Inc., P. O. Box 194, Wabash, Indiana.

### • • • HI-FI

**RECORDERS, HI-FI!** Free Wholesale Catalogue. CARSTON, 125-G East 88, NYC 28.

### • • • TAPE RECORDERS

**LEARN WHILE Asleep** with your recorder, phonograph or amazing new "Electronic Educator" endless tape recorder. Details free. Sleep-Learning Research Association, Box 24-EI, Olympia, Washington.

**NEW CONCEPT** of self-hypnosis teaches you quickly, easily. New tape! New record! Free literature. McKinley-Smith Co., Dept. T-3, Box 3038, San Bernardino, Calif.

**TAPE RECORDERS Hi-Fi Components.** Sleep Learning Equipment, tapes. Unusual values. Free Catalog. Dressner, 1523Z Jericho Tpke., New Hyde Park, N. Y.

**RENT STEREO Tapes**—over 1500 different—all major labels—free catalog. Stereo-Parti, 811-AY Centinela Ave., Inglewood 3, California.

### • • • RADIO & TV

**FREE! GIANT 1000 item** discount catalog. Special! Jumbo Pak, 400 pcs; ceramics, discs, tubulars, resistors. \$3.00 postpaid. Write: Lektron, 241B Everett Ave., Chelsea 50, Mass.

**FREE! 1961 CATALOGS** for newest, best electronic bargains available. Stereo, hi-fi, ham radio, 1000 other items. Alco Electronics, Lawrence 4, Mass.

**BUY—SELL—Trade—Cameras, Lenses, Telescopes, Amateur Radio Equipment.** Denson Electronics, Box #85, Rockville, Conn.

**DIAGRAMS FOR** Repairing Radios, Television \$2.00. Give make, model. Diagram Service, Box 672EI, Hartford 1, Conn.

**INSTRUCTIONS ON** how to convert car radios to 110 volt operation. Send 50¢ to Hanson Electric, Northwood, Iowa.

### • • • PHOTOGRAPHY

**35MM ENLARGER.** Large-size plans for the construction of an enlarger expressly designed to be used with miniature negatives are now available for readers of MI. This enlarger uses a single condenser which also serves to hold the negative absolutely flat in the focal plane. For the easy-to-follow drawings, send 50 cents to the MI Reader Plan Service. Fawcett Publications, Inc., Greenwich, Conn. Ask for Plan No. P-4A.

### • • • MUSIC

**SWISS MUSICAL** Movements. Electrical \$6.50. Mechanical \$2.50. Spielman, 131 West 42nd, New York 36.

### • • • PERSONAL

**LOANS ENTIRELY** By Mail—\$600 or Less. Repay in 24 monthly payments. Write: Budget Finance Co., Dept. AL-51, 114 S. 17, Omaha 2, Nebr.

### • • • MISCELLANEOUS

**VTO, YOU** can build a flying model of this most revolutionary of all aircraft—a plane that takes off vertically. Send 50¢ for full-scale plans, plus instructions, to MI Reader Plan Service, Fawcett Place, Greenwich, Conn. Please specify VTO, Plan No. M-236.





## New Electronic Larynx

**A** NEW electronic larynx is being introduced on a non-profit basis by the Bell Telephone System to aid those whose larynx has been removed or paralyzed. The electronic larynx provides a substitute for the sound of the vocal chords.

Looking much like a modern electric razor, the unit is held against the throat. It transmits sound waves into the throat-cavity, replacing those normally emanating from the vocal chords. Speech is produced by forming words with the teeth, tongue and lips, just as in normal talking.

Some persons who have lost their voices are able to talk by esophageal speech, that is, by modulating air which is first swallowed and then released from the esophagus in a controlled manner.

However, many cannot master this type of speech and those who do master it lose the ability from time to time. These are the persons who may be helped most by the electronic larynx.

The larynx is produced in two models. One is high-pitched to simulate the female voice; the other, for men, has a lower pitch. Both models, contoured to fit the hand, have a finger control so the user may vary the pitch of his voice over a half-octave range, giving his speech natural inflections and emphasis of words and phrases. With practice, naturalness is possible.

The larynx is manufactured by Western Electric and sold at cost—\$45.

Full information about the unit may be obtained from local Bell offices.



## Build Your Own TOP-RATED SPEAKER

Jan Kit 41  
with JansZen  
Electrostatic  
\$99.95

JanKit 41 contains the speaker components from the famous JansZen Z-300 and Z-400 speaker systems—praised by critics and laboratories alike for their remarkably natural, virtually distortionless high-fidelity sound. Mounted on a rigid 19 1/2" by 16" panel, they're ready for easy installation in existing furniture, in walls, or in a small cabinet you can easily build. Any enclosed cabinet of only 2 cubic feet or more will do. No circuits to cut, no interconnecting wire to worry about, no critical dimensions. Two JanKit 41's let you create the finest stereo at a sensible price.

### ELECTROSTATIC TWEETER

Heart of the JanKit 41 is the famous 2-element JansZen Electrostatic. More than a tweeter, the JansZen's exclusive push-pull design gives flat, absolutely clean reproduction from critical mid range to beyond 30,000 cycles. No need for "super tweeters", mid-range speakers, or distortion-producing crossover networks.

### DYNAMIC WOOFER

Bass comes from our Model 350 Dynamic—the only woofer specifically designed to match the clarity and acoustic efficiency of electrostatics in minimum-sized enclosures. It offers clean, honest bass—devoid of false resonances, hangers or boom with uncannily flat response from 30 to 2,000 cycles.

**FREE  
INSTALLATION  
& CABINET  
PLANS**

Mail coupon today for complete data on JanKit 41 plus plans for a compact shelf model cabinet you can quickly build.

Name

Address

City  State

\*Including designs by A. A. JansZen  
**NESHAMINY ELECTRONIC CORP.**  
Department E12, Neshaminy, Pa.

## New Electronic Audio Device Trains Your Memory For Immediate Recall *While you sleep!*

**NEW YORK, N.Y.**—If you have trouble remembering names, dates, facts, languages, here's wonderful news: There's no need to suffer with a poor memory any longer . . . for now you can memorize detailed data, master another language, recall speech material, statistics, math tables, learn bridge rules, music, poetry, or prose. You can actually train your memory—automatically—while asleep!



Here's how: The patented new Dormiphone Memory Trainer, using a dramatic new recording principle, electronically increases memory retention as it speeds the learning process. This amazing teaching tool is used by educators, psychologists, people of all ages and professions. Yet it's so simple, even a child can work its clock-controlled electronic tape system.

While a poor memory may handicap even the most brilliant individual, a good memory opens doors to greater success, added confidence and enjoyment. And now, with the Dormiphone, you can learn not to forget anything you want to remember.

Start right now: *Don't forget* to send for scientific evidence of the Dormiphone's effectiveness. Write for **FREE** literature **TODAY** or call for **FREE** demonstration. There's no obligation. Modernophone, Inc., 367-071 Radio City, New York 20, N. Y. Circle 7-0830.

BEFORE You Buy Tubes . . .

COMPARE

Rad-Tel's money-saving low prices . . .

> UP TO 75% OFF

COMPARE

Rad-Tel's dependability . . .

> BRAND NEW TUBES

COMPARE

Rad-Tel's reliable . . .

> ONE FULL YEAR GUARANTEE

COMPARE

Rad-Tel's . . .

> RELIABLE PERFORMANCE

SERVICEMEN: Now speedy one-day service.

Rad-Tel sells only Brand New Tubes, not used, not pulled out of old sets . . . reduce costly call backs.

THE SIGN OF RAD-TEL'S RELIABILITY



Qty. Type	Price
024M	.79
1AX2	.82
1B3GT	.79
1DN5	.55
1E3	.79
1J3	.79
1K3	.79
1LN5	.59
1R5	.62
1S5	.51
1T4	.58
1U4	.57
1U5	.50

Qty. Type	Price
5CL8	.76
5EA8	.80
5EU8	.80
5I6	.88
5T8	.81
5U4	.60
5U8	.81
5V6	.56
5X8	.78
5Y3	.46
6AB4	.46
6AC7	.96

EACH TUBE INDIVIDUALLY & ATTRACTIVELY BOXED

Qty. Type	Price	Qty. Type	Price	Qty. Type	Price
6AU7	.61	6SK7	.74	12CN5	.56
6AU8	.87	6SL7	.80	12CR6	.54
6AV6	.40	6SN7	.65	12CU5	.58
6AW8	.89	6SQ7	.73	12CU6	1.06
6AX4	.65	6T4	.99	12CX6	.54
6AX7	.64	6U8	.78	12DB5	.69
6BA6	.49	6V6GT	.54	12DE8	.75
6BC5	.54	6W4	.54	12DL8	.85
6BC7	.94	6W6	.69	12DM7	.67
6BC8	.97	6X4	.39	12DQ6	1.04
6BD6	.51	6X5GT	.53	12DS7	.79
6BE6	.55	6X8	.77	12DZ6	.56
6BF6	.44	7AU7	.61	12EL6	.50
6BG6	1.66	7A8	.68	12EG6	.54
6BH6	.65	7B6	.69	12EZ6	.53

6BH6	.87	7Y4	.69	12F8	.66
6BJ6	.62	8AU8	.83	12FM6	.45
6BK7	.85	8AW8	.93	12K5	.65
6BL7	1.00	8BQ5	.60	12SA7M	.86
6BN4	.57	8C67	.62	12SK7G7	.74
6BN6	.74	8CM7	.68	12SN7	.67
6BQ5	.65	8CN7	.97	12SQ7M	.73
6BQ6GT	1.05	8CX8	.93	12U7	.62
6BQ7	.95	8EB8	.94	12V6GT	.53
6BR8	.78	11CY7	.75	12W6	.69
6BU8	.70	12A4	.60	12X4	.38
6BY6	.54	12AB5	.55	17AX4	.67
6BZ6	.54	12AC6	.49	17BQ6	1.09
6BZ7	.97	12AD6	.57	17C5	.58
6C4	.43	12AE6	.43	17CA5	.62

6CB6	.54	12AF3	.73	17D4	.69
6CD6	1.42	12AF6	.49	17DQ6	1.06
6CF6	.64	12AJ6	.46	17L6	.58
6CG7	.60	12AL5	.45	17W6	.70
6CG8	.77	12AL8	.95	19AU4	.83
6CM7	.66	12AQ5	.52	19B6G	1.39
6CN7	.65	12AT6	.43	19T8	.80
6CR6	.51	12AT7	.76	21EX6	1.49
6CS6	.57	12AU6	.50	25BQ6	1.11
6CU5	.58	12AU7	.60	25C5	.53
6CU6	1.08	12AV5	.97	25CA5	.59
6CY7	.71	12AV6	.41	25CD6	1.44
6DA4	.68	12AV7	.75	25CU6	1.11

RAD-TEL TUBE CO.

NOT AFFILIATED WITH ANY OTHER MAIL ORDER TUBE COMPANY

Qty. Type	Price
1X2B	.82
2AN4	.96
2AL5	.42
3AU6	.51
3AV6	.41
3BA6	.51
3BC5	.54
3BE6	.52
3BN6	.76
3BU8	.78
3BY6	.55
3BZ6	.55
3CB6	.54
3CF6	.60

Qty. Type	Price
3CS6	.52
3DK6	.60
3DT6	.50
3Q5	.80
3S4	.61
3V4	.58
4BC8	.96
4BN6	.75
4BQ7	.96
4BS0	.98
4BU8	.71
4BZ6	.58
4BZ7	.96

Qty. Type	Price
4CS6	.61
4DE6	.62
4DK6	.60
4DT6	.55
5AN8	.79
5AN8	.86
5AQ5	.52
5AT8	.80
5BK7A	.82
5BQ7	.97
5BR8	.79
5CG8	.76

Qty. Type	Price
6AF3	.73
6AF4	.97
6AG5	.65
6AH6	.99
6AK5	.95
6AL5	.47
6AM8	.78
6AQ5	.50
6AR5	.55
6AS5	.60
6AT6	.43
6AT8	.79
6AU4	.82
6AU6	.50

Qty. Type	Price
6BD5	.69
6DE6	.58
6DG6	.59
6DQ6	1.10
6DT5	.76
6DT6	.53
6E08	.79
6EAB	.79
6H6GT	.58
6J5GT	.51
6J6	.67
6K6	.63
6S4	.48
6SA7GT	.76

Qty. Type	Price
12AX4	.67
12AX7	.63
12AZ7	.86
12B4	.63
12BA6	.50
12B06	.50
12BE6	.53
12BF6	.44
12BH7	.73
12BL6	.56
12B06	1.06
12BY7	.74
12BZ7	.75
12C5	.56

Qty. Type	Price
25DN6	1.42
25EN5	.55
25L6	.57
25W4	.68
25Z6	.66
35C5	.51
35L6	.57
35W4	.52
35Z5GT	.60
50B5	.60
50C5	.53
50OC4	.37
50E5	.55
50L6	.61
117Z3	.61



SEND FOR FREE TROUBLE SHOOTER GUIDE AND NEW TUBE & PARTS CATALOG

**RAD-TEL TUBE CO.**

DEPT. EI-761 55 CHAMBERS STREET, NEWARK 5, N. J.

TERMS: 25% deposit must accompany all orders, balance COD. Orders under \$5: add \$1 handling charge plus postage. Orders over \$5: plus postage. Approx. 8 tubes per 1 lb. Subject to prior sale. No COD's outside continental USA.

QUANTITY USERS • MACHINE OPERATORS  
• MANUFACTURERS • EXPORTERS

**HUGE STOCKS !!**  
**OVER 175 TYPES SPECIALLY PRICED !**

All tubes fully Guaranteed — Brand New!  
MINIMUM ORDER . . . 100 PER TYPE . . . NO ASSORTMENT  
Write, Wire, Types Needed; get our Low "Large Quantity" price



**DeVRY  
OFFERS**

# Electronics Training

## FROM BASICS TO OUTER SPACE ROCKETRY!

Not only the basic applications of electronics like Radio and TV, but also the satellites, space ships, guided missiles, all depend on Electronics Technicians who install, adjust, maintain and repair the equipment needed. What other job can be so exciting, profitable and promising? Yet many men, 17-55, can now train in the DeVry way at home for such jobs—without previous technical experience or advanced education.

## DeVRY TECH PRESIDENT VISITS MISSILE FACILITIES!

Mr. T. J. Lafeber, DeVry's President, is shown here at missile test stand. During an inspection tour, he was deeply impressed with the role that is being played in national defense by electronic technicians.

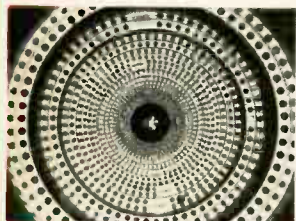
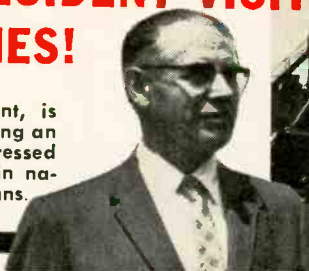

**A RARE VIEW!** This inside view of a ballistic missile is seldom seen by a civilian. It's a sight that greatly impressed Mr. Lafeber.

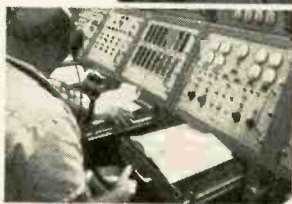

**THE COUNT DOWN!** Here is a control panel for missile tests. Missile check-out and adjustment are largely the work of the Electronics Technician.

## WHAT SOME DeVRY TECH GRADUATES ARE DOING!

Edward Hahn, Illinois, was a laborer. Now he is an Electronic Project Engineer with the Martin Company, a large producer of missiles.

Dale L. Gawthorpe, Illinois, left a clerk's job to take the DeVry program. He is now enjoying his work with automatic pilot equipment at Sperry Phoenix Company.

Charles Morishita, Oregon, worked as a farmer before taking DeVry's training. Now he builds and tests equipment at Lockheed's Space and Missile Division.

George D. Crouch, California, was a retail store clerk. He took the DeVry training program and today he is doing very well with his own business in the servicing field.

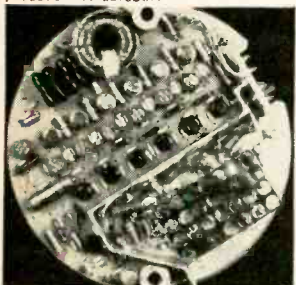

**THE HEART OF THE MISSILE!** Missile wiring soon becomes clear to a DeVry Tech man because he learns basic circuits by use of the "Electro-Lab," a training device that helps speed up learning.

**SEND FOR 2 FREE BOOKLETS!**

Postage  
Will be Paid  
by  
Addressee

No  
Postage Stamp  
Necessary  
if Mailed in the  
United States

**BUSINESS REPLY MAIL**

First Class Permit No. 4148, Chicago, Ill.

# DeVry Tech

4141 Belmont Avenue  
Chicago 41, Illinois

**DON'T DELAY  
MAIL TODAY!**



**COMPLETELY NEW  
DIFFERENT!  
EXCITING!**

**Men-Women  
17-55**

**NO ADVANCED  
EDUCATION NEEDED!**

To help you EARN GOOD MONEY later in industry, DeVry's modern training provides a thorough grounding in basics . . . then develops your skill. Thus there is no need for advanced education or previous technical experience at the start. Whether you train in your spare time at home or in our well-equipped Chicago or Toronto Laboratories, DeVry helps you become a well-trained technician, ready for a real career in Electronics.

**NEW! ALL NEW!**

Shown below is the valuable new combination oscilloscope and voltmeter which DeVry Tech men build during the new "space" training program. But that's not all! New movies, new subjects, new texts, new experimental projects — all prepare you thoroughly in this latest and greatest DeVry Tech training program.

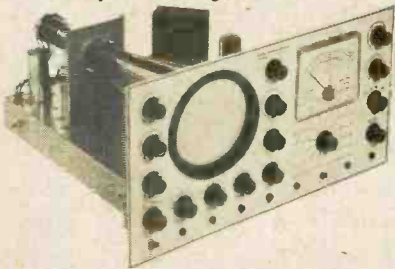

Prepare Now for a **REAL** Job in  
**SPACE and  
MISSILE  
Electronics**  
from **RADIO to ROCKETRY**

**NO PREVIOUS  
ELECTRONICS  
EXPERIENCE  
NEEDED!**



Here is an opportunity you won't want to pass up! Now a wider range of Electronic opportunities lies ahead for the trained technician—from starting your own Radio-TV service shop to working with rockets and missiles . . . from industrial electronics to space electronics. And make no mistake about it, this is one of the largest and finest opportunity fields of our time. Here, trained technicians are in demand, to build, install, service and maintain all sorts of equipment used in Communications, Radar, Broadcasting, Automation, Industrial Electronics . . . and the exciting developments in Space and Missile Electronics. Now DeVry makes it possible for you to prepare for just such opportunities. Check the fields that interest you on the coupon below, and mail TODAY. You'll get honest-to-goodness FACTS about your chances of preparing for a better career in Electronics.

**Get  
FREE  
Facts!**

**DeVry Technical Institute**

4141 Belmont Ave., Chicago 41, Ill. Dept. **EI-7-R**

POCKET GUIDE

**Real  
Earnings**

Please give me your two free booklets, "Pocket Guide to Real Earnings" and "Electronics in Space Travel!"; also include details on how to prepare for a career in Electronics. I am interested in the following opportunities (check one or more):

- Space & Missile Electronics     Television and Radio     Microwaves  
 Radar     Automation Electronics     Communications  
 Computers     Broadcasting     Industrial Electronics  
 Special "Short Courses"

Name \_\_\_\_\_ Age \_\_\_\_\_  
Please Print

Address \_\_\_\_\_ Apt. \_\_\_\_\_

City \_\_\_\_\_ Zone \_\_\_\_\_ State \_\_\_\_\_

Check here if you face military service. Canadian residents: Write DeVry Tech of Canada, Ltd., 970 Lawrence Avenue West, Toronto 19, Ontario.

**EFFECTIVE  
EMPLOYMENT SERVICE**

When your training is completed our Employment Service helps you get started in Electronics. Yes, you get the same effective nationwide employment aid that has helped so many men in the past toward good jobs—a business of their own.

**DRAFT AGE?**

If you are subject to military service, mark the coupon. We have valuable information for you.

**MAIL TODAY!**

**2 FREE  
BOOKLETS**

**GIVE YOU FULL FACTS ON  
HOW YOU MAY GET STARTED!**

**MAIL POSTAGE-FREE CARD NOW!**