

By the Publishers of  
**MECHANIX  
ILLUSTRATED**

**16 PAGE BONUS—Build  
Your Own All-Transistor Organ**

# **ELECTRONICS ILLUSTRATED**

**What's New For STEREO HI-FI?**

**MARCH • 35¢**



**How To:**

**Use Tube Testers • Learn While You Sleep • Build a CB 2-Way Radio**

You do the choosing! The Army's new "Choose-it-Yourself" System lets you pick valuable training before you enlist. Here's how it works:

1. **Choose** before enlistment. Choose your training from fields like Aircraft Maintenance, Radar and TV Repair, Drafting, Atomics, Printing—and many more.
2. **Qualify** before enlistment. Take aptitude and physical exams to qualify for the training you've chosen.
3. **Know** before enlistment. If you qualify, you know you'll get the training you want. Your choice is written into your future Army record—guaranteed before you enlist.

**Choose, qualify, know—this week!** Ask your Army recruiter to show you his complete list of available training fields.

*Want training in Aircraft Maintenance?  
Communications? Engineering?*

**choose-it-  
yourself  
before  
enlistment!**

*Helicopter Mechanic and Instructor*

**CHOOSE IT**



**YOURSELF** VOCATIONAL TRAINING SYSTEM

**US ARMY**



Lloyd Parknell

# Make More Money Soon Fixing Electric Appliances



**Actual Lesson  
FREE** Fast Growing  
Field Offers  
Good Pay, Security  
Interesting Work

## Learn at Home in Spare Time

Earn more money. Enjoy doing important, interesting work. Learn Electrical Appliance Servicing. This is a field of increasing opportunity. Today every wired home has many electrical appliances and millions and millions of new appliances are made and sold each year. Find out more about this great, growing field. Find out how NRI can train you, at home and in spare time to be an Appliance Service Technician. See how you can start soon to make extra money servicing appliances.

## Add to Your Income Soon After Enrollment Opportunities Increasing for Service Technicians

NRI Training is practical, thorough. You get easy-to-understand lessons, and NRI supplies parts to build professional type Multi-Use Tester. Use it to get practical experience. Soon, you can add to your income by servicing appliances. Build a profitable sideline for your spare time—qualify for a good job—develop a business and be your own boss. As an Appliance Service Technician, your opportunities are broad—your services wanted, gladly paid for, highly regarded in your community.

Appliances are necessary to comfortable, convenient living. Owners pay well to keep them in repair. The field is amazingly big. In addition to major appliances such as electric ranges, air conditioners, refrigerators, there are over 40,000,000 electric irons, 5,000,000 electric blankets, 15,000,000 coffee makers, plus more millions of vacuum cleaners, fans, toasters, mixers, etc.

## Learn and Earn With Tester Diploma When You Finish

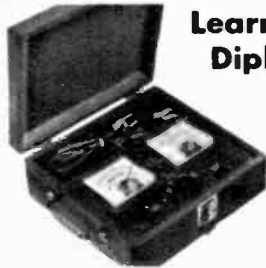

Locate appliance troubles easily with Portable Appliance Tester you build. You use it to learn and do actual electric appliance repair jobs. For only \$3.00 with enrollment and \$6 per month, get training including Tester—a small price to pay for increased earnings. Mail coupon for Sample Lesson and Book—your first step toward more interesting work, bigger earnings. **NATIONAL RADIO INSTITUTE, Dept. KCO, Washington 16, D. C.**



**Find Out What  
Appliance Repair  
Offers You**

## Mail Coupon FOR LESSON AND BOOK FREE

**National Radio Institute**  
Dept. KCO, Washington 16, D. C.

Please send me Electric Appliance Servicing Lesson and Book FREE. (I understand no salesman will call.)

Name \_\_\_\_\_ Age \_\_\_\_\_

Address \_\_\_\_\_

City \_\_\_\_\_ Zone \_\_\_\_\_ State \_\_\_\_\_

ACCREDITED MEMBER NATIONAL HOME STUDY COUNCIL

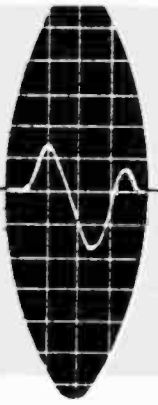

# ELECTRONICS ILLUSTRATED

March, 1960

Vol. 3, No. 3

A Fawcett Publication

## CONTENTS



A Message From the Editor .....	4
Electronics in the News .....	8
What's New for Stereo .....	29
All About Fax .....	33
Build-It Course-7 .....	36
Oddball Antennas .....	40
Loudspeaker Substitution Box .....	46
Check Out Your Kit .....	47
Build a Fire Alarm .....	50
Milt Kiver on Tube Testers—I .....	52
Hi-Fi Doctor and Clinic .....	56
Spotlight on 20 Meters .....	58
Communications Receiver Kit .....	62

Try These .....	64
Build an All Transistor Organ .....	65
All About Sleep Learning .....	42
World's Smallest TV Screen .....	82
Electronic Brain .....	84
Mobile Command Post .....	86
Telephone Amplifier .....	87
Atom Bomb Alarm .....	90
Electronic Discoveries During IGY .....	92
Wire Shielded Cables .....	96
Tracking Cold Bugs .....	98
4-Watt Stereo Amplifier .....	100
So Mutes May Speak .....	102



CHARLES TEPPER ..... Editor  
 Leonard Buckwalter ..... Associate Editor  
 Edward Nanos ..... Feature Editor  
 David Kipnes ..... Assistant Editor  
 Murray Cooper ..... Art Editor  
 Lou Rubsamen ..... Art Associate  
 Elaine Sapoff ..... Editorial Assistant

Larry Eisinger ..... Editor-in-Chief  
 Phyllis Bendroemer ..... Production Editor  
 Benita Mills ..... Assistant Production Editor  
 John F. Webster ..... Advertising Manager

Rolph Daigh ..... Editorial Director  
 James Boynton ..... Advertising Director  
 Al Allard ..... Art Director  
 Ralph Mattison ..... Associate Art Director  
 George H. Carl ..... Production Director

ELECTRONICS ILLUSTRATED is published monthly by Fawcett Publications, Inc., Fawcett Place, Greenwich, Conn. W. H. Fawcett, Jr., President; Gordon Fawcett, Secretary and Treasurer; Roger Fawcett, General Manager; Roscoe K. Fawcett, Circulation Director; Donald P. Hanson, Assistant General Manager.

EDITORIAL AND ADVERTISING OFFICES: 67 West 44th Street, New York 36, N. Y.  
 ADDRESS ALL MAIL: Subscriptions, change of address, Form 3579 to Circulation Dept., Fawcett Bldg., Greenwich, Conn.; and all editorial and advertising to Fawcett Publications, Inc., 67 W. 44th St., New York 36, N. Y.

Second-class postage paid at Greenwich, Conn., and at additional mailing offices.  
 Subscription price \$4.00 per year in the U. S. and possessions and Canada. All other countries \$6.00 per year. Foreign subscriptions and sales should be remitted by International Money Order in U. S. funds payable at Greenwich, Conn.  
 Printed in U.S.A. Copyright 1960 by Fawcett Publications, Inc.  
 Permission hereby granted to quote from this issue of this magazine on radio or television provided a total of not more than 1,000 words is quoted and credit is given to the title of the magazine and issue, as well as the statement, copyright 1960, by Fawcett Publications, Inc.





*Prepare now  
IN SPARE TIME  
AT HOME  
for great opportunity  
field of...*

*You Can Quickly  
be doing interesting  
profitable work  
like this!*

# TELEVISION

The future is **YOURS** in  
**TELEVISION—RADIO—COLOR-TV!**

A fabulous field—good pay—fascinating work—a prosperous future! Good jobs or independence in your own business!

**Modern Training by Coyne  
RIGHT IN YOUR OWN HOME**

Coyne brings you the first truly lower cost, MODERN—QUALITY Television Home Training; training designed to meet Coyne standards. Not an old Radio Course with Television "tacked on." Here is MODERN TELEVISION TRAINING including **RADIO, UHF and COLOR TV**. No previous experience needed. Personal guidance by Coyne Staff.

**The Institution Behind this Training**

Famous for over a half century, COYNE occupies this entire building which is the new home of COYNE. COYNE'S modern resident training of men for Television, Radio, Electronics and Electricity has produced thousands of successful graduates.



D. W. COOKE, Jr., President

FOUNDED 1888

**COYNE**  
**ELECTRICAL SCHOOL**  
CHARTERED AS AN EDUCATIONAL INSTITUTION  
NOT FOR PROFIT

1501 W. Congress Parkway, Chicago 7, Dept. 30-H8

**MAIL COUPON NOW FOR DETAILS FREE**

## LEARN TO

### EARN IN SPARE TIME AT HOME

COYNE offers a most practical, Home Television Training. Easy to follow step-by-step instructions, fully illustrated with 2150 photos and diagrams. **Practical Job Guides** to show you how to do actual servicing jobs—make money early in course. Keep your present job while training.

### Low Cost—Easy Terms

We save you money because we don't send you—AND CHARGE FOR—a long list of parts or "put together kits," which you may not want or do not need. With Coyne Television Home Training you pay only for your training, **no costly extras**.

Let us show you that this is not only the newest, most up-to-the-minute Training in Television—but also **it costs you much less than other leading home training courses**. Send coupon today for details including Easy Payment Plan.

### SEND COUPON OR WRITE TO ADDRESS BELOW FOR FREE BOOK

and full details, including Easy Payment Plan. **No obligation, no salesman will call.**

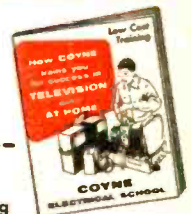

COYNE Television  
Home Training Division  
Dept. 30-H8 — New Coyne Building  
1501 W. Congress Parkway, Chicago 7, Illinois  
Send Free Book and details on Television Home Training. This does not obligate me in any way.

Name \_\_\_\_\_

Address \_\_\_\_\_

City \_\_\_\_\_ State \_\_\_\_\_

(It is understood no salesman will call.)

# A Message From the Editor

**S**HORTWAVE listeners—your day in the Sun has come, world governments are on your side! No longer will the airwaves be a scramble of programs from all over the world; no longer will you have to be a tuning whiz with a super selective (and expensive) receiver. Now, because of a plan by the 101 member International Telecommunications Union, listeners will have a better chance of tuning in on the programs they want. The new plan provides for a coordination procedure so that conflicting broadcasting schedules from all nations can be known in advance and adjusted voluntarily. All broadcasting countries will send to the Union's Board in Geneva, four times each year, their regular schedules showing

the frequencies they plan to use and the hours at which time they will use them. The Board will determine where and at what time the schedules will be conflicting, and will then notify the countries concerned. It will be up to the countries themselves to change the schedules so that they do not conflict. This should make room on the air for the many newly developing countries (with their novel native programs).

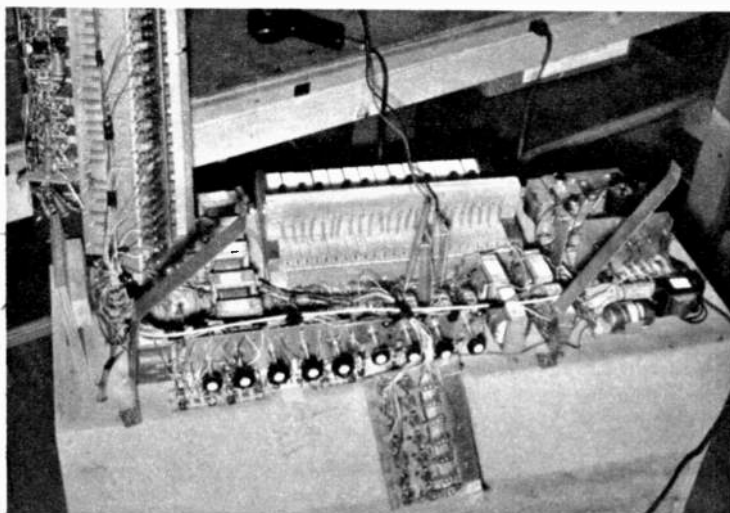

This is how the organ (p. 65) looked as we tested it.

If you haven't already flipped to page 65 and seen our special BONUS in this issue, you ought to do it after you read this editorial. As I promised you last month, we are herewith presenting the plans, etc., for an All-Transistor Electronic Organ. Frankly, there were times when we thought we had bitten off more than we could chew in trying to get the instructions and easy-to-follow diagrams in the space we had. However, the combined brain power of *EI* has done it again. We are not including *EI*'s exclusive wiring guides with this project because we don't think of this project as something for the beginner. If you have never built any complicated electronic gear, stay away from this one; but if you have built advanced kits or original equipment, and you can follow a complicated project from the schematic diagrams, this is your meat.

Another interesting project in this issue is the 2-way Citizens Band radio (P36). This will be continued in the next three issues and will be, for all of you who are interested in getting on the air via this fascinating new band, an inexpensive way to do it. But be assured that we have not stinted on quality. The receiver works into your car or home radio with full super-het action and

**Men 17 to 55—GET FREE FACTS!**

See How **DeVry Tech** Can  
Prepare You For A Profitable Future In Many Fields

from **Communications** to  
**Guided Missiles, etc.**



**NO PREVIOUS TECHNICAL EXPERIENCE  
OR ADVANCED EDUCATION NEEDED!**

Laborers and bookkeepers, store clerks, shop men, farmers, salesmen — men of nearly every calling — have taken the DeVry Tech program and today have good jobs or service shops of their own in Electronics. You don't have to quit your present job. If you are 17 to 55, see how you may get yourself ready for a future in the fast-growing Electronics field.

Whether you prepare at home or in our well-equipped Chicago or Toronto Laboratories, you get sound, basic training in both principles and practice. At home, you use educational movies. You build actual circuits and test equipment. You read simple directions; follow clear illustrations. When you finish, you are prepared to step into a good job in this excitingly different field. You may even start a service shop of your own. Mail coupon for free facts today.

Get **FREE** Booklet!

We'll give you a free copy of an interesting booklet, "Electronics in Space Travel." See for yourself how you may take advantage of the opportunities in this fast-growing field.



**FREE  
EMPLOYMENT  
SERVICE**

Puts you in touch with job opportunities—or helps you toward a better position in the plant where you are now employed.

**Draft Age?**

We have valuable information for every man of draft age; so if you are subject to military service, be sure to check the coupon.

**DeVry** TECHNICAL INSTITUTE

**Chicago 41, Illinois**  
**Formerly DeFOREST'S TRAINING, INC.**

"One of North America's Foremost Electronics Training Centers"  
Accredited Member of National Home Study Council



**Radar**



**Automation  
Electronics**



**Television**



**Micro-Waves**



**Computers**



**Broadcasting**



**Your Own  
Service Shop**

**DeVRY TECHNICAL INSTITUTE**  
4141 Belmont Ave., Chicago 41, Ill., Dept. M-3-Q  
Please give me your FREE booklet, "Electronics in Space Travel," and tell me how I may prepare to enter one or more branches of Electronics as listed above.

Name \_\_\_\_\_ Age \_\_\_\_\_  
Street \_\_\_\_\_ Please Print Apt. \_\_\_\_\_  
City \_\_\_\_\_ Zone \_\_\_\_\_ State \_\_\_\_\_

Check here if subject to Military Training.  
DeVry Tech's Canadian Training Center is located  
at 626 Roselawn Avenue, Toronto 12, Ontario  
2040



**COYNE'S New Complete**  
*Pin-Point*  
**TROUBLE SHOOTING**  
*Series*  
**Takes Headaches Out Of All Servicing Problems!**

See All 4 Books On 7-Day FREE TRIAL!



*Pin-Point*

**Transistor Troubles in 12 Minutes!**  
 Trouble-shoot every type of circuit in ALL transistorized equipment! 525 pages; hundreds of illustrations; 120 check charts! \$5.95

*Pin-Point*

**Record Changer Troubles in 5 Minutes!**  
 Locate mechanical and electronics troubles fast. Covers all makes. 320 pages; 450 photos; 58 check charts! \$3.95

*Pin-Point*

**TV Troubles in 10 Minutes!**  
 Find the exact sound or picture trouble in ANY TV set from 700 possibilities! 300 pages; 300 diagrams, check charts! \$3.95

*Pin-Point*

**Color TV Troubles in 15 Minutes!**  
 Covers every type of color TV and picture tube! 550 pages; 362 check charts, diagrams, picture patterns! \$5.95

**Simple Check Chart System Saves Time**  
 These amazing practical handbooks with an ENTIRELY NEW METHOD, show you how to find the trouble in ANY tv, record changer or transistor circuit FAST! Index tells you where to look; famous Check-Charts help you pin-point the exact trouble in minutes! These on-the-job books quickly pay for themselves in profitable new business and valuable time saved!

**SEND NO MONEY!**

Just mail coupon for free trial. After 7 days, send only low price or return books and pay nothing! If you keep all 4 books, send only \$3.00 after 7 days, and \$3.00 a month until \$19.80 plus postage is paid.

**VALUABLE FREE GIFT!**  
 Send for FREE TRIAL OFFER of all 4 Pin-Point books and get FREE book, "Bigger Profits in TV" whether you keep series or not!

**FREE TRIAL OFFER... Mail Coupon Now!**

Educational Book Publishing Div.  
 COYNE ELECTRICAL SCHOOL, Dept. 30-EI  
 1801 W. Congress Pkwy., Chicago 7, Ill.

Rush 4-book PIN-POINT Series for 7-day FREE TRIAL per offer. For individual books, check below.  
 RECORD CHANGER (\$3.95 plus postage)  
 TRANSISTORS (\$5.95 plus postage)  
 TV (\$3.95 plus postage)  
 COLOR TV (\$5.95 plus postage)

Name \_\_\_\_\_ Age \_\_\_\_\_  
 Address \_\_\_\_\_  
 City \_\_\_\_\_ Zone \_\_\_\_\_ State \_\_\_\_\_  
 Check here if enclosing full price; we pay postage. 7-day money-back guarantee.

good sensitivity and the transmitter is as stable as a rock.

New York City and its environs will shortly be the locale of a non-commercial FM broadcasting experiment which has already proven successful in California. WBAI-FM, a local commercially-operated broadcasting station, has recently been acquired by the Pacifica Foundation of Berkeley, California. The Foundation plans to support WBAI-FM by listener subscription. There will be no commercials broadcast over the station; the programs will make no attempt to please a mass audience. Anyone can listen, but if you send in \$12 you will receive the WBAI Folio, a complete bi-weekly listing and description of all the programs broadcast. There are also other categories of subscriptions and contributions which run from "Supporting" for \$18 per year to "Founder" for \$1,000. Pacifica's pioneer station in the San Francisco Bay area, KPFA is now celebrating its eleventh year on the air as a listener subscription station. To assure WBAI's success they require many charter subscriptions. Anyone interested may write to WBAI-FM at 30 East 39th Street, New York 16, New York for additional information.

Next month EI will bring you a special 16 page bonus section on how to fix your own TV receiver—if it goes on the fritz. This section has been specially written for us by one of the most respected names in the TV servicing profession. I know this is something you will treasure as you treasure your TV. We are also starting a series on money making ideas in electronics, here you will be introduced to plain folks who have used good electronic ideas to make full-time or spare-time money. This series is devised to give you the ideas that may be profitable to you too. If you are thinking of buying a tone arm for your hi-fi, be sure to read our exclusive laboratory report on hi-fi tone arms in the next issue. See you then.

*Charles Tupper*



# How to pass a genius



All of us can't be geniuses. But any ordinarily talented mortal can be a success—and that's more than some geniuses are.

Now, as in Aesop's time, the race doesn't always go to the one who potentially is the swiftest. The *trained* man has no trouble in passing the genius who hasn't improved his talents.

In good times and bad times, in every technical and business field, the *trained* man is worth a dozen untrained ones, no matter how gifted.

The International Correspondence Schools can't make you into a genius. For more than 60 years, however, I. C. S. has been helping its students to become *trained, successful leaders*—and it can do the same for you.

Mark your special interest on the coupon. Don't be like the unsuccessful genius who wastes his life in dreaming of what he intends to do. Act now!

For Real Job Security—Get an I. C. S. Diploma! I. C. S., Scranton 15, Penna.

Accredited Member.  
National Home Study Council

## INTERNATIONAL CORRESPONDENCE SCHOOLS



BOX 59574B, SCRANTON 15, PENNA.

(Partial list of 258 courses)

Without cost or obligation, send me "HOW TO SUCCEED" and the opportunity booklet about the field BEFORE which I have marked X (plus sample lesson):

### ARCHITECTURE and BUILDING CONSTRUCTION

- Air Conditioning
- Architecture
- Arch. Drawing and Designing
- Building Contractor
- Building Estimator
- Carpenter Builder
- Carpentry and Millwork
- Carpenter Foreman
- Heating
- Painting Contractor
- Plumbing
- Reading Arch. Blueprints

### ART

- Commercial Art
- Magazine Illus.
- Show Card and Sign Lettering
- Sketching and Painting

### AUTOMOTIVE

- Automobile
- Auto Body Rebuilding and Refinishing
- Auto Engine Tuneup
- Auto Technician

### AVIATION

- Aero-Engineering Technology
- Aircraft & Engine Mechanic

### BUSINESS

- Accounting
- Advertising
- Business Administration
- Business Management
- Cost Accounting
- Creative Salesmanship
- Managing a Small Business
- Professional Secretary
- Public Accounting
- Purchasing Agent
- Salesmanship and Management
- Traffic Management

### CHEMICAL

- Analytical Chemistry
- Chemical Engineering
- Chem. Lab. Technician
- Elements of Nuclear Energy
- General Chemistry
- Natural Gas Prod. and Trans.
- Petroleum Prod. and Engr.
- Professional Engineer (Chem.)
- Pulp and Paper Making

### CIVIL ENGINEERING

- Civil Engineering
- Construction Engineering
- Highway Engineering
- Professional Engineer (Civil)
- Reading Struc. Blueprints
- Sanitary Engineer
- Structural Engineering
- Surveying and Mapping

### DRAFTING

- Aircraft Drafting
- Architectural Drafting
- Drafting & Machine Design
- Electrical Drafting
- Mechanical Drafting
- Sheet Metal Drafting
- Structural Drafting

### ELECTRICAL

- Electrical Engineering
- Elec. Engr. Technician
- Elec. Light and Power
- Practical Electrician
- Practical Lineman
- Professional Engineer (Elec.)

### HIGH SCHOOL

- High School Diploma

- Good English
- High School Mathematics
- High School Science
- Short Story Writing

### LEADERSHIP

- Industrial Foremanship
- Industrial Supervision
- Personnel Labor Relations
- Short Story Writing
- Supervision

### MECHANICAL and SHOP

- Diesel Engines
- Gas-Elec. Welding
- Industrial Engineering
- Industrial Instrumentation
- Industrial Metallurgy
- Industrial Safety
- Machine Shop Practice
- Mechanical Engineering
- Professional Engineer (Mech)
- Quality Control
- Reading Shop Blueprints
- Refrigeration and Air Conditioning
- Tool Design
- Tool Making

### RADIO, TELEVISION

- General Electronics Tech.

- Industrial Electronics
- Practical Radio-TV Eng'g's
- Practical Telephony
- Radio-TV Servicing

### RAILROAD

- Car Inspector and Air Brake
- Diesel Electrician
- Diesel Engr. and Fireman
- Stationary Locomotive

### STEAM and DIESEL POWER

- Combustion Engineering
- Power Plant Engineer
- Stationary Diesel Engr.
- Stationary Fireman

### TEXTILE

- Carding and Spinning
- Cotton Manufacture
- Cotton Warming and Weaving
- Loom Fixing Technician
- Textile Designing
- Textile Finishing & Dyeing
- Throwing
- Warming and Weaving
- Worsted Manufacturing

Name \_\_\_\_\_ Age \_\_\_\_\_ Home Address \_\_\_\_\_

City \_\_\_\_\_ Zone \_\_\_\_\_ State \_\_\_\_\_ Working Hours \_\_\_\_\_ A.M. to P.M. \_\_\_\_\_

Occupation \_\_\_\_\_

Canadian residents send coupon to International Correspondence Schools, Canadian, Ltd., Montreal, Canada. . . . Special low monthly tuition rates to members of the U. S. Armed Forces.

# Electronics

## in the news

Photos courtesy BBC



When Pres. Eisenhower was making history in Asia and Europe recently, you were able to see what he did as he did it on TV. Ever wonder how? The BBC made it possible for one network televising the on-the-spot films flown to London from Asia, by compressing the 3 mc television signal in order for it to be carried over the 5 kc carrier of the transatlantic phone cable to Canada and then to the U.S. The transmitting equipment, above left, was used to modulate the carrier with the TV signal which was received by the telerecorder, above right, and recorded on 16mm film. All this is done with such speed to enable the film to be shown in the U.S. before the time the event happened in Europe! How? Difference in time between us makes it possible.



**NOW!**  
at a price  
you can afford!

# MAKE MORE MONEY in TELEVISION RADIO-ELECTRONICS

**BETTER...MORE COMPLETE...LOWER COST...  
WITH NATIONAL SCHOOLS SHOP-METHOD  
HOME TRAINING!**

**BETTER...** Training that is proved and tested in Resident School shops and laboratories, by a School that is the **OLDEST and LARGEST** of its kind in the world.

**MORE COMPLETE...** You learn **ALL PHASES** of *Television-Radio-Electronics*.

**LOWER COST...** Other schools make several courses out of the material in our **ONE MASTER COURSE**... and you pay more for less training than you get in our course at **CNE LOW TUITION!**

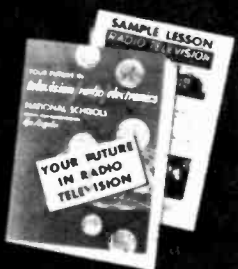

These two **FREE** books will show you how!

You get all information by mail... You make your own decision... at home! **NO SALESMAN WILL CALL**

## TOP PAY... UNLIMITED OPPORTUNITIES LIFETIME SECURITY CAN BE YOURS!

You are needed in the Television, Radio, and Electronics industry! Trained technicians are in growing demand at excellent pay—in **ALL PHASES**, including Servicing, Manufacturing, Broadcasting and Communications, Automation, Radar, Government Missile Projects.

**NATIONAL SCHOOLS SHOP-METHOD HOME TRAINING**, with newly added lessons and equipment, trains you in your spare time at home, for these unlimited opportunities, including many technical jobs leading to supervisory positions.

**YOU LEARN BY BUILDING EQUIPMENT WITH KITS AND PARTS WE SEND YOU.** Your National Schools course includes thorough *Practical* training—**YOU LEARN BY DOING!** We send you complete standard equipment of professional quality for building various experimental and test units. You advance step by step, perform more than 100 experiments, and you build a complete TV set from the ground up, that is yours to keep! A big, new TV picture tube is included at no extra charge.

**EARN AS YOU LEARN.** We'll show you how to earn extra money right from the start. Many of our students pay for their course—and more—while studying. So can you!

### RESIDENT TRAINING AT LOS ANGELES

If you wish to take your training in our Resident School at Los Angeles, the world's TV capital, start NOW in our big, modern Shops, Labs and Radio-TV Studios. Here you work with latest Electronic equipment!—professionally installed—finest, most complete facilities offered by any school. Expert, friendly instructors. Personal attention. Graduate Employment Service. Help in finding home near school... and part time job while you learn. Check box in coupon for full information.

**LESSONS AND INSTRUCTION MATERIAL ARE UP-TO-DATE, PRACTICAL, INTERESTING.** Every National Schools Shop-Method lesson is made easy to understand by numerous illustrations and diagrams. All instruction material has been developed and tested in our own Resident School Shops, Laboratories and Studios.

**SEND FOR INFORMATION TODAY**... it can mean the difference between **SUCCESS** and failure for you! Send for your **FREE BOOK** "Your Future in Television-Radio-Electronics" and **FREE Sample Lesson.** Do it **TODAY**, while you are thinking about your future. It doesn't cost you anything to investigate!

### GET THE BENEFITS OF OUR OVER 50 YEARS' EXPERIENCE

Approved for  
GI Training

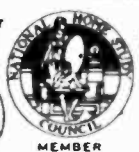

**NATIONAL SCHOOLS**  
Los Angeles 37, Calif.

## YOU GET...

- 19 Big Kits—**YOURS TO KEEP!**
- Friendly Instruction and Guidance
- Job Placement Service
- Unlimited Consultation
- Diploma—Recognized by Industry
- **EVERYTHING YOU NEED FOR SUCCESS!**

**SHOP-METHOD HOME TRAINING COVERS ALL PHASES OF INDUSTRY**

1. Television, including Color TV
2. Radio AM & FM
3. Electronics for Guided Missiles
4. Sound Recording and Hi-Fidelity
5. FCC License
6. Automation and Computers
7. Radar & Micro-Waves
8. Broadcasting and Communications

## NATIONAL TECHNICAL SCHOOLS

WORLD-WIDE TRAINING SINCE 1905

**MAIL NOW TO**  
**NATIONAL SCHOOLS, Dept R4Y-20**  
 4000 S. FIGUEROA ST. LOS ANGELES 37, CALIF.  
 Rush free TV-Radio "Opportunity" Book and sample lesson. No salesman will call.

NAME \_\_\_\_\_ AGE \_\_\_\_\_  
 ADDRESS \_\_\_\_\_  
 CITY \_\_\_\_\_ ZONE \_\_\_\_\_ STATE \_\_\_\_\_

Check if interested **ONLY** in Resident School training at Los Angeles.  
**VETERANS:** Give date of Discharge \_\_\_\_\_



## CITIZEN BAND CLASS "D" CRYSTALS

All 22 Frequencies In Stock

3rd overtone, .005% tolerance—to meet all FCC requirements. Hermetically sealed HC6/U holders. 1/2" pin spacing—.050 pins. (.093 pins available, add 15¢ per crystal). Add 5¢ per crystal for postage and handling.

**\$2.95 EACH**

The following Class "D" Citizen Band frequencies in stock (frequencies listed in megacycles): 26.965, 26.975, 26.985, 27.005, 27.015, 27.025, 27.035, 27.055, 27.065, 27.075, 27.085, 27.105, 27.115, 27.125, 27.135, 27.155, 27.165, 27.175, 27.185, 27.205, 27.215, 27.225.

Matched crystal sets for Globe, Gosset, Citi-Fone and Hallcrafters Units . . . \$5.90 per set. Specify equip. make.

### RADIO CONTROL CRYSTALS IN HC6/U HOLDERS

Specify frequency, 1/2" pin spacing . . . pin diameter .05 (.093 pin diameter, add 15¢) . . . \$2.95 ea.

### FUNDAMENTAL FREQ. SEALED CRYSTALS

in HC6/U holders  
From 1400 KC to 4000 KC, .005% Tolerance . . . \$4.95 ea.  
From 4000 KC to 15,000 KC any frequency .005% Tolerance . . . \$3.50 ea.

### SEALED OVERTONE CRYSTALS

Supplied in metal HC6/U holders  
Pin spacing .486, diameter .050  
15 to 30 MC .005 Tolerance . . . \$3.85 ea.  
30 to 45 MC .005 Tolerance . . . \$4.10 ea.  
45 to 60 MC .005 Tolerance . . . \$4.50 ea.



## QUARTZ CRYSTALS FOR EVERY SERVICE

All crystals made from Grade "A" imported quartz—ground and etched to exact frequencies. Unconditionally guaranteed! Supplied in:

FT-243 holders	MC-7 holders	DC-34 holders	FT-171 holders
Pin spacing 1/2"	Pin spacing 3/4"	Pin spacing 3/4"	Pin spacing 3/4"
Pin diameter .093	Pin diameter .125	Pin diameter .156	Banana pins

### MADE TO ORDER CRYSTALS

1001 KC to 2600 KC:	.01% Tolerance . . . \$2.00 ea.	.005% Tolerance . . . \$2.75 ea.
2601 KC to 9000 KC:	. . . \$2.50 ea.	
9001 KC to 11,000 KC:	. . . \$3.00 ea.	

Specify holder wanted

Amateur, Novice, Technician Band Crystals  
.01% Tolerance . . . \$1.50 ea.—80 meters (3701-3749 KC), 40 meters (7152-7198 KC), 15 meters (7034-7082 KC), 6 meters (8335-8450 KC) within 1 KC  
FT-241 Lattice Crystals in all frequencies from 370 KC to 540 KC (all except 455 KC and 500 KC) . . . 50¢ ea.  
Pin spacing 1/2" Pin diameter .093  
Matched pairs ± 15 cycles \$2.50 per pair  
200 KC Crystals, \$2.00 ea.; 455 KC Crystals, \$1.50 ea.; 500 KC Crystals, \$1.50 ea.; 100 KC Frequency Standard Crystals in HC6/U holders \$4.50 ea.; Socket for FT-243 crystal 15¢ ea.; Dual socket for FT-243 crystals, 15¢ ea.; Sockets for MC-7 and FT-171 crystals 25¢ ea.; Ceramic socket for HC6/U crystals 20¢ ea.

(Add 5¢ per crystal for postage and handling)  
Write for free catalog complete with oscillator circuits

### ASK YOUR PARTS DEALER FOR TEXAS CRYSTALS

See big red display . . . if he doesn't stock them, send us his name and order direct from nearest factory

OUR NEW FLORIDA PLANT NOW OPERATING  
—Send orders to our nearest location!

### TEXAS CRYSTALS

Texas Crystals, Dept. E-30 8538 W. Grand Ave. River Grove, Ill. Phone GL 3-3555	OR	Texas Crystals, Dept. E-30 1000 Crystal Drive Ft. Myers, Florida Phone WE 4-2100
--	----	---

ATTACH THIS COUPON TO YOUR ORDER FOR SHIPMENT VIA 1ST CLASS MAIL AT NO EXTRA COST  
TERMS: All items subject to prior sale and change of price without notice. All crystal orders must be accompanied by check, cash or M.O. with PAYMENT IN FULL.  
NO COD'S. Add 5¢ per crystal for postage and handling charge. E-30

## . . . News



DeJur-Amsco announced the new Stenorette "Companion," a self-powered, transistorized, portable dictating machine. This machine uses magnetic tape and reels that may be interchanged with the standard office Stenorette. Providing up to 50 minutes of recording time, the Companion is push-button operated. Priced at \$199.50 complete with accessories.

"The Amazing World of Short Wave Listening," a 45 rpm recording, contains many historic and unusual events originally broadcast on short wave radio such as: the President's voice transcribed from a satellite in outer space; actual capture of a criminal; military aviation, etc. Available through radio parts distributors or Hallicrafters, 4401 W. 5th Avenue, Chicago, Illinois for 25¢

UN NEWS . . . UNESCO has asked for development of new standard receiving and transmitting equipment designed to unsnarl the congestion of radio frequencies. Also, very low priced standard radio receiving equipment to enable people in underdeveloped countries to own such radios. An estimated 350 million sets must be produced to supply families in Asia and Africa alone. The International Telecommunications Union met recently in Geneva to discuss resolutions providing for interference free transmission in the VHF bands. See editorial for results.



# **knight-kits**® are years ahead... A PRODUCT OF ALLIED RADIO

so much easier to build...so much more value



see them all in  
**ALLIED'S 1960 CATALOG**  
**FREE** send for it

**K** *BEST...by Design!*

exciting to build...satisfying to own!  
quality electronic equipment at  
**SAVINGS UP TO 50%**



**Y-731** Deluxe FM-AM Stereo HI-FI Tuner (Multiplex add-in) \$67.50  
only \$5 down



**Y-774** Deluxe 40-Watt Stereo Amplifier (with Center Channel) \$79.50  
only \$5 down

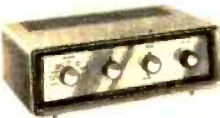

**Y-775** Super-Value 20-Watt Stereo HI-FI Amplifier...\$44.50  
only \$2 down



**Y-737** FM-AM HI-FI Tuner (with Multiplex Jack) \$49.95  
only \$2 down



**Y-737** "Ranger" Clock-Radio with "sleep" switch...\$24.95  
only \$2 down

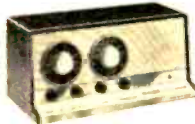

**Y-254** 4-Band "Span Master" Receiver (with cabinet) \$25.95  
only \$2 down



**R-100** Amateur Communications Receiver (HI-gain, with built-in Q-Multiplier)...\$104.50  
only \$5 down



**Y-708** 1000 Ohm/Volt Pocket Volt-Ohm-Milliammeter \$9.95



**Y-713** Citizen's Band, 27 mc Transceiver...\$39.95  
only \$2 down



**Y-771** 5-Transistor Superhet Portable Radio (less battery) \$25.95  
only \$2 down



**Y-125** Electronic VTVM (11 meg. input resistance) \$25.75  
only \$2 down



**Y-143** Model "600" Tube Checker (checks over 700 types)...\$32.95  
only \$2 down

see scores of other **knight-kits**

### HI-FI KITS

Stereo Preamp  
60-W Stereo Amplifier  
25-W Amplifier  
18-W Amplifier  
12-W Amplifier  
Hi-FI Tuners  
Speaker Systems  
and others

### HOBBYIST KITS

"Space-Spanner" Radio  
"Ranger" Radios  
"Ocean Hopper" Radio  
Transistor Radios  
2-Way Intercom  
Electronic Lab Kits  
and many others

### INSTRUMENT KITS

Lab AC VTVM  
VOM's  
5" Scopes  
Tube Checkers  
Signal Tracer  
Audio Generator  
Sweep Generator  
plus many others

### AMATEUR KITS

400-Watt Transmitter  
50-Watt Transmitter  
Self-Powered VFO  
100 kc Crystal Calibrator  
Code Practice Oscillator  
Grid Dip Oscillator

**ONLY \$2 DOWN**  
on orders up to \$50;  
\$5 down on orders  
up to \$200.

There's a money-saving **knight-kit** for every need...see them all in **ALLIED'S 1960 CATALOG**

Describes the complete **KNIGHT-KIT** line in detail—the leading Buying Guide to everything in Electronics. Send for your **FREE** copy today!

**FREE**



## ALLIED RADIO

ALLIED RADIO, Dept. 75-C  
100 N. Western Ave., Chicago 80, Ill.

SEND FREE 1960 ALLIED CATALOG

Name \_\_\_\_\_

Address \_\_\_\_\_

City \_\_\_\_\_ Zone \_\_\_\_\_ State \_\_\_\_\_

# FIX ANY TV or

## These 2 great Ghirardi books bring you COMPLETE TRAINING FOR MODERN RADIO-TV SERVICING!



A. A. Ghirardi  
Electronic's best-  
known instructor

Let these two famous Ghirardi training books teach you to handle all types of AM, FM and TV service jobs by approved professional methods! Almost 1500 pages and over 800 clear pictures and diagrams explain EVERY troubleshooting and repair operation as clearly as A-B-C. No needless mathematics. No involved theory. You get practical training of the type that teaches you to do the best work in the shortest time. Sold separately—or you save \$1.25 by buying both books. Use coupon or order from Rinehart & Co., Inc., Dept. PR-30, 232 Madison Ave., New York 16, N. Y.

### ① RADIO & TV CIRCUITRY AND OPERATION

Complete training in modern circuits and how to service them

You can repair ANY radio, television or other electronic equipment lots easier, faster and better when you really understand circuits and know just how and why each one works. That's exactly the kind of training you get in Ghirardi's 669-page Radio & TV CIRCUITRY AND OPERATION handbook! Gives a complete understanding of modern circuits. Shows what troubles to look for, and how to eliminate useless testing in servicing them. Throughout, it brings you the above-average training that takes the guesswork out of troubleshooting and fits you for the best paid service jobs. 417 illustrations. Price \$6.75 but see money-saving offer!

Circle No. 1 in coupon to order

### ② RADIO & TV TROUBLE- SHOOTING AND REPAIR

Complete training in modern service methods

Save \$1.25

Get both of these famous Ghirardi books at a saving of \$1.25 under the regular price. Check MONEY-SAVING OFFER in coupon!

Ghirardi's Radio & TV TROUBLESHOOTING AND REPAIR is a complete 822-page guide to professional service methods. For beginners, this giant book with its 417 clear illustrations is an easily understood course in locating troubles fast and fixing them right. For experienced men, it is ideal for developing better methods and finding fast answers to puzzling problems. Covers troubleshooting by all methods including both "static" and "dynamic" signal tracing types. Step-by-step charts demonstrate exactly how to proceed. A big television section is a down-to-earth guide to all phases of TV troubleshooting and service. Price \$7.50. See money-saving offer!

Circle No. 2 in coupon to order

## LEARN ALL ABOUT INSTRUMENTS!

Save time—avoid buying instruments you don't really need!

It pays to think twice before you buy new instruments—without first determining whether you really need them—or just how and where you'll actually use them! BASIC ELECTRONIC TEST INSTRUMENTS discusses and explains over 60 modern instrument types and the advantage and limitations of each. Shows how to choose the instruments you really need; how to understand instrument readings and put them to practical

use; how to work with fewer instruments, and how to put old instruments to new uses. Includes details on every type of instrument in ordinary service or communications use including V-O-M's; V-T voltmeters; capacitor checkers; oscilloscopes; special-purpose bridges; R-F oscillators; signal generators; audio oscillators; signal tracers and over 50 more. 254 pages, 171 illus. Price \$4.95.

Circle No. 3 in coupon to order

## REPAIR ANY ELECTRIC MOTOR!

... handle any job from minor repairs to complete rewinding

It pays to train for something different! ELECTRIC MOTOR REPAIR is a complete guide that helps you cash in on this fast, rapidly growing field. Shows how to handle all repair jobs (including complete rewinding) on practically ANY AC or DC motor or generator in common use. Special duo-spiral binding brings text

and related how-to-do-it diagrams side by side so that you learn fast, easily and right. Every job is explained so clearly you can hardly fail to understand it. Over 100,000 copies in use in motor repair shops, schools and for home study. 560 pages. Over 900 how-to-do-it pictures. Price only \$6.95 for the complete training.

To order, circle No. 4 in coupon

## SHORT CUTS TO TV REPAIRS!

Eliminate Useless Testing—Fix TV Receivers Twice as Fast!

Just turn the dials of these handy, pocket-size Ghirardi & Middleton PIX-O-FIX TV Trouble Finder Guides. When the picture in the PIX-O-FIX window matches the screen image on the television set you're repairing... presto!... you've got your slue.

PIX-O-FIX shows the causes of the trouble,

indicates the receiver section where it has probably happened, then gives repair instructions. PIX-O-FIX No. 1 identifies 24 common troubles and gives 192 causes and 253 remedies for them. No. 2 covers 24 more advanced troubles. Together, they are an easy guide to quick "picture analysis" servicing of any TV set... AND THE PRICE IS ONLY \$2.00 for both.

To order, circle No. 5 in coupon

# RADIO EVER MADE!

## DON'T THROW OLD RADIOS AWAY!

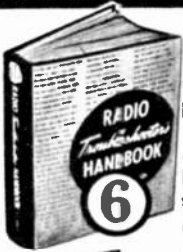

The only how-to-do-it handbook of its kind still in print!

Here's the data you need to fix them in a jiffy!

Just look up that troublesome old radio you want to fix. Four times out of five, this giant, 3½-pound, 744-page Ghirardi RADIO TROUBLESHOOTER'S HANDBOOK tells what is causing the trouble . . . shows how to fix it. Cuts service time in half. Eliminates useless testing. Even beginners can easily fix old sets which might otherwise be thrown away.

over 4,800 specific models of old home, auto radios and record changers made between 1925 and 1942. Airline, Apex, Arvin, Atwater Kent, Belmont, Bosch, Brunswick, Clarion, Crosley, Emerson, Fada, G-E, Kolster, Majestic, Motorola, Philco, Pilot, RCA, Silverstone, Sparton, Stromberg and dozens more. Has hundreds of pages of old tube and component data, service short cuts, etc. Price \$6.95.

Circle No. 6 in coupon to order

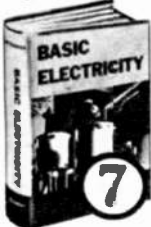

The most important training of all!

## HOW TO GET STARTED IN ELECTRONICS

Now you'll really understand circuits—components—equipment!

Learn basic electricity thoroughly—then everything else in electronics, radio, TV, communications, hi-fi etc. comes 10 times as easy—because they're all based on the same fundamental electrical principles.

transistors and all the rest. More than 300 pictures make everything doubly clear. Set-up diagrams explain procedures. Basic electrical problems are explained. Also includes a complete, easy-to-understand 61-page INTRODUCTION TO ELECTRONICS. Backed with this great training, every detail of electrical-electronic operation will be far clearer to you than ever before! Price only \$6.50.

This big 396-page BASIC ELECTRICITY manual covers the entire field . . . from circuits and currents to electromagnetism . . . from tubes to

Circle No. 7 in coupon to order



## PASS FCC LICENSE EXAMS . . . easier . . . faster!

Train for communication's good paying communication jobs!

Get one of radio's best paying jobs—as a commercial operator aboard ship. In aviation, in broadcasting or telecasting—wherever an FCC license is a "must!" LICENSE MANUAL FOR RADIO OPERATORS by J. R. Johnson is a quick, easily understood guide to help you breeze through FCC exams. Covers ALL EIGHT exam elements.

Reviews almost 2200 typical questions. Covers everything from fundamentals to navigation and related subjects. Remember . . . only 1st or 2nd class radio-phone license holders can do any work that affects the broadcasting of a transmitter! This is just one of many job opportunities open to you! Price only \$5.00.

Circle No. 8 in coupon to order



## GET MORE WORK OUT OF YOUR OSCILLOSCOPE!

Learn all about the handiest service instrument of all!

Here, in a big, revised 2nd edition, is THE book that really shows you how to get more work out of your oscilloscope.

explained—from making connections to adjusting circuit components and setting the oscilloscope controls. And you learn to analyze patterns fast and RIGHT!

Clearly as A-B-C MODERN OSCILLOSCOPES AND THEIR USES gets right-down to "brass tacks" in telling you exactly when, where and how. You learn to locate either AM or FM radio or television troubles in a jiffy. Even tough reassignment jobs are made easy. Every detail is clearly

Includes latest data on quantitative measurements (the slickest method of diagnosing many color TV troubles and aligning sets properly); using "scopes in industrial electronics, teaching . . . even in atomic energy work. Over 400 helpful pictures include dozens of pattern photos. Price \$6.50.

Circle No. 9 in coupon to order

## New guide to TIME-SAVING TEST PROCEDURES



This big manual brings the kind of training that helps you locate radio and television troubles in a jiffy. Teaches you exactly what instruments to use. Shows how, where and why to use them. Tells how to substitute one instrument for another and how to develop time-saving test methods all along the line. Basic Electronic TEST PROCEDURES includes: Current Checks; measuring Power, Capacitance, Inductance, Resistance, AF, RF, Phase, Distortion and Modulation; checking Sensitivity, RF Gain, Fidelity, AVC Voltage, Operating Voltages, etc. Includes visual alignment techniques—even transmitter and industrial electronics test procedures. Helpful data on using oscilloscopes. 316 pages, 190 how-to-do-it pictures and dozens of step-by-step troubleshooting procedures. Price \$6.50.

Circle No. 10 in coupon to order

## TRY ANY BOOK 10 DAYS FREE!

Dept. PR-30, RINEHART & CO., INC.

232 Madison Ave., New York 16, N. Y.

Send books indicated for free examination. (Circle the numbers of those you want.) In 10 days I will remit price indicated plus postage or return books postpaid and owe nothing. (SAVE! Send cash with order and we pay postage. Same 10-day return privilege with money promptly refunded.)

Check here for MONEY-SAVING COMBINATION OFFER

CIRCLE NUMBERS OF THE BOOKS YOU WANT

1	2	3
4	5	6
7	8	9 10

on books Nos. 1 and 2. Make your radio-TV service training library complete! Send both big books at only \$13 for the two plus postage. (Regular price \$14.25—you save \$1.25) Payable at rate of \$4 plus postage after 10 days and \$3 a month for three months until \$13 has been paid.

Name .....

OUTSIDE U.S.A.

Address .....

Add 50c to price of each book. Combination offer \$14. Cash with order. Same 10-day return privilege.

City, Zone, State .....

**FREE**

it's value-packed...

SEND FOR IT!

# ALLIED'S MONEY-SAVING 1960 ELECTRONIC SUPPLY CATALOG

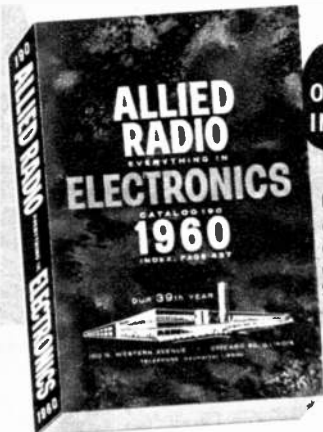

**SAVE ON EVERYTHING IN ELECTRONICS**

**ONLY \$2 DOWN** on orders up to \$50; **only \$5 down** on orders up to \$200; **\$10 down** over \$200.



## Largest Selection—Lowest Prices

Send for the most widely used buying guide to everything in Electronics for Builders, Experimenters, Hi-Fi fans, Amateurs, Servicemen and Engineers. Save on:

- KNIGHT-KITS®—Best in Build-Your-Own
- Everything in Stereo Hi-Fi
- Hi-Fi Music Systems and Components
- Tape Recorders & Phono Equipment
- TV Tubes, Antennas, Accessories
- Parts, Tubes, Transistors
- Everything in Tools & Technical Books
- Amateur Station Equipment
- Public Address & Paging Systems
- Latest Test & Lab Instruments

SAVE on everything in Electronics at ALLIED—get fastest service, expert personal help, guaranteed satisfaction. Send today for your FREE 1960 ALLIED Catalog.

our 39th year



ALLIED RADIO CORP., Dept. 84-C  
100 N. Western Ave., Chicago 80, Ill.

Rush FREE 1960 ALLIED Catalog.

Name \_\_\_\_\_

Address \_\_\_\_\_

City \_\_\_\_\_ Zone \_\_\_\_\_ State \_\_\_\_\_

SEND FOR FREE CATALOG



## ... News



A new use for closed circuit TV has been initiated at O'Hare Airport in Chicago. Flight numbers, gate positions, arrival and departure times are placed on a board and transmitted to 13 monitors throughout the terminal. Plans are being developed for a similar system for New York's International Airport.

When civilization starts on the moon, engineers will have to design all appliances, buildings, communications equipment, etc. to meet the special requirements of moon people. Since the temperature on the moon varies from -240°F to a searing 250°F many special problems must be faced. For instance, the intense heat and cold will cause such expansion and contraction as to cause misalignment or structural failure; hydraulic fluids to evaporate; even allow solder to melt. Also, protection must be obtained against meteors crashing into buildings making holes from which air can escape. Moon equipment must be able to withstand high g-shocks of launchings and landings. All in all, since eventual habitation of the moon has become a reality, moon pioneers had better start thinking and planning for the future.



# BUILD 16 RADIO CIRCUITS AT HOME

with the New **\$22.95** only  
PROGRESSIVE RADIO "EDU-KIT" ®

Reg. U.S.  
Pat. Off.



## A Practical Home Radio Course

### Now Includes

- ★ 12 RECEIVERS
- ★ TRANSMITTER
- ★ SIGNAL TRACER
- ★ SIGNAL INJECTOR
- ★ CODE OSCILLATOR
- ★ No Knowledge of Radio Necessary
- ★ No Additional Parts or Tools Needed
- ★ EXCELLENT BACKGROUND FOR TV
- ★ School Inquiries Invited
- ★ Sold in 79 Countries

**YOU DON'T HAVE TO SPEND  
HUNDREDS OF DOLLARS FOR A RADIO COURSE**

The "Edu-Kit" offers you an outstanding PRACTICAL HOME RADIO COURSE at a rock-bottom price. Our Kit is designed to train Radio & Electronics Technicians, making use of the most modern methods of home training. You will learn radio theory, construction practice and servicing. THIS IS A COMPLETE RADIO COURSE IN EVERY DETAIL. You will learn how to build radios, using regular schematics; how to wire and solder in a professional manner, how to service radios. You will work with the standard type of punched metal chassis as well as the latest development of Printed Circuit chassis. You will learn how to build radio circuits, and learn how to operate them. You will receive and practice code, using the Progressive Code Oscillator. You will learn and practice trouble-shooting using the Progressive Signal Tracer, Progressive Signal Injector, Progressive Dynamic Radio & Electronics Tester and the accompanying instructional material. You will receive training for the Novice, Technician and General Classes of F.C.C. Radio Amateur Licensees. You will build 16 Receiver, Transmitter, Code Oscillator, Signal Tracer and Signal Injector circuits, and learn how to operate them. You will receive an excellent background for Television, Hi-Fi and Electronics.

Absolutely no previous knowledge of radio or science is required. The "Edu-Kit" is the product of many years of teaching and engineering experience. The "Edu-Kit" has been carefully designed, step by step, so that you cannot make a mistake. The "Edu-Kit" allows you to teach yourself at your own rate. No instructor is necessary.

## THE KIT FOR EVERYONE

You do not need the slightest background in radio or science. Whether you are interested in Radio & Electronics because you want an interesting hobby, a well paying business or a job with a future, you will find the "Edu-Kit" a worthwhile investment. Many thousands of individuals of all

ages and backgrounds have successfully used the "Edu-Kit" in more than 79 countries of the world. The "Edu-Kit" has been carefully designed, step by step, so that you cannot make a mistake. The "Edu-Kit" allows you to teach yourself at your own rate. No instructor is necessary.

## PROGRESSIVE TEACHING METHOD

The Progressive Radio "Edu-Kit" is the foremost educational radio kit in the world, and is universally accepted as the standard in the field of electronics training. The "Edu-Kit" uses the modern educational principle of "Learn by Doing." Therefore you construct, learn schematics, study theory, practice trouble-shooting—all in a closely integrated program designed to provide an easily-learned, thorough and interesting background in radio.

You begin by examining the various radio parts of the "Edu-Kit." You then learn the function, theory and wiring of these parts. Then you build a simple radio. With this first step you will enjoy listening to regular broadcast stations, learn theory, practice testing and trouble-shooting. Then you build a more advanced radio, learn more advanced theory and techniques. Gradually, in a progressive manner, and at your own rate, you will find yourself constructing more advanced multi-tube radio circuits, and doing work like a professional Radio Technician.

Included in the "Edu-Kit" course are sixteen Receiver, Transmitter, Code Oscillator, Signal Tracer, and Signal Injector circuits. These are not unprofessional "breadboard" experiments, but genuine radio circuits, constructed by means of professional wiring and soldering on metal chassis, plus the new method of radio construction known as "Printed Circuitry." These circuits operate on your regular AC or DC house current.

## THE "EDU-KIT" IS COMPLETE

You will receive all parts and instructions necessary to build 16 different radio and electronics circuits, each guaranteed to operate. Our Kits contain tubes, tube sockets, variable, electrolytic, mica, ceramic and paper dielectric condensers, resistors, tie strips, coils, hardware, tubing, punched metal chassis, Instructor Manuals, hook-up wire, solder, etc.

In addition, you receive Printed Circuit materials, including Printed Circuit chassis, special tube sockets, hardware and instructions. You also receive a useful set of tools, a professional electric soldering iron, and a self-powered Dynamic Radio & Electronics Tester. The "Edu-Kit" also includes Code instructions and the Progressive Code Oscillator, in addition to F.C.C. type Questions and Answers for Radio Amateur License training. You will also receive lessons for servicing with the Progressive Signal Tracer and the Progressive Signal Injector, a High Fidelity Guide and a Quiz Book. You receive Membership in Radio-TV Club, Free Consultation Service, Certificate of Merit and Discount Privileges. You receive all parts, tools, instructions, etc. Everything is yours to keep.

## PRINTED CIRCUITRY

At no increase in price, the "Edu-Kit" now includes Printed Circuitry. You build a Printed Circuit Signal Injector, a unique servicing instrument that can detect many Radio and TV troubles. This revolutionary new technique of radio construction is now becoming popular in commercial radio and TV sets. A Printed Circuit is a special insulated chassis on which has been deposited a conducting material which takes the place of wiring. The various parts are merely plugged in and soldered to terminals.

Printed Circuitry is the basis of modern Automatic Electronics. The knowledge of this subject is a necessity today for anyone interested in Electronics.

## FREE EXTRAS

- SET OF TOOLS
- SOLDERING IRON
- ELECTRONICS TESTER
- PLIERS-CUTTERS
- ALIGNMENT TOOL
- WRENCH SET
- VALUABLE DISCOUNT CARD
- CERTIFICATE OF MERIT
- TESTER INSTRUCTION MANUAL
- HIGH FIDELITY GUIDE & QUIZZES
- TELEVISION BOOK & RADIO TROUBLE-SHOOTING BOOK
- MEMBERSHIP IN RADIO-TV CLUB: CONSULTATION SERVICE & FCC AMATEUR LICENSE TRAINING
- PRINTED CIRCUITRY

## SERVICING LESSONS

You will learn trouble-shooting and servicing in a progressive manner. You will practice repairs on the sets that you construct. You will learn symptoms and causes of troubles in home, portable and car radios. You will learn how to use the professional Signal Tracer, the unique Signal Injector and the Dynamic Radio & Electronics Tester. While you are learning in this practical way, you will be able to do many a repair job for your friends and neighbors, and charge fees which will far exceed the price of the "Edu-Kit." Our Consultation Service will help you with any technical problems you may have.

J. Statistis, of 25 Poplar Pl., Waterbury, Conn., writes: "I have repaired several sets for my friends, and made money. The 'Edu-Kit' paid for itself, I was ready to spend \$240 for a course, but I found your ad and sent for your Kit."

## FROM OUR MAIL BAG

Ben Valerio, P. O. Box 21, Magna, Utah: "The Edu-Kits are wonderful. Here I am sending you the questions and also the answers for them. I have been in Radio for the last seven years, but like to go work with Radio Kits, and like to build Radio Testing Equipment. I enjoyed every minute I worked with the different kits; the Signal Tracer works fine. Also like to let you know that I feel proud of becoming a member of your Radio-TV Club."

Robert L. Shuff, 1534 Monroe Ave., Huntington, W. Va.: "Thought I would drop you a few lines to say that I received my Edu-Kit, and was really amazed that such a bargain can be had at such a low price. I have already started repairing radios and photographs. My friends were really surprised to see me get into the wiring of the kit. The Troubleshooting Tester that comes with the Kit is really swell, and finds the trouble, if there is any to be found."

## UNCONDITIONAL MONEY-BACK GUARANTEE

It is understood and agreed that should the Progressive Radio "Edu-Kit" be returned to Progressive "Edu-Kits" Inc. for any reason whatever, the purchase price will be refunded in full, without quibble or question, and without delay.

The high recognition which Progressive "Edu-Kits" Inc. has earned through its many years of service to the public is due to its unconditional assistance upon the maintenance of perfect engineering, the highest instructional standards, and 100% adherence to its Unconditional Money-Back Guarantee. As a result, we do not have a single dissatisfied customer throughout the entire world.

- Send "Edu-Kit" Postpaid. I enclose full payment of \$22.95.
- Send "Edu-Kit" C.O.D. I will pay \$22.95 plus postage.
- Rush me FREE descriptive literature concerning "Edu-Kit."

Name \_\_\_\_\_  
Address \_\_\_\_\_

**PROGRESSIVE "EDU-KITS" INC.**  
1186 Broadway, Dept. 521AE, Hewlett, N. Y.

# FREE CAREER BOOKLET

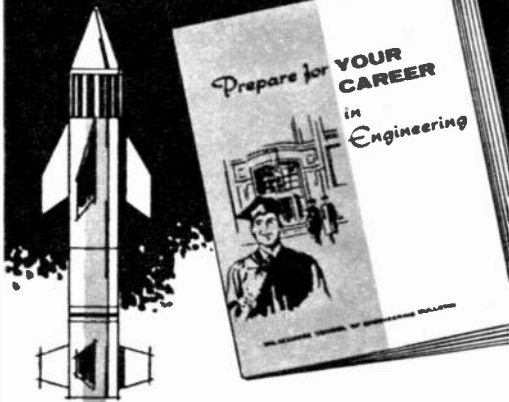

To guide you to a successful future in

## ELECTRONICS RADIO-TV COMPUTERS ELECTRICAL ENGINEERING

This interesting pictorial booklet tells you how you can prepare for a dynamic career as an Electrical Engineer or Engineering Technician in many exciting, growing fields:

**MISSILES • AVIONICS • AUTOMATION  
SALES • DEVELOPMENT  
ELECTRICAL POWER • ROCKETRY  
RADAR • RESEARCH**

Get all the facts about job opportunities, length of study, courses offered, degrees you can earn, scholarships, part-time work — as well as pictures of the Milwaukee School of Engineering's educational and recreational facilities. No obligation — it's yours free.

**MILWAUKEE SCHOOL OF ENGINEERING**

### MAIL COUPON TODAY!

Milwaukee School of Engineering  
Dept. EI-360, 1025 N. Milwaukee St., Milwaukee, Wis.  
Please send FREE "Your Career" booklet  
I'm interested in  
 Electronics     Radio-TV     Computers  
 Electrical Engineering     Mechanical Engineering

Name \_\_\_\_\_ Age \_\_\_\_\_

PLEASE PRINT

Address \_\_\_\_\_

City \_\_\_\_\_ Zone \_\_\_\_\_ State \_\_\_\_\_

I'm eligible for veterans education benefits.  
Discharge date \_\_\_\_\_ MS-117

## ...News



Lafayette has introduced a new AM-FM stereo tuner. Both AM and FM broadcasts may be received independently, or together they can provide stereo reception. A multiplex output and tuning meters for AM and FM included. \$74.50. 165-08 Liberty Avenue, Jamaica 33, New York. Model LT-77.



Engineers of the A. C. Gilbert Company, producers of science sets and electric trains picked up the distinctive bag-pipe-type signal of Explorer VII and converted it into power to run a 3-train layout of pioneer and modern trains atop the Empire State Building in New York City recently. Utilizing a highly sensitive and stable Collins 5J-4 communications receiver and a specially designed antenna, the Gilbert Engineers transformed the signal into electrical impulses which were led to a relay which triggered the switch to start the trains rolling.

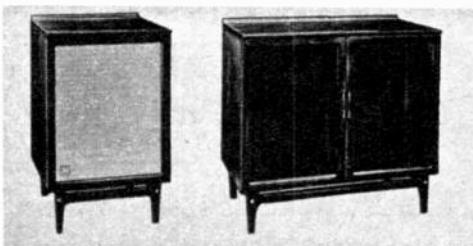

A hi-fi equipment cabinet in Scandinavian style furniture and matching speaker enclosure have been introduced by Allied Radio Corp. Both are available in kit or factory built form. Specs and prices are available from Allied, 100 N. Western Ave., Chicago 80, Ill.



# RCA INSTITUTES



# OFFERS YOU THE FINEST OF HOME STUDY TRAINING

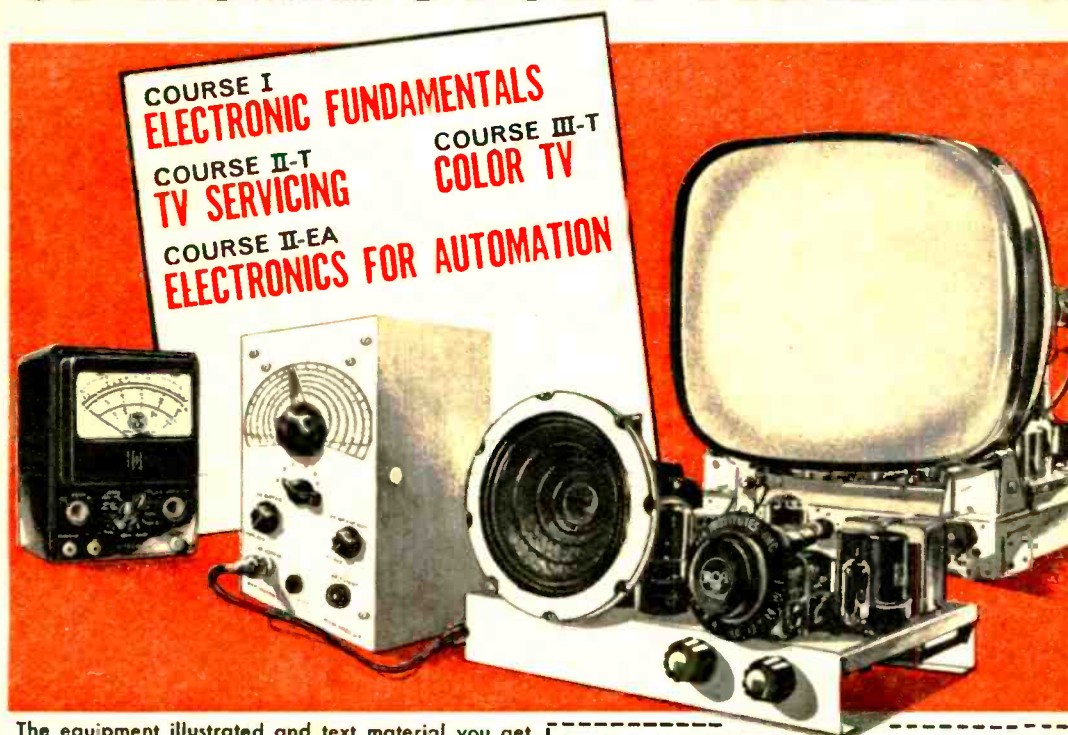

The equipment illustrated and text material you get with each course is yours to keep. Practical work with very first lesson. Courses for the beginner and the advanced student. Pay-as-you-learn. You need pay for only one study group at a time.



**SEND FOR THIS FREE BOOK NOW** ▶

Resident School courses in New York City offer comprehensive training in Television and Electronics. Day and evening classes start four times each year. Detailed information on request.

Another way RCA serves education through electronics

**RCA INSTITUTES, Inc.** Home Study School EI-30

A Service of Radio Corporation of America  
350 West Fourth Street, New York 14, N. Y.  
Without obligation, send me **FREE 64-page CATALOG** on Home Study Courses. No salesman will call.

Name ..... Age .....  
Please print

Address .....

City ..... Zone ..... State .....

Korean Vets! Enter discharge date .....

**CANADIANS** — Take advantage of these same RCA courses at no additional cost. No postage, no customs, no delay. Send coupon to:

**RCA VICTOR COMPANY, LTD.**  
5001 Cote de Liesse Rd., Montreal 9, Que.

To save time, paste coupon on postcard

# ⚡ RADIO SHACK *flash!*

Send Coupon for Latest

**FREE**  
ELECTRONICS Catalog  
plus every new issue for 1960



Act today! See the newest, the best, the most complete lines of electronic equipment in America—stereo, hi-fi, ham radio, LP records, tapes, optical goods and scores of others. Over 100,000 items—everything for the amateur, the pro, the devotee or just the interested.

Mail the coupon now! We will send you immediately, Free and Postpaid, not only our latest 312 page Electronic Catalog but every new issue for next 12 months—a full year's Free subscription to the finest in electronics and associated products all at famous money-saving Radio Shack prices. Satisfaction guaranteed on every order or your money back.

**RADIO SHACK CORPORATION** Dept. 60C8  
730 Commonwealth Ave.  
Boston 17, Massachusetts

Just one of thousands of  
RADIO SHACK buys

Transistor  
Battery Radio  
19.95 Value  
only  
**\$9.95**



Exclusive Radio Shack transistor battery radio. Only 2½x4x1¼ inches in size. Weighs less than 10 ounces. Built-in speaker and ferrite antenna. Conelrad markings, handsome molded case.

Radio Shack Corporation Dept. 60C8  
730 Commonwealth Ave.  
Boston 17, Massachusetts

Please send me, FREE and POSTPAID, your latest Electronic Catalog. Also send me every new issue for the next 12 months—a full year's subscription FREE.

Name \_\_\_\_\_

Address \_\_\_\_\_

Postoffice or City \_\_\_\_\_ Zone \_\_\_\_\_ State \_\_\_\_\_

## ...News



A device designed to turn lights on when it gets dark, and off again at dawn has been marketed by The Fisher-Pierce Company. This is accomplished by the use of a cadmium sulfide cell which operates a Sigma sensitive relay. The Nitelighter is useful for lighting stairways, etc. It can control 300 watts of light. So. Braintree, Mass. \$17.95.



A pair of matched, dynamic microphones has been announced by Shure Brothers, Inc. Model 55S Unidynes mikes are said to be within 2 db of each other across their entire frequency range. The Unidynes are unidirectional with multi-impedance switches. Further information may be obtained from Shure Brothers, Inc., 222 Hartrey Avenue, Evanston, Illinois. Price is \$48.80 each.



# Here's The Offer No Other Radio-TV School DARES MAKE!

**LEARN AT HOME in Spare Time!**

YOU DO MANY PRACTICAL JOBS with the kits we send you. That's right, you PRACTICE what we TEACH! You build a Signal Generator, AC-DC Power Pack, and AC-DC Superheterodyne Radio Receiver and top quality 21 inch TV Set. EARN AS YOU LEARN with the famous RTS 30 Day Income Plan. Full instructions provided. NO HIGH SCHOOL DIPLOMA NECESSARY. This is a COMPLETE course which starts with basic subjects and gradually advances to Radio-TV. . . . ALL FOR A PRICE YOU CAN AFFORD!

**\*THE ONLY VERTICAL MULTI-CHASSIS 21" TV KIT OFFERED BY ANY RADIO-TV SCHOOL**



**YOU BUILD THESE AND OTHER UNITS!**

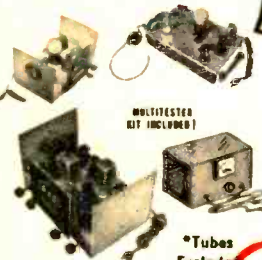

MULTIMETER KIT INCLUDED!

\*Tubes Exclude

RTS' Membership in The Association of Home Study Schools is your assurance of Reliability, Integrity and Quality of Training.



**RADIO-TELEVISION TRAINING SCHOOL**  
5100 S. VERMONT AVENUE  
LOS ANGELES 37, CALIFORNIA

L 101B Est. 1922



**COMPLETE COLOR TV INSTRUCTION INCLUDED!**

Each student is entitled to unlimited consultation service. All questions are answered promptly and completely by highly specialized instructors.



**Rush Coupon for FREE FACTS!**

**RTS Will Train You at a Price You Can Afford and When You Are a Qualified Graduate Will Help You Open a Service Shop of Your Own and Supply You With Every Bit of Equipment You Need to Get Started - Plus an Inventory of Parts and Necessary Supplies.**

**ALL FINANCED WITHOUT INTEREST OR CARRYING CHARGES!!**

**You Also Receive . . . Advertising Help and Material, Shop Plans, Business Systems, Letterheads, Calling Cards and Much More!**

**Here's What Two of Many Business Plan Shop Owners Have to Say!**

This business takes in between \$1500 and \$2000 a month. I've had to hire help to keep up with it.

CULLEN W. IRBY  
Corpus Christi, Texas

The school lives up to its promises 100%. RTS does not lose interest in its students once they graduate.

HAROLD R. STANLAKE  
Perry, Michigan

**DON'T LOSE OUT — FIND OUT!**

RADIO TELEVISION TRAINING SCHOOL, Dept. E1-360  
5100 S. Vermont Ave., Los Angeles 37, Calif.  
Rush me full information by return mail. (Please Print)

NAME \_\_\_\_\_ AGE \_\_\_\_\_

STREET \_\_\_\_\_

CITY \_\_\_\_\_ ZONE \_\_\_\_\_ STATE \_\_\_\_\_

**NO SALESMAN WILL CALL ON YOU!**



# engineering degree in only 27 months

Grasp your chance for a better life. Become a graduate Electronics Engineer. Then promotion will not pass you by. Share rewards that await college graduates. Important firms visit Tri-State campus to interview seniors. Start any quarter. Founded 1884. Bachelor of Science Degree in 27 months in Electrical Engineering with either Electronics or Power major . . . also in Mechanical, Civil, Chemical, Aeronautical Engineering. In 36 months a B.S. in Business Administration (General Business, Accounting, Motor Transport Management majors). Mature students. Enrollment limited. Small classes. More professional class hours. Campus. Well-equipped, new and modernized buildings, labs, dorms. Modest costs. Enter July, September, January, March. Mail coupon today for information.



J. A. McCarthy, Director of Admissions  
4830 College Avenue, Angola, Indiana

Please send me Your Career Book and Catalog with full information on Electronics Engineering and other degree courses. I am especially interested in courses checked:

- |   |   |  |
|---|---|--|
| <input type="checkbox"/> Electrical (Radio, TV, Electronics Option) | <input type="checkbox"/> Chemical                   | <input type="checkbox"/> Aeronautical      |
| <input type="checkbox"/> Electrical (Power option)                  | <input type="checkbox"/> Mechanical                 | <input type="checkbox"/> General Business  |
| <input type="checkbox"/> Civil                                      | <input type="checkbox"/> Motor Transport Management | <input type="checkbox"/> General Education |

Name .....

Street Address .....

Postoffice ..... Zone ..... State .....

## IT'S FUN TO BE AN ARMCHAIR ADVENTURER



With a NATIONAL NC-60 SPECIAL "A" Shortwave Radio Receiver you can cross the six continents in the comfort of your favorite chair, visit foreign lands, eavesdrop on aircraft, ships at sea and radio hams. Enjoy standard broadcast too, with this powerful new radio receiver. Suggested price only \$59.95. Write for literature and name of nearest dealer.

### JOIN THE NATIONAL ASSOCIATION OF ARMCHAIR ADVENTURERS

SEND 50c for membership certificate and exciting new book on Shortwave Listening. Tells when, where, how to listen, provides log for listing countries you hear. SEND 50c to:

**National Radio Co., Inc.**  
MELROSE 76, MASS.



A wholly owned subsidiary of National Company, Inc.  
Export: AD AURIEMA, INC. 85 Broad St., New York, N. Y., U.S.A.  
In Canada: CANADIAN MARCONI CO., Toronto 17

## ...News



A new Almquist transistor tachometer kit has been announced by the manufacturer. It can be installed on dash or steering column. Priced at \$12.95 ppd or \$14.95 for the deluxe model, it is available for 4, 6 and 8 cylinder cars. Almquist Engineering Co., Dept. PR 75, Milford, Pa. Specify car, year and model, number of cylinders and voltage when ordering.



Music hath charms to soothe the pain of the dentist's drill and has been proven 63% effective. Called an Audio Analgesiac, the device uses earphones which can bring any kind of music or sounds to both the patient and dentist. The patient may choose which type of music he prefers and also control the volume. The music serves to drown out the sound of the drill and give the patient something to do to divert his attention from the operations taking place.



To be able to build a computer with an intelligence quotient of 100 seems to be the present goal of computer engineers. As Professor Eiichi Goto of Tokyo University explained, when this goal is reached, this computer should itself be able to provide plans for a computer with an IQ in the 150 range.

Douglas Darknell

# NOW! McGraw-Hill's Low-Cost Home Course Shows

## HOW TO FIX TV Radio and Record Changers RIGHT AWAY

— even if you've never looked inside a set before!



**AT LAST! at Amazing LOW COST — the Most Complete TV-Radio Repair Course Ever Published. TELLS and SHOWS How to do Every Job Quickly and Easily — Make GOOD MONEY, Full or Spare Time, in the BOOMING Repair Business**

How would you like to be boss of a nice TV-radio-record changer repair business — making \$50 to \$75 spare time, or \$150 and up in your own shop?

Now, thanks to McGraw-Hill's new 6-volume Course, you can get started right away! This Course brings you EVERYTHING you need to "cash in" on the TV-Radio-Changer boom. Over 2,350 pages of money-making ideas and techniques by top factory engineers and electronics experts. TWO HUGE TROUBLESHOOTERS tell exactly WHERE to begin, WHAT tools to use. THREE GIANT REPAIR MANUALS tell and show how to FIX every trouble the easy way, "polish off" every job like a whiz. Complete Home Study Volume guides you every step of the way, tells how to-build your business into a spare- or full-time MONEY-MAKER!

### EARN While You Learn

Tested — and now used in repair shops and by electronics instructors — Course volumes are simple enough for green beginners, amaze "pros" with quick, easy methods. Start you doing simple repairs — and earning money — from very first chapter. ABC pictures and directions make tougher jobs a "snap." Before you finish you earn many times Course's low cost.

NO previous training needed; TV repair business pays well in good times or bad. NO complicated formulas. PLAIN ENGLISH pictures and directions cover ANY job on EVERY SET — tubes, circuits, speakers, new ac/dc, am/fm/shortwave portables, Color TV, even what to charge for every job and how to get customers!

### Age and Education No Barrier

Age doesn't matter. Past experience doesn't matter. Your formal education isn't important. Over 40 MILLION TV sets, 130 MILLION radios — and the shortage of repairmen — mean big money for you. Course makes it easy to cash in, start your own secure, profitable business.

### SEND NO MONEY

Try Course 10 days FREE. (We pay shipping!) If you don't agree it can get you started in a money-making repair business — return it, pay nothing. Otherwise keep it, earn while you learn; and pay the low cost on easy terms. Mail coupon NOW. McGraw-Hill Book Co., Dept. EI-3, 327 W. 41st St., New York 36, N. Y.

**Free** 4 Valuable Repair Aids: TV, RADIO, CIRCUIT and TRANSISTOR Detect-O-Scopes (Total Value \$4.00)

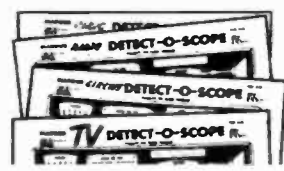

FREE — whether you keep Course or not — FOUR DETECT-O-SCOPE Charts. TV and RADIO Scopes enable you to spot tube troubles in a jiffy. CIRCUIT and TRANSISTOR Scopes spot circuit and transistor troubles. Make fix-it jobs easier, faster. 16 x 21 inches each. ALL FOUR (worth \$4.00) yours FREE.

New **FREE EXTRA** New 1960 Transistor Detect-O-Scopes



Examine Entire Course **FREE** for 10 Days!

- ### PARTIAL CONTENTS
- Television and Radio Repairing** — Testing, repairing, replacing parts, 566 pages. 700 "This-Is-How" pictures, diagrams, By John Markus, Feature Ed., Electronics Magazine.
  - Practical Radio Servicing** — Easy-to-follow directions, diagrams, drawings — with job sheet for every repair job. 599 pages. 473 illus. By William Marcus, Alex Levy, Electronic Training Experts.
  - Profitable Radio Troubleshooting** — WHERE to look and WHAT to do for every trouble. How to avoid costly mistakes, handle customers profitably. 330 pages. 153 "how to" illus. By William Marcus, Alex Levy.
  - Profitable TV Troubleshooting** — Short-cuts to SPOT and FIX every trouble — fast, for big profits. By Eugene A. Anthony, Service Consultant, General Elec. Co.
  - Repairing Record Changers** — Step-by-step pictures and directions — how to set up service bench, etc. 278 pages. 202 A-B-C pictures. By Eugene Ecklund, Eng. DuMont Lab., Inc.
  - Complete Home Course Outline** — Getting started in television and radio servicing. How to get the most out of your Course. How to get ahead FAST. By John Markus.

This Amazing Offer Saves You **\$12.85**  
**6 BIG VOLUMES**  
Including Home Course Outline! Shows How to Get Ahead Fast

### THIS COUPON SAVES YOU \$12.85

**McGraw-Hill Book Co., Dept. EI-3  
327 West 41st St., New York 36, N. Y.**

Send me — postpaid — for 10 DAYS' FREE TRIAL the 6-Vol. McGraw-Hill TV, Radio and Changer Servicing Course. If okay, I'll remit \$4.95 in 10 days; then \$5.00 monthly for 5 months. (A total savings of \$12.85 on the regular price of Course and Detect-O-Scopes.) Otherwise, I'll return Course in 10 days; pay nothing.

ALSO send FREE (to KEEP whether or not I keep Course) the TV, RADIO, and CIRCUIT DETECT-O-SCOPE CHARTS plus up-to-the-minute 1960 Transistor Detect-O-Scopes — total value \$4.00.

Name \_\_\_\_\_ (Please Print Clearly)

Address \_\_\_\_\_

City \_\_\_\_\_ Zone No. \_\_\_\_\_ State \_\_\_\_\_ (if any)

CHECK HERE if you prefer to enclose first payment of \$4.95 with coupon. Same easy pay plan; same 10-day return privilege for full refund.

EI-3

Another outstanding plus value from University

The superb,  
folded horn  
**TINY-MITE**  
enclosure

plus

The new  
**MODEL UC-82**  
2-Way  
Diffaxial



Model TM-812 Tiny-Mite  
Enclosure 2 1/4" x  
1 5/8" x 1 1/2" d.  
\$33.75 unfinished

Model UC-82  
8" 2-Way  
Diffaxial \$16.95

**BOTH \$50 TO**  
for only

Here's a high fidelity combination of fine sound and terrific value. Because the Tiny-Mite enclosure combines direct radiation with rear horn loading, it will give you excellent results wherever placed...along wall, in corner, even upside down near ceiling! Install the Model UC-82 8" Diffaxial...especially designed for small cabinet applications...and enjoy the thrill of smooth, wide-range high fidelity reproduction. Only 2 1/4" high, it's a natural for compact monophonic installation, or for use as a stereo pair. Attach it to your TV or radio and hear music as it should be heard. The Tiny-Mite enclosure will accommodate any of University's full line of 8" and 12" speakers, fully described in our new *Informative Guide to High Fidelity Speakers*. Write for your copy today.

Desk E-2, University Loudspeakers, Inc., White Plains, N. Y. A subsidiary of Ling-Altec Electronics, Inc.



**YOU NEED THIS**

**FREE GIANT 1960 B-A CATALOG**



**204 KING-SIZED PAGES**

**EVERYTHING IN RADIO TV AND ELECTRONICS**

**100'S OF NEW ITEMS LISTED HERE FOR 1st TIME**

**21 PAGES OF BARGAINS NOT IN ANY OTHER CATALOG**

**BURSTEIN-APPLEBEE CO.**

Dept. E1, 1012 McGee St., Kansas City 6, Mo.

Send Free 1960 B-A Catalog No. 601.

Name .....

Address .....

City .....

State .....

**SEND FOR IT TODAY**

...News

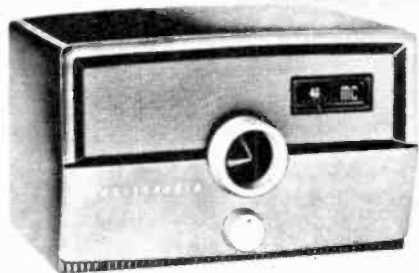

Two new Monitoradio FM receivers; PR-35 for the 30-50 mc band; and PR-155 for the 152-174 mc band, have been released. Designed to operate on 115V AC-DC, they are priced at \$49.95 each. Monitoradio Division, I.D.E.A., 7900 Pendleton Pike, Indianapolis 26, Indiana.



Conversion of mono tape recorders to 1/4 track stereo may now be accomplished with Robins Industries' two new products. One, a 1/4 track stereo record/playback head, model 5Q8; and a 1/4 track erase head, model 9QE3. They are interchangeable with all Robins M/M B & L series heads. The recording head is priced at \$30 and the erase at \$14. Robins Industries, 36-37 Prince Street, Flushing, N. Y.



# F.C.C. COMMERCIAL OPERATOR F.C.C. LICENSE

*Training...*

## for Jobs in Electronics

### F.C.C. LICENSE—THE KEY TO BETTER JOBS

An F.C.C. *commercial* (not amateur) license is your ticket to higher pay and more interesting employment. This license is Federal Government evidence of your qualifications in electronics. Employers are eager to hire *licensed* technicians.

### WHICH LICENSE FOR WHICH JOB?

The **THIRD CLASS** radiotelephone license is of value primarily in that it qualifies you to take the second class examination. The scope of authority covered by a third class license is extremely limited.

The **SECOND CLASS** radiotelephone license qualifies you to install, maintain and operate most all radiotelephone equipment except commercial broadcast station equipment.

The **FIRST CLASS** radiotelephone license qualifies you to install, maintain and operate every type of radiotelephone equipment (except amateur) including all radio and television stations in the United States, its territories and possessions. This is the highest class of radiotelephone license available.

### GRANTHAM TRAINING PREPARES YOU

The Grantham Communications Electronics Course prepares you for a **FIRST CLASS F.C.C.** license, and it does this by **TEACHING** you electronics. Each point is covered simply and in detail, with emphasis on making the subject easy to understand. The organization of the subject matter is such that you progress, step-by-step, to your specific objective—a first class F.C.C. license.

### CORRESPONDENCE OR RESIDENCE CLASSES

Grantham training is available by correspondence or in resident classes. Either way, you are trained quickly and well. Write, or mail the coupon below, to any division of Grantham School of Electronics. Our free booklet will be sent to you immediately.

### HERE'S PROOF...

that Grantham students prepare for F.C.C. examinations in a minimum of time. Here is a list of a few of our recent graduates, the class of license they got, and how long it took them:

Name	Address	License	Weeks
Richard M. Witholt	2104 Santa Paula, Las Vegas, Nev.	1st	12
Larry B. Perrine	7 Normandy Place, Champaign, Ill.	1st	15
Marlon Woolsey	3246 Warwick, Kansas City, Mo.	1st	12
Harold W. Johnson	5070 Hermosa Ave., Los Angeles, Calif.	1st	15
Ralph Frederick Beisner	2126 Grand, Joplin, Mo.	1st	12
N. B. Mills, II	110 So. Race St., Statesville, N. C.	1st	12
Dean A. Darlino	403 S. Chase Ave., Columbus 4, Ohio	1st	12
Gerald L. Chopp	518 Audubon Road, Kohler, Wisc.	1st	12

**FOUR COMPLETE SCHOOLS:** To better serve our many students throughout the entire country, Grantham School of Electronics maintains four complete Divisions—located in Hollywood, Calif., Seattle, Wash., Kansas City, Mo., and Washington, D.C. All Divisions of Grantham School of Electronics offer the same rapid courses in F.C.C. license preparation, either by home study or in resident classes.

Get your First Class Commercial F.C.C. License in 12 weeks by training at

# Grantham School OF ELECTRONICS

for **FREE** Booklet **CLIP COUPON** and mail in envelope or paste on postal card.

**HOLLYWOOD  
CALIF.**

1505 N. Western Ave.  
Hollywood 27, Calif.  
(Phone: HO 7-7277)

**SEATTLE  
WASH.**

408 Marion Street  
Seattle 4, Wash.  
(Phone: MA 2-7227)

**KANSAS CITY  
MO.**

3123 Gillham Road  
Kansas City 9, Mo.  
(Phone: JE 1-6320)

**WASHINGTON  
D. C.**

821-19th Street, N.W.  
Washington 6, D. C.  
(Phone: ST 3-5614)



**TO: GRANTHAM SCHOOL OF ELECTRONICS**

1505 N. Western Hollywood • 408 Marion Seattle • 3123 Gillham Rd. Kansas City • 821-19th, N.W. Washington

Please send me your free booklet telling how I can get my commercial F.C.C. license quickly. I understand there is no obligation and no salesman will call.

Name \_\_\_\_\_ Age \_\_\_\_\_

Address \_\_\_\_\_

City \_\_\_\_\_ State \_\_\_\_\_

I am interested in:  Home Study,  Resident Classes **08-C**

MAIL COUPON NOW

ON LAND IN THE AIR and ON THE SEA.

**BIG MONEY!**

awaiting  
**TRAINED  
TECHNICIANS**  
in  
**TELEVISION-RADIO  
ELECTRONICS-RADAR**

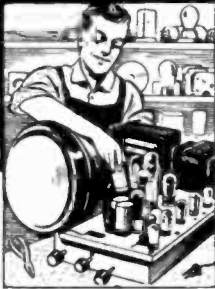

**EARN AS YOU  
LEARN!**

Get CHRISTY's Complete Course. Why be satisfied with less? CTS Shop Method, Home Training makes learning easy. You receive Comprehensive training from the start. **EARN AS YOU LEARN!** You become qualified to open your own Electronics Repair business or to gain high pay as a TV, Radio, Electronics Technician.

**19 TRAINING KITS INCLUDED!**  
Multi-Tester, Oscillator, Signal Tracer, Oscilloscope, Signal Generator, Electronic Timer, Regenerative Radio, 24" TV set (Optional) and other valuable equipment sent. Send today for **3 FREE BOOKS**. No obligation.



**CHRISTY TRADES SCHOOL, Dept. T-713,  
3214 W. Lawrence Ave., Chicago 25**  
Send me 3 Free Books and Special Form for **PAYING LATER** from **EARNINGS MADE WHILE LEARNING.**

NAME \_\_\_\_\_ Age \_\_\_\_\_  
ADDRESS \_\_\_\_\_  
CITY \_\_\_\_\_ Zone \_\_\_\_\_ STATE \_\_\_\_\_



**\* FREE**

Fill in coupon for a **FREE** One Year Subscription to **OLSON RADIO'S Fantastic Bargain Packed Catalog** — Unheard of **LOW, LOW, WHOLESAL** PRICES on Brand Name Speakers, Changers, Tubes, Tools, Hi-Fi's, Stereo Amps, Tuners, and other Bargains.

NAME \_\_\_\_\_  
ADDRESS \_\_\_\_\_  
CITY \_\_\_\_\_ ZONE \_\_\_\_\_ STATE \_\_\_\_\_

If you have a friend interested in electronics send his name and address for a **FREE** subscription also.

**OLSON RADIO  
CORPORATION**  
405 Forge Street Akron 8, Ohio

... News

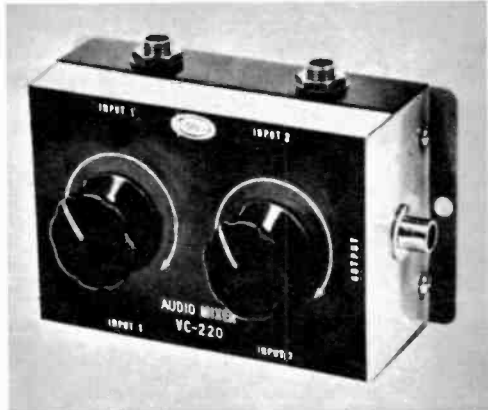

A dual audio mixer, model VC-220 has been introduced by Olson Radio. It can be used to control any two audio sources separately from one output. 260 S. Forge St., Akron, Ohio. \$3.00.

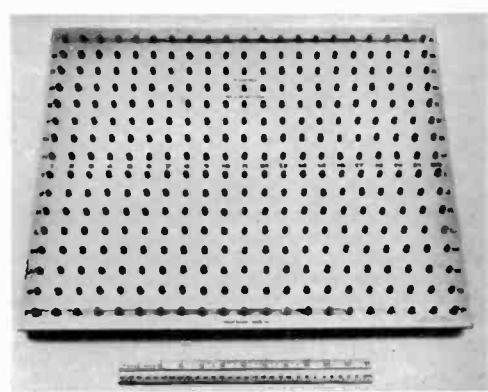

A jumbo sized circuit board, model 24, containing 352 separate connectors, has been offered by Plastic Associates. 185 Mountain Road, Laguna Beach, Calif.

Shortwave listeners . . . pay close attention to your rig on February 14th at 8:10 pm EST. The Moscow radio, on that day, will launch a series of Russian-language lessons for beginners in North America. If you miss it, the broadcast will be repeated on Tuesday and Friday. Following lessons will be transmitted every Sunday until the end of June.

# Train in New Coyne Shop-Labs for Today's Top OPPORTUNITY FIELDS!

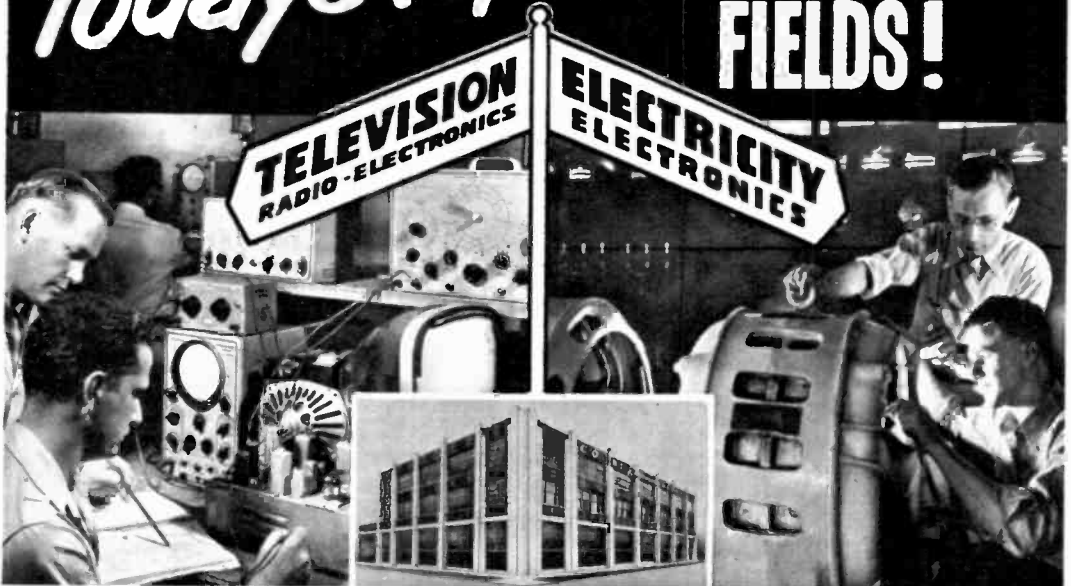

Instructor helping students check the wiring and trace the circuits of television receivers.

This modern fire-proof building which is occupied entirely by Coyne, houses the NEW COYNE SHOP-LABS.

Instructor explaining operation and testing of a large Motor Generator.

## TELEVISION-RADIO ELECTRONICS

Here at COYNE you're trained for Testing, Trouble-Shooting and Servicing on AM and FM Radio, Auto Radio, Television, Color TV, etc. Thousands of COYNE trained men in good jobs or own well paying TV-Radio businesses.

## ELECTRICITY ELECTRONICS

Big opportunities everywhere—city, town and country, in Power Plant Work, Motors, Industrial Electronics, Armature Winding, Home and Factory Wiring, Appliances, Refrigeration, Maintenance, Illumination, etc.

**OLDEST AND BEST  
EQUIPPED SCHOOL OF ITS  
KIND IN THE U. S.**

Send Coupon or Write for

## FREE BOOK

### "GUIDE TO CAREERS"

Whether you prefer Electricity—Television—Radio or Combined Electronics Training this book describes all training offered.

Information comes by mail and no salesman will call.



## WE TRAIN YOU IN CHICAGO

Our famous Practical-Technical method gives you practical experience on a massive outlay of equipment—over a quarter of a million dollars worth—plus necessary technical training right here in the *NEW COYNE Shop-Labs*.

*Training in Refrigeration and Electric Appliances can be included.*

**Training offered  
to VETERANS and  
NON-VETS alike**

### START NOW—PAY LATER

Enroll now, pay most of tuition after Graduation. Part time employment help for students. Lifetime employment service to Graduates. Starting dates, every six weeks.

B. W. COOKE, JR., President

**COYNE  
ELECTRICAL SCHOOL**

FOUNDED 1899

CHARTERED AS AN EDUCATIONAL INSTITUTION NOT FOR PROFIT  
1501 W. Congress Parkway, CHICAGO, Dept. 30-8C  
ELECTRICITY • RADIO • TELEVISION • REFRIGERATION • ELECTRONICS

To get Free Book and information, mail this Coupon in envelope or Paste on Postal Card, or write to address below

COYNE ELECTRICAL SCHOOL, Dept. 30-8C  
1501 W. Congress Pkwy., Chicago 7, Ill.

At no obligation to me send FREE book "Guide to Careers" and details of all the training you offer. However, I am especially interested in:

ELECTRICITY  TELEVISION  BOTH FIELDS

Name \_\_\_\_\_

Address \_\_\_\_\_

City \_\_\_\_\_ State \_\_\_\_\_

(I understand no Salesman will call.)



Seco Manufacturing Company recently introduced a self-power transistor checker priced at \$19.95. Checker tests for "opens," shorts and gain, etc. and identifies PNP and NPN models. Detailed specifications on model 100 are available from the manufacturer at 5015 Penn Ave. S., Minneapolis, Minnesota.

A new tap-proof phone cable has been perfected by Mosler Research Products. If an attempt is made to connect into the cable, an alarm is sounded, unbeknown to the potential wire tapper. The communications circuits are covered by successive layers of foil sheathed in plastic and connected to a highly sensitive relay apparatus which responds to changes in electrical current as low as two-one millionths of an ampere. Mosler says that the alarm is so sensitive, even the insertion of a pin will cause it to sound, and contends that an induction tap is impossible. Further information is available from Mosler, 320 Fifth Avenue, New York, New York.

Baseball managers watch out! An IBM computer is being taught how to play ball! It can decide whether a sacrifice, walk or steal should take place. R. E. Trueman of the University of California presented this news to the Operations Research Society of America.



Build the Best Portable... **EICO**

**6-TRANSISTOR RADIO RA-6**

Kit \$29.95      Wired \$49.95

INCLUDED P. E. T., LESS BY BATTERY

Easy creative fun to build... a lifetime of big-set entertainment wherever you go... designed so that even the novice can build it & obtain a handsome professional assembly & outstanding performance. American-made modern super-heterodyne all-transistor circuitry, plus finest quality parts throughout, assure you of highest durability & stability.

- high sensitivity & selectivity
- big-set volume & tone quality with 4" x 6" PM speaker & 250 mw push-pull audio output stage
- built-in Ferrite rod antenna for good reception in any location
- pre-aligned RF & IF transformers
- planetary vernier tuning (7:1 reduction) for easy station selection & tuning
- high-impedance earphone jack for private listening; eliminates drain of output stage when using earphone
- attractive tan leatherette case, retractable handle
- compact: 8 1/2" w, 4 1/2" h, 2 1/2" d. Only 3 lbs.

Build the BEST BUYS in "HAM" gear...



\* U.S. Pat. No. D-184,778

**90-WATT CW TRANSMITTER #720**  
 Kit \$79.95      Wired \$119.95  
 "Ideal for veteran or novice" — **ELECTRONIC KITS GUIDE**. "Top quality" — **POPULAR ELECTRONICS**. "Well designed" — **ELECTRONICS WORLD**. 80 thru 10 meters with one-knob band-switching. Full "clean" 90W input, 65W external plate mod. Matches loads 50 to 1000 ohms. May be used as basic exciter unit. TVI shielded. Tubes: 6146, 6CL6, 2-6AQ5, 6Z34. Attractive "living room" low-silhouette design. 15" w, 5" h, 9" d.

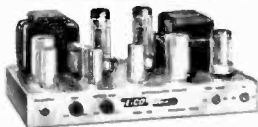

**UNIVERSAL MODULATOR-DRIVER #730**  
 Kit \$49.95      Wired \$79.95  
 Cover E-5 \$4.50

Delivers 50W undistorted audio. Modulates transmitters having r.f. inputs up to 100W. Unique over-modulation indicator. Output transformer matches 500-10,000 ohms. Low-level speech clipping & filtering. Inputs for xtal or dynamic mikes, phone patch, etc. 7 tubes. 8" h, 14" w, 8" d.



**GRID DIP METER #710**  
 Kit \$29.95      Wired \$49.95  
 Includes complete set of coils for full band coverage. 400 kc-230 mc in 8 overlapping ranges. 500 ua meter. Plug-in coils are pre-wound, pre-calibrated to 0.5% accuracy. Transformer-operated power supply. 2 1/4" h, 2 1/2" w, 6 1/2" l.

Compare — judge for yourself — at your neighborhood EICO distributor. For free catalog on 65 models of EICO test instruments, hi-fi & "ham" gear, fill out coupon on Page 28. Add 5% in the West.

**ELECTRONIC INSTRUMENT CO., Inc., 33-00 N. Blvd., L. I. C. 1, N. Y.**



**WE'RE MAKING IT EASIER THAN EVER TO BECOME A WELL PAID  
RADIO-TELEVISION SERVICE TECHNICIAN**

**NOW - Just \$6 Starts You Training in  
RADIO-TELEVISION  
the SPRAYBERRY "Learn-by-Doing" Way . . .**

**25 BIG, COMPLETE KITS  
of PARTS & EQUIPMENT**

To help you learn *fast* the practical side of Radio-Television, we send you expertly engineered training kits to test and assemble for interesting, valuable shop-bench practice!

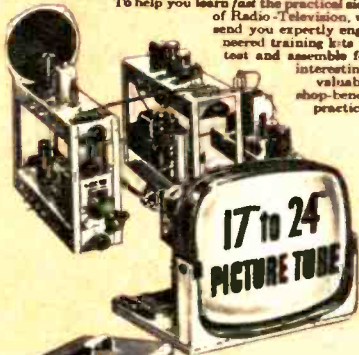

• The new Sprayberry Training Television Receiver, built and tested in 5 sections.

• Now offered . . . this fine modern oscilloscope.

• You build this powerful two-band superheterodyne radio receiver.

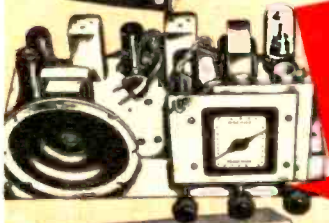

**Big New  
CATALOG  
AND  
Sample Lesson  
FREE!**



You build the new Sprayberry Tester—a complete 18-page Volt-Ohm-Milliammeter test meter.

★ ★ ★ This great industry is begging for trained men . . . to step into good paying jobs or a profitable business of their own! Our new plan opens the doors of Radio-Television wide to every ambitious man who is ready to act at once!

Men by the thousands . . . trained Radio-Television Service Technicians . . . are needed at once! Perhaps you've thought about entering this interesting, top paying field, but lack of ready money held you back. Now—just \$6 enrolls you for America's finest, most up to date home study training in Radio-Television! Unbelievable? No, the explanation is simple! We believe Radio-Television *must* have the additional men it needs as quickly as possible. We are willing to do our part by making Sprayberry Training available for less money down and on easier terms than ever before. This is your big opportunity to get the training you need . . . to step into a fine job or your own Radio-Television Service Business.

**Complete Facts Free—Act Now; Offer Limited**

Only a limited number of students may be accepted on this liberal and unusual basis. We urge you to act at once . . . mail the coupon below and get complete details plus our big new catalog and an actual sample lesson—all free. No obligation . . . no salesman will bother you.

**HOME STUDY TRAINING IN SPARE TIME**

Under world-famous 27-year old Sprayberry Plan, you learn entirely at home in spare time. You keep on with your present job and income. You train as fast or as slowly as you wish. You get valuable kits of parts and equipment for priceless shop-bench practice. And everything you receive, lessons and equipment alike, is all yours to keep.

**LET US PROVE HOW EASILY YOU CAN LEARN!**

Radio-Television needs YOU! And Sprayberry is ready to train you on better, easier terms, than any ambitious man can afford. Just \$6 starts you! Mail coupon today . . . let the facts speak for themselves. You have everything to gain. Let us prove the kind of opportunity in store for you!

**SPRAYBERRY Academy of Radio-Television**  
1512 Jarvis Avenue, Dept. 120-M, Chicago 26, Illinois

**Mail This Coupon Now—No Salesman Will Call**

**Sprayberry Academy of Radio-Television**  
Dept. 120-M, 1512 W. Jarvis Ave., Chicago 26, Ill.  
Please rush all information on your ALL-NEW Radio-Television Training Plan. I understand this does not obligate me and that no salesman will call upon me. Include New Catalog and Sample Lesson FREE.

NAME..... Age.....  
ADDRESS.....  
CITY..... ZONE..... STATE.....



the experts say  
**your BEST BUY**  
 is **EICO**...

EICO, 33-00 Northern Blvd., L. I. C. 1, N. Y. E1-3  
 Show me HOW TO SAVE 50% on 65 models of top-quality:

HI-FI  TEST INSTRUMENTS  "HAM" GEAR  
 Send FREE catalog & name of neighborhood EICO dealer.  Send free STEREO HI-FI Guide.

NAME.....  
 ADDRESS.....  
 CITY..... ZONE..... STATE.....

ADD 5% IN THE WEST

...in  
**STEREO and MONO HI-FI**



STEREO Dual Amplifier-Preamp HF81  
 Kit \$69.95.  
 Wired \$109.95.  
 "Excellent" — SATURDAY REVIEW: HI-FI MUSIC AT HOME.



Mono Preamp HF65A:  
 Kit \$29.95. Wired \$44.95.  
 With Power Supply HF65:  
 Kit \$33.95. Wired \$49.95.



FM Tuner HFT90  
 Kit \$39.95\*.  
 Wired \$45.95\*.  
 Cover \$3.95.  
 "One of the best buys" — AUDIOCRAFT.  
 AM Tuner HFT94  
 Kit \$39.95. Wired \$45.95.  
 incl. Cover & F.E.T.  
 FM/AM Tuner HFT92  
 Kit \$58.95. Wired \$94.95.  
 Includes Cover & F.E.T.



STEREO Dual Preamp HF85  
 Kit \$39.95.  
 Wired \$64.95.  
 "Extreme flexibility" — HI-FI REVIEW  
 a bargain!



Mono Power Amplifiers (60, 50, 35, 30, 22, 14-Watt; use 2 for Stereo) from Kit \$23.50. Wired \$41.50.



2-Way Bookshelf Speaker System HFS1 complete with factory-built cabinet: \$39.95.



70W STEREO Dual Power Amplifier HF87  
 Kit \$74.95. Wired \$114.95.



Mono Integrated Amplifiers (50, 30, 20, 12-Watt; use 2 for Stereo) from Kit \$34.95. Wired \$57.95.



NEW! COMPLETE STEREO DUAL AMPLIFIER AF-4  
 Kit \$38.95.  
 Wired \$64.95.  
 TRUE HI-FI quality to drive hi efficiency speakers to concert volume.

...and in  
**TEST INSTRUMENTS**



New Power & Bias Supply for Transistorized Eqp. #1020  
 Kit \$19.95.  
 Wired \$27.95.  
 \* Patent Pending



Miniaturized Multi-Signal Tracer #145A  
 Kit \$19.95.  
 Wired \$28.95.



Vacuum Tube Voltmeter #221  
 Kit \$25.95.  
 Wired \$39.95.



Peak-to-Peak VTVM #232 & Uni-Probe (pat. pend.)  
 Kit \$29.95.  
 Wired \$49.95.



New TUBE & CRT FIL. Tester #612  
 Kit \$3.95.  
 Wired \$5.95.  
 Fast-checks radio/TV tubes, pilot lamps, etc.



1000 Ohms/Volt V-O-M. #536  
 Kit \$12.90.  
 Wired \$14.90.



5" Push-Pull Scope #425  
 Kit \$44.95.  
 Wired \$79.95.



DC-5 MC 5" Scope #460  
 Kit \$79.95.  
 Wired \$129.50.

Tube Tester #625  
 Kit \$34.95.  
 Wired \$49.95.



RF Signal Generator #324  
 Kit \$26.95.  
 Wired \$39.95.



Series/Parallel R-C Combination Box #1140  
 Kit \$13.95. Wired \$19.95.  
 1350 Combinations!



6V & 12V Battery Eliminator & Charger #1050  
 Kit \$29.95. Wired \$38.95.  
 Extra-filtered for transistor equip. #1060  
 Kit \$38.95. Wired \$47.95.



R-C Bridge & R-C-L Comparator #950B  
 Kit \$19.95.  
 Wired \$29.95.

IN STOCK! Compare, take them home — right "off the shelf" — from 2000 neighborhood dealers. Over 1 MILLION EICO instruments in use throughout the world.

© 1960, ELECTRONIC INSTRUMENT CO., INC., 33-00 N. BLVD., L. I. C. 1, N. Y.

◀ See Page 26. for EICO's BEST BUYS in "HAM" GEAR and TRANSISTOR RADIOS.

# What's New for Stereo

By Joseph Marshall

**A high fidelity expert talks candidly about the more striking developments in stereo reproduction.**

**T**HE big news in stereo is that this year you can have it with the bugs taken out. After two years of experimentation and improvisation the industry has made the jump to products that generally make good on the promises made for stereo.

To begin with, stereo records themselves have caught up with monophonic LP's in overall quality. In addition, stereo tape is making a big comeback. With four tracks on the regular  $\frac{1}{4}$ -inch





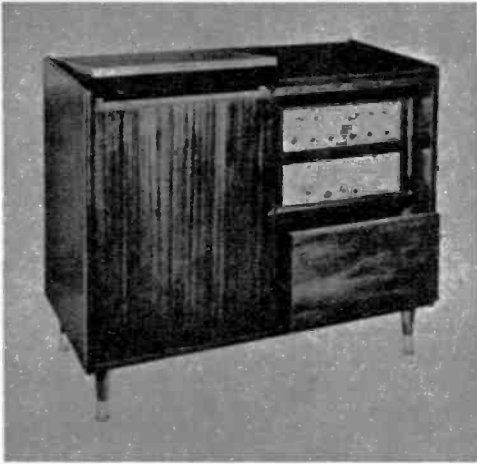

All-in-one equipment cabinet (above), made by Rockford, allows mounting of almost all components in one package. Model without speaker space sells for \$109.50. New Stromberg-Carlson FM tuner (top right), has space for multiplex adapter and auxiliary power for adapter or AM tuner. At right is the new Dynakit "Stereo 70" power amplifier. Note the oversize components and printed board in center of the chassis.

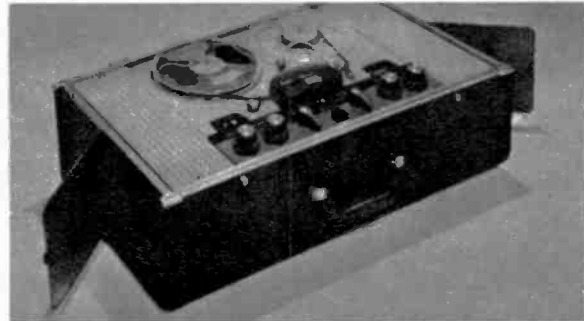
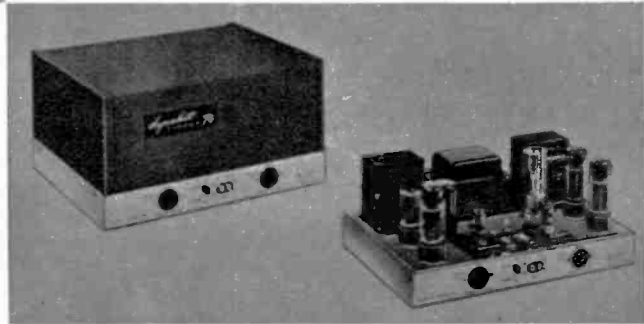
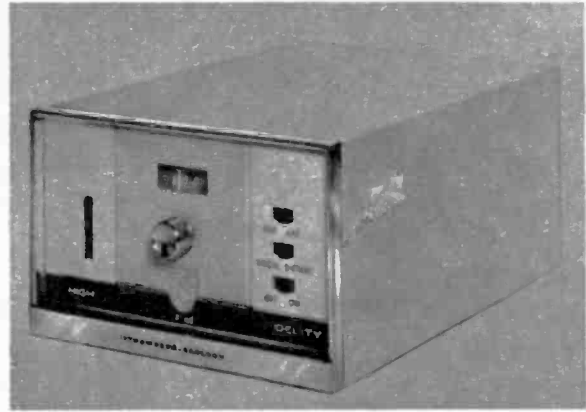

Left, new Channel Master 4-speed turntable. Ampex portable, above, has stereo speakers built into the recorder itself.

tape, instead of the former two, stereo tape now offers as much or more playing time on a reel than a 12-inch stereo disc, and at a price close to that of the disc.

You can have 4-track stereo tape in two forms. The standard reels run at  $7\frac{1}{2}$  inches per second and can be played

on any tape player or recorder equipped with a 4-track head. On the best machines they will deliver the finest stereo sound so far attained. You can also get tape in special magazines which run at  $3\frac{3}{4}$  ips. While the fidelity is not quite up to the  $7\frac{1}{2}$  ips type, these magazines



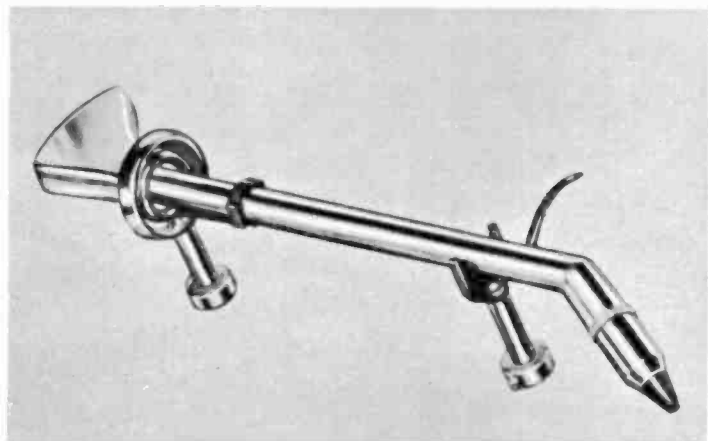

Above is the Dynaco B&O Stereodyne II described in text. The needle shaft is supported in a very compliant bearing. At right is the Audio-Empire 98 arm. This stereo arm utilizes a single calibrated knob for vertical stylus force adjustment. Top right, the new, lower priced Fairchild cartridge. It operates on improved moving magnet principle, adapted for stereo.

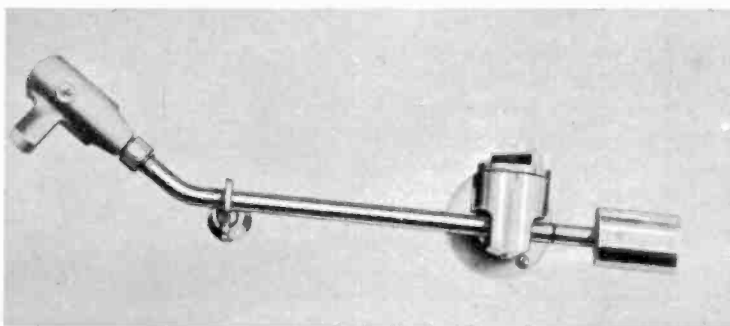

Transistorized high fidelity gear is coming into its own. Above is the handsome stereo preamp by Nobles, with channel meters. Right, rocket scientist Willy Ley tunes Transi-Tronics' power amplifier.



are simpler to use than disc records. But they can only be played in special players such as the Bell and RCA cartridge machines.

Pick-ups have heretofore been the big bottleneck in stereo, but there are now several that approach or equal the

best previous monophonic pick-ups. The .7 mil stereo needle ought to track at 3 grams or less to keep record wear down to the level of a 1 mil monophonic needle tracking at 6 grams. To track at this low pressure it has to have much higher compliance (be easier to move). But the

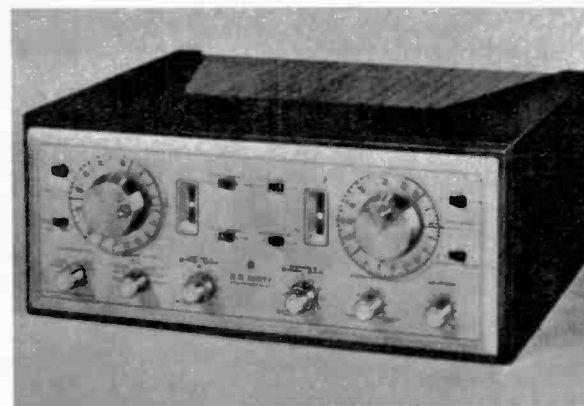
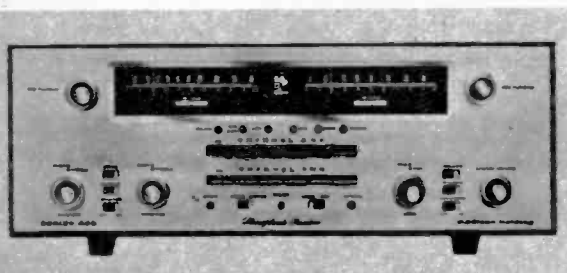
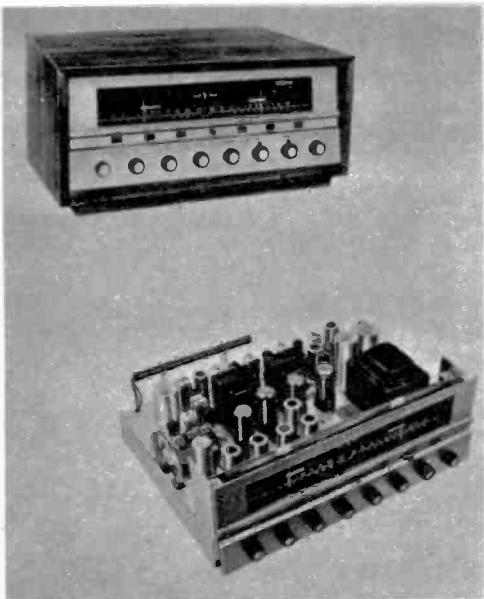

There are now many combination AM-FM tuners, stereo preamps and amplifiers (all on one chassis) on the market. Pictured clockwise from upper left are: Harmon-Kardon TA230; the Fisher model 600; Sargent-Raymont; the H. H. Scott Stereomaster; and finally, directly above, the Madison Fielding entry. Each has a multitude of channel and function controls easily accessible. These are fairly large components.

compliance depends on how much mass the needle has to move. To improve compliance you have to reduce the movable mass. How can you do this when you have two simultaneous movements, instead of just one?

In the Dynaco B & O cartridge the needle shaft is attached to an extremely small, light metal cross. The four flat "arms" of this cross are spaced from the ends of four corresponding coils and magnetic cores. Movement of the needle in the groove varies the gap between the arms and the cores. The four coils are

arranged in push-pull pairs—one pair for each channel—to reduce distortion and cancel hum. The needle shaft is supported by and pivots in a flexible bearing made of very compliant "elastomer."

In the "moving magnet" type of pick-up, pioneered by Shure, the problem of compliance is far simpler than in the moving coil or variable reluctance types. Here a single magnet can be arranged to energize a pair of coils in a stereo pick-up as readily as the single coil of a monophonic one. Therefore,

[Continued on page 112]

Photo courtesy  
Times Facsimile Corp.

U.S. Army photo



These photos show fax in action. Above, radio operator aboard Danish ship *Laust Maersk* watches sea condition chart being printed out on fax reproducer. Receiver is tuned to 3143 kc for fax station GFA25, Dunstable, England. Left, Polaroid picture of battle scene is slipped into Army's new portable fax scanner which transmits it to headquarters via jeep radio.

# All About FAX

By Kerry Matthews

**Little known but much used, facsimile has proved a reliable electronic workhorse in many fields.**

**F**AX" is the nickname for facsimile, one of the cleverest and most useful communications devices we have around—and perhaps the least known. With fax, almost any graphic data can be transmitted from one place to another by radio or wire. Today you, me or anybody can walk into a Western Union office in one of several cities and have a letter, sketch, handwritten copy or what-have-you transmitted from coast to coast in a matter of minutes.

Western Union isn't the only one using fax, although they have been doing so in one way or another for about 30 years. The armed services use fax in applications ranging from sending weather

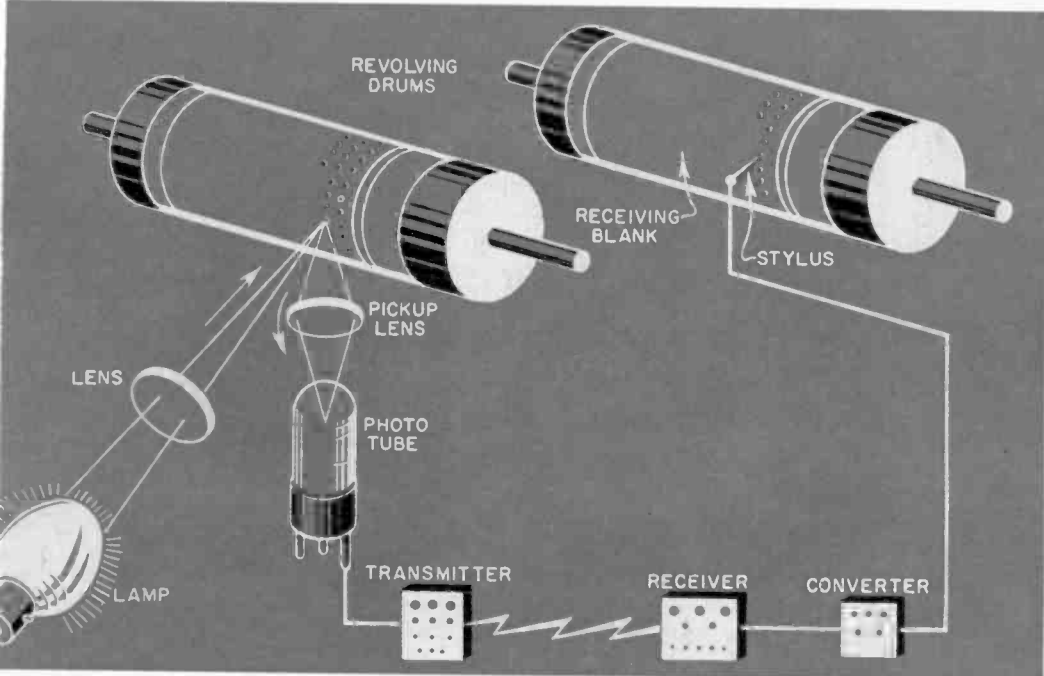
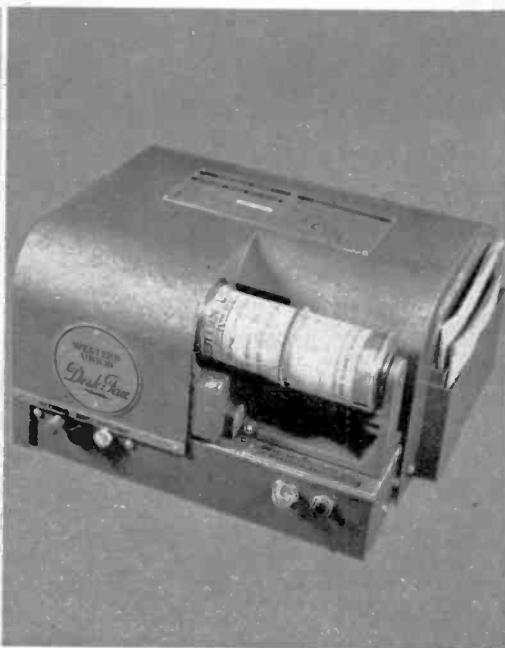

Diagram shows basic operation of facsimile. Transmission of the image may be by wire or radio. Stylus at right moves across chemically treated paper.



Western Union's coast-to-coast facsimile service is now available to all. Operator sets up letter on scanning unit while incoming fax copy arrives in basket of companion machine.



Desk-Fax is a small unit available to business offices. It is linked with local office and transmits telegrams immediately, eliminating messenger pickup delays and telephone errors.



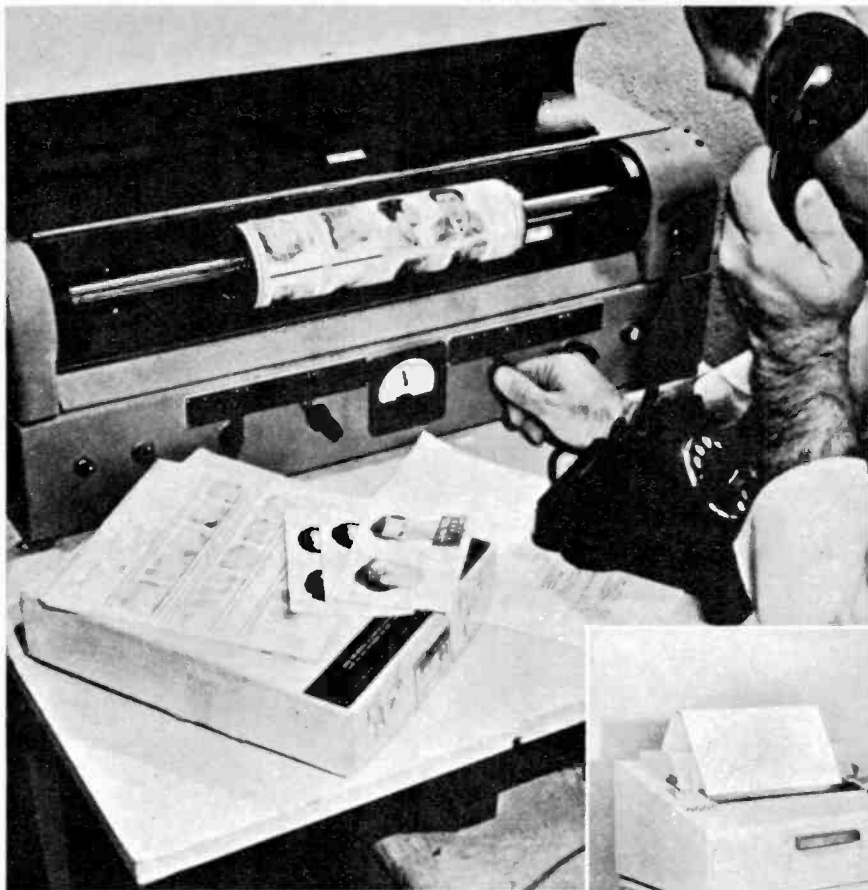

Texas Ranger at Department of Public Safety in Austin, gets set to send suspect's "mug" photos, fingerprints and records across the country via fax. At right, large weather map, complete with isobars, etc., is recorded on Times Facsimile Corp. gear.



maps to ships at sea, to transmitting combat photos back to headquarters. The radio amateurs also have frequencies set aside which they may use for fax transmission. A commercial FM station in New York has even used the FM multiplex subcarrier for the transmission of fax while listeners throughout the city continued to hear high fidelity music on their FM radios and tuners.

Fax works on a fairly simple principle. An electric eye is permitted to view a photo or other printed matter a small area at a time in a planned order until the entire copy is "scanned." The photocell transforms the densities of light into variations of electrical current. The currents are then transmitted via radio or cable to a receiving station, or "recorder," where they are put back

into their original form by a stylus writing on a sheet of electrically sensitive paper. These marks on the piece of paper produce an exact copy, or facsimile, of the original material.

This whole process is very similar to the workings of the human eye. When you read this magazine page your eye does not take in the entire page at once. Your field of vision is limited and you must "scan" line by line until the entire page has been read. Naturally, if the page were to be moved back and forth across your field of vision, your eye could remain stationary. The page could also be placed on a revolving drum so that your gaze would simply shift down to a new line after every complete revolution.

[Continued on page 106]

*the E.I.*

# Build-it Course-7

The start of a new project—building a 2-way Citizens radio. First "module" is the converter.



Completed unit, with its three operating controls on the front panel. A crystal microphone is plugged into the "Mic." jack at the lower right.

Top view, cover removed, shows finger pointing to converter (A). Modules to be described later are; (B) RF osc.-amplifier, (C) modulator, (D) power supply. Lower right, underside view of receiving converter. L4 is at center.

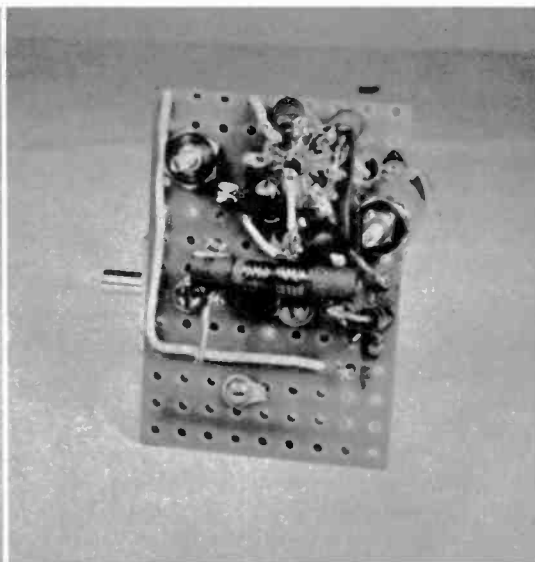
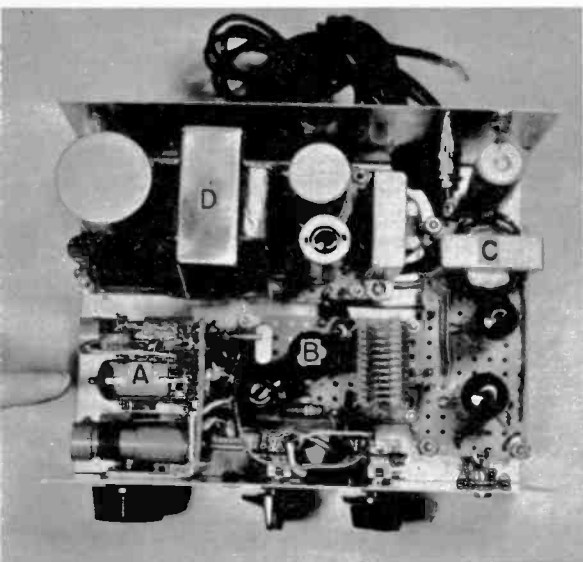

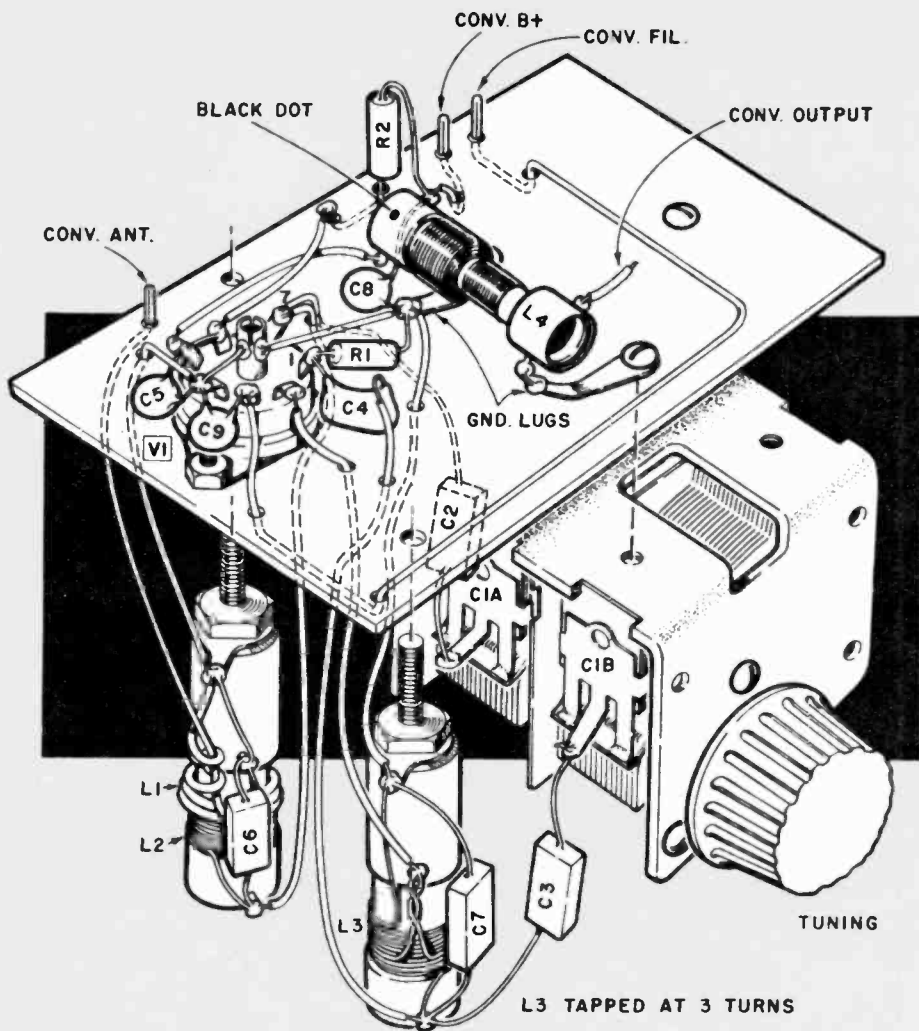

Tuning capacitor and coil forms have been displaced for clarity in the wiring guide. Consult photos for exact physical location of the components.

**T**HIS article commences a four-part series on a Citizens Band rig. In keeping with the former projects described here, the construction information will be coupled with the theory governing the operation of the various components.

If a license for this band has not been acquired, it would be a good idea to apply for one at the earliest date since the rig cannot be legally operated without it. It is available to U.S. citizens over 18 years of age, with about a six-week wait after the application has been filed. Detailed information on the license is secured by writing to U.S. Government Printing Office, Washington 25, D. C. Request information on Part 19 of the FCC's rules and regulations.

The unit employs modular type construction with one module to be described per article. The first is the receiving converter. A converter, rather than a complete receiver, was chosen for two reasons; to keep costs down, and to achieve the simplest circuitry

## HOW THE CONVERTER WORKS

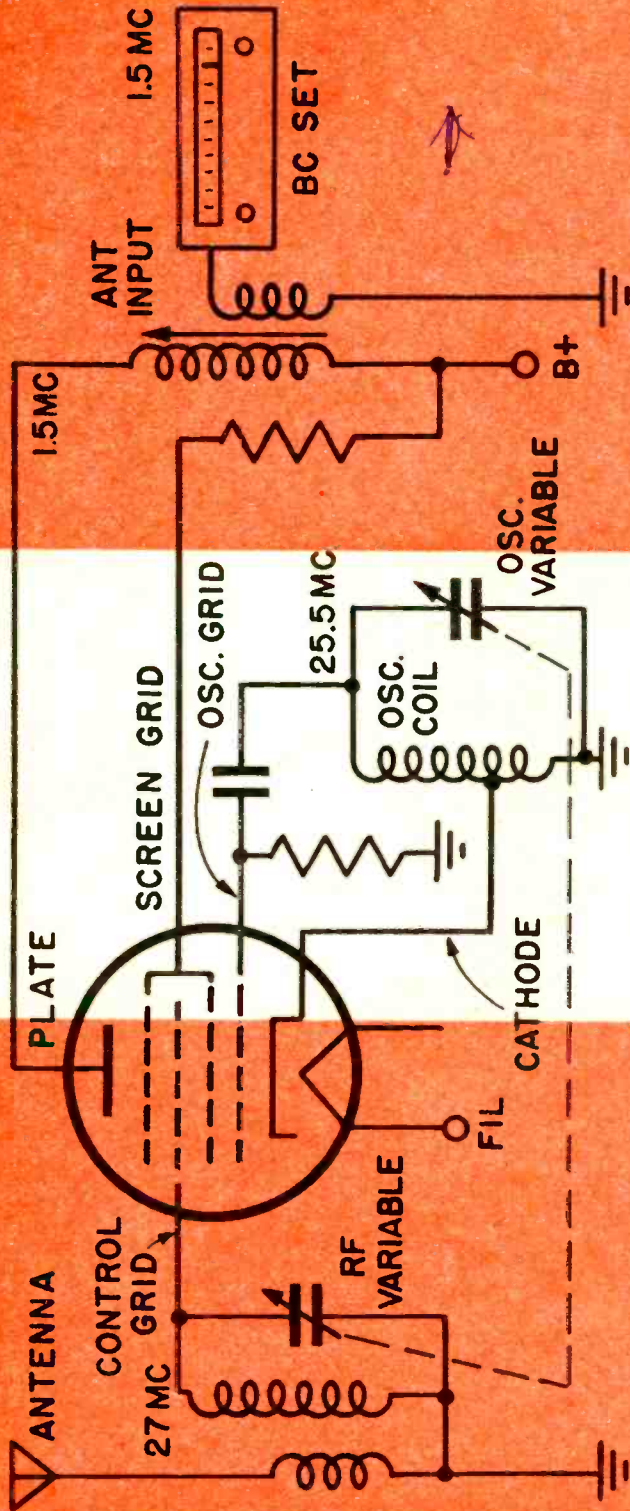

Signals in the 27 megacycle Citizens Band are intercepted by the antenna and travel to the primary winding of the antenna coil. They couple to the winding in the antenna tuning circuit. RF variable capacitor resonates with secondary of the coil, selects the desired station, rejects others. Signal voltage appears on the tube's control grid. Its fluctuations control the flow of electrons emitted from the cathode. Thus, amplification is obtained: tiny grid voltages vary the large current flow from cathode to plate. The electron stream, however, is subject to the influence of other grids in the tube. Note the two part screen grid.

The oscillator is a basic Hartley type; the feedback to sustain oscillations is supplied to the cathode from the oscillator coil, tapped one-third up from the ground end. The screen grid serves as the anode similar to the action of the tube's plate. The oscillation in this section of the tube varies the electron flow, much in the same manner as the control grid above it. The net effect is a mixing of frequencies in the electron stream. The oscillator's variable capacitor (synchronized with RF variable) produces oscillator signal at 1.5 mc less than RF.

Note that 27 mc is being received by the converter, appearing at its control grid. The oscillator therefore is producing 25.5 mc. The mixture of the two is 1.5 mc appearing in the plate circuit. The plate feeds the above coil, tuned only to 1.5 mc, rejecting the other undesirable mixing products. The secondary winding acts to transform the high impedance of the primary down to the low value of the broadcast receiver's antenna input. The tuning knob (or push button) of the BC set is adjusted to 1.5 mc. The converted signal proceeds through the BC set, amplified, converted to IF frequency, detected and reproduced as an audio signal in speaker. If 1.5 mc is a station, tune to another spot.



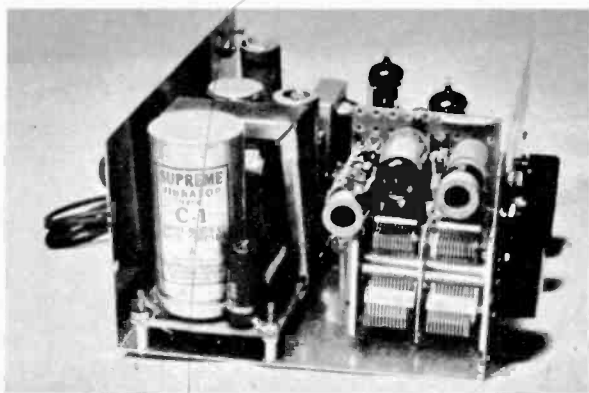

Converter in its mounted position is behind front panel at right. Power supply is to left.

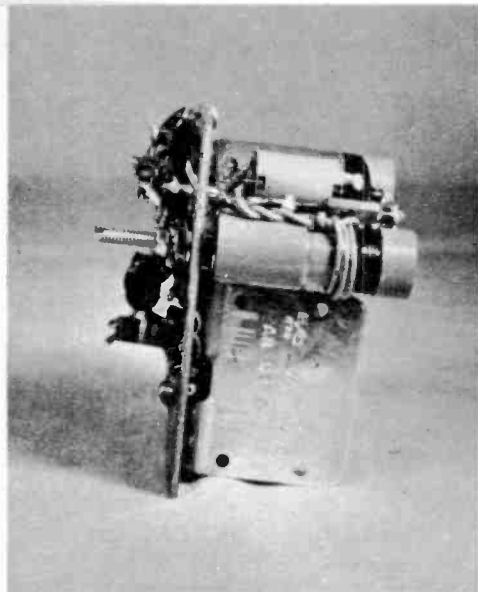

Side of converter mounted away from panel. Note L1, wound over lower end of L2 on coil.

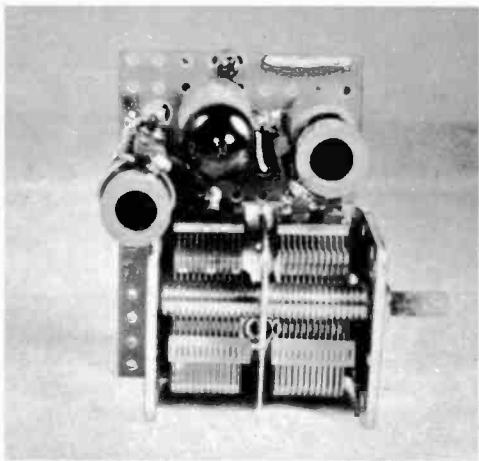

Closeup of converter. Carefully follow these mounting positions for the large components.

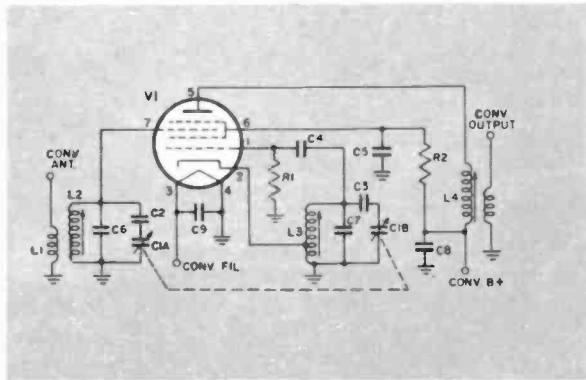

Input and output of converter are shown in schematic. They terminate as described in text.

consistent with good performance. The other modules include a modulator, RF oscillator-amplifier and power supply.

As an expedient toward making the rig as flexible as possible, three distinct power supplies are offered; 6 volt DC, 12 volt DC, and 117 volt AC. Before proceeding with construction, decide the one suited to your needs. A completed unit may be converted from one power supply to another at an expense of less than ten dollars.

Both mobile and home operation of the unit is possible. The one prerequisite is a broadcast receiver for the converter to work into. This can be a table

[Continued on page 118]

#### PARTS LIST

- C1A, C1B—Dual-section variable capacitor 365 mmfd per section (use Lafayette MS-142)
- C2, C3—5 mmfd mica capacitor 500 volt
- C4—50 mmfd mica capacitor 500 volt
- C5, C8, C9—.001 mfd ceramic capacitor 600 volt
- C6, C7—15 mmfd mica capacitor 500 volt
- R1—10,000 ohm resistor 1/2 watt
- R2—10,000 ohm resistor 1 watt
- V1—6BE6 tube
- L1—3 turns #20 plastic insulated hookup wire wound over ground end of L2
- L2—Slug-tuned antenna coil, 9 turns #20 enamel wire (National XR-50 coil form)
- L3—Slug-tuned oscillator coil, 9 turns #20 enamel wire tapped at three turns. (National XR-50 coil form)
- L4—Slug-tuned broadcast antenna coil (Meissner 14-1071)
- Misc.—Solder lugs, 7-pin tube socket with center-post, 1-inch knob. Two perforated boards 2 7/16" x 8 1/2" x 3/32" (Vector 32AA9—available at Harvey Radio, 103 W. 43rd St., New York, N. Y., at 54¢ each). Cut one piece to 2 7/8" x 3 1/4" for converter sub-assembly.

# Odd-Ball Antennas

Stranger-than-fiction, but big-as-life . . . here's a gallery of the Space Age's most unusual rigs.



No, it isn't a boxcar atop a tower. It's Raytheon's "super sentry" 104-foot long radar antenna developed for the Air Force's SAGE air defense network in Massachusetts. Range extends for hundreds of miles.

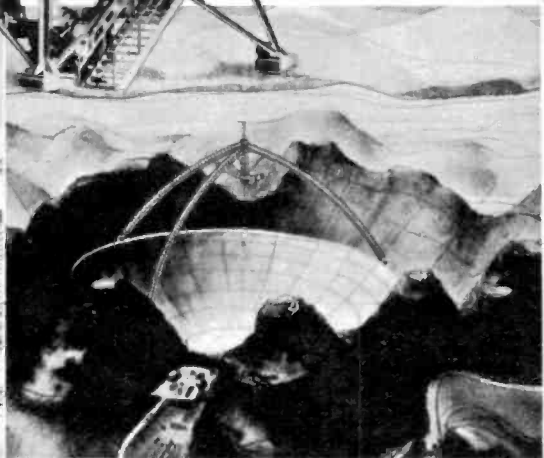

Drawing, left, shows 500' space research antenna strung between towers near Cornell U., N. Y. Reflector will cover 150,000 square feet. Dish shown nestling in hills of Puerto Rico will allow scientists to investigate underside of Jupiter, 400-million miles away. Antenna feed is supported by 600' tripod.

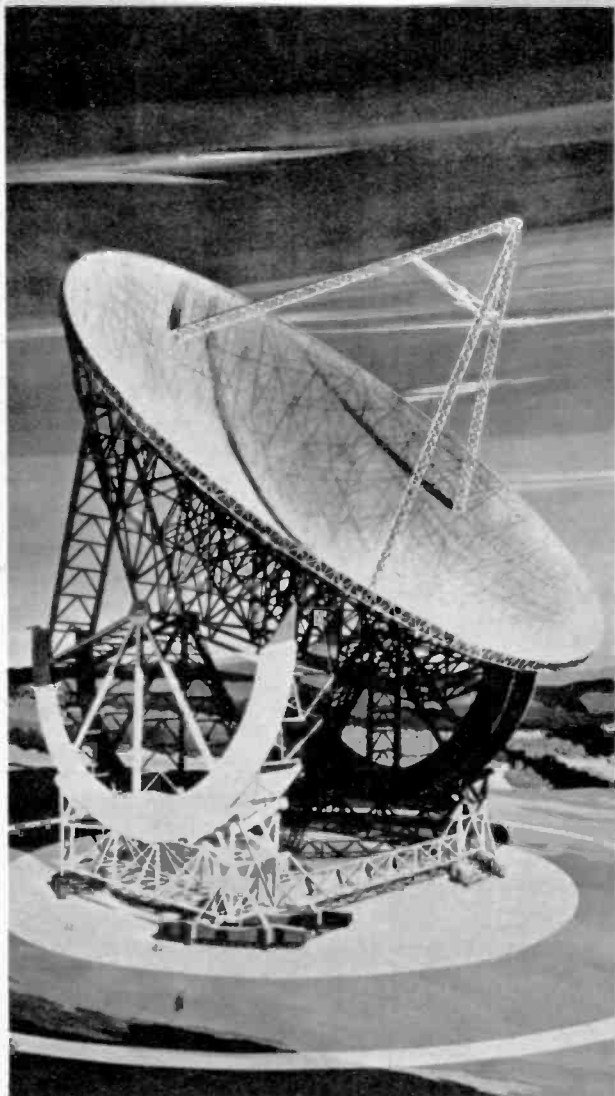

Twice as large as Britain's Jodrell Bank, the U. S. Navy's radio-telescope at Sugar Grove, W. Va., above, will have a steerable aluminum reflector 600' in diameter.



Checker-boarded to warn airplane pilots of its football field size, radar colossus at Thomasville, Ala., top right, searches for attacking enemy planes and guided missiles.

Pie-shaped antenna, center right, is designed to receive telemetered data from satellites and missiles in Palo Alto, Calif. Its mount allows movement like man's wrist.

Three-band antenna on one tower, that's GB Electronics' lightweight "end fire" array, right. For tracking and communications, it is located at Princeton, N. J.

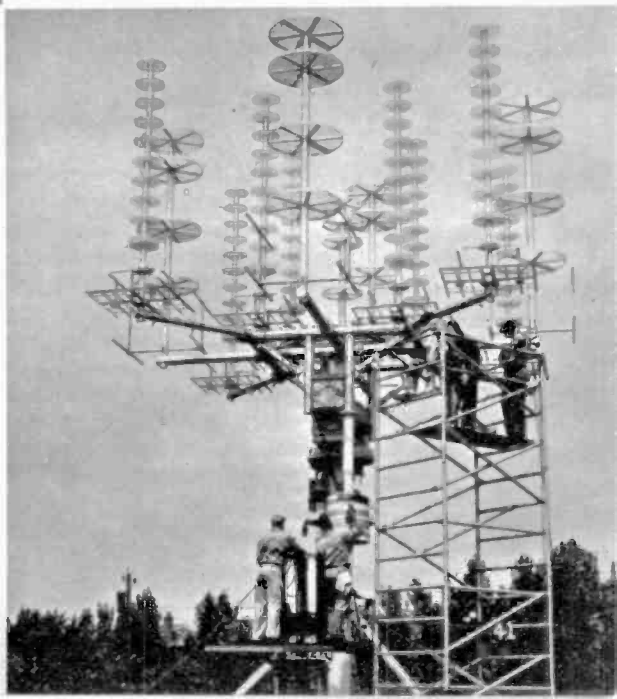

March, 1960



Coach Warren Giese, University of South Carolina football team, puts snooze time to use with Dormiphone quietly coaching him on key play combinations.

# All About Sleep-Learning

By Norman Eisenberg

**Can you learn while you sleep? Psychologists say yes. What's more, you can rig the gear yourself!**

**S**IGNAL Corps radio trainees in World War II used to make jokes about the necessity for two instructors in radio class. One teacher, they said, was for teaching; the other, to keep students awake. If the theory behind present-day "sleep-learning" had been applied, that second teacher wouldn't have bothered to stir dozing students. He simply would slip a "pillow speaker" under his head and turn on a recorded lesson.

The technique of getting a message across to a sleeping person is fairly new, yet enough evidence has been gathered to indicate that, within reasonable limits, the process does work. What's more, the mechanics are neither mysterious nor complicated. You can do-it-yourself, assuming, of course, you own a tape recorder and a few other accessories. How you will respond—whether it actually will help you memorize things, or improve your speech, or whatever—cannot be predicted. But it has helped many.



For repeating short messages, an endless tape loop may be used. A simple splice does the trick. For a pause between repeats, just give tape a half-twist before splicing. Tape will then turn over automatically again and again. Keep tape short enough to fit snugly around one reel and empty spindle. Tension is not needed since rollers press against capstan when the operating button is pushed.

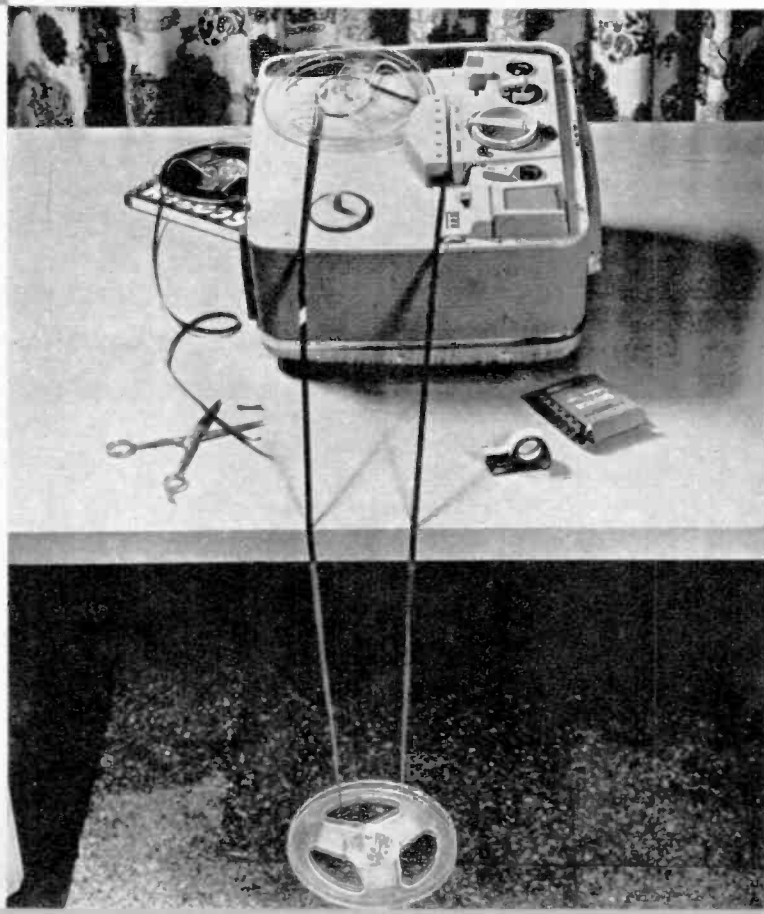
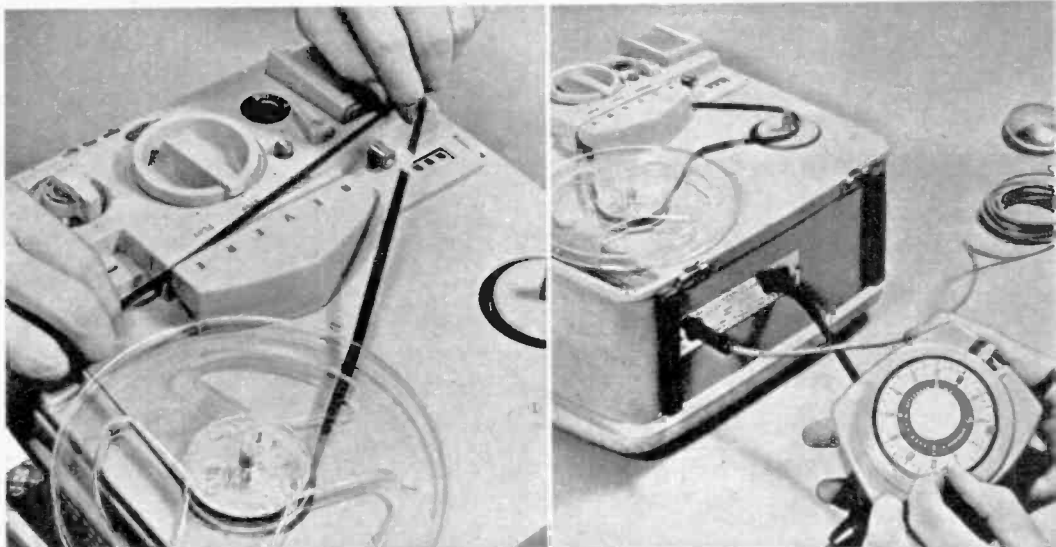

For longer message, or repeat of same message several times, a longer segment of tape is required. When draped in this way, weight of hanging reel will keep tape from snarling.

**"Electronic Educator" by SLRA includes cartridge tape recorder, automatic timer, mike, under-pillow speaker, extra tape packs and a patch cord. Entire package costs about \$205.**



**Here is close-up of Dormi-phone cartridge. It contains an endless tape on which just about anything may be recorded by the user. Best results come from planned repetition of information.**



**In an effort to master grammar and vocabulary of a foreign language for Doctor of Philosophy examination, this chap records lesson with "I'll-learn-it-or-go-down-trying" look on his face. At right, our almost horizontal friend pre-sets repetition cycle.**

Sleep-learning developed soon after World War II (a little too late for those army schools) as a result of electronic advances and a series of discoveries in educational psychology. The electronics included the modern record player (later, the tape recorder) and the flat "pillow" loudspeaker. Also, a series of experiments conducted by psychologist Dr. Charles R. Elliot with students at the University of North Carolina, showed that "... there is some retention of auditory material presented during sleep." By "sleep" Dr. Elliot meant *deep sleep*. Dr. Elliot had the benefits of two electronic devices to help him. One was an electroencephalograph which made certain subjects were indeed fast asleep. The other was a specially rigged record player, set up by Max Sherover, head of the Linguaphone Institute.

For Dr. Elliot's work, Sherover wired a clock-timer to a record player so that the latter would be turned on after the subject had fallen asleep. Messages from

the record were "whispered" to the subject via a loudspeaker imbedded in a sponge-rubber pillow.

The idea grew. Sherover went on to improve and refine his machine, and coined the phrase "dormiphonics" to describe the sleep-learning technique. The original "dormiphones" used a record player that had to be modified so that it would repeat the playing of the record instead of going into the automatic shut-off cycle that ordinary changers use. This model still is made, but four years ago a tape cartridge machine for recording and playback was marketed.

It is estimated that some 100,000 persons are making use of sleep-learning. About one out of every four machines sold goes to a doctor, often a psychiatrist. "Memory-trainers" (the name given to the tape version) and the less costly record playing models have been supplied to armed services. They have been used for speech correction, by per-

[Continued on page 111]



"Memory Trainer" by Dormiphone is complete sleep-learning package with timer built right into recorder. Cost is about \$200. There is also a monitoring speaker inside the main unit.

# Loudspeaker Substitution Box

By Don A. Smith

Build this handy test unit. It will substitute for a speaker, output transformer or field coil.

Speaker in unit is behind screen near right edge. Designations on banana jacks correspond to those in schematic. Observe plus and minus on front panel when using internal filter capacitor. Below is inside view, case removed.

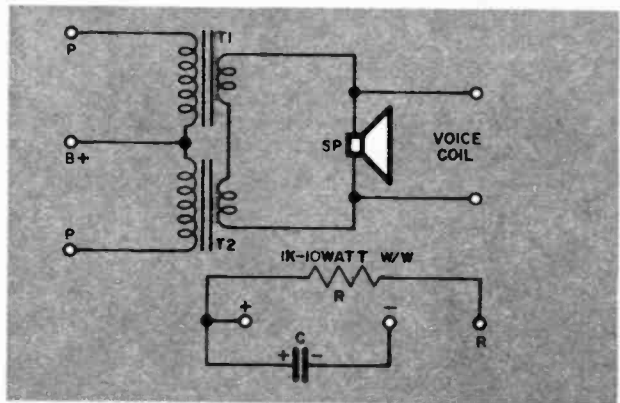
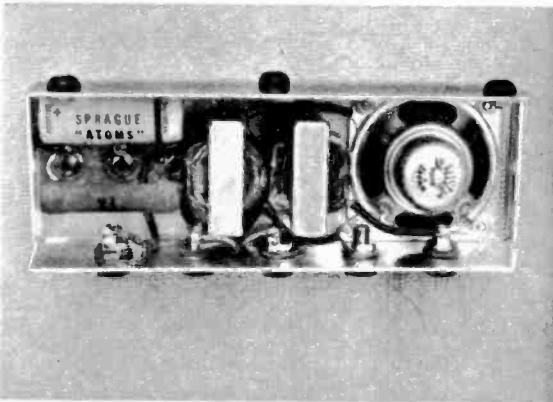
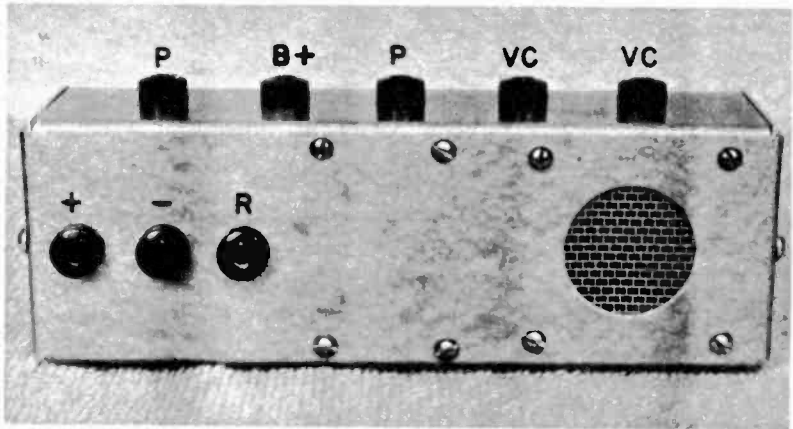

**H**ERE is a compact unit that will lend itself to a variety of jobs. By plugging into the banana jacks shown in the photos and schematic, you have a choice of a push-pull or single ended audio output transformer. This is useful for checking a doubtful unit, by substitution, in an amplifier. The [Continued on page 127]

#### PARTS LIST

R—1000 ohm resistor 10 watt wirewound  
C—10 mfd electrolytic capacitor 450 volt  
T1, T2—Output transformer (Merit A-3026 or equiv.)

SP—Speaker, 1 1/2" with 3.2 ohm voice coil  
Misc.—Case 6 1/2" x 2 1/2" x 1 1/8" (LMB # 650), 8 banana jacks, piece of screen 1 1/2" square



# how to Check Out Your Kit

By Norman Eisenberg

Protect the time and money invested in your new kit by following the simple steps in this article.

A VOM or VTVM is the only tool necessary for tests. Probe is used here to check out transformer leads.



**E**VEN with the clear instructions furnished with most kits, it is always possible for the unpredictable element of human error (yours or the kit designer's!) to frustrate your hours of effort. This can mean anything from a unit that won't work to one in which valuable components—such as transformers, tubes, capacitors, and the like—may be damaged when the power is turned on. A few simple checks, with a VOM or VTVM, can go a long way in reducing this chance for error.

To demonstrate, let's take an unhurried look at a typical, popular priced amplifier kit such as Allied Radio's Knight-Kit model 83 YX 797. This is an 18-watt combination preamp-power amp that is fairly representative of similar units in its price and power class made by EICO, Heath, Lafayette, and others.

The things to be checked logically arrange themselves in a

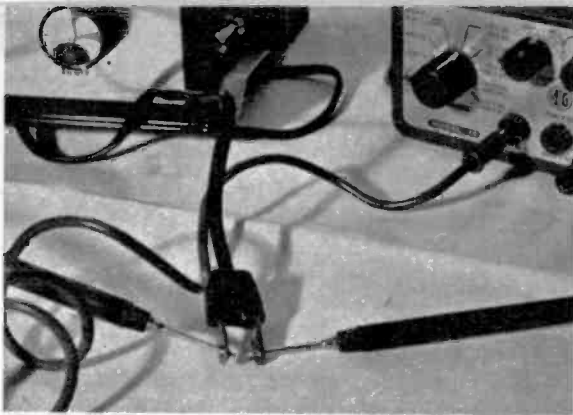

Connect VTVM leads to prongs of AC plug. With power switch off, meter will read infinity. Zero ohms would indicate a short in wiring of primary.

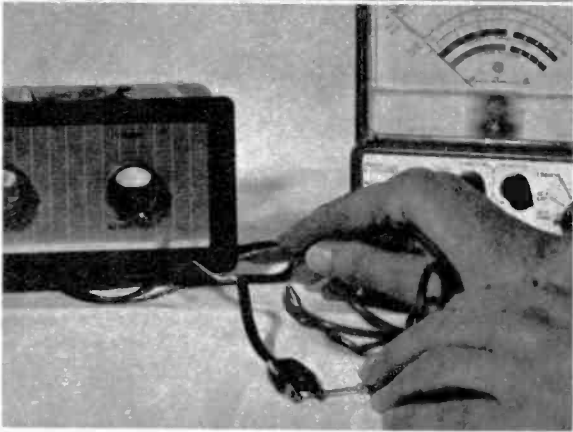

In a test for shock hazard measure the resistance between each prong and the chassis. Meter should read infinity to obtain maximum safety.

Place meter's "hot" lead to each positive lug of the filter capacitor, grounding negative meter lead to chassis. Allow time for charging.

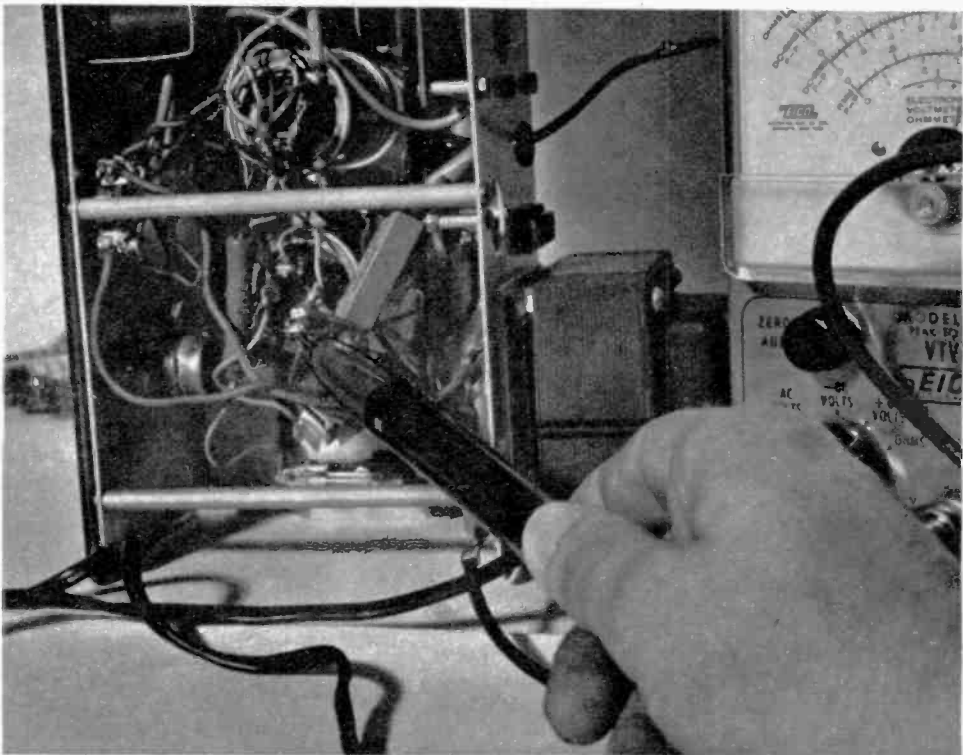

Measure the voltage across tube's socket terminals. Below socket count clockwise.

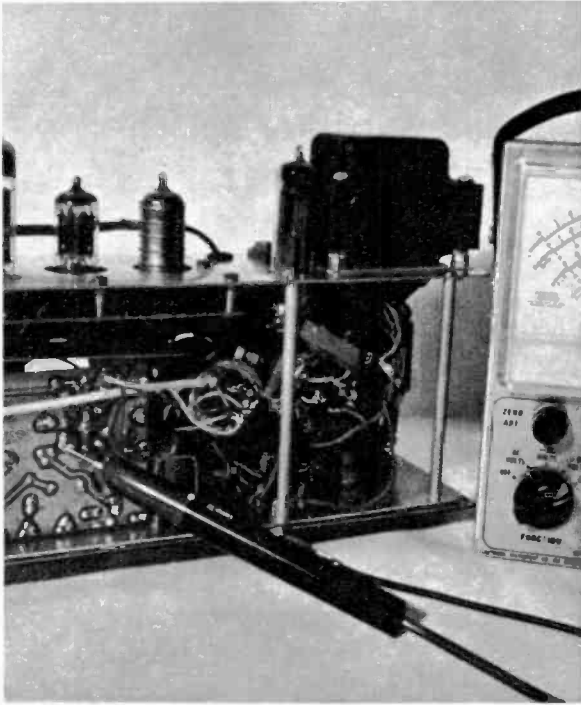

A wirewound resistor connected to the output terminals can replace a speaker as load.



sequence of three steps. The first is with power off and no tubes inserted; next is with power on but tubes still not inserted; finally, the checks with power on and tubes in place.

#### Power Off, Tubes Out

To begin, take the amplifier at the stage where all the wiring has been completed but the tubes have not yet been plugged into their sockets and the unit is still out of its wrap-around case. Connect the leads of an ohmmeter across the prongs of the AC power plug. The ohmmeter must be a VOM or VTVM; it cannot be a simple "continuity tester" since we are interested in some kind of definite reading in ohms. Set the ohm range for a scale convenient for readings of 100 ohms or less. Now, with the amplifier's power switch "off," the reading should be infinity (full deflection of the indicator). Next, turn the switch "on." The reading now should be fairly low. How low depends on the specific power transformer used in the kit. In this case,

we measure about 10 ohms, which is the DC resistance of the primary winding of the power transformer. A reading of zero ohms (direct continuity) could indicate a shorted primary or some other short in the wiring between plug and primary. The actual reading of some value in ohms "proves" the primary of the power transformer as well as the action of the switch, the power cord, the fuse, and the interconnecting wiring between these parts as well as to any auxiliary AC outlets provided. A reading of "infinite resistance" after the switch has been turned "on" would indicate an open primary circuit. With such a reading, go back and re-check all the wiring in this circuit. You might discover a loose connection or a cold-soldered joint.

Assuming this first test is done, your next check is to measure the resistance between each prong of the power plug and the chassis. Here, the readings should remain on "infinite resistance"

[Continued on page 115]

# build a Fire Alarm

By Morris Goodman

Protect your home or office with this simple unit.

It requires few parts and can be built in an evening.

**O**PERATION is based on the fact that a crystal diode's resistance will drop as it is heated. Several diodes may be strategically located about the house. Follow the illustrations during construction; and test the model by passing a lighted match near diode D2. The bell should sound.

#### PARTS LIST

R—10 ohm resistor 2 watt

C—500 mfd electrolytic capacitor 25 volt

T—Filament transformer 117 volt AC to  
6 volt AC (Stancor P-6134)

D1—1N538 diode

D2—1N34 diode, glass bead type

TR—2N307 transistor

RY—Relay 180 ohm coil 12 volt DC with

SPST contacts

Misc.—6 volt doorbell, 3-terminal tie  
point strip, barrier strip terminal  
block, 9-pin tube socket with cen-  
terpost (run lead from TR col-  
lector to socket centerpost), Bud  
Minibox CU-3006, line cord and  
AC plug

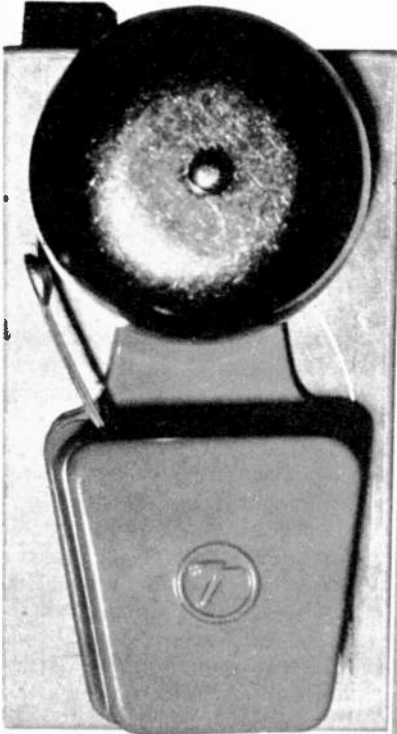

Ordinary 6 volt household bell is mounted on case, terminal block at upper left. Below, view with cover removed. Transformer is seen at right. Layout of the parts and wiring is not critical.

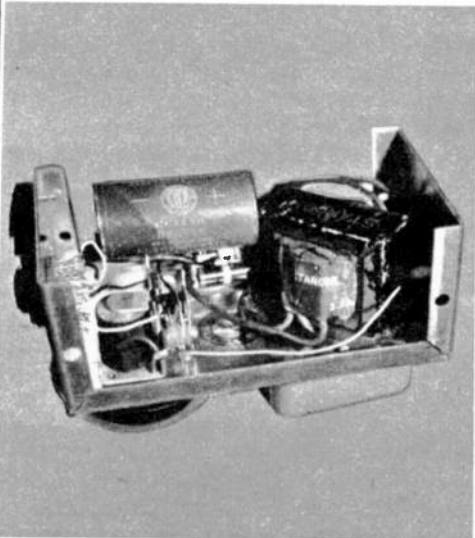



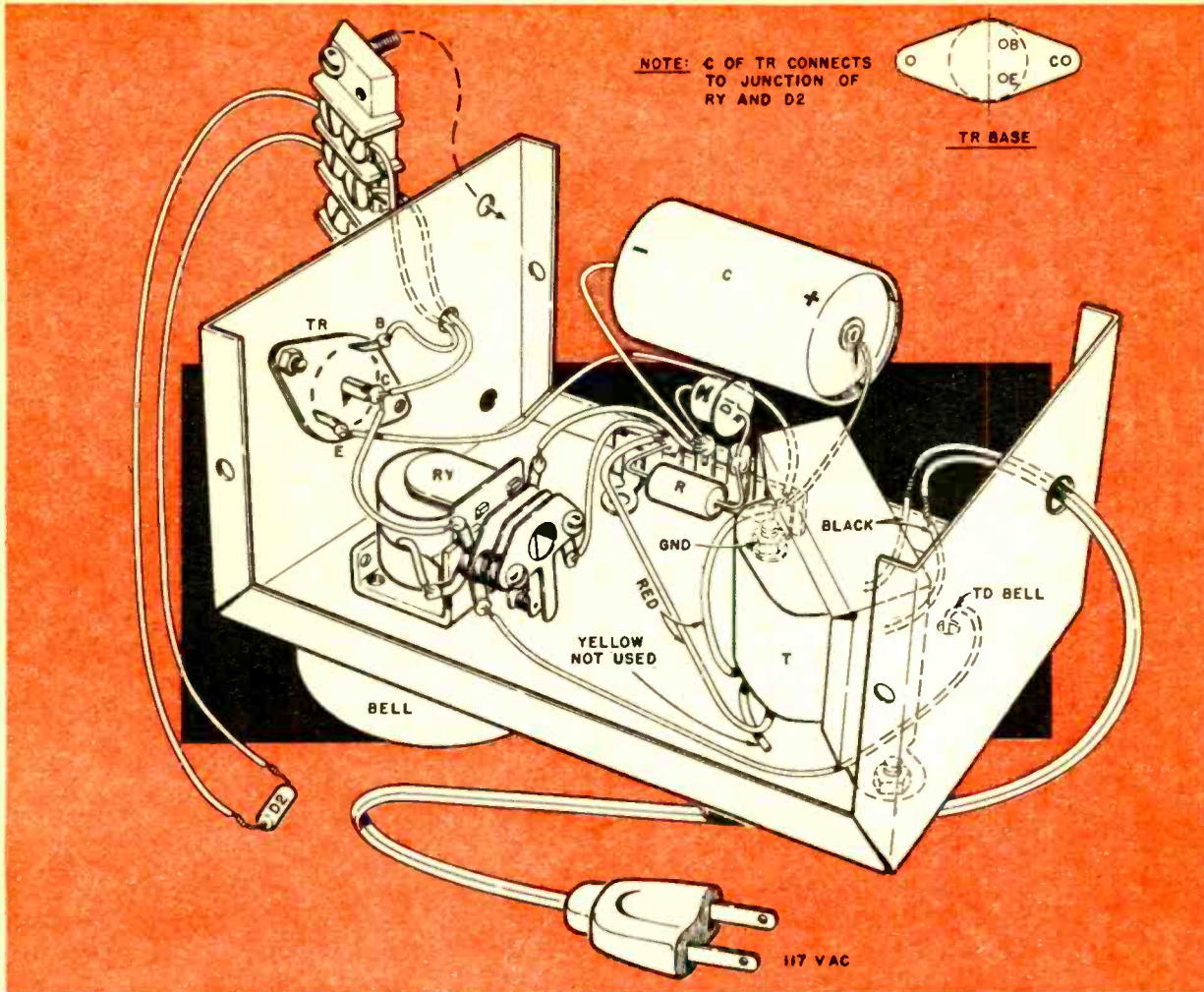

Terminal block at upper left of wiring guide is shown removed from chassis for clarity. TR, below it, is insulated from the metal case by tube socket.

Top view of case showing mounting of TR and terminal block. Black tape under TR insulates it from case. Lug at lower right contacts TR collector.

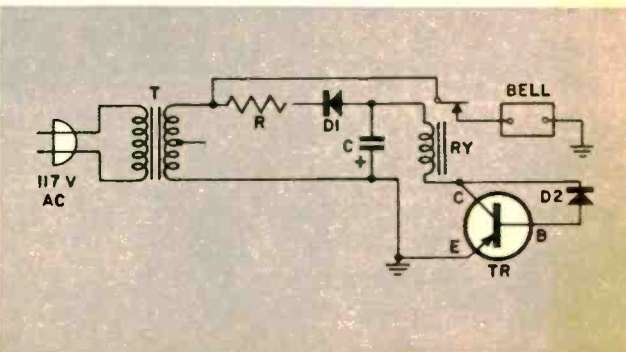
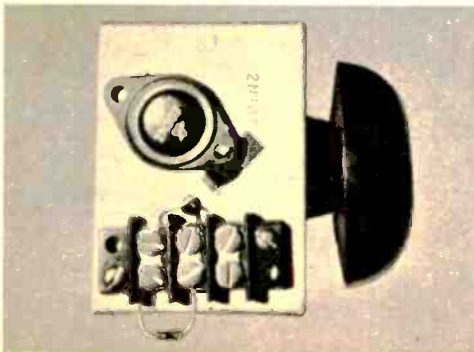

*Milt Kiver on*

# Tube Testers -1

**This part tells how tube testers perform three basic tests; for shorts, emission and mutual conductance.**

**T**UBE testers are used more than any other instrument in the servicing of radio and television receivers. In most instances, when a circuit becomes defective, the tube is the prime suspect and is the first component to be checked. Also, because it is so easily removable, it is the simplest component in a receiver to get at.

Tube testers fall into two general categories. There is the lower priced emission tester which determines the ability of a tube to provide the necessary number of electrons. The principal argument in favor of this type of checker is that tube operation depends on the number of electrons emitted by the cathode. Anything that causes the emission to drop below its normal value usually affects all of the other electrical features of the tube.

The second type of tube tester, higher in cost because of its

**Fig. 1. Compactness in this emission and mutual conductance tube checker is achieved by using the cover for sockets. Note the interconnecting cable.**

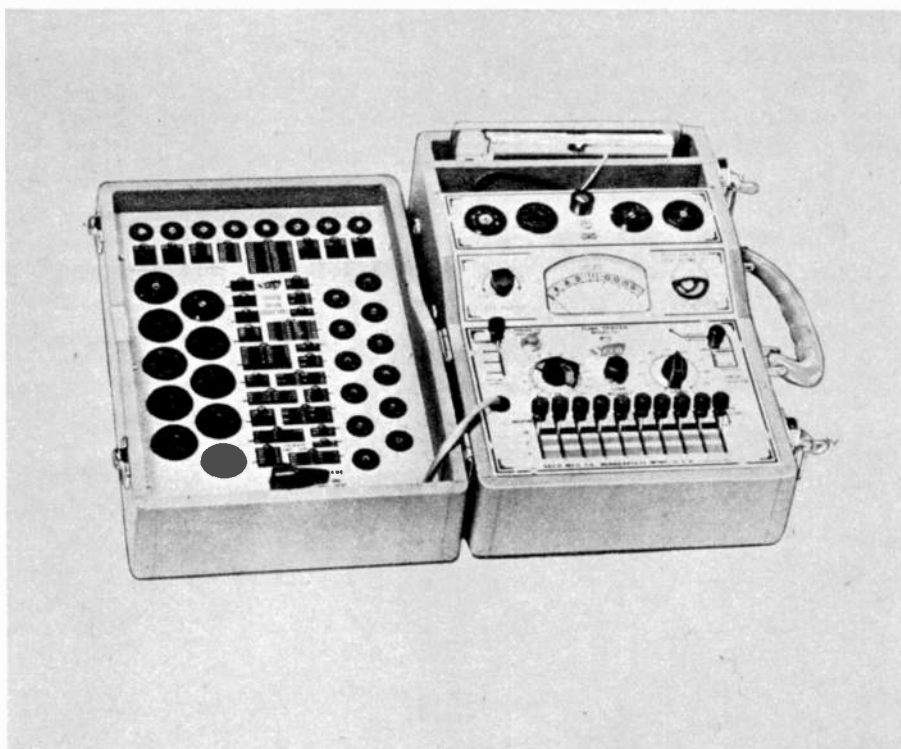

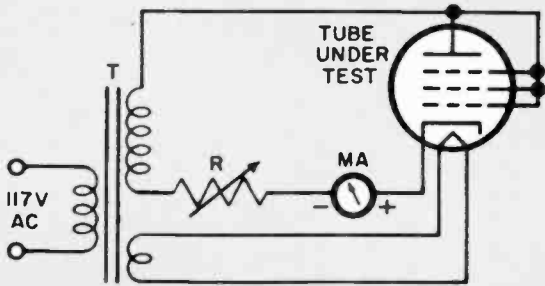

Fig. 2. Basic circuit of emission tester. Meter measures current flow, adjustable by resistor R.



Fig. 3. Typical meter face on emission-type checker indicates on a "Replace-Weak-Good."

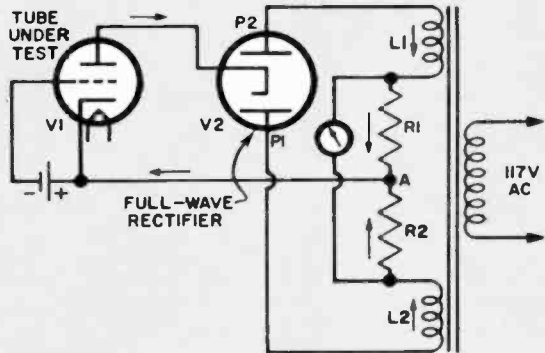
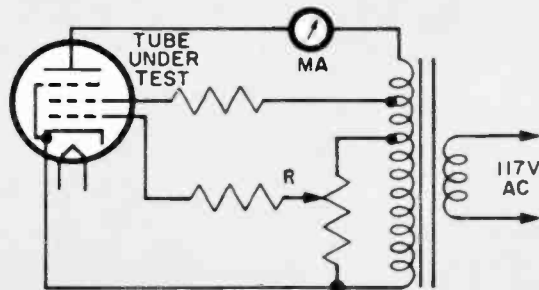

Fig. 4. Basic mutual conductance test, described in text. Current through the rectifier tube passes through the tube under test, V1.

Fig. 5. In this Gm test potentiometer R provides the tube grid with a small AC signal. It is tapped off transformer winding.



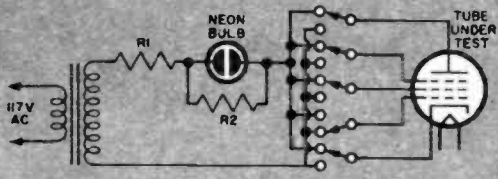

Fig. 6. Tube elements may be checked for shorts between them by vertical row of switches. Neon bulb gives this indication.

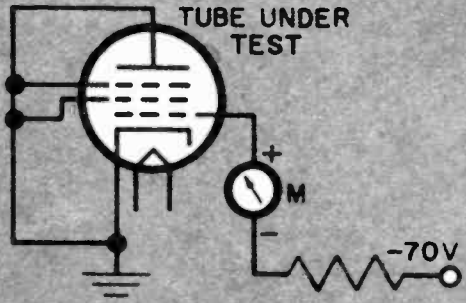

Fig. 7. Another circuit designed to detect shorts applies a DC voltage to one element while all the other elements are grounded.

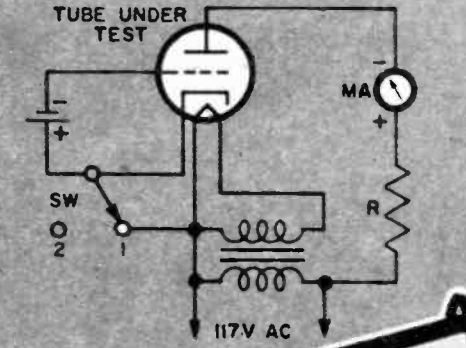

Fig. 8. Circuit shown below left checks leakage between the cathode and filament. Meter will read with switch in position 1.

Fig. 9. Typical low-cost tube checker available in kit form. This model features replaceable loose-leaf tube data charts.

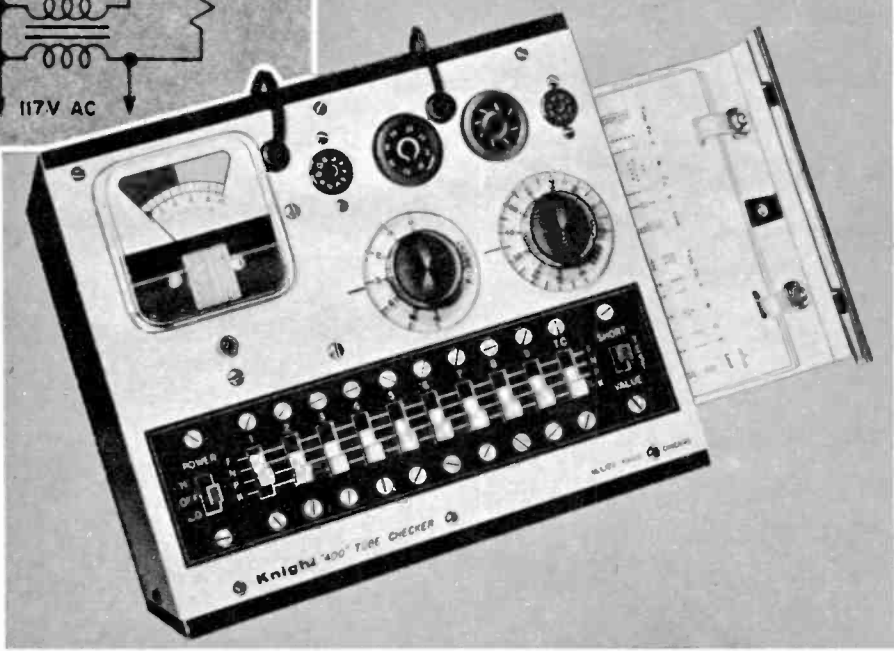

Fig. 10. Another kit emission tester. Data for checking is on roll chart, above switches.



Fig. 11. This small unit checks TV picture tubes only. Also serves as picture tube rejuvenator.



greater circuit complexity, is the mutual conductance checker. This ascertains how much a voltage change at the control grid will affect the plate current. Since the amplifying ability of a tube depends directly on this feature, the mutual conductance test is a direct indication of how well a tube can amplify.

Each test has certain advantages. In diodes and rectifiers, amplification is not a factor and only the emissive ability of the cathode is important. Consequently, only the emission check can be performed here.

In vacuum tubes possessing one or more grids, the ability to amplify is the dominant feature, and for these tubes mutual conductance is important. In power output tubes where large currents must be developed and where gain is important too, both characteristics should actually be checked in order to obtain a full picture of the operating condition of the unit. For example, a tube can give a good indication on the  $G_m$  test and yet not be able to deliver peak rated current. Only a suitable emission check will reveal this deficiency. If the circuit where this tube is used relies on this peak current, operational distortion will result. In spite of this, Both  $G_m$  and emission tests are seldom performed.

The mutual conductance test also checks the tube under conditions which more closely approach those encountered in an actual application. From this standpoint, this test gives a more useful indication of the ability of a tube to perform in the circuit. The emission check, on the other hand, simply measures the ability of the cathode to provide electrons. It is in no way related to the operation of the tube as an amplifier within a normally functioning circuit.

[Continued on page 122]



# EI'S Hi-Fi Doctor . . . .

## How Many Cycles—Counterpoint!

WITH the techniques and instruments at our disposal, we needn't be subjective in evaluating a high fidelity system. We can measure, compute, and count up the quantities that constitute its performance characteristics.

To begin with, we all agree on the fundamental frequency ranges of various instruments in our music. The bass viol is the lowest at 41.2 cps and the piccolo is the highest at 4698.6 cps. BUT THESE ARE ONLY THE FUNDAMENTALS.

These instruments do not put out sine waves. Overtones or harmonics extend considerably higher, and these harmonics give the sounds their characteristic qualities. The harmonics of a violin identify a tone as that of a violin and not as a clarinet, although the tone might be the same in frequency and intensity. Take the harmonics away and the instruments would all sound like sine-wave oscillators. An A of 440 cps on a trumpet would sound exactly like an A played by a cello, a violin, a bassoon, a trombone, or an oboe. Clearly we must have these harmonics if our system is to be rightfully called Hi-Fi.

Now these harmonics are multiples of the fundamental—the second harmonic is a tone at double the frequency and sounds an octave higher; a third harmonic is approximately one and a half octave higher, etc. How high do the harmonics go? Higher and higher at ever-decreasing amplitudes. The significant harmonics—those that can be said to contribute to the sound—vary with the particular instrument. A flute tone is relatively free of harmonics while a trumpet is rich with them.

Here measurement and computation come into the picture. The waveforms differ widely but all have steep fronts and sharp breaks. Not one puts out a

pure square wave but a square wave is the *kind* of waveform that is used in analyzing a tone. Detailed study shows a Fourier analysis to be involved here—this is a method of finding an equivalent tone made up of a single fundamental with added harmonics.

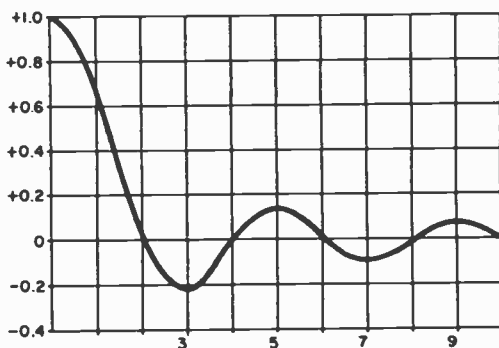

The summary of such analysis is plotted in this graph. Taking the peak amplitude as 1, the 3rd harmonic is approximately  $-0.22$ , the 5th harmonic is  $+0.13$ , the 7th is almost  $-0.1$ , and the 9th is about  $+0.07$ . This is clear evidence that, with a harmonic-rich instrument like an oboe, there are important contributions to the tone in harmonics extending to seven and even nine times the fundamental frequency.

Now let's look at the frequency ranges again. The trumpet whose highest tone is 987.77 cps also has musical components up to 8892 cps. The oboe's 9th harmonics go up to about 14 kc and those of a violin to an octave past that or 28 kc.

It is immediately clear to all of us who rely on measurement rather than on subjective "feelings" that we will get the highest fidelity by having our audio response band as wide as we can get it—past the limits of audibility.

Hi-fi questions are all answered by mail. If of general interest they will appear in this column.

## Compact Phono Oscillator

Please print a diagram of a small phonograph transmitter for use with a radio in the same room.

A Reader

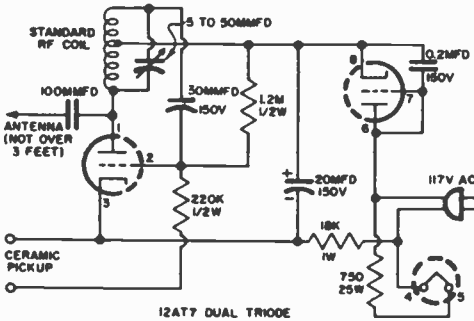

Here is a small one-bottle oscillator for modulation by a ceramic cartridge. If you want to use a variable reluctance unit, better add a preamp. This may not be very high fidelity but it saves stringing wires. Don't let the antenna get too long or you're in trouble with Uncle Sam.

## Low Power Amplifier

Please provide a circuit for a phonograph amplifier using a 50L6 and a 35Z5 rectifier.

Alfred Parish, Jr.  
Union City, Tenn.

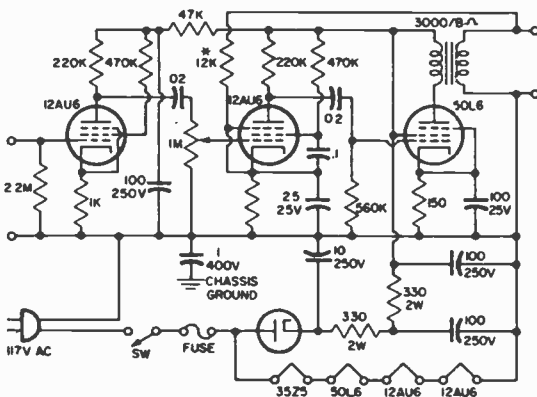

Yes and here it is. There is about 20 db of negative feedback and the output, although low, should be very clean. A signal of 0.02 volt will drive it to full output. The 12K resistor with the asterisk is the one to juggle to change the feedback factor.

## Tuning Meter

I'm tired of squinting into the 6U5 "eye" tube. Can you provide a circuit to let me replace the eye with some inexpensive meter?

Lee B. Statom  
Arroyo Grande, Calif.

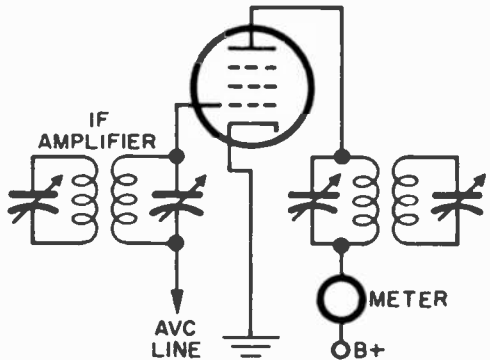

A tuning eye is a very high impedance gizmo requiring almost no current. A meter needs milliamps to swing the needle up on the scale. Consequently, you don't just plain replace an eye with a meter. You can use a small milliammeter in the plate circuit of an AVC-controlled tube, however—in series with the B+. Pick a meter that will go to full scale with the current flowing when tuned between stations. Tuning in a station will cause AVC voltage in the line, cutting down the current in the stage. The sharper the tuning, the more signal and the more AVC voltage; hence, the smaller the current in the stage.

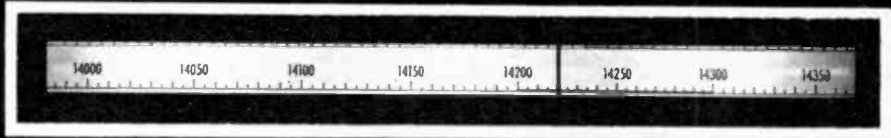

*spotlight on:*

## 20-Meters

**By C. M. Stanbury II**

**Here's a round-the-globe amateur band chock full of excitement—everything from DXpeditions to overseas phone—if you use it wisely and well.**

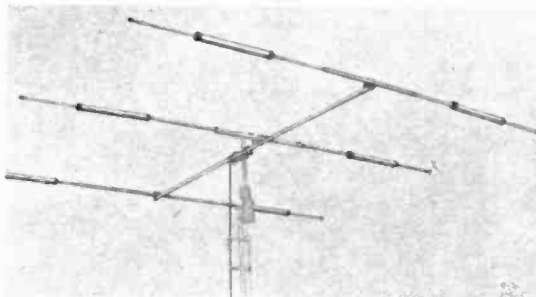

Mosley Model TA-33

THE frequencies between 14000 and 14350 kc represent the amateur's first full-fledged international band. Here, as with all frequencies above 12 mc, ionospheric absorption is a minor problem and only in the tropics is there much atmospheric noise. The two main limiting factors are skip and QRM (man-made interference). Of the three short wave ham bands above 12 mc, this is the lowest in frequency and therefore experiences the least skipping. Compared to the crowded 80 and 40 meter bands discussed in previous articles, QRM is light, although certainly not negligible. Intelligent operation can cut it down even more. In short, if you have a General Class license and are looking for DX (distance), this is where you start.

Occasionally an amateur, or a group of them, will gather together some portable equipment and travel to a very remote spot, frequently an uninhabited

THE frequencies between 14000 and 14350 kc represent the amateur's first full-fledged international band. Here, as with all frequencies above 12 mc, ionospheric absorption is a minor problem and only in the

Gonset 2-element beam

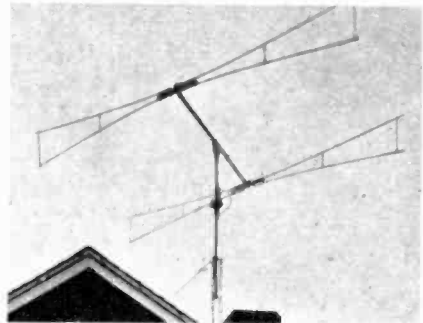

**DXpedition in progress: Mac Reynolds, W9EVI, fires up rig on Southwest Cay, about 200 miles east of Nicaragua. Claimed both by the U.S. and Colombia, this uninhabited place was really rare DX. Best band proved to be 20 meters, with thousands of QSO's.**

**QST photo, published by ARRL**



**Chuck Hansen, K2HUK, runs 100 watts output, single sideband with his Collins KWM-1 mobile rig. He has succeeded in logging no less than 38 different DX countries from his mobile station. All these contacts were on the hot 20 meter band.**

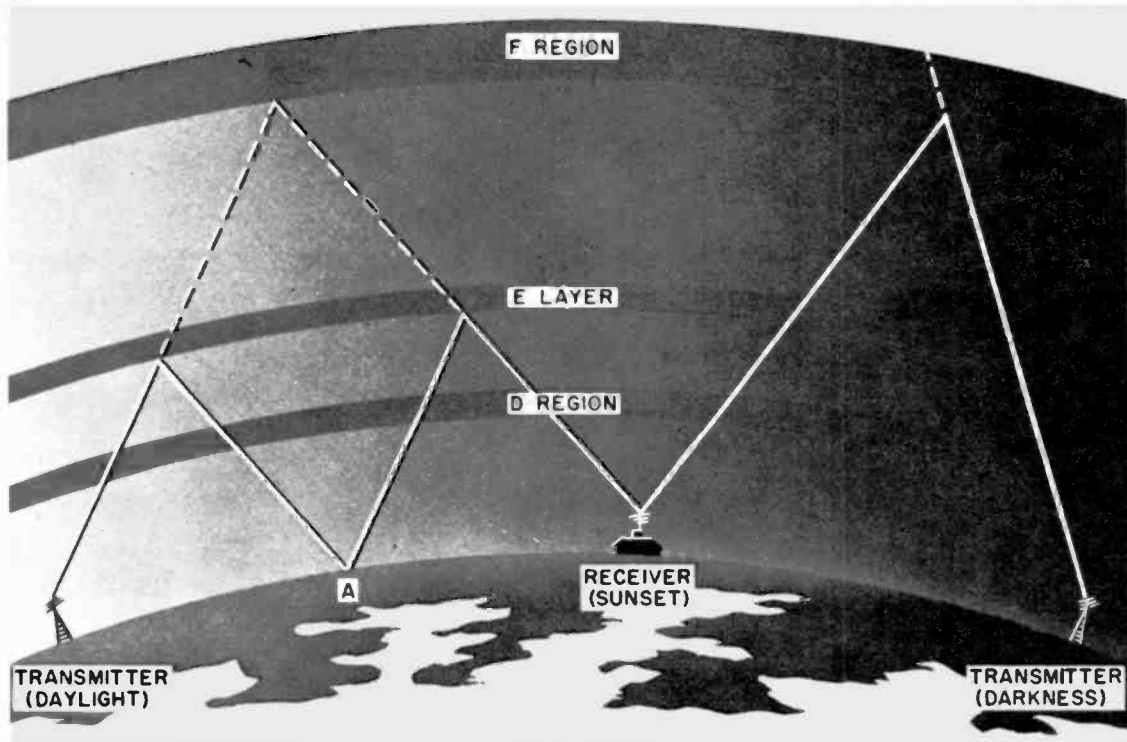

Daylight transmitter's signals suffer absorption passing through D region four times, while xmtr to east takes advantage of D and E layers' disappearance.

island, thus giving many amateurs a chance to work impossibly rare and exotic countries. This is called DXpedition. In ham circles, the most famous DXplorer of them all is the Yacht Yasme. This vessel, which was wrecked and rebuilt three times, has visited remote islands both in the Pacific and Caribbean. DXpeditions almost invariably conduct most of their operations on the 20 meter band.

The first article in this series outlined the layers and regions of the ionosphere. Each of them exert at least some effect on the 20 meter band. As you probably recall, the lowest portion of the ionosphere is the D region and its only function is to absorb radio energy. At 1400 local standard time there is a drop in 20 meter range caused by this region. However the difficulty is short-lived and not a major problem for DX hunters.

Moving a little higher, we find the E layer. This can both reflect and absorb, and does a little of both on 20. For a few

hours in the afternoon the layer can reflect (actually refract) 14 mc signals. This is seldom an advantage due to the layer's comparatively low altitude. In above diagram, wave propagated by the E layer requires more hops to cover the same distance than one reflected by the higher F region. For each hop there is a corresponding drop in signal strength.

During the day the F region is divided into two layers, F1 and F2. At night  
*[Continued on page 110]*

#### Single Sideband (SSB)

SSB transmission involves suppressing the carrier and either sideband, thereby concentrating power in one sideband. This technique, while requiring more complicated and costly gear, can boost effective power about eight times. Most SSB operators work at the edge of the phone bands in the belief that channels will be clearer. SSB offers marked reduction in QRM.



The 20 meter band is the lowest frequency band that lends itself conveniently to highly directional antennas. The rotary beam antenna is made in many variations, and often constructed to handle more than one band. Diagram at right shows the construction of a basic beam.

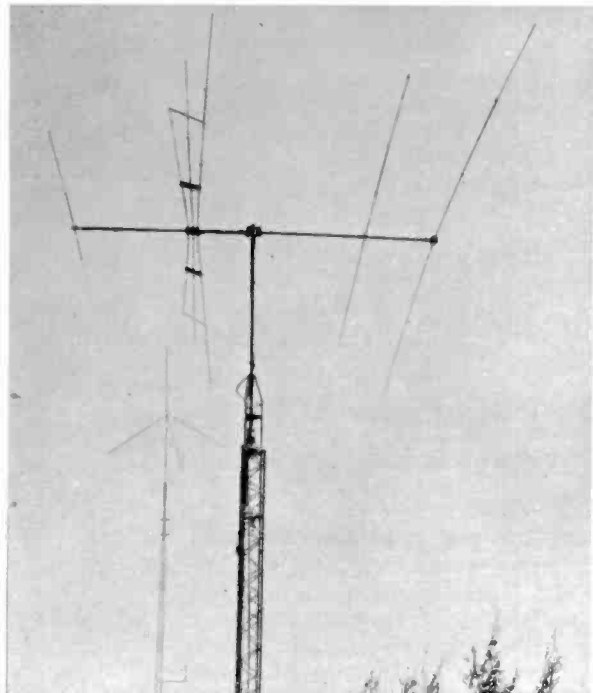
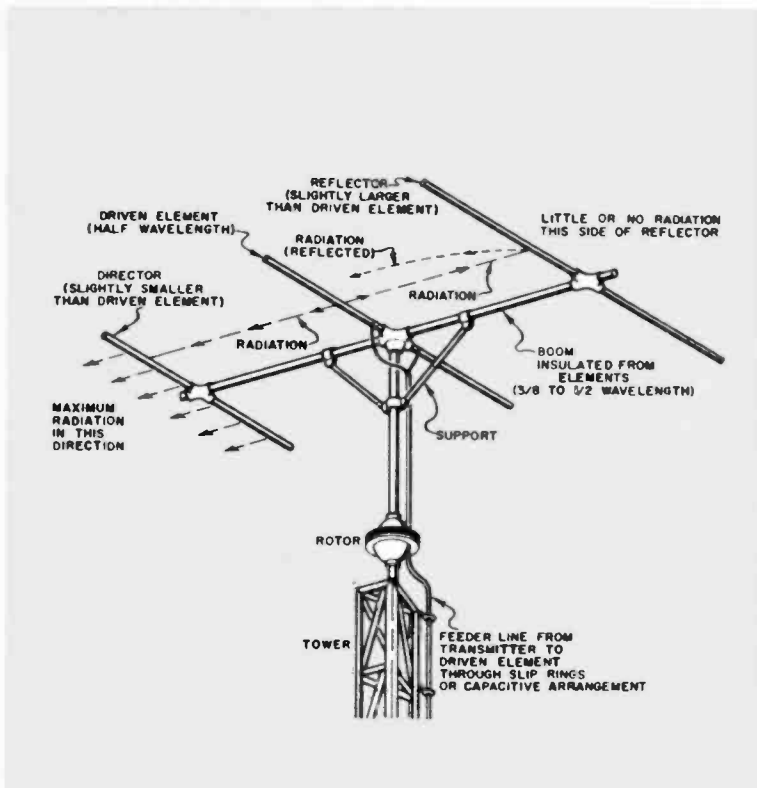

Here is a variation of the rotary beam antenna that contains elements cut to provide good service on three bands. But reflector, driven element and director are still discernible.



Antenna farm at Fort Monmouth, N. J., (K2USA) features several Telex beams for different bands. Shack has antenna patch panel. You can use simple dipole for 20 meters.



Completed receiver. "S" meter is at left side of front panel, with speaker mounted below louvres atop cabinet. Frequency coverage is in four bands.

## *El assembles a* **Communications Receiver Kit**

**The Philmore CR-5AC should be of interest to the SWL and beginning ham. Coverage is 550kc to 30 mc.**

**T**HE Philmore CR-5AC bridges the gap between two basic categories that communications receivers could be divided into; "economy" AC-DC circuits and more elaborate, high-priced sets. For example, the CR-5AC has no radio-frequency amplifier stage which brings the sensitivity down somewhat, and makes the receiver more susceptible to "image" signals. But, Philmore has liberally sprinkled their unit with features not commonly found in their price category. Most notable is the "S" meter for visual indication of signal strength. The bandspreading, or fine tuning, is accomplished both electri- [Continued on page 125]



Layout of kit parts prior to assembly. The steel cabinet in the background is sold separately at \$7.95. It is possible to use the CR-5AC without it.



Underside of chassis, wired and ready to receive the coil and bandswitch sub-assembly. It will mount in the chassis' large square cutout, center.

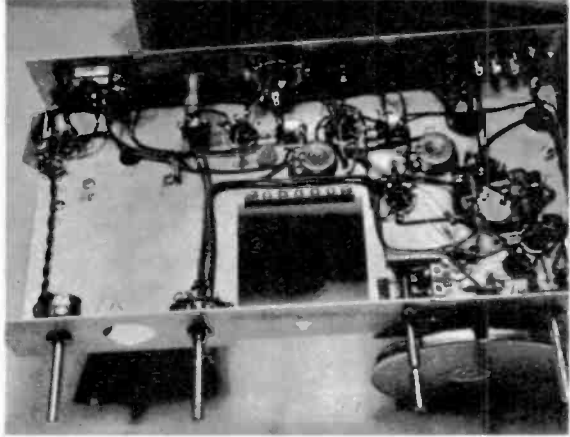

Closeup of coil and bandswitch sub-assembly, wired separately, then placed on chassis.

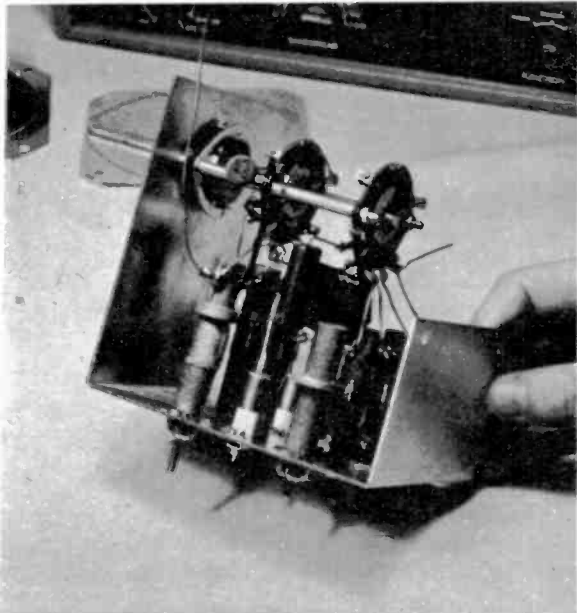

Coils are adjusted with tool supplied in kit. Note speaker, mounted on spacers at left.

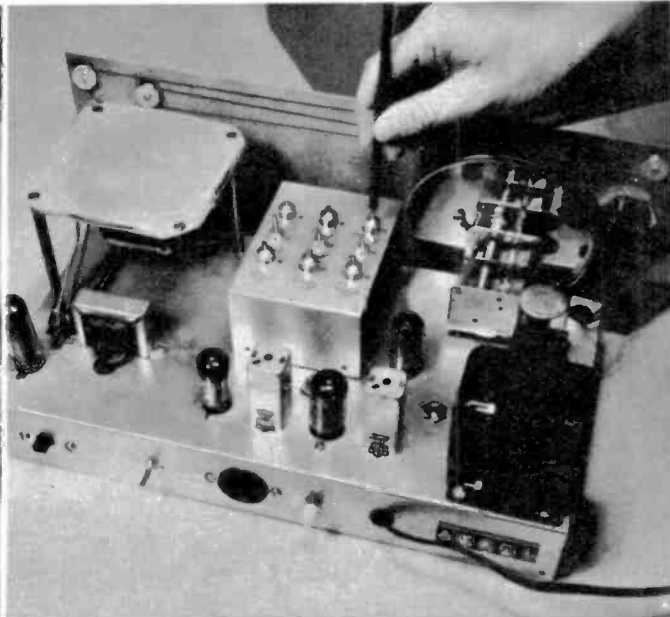

*Try These*

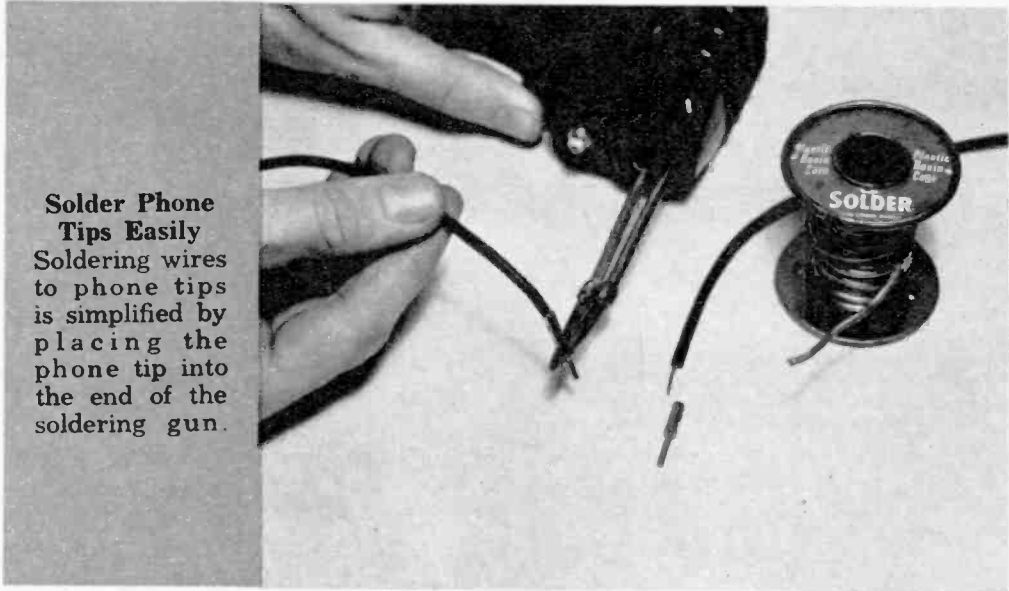

**Solder Phone Tips Easily**

Soldering wires to phone tips is simplified by placing the phone tip into the end of the soldering gun.

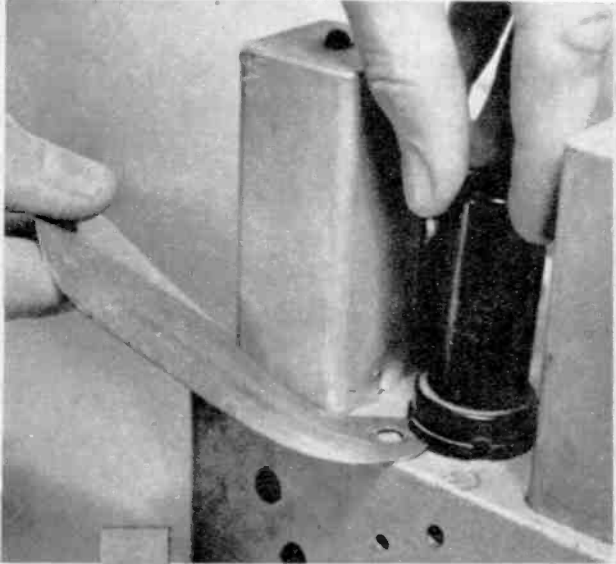

**Shoe Horn Lifts Tubes**

A metal shoe horn is a handy tool for lifting hard-to-remove tubes. With the set off, insert horn under base and pry upward very gently.

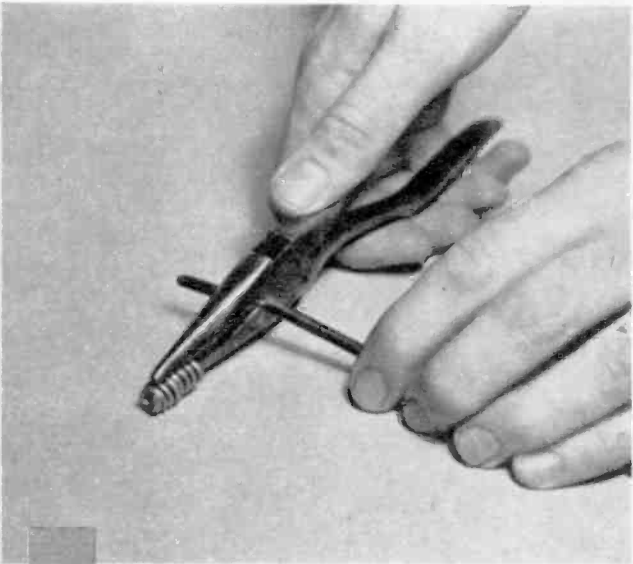

**Needle Nose Stripper**

By wrapping several turns of solder around one jaw of a pair of needle-nose pliers you can strip insulation without damage to strands, as shown.

## **build your own All-Transistor Organ**

**By Fred B. Maynard**

**Only 7 watts power this electronic organ! Use it outdoors with batteries—or on AC house current.**

**T**HIS article describes the design and circuitry of a completely transistorized organ. This organ is not a toy. Rather, it is a high grade musical instrument capable of producing fine organ and instrumental effects. By combining ten simple resistance-tuned blocking oscillators and a distributed keyboard switching arrangement, this design makes possible the following features:

1. Two manuals, or keyboards, 2 and 2.5 octaves long.
2. Four note chords on both manuals. The key switching arrangement is such that almost any four-note chord within any octave may be played on either or both manuals. This means that only one hand must be used on a manual since, except in special cases, the use of two hands on the same manual will limit some of the intervals.
3. Bass and preset chord button register. This uses the bass and lower manual oscillators. It may be used together with the upper manual for the right hand playing solo or chord effects.

**The two manuals (keyboards) may be played simultaneously. Voicing switches are above upper manual. Note bass pedals near floor.**

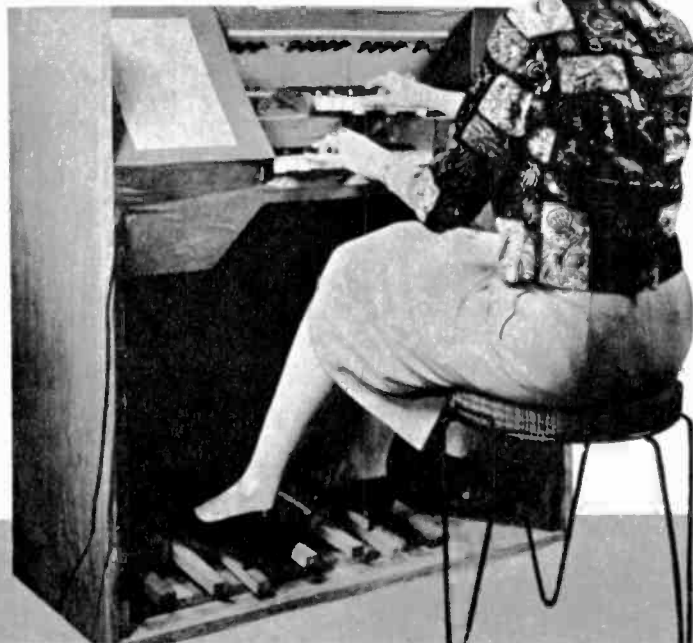



- Two pedal, five lower manual, and five upper manual voices are provided. These are general musical tone effects; Brilliant, Vox Humana, Bright, Mellow, and Deep Tones.

### Organization of the Organ

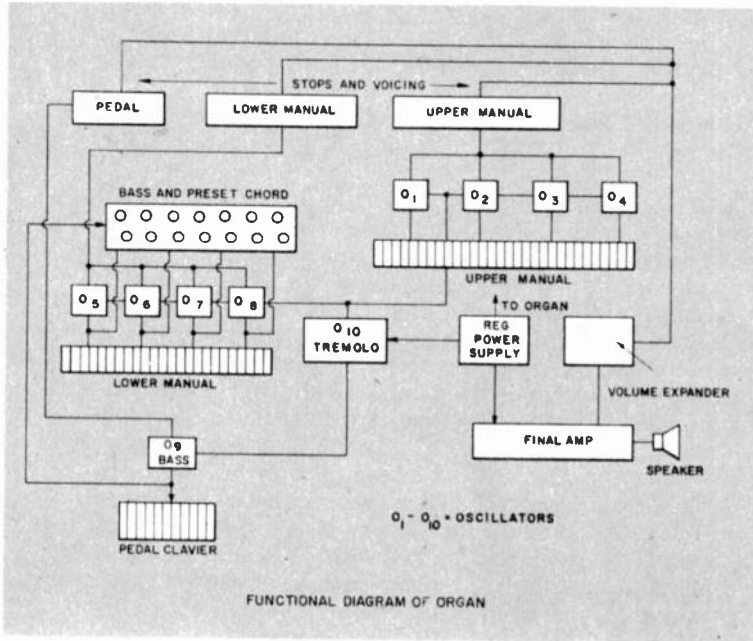

A block diagram of the complete organ is given in Figure 1. The 10 oscillators are indicated as O<sub>1</sub> to O<sub>10</sub>. The upper or solo manual is independent of the other parts of the organ. The lower manual oscillators are shared with the preset chord register. The bass oscillator is shared between the pedal clavier and the preset bass buttons.

Fig. 1

the keyboard and bass register. The lower manual cannot be played simultaneously with the preset register.

The upper and lower manuals are identical, except for the 6-note extension on the upper manual. Each controls 4 oscillators in the 3-half-note staggered arrangement shown in the circuit detail. This arrangement has many limitations, but does allow the playing of almost any 3 or 4 note chord, as long as all components of that chord are within one octave anywhere on the keyboard.

Preset 3 note chords are tapped in on the lower manual oscillator and tuning system. These are not to be used while playing the lower manual, but may be used without any restriction in conjunction with the upper manual. A single bass oscillator provides one octave from C<sub>11</sub> (64 cps) through B<sub>11</sub> (120 cps) to a pedal board and to the chord register bass buttons.

It is quite obvious that one can build a simpler organ by eliminating the lower manual and the pedal board, depending entirely on the chord organ for bass and accompaniment, or conversely by not using the preset chord arrangement at all if the builder prefers to finger his accompaniment.

### The Organ Oscillators

All 10 oscillators in this organ are the same simple, basic grounded base blocking oscillator shown in Figure 2. In this circuit, T is any suitable transformer with high impedance winding L<sub>1</sub> and a lower impedance winding L<sub>2</sub>. The Stancor A-3841

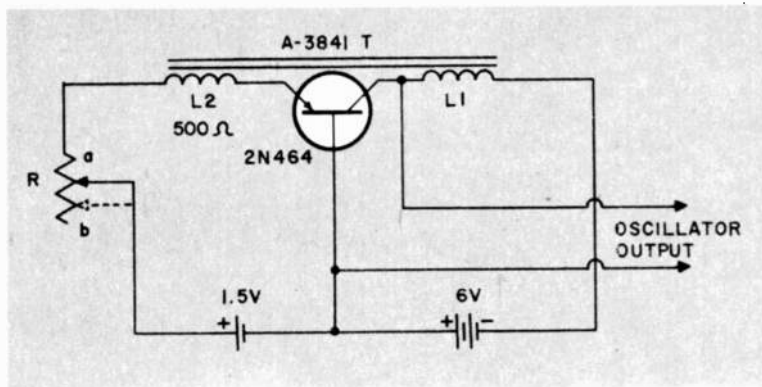

Fig. 2

transformers specified are well adapted to this oscillator, but are physically rather large. In all probability, smaller plate-to-line transformers can be found which will function as well. The blocking rate is controlled by R. In terms of musical frequency, the

tuning to various notes is controlled by introducing various values of R. The pitch becomes higher as the value of R is increased.

In setting up these oscillators, one must remember that as in any oscillator the transformer windings must be phased correctly to obtain oscillation. We have observed that some of the 10 identical transformers used in the model require different tap numbers for correct phasing; hence, one cannot depend on the tap numbers.

### Upper and Lower Manual Circuitry

The upper and lower manuals for this organ are essentially the same. The upper manual tone frequencies extend over  $2\frac{1}{2}$  octaves, from C (128 cps) to F (683 cps). The lower manual is shorter with a range of C, 128 cps, to B, 480 cps.

The oscillators, resistance tuning arrangements, and keyboard switching are on pages 72 and 73. This may be used as a guide to the circuitry of both manuals. The 4 oscillators,  $O_{1, 2, 3}$  and  $O_4$  (as well as the oscillators on the other manual,  $O_{5, 6, 7}$  and  $O_8$ ) are identical. Taps 1 and 2 on the A-3841 transformer are used in the collector circuit.

The values of the resistors in these strings are given as used on the model. With different transformers, transistors, voltage supply levels, these values may change somewhat and should be considered as approximate values only. The final tuning must be done by adjustment, using either the ear or a standard source of tones such as a well tuned piano as a guide. Considering the resistor string associated with  $O_1$  as an example,  $R_1$  and  $R_2$  establish the basic frequency of C = 128 cps.  $R_1$  is a fixed  $\frac{1}{2}$  watt resistor and  $R_2$  a 100 ohm 2 watt potentiometer.  $R_2$  can be used as a variable tuning control for the "C-string" of keyboard tones.  $R_3$  is a 10 watt wire wound adjustable resistor of 50 ohms with two ring taps for C# and D, respectively.  $R_4$  is again a fixed  $\frac{1}{2}$  watt resistor,  $R_5$  another 10 watt adjustable of 100 ohms,  $R_6$  another fixed, and  $R_7$  a 100 ohm adjustable. These resistors establish the frequencies for the C string as:

$C_1$	— 128 cps	C	— 256 cps	upper	$C^1$	— 512 cps
$C\#_1$	— 136 cps	$C\#$	— 272 cps	manual	$C\#^1$	— 544 cps
$D_1$	— 144 cps	D	— 288 cps	only	$D^1$	— 576 cps

In a like manner, the other 3 strings, called D#, F#, and A strings, tune the other 3 oscillators, forming a complete chromatic scale:

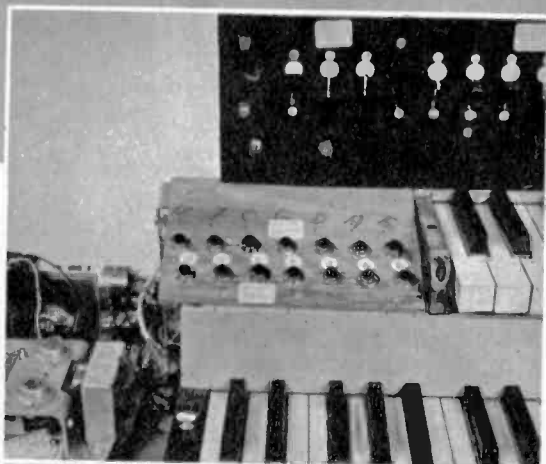
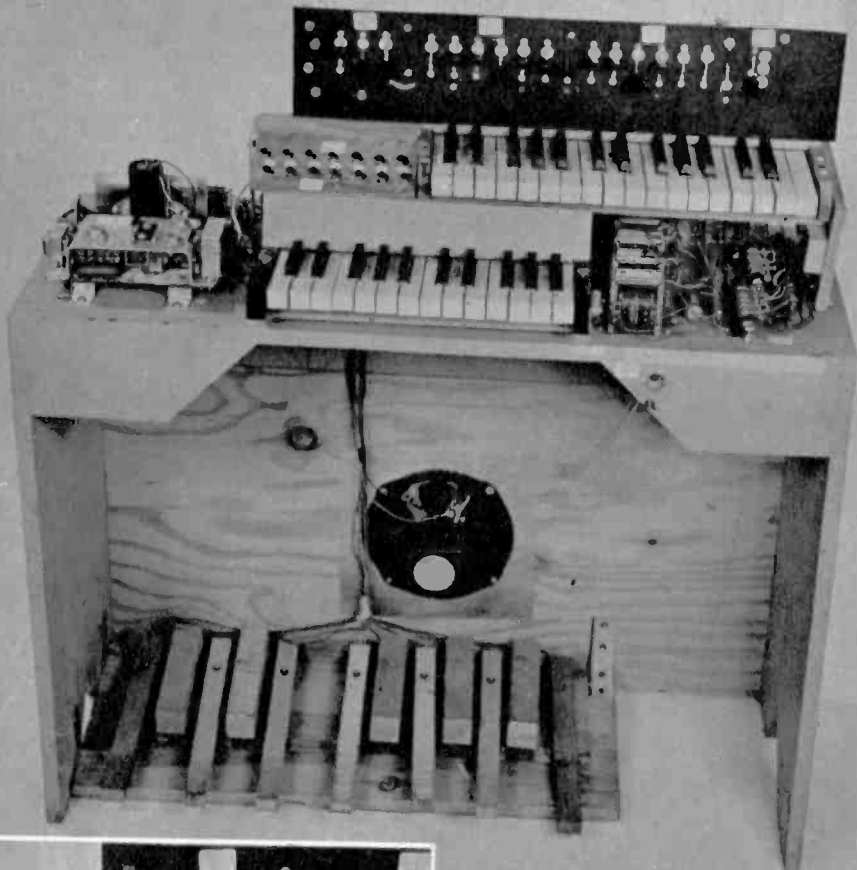

Overall view of organ, with cabinetry removed, reveals basic table on which most parts are mounted. Speaker is at center. Foot pedals are spring loaded.

Left side of organ showing preset bass and chord buttons. Bass buttons sound same notes as pedals—chords are groups of seven major keyboard notes.



Top panel holds voicing and stop switches. Last switch on right is set low, medium or high volume; adjusts speaker level to center of dynamic range.

	D# String	F# String	A String
	D# <sub>1</sub>	F# <sub>1</sub>	A <sub>1</sub>
	E <sub>1</sub>	G <sub>1</sub>	A# <sub>1</sub>
	F <sub>1</sub>	G# <sub>1</sub>	B <sub>1</sub>
	D#	F#	A
	E	G	A#
	F	G#	B
Upper	D# <sup>1</sup>		
Manual	E <sup>1</sup>		
Only	F <sup>1</sup>		

Note that the C and D# strings extend into three octaves for the upper manual. If it is desired to use, for example, two three-octave manuals, it is possible to extend the F# and A strings another octave and obtain the required range.

This system of keyboard switching enables the playing of quite unrestricted chord forms on both manuals. There are some four note chords forms in which one of the components will not be obtained. For most three note chords, progression-playing in thirds or sixths, and so on, the keyboards are essentially as flexible as one using individual oscillators. One rather stringent restriction is that except for carefully worked out sequences, only one hand must be used on either of the keyboards at a time.

The oscillator outputs are coupled together through resistors

#### PARTS LIST

(Main organ, not including power supply or output amplifier. Note that one number may represent more than one part, especially in the similar circuitry of the upper and lower manuals. In these cases, the part will be followed by a number in parentheses showing the total amount required.)

TR1-TR13—2N464 transistor  
 (All transistors and diodes are Motorola)  
 T1-T10—Transformer (Stancor A-3841)  
 CH1-CH3—Choke (Triad F13X)  
 R2, R21, R28, R33—100 ohm, 2 watt potentiometer (8)  
 R39—1000 ohm potentiometer

#### Adjustable 10 Watt Resistors

R3, R22, R29, R34—50 ohm (8)  
 R5, R24, R31, R36—100 ohm (8)  
 R7, R26—100 ohm  
 R40—500 ohm  
 R41—100 ohm  
 R42—500 ohm

#### Fixed 1/2 Watt Resistors

(Some resistors used for tuning may require somewhat different values than those given. Miscellaneous values between 10 and 90 ohms may be needed.)

R1—180 ohm (2)	R38—2000 ohm
R4—160 ohm (2)	R43—62 ohm
R6—360 ohm	R44—1100 ohm
R8, R11—1 megohm (8)	R46—30,000 ohm (2)
R12, R15—100,000 ohm (8)	R47—150,000 ohm (2)
R16—39 ohm (2)	R48—150,000 ohm (2)
R17—22 ohm	R49—100,000 ohm (2)
R18—1000 ohm (2)	R50A—5100 ohm
R20—200 ohm (2)	R50B—10,000 ohm
R23—10 ohm (2)	R51—12,000 ohm
R25—510 ohm	R52—18,000 ohm
R27—200 ohm (2)	R53A—1500 ohm
R30—200 ohm (2)	R53B—30,000 ohm
R31A—22+39 ohm	R53C—160,000 ohm
R32—360 ohm (2)	R57—56,000 ohm (2)
R35A—430+22 ohm	R58—620 ohm (2)
R35B—300 ohm	R59—11,000 ohm
R37—500,000 ohm	R71—200,000 ohm

#### Capacitors

C1—1 mfd 200 volt (2)	C9—.02 mfd 200 volt
C2—2 mfd 200 volt (2)	C10—.02 mfd 200 volt

C3—.05 mfd 200 volt	C11—.2 mfd 200 volt
C4—40 mfd electrolytic	C12—.2 mfd 200 volt
C5—1 mfd 200 volt	C13—.1 mfd 200 volt
C6—1 mfd 200 volt	C16—100 mfd elec. 6 volt
C7A—.001 mfd 200 volt (2)	C23—5 mfd 25 volt elec.
C7, C8—.005 mfd 200 volt (2)	C24—2 mfd 200 volt

S1-S9, S15, S18—Lever switches (Centralab 1454) (16)  
 Relay Leaf Spring Contact Parts (Guardian 206-3; contains 12 springs and insulating leaves and tubes)  
 (Optional to Homemade Contacts; Guardian Midget 200 M3; contains 12 springs and insulating sleeves and tubes)

Preset Bass Buttons—Normally open pushbutton switches, 7 required

Preset Chord Buttons—Normally closed pushbuttons to operate leaf springs (above). See text

#### Parts List for Output Amplifier and Power Supply

R59A—3300 ohm resistor 1/2 watt  
 R60—30,000 ohm 1/2 watt resistor  
 R61—10,000 ohm 1/2 watt resistor  
 R62—10,000 ohm potentiometer 2 watt (Ohmite CU1031)  
 R63—100 ohm 1/2 watt resistor  
 R64, R66—10 ohm 1/2 watt resistor  
 R65—1000 ohm potentiometer 2 watt (Ohmite CU1021)  
 R67—1 ohm resistor 10 watt  
 R68—100 ohm resistor 2 watt  
 R69—200 ohm resistor 2 watt  
 R70—750 ohm resistor 2 watt  
 R72—1000 ohm wirewound potentiometer (Mallory MIMPK)  
 C17—1 mfd capacitor 200 volt  
 C18—25 mfd elec. capacitor 25 volt  
 C19—500 mfd elec. capacitor 25 volt  
 C20—500 mfd elec. 15 volt  
 C21A, B, C—2000 mfd elec. capacitor 15 volt  
 C22—2000 mfd elec. 25 volt  
 TR14, TR15—Transistor 2N464 (Motorola)  
 TR16, TR17, TR18—Transistor 2N554 (Motorola)  
 Z—Zener diode regulator 1.M12Z10 (Motorola)  
 BR—Bridge rectifier 1N1563 (4 required)  
 T11—Driver transformer (Thordarson TR32)  
 T12—Audio output transformer (Lafayette TR94)  
 T13—Filament transformer 12.6 volt, 1.5 amp. (Triad F25X)  
 SP—Speaker PM 3.2 ohm voice coil, 8"  
 S16—Toggle switch SPST  
 B—1.5 volt battery, Size D cell

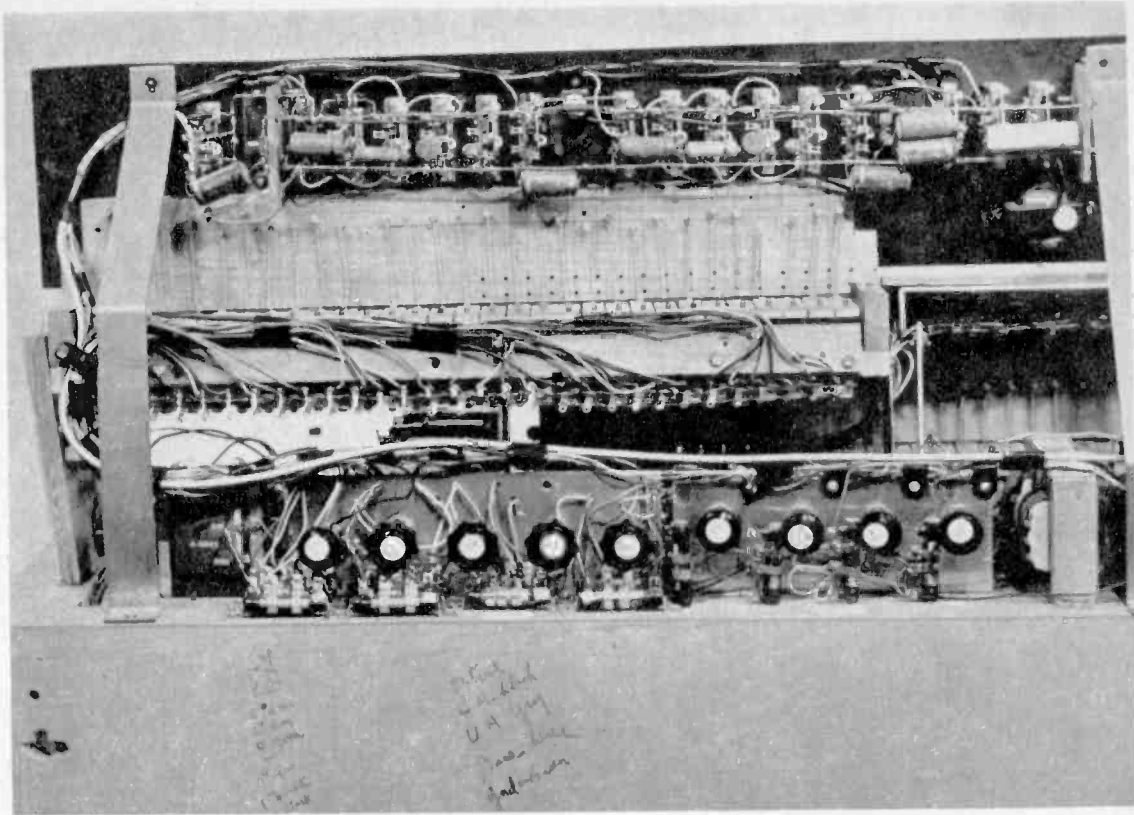

Overall rear view. Below voicing and stop switches on top panel is row of springs which are adjusted for proper tension of upper manual keys.

Finger points to bracket holding top panel. Wood block supports the upper keyboard.

Top panel has been removed to show components on the left side (as viewed from rear).

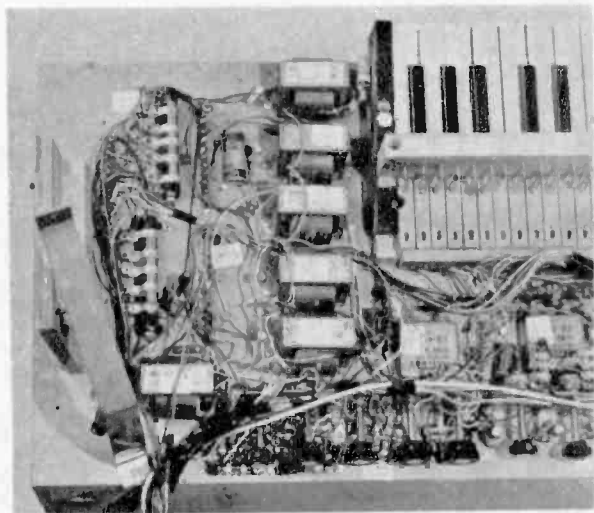
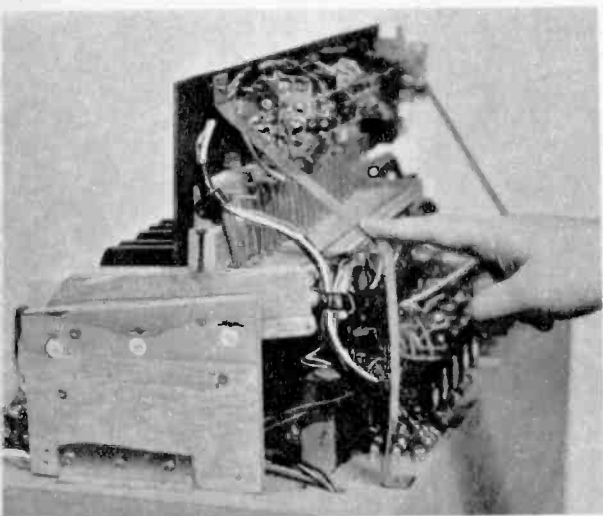



$R_{8-11}$ . These are nominally 1 megohm value. This high impedance prevents excessive feedback and coupling between the oscillators. In the event one or more of the oscillators are weak or strong compared to the others, balancing is obtained by adjusting the values of these resistors to higher values to obtain output reduction, or to lower values for output build-up.

The vibrato or tremolo signal, which is a low frequency sinusoidal oscillation of approximately 6 cps, is applied to the oscillators through the 100K resistors  $R_{12-15}$ . Here again, higher or lower values may be used to balance the vibrato effect if necessary. Both the output and vibrato resistors should be connected before any final tuning is done, since detuning will result if these are connected later.

The combined oscillator outputs go to an amplifier stage K, which serves not only to isolate and to amplify the output signal,

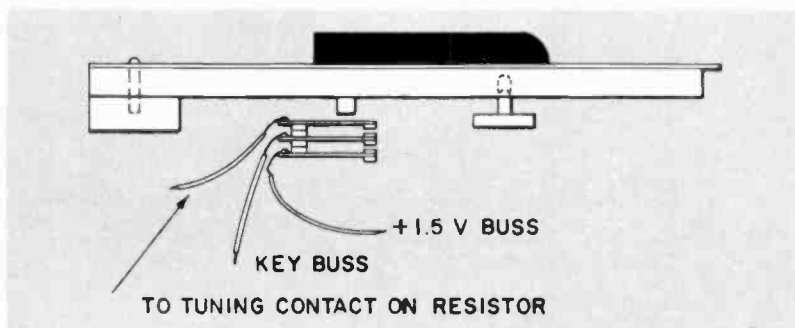
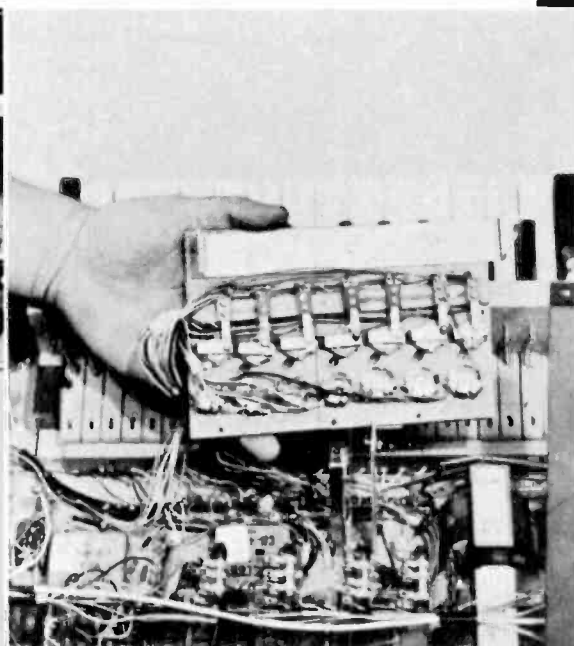
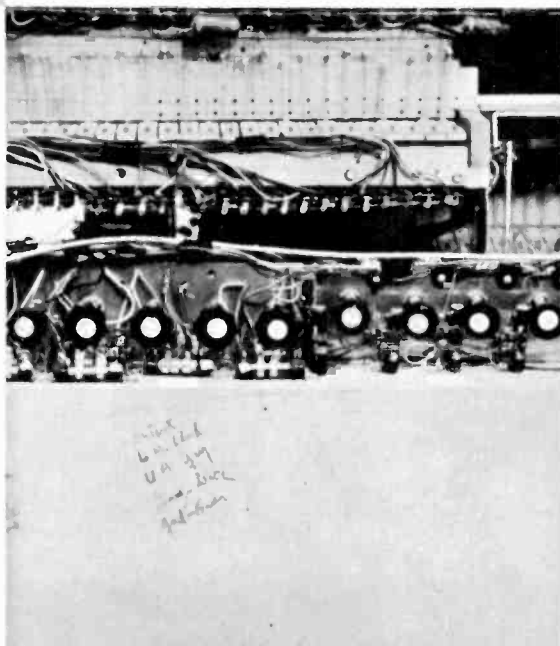
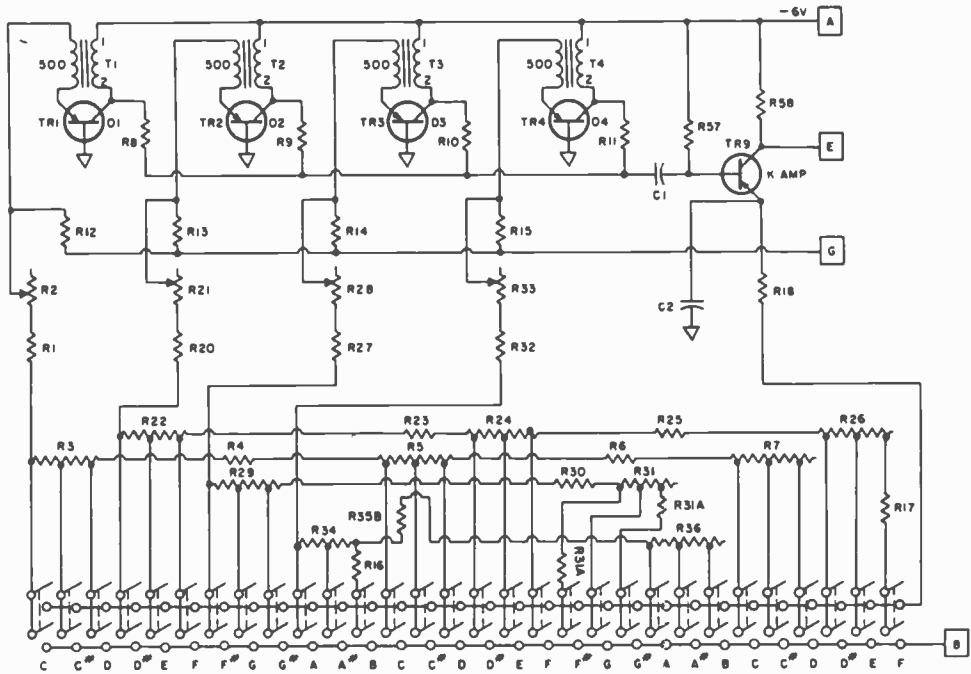

Fig. 3



Rear, center view. Row of knobs that control tuning of organ are at center. Right photo shows rear of panel with preset bass and preset chord buttons.

# UPPER MANUAL



OUTPUT AMPLIFIER

FOOT PEDALS AND BASS BUTTONS

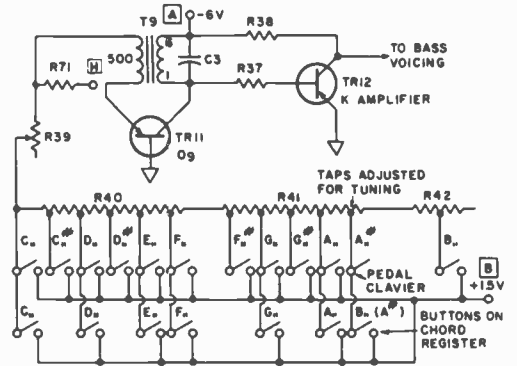
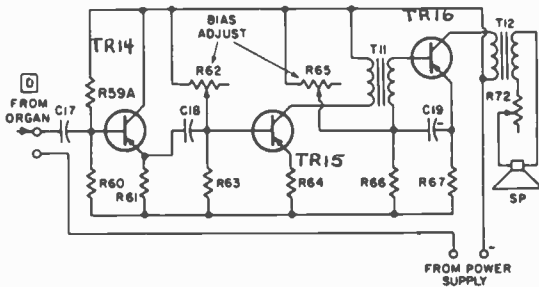

POWER SUPPLY

TREMOLO

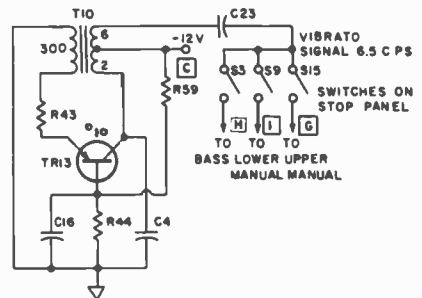
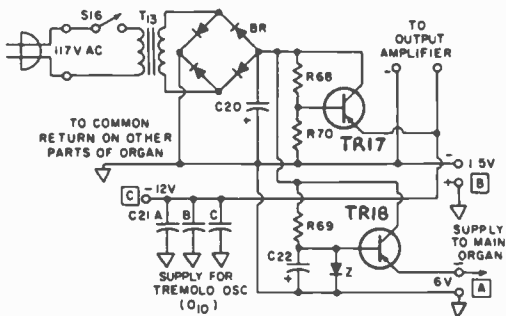

## LOWER MANUAL

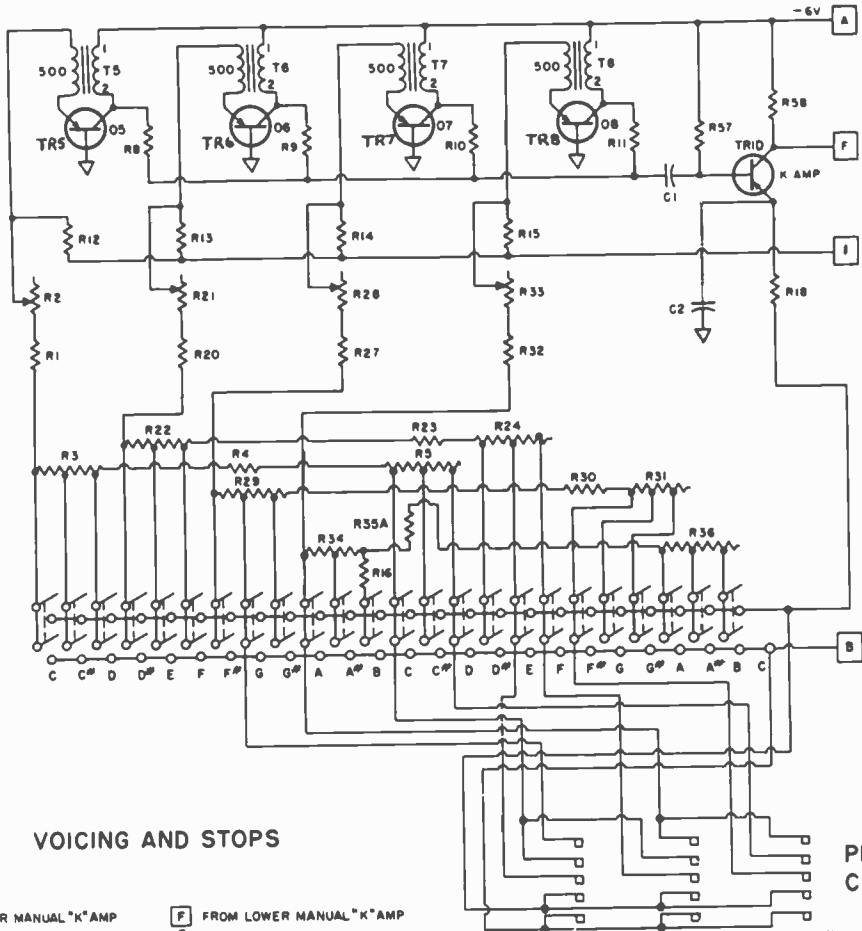

### VOICING AND STOPS

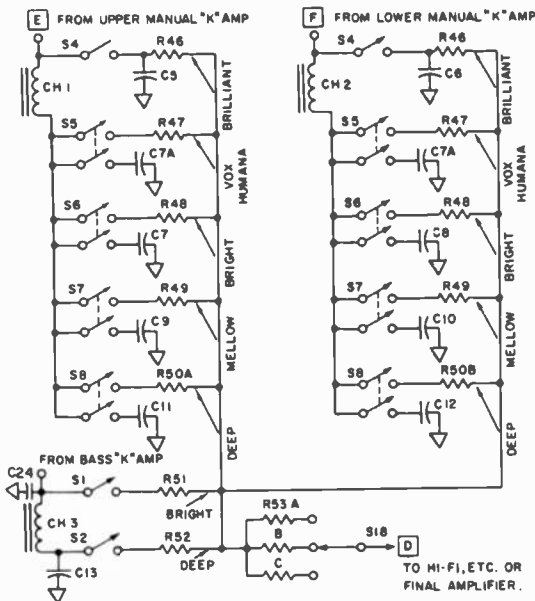

**Schematic of complete organ. Interconnections between various sections of the organ are shown by a letter inside a square. During construction, the builder should match up these points. Note that the upper and lower manuals are almost identical in circuitry. The lower manual, however, has fewer notes and supplies the combinations for the preset chords. Three chord examples are shown here; see the text for other combinations. Output of "Voicing And Stops" feeds the output amplifier (Point D). This output could be used with a standard, external amplifier to reduce costs, if desired. Motorola Corp. has available a complete kit of transistors, rectifiers and zener diodes for this electronic organ at a special experimenter's price. For information, write to the Motorola Semiconductor Div., P.O. Box 5188, Phoenix, Ariz.**

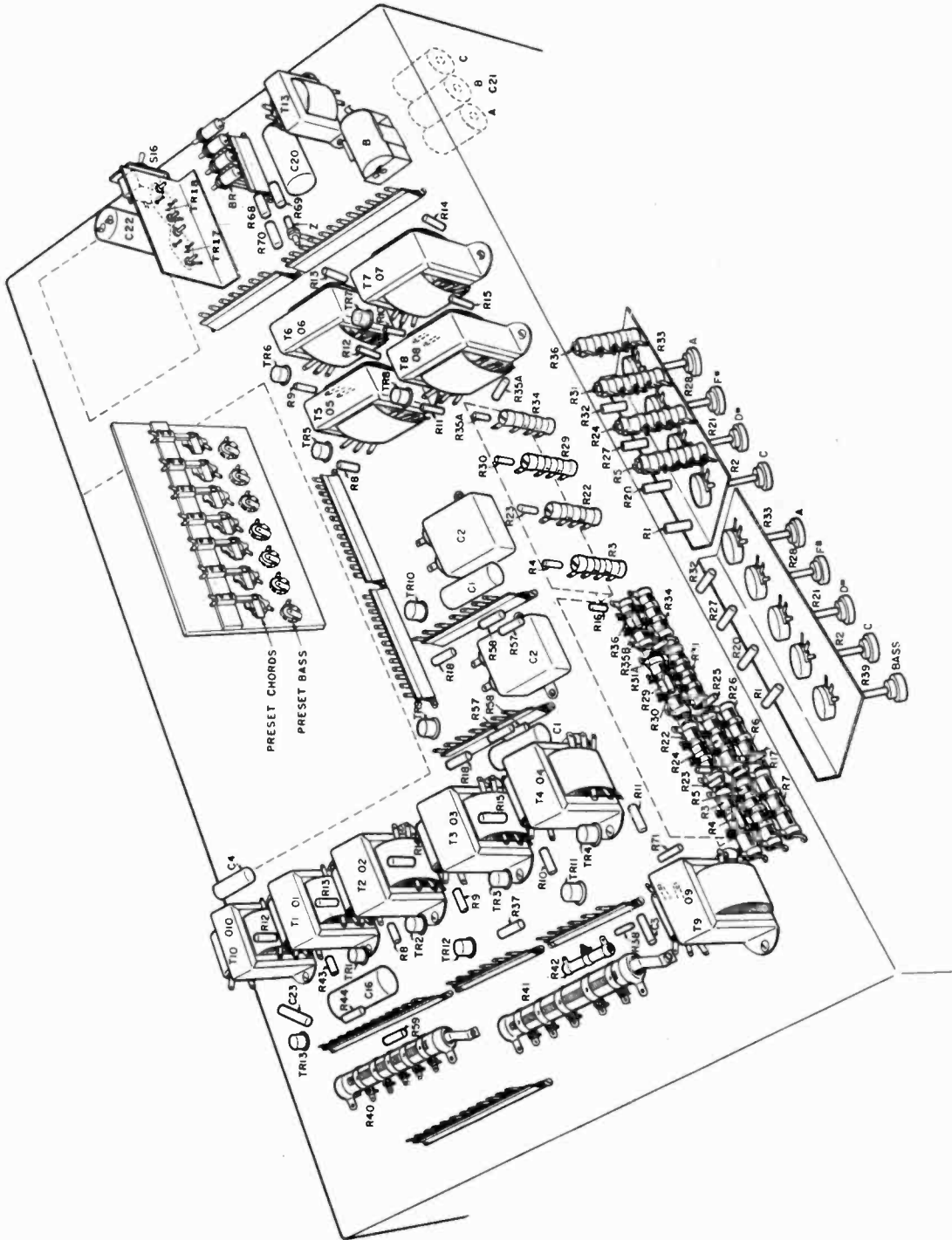

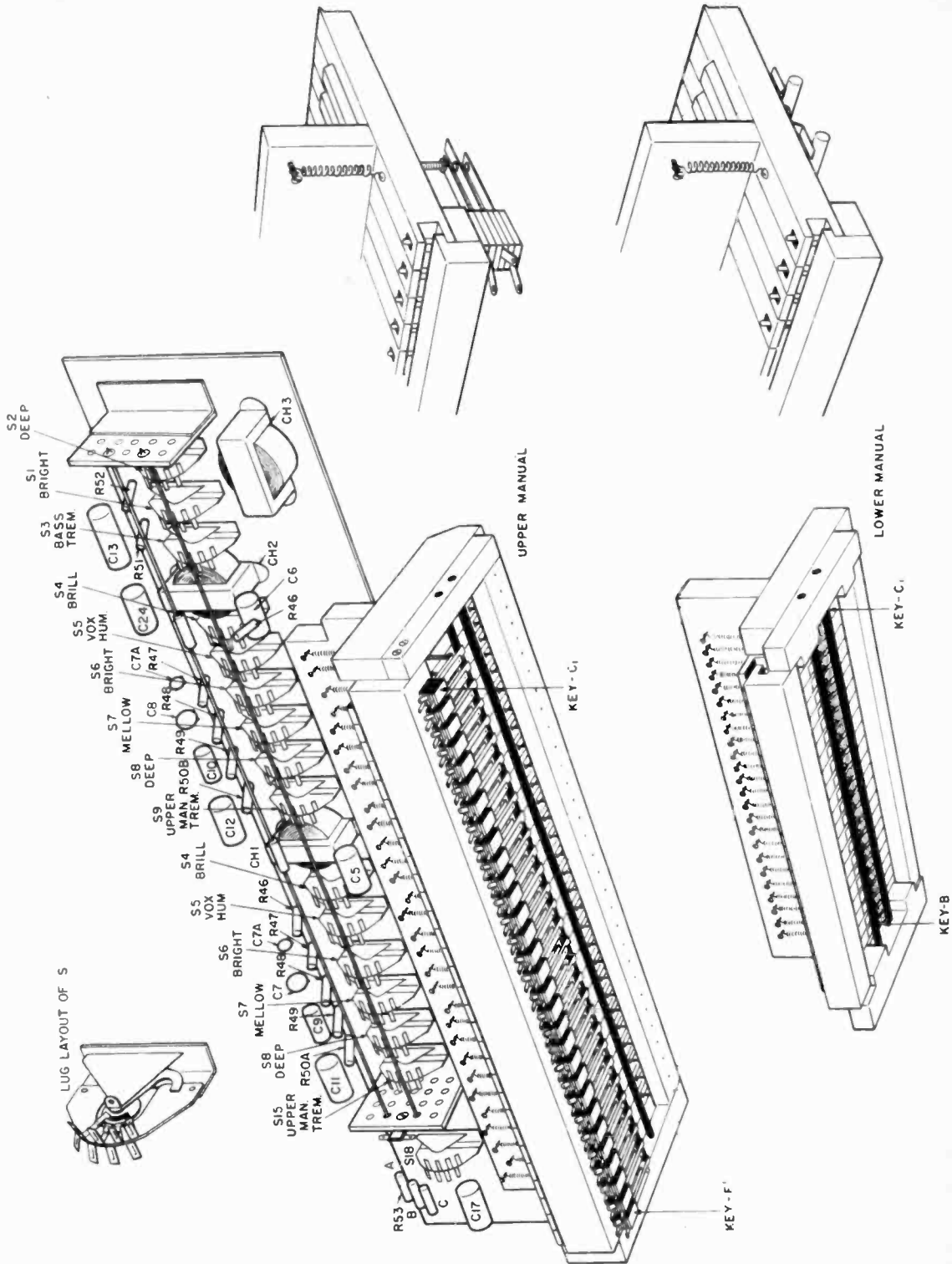



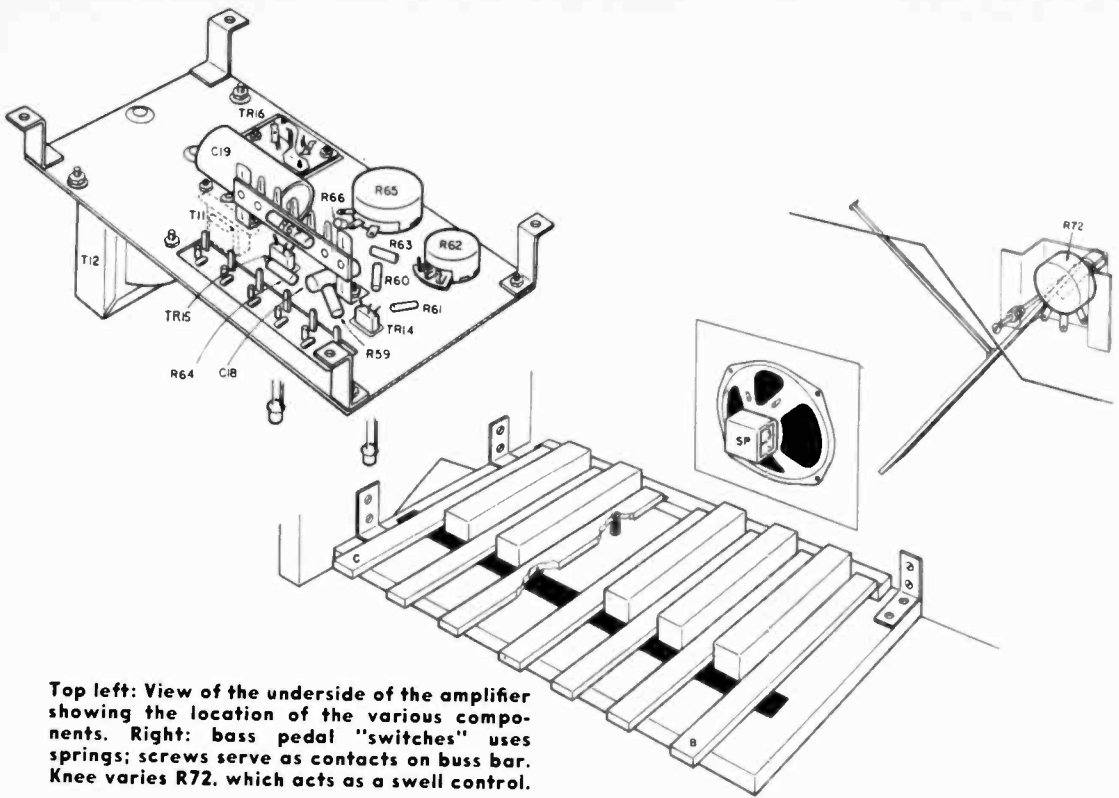

**Top left:** View of the underside of the amplifier showing the location of the various components. **Right:** bass pedal "switches" uses springs; screws serve as contacts on buss bar. **Knee varies R72,** which acts as a swell control.

but, more important, as a key click filter and attack rate control.

### Keyboard Contacts and Preset Chord Organ

The taps on the tuning resistor strings are brought to contact springs on the respective manual keys. The contact arrangement provides a contact to the +1.5 volt buss, which starts oscillation in the appropriate oscillator and at the same time connects this

Fig. 4

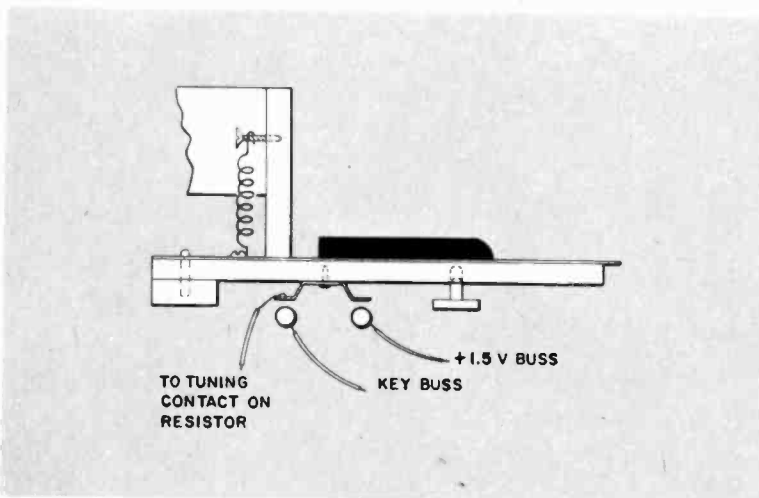

buss to the keying buss which initiates the attack control circuitry.

The best arrangement to obtain this switching is a stack of three leaf springs under each key, as suggested in Figure 3. Convenient springs for this purpose are those commonly used on relays. These may be built from available sets, see parts list.

A more economical and simpler contact arrangement is a double fold single spring and two solid copper busses running the length of the keyboard. This is sketched in Figure 4. These springs are conveniently folded from  $\frac{3}{8}'' \times 1\frac{1}{4}''$  strips of .005 phosphor bronze. They are held to the key by a screw or bolt. The buss bars are  $\frac{1}{4}$  inch diameter copper or brass rod.

### Preset Chord Switching

In the event a preset chord register is desired, this is conveniently obtained by tapping off the lower manual resistor contacts at proper intervals to form the desired chords and keying these on a push-button multiple contact switch. The taps for four representative three-tone major chords are shown on page 73. Of course, as many chords as desired can be incorporated in this section. For reasonably complete playing in any possible key, approximately 90 buttons will be required. However, a good deal of playing in two or three of the simpler keys can be obtained with relatively few preset chords. In the model organ, seven major chords have been provided. The addition of a few minor and diminished chords would be desirable. A schematic list and layout of the chord system used on the model is given here:

O	O	O	O	O	O	O		Chord Buttons
	O	O	O	O	O	O	O	Bass Buttons
(Bb)	F	C	G	D	A	E		

Bb maj.	F maj.	C maj.	G maj.	D maj.	A maj.	E maj.
A <sub>1</sub> <sup>#</sup> (Bb)	A <sub>1</sub>	G <sub>1</sub>	G <sub>1</sub>	A <sub>1</sub>	A <sub>1</sub>	C <sub>1</sub> <sup>#</sup>
D	C	C	B <sub>1</sub>	D	C <sub>1</sub> <sup>#</sup>	B <sub>1</sub>
F	F	E	D	F <sub>1</sub> <sup>#</sup>	E	E

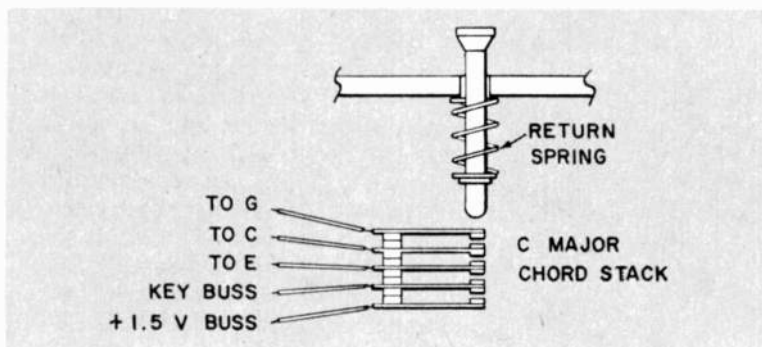

The bottom row of buttons in the box are connected to the indicated intervals on the bass resistor contacts.

One way of obtaining the multiple contacts required is again using the relay leaf springs. Five springs are required for each chord—three contacting the chord intervals, the remaining two acting as keying and +1.5 volt buss contacts, respectively. A spring stack suitable for the purpose is shown above.

Bass push buttons require only a simple "make" contact.

### The Bass Organ and Vibrato Generator

The bass oscillator O<sub>1</sub> is similar to the keyboard oscillators already described. The circuitry is shown on page 72. A .05 mfd

capacitor is applied across the collector coil. Taps 1 and 6 on the A-3841 transformer are used. The lower tone is  $C_{11}$ , 64 cps. This is obtained through  $R_{39}$ , a 1000 ohm potentiometer set at about 320 ohms.  $R_{40}$  and  $R_{41}$  are conveniently 500 ohm and 100 ohm 10 watt adjustable resistors with tap rings. The large size of these resistors aids in the distribution of the contacts without interference due to close spacing.

The base tones,  $C_{11}$  to  $B_{11}$ , are actuated by a 12 note pedal clavier on the floor or by the bass buttons on the preset chord register.

The tremolo oscillator,  $O_{10}$  (Page 72), is set up using the same A-3841 transformer as in the other oscillators. The collector circuit operates on -12 volts and the autoformer output from the collector coil of the transformer provides about 30 volts peak to peak for the vibrato modulation. This signal is attenuated with a knob control for vibrato intensity and fed into the manual and bass oscillators through stop switches. If a faster vibrato is preferred, this may be obtained by reducing the size of the capacitor  $C_{16}$ .

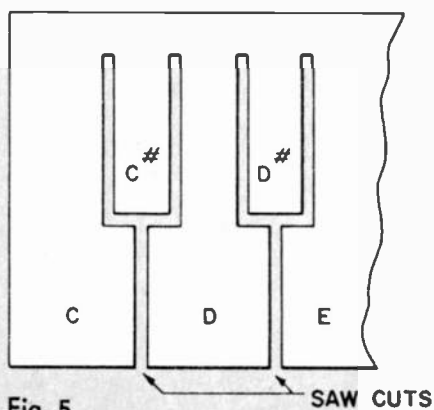

Fig. 5

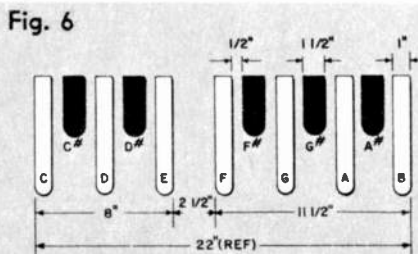
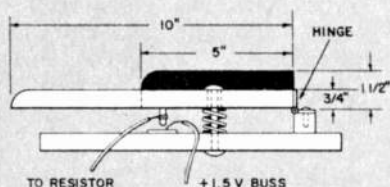

Fig. 6



### Keyboards and Pedal Clavier

Suitable keyboards for building this instrument may be obtained in various ways. Standard 5 octave organ keyboards can be obtained with or without contacts for approximately \$100.00 to \$150.00 from Electronic Organ Arts, Los Angeles, California. Three octave piano practice keyboards may be purchased through most piano stores for approximately \$50.00. Keyboards may also be obtained from discarded piano or reed organs. The latter keyboards are especially adaptable.

Finally, of course, keyboards can be built. This is especially practicable with power wood working tools. The key dimensions and layout can be obtained from any keyboard instrument. The wooden key forms can be covered with white plastic for the best appearance. In the event a keyboard without return spring action is obtained or built, excellent key "feel" can be obtained by suspending each key on a coil spring of the proper weight and length. A  $\frac{3}{4}$ -inch length of  $\frac{3}{16}$ -inch diameter spring close wound with 10 mil steel wire and stretched to about  $1\frac{1}{2}$  inches is about right. This is shown at left.

A novel form of keyboard which is very much simpler to make can be cut from a piece of copper clad laminate. This is a copper coated plastic sheet de-

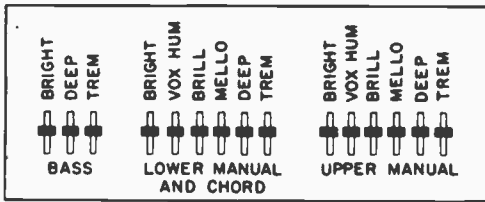

since the action is quite hard.

A twelve note (one octave) pedal keyboard can be purchased from the same source quoted previously for about \$35.00. It can also be easily built from pieces of wood. Some suggested construction details are given in Figure 6.

### Voicing and Balancing

The circuitry used in the model organ for voicing the outputs of the manual and bass oscillators is shown on page 73. Five voices have been included for each manual and two voices for the bass. These tones, as well as a vibrato "on" for each component are switched in by means of the stops on the panel across the top of the instrument.

Balancing is obtained through the series resistors out of the voicing filters. This balancing is required to render the outputs from the filters approximately the same in output intensity, and is necessary since the filters attenuate the oscillator output signal more or less. Some variation from the resistor values given may be desirable. A weak output is built up by reducing the resistor, and a strong one attenuated by increasing the resistor.

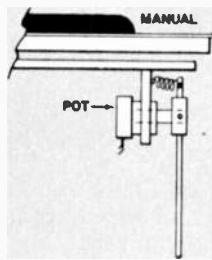
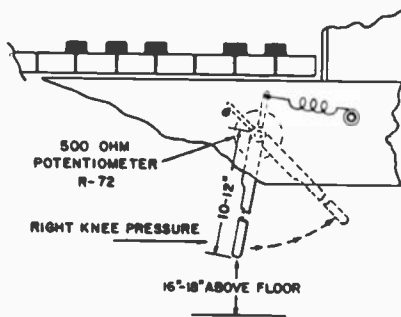

Fig. 11

control arrangement is probably a knee operated control at the right under the keyboards, as shown on this page.

The output may be fed through a suitable cable into a record player, hi fi, or television. A good amplifier and speaker system of this type makes an excellent reproducer for the organ music and saves the expense of the built-in amplifier and speaker.

### Final Amplifier and Power Supply

The final amplifier and associated power supply used in the organ model is quite suitable for home playing. The Class A amplifier delivers about 2 watts into the speaker at full usable volume. The amplifier, whose schematic is on page 72, uses three transistors and is easily built. A six contact terminal strip is used for the input and output. The parts layout appears on page 76.  $R_{72}$  is the knee-operated swell control which is mounted on the right side of the organ beneath the table top.

### Volume Control

The common output line from the voicing filters goes to the volume control. The simplest dynamic volume control.

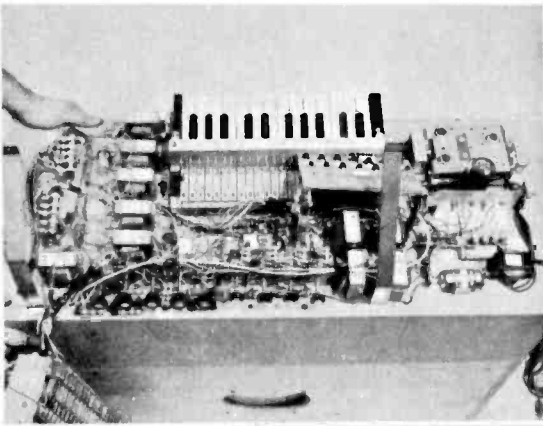

Left, organ with upper manual keyboard and voicing and stop panel removed. Old audio amplifier is at upper right of console. Below is EI designed audio amplifier, easier to build. Note power transistor mounting.

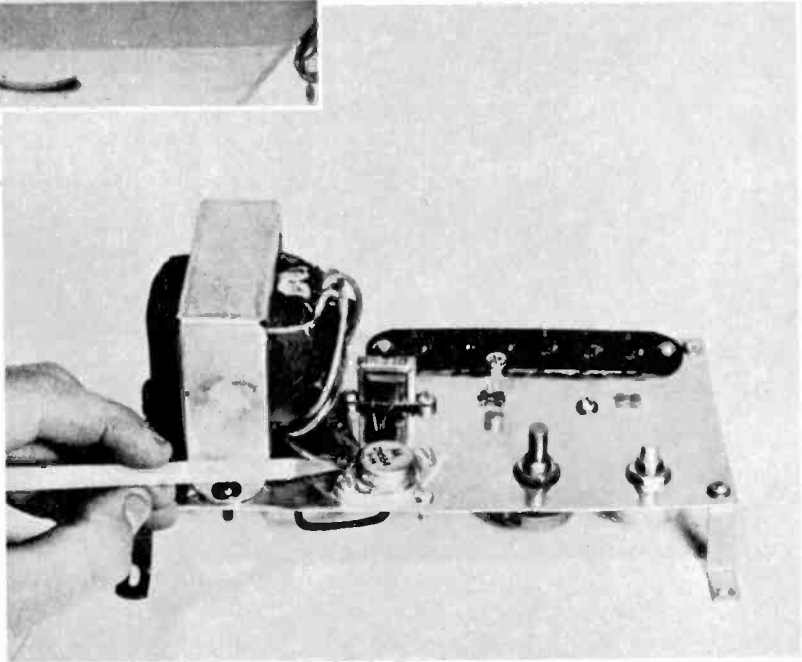

### Final Tuning and Stability

The final tuning consists of adjustment of the various "string" and bass potentiometers to tune in accurately the fundamental tones.

To reiterate, these are on both manuals— $C_1$ ,  $D\sharp_1$ ,  $F\sharp$ , and  $A$ , and on the bass,  $C_{11}$ . The manual tones are in the octave below middle  $C$ . The bass note  $C_{11}$  is the second octave below middle  $C$ . The four tuning notes for the manuals form a diminished seventh chord on  $C$  when sounded together.

The final tuning should be done at a time when the room temperature is normal. Even though the oscillator circuits are quite stable, large changes in temperature may tend to detune the instrument. This will be worse on the extended higher tones, such as those tuned by  $R_5$  and  $R_7$  on the  $C$  string. If those drift off, adjustment of  $R_4$  and  $R_6$  will correct them. Therefore, if difficulty is experienced in keeping the instrument in tune, "span" controls can be introduced by making  $R_4$  and  $R_6$  adjustable. The same conditions will prevail in reference to the  $D\sharp$ ,  $F\sharp$ , and  $A$  strings.

The half tone intervals are tuned by adjusting the clamp rings on  $R_3$ ,  $R_5$ , and  $R_7$ . In the event one of these cannot quite reach the required interval, a small series resistor may be introduced in the take-off line as indicated by  $R_{16}$  and  $R_{17}$  on the upper and lower manual schematics. 



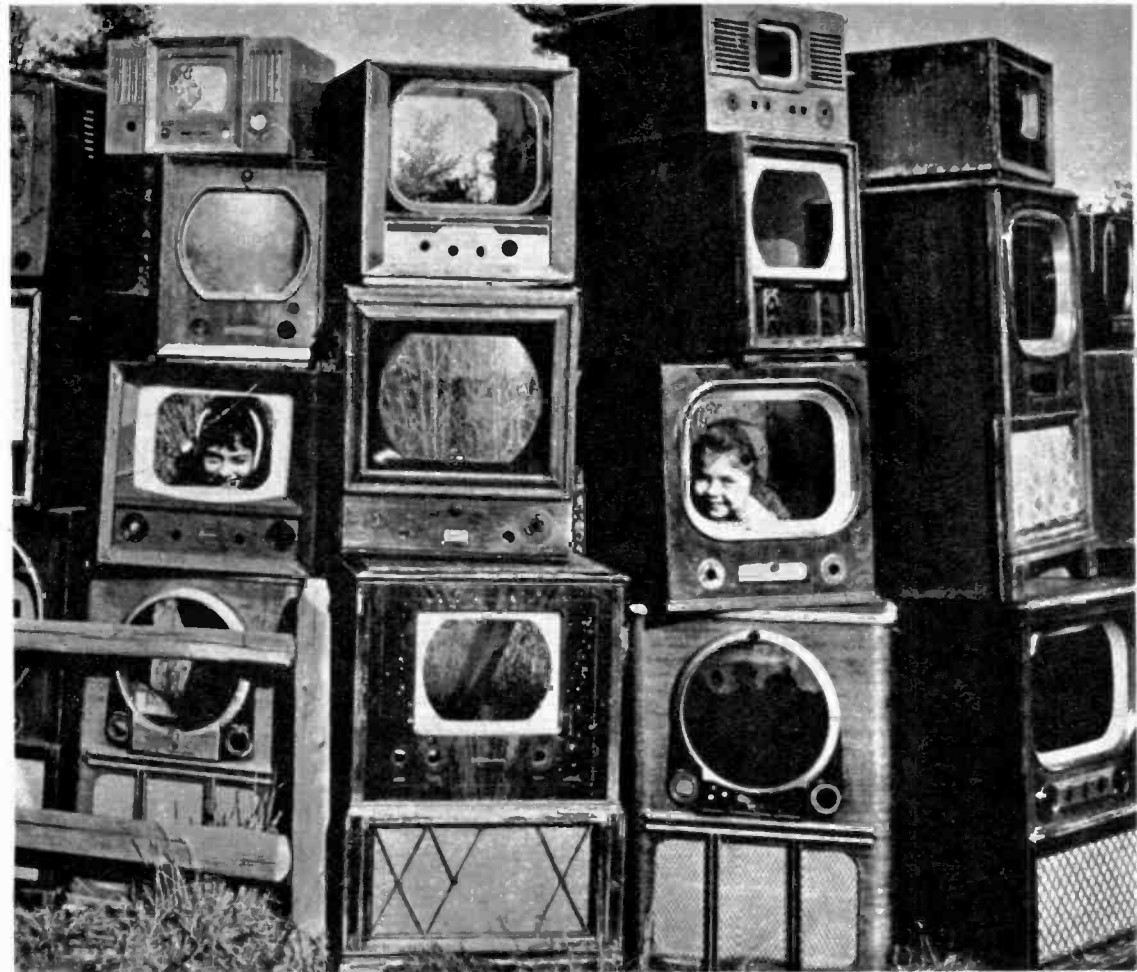

Ever wonder what happened to that old TV set of yours, vintage 1947-50? In Raynham, Mass., two girls have turned a TV graveyard into a playground where they can let their imaginations and smiling faces shine through the screens in "programming" that would warm the heart of any viewer.

It looks like a typewriter, but it's a new battery-operated Morse code transmitter that allows anyone to send dits and dahs just by depressing the appropriate key. It is being installed in lifeboats throughout Scandinavia and is made by Automorse Ltd., Gothenburg, Sweden. Perhaps a model will be made for hams (lids only).





Photos by  
John Hamilton  
of Globe

Television set in miniature home actually works. Although screen is tiny, the other parts of the set extend for about a foot beyond back of display.

Finding proper components for tiny set was a big problem for Jack Shepard, shown assembling the unit. Tubes are on a printed circuit.

Shepard makes final connections before installing set in "room." Many viewers think picture is from standard set reflected onto small screen.

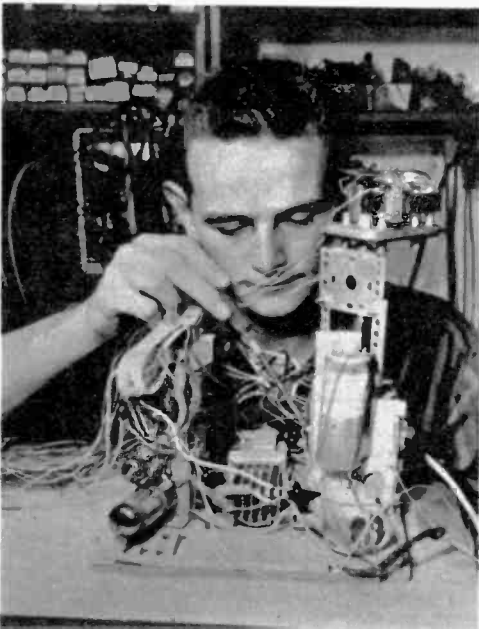

# World's Smallest TV Screen

There was no two-inch picture tube, so they made one for this sharp Lilliputian television set.

**Y**ES, a two-inch television screen, probably the world's smallest, is working a 12-hour day in Pomona, Calif. The man who made it was told it couldn't be done—but he did it.

Jack Shepard was called in to service a three-inch pilot set at the Mott Miniatures exhibit in Knott's Berry Farm, a popular tourist attraction. The subject of a two-inch screen was raised by Mr. Mott. Shepard accepted the challenge and set to work, but soon found out that there was no such thing as a two-inch cathode ray tube. The skeptics had a field day wagering that the project would go down the drain.

Undaunted, Shepard finally located a company in Los Angeles that claimed it could build any tube from scratch. After testing a rectangular tube, they evolved a two-inch round picture tube a foot long. Anode voltage had to be below 500 volts and Shepard had to find a suitable yoke and flyback transformer. The yoke nearest satisfactory still required much modification. A printed circuit holds the audio, IF, horizontal and vertical circuitry. There is also a remote control unit. It took Shepard a year to complete the job, but now the set operates from 10:30 a.m. to 10:30 p.m. daily and requires less adjustment than many a 21-incher.

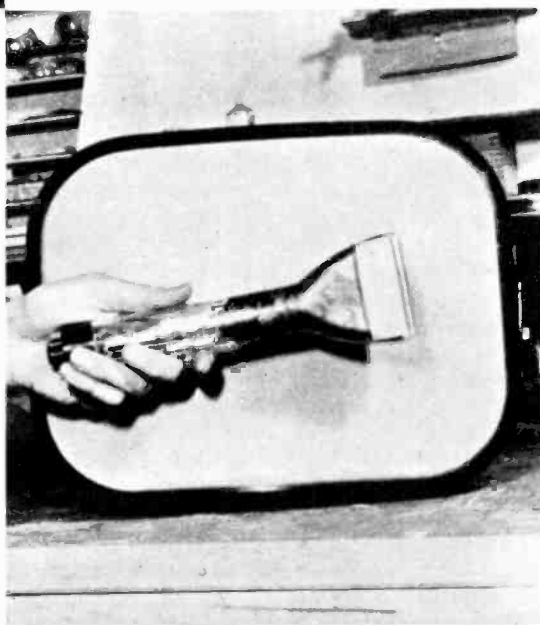

Specially built rectangular two-inch tube is compared with standard console 21-incher. The rectangular tube gave an out-of-focus picture (right) and was abandoned in favor of round tube. Remote control box contains audio.

# Electronic Brain

Have you any question on electronics? Send it in and the Electronic Brain will provide the answer.

## Convert Hearing Aid to Radio

How can I convert a three-transistor hearing aid to a portable radio?

Kenneth C. Bachman,  
Clearwater, Fla.

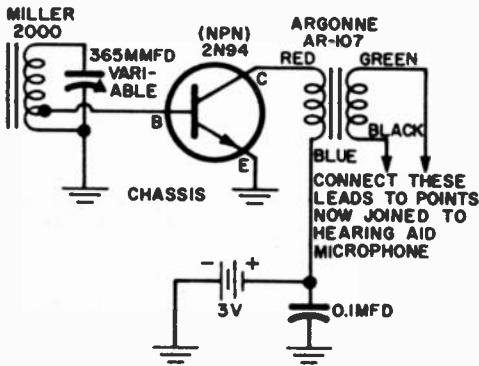

The circuit for converting a transistor hearing aid into a portable radio appears above. Since we cannot tell whether your hearing aid contains npn or pnp transistors, the circuit we are providing is equipped with its own battery to avoid complications.

## Electronic Vibrato

On what principle is electronic vibrato for musical instrument amplifiers based? Where can I obtain a simple schematic diagram for a vibrato unit?

A. L. Crawford, Newfoundland

In electronic vibrato, the audio voltages from the instrument microphone are varied in amplitude by changing the gain of one of the voltage amplifier tubes at a periodic rate. Generally, a sine wave oscillator of low frequency—such as a phase-shift oscillator or Wien Bridge oscillator—is coupled to a so-called mixer or modulator tube which also acts as a voltage amplifier for the music signal. As the oscillator output voltage swings up and down between peak values, the gain of the mixer tube is changed accordingly so that the sound

from the speaker changes in volume at the vibrato rate.

Electronic tremolo is not what one would call a "simple" process. Hence, there is no simple schematic diagram for such a unit. However, in the December 1958 issue of *Electronics Illustrated* we have an article on a complete tremolo amplifier system from which you could extract the tremolo portion if you so desired. This would require some electronic experience and is not recommended unless you have done some circuit study in the past.

## Ham Transmitter Conversion

Is it feasible to convert a bandswitching, crystal-controlled, 10 meter to 80 meter transmitter for 2-meter operation?

Jack Pinkham, W. Hyattsville, Md.

This type of conversion is seldom advisable for the following reasons:

(a) The power amplifier tube was very probably designed for normal high-frequency operation and would not be suited for the very-high frequencies. This would mean that you would have to replace the present power tube with another of the proper characteristics.

(b) To use crystal-control at these frequencies is possible, but difficult, unless the transmitter has been designed specifically toward this end. It is certainly not a good idea to use the final amplifier as a frequency multiplier.

(c) Your present bandswitching system would have to be completely redesigned. This would undoubtedly introduce serious power losses and might affect the performance of the transmitter on the lower frequencies.

In general, transmitters for 2-meters should be carefully planned and executed for this band of frequencies alone, giving special attention to avoiding losses that are so common at very-high frequencies.

## DX on Broadcast Band

I would like to try "dx-ing" the broadcast band with an ordinary table model radio. What sort of antenna would be best?

Bob Drake,  
Chicago, Illinois

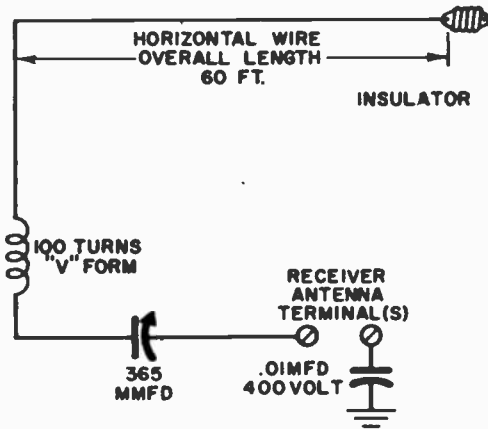

It is questionable whether a standard table model radio has sufficient selectivity to any amount of successful "dx-ing" on the broadcast band. If its sensitivity is improved by working it from a long wire antenna, its selectivity may prove inadequate. This would have to be determined experimentally.

The simplest and least expensive type of antenna for this application consists of a single wire as high as possible, from 60 to 100 feet in length. It should be terminated at the receiver end in a coil having about 100 turns of any kind of wire wound on a 1 inch diameter cardboard cylinder in series with an old variable capacitor taken from a discarded radio. The receiver should be grounded by connecting its chassis to a cold water pipe through a .01 mfd capacitor having a voltage rating of not less than 400 volts. (See diagram).

In use, the antenna is tuned to the station being received by peaking its response with the variable capacitor. In this way, interference from nearby stations can often be minimized.

## BC Oscillator

Can you tell me what factor or factors control the power output of this oscilla-

tor circuit? It is designed to operate within the broadcast band.

Richard L. Hackney,  
Fountain City, Tenn.

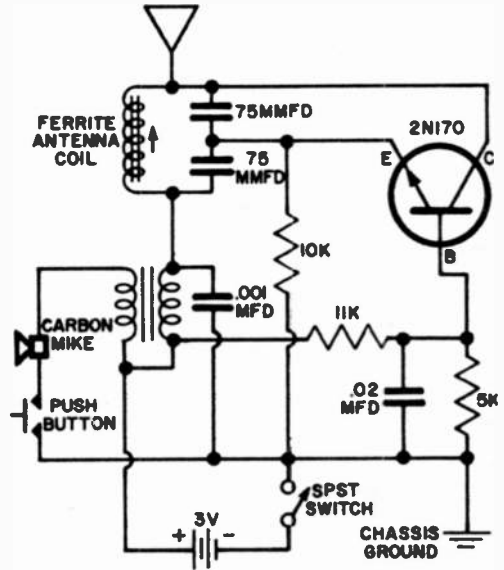

This circuit is a base-modulated radio frequency oscillator apparently tuned to some portion of the broadcast band. When considering the output of such a device, one must take two separate factors into account: (a) the RF power delivered to the radiator by the transistor oscillator and (b) the percentage of modulation that can be expected.

The RF power is governed entirely by the power input to the transistor and its efficiency of oscillation. The 2N170, a General Electric transistor, is rated at a maximum collector power dissipation of 55 milliwatts. Assuming something like 50% efficiency, the power output with 110 mw input would then be 55 milliwatts, too. Thus, power output can be varied only below this value; reduction of battery voltage would be the most sensible way to do this.

Unless the carbon microphone has high output, it would be impossible to realize more than possibly 25% modulation. This would be another limitation on the amount of output. Remember, too, that too much modulation will cause frequency as well as amplitude changes in the emitted wave.



# Mobile Command Post

**H**ERE is a mobile communications unit so complete that just about any disaster or emergency happening in the Los Angeles area can be handled by the police without wasted time or effort. A 12-channel transmitter, one channel for each of nine police division frequencies, the sheriff's department, Civil Defense, and one miscellaneous frequency provide enough two-way radio to coordinate operations involving police cars on the move, fire fighters and the various headquarters stations.

Also available in the van are tape recording facilities to record witnesses' statements on the spot, a public address system, external telephone terminals, a special radio channel which can be used by newsmen to call in their stories directly from the disaster scene, a map library, transistorized megaphones, portable walkie-talkies, a heli-light to direct the police helicopter at night, and five different power systems. The main power supply is a Kohler generator that puts out 3500 watts and can run 74 hours on the 240 gallon gasoline tank in the van.



Photos by Lou Jacobs Jr.

No less than 13 antennas protrude from mobile communications station. PA speakers, too!

Driver of the van can maintain radio contact with other units, control power distribution.



Gasoline generator at truck's rear can power all radio and electrical gear for 72 hours.

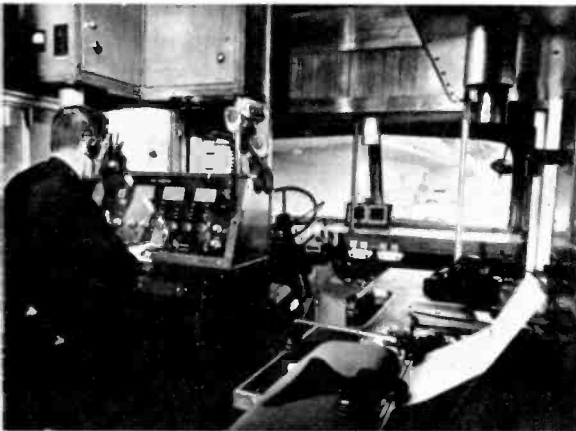

Console, above, handles 12 frequencies. Operator acts as liaison for all disaster units.

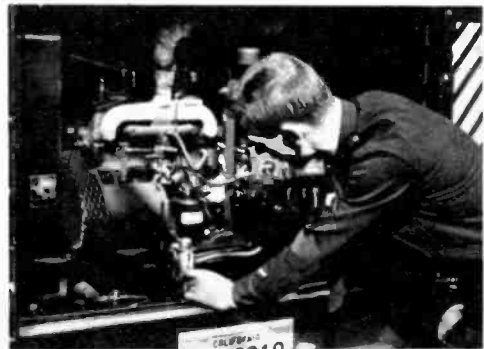

# Telephone Amplifier

By Steven Hahn

**Built into a drinking glass, this unit serves two uses: for the hard of hearing and group listening.**

**T**HE telephone amplifier described here can be constructed for under \$10. The little amplifier contains its own miniature speaker, pickup coil, volume control with switch, battery, and 3 stage transistor amplifier. The entire unit is built into a dime store polyethylene or plastic drinking glass. These plastic glasses can easily be worked with a sharp razor blade or knife. If a hard plastic is used, a heated knife can be employed to make the various holes and openings.

A pickup coil for the telephone amplifier is not commercially available and must be wound. To wind it, two squares measuring approximately  $1\frac{1}{2}$ " x  $1\frac{1}{2}$ " are cut out of very stiff cardboard. A  $\frac{1}{4}$ " hole is punched through the center of each square and the

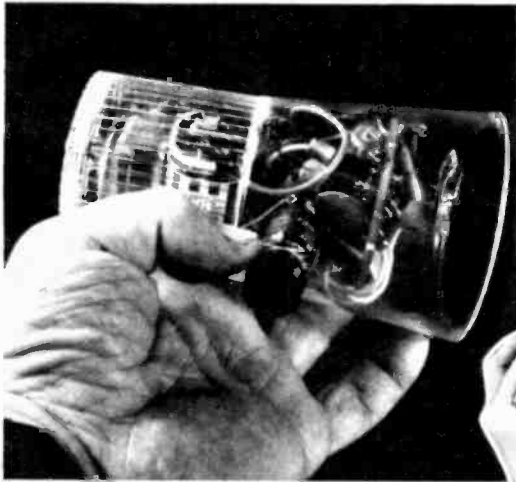

Thumb points to volume control knob on the completed unit, here unpainted. Photo at right shows device in use. Speaker end is placed against ear, other end to telephone.



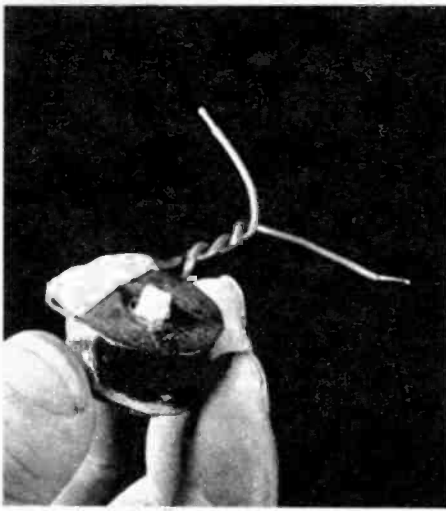

Inductive pickup coil is at the left. Two heavy wires are soldered to coil leads.



Hole in closed end of glass is cut for speaker, secured in place by two screws.

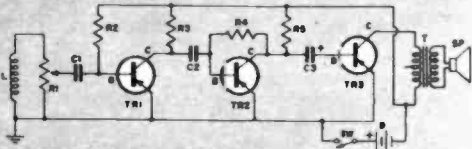

Amplifier schematic. Three transistors are used between pickup L and speaker SP.

Basic components removed from glass include electronic sub-assembly, battery, and volume control.



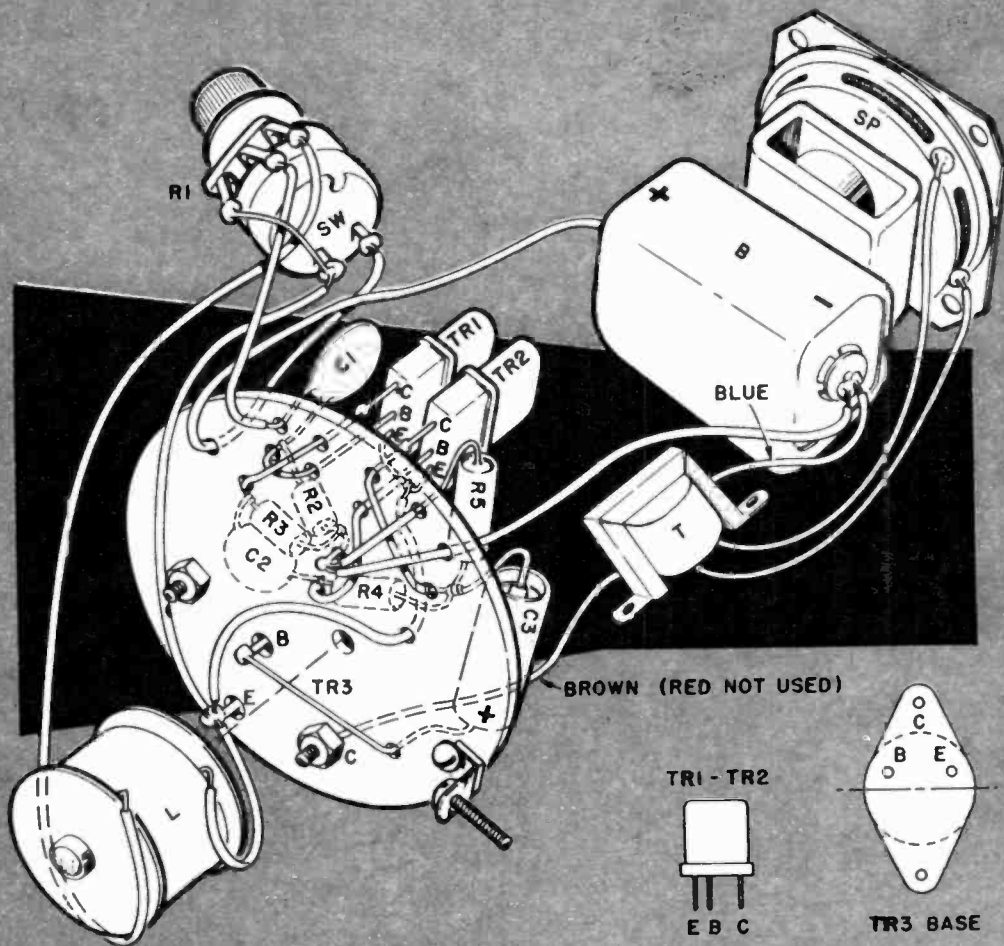

The components shown in the wiring guide are drawn in the relative positions they occupy when mounted within the glass. TR base layouts are lower right.

squares are then slid on a 5" piece of 1/4" wooden dowel. The two squares are positioned in the center of the dowel and are spaced 3/4" apart. Some Duco cement is used to hold the cardboard pieces firmly to the dowel. This fixture constitutes the coil winding form.

The dowel is then inserted into the chuck of a small hand drill or into the chuck of a slow electric drill. The actual winding is done with No. 38 or No. 42 enamel magnet wire. An ohmmeter comes in very handy in winding this coil since the total DC resistance should be no less than 1000 ohms. If an ohmmeter is not available, you will have to keep track of the number of turns; at least 3,000 to 4,000 turns are necessary in order to achieve proper coil resistance.

After the coil has been wound in this fashion, the dowel bobbin is carefully removed from the chuck. A saw or good pair of wire cutters is used to clip the  
 [Continued on page 116]

#### PARTS LIST

- R1—5000 ohm potentiometer with switch SW (Lafayette VC-27)
- R2, R4—1 megohm resistor 1/2 watt
- R3—5600 ohm resistor 1/2 watt
- R5—56,000 ohm resistor 1/2 watt
- C1, C2—1 mfd capacitor 20 volts
- C3—100 mfd electrolytic capacitor 6 volts
- L—Pickup coil (see text)
- TR1, TR2—transistor GT 82 (available at Hudson Radio, 48 W. 48th St., New York, N. Y.)
- TR3—Transistor 2N255
- T—Audio transformer 500 ohm to voice coil (Argonne AR 118)
- SP—Miniature speaker (Lafayette SK-61)
- B—9 volt battery (Eveready 216 or equiv.)
- Misc.—Transistor sockets, drinking glass (see text), perforated board

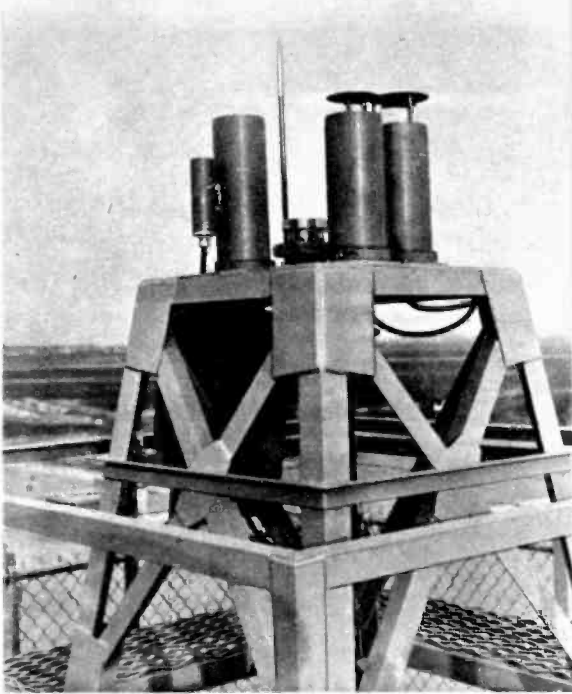

Mounted on steel towers high above vital military and civilian installations are three detectors that work together to recognize nuclear explosions. They are immune to other blasts and lightning. If destroyed, alarm still functions.

Diagrams at right show a typical tower installation and its component parts. Test units which supply a simulated nuclear explosion are mounted near the detectors to permit remote checking of the system for fail-safe readiness.

**Survival or disaster? In an atomic war a few seconds warning may spell the difference. Here is a new . . .**

# Atom Bomb Alarm

**A** SURPRISE nuclear attack resulting in a direct hit would certainly mean the complete destruction of any target. There is no defense against a direct hit. But a near miss in the area of a key underground installation need not mean disaster, even if the bomb blast itself is the first warning. A quick, last-minute button-up—closing blast doors, shielding communications gear and circuitry, turning on air filters—could very well spell the difference between survival and disaster. The button-up must come in that brief period between the moment of explosion and the time it takes the resulting shock, heat and radiation waves to hit the target.

But how can personnel underground know that a blast has occurred before the death-dealing waves reach them? How can they be sure it's an atomic blast and not merely a conventional explosion?

The U.S. Army Signal Research Lab at Fort Monmouth, N.J., has developed an automatic radiation detection and alarm system that not only gives immediate warning of a nuclear blast, but eliminates the need for human decision or delay in the button-up operation.

Atop a steel tower surrounding the installation to be protected are three basic detection instruments: A thermal radiation detector that senses only the waveform of a nuclear detonation; a gamma radiation detector that responds only to radiation with a high rise-rate, as in a nuclear explosion; [*Continued on page 127*]



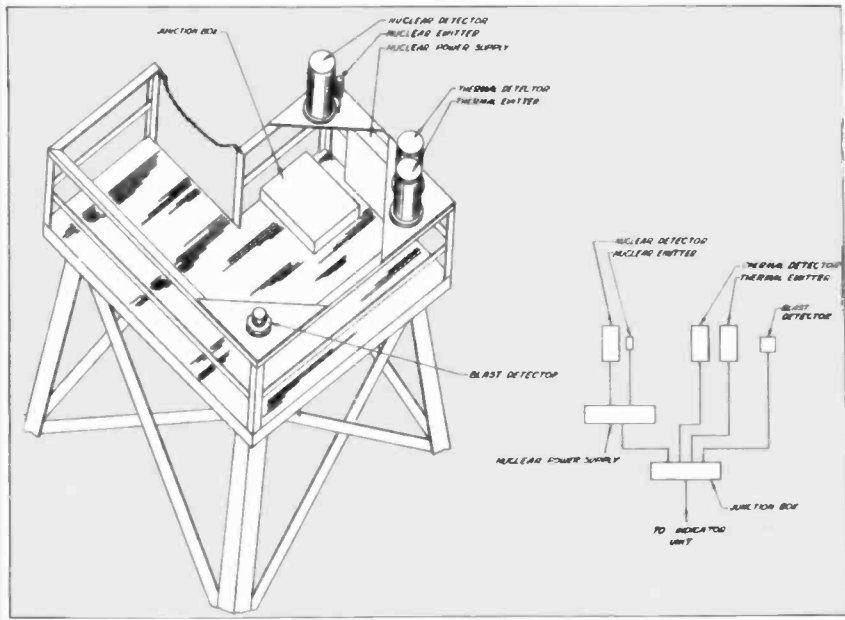

Thermal emitter simulates waveform of atom blast—fast-rising pulse, then longer pulse.

Thermal detector uses red-sensitive photocell to receive flash, sends pulse to relays.

Nuclear detector spots gamma rays from blast; it is immune to cosmic showers, fallout.

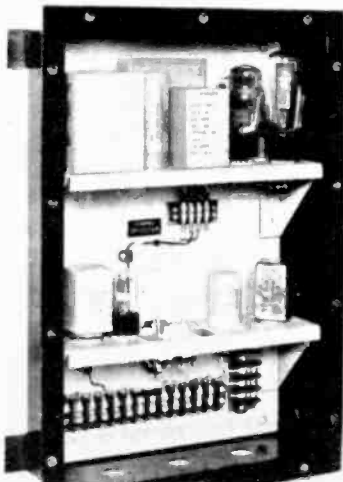

U.S. Army Photos

Power supply panel is located beneath ground. Normal 117-volt, 60-cycle current does the job, but is backed up by battery powered motor generators in case of a sudden power failure.

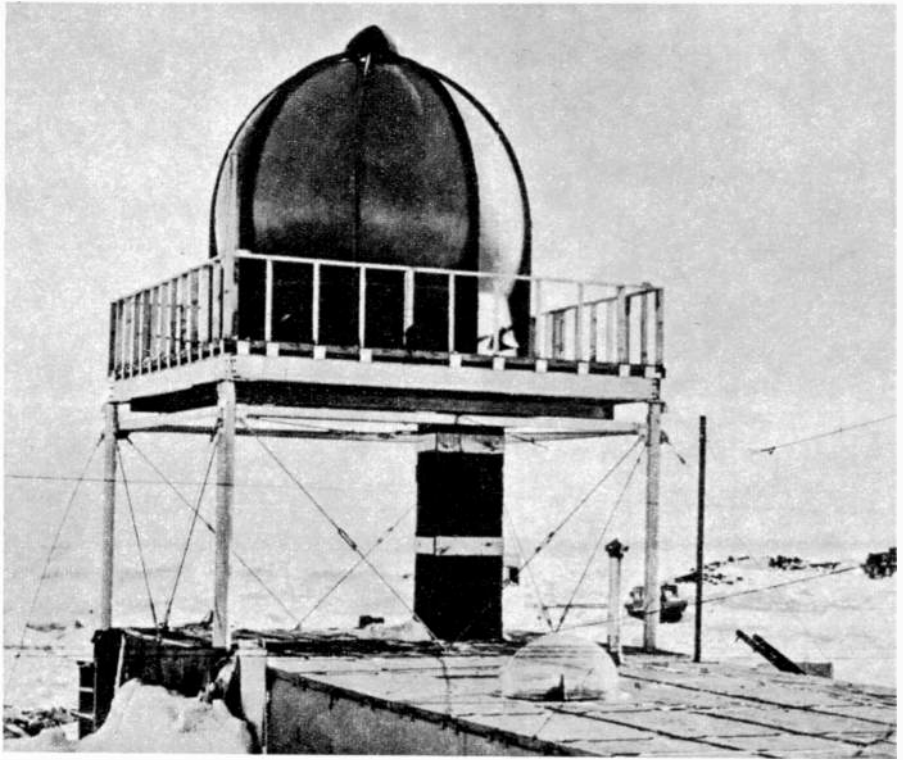

Thanks to permanent outposts at the bottom of the world, weathermen have, for the first time, a fairly complete picture of weather on planet-wide basis.

# What Did Electronics Discover During IGY?

By Lloyd Mallan

**W**ITHIN the past two years, electronics probably has increased man's knowledge of our world by as much as other sciences have contributed during the last half-century. All sciences, of course, interlock. Each gains from the progress of another. But without modern electronics, the greatest cooperative scientific effort in the history of mankind, IGY, might have been impossible.

In fact, the rapid technological advances in electronics and rocketry—two closely united sciences—were the basic inspirations for the establishment of an International Geophysical Year from July 1957 through December 1958. During this 18-month period and beyond, the unknown was sought and found, the unsuspected was unveiled. We have added an immense amount of information to what we already know about the Earth and its environment, planetary space. Not all the data has been evaluated, but almost all of it was recorded electronically.

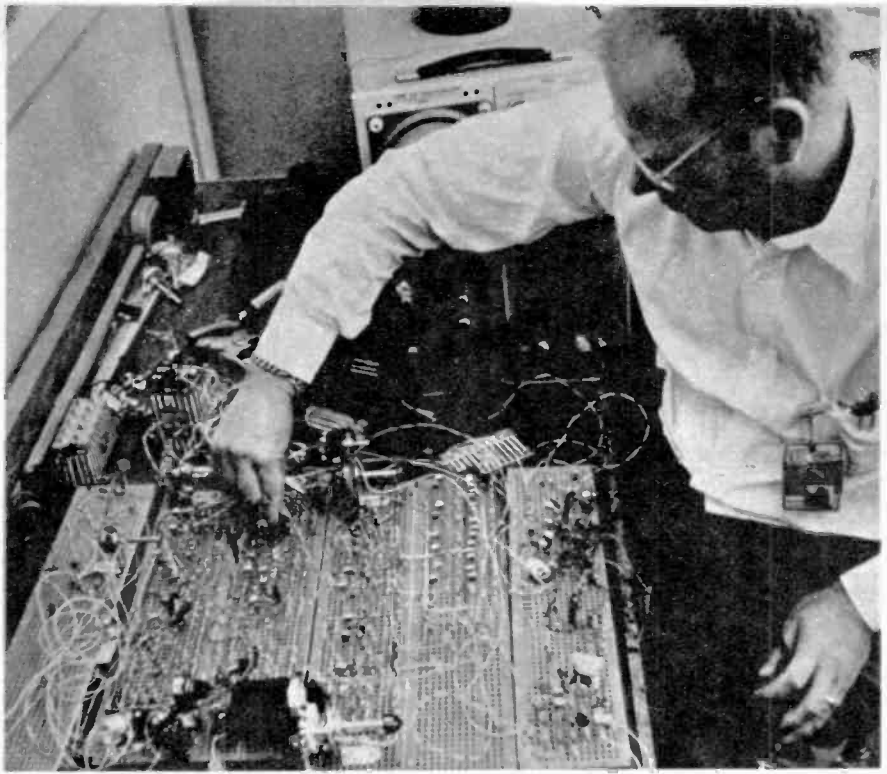

Much planning, breadboarding, and testing of components went into the U.S. satellite program. Here an expert at the Naval Research Laboratories "plays around" with preliminary satellite instrumentation. First Vanguard launched is still transmitting.

At Fort Churchill in Manitoba, Canada, engineer checks Aerobee rocket gear. Aerobee is used in auroral upper atmosphere research.

Here wiring of nose cone instrumentation gets final check before being fired aloft. Engineers came from universities, industry, armed forces,

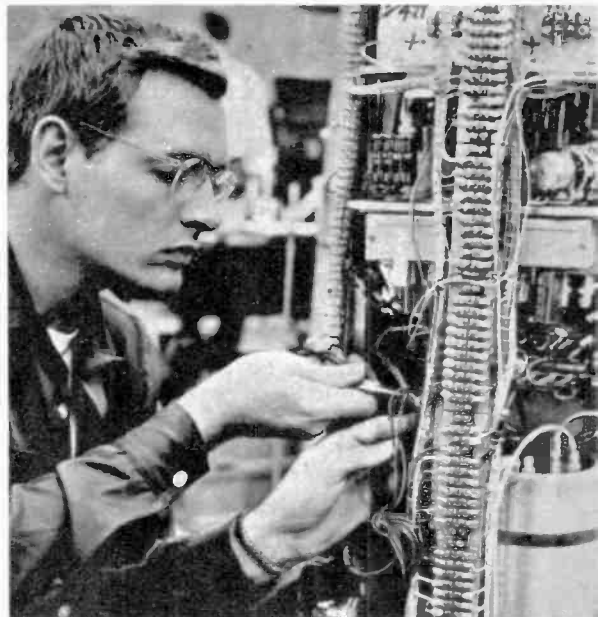

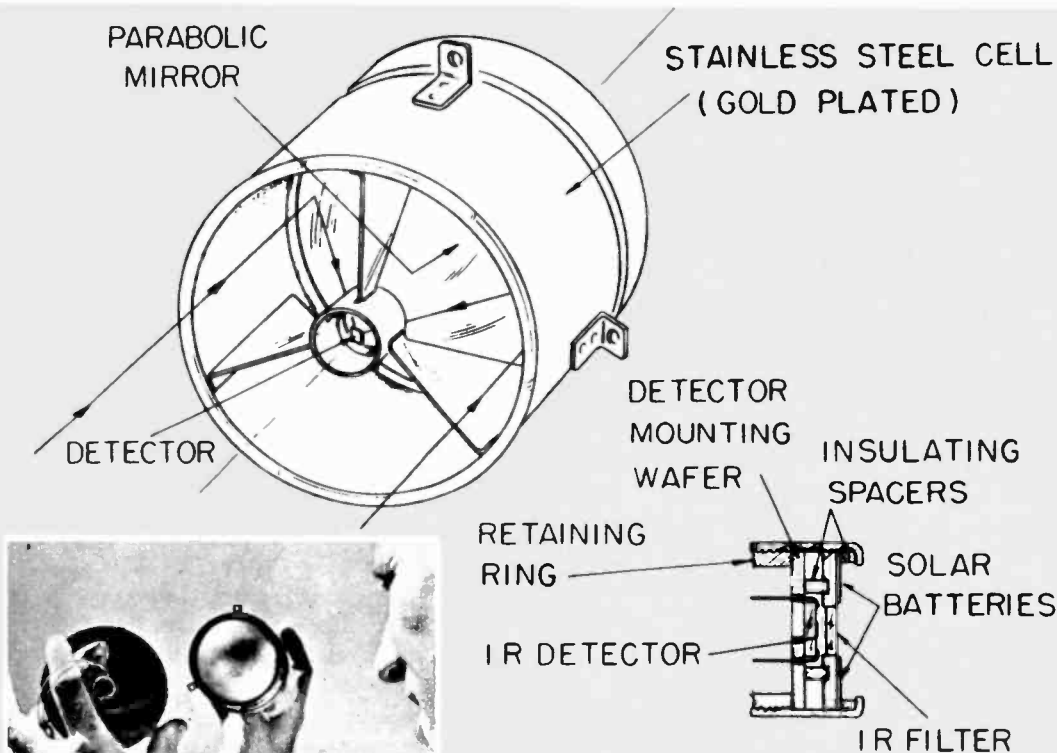

"Eyes" of first U.S. weather satellite "saw" clouds through two optical systems, 3½ oz. each.

Now we know, for instance, that we live in a world surrounded by electricity. Over our heads flows the so-called electrojet, a planet-circling electrical current of about 50,000 amperes less than 200 miles up. Not only was this current's position mapped and found to be over the equator, but similar currents were found circling the North and South magnetic poles. These, it is strongly believed, are responsible for changes in the earth's magnetic field.

Farther out into space, from a few hundred to at least 40,000 miles are the most spectacular discoveries of the IGY—the low and high intensity radiation belts named after Dr. James Van Allen (see "All About Radiation Belts," *Electronics Illustrated*, July 1959). These belts are composed of trapped charged particles, both negative and positive, and were discovered with miniaturized electronic equipment in the Explorer satellites launched by the U. S. Calcula-

tions made from data supplied by similar instruments in rockets fired at the White Sands Proving Ground, New Mexico, and much farther north at Fort Churchill, Canada, showed that the air above the Arctic regions was about 1,400 degrees Kelvin *hotter* than the air above New Mexico! The highest temperatures were recorded at the center of the zone of most intense auroral displays. This tied-in directly with the fact that the outer radiation belt comes very close to the Earth (within 300 kilometers) at the magnetic poles, where the fast-moving charged particles collide with air molecules to generate heat and help create the auroras.

Equally important in terms of manned spaceflight were two other discoveries made possible by electronics. First was the fact that artificial satellites orbiting through clouds of charged particles became charged themselves. These ac-

[Continued on page 114]

The Vanguard Computing Center in Washington, D.C., is the nerve center of IGY data gathering programs. It will take many months to correlate and evaluate great mass of data.



As varied information comes in, it is fed to huge IBM 704 computer installation which sorts and stores valuable tape recorded data for future rapid reference use by all scientists.



**Ionospheric physics:** At Sunset Field Station, very low frequency (VLF) emissions and whistlers are received and recorded via tape.

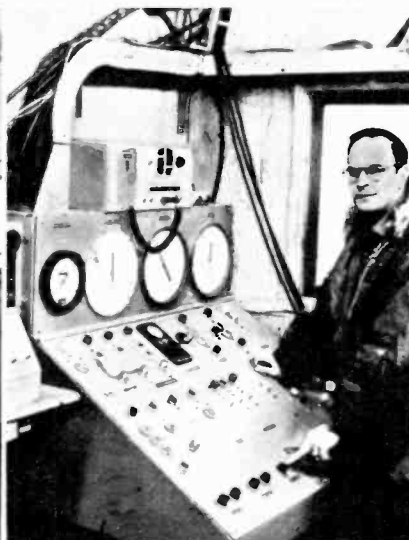

It was parka weather where much of high altitude work was done. Panel is Aerobee check-out system, firing controls for versatile rocket.

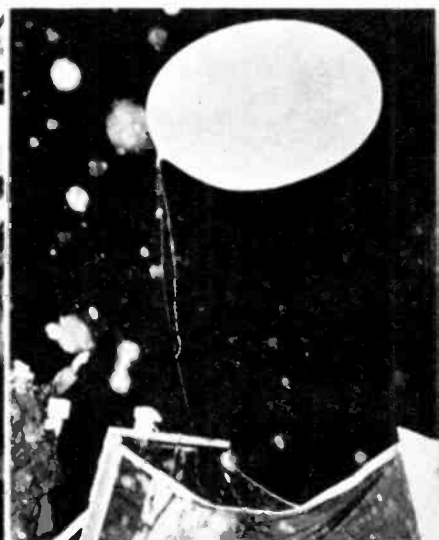

Advanced radiosonde gear in balloons measures temperature, density, pressure and humidity of the upper air at Little America Station.

# how to Wire Shielded Cables

By Joe Roche

**Eliminate noise and hum in your equipment by making proper plug connections on shielded cable.**

**W**HEN your favorite record sounds like a recording of an electrical storm, or the mobile rig begins to make like a sputnik it is time to view the input cable terminals with suspicion. Poor connections at this point become worse than none at all.

The terminal point is the weakest link in the cable after the inner insulation has been cooked with a soldering iron and the shielding stripped back for the connection. And no amount of externally applied tape will help for long.

What makes a good terminal connection? Stripping the cable to correct dimensions, adding additional insulation for heat resistance and providing strain relief for the core conductor does the trick.

Strip the cable end to match the dimensions of the plug or jack to which it attaches. Cut back the center insulation only enough to permit making the connection; the insulation prevents excessive flexing of the core wire at the terminal junction.

A length of varnished spaghetti slipped over the core insulation prevents heat damage. ●

Form shielding pigtails for jack terminal connections by expanding the loom and removing the core wire as shown. A pull on the loom will contract it into a neat pigtail wire as shown below.

To prevent the cable from being pulled off, solder completely around plug. Clip strands from solder joint and cover it with a sleeve, previously slid on cable. Check for cold solder joints.

Trim jacket of the cable to fit this shell type plug. The center conductor must go through the plug's center. A quarter inch of shielding should also be stripped back for a good connection.

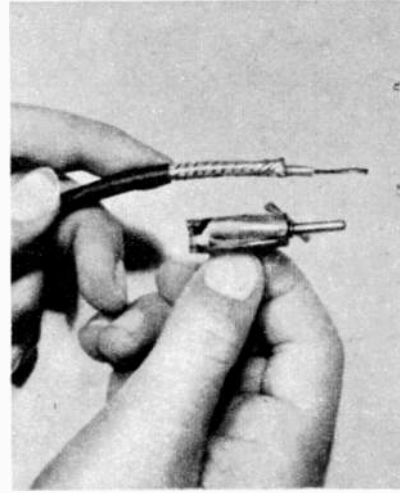
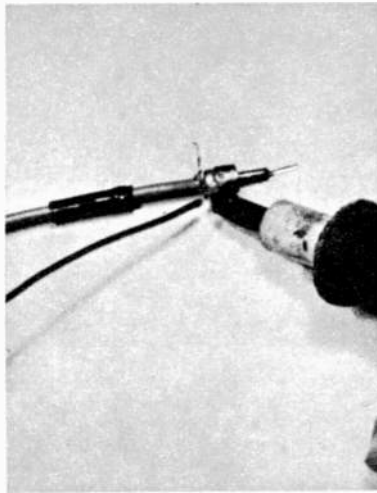
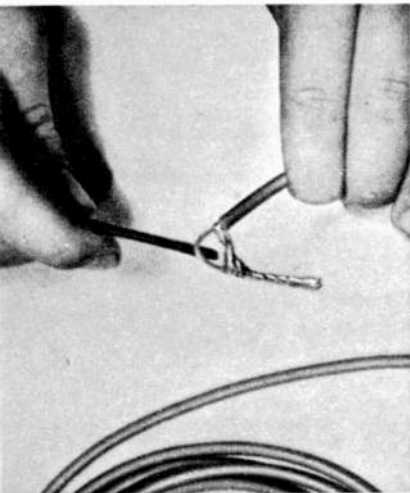



Place the cable shielding over the top of the plug for strong connection. Pushing back on the shield will expand it, permitting the plug to be inserted more easily.

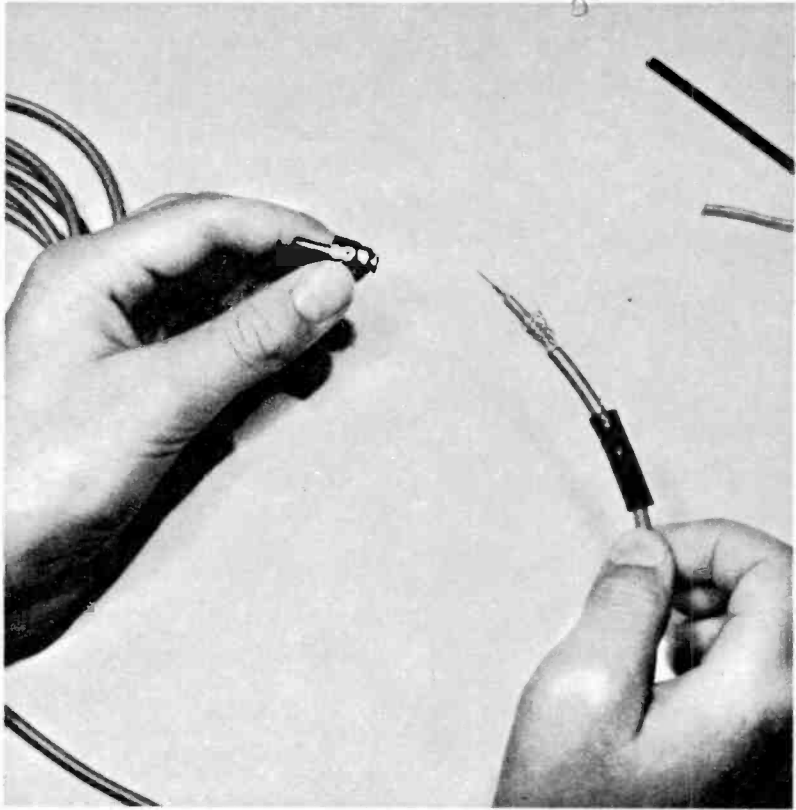

Tin center conductor so strands will not short to shell. Push a length of spaghetti (cambric tubing) over the center conductor and under the shield. This protects inner insulation.

Wrap some turns of tinned wire over the cut ends of the shielding. Clip wire ends and push them flush to the shield. Solder plug shell to wrap. Plastic sleeve may be added, partly covers plug.

Photo shows a shorted antenna plug caused by loose, frayed ends of co-axial shielding. You can avoid these troubles by following the wrapping procedure that is shown at the left.

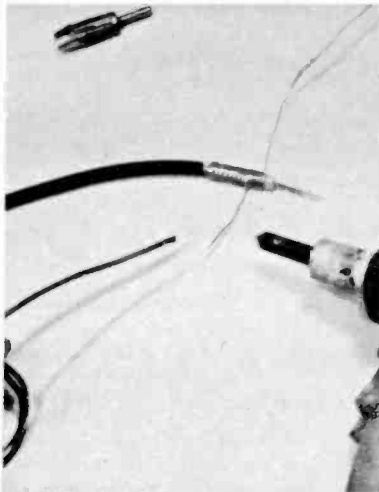
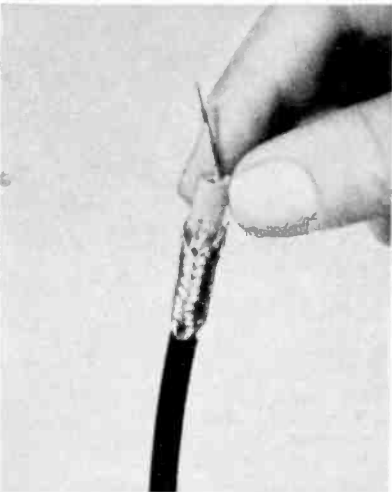

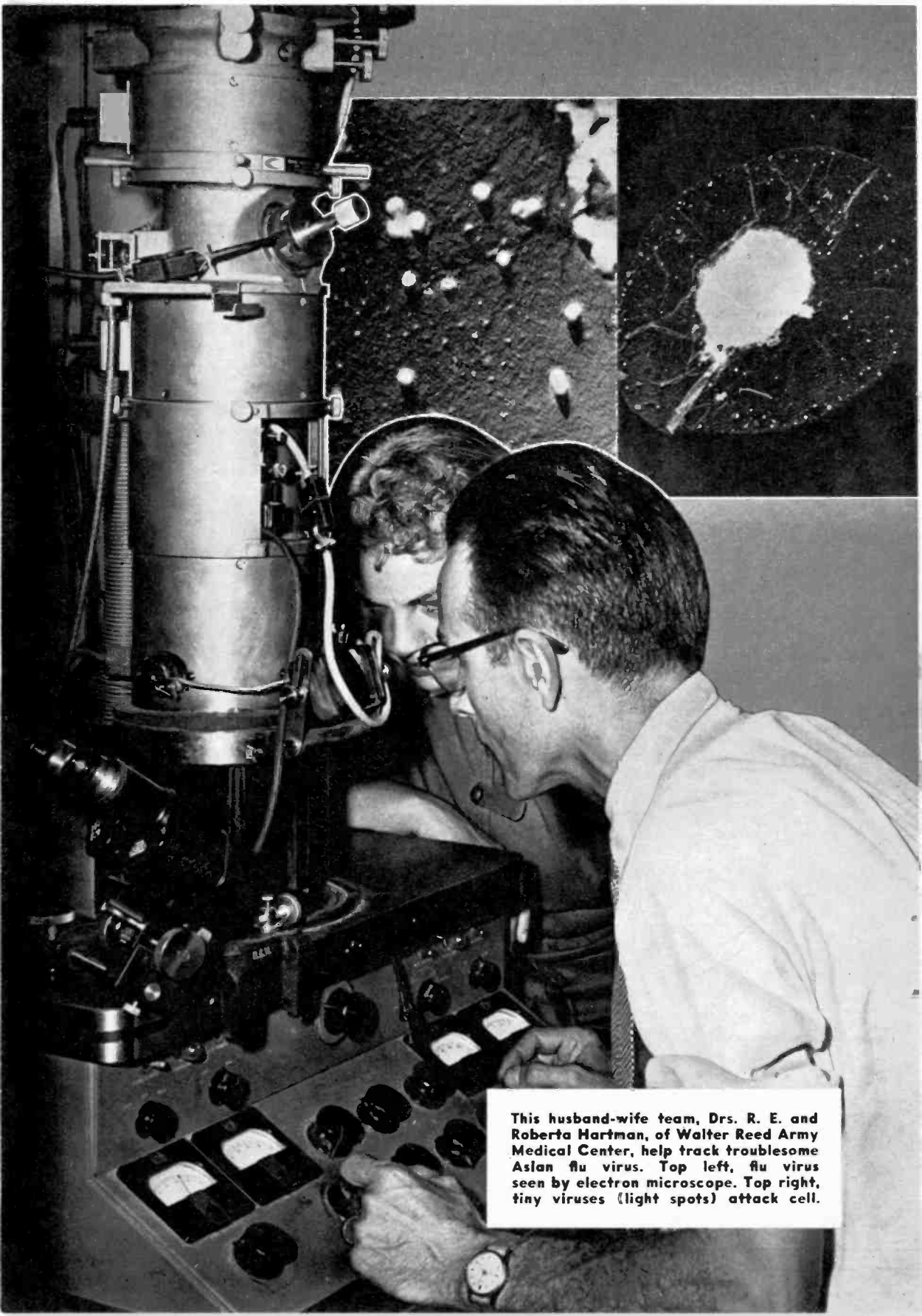

**This husband-wife team, Drs. R. E. and Roberta Hartman, of Walter Reed Army Medical Center, help track troublesome Asian flu virus. Top left, flu virus seen by electron microscope. Top right, tiny viruses (light spots) attack cell.**

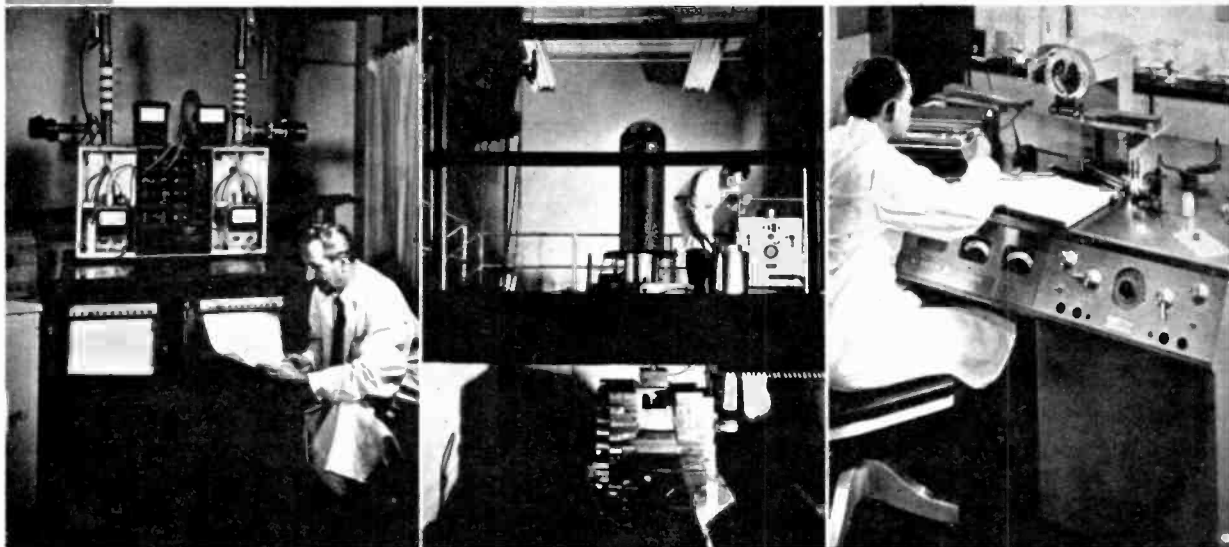

Researcher, left, checks on records of apparatus that negatively ionizes the air. Negative ionization helps some respiratory conditions, particularly those caused by airborne germ fragments, dust and pollen. Center, Van de Graaff generator sterilizes packaged injectable medications by bombarding boxes with electrons at Upjohn's research labs. Right, at Abbott Labs, patterns made by X-ray diffraction through virus crystals aid structure analysis.

**electronics takes to . . .**

## Tracking the "Cold Bugs"

By R. E. Atkinson

**Science closes in on the elusive virus that causes the common cold, flu and other respiratory troubles.**

**G**OT a cold today? About 20-million of us do on an average winter day.

Electronics gave us our first good look at the little beasts—viruses—that cause most of these respiratory ills, the common cold, certain pneumonias, influenza, and the like. The all-out attack by medical electronics on this common but complex—and sometimes deadly—group of diseases began in 1939. That year the German Ruska brothers invented the electron microscope, now used by anyone who can afford \$30,000 or so. Employing electron beams instead of light rays, magnetic coils instead of lenses, it can magnify up to about 100,000 times, compared to 2,500 times for a good optical microscope.

One of the respiratory viruses that scientists now could visualize for the first time was the influenza germ. This tiny beast killed 20-million people in the infamous 1918 epidemic! This virus measures only a few millionths of an inch in diameter.

The New York Academy of Sciences this winter (November 1959) heard a Finnish inventor, Dr. [Continued on page 120]

# *El reports on a* **4-Watt Stereo Amplifier**

**Two single-ended amplifiers and a flexible control unit are housed in a complete economy kit.**

**W**ITH the Model AF-4, EICO is offering a new low power dual preamp-amplifier combination to the low-cost field. All you need add to it are two speakers and a program source and you're in business.

It is well known that to achieve stereophonic sound you need to double the amount of monophonic components on hand with the exception of the turntable and the stereo cartridge. This means of course that you have an additional expense to your pocket plus the requirement for more [Continued on page 121]



Parts prior to assembly are shown above. Small components are contained in paper bags.

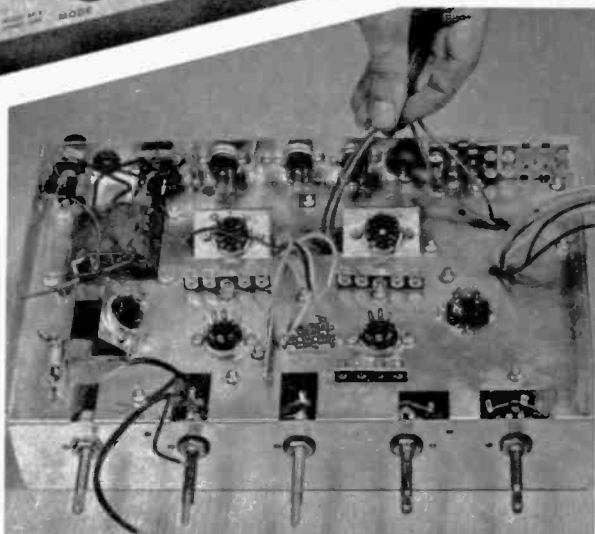

Underside of chassis after mounting hardware. Hand holds primary leads of output xfmrs.

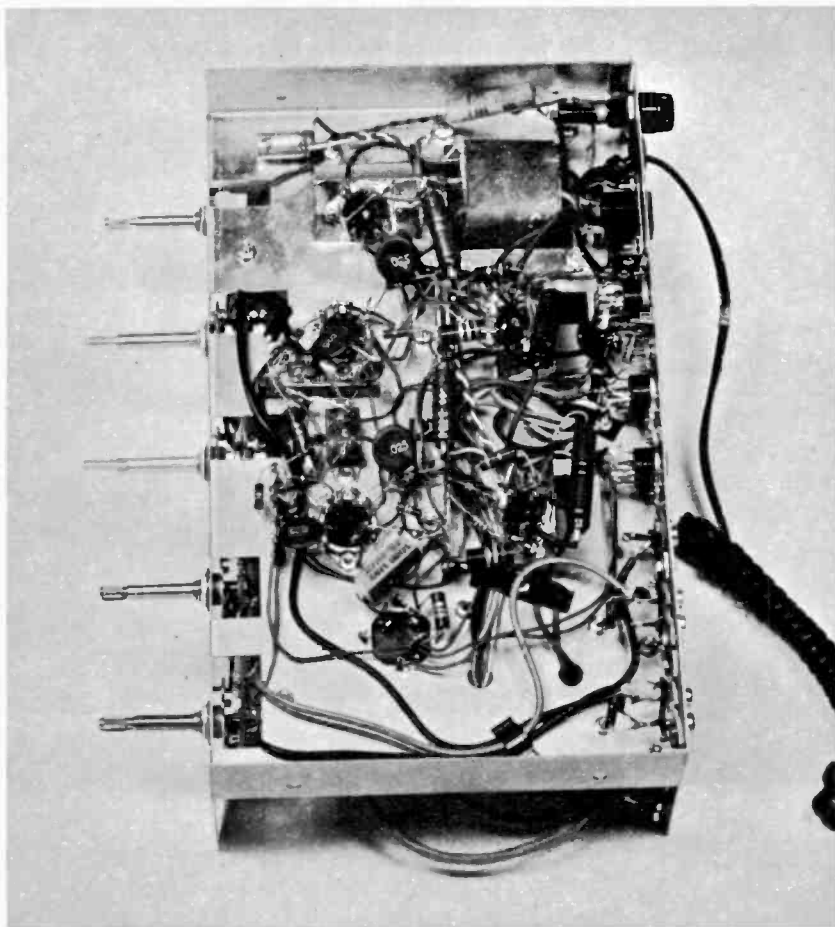

Underside of chassis is shown completely wired. Insert parts so that their values are readable. The power transformer is in well, at upper right.

Chassis ready for cabinet. Three four prong speaker jacks are centered on rear bottom strip. Pencil points to mono-stereo slide switch.

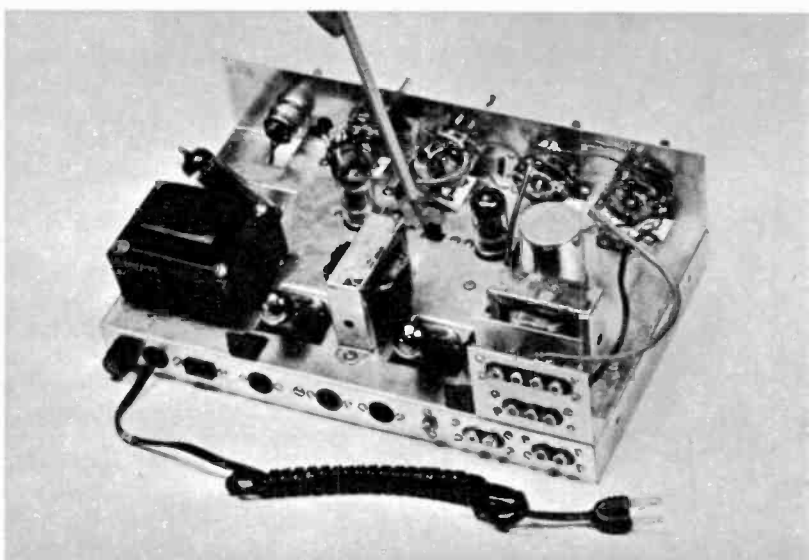



Ladder-marked cathode ray tube shows mute how much his voice varies in pitch, volume and timbre. Below, Plant works on "Mandy."

Photos by BIPS

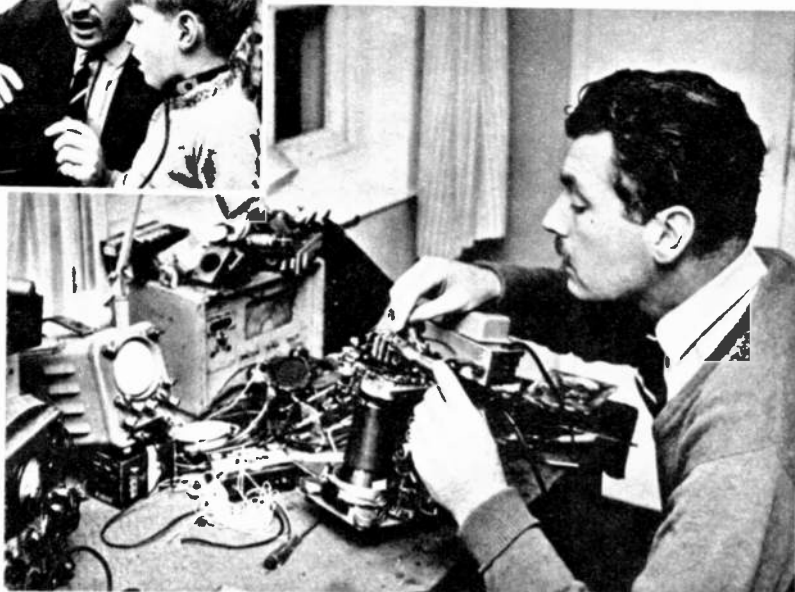

## he worked overtime So Mutes May Speak

"**M**ANDY" was a movie about a deaf-mute girl who learned to speak. London businessman George Plant knew that although the film had a happy ending, there were still many children who were unable to speak. Touched and inspired by "Mandy"—and thankful that his own three children were normal—Plant spent evening after evening in his home electronics workshop. Result: the "Mandy" machine.

Since a deaf-mute child cannot hear the sounds he makes, this device is designed to *show* him what his voice is like, thereby helping him to form it into intelligible speech. A microphone carries vibrations from the child's vocal chords to a specially marked cathode ray screen where the quality, pitch and loudness of the voice are visible all at once. By following the teacher, the child can begin to modify his voice characteristics to make the luminous green line rise and fall, and to vary its length by increasing or decreasing voice volume. When there is silence, no line appears.

Tests at schools for the deaf have shown that by the age of six children can interpret this information about pitch. After a brief training period, six completely deaf "monotones" about 10 years old learned to alter their voices' pitch at will within the range of an octave. Plant has assigned patent rights to a non-profit organization, Speech Research for the Deaf, Ltd. ●



# Compare your job, your age your pay, with that of men who enroll at CREI

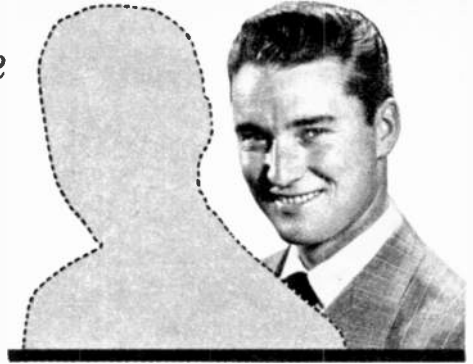

... then consider how handicapped you'll be without the knowledge of advanced electronics engineering technology which CREI teaches via home study

Men can stand still—or lose their jobs—even in a growing industry. They're doing it now in the fast-growing electronics industry. Companies actively seeking men with advanced technological knowledge are simultaneously firing mediocre men.

CREI students (more than 20,400 are currently enrolled) keep pace with electronics progress—and are eagerly sought by employers who offer solid opportunities for rapid advancement.

We analyzed the backgrounds of men who enrolled for CREI advanced electronics home study in a recent month. Compare yourself:

- 62% were civilians. 38% were in the Armed Services.

- Of the 62% who were civilians, 35% were electronic technicians, lab technicians, engineering aides, research assistants, electronic specialists, and similar high-rated electronics engineering men.

- Average pay: \$435 per month (range: \$300 to \$900). Average age: 28. Median age: 26. Previous formal electronic training varied from six months to more than a year.

- 9.4% of the civilians were technical representatives—field engineers who were school- or factory-trained to help install, maintain, service and teach the use and operation of electronic equipment. Average pay: \$525 per month. Median age: 28.

- 6.5% of the civilians held college degrees, most in a field more or less related to electronics (engineering,

physics, chemistry, etc.). These men were not in basic electronic work. Reason most often given for enrollment: to supplement job-know-how with better understanding of electronics.

- The remainder of the civilians were small groups of small percentages.

Even if you compare favorably with new CREI enrollees now, how do you think your salary will compare with theirs a year from now? Five years from now?

Qualify for positions which require advanced electronics education—while retaining your present job—via CREI home study. Meet your family responsibilities while gaining knowledge of electronic engineering technology so essential for career advancement. College degree is not essential. If you have had basic electronic education, practical experience in electronics, and a high school education, you can probably qualify. Use coupon below to find out, or write CREI, Dept. 1703-G, 3224 16th St., N.W., Wash. 10, D. C.

CREI RESIDENCE SCHOOL IN WASHINGTON, D. C.

For those who can attend classes, CREI operates full time residence school. Day and evening classes start at regular intervals. Qualified graduates earn AAS degree. Electronics experience not required for admission.



## Get This New Fact-Packed Booklet—It's Free!

### CAPITOL RADIO ENGINEERING INSTITUTE

ECPD Accredited Technical Institute Curricula • Founded 1927  
Dept. 1703-G, 3224 Sixteenth St., N.W., Washington 10, D. C.

Please send me your course outline and FREE illustrated Booklet "Insurance for Your Future in the New World of Electronics" . . . describing opportunities and CREI home study courses in Practical Electronic Engineering Technology.

- CHECK FIELD OF GREATEST INTEREST
- Radar, Servo & Computer Engineering Technology
  - Electronic Engineering Technology
  - Communications Engineering Technology
  - Television Engineering Technology
  - Aeronautical Electronic Engineering Technology

Automation and Industrial Electronics Engineering Technology

Name \_\_\_\_\_ Age \_\_\_\_\_

Street \_\_\_\_\_

City \_\_\_\_\_ Zone \_\_\_\_\_ State \_\_\_\_\_

Check:  Home Study  Residence School  Korean Veteran

To obtain fast, immediate service and to avoid delay, it is necessary that the following information be filled in:

Employed By.....

Type of Present Work.....

Education:

Yrs. High School.....

Other.....

Electronics Experience.....

# Superior's New Model 70 UTILITY TESTER® FOR REPAIRING ALL ELECTRICAL APPLIANCES and AUTOMOBILE CIRCUITS



**Model 70—UTILITY TESTER**  
... Total Price \$15.85—  
Terms: \$3.85 after 10 day  
trial, then \$4.00 monthly for  
3 months, if satisfactory.  
Otherwise return, no ex-  
planation necessary.

As an electrical trouble shooter the Model 70:

- Will test Toasters, Irons, Broilers, Heating Pads, Clocks, Fans, Vacuum Cleaners, Refrigerators, Lamps, Fluorescents, Switches, Thermostats, etc.
- Measures A.C. and D.C. Voltages, A.C. and D.C. Current, Resistances, Leakages, etc.
- Will measure current consumption while the appliance under test is in operation.
- Incorporates a sensitive direct-reading resistance range which will measure all resistances commonly used in electrical appliances, motors, etc.
- Leakage detecting circuit will indicate continuity from zero ohms to 5 megohms (5,000,000 ohms).

As an Automotive Tester the Model 70 will test:

- Both 6 Volt and 12 Volt Storage Batteries • Generators • Starters • Distributors
- Ignition Coils • Regulators • Relays • Circuit Breakers • Cigarette Lighters • Stop Lights • Condensers • Directional Signal Systems • All Lamps and Bulbs • Fuses
- Heating Systems • Horns • Also will locate poor grounds, breaks in wiring, poor connections, etc.



**INCLUDED FREE** This 64-page book—practically a condensed course in electricity. Learn by doing.

Just read the following partial list of contents:  
What is electricity? • Simplified version of Ohms Law • What is wattage? • Simplified wattage charts • How to measure voltage, current, resistance and leakage • How to test all electrical appliances and motors using a simplified trouble-shooting technique.  
• How to trace trouble in the electrical circuits and parts in automobiles and trucks.

Model 70 comes complete with 64 page book and test leads

Only  
**\$15<sup>85</sup>**

## Superior's New Model 82A A truly do-it-yourself type **TUBE TESTER**



**Model 82A—TUBE TESTER** . . . Total Price \$36.50—Terms: \$6.50 after 10 day trial, then \$6.00 monthly for 5 months if satisfactory. Otherwise return, no explanation necessary.

**TEST ANY TUBE IN 10 SECONDS FLAT!**

- 1 Turn the filament selector switch to position specified.
- 2 Insert tube into a numbered socket as designated on our chart (over 600 types included).
- 3 Press down the quality button—

**THAT'S ALL!**

Read emission quality direct on "BAD-GOOD" meter scale.

### FEATURES:

- Tests over 600 tube types.
- Tests OZ4 and other gas-filled tubes.
- Employs new 4" meter with sealed air-damping chamber resulting in accurate vibrationless readings.
- Use of 22 sockets permits testing all popular tube types and prevents possible obsolescence.
- Dual Scale meter permits testing of low current tubes.
- 7 and 9 pin straighteners mounted on panel.
- All sections of multi-element tubes tested simultaneously.
- Ultra-sensitive leakage test circuit will indicate leakage up to 5 megohms.

Production of this Model was delayed a full year pending careful study by Superior's engineering staff of this new method of testing tubes. Don't let the low price mislead you! We claim Model 82A will outperform similar looking units which sell for much more—and as proof, we offer to ship it on our examine before you buy policy.

Model 82A comes housed in handsome, portable Saddle-Stitched Texon case. Only \$36<sup>50</sup>  
(Picture Tube Adapter available for \$5.50 additional)

**EXAMINE BEFORE YOU BUY!**  
**USE APPROVAL FORM ON NEXT PAGE**

The Most Versatile All-Purpose Multi-Range Tester Ever Designed!

SUPERIOR'S NEW  
MODEL 79

# SUPER-METER

WITH NEW 6" FULL-VIEW METER

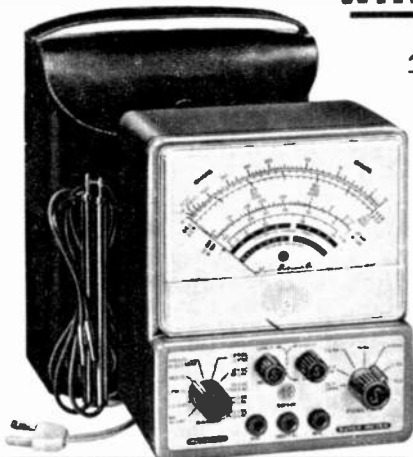

**Model 79—SUPER-METER . . . Total Price \$38.50—Terms: \$8.50 after 10 day trial, then \$6.00 per month for 5 months if satisfactory. Otherwise return, no explanation necessary!**

### Specifications

D.C. VOLTS: 0 to 7.5/15/75/150/750/1,500.  
A.C. VOLTS: 0 to 15/30/150/300/1,500/3,000.  
D.C. CURRENT: 0 to 1.5/15/150 Ma. 0 to 1.5/15 Amperes.  
RESISTANCE: 0 to 1,000/100,000 Ohms. 0 to 10 Megohms.  
CAPACITY: .001 to 1 Mfd. 1 to 50 Mfd.  
REACTANCE: 50 to 2,500 Ohms, 2,500 Ohms to 2.5 Megohms.  
INDUCTANCE: .15 to 7 Henries, 7 to 7,000 Henries.  
DECIBELS: -6 to +18, +14 to +38, +34 to +58.

The following components are all tested for QUALITY at appropriate test potentials. Two separate BAD-GOOD scales on the meter are used for direct readings.

All Electrolytic Condensators from 1 MFD to 1000 MFD.  
All Selenium Rectifiers. All Germanium Diodes.  
All Silicon Rectifiers. All Silicon Diodes.

### A Combination

VOLT-OHM MILLIAMMETER.

Plus CAPACITY, REACTANCE, INDUCTANCE AND DECIBEL MEASUREMENTS.

Also Tests SELENIUM AND SILICON RECTIFIERS, SILICON AND GERMANIUM DIODES.

The Model 79 represents 20 years of continuous experience in the design and production of SUPER-METERS, an exclusive SICO development.

In 1938 Superior Instruments Co. designed its first SUPER-METER, Model 1150. In 1940 it followed with Model 1250 and in succeeding years with others including Models 670 and 670-A. All were basically V.O.M.'s with extra services provided to meet changing requirements.

Now, Model 79, the latest SUPER-METER includes not only every circuit improvement perfected in 20 years of specialization, but in addition includes those services which are "musts" for properly servicing the ever increasing number of new components used in all phases of today's electronic production. For example with the Model 79 SUPER-METER you can measure the quality of selenium and silicon rectifiers and all types of diodes—components which have come into common use only within the past five years, and because this latest SUPER-METER necessarily required extra meter scale, SICO used its new full-view 6-inch meter.

Model 79 comes complete with operating instructions and test leads. Use it on the bench—use it on calls. A streamlined carrying case included at no extra charge accommodates the tester, instruction book and test leads . . . . . Only

**\$38<sup>50</sup>**  
NET

# SHIPPED ON APPROVAL NO MONEY WITH ORDER — NO C. O. D.

Try any of the instruments on this or the facing page for 10 days before you buy. If completely satisfied then send down payment and pay balance as indicated on coupon. No Interest or Finance Charges Added if not completely satisfied return unit to us, no explanation necessary.

### MOSS ELECTRONIC, INC.

Dept. D-715, 3849 Tenth Ave., New York 34, N. Y.

Please send me the units checked on approval. If completely satisfied I will pay on the terms specified with no interest or finance charges added. Otherwise, I will return after a 10 day trial positively cancelling all further obligations.

Name.....

Address.....

City..... Zone..... State.....

All prices net, F.O.B., N. Y. C.

- Model 70 . . . . . Total Price \$15.85  
\$3.85 within 10 days. Balance \$4.00  
monthly for 3 months.
- Model 82A . . . . . Total Price \$38.50  
\$8.50 within 10 days. Balance \$6.00  
monthly for 5 months.
- Include Model 82A Picture  
Tube Adapter at \$5.50
- Model 79 . . . . . Total Price \$38.50  
\$8.50 within 10 days. Balance \$6.00  
monthly for 5 months.

## All About FAX

Continued from page 35

The human eye passes all the printed symbols on to the brain, which stores the fragments of intelligence, line by line, until the knowledge contained on the page is assembled into a complete series of thoughts. So it is with fax. The electric eye scans the copy, which is wound around a revolving drum. The "field of vision" is purposely reduced to a pinpoint about one-hundredth of an inch across. After each scan of the copy, the field of vision moves over to scan the next line.

The reason for limiting the view of the electric eye is because the printed character, as a whole, means nothing to the photocell. It can only distinguish between variations in light. When white passes in front of the cell, electrical current is passed. When it encounters black, no current is passed.

The principle of fax scanning is just about universal to all fax gear, but individual equipment may vary in size depending upon the size of the material to be copied.

Transmitting ocean weather maps to Navy ships via radio has proven itself over many years. The use of fax by merchant vessels has been a comparatively recent development.

Western Union is perhaps one of the largest commercial users of fax in the United States today. On December 1, 1959, the company made facsimile available to everyone. The service is called Wirefax. Initially offered between Washington, New York, Chicago, Los Angeles and San Francisco, it provides for the transmission of full-page correspondence, letter-size documents, drawings, photostats and other black and white data coast-to-coast. Cost? From \$2 to \$4, depending on destination.

American business firms are now using over 36,000 Western Union Desk-Fax facsimile machines for the local pick-up and delivery of some 40-million telegrams annually between their offices and central telegraph offices.

The United States Weather Bureau's hurricane plotters have come up with a

novel application. Many weather reporting stations located in the southeastern states, "hurricane alley," are equipped with radar. When a hurricane approaches one of these outposts, like the one at Cape Hatteras, N. C., it's picked up on the radar. The radar screen is then photographed with a large Polaroid camera and 60 seconds later the hurricane's portrait is on its way to Washington, D. C., via fax for study by experts.

The Post Office department has suggested an instantaneous coast-to-coast transmission of first-class mail by fax. Although still in the developmental stages, it has been approved by the Federal Communications Commission and is being hailed as a big step toward faster mail service. Tests are now being conducted at a transmitting rate of about 4 minutes per page. However the goal of the tests is a transmission speed of 1800 pages per minute.

Even though an "open letter" service at less than the present seven cent air mail rate is being considered, extensive tests are being made with automatic devices which would insure *complete* privacy of all mail sent via fax. This would be done by single sheet letters in special envelopes which could be read by the electric eye right through the sealed envelope. At the receiving end, the letter would be automatically inserted in an envelope and sealed while inside a locked machine.

Ham operators holding Technician or higher class licenses are permitted to use facsimile on certain frequencies above 50 mc. There isn't a great deal of activity in amateur fax (A4 transmission) because of the specialized nature of the additional equipment involved.

The probability of receiving your morning newspaper via fax is certainly on the horizon, especially if you own an FM tuner or radio. For instance, Capt. W. G. H. Finch broadcast fax on WGHF's multiplex sub-carrier without any adverse effect on the continuous music program in progress.

What else is in store for fax? It's sort of an electronic soya bean. Every day someone seems to come up with another use, and each new use is just as interesting as the previous one. ●



tells how

# FREE

The Master Course in Electronics will provide you with the mental tools of the electronics technician and prepare you for a First Class FCC License (Commercial) with a radar endorsement. When you successfully complete the Master Course, if you fail to pass the FCC examination, you will receive a full refund of all tuition payments.

## Get your FCC Commercial License -or your money back

**"License and \$25 raise due to Cleveland Institute training"**

"I sat for and passed the FCC exam for my second class license. This meant a promotion to Senior Radio Technician with the Wyoming Highway Department, a \$25 a month raise and a District of my own for all maintenance on the State's two-way communication system. I wish to sincerely thank you and the school for the wonderful radio knowledge you have passed on to me. I highly recommend the school to all acquaintances who might possibly be interested in radio. I am truly convinced I could never have passed the FCC exam without your wonderful help and consideration for anyone wishing to help themselves."

CHARLES C. ROBERSON, Cheyenne, Wyoming

**CIE HELPS  
TRAINEES GET BETTER JOBS**

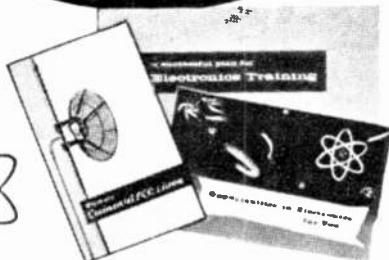

**Employers Make Job Offers  
Like These To Our Graduates  
Every Month**

Broadcast Station in Illinois: "We are in need of an engineer with a first class phone license, preferably a student of Cleveland Institute of Electronics, 40 hour week plus 8 hours overtime."

West Coast Manufacturer: "We are currently in need of men with electronics training or experience in radar maintenance. We would appreciate your referral of interested persons to us."

### Cleveland Institute of Electronics

Desk E1 18      4900 Euclid Bldg.      Cleveland 3, Ohio

Cleveland Institute of Electronics  
Desk E1 18, 4900 Euclid Bldg., Cleveland 3, Ohio  
Accredited by National Home Study Council.  
Please send Free Booklets prepared to help me get ahead in Electronics. I have had training or experience in Electronics as Indicated below.

<input type="checkbox"/> Military	<input type="checkbox"/> Broadcasting
<input type="checkbox"/> Radio-TV Servicing	<input type="checkbox"/> Home Experimenting
<input type="checkbox"/> Manufacturing	<input type="checkbox"/> Telephone Company
<input type="checkbox"/> Amateur Radio	<input type="checkbox"/> Other

In what kind of work are you now engaged? .....

.....

In what branch of Electronics are you interested? .....

.....

Name ..... Age .....

Address .....

City ..... Zone .... State .....

E1 18

# NOW YOU CAN HAVE YOUR CHOICE OF CENTURY'S UNIQUE Peak-to-Peak VACUUM TUBE VOLT METERS

Model VT-10  
LINE OPERATED

WITH LARGE EASY-TO-READ 6" METER

Model VT-1  
BATTERY OPERATED

featuring the sensational new  
**MULTI-PROBE** (Patent Pending)

No extra probes to buy! The versatile  
**MULTI-PROBE** does the work of 4 probes

- ① DC Probe ② AC-Ohms Probe  
③ Lo-Cap Probe ④ RF Probe

No longer do you have to cart around a maze of entangled cables, lose time alternating cables or hunting for a misplaced probe. With just a twist of the **MULTI-PROBE** tip you can set it to function as either a DC Probe, AC-Ohms Probe, Lo-Cap Probe or RF Probe.

## LINE OPERATED

Ideal for use on the test bench. Designed to run cool even under continuous operation... Line isolated.

## BATTERY OPERATED

Completely portable... Invaluable wherever line connection is undesirable or unavailable... Unique circuitry assures low battery drain.

## FUNCTIONS OF VT-1 and VT-10

**DC VOLTMETER**... Will measure D.C. down to 1.5 volts full scale with minimum circuit loading, and give accurate readings of scale divisions as low as .025 volts... Will measure low AGC and oscillator bias voltages from .1 volts or less up to 1500 volts with consistent laboratory accuracy on all ranges... Zero center provided for all balancing measurements such as discriminator, ratio detector alignment and hi-fi amplifier balancing.

**AC VOLTMETER**... True Peak-to-Peak measurements as low as 3 volts of any wave form including TV sync, deflection voltages, video pulses, distortion in hi-fi amplifiers, AGC and color TV gating pulses... Scale divisions are easily read down to .1 volts... Measures RMS at 1/20th the circuit loading of a V.O.M.... Unlike most other V.T.V.M.'s there is no loss in accuracy on the lowest AC range.

**ELECTRONIC OHMMETER**... Measures from 0 to 1000 megohms... Scale divisions are easily read down to .2 ohms... Will measure resistance values from .2 ohms to one billion ohms... Will detect high resistance leakage in electrolytic and by-pass condensers.

**RF and LO-CAP MEASUREMENTS**... With these extra VT-1 functions you can measure voltages in extremely high-impedance circuits such as sync and AGC pulses, driving saw tooth voltages, color TV gating pulses, mixer output levels, I.F. stage-by-stage gain and detector inputs.



Model VT-10  
**\$58.50** Net  
TERMS: \$14.50 within 10 days. Balance \$11 monthly for 4 months.

## FEATURES OF VT-1 and VT-10

- New advanced pentode amplifier circuit
- Large 6" 100-microampere meter, many times more sensitive than meters used in most V.T.V.M.s
- Simplified multi-color easy-to-read 4-scale meter
- No heat operation assures stability and accuracy
- Amplifier rectifier circuit with frequency compensated attenuator — a feature found only in costly laboratory instruments
- Meter completely isolated
- Hand-crafted circuitry eliminates the headaches of printed circuitry
- 1% resistors used for permanent accuracy
- Rugged gray hammertone steel case provides necessary shielding and eliminates plastic case drawbacks of cracking or melting
- Deep brushed long lasting etched aluminum panel
- Matching cover protects instrument face — snaps on and off instantly.



Model VT-1  
**\$58.50** Net  
TERMS: \$14.50 within 10 days. Balance \$11 monthly for 4 months.

## SPECIFICATIONS OF VT-1 and VT-10

- DC Volts — 0 to 1.5/6/30/150/300/600/1500 volts
- AC Volts (RMS and Peak-to-Peak) — 0 to 3/12/60/300/1200 volts
- Ohms — to a billion ohms, 10 ohms center scale — RX1.10/100/1K/10K/100K/1M
- RF — Peak reading demodulator supplied for use on all DC ranges
- Zero Center — available on all DC volt ranges with zero at mid-scale
- Decibels — from -10 Db to +10/22/36/50/62 based on the Dbm unit: ODb-1MW in 600 ohms
- Impedance — 11 megohms DC, 1 megohm AC, 10 megohms Lo-Cap
- Input Capacity — 130 mmfd. RMS, 250 mmfd. Peak-to-Peak, 25 mmfd. Lo-Cap

## Model CT-1 IN-CIRCUIT CONDENSER TESTER

Here is an **IN-CIRCUIT CONDENSER** that **DOES THE WHOLE JOB!** The CT-1 actually steps in and takes over where all other in-circuit condensers fail. The ingenious application of a dual bridge principle gives the CT-1 a tremendous range of operation... and makes it an absolute 'must' for every serviceman.

### in-circuit checks:

- ✓ Quality of condensers even with circuit shunt resistance... (This includes leakage, shorts, opens, intermittents)
- ✓ Value of all condensers from 200 mmfd. to .5 mfd.
- ✓ Quality of all electrolytic condensers (the ability to hold a charge)
- ✓ Transformer, socket and wiring leakage capacity

### out-of-circuit checks:

- ✓ Quality of condensers... (This includes leakage, shorts, opens and intermittents)
- ✓ Value of all condensers from 50 mmfd. to .5 mfd.
- ✓ Quality of all electrolytic condensers (the ability to hold a charge)
- ✓ High resistance leakage up to 300 megohms
- ✓ New or unknown condensers... transformer, socket, component and wiring leakage capacity

### OUTSTANDING FEATURES

- Ultra-sensitive 2 tube drift-free circuitry
- Multi-color direct scale readings for both quality and value... in-circuit or out-of-circuit
- Simultaneous readings of circuit capacity and circuit resistance
- Built-in hi-leakage indicator sensitive to over 300 megohms
- Cannot damage circuit components
- Electronic eye balance indicator for even greater accuracy
- Isolated power line
- Deep brushed long lasting etched aluminum panel
- Housed in sturdy gray hammertone finish steel case... comes complete with test leads



Model CT-1  
**\$34.50** Net  
TERMS: \$9.50 within 10 days. Balance \$5 monthly for 5 months.

## 10 DAY FREE TRIAL ON CENTURY INSTRUMENTS OF YOUR CHOICE

See for yourself at no risk why thousands of servicemen all over the country selected CENTURY test equipment above all others. Send for instruments of your choice without obligation... try them for 10 days before you buy... only then, if satisfied, pay in easy-to-buy monthly installments — without any financing or carrying charges added.





Housed in hand-rubbed oak carrying case — complete with MULTI-HEAD

Model CRT-2  
**\$57.50** Net  
 TERMS: \$13.50 within 10 days. Balance \$11 monthly for 4 months.

THE CRT-2 DOES ALL THIS RIGHT IN THE CARTON, OUT OF THE CARTON OR IN THE SET

- TEST**
- For quality of every black and white and color picture tube, employing the time proven dynamic cathode emission test principle.
  - For inter-element shorts and leakage up to one megohm. Separate short test provided for each element in the picture tube.
  - For life expectancy.
- REPAIR**
- Will clear inter-element shorts and leakage.
  - Will weld open elements.
- REACTIVATE**
- The "SHOT" (high voltage controlled pulse) method of reactivation provided by the CRT-2 will restore picture tube to new life in instances where it was not possible before. The high voltage is applied without danger of stripping the cathode as you always have perfect control of the high voltage pulse.
  - The "BOOST" method of reactivation also provided by the CRT-2 is used effectively on tubes with a superficially good picture but with poor emission and short life expectancy. It will also improve definition, contrast and focus greatly and add longer life to the picture tube.

Model CRT-2

# CRT TESTER-REACTIVATOR

## TESTS, REPAIRS and REACTIVATES

- **ALL BLACK AND WHITE PICTURE TUBES** (including 110° tubes) . . . from 8" to 30", whether 12 pin base, 8 pin base, 14 pin base . . . and the very latest 7 pin base.
- **ALL COLOR PICTURE TUBES** . . . Each of the red, green and blue color guns is handled separately.

### CHECK THESE EXCLUSIVE FEATURES

- ✓ **THE MULTI-HEAD** (Patent Pending) . . . A SINGLE PLUG IN CABLE AND UNIQUE TEST HEAD — A tremendous advance over the maze of cables and adapters generally found with other testers.
- ✓ **WATCH IT REACTIVATE THE PICTURE TUBE** — You actually see and control the reactivation directly on the meter as it takes place. This allows you for the first time to properly control the reactivation voltage and eliminates the danger of stripping the cathode of the oxide coating. It also enables you to see whether the build-up is lasting.
- ✓ **CONTROLLED "SHOT" WITH HIGHER VOLTAGE FOR BETTER REACTIVATION** — Stronger than any found in other testers — high enough to really do the job — yet controlled to avoid damage to the picture tube.
- ✓ **UNIQUE HIGH VOLTAGE PULSE CIRCUIT** — Will burn out inter-element shorts and weld open circuits with complete safety to the picture tube.

- ✓ **VISUAL LIFE TEST** — Enables both you and your customer to see the life-expectancy of any picture tube right on the meter . . . helps eliminate resistance to picture tube replacement when necessary.
- ✓ **SPECIAL LOW SCREEN VOLTAGE TUBES** — Will handle new type picture tubes with special low voltage of approximately 50 volts.
- ✓ **SEPARATE FILAMENT VOLTAGES** — including the very latest 2.35 volt and 8.4 volt types as well as the older 6.3 volt types.
- ✓ **NEW "S" PICTURE TUBES** — Accommodates the different base pin connections of this new type picture tube.

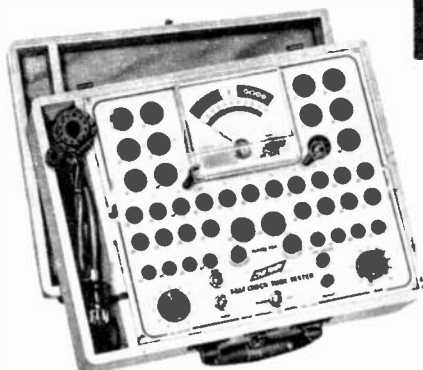

Housed in hand-rubbed oak carrying case complete with CRT ADAPTER

Model FC-2  
**\$69.50** Net  
 TERMS: \$14.50 within 10 days. Balance \$11 monthly for 5 months.

Model FC-2

# FAST-CHECK TUBE TESTER

Simply set two controls . . . insert tube . . . and press quality button to test any of over 900 tube types completely, accurately . . . IN JUST SECONDS!

The FAST-CHECK enables you to cut servicing time way down, eliminate unprofitable call-backs and increase your dollar earnings by selling more tubes with very little effort on your part. You make every call pay extra dividends by merely showing your customer the actual condition and life expectancy of the tube. The extra tubes you will sell each day will pay for the FAST-CHECK in a very short time.

### PICTURE TUBE TEST ADAPTER INCLUDED WITH FAST-CHECK

Enables you to check all picture tubes (including the new short-neck 110 degree type) for cathode emission, shorts and life expectancy . . . also to rejuvenate weak picture tubes.

### RANGE OF OPERATION

- ✓ Checks quality of over 900 tube types, employing the time proven dynamic cathode emission test. This covers more than 98% of all tubes in use today, including the newest series-string TV tubes, auto 12 plate-volt tubes, OZ4s, magic eye tubes, gas regulators, special purpose hi-fi tubes and even foreign tubes.
- ✓ Checks for inter-element shorts and leakage.
- ✓ Checks for gas content.
- ✓ Checks for life-expectancy.

### SPECIFICATIONS

- No time consuming multiple switching . . . only two settings are required instead of banks of switches on conventional testers
- No annoying roll chart checking . . . tube chart listing over 900 tube types is located inside cover. New listings are added without costly roll chart replacement
- Checks each section of multi-section tubes and if only one section is defective the tube will read "Bad" on the meter scale
- 41 phosphor bronze beryllium tube sockets never need replacement
- 7-pin and 9-pin straighteners mounted on panel
- Large 4V- D'Arsonval type meter is the most sensitive available, yet rugged — fully protected against accidental burn-out
- Special scale on meter for low current tubes
- Compensation for line voltage variation
- 12 filament positions
- Separate gas and short jewel indicators
- Line isolated — no shock hazards
- Deep brushed long lasting etched aluminum panel.

**NOTE:** The Fast-Check positively cannot become obsolete . . . circuitry is engineered to accommodate all future tube types as they come out. New tube listings are furnished periodically at no cost.

**MAIL FREE TRIAL COUPON TODAY!**

## CENTURY ELECTRONICS CO., INC.

117 Roosevelt Ave., Dept. 403, Mineola, N. Y.

- Model VT-10 Vacuum Tube Volt Meter \$58.50 \$14.50 within 10 days. Balance \$11 monthly for 4 months.
  - Model VT-1 Battery Vacuum Tube Volt Meter \$58.50 \$14.50 within 10 days. Balance \$11 monthly for 4 months.
  - Model CT-1 In-Circuit Condenser Tester \$34.50 \$9.50 within 10 days. Balance \$5 monthly for 5 months.
  - Model CRT-2 CRT Tester-Reactivator \$57.50 \$13.50 within 10 days. Balance \$11 monthly for 4 months.
  - Model FC-2 Fast-Check Tube Tester \$69.50 \$14.50 within 10 days. Balance \$11 monthly for 5 months.
- Prices Net F.O.B. Mineola, N. Y.

Yes, I want to take advantage of your 10 day FREE try-before-you-buy offer. Ship on approval the instruments I have checked. After I have tried the equipment for 10 full days I will either send you the down payment and agree to pay the balance in the monthly payments shown, or I will return the units and owe nothing.

Name \_\_\_\_\_  
 Address \_\_\_\_\_  
 City \_\_\_\_\_ State \_\_\_\_\_

Please print clearly

## 20 Meters

*Continued from page 61*

these combine and for all practical 20 meter purposes, the E layer vanishes at night. This combined F region is the determining factor during the hours of darkness. It is solely responsible for returning radio signals to earth.

This thumbnail sketch holds good for normal conditions only. There are two other phenomena which can change things considerably. First, the Sporadic-E layer which occurs at the same height as the normal E layer, but is frequently more ionized (denser). It occasionally reflects even VHF signals, and it may appear any time of the day or night. Second, ionospheric disturbances may be caused by sudden bursts of electrically-charged particles from the sun. When these particles reach the ionosphere, its layers become less effective reflectors and absorption is increased. This effect is most pronounced in those latitudes farthest from the equator.

Normally there is another dead spot in addition to the one at 1400. Around 0300 ionization, even in the F region, has dropped to such a low level that usually all 20 meter signals will skip. This period frequently takes in all the early morning hours of darkness and will lengthen even more as the sunspot count drops. Prior to it Europe and Africa dominate the transoceanic signals. After it, Pacific and Asia are best heard. Latin American operators can be worked anytime, except during the deadspots.

We're sure it won't surprise you that CW has its usual lion's share of the band, with only 100 kc (between 14200-14300 kc) open to phone use. However this does give certain advantages to the phone operator. Many foreign hams operate phone on U.S. CW frequencies. These channels are considerably less crowded than those allocated by the FCC for voice. The result: many rare stations will at one time or another be in the clear, or almost in the clear.

On the minus side, the American phone section of the band is crowded, causing QRM. The foreign operator will only pick the strongest, clearest signal.

We said that skill could combat this problem. Courtesy is equally important. A third major factor is proper equipment.

In the first place, you can switch to CW and stand an excellent chance of out-DXing all the phone men on the band. As you may already know, Al (CW) tops all the various types of modulation in penetrating interference. Of course, you'll be operating on the same frequencies as your foreign quarry, which brings us to the matter of courtesy and skill. Don't call a rare station on his own frequency. If he's really rare, a hundred others are going to be after him also, and if they all were on his frequency nobody could possibly work him. It comes down to a matter of judgment, or experience.

Despite the advantages of CW, many hams prefer to use voice, probably because it most closely approaches normal conversation, from both the standpoints of sound and pace. Many operate on SSB, single sideband (see box). The successful voice DXer possesses at least one of two things. The first is power—enough power to “punch a hole in the band.” This does not mean powerful, complicated and expensive transmitters. With wavelengths of 20 meters and less, it is quite possible for the ham to erect highly directional beam antennas. These can concentrate radiation within a few degrees and multiply signal strength up to 40 times in the desired direction. A transmitter putting out only 50 watts, but efficiently beamed, would have the equivalent power of a 2 kw station.

After a good antenna comes the ability to pick the right spot on the band, one with a minimum of QRM. Some hams get by with a crystal-controlled oscillator and a good selection of different crystals. However a variable frequency oscillator (VFO) is nearly always the superior arrangement, although it is slightly more complex and difficult to operate. With a VFO, any spot on the band can be selected. Frequently, when working DX, the foreign operator will ask you to move up or down a few kc to avoid QRM. Without the VFO you would probably not be able to comply. ●

## All About Sleep Learning

*Continued from page 45*

sons in public life—actors, lecturers, ministers and singers. Others have used this technique for memorizing sales talks and to cram for school exams.

In addition to Dormiphone, there are at least two other producers of similar sleep-learning equipment. One is called Blackhawk Message Repeater; the other, Electronic Educator. The latter is marketed by the Sleep-Learning Research Association (SLRA), of Olympia, Wash.

Dormiphone disavows any claims or implications of hypnosis or therapy, although the machine—like any educational tool—could conceivably be used by a qualified doctor in specific applications. The device and the technique are put forth as a supplement, not a substitute, for ordinary learning by conventional methods. It is essentially a “memory-reinforcer” that can speed the teaching process, but will not accomplish great advances unless the learner has conscious, deliberate contact with the material to be assimilated.

Regardless of what you may expect such a machine to do, and whichever one you use, operation is similar. You record the message to be learned onto the tape cartridge via a microphone. Set the cartridge in its place on the machine, put the little speaker under your pillow, pre-set the timer, and go to sleep. Depending on how you set the timer, the message will be gently whispered to you at any time, and as often, as you like.

### Doing It Yourself

Any standard tape recorder may be adapted for sleep-learning with a little effort, and a little extra cost. What you need is a repeating tape, an automatic time-switch, like the Telechron, and an under-pillow speaker, such as the Telex.

You may also use a simple clock-timer, like the ones used in clock-radios. Often such a device may be found at a parts store for \$10 or less. This type of timer will only start and stop the recorder once; it will not, as the automatic time-switch, do it several times and at

pre-determined intervals. This feature, of course, is found on the commercial sleep-learners and is held to be one of the main factors in sleep-learning—the planned repetition of a message.

To overcome the limitation imposed by using a mere clock-timer, you can arrange for the repeats and the intervals yourself by recording your message several times on the tape reel, leaving a relatively long section of blank tape between each message.

There are two main ways of fashioning your own repeating tape. For repeating a short message, simply splice a section of tape to make a continuous loop. The loop is threaded around one reel, past the head assembly, and around the empty spindle.

For a longer message, or several messages with spaced intervals, make the loop correspondingly longer. Then, allow one reel to drape over the edge of a table while the other one is fitted to a spindle and, of course, the head assembly.

A neat twist to either of these loops is to make it a “mobius loop.” This simply is an endless loop with a half-twist in it. (Take a given length of tape, give it a half-twist, then splice.) The unique, and fascinating thing about a mobius loop is that it effectively turns itself over automatically. Long regarded as a mathematical oddity, its unique use here is that it permits a given length of tape to serve as twice its normal length by combining a certain amount of material and then an automatic interval of silence before the material is repeated.

These accessories, by the way, also are sold by the sleep-learning people. SLRA, for example, markets an endless tape on a special reel that fits a standard tape recorder. This is called the “de luxe audio vendor” and is an adaptation of endless tapes that originally were developed for advertising purposes. Prices start at \$18.50. For an additional \$30 you can get their “Somnoclock,” an automatic timer. Twelve dollars more buys the underpillow speaker. Similarly, Dormiphone is planning to bring out a sleep-learning adapter kit for about \$70 that may be used with any tape recorder. 

## What's New for Stereo

*Continued from page 32*

this movement has suddenly jumped to the fore in stereo and practically all the new pick-ups are moving magnet types.

By tailoring the arm to a specific cartridge it is possible to realize the best potentialities of the cartridge. The Shure *Studio Dynetic*, Dynaco B & O, Pickering Unipoise, and London-Scott integrated combinations give very fine performance with pressures between 1½ and 2 grams.

There is a wide variety of turntables in every price range with rumble levels low enough to be insignificant. But changers have presented two problems—rumble, and the need for high needle pressure to actuate the changing mechanism. The new Dual changer is therefore highly interesting because it has an unusually low rumble level and also because its critical arm balance permits needle pressures as low as 2 grams.

Stereo preamps and amplifiers are generally superior to their monophonic predecessors and the trend to integrated units continues. Stereo preamplifier-

amplifier combinations are now available from \$50 up. A combination that makes very good sense is that of the stereo tuner and a stereo preamp and this is now available from Pilot, Bogen, Sargent-Rayment and others. In addition we now have complete all-in-one combinations of tuner, stereo preamp and stereo amplifiers all on *one* chassis by Harman-Kardon, Fisher, Scott, Bogen and Madison Fielding.

It stands to reason that when you combine a preamp and amplifier on a single chassis you save on material costs and reduce a hookup stage for the installer. The disadvantage—and there is a big one—is that you can't always use the husky output transformers and other parts that a full frequency range amplifier needs. How much audible difference is there? If you can detect it you will have to balance it against savings in cost and space.

It is inevitable that transistors will eventually take over a large part of the preamplifier, and possibly the amplifier job. And this may well be the year in which transistorized hi-fi breaks through. Nobles Engineering and Manufacturing Co. of St. Paul is offering a

**Rek-O-Kut Audax speaker system, right, may be used as bookshelf unit or on floor. University's TMS-2, below, has a complete stereo speaker system in one cabinet.**

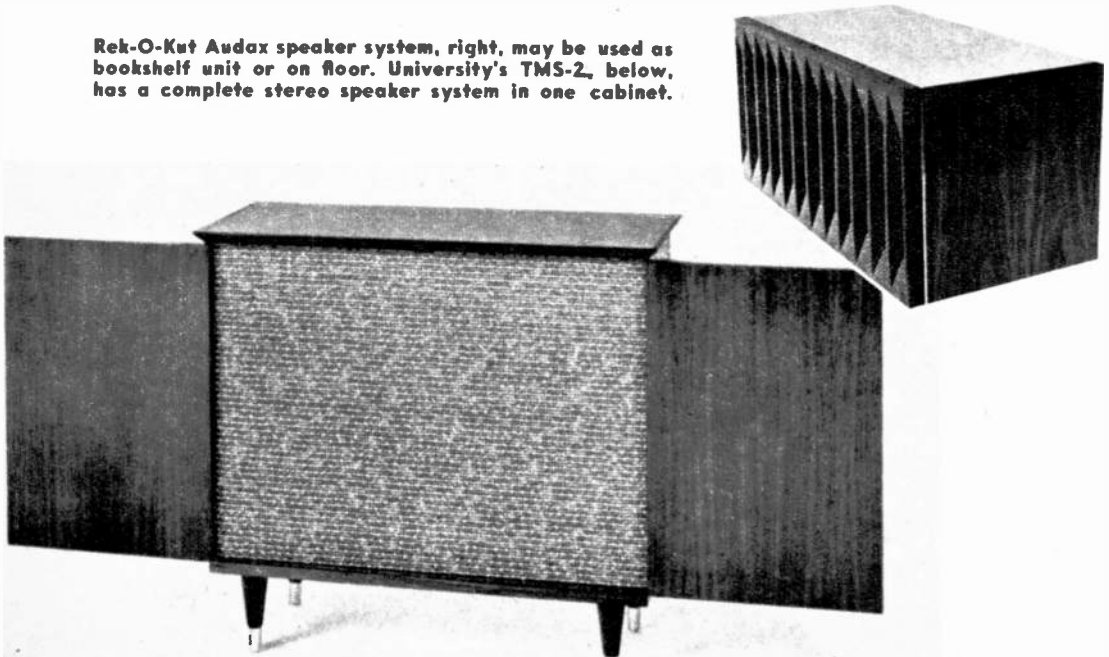

Bell stereo tape deck has two speeds and switch to select two- or four-track tape head.

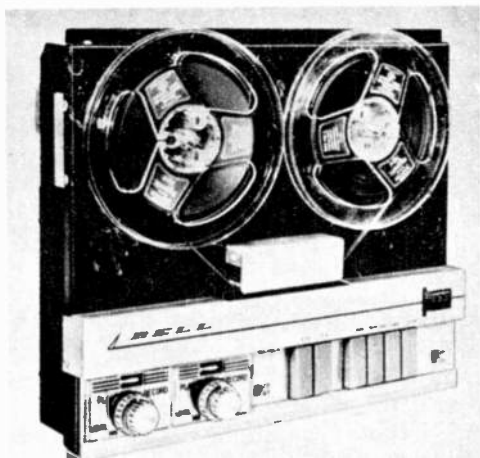

This Dual changer operates at four speeds and may be used as changer or manual turntable.

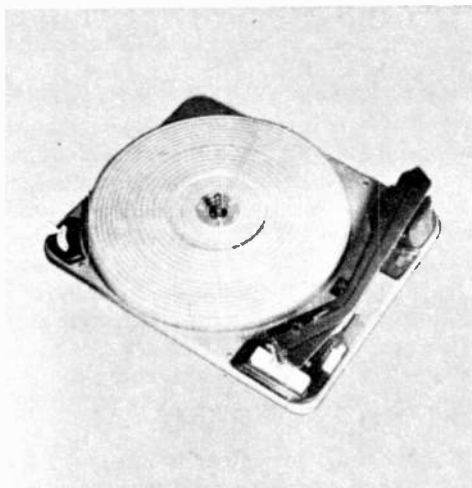

complete line of transistorized units.

The very compact all-transistor stereo preamp-amplifier with 25 watts output per channel shown by Transi-Tronics of California has received a lot of favorable comments, particularly since it is offered with a two year guarantee!

In kits the big news to many will be that at long last Dynaco has put out its stereo preamp and the Stereo 70 amplifier.

Harman-Kardon has entered the kit field with its Citation line designed by Stewart Hegeman. These are deluxe (and expensive) kits for those who want to travel every last inch of the hi-fi road with all the fixin's.

Equally surprising was the addition by Heath of the AS-2 speaker at \$69.50. This is a kit counterpart of the famous Acoustic Research AR-2, using AR woofers and tweeters.

A dozen or more new compact speakers are now on the market that cover the range between 40 and 16,000 cycles, or better, at prices ranging from \$50 to \$300 each. Practically all of these use a combination of high compliance woofers with free-air resonances from 15 to 35 cycles and ducted-port enclosures. The high compliance lowers the speaker resonance and improves ability to handle the very low bass frequencies

below 50 cycles. The ducted port makes it possible to house these low resonance speakers in very compact enclosures. The result is a clean low-down response.

A lot of people would like to stick their entire stereo system in one piece of furniture and the mass-produced stereo hi-fi units that you see in department stores cater to this desire. But when you put the speakers in the same cabinet with the record player, you may very well be asking for trouble. Bass tones have a tendency to vibrate the cabinet, and this vibration may be communicated to the pick-up, causing it to skip, jump and perhaps generate an annoying acoustic feedback. Most of the one-package outfits avoid this by cutting down the bass response, but of course you then lose one of the most impressive qualities of high fidelity.

Stromberg-Carlson has pioneered a way out of this trouble. They float the speakers in separate boxes cushioned from the cabinet with pads of vibration-absorbing artificial rubber. Now, the Rockford Special Furniture Co., of Rockford, Ill., is offering a handsome cabinet with this "floating speaker" feature that can be used with almost any combination of components and a wide choice of speakers. Price: \$150. -

Continued from page 95

quired charges created a drag to their forward motion. Briefly, here's what the electronic instruments reported back to earth receiving stations: As the metal skin of a satellite collides with high energy electrons, the skin becomes negatively charged. From then on it repels electrons but attracts protons, which are positively charged. Soon a broad "shell" of protons surrounds the satellites, giving it a much greater effective size electrically. This greater size leads to a greater resistance by the neutral air molecules, which tends to slow the satellite.

Now that this effect is known, it can be turned to man's advantage by being used consciously as a braking system for space vehicles re-entering the earth's atmosphere. Engineers have the basis to calculate the amount of electrical charge needed on the skin of a space ship to decelerate it safely. A system can be worked out to allow the space pilot to control the amount and sign of the charge required to decelerate properly without burning up the ship by friction with the atmosphere.

The second discovery was that the density of micrometeorites between the earth and moon (cislunar space) would be no hazard to space crews. This information was double-checked by high-altitude rockets carrying micrometeorite counting devices and by measurements of the sediment on the ocean floors. The data agreed with that recorded by the Explorer satellites. It was found that the annual penetration of micrometeorites (which are a kind of cosmic dust) into the earth's atmosphere amounted to about 2,000 tons. Spread over a year, that's not enough to endanger a space ship at any one instant of flight.

The electronic instrumentation designed to detect the amount of cosmic dust swirling through earth's surrounding space was designed and built at the California Institute of Technology.

Essentially there were two devices. A sensitive microphone was anchored

inside the payload housing. In addition there was a micrometeorite erosion gauge which consisted of 11 grids of fine brittle wire. This was mounted just forward of the last stage rocket motor nozzle and the grids were wired in parallel. When anything hit the shell of the satellite an amplifier and a "scale-of-two" circuit caused a frequency shift of a subcarrier oscillator. Each time a grid was broken by the impact of a micrometeorite; the resistance of the circuit changed and the change was reflected in the frequency of a subcarrier oscillator.

Other electronic instrument reports from the IGY have revealed more clearly the true nature of violent solar and cosmic radiations, the effect of these upon the weather and radio communications, and the effect of ionized gases upon the Earth's magnetic field. One day this information may even be applied to preventative medicine, for there is reason to believe that cancer, premature aging, sterility and other mysterious ailments of the human race are caused, or at least encouraged, by all of these phenomena surrounding the Earth. It is strongly suspected what is considered to be a normal human life span today may be quite brief indeed compared to the true normality of longevity in the future, when violent radiations might be controlled or deflected from our environment.

Already, as a result of electronic information supplied during the IGY, the National Aeronautics and Space Administration (NASA) is suggesting that some day even a means to control the weather is possible.

Using advanced sonar techniques, oceanographers roamed far and wide over the three-quarters of the earth that is covered by water. Their efforts were very successful. An undersea mountain range was found in the Arctic Ocean that we didn't know about before. Remote reading temperature devices discovered an important counter-current under the Gulf Stream off the east coast of the United States. Still another counter-current was located flowing under the Pacific from Asia toward Panama.



## Check Out Your Kit

*Continued from page 49*

to indicate a (desired) open circuit. An actual resistance reading here means that part of the 117-volt AC is connected to the chassis; this could give rise to serious shock hazard when the unit is used later.

Now set the meter to the "R X 1000" scale. Connect the meter's ground prod to the chassis; connect its "hot" prod to each of the positive lugs on the electrolytic filter capacitor. (This is the "can" capacitor generally located very close to the power transformer.) Wait a full minute for the meter needle to deflect and then slowly return to a certain value on the ohmmeter scale. If it hits 20,000 ohms or more, fine. If it goes substantially below 20K, it may be a sign of trouble. First, look for a short in the wiring of the B+ circuit to ground. The low reading could also be caused by a defective by-pass capacitor in any of the screen or plate circuits using one. Finally, a very low reading might indicate that the electrolytic itself is defective. Remove the lead soldered to the hot lug of the can and measure the resistance of lug to ground. If the reading falls much below 20K, the capacitor is defective. (Some meters, like the Superior Model 79, provide a convenient method of reading capacitor condition directly with portions of the meter scale marked "good" and "bad.")

### Power On, Tubes Still Out

Having checked out the power supply in its "at rest" condition, you now are ready to test it "live" under dynamic conditions. Do not insert any tubes yet, but plug in the power cord and turn the set on. Set your meter for low AC and measure the voltage across the appropriate secondary winding of the power transformer (the color green for these leads is fairly standard by the way). Next, just to double-check, measure the voltage across the proper holes or terminals (whichever is more accessible) of each tube socket.

Another thing to remember when checking filament voltage is that some

amplifiers use DC on some filaments. In the case of an amplifier using DC on filaments, remember that the filament voltage coming from the transformer secondary always is AC—if you then check for DC voltage at a tube socket so supplied, that voltage is coming after a rectifier—change your meter setting accordingly.

### Power On, Tubes In

After the above checks, turn the power off. Now insert all tubes. Make certain that each tube is placed in its correct socket; also check that any metal shields provided are placed around the tubes intended to be housed in them—and no others. Also, make sure that a metal shield makes contact with the little metal clip at the base of the tube socket. Now connect a speaker to the output terminals of the amplifier. If you are running these checks on a workbench and a speaker is not handy, use a "dummy load" instead. This simply is a wirewound resistor that should provide a close approximation of the load represented by a speaker. Its wattage rating should be sufficient to handle the power output of the amplifier. With the speaker or dummy load connected, you may now turn on the power. Do not advance the volume control.

First, observe the tubes. Do the filaments glow? Good. Next, allow the set to "warm up" for about two minutes and observe the rectifier tube. If the plates glow a bright red (do not confuse this with the normal red-orange glow of the filaments), something is amiss. Turn off the power; pull out the plug. Once again, check the B+ wiring, first taking the precaution to discharge the filter capacitor by holding the wooden or plastic handle of a long screwdriver and allowing the blade to contact the hot lugs of the filter capacitor and the chassis. In addition to all parts of the B+ circuit, pay special attention to the measurement of resistance between the rectifier cathode and ground. A low reading here is a sure sign of trouble. Also possible (but not too often likely) is the chance of breakdown in the filter capacitor on the first surge of voltage through it. Make sure; check it as described earlier.

Assuming the unit has passed all the tests so far, next connect the amplifier to a speaker, plug in a program source, and listen. If it doesn't seem to be performing properly, turn off the power. Begin making resistance measurements from all tube socket terminals to ground. Check these against the readings provided in the kit instruction book. If a serious discrepancy is discovered at any point, the trouble has been localized and chances are a careful recheck of wiring will reveal the defect. If all resistance readings match those listed by the manufacturer, turn the power on and take voltage readings from the same points. Check these readings against the values given in the instruction book (either on a separate chart or inserted right on the wiring diagram). In evaluating voltage readings, remember that even when a set is working properly, voltages may vary as much as  $\pm 20$  percent. This means, for example, if a given point is supposed to read 100 volts, it may read anywhere from 80 to 120 volts and still be okay. If, on the other hand, you get a reading as low as 70 volts or as high as 130 volts, something is wrong between that point and ground. When making voltage measurements, try to follow the manufacturer's procedure; if, for example, his voltage readings are specified as having been obtained with no signal input, you should do likewise when making your own measurements.

### Other Checks

Some, though not all, amplifiers—particularly the higher powered ones such as the Dynakits—require such adjustments as balancing the output tubes or setting the correct bias voltage. Do not ignore these adjustments or treat them lightly. Follow the manufacturer's instructions to the letter.

Yet another adjustment. Different cartridges require different loads for optimum frequency response. Make certain the one you use "works into" the correct value resistance. If an adjustment is provided for setting this value, check it. If no adjustment is provided, make sure the specific resistor soldered across the phono input is of a value

suited for the cartridge you'll be using. If the kit instructions do not list the values needed for the different cartridges, determine what is needed by studying the instruction sheet furnished with the cartridge itself.

Finally, consider your interconnecting cables and plugs. If you use the kind that are pre-connected, with the plugs already fitted to the cables, fine. If you are soldering your own, you might check for proper continuity and good solder joints. An amazing number of complaints can be traced to defective cables. The best amplifier in the world cannot deliver music if, for example, the signal from a phono player is going through a carelessly rigged cable only to become grounded at the plug! 

## Telephone Amplifier

*Continued from page 89*

excess wooden dowel from the coil form almost flush with the cardboard coil ends. After securing the two wire ends of the coil to the cardboard through tiny holes, the excess cardboard may be cut off. The enamel on the coil wire ends is carefully removed and a stiffer connecting wire is soldered to each end. Remember the coil wire is very fragile and great care must be taken not to strain it, heat it, or in other ways deform it excessively. Once the two connecting wires have been soldered to the ends, the actual solder connections are supported and held by masking tape. In order to protect the coil the entire unit is given a liberal application of Duco cement. This includes the winding as well as the coil form.

The first thing to build is the little sub-assembly which contains all the electronic components except the output transformer, battery, speaker and volume control. This sub-assembly is built on a piece of phenolic mounting board having diameter of  $2\frac{1}{4}$ ". In this particular unit, a standard transistor circuit mounting board with pre-punched holes was used. However, a piece of fiberboard cut and drilled to proper dimensions will also serve. A small notch is cut in one side of the

mounting board in order that the cables from the volume control may be passed through. If a piece of undrilled fiber-board is used, holes will of course have to be drilled for all the components. If the prepunched transistor board is used, the existing holes will accommodate the components nicely. In addition to the notch, only four more holes will have to be drilled to accommodate the mounting screws and the terminals for the power transistor.

All transistors, resistors and capacitors are mounted on one side of the circular board. In this instance, sockets were used for the smaller transistors but they may be wired in directly if care is taken not to subject them to excessive heat. The various interconnecting wires are pushed through the holes in the board and connected on the reverse side. The physical layout of the parts and the wiring is not too critical but should generally follow the layout shown in the assembly drawings. The induction pickup coil is mounted on the side of the circular board containing the interconnecting wiring. Mounting is accomplished by a small wood screw which is screwed into the dowel of the pickup coil. Leads for connecting the volume control switch, battery and output transformer are brought out from the circular mounting board to approximately 4" in length for easy wiring. Standard battery connecting clips are used on the power leads. The volume control is also soldered on to the end of its proper cables. A small L-shaped lug is secured through one of the holes on the periphery of the circular board. This lug is used to secure the board to the drinking glass chassis.

### Mounting the Assembly in the Glass

Virtually any plastic or polyethylene glass will serve as a suitable container for the unit. The builder's judgment can be given free rein as long as a few dimensional limitations are observed. The glass used should have an open end diameter of no less than 2¾" and a closed end diameter of no less than 2¼". Its length should be a minimum of 4¾". Any glass meeting these dimensions or

exceeding them will do very nicely.

In induction amplification devices, the pickup loop should be as far away as possible from the output transformer. If this principle is not adhered to, the loop will pick up signals from the transformer, resulting in instability and feedback. In this unit the output transformer is mounted right behind the speaker. The 9 volt battery is placed on top of the output transformer, just behind the speaker and the fit is usually sufficiently tight to hold the battery in place without any additional support. A ¼" hole is drilled into the side of the glass to accommodate the volume control. Usually this hole falls about half-way in the length of the glass. The volume control is inserted and the mounting screw tightened. Care should be taken not to tighten the mounting nut excessively because in some plastics there is a tendency toward cracking. The circular electronic sub-assembly is then mounted by means of its L-bracket with the pickup coil facing the open end.

### Using the Telephone Amplifier

In use, the telephone receiver is gently pushed into the open end of the glass containing the pickup coil. The volume is then adjusted as required. The telephone receiver can be placed on a table with the amplifier fitted over it so the unit serves as a conference amplifier. It is also light enough to be held in the same hand with the telephone.

The unit is capable of considerable volume and amplification. If additional volume is desired, a 3" wide ring radiator made out of paper can be placed over the speaker end. Since the unit uses a power transistor, fairly high currents are drawn. In order to keep the device small, a comparatively low current battery was used. This means that the unit will not operate as long as some transistorized devices. In checking it, we found we could get about six hours of continuous duty, or roughly eight hours of intermittent duty. Although this is not very impressive, as far as other transistorized devices are concerned, it certainly represents a lot of telephone conversations. ●

Continued from page 39

radio at home, or the car radio for mobile operation. Suitable interconnections will be shown later.

When used in a car (the compact case lends itself to under-the-dash mounting), the car's broadcast antenna is used for three functions; broadcast reception (as usual), and Citizens Band reception and transmission. This antenna plugs into the unit whose switching arrangement connects the antenna to the desired section. Thus, normal broadcast reception remains undisturbed. This system foregoes an additional antenna installation for CB use.

No elaborate test equipment is necessary during construction, though one piece of gear will be of great assistance. A grid-dip meter is invaluable for checking the frequency of coils, and for tuning purposes.

The first module is the receiving converter. Its job is to receive signals in the 27 megacycle Citizens Band and convert them to a frequency usable by the broadcast receiver. Considerable saving is thus effected: the BC set's RF, IF, detector and audio stages will be used. The signals on the Citizens Band will be heard in the speaker of the BC set, and their level adjustable by its volume control.

Recalling the theory discussed in an earlier article in this series, the converter acts much in the same manner as the mixer-converter tube in the superheterodyne receiver.

The CB converter is placed immediately before the mixer (or RF stage, if the BC set has one). The net effect is *dual conversion*. For the specific signal pathways see theory diagram on page 38.

The first conversion occurs as the received signal is mixed with the oscillator frequency produced by the oscillator section in the 6BE6 tube. The result of the mixture will be 1500 kc. Remember that the oscillator capacitor tracks with the antenna tuning capacitor so the oscillator will always produce a 1500 kc difference. The BC set is tuned to

1500 kc. Customarily, the last push-button on the car radio is adjusted to 1500 kc so this frequency may be conveniently selected when the converter is used. If 1500 kc is not a clear spot on the broadcast band in your area, the converter's output may be shifted by adjusting its oscillator coil slug.

The second frequency conversion occurs in the BC receiver's mixer stage, where 1500 kc is converted down to the set's IF frequency of 455 kc.

The key factor here is that the BC set accepts the converter's output and treats it as though it were any broadcast station. A complete 27 megacycle receiver has been assembled through the addition of a single tube! This combination yields the high sensitivity and "image" rejection features found in good communications receivers.

The dual-section tuning capacitor used here may seem to be an unusually high-capacitance unit. In the search for an inexpensive receiving capacitor of sufficiently low value, the catalogs listed only expensive transmitting types. But, the simple expedient of putting small mica capacitors in series with each section of C1 brings their capacity down. Basic capacitor theory indicates that the total capacity of two capacitors in series yields a *total* capacity of less than either one. Note that C2 and C3 are only 5 mmfd each. Another desirable effect is that the complete travel of the tuning capacitor just about covers the Citizens Band, thereby providing the necessary bandspread.

### Construction

Careful attention to the mounting position of the various modules is important. The locations of the individual components in a particular module must follow those shown in the photos. Otherwise, difficulty in fitting them into the case will result. It's a good idea to purchase the case at the same time as the parts for the converter are secured. It will serve as a guide, though its wiring will not be shown in this article. It is a Bud Minibox CU-2109-A.

Each module uses a perforated board sub-assembly. The widely available board of the phenolic-type is too thin for



**Look what \$29<sup>95</sup> buys in  
high fidelity equipment!**

*A complete 14-watt hi-fi rated amplifier-preamplifier combination in one attractively styled unit . . . and at less than half the price you would expect to pay!*

Learn how you can "build-it-yourself" and save 50% or more on the world's finest high fidelity equipment. Send today for your FREE Heathkit catalog—or see your nearest authorized Heathkit dealer!

**14-WATT HI-FI RATED AMPLIFIER KIT (EA-3)**

From HEATHKIT audio labs comes an exciting new amplifier . . . New Styling, New Features, Brilliant Performance! Designed to function as the "heart" of your hi-fi system, the EA-3 combines the pre-amplifier and amplifier functions into one compact package with an

honest 14 watts of high-fidelity-rated power, capable of driving the most demanding systems, and all the necessary controls for precise blending of sound reproduction to your individual taste. Clearly marked controls give you finger-tip command of bass and treble "boost" and "cut" action, switch selection of three separate inputs, "on-off" and volume control. A hum balance control is also provided. **ORDER YOUR EA-3 TODAY!** . . . a few hours of easy kit building fun will earn you a lifetime of hi-fi pleasure! Shpg. Wt. 15 lbs.

**NOTE THESE OUTSTANDING SPECIFICATIONS:** Power output: 14 watts, Hi-Fi; 12 watts, Professional; 16 watts, Utility. Power response:  $\pm 1$  db from 20 cps to 20 kc at 14 watts output. Total harmonic distortion: less than 2%, 30 cps to 15 kc at 14 watts output. Intermodulation distortion: less than 1% at 16 watts output using 60 cps and 6 kc signal mixed 4:1. Hum and noise: mag. phono input, 47 db below 14 watts; tuner and crystal phono, 63 db below 14 watts.



Complete line of monophonic stereo-tape recorders . . . from \$99.95



Finest quality hi-hi speaker systems . . . from \$34.95



Everything for stereo! Amplifiers . . . from \$29.95

World's finest monophonic amplifiers . . . from \$15.95

**HEATH COMPANY**  
 a subsidiary of Daystrom, Inc.  
 Benton Harbor 39, Michigan

Please send the latest Free Heathkit Catalog.

NAME \_\_\_\_\_

ADDRESS \_\_\_\_\_

CITY \_\_\_\_\_ STATE \_\_\_\_\_

All prices F.O.B. Benton Harbor, Mich. Prices and specifications subject to change without notice.

*Continued from page 99*

this purpose, so a more rigid material was selected.

All modules, except the converter, are supported by four screws, one at each corner. Small spacers (made by Walasco) prevent the board from touching the metal case.

The converter sub-assembly is held to the front panel of the case by three screws located around the shaft of the tuning capacitor. The frame of the capacitor is tapped with threads for this purpose. Don't use overly long screws or they will interfere with the rotation of the capacitor plates; 6/32x $\frac{1}{4}$ " screws are OK if a lockwasher is used between their heads and the outside of the front panel. When the hole for the shaft of the tuning capacitor is cut, enlarge it sufficiently to accommodate the raised shoulder that surrounds the shaft. This serves to lock the capacitor in place after the three mounting screws are tightened. Also, the frame of the capacitor will automatically ground to the case and complete the converter's return circuits.

In the diagrams several input and output connections are labeled. These will connect to other modules as they are added. These points may terminate on the board in one of two ways; you can form a loop after the wire has been pushed through a hole in the board, or use small terminal posts.

Carefully note the position of the converter shown in the photos. Its bottom edge touches the bottom surface of the case and the two large coil forms will be about  $\frac{1}{8}$ " short of the case's left edge. Be sure that no wires or terminals short to ground when the converter is in its mounting position. An ample supply of lockwasher-type ground lugs should be on hand. Two are used to hold the board to the capacitor frame and also serve as support for output coil L4. The capacitor has tapped holes to receive 6/32 screws at the ground lug points shown.

Tuning and testing of the converter will have to be reserved for a future date since no source of power is available in the unit at this point. Next month's module will be the RF oscillator-amplifier. ●

Alvar P. Wilska, report on a new electron microscope that may give us a better look not only at the respiratory viruses, but at some of their structural parts, like proteins. Dr. Wilska says his microscope gives excellent contrast and operates on a voltage intensity as little as one-quarter that of conventional electron microscopes. Biological tissue is much less transparent to the low voltage electron, causing it to show up better on the screen.

We need the best possible weapons, for germs are cunning. One of the devilish tricks at which the influenza agent is particularly adept is the ability to mutate, that is, to give birth to slightly different viruses against which humans have no "combat experience." Our recent Asian influenza was a new strain.

Electronics is an indispensable aid to a group of scientists at the University of California laboratories in trying to find how a virus can change form this way. A respiratory virus is usually a comparatively dangerous "laboratory animal" so these investigators are using a plant virus, the one that causes tobacco mosaic disease. The most detailed information on the structure of this virus has been obtained from X-ray diffraction.

Roentgen rays (X rays) have been particularly useful in virus studies, although they are used for analysis of other substances, too. These rays form diffraction patterns when passing through a crystal (and viruses, which have been called "living chemicals," can usually be crystallized). The regular spaces between the atoms of the crystal represent slits in a diffraction grating. Light is "bent" around the edge of a slit and the angle of diffraction will indicate wave lengths of the light rays. In the case of X-ray diffraction, the patterns reveal the position of the atoms and the spaces between them, that is, the *structure* of this biological material.

But don't catch cold if you can help it. Even with the aid of medical electronics, our war against the cold bugs is only just beginning. ●



# BETTER T. V. RECEPTION WITH T. V. BOOSTER!

Amazing new T.V. Booster plugs in to any wall socket connects to antenna of your T.V. set—increases T.V. range helps get BETTER pictures on all T.V. Channels. Uses practically no electricity. Improves reception. Helps give you the clearest pictures in town. So good it works even without expensive antennas. Helps give Stabilized Reception. No more jumping up and down to adjust pictures! Improves performance of any make or year T.V. Must improve your T.V. or money back. Comes for \$4.98 post paid, or Delux Model \$5.98 ppd. from T.V. Booster Co. Dept. 6, 403 Market St., Newark, New Jersey.

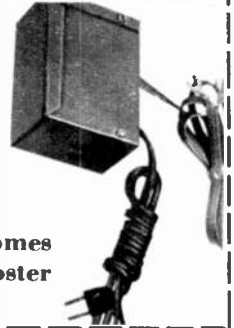

## 4-Watt Stereo Amplifier

Continued from page 101

space. Both of these problems are neatly solved if you build or buy ready made an integrated unit such as this kit.

On the front panel are five controls: input selector, mode, level, tone, and power "on-off." Five pairs of stereo inputs are featured for ceramic or crystal stereo cartridges, stereo tape deck with pre-amplifier, AM tuner, FM tuner, and multiplex adapter.

Construction time for the kit was approximately fifteen hours which includes proper checkout of components.

Building this kit is not difficult as EICO assumes the builder to be a novice. Their manual is well illustrated with step by step wiring diagrams.

On the debit side, it was found that the manual does not always give the correct wire lengths for each connection. Before cutting the hookup wires to the length stated in the manual, string the wire between the two points to be connected and then cut the wire to the correct length. Also, the level and tone controls are not clutch operated, rather, they are conventional concentric controls; hold one to turn the other.

Listening tests with high efficiency speakers showed the unit put out enough sound with the volume control set about half way up. It is not recommended for low efficiency speakers.

Summing up, the EICO AF-4 is an economical kit to start you on the road to a stereophonic sound system for a small to medium sized room.

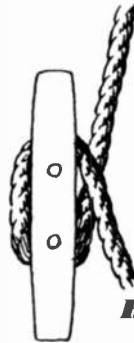

*Boaters Ahoy!*

**TRUE**  
THE MAN'S MAGAZINE

**BOATING**

**MAGAZINE**

*Big Boat Show Issue  
now on sale*

## ONE CENT SALE

**BUY ONE AT OUR REGULAR LOW PRICE AND  
GET THE SECOND FOR ONLY 1¢ MORE**

**CITIZENS BAND TRANSMITTER** (27 MC) chassis complete with crystal. \$12.49 each, two for \$12.50.

**TRANSMITTER** similar to above but with 5 watt RF stage instead of 1 watt. \$14.99 each, two for \$15.00.

**CITIZENS BAND RECEIVER** chassis tunable through all 22 channels. Complete with audio amplifier. \$9.99 each, two for \$10.00.

**AMATEUR BAND TRANSCEIVER** (144-148 MC) chassis with dual VHF triodes for walkie-talkie radiophone. \$9.99 each, two for \$10.00.

**TRANSFORMER**: Mike to grid input and plate to low impedance headphone output. Good for telephone handsets. \$1.99 pair, two for \$2.00.

**TELEPHONE HANDSET** with push-to-talk switch. \$5.99 each, two for \$6.00.

**MICROPHONE** High output 200 ohm carbon with terminal lugs. \$1.49 each, two for \$1.50.

**COILED CORD** 4 conductor 11" telephone cord. Extends to over 4 ft. .99 each, two for \$1.00.

**KIT OF PARTS** for AM-FM VHF radio receiver. Tunable from 80-200 mc. which includes U. S. satellite frequencies. \$6.99 each, two for \$7.00.

**TRANSISTOR AUDIO AMPLIFIER** gives 50X voltage gain on low level signals. Operates on 1½ volts. \$3.99 each, two for \$4.00.

**CONVERTER** (crystal controlled) for 27 MC Citizens Band. Adapts any standard broadcast radio to 27 MC band. Tunes all 22 channels. Complete with tubes and crystal \$14.99 each, 2 for \$15.00.

**TRANSMITTER CRYSTALS** in holders. Assorted frequencies for experimenters. Bag of 10 only \$1.49, two bags for \$1.50.

**ALL MERCHANDISE GUARANTEED**

Limited Quantity—No literature or Catalog

Remit in full, include sufficient postage. No C.O.D.'s.

**VANGUARD ELECTRONIC LABS.** Box 12-EL3  
Mollis 23, N. Y.

Continued from page 55

### Emission Testers

The basic circuit of an emission tester is shown in Fig. 2. All of the elements of a tube, with the exception of cathode and heater, are tied to one side of the secondary winding of a transformer. The cathode itself is connected through a milliammeter and a variable resistance to the other side of the transformer winding, completing the circuit. The filament receives the necessary driving voltage from a separate filament winding on the transformer.

In this circuit, the tube operates as a rectifier, permitting current to flow during the half cycle when the cathode is negative with respect to the plate. During these periods, current will flow through resistance R and the meter will indicate the value of the pulsating DC present. Each tube that the checker is capable of testing has a certain setting of resistance R which the instrument manufacturer indicates on a Roll Chart. When R is set to the proper value and the tube under test is operating normally, the current that flows through the meter will swing the needle over to a section of the dial marked "Good." See Fig. 3. If the tube emission is not sufficiently strong, the needle may only reach the dial section containing the question mark. A still weaker tube will only bring the needle to the section of the dial marked "Bad." Tubes which cannot swing the meter needle to the "Good" section should be replaced, even if the needle comes to rest just slightly below this section. This is a safe rule to follow. Whenever tube emission falls below its normal value, some deterioration has probably started and is likely to continue.

If any of the tube elements are open, it can be detected by the emission checker in the following manner. In the initial test, all of the elements except the cathode are connected to the plate terminal and the meter reads the total current flowing through the circuit. If, now, we disconnect one of these elements from the plate terminal, the

amount of current read should decrease somewhat because each of the elements ordinarily carry some portion of the total current and by disconnecting one of these elements we reduce the number of elements feeding current into the circuit. The drop may not be much, but some small indication should be observable. This test can be performed on each element. If it is found that the switching out of a certain element produces no effect on the overall meter reading, it indicates that element was open in the first place.

While only a single filament winding is shown on transformer T in Fig. 2, an actual commercial tube checker would have a variety of filament voltages available so that tubes with different filament requirements could be tested. By the same token, the tube tester would contain a number of different types of sockets such as octal, 7-pin, 9-pin, etc. to enable tubes with different bases.

### Mutual Conductance Testers

All tubes other than diodes and rectifiers perform the function of amplification no matter what their circuit use. Amplification, in turn, is governed by the mutual conductance of a tube.

Mutual conductance is the ratio of the change in the plate current that results from a small change in grid voltage. The amplification of a circuit is equal to the product of the mutual conductance times the load resistance. Since the load resistance is generally constant, amplification becomes directly proportional to the mutual conductance of the tube. The  $G_m$  for a given tube can be measured quite accurately by applying the correct amount of AC signal voltage to the grid and measuring the resulting plate current.

One arrangement that has been employed is shown in Fig. 4. The tube under test has its plate connected to the cathode of a duo-diode full-wave rectifier. This rectifier receives its driving voltage from two windings on a transformer. The current that flows through the rectifier passes not only through a transformer winding but also through one of two resistances, R1 or R2. The common point of these two resistances is

brought back to the cathode of the tube under test.

To follow the operation of this circuit, assume that a small negative voltage is applied to the tube under test, V1. This voltage causes current to flow through V1 and to the cathode of the full-wave rectifier, V2. At the rectifier, the current will pass to either plate 1 or plate 2, depending on which plate happens to be positive at that particular instant. If we assume P2 is positive, current will flow from the cathode of V2 to P2, through winding L1 on the transformer, down through R1 to point A and back to the cathode of V1. The voltage which this current produces across R1 will cause the meter needle to deflect in one direction. During the next half cycle, the current through V2 will flow from the cathode to P1, through winding L2 to resistor R2, to point A, and back to the cathode of V1. Since the voltage developed across R2 is opposite in polarity to the voltage previously developed across R1, the meter needle will swing in the opposite direction. Thus, during any one full cycle, the meter needle should swing first one way and then the other. However, since the voltage is changing fairly rapidly, and the meter needle possesses too much inertia to follow these swings, all it actually does is stay at the zero mark and quiver slightly.

Now assume that in addition to the fixed negative voltage applied to the grid of the tube under test, we add another winding to the transformer and apply a small AC signal to the grid of V1. This AC signal is in phase with the voltage applied to plate P2 of the full-wave rectifier. Under these conditions, when the AC grid signal of V1 is going positive and current is increasing through the tube, plate P2 is also going positive and the current from the tube under test will swing through the diode to the plate P2, down through resistance R1, and back to the cathode of the tube under test. During the next half cycle, when the plate of P1 is positive, the grid is receiving a negative AC voltage and consequently the current produced will be less than the current that flowed during the previous half cycle. This current flows through the rectifier to plate P1,

## TUBE REPLACEMENT GUIDE

EVERYONE who uses vacuum tubes NEEDS this new 1960 Expanded Edition TUBE GUIDE.

Contains over 2700 substitutes for over 1500 tubes, including radio & TV receiving tubes, tubes used in Hi-Fi & Stereo, foreign tubes and TV picture tubes.

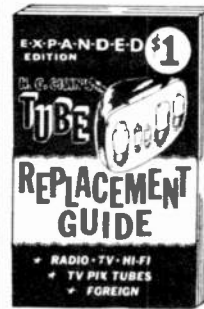

All tubes suggested for substitution have characteristics similar to those they are to replace, FIT INTO SAME SOCKET & NEED NO WIRING CHANGE.

Two chapters cover complete listing of TV Pix tube replacements including newest 110° tubes.

Substitutes given for over 225 foreign tubes. Last chapter lists transistor substitutes. The only complete GUIDE featuring all

receiving tube substitutions WITHOUT SOCKET CHANGING OR REWIRING. This valuable book will save you TIME & MONEY and permit operation of your set even though original tubes are unobtainable.

Guaranteed Money Back in 5 Days if Not Satisfied

\$1 Post-paid

RUSH COUPON NOW!

H. G. CISHIN, Consulting Engineer—Dept. EL-12  
Amagansett, N. Y.

Enclosed find \$1. Rush TUBE REPLACEMENT GUIDE.

Name \_\_\_\_\_  
Address \_\_\_\_\_  
City \_\_\_\_\_ Zone \_\_\_\_\_ State \_\_\_\_\_

## CUT HOLES IN 1-1/2 MINUTES

(OR LESS)

with Greenlee  
Chassis Punches

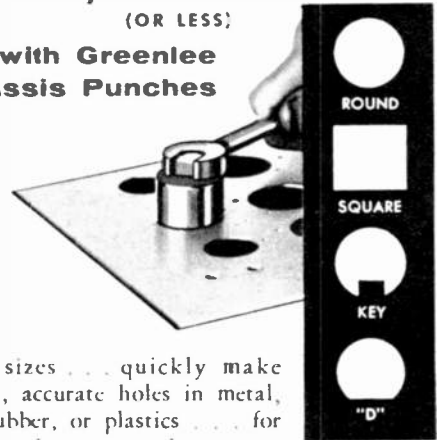

Many sizes . . . quickly make smooth, accurate holes in metal, hard rubber, or plastics . . . for sockets, plugs, controls, meters, panel lights, etc. Easy to use, simply turn with a wrench. Write today for free literature.



GREENLEE TOOL CO.

1783 Columbia Avenue, Rockford, Ill.



through winding L2, up through R2, and back to the cathode of the testing tube. The voltage produced across R2 is smaller than the voltage developed across R1. With these unbalanced currents in successive cycles, the meter reading becomes proportional to their difference. Therefore, the meter indicates the change in plate current produced by the change in grid voltage.

The foregoing arrangement or some variation is representative of the basic circuitry of most mutual conductance tube testers. There is, however, one variation which acts to determine the mutual conductance of a tube as well as its ability to provide peak currents. In short, what this manufacturer is striving for is an indication of grid-to-plate mutual conductance at the peak output levels of the tube. This is achieved by using a large driving signal at the grid, large enough, in fact, to cause the tube to operate in the positive grid region. Basically, the test circuit appears as shown in Fig. 5. AC voltages are applied to the various elements of the tube in phase with each other. These voltages are selected so that they fall within the operating range of the particular tube being checked.

If there were no grid signal, the meter would read some value corresponding to the zero grid plate conductance of the tube being tested. The increased plate current created by the application of the grid signal is that portion of the total meter indication attributable to mutual conductance. By swinging the grid over a wide range, an indication of grid-to-plate mutual conductance at peak levels can be obtained.

### Short and Leakage Tests

There are two supplemental tests that are almost always included in mutual conductance and emission type tube checkers. These are short and leakage tests. The short test is designed to uncover any electrical short that may exist between two elements. A suitable circuit for this purpose is shown in Fig. 6. With the various switches in the positions indicated, we are checking for a short-circuit between the control grid and each of the other elements. If such

a short does exist, a complete circuit will be formed across the transformer secondary and both plates of the neon bulb will glow. On the other hand, if the control grid is not shorting to any other element, only one plate of the neon tube will glow and this will occur during that half of the input cycle when the grid is positive with respect to the cathode and current can pass through the tube. Each element of the tube is checked in similar fashion. Resistor R1 serves to limit the current through the neon bulb to a safe value and resistor R2 bypasses any small alternating currents in this circuit caused by the stray capacitance of the wiring between other parts of the tester. This prevents these stray currents from causing the neon to glow.

In making the short test, it is desirable to have the tube first reach its operating temperature, because it can happen that the short appears only after the various elements of the tube have heated up and expanded. Then tap tube gently while the short test is being performed.

A short test can also be performed by applying a DC voltage to one element while all the other elements are connected to ground. See Fig. 7.

Leakage testing is designed to reveal high resistance paths between various tube elements.

One suitable circuit is shown in Fig. 8. Here, the chief objective is to check for leakage between cathode and filament. With the switch SW in position 1, the circuit is complete and current will flow through the meter. The switch is then thrown to position 2, thereby breaking the circuit. If any current is now indicated by the meter, a leakage path exists from filament to cathode.

In many testers, arrangement shown in Fig. 8 (or Fig. 7) will provide only a nominal test because meter M requires currents in the milliamperere range before it is actuated. On the other hand, a typically high leakage resistance will permit only microamperes to flow. Thus, in these testers, no leakage will be indicated when in fact it is present.

Special sensitive leakage testing circuits are available, either separately or as part of a complete tube tester, and these will be discussed later. ●

## .22 CAL. NEW 7 SHOT REPEATER AUTOMATIC

The skilled hand of the German gunsmith is responsible for this .22 caliber 7 shot repeater automatic with self-ejecting empty shells. Just 4 inches long, fits easily into pocket or purse. Ideal for sporting events, stage use (not available to Calif. residents). Not a lethal weapon. Comes for \$6.95 from

**BEST VALUES CO.**

Dept. F-104, 403 Market St., Newark, New Jersey

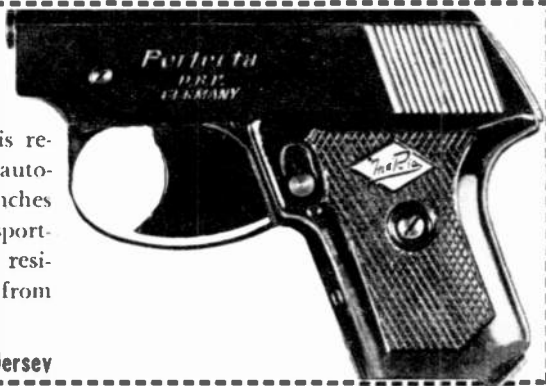

### Communication Receiver Kit

*Continued from page 63*

cally and mechanically. A jack is provided for the addition of a "Q" multiplier—a device that will considerably enhance the receiver's selectivity, and its ability to reject interference.

The large chassis provided simplifies construction. There are no tight corners or pile-up of wires. But this has its attendant evil; long leads can cause losses at the higher frequencies and feedback and oscillation to occur. They can be avoided by keeping wires as short as possible. If the "S" meter gives an abnormally high reading with no signal being received, the wires to the IF transformers might have to be repositioned.

Instructions for alignment of the completed set are given in the manual. An RF signal generator should be used to attain the best sensitivity and calibration accuracy. The "S" meter itself serves as the output indicator.

Construction time ran about 13 hours, including alignment. The instruction manual was well written and a large blow-up pictorial clarified much of the parts and wiring. A wiring pictorial for the coil and bandswitch sub-assembly was not included. The addition of this could speed up construction time.

The receiver performed well, tapering off in sensitivity only on the highest band when compared to a more expensive, commercially-built ham receiver. Considering the amount of extras available in the unit (it also has a noise limiter and accessory power socket) it is a Good Buy at \$39.95. ☺

## HELP

yourself to better service from your postal service by including postal zone numbers on all correspondence.

Don't forget to include your own postal zone number in your own return address.

Postal zoning helps your post office give you better service.



## New "Mechanical Educator" to IMPROVE MEMORY

Inability to recall names, places, facts quickly is a common, often costly, shortcoming that can now be easily overcome with the aid of a new device for mental training. This versatile new educational tool can also be used effectively in language learning, speech correction and improvement, in mastering tables, formulae—anything to be memorized—faster than ever while you sleep.

### DORMIPHONE Memory Trainer Works for you—You learn while you sleep

- Speeds up learning processes
- Aids concentration
- Provides entertainment

Using a new recording principle the Memory Trainer records, instantly plays back, and automatically repeats speech, music, or any spoken or broadcast material by clock control. No reels of tape to snarl or rewind. Completely portable. Ideal aid for home, school, industrial safety training use. So simple to use, children benefit—so helpful and practical, it is used by educators, psychologists, people of all ages and professions.

#### SELF-

#### CONTAINED RECORDING CARTRIDGES

from 30 seconds to 95 minutes. Easily removed. Can be stored or "erased" instantly and re-used repeatedly. Just record, flip a switch for play-back and listen!

Write TODAY for FREE folder with complete information. Modernophone, Inc. 367-030 Radio City, New York 20, N. Y.



#### MODERNOPHONE, INC.

367-030 Radio City, New York 20, N. Y.

Circle 7-0830

Gentlemen: Please send me your FREE booklet. I am interested in reading more about Scientific Sleep Learning and what the Dormiphone Memory Trainer can do for me. No obligation—no salesman will call.

Name \_\_\_\_\_

Address \_\_\_\_\_

City \_\_\_\_\_ Zone \_\_\_\_\_ State \_\_\_\_\_

My main interest in the Memory Trainer is for:

- Language Learning  Speech Improvement  
 Memorization  School or College Work

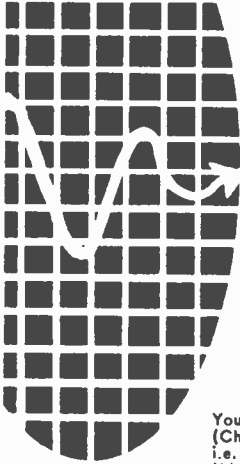

## ELECTRONICS ILLUSTRATED

Classified Ads

Your advertisement can reach this mail-buying audience for only 35¢ per word . . . payable in advance (Check or M.O. please) . . . minimum 10 words. Closing dates are the 20th of 3rd preceding month i.e. copy for the June issue must be in our office by March 20th. Mail to ELECTRONICS ILLUSTRATED, 67 West 44th St., New York 36, N. Y. Word count: Zone number free. Figure one word: Name of state (New Jersey), name of city (New York); sets of characters as in key (I4-D); also abbreviations as 35MM, 8x10, D.C., A.C.

### SAVE MONEY • ORDER BY MAIL

#### • • • FOR SALE

**MONEY SAVING** Prices on tubes. TV, Radio, Transmitting and Industrial Types. New, 1st quality, guaranteed. Top name brands only. Government surplus and commercial test, lab and communications equipment in stock. Sell us your excess tubes and equipment. Unused, clean tubes of all types wanted. Send specific details in first letter. Write for "Green Sheet" catalog 25¢. Barry Electronics Corp., 512 Broadway, (Dept. E.), WA 5-7000, New York 12, N. Y.

**GOVERNMENT SELLS:** Surplus Electronics; Test Equipment; Oscilloscopes; Transceivers; Jeeps; Boats; Aircrafts; Misc.—Send for U. S. Depot Directory & Procedure \$1.00. "Government Surplus Sales," Box 425-EL, Nanuet, N. Y.

#### • • • PRINTING, MULTIGRAPHING, MIMEOGRAPHING

**RUBBER STAMP** 3 Lines pocket, \$1.00. Armstrong, 52724 Frances, South Bend 17, Indiana.

#### • • • BUSINESS OPPORTUNITIES

**GROW MUSHROOMS.** Cellar, shed and outdoors. Spare, full time, year round. We pay \$4.50 lb. dried. We have 29,000 customers. Free Book. Mushrooms, Dept. 315, 2954 Admiral Way, Seattle, Wash.

**VENDING MACHINES**—No selling. Operate a route of coin machines and earn high profits. 32-page catalog free! Parkway Machine Corp., Dept. 33, 715 Ensor St., Baltimore 2, Md.

**MAKE \$5,000-\$10,000 YEARLY** at home, in respectable field. Future growth unlimited! No experience necessary, no public contact, nothing to grow or make. Free expert guidance helps you achieve financial success. Rush name for Free, Complete Plan! Columbia Enterprises, 9268-EL Piney Branch Road, Silver Spring, Maryland.

#### • • • EMPLOYMENT OPPORTUNITIES

**PRINTING - ADVERTISING SALESMEN.** Excellent moneymaking sideline selling Decalomania Name Plates. Advertising Specialties. Sign letters, Automobile initials. Free Samples. "Ralco"-El, Box L, Boston 19, Mass.

#### • • • HI-FI

**UNUSUAL BUDGET Values.** Tape recorders, tapes and Hi-Fi components. Send for package quotations and free catalogue. Budget Hi-Fi Distributors, 83-06 Victor Ave., Elmhurst, N. Y.

#### • • • TAPE RECORDERS

**TAPE RECORDERS, Hi-Fi components,** Sleep Learning Equipment, tapes. Unusual values. Free catalog. Dressner 69-02 Z 174 St., Flushing 65, N. Y.

**HI-FI, RECORDERS.** Free Wholesale Catalogue. Carston, 125-G East 88, N. Y. C. 28.

#### • • • MISCELLANEOUS

**CHEMICALS AND Apparatus Catalog** 25¢. Nu-Age Laboratories, Box 232, Bellmore, N. Y.

#### • • • RADIO & TV

**10 DISTANCE CRYSTAL Set plans**—25¢; 20 different 50¢, with Transistor experiments, catalog. Laboratories, 1131-K Valota, Redwood City, California.

**DIAGRAMS FOR repairing** radios, amplifiers, \$1.00; television \$2.00. Give make, model. Diagram Service, Box 672-El, Hartford 1, Conn.

**NEW BOOK (Mobile Hi-Fi) Tape Recorders, Stereo, F-M, etc.** \$5.00. Ekeradio, 650 N. Fair Oaks, Pasadena, California.

#### • • • STAMPS & COINS

**THREE BRILLIANT uncirculated Mexican silver dollars** \$1.00. Universal Services, Box 675, San Antonio 6-P3, Texas.

#### • • • DETECTIVES

**DETECTIVES—WORK Home—Travel.** Experience unnecessary. Detective Particulars free. Write, Wagner, B-125 West 86th, New York 24.

#### • • • MUSIC

**ACCORDIONS—SAVINGS to 50%.** Free trial. Trades accepted. Free catalog. Accordion Manufacturers, Dept. 30-EL, 2003 Chicago, Chicago 22.

**SAXOPHONE-CLARINET. BEAUTIFUL** ad-lib solos. Standards—5 for 1.00. "Studio," 59 Blaine, Pontiac, Mich.

**SONGPOEMS AND Lyrics Wanted!** Mail to: Tin Pan Alley, Inc., 1650 Broadway, New York 19, N. Y.



# MICRO

ELECTRON TUBE

INTRODUCES FOR THE FIRST TIME ANYWHERE A SELECT STOCK OF USED TUBES AT A FABULOUS LOW PRICE

# 37¢

FOR any TUBE LISTED

**\$35** PER HUNDRED ASSTD

ALL TUBES SENT POSTAGE PAID  
Please send 25¢ handling for orders under \$5. Send 25% deposit on C.O.D. orders. Send approximate postage on Canadian and foreign orders.

# MICRO

ELECTRON TUBE CO. Dept. EI-3, P. O. Box 53 Park Sta., Paterson 3, N. J.

- Exact and every tube is tested in our own laboratory for mutual conductance and life test.
- We guarantee FREE replacement for one year of any tube any or all operating conditions. Prompt refunds are made on any defective merchandise.
- The advertised tubes are not necessarily new, but may be electrically perfect factory seconds or used tubes—each is clearly so marked.

6A3	6X6	6BM6	6BF5	724	19R06G
024	6Y9GT	6BK5	6BF7	12A8	19J8
1A7GT	6Y9G	6BK6	6BJ7	12AQ5	19T8
1B3GT	6A7	6BK7	6BJ7	12AT6	24A
1H6GT	6A8	6UL7GT	6SM7	12AT8	25AV5
1L6	6A8A	6C1	6SL7GT	12AY7	25BQ6
1L6	6AC7	6C2	6SN7GT	12AU7	25DNG
1R5GT	6AF4	6C3	6SQ7	12AV8	25L6GT
1Q5GT	6AQ5	6C4	6SV5	12AV8	25W4GT
1R5	6AQ7	6C5	6T4	12AV7	25Z5
15A	6AH4GT	6C6	6T8	12AX4GT	25Z5
174	6AH6	6C7	6U6	12A7	25Z5
1U4	6AR5	6C8	6V6	12B4	26
1U8	6AL6	6C9	6W4GT	12B6	35A5
1V2	6AL7	6CA	6W6GT	12B7	35B5
2A3	6AN6	6CB6	6W8GT	12C4	35C5
2A3	6AN6	6CB6	6W8GT	12C6	35L6GT
2AF4	6AQ5	6C7	6X5	12H7	35W4
3BC5	6AQ6	6C8	6X5	12H7	35Y4
3BN6	6AQ7GT	6C9	6X5	12H7	35Z5GT
3BZC	6AR5	6CL6	6X5	12H7	37
3BZC	6AR5	6CM7	7A4/XXL	12CA5	39/44
3C7	6AT5	6CN7	7A8	12J5	42
3C8	6AT5	6C8	7A8	12K7	43
3L6	6AU4GT	6C9	7B6	12L6	45
3Q4	6AUSGT	6C9	7B6	12M7	60A5
354	6AUS	6C9	7B6	12N7	60B5
3V4	6AV5GT	6H6	7B7	12P7	60C5
4007A	6AV6	6J4	7B8	12S7	60D5
4B27	6AV6	6J5	7C4	12T7	60E5
6AT8	6AX4GT	6J7	7C5	12U7	60F5
6AT8	6AX4GT	6J7	7C6	12V7GT	60G5
6AV8	6A19GT	6H6GT	7C7	12W7	60H5
6AW4	6B6	6H7	7C7	12X7	60I5
6BK7	6B6	6H7	7C8	12Y7	60J5
6J6	6BC5	6K8	7E7	12Z7	60K5
6T6	6BC5	6L7	7F7	12Z7	60L5
6U6	6BC6	6M7	7F7	12Z7	60M5
6U6	6BC6	6N7	7F7	12Z7	60N5
6U6	6BC6	6O7	7F7	12Z7	60O5
6U6	6BC6	6P7	7F7	12Z7	60P5
6V4	6BF5	6S4	7H7	12Z7	60Q5
6V6GT	6BF5	6S4GT	7H7	12Z7	60R5
	6CG6	6SA7	7Q7	12Z7	60S5
	6C7	6SB7	7Q7	12Z7	60T5
		6SC7	7X7/XXFM	12Z7	60U5
			7Y4	12Z7	60V5
				12Z7	60W5
				12Z7	60X5
				12Z7	60Y5
				12Z7	60Z5
				12Z7	60A6
				12Z7	60B6
				12Z7	60C6
				12Z7	60D6
				12Z7	60E6
				12Z7	60F6
				12Z7	60G6
				12Z7	60H6
				12Z7	60I6
				12Z7	60J6
				12Z7	60K6
				12Z7	60L6
				12Z7	60M6
				12Z7	60N6
				12Z7	60O6
				12Z7	60P6
				12Z7	60Q6
				12Z7	60R6
				12Z7	60S6
				12Z7	60T6
				12Z7	60U6
				12Z7	60V6
				12Z7	60W6
				12Z7	60X6
				12Z7	60Y6
				12Z7	60Z6
				12Z7	60A7
				12Z7	60B7
				12Z7	60C7
				12Z7	60D7
				12Z7	60E7
				12Z7	60F7
				12Z7	60G7
				12Z7	60H7
				12Z7	60I7
				12Z7	60J7
				12Z7	60K7
				12Z7	60L7
				12Z7	60M7
				12Z7	60N7
				12Z7	60O7
				12Z7	60P7
				12Z7	60Q7
				12Z7	60R7
				12Z7	60S7
				12Z7	60T7
				12Z7	60U7
				12Z7	60V7
				12Z7	60W7
				12Z7	60X7
				12Z7	60Y7
				12Z7	60Z7
				12Z7	60A8
				12Z7	60B8
				12Z7	60C8
				12Z7	60D8
				12Z7	60E8
				12Z7	60F8
				12Z7	60G8
				12Z7	60H8
				12Z7	60I8
				12Z7	60J8
				12Z7	60K8
				12Z7	60L8
				12Z7	60M8
				12Z7	60N8
				12Z7	60O8
				12Z7	60P8
				12Z7	60Q8
				12Z7	60R8
				12Z7	60S8
				12Z7	60T8
				12Z7	60U8
				12Z7	60V8
				12Z7	60W8
				12Z7	60X8
				12Z7	60Y8
				12Z7	60Z8
				12Z7	60A9
				12Z7	60B9
				12Z7	60C9
				12Z7	60D9
				12Z7	60E9
				12Z7	60F9
				12Z7	60G9
				12Z7	60H9
				12Z7	60I9
				12Z7	60J9
				12Z7	60K9
				12Z7	60L9
				12Z7	60M9
				12Z7	60N9
				12Z7	60O9
				12Z7	60P9
				12Z7	60Q9
				12Z7	60R9
				12Z7	60S9
				12Z7	60T9
				12Z7	60U9
				12Z7	60V9
				12Z7	60W9
				12Z7	60X9
				12Z7	60Y9
				12Z7	60Z9
				12Z7	60A0
				12Z7	60B0
				12Z7	60C0
				12Z7	60D0
				12Z7	60E0
				12Z7	60F0
				12Z7	60G0
				12Z7	60H0
				12Z7	60I0
				12Z7	60J0
				12Z7	60K0
				12Z7	60L0
				12Z7	60M0
				12Z7	60N0
				12Z7	60O0
				12Z7	60P0
				12Z7	60Q0
				12Z7	60R0
				12Z7	60S0
				12Z7	60T0
				12Z7	60U0
				12Z7	60V0
				12Z7	60W0
				12Z7	60X0
				12Z7	60Y0
				12Z7	60Z0
				12Z7	60A1
				12Z7	60B1
				12Z7	60C1
				12Z7	60D1
				12Z7	60E1
				12Z7	60F1
				12Z7	60G1
				12Z7	60H1
				12Z7	60I1
				12Z7	60J1
				12Z7	60K1
				12Z7	60L1
				12Z7	60M1
				12Z7	60N1
				12Z7	60O1
				12Z7	60P1
				12Z7	60Q1
				12Z7	60R1
				12Z7	60S1
				12Z7	60T1
				12Z7	60U1
				12Z7	60V1
				12Z7	60W1
				12Z7	60X1
				12Z7	60Y1
				12Z7	60Z1
				12Z7	60A2
				12Z7	60B2
				12Z7	60C2
				12Z7	60D2
				12Z7	60E2
				12Z7	60F2
				12Z7	60G2
				12Z7	60H2
				12Z7	60I2
				12Z7	60J2
				12Z7	60K2
				12Z7	60L2
				12Z7	60M2
				12Z7	60N2
				12Z7	60O2
				12Z7	60P2
				12Z7	60Q2
				12Z7	60R2
				12Z7	60S2
				12Z7	60T2
				12Z7	60U2
				12Z7	60V2
				12Z7	60W2
				12Z7	60X2
				12Z7	60Y2
				12Z7	60Z2
				12Z7	60A3
				12Z	

# NEW! Lafayette 50 Watt Complete Stereo Phono System



LAFAYETTE LA-250

**COMPLETE STEREO SYSTEM**  
**174.50**



GARRARD RC121/11  
WOOD BASE



NEW GE  
VR-22



LAFAYETTE  
SK-58

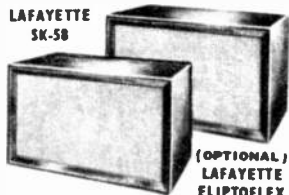

(OPTIONAL)  
LAFAYETTE  
ELIPTOFLEX

## COMPONENTS

LAFAYETTE LA-250 50-WATT AMPLIFIER .....	89.50
NEW GE VR-22 (.7 MIL) DIAMOND STEREO CARTRIDGE ..	24.45
GARRARD RC 121/11 STEREO CHANGER .....	41.65
LAFAYETTE WOOD CHANGER BASE .....	3.95
2- LAFAYETTE SK-58 FAMOUS FREE EDGE .....	59.00
12" COAXIAL SPEAKERS @ 29.50 .....	

REGULAR CATALOG PRICE ~~218.95~~

**YOUR GUARANTEED BEST STEREO SYSTEM BUY!**  
**You Save 44.05**

This superb system will add a new dimension in living to your home with all the excitement and realism of a live concert. The new Lafayette LA-250, 50-watt stereo amplifier (25 watts each channel) forms the heart of this outstanding stereo hi-fi phonograph music system—the features, versatility and advanced circuitry of this unit are second to none. Also included is the famous Garrard RC121/11 intermix 4-speed automatic record changer with full manual or automatic operation supplied with your choice of stereo cartridges—the new GE VR-22 (.7 Mil) diamond stereo cartridge, Pickering 371-7D (.7 Mil) diamond stereo cartridge, Shure M7D (.7 Mil) diamond stereo cartridge or the new Electro-Voice 31 MD7 (.7 Mil) diamond stereo cartridge. Supplied with the Lafayette wood base cut for the RC121 in your choice of finishes. These outstanding components are coupled

with the 2 famous free edge Lafayette SK-58 12" Coaxial speakers with built-in crossover network and brilliance level control. System supplied with plugs, cables and simple instructions. Shpg. wt., 67 lbs.

HF-681 HI-FI STEREO PHONO SYSTEM with choice of cartridge and mahogany, walnut or blond changer base (please specify) 17.45 down 12.00 Monthly .....Net 174.50

HF-683 Same as HF-681, but with 2 Lafayette Eliptoflex Series Bookshelf Enclosures (please specify finish). Shpg. wt., 143 lbs. 22.99 Down, 15.00 Monthly .....Net 229.95

HF-682. Stereo AM-FM-Phono System. Same as HF-681 but including the new Lafayette LT-50 stereo tuner. Shpg. wt., 85 lbs. 28.75 Down, 17.00 Monthly .....Net 287.50

# LAFAYETTE'S FREE CATALOG!

## 308 GIANT SIZED PAGES

The Complete Catalog Featuring  
"The Best Buys In The Business"



FOR THE NEWEST AND FINEST IN  
STEREOPHONIC HI-FI EQUIPMENT AND SYSTEMS

- TAPE RECORDERS ● PUBLIC ADDRESS SYSTEMS
- AMATEUR EQUIPMENT ● INDUSTRIAL SUPPLIES
- MINIATURE COMPONENTS ● RADIO & TV TUBES AND PARTS
- EXCLUSIVE LAFAYETTE TRANSISTOR & HI-FI KITS

Send for Lafayette's FREE Catalog—the most complete, up-to-the-minute electronic supply catalog crammed full of everything in electronics at our customary down-to-earth money-saving prices.

*Leaders in Hi-Fi*

The most complete selection and largest stocks of hi-fi components and systems—available for immediate delivery at the lowest possible prices. Save even more on Lafayette endorsed "best-buy" complete systems.

NEW YORK  
100 SIXTH AVENUE  
NEW YORK 13, N. Y.

JAMAICA  
165-06 LIBERTY AVE.  
JAMAICA 33, N. Y.

BOSTON  
110 FEDERAL ST.  
BOSTON 10, MASS.

NEWARK  
24 CENTRAL AVE.  
NEWARK 2, N. J.

PLAINFIELD  
139 W. 2nd ST.  
PLAINFIELD, N. J.

**FREE!**  
**1960**  
**CATALOG**

CUT OUT  
AND PASTE  
ON POST  
CARD

LAFAYETTE RADIO  
P.O. BOX 222  
JAMAICA 31, N. Y.  
DEPT. EIC-6

Name.....  
Address.....  
City..... Zone..... State.....





## IT'S EASY TO LEARN

You train in your own home—keep your present job while learning. Well illustrated NRI lessons teach Radio-TV-Electronic principles. You build, test, experiment with Radio-TV circuits, get actual practice with kits NRI gives you. Graduate Vagnoni, at right, knew nothing about Radio when he enrolled.



## NO EXPERIENCE NEEDED

You don't have to know anything about electricity or Radio to understand and succeed with NRI courses. Many successful NRI men did not finish high school. NRI trained men have been accepted for responsible positions throughout the United States and Canada. Graduate Barneil, for instance, is Chief Engineer with station KGCU.



## NRI HAS TRAINED THOUSANDS

For over 40 years, NRI has been training men for success in Radio-TV. Start now on your road to success, get training you need for good pay and a bright future. You can get the training you need, at home in your spare time. NRI can provide it for you.

# FOR GOOD Learn R

MAIL POSTAGE-FREE CARD  
for SAMPLE LESSON and  
64-PAGE **FREE**  
CATALOG

How Electricity  
is Produced  
for Electronics

Job and Career  
Opportunities  
for  
RADIO-TV  
TECHNICIANS



Broadcasting offers satisfying careers. Hundreds of television stations or the air offer interesting jobs and Technicians. Police, Aviation, Two-Way are expanding. Men with Radio-TV training at



A solid, proven field of opportunity for good pay. The millions of Radio and TV sets now in use. Government, guided missile manufacturers, industry Technicians. Color-TV, Hi-Fi are increasing the

# National

Washington

**BUSINESS REPLY CARD**  
NO POSTAGE STAMP NECESSARY IF MAILED IN THE UNITED STATES

POSTAGE WILL BE PAID BY

**NATIONAL RADIO INSTITUTE**

3939 Wisconsin Ave.

Washington 16, D.C.

**FIRST CLASS**  
PERMIT NO. 20-R  
(Sec. 369 P.L. & R.)  
WASHINGTON, D. C.







These kits were developed with famous  
**SOUTHWEST RESEARCH INSTITUTE**

and are a  
**TRUE BASIC SCIENCE COURSE**

- The 8 instruction manuals are expertly written, clearly illustrated — exciting, interesting
- **WITHOUT PREVIOUS EXPERIENCE** you can complete every project and gain a valuable, comprehensive science background

**EASY - FUN - EDUCATIONAL**

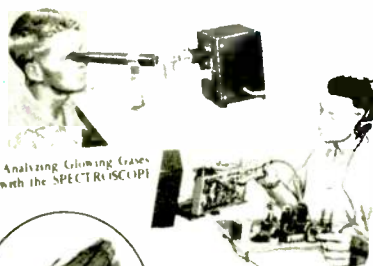

Analyzing Glowing Flames with the SPECTROSCOPE



Trouble Shooting with the SIGNAL TRACER



PHOTOMICROGRAPH of a Fly's Wing made with Microscope and Photo Lab (Actual Size 5" diameter)

These 8 Kits Make Up a Valuable, Versatile Science Laboratory Containing Standard Parts by:  
SYLVANIA, MALLORY, G. E., PYRAMID, STACKPOLE, TRIM AND OTHER RELIABLE MANUFACTURERS  
Retail value of parts alone is over **FIFTY DOLLARS**

**FOR SAFETY!**

Circuits are low voltage supplied by isolation transformer that comes with first kit

Describe and ordering this complete Laboratory to the Public at such a low price, is a noble service to our society.

R. M. Helm, Professor of Physics, East Carolina College, Greenville, N. C.

**MEMBERS ARE ENTHUSIASTIC!**

I wish I could provide each of my Physics students with all of your wonderful kits. You are doing a wonderful job.

Allen T. Myers, Physics Department, Jamestown High School, Jamestown, New York

**FREE!** These 6 Auxiliary Textbooks



**ALL THE EQUIPMENT FOR ALL THE ABOVE—only \$29.60**

SEND **\$2.00** ONLY WITH COUPON    PAY **\$3.45** ONLY FOR EACH KIT YOU RECEIVE (ONE A MONTH FOR 8 MONTHS)    **FREE** SOLDERING IRON with second Kit

Your Satisfaction or Your Money Back... AND you may cancel at any time without obligation.

These "no risk" assurances because we know you will be... **SURPRISED! AMAZED! DELIGHTED!**



**COMPLETE LABORATORY COMES IN 8 KITS... ONE A MONTH SUPPLIES ALL THE EQUIPMENT FOR ALL THE FOLLOWING:**

**SOUND    ELECTRICITY    HEAT    ELECTRONICS    LIGHT    ATOMIC ENERGY**

- ELECTRICAL EXPERIMENTS**  
Educational fun with Electro Magnets, Transformer, Galvanometer, Rheostat, Relay, Voltmeter, Wheatstone Bridge, and other electric equipment
- RADIO RECEIVER**  
A sensitive three tube Regenerative Radio that has its own DC power supply. Plug in regular 115 volt AC outlet. Complete with Head Set
- SPECTROSCOPE**  
Fascinating optical instrument used to identify and analyze substances by observing the spectrum of their flame. Spectrum charts are included.
- ELECTRONIC EXPERIMENTS**  
Explore functions of vacuum tubes and other electronic components. Build an Electronic Switch—Amplifier and other experimental circuits.
- BROADCAST TRANSMITTER**  
Can be used with your microphone, record player, or code oscillator.
- TELESCOPE**  
A mounted astronomical Telescope. High quality ground lens enables you to examine details of the moon's surface and distant objects.
- MICROSCOPE**  
High and low power, precision ground lens. Substage light and Polarizer. Adaptable for photomicrography in conjunction with Photo Lab.
- ATOMIC CLOUD CHAMBER**  
See illuminated tracks of speeding nuclear particles emanating from radioactive alpha source and mysterious cosmic rays from outer space.
- WEATHER STATION**  
 Aneroid Barometer, Cup Anemometer that electronically measures wind speed. Sling Psychrometer, Humidity Gauge, Cloud Speed Indicator, Cloud Chart and Weather Map.
- PHOTOELECTRIC EYE**  
Photoelectric Cell, Exciter lamp — and Electronic Relay. Everything you need to control motors, bells, alarms and do other light beam experiments.
- MICROPHONE**  
A sensitive carbon button microphone that greatly amplifies unexpected noise. Also adaptable for use with your radio transmitter.
- STROBE LIGHT**  
A variable pulse neon light. Freezes motion of rapidly vibrating or rotating objects for close study and checking frequencies. 8PM
- SOUND EXPERIMENTS**  
Laboratory demonstration of sound waves resonance and pitch. Includes Variable Frequency Oscillator, Sonometer and Loud Speaker.
- SLIDE PROJECTOR**  
Takes 16mm and 35mm slides. Sharp focusing. Convection cooled. GE Projection lamp included. Also adaptable as a Projection Microscope.
- SPINTHARSCOPE**  
Gives you a blown up inside view of the brilliant explosions of discrete grating radium atoms ejecting alpha particles at 11,000 miles per second.
- HEAT EXPERIMENTS**  
Study the Molecular Theory of heat using 2 Thermometers, Thermal 3 foot Gas Thermometer and special Microscope arrangement that shows the effect of Molecular Movement.
- PHOTOGRAPHY LAB**  
Complete dark room equipment: Printer—Enlarger—Electronic Timer—Safe Light—Developing Trays and supply of paper and chemicals
- ATOMIC RADIATION EXPM.**  
Check radioactivity of ores and do radiation experiments with sensitive Electroscopic Sample. Radioactive sources of Radium Uranium included.
- ULTRAVIOLET LAMP**  
Produce dazzling color effects with invisible blacklight. Used extensively for crime detection, mineralogy and science and industrial research. Fluorescent Tracer Chemical included.
- CODE PRACTICE SET**  
Signal Oscillator, Key and Flasher — the complete outfit to learn to receive and transmit the Morse Code — the first step to a Ham License.
- RADIO SERVICE EQUIPMENT**  
All the parts to build your own Radio Signal Tracer and a Probe Light Continuity Tester. Both pieces are invaluable in radio servicing.

**AMERICAN BASIC SCIENCE CLUB, Inc.** San Antonio, Texas

NAME \_\_\_\_\_

STREET \_\_\_\_\_

CITY \_\_\_\_\_ STATE \_\_\_\_\_

**MAIL COUPON TODAY**