

By the Publishers of
**MECHANIX
ILLUSTRATED**

**How To Buy A
Hi-Fi Tape Recorder**

ELECTRONICS ILLUSTRATED

JANUARY • 364

16 More Pages

SPECIAL BONUS FEATURE

**How To Build
This Electronic
Computer**



Locate Car Rattles Electronically

EI Can Help You*

BEST IN HI-FI

BASIC ELECTRONICS

PRACTICAL PROJECTS

SWL AND HAM

***if you build things for your home
if you are an active hobbyist
if you want the best in hi-fi
if you want to keep up with electronics**

Get EI Every Month—35¢

ELECTRONICS ILLUSTRATED

Fawcett Building, Greenwich, Conn.

Make More Money Soon Fixing Electric Appliances



**Actual Lesson
FREE** Fast Growing
Field Offers
Good Pay, Security
Interesting Work

Learn at Home in Spare Time

Earn more money. Enjoy doing important, interesting work. Learn Electrical Appliance Servicing. This is a field of increasing opportunity. Today every wired home has many electrical appliances and millions of new appliances are made and sold each year. Find out more about this great, growing field. Find out how NRI can train you, at home and in spare time to be an Appliance Service Technician. See how you can start soon to make extra money servicing appliances.

Add to Your Income Soon After Enrollment Opportunities Increasing for Service Technicians

NRI Training is practical, thorough. You get easy-to-understand lessons, and NRI supplies parts to build professional type Multi-Use Tester. Use it to get practical experience. Soon, you can add to your income by servicing appliances. Build a profitable *sideline* for your spare time—qualify for a good job—develop a business and be your own boss. As an Appliance Service Technician, your opportunities are broad—your services wanted, gladly paid for, highly regarded in your community.

Appliances are necessary to comfortable, convenient living. Owners pay well to keep them in repair. The field is amazingly big. In addition to major appliances such as electric ranges, air conditioners, refrigerators, there are over 40,000,000 electric irons, 5,000,000 electric blankets, 15,000,000 coffee makers, plus more millions of vacuum cleaners, fans, toasters, mixers, etc.

Learn and Earn With Tester Diploma When You Finish

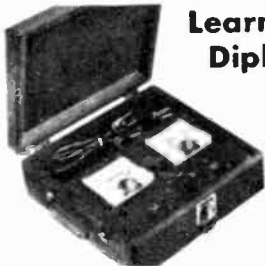

Locate appliance troubles easily with Portable Appliance Tester you build. You use it to learn, and do actual electric appliance repair jobs. For only \$3.00 with enrollment and \$6 per-month, get training including Tester—a small price to pay for increased earnings. Mail coupon for Sample Lesson and Book—your first step toward more interesting work, bigger earnings. **NATIONAL RADIO INSTITUTE, Dept. KAO, Washington 16, D. C.**

**TESTING APPLIANCES FOR
ELECTRICAL TROUBLES**

NATIONAL RADIO
WASHINGTON D. C.

Over 40 Years
Experience
Backs Up
NRI Training

How to Learn
SERVICING
ELECTRICAL
APPLIANCES

Find Out What
Appliance Repair
Offers You

Mail Coupon FOR LESSON AND BOOK FREE

National Radio Institute
Dept. KAO, Washington 16, D. C.

Please send me Electric Appliance Servicing Lesson and Book FREE. (I understand no salesman will call.)

Name _____ Age _____

Address _____

City _____ Zone _____ State _____

ACCREDITED MEMBER NATIONAL HOME STUDY COUNCIL

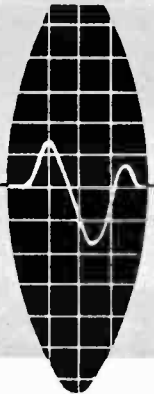

ELECTRONICS ILLUSTRATED

January, 1960

Vol. 3, No. 1

A Fawcett Publication

CONTENTS



A Message From The Editor	4
Electronics In The News	12
Off-Track Betting	29
Hi-Fi In Japan	33
Earphone Echo Chamber	34
El Build-It Course	36
Spotlight On 80 Meters	40
Milt Kiver On Oscilloscopes	44
How To Buy A Hi-Fi Tape Recorder	48
When Kit Builders Get Together	52
A Stereo Tape Recorder	53

Hi-Fi Doctor And Clinic	56
Transistor Car Ignition	58
When Chaos Hit The Airwaves	60
Build A Computer	65
Prepare For Tomorrow	81
Microwave Hazards	82
Electronic Brain	84
The Solid Circuit	86
Emergency Flasher	88
The Animals Talk Back	91
Prerecorded Hi-Fi Tape	92
Try These	95
Car Rattle Tracer	96
Label Your Equipment	99
El Picturescope	100
A Transistorized Power Supply	102

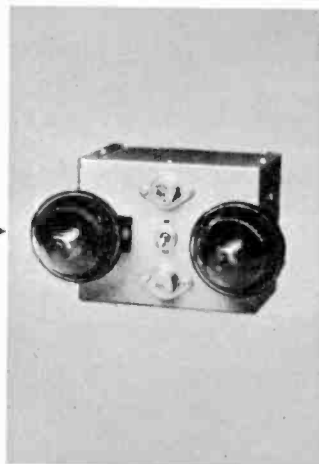

CHARLES TEPFER.....Editor

Leonard Buckwalter.....Associate Editor

Edward Nanas.....Feature Editor

Murray Cooper.....Art Editor

Lou Rubsamen.....Art Associate

Elaine Sapoff.....Editorial Assistant

Larry Eisinger.....Editor-in-Chief

Phyllis Bendremer.....Production Editor

Benito Mills.....Assistant Production Editor

John F. Webster.....Advertising Manager

Ralph Daigh.....Editorial Director

James Boynton.....Advertising Director

Al Allard.....Art Director

Ralph Mattison.....Associate Art Director

George H. Carl.....Production Director

ELECTRONICS ILLUSTRATED is published monthly by Fawcett Publications, Inc., Fawcett Place, Greenwich, Conn. W. H. Fawcett, Jr., President; Gordon Fawcett, Secretary and Treasurer; Roger Fawcett, General Manager; Roscoe K. Fawcett, Circulation Director; Donald P. Hanson, Assistant General Manager.

EDITORIAL AND ADVERTISING OFFICES: 67 West 44th Street, New York 36, N. Y.
ADDRESS ALL MAIL: Subscriptions, change of address, Form 3579 to Circulation Dept., Fawcett Bldg., Greenwich, Conn.; and all editorial and advertising to Fawcett Publications, Inc., 67 W. 44th St., New York 36, N. Y.

Second-class postage paid at Greenwich, Conn., and at additional mailing offices.

Subscription price \$4.00 per year in the U. S. and possessions and Canada. All other countries \$6.00 per year. Foreign subscriptions and sales should be remitted by International Money Order in U. S. funds payable at Greenwich, Conn.

Printed in U.S.A. Copyright 1960 by Fawcett Publications, Inc.

Permission hereby granted to quote from this issue of this magazine on radio or television provided a total of not more than 1,000 words is quoted and credit is given to the title of the magazine and issue, as well as the statement, copyright 1960, by Fawcett Publications, Inc.

Train in New Coyne Shop-Labs for Today's Top OPPORTUNITY FIELDS!

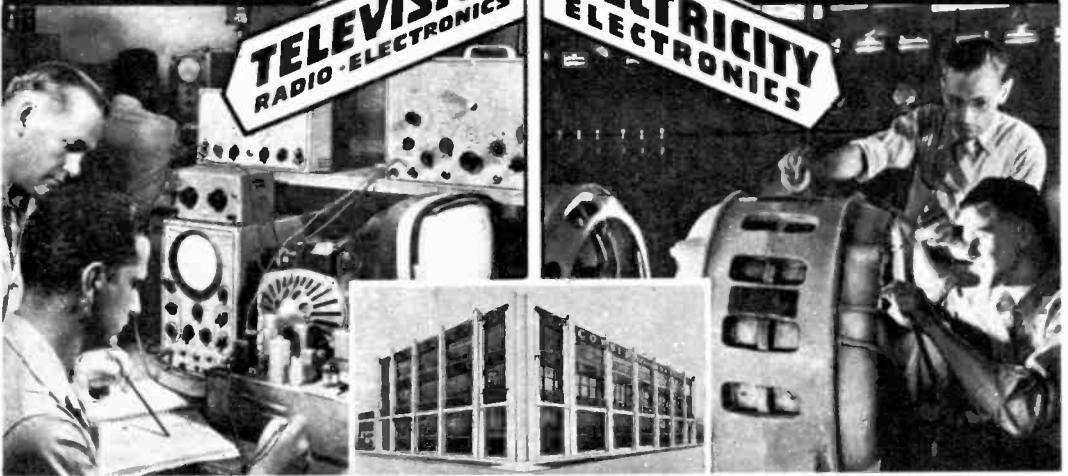

Instructor helping students check the wiring and trace the circuits of television receivers.

This modern fire-proof building which is occupied entirely by Coyne, houses the NEW COYNE SHOP-LABS.

Instructor explaining operation and testing of a large Motor Generator.

TELEVISION-RADIO ELECTRONICS

Here at COYNE you're trained for Testing, Trouble-Shooting and Servicing on AM and FM Radio, Auto Radio, Television, Color TV, etc. Thousands of COYNE trained men in good jobs or own well paying TV-Radio businesses.

ELECTRICITY ELECTRONICS

Big opportunities everywhere—city, town and country, in Power Plant Work, Motors, Industrial Electronics, Armature Winding, Home and Factory Wiring, Appliances, Refrigeration, Maintenance, Illumination, etc.

**OLDEST AND BEST
EQUIPPED SCHOOL OF ITS
KIND IN THE U. S.**

Send Coupon or Write for

FREE BOOK

"GUIDE to CAREERS"

Whether you prefer Electricity—Television—Radio or Combined Electronics Training this book describes all training offered.

Information comes by mail and no salesman will call.



WE TRAIN YOU IN CHICAGO

Our famous Practical-Technical method gives you practical experience on a massive outlay of equipment—over a quarter of a million dollars worth—plus necessary technical training right here in the *NEW COYNE Shop-Labs*.

Training in Refrigeration and Electric Appliances can be included.

**Training offered
to VETERANS and
NON-VETS alike**

START NOW—PAY LATER

Enroll now, pay most of tuition after Graduation. Part time employment help for students. Lifetime employment service to Graduates. Starting dates, every six weeks.

B. W. COOKE, JR., President

**COYNE
ELECTRICAL SCHOOL**

FOUNDED 1895

CHARTERED AS AN EDUCATIONAL INSTITUTION NOT FOR PROFIT
1501 W. Congress Parkway, CHICAGO, Dept. 10-8C
ELECTRICITY • RADIO • TELEVISION • REFRIGERATION • ELECTRONICS

COYNE ELECTRICAL SCHOOL, Dept. 10-8C
1501 W. Congress Pkwy., Chicago 7, Ill.

At no obligation to me send FREE book "Guide to Careers" and details of all the training you offer. However, I am especially interested in:

ELECTRICITY TELEVISION BOTH FIELDS

Name _____

Address _____

City _____ State _____

(I understand no Salesman will call.)

A Message From the Editor

ORDINARILY, I do not refer to a commercial product in this column, but the recent introduction of what has been publicized, correctly I think, as a new concept in the hi-fi field merits special mention here. It has stirred up some controversy in our own office and probably will among hi-fi fans. I am referring to Harman-Kardon's "Citation" line, consisting of a stereo preamplifier control center and stereo power amplifier, both available as kits for, now hold on to your hat, \$139.95 and \$159.95 respectively. The same units are also available factory wired for \$239.95 and \$219.95 respectively. Despite the fact that good hi-fi kits are not really cheap in price, none of the other kit manufacturers has gone this far yet. Kits were first developed and became popular because the builder could utilize knowledge and skills he possessed to save money. Now, here is a kit manufacturer who states as his goal the desire to serve those who want the maximum

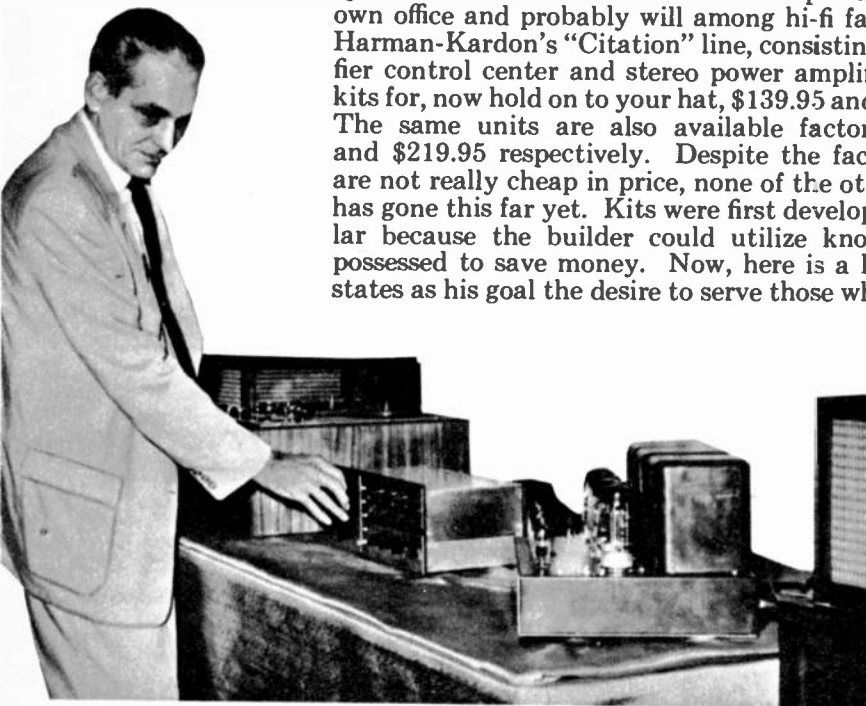

New kit idea from purist engineer Stewart Hegeman.

performance for the number of dollars spent. This means that the buyer is not looking to save money necessarily, but, more important, wants the best piece of equipment he can possibly get for the amount of money that he does spend. Other kit manufacturers have, of course, marketed fairly high priced units as part of their line. And the high quality of many hi-fi kits is beyond question. But this is, I think, the first major attempt to set up a "Rolls-Royce" of the kit field. The performance specifications for the "Citation" kits as quoted by the manufacturer are extremely good but can the kit assembled by the customer-builder duplicate them? Whether this can be done and how much work is involved in doing so will be the subject of a future "we-built-it"

report in *EI* on the "Citation" kits.

Since starting our popular feature, "The Electronic Brain," we have received many, many letters from readers requesting diagrams and information on power supplies. The demand has been so

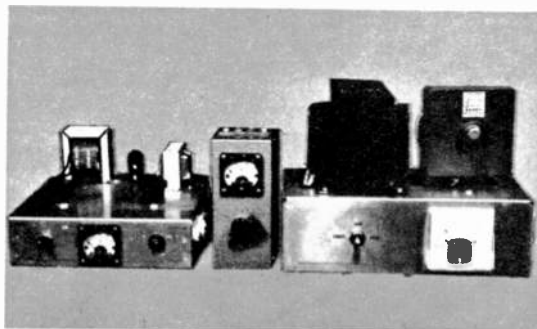

Next month: How to build these 3 power supplies.



Now! Work Over
300 PRACTICAL
PROJECTS with these
PARTS AT HOME!



to help You learn
ELECTRONICS
RADIO - TELEVISION - RADAR

NOW . . . at home in your spare time you can get the very kind of training and subsequent Employment Service you need to get started toward real earnings in one of today's brightest opportunity fields—TELEVISION-RADIO-ELECTRONICS. Now that Electronics is entering so many new fields, here is a chance of a lifetime to prepare to cash in on its remarkable growth.

DeVry Tech's amazingly practical home method enables you to set up your own HOME LABORATORY. You spend minimum time to get maximum knowledge from over 302 practical projects, using the same type of basic equipment used in our modern Chicago and Toronto Training Centers!

DeVry Tech Provides EVERYTHING YOU NEED . . .

—to help you master TV-ELECTRONICS. In addition to the home laboratory and easy-to-read lessons, you even use HOME MOVIES—an exclusive DeVry Tech advantage. You watch hidden actions . . . see electrons on the march. Movies help you to learn faster . . . easier . . . better.

LABORATORY TRAINING

Full time day and evening training programs in our modern Chicago and Toronto Laboratories are also available. MAIL COUPON TODAY for facts.



Build and KEEP Valuable TEST EQUIPMENT

As part of your training, you build and keep a fine Jewel-Bearing Vacuum Tube VOLTMETER and a 5-inch COLOR OSCILLOSCOPE—both high quality, needed test instruments.

EFFECTIVE EMPLOYMENT SERVICE

Get the same Employment Service that has helped so many DeVry Tech graduates get started in this fast-growing field.

"One of North America's Foremost Electronics Training Centers"

Accredited Member of National Home Study Council



DeVRY TECH INSTITUTE
Formerly DeForest's Training, Inc.
CHICAGO 41, ILLINOIS

EARN WHILE YOU LEARN

DeVry Tech's practical training helps you toward spare time income servicing Radio and Television sets.

VACUUM TUBE VOLTMETER



5-INCH COLOR OSCILLOSCOPE

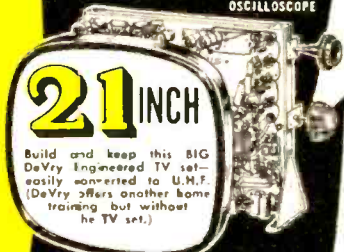

21 INCH

Build and keep this BIG DeVry Engineered TV set—easily converted to U.M.F. (DeVry offers another home training but without the TV set.)

CHECK
These Exciting
Job
Opportunities:

- TV-Radio Broadcast Technician
- Color Television Specialist
- Radar Operator
- Laboratory Technician
- Airline Radio Man
- Computer Specialist
- Quality Control Manager
- Your Own Sales & Service Shop
- . . . PLUS MANY OTHERS

MAIL COUPON TODAY!

DeVRY TECHNICAL INSTITUTE
4141 Belmont Ave., Chicago 41, Ill., Dept. E1-1-Q

Please give me your FREE booklet, "Electronics and YOU," and tell me how I may prepare to enter one or more branches of Electronics.

Name _____ Age _____
PLEASE PRINT
Street _____ Apt. _____
City _____ State _____
2045 Canadian residents address DeVry Tech of Canada, Ltd.
626 Roselawn Ave., Toronto 12, Ontario

FREE ALLIED'S MONEY-SAVING 1960 ELECTRONIC SUPPLY CATALOG



value-packed
SEND FOR IT!

SAVE
ON EVERYTHING
IN ELECTRONICS

EASIEST TERMS
only \$2 down on
orders up to \$50

WORLD'S LARGEST STOCKS

Send for the most widely used buying guide to everything in Electronics for Experimenters, Builders, Amateurs, Servicemen, Engineers and Hi-Fi enthusiasts. Save on:

- KNIGHT-KITS®—Best in Build-Your-Own
- Everything in STEREO Hi-Fi
- Hi-Fi Music Systems and Components
- Tape Recorders & Phono Equipment
- Public Address & Paging Systems
- TV Tubes, Antennas, Accessories
- Amateur Station Equipment
- Latest Test & Lab Instruments
- Parts, Tubes, Transistors
- Everything in Tools & Technical Books

SAVE on everything in Electronics at ALLIED—get fastest service, expert personal help, guaranteed satisfaction. Send today for your FREE 1960 ALLIED Catalog.

*Everything in Electronics
from One Reliable Source*

our 39th year



ALLIED RADIO CORP., Dept. 86-AO
100 N. Western Ave., Chicago 80, Ill.

Rush FREE 1960 ALLIED Catalog.

Name _____

Address _____

City _____ Zone _____ State _____



great that we decided to present in our next issue a full 16 page section on power supplies: how they work, how to build them, and construction plans for three of the most popular types. This section has been developed for us by Harvey Pollack, well known science teacher and electronics author.

Some startling news has come our way. An electronic computer authority recently advanced the idea that there is really no need for us to use money at all anymore. In his words, "Our present system of using cash can be replaced with a truly universal credit card system," with electronics serving as cashier. For instance, company payrolls in the future may be compiled on magnetic tape and transmitted to employees' accounts at central banks. This information would be fed into a computer which would then keep track of all transactions that need to be made by the employee such as paying rent, buying food, going to the movies, etc. All of these transactions would be transmitted to the computer via dial phone. The employee would never use cash, and the only time we would see Lincoln's picture would be when we visited a government building or coin museum. But how would we pay gambling debts?

Among all of the advances claimed for the 1961 model automobiles, one new feature available on some of them has escaped widespread notice — transistor ignition systems. This is the first major advance in the electrical system in the automobile since the introduction of the self starter. We have a complete how-it-works article on this subject in this issue and plan to follow up very shortly with an article on how you can convert your present system to a transistor type. Our February issue will present to you a real scoop on the airship which rides on a beam of radio power from earth. To get first details on this, be sure to read our next issue.

Charles Tupper

Cast your ballot for a successful future!

258 I. C. S. COURSES



I. C. S. is the oldest and largest correspondence school. 258 courses. Business, industrial, engineering, academic, high school. One for you. Direct, job-related. Bedrock facts and theory plus practical

application. Complete lesson and answer service. No skimping. Diploma to graduates.

Send for the 3 free booklets offered below and find out how I. C. S. can be your road to success.

ACCOUNTING
Accounting
Auditing
Bookkeeping & Cost Accounting
General Accounting
Junior Accounting
Practical Accounting
Public Accounting

ADVERTISING
Advertising Production
Direct Mail Advertising
Magazine & Newspaper Advertising

ARCHITECTURE AND BUILDING CONSTRUCTION
Architectural Drawing & Designing
Architectural Interiors
Architecture
Building Contractor
Building Contractor with Drawing
Building Estimator
Building Maintenance
Carpenter-Building
Carpenter Foreman
Carpentry & Millwork
House Planning
Lumber Dealer
Mason Foreman
Painting Contractor
Reading Arch. Blueprints
Reading Street. Blueprints

ART
Advertising Layout & Illustration
Amateur Artist
Commercial Art
Commercial Cartooning
Fashion Illustrating
Figure Drawing & Painting
Magazine Illustrating
Show Card & Sign Prod'n
Show Card Writing
Sign Painting & Designing
Sketching & Painting

AUTOMOTIVE
Auto Engine Tune-up
Automobile
Automobile Body Rebuilding and Refinishing
Automobile Electrical Technician

Automobile Technician
Diesel Engines
Diesel-Gas Motor Vehicle Engines
Gas Engines
Internal Combustion Engines

AVIATION
Aero-Engineering Technology
Aircraft & Engine Mechanic
Aircraft Mechanic
Aviation Engine Mechanic
Reading Aircraft Blueprints

BUSINESS
Business Administration
Business Correspondence
Business Law
Business Management
Business Management & Marketing
Business Management & Production
Canadian Business Management
Clerk-Typist
Commercial
Condensed Business Practice
Federal Tax Course
Managing a Small Business
Office Administration for Engineers
Office Management
Professional Secretary
Programming for Digital Computers
Purchasing Agent
Retail Business Management
Retail Merchandising
Shorthand
Stenographic
Typewriting

CHEMICAL
Analytical Chemistry
Chemical Engineering
Chemical Engineering Unit Operation
Chemical Laboratory Technician
Chemical Prod'n Foreman
Elements of Nuclear Energy
General Chemistry
Industrial Analytical Chemistry
Industrial Chemistry
Paper Making
Professional Engineer—Chemical
Pulp & Paper Engineering

Pulp & Paper Making
Pulp Making

CIVIL ENGINEERING
Bridge & Building Foreman
Civil Engineering
Construction Engineering
Highway Engineering
Mine Surveying & Mapping
Principles of Mapping
Principles of Surveying
Professional Engineer—Civil
Railroad Engineering
Roadmaster
Sanitary Engineering
Section Foreman
Sewage Plant Operator
Structural Engineering
Surveying and Mapping
Water Works Operator

DRAFTING
Aircraft Drafting
Architectural Drafting
Drafting & Machine Design
Electrical Drafting
Electrical Engineer Drafting
Industrial Piping Drafting
Junior Mechanical Drafting
Mechanical Drafting
Sheet Metal Drafting
Structural Drafting

ELECTRICAL
Design and Construction of Overhead Power Lines
Elec. Appliance Servicing
Electrical Contractor
Electrical Eng'g (Power Plant option—Electronic option)
Electrical Engineering Tech.
Electrical Instruments
Electric Light & Power
Electric Motor Repairman
Electrical Operating Eng'r
Hydroelectric Power Plant Equipment
Industrial Electrical Eng'g
Lighting Technician
Power-House Electric
Practical Electrician
Practical Lineman
Principles of Steam-Electric Power Plants
Professional Engineer—Electrical
Reading Electrical Blueprints

HIGH SCHOOL
Good English

High School Business
High School College Prep (Arts)
High School College Prep (Engineering & Science)
High School General
High School Mathematics
High School Secretarial
Letter Writing Improvement
Short Story Writing

LEADERSHIP
Industrial Foremanship
Industrial Supervision
Personal-Labor Relations Supervision

MECHANICAL
Industrial Engineering
Industrial Instrumentation
Junior Mechanical Engineer
Mathematics and Mechanics for Engineers
Mechanical Engineering
Professional Engineer—Mechanical
Quality Control

PETROLEUM
Natural Gas Production & Transmission
Oil Field Technology
Petroleum Production
Petroleum Prod'n Eng'g
Petroleum Refinery Operator
Petroleum Refining
Petroleum Technology

PLASTICS
Plastics Production Foreman
Plastics Technician

PLUMBING, HEATING, AIR CONDITIONING
Air Conditioning
Air Conditioning with Draw'g Maintenance
Domestic heating with Oil & Gas
Domestic Refrigeration
Heating
Heating & Air Conditioning
Heating Drawing & Estimal'g
Plumbing
Plumbing Drawing & Estimating
Plumbing & Heating
Plumbing & Steamfitting

Practical Plumbing
Refrigeration
Refrigeration & Air Conditioning
Steamfitting

RAILROAD
Air Brake Equipment
Car Inspector & Air Brake Diesel Electrician
Diesel Engineer & Fireman
Diesel Locomotive
Diesel Mechanic
Railroad Administration
Railroad Car Repairer

SALESMANSHIP
Creative Salesmanship
Marketing
Real Estate Salesmanship
Retail Salesmanship
Sales Management
Salesmanship
Salesmanship & Sales Management

SHOP PRACTICE
Quality Control
Boilermaking
Electric Welding
Forging
Foundry Practice
Gas and Electric Welding
Gas Welding
Heat Treatment of Metals
Industrial Metallurgy
Inspection and Physical Testing of Metals
Machine Shop Inspection
Machine Shop Practice
Machine Shop Practice & Toolmaking
Metallurgical Engineering Technology
Practical Millwrighting
Reading Shop Blueprints
Resistance Welding Technology
Rigging
Safety Eng'g Technology
Sheet Metal Worker
Tool Designing
Tool Engineering Technology
Toolmaking
Welding Engineering Technology

STEAM AND DIESEL POWER
Combustion Engineering
Power Plant Engineering

Stationary Building Eng'r
Stationary Diesel Eng'r
Stationary Diesel-Electric Engineering
Stationary Fireman
Stationary Steam Eng'g
Steam Engine Operation

TEXTILES
Carding and Spinning Supervisor
Carding Technician
Cotton Manufacturing
Cotton Warping & Weaving Supervisor
Cotton Warping & Weaving Technician
Hosiery and Circular Knitting Loom Fixing Supervisor
Loom Fixing Technician
Spinning Technician
Synthetic Fabric Manufacturing
Synthetic Fabric Warping & Weaving
Synthetic Yarn Throwing & Warping Technician
Textile Designing
Textile Engineering
Textile Finishing & Dyeing Supervisor
Textile Finishing & Dyeing Technician
Textile Mill Supervisor
Woolen Manufacturing
Worsted Manufacturing

TRAFFIC
Motor Traffic Management
Railroad Rate Clerk
Traffic Management

TV-RADIO-ELECTRONICS
Gen'l Electronics Technician
Industrial Electronics
Practical Radio-TV Eng'g
Radio Operating
Radio Servicing
Radio Servicing with Practical Training
Radio & TV Servicing
Radio & TV Servicing with Practical Training
Servicing Electric Devices
Servicing Sound Equip't
Practical Telegraphy
TV Receiver Servicing
TV Technician

For Real Job Security—Get an I. C. S. Diploma! I. C. S., Scranton 15, Penna.

Accredited Member,
National Home Study Council

INTERNATIONAL CORRESPONDENCE SCHOOLS



BOX 84423M, SCRANTON 15, PENNA.

Without cost or obligation, send me "HOW TO SUCCEED," the opportunity booklet about the field I have indicated below, and a sample lesson (Math.)

Name of the course in which you are interested _____

Your Name _____ Age _____ Home Address _____

City _____ Zone _____ State _____ Working Hours _____ A.M. to _____ P.M.

Occupation _____ Canadian residents send coupon to International Correspondence Schools, Canadian, Ltd., Montreal, Canada. . . . Special low monthly tuition rates to members of the U. S. Armed Forces.

SPECIAL 5th ANNIVERSARY OFFER

FROM THE WORLD'S LARGEST RECORD CLUB



3. You Do Something to Me, When You're Smiling, 10 others



12. A brilliant new performance of this popular concerto

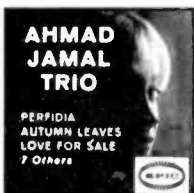

11. Also: Donkey Serenade, Don't Blame Me, etc.



30. But Not for Me, Fascinatn' Rhythm, Man I Love, 9 more



15. This musical portrait is a beloved American classic



21. "No symphony like it . . . Incomparable"—Olin Downes

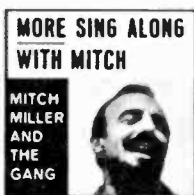

20. Sweet Adeline, For Me and My Gal, Pretty Baby, 13 more



24. Seven brilliant selections played by a great young pianist

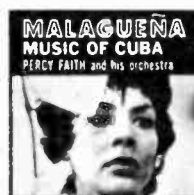

13. "Musical excitement that's hard to beat" — Variety



5. Tales from the Vienna Woods, Blue Danube, 8 others



27. Complete score. "...practically flawless" — New Yorker

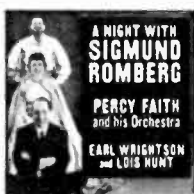

40. One Kiss, Will You Remember, Song of Love, 9 more



6. Blue Moon, Fools Rush In, Don't Worry 'bout Me, 9 more



60. Malaguena, Fire Dance, Golliwog's Cake Walk, 10 more



10. "Sure-fire Puccini . . . fine cast" — New York Times



32. Also: That's My Desire; Rose, Rose I Love You; etc.



56. No, Not Much!; Moments to Remember; Istanbul; 9 more



17. Pacific Sunset, Stella by Starlight, Yesterdays, 9 more



43. Solitude, Where or When, Dancing in the Dark, 6 more



51. The Man I Love, Blue Room, Stardust, Am I Blue, 11 more



29. A superb recording of this enchanting dance drama

Records for Every Musical

To celebrate its 5th Anniversary, the Columbia Record Club now makes the greatest offer in its history! As a new member, you may have ANY 5 of the superb high-fidelity records shown on these two pages — up to a \$24.90 retail value — ALL 5 for only \$1.97.

TO RECEIVE 5 RECORDS FOR \$1.97 — fill in and mail the coupon at the right. Also indicate which one of the Club's four musical Divisions you wish to join: Classical; Listening and Dancing; Broadway, Movies, Television and Musical Comedies; Jazz.

HOW THE CLUB OPERATES: Each month the Club's staff of music experts selects outstanding recordings for all four Divisions. These selections are fully described in the Club's entertaining Music Magazine, which you receive free each month.

You may accept the monthly selection for your Division . . . take any of the wide variety of other records offered in all four

More than 1,000,000 families now enjoy the music program of . . .

COLUMBIA  RECORD CLUB
offers new members
ANY FIVE
of these \$3⁹⁸ and \$4⁹⁸ high-fidelity 12" long-playing records
FOR ONLY \$1⁹⁷ **RETAIL VALUE**
up to \$2⁴⁹⁰
if you join the Club now and agree to purchase as few as 5 selections from the more than 200 to be offered during the coming 12 months



8. Also: Let It Rain, Stairway to the Sea, Flame of Love, etc.



4. A Night on Bald Mountain, Steppes of Central Asia, etc.



2. Bess, You Is My Woman Now; It Ain't Necessarily So; etc.



1. Also: Everybody Loves a Lover, Love Me or Leave Me, etc.



7. 1001 hi-fi delights. "...top-notch sound" — Billboard



38. Complete score of this Rodgers and Hammerstein hit



37. Ebb Tide, If I Loved You, Unchained Melody, 9 others



36. Superbly played - by one of Europe's finest orchestras



14. Rain in Spain, I Could Have Danced All Night, etc.



16. "Hilarious... truly priceless comedy" — L.A. Examiner



18. Also: Blessed Are They That Mourn, Come Ye Saints, etc.

Taste • CLASSICAL • POPULAR • DANCE MUSIC • BROADWAY HITS • JAZZ

of the Club's Divisions... or take NO record in any particular month.

Your only obligation as a member is to purchase five selections from the more than 200 Columbia and Epic records to be offered during the coming 12 months. You may discontinue your membership at any time thereafter.

FREE BONUS RECORDS GIVEN REGULARLY. If you wish to continue as a member after purchasing five records, you will receive a Columbia or Epic Bonus record of your choice free for every two selections you buy — a 50% dividend.

The records you want are mailed and billed to you at the regular list price of \$3.98 (Classical and Original Cast selections, \$4.98), plus a small mailing and handling charge.

THIS SPECIAL 5th ANNIVERSARY OFFER may never be repeated! So act now — mail the coupon today to receive your 5 records for only \$1.97!

COLUMBIA  RECORD CLUB
Terre Haute, Ind.

SEND NO MONEY — Mail coupon to receive 5 records for \$1.97

COLUMBIA  RECORD CLUB, Dept. 200-8
Terre Haute, Indiana

I accept your special 5th Anniversary Offer and have circled at the right the numbers of the five records I wish to receive for \$1.97, plus small mailing and handling charge. Enroll me in the following Division of the Club:

(check one box only)

Classical Listening and Dancing Jazz
 Broadway, Movies, Television and Musical Comedies

I agree to purchase five selections from the more than 200 to be offered during the coming 12 months, at regular list price plus small mailing and handling charge. For every two additional selections I accept, I am to receive a 12" Columbia or Epic Bonus record of my choice FREE.

Name.....
(Please Print)

Address.....

City..... ZONE..... State.....

ALASKA and HAWAII: write for special membership plan
CANADA: prices slightly higher; 1111 Leslie St., Don Mills, Ont.

To credit this membership to an established Columbia or Epic record dealer, authorized to accept subscriptions, fill in below:

Dealer's Name.....
Dealer's Address..... 23

CIRCLE 5
NUMBERS:

1	13	30
2	14	32
3	15	36
4	16	37
5	17	38
6	18	40
7	20	43
8	21	51
10	24	56
11	27	60
12	29	

Q-AE

© Columbia Records Sales Corp., 1960 © "Columbia," ®, "Epic," ® Marcas Reg.

knight-kits[®] make the **Big News** ...

A PRODUCT OF ALLIED RADIO



FREE
send
for it

see them in **ALLIED'S** 1960 catalog
THE WORLD'S LEADING ELECTRONIC SUPPLY GUIDE

See these and scores of other great **knight-kits**



Y-731 Deluxe FM-AM Stereo HI-FI Tuner (Multiplex add-in) \$87.50
only \$5 down



Y-712 Custom Superhet Citizen's Band Transceiver \$79.95
only \$5 down



Y-608 Lab AC VTVM with Automatic Range Selection \$99.50
only \$5 down



Y-411 Lab DC Scope with Triggered Sweep and Plug-In Vertical Preamps (less Preamps) \$285.00
only \$10 down



Y-773 Super-Value 20-Watt Stereo HI-FI Amplifier \$44.50
only \$2 down



T-400 400-Watt Transmitter (AM and SSB add-ins available) \$395.00
only \$10 down



Y-708 1000 Ohm/Volt Pocket Volt-Ohm-Milliammeter \$9.95



G-30 Amateur Grid Dip Meter (1.5-300 mc) \$22.95
only \$2 down



Y-711 Ammeter-Voltmeter for Cars and Boats \$10.75



there's a money-saving **knight-kit** for every need

SEE PAGE AFTER PAGE OF FASCINATING KITS, INCLUDING:

NEW LOWEST TERMS

Only \$5 down (or less) on orders up to \$200; up to 24 months to pay. Fast handling—no red tape.

HI-FI KITS

Stereo Deluxe Preamp
60-Watt Stereo Amplifier
Stereo Control
25-Watt Amplifier
18-Watt Amplifier
12-Watt Amplifier
FM-AM Tuner
FM Tuner
Speaker Systems
and others

HOBBYIST KITS

"Span-Master" Receiver
"Space-Spanner" Receiver
"Ranger" Radios
"Ocean Hopper" Radio
Clock-Radio
Radio-Intercom
5-Transistor Portable
2-Transistor Pocket Set
2-Way Intercom
Electronic Lab Kits
Photoelectronic System,
and many others

INSTRUMENT KITS

DC VTVM
Volt-Ohm-Milliammeters
5" Oscilloscopes
Tube Checkers
RF Signal Generator
Signal Tracer
Audio Generator
Sweep Generator
Battery Eliminator
Capacity Checker
Transistor Checker
R/C Tester, plus many others

sold exclusively by **ALLIED RADIO**

the **Best News** in electronic kits for 1960

world's easiest-to-build kits

SAVE UP TO 50%

BUILD THE BEST



Y-774 Deluxe 40-Watt Stereo Amplifier (with Center Channel) **\$79.50**
only \$5 down



R-100 Amateur Communications Receiver (Hi-gain, with built-in Q-Multiplier) **\$104.50**
only \$5 down



Y-713 Citizen's Band Transceiver **\$39.95**
only \$2 down

BEST...by Design!



with the exclusive **knight-kit**

MONEY-BACK GUARANTEE

KNIGHT-KITS are an exclusive product of Allied Radio. Every KNIGHT-KIT meets or exceeds published specifications, or we refund your money in full.

**BUY ANY KNIGHT-KIT! BUILD IT!
IT MUST PERFORM EXACTLY AS CLAIMED
-OR WE REFUND YOUR MONEY!**

only **knight-kits** have
"CONVENIENCE ENGINEERING"
for easiest building...no previous
electronic experience needed

Exclusive in Knights-Kits, "convenience engineering" means special attention to every detail: resistors are carded and numbered for easy selection...all parts and hardware are packaged in clear plastic bags for easy identification...wire is precut, stripped, tinned and color-coded to save time... special printed circuitry is used to eliminate complex wiring...all parts are top premium quality...you get everything—even the solder! Finally, Knight-Kit instructions are clear as crystal; step-by-step procedure and wall-sized picture diagrams make assembly a marvel of simplicity. Your final reward is proud enjoyment of the superior performance designed into your Knight-Kit.



SEE THEM HERE ▶

AMATEUR KITS

50-Watt Transmitter
Self-Powered VFO
100 kc Crystal Calibrator
RF "Z" Bridge
Code Practice Oscillator

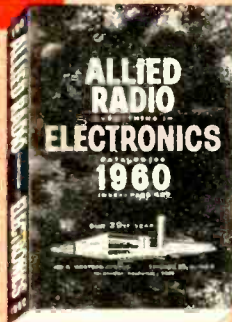

FREE send for the value-packed

1960 ALLIED CATALOG

Write for the 1960 ALLIED Catalog featuring the complete KNIGHT-KIT line—see the big news in electronic kits—get this leading Buying Guide for everything in Electronics. Send for your **FREE** copy.

ALLIED RADIO CORP., Dept. 164-AO
130 N. Western Ave., Chicago 80, Ill.

Send **FREE** 1960 ALLIED Catalog

Name _____

Address _____

City _____ Zone _____ State _____

Pioneers in the development of the world's finest electronic kits



our 39th year
THE WORLD'S LARGEST ELECTRONIC SUPPLY HOUSE

Electronics in the news

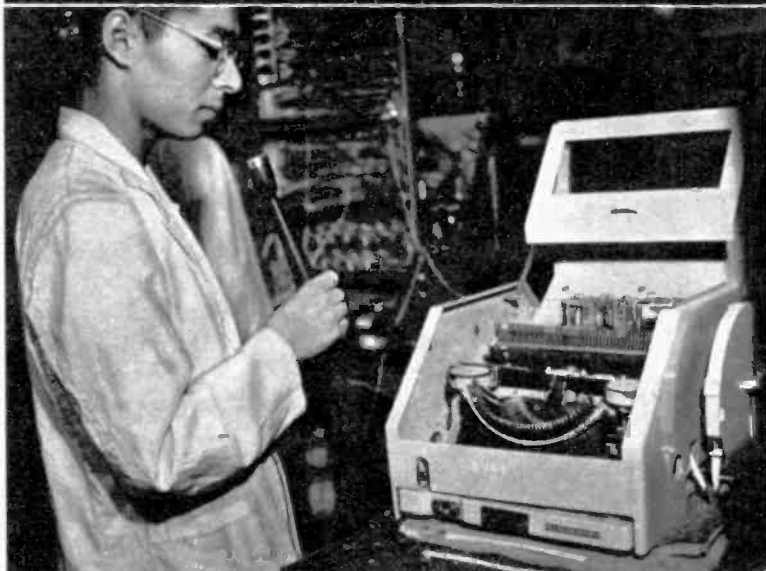

Researchers at Japan's Kyoto U. have announced the perfection of the world's first talking typewriter. Just speak into the mike and out comes a written copy in either Japanese "kana" or Roman characters. The unit involves an electronic "brain," 300 tubes, 600 semi-conductors, and 6000 other components. Future models will be entirely transistorized and are to be manufactured by Nippon Electric.

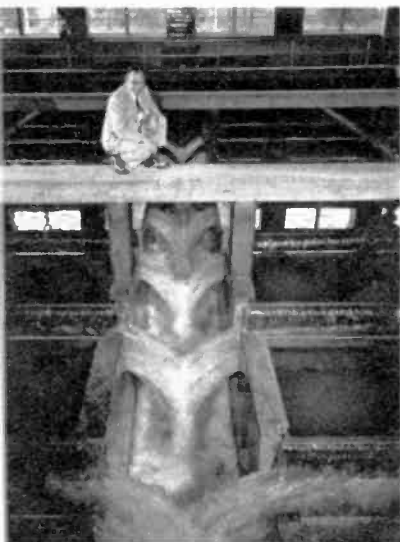

The old joke went: "Turn on the faucet in Philly and out comes a fish." This is no longer the case thanks to Philadelphia's new \$25-million filtration plant monitored and controlled automatically by Minneapolis-Honeywell instrumentation. A normal daily flow, left, is about 300-million gallons. The amount of chemicals added is pre-programmed into the system, which may be controlled entirely from the console-dotted nerve center, above. Hundreds of valves, drains and cleaning mechanisms are also operated from the one location.

NOW!
at a price
you can afford!

MAKE MORE MONEY in TELEVISION RADIO-ELECTRONICS

**BETTER...MORE COMPLETE...LOWER COST...
WITH NATIONAL SCHOOLS SHOP-METHOD
HOME TRAINING!**

BETTER... Training that is proved and tested in Resident School shops and laboratories, by a School that is the **OLDEST** and **LARGEST** of its kind in the world.

MORE COMPLETE... You learn **ALL PHASES** of *Television-Radio-Electronics*.

LOWER COST... Other schools make several courses out of the material in our **ONE MASTER COURSE**... and you pay more for less training than you get in our course at **ONE LOW TUITION!**



These
two FREE books will
show you how!

You get all information
by mail... You make
your own decision... at
home! **NO SALESMAN
WILL CALL**

TOP PAY... UNLIMITED OPPORTUNITIES LIFETIME SECURITY CAN BE YOURS!

You are needed in the Television, Radio, and Electronics industry! Trained technicians are in growing demand at excellent pay—in **ALL PHASES**, including Servicing, Manufacturing, Broadcasting and Communications, Automation, Radar, Government Missile Projects.

NATIONAL SCHOOLS SHOP-METHOD HOME TRAINING, with newly added lessons and equipment, trains you in your spare time at home, for these unlimited opportunities, including many technical jobs leading to supervisory positions.

YOU LEARN BY BUILDING EQUIPMENT WITH KITS AND PARTS WE SEND YOU. Your National Schools course includes thorough *Practical* training—**YOU LEARN BY DOING!** We send you complete standard equipment of professional quality for building various experimental and test units. You advance step by step, perform more than 100 experiments, and you build a complete TV set from the ground up, that is yours to keep! A big, new TV picture tube is included at no extra charge.

EARN AS YOU LEARN. We'll show you how to earn extra money right from the start. Many of our students pay for their course—and more—while studying. So can you!

RESIDENT TRAINING AT LOS ANGELES

If you wish to take your training in our Resident School at Los Angeles, the world's TV capital, start **NOW** in our big, modern Shops, Labs and Radio-TV Studios. Here you work with latest Electronic equipment—professionally installed—finest, most complete facilities offered by any school. Expert, friendly instructors. Personal attention. Graduate Employment Service. Help in finding home near school—and part time job while you learn. Check box in coupon for full information.

LESSONS AND INSTRUCTION MATERIAL ARE UP-TO-DATE, PRACTICAL, INTERESTING. Every National Schools Shop-Method lesson is made easy to understand by numerous illustrations and diagrams. All instruction material has been developed and tested in our own Resident School Shops, Laboratories and Studios.

SEND FOR INFORMATION TODAY... it can mean the difference between **SUCCESS** and failure for you! Send for your **FREE BOOK**, "Your Future in Television-Radio-Electronics" and **FREE Sample Lesson**. Do it **TODAY**, while you are thinking about your future. It doesn't cost you anything to investigate!

GET THE BENEFITS OF OUR OVER 50 YEARS EXPERIENCE

Approved for
GI Training



MEMBER



NATIONAL SCHOOLS

Los Angeles 37, Calif.

YOU GET...

- 19 Big Kits—**YOURS TO KEEP!**
- Friendly Instruction and Guidance
- Job Placement Service
- Unlimited Consultation
- Diploma—Recognized by Industry
- **EVERYTHING YOU NEED FOR SUCCESS!**

**SHOP-METHOD HOME TRAINING
COVERS ALL PHASES OF INDUSTRY**

1. Television, including Color TV
2. Radio AM & FM
3. Electronics for Guided Missiles
4. Sound Recording and Hi-Fidelity
5. FCC License
6. Automation and Computers
7. Radar & Micro-Waves
8. Broadcasting and Communications

NATIONAL TECHNICAL SCHOOLS

WORLD-WIDE TRAINING SINCE 1905

MAIL NOW TO
NATIONAL SCHOOLS, Dept R4Y-129
4000 S. FIGUEROA ST. LOS ANGELES 37, CALIF
Rush free TV-Radio "Opportunity" Book and sample
lesson. No salesman will call.

NAME _____ AGE _____
ADDRESS _____
CITY _____ ZONE _____ STATE _____

Check if interested **ONLY** in Resident School training at Los Angeles
VETERANS Give date of Discharge _____

Handle any Radio-TV Service Job

EASIER - BETTER - FASTER!

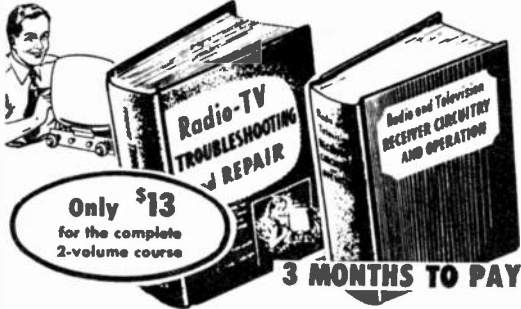

COMPLETE SERVICE TRAINING

... written so you can understand it!

No complicated theory or mathematics! These famous Ghirardi books get right down to brass tacks in showing you how to handle all types of AM, FM, and TV service work by approved professional methods. Almost 1500 pages and over 800 clear illustrations show how to handle every phase of troubleshooting and servicing. Each book is co-authored by A. A. Ghirardi whose manuals have helped train more servicemen than any other books or courses of their kind!

1—Radio and Television Receiver TROUBLESHOOTING AND REPAIR

A complete guide to profitable professional methods. For the beginner, it is a comprehensive training course. For the experienced serviceman, it is a quick way to "brush up" on specific jobs, to develop improved techniques or to find fast answers to puzzling service problems. Includes invaluable "step-by-step" service charts. 820 pages, 417 illustrations, price \$7.50 separately.

2—Radio and Television Receiver CIRCUITRY AND OPERATION

This 669-page volume is the ideal guide for servicemen who realize it pays to know what really makes modern radio-TV receivers "tick" and why. Gives a complete understanding of basic circuits and circuit variations; how to recognize them at a glance; how to eliminate guesswork and useless testing in servicing them. 417 illustrations. Price separately \$6.75.

Special low price . . . you save \$1.25

If broken into lessons and sent to you as a "course," you'd regard these two great books as a bargain at \$75 or more! Under this new offer, you save \$1.25 on the two books—and have the privilege of paying in easy installments while you use them! No lessons to wait for. You learn fast—and right!

STUDY 10 DAYS FREE!

Dept. PR-10, RINEHART & CO., Inc.
232 Madison Ave., New York 16, N. Y.

Send books below for 10-day FREE EXAMINATION. In 10 days I will either remit price indicated (plus postage) or return books postpaid and owe you nothing.

Radio & TV Receiver TROUBLESHOOTING & REPAIR (Price \$7.50 separately)

Radio & TV CIRCUITRY & OPERATION (Price \$6.75)

Check here for **MONEY-SAVING COMBINATION OFFER**—Save \$1.25. Send both of above big books at special price of only \$13.00 for the two. (Regular price \$14.25— you save \$1.25.) Payable at rate of \$4 plus postage after 10 days if you decide to keep books and \$3 a month for 3 months until the total of \$13.00 has been paid.

Name _____

Address _____

City, Zone, State _____

Outside U.S.A.—\$8.00 for TROUBLESHOOTING & REPAIR; \$7.25 for CIRCUITRY & OPERATION; \$14.00 for both. Cash only, but money refunded if you return books in 10 days.

...News



A new automatic 4-speed record changer has been placed on the hi-fi market by Norelco. The model AG 1024 features push-button controls, including automatic stop, manual or automatic operation and automatic intermix of 7", 10" and 12" records at the same speed. For more information contact North American Philips Co., Inc., Hi-Fi Products Div., 230 Duffy Avenue, Hicksville, L. I. Price without stylus is \$39.50.



Lafayette Radio has added a super-heterodyne communications receiver to its line of amateur equipment. All controls including switches, phono jack and a built-in S meter with adjustment control are located on the front panel. BFO and RF gain controls are variable. AVC and noise limiter are switchable. Complete band switching has been provided. Coverage of from 455 kc to 31 mc is obtained through use of four switchable ranges. Available both in kit and factory wired form. Kit model KT-200 is priced at \$64.50 and factory-wired model HE-10 is \$79.50 from Lafayette, 165-08 Liberty Avenue, Jamaica 33, New York.

Opportunities in Electronics

- Radar
- Guided Missiles
- Broadcasting
- Aeronautical Electronics
- Computers
- Automation
- Industrial Electronics
- Home Electronics

Are you interested in learning how you can have a profitable career in any or all of the above fields?

Find out how modern technical training and a Government License (FCC) can lead to profitable employment in any branch of electronics.

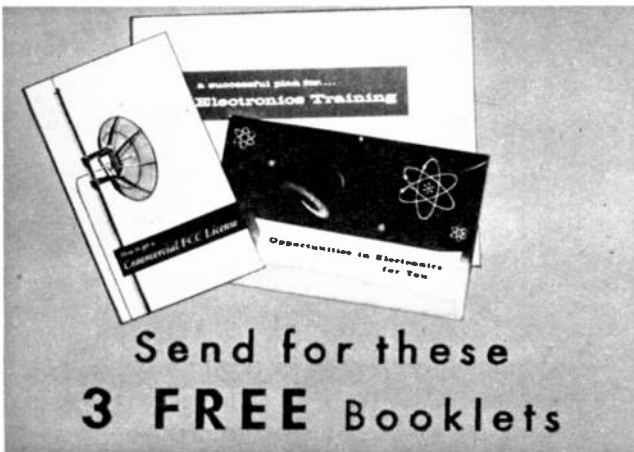

Thousands of interesting well-paid jobs in electronics must be filled. To fill such jobs, you need sound technical training. An FCC license is convincing proof of technical skill. Send for the three Cleveland Institute booklets offered here. They explain how you can prepare for an interesting and profitable career in electronics. Mail the coupon today—no obligation.

good training doesn't cost—it pays!

Cleveland Institute of Electronics

Desk EI-16 4900 Euclid Ave. Cleveland 3, Ohio

Accredited by
the National
Home Study
Council



Please send FREE Booklets prepared to help me get ahead in Electronics. I have had training or experience in Electronics as indicated below:

- | | |
|---|---|
| <input type="checkbox"/> Military | <input type="checkbox"/> Broadcasting |
| <input type="checkbox"/> Radio-TV Servicing | <input type="checkbox"/> Home Experimenting |
| <input type="checkbox"/> Manufacturing | <input type="checkbox"/> Telephone Company |
| <input type="checkbox"/> Amateur Radio | <input type="checkbox"/> Other..... |

In what kind of work are you now engaged?.....

In what branch of Electronics are you interested?

Name..... Age.....

Address

City..... Zone.... State.....

Desk EI-16

RESIDENT SCHOOL COURSES

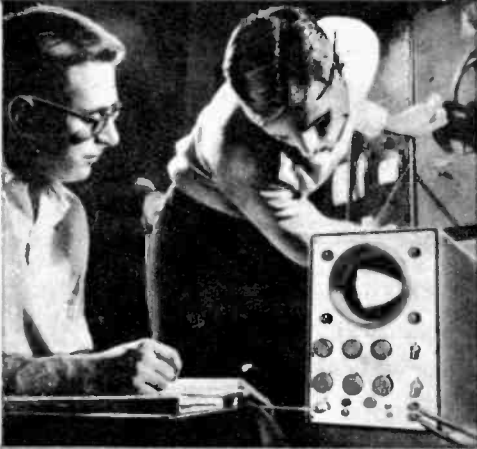

Industry needs Electronic Technicians!

Let RCA train you in Advanced Electronics

This is the college-level training you need to work with professional engineers on research, development or production projects in such fields as: automation, guided missiles, radar, television, computers and other advanced electronic applications.

RCA Institutes Resident School in New York City offers this comprehensive course that prepares you for any field of electronics you may choose. Other courses in TV & General Electronics, Radio & TV Servicing, and Radio Telegraph Operating.

Classes start four times each year. Applications now being accepted. Approved for Veterans.



RCA INSTITUTES, INC.
SCHOOLS OF TELEVISION
AND ELECTRONIC TECHNOLOGY

A Service of Radio Corporation of America
ANOTHER WAY RCA SERVES EDUCATION THROUGH ELECTRONICS

RCA INSTITUTES, DEPT. EIR-10
350 W. Fourth St., N.Y. 14, N.Y.

Please send me your FREE catalog of
Resident School courses in New York.

NAME _____ please print

ADDRESS _____

CITY _____ ZONE _____ STATE _____

For Home Study Courses see ad on opposite page

...News



Heathkit has announced a new high fidelity preamplifier amplifier in the low price range—\$29.95. Providing 14 watts of power the EA-3 features bass, treble, hum balance and volume controls. Three inputs are provided. A neon pilot light on the front panel shows when the instrument is on. The case is designed in black and gold. Heath Co., Benton Harbor, Mich.



Gyro Electronics Co. has announced a new compact battery charger that operates on 110-120 volts, 60 cycles with a maximum charging current of 12 amps. Designed to charge wet cells, nickel cadmium and silver cells, it features a control for varying the charging current which may be read on a self-contained milliammeter-ammeter with ranges of 0-50 ma, and 0-5 amps. Model C-300 comes factory wired and tested. It measures 4" x 5" x 6"—\$13.95 from 36 Walker Street, New York, New York.

ANOTHER WAY RCA
SERVES EDUCATION
THROUGH
ELECTRONICS



6 REASONS WHY RCA TRAINING IN ELECTRONICS can be the smartest investment you'll make in your *entire lifetime!*

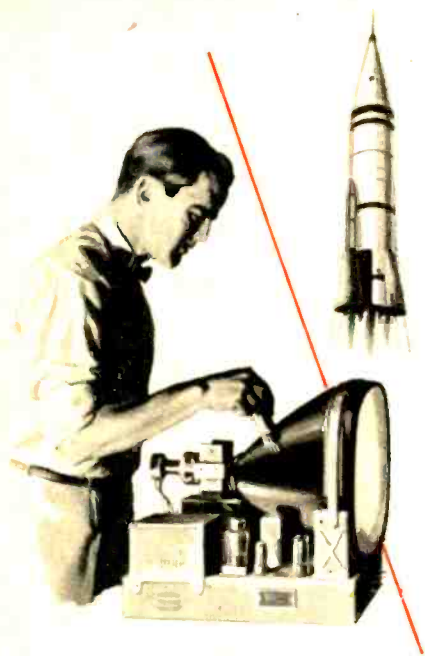

1. You get the finest training-at-home under the supervision of the RCA INSTITUTES, experts in technical training for over 50 years. The very name "RCA" means dependability, integrity, and scientific advance.

2. You get comprehensive training in your choice of four complete, up-to-date Courses . . . from basic electronics theory to Color TV and Automation.

3. You get an evaluation of your aptitude for advanced training. RCA determines, for your benefit, whether you have the requirements for a career in the electronics field.

4. You get prime quality equipment as a regular part of your Course . . . equipment that you keep and use on the job. You never have to take apart one piece to build another.

5. You get each study group on a pay-as-you-go basis. Should you wish to interrupt your training at any time, you will not owe RCA Institutes a penny more, unless and until you decide to resume the Course.

6. You get top recognition — nationwide. Graduates of RCA Institutes now work for leaders in the electronics field; many have their own businesses. This record is true tribute to the high quality of RCA Institutes training.

Send for this
64-page Home
Study Catalog
FREE!



FOR RESIDENT
SCHOOL COURSES SEE
AD ON OPPOSITE PAGE

RCA INSTITUTES, Inc. Home Study School EI-10

A Service of Radio Corporation of America

350 West Fourth Street, New York 14, N. Y.

Without obligation, send me **FREE 64-page CATALOG** on Home Study Courses. No salesman will call. (Please Print)

Name Age

Address

City Zone State

Korean Vet! Enter discharge date

CANADIANS — Take advantage of these same RCA courses at no additional cost. No postage, no customs, no delay. Send coupon to: RCA Victor Company, Ltd., 5001 Cote de Liesse Rd., Montreal 9, Quebec
To save time, paste coupon on postcard.

It's easy to master
BASIC TELEVISION
 THE RIDER 'PICTURE-BOOK' WAY

The whole world of black and white television is before you for only \$10.00

NOW AVAILABLE



New 5-volume Rider 'picture book' course by Dr. Alexander Schure teaches the complete basic principles and practices of black and white television easily, quickly and understandably. You can master the basics of television easily, rapidly and thoroughly with this "learn by pictures" training course.

No experience, education needed

BASIC TELEVISION uses the same methods that have proven so successful in the famous Rider 'picture books' on electricity and electronics. This comprehensive course presents Basic Television in simple, down-to-earth language that everyone can understand—regardless of previous education. All that is assumed is that you have a knowledge of radio. Every phase of television is made instantly clear—explained in plain English supported by carefully prepared, large and exciting drawings that make every idea crystal-clear.

5 complete volumes

It starts with the transmitter and discusses in detail the following subjects: Volume 1 deals with the transmitter; the handling and the operation of the camera; formation of the picture signal and the general content of the transmitter. Volume 2 covers the organization of the entire TV receiver treating each section individually from antenna to picture tube. Volumes 3, 4 and 5 contain the TV receiver circuit explanations. Each volume covers a specific number of sections in the receiver.

Learn at home—no correspondence

This course is so complete, so different—there's no need for the usual letter writing, question and correspondence. You learn in the comfort of your home, in your spare time... at your own pace.

HOW TO KNOW MORE—EARN MORE WITH
 THESE RIDER 'HOW TO' BOOKS

HOW TO READ SCHEMATIC DIAGRAMS

by David Mark

Teaching theory and the recognition of symbols, this book is an ideal way to start a career or an electronic hobby. Covering the symbols and abbreviations used in schematic diagrams related to the electronics field, this book starts with the individual components and carries through to receivers and similar equipment. Components and circuits are identified and explained. #208, \$3.50.

HOW TO TROUBLESHOOT A TV RECEIVER (2nd Edition)
 by J. Richard Johnson, #152, \$2.50

HOW TO USE METERS by John F. Rider, #144, \$2.40

HOW TO USE TEST PROBES by A. Ghirardi and R. Middleton, #165, \$2.90

HOW TO USE SIGNAL & SWEEP GENERATORS by J. Richard Johnson, #147, \$2.10

ORDER TODAY!

Available at electronic parts jobbers or use coupon—



10-DAY UNCONDITIONAL MONEY-BACK GUARANTEE

JOHN F. RIDER PUBLISHER, INC., Dept. EI-1
 116 West 14th St., New York 11, N. Y.

I have enclosed \$..... Please send me:

- BASIC TELEVISION, 5 vol. SOFT COVER SET, \$10
 CLOTH BOUND, \$11.50
 #152, \$2.50 #144, \$2.40
 #165, \$2.90 #147, \$2.10

Name

Address

City Zone State

In Canada 5% higher; add state and city sales taxes where applicable

GUARANTEE: Satisfaction guaranteed. All books returnable within 10-days for full refund.

...News

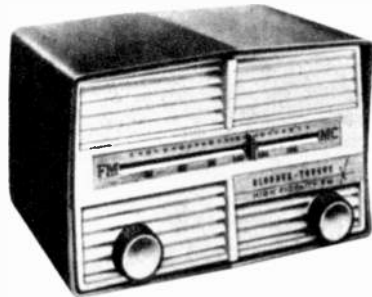

A new FM radio priced at \$39.95 has been introduced by Blonder-Tongue Labs. The model R-20 radio uses 6 tubes and is available in many colors. Write to 9 Alling Street, Newark 2, N. J. for information.

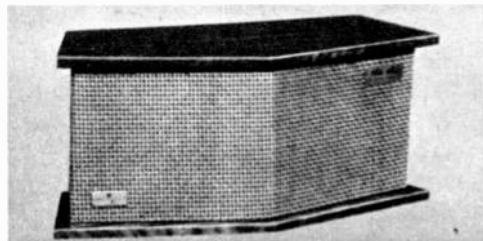

Cosmos Industries, Inc., a newcomer to the field of high fidelity has announced production of its first hi-fi component, the AH electrostatic transducer. The AH is a mid-range tweeter with R/C crossover and built-in power supply. Specs available from Cosmos, 31-28 Queens Blvd., Long Island City, N. Y. Price is \$49.95.



When we stated in Mr. Clurman's "Made in Japan" article (October 1959) that "The Japanese invented some original devices that are almost unknown in America," we included a burglar and fire alarm that telephoned the proper authority in case of emergency. However, this is made in the U. S. by Electronic Secretary Industries. The Electronic Sentry, warns against any malfunction depending on the type of detecting device used. Information available, Electronic Secretary Industries, 1101 S. Prairie Ave., Waukesha, Wis.

**WE'RE MAKING IT EASIER THAN EVER TO BECOME A WELL PAID
RADIO-TELEVISION SERVICE TECHNICIAN**

**NOW - Just \$6 Starts You Training in
RADIO-TELEVISION**

the SPRAYBERRY "Learn-by-Doing" Way . . .

**25 BIG, COMPLETE KITS
of PARTS & EQUIPMENT**

To help you learn fast the practical side of Radio-Television, we send you expertly engineered training kits to test and assemble for interesting, valuable shop-bench practice!

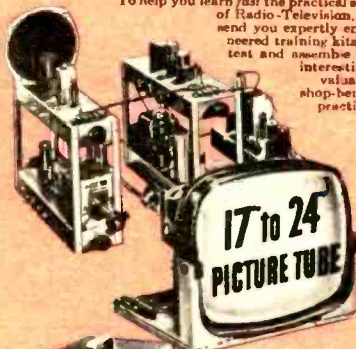

• The new Sprayberry Training Television Receiver, built and tested in 5 sections.

• Now offered . . . this fine modern oscilloscope.

• You build this powerful two-band superheterodyne radio receiver.

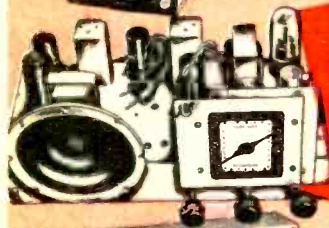

**Big New
CATALOG
NO
Sample Lesson
FREE!**



You build the new Sprayberry tester—a complete 18-range Volt-Ohm-Milliammeter test meter.

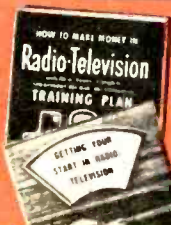

*** This great industry is begging for trained men . . . to step into good paying jobs or a profitable business of their own! Our new plan opens the doors of Radio-Television wide to every ambitious man who is ready to act at once!

Men by the thousands . . . trained Radio-Television Service Technicians . . . are needed at once! Perhaps you've thought about entering this interesting, top paying field, but lack of ready money held you back. Now - just \$6 enrolls you for America's finest, most up to date home study training in Radio-Television! Unbelievable? No, the explanation is simple! We believe Radio-Television *must* have the additional men it needs as quickly as possible. We are willing to do our part by making Sprayberry Training available for less money down and on easier terms than ever before. This is your big opportunity to get the training you need . . . to step into a fine job or your own Radio-Television Service Business.

Complete Facts Free—Act Now; Offer Limited

Only a limited number of students may be accepted on this liberal and unusual basis. We urge you to act at once . . . mail the coupon below and get complete details plus our big new catalog and an actual sample lesson—all free. No obligation . . . no salesman will bother you.

HOME STUDY TRAINING IN SPARE TIME

Under world-famous 27-year old Sprayberry Plan, you learn entirely at home in spare time. You keep on with your present job and income. You train as fast or as slowly as you wish. You get valuable kits of parts and equipment for priceless shop-bench practice. And everything you receive, lessons and equipment alike, is all yours to keep.

LET US PROVE HOW EASILY YOU CAN LEARN!

Radio-Television needs YOU! And Sprayberry is ready to train you on better, easier terms, than any ambitious man can afford. Just \$6 starts you! Mail coupon today . . . let the facts speak for themselves. You have everything to gain. Let us prove the kind of opportunity in store for you!

SPRAYBERRY Academy of Radio-Television
1512 Jarvis Avenue, Dept. 120-F, Chicago 26, Illinois

Mail This Coupon Now—No Salesman Will Call

Sprayberry Academy of Radio-Television

Dept. 120-F, 1512 W. Jarvis Ave., Chicago 26, Ill.

Please rush all information on your ALL-NEW Radio-Television Training Plan. I understand this does not obligate me and that no salesman will call upon me. Include New Catalog and Sample Lesson FREE.

NAME..... Age.....

ADDRESS.....

CITY.....ZONE.....STATE.....

a quarter century of **PRECISION**[®]
 know-how is yours in . . .

P A C O

quality electronic
 equipment in **KIT FORM**

PACO is the only line of test instrument kits engineered and produced under the auspices of a leading test equipment and meter manufacturer.

and, you pay nothing extra for the convenience of buying PACO kits directly from your own local parts distributor.

COMPARE PACO against any other kits for performance, appearance, ruggedness, ease of operation and simplicity of assembly and wiring.

COMPARE PACO'S superbly detailed, step-by-step instruction manuals and giant size wiring diagrams, against any you have ever seen.

MODEL B-10
 BATTERY ELIMINATOR KIT
 KIT NET PRICE: \$41.95
 FACTORY WIRED: 49.50

MODEL C-20
 RES-CAP-RATIO BRIDGE KIT
 KIT NET PRICE: \$20.95
 FACTORY WIRED: 31.50

MODEL G-30
 RF SIGNAL GENERATOR KIT
 KIT NET PRICE: \$28.50
 FACTORY WIRED: 39.95

MODEL M-40
 HIGH SENSITIVITY V-O-M KIT
 KIT NET PRICE: \$31.50
 FACTORY WIRED: 37.50

MODEL S-50
 5" OSCILLOSCOPE KIT
 KIT NET PRICE: \$49.50
 FACTORY WIRED: 84.50

MODEL S-55
 WIDEBAND 5" OSCILLOSCOPE
 KIT NET PRICE: \$87.50
 FACTORY WIRED: 139.50

MODEL T-60
 TUBE CHECKER KIT
 KIT NET PRICE: \$38.75
 FACTORY WIRED: 54.50

MODEL T-65
 TRANSISTOR AND CRYSTAL
 DIODE TESTER KIT
 KIT NET PRICE: \$39.95
 FACTORY WIRED: 59.50

MODEL V-70
 VACUUM TUBE VOLTMETER KIT
 KIT NET PRICE: \$31.50
 FACTORY WIRED: 47.50

MODEL Z-80
 RF-AF SIGNAL TRACER KIT
 KIT NET PRICE: \$29.50
 FACTORY WIRED: 42.50

▶ Available and on display
 at leading electronic parts distributors.
 ▶ Write for free descriptive bulletin



B-10



C-20



G-30



M-40



S-50



S-55



T-60



T-65



V-70



Z-80

. . . News

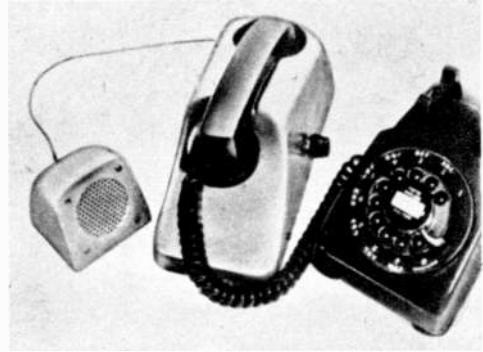

Would you like to have both hands free when you talk via the telephone? North American Industries has designed a Fone-Master to make it possible. Simply place the receiver in the Fone-Master and speak from any place in the room—the incoming call will be amplified enough to be heard throughout the room. No installation is necessary. North American Industries, Dept. X-69, 101 West 31st Street, New York, N. Y. \$39.95.

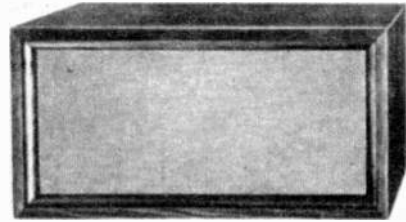

Rockford Special Furniture Company has announced the new Model 108 semi-back-loaded speaker enclosure. The enclosure is designed to accommodate any 8-inch speaker and any size tweeter. In walnut, mahogany, blonde and ebony, the enclosure may be used horizontally or vertically in any location. Priced at \$24.00, it measures 12" x 24" x 12". Bulletin R-14 available from the manufacturer gives more complete specifications. Rockford, 2024 23rd Ave., Rockford, Ill.

P A C O

ELECTRONICS CO., INC.

70-31 84th Street, Glendale 27, L.I., N.Y.

Export: 458 B'way., N. Y. 13 • Canada: Atlas Radio Corp., Toronto 19

• A DIVISION OF **PRECISION** Apparatus Company, Inc.

BUILD 16 RADIO CIRCUITS AT HOME

with the New Deluxe
PROGRESSIVE RADIO "EDU-KIT"®

only
\$22.95

Reg. U.S.
Pat. Off.



A Practical Home Radio Course

Now Includes

- ★ TRANSMITTER
- ★ SIGNAL TRACER
- ★ SIGNAL INJECTOR
- ★ CODE OSCILLATOR
- ★ No Knowledge of Radio Necessary
- ★ No Additional Parts or Tools Needed
- ★ EXCELLENT BACKGROUND FOR TV
- ★ School Inquiries Invited
- ★ SOLD IN 79 COUNTRIES

YOU DON'T HAVE TO SPEND HUNDREDS OF DOLLARS FOR A RADIO COURSE

The "Edu-Kit" offers you an outstanding PRACTICAL HOME RADIO COURSE at a rock-bottom price. Our Kit is designed to train Radio & Electronics Technicians, making use of the most modern methods of home training. You will learn radio theory, construction practice and servicing. THIS IS A COMPLETE RADIO COURSE IN EVERY DETAIL.

You will learn how to build radios, using regular schematics; how to wire and solder in a professional manner, how to service radios. You will work with the standard type of punched metal chassis as well as the latest development of Printed Circuit chassis.

You will learn the basic principles of radio. You will construct, study and work with RF and AF amplifiers and oscillators, detectors, rectifiers, test equipment. You will learn and practice code, using the Progressive Code Oscillator. You will learn and practice trouble-shooting, using the Progressive Signal Tracer, Progressive Signal Injector, Progressive Dynamic Radio & Electronics Tester and the accompanying instructional material.

You will receive instruction in the General Classes, F.C.C. Radio Amateur License. You will build 16 Receiver, Transmitter, Code Oscillator, Signal Tracer and Signal Injector circuits, and learn how to operate them. You will receive an excellent background for Television, Hi-Fi and Electronics.

Absolutely no previous knowledge of radio or science is required. The "Edu-Kit" is the product of many years of teaching and engineering experience. The "Edu-Kit" will provide you with a basic education in Electronics and Radio, worth many times the complete price of \$22.95. The Signal Tracer alone is worth more than the price of the entire Kit.

THE KIT FOR EVERYONE

You do not need the slightest background in radio or science. Whether you are interested in Radio & Electronics because you want an interesting hobby, a well paying business or a job with a future, you will find the "Edu-Kit" a worth-while investment. Many thousands of individuals of all

ages and backgrounds have successfully used the "Edu-Kit" in more than 79 countries of the world. The "Edu-Kit" has been carefully designed, step by step, so that you cannot make a mistake. The "Edu-Kit" allows you to teach yourself at your own rate. No instructor is necessary.

PROGRESSIVE TEACHING METHOD

The Progressive Radio "Edu-Kit" is the foremost educational radio kit in the world, and is universally accepted as the standard in the field of electronics training. The "Edu-Kit" uses the modern educational principle of "Learn by Doing." Therefore you construct, learn schematics, study theory, practice trouble-shooting—all in a closely integrated program designed to provide an easily-learned, thorough and interesting background in radio.

You begin by examining the various radio parts of the "Edu-Kit." You then learn the function, theory and wiring of these parts. Then you build a simple radio. With this first set you will enjoy listening to regular broadcast stations, learn theory, practice testing and trouble-shooting. Then you build a more advanced radio, learn more advanced theory and techniques. Gradually, in a progressive manner, and at your own rate, you will find yourself constructing more advanced multi-tube radio circuits, and doing work like a professional Radio Technician.

Included in the "Edu-Kit" course are sixteen Receiver, Transmitter, Code Oscillator, Signal Tracer, Signal Injector, and a professional "breadboard" station. These are not unprofessional experiments, but genuine radio circuits, constructed by means of professional wiring and soldering on metal chassis, plus the new method of radio construction known as "Printed Circuitry." These circuits operate on your regular AC or DC house current.

THE "EDU-KIT" IS COMPLETE

You will receive all parts and instructions necessary to build 16 different radio and electronics circuits guaranteed to operate. Our Kits contain tubes, tube sockets, variable electrolytic, mica, ceramic and paper dielectric condensers, resistors, the strips, coils, hardware, tubing, punched metal chassis, Instruction Manuals, hook-up wire, solder, etc.

In addition, you receive Printed Circuit materials, including Printed Circuit chassis, special tube sockets, hardware and instructions. You also receive a useful set of tools, a professional electric soldering iron, and a self-powered Dynamic Radio & Electronics Tester. The "Edu-Kit" also includes Code Instructions and the Progressive Code Oscillator. In addition to F.C.C.-type Questions and Answers for Radio Amateur License training. You will also receive lessons for servicing with the Progressive Signal Tracer and the Progressive Signal Injector, a High Fidelity Guide and a Quiz Book. You receive Membership in Radio-TV Club, Free Consultation Service, Certificate of Merit and Discount Privileges. You receive all parts, tools, instructions, etc. Everything is yours to keep.

FREE EXTRAS

- SET OF TOOLS
- SOLDERING IRON
- ELECTRONICS TESTER
- FLIERS-CUTTERS ● ALIGNMENT TOOL
- WRENCH SET
- VALUABLE DISCOUNT CARD
- CERTIFICATE OF MERIT
- TESTER INSTRUCTION MANUAL
- HIGH FIDELITY GUIDE ● QUIZZES
- TELEVISION BOOK ● RADIO TROUBLE-SHOOTING BOOK
- MEMBERSHIP IN RADIO-TV CLUB
- CONSULTATION SERVICE ● FCC AMATEUR LICENSE TRAINING
- PRINTED CIRCUITRY

SERVICING LESSONS

You will learn trouble-shooting and servicing in a progressive manner. You will practice repairs on the sets that you construct. You will learn symptoms and causes of troubles in home, portable and car radios. You will learn how to use the professional Signal Tracer, the unique Signal Injector and the Dynamic Radio & Electronics Tester. While you are learning in this practical way, you will be able to do many a repair job for your friends and neighbors, and charge fees which will far exceed the price of the "Edu-Kit." Our Consultation Service will help you with any technical problems you may have.

J. Stalatis, of 23 Poplar Pl., Waterbury, Conn. writes: "I have repaired several sets for my friends, and made money. The "Edu-Kit" paid for itself. I was ready to spend \$240 for a Course, but I found your ad and sent for your Kit."

FROM OUR MAIL BAG

Ben Valerio, P. O. Box 21, Magna, Utah: "The Edu-Kits are wonderful. Here I am sending you the questions and also the answers for them. I have been in Radio for the last seven years, but like to work with Radio Kits and like to build Radio Testing Equipment. I enjoyed every minute I worked with the different kits; the Signal Tracer works fine. Also like to let you know that I feel proud of becoming a member of your Radio-TV Club."

Robert L. Shuff, 1534 Monroe Ave., Huntington, W. Va.: "Thought I would drop you a few lines to say that I received my Edu-Kit, and was really amazed that such a bargain can be had at such a low price. I have already started repairing radios and phonographs. My friends were really surprised to see me get into the swing of it so quickly. The Troubleshooting Tester that comes with the Kit is really swell, and finds the trouble, if there is any to be found."

UNCONDITIONAL MONEY-BACK GUARANTEE

The Progressive Radio "Edu-Kit" has been sold to many thousands of individuals, schools and organizations public and private, throughout the world. It is recognized internationally as the Ideal radio course. By popular demand, the Progressive Radio "Edu-Kit" is now available in Spanish as well as English.

It is understood and agreed that should the Progressive Radio "Edu-Kit" be returned to Progressive "Edu-Kits" Inc. for any reason whatever, the purchase price will be refunded or returned without quibble or question, and without delay.

The high recognition which Progressive "Edu-Kits" Inc. has earned through its many years of service to the public is due to its unconditional insistence upon the maintenance of perfect engineering, the highest instructions standards and 100% adherence to its Unconditional Money-Back Guarantee. As a result, we do not have a single dissatisfied customer throughout the entire world.

ORDER DIRECT FROM AD—RECEIVE FREE BONUS RESISTOR AND CONDENSER KITS WORTH \$7

- Send "Edu-Kit" Postpaid. I enclose full payment of \$22.95.
- Send "Edu-Kit" C.O.D. I will pay \$22.95 plus postage.
- Send me FREE additional information describing "Edu-Kit."

Name

Address

PROGRESSIVE "EDU-KITS" INC.
1186 BROADWAY, DEPT. 519AE, HEWLETT, N.Y.

...News

Radio hams all over the country have been requested to listen and record signals transmitted on 108 mc by Vanguard III. In making this request, the National Academy of Sciences explained that in event of a solar flare, the hams would be requested to send their tapes to the Academy in the hope that they might have recorded the flare at a time at which the tracking stations were not able to catch it. Dr. Porter, Chairman of the Earth Satellite Technical Panel of the U. S.-IGY program under which the Vanguard III experiments were developed, indicated that scientists are particularly anxious to obtain tape recordings of transmissions that show effects of a solar flare which might occur when the satellite is below the Van Allen radiation belt.

The Academy requested that tapes be retained for at least 48 hours. In the event of a solar flare the Academy will notify the ARRL, requesting members send in tapes made during that period.

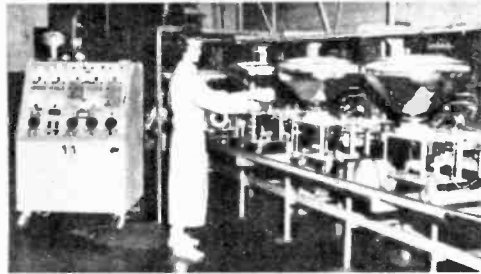

A new machine that can perform twenty-six different tests on TV picture tubes at the rate of more than 600 tubes an hour has been installed in RCA's Marion, Indiana plant. Electrical limits for the tube under test covering shorted or open elements, emission from the electron gun, modulation characteristics, screen condition, optical quality, focus and resolution, dielectric strength of insulators between elements, degree of vacuum, and high voltage stability are built into test circuits of the new machine. Picture tubes are passed or rejected according to these limits by the inspection operator.

MICRO

ELECTRON TUBE

INTRODUCES FOR THE FIRST TIME ANYWHERE A SELECT STOCK OF USED TUBES AT A FABULOUS LOW PRICE

37¢ ea.

FOR any TUBE LISTED

Jan Surplus Tubes!

\$35 PER HUNDRED ASSTD.

ALL TUBES SENT POSTAGE PAID
Please send 25¢ handling for orders under \$5. Send 25% deposit on C.O.D. orders. Send approximate postage on Canadian and foreign orders.

MICRO

ELECTRON TUBE CO. P.O. BOX 55 Park Station, Paterson 3, N. J.

- Each and every tube is tested in our own laboratory for mutual conductance and life test.
- We guarantee FREE replacement for one year of any tube purchased from us which fails to function efficiently under any or all operating conditions. Prompt refunds are made on any defective merchandise.
- The advertised tubes are not necessarily new, but may be electrically perfect factory seconds or used tubes—each is clearly so marked.

0A2	6X8	6BM6	6CF8	7Z4	19BG6
0Z4	6Y3GT	6BJ6	6SF7	12A8	19J6
1A7GT	6Y4Q	6BK6	6SJ7	12A8	19T8
1B3GT	6A7	6BK7	6SK7	12A8	19T8
1N4G	6A8	6BK7	6SK7	12A8	24A
1N8GT	6A8A	6BK7	6SK7	12A8	25AV5
1L4	6A8A	6BK7	6SK7	12A8	25B08
1L6	6A8A	6BK7	6SK7	12A8	25D06
1M8GT	6A8A	6BK7	6SK7	12A8	25L6GT
1Q8GT	6A8A	6BK7	6SK7	12A8	25W4GT
1R8	6A8A	6BK7	6SK7	12A8	25Z5
1S5	6A8A	6BK7	6SK7	12A8	25Z6
1T4	6A8A	6BK7	6SK7	12A8	26
1U4	6A8A	6BK7	6SK7	12A8	35A5
1U8	6A8A	6BK7	6SK7	12A8	35B8
1V2	6A8A	6BK7	6SK7	12A8	35C5
1X2	6A8A	6BK7	6SK7	12A8	35L6GT
2A3	6A8A	6BK7	6SK7	12A8	35W6
2A4	6A8A	6BK7	6SK7	12A8	38V4
3BC8	6A8A	6BK7	6SK7	12A8	35Z8GT
3BN8	6A8A	6BK7	6SK7	12A8	37
3B8	6A8A	6BK7	6SK7	12A8	39/44
3CB6	6A8A	6BK7	6SK7	12A8	42
3CF8	6A8A	6BK7	6SK7	12A8	43
3C56	6A8A	6BK7	6SK7	12A8	48
3L4	6A8A	6BK7	6SK7	12A8	50A5
304	6A8A	6BK7	6SK7	12A8	50B5
354	6A8A	6BK7	6SK7	12A8	50C5
3V4	6A8A	6BK7	6SK7	12A8	50L6GT
4BQ7A	6A8A	6BK7	6SK7	12A8	50K6
4B7	6A8A	6BK7	6SK7	12A8	86
4B8	6A8A	6BK7	6SK7	12A8	88
4B9	6A8A	6BK7	6SK7	12A8	71A
4C5	6A8A	6BK7	6SK7	12A8	75
4D6	6A8A	6BK7	6SK7	12A8	77
4E6	6A8A	6BK7	6SK7	12A8	78
4F6	6A8A	6BK7	6SK7	12A8	84/824
4G6	6A8A	6BK7	6SK7	12A8	117
4H6	6A8A	6BK7	6SK7	12A8	117Z

WRITE DEPT. FI-1 FOR OUR FREE COMPLETE LIST OF TUBES & SPECIAL PURPOSE TUBES

Here's The Offer No Other Radio-TV School DARES MAKE!

LEARN AT HOME in Spare Time!

YOU DO MANY PRACTICAL JOBS with the kits we send you. That's right, you PRACTICE what we TEACH! You build a Signal Generator, AC-DC Power Pack, and AC-DC Superheterodyne Radio Receiver and top quality 21 Inch TV Set. EARN AS YOU LEARN with the famous RTS 30 Day Income Plan. Full instructions provided. NO HIGH SCHOOL DIPLOMA NECESSARY. This is a COMPLETE course which starts with basic subjects and gradually advances to Radio-TV. . . . ALL FOR A PRICE YOU CAN AFFORD!

*THE ONLY VERTICAL MULTI-CHASSIS 21" TV KIT OFFERED BY ANY RADIO-TV SCHOOL



YOU BUILD THESE AND OTHER UNITS!

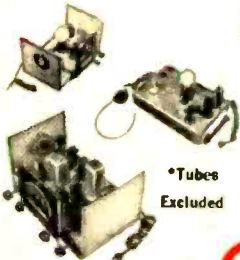

COMPLETE COLOR TV INSTRUCTION INCLUDED!

Each student is entitled to unlimited consultation service. All questions are answered promptly and completely by highly specialized instructors.

*Tubes Excluded

RTS' Membership in The Association of Home Study Schools is your assurance of Reliability, Integrity and Quality of Training.



RADIO-TELEVISION TRAINING SCHOOL
5100 S. VERMONT AVENUE
LOS ANGELES 37, CALIFORNIA

L 101 Est. 1922



RTS Will Train You at a Price You Can Afford and When You Are a Qualified Graduate Will Help You Open a Service Shop of Your Own and Supply You With Every Bit of Equipment You Need to Get Started - Plus an Inventory of Parts and Necessary Supplies.

ALL FINANCED WITHOUT INTEREST OR CARRYING CHARGES!!

You Also Receive . . . Advertising Help and Material, Shop Plans, Business Systems, Letterheads, Calling Cards and Much More!

Here's What Two of Many Business Plan Shop Owners Have to Say!

This business takes in between \$1500 and \$2000 a month. I've had to hire help to keep up with it.

CULLEN W. IRBY
Corpus Christi, Texas

The school lives up to its promises 100%. RTS does not lose interest in its students once they graduate.

HAROLD R. STANLAKE
Perry, Michigan



RUSH COUPON for FREE FACTS!

DON'T LOSE OUT — FIND OUT!

RADIO TELEVISION TRAINING SCHOOL, Dept. RT-160
5100 S. Vermont Ave., Los Angeles 37, Calif.
Rush me full information by return mail. (Please Print)

NAME _____ AGE _____

STREET _____

CITY _____ ZONE _____ STATE _____

NO SALESMAN WILL CALL ON YOU!



only 27 months for engineering degree

Unlock your talents. Start to realize your dream of becoming a graduate Electronics Engineer. Then promotion will not pass you by. You will share rewards awaiting college graduates. Important firms visit Tri-State campus to interview seniors. Founded in 1884. Bachelor of Science Degree in 27 months in Electrical Engineering with either Electronics or Power major . . . also in Mechanical, Civil, Chemical, Aeronautical Engineering. In 36 months a B. S. in Business Administration (General Business, Accounting, Motor Transport Management majors). Mature students. Enrollment limited. Small classes. More professional class hours. Beautiful campus. Well-equipped, new and modernized buildings and labs. Modest costs. Enter March, June, September, January. Mail coupon today for information.



TRI-STATE COLLEGE

J. A. McCarthy, Director of Admissions
4810 College Avenue, Angola, Indiana

Please send me Your Career Book and Catalog with full information on Electronics Engineering and other degree courses. I am especially interested in courses checked:

- Electrical (Radio, TV, Electronics option)
 Electrical (Power option) Chemical Aeronautical
 Civil Mechanical General Business
 Accounting Motor Transport Management General Education

Name

Street Address

City Zone..... State.....

FREE

Fill in coupon for a FREE One Year Subscription to OLSON RADIO'S Fantastic Bargain Packed Catalog — Unheard of LOW, LOW, WHOLESALe PRICES on Brand Name Speakers, Changers, Tubes, Tools, Hi-Fi's, Stereo Amps, Tuners and other Bargains:

NAME _____
 ADDRESS _____
 CITY _____ ZONE _____ STATE _____

If you have a friend interested in electronics send his name and address for a FREE subscription also.

OLSON RADIO CORPORATION

403 Forge Street Akron 8, Ohio

...News

New Bulletins and Catalogs . . .

Allied Radio's 1960 Electronics Catalog is now available upon request. Contains over 40,000 items. Write to Allied Radio Corp., 100 N. Western Ave., Chicago, Ill.

Two transistor bulletins entitled, "Are You Destroying Transistors?" and "How to Test Transistors" are being offered by CBS Electronics, Information Services, 100 Endicott St., Danvers, Mass.

"The Final Authority," a bulletin discussing the impracticality of a universal tube tester is available free from distributors of CBS tubes. Ask for bulletin AP-500.

Entron, Inc. is offering a brochure on recommended practices for the design and installation of master antenna systems. The six-page booklet F-1106 is free from Entron, P. O. Box 287, Bladensburg, Maryland.

The fourth edition of General Electric's transistor manual has been published. Priced at \$1.00 it contains 227 pages of rewritten information on transistors and their use in electronic circuits. It may be obtained from GE, Semiconductor Products Dept., Charles Building, Liverpool, N. Y.

Heath Company has announced publications of their new 1960 catalog featuring over 150 do-it-yourself electronic kits including hi-fi, ham, test instruments, marine equipment, etc. Available for the asking from Heath Company, Benton Harbor, Mich.

A 130 page manual covering basic theory, design characteristics and applications for zener diodes has been announced by Motorola's Semiconductor Products Div. Copies may be obtained for \$1.00 from Motorola distributors.

A new catalog covering sockets, caps and terminals has been announced by National Radio Co. Bulletin 59-4 gives specs for these components. Free from National Co., Walden, Mass.

A new characteristics and replacement guide for semiconductor diodes has been made available by Sylvania Electric Products, Inc. Copies may be obtained from Sylvania, 1100 Main St., Buffalo 9, New York.

Do you WISH you were EMPLOYED in ELECTRONICS?

F.C.C. LICENSE—THE KEY TO BETTER JOBS

An F.C.C. *commercial* (not amateur) license is your ticket to higher pay and more interesting employment. This license is Federal Government evidence of your qualifications in electronics. Employers are eager to hire *licensed* technicians.

WHICH LICENSE FOR WHICH JOB?

The **THIRD CLASS** radiotelephone license is of value primarily in that it qualifies you to take the second class examination. The scope of authority covered by a third class license is extremely limited.

The **SECOND CLASS** radiotelephone license qualifies you to install, maintain and operate most all radiotelephone equipment except commercial broadcast station equipment.

The **FIRST CLASS** radio telephone license qualifies you to install, maintain and operate every type of radiotelephone equipment (except amateur) including all radio and television stations in the United States, its territories and possessions. This is the highest class of radiotelephone license available.

GRANTHAM TRAINING PREPARES YOU

The Grantham course covers the required subject matter completely. Even though it is planned primarily to lead directly to a first class FCC license, it does this by **TEACHING** you electronics. Some of the subjects covered in detail are: Basic Electricity for Beginners, Basic Mathematics, Ohm's and Kirchhoff's Laws, Alternating Current, Frequency and Wavelength, Inductance, Capacitance, Impedance, Resonance, Vacuum Tubes, Transistors, Basic Principles of Amplification, Classes of Amplifiers, Oscillators, Power Supplies, AM Transmitters and Receivers, FM Transmitters and Receivers, Antennas and Transmission Lines, Measuring Instruments, FCC Rules and Regulations, and extensive theory and mathematical calculations associated with all the above subjects explained simply and in detail.

OUR GUARANTEE

If you should fail the F. C. C. exam after finishing our course, we guarantee to give additional training at **NO ADDITIONAL COST**. Read details in our free booklet.

Get Your First Class Commercial F.C.C. LICENSE QUICKLY!

CORRESPONDENCE OR RESIDENCE CLASSES

Grantham School of Electronics *specializes* in F.C.C. license preparation. Correspondence training is conducted from Hollywood, Seattle, Kansas City and Washington; also, resident **DAY** and **EVENING** classes are held in all four cities. Either way, by correspondence or in resident classes, we train you quickly and well.

This booklet FREE!

This free booklet gives details of our training and explains what an F. C. C. license can do for your future.

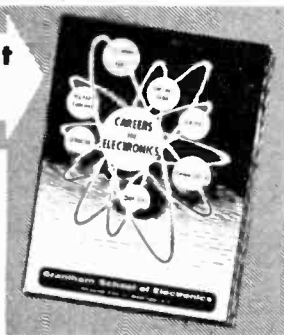

HERE'S PROOF...

that Grantham students prepare for F.C.C. examinations in a minimum of time. Here is a list of a few of our recent graduates, the class of license they got, and how long it took them:

	License	Weeks
Robert J. Conley, 129 W. 46th St., New York 36, N. Y.	1st	14
W. R. Smith, 1335 E. 8th St., Long Beach, Calif.	1st	12
Howard E. Martz, 301 S. Penn. St., Fairmount, Ind.	1st	24
John W. Dempsey, Box 55, Rising Sun, Md.	1st	12
Donald M. Ford, Hyannis Rd, Barnstable, Mass.	1st	12
Richard J. Falk, 2303 Holman St., Bremerton Wash.	1st	22
Denson D. McNully, 1117 N. Houston St., Amarillo, Texas	1st	9
James D. Haugh, 400 S. Church St., East Troy, Wisc.	1st	12
Odie B. Perry, Jr., Rt. #3, Zebulon, N. C.	1st	12
Milton C. Gee, Rt. #1, Washington, N. J.	1st	11

Grantham School of Electronics

Hollywood Division

1505 N. Western Ave.
Hollywood 27, Calif.
(Phone: HO 7-7727)

Seattle Division

408 Marion Street
Seattle 4, Wash.
(Phone: MA 2-7227)

Kansas City Division

3123 Gillham Road
Kansas City 9, Mo.
(Phone: JE 1-6320)

Washington Division

821-19th Street, N. W.
Washington 6, D. C.
(Phone: ST 3-3614)

MAIL COUPON TO SCHOOL NEAREST YOU



(Mail in envelope or paste on postal card)

TO: GRANTHAM SCHOOL OF ELECTRONICS

1505 N. Western • 408 Marion • 3123 Gillham Rd • 821-19th, NW
Hollywood • Seattle • Kansas City • Washington

Gentlemen:

Please send me your free booklet telling how I can get my commercial F.C.C. license quickly. I understand there is no obligation and no salesman will call.

Name _____ Age _____

Address _____

City _____ State _____

I am interested in: Home Study, Resident Classes **08-A**

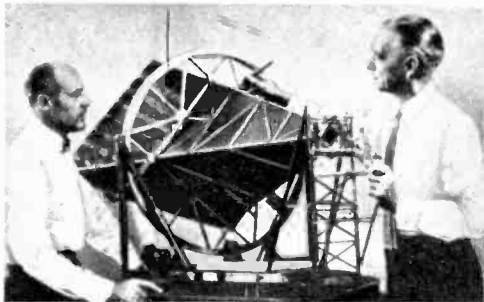

This unusual horn antenna, designed by Bell Telephone Laboratory engineers, will be used in an experimental ground station to explore the possibility of sending phone calls and live television to distant parts of the world. These stations would bounce radio signals off dozens of "sky-mirror" satellites. One of the projects at the Homdel, New Jersey site will be to determine whether television's broadband signals could be bounced between stations on opposite sides of the U. S. by means of

reflections from a satellite. Such broadband signals cannot now be transmitted directly by radio because the signals are blocked by the earth's curvature. The West Coast experimental location will be NASA's Jet Propulsion Laboratory tracking station at Goldstone, Calif. At the Homdel installation, a dish-shaped antenna will transmit the signals and the horn antenna will be the receiver.

A new tape recorder cleaner that the manufacturer guarantees not to affect plastic parts of tape recorders has been announced by Chemtronics, Inc. The new liquid cleans the play-record head, erase head, capstan and pressure rollers and tries to eliminate wow and tape squeal. The felt applicator has been specially designed to get into the critical parts and should not stain nor mar plastic parts of the tape recorder. Packaged in a 2-oz. bottle, the Chemtronics tape recorder cleaner with felt applicator is priced at \$1.49.



Build the Best Portable... **EICO**

6-TRANSISTOR RADIO RA-6

Kit \$29.95 Wired \$49.95

Easy creative fun to build... a lifetime of big-set entertainment wherever you go... designed so that even the novice can build it & obtain a handsome professional assembly & outstanding performance. American-made modern super-heterodyne all-transistor circuitry, plus finest quality parts throughout, assure you of highest durability & stability.

- high sensitivity & selectivity
- big-set volume & tone quality with 4" x 6" PM speaker & 250 mw push-pull audio output stage
- built-in Ferrite rod antenna for good reception in any location
- pre-aligned RF & IF transformers
- planetary vernier tuning (7:1 reduction) for easy station selection & tuning
- high-impedance earphone jack for private listening; eliminates drain of output stage when using earphone
- attractive tan leatherette case, retractable handle
- compact: 8 1/2" w, 4 1/2" h, 2 1/2" d. Only 3 lbs.

Build the BEST BUYS in "HAM" gear...



• U.S. Pat. No. D-184,776

90-WATT CW TRANSMITTER #720
Kit \$79.95 Wired \$119.95
"Ideal for veteran or novice" **ELECTRONIC RITS GUIDE**. "Top quality" **POPULAR ELECTRONICS**. "Well designed" **ELECTRONICS WORLD**. 80 thru 10 meters with one-knob band-switching. Full "clean" 90W input, 65W external plate mod. Matches loads 50 to 1000 ohms. May be used as basic exciter unit. TVI shielded. Tubes: 6146, 6CL6, 2-6AQ5, 6Z34. Attractive "living room" low-silhouette design. 15" w, 9" h, 9" d.



UNIVERSAL MODULATOR-DRIVER #730
Kit \$49.95 Wired \$79.95

Cover E-5 \$4.50
Delivers 50W undistorted audio. Modulates transmitters having r.f. inputs up to 100W. Unique over-modulation indicator. Output transformer matches 500-10,000 ohms. Low-level speech clipping & filtering. Inputs for steel or dynamic mikes, phone patch, etc. 7 tubes. 8" h, 14" w, 8" d.



GRID DIP METER #710
Kit \$29.95 Wired \$49.95

Includes complete set of coils for full band coverage. 400 kc-230 mc in 8 overlapping ranges. 500 ua meter. Plug-in coils are pre-wound, pre-calibrated to 0.5% accuracy. Transformer-operated power supply. 2 1/4" h, 2 3/4" w, 6 7/8" l.

Compare — judge for yourself! — at your neighborhood EICO distributor. For free catalog on 65 models of EICO test instruments, hi-fi & "ham" gear, fill out coupon on Page 28. Add 3% in the West.

ELECTRONIC INSTRUMENT CO., Inc., 33-00 N. Blvd., L. I. C. 1, N. Y.



Prepare now
IN SPARE TIME
AT HOME
for great opportunity
field of...

TELEVISION

The future is YOURS in
TELEVISION—RADIO—COLOR-TV!

A fabulous field—good pay—fascinating work—a prosperous future! Good jobs or independence in your own business!

Modern Training by Coyne
RIGHT IN YOUR OWN HOME

Coyne brings you the first truly lower cost, MODERN—QUALITY Television Home Training; training designed to meet Coyne standards. Not an old Radio Course with Television "tacked on." Here is MODERN TELEVISION TRAINING including RADIO, UHF and COLOR TV. No previous experience needed. Personal guidance by Coyne Staff.

The Institution Behind this Training

Famous for over a half century, COYNE occupies this entire building which is the new home of COYNE. COYNE'S modern resident training of men for Television, Radio, Electronics and Electricity has produced thousands of successful graduates.



B. W. COOKE, Jr., President



FOUNDED 1899

COYNE
ELECTRICAL SCHOOL

CHARTERED AS AN EDUCATIONAL INSTITUTION
 NOT FOR PROFIT

1501 W. Congress Parkway, Chicago 7, Dept. 10-H8

MAIL COUPON NOW FOR DETAILS FREE

LEARN TO
EARN IN SPARE TIME AT HOME

COYNE offers a most practical, Home Television Training. Easy to follow step-by-step instructions, fully illustrated with 2150 photos and diagrams. **Practical Job Guides** to show you how to do actual servicing jobs—make money early in course. Keep your present job while training.

Low Cost—Easy Terms

We save you money because we don't send you—AND CHARGE FOR—a long list of parts or "put together kits," which you may not want or do not need. With Coyne Television Home Training you pay only for your training, no costly extras.

Let us show you that this is not only the newest, most up-to-the-minute Training in Television—but also it costs you much less than other leading home training courses. Send coupon today for details including Easy Payment Plan.

SEND COUPON OR WRITE TO ADDRESS BELOW
FOR FREE BOOK

and full details, including Easy Payment Plan. No obligation, no salesman will call.



COYNE Television
 Home Training Division
 Dept. 10-H8 — New Coyne Building
 1501 W. Congress Parkway, Chicago 7, Illinois
 Send Free Book and details on Television Home Training. This does not obligate me in any way.

Name _____

Address _____

City _____ State _____

(It is understood no salesman will call.)

the experts say
your BEST BUY
 is **EICO**...

EICO, 33-00 Northern Blvd., L.I.C. 1, N.Y. E1-1
 Show me HOW TO SAVE 50% on 65 models of top-quality:

HI-FI TEST INSTRUMENTS "HAM" GEAR
 Send FREE catalog & name of neighborhood EICO dealer. Send free STEREO HI-FI Guide.

NAME.....

ADDRESS.....

CITY.....ZONE.....STATE.....

ADD 6% IN THE WEST

...in
STEREO and MONO HI-FI



STEREO Dual Amplifier-Preamplifier HF81
 Kit \$69.95. Wired \$109.95.
 "Excellent" — SATURDAY REVIEW: HI-FI MUSIC AT HOME.



Mono Preamplifier HF65A:
 Kit \$29.95. Wired \$44.95.
 With Power Supply HF65: Kit \$33.95. Wired \$49.95.



FM Tuner HFT90
 Kit \$39.95*. Wired \$65.95*.
 Cover \$3.95.
 "One of the best buys" AUDIOCRAFT.

*Less Cover, F.E.T. incl.

AM Tuner HFT94
 Kit \$39.95. Wired \$65.95, incl. Cover & F.E.T.
FM/AM Tuner HFT92
 Kit \$59.95. Wired \$94.95. Includes Cover & F.E.T.



STEREO Dual Preamplifier HF85
 Kit \$39.95. Wired \$64.95.
 "Extreme flexibility... a bargain" — HI-FI REVIEW



Mono Power Amplifiers (60, 50, 35, 30, 22, 14-Watt; use 2 for Stereo)
 from Kit \$23.50. Wired \$41.50.



2-Way Bookshelf Speaker System HFS1
 complete with factory-built cabinet: \$39.95.



70W STEREO Dual Power Amplifier HF87
 Kit \$74.95. Wired \$114.95



Mono Integrated Amplifiers: (50, 30, 20, 12-Watt; use 2 for Stereo)
 from Kit \$34.95. Wired \$57.95.



NEW! COMPLETE STEREO DUAL AMPLIFIER AF-4
 Kit \$38.95. Wired \$64.95.
 TRUE HI-FI quality to drive hi efficiency speakers to concert volume.

...and in
TEST INSTRUMENTS



New Power & Bias Supply for Transistorized Eqpt. #1020*
 Kit \$19.95. Wired \$27.95.
 * Patent Pending



Miniatrized Multi-Signal Tracer #145A
 Kit \$19.95. Wired \$28.95.



Vacuum Tube Voltmeter #221
 Kit \$25.95. Wired \$39.95.



Peak-to-Peak VTVM #232 & Uni-Probe (pat. pend.)
 Kit \$29.95. Wired \$49.95.



New TUBE and CRT FIL Tester #612
 Kit \$3.95. Wired \$5.95.
 Fast-checks radio/TV tubes, pilot lamps, etc.



1000 Ohms/Volt V-O-M.#536
 Kit \$12.90. Wired \$14.90.



5" Push-Pull Scope #425
 Kit \$44.95. Wired \$79.95.



DC-5 MC 5" Scope #460
 Kit \$79.95. Wired \$129.50.

Tube Tester #625
 Kit \$34.95. Wired \$49.95.



RF Signal Generator #324
 Kit \$26.95. Wired \$39.95.



Series/Parallel R-C Combination Box #1140
 Kit \$13.95. Wired \$19.95.
 1350 Combinations!



6V & 12V Battery Eliminator & Charger #1050
 Kit \$29.95. Wired \$38.95.
 Extra-filtered for transistor eqpt. #1060
 Kit \$38.95. Wired \$47.95



R-C Bridge & R-C-L Comparator #950B
 Kit \$19.95. Wired \$29.95.

IN STOCK! Compare, take them home — right "off the shelf" — from 2000 neighborhood dealers. Over 1 MILLION EICO instruments in use throughout the world.

© 1960, ELECTRONIC INSTRUMENT CO., INC., 33-00 N. BLVD., L.I.C. 1, N.Y.

See Page 26 for EICO'S BEST BUYS in "HAM" GEAR and TRANSISTOR RADIOS.



Money and controversy—
With electronics in the middle . . .

Off-Track Betting

By Harry Kursh

WHATEVER happens to off-track betting in New York City does not concern only New Yorkers. If and when the much-publicized off-track betting dream becomes a reality in the big city—and the wise-money boys are giving odds that soon it will—the results will surely be felt throughout the United States. Politicians the nation-over are just waiting for someone else to make the first move.

Why? In a word—taxes. There is scarcely a town or city that is not in need of new revenue. But more important, new “painless” forms of taxation are necessary. Taking money from bettors is always considered clinically harmless. But the problem is how to get enough people to bet so that the tax bite is worth the effort.

New York City officials, led by the almost desperate



Robert Owen

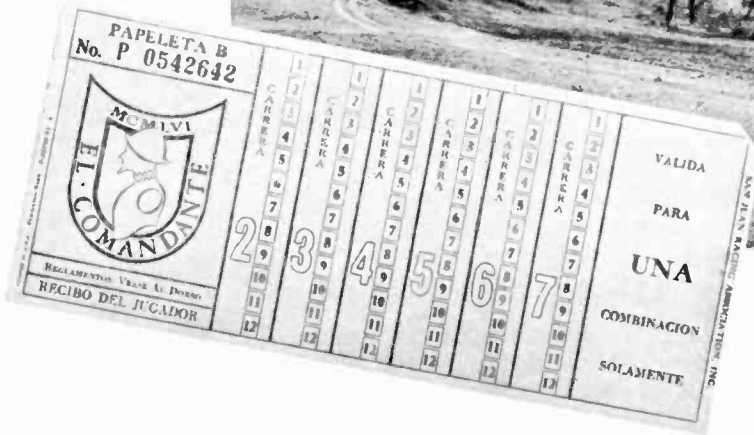
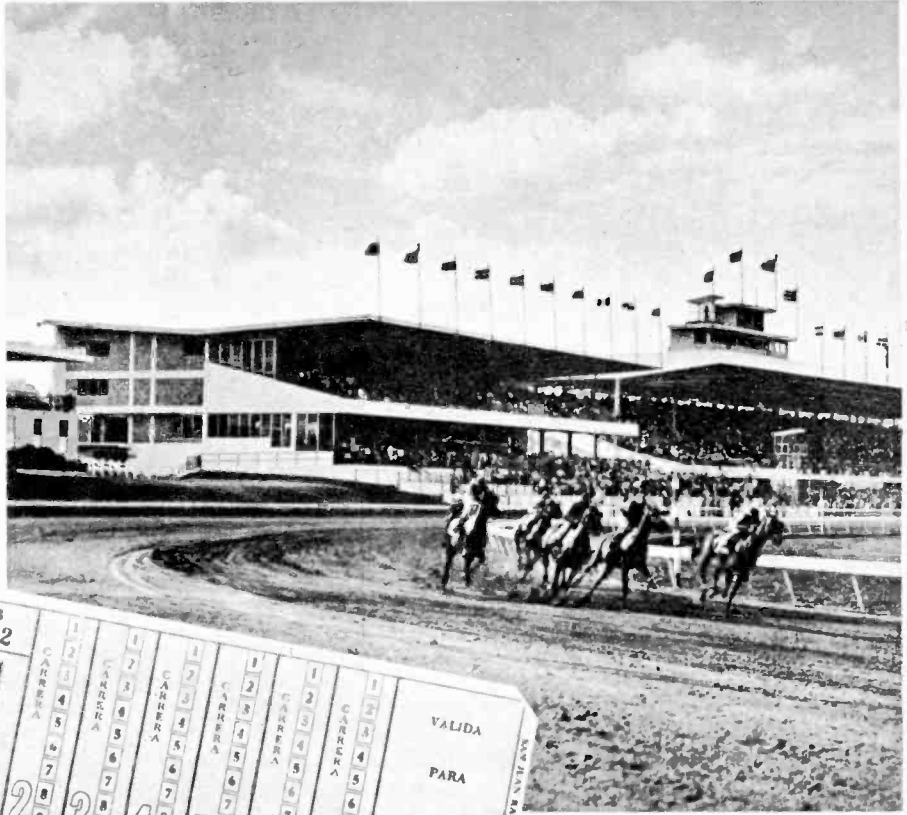

Above, clubhouse turn at El Comandante track in Puerto Rico. Thanks to electronics, persons can place bets miles away by means of computer punch cards, such as one at left.

Mayor Robert Wagner, say that the only way this can be done is to legalize off-track betting so that all those countless thousands who cannot get to the race-track window can put down an honest bet, receive an honest return (if lucky!), and let the city take an honest bite out of the transactions.

But then comes the most important question of all: How on earth can you keep tabs on thousands of bets made daily, not at one place, but at scores of different betting stations all over town? Then there is the problem of getting all the bets to the track before post time so that proper odds can be computed. As anyone who has ever seen a newsreel

knows, most betting is based on the pari-mutuel system. Under this system bets made at the track window are promptly fed into the famous Totalisator machines which electronically place the money into a pool and the odds on each horse are figured according to the amount in the pool divided by the number of bets on each horse.

Off-track betting, in effect, would be like exploding the pari-mutuel system all over town and then trying to gather in the debris. But New York City officials say it can be done—with electronics.

As a matter of fact, a committee of high-minded citizens, headed by the fa-

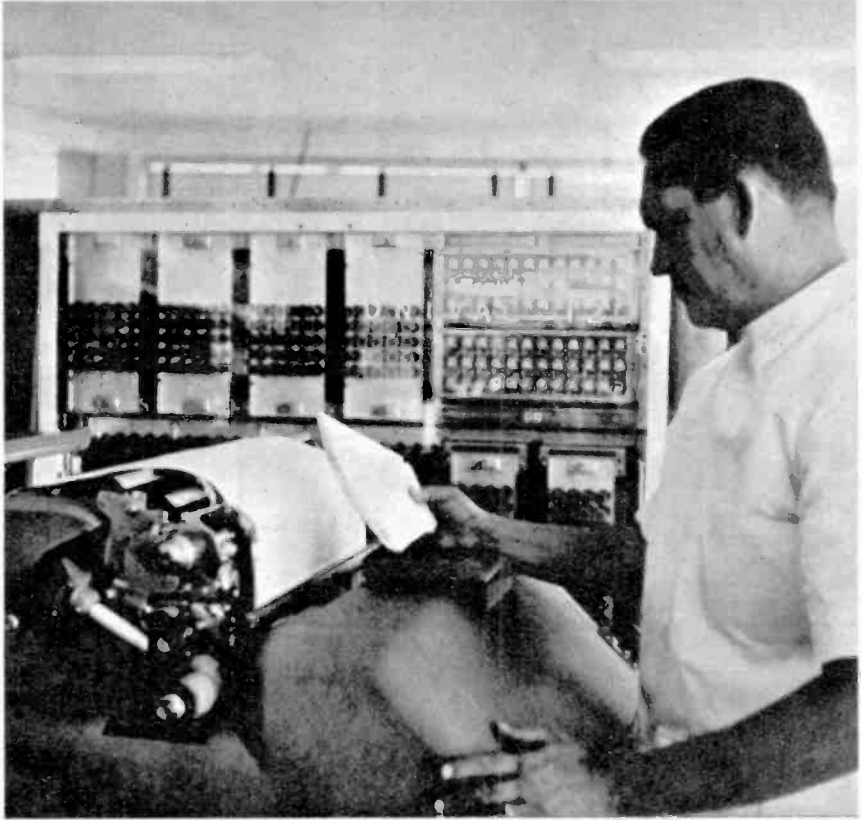

Bets from both on-track and off-track selling agencies are sorted, tabulated and recorded by Remington Rand Univac installation, which automatically figures odds and proper payoff. It also writes checks for those lucky off-track bet winners.

Amteller, now in use at Yonkers Raceway, is automatic ticket seller. Customer puts bill, face up, in money drawer, closes it and presses one of 12 buttons to indicate his choice. Photo-electric scanner certifies bill, issues pari-mutuel ticket.

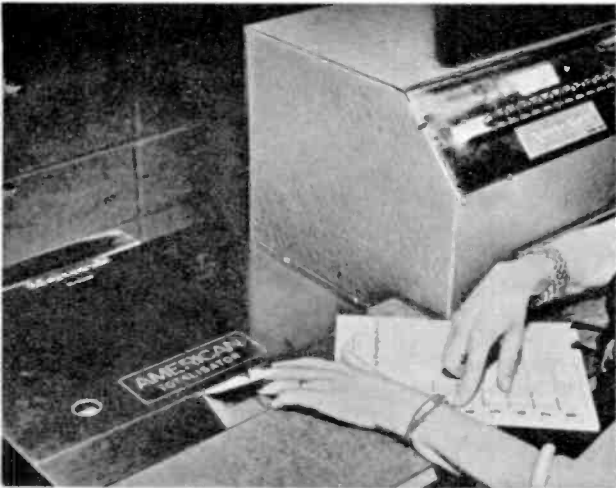

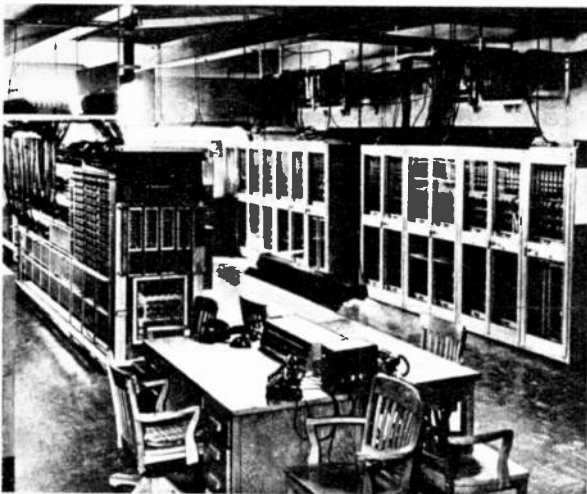

Most racetracks already have electronic set-up. Typical tote room, above, sorts wagering impulses from ticket issuers and routes them to win, place and show odds computers, (right), which constantly figure changing odds, send results to tote board on the track's infield.

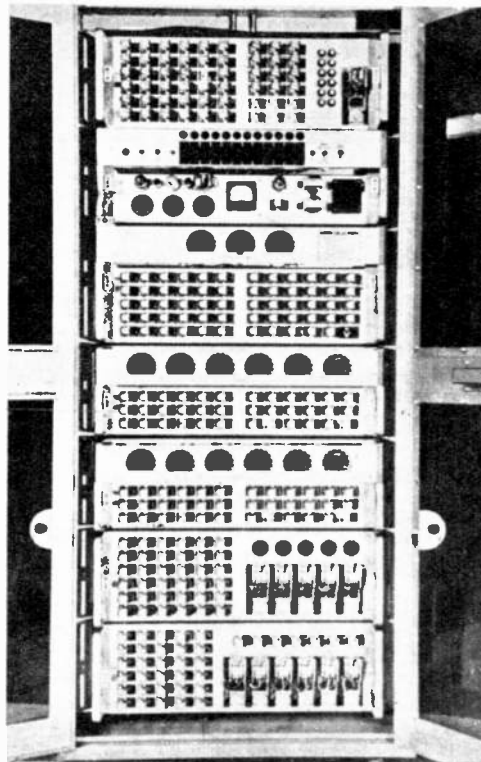

mous industrialist Robert W. Dowling, recently reported to Mayor Wagner, following a long study, that the entire off-track betting problem can be licked if the city would "utilize, to the greatest extent possible, advanced types of electronic equipment in order to insure efficient operation, and to promote public confidence in the integrity of the system."

Can it be done?

When *Electronics Illustrated* asked me to get the answers, I hopped a Trans Caribbean airliner for the only known place where electronics rules the roost in off-track betting, the El Comandante racetrack, an exquisitely modern gathering place for improvers of the breed, a few miles outside San Juan, Puerto Rico.

One of New York's most prominent officials, Commissioner of Correction Anna Kross, had recently paid an "unofficial" visit to El Comandante, although she is not a racing fan. Like myself, she spent all her time going over the electronic system and asking questions about how it works for off-track betting.

Actually, El Comandante has at-

tracted official representatives from nations all over the world. Relatively new, the track is considered one of the most efficient in the world. Its Univac installation alone cost more than \$1,000,000.

The electronic system is a model of simplicity, and it helps make racing and off-track betting a year-round sport in Puerto Rico. Although El Comandante is the only track on the island, it receives bets from nearly 300 different betting stations scattered in tiny stores throughout the island.

If you place a bet at any of these stations, your choice, and the amount of money supporting your choice, is recorded on a pre-printed punch-type card. You get a duplicate of the card (so that you can collect, if lucky). All the other cards are then rushed out to the track just before race time. Stations far distant from the track get their cards in by motorcycle messengers, even helicopters. This is one feature that probably would be modified in any installation in the Continental United States. Speedy, reliable electronic means of transmitting betting data to the track are available. Cards may even

[Continued on page 107]

new wrinkle in
Hi-Fi in Japan

HI-FI and stereo have hit Japan. Among other things, the new rage has created a whole new Tokyo district and actually changed drinking habits! The new hi-fi district is called Akihabara, where shop after shop features a full line of equipment at prices that would make Americans sit up and take notice.

Tea and coffee shops have given way to modern "music mills." Soft drinks, beer and coffee are served to customers, most of them young college students. As they sit and sip at their small tables, exceedingly elaborate hi-fi installations treat their ears to the recorded specialties of the house—classical, pops, chamber music, etc. There's no stompin' and no talkin'—just plain listenin', and perhaps a silent sip or two of coffee.

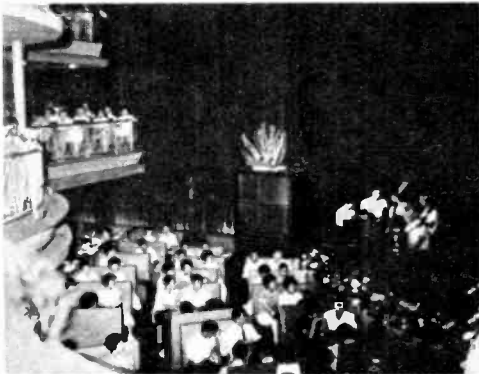

Above: American auto stops on Tokyo street in front of elaborate Kamikochi hi-fi hall.

Top left: Young people gather at New Mimatsu "music mill" to hear jazz combo perform "live."

Attendant at Kamikochi prepares to play a monophonic disc. Note tape deck, amplifier rig.

Street stalls, crowded stores featuring hi-fi gear are attraction of Akihabara district.

Earphone Echo Chamber

By Steven Hahn

This simple acoustic delay line will impart a three-dimensional quality to monophonic sound.



Phone plug, visible on top panel of unit, brings audio voltage from the amplifier's speaker terminals. Tubing carries sound to ears.

On panel, from left to right, are on-off switch, balance knobs and phone jack. Long rubber tubes with white tips act as earphones.

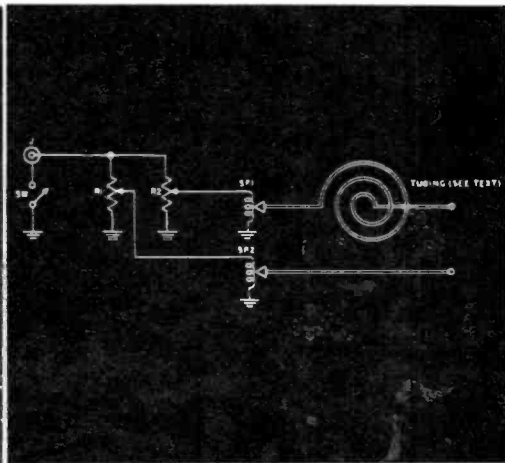
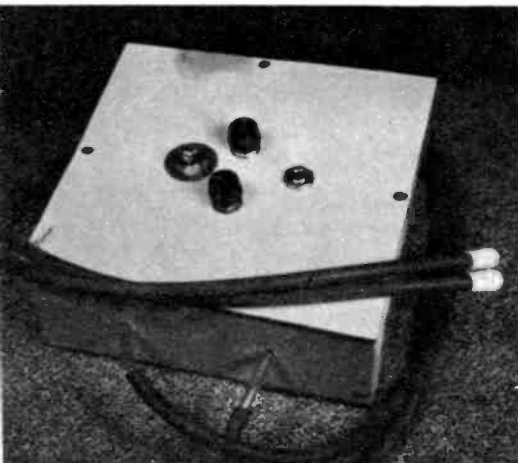

THE human ear is very sensitive to slight time delays. We can tell, for example, the differences in arrival time from as little as .00001 seconds. The unit described here is actually an acoustic delay line, not unlike the old speaking tube of the Victorian era. A monophonic signal is simply fed into a length of plastic tubing which serves as the delay line. One ear receives this signal while the other ear receives the original one, causing a remarkable sense of spaciousness to be imparted to the sound.

The actual delay line coil can be made of virtually any kind of tubing. The only critical dimension is the matter of the internal diameter and this should not be smaller than $\frac{3}{16}$ ". Generally speaking, the frequency response will become better as the internal diameter of the tubing increases. Of course, tubing in

excess of $\frac{1}{2}$ " internal diameter makes the delay line cumbersome and a very large box will have to be constructed to accommodate it. In testing various kinds of tubing, we obtained optimum results by utilizing a clear plastic tubing (approximately $\frac{3}{8}$ " outside diameter) which is easily obtained in any pet shop. The tubing is widely used for various tropical fish aquarium systems and sells for about 5¢-10¢ a foot. In the particular delay line described here, 20 ft. of tubing was used and this gives a delay

[Continued on page 111]

PARTS LIST

- R1,R2—15 ohm wirewound potentiometers 4 watt
- SW—SPST switch (optional)
- J—phone jack
- SP1,SP2—Magnetic earphones 15 to 128 ohms (Telex or equiv.)
- Misc.—plastic tubing (see text), cotton, wood cabinet approx. 7 $\frac{1}{4}$ "x6 $\frac{1}{4}$ "x2 $\frac{1}{2}$ "

Photo at right shows inside of unit. Sides of box are $\frac{1}{2}$ " wood. Top and bottom panels can be made of Masonite.

Wiring guide is below, schematic on facing page. Tubing in box is sandwiched between cotton to lessen vibration.

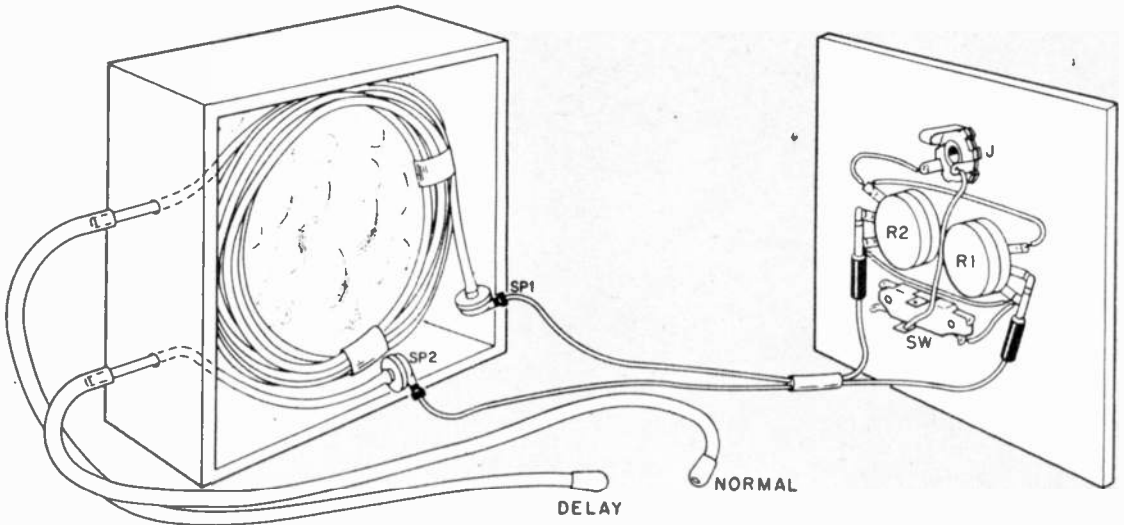
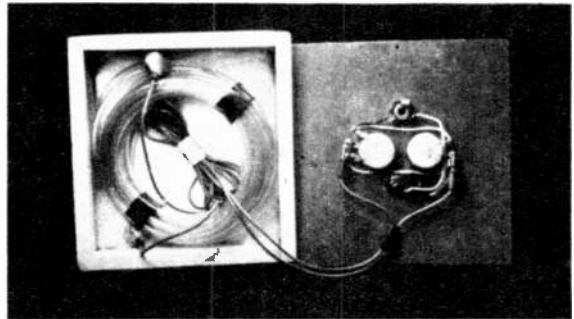

the E 1

Build-It Course 5

A factory-made "front end" simplifies construction of the FM tuner described in Part 5 of this series.

THE principles underlying the operation of the FM tuner bear close resemblance to the AM tuner described last month—except for an important difference. This occurs in the detector circuit, where the intelligence (voice or music) is recovered from the radio wave. Reference should be made, if necessary, to the superheterodyne, mixer and intermediate frequency circuits detailed in the article on AM. Here, we'll concentrate on how the FM detector works.

The practical side of this article will show how to build an operating FM tuner, simply constructed along the lines of the plug-in units featured throughout this series. Fortunately, a factory-made "front end" is available. It eliminates the difficulty a home constructor would encounter with this extremely critical section. No need for expensive test equipment or advanced techniques demanded by very high frequency equipment.

FM is frequency modulation, so-called because the intelligence varies the *frequency* of the radio carrier wave. This differs from AM, wherein the strength, or *amplitude*, of the carrier varies

FM tuner in foreground is shown unplugged from the other units covered in this series; power supply at top right, amplifier and preamp at left.



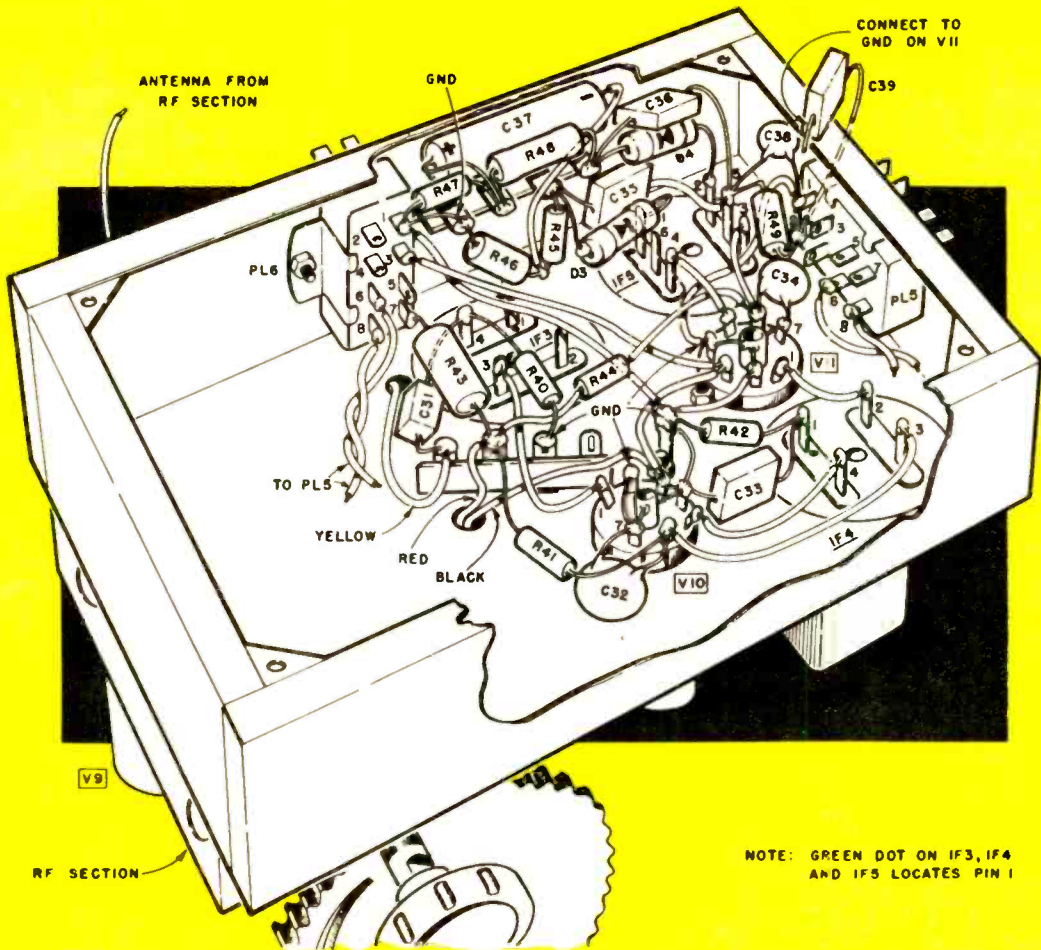

Components in the factory-made RF section, mounted on topside of chassis, are not shown.

Granco unit comes with dial and tuning shaft. IF, filament and B+ wires emerge from side.

Two holes could be drilled in chassis to align tuning unit, but it was found to be unnecessary.

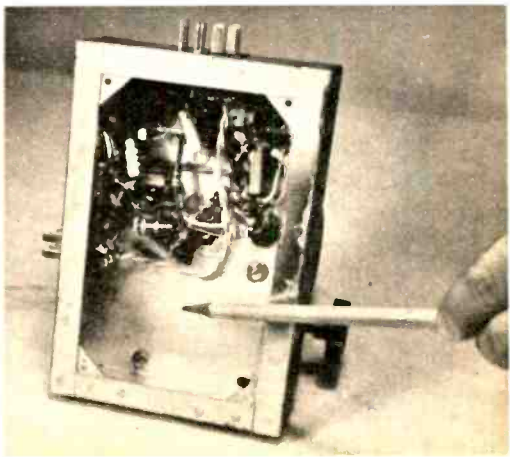
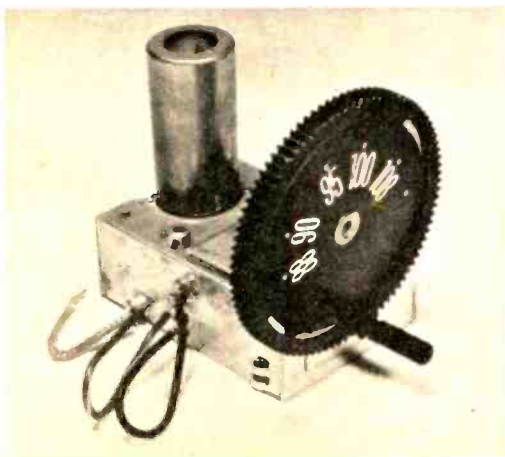

HOW THE FM TUNER WORKS

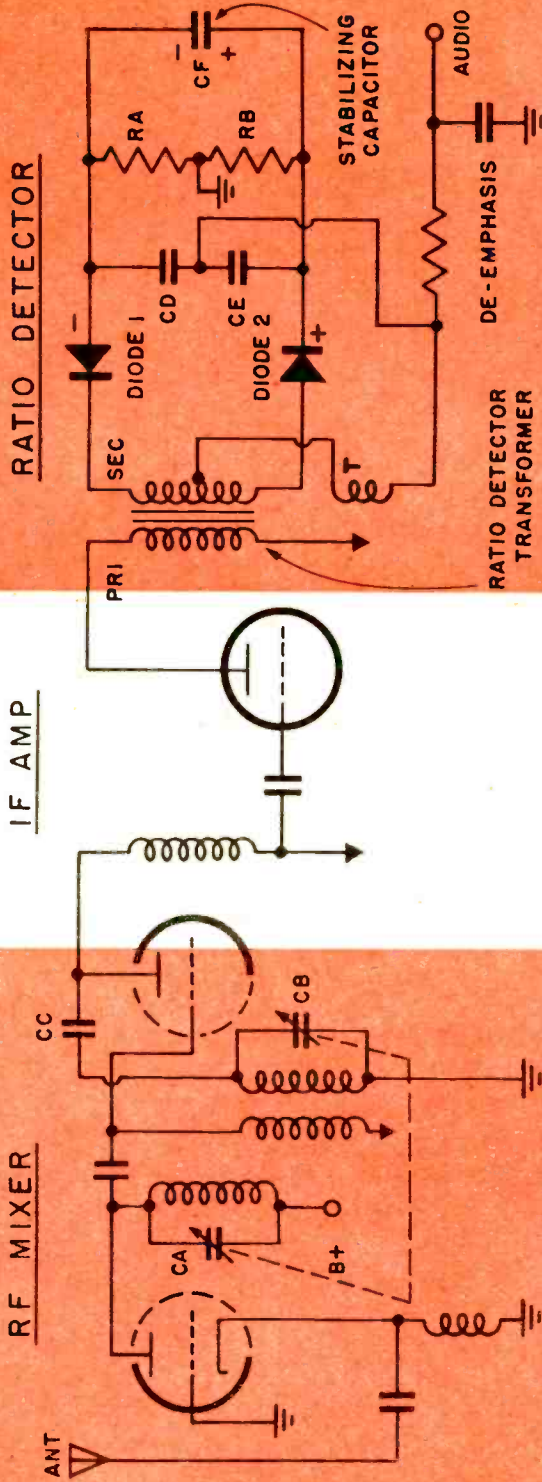

FM signals induce a voltage in the antenna which couples into cathode of the tube, not the control grid, as is customary. This is a grounded grid amplifier, useful at high frequencies to prevent oscillation caused by plate-to-grid feedback. Capacitor CA, across coil, selects station. It is ganged to CB, in the oscillator which always generates a signal 10.7 mc above the received signal. The signals mix in tube's 2nd half.

The intermediate frequency stage is tuned only to 10.7 mc by its input and output transformers. It picks up the difference between the oscillator and received frequencies (10.7 mc). Signal goes to the detector.

Signals from the primary winding are matched and coupled into the secondary by tertiary winding T. Since the secondary winding is a tuned, resonant circuit, the shifting frequency causes a changing voltage across the diodes. The ratio appearing at the junction of CD-CE, RA and RB act as the diode load resistors. Stabilizing capacitor CF, and the de-emphasis circuit are explained in the text. Audio output feeds amplifier.

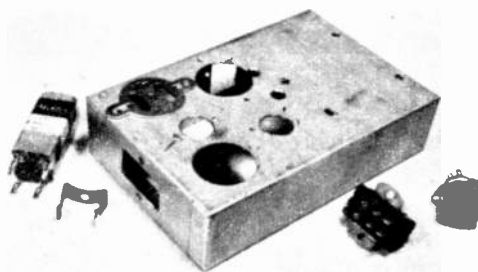

IF transformers mount on adapter plates bolted over octal-size holes (see upper left).

Granco unit is in dotted lines. A ground is established when bolted to main chassis.

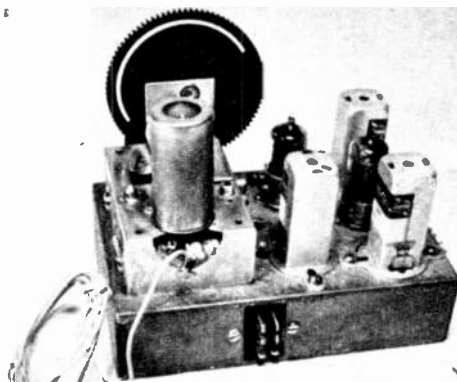

Antenna connects at rear, on tube socket lug.

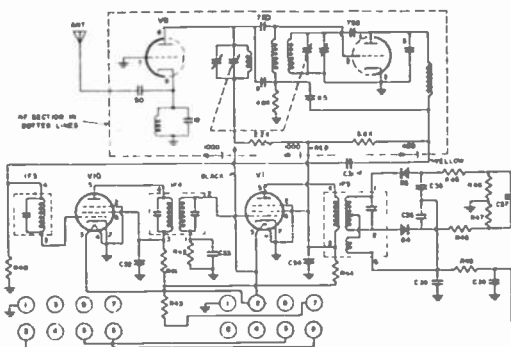

with the applied audio modulation.

Why use FM? The answer lies in the manner in which static acts on a radio wave. Atmospheric disturbances (lightning, for example) sharply change the strength of the carrier, leaving its frequency relatively unaffected. If the receiver is made immune to this, responding only to frequency changes, freedom from atmospherics is possible. The detector plays an important role here.

Before detailing detector operation, it is profitable first to reduce an FM signal to its basic components. The FM transmitter generates a radio wave somewhere in the 88 to 108 megacycle band. Assume that the assigned frequency is 100 mc. The carrier remains fixed at 100 mc during periods of silence—no modulation from microphone or recording.

[Continued on page 116]

PARTS LIST

(Part numbers continue from last month's project)

- C31—100 mmfd mica capacitor 500 volt
- C32—.0047 mfd disc ceramic capacitor 1000 volt
- C33, C39—.001 mica or ceramic capacitor 1000 volt
- C34—.0033 disc ceramic capacitor 1000 volt
- C35, C36—330 mmfd mica capacitor 500 volt
- C37—10 mfd electrolytic capacitor 25 volt
- C38—330 mmfd mica or disc ceramic capacitor 1000 volt
- R40—1 megohm resistor 1/2 watt
- R41, R44—330 ohm 1/2 watt
- R42—100,000 ohm resistor 1/2 watt
- R43—4700 ohm resistor 2 watt
- R45—1000 ohm resistor 1/2 watt
- R46, R47—6800 ohm resistor 1/2 watt
- R48—1500 ohm resistor 1/2 watt
- R49—68,000 ohm resistor 1/2 watt
- V9—6DT8 tube
- V10, V11—68A6 tube
- IF3, F4—FM IF transformer 10.7 mc (Miller 1463)
- IF5—FM ratio detector transformer 10.7 mc (Miller 1465)
- PL5, PL6—8-pin chassis mount plug (Cinch-Jones P308A)
- D3, D4—single 1N35 or two 1N34 crystal diodes
- RF Tuning Unit—Granco FM "front end" (Lafayette Radio, 165-08 Liberty Ave., Jamaica 33, N. Y. Hudson Radio, 48 W. 48th St., New York, N. Y.)
- Misc.—Aluminum chassis 4"x6"x1 1/2" (Premier ACH-436), two 7-pin tube sockets with center posts, two 4-lug terminal strips with one ground lug on each



spotlight on:

80-Meters

By C. M. Stanbury II

Each month we'll inspect a different amateur radio band to find out what's on it, how and when to use it, and explore the more interesting angles.

A COMBINATION of heavy static, plenty of QRM (man-made interference) and comparatively short transmission distances seem to add up to a dull band with few uses. But for those amateurs who use the 500 kilocycles between 3500-4000 kc known as the 75 and 80 meter bands, these conditions represent a challenge to be met, not ignored. The amateur has precious few frequencies and he is not ready to abandon any of them by default. As a matter of fact, the ham has found advantages in 75 and 80 meters and has lifted the band to the position of a vital cog in amateur radio activities. Further, some really skillful operators have even explored and worked DX down here.

What are these advantages? Actually there's just one big advantage, *reliability*. This band, like the others, does vary from day to day, or night to night. However, these changes are minor when compared to the higher short-wave frequencies. Its reliability means that the 80 meter band (75 included) is almost always open for short range communications (within 200 miles). Thus, a majority of message traffic handled through amateur radio eventually passes over 75 or 80 meters. Aside from formal messages, many new and old friendships can be carried on via radio because contact is more or less uninterrupted.

The 75 and 80 meter bands are just barely "short wave" bands, only 500 kc above the dividing line between high and medium frequencies. This results in severe absorption almost approaching that of the standard broadcast band. Like the BCB, static becomes a problem during the summer months.

Also, lower frequency means less skipping. Above 5 mc, signals frequently pass through the entire ionosphere into outer space making reception on earth impossible. This almost never happens below 5 mc, except during the early morning hours. Skip down here is usually caused by a signal passing through the E layer

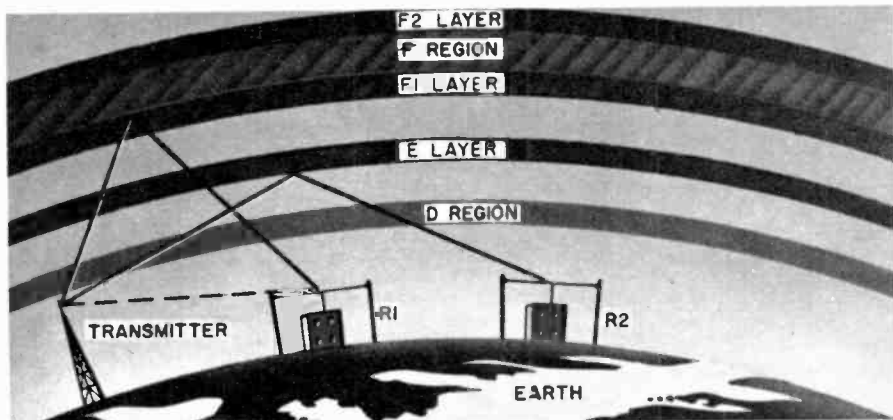

Density of ionosphere layer, frequency and angle of incidence determine reflection or refraction of signals. Daytime D region absorbs but does not reflect. E layer absorbs and reflects but grows weak during dark hours. F1 and F2 are good reflectors and combine at night into one layer. Below 7 mc, signals are partially absorbed when passing through a layer. A signal going through only the lower edge of a layer will be stronger than one passing through layer twice, but will not achieve as much distance.

Chart below courtesy Marconi's Wireless Telegraph Co., Ltd.

The entire usable radio spectrum is divided below into convenient categories and characteristics. Band discussed this month is in lower part of highlighted section.

Frequency Band	Range	Propagation Medium	Propagation Influences	Disturbances	Principal Services
VLF BELOW 30 Kc/s	LONG	GROUND D REGION	DIURNAL ABSORPTION	ATMOSPHERIC NOISE	COMMUNICATION NAVIGATION
LF 30-300 Kc/s	LONG MEDIUM	GROUND E REGION	DIURNAL ABSORPTION GROUND CONDUCTIVITY	ATMOSPHERIC AND MAN-MADE NOISE	COMMUNICATION BROADCASTING NAVIGATION
MF 300 Kc/s-3 Mc/s	MEDIUM SHORT	GROUND E REGION	DIURNAL ABSORPTION GROUND CONDUCTIVITY	ATMOSPHERIC AND MAN-MADE NOISE	BROADCASTING NAVIGATION COMMUNICATION
HF 3-30 Mc/s	LONG	E AND F REGIONS	SOLAR RADIATION SUNSPOT ACTIVITY	ATMOSPHERIC AND MAN-MADE NOISE IONOSPHERIC STORMS	COMMUNICATION BROADCASTING
VHF (LOWER) 30-300 Mc/s (HIGHER)	MEDIUM	IONOSPHERIC SCATTER	IONOSPHERIC TURBULENCE METEORS	ATMOSPHERIC, COSMIC AND MAN-MADE NOISE	COMMUNICATION
	SHORT	LOWER ATMOSPHERE	WEATHER	ATMOSPHERIC, COSMIC AND MAN-MADE NOISE	TELEVISION BROADCASTING RADAR NAVIGATION COMMUNICATION
	BEYOND HORIZON	TROPOSPHERIC SCATTER	CLIMATE	MAN-MADE NOISE WEATHER	COMMUNICATION
UHF 300-3000 Mc/s	LINE OF SIGHT	LOWER ATMOSPHERE	WEATHER	MAN-MADE AND SOLAR NOISE	COMMUNICATION RADAR NAVIGATION TELEVISION
	BEYOND HORIZON	TROPOSPHERIC SCATTER	CLIMATE	WEATHER MAN-MADE AND SOLAR NOISE	COMMUNICATION
SHF 3000-30,000 Mc/s	LINE OF SIGHT	LOWER ATMOSPHERE	WEATHER	SOLAR NOISE RAIN SCATTER	COMMUNICATION RADAR DOPPLER NAVIGATION
EHF ABOVE 30,000 Mc/s	LINE OF SIGHT	LOWER ATMOSPHERE	ATMOSPHERIC ABSORPTION WEATHER	RAINFALL FOG	SHORT RANGE RADAR

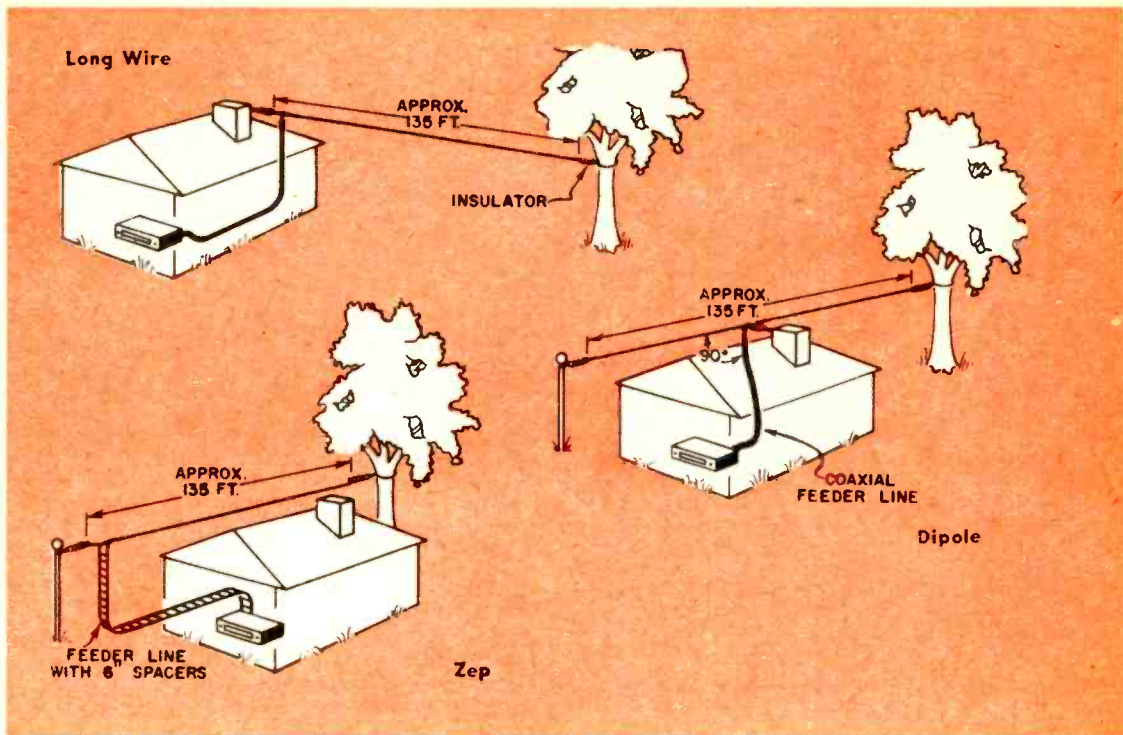

Common half wave antenna systems for use on 80 meters are drawn above. The 6-inch spacers on Zep feeder line aid in impedance matching.

Below is folded dipole installation which has plastic-covered "twin lead" stretched from TV pole to chimney. Should be longer for 80.

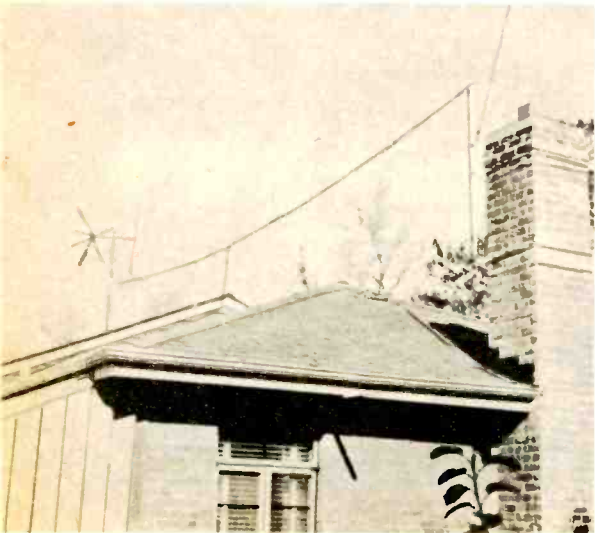

only, absorbed and weakened by it, then partially returned to earth by a higher layer.

We compared this frequency range to the BCB and we can do it again. Day-time distances achieved are almost the same, but 75 and 80 produce slightly stronger skywaves. However, the BCB offers much better ground wave. While the sun is up, both are equally effective transmission media. At night, of course, skywave becomes all important and it is only at night that any great distance can be reached below 7 mc. (Remember, night varies from one time zone to another).

Reliability does have one or two drawbacks. The 80 meter band is always crowded, and clear channels for a distant or low powered station are hard to find, especially on the smaller phone portion of the band (75 meters), since phone transmissions require a larger bandwidth than does CW (continuous wave-telegraphy). Also, when skip does occur, QRM tends to crowd the locals even moreso.

Because of the reliability of the "rag chewing" 80 meter band, many Novices start here between 3700 and 3750 kc. Limited to 75 watts, they know they will not need more power than that to maintain a contact and improve code speed, techniques.

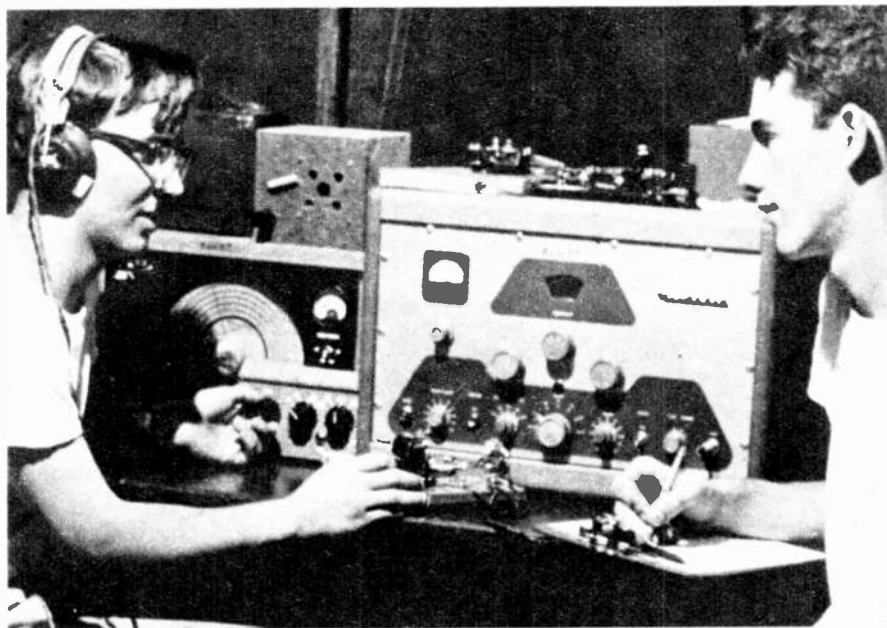

The frequency layout of the band is simple. That portion between 3800 and 4000 kc is assigned for phone (voice) use and has been designated by the ham "75" meters, while those frequencies below 3800 kc are called 80 meters and only CW operations are permitted by the FCC. In Canada, however, the amateur is permitted some phone on 80 meters. The novice may transmit between 3700 and 3750, but as usual he is limited to 75 watts. This limitation on power naturally leads the novice to the 80 meter band, where reliability almost assures him of a contact.

Due to space limitations faced by many hams, highly directional low frequency antennas are generally impractical. The most common antenna for this band is the single (or "long") wire, and in order to obtain any real directional effect, it would have to approach one wave length, somewhere in the neighborhood of 250 feet! In most cases a shorter wire is substituted with correct tuning achieved artificially via the feeder system.

As we've indicated, 75 and 80 are pri-

marily rag chewing bands, and some 70% of the activity at these lower frequencies is taken up with it. Next comes message handling, a privilege granted to amateurs in only a few countries. Fortunately the U.S. is one of them. If the message comes from abroad, (American servicemen overseas), it is usually sent first on 20, possibly 15 or 10 meters (to be discussed in future

[Continued on page 110]

The Popular Ham Bands

Frequency in Megacycles	Wavelength in Meters
3.5-4.0	80-75
7.0-7.3	40
14.0-14.35	20
21.0-21.45	15
28.0-29.7	10
50.0-54.0	6
144-148	2

Wavelength figures are useful because they offer idea of physical size of antenna elements, etc. The lower the frequency, the higher the wavelength. A meter is equivalent to 39.37".

Milt Kiver on

Oscilloscopes-3

Part three of this series explains how to use an oscilloscope for waveform display and calibration.

ONCE the purpose of the various controls on the front panel of an oscilloscope is known and understood, it becomes a relatively simple matter to apply the instrument successfully. Perhaps the best way of illustrating this is by an actual example of a commonplace application. Let us suppose that we wish to see the shape of the wave present at the grid of an audio amplifier. (An audio signal generator is injecting this signal at a prior stage.) The circuit of this amplifier is shown in Fig. 2.

The first step is to set up the oscilloscope correctly so that any applied signal will be seen in its true form. Toward this end the oscilloscope is turned on and permitted to heat up for about five minutes. During this preliminary heating period, the intensity control should be turned up until a dot or a trace is visible on the screen of the instrument. (If nothing appears on the screen, check the vertical and horizontal centering controls.) To obtain a straight-line trace, turn the horizontal selector switch to some arbitrary sweeping frequency, perhaps somewhere in the vicinity

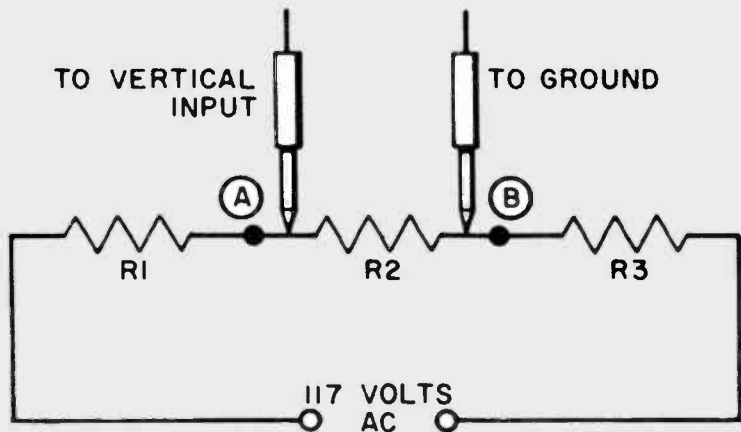

Fig. 1. Input probes of 'scope are shown across R2 for measurement. Don't touch case of 'scope, it could become "hot" from lead at point B.

of 1,000 cycles. The final setting of this control will be determined by two things—the frequency of the signal and the number of cycles of this signal that you wish on the screen. For example, if a 400-cycle note is to be viewed, the switch might initially be set to the 400-cycle range. However, if you want to see two cycles of this wave, the switch would be set to 200 cycles.

Once a trace is obtained, the horizontal gain control is adjusted until the trace covers as much of the screen horizontally as you wish it to, usually $\frac{3}{4}$'s of the full distance. At the same time, the vertical gain control is set to some mid-position so that any voltage which is applied to the input terminals will produce a noticeable vertical deflection on the screen.

The oscilloscope has now been set up in preliminary fashion and you are ready to bring in the voltage to be viewed. To do this, connect a lead from the ground terminal of the oscilloscope to the ground terminal of the amplifier circuit. Then, a second lead is connected

between the vertical input terminal and the grid of the tube shown in Fig. 2. The connecting point in the amplifier is at the top end of R1 at point A.

With the applied voltage coming into the instrument, observe the trace on the screen. If the pattern is too large, reduce the setting of the vertical gain control. If there is a vertical attenuator on the scope, this is adjusted to the setting which brings the pattern closest to the height you wish it to possess. Fine adjustments can then be made with the vertical gain control. If the pattern is not stationary, rotate the fine frequency control and the sync amp control until it does become stationary. At this point, there may not be as many cycles on the screen as you would like. To increase the number of cycles, decrease the sweeping frequency, each time readjusting the fine frequency control and the sync amp control until the pattern becomes stationary. To decrease the number of cycles on the screen, the reverse procedure would be followed.

After the voltage wave at the control

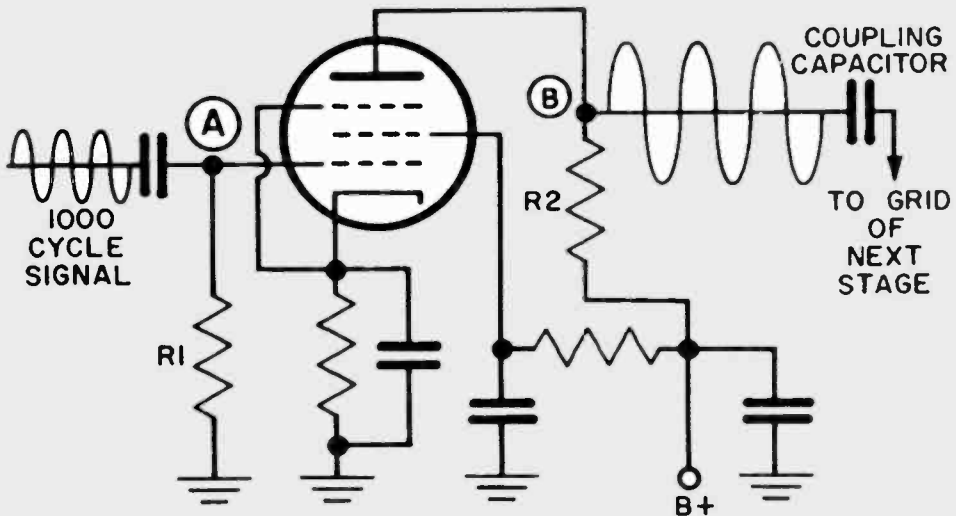

Fig. 2. typical audio amplifier. Vertical probe placed at point A will pick up the 1000 cycle input. Amplified waveform appears at point B.



Fig. 3. This 'scope has three controls for measuring peak-to-peak voltages. See text.

grid has been checked, you may wish to check the waveform at the plate of the tube. This would be point B in Fig. 2. The procedure is essentially the same as that employed at the grid despite the fairly high positive voltage that is present at point B. This voltage will have no effect on most oscilloscopes because a blocking capacitor is generally present between the vertical input terminal and the first vertical deflection amplifier. However, there are oscilloscopes which do not have such a capacitor and it is important to find this out *before* the unit is used in circuits where DC voltages are present. This information is found in the operating manual where a schematic diagram of the oscilloscope will almost always be present.

If you have any doubts at all about such a coupling capacitor, you can provide the necessary protection yourself by inserting a 0.1 mfd capacitor between the test lead and the vertical input terminal of the oscilloscope. This will protect the instrument if there is no internal DC blocking capacitor and it will not introduce any noticeable effect if

there is such a capacitor. The ground terminal of the oscilloscope still connects to the chassis of the circuit being checked.

Instead of actually bringing the oscilloscope leads into the plate circuit of an amplifier, you can usually check the waveform at the grid of the following stage. The only thing between the plate of one stage and the grid of the following is a coupling capacitor and the wave of a signal passing through should not be affected by this capacitor if the circuit is operating normally. However, suppose you find that there is no signal at the next grid. In this case, it might be desirable to go back to the plate of the preceding tube to check the waveform here. If, now, you do find a signal, then it indicates the intervening coupling capacitor is defective.

In the use of an oscilloscope, it is well to remember that the vertical deflection amplifier system possesses a certain bandwidth. This may extend as high as 5 or 10 megacycles, although usually it is considerably less. Thus, you can only display signals having frequencies up to

the point where the vertical amplifier system response begins to fall off. Above this frequency, you will either see nothing on the screen because the signal will be unable to pass through the vertical system or what you do see may be attenuated or distorted. Therefore, when you get an oscilloscope, always become familiar with its vertical bandpass so that you know up to what frequency it will provide suitable indications. The vertical bandwidth of most moderately-priced oscilloscopes extends to about 1 megacycle. This enables the unit to be used directly in audio systems and to some extent in video amplifiers. It can not be used at the front end of radio or television receivers.

Sometimes you may want to use an oscilloscope to check the waveform across a component, neither end of which is either at AC or DC ground. Such a situation is illustrated in Fig. 1. Here we wish to display the wave present across resistor R2. Note that neither end of this resistor connects to ground. To connect the oscilloscope, run a lead

from the vertical input terminal to point A. No isolating capacitor is required because there is only AC in the circuit, no DC. (If DC is present, such a capacitor would be required, either in the oscilloscope or in the connecting lead.) For the second connection, to point B, a wire would go from here to the ground terminal of the oscilloscope. An isolating capacitor would serve no purpose in this circuit since there is no DC present and AC must pass through the capacitor in order to complete the circuit at the oscilloscope. Note, however, that because of this, the oscilloscope cabinet will be "hot" and care must be taken to avoid either coming in contact with the cabinet or accidentally grounding it through physical contact with any conduit pipes or other metallic surfaces on the bench. The latter precaution is necessary because one end of the 117-volt AC line is grounded.

Aside from the observation of voltage and current waveforms, the oscilloscope can also be used to measure the peak-to-
[Continued on page 104]



Fig. 4. A 1 volt peak-to-peak calibrating voltage is supplied by a terminal at lower left. It is the third post from the edge.

How to Buy a Hi-Fi Tape Recorder

How should you choose a tape recorder? Here are a few simple tests you can perform before you buy.

THERE are some *audiophilus humanus* among us that believe you might just as well forget about buying a high fidelity tape machine unless you are prepared and willing to dole out in excess of \$500, "Because you just can't get 'real hi-fi' from anything less than professional gear."

Then again, there are certain manufacturers and many discount-house salesmen who will tell you that just about anything with two reels (and some now with only one reel!) is "honest-to-goodness hi-fi."

The truth probably lies somewhere in between. For many listeners with less than perfect ears, the super-fidelity of professional equipment would be wasted, while some of the lesser instruments profusely labeled "HI-FI" tend to sound terrible no matter who listens to them.

Startling effects can be had through stereo earphones, but you would be wise to appraise machine through hi-fi speaker. Magnecordette is shown.





Recording from radio or friends' discs is good way to build tape library. Units such as Ampex 960 (over \$500) mix in microphone talk when dubbing LP discs.



Webcor model 2001 is popularly priced monophonic portable, one of several models. Head is dual track, indicator is "magic eye."

Norelco model EL3536 stereo record and playback unit features four tracks and three speeds. It is priced at \$399.95.





Bell Sound has reel-to-reel tape cartridge players in production, six models of which range in price from \$99.95 to \$299.95.

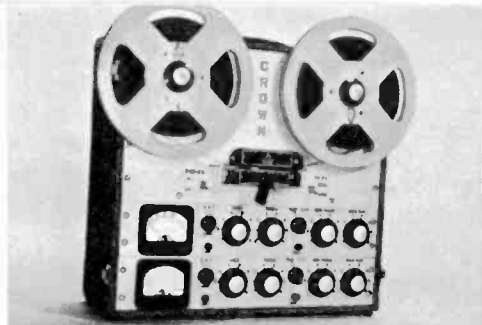

Crown's GCSX is deluxe stereo unit that plays vertically and horizontally. This unit has meters and multichannel input mixing.



Knight-kit 4050 tape recorder above is monophonic unit priced at \$99.50. Here music is taped off the air directly from AM-FM tuner.

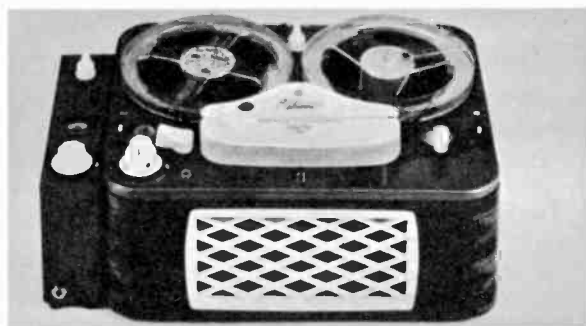

Tandberg tape recorder above is equipped with an outboard stereo recording adapter with second channel tuning eye and control.

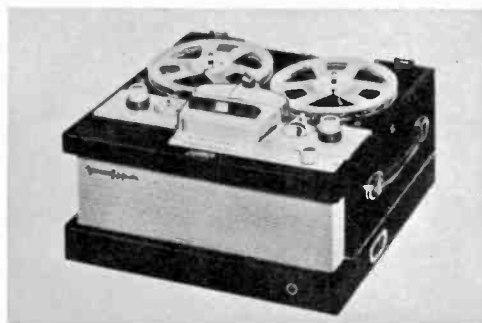

V-M model 710A, right, is fairly inexpensive monophonic unit. There are other V-M models that are designed for stereo reproduction.

Let's get one thing straight right now: If a tape recorder can't play back and/or record the complete hearable range of *music* in a natural manner, it isn't high fidelity. This rules out just about all "special purpose" machines that are primarily designed for dictating or carrying around in your hip pocket.

Later in this article we're going to suggest a few simple tests that will help

you store-evaluate a tape recorder. But first, what kind of tape machine is for you?

Let's assume the main reason you want a tape recorder is to listen to music. There may be other reasons, such as to record the children's (or your own) parties, record lectures, or what have you. These "fringe benefits," of course, will all figure into your selection of a tape recorder. But remember, if it's

high fidelity music you're primarily after, the main question is, "How well does this machine reproduce sound?"

Another big question is stereo. First of all you have to decide whether you want stereo at all. We strongly advise that you get a machine that at least plays back stereophonic tape, or one that later can be converted to stereo by the introduction of a stereo head assembly. True, there are many fine monophonic tapes on the market, and chances are that if you record off the air, you'll be recording monophonically. But let's face it: Pre-recorded stereo tapes at present outsell mono ones.

Revere makes several models including a stereo tape deck. At right is T-1120, with dual in-line channels selling for \$199.50.

Wollensak 1600 is monophonic version of their model 1616, which is stereo and costs about \$30 more. List price on model 1600: \$249.50.

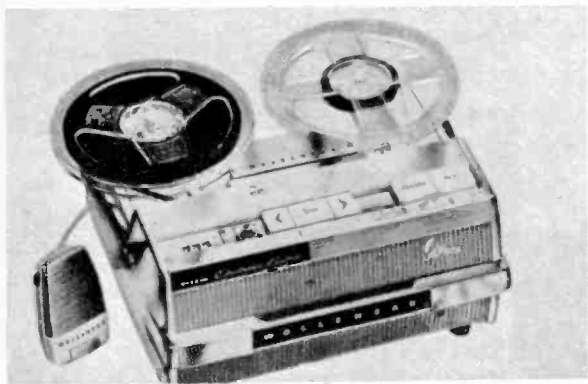

Concertone's model 505, below, lists for \$495 and features instant monitoring off the tape while recording is in progress.

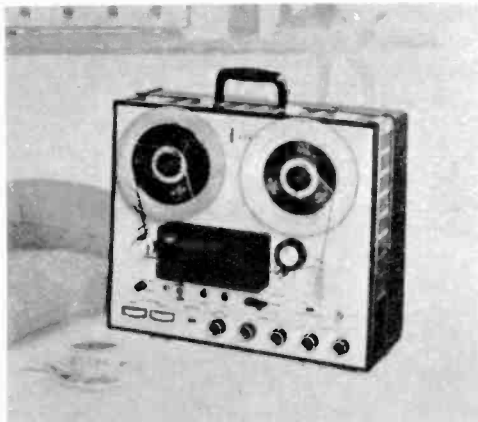

Speaking of stereo, you will have to decide between two- and four-track stereo. Both are on the market, four-track being relatively new, yet catching up fast. The fidelity of four-track tape is certainly good, but experts agree that it is not quite so good as two-track.

But it is our prediction that four-track will eventually be the accepted form for stereo on tape, and we base this opinion on cold economic analysis: You can get more music (twice as much, as a matter of fact), from four-track.

The problem of deciding between
[Continued on page 114]



Stereophonic Magnecordette has side-by-side VU meters for ease of balancing both stereo channels. It is in the semi-professional class.

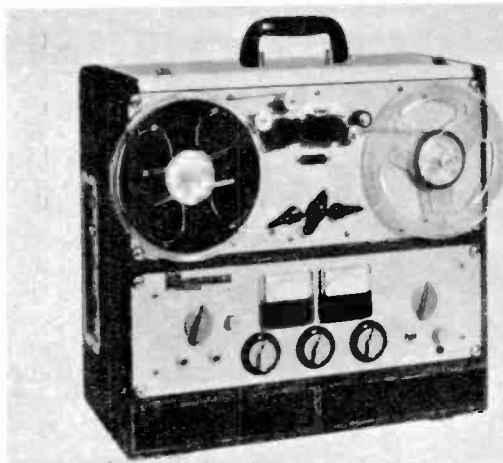



Test equipment—and advice—are available to all away-from-home kit builders.



Here audio signal is fed through a hi-fi amplifier and observed on oscilloscope.

Photos by Myron B. Gubitz



Women are not infrequent visitors to the workshop. Interest in hi-fi kits seems to transcend the sexes.

At right, an RF signal is generated for a tuner that has been completed by junior high school student.



When Kit Builders Get Together

NEW YORK'S Greenwich Village is famous for the "unusual," and The Audio Workshop definitely falls into this category. It's a place where just about anybody who wants to build a kit can rent workbench, soldering iron, nut drivers, etc., for a total of \$1.00 per hour. Use of scopes, meters, audio and RF signal generators is on the house—as well as plenty of expert advice.

The workshop idea was dreamed up by Dave Muirhead and Elliot Gordon, two experienced audio men, who rented a loft at 732 Broadway and parlayed it into a kit builder's home away from home. Habitués include attorneys, mailmen, a concert violinist and a lady psychologist—kit builders all. —

E I kit report on **A Stereo Tape Recorder**

Assembly time was low and the resulting unit is first rate—and you can learn how it works too!

The tape deck assembled is ready to go into hi-fi cabinet. It contains two preamps for stereo playback and note meter for volume level and bias adjustments.

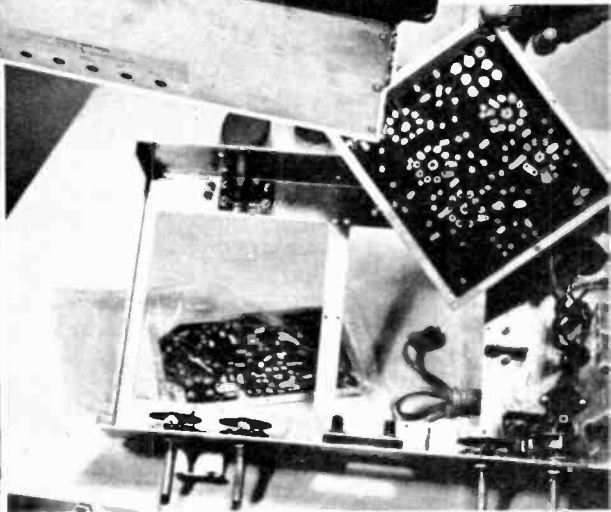

The photo at left shows the various parts comprising the kit. The tape deck with motor is at upper right; a reel of tape is furnished. Two printed wiring boards simplify assembly. Hand holds playback board in photo at right.

THE Heathkit TR-1D is part of a significant trend currently developing in the kit field. It offers the hi-fi enthusiast an opportunity to not only solder electronic components in place—but to participate in mechanical aspects as well. It hasn't quite reached the point where you wind your own motor, though the builder of this tape recorder is called upon to mount the tape head assembly,

Underside of electronic chassis, circuit boards in place. Holes at bottom are for adjustments.

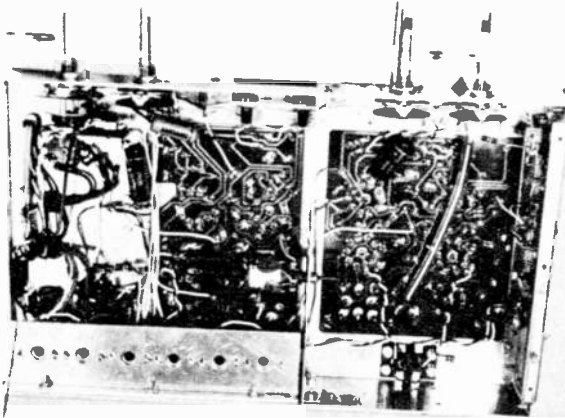

All components mounted on top side of preamp chassis with the power supply unit at the left.

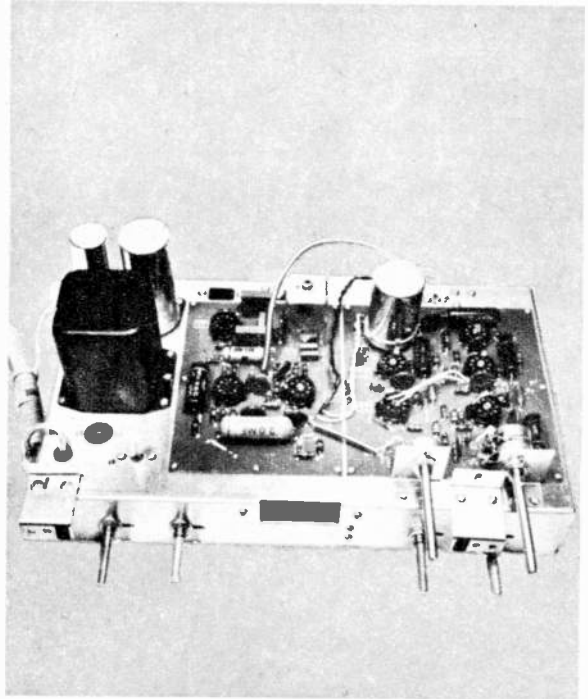

install the footage counter and other accessories. More important is the working knowledge the builder can acquire of his instrument.

The TR-1D is designed to operate into an existing hi-fi system. It has no power amplifiers or speakers and no case—the recorder is intended for installation in the same cabinetry that houses the rest of the hi-fi system.

The electronics portion of the unit is capable of several functions. It will record monophonic program material on half-track. It will not record stereophonically since it contains just a single recording channel. But, “in-line” stereo tapes may be played back. Two separate playback preamplifiers permit this function.

A truly professional feature is the VU (volume unit) meter. It measures record and playback levels with greater accuracy than a neon bulb or “magic eye” tube. Of equal importance is that recording bias is adjusted and measured with its aid. Bias is a signal fed to the

recording head to supply a “reference” point about which the program signal fluctuates. Distortion and loss of high frequency response result if the bias is not set properly.

Construction time for the kit totaled about 17 hours. This would be considerably lengthened were it not for the two printed circuit boards.

Excess solder will build up bridges between the foil conductors and cause short circuits. As each board is completed, examine it closely under a bright light for any such defects.

Joining the tape transport mechanism to the electronic chassis is a simple matter. One precaution though—be certain that the AC leads from the motor cannot become snarled in the spinning fan blades. Some judicious bending of the wires will prevent a mishap.

Listening tests with the TR-1D reveals it a Good Buy at \$169.95. The speed changing mechanism is positive and effective and there was no perceptible wow or flutter. ♪

Two large brackets support tape deck on electronic chassis. The twisted wire between the brackets feeds the pilot lamp on deck.

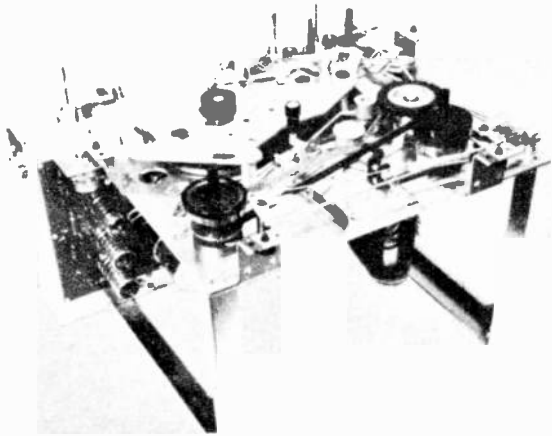
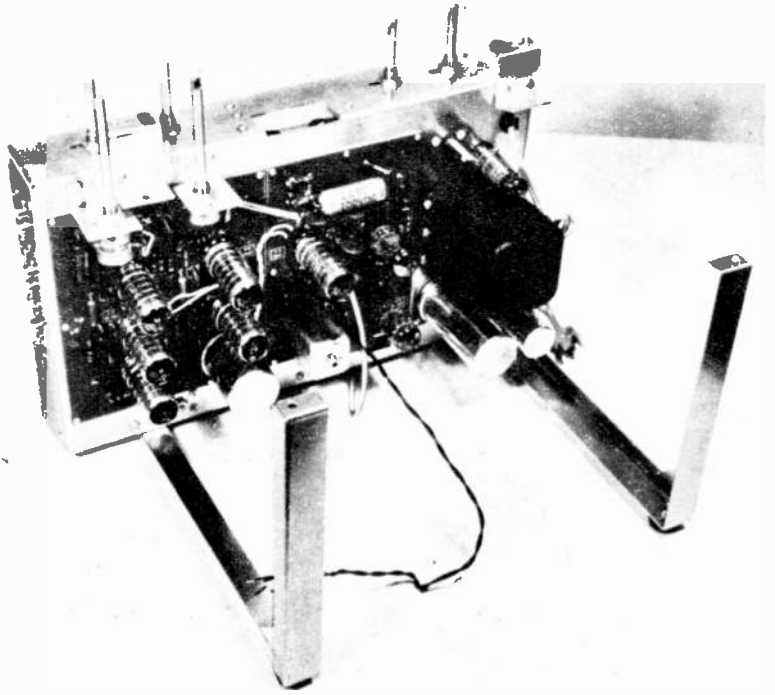

Tape deck bolted to electronic chassis forms a compact sturdy assembly, readily accessible.

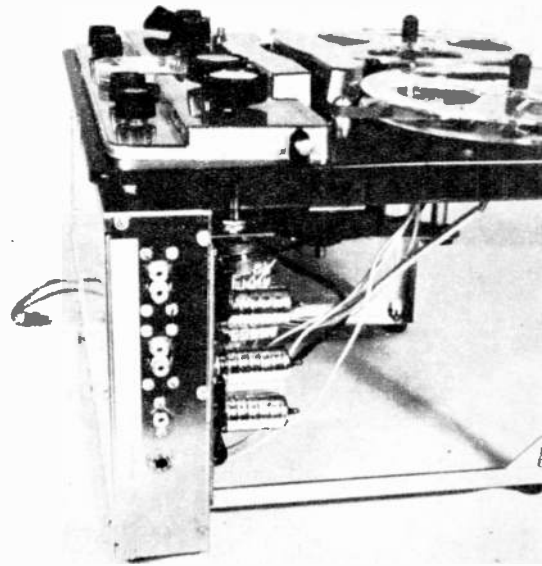

The addition of top trim and escutcheon plate completes assembly. No e input & output jacks.

EI'S Hi-Fi Doctor . . .

The Small-Stylus Myth

Some time ago a phono pickup manufacturer came up with the discovery that microgroove records were best played with the wrong-sized stylus. The New Idea involved the use of a 0.7- or 0.5-mil stylus on discs cut for a 1-mil stylus, and the extent to which it caught on is evidenced by the number of pickup manufacturers who now supply all of their pickups with these styli.

The purpose of the undersized stylus is to minimize what is known as pinch effect, which stems from the fact that records are cut with a triangular stylus. When the groove swings rapidly to one side in response to a particularly intense sound, the angle between the straight

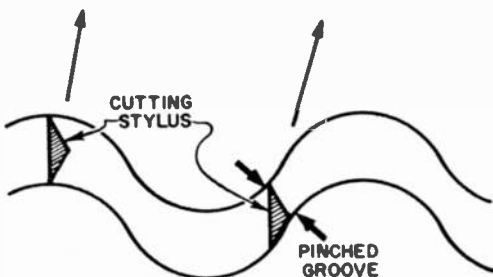
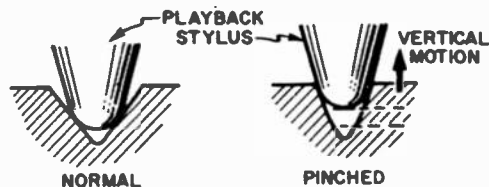

walls of the groove diminishes (see drawing). This tends to force the hemispherical stylus tip farther up the groove walls, and the resulting vertical motion is reproduced as distortion. It was reasoned that a smaller playback stylus would react less vigorously when the groove pinched in, and it *did* make many pickup cartridges sound better. But there has always been a far better way of making any pickup sound cleaner, without resorting to subsized styli.

The same pickup designers who started the small-stylus craze could prove mathematically that their monophonic pickup stylus had enough vertical flexibility (vertical compliance) to cope with the small up-and-down motions of pinch effect. Yet their most expensive mono pickup, with a 1-mil stylus, sounded dreadful in the inner grooves of loudly-cut discs, whereas competing 1-mil pickups—no smoother in response, *but having plenty of vertical compliance*—traced the same grooves with no trouble at all.

This was the secret of the small stylus; it cleans up the sound of cartridges which lacked adequate vertical compliance. But its side effects are so bad that we must, in perspective, wonder whether this wasn't a giant step backward.

The walls of a groove are flat where they contact the stylus, and the stylus is hemispherical, so the stylus should *in theory* touch the groove walls only at two tiny points. In practice, however, there is a certain amount of elasticity in the groove walls, so the two contact points are actually small contact areas.

When we reduce the size of a stylus tip from 1-mil radius to, say, 0.7 mils, the contact area decreases and thus the *pressure* per unit area *increases* drastically. The effect is the same as *doubling* the tracking force of the pickup, and what this does to record and stylus wear need not be pointed out.

Couldn't we just reduce the pickup's tracking force to half its previous value? No, we can't, because a cartridge's minimum tracking force is a function of the compliance and moving mass of its stylus. Reducing its force would simply make it distort more readily on loudly-recorded discs. It would be easier to stick with the old 1-mil stylus and just run the pickup at twice its recommended tracking force.

Hi-fi questions are all answered by mail. If of general interest, they will appear in this column.

There's another less-than-desirable characteristic of the small stylus, too. Any pickup stylus, unless damped, tends to resonate with the vinylite of the record groove at some high frequency, causing a response peak. Many pickups, inherently deficient in high-frequency response, use this peak to maintain flat response to beyond audibility. But if a small stylus is installed, the increased contact pressure with the groove walls lowers this resonance frequency, dropping the pickup's high-frequency peak to well within the audible range. This accounts for the common observation that a small stylus gives "more highs." It does; it exaggerates them.

Small styli are an evasion of the tracking problem, not a solution to it. Their detrimental effects far outweigh their advantages, yet the 0.7-mil stylus has been adopted as the standard size for stereo disc reproduction. And *this* at a time when most pickup manufacturers are going crazy trying to get the peaks out of their stereo cartridges. No wonder stereo discs never sound quite as smooth as monophonic ones!

Stereo Disc Compatibility

Can a stereo record be played on a conventional monophonic phonograph? Or vice versa? How compatible are these stereo discs, anyway?

Alan Lind, Laurelton, N. Y.

Stereo equipment is compatible, but stereo discs are not. A stereo record played on a conventional phonograph will be badly damaged if not completely ruined. However, a monophonic disc can be played on a stereo phonograph with full fidelity and without damage.

The reason is that a stereo groove, as well as wiggling from side to side (like a mono groove), also moves up and down, varying in depth. A stereo pickup cartridge is, of course, designed with enough vertical compliance to cope with

these undulations, so it can track with equal ease a stereo disc or a monophonic disc. A mono pickup, on the other hand, does not need to, and is not designed to trace vertical groove modulations. So while it can handle mono discs with the requisite gentleness, its inability to give with the vertical movements of a stereo groove results in rapid abrasion of the disc.

The Law of the Ohm

A power outlet at the rear of my amplifier provides 300 volts of B+ supply at a current of 10 millamps. The device I wish to power from this calls for 250 volts at 10 ma. What value of series resistor will be required, and what should its power rating be?

John McClain, Chester, Va.

Current, voltage, resistance in a circuit can be determined (as long as two of the terms are known) by applying Ohm's law. This states that voltage (E) equals current (I, expressed in Amps) multiplied by resistance (R, in ohms).

In this case, resistance is the unknown value, so:

$$R = \frac{E}{I}$$

In all Ohm's law calculations, the voltage term E (short for Electro-Motive Force, which is the same thing) represents the *difference* in voltage between the two ends of the resistance. Thus:

$$R = \frac{50}{10/1,000}$$

$$\text{which is } R = \frac{50}{1} \times \frac{1,000}{10}$$

$$\text{or, } R = 5,000 \text{ ohms.}$$

The formula for power is $P = IE$;

$$P = \frac{10}{1,000} \text{ Amp} \times 50 \text{ v.}$$

which comes out to $P = \frac{1}{2}$ watt. This is dangerously close to the actual rating of a standard value of resistor, so a 1-watt type would be a safer choice. —

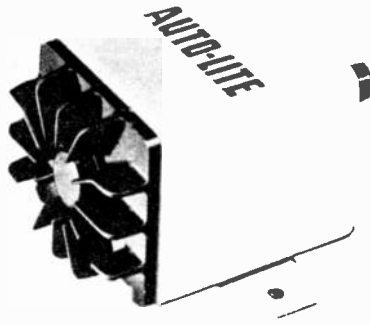

Here is a combined ignition coil and transistor triggering unit. The heat sink is designed to dissipate the little heat generated by power transistor.

the lowdown on

Transistor Car Ignition

By Simon Dresner

First "perfect" ignition system: How it works and what it will do for you, the American motorist.

HOW would you like to have a complete ignition system which is absolutely dependable for at least 100,000 miles, which gives immediate starting in sub-zero cold or 100°-plus desert heat, and which provides a constant super-hot spark with perfect timing at all engine speeds?

In other words, how would you like to have an ignition system which will need no repair or adjustment [*Continued on page 120*]

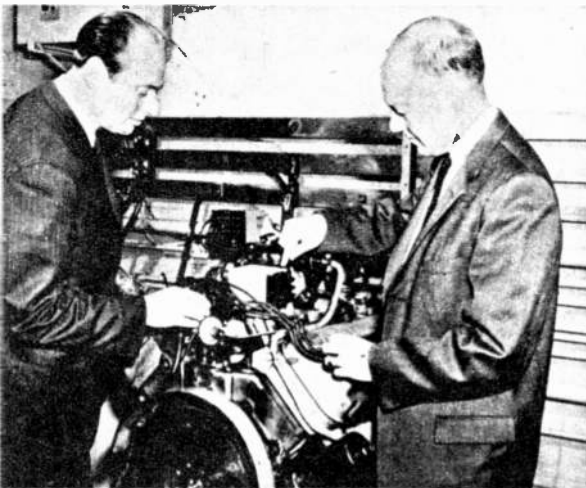

Auto-Lite transistorized system is tested on industrial engine in lab. Thousands of hours operation did not inhibit unit's performance.

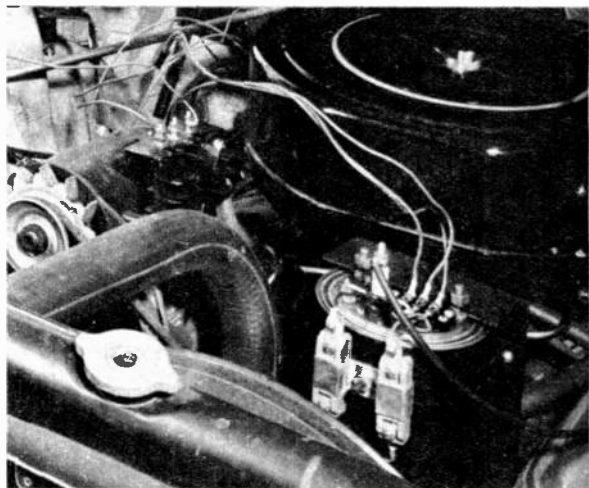

Prototype model of transistorized ignition is mounted in car, replacing conventional condenser. Makes for fast starting in cold weather.

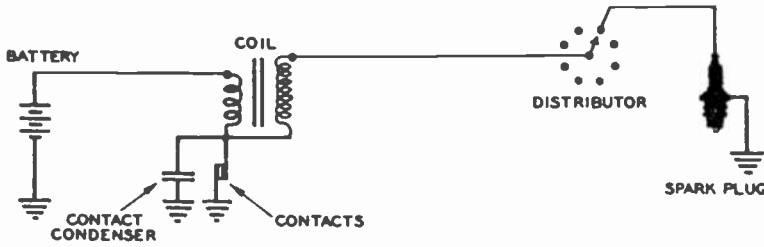

CONVENTIONAL IGNITION CIRCUIT

The big difference between conventional and transistorized ignition circuits is that the distributor contact points, instead of carrying five-plus amps, will carry only one-quarter ampere.

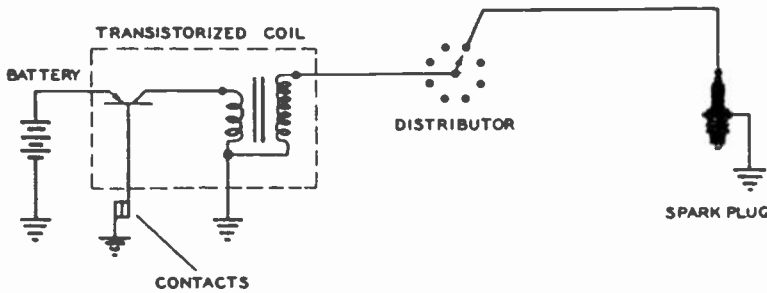

TRANSISTORIZED HIGH VOLTAGE IGNITION SYSTEM

Deeply eroded contact, right, ran 44,000 miles in conventional system. Almost clear transistorized system contact, left, ran for same time.

Graph below compares the new transistorized output with that of a conventional ignition system across full range of engine speeds.

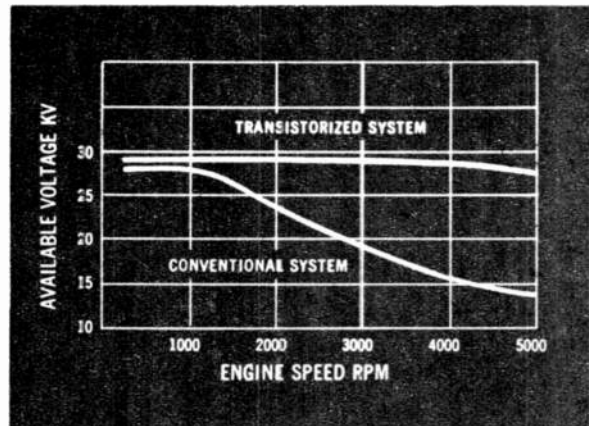
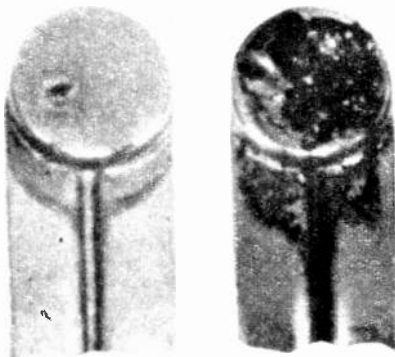



I was a radio inspector

When Chaos Hit the Airwaves

By Howard S. Pyle, W7OE

When wireless was in its infancy, the hearty men of the Radio Service brought order from confusion.

THE steamer, *City of Cleveland III* was warping into the dock at Detroit after her overnight run from Buffalo. I waited nervously until her last passenger debarked, then mounted the gangplank to where the quartermaster-of-the-watch stood.

"Where's the radio shack?" I asked, somewhat shakily.

"And who wants to know?" came the garrulous reply.

I opened my coat. Pinned to my vest was a shiny new badge: "U. S. DEPT. OF COMMERCE—RADIO INSPECTOR."

A 1916 spark transmitter undergoes tests. Note Leyden jars overhead. They were used as series condensers to reduce effective length of antennas.

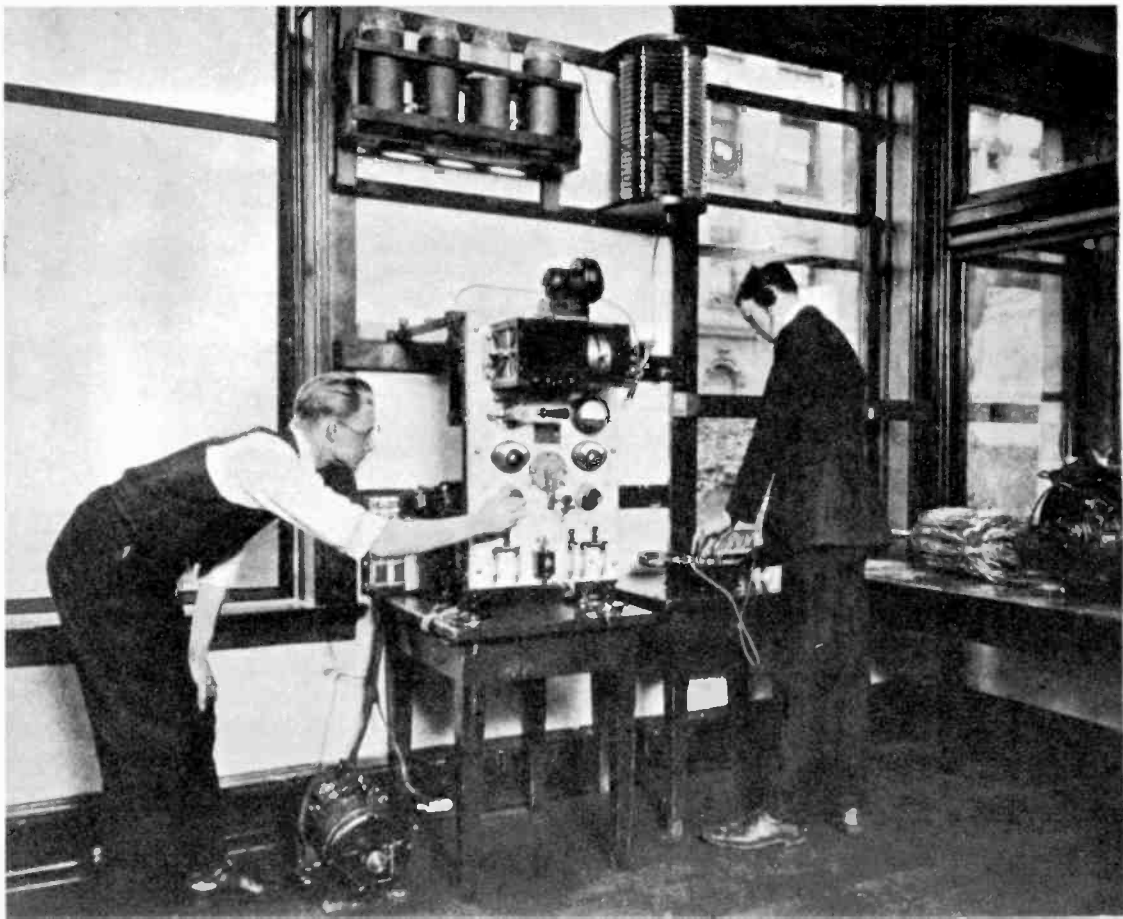



Here is famed Kolster Decremeter, used by pioneer Radio Inspectors to check emissions of spark transmitters. Pickup loop is at right, RF galvanometer at left behind crystal detector.

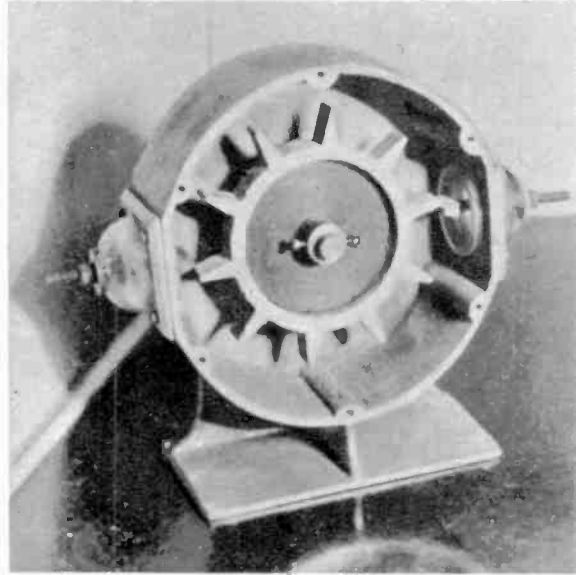

Benwood rotary spark gap, with cover removed, was popular in the early days of amateur spark transmitter. It was legal then, and capable of knocking out all other broadcasts.

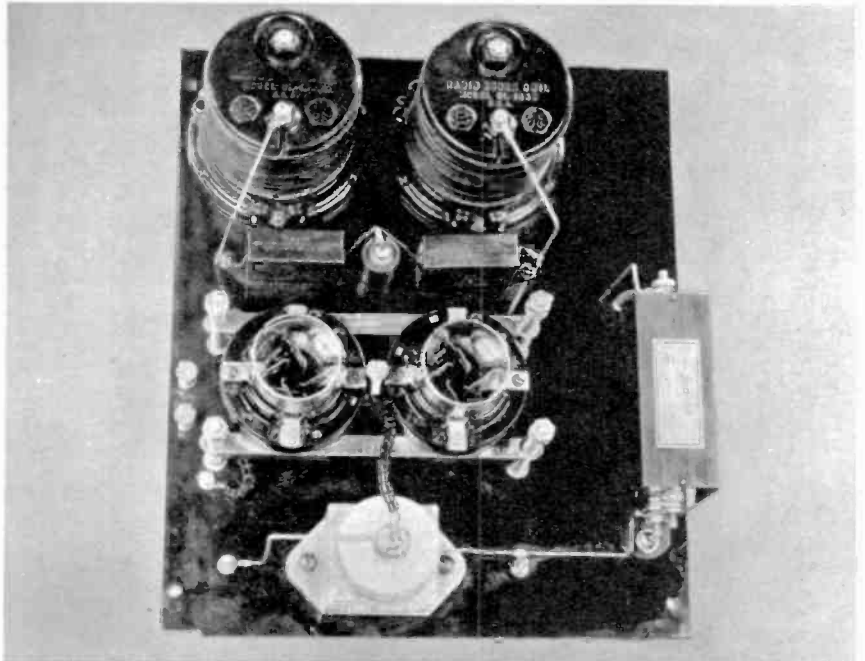

Conversion of military surplus gear was also popular after World War I. This 1925 RCA conversion unit changed Navy 500 cycle, 500 watt spark transmitter to vacuum tube operation, reduced possible interference.

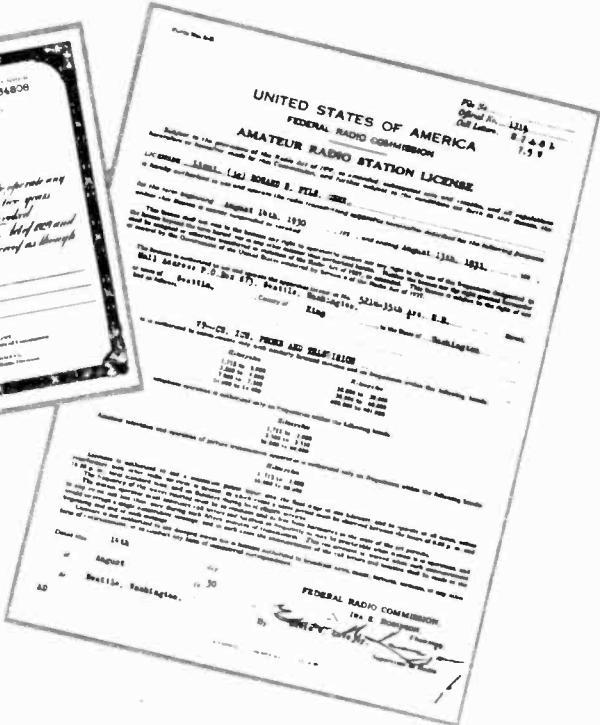
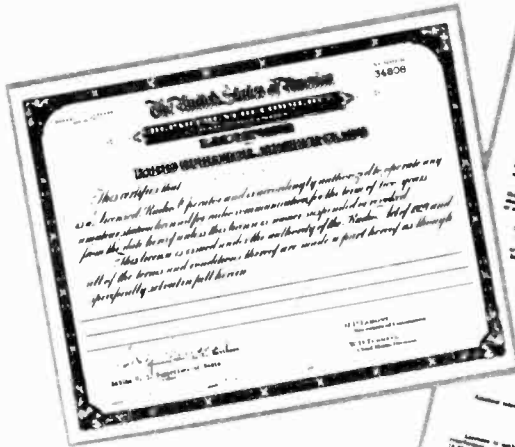

Author Pyle has been active in ham radio for over forty years. He has 11 expired amateur licenses and 13 expired commercial radio telegraph licenses. Early amateur certification required separate operator and station tickets. Those shown here are from early Thirties. Station license tells of "silent hours" between 8:00 and 10:30 p.m.

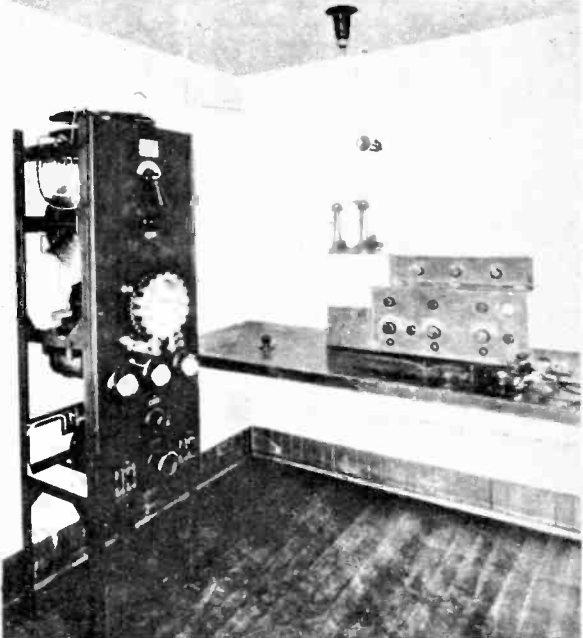
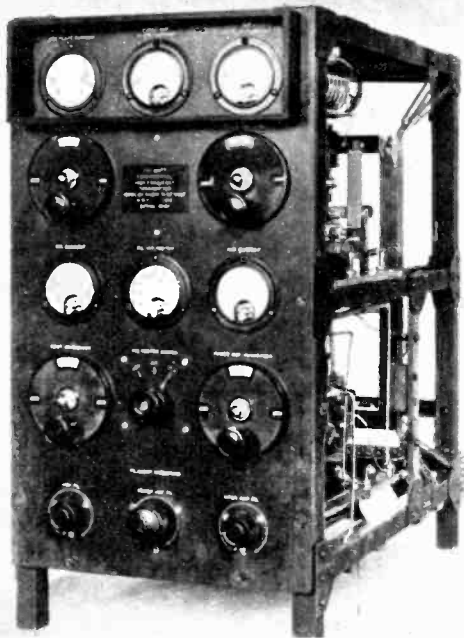

Along with commercial operating companies and amateurs, the U.S. Navy devoted much effort to the development of vacuum tube transmitters. Shown here: 250 watt HF rig.

The Federal Telegraph Co. manufactured 750 watt spark transmitters such as this shortly after World War I. Sparks caused interference on all frequencies, had to be carefully checked.

Famous Thordarson 1 kw transformer of amateur spark days would produce 20,000 volts, and was a lethal weapon. It was demon which "busted up" early entertainment broadcasts.

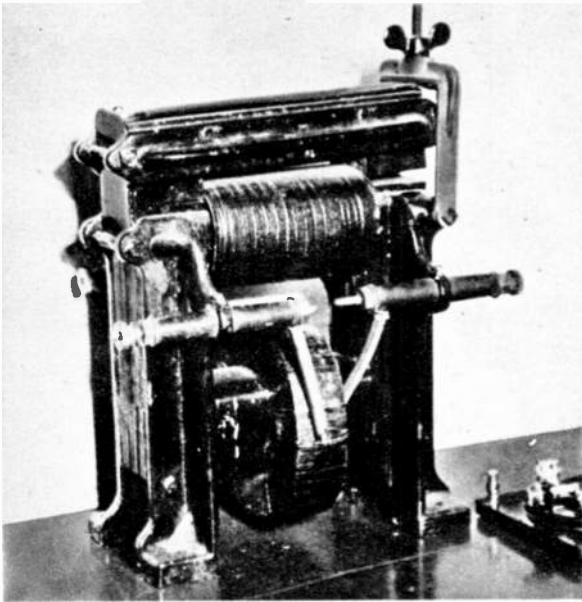

Amateur wireless operators of 1916 used equipment of this kind. Spark transmitters, in addition to being inefficient, disrupted military and commercial radio, were declared unlawful.

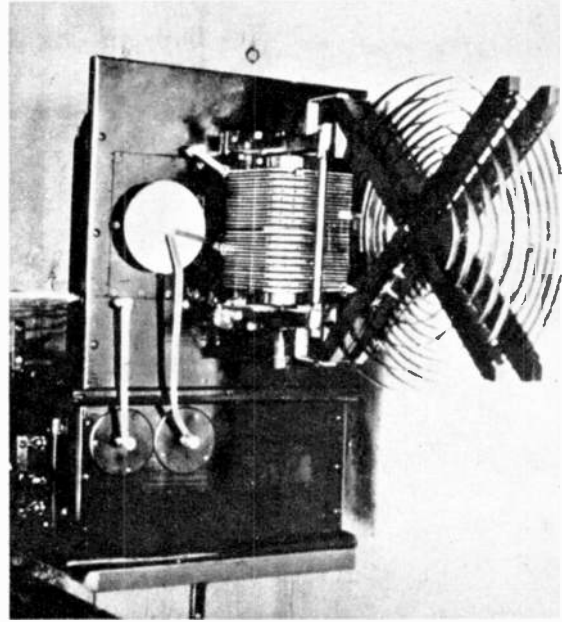

"Yes, sir!" said the quartermaster. "Right this way, sir . . ."

I had been a Radio Inspector all of two weeks and my territory was the Eighth Radio District in Michigan. That first fortnight had been a period of indoctrination. I had been shown how to use the Omnigraph—the infernal machine which shot dots and dashes at bewildered applicants for the various grades of radio operator licenses. I had received careful training in the use of the Kolster Decremeter, a device which made precision measurements of RF emission.

Now I was on my own. The *City of Cleveland III* was to be my first independent inspection of a vessel required by law to carry radio equipment. Her license was due to expire and the law called for a formal inspection to insure that her radio equipment complied with the Radio Act of 1912.

My confidence was somewhat bolstered by the change in attitude of the quartermaster. At least he recognized the fact that I had a perfectly legal right to come aboard the ship. I felt even bet-

ter when I met the senior radio operator. He was about the same age as myself. Most persons concerned with radio in those days were young. Within 45 minutes we had made the required measurements, filled out the necessary forms and parted with a handshake.

Chaos

Marconi's successful "wireless telegraph" transmission across the Atlantic Ocean in 1901 immediately aroused commercial interests, scientists and scores of private experimenters.

By 1910, the ether had become chaotic. Deliberate interference or "jamming" was common between rival operating companies. Amateurs blithely called and often communicated with ships at sea and with shore stations, both military and commercial. Jamming had become so acute that vessels in distress on the high seas had difficulty getting out calls for assistance. Important military and naval communications were

[Continued on page 112]

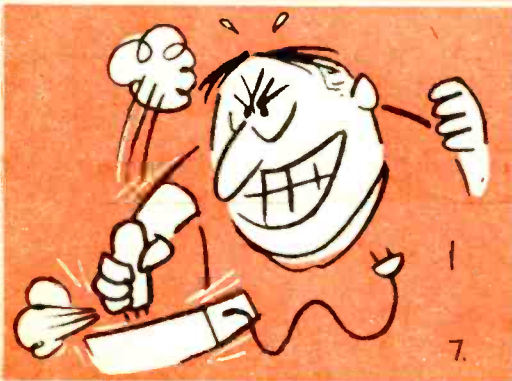

Special Bonus Feature

build an

Electronic Computer

By Ronald Benrey

THEORY: it uses principles of actual computer.

CONSTRUCTION: details show how to build it.

OPERATION: demonstrate computer works.

IN the time it takes you to read this sentence a large, high-speed, electronic digital computer could easily complete several hundred thousand individual mathematical computations with fifteen-digit numbers. An average man, working with pencil and paper, could achieve the same results in five years! Speed is the secret, and the reason behind the introduction of the "Giant Brains," for it is speed which makes large scale data-processing operations feasible, and enables multi-million dollar scientific computation installations to operate fruitfully and economically.

You can perform any arithmetic operation that an electronic computer can do. These machines use only combinations of addition, subtraction, multiplication and division in reaching a solution. Probably, if given enough time, you could solve the most complex problems presented to the calculator, including those usually classified under "higher mathematics." Much of the so

Sloping-panel cabinet houses complete computer. Telephone dial feeds in problem, answers appear on two rows of lamps at right.



called higher mathematics were developed to reduce the enormous number of basic calculations required to solve problems such as the determination of the trajectory of an artillery shell, the orbit of a space satellite, and others where many constantly varying factors are present. The ultra-high speed of electronic calculators makes direct solution of many problems possible in a few moments.

The miniature electronic digital computer described in this article which can be constructed at a cost of approximately \$35, and an outlay in time of a few evenings, demonstrates many of the operating principles of full-scale electronic calculators.

Operation of a Full Scale Computer

The operation of an actual computer will become clear if, for a moment, you assume that it is comprised of four major components, all located in a small room; you, a tele-typewriter, a blackboard and a multi-drawer cabinet which, for the sake of simplicity will have fifty numbered drawers. The tele-typewriter connects to a similar unit outside the room, and you receive instructions and relay answers on it. At some earlier date you were instructed, via the tele-typewriter, to write certain numbers and instructions on slips of paper and place them in certain drawers. You are adept in the four basic arithmetic operations, and can work with fifteen-digit numbers quickly and accurately. The tele-typewriter starts clicking and you receive your first operational instructions:

1. Take the number in drawer No. 5 and write it on the blackboard.
2. Take the number in drawer No. 6 and write it on the blackboard.
3. Multiply the numbers, and round the results to 15 places.
4. Place the answer in drawer No. 7 and erase the blackboard.
5. Take your next instruction from drawer No. 8.

After performing several operations, taking your instructions from "storage" in the cabinet, you are finally told to relay the last result over the tele-typewriter, and to prepare for new instructions.

There is nothing mysterious about any of these operations, yet they demonstrate the action that takes place in a computer. Notice, that each is a discreet step. The group of operations which resulted in a multiplication followed a preset plan, or "program." This series of actions is the hallmark of a digital computer. The many-drawer cabinet represents the storage or "memory" device of the computer. This would actually consist of a magnetic tape recorder, ferrite cores, a revolving magnetic drum or one of the newer storage units. The tele-typewriter is analogous to the input and output sections of the calculator. Input might be accomplished through a punched card, while the results could be "read-out" through a high speed printer. "You" and the blackboard comprise the actual arithmetic stages of the computer where the mathematical calculations are done. Now for the "alphabet" of the modern computer, the one also used in our model.

Fig. 1

100	10	1
	20	2
	30	3
	40	4
	50	5
	60	6
	70	7
	80	8
	90	9
	100	10

The Binary Number System

If you were given the task of representing all the numbers from 1 to 100 on a board using electric lights, how would you go about it? You could place 100 small lamps on the board, each lamp standing for one number. Though this method is certainly straightforward, the wiring and switching circuits for 100 lamps would be very cumbersome. And just imagine if you then wanted to increase coverage to 1000!

Another method, shown in Fig. 1, that would be a good deal simpler, consists of twenty-one lamps mounted so that ten lamps stand for "unit" digits, ten lamps for "tens" digits, and a single lamp for a "hundreds" digit. Although we've cut the number of lamps by over 75 percent, the switching circuit is still quite complicated, and ten additional lamps are required for every power of ten that we extend the scale.

All this is of course leading up to the simplest method, the binary notation, and, as will be explained shortly this system is

$$\begin{array}{r}
 345 \text{ IS ACTUALLY EQUAL TO;} \\
 5 \times 10^0 = 5 \\
 + 4 \times 10^1 = 40 \\
 + 3 \times 10^2 = 300 \\
 \hline
 345
 \end{array}$$

$$\begin{array}{l}
 \text{NOTICE THAT} \text{-----} 10 \times 10^0 = 10 = 1 \times 10^1 \\
 \text{AND} \text{-----} 2 \times 2^0 = 2 = 1 \times 2^1
 \end{array}$$

Fig. 2

perfectly adaptable to electronics since it uses "bistable" devices in its operation. A bistable device, as its name implies, is stable, or remains in two different states. A good example is the common switch. It is either open or closed, and can remain in either state for an indefinite period of time. Others are the relay, vacuum tube, transistor, "flip-flop," and certain semiconductor devices.

The common number system we are familiar with is constructed of numbers to the base 10. For example, as shown in Fig. 2 the number 345 is actually equal to:

$$5 \times 10^0 + 4 \times 10^1 + 3 \times 10^2$$

Any number to the zero power is considered to be equal to one. The binary number system is constructed of numbers to the base 2. In the base 10 system the multipliers (3, 4 and 5) could range from 0 through 9, a multiplier of 10 being equal to 1 in the next higher power of ten. In the binary system the only multipliers are 0 and 1, 2 being similarly equal to 1 in next higher power of 2. With only two multipliers to worry about, switching circuits become very simple.

Fig. 3

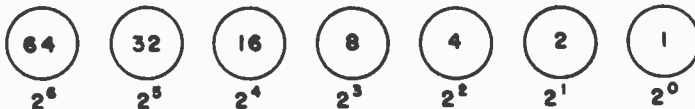

LIGHTED LAMPS ADD UP TO 37

A switch in the "off" position can signify a "0" and a switch in the "on" position can stand for a "1." Fig. 3 represents seven lamps in a row.

The first lamp on the right stands for 2^0 , the second for 2^1 , and so on until the lamp on the extreme left represents 2^6 or 64. If a lamp is lit it will stand for a "1," if it is unlit, it signifies a "0." Thus, all the lamps lit means:

$$2^0 + 2^1 + 2^2 + 2^3 + 2^4 + 2^5 + 2^6$$

which equals:

$$1 + 2 + 4 + 8 + 16 + 32 + 64$$

which equals 127

All the lamps off is equal to 0.

From right to left, if the first, third and sixth lamp are on the total is: 37. The top row of lamps in the model computer corresponds to the notation shown in Fig. 3.

Fig. 4

64	32	16	8	4	2	1	
2^6	2^5	2^4	2^3	2^2	2^1	2^0	
○	○	○	○	○	○	○	90
○	○	○	○	○	○	○	19
○	○	○	○	○	○	○	38
○	○	○	○	○	○	○	99

Here, then, with seven lamps and a very simple associated switching circuit all the numbers from zero through one hundred twenty-seven can be represented. And expansion is very easy to accomplish since one lamp is added for every power of two. The formula for the

total number that can be represented by a given number of lamps is:

$$N = 2^n - 1$$

N = the total number

n = the number of lamps

Fig. 5

Summing up, to read a number in the binary code, add to the

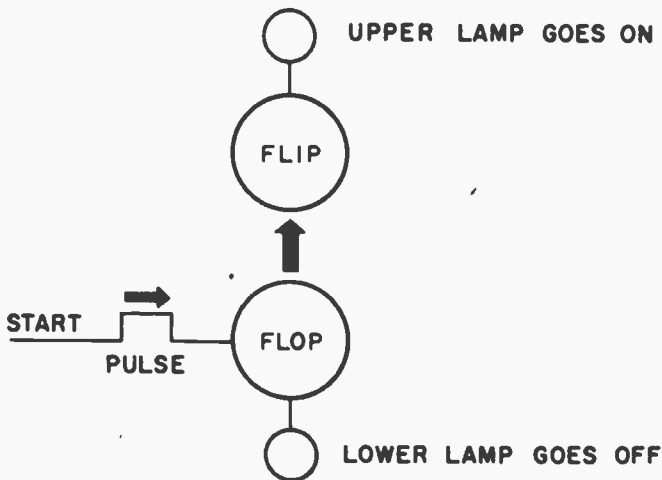

total the number represented by any lamp that is on. Discount it, and pay no attention to it, if the lamp is off. Fig. 4 shows binary representation of several numbers.

Theory of the Model Computer

The heart of the computer described in this article is a binary counter. This device counts the number of pulses presented to it

and displays the total in binary notation. The counter, which may have any desired number of stages depending upon the

maximum desired count, consists of a series of transistorized "flip-flops." A flip-flop is a bistable device with an added feature, it can pass the count along to following stages. An easy way to

visualize the action of the flip-flop is to picture it as a "little black box" with two lamps mounted on it, and four protruding leads. The first set of leads comprise a positive pulse input, the second set a positive pulse output. Initially the bottom lamp is lit. See Fig. 5. A positive pulse applied to the input will "flip" the device turning on the top lamp and extinguishing the bottom lamp. A second pulse will cause the unit to "flop," turning out the top light and lighting the bottom, and, in addition, supply a positive pulse at the positive pulse output terminals.

Now, imagine that several flip-flops are connected in series as in Fig. 6A, with all the bottom lamps lit. The first positive pulse applied to the input will "flip" the first unit (6B), the second will "flop" it, but, because of the positive output, the pulse will "flip" the second unit (6C). A third pulse (6D) will "flip" the first again and leave the second alone,

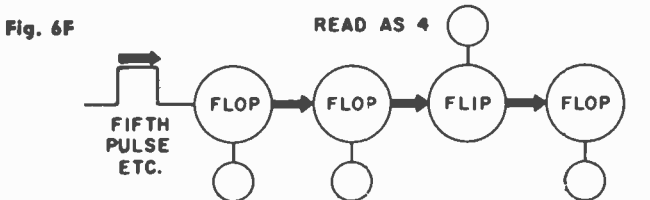
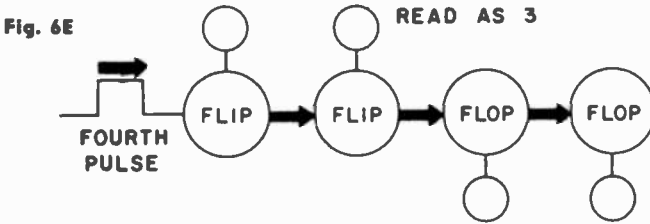
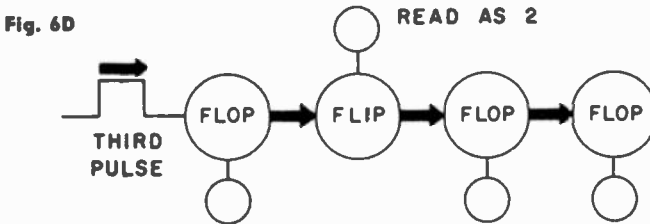
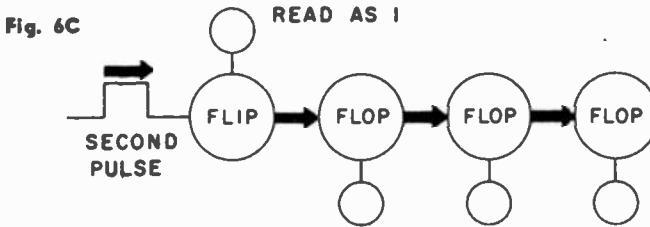
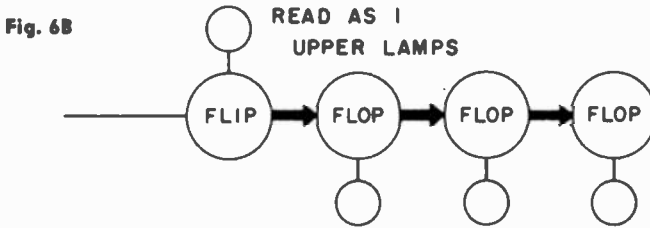
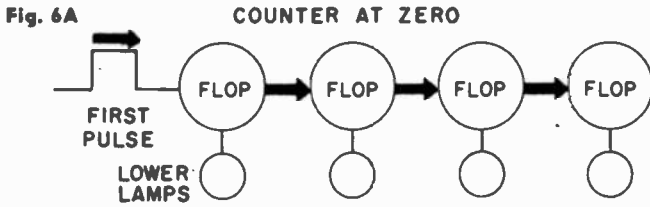

while a fourth (6E) will “flop” the first and second and “flip” the third. A little thought will enable you to trace out the action of the other units in terms of “flipping” and “flopping.”

This time, go through the same sequence but only pay attention to the top lamps. At the start the top lights are all extinguished. If you assign a power of 2 to each lamp in ascending order from left to right as shown in Fig. 7 the series flip-flops become a “binary counter.” Initially, as all top lamps are out the counter

Fig. 7

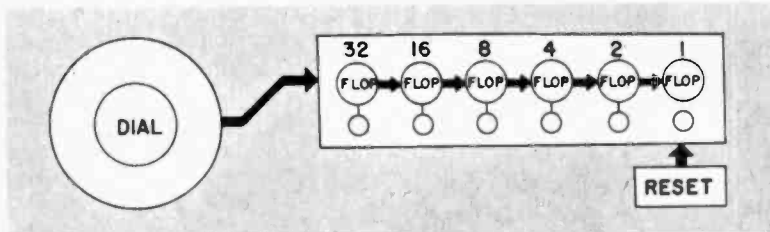

reads zero. The first pulse turns the first lamp on, indicating a “one”, the second pulse switches lamp one off and turns lamp number two on, indicating a “two.” The third pulse turns the first

lamp on again, and leaves the second alone indicating a “one” plus “two” equals “three.” And so on, until the count following the $2^n - 1$ count resets the counter to zero.

The computer built in this article uses a counter composed of 6 flip-flops, although more or less may be used. What ever number you decide on, try to keep it an even number. The reason for this will be explained later.

For flexibility of operation, the input and output of each flip-flop counter appears on posts at upper right. Note jumper wires for normal operation.

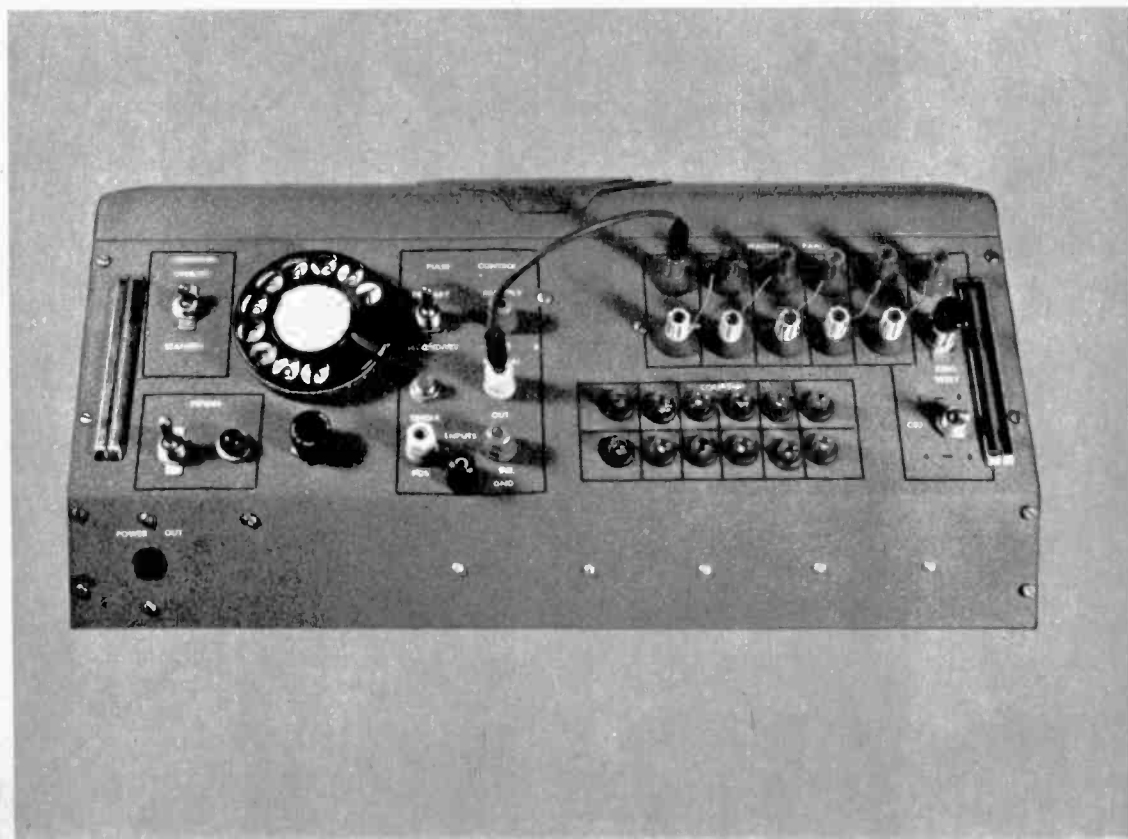

Top view showing the component side of a single flip-flop counter circuit on phenolic board.

Underside of same board. Although printed circuits are used, wires may serve instead.

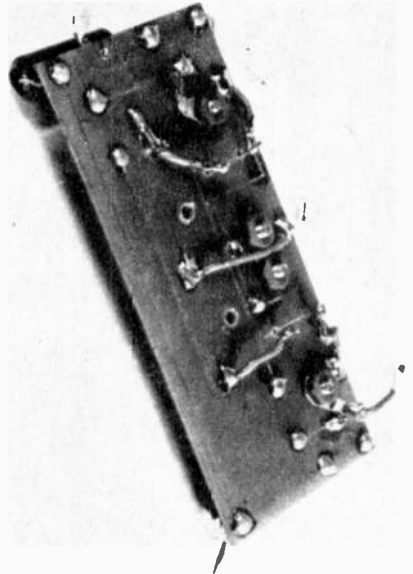
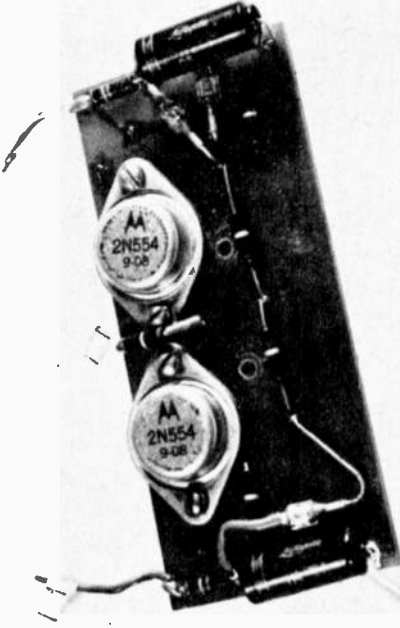

Construction of the Computer

Begin construction by assembling the six flip-flops. Printed circuit construction was used in the author's model to facilitate "mass production" techniques, although you can use regular wiring if you desire. Complete instructions for making printed circuits can be found in the October, 1959 issue of *Electronics Illustrated* or in one of the printed circuit kits available from many parts distributors. In either case, use the full scale template on page 76 as a construction guide.

You can cut the cost of each individual flip-flop with some judicious shopping and careful planning. For example, most distributors offer a price reduction for quantity buying. Since you will require a minimum of 24 1200 ohm resistors, buy them all at once for a possible saving. The same is true of the power transistors (twelve required), and the germanium diodes (fifteen required).

The six completed units are mounted on a small piece of scrap Lucite which serves as a sub-chassis. Any other rigid material may be used, or an aluminum or steel chassis may be substituted.

It is easy to keep track of the interconnections and not get tangled up if you use one-color wire for each series of connections. Follow the diagrams connecting all "A's", all "B's", etc.

To add color to the finished Computer, and to make "pro-

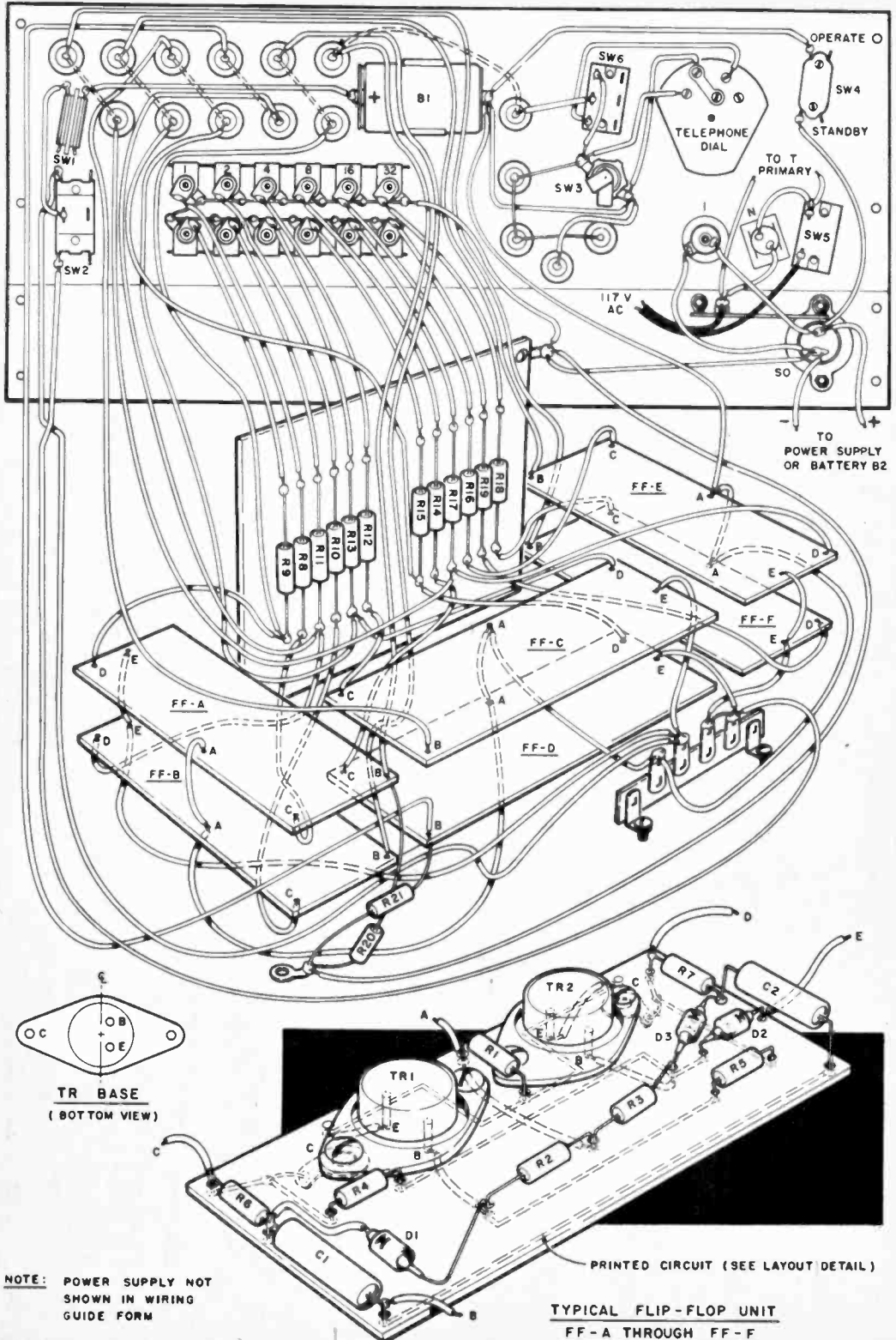

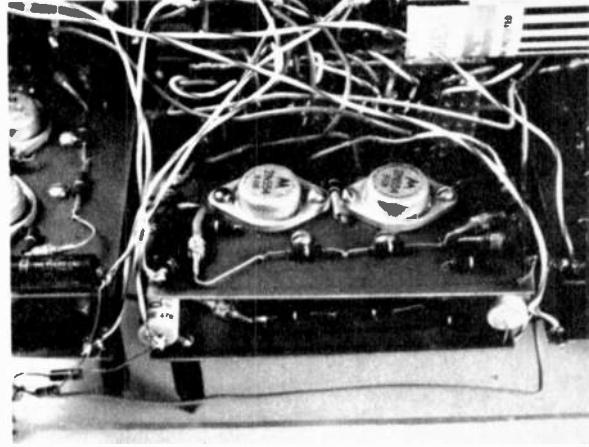
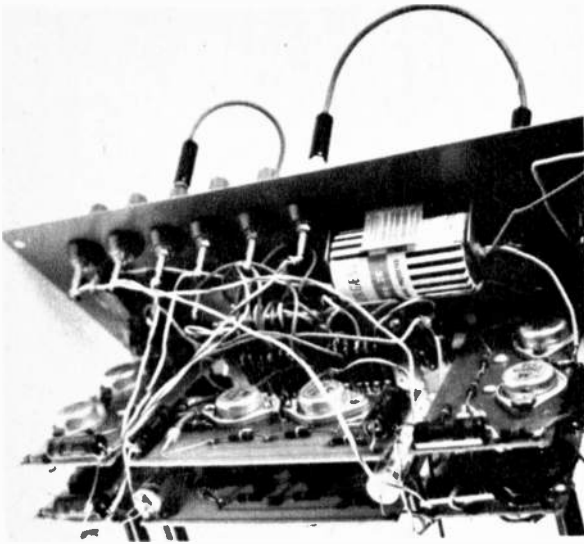

Only outline of the six flip-flops, FF-A through FF-F, is shown in wiring guide on facing page. Parts and wiring are same as typical circuit at bottom of page. Follow code letters for wiring into circuit. Actual location of major parts is shown above. Note spacers which support flip-flops.

gramming" easier, various color binding posts should be used. Some model airplane dope can be used to paint the posts if only one or two colors are obtainable.

The author's model contains a built in AC power supply which you can duplicate if you desire. However, if you plan to use the computer only occasionally the use of a medium 6 volt lantern battery is recommended because of the high cost of the power supply components.

The six completed flip-flops are mounted on the plastic sub-chassis in three two-deck units, which are positioned in the shape of a "C", the "hollow" side facing the inside of the cabinet front panel. A perforated Bakelite board, on which the readout lamp load resistors are mounted with flea clips, is bolted to the plastic board in the "hollow."

Complete the wiring of the panel mounted components before bolting the sub-chassis to the panel. Take care when connecting the telephone dial, as there may be several extra contacts. The only contacts used by the computer are the "primary" and "secondary" ones, and these may be determined with the aid of an ohmmeter if there is any doubt.

The "primary" contacts close one time for each numeral that the dial is turned. For example, if the dial is turned to 8 and then released, the contacts close and open eight times, if the dial is turned to 1, the contacts close once, and so on. The "secondary" contacts close and open once each time the dial is turned, regardless of the number that the dial is turned to.

When the computer is completed, recheck that the flip-flops are connected in the "right direction", and to the proper lamps. If they are not, the counter will not function properly, the "reset" will not operate, and some polarity sensitive components such as the transistors and diodes may be severely damaged.

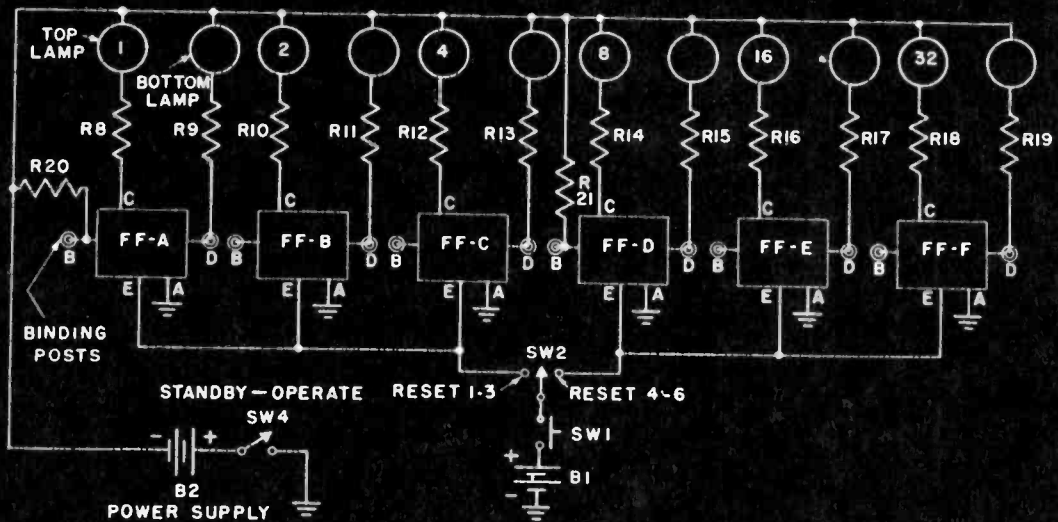

To simplify schematic, the six flip-flops are drawn in outline form. Detail appears on facing page. Code letters indicate how they connect into circuit.

The twelve "readout" lamps may be mounted in any convenient way. Regular sockets can be used if desired. However, you could mount the lamps in rubber grommets in holes through the panel. Connections to the lamps are made through inexpensive base sockets.

Once again it must be emphasized: Take your time. This project is a very difficult one to troubleshoot, and a careless mistake can cost a lot of time. As wiring progresses, it is helpful to check on the pictorial wiring guide.

Modifications

The Computer described in this article is more elaborate than is actually necessary for satisfactory operation. If you desire, you may make several modifications that will reduce the cost of the device.

1. Eliminate the free point connection system in the flip-flop bank, and connect the units directly to each other.
2. Mount the entire computer on a "bread-board." This will cut cabinet costs and also aid in describing the action of the computer as everything will be visible.
3. As previously mentioned, use a battery instead of the AC power supply.
4. Eliminate some of the "frills" such as a standby-operate switch, pilot lights, etc.

Rear view of unit, upside down to show Lucite base. It is held to front panel with small L-brackets.

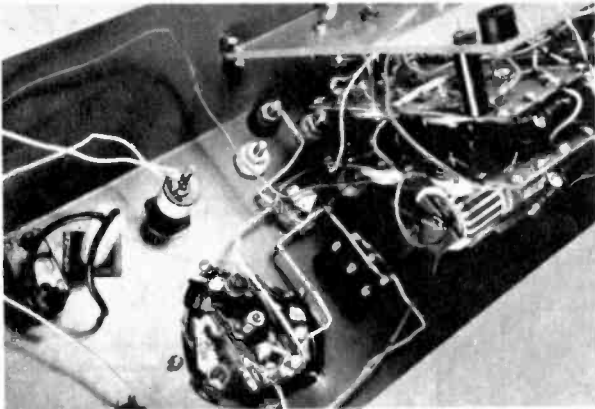

Rear view of other end. Spacers keep flip-flops apart, also mount them to base.

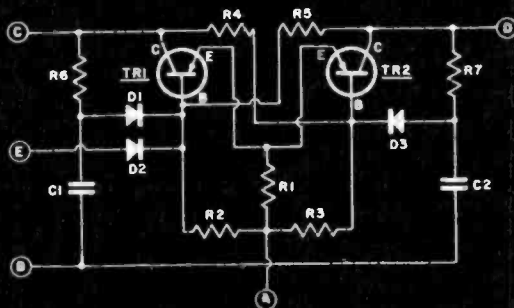
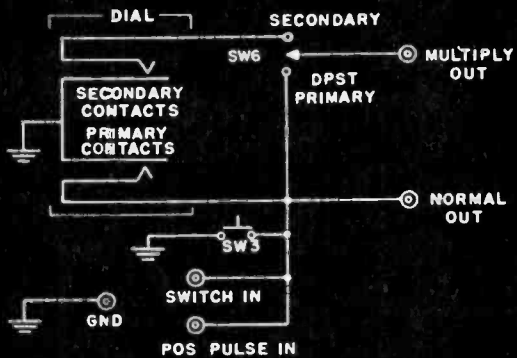
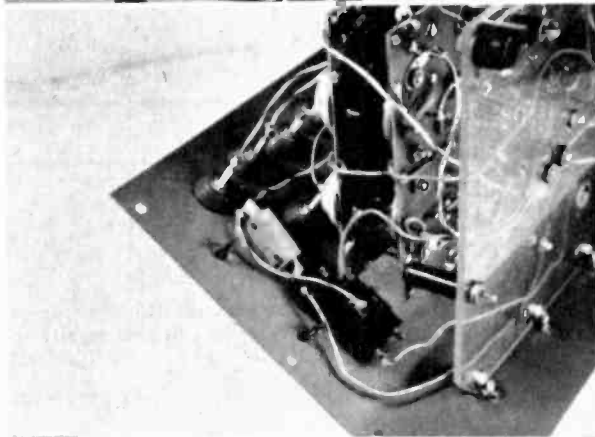

Telephone dial and related connections. Wiring guide shows how this connects to circuit.

Schematic detail of one flip-flop, with code letters. All of the flip-flops are identical.

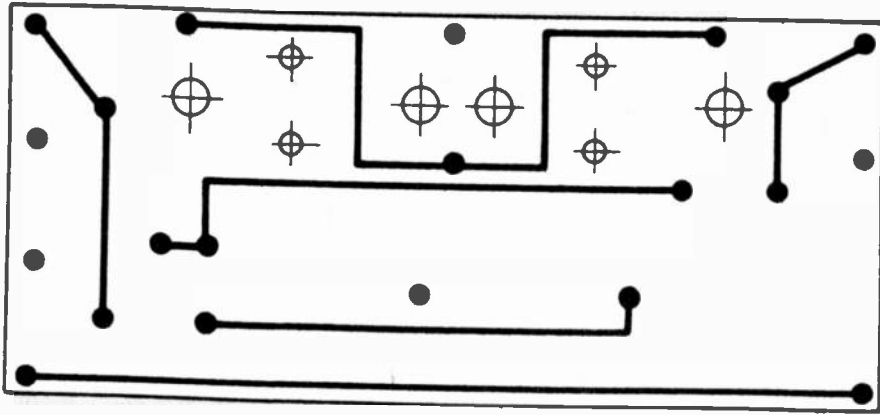

Actual-size template for flip-flop printed board. Black lines are copper foil. White circles are drilled to size shown, heavy dots to half their diameter.

Operating the Computer

The unit is capable of addition, subtraction, multiplication and division. It will also solve many simple first degree equations.

The computer is basically a binary counter, connected so as to be able to count positive pulses which are generated by the

PARTS LIST

- Flip-Flops (six of each part required unless noted otherwise)
- R1—10 ohm resistor 1/2 watt
- R2,R3,R4,R5—1200 ohm resistor 1/2 watt
- R6,R7—10,000 ohm resistor 1/2 watt
- C1,C2—.05 mfd paper capacitor 150 volt or less
- D1,D2,D3—1N34 crystal diode
- TR1,TR2—Power transistor (Motorola 2N554 or equiv.)
- Misc.—Phenolic board (see template), spacers, twelve 2-volt lamps with bases, 16 five-way binding posts
- Remainder of Circuit (one part per number)
- R8 through R19—68 ohm resistor 1/2 watt
- R20,R21—10,000 ohm resistor 1/2 watt
- Telephone Dial—Standard ten-digit type, available from most surplus stores
- SW1,SW3—SPST pushbutton switch, normally open
- SW2,SW6—SPDT toggle switch
- SW4—SPST toggle switch
- B1—Size D flashlight cell and holder
- B2—6 volt lantern-type battery (used in place of AC power supply)
- Misc.—Perforated board 4"x3" (for mounting R8 through R19), flea clips, grommets, etc., sloping panel cabinet 18" wide (Bud C-1896)
- AC Power Supply, if desired in place of B2:
- C3—2000 mfd electrolytic capacitor 25 volt
- SW5—SPST toggle switch
- SR—Selenium rectifier 1.3 amps (Mallory 1B12R)
- I—Pilot lamp 6.3 volt with socket
- T—Filament transformer 117 volts AC to 6.3 volts 2 amps
- N—Neon bulb (Lafayette MS-478 with 100K series resistor)
- SO—2-prong Power socket (not needed if power supply is built in main cabinet)

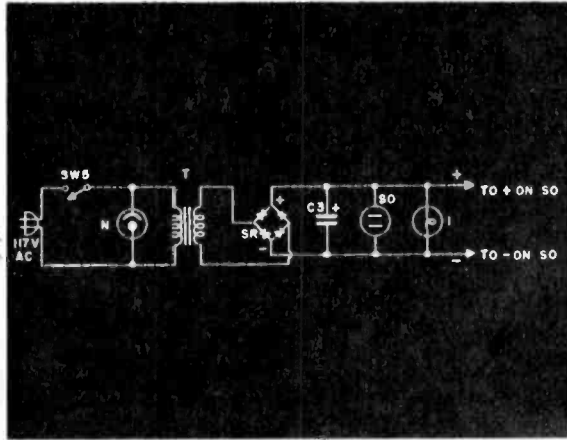
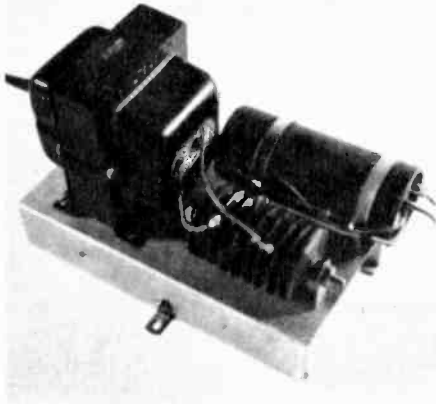

Though battery operation is recommended, an AC power supply may be constructed to energize computer. Schematic is shown at right. Unit may be mounted in cabinet.

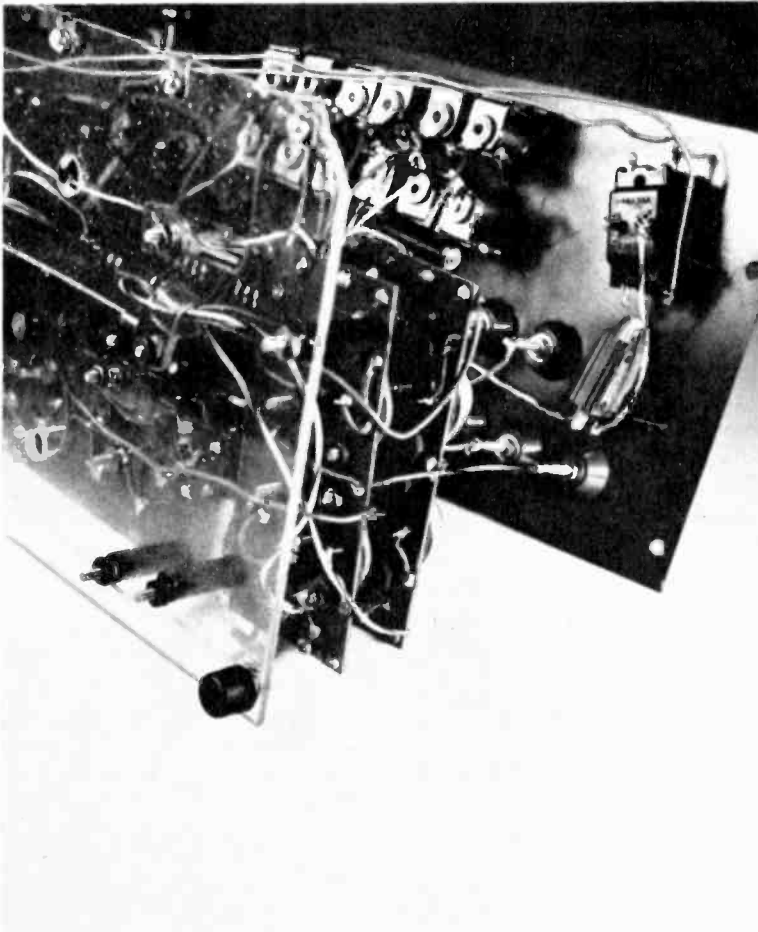

Two rows of pilot lamps are visible at top in this view.

“primary” contacts of a telephone dial. Obviously, this is automatically an adding machine, which in the author’s model has an upper limit of 63. ($2^n - 1$, where $n = 6$)

Subtraction is a bit more subtle, and therefore requires a bit more thought. Although the counter runs to 63, there are actually 64 numbers since zero must be counted. Now, assume for a moment that you kept on adding “tens” to each other. The counter would read: 10, 20, 30, 40, 50, 60, 06. Notice that when the final “ten” was added the counter went through zero (which took four pulses) and then continued until it reached 06. We exceeded the limit of the counter, and it “overflowed.” Keep this point in mind. An additional example is illustrated if you add 75 to the counter when it is at zero. It will read $75 - 64 = 11$. This is a direct method of subtracting 64 from any number less than 127.

For the sake of simplicity let’s establish a definition of an important term: the complement. The complement of the number X is that number that when added to X will reset the counter to zero. In this computer the complement of X is simply $64 - X$.

To subtract a number X from a number Y , add the complement of X to the number Y . For example, to subtract 20 from 30, add the complement of 20 (44) to 30. The result is 74, which, because of the “overflow” gives a result of 10, the correct answer. Now of course it would be foolish to require one subtraction to achieve another. This is not necessary due to the action of the flip-flops.

Notice, that one light, either the top or the bottom, is always on in each unit. Suppose that the top bank of lights, the bank that we are normally interested in, reads 15. Notice that the



Pilot lights on front panel light up to show totals in response to problem fed into brain.



The computer is fed by the telephone dial. To add $4 + 4$ dial the number 4 twice in succession.

For more automatic multiplication by the brain flip the switch shown to "secondary" position.

The "normal" pulse output is connected to the input of the first counter stage for addition.

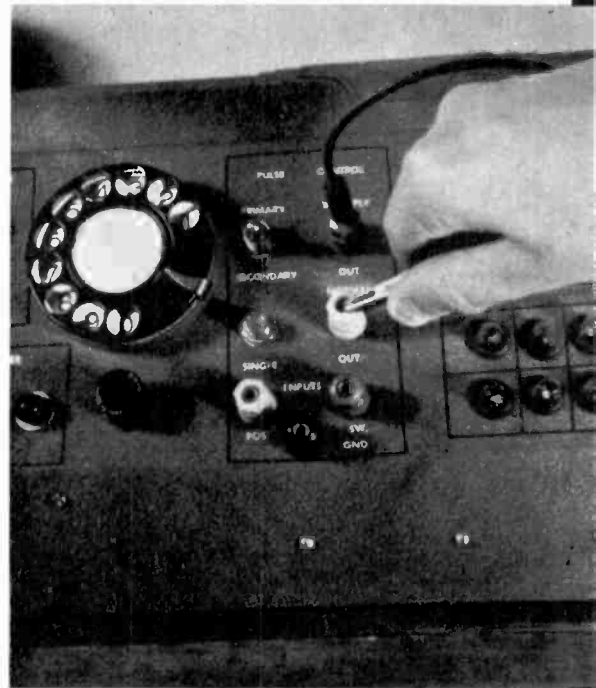
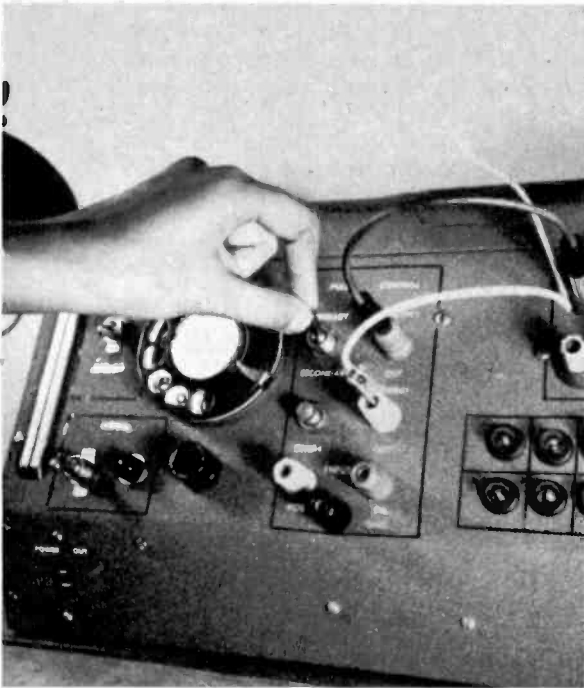

bottom bank of lights reads 48, or *one less than the complement of 15*. This deficit of one unit results because zero must be considered a number. The bottom bank will always read one less than the complement of the number in the top bank. Therefore, to find the complement of any number, enter it in the counter in normal fashion and add one to the number on the bottom bank.

Multiplication is a process of repetitive addition, and as such is easily done on the computer. For example, to multiply 5 by 7, add seven fives to each other:

$$5 + 5 + 5 + 5 + 5 + 5 + 5 = 35$$

You can keep track of the number of times you have added a number to itself in your mind, or you can set the computer to remember for you. This will be explained in the section on the mechanics of the computer.

Division is a process of "backwards" multiplication. For example, to divide 25 by 5 set up a small algebraic equation:

$$X = 25/5 \text{ or } 5X = 25$$

Now, all that is necessary to solve the equation is to find the number of times that 5 must be *added to itself* (find the other multiplication factor). This is easily accomplished by adding "fives" to the adder in the standard fashion, keeping track of the number added, until the counter reads 25.

Simple linear equations may be solved in the same manner as the above division if they are already in the $aX = b$ form. Remember however, that the computer does not handle fractions, and that it has an upper limit on the magnitude of the numbers it can handle. In solving an equation that requires the addition of a negative number, just add the complement of the number.

Mechanics of Operation

Addition:

Interconnect the flip-flops as shown. Connect the "Normal" pulse output to the input of the first (2") flip-flop; reset the counters to zero; proceed with addition by using telephone dial, "individual" pulse button, or external pulser such as a code key.

Subtraction:

Make all connections as above; first find the complement of the number to be subtracted with method described above; reset the counter; add the first number then complement of second.

Division:

Proceed as described under solving linear equations.

Multiplication:

There are two methods of multiplying with the computer, the "direct" method as already described, and the "indirect" method wherein the computer keeps track of the number of times "X" was added to itself.

Divide the flip-flops into two equal sections (this is why an even number of units were suggested. Connect the "multiply" pulse output to one section, and the "normal" plus output to the other. Switch the "multiply" pulse control switch to "secondary." Now, for example, if you are multiplying 3 by 2, operate the dial in the normal fashion. The counter section connected to "multiply" output will indicate the number of times that you have operated the dial, or, in effect, one of the two factors, say 2, if you turned the dial to 3 each time. The other counter section will keep a total, which will equal six, the correct answer.

This computer was designed to be a *demonstration* model to be used to illustrate many of the basic calculator principles. However, it is a project of little practical use unless the builder takes the time to study some of the readily available literature on computer techniques and mathematics. I do not recommend that anyone not familiar with high school mathematics attempt to construct it, as it will merely become a toy of limited value.

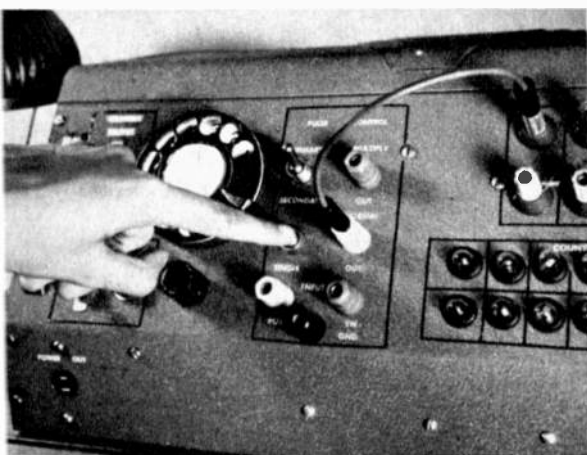

For greater flexibility of operation, single pulses may be fed into brain bypassing dial.

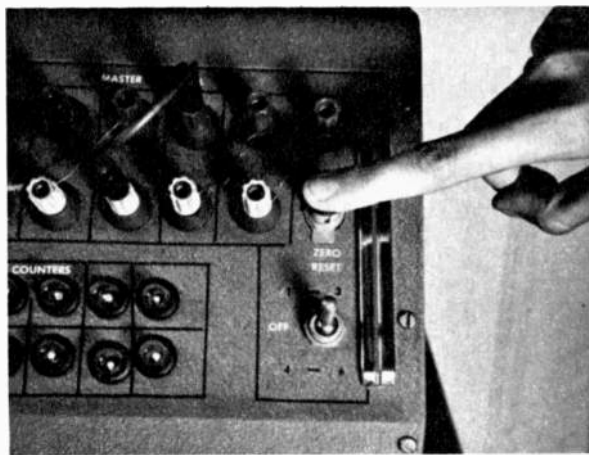

When setting up a new problem first push zero reset button to clear brain of previous answer.

JETS . . science and industry

Prepare for Tomorrow

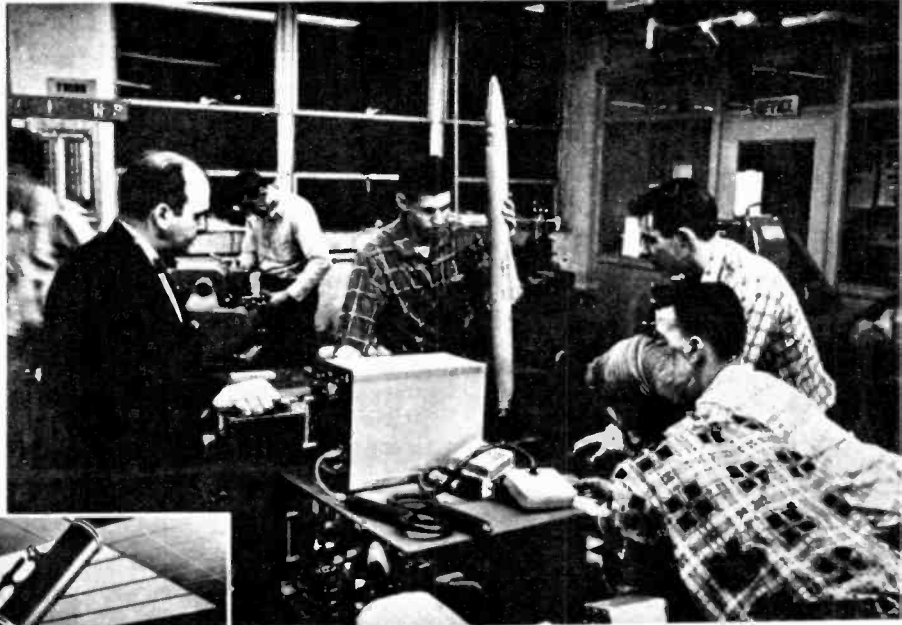

Engineering training head at Republic, Carl Parenti, discusses nose cone telemetry with JETS over communications gear in well-equipped machine shop.

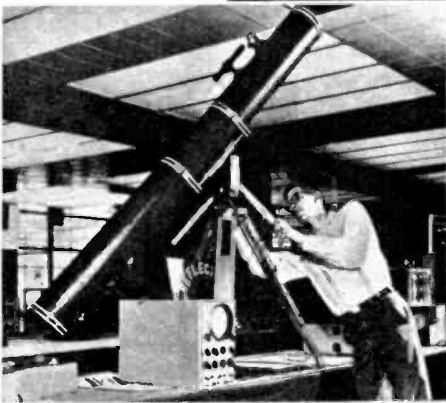

Scholarships are awarded for best of JETS projects annually. Many projects are centered on electronics and space. This winner built reflecting telescope.

ONE vitally important by-product of recent Russian technological advances has been the realization that America faces a shortage of engineers and scientists. But long before Sputnik I, an organization of educators, industrialists, scientists and, of course, teenagers, was formed to look toward the future. Now more than 10,000 high school boys and girls are members of the Junior Engineering Technical Society (JETS), and from their ranks will come a major portion of the free world's future technical talent.

L. G. Miller, Dean of Engineering at Michigan State U., saw in 1950 that many high school students interested in scientific careers were falling by the wayside because they simply did not know what was expected of the engineer and lacked basic qualifications. With a colleague, Professor Harold Skamser, he organized JETS, a national program at the [Continued on page 124]

Microwave Hazards

At last science is bringing to light new data on how intense radar beams can affect the animal world.

CAN radar kill? Using rats, mice, rabbits and chicks, researchers at the University of Miami have been exploring the physical effects of pulsed microwave energy at a frequency of 24,000 mc. Some of the results were:

- A rat could be killed in as little as 12.3 minutes if intense microwaves were directed at the abdomen; 18.5 minutes if directed at the head.

- Microwave intoxication depended on the severity of exposure. When in the central area of a radar beam, a chick will stagger, lose muscular control or collapse, and will sometimes have wing spasms. Rats will squeal and struggle to avoid the beam.

- If rats are exposed for one minute and not exposed for three minutes to 0.3 watts/cm², and if this intermittent exposure is continued, the rats will die after 28 minutes. However, if exposed for one second and not exposed for three seconds, and if this exposure is also continued, most will survive. Both groups were, in effect, exposed to the same "amount" of radiation.

Man, because of his size and body weight, is much more resistant to the effects of microwaves than small animals, but prolonged exposure to a radar beam may produce serious injury. Rotating antennas tend to minimize danger. A power density of 0.01 watt/cm² is generally considered safe for repeated human exposures. ●

Photos by Flatow

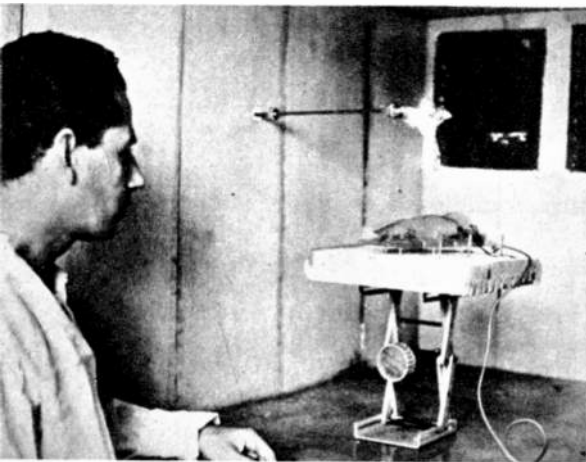

Left, a white rat is placed beneath microwave antenna that aims a 24,000 mc beam at any part of the mammal's body. Exposure is timed.

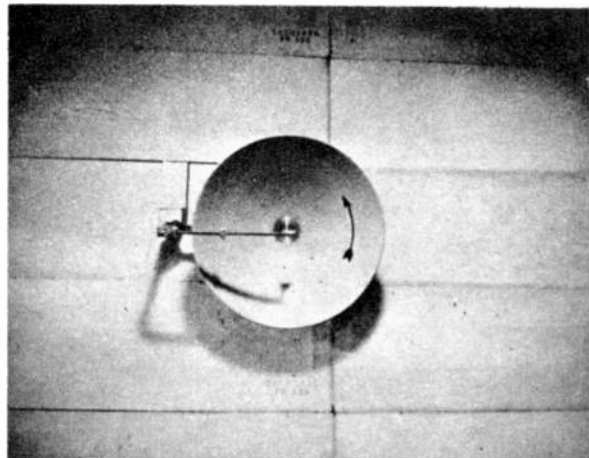

At right, pulsed microwave beams are directed from this antenna at animals in experiments to determine non-lethal effects on larger animals.

Microwave generating equipment consisted mainly of a pulse-modulated magnetron and power measurement devices. Bronze shielding surrounds radar exposure chamber.

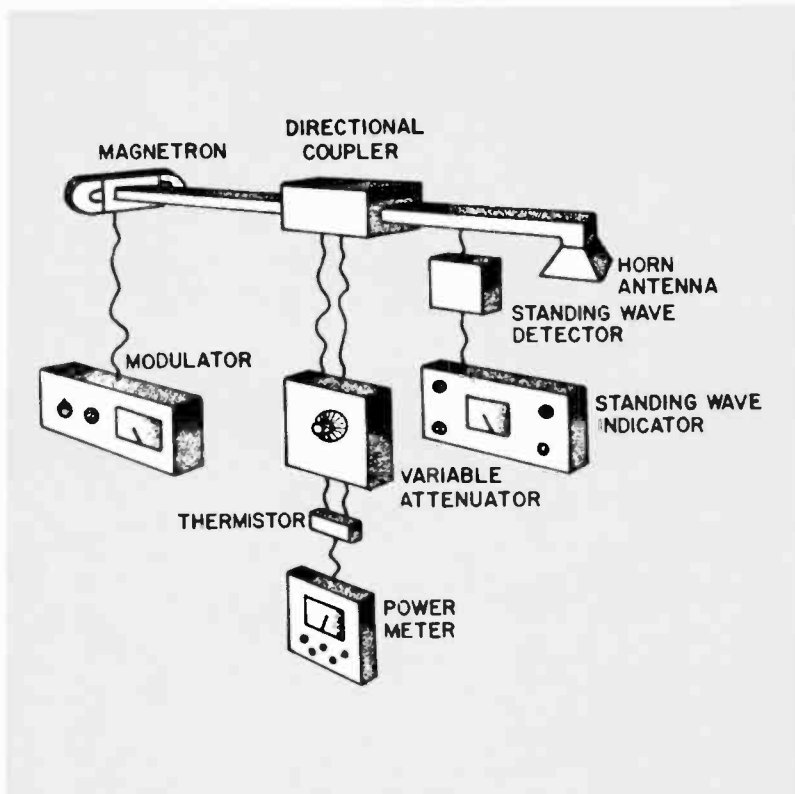

At left, Dr. William Deichmann pauses to look over rotating table partitioned with Plexiglas. Animals in each section are exposed to radar.

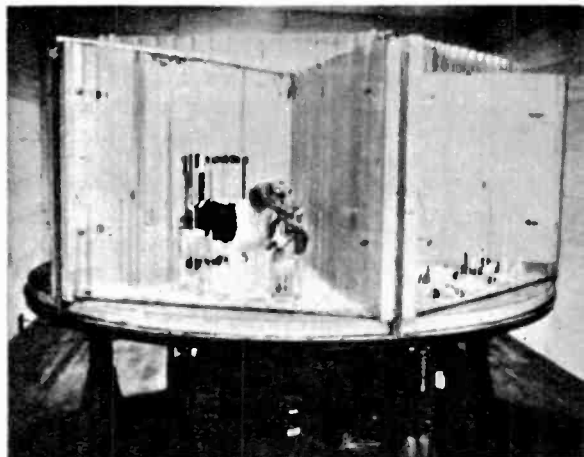

Beagles have proven very good subjects in varied laboratory experiments since they have a high percentage of complete recoveries.

Electronic Brain

Have you any question on electronics? Send it in and the Electronic Brain will provide the answer.

Car Battery Powers Transistor Radio

Can a 5-transistor portable radio that normally operates from a 9-volt battery be used in a car with a 12-volt battery system? What changes or additions would have to be made?

Charles P. Schappach, Jr.,
Hastings-on-Hudson, N. Y.

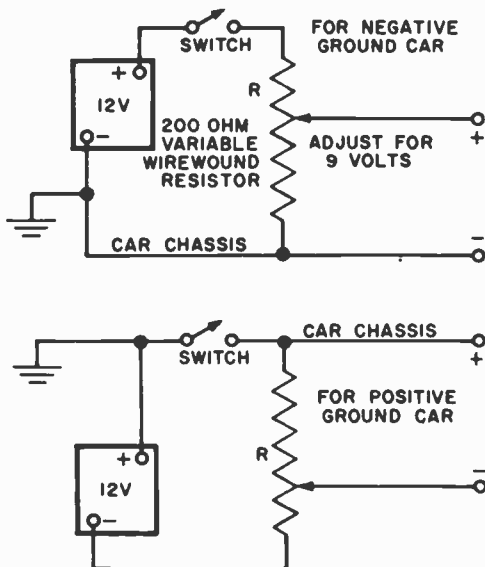

Yes, this can be done without too much difficulty. Although virtually all 9-volt radios will operate successfully with 12 volts applied, it might be wiser to equip it with a voltage divider as shown in the accompanying sketch. An outside antenna is essential, however, just as it is with any automobile radio.

Be very positive of battery connection polarity before connecting the transistor radio. In addition, determine whether your car has a positive or negative ground to the chassis. Then, ascertain whether the transistor radio has any metallic contacts protruding from the case that might come in contact with the metal of the car. If both the car and the radio have the same polarity "ground,"

the radio need not be insulated from the car body; otherwise, it will be necessary to isolate it very carefully to avoid battery short-circuits.

The antenna connection is made from the auto antenna lead to the "hot" terminal of the Ferriloop through a 50 mmfd capacitor. A little experimenting with the point of connection will disclose the best tap to use.

Filter Choke

Would there be any value in replacing a filter resistor with a filter choke in a small power supply? If so, how would I select the proper choke?

Louis Chestnut, Bronx 51, New York

The great advantage of a filter choke over a filter resistor is that the former produces smoothing action by virtue of its inductance rather than ohmic resistance. Thus, a choke reduces ripple without adding much resistance to the power supply. This results in the following:

(1) It improves the regulation of the power supply. Now the load can vary over a much wider range without changing the output voltage nearly as much as a resistor filter unit would.

(2) Greater power is obtainable from a given power transformer. The output voltage of a good choke supply is always greater than the voltage from the same supply with a resistor.

(3) Better filtering action is generally possible if a good choke is used. This makes it feasible to use smaller and less expensive filter capacitors for the same reduction of ripple voltage.

The selection of the proper choke for a given set of conditions is an engineering calculation. In practice, the hobbyist or experimenter must know the current drain that the equipment will place on the power supply. He then purchases a choke that will handle this current, having as high an inductance as space limitations (and his purse!) will permit.

Hi-Fi Detector

Can you explain how it is possible for me to hear a radio amateur coming in over my hi-fi system? It has no radio in it or near it, yet I heard W3—clearly one Sunday afternoon.

Donald Belfer, Broomall, Penna.

This is an unusual occurrence but has been known to happen many times in the past. It is quite easy to explain and you can test our explanation by trying a few tricks of your own the next time it happens.

We have checked the location of the amateur you mention (we withhold his call for obvious reasons) and have found that he is quite close to you, in Narbeth, Pa. Although you did not mention the type of cartridge you use in your pickup arm, we are almost willing to wager that it is either a reluctance type or a magnetic. These act as excellent antennas for certain frequencies, especially if the ham is working around 28 mc. Now, very few voltage amplifiers such as you have in the preamp of your hi-fi are absolutely linear. Even a small degree of non-linearity results in the detection and consequent demodulation of the signal your cartridge picks up. Thus, your hi-fi, accidentally "tuned" to an amateur frequency, is behaving as a radio—nothing more!

Self-Oscillation

In attempting to drive the class C stages of my transmitter with a VFO, I find that there are two separate signals in my antenna: one from the VFO and the other at a slightly higher frequency. What causes this and how is it remedied?

James C. Matt, Rochester, New York

From your description, it appears that there are two possibilities that might explain your difficulty:

(a) It is possible that the transmitter is not properly neutralized. This would cause it to break into oscillation when "shock" driven by the VFO. More often than not, the self-excited oscillation frequency is slightly different from the exciter frequency. This requires very careful analysis of the transmitter performance to determine why it is not neutralized.

(b) You may have parasitic oscillations in one of the class C stages. These are difficult to track down without suitable equipment, but sometimes can be located by a small neon lamp.

PA System

Is it possible to convert a jukebox into a public address system?

Joseph Szymanski, Pittsfield, Mass.

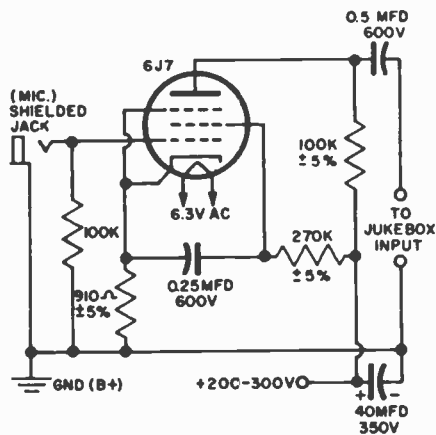

A good jukebox could make a wonderful PA system since the fidelity built into these amplifiers is extremely good. Jukebox equipment is designed to be used with phono input, usually obtained from a relatively high output cartridge. Assuming that you would like to use a microphone with the PA system, it would then be necessary to build a one or two stage pre-amplifier with sufficient gain to bring the microphone input level up high enough to drive the first amplifier in the jukebox.

The diagram shows a low-distortion input amplifier stage that would be suitable for use with a good quality crystal or dynamic microphone. This is a tested circuit of excellent design, but must be carefully constructed to avoid hum pickup since it does have substantial gain. The power to operate it could be taken from the jukebox by connecting the heaters to the 6.3 volt output of the power supply and the positive input terminal of the pre-amplifier to any point in the jukebox where 200 to 300 volts of well-filtered DC is available.

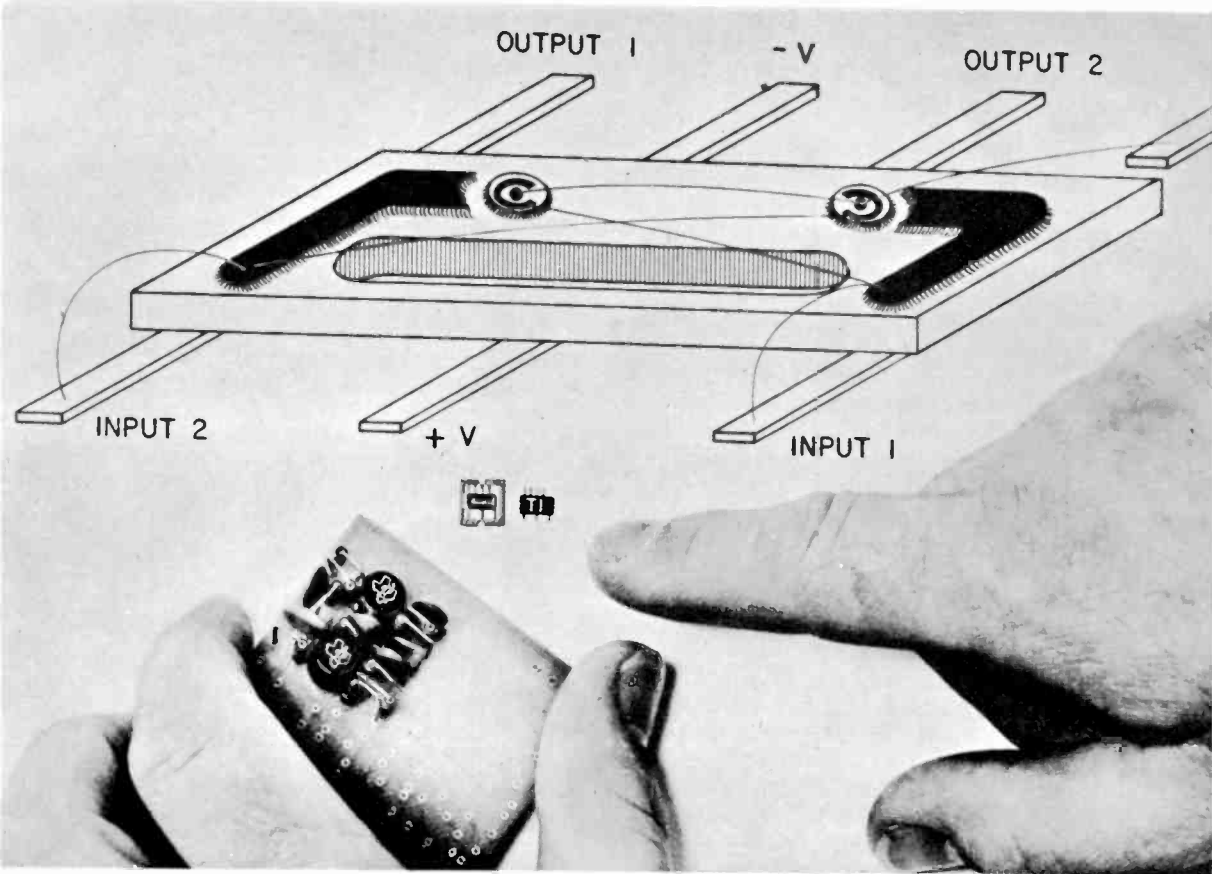

Finger points to two solid circuit multivibrators by Texas Instruments. Shown beside diagram, are equivalent to circuit on phenolic board in hand.

Molelectronics, integrated circuits—it all boils down to single units that contain all elements of . . .

The Solid Circuit

THERE is no wiring to interconnect components. You'd find it mighty difficult (if not impossible) to pick out individual components in the circuit. The entire circuit is a *single part* of unbelievably small size! This is the solid circuit—molecular electronics—and further research in this field may very well reduce resistors, capacitors and transistors as we now know them to merely sentimental memories in the minds of "old time" dabblers in electronics.

Conventional circuits for radio receivers, television sets, or most any piece of electronic equipment are usually made up of separate connected components. The complete circuit contains at least one part or component for each symbol in the circuit diagram. Sometimes several components are grouped together, interconnected and packaged as a single unit with a large number of leads. An example of this would be a tone compensating network in a hi-fi preamplifier.

But the new approach, already saddled [*Continued on page 109*]

GND

Carefully deposited layers of semiconducting films make up this Air Force multi-vibrator that weighs only .015 oz. There are no conventional resistors, capacitors.

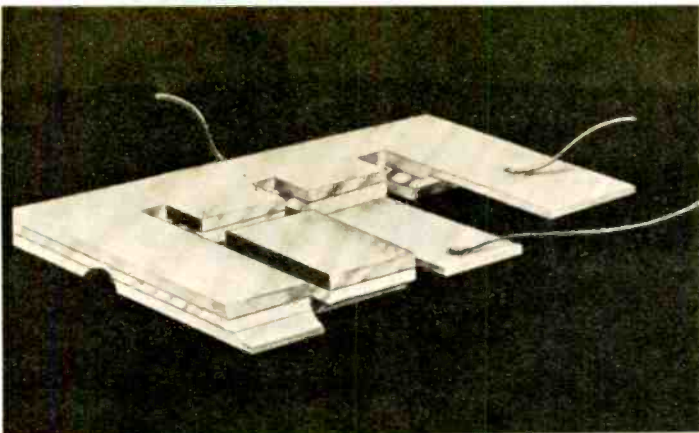

Enlarged drawing of Texas Instruments' phase shift oscillator shows equivalent of 9 components—1 transistor, 2 resistors and RC net acting as 3 resistors, 3 capacitors.

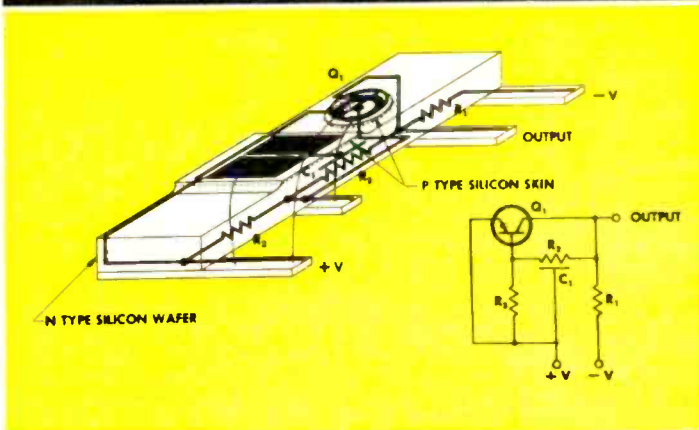

Small silicon slice does everything that transistorized oscillator (parts shown) will do. Westinghouse photo

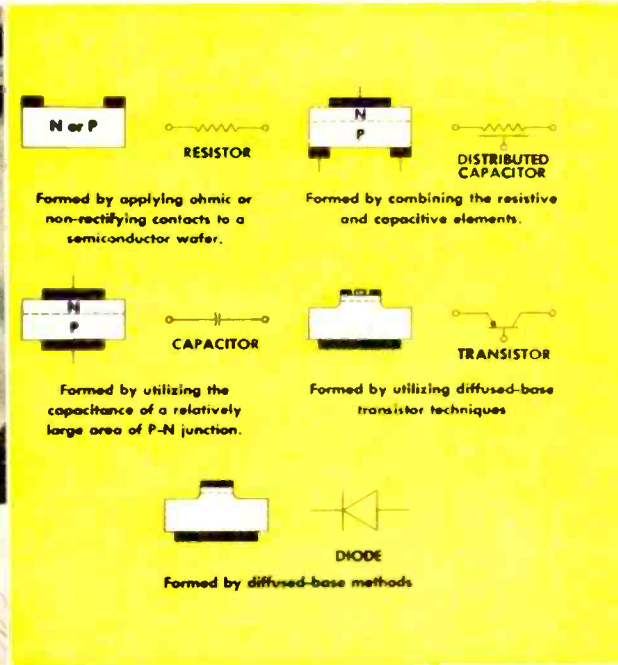

Here's how ultramicroscopic solid circuit elements can be built up in pieces of silicon.

build this

Emergency Flasher

By J. E. Pugh, Jr.

Keep this unit in your car—if needed, it signals "Danger" with two alternately flashing red lights.



Lamps and two power transistors are on outside of case. Wiring guide is below.

NOTE TYPE OF EXTRUDED FIBRE INSULATING WASHERS USED UNDER TR3 AND TR4 (ISOLATES BOLTS FROM CASE).

ALUMINUM CASE - (APPROX. 3"X4"X5")

TO BATTERY CLIP ON OPPOSITE SIDE OF CASE (POSITIVE TERMINAL OF BATTERY B3)

MICA INSULATORS

PL2



TO NEGATIVE TERMINAL OF BATTERY B4

TERMINAL STRIP

BOTH HOLD LAMP PL1

PL1

TO PL1

BOTTOM BATTERY TERMINALS ARE CONNECTED (+ TO -)

TR3 MOUNTED ON LOWER PART OF CASE SIMILAR TO TR4

NOTE:

RIGHT SIDE OF CASE (INCLUDING BATTERY CLIP FOR B3 AND B4) OMITTED TO CLARIFY WIRING. (BOTTOM TERMINALS OF B3 AND B4 ARE CONNECTED LIKE B1 AND B2 AT LEFT).

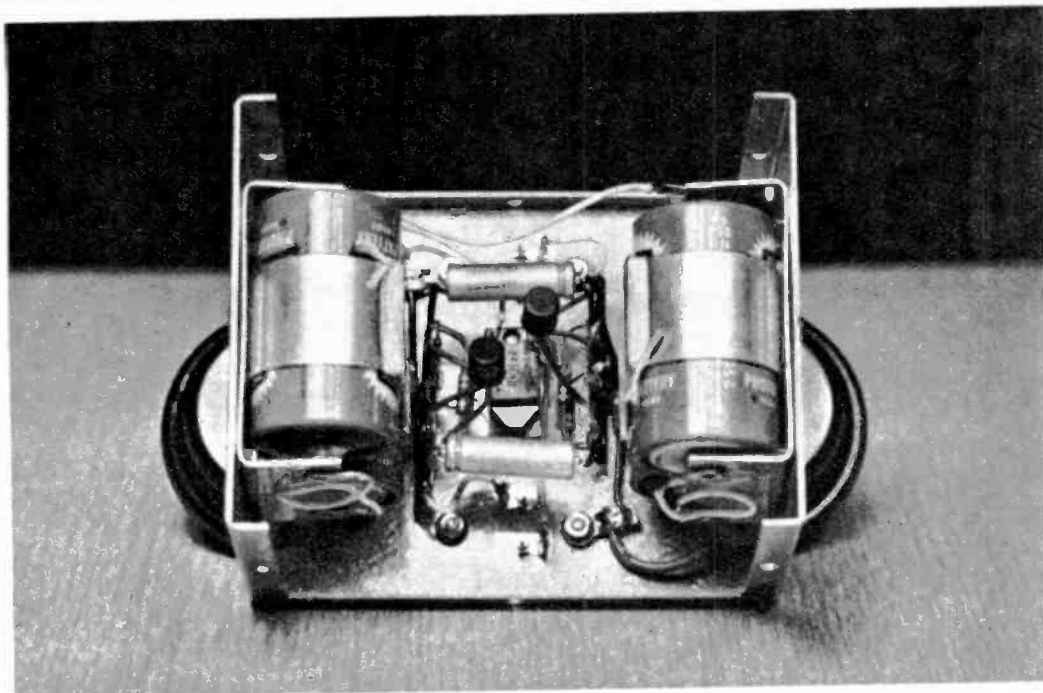

Rear view of flasher with its cover removed. Note mounting of flashlight batteries. The pair at right were omitted in the wiring guide for clarity.

A FLASHER using two alternately operating incandescent lamps is one of the most efficient attention attractors available. It is very useful as an automobile emergency light, an obstruction marker, or a portable runway marker for private airfields. Four type D flashlight cells ensure maximum life at the least cost and weight. Under continuous use the batteries should last about 3 hours, and of course, they are obtainable nearly everywhere.

The flashing lamps are rated at three candle power and are visible over a long distance. Red plastic caps are used on the lamp holders to give warning signals. They can be replaced with amber, green, or clear caps if you wish.

For those interested in how the circuits operate, here it is in detail. Two inexpensive, medium-power transistors (TR1 and TR2) in a multivibrator circuit are used to key a pair of power transistors (TR3 and TR4) in a very efficient electronic switch which turns the lamps alternately on and off.

The output of TR1 is coupled to the input of TR2 through capacitor C2, and the output of V2 is coupled back to the input of V1 through capacitor C1. This combination generates a series of pulses, with the pulse rate being determined by the size of C1,R3 and C2,R4. In addition, R3 and R4 serve as base bias resistors for TR1 and TR2 and temperature stabilization is provided by returning them to their respective collectors.

A small portion of the pulse generated by TR1 is applied to the input of TR3 by direct-coupling the TR1 emitter to the TR3 base. Similarly the TR2 output pulse is coupled to the TR4 input.

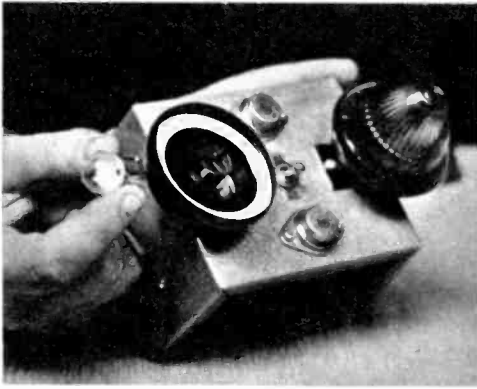

Left, plastic cap is shown removed to reveal auto-type 6-volt bulb rated at 3 candlepower.

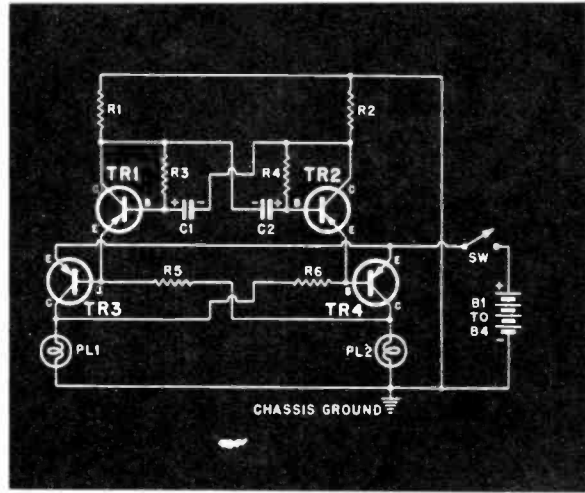
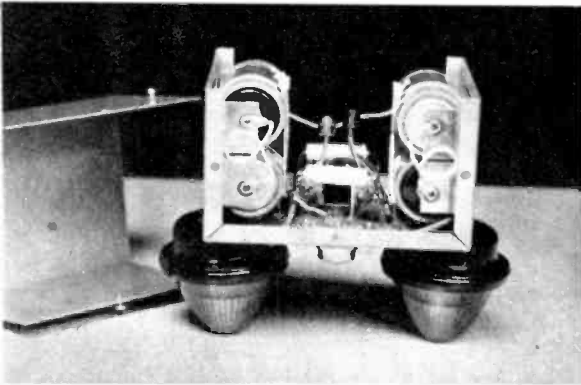

"C" on TR3 and TR4 is transistors' metal case, isolated from ground by the mica insulators.

Side view, cover removed. The brackets that come with lamps are used for mounting them.

TR3, TR4, R5, and R6 form a flip-flop electronic switch that turns PL1 and PL2 on and off. In this circuit one transistor is "on" (conducts current heavily) while the other is turned "off" (not conducting). When a pulse is applied to the "off" transistor it immediately switches to the "on" condition and at the same time turns the "on" transistor "off."

Using the values given for C1, R3 and C2, R4 the flash rate will be about 100 per minute. By making R3 and R4 (or C1 and C2) smaller the flash rate can be increased, but do not try to make it too high because the lamps will not have time to light completely.

To mount the power transistors TR3 and TR4, drill the mounting screw holes, and then make $\frac{1}{8}$ " holes for the base and emitter pins. Now fasten the transistors to the case and carefully scribe an outline around their shells. Remove the transistors and carefully scrape the paint off the case within this outline. This must be done to provide good ther-

mal contact between the transistors and the chassis, through the mica insulators.

Some parts suppliers now sell a power transistor mounting kit but you can make your own quite easily at a fraction of the cost. With a drill carefully make holes for the mounting screws and base and emitter pins in a sheet of mica. A suitable grade of mica is obtainable at most hardware stores. Scribe an outline of the transistor shell on the mica and cut out along this outline. Now ease a
[Continued on page 115]

PARTS LIST

- C1, C2—50 mfd electrolytic capacitor 12 volt
- R1, R2—330 ohm resistor $\frac{1}{2}$ watt
- R3, R4—33,000 ohm resistor $\frac{1}{2}$ watt
- R5, R6—220 ohm resistor $\frac{1}{2}$ watt
- B1 thru B4—1.5 volt type D flashlight cells
- PL1, PL2,—6 volt lamps, 3-CP (GE type 63)
- SW—SPST toggle switch
- TR1, TR2—2N270 transistor (RCA)
- TR3, TR4—2N301 transistor (RCA)
- Misc.—two holders for 2 type D cells, 2 holders for type 63 lamps (Auto Lamp Co. Model 666, sold by Sears Roebuck), two 4-terminal tie points (1 lug grounded) aluminum box 3"x4"x5", mica

here's a zoo where . . .

The Animals Talk Back

SNAKES, reptiles and fish at the Frankfurt Zoo in West Germany are ordinarily isolated from visitors by thick, sound-blocking glass. But with the aid of small radio receivers, guests can hear not only the sounds of the animals, but also expert tape recorded zoological lectures on the animals' habits, living conditions, etc. The palm-sized receivers pick up the zoo's own low-powered radio station. Guided tours are often conducted in this manner.



Below, youngster rents a transistorized radio for the German equivalent of 37 cents. It will permit him to hear many interesting sounds and facts about the animals. At left, two girls hear about and watch "friendly" crocodiles.



Glass between reptile and visitors is no problem here. Animals' sounds are tape recorded, amplified, and then played over air. At right, the director of the zoo's aquarium prepares an expert lecture on new additions to fish tanks.





Master tapes, everything from pops to the classics, are re-recorded originally at 15 ips. Dubbing them with high fidelity onto reels for home use at 7½ ips is now a booming industry.

Photos by Mike Bonvino

how they

Pre-Record Hi-Fi Tape

Electronics Illustrated visits one of the leading companies producing prerecorded hi-fidelity tapes.

The electronics of the duplication mechanism must power up to 12 tape heads at one time. Master tape is placed at top left. Take-up reels are at right. Below master are blank tapes. Six more take-up reels and blanks are on opposite side of machine, which runs at 30 ips. At right is close-up of threading spindles and heavy flywheel, bottom.

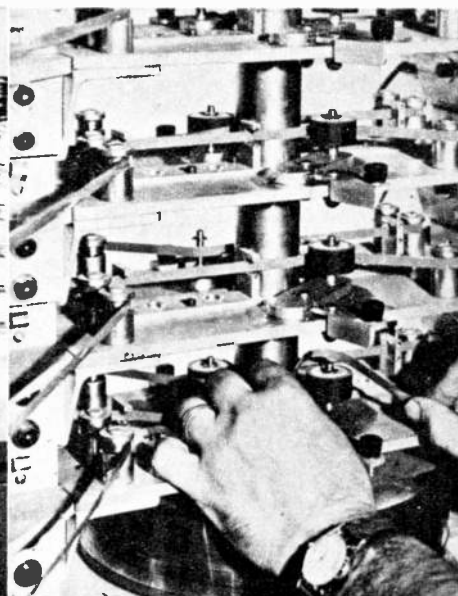
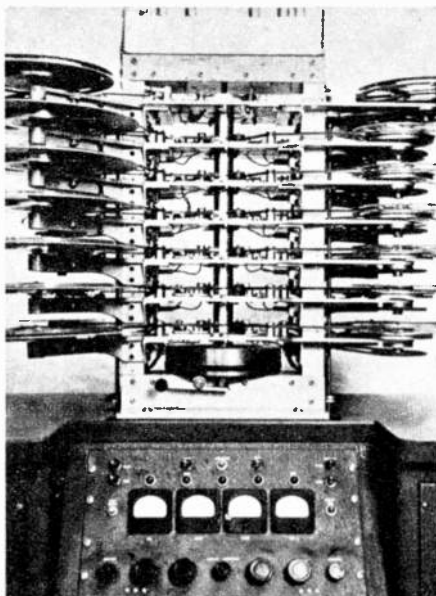

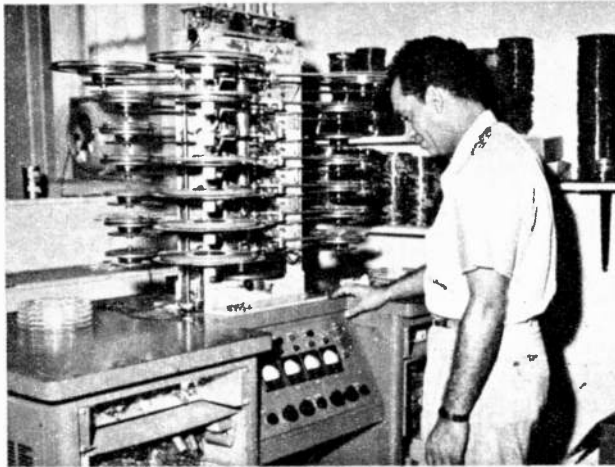

Technician watches audio levels as master and slaves merrily spin out on spindles. When it comes to the end of the run, two pairs of . . .



. . . very fast hands remove the completed tapes. Tape heads can be changed from monophonic to two- and four-track stereo easily.

TO many hi-fi buffs, the sounds that come from pre-recorded stereo and monophonic tapes still represent the best in music listening. These audiophiles will admit that records are often good, inexpensive and long-lasting. But they are quick to point out that the original performance was, after all, recorded on tape. And the best fidelity, they claim, is not achieved by pressing the sound into mechanical grooves on a plastic platter, but by going from tape to—you guessed it—tape.

In order to satisfy this growing army of listeners (many of whom remained loyal to tape throughout the initial boom of stereo records), dubbing plants are working full blast, sometimes seven days a week. *Electronics Illustrated* recently visited such a plant, Dubblings Inc., at Hewlett, New York. We wanted to see first hand just how a master tape recording is duplicated hundreds, even thousands of times. And we also wanted to see how the challenge of two- and four-track stereo tape is being met.

Don't go looking through your music library for the Dubblings label. Chances are you won't find one because the only tape they ever issued under their own signature was a very popular test tape. That was a few years back. Now Dubblings is concerned mainly with taking master tape recordings made by some of the top label companies and duplicating them on 7" reels for the consumer. Almost all the well-known, and some of the lesser known labels send their masters to Dubblings for the "production run."

What happens when a master tape, originally recorded at 15 inches per second on an oversize reel, comes in for duplication? Let's take a look . . .

The emphasis, of course, is on fidelity. First the master is placed on a professional Ampex tape playback and fed through specially designed Hegeman speakers. The music also shows up as tracings on an oscilloscope. A trained audio engineer listens and watches for balance, gain, peaks, etc., making notes all the while. The most favorable overall settings for the duplication gear are determined in the light of the master tape's quality. Any special instructions



Audio engineer, using Ampex professional playback, checks sample tape for quality.



Tapes that have passed listening tests are packaged in colorful recording company boxes.

Those that have even minor flaws are erased by this girl using a magnetic bulk tape eraser.

sent along by the recording company are also carefully noted.

The master is then placed on unique design duplication and amplification racks that can make as many as 12 dubbings from one run-through of the master. Large reels of blank magnetic recording tape are placed on the proper spindles, as are the empty take-up reels. The most commonly used tape is $1\frac{1}{2}$ mil acetate, which has been found to give the most satisfactory results in the home.

The master, you will recall, was originally recorded at 15 ips. Now it is run at 30 ips after being threaded around several capstans placed so as to maintain just the right pressure.

It takes about eight minutes for one



Gain of each stereo channel is checked on VU meters while music is traced on oscilloscope.



run producing 12 tapes. Trained operators carefully watch the run and with lightning-like hands remove the completed reels. These are then tested at $7\frac{1}{2}$ ips, packed and shipped. Any tapes found to be not quite up to snuff are either erased and re-run, or discarded entirely.

Stereo tapes are being produced at the rate of four for every one of monophonic. But when you have two or four tracks on a thin strip of tape, head alignment becomes very important. Gaps between tracks are very narrow and a slight misalignment usually results in unpleasant crosstalk. Julie Komins, head of Dubbings, insists that his tape heads be aligned every few weeks and

[Continued on page 126]

Try These

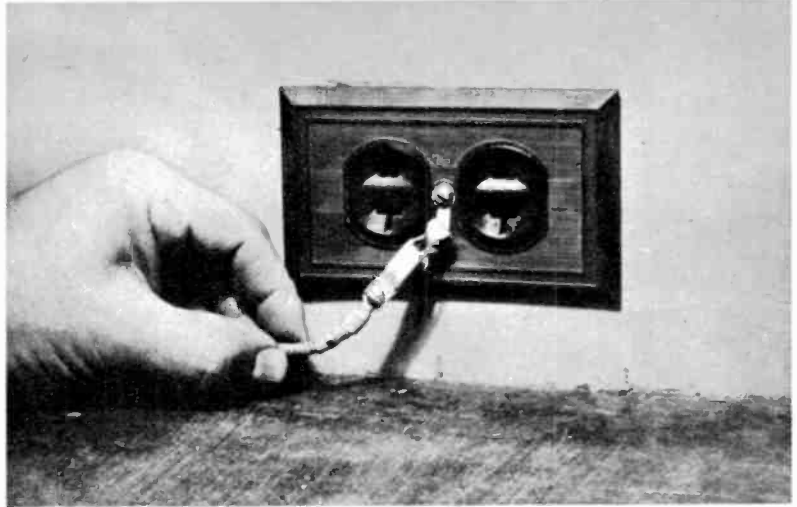

Ground Connection

Place a lug under the screw that holds the cover plate on an AC wall outlet. Clip onto lug when equipment requires a good electrical ground connection.



Dated Batteries

Batteries left inside a multimeter over a period of time may cause damage through leakage. Use label as a reminder to change batteries once a year.

Tin Can Shield

Recording tape can be affected by exposure to magnetic fields generated by motors, transformers and electronic gear. Can acts as magnetic shield.



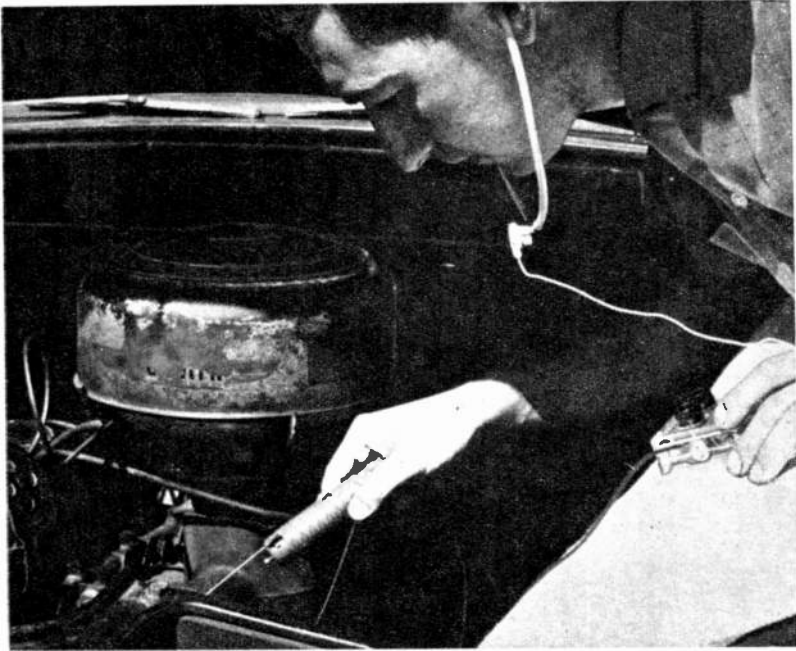

Thin wire at end of hand-held probe reveals noise source in car engine. Sounds are amplified in case at right, then fed to stethoscope earphone.

Car Rattle Tracer

By Paul Hertzberg

Track down vibration and rattles in your car. This sensitive probe helps to pinpoint the noise.

THE home mechanic, auto repair man and the experimenter will find many uses for this vibration and rattle detector such as finding loose engine valves, poorly bolted fenders and checking surface smoothness.

The hand held probe, containing a crystal phono cartridge, changes mechanical movements into electrical impulses. The pulses are coupled to a single stage transistor audio amplifier by a sub-miniature input transformer. The volume of the amplifier is controlled by potentiometer R1, which also acts as an on-off switch similar to a conventional radio volume control. A tone control circuit has been added which can help interpret sounds. The output of the amplifier is heard through a stethoscope type headset.

The amplifier and battery power supply fit into a small plastic box. All the parts are mounted on a piece of perforated Bakelite board and to the plastic box. The transistor is held in place by passing its leads down through one set of holes on one side of the board and up the next set of holes on the other side. The mounting

Visible on front panel of unit are R1, at left, to control volume, and R3 right, the tone control.

Schematic shows 1-transistor circuit. Probe wire is inserted into cartridge. Wiring guide is below.

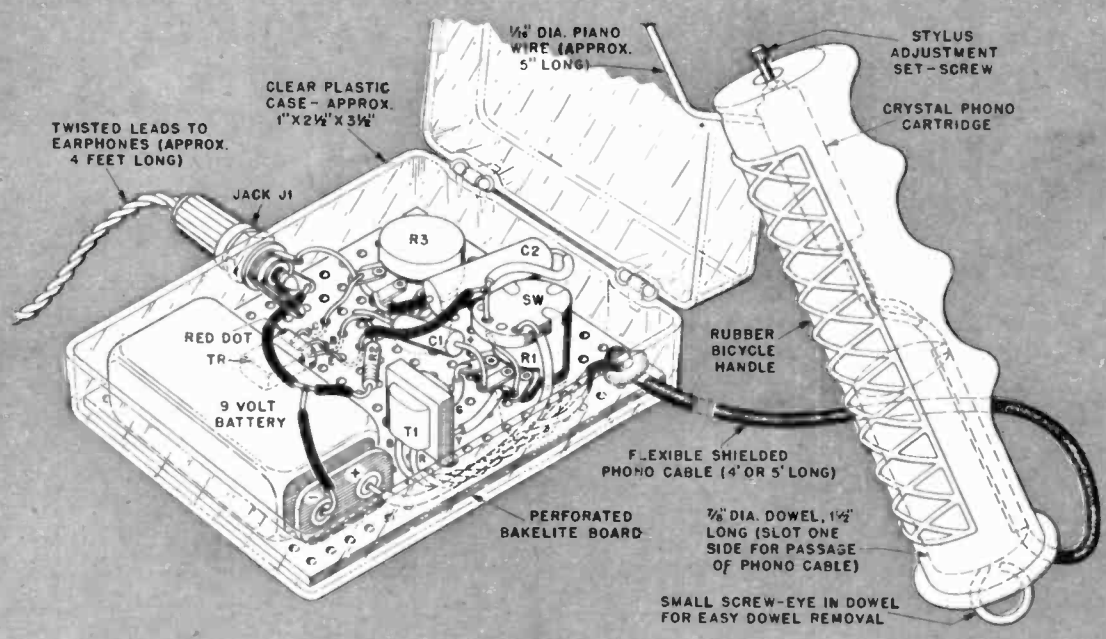
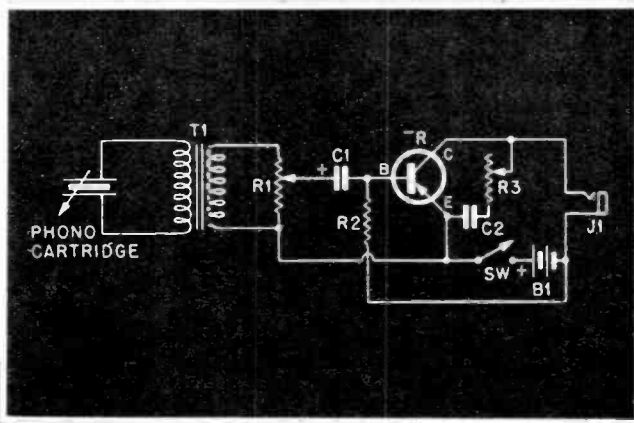
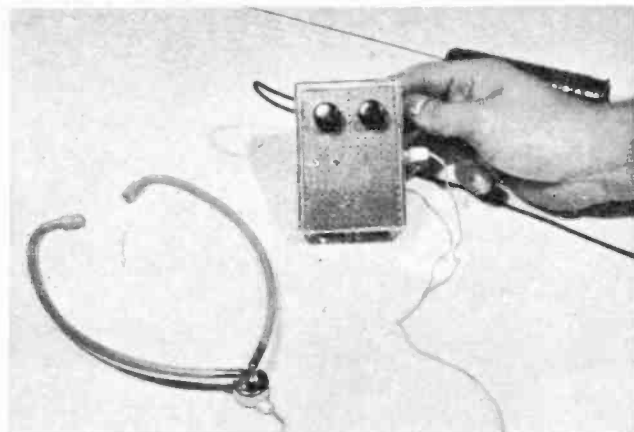

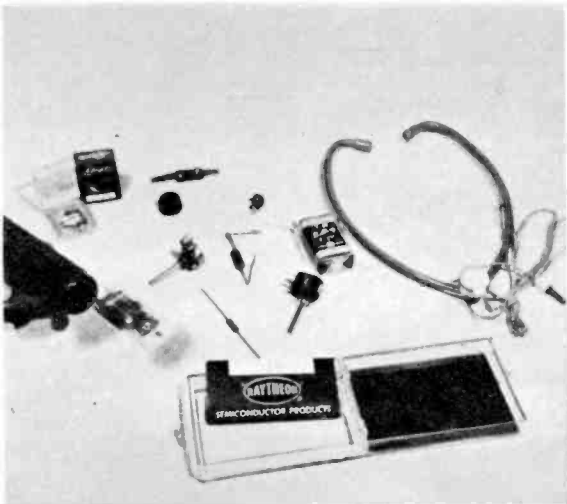

Necessary parts for unit are shown here. Hand at left holds bicycle grip used for probe.

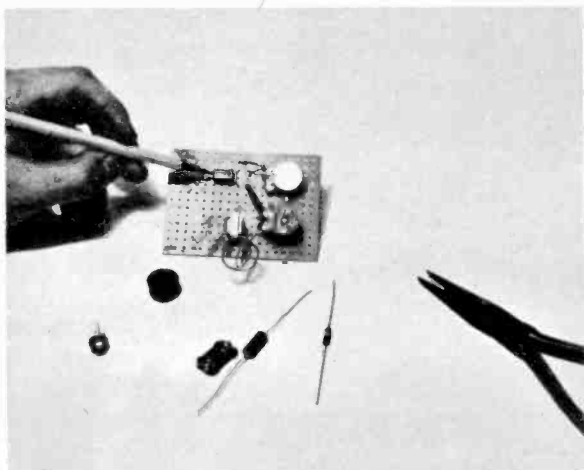

Above, pencil points to transistor TR, threaded into holes of perforated board and soldered to other parts.

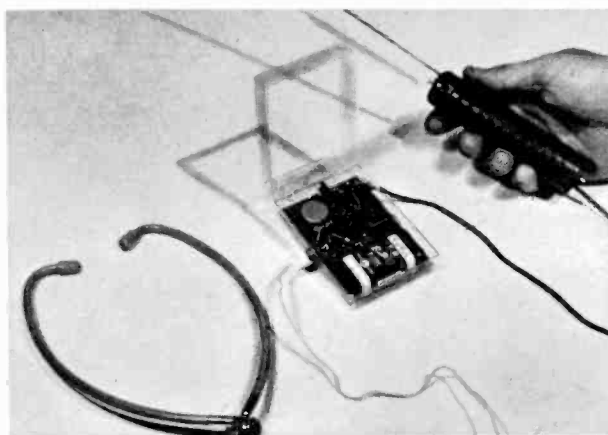

After all the parts have been mounted and wired, the perforated board is placed into the plastic case.

tabs of the small transformer are passed through and crimped on the underside of the board. Control shafts pass through the box and are turned by small plastic knobs. A miniature jack mounted to the box allows the removal of the headset for use on other projects. Special care should be taken when soldering the transistor leads. Hold the lead to be soldered with a pair of long-nosed pliers between the transistor and the joint to act as a heat sink.

The probe consists of a rubber bicycle handle with the phono cartridge inside. The end of the handle is closed with a piece of dowel stick which also holds the cartridge in place. The metal needle or tip is a piece of $\frac{1}{16}$ " piano wire slightly rounded at the end.

Putting the unit into operation, the

auto mechanic can localize noisy valves, loose bearings, rattling tail pipes or fenders, etc. The probe will also pick up sound inside a wrist watch.

PARTS LIST

- C1—10 mfd electrolytic capacitor 15 volt
- C2—.05 mfd paper capacitor 200 volt
- R1—50,000 ohm volume control with SPST switch (SW)
- R2—150,000 ohm resistor $\frac{1}{2}$ watt
- R3—25,000 ohm potentiometer
- J1—Miniature open circuit jack (Telex 12102)
- B1—9 volt battery, type 2U6
- T1—Sub-miniature input transformer 100K to 1K (Lafayette TR-97)
- TR—CK721 transistor
- Phono Cartridge—Crystal type with approx. 3 volts output
- Misc.—Plastic box $3\frac{1}{2}$ "x $2\frac{3}{4}$ "x $1\frac{1}{8}$ ", knobs, perforated board, flea clips, 5000 ohm magnetic ear-phones (Lafayette MS-340), shielded phono cable, rubber bicycle handle, piano wire.

Label Your Equipment

By Morris Goodman

DECALS have long been popular with the home constructor as a means of dressing up his equipment. They are widely available in booklet or sheet form from radio supply houses. But, occasionally some non-standard label is needed—one that doesn't appear on the sheets that have labels for hi-fi, communications receiver, etc.

Here is a method that enables you to do your own printing. Special marking ink and rubber type permit any combination of letters. A complete kit, shown in these illustrations, was purchased from C. Nelson Labs, Box 449, Radio City, N. Y. at a cost of \$3.75.

Obtain a flat piece of glass about [Continued on page 126]

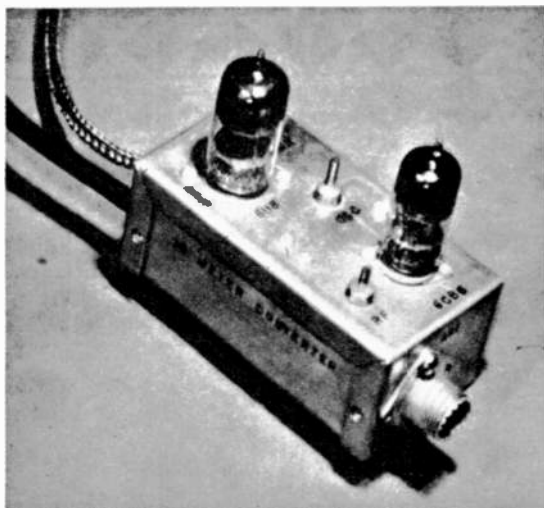

Typical labeling job, above, lends professional touch to a homebrew ham converter used in 10 meter rig.

Below, required materials include glass plate, ink, type, acetone, tweezers, ruler.

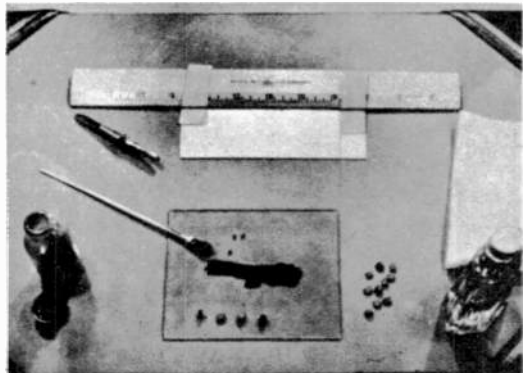

Using a guide ruler taped to the work, each letter is printed onto metal panel with the aid of tweezers.

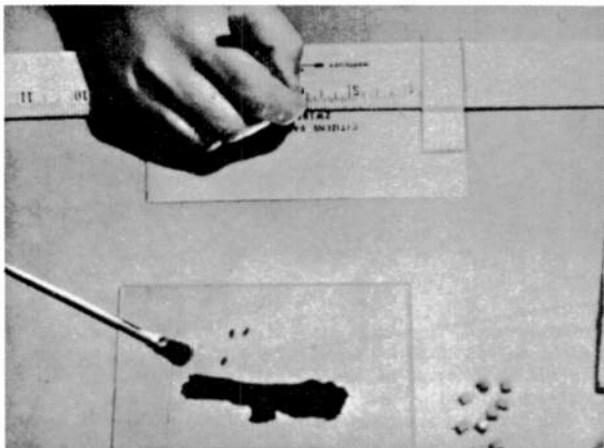

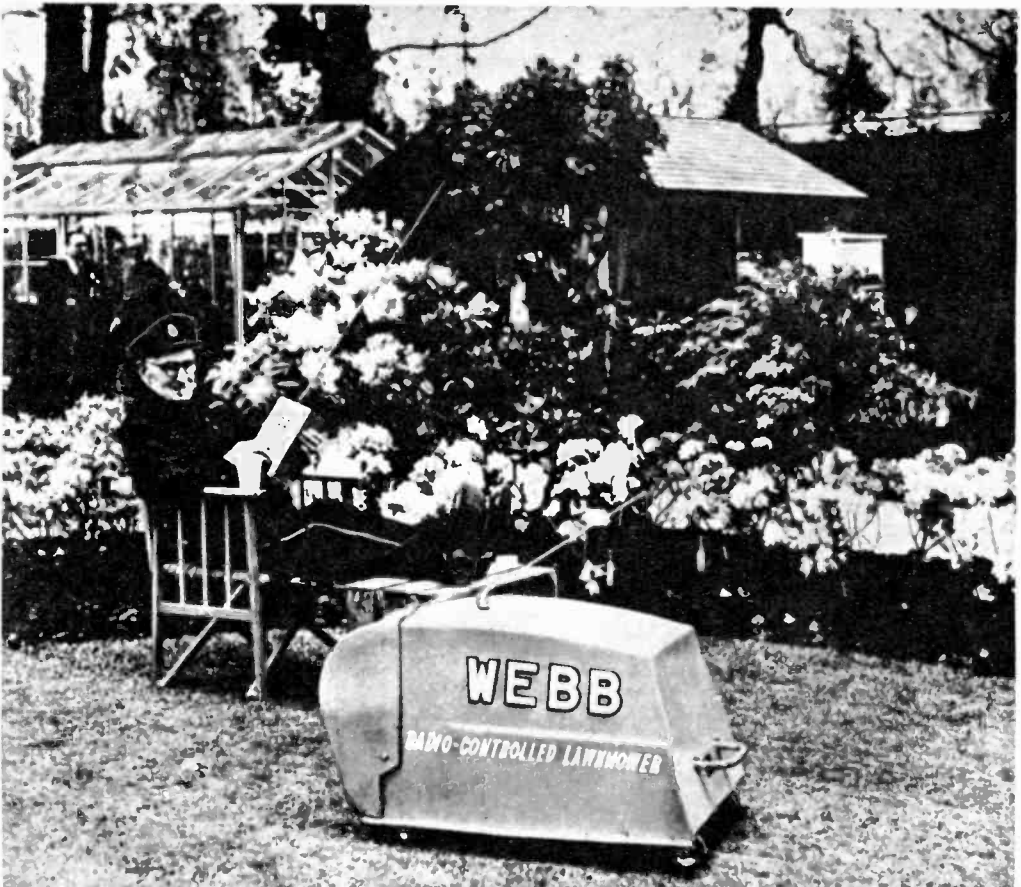
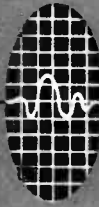

Legs crossed, cigarette between his smiling lips and radio transmitter in his hands—that's really living! And what's he doing? Why, of course, he's cutting the grass! It took 78 years for Alfred Elleray to realize this gardener's dream-come-true. Here he demonstrates a radio-controlled lawn mower at London's fashionable Chelsea Flower Show, the most important event of the British gardening year. The lawn mower is limited to a safe speed of two miles an hour and is manufactured by H. C. Webb & Co., Ltd., of Birmingham, England. It is guided by a touch of a switch and virtually guarantees a comfortable old age for the tired, harrassed homeowner.



A horse show can be a wide open affair, and the Devon festivities in Philadelphia this year were no exception. But radio stepped in to aid the ringmasters in the form of RCA's "personal-fone." The small FM units were used to relay results of judging directly to the public address announcer who, in turn, passed them on to "horsey set" in stands.

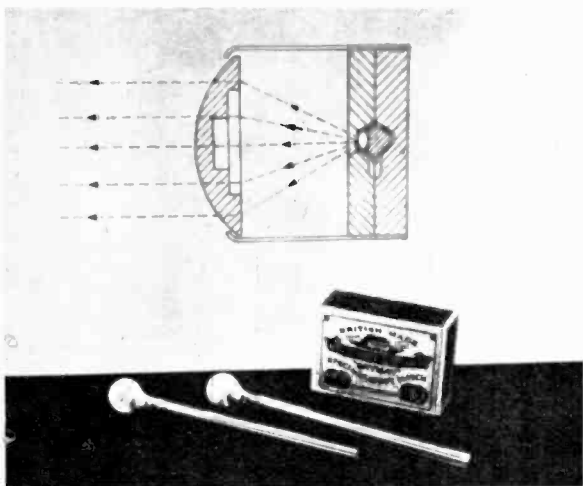

Atomic lamps have been developed by A.E.I. Co. of England. Phosphors are bonded to the inside of the bulb, with a tiny clear glass "window" left uncoated. With a radioactive gas sealed in, the phosphor glows and light escapes from the window. Diagram of a completed bulb is shown above two tiny units.

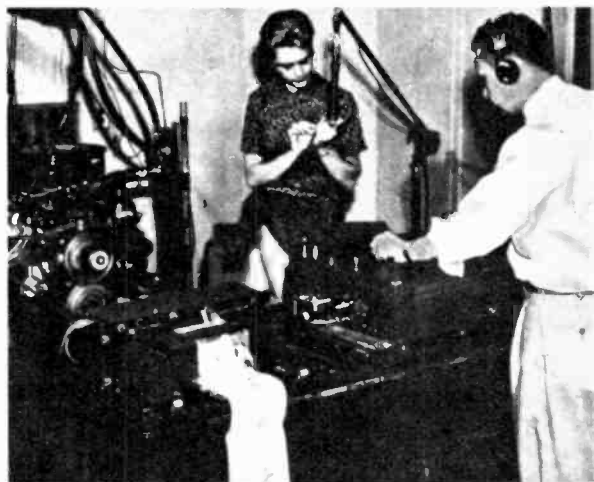

One engine noise is separated from another by Buick's ultra-sensitive frequency analyzer and level recorder. The object is to find out what makes a car noisy, and then alter it to make it quiet. The unit, with two-cycle-wide band pass filter, excludes all but one noise at a time. We wonder how many db nail file is producing.

E I assemblies

A Transistorized Power Supply

The EICO 1020 kit is a handy substitute for battery power—useful to the experimenter and serviceman.

THE EICO 1020 Power Supply is the experimenter's and serviceman's answer to cumbersome battery packs. The supply can be used for servicing transistor radios, hearing aids and electrical devices needing up to 30 volts. The unit will also supply DC for tube filaments and electroplating. The output voltage is adjustable over its full range.

Two silicon rectifiers and two power transistors are used to keep undesirable ripple voltage to a minimum. Under full load ripple content is 1/200 of 1%. A meter on the front panel monitors the output voltage on two scales. One reads from 0 to 6 volts and the other from 0 to 30 volts. To prevent any damage to the power transistors, the circuit is fused at the power transformer secondary where it will react to overload directly and not through the transformer's resistance and core.

The mechanical assembly entails [Continued on page 110]

Unit is supplying 9 volts, in place of six flashlight batteries, during alignment of transistor radio set.

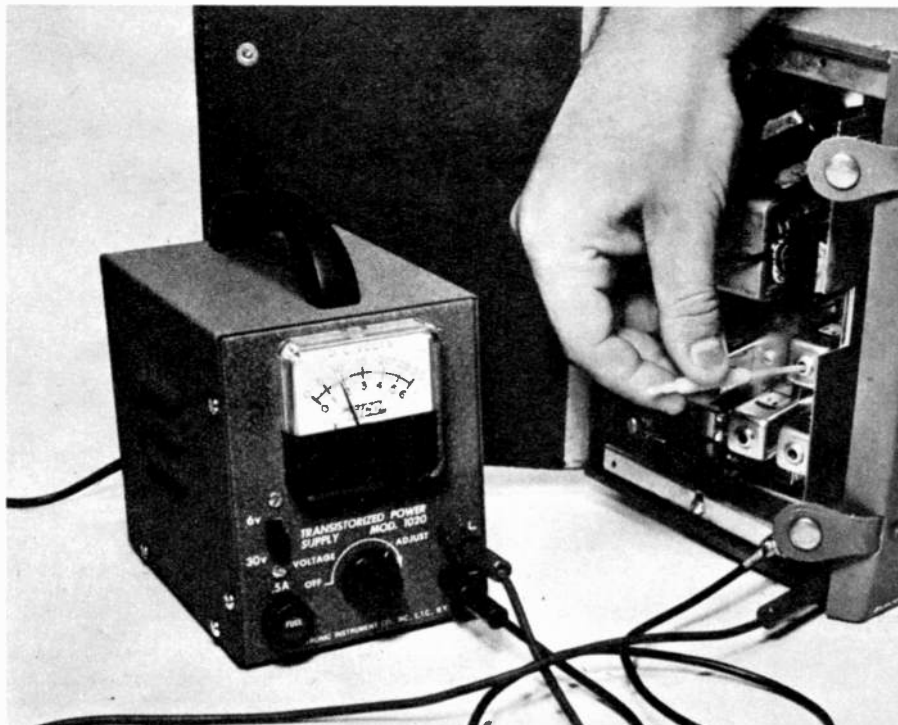

All parts are spread out and checked against parts list prior to assembly. Hand, at right, holds two power transistors.



Completed power supply outside its case. Pencil points to tiny button-like silicon diode, part of full-wave rectifier.

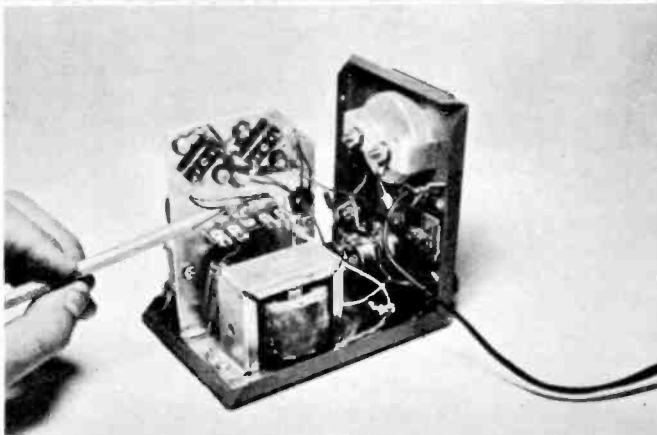

Other side shows two transistors mounted at top edge. Below them are large electrolytic capacitors in filter section.

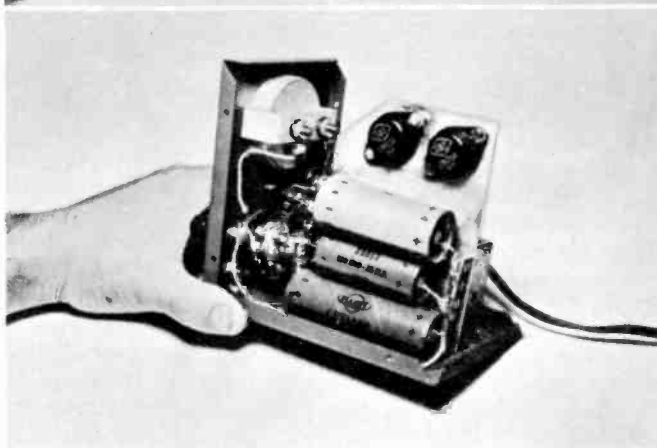

TR1 and TR2 at top center of schematic are the transistors. They regulate output voltage and smooth out ripple content.

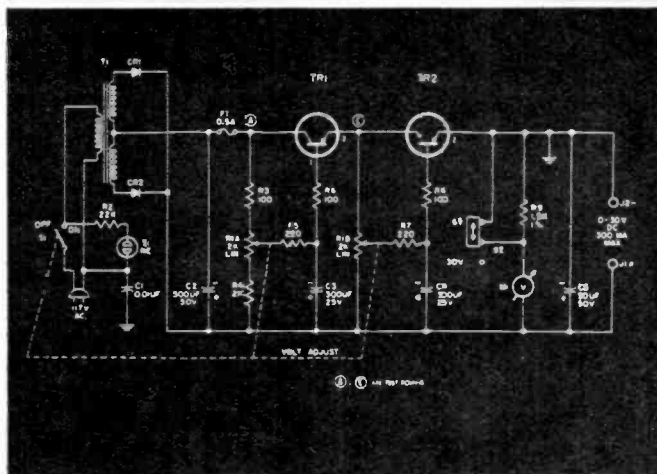

Continued from page 47

peak value of any wave applied to it. Some oscilloscopes contain an internal voltage calibrating circuit and this simplifies the procedure considerably. In other 'scopes no such facility is present and an external calibrating voltage must be used. The end result, in either case, is the same.

Let us consider first an instrument which contains its own voltage calibrator. Such an oscilloscope is shown in Fig. 3 and it has three front panel controls for this purpose. In the center of the panel there is a continuously variable knob labeled "P-P CAL. VOLTAGE." Right next to it is a 3-position selector switch labeled "P-P RANGE." These two controls operate together, with the "P-P RANGE" control establishing the maximum calibrating voltage which is fed into the vertical deflection system. For example, in Fig. 3, this control is set to the 5V range. Hence, when the control "P-P CAL. VOLTAGE" is turned completely clockwise, a full 5 volts peak-to-peak square wave will appear on the screen. If the "P-P CAL. VOLTAGE" control is set to an intermediate position, the peak-to-peak value of the wave seen on the screen will decrease accordingly. Thus, there is available a continuous variation of the calibrating square wave from 0 to 5 volts.

The two additional positions on the "P-P RANGE" control are .5 volts and .05 volts. The third control associated with the voltage measurement circuit is in the lower left-hand corner of the oscilloscope panel; it is the pushbutton labeled "P-P CAL." Its purpose is to bring in the calibrating voltage when this is required, at the same time removing whatever other signal may be present on the screen.

Now let us see how this measurement circuit is employed. As a first step, the wave whose amplitude is to be measured is applied to the vertical input terminals. Then, with the vertical gain control, adjust the amplitude of this wave until it occupies a reasonable height—say about one-half the size of

the screen. The position of the vertical attenuator control is important in this measurement but for the moment we will assume that it is set on the X1 position. To facilitate the measurement, it is generally best to have the wave extend over a specific number of vertical squares on the screen mask. A simple figure to work with in this respect is 10 or 15 squares.

Next, the "P-P CAL." pushbutton is depressed. The "P-P CAL. VOLTAGE" knob is then rotated until the square wave pattern occupies the same number of vertical squares on the screen mask as the original wave pattern. Note that while this square calibrating voltage pattern is on the screen, the input signal is disconnected from the vertical deflection amplifier. Therefore, only the square wave pattern appears on the screen. Once the calibrating pattern attains the same height as the input wave, the peak-to-peak value of this wave is obtained from the settings of the "P-P RANGE" and the "P-P CAL. VOLTAGE" controls. For example, if the "P-P RANGE" control is set for 5 volts and the "P-P CAL. VOLTAGE" control is set to 3, only 3 of that 5 volts are being employed by the calibrating voltage and the peak-to-peak voltage is 3 volts.

Now suppose that instead of the vertical attenuator being on the X1 position, it had been placed on the X10 position. In this case, the settings of the "P-P RANGE" control and the "P-P CAL. VOLTAGE" control would have had to be multiplied by 10 because with the vertical attenuator in the X10 position all input signals are reduced by a factor of 10. Finally, if the vertical attenuator had been in the X100 position, all the readings would have had to be multiplied by 100 to get the peak-to-peak value of the input signal. In this way, a wide range of peak-to-peak values can be measured.

The oscilloscope shown in Fig. 3 has a fairly elaborate measurement section. On many 'scopes all that is available for this purpose is a single fixed voltage having a known peak-to-peak value. For example, in the oscilloscope shown in Fig. 4, there is a knob in the lower left-hand corner of the front panel

which provides one volt peak-to-peak voltage. To use it for measurement purposes, we would proceed as follows:

Apply the wave whose amplitude is to be determined to the vertical input terminals of the oscilloscope, adjusting the vertical gain control until the wave occupies a specific number of vertical squares on the screen mask. Let us say that it is 15 squares. Now, remove the signal, and without touching the vertical gain control, apply the 1 volt peak-to-peak calibration voltage to the same vertical input terminals. A sine wave will appear on the screen. Compare its height with that of the previous wave and if the two cover as many vertical squares, then both possess the same peak-to-peak value. However, for the more general case, when it does not occupy the same number of the squares as the original wave, the following computation would be made:

Calibration Voltage Value		Unknown Voltage		
No. of Vertical Squares it Covers	=	No. of Vertical Squares it Covers		

The calibration voltage value here is 1 volt. Let us say it covers 2 squares. The unknown input voltage covers 15 squares. Hence,

$$\frac{1 \text{ volt}}{2} = \frac{X}{15}$$

then,

$$2X = 15$$

and

$$X = 7.5 \text{ volts peak-to-peak}$$

(The same formula would be employed had the amplitude of the calibration wave been greater than that of the unknown wave.)

If the vertical attenuator is in a position other than X1, the final result above is multiplied by the factor on the attenuation control; i.e., X10 or X100. This follows the preceding procedure.

If an oscilloscope has no provision for a calibrating voltage, it can still be utilized for voltage measurements by employing an external calibrating voltage.

The procedure would be as follows:

Apply the wave whose amplitude is to be measured to the vertical input terminals of the oscilloscope, adjusting the vertical attenuation and vertical gain controls until the wave occupies a specific number of vertical squares on the screen mask. Now, remove the signal and in its place, apply the known calibrating voltage. Note the number of squares it covers. (Do not touch any of the oscilloscope controls during this portion of the procedure.) Then, by using the formula given previously, the peak-to-peak value of the unknown signal can be determined.

Measurements made this way can be as accurate as measurements made with conventional VOM's or VTVM's.

Off-Track Betting

Continued from page 32

be punched at the track or central location by pulses from the off-track betting stations.

At El Comandante, as the cards are received, they are run through the Univac computer located in a special "pool" building. By post time, a complete and permanent record is made of every bet, the total in the pool, and the odds. Immediately following each race, the winning cards are automatically selected by electronic sorters, operating at a rate of 800 cards per minute.

From the first to the last, everything is automatic. Not a single human corrupt hand can get near the bets or the results. In addition, as soon as the machines pick out the winners, a new electronic circuit whirs into action and each winner's check is automatically printed.

This system, in operation for two years, is considered eminently successful. Not once has it broken down. Not once has anyone yelled foul or fake. Yet it has already processed more than 30-million off-track bets.

Off-track betting system is now pouring more than \$2,000,000 a year into Puerto Rico's treasury. This represents the sixth largest source of income for the island government. The figures might be much higher if it were not for the fact that a large proportion of Puerto

Rico's population are too poor to bet at all. There is perhaps hardly a mayor—or governor—in all the United States who would not consider his administration blessed to receive a similar proportion of tax money from a single, "painless" source.

Returning to New York to talk with officials and off-track betting aficionados, I could easily see why all hopes for off-track betting's Stateside success hinges on electronics. While Puerto Ricans can take the bets to the computers at El Comandante by auto and helicopter, any attempt to do this in New York would send the highway casualty figures rocketing upwards.

Here's how the system would work in New York:

Business machines will be provided for accepting wagers at tellers' windows; such machines will issue a non-alterable ticket on "safety" paper.

The machine will produce an electrical impulse which marks paper tape. The tape information then can be transmitted over cables to a control center. Or the window machines may directly impulse the transmitting wires, thereby recording the information in the control center.

The window machine will be equipped to record the number of transactions by denominations and type so as to provide local office accountability. Provision will be made so that when a certain race is closed for wagering, the machine will not accept such late-time bets.

The machine will be capable of handling more than one track and one race at a time, with acceptances of wagers in the amounts of \$2, \$10, and \$50 and for win, place and show. The same machine will also be capable of accepting daily double bets and validating winners.

At the central control office, modern electronic computers for the receipt of information from branch offices will be capable of providing full accounting control both for the receipt and for the disbursing of funds. An auxiliary source of power will be provided so operations may continue in event of power failure.

In a sense, at least one vital electronics element in any future off-track

betting plan has already gone through the mill of field trials and proven successful. It is a machine called the "Amteller," invented and produced by the American Totalisator division of Universal Controls, Inc.

Shaped and designed pretty much like a streamlined cash register, Amteller electronically takes a paper currency bet from anyone, anywhere, and automatically activates the ticket-issuing machine alongside to deliver the ticket. Of course, it was designed to speed up betting at crowded racetracks, but its potential is obvious.

Consider this: You walk up to Amteller, place a \$5 bill face up in a special slot. You select your horse by pressing a button. Amteller's electronic scanner gives the bill the once-over to verify the amount and genuineness, slips the bill into a till, and sets the ticket-issuing machine to turning. The bettor picks up his ticket and the machine is ready for the next bet—all in one second.

Since Amteller can be electronically linked to any electro-mechanical control system, for all we know the first off-track betting scheme in the U. S. may very well see a form of vending-machine betting, with Amtellers scattered about town like public telephone booths, soft drink machines, etc.

Just in case you think you might be able to pull a fast one, like laying \$5 on the nose of a horse that happens to be heading for the winning wire in the home stretch and then, with split-second timing, get yourself a winning ticket from Amteller, perish the thought of larceny. Totalisator engineers have taken care of that little thought. Just before the race starts, an official at the track presses a button and Amtellers everywhere shut down until race is over.

So, that's it. If nothing else, off-track betting is sure to fill the coffers of many electronics producers, designers, engineers and technicians. Meanwhile, if perchance you've had a little experience in the "sport of kings" and you happen to have some ideas as to how electronics can better serve civilization's yearning for off-track bets, Mayor Wagner would sure be delighted to hear from you. He gets his mail at City Hall, New York. ●

The Solid Circuit

Continued from page 87

with an impressive list of names—molecular electronics, molelectronics, solid circuits, functional circuits, integrated circuits—is quite different.

How is it possible to make entire circuits as single units? There is more than one technique, but you must begin with a substrate, a foundation material upon which the entire circuit is built. The substrate might be an insulating material or semiconductor material similar to that used in transistors.

When an insulating material is used as the foundation substrate, resistances and capacitances can be obtained by the "deposition process." This is simply a technique whereby the substrate is placed in a carefully controlled vacuum and by carefully adding thin films of resistive material, desired values of resistance can be obtained.

In practice, the desired amount of film is "deposited" on the substrate by actually masking out the area of the substrate where no film is desired. Remember, the masked substrate is in a vacuum with the resistive material. By heating the resistive material until it vaporizes and carefully controlling the vacuum, the vaporized material adheres to the substrate in a thin film.

In a similar manner, it is possible to deposit thin films to act as the interconnecting "wires" of the circuit. In this case, a different material is used—one that has very little resistance to current flow.

Values of capacitance can be obtained by choosing a third type of film—one that has a high dielectric constant or is nonconducting. Use of insulating material as a substrate limits the circuits obtainable to "passive" circuits. These are circuits, if produced conventionally, that would only contain resistors, capacitors and chokes, but no diodes or transistors. A typical example would be a filter.

In a more exciting approach, semiconductor material is used as the substrate. Desired values of resistance and capacitance can again be obtained by depositing thin films of different mate-

rials. Here, however, it is possible to form "active" components such as transistors and diodes by the usual diffusion process as described in the August issue of *Electronics Illustrated* ("What's New With Transistors").

These solid circuit techniques are not the only known ones. They are the most popular, however, and perhaps the simplest in concept. It is possible with these techniques to build circuits in layers. This can be done, for example, by making a circuit as described and then depositing an insulating film that completely covers the circuit. Then, another circuit is simply fabricated on top of this insulating film, and so on.

What does this solid-circuit concept mean to the man and woman on the street? It could mean personal portable radios completely contained in a woman's earring. Wall-hugging flat TV sets. What's more, solid circuits are most likely to be tougher, able to withstand more shock and vibration than the interconnected component circuits of today.

Many companies here and abroad are working on solid circuits. Texas Instruments, RCA, Westinghouse, Varo Mfg. Co. are a few. Each firm has its own approach. Texas Instruments, for example, uses semiconductor substrate with diodes and transistors formed by diffusion. However, as seen in the accompanying illustrations, resistors are not formed by thin films nor are capacitors. Resistance values are obtained simply by using a contact to the substrate that has the desired amount of resistance. Capacitance values are obtained by taking advantage of the fact that a PN junction exhibits a definite amount of capacitance. The larger the junction area, the more capacitance.

The major problem today is that there doesn't seem to be any workable way of obtaining values of inductance that are useful. This limits the kinds of circuits, or else a compromise has to be made by placing the inductive component external to the rest of the circuit. There will most likely be a solution soon to the inductance problem, thereby lifting any restriction on the circuit type. ●

80 Meters

Continued from page 43

articles). It will then pass through the national net, then into a regional system, and finally to the area net. Sometimes one or more of these stages can be eliminated. Nearly all area nets operate on 75 or 80 meters. Most begin at 1900 local standard time before the regional and national schedules. A few also convene later at 2200 so that the new traffic which has just come in from the regional net is handled promptly.

DX on 80

We said there was such a thing as DX on this band, and there is. That's assuming you go by the real definition of DX. DX for the ham is either the contacting of any station beyond its normal range, or contact with a rare, unusual or new place. Thus a QSO (contact) between an American ham and a DL (Germany) on 20 meters would not be considered DX (unless the DL was running something like 5 watts). But oceanspanning on 75 and 80 is always difficult and therefore it is always DX.

The usable radio spectrum is divided into several segments (see chart). You're probably most familiar with what the layman calls shortwave and medium wave. Now for practical purposes, 80 meters is the closest thing to a medium wave challenge the amateur can take on. His only real MW frequencies, 160 meters (not being discussed in this series), are so clogged with LORAN interference that most hams have just about given up on their "Basement Band." Thus if an individual operator were willing to try DX 160 style, he'd have trouble finding another station also willing to buck the high noise level created by LORAN.

So for the time being at least, amateurs looking for low frequency DX will have to content themselves with 80 meters, 3.5-4.0 mc. And this "easier substitute" will certainly provide all the battle they can handle. Best time for your fight with the elements is late fall, winter and very early spring, during the morning hours of darkness, between midnight

and 6 a.m. That time period is best because absorption is at a minimum and most stations interested primarily in rag chewing are off the air, thereby creating many clear channels. During the first couple hours trans-Atlantic contacts will be possible, especially along the east coast. Then toward sunrise trans-Pacific DX can be had. And just so you don't miss anything, we'll mention that occasionally DX can be had in the evening.

A final note: Make-up of the band differs throughout the world. For example, skillful tuners will sometimes hear programming between 3900 and 4000 kc. These aren't amateurs with special privileges, but actual broadcast stations overseas. Don't attempt to contact them. ●

Transistorized Power Supply

Continued from page 103

mounting the front panel terminals, voltage control, range switch, transistor chassis and meter. Extreme care must be taken with the thin mica washers used to insulate the transistors from the chassis. Overtightening causes the mica to crack allowing the body of the transistor to short circuit to the chassis. Only seven fixed resistors and five capacitors are used and they are quickly soldered into place. Total time from the sealed carton to power supply operation was about two hours.

In actual operation it is necessary to know the current that will be drawn by the device you wish to operate or test. Do not exceed more than 150 ma up to 12 volts, 200 ma up to 24 volts and 300 ma up to 30 volts. Connecting a milliammeter in series with the load will give you an idea when you are approaching the power supply's limits.

The Model 1020 will substitute for batteries when you wish to operate any low voltage equipment from the AC power lines. During alignment of radios and TV the 1020 can be used to "kill" AVC and AGC voltage. This Transistorized Power and Bias Supply is sold by Electronic Instrument Co., 33-00 Northern Blvd., Long Island City 1, N. Y. It is priced at \$19.95 in kit form. ●

Earphone Echo Chamber

Continued from page 35

of approximately .0015 seconds. The amount of delay (in other words, the length of tubing used) may be varied in accordance with the acoustic needs of the listener. In testing this device with a number of friends, preferred delay footages varying from 10 to 35 feet were encountered. Once the footage has been determined, the tubing is coiled in a circular fashion and taped with friction or electrical tape. In order to isolate the line from any possible vibrations, a thin layer of ordinary absorbent cotton is placed on the bottom of the box and the coiled tubing is laid on top of it. One end of the tubing is pushed out through one of the holes in the side of the delay line box. The other end of the tubing is attached directly to the Telex magnetic driver. Because of these units' low power requirements, stringent impedance matching need not be adhered to. Any unit from 15 to 128 ohm impedance will do nicely. These magnetic drivers are terminated in a small metal lip and the tubing described here can be press-fitted directly over this lip and no further gluing is necessary. If tubing of different diameters is used, it may be necessary to glue the tubing to the Telex driver. The delay driver and line have now been connected. Another piece of tubing, about 6" long, is employed to feed the undelayed signal. One end of this tubing is pushed through the remaining hole while the other end is attached to the other Telex driver and the whole assembly is then placed into the delay line box. The cables supplied with the Telex drivers are attached to the units and the box is filled with sound absorbing cotton.

The wiring of the top plate is very simple. One important point should be borne in mind: the cords from the Telex drivers contain a special soft cable which is very difficult to work. Consequently, the plugs supplied should be soldered directly into the circuit and no attempt should be made to clip short the cable and work with the actual conductors. Any excess wire is simply coiled and taped and left in the center

of the delay line box. Note: a DPDT switch is shown on the wiring guide. It was available; an SPST is preferable.

The lid of the delay line box is screwed on with four wood screws. In this particular unit, gum rubber surgical tubing was used to bring the sound to the ears. One end of this gum rubber tubing was press-fitted over the two delay line output tubes. On the other ends of the gum rubber tubing we pushed two standard plastic earphone pieces. It is of course not necessary to use gum rubber tubing since any tubing, including delay line tubing, will do the trick.

Operation

The output from any monophonic power amplifier is fed to the input of the delay line box. The 4, 8 or 16 ohm tap on the amplifier output transformer may be used. The two gain controls on the delay line regulate the power input to each of the two drivers. These two controls are actually balance controls. Once a proper balance has been obtained, the volume should be controlled from amplifier's main volume control.

The unit can also be used as an echo generator. This is accomplished by removing the earpiece tubing from the delay line output and replacing it with a high impedance crystal earphone. The output of this earphone is then fed back into a high gain channel on the amplifier, giving a distinct echo effect.

One word of caution? the frequency response of this delay line and its associated magnetic drivers is only fair. However, the effect generated by this device is very, very striking and tends to prove, to some extent, that tonal effects are possibly more pleasing in some instances than extremely linear response. The device works best, unquestionably, when it is used in a manner for which it was originally designed: that is, with two earpieces. When used as an echo chamber for recording or playback through speakers, the end effect may very well be striking but will have an essentially poor frequency response, especially in the low frequencies below 300 cycles and in the high frequencies above 7,000 cycles. ●

When Chaos Hit Airwaves

Continued from page 63

being seriously disrupted. Obviously, Government legislation of some kind was needed. The result was the enactment of the Radio Act 1912.

The new Act created a law enforcement body in the Department of Commerce, the Radio Service. Under the Bureau of Navigation, it was to determine the legality of radio apparatus adjustment, issue station licenses, and examine all would-be operators to determine their technical qualifications and code proficiency.

Radio schools were hastily established by communications companies and others. The operator shortage was acute.

Amateurs too, were not immune from examination and licensing requirements, both for themselves and for their equipment. District offices had been established at nine strategic points in major cities along all U. S. seacoasts. These were staffed with one or two Inspectors. Examinations for operator licenses, both amateur and commercial, were conducted at these points. Routine inspections of shipboard and land stations were made periodically. Occasional violations of regulations by amateurs were investigated and appropriate corrective action taken. All in all, the Radio Service was fast becoming a smooth operation when the United States entered World War I.

Many merchant vessels were taken over by the Navy, as were shore stations serving the marine interests. Amateur stations were immediately closed "for the duration," all except 7DJ at Hoquiam, Wash. This station was taken over intact by the Navy Department, staffed with Naval personnel.

A large number of the personnel of the Radio Service volunteered for duty with the various combat branches and were given leaves of absence by the Department. The skeleton force in Radio Service offices carried out the highly secret and important function of tracking down illegal radio stations being operated by the enemy engaged in es-

spionage work. One such was the huge German-owned trans-Atlantic station at Sayville, N. Y. With the co-operation of Charles Apgar, an amateur radio operator of Westfield, N. J., who made wax recordings of all of Sayville's transmissions and turned them over to officials, the Sayville station was seized and closed.

The 1918 Armistice brought an avalanche of license applications for sea-going vessels and shore stations released by the Navy to their former owners. Where some 6000 amateurs had existed prior to the war, many additional thousands of released military and Naval personnel who had been radio-trained in service schools were eager to join their ranks. As a result, it was *two and one-half years* since the ban had been placed on amateur operation before the word went out: "Radio amateur operating and licensing procedures will be resumed effective October 1, 1919!"

If commercial applications had been an avalanche, the flood of amateur applicants was a tidal wave! By the *thousands* applications for both station and operator licenses poured in! Each operator had to be examined individually by a qualified Inspector.

An inspection usually consisted of measuring the primary power input to the high voltage transformer by means of a portable watt-meter to insure that power input did not exceed the legal 1000 watts. The wavelength was then measured and the logarithmic decrement of the oscillations determined by means of the Kolster Decremeter.

The initial flood of applications subsided. Then, in the fall of 1921, Frank Conrad, chief engineer of the Westinghouse Co., inaugurated regularly scheduled broadcasting of music and entertainment from his private experimental station, 8XK, in Pittsburgh. The initial experiments proved so successful that the station was soon moved to the Westinghouse plant and began regular operation as KDKA.

This novel form of entertainment immediately caught the public fancy and demands for receiving equipment swamped the few factories then manufacturing radio apparatus.

Radio telegraph stations had never been a serious licensing and inspection problem. But now a number of applications disclosed an ominous threat. Many were for small, low-powered radio telephones, 20 to 50 watts. Schools, churches, villages, individuals. What was all this? Further examination of the forms indicated that most were planning to, or already had built, their own transmitting equipment. Many applicants were woefully under-financed. Their equipment was meager and, on paper, appeared to be a heterogeneous collection of odd parts of doubtful quality. Many applicants also expected to act as "engineers" and operators of these peanut whistle stations. They were long on enthusiasm and very short on radio know-how. Again chaos!

The state of the art at that time was such that many applicants could be turned down flat on the strength of technical limitations which would permit only a relatively few stations in a geographical area. At that time only two wavelengths were available, 360 and 400 meters. Stations had to be staggered geographically, as well as by wavelength and time of operation.

And then, a new storm burst! District offices of the Radio Service suddenly experienced an alarming increase in their mail. Complaints by the hundreds poured in accusing the radio amateur of deliberate interference with reception of the programs.

The Service realized that it was entirely probable that not only a legally operated amateur station, but ships and shore stations as well could cause interference on the crude receiving equipment being used for broadcast reception. Radio telegraph transmitters of the spark type were still perfectly legal and were being used by the vast majority of amateur and commercial stations. To force immediate conversion to the more modern vacuum tube transmitter would result in a storm of protest from those who had made substantial investments in existing equipment.

I well remember crouching on a street corner in Buffalo in the dead of winter, equipped with a "MURAD" six tube receiver, loop antenna and battery, trying

to ferret out the probable location of an offending amateur station through swirling snow flakes, a cutting wind and a temperature close to zero! It was many hours and early morning before we were able to pinpoint him.

So strong was the tide of public opinion against them that in spite of their splendid war services and their technical contributions to the art, amateurs *voluntarily* established a "silent period." From 7 to 10:30 p.m. nightly they would shut down their transmitters to enable new listeners to receive the broadcast entertainment. As it had proven very effective where it had been observed, the Service established *compulsory* quiet hours from 8 to 10 p.m. nightly and on Sunday mornings during the broadcasting of church services.

I recall one instance when I was serving in Detroit. I had installed in my home a 20 watt vacuum tube transmitter, equipped for both CW and ICW operation so that I could communicate with either spark or vacuum tube equipped amateur stations, if need be. During one period of monitoring the amateur wavelengths during silent hours, I picked up a fairly loud spark signal peaked in the neighborhood of 180 meters. He was calling CQ. I answered him and he came right back with a lengthy discourse on my signal, etc.

I replied briefly in kind and then inquired, "How come you are operating during silent hours?" hoping that he would not ask me the same! His reply came right back, "Ha, ha, old man! The Radio Inspector doesn't know it!"

I hesitated a moment, then called him back and said, "But this is the Radio Inspector!" I'll never forget the sudden change in his fist when he replied!

In 1927 there came the "Radio Act of 1927." Substantially the same as the "Radio Act of 1912," additional provisions were set up to keep pace with the rapid development of the art. The Federal Radio Commission was set up, absorbing the personnel and functions of the Radio Service.

Seven years later the Federal Radio Commission was superseded by the present-day Federal Communications Commission. ●

How To Buy a Hi-Fi Tape Recorder

Continued from page 51

two- and four-track playback is not so knotty as you might imagine. Most manufacturers, sensing possible public confusion, have made some provision so that a simple lever or screw adjustment will result in the desired number of stereo tracks. This is a feature to consider when looking over the field.

For every additional mechanical or electronic feature, expect to pay. Decide carefully what features you need or want before you walk into the store.

Speed? Ah, yes, speed. Pre-recorded tapes are issued at $7\frac{1}{2}$ ips (inches of tape passing by the tape head per second), which seems to be the best balance between fidelity and playing time. That speed is the standard for music. The higher-fidelity 15 ips is usually restricted to professional machines.

The slower $3\frac{3}{4}$ ips speed, while more than adequate for voice reproduction, has yet to prove itself with music. Attempts to do just that are still being pushed by certain manufacturers.

Just about all machines have external speaker jacks and inputs for microphone and phonograph or tuner. Other desirable features include automatic cut-offs so that the machine shuts off when the reel is played out, speaker cut-offs, monitoring heads, recording indicators, etc.

Volume indicators come in three varieties: Neon bulbs, "magic eyes," and meters. Of the three, the meter gives the most accurate indication and can be read with a greater degree of certainty than the fluctuations of either the neon bulbs or the "magic eye." Some machines designed for stereo duplicate the volume indicator for each channel. Two meters represent more ease of balancing stereo channels, but neon bulbs and "magic eyes" can give you quite satisfactory indications once you learn how to read them properly.

When they tell you the machine you're looking at has a "monitoring" feature look close! To monitor the actual recording there must be a separate playback head in position right

after the recording head, and a separate preamp. You won't find this on many machines under \$425.

With regard to motors, about the only thing that can be said is that the more the better. More motors mean fewer belts to slip and wear and less functions for any given motor to perform. Of course, the more motors, the more money it will cost you. Hysteresis synchronous motors are generally found on the more expensive machines, but are not necessary for home recorders. A good four-pole motor is fine.

Perhaps the most important feature to be considered is that of portability. Do you really need and want a portable machine? Unless you're willing to buy a tape machine that lists for well over \$200, chances are its electronics are not going to be as good as those of your existing home high fidelity system. Certainly the self-contained speakers in the lower-priced units leave much to be desired.

The fast rising popularity of tape decks is a deserved popularity. First of all, this is the easy and *inexpensive* way to add tape to an existing system, especially stereo. Tape-head inputs may be found on just about all preamp control centers and amplifiers, stereo and monophonic.

Now after you've decided on what you want in a tape recorder, how do you go about selecting the best one in your price range? Remember that the salesman is there to serve you, so take advantage of this fact. He may have some ideas on what you should buy, but don't settle for any machine strictly on his say-so. Insist upon testing and comparing the machines that have the features you want. If he is too busy to assist you, come back another time when he is not so busy.

What tests should you perform? First of all, have the salesman show you how the recorder operates, and then you operate it! You will soon know exactly how easy or difficult it is to thread the machine, rewind, record, monitor, etc.

For all listening tests, have the salesman plug in an external high fidelity speaker, since the monitor-type speakers, especially in portable units,

do not show the recorder to best advantage.

A friend or relative should accompany you to the store. He will come in handy when you test the recorder on voice. Have your companion talk into the microphone, then have the salesman play back the recording. Then determine to what degree the recording sounds like your friend. It is not a good idea to record and listen to your own voice since most people just cannot recognize their own voice.

The next listening test also involves recording, this time from either a record or a good FM radio or tuner. Record at $7\frac{1}{2}$ ips. The playback should sound as good as the original. Now shift this recording to another machine. Does it sound the same? Does it lose anything?

Now ask the salesman for a test tape that has a steady signal somewhere around 3000 cycles. If he doesn't have a test tape, settle for a recording of a solo instrument such as a piano or violin. Listen for variation in tone. If the variation is noticeable, forget about buying that particular machine and turn to another. Wow and flutter, serious bugaboos, show up readily in this sort of test. They are usually a result of poor design of the tape transport mechanism. Such a condition will get worse, not better.

Then play the test tape or solo recording at the slowest speed the machine offers. While holding the take up reel, place your finger on the feed reel and spin it to release all tension on the tape. As this length of tension-less tape goes past the heads, there should be no variation in the sound.

Too much tension on the tape between the guide and the take up reel will result in unnecessary wear on the tape heads. But even more undesirable is wear on the tape itself, and stretching of the tape. The lower the tension, the better. How do you check for too much tension? The same way you checked for wow and flutter, but this time advance the test tape until only about a minute of the recording remains on the feed reel. Excess tension will show up at this point as pronounced wow and flutter.

Next put just any reel of tape on the machine, preferably one that is blank

or that has something unimportant recorded on it. Run this tape at the fast forward speed, allowing it to go just as fast as possible. Then switch it quickly to stop. Does the tape spill? Did it snap? Stretch? If it does any of these, you may be in for trouble at home. Then do the same thing on rewind.

Finally, listen carefully at high volume for crosstalk from a dual-track monophonic tape or from a stereo tape. The less feedthrough sound, the better.

The extra time you take in making these simple tests will give you fair certainty that the tape machine you purchase will be a "high fidelity" unit. Of course, make sure you can return the machine you buy before a reasonable time if you find you have one of those rare "lemons" or a machine that does not live up to expectations. The unhurried home appraisal may turn up points overlooked in the store. ●

Emergency Flasher

Continued from page 90

sharp knife into one edge of the mica to split it in sheets about .003" thick. Coat both faces of the mica with silicone grease, or thin household oil, and after making sure that there are no burrs on the case or transistor, mount each transistor with one such insulator between it and the case.

Now cut out a small piece of mica and drill $\frac{1}{16}$ " holes in it, to fit over the base and emitter pins inside the chassis. This insulator will prevent the base and emitter contact clips from accidentally touching the metal case. The base and emitter connectors are obtained by dismantling a 7-pin miniature wafer tube socket and salvaging four of the contacts. Save the other three for the next project.

When soldering to the various contact lugs on TR3 and TR4, remove these lugs temporarily to avoid overheating the transistors. Also, when soldering TR1, TR2, C1 and C2 in place take the usual precautions to avoid damaging them.

After construction is completed adjust the lamp filaments so that they are parallel to obtain best beam separation. ●

Continued from page 39

The instant modulation is applied the carrier deviates from its rest point. Strength remains constant, but frequency "swings" above and below 100 mc.

Audio shifts the carrier in two important ways; the key to how modulation is superimposed onto the carrier which transports it over the miles between transmitting and receiving antennas.

First is *rate*. If the audio is a 1000 cycle tone, the carrier shifts from its rest point 1000 times per second. Thus, we have encoded the frequency (or pitch) of the audio tone into a carrier shifting at the identical rate.

But this is not enough. The carrier must also bear information regarding the loudness of the audio. *Deviation* is the answer. The louder the audio tone, the *further* the carrier is driven from its rest point. Standards in FM broadcasting permit the carrier to depart from its rest point within the bandwidth of plus or minus 75 kilocycles. This shouldn't be confused with audio frequency response. It indicates that the 100 mc carrier may swing up to 100.075 mc, and down to 99.925 mc, for the very loudest tones. The pitch of the tone governs only how *rapidly* the carrier deviates within its prescribed limits. The detection process in the FM tuner takes this information off the carrier and reproduces the original audio voltage.

The *slope detector* is the forerunner of the more modern FM ratio detector. We'll pause here to explain it since it

should aid in understanding the more complex circuit. Fig. 1 is a response curve of a 10.7 mc IF transformer. Its operation is the same as the units used in AM, where 455 kc is the standard IF frequency. Note how its voltage output rises as the incoming frequency approaches the transformer's resonant point at the center of the curve. The base line in Fig. 1 shows frequency, compared to the vertical line which reveals voltage. Note that if the carrier wave (now at 10.7 mc) is centered on the *peak* of the curve the output voltage will merely drop off as deviation in frequency occurs. But let's tune the transformer to a higher frequency and center the 10.7 mc down on the "slope" of the curve. Detection is now accomplished. If the carrier rises in frequency (closer to transformer resonance) output voltage increases. If the carrier shifts downward (going further from resonance) the output voltage will correspondingly drop.

The slope detector has its drawbacks. The slope is rather short and can only accommodate a limited amount of swing. Distortion results when deviation is too great. It is interesting to note that FM can be detected on an AM radio due to this very principle of slope detection. It is of definite value in ham radio where FM of the narrow band type (limited deviation) is occasionally used for transmission.

The detector in the tuner illustrated in this article is a *ratio detector*. It was selected in preference to the Foster-Seeley discriminator, another common type, since it does not require limiter stages before it. A limiter serves to remove undesirable amplitude modulation from the FM waveform. Note that although the simple slope detector successfully converted FM to audio, it is still responsive to AM. The limiter slices off amplitude variations leaving the frequency unchanged. One popular limiter circuit is simply a tube in the IF stage operated at low plate voltage. If the input goes too positive, the tube saturates and will not conduct at higher signal strengths. And, if the input exceeds a given negative voltage, the tube

[Continued on page 127]

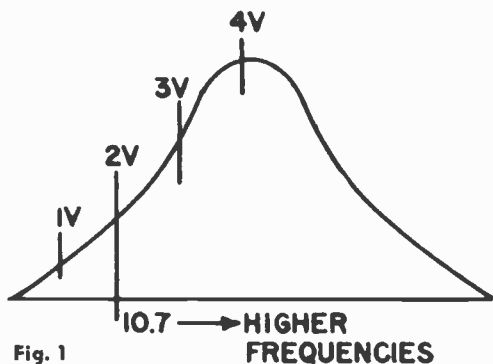
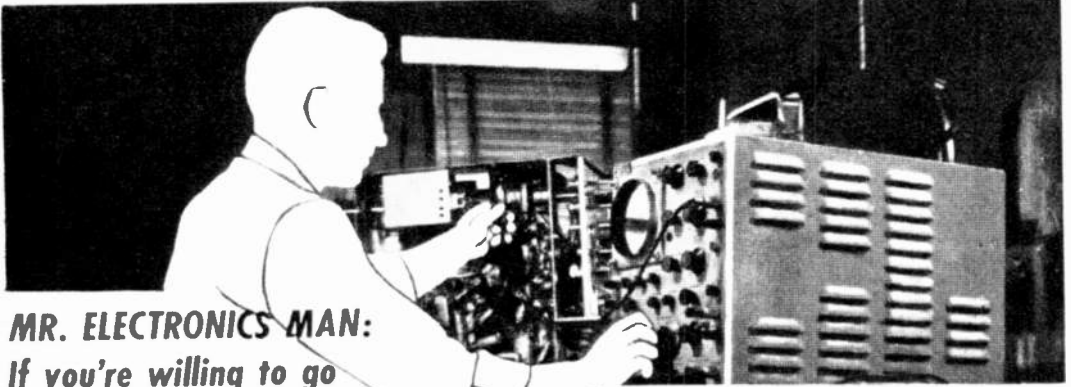

Fig. 1



MR. ELECTRONICS MAN:
If you're willing to go
just half-way in electronics
TURN THIS PAGE!

But if you're interested in an honest-to-goodness career in electronics, here's how to step ahead of job-competition, get a better job, earn more money, and be sure of holding your technical job, even when the brass starts "laying off."

The "how" is CREI home-study education. CREI offers you recognized advanced, professional home study education in Electronic Engineering Technology, including **SERVOMECHANISMS; COMPUTERS; RADAR; AUTOMATION; AERONAUTICAL ELECTRONICS; COMMUNICATIONS AND MANUFACTURING**, and the **ELECTRONIC PRINCIPLES ASSOCIATED WITH GUIDED MISSILES, TELEMETERING, ASTRONAUTICS AND INSTRUMENTATION**. You can choose your preferred course of study. You don't have to be a college graduate. You do have to be willing to study—at home. You can do it while holding down a full-time job. Thousands have. Remember this: CREI starts with fundamentals and takes you along at your own speed. You are not held back by a class, not pushed to keep up with others who have more experience or education. Your instructors guide your study and grade your written work personally. You master the fundamentals, then get into more advanced phases of electronic engineering principles and practice.

Since 1927 CREI has provided alert young men with the technical knowledge that leads to more responsibility, more job security, more money. And CREI has constantly kept pace with the rapid expansion and progress in electronics. More than 33 years' experience qualifies CREI to educate you.

How good is CREI education? CREI home study courses are accredited by the Engineers' Council for Professional Development; CREI is an approved member of the National Council of Technical Schools. Ask personnel managers how they regard a man with a CREI "ticket." Many organizations recommend CREI courses for their own personnel. These are but a few examples: United Air Lines, Canadian Broadcasting Corp., The Martin Co., Federal Electric Corp., and USIA (Voice of America).

CREI ALSO OFFERS RESIDENCE SCHOOL COURSES at the same high technical level in Washington, D.C. Classes start at regular intervals. Qualified residence school graduates earn degree, "Associate in Applied Science." Check coupon if you prefer residence study. **VETERANS:** If eligible for training under the G.I. Bill of Rights, check the coupon for full information.

NOT FOR BEGINNERS. If you have the equivalent of a high school education, and are good at mathematics, if you have some electronics experience (advanced amateur, industrial or military)—and realize the need of high-level technical knowledge to make good in the better electronic jobs—you can qualify for CREI home study. (Electronic experience is not required for admission to CREI Residence School.)

What's the next step? The logical one is to get more information than we can cram into this page. The coupon below, completely filled out, will bring you a fact-packed booklet, "Insurance for Your Future in the New World of Electronics." It includes outlines of courses, a resume of career opportunities, and tuition details. It's free.

Mail coupon today or write Capitol Radio Engineering Institute, Dept. 1701-G, 3224 16th St., N.W., Washington 10, D.C.

MAIL COUPON FOR FREE 54-PAGE BOOK

CAPITOL RADIO ENGINEERING INSTITUTE

ECPD Accredited Technical Institute Curricula—Founded 1927
 Dept. 1701-G, 3224 16th St., N.W., Washington 10, D.C.

Please send me your course outline and **FREE 54-page book, "Insurance for Your Future in the New World of Electronics"** . . . describing opportunities and CREI Home Study courses in Practical Electronic Engineering Technology.

- CHECK FIELD OF GREATEST INTEREST**
- Radar, Servo and Computer Engineering Technology
 - Electronic Engineering Technology
 - Communications Engineering Technology
 - Television Engineering Technology
 - Aeronautical Electronic Engineering Technology
 - Automation & Industrial Electronic Engineering Technology

12

Name..... Age.....

Street

City..... Zone..... State.....

CHECK: Home Study Residence School Korean Veteran

To obtain fast, immediate service and to avoid delay, it is necessary that the following information be filled in:

EMPLOYED BY

TYPE OF PRESENT WORK

EDUCATION: YEARS HIGH SCHOOL

OTHER

ELECTRONIC EXPERIENCE

SHIPPED ON APPROVAL

NEW

CRT TESTER-REACTIVATOR Model CRT-2

NOW . . . a TESTER-REACTIVATOR really designed to test, repair and reactivate EVERY PICTURE TUBE MADE — whether black and white or color . . . with exclusive features never before found in picture tube testers.



Housed in hand-rubbed oak carrying case—complete with MULTI-HEAD*

Model CRT-2
\$57.50 Net
TERMS: \$13.50 within 10 days. Balance \$11 monthly for 4 months.

The CRT-2 steps in and solves the limitations and shortcomings of present day CRT Testers. Unlike ordinary CRT testers that keep entering the field with a limited range of operation, the CRT-2 employs a new brilliantly engineered circuit designed to test, repair and reactivate every black and white or color picture tube made. The CRT-2 eliminates the guesswork and risk that until now, has always been present when a picture tube is reactivated. It accomplishes this by providing perfect control of either the 'Boost' or 'Shot' method of reactivation.

THE CRT-2 DOES ALL THIS RIGHT IN THE CARTON, OUT OF THE CARTON OR IN THE SET

TEST

- ✓ for quality of every black and white and color picture tube
- ✓ for all inter-element shorts and leakage up to one megohm
- ✓ for life expectancy

REPAIR

- ✓ Will clear inter-element shorts and leakage
- ✓ Will weld opens between any two elements in the tube gun

REACTIVATE

- ✓ The unique controlled 'SHOT' (high voltage pulse) method of reactivation provided by the CRT-2 will restore picture tubes to new life in (ton) previously used by the CRT-2 with no danger of stripping the cathode as you voltage is applied without danger of stripping the cathode as you always have perfect control of the high voltage pulse.
- ✓ The 'BOOST' method of reactivation also provided by the CRT-2 is used effectively on tubes with a superficially good picture but with poor emission and short life expectancy. It will improve definition, contrast and focus greatly and add longer life to the picture tube.

1. **THE MULTI-HEAD** (patent pending) . . . A SINGLE PLUG IN CABLE AND UNIQUE TEST HEAD — A tremendous advance over the maze of cable and adapters generally found with other testers. Enables you to test, repair and reactivate every type of picture tube with greater convenience than ever before . . . 50 degree to 110 degree types from 8 to 30", whether 12 pin base, 8 pin base, 14 pin base . . . even the very latest 7 pin base. A special color switch on the MULTI-HEAD enables you to test, repair and reactivate each of the red, green and blue color guns separately.
2. **WATCH IT REACTIVATE THE PICTURE TUBE** — You actually see and control the reactivation directly on the meter as it takes place, allowing you for the first time to properly control the reactivation voltage. This eliminates the danger of stripping the cathode of the oxide coating. It enables you to see the speed of reactivation and whether the build-up is lasting. You will see if the cathode contamination is too great and if the picture tube is too far gone to be reactivated.
3. **CONTROLLED "SHOT" WITH HIGHER VOLTAGE FOR BETTER REACTIVATION** — Stronger than any found in other testers . . . high enough to really do the job — yet controlled to avoid damage to the picture tube.
4. **UNIQUE HIGH VOLTAGE PULSE CIRCUIT** — Will burn out inter-element shorts and weld open circuits with complete safety to the picture tube.
5. **VISUAL LIFE TEST** — Enables both you and your customer to see the life expectancy of any picture tube right on the meter. The fact that your customer can see the results of your tests as you make them virtually eliminates resistance to picture tube replacement when necessary.
6. **TESTS, REPAIRS AND REACTIVATES SPECIAL LOW SCREEN VOLTAGE TUBES** — Many new type picture tubes use special low voltage of approximately 50 volts. The CRT-2 will test, repair and reactivate these types with the same thoroughness as the regular types with complete safety.
7. **SEPARATE FILAMENT VOLTAGES** — Including the very latest 2.35 volt and 8.4 volt types as well as the older 6.3 volt types.
8. **TESTS, REPAIRS AND REACTIVATES 'SF' PICTURE TUBES** — found in the newest Sylvania and Philco TV sets. These picture tubes have different base pin connections than standard picture tubes and there is always an element of risk that the tube may be burned out when tested with ordinary picture tube testers. The CRT-2 is designed to accommodate this new base pin arrangement and will test the tube with no danger of damage.

ADDITIONAL FEATURES

- Employs the time proven dynamic cathode emission test principle • Large 4½" meter with heavily damped movement for smooth action, accuracy and long life
- Provides separate shorts test for each element in the picture tube • Filament continuity is shown on a separate glow indicator • An easy to read instruction manual contains all the latest testing information on old and new type picture tubes • Housed in handsome hand-rubbed oak carrying case with special compartment for MULTI-HEAD and line cord. * patent pending

IN-CIRCUIT CONDENSER TESTER Model CT-1

Here is an IN-CIRCUIT CONDENSER that DOES THE WHOLE JOB! The CT-1 actually steps in and takes over where all other in-circuit condenser fail. The ingenious application of a dual bridge principle gives the CT-1 a tremendous range of operation . . . and makes it an absolute 'must' for every serviceman.

in-circuit checks:

- ✓ Quality of condensers even with circuit shunt resistance . . . (This includes leakage, shorts, opens, intermittents)
- ✓ Value of all condensers from 200 mmfd. to .5 mfd.
- ✓ Quality of all electrolytic condensers (the ability to hold a charge)
- ✓ Transformer, socket and wiring leakage capacity

out-of-circuit checks:

- ✓ Quality of condensers . . . (This includes leakage, shorts, opens and intermittents)
- ✓ Value of all condensers from 50 mmfd. to .5 mfd.
- ✓ Quality of all electrolytic condensers (the ability to hold a charge)
- ✓ High resistance leakage up to 300 megohms
- ✓ New or unknown condensers . . . transformer, socket, component and wiring leakage capacity

OUTSTANDING FEATURES

- Ultra-sensitive 2 tube drift-free circuitry
- Multi-color direct scale readings for both quality and value . . . in-circuit or out-of-circuit
- Simultaneous readings of circuit capacity and circuit resistance
- Built-in hi-leakage indicator sensitive to over 300 megohms
- Cannot damage circuit components
- Electronic eye balance indicator for ever greater accuracy
- Isolated power line
- Housed in sturdy hammertone finish steel case . . . comes complete with test leads

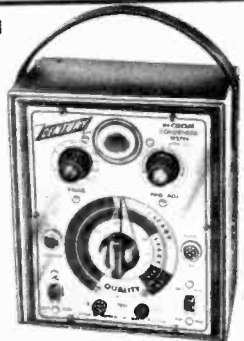

Model CT-1
\$34.50 Net
TERMS: \$9.50 within 10 days. Balance \$5 monthly for 5 months.

EASY TO BUY IF SATISFIED — see order form on facing page

FOR 10 DAY FREE TRIAL

Convince yourself at no risk that CENTURY Instruments are indispensable in your every day work. Send for instruments of your choice without obligation... try them for 10 days before your buy... only then, when satisfied, pay in easy-to-buy monthly installments — without any financing or carrying charges added.

NOW a Battery Operated Peak-to-Peak VACUUM TUBE VOLT METER Model VT-1

WITH LARGE EASY-TO-READ 6" METER —

featuring the sensational new MULTI-PROBE * Patent Pending

No extra probes to buy! The versatile MULTI-PROBE does the work of 4 probes

- ① DC Probe ② AC-Ohms Probe ③ Lo-Cap Probe ④ RF Probe

The VT-1 is a tremendous achievement in test equipment. With its unique MULTI-PROBE it will do all the jobs a V.T.V.M. should do without the expense of buying additional probes. No longer do you have to cart around a maze of entangled cables, lose time alternating cables or hunting for a misplaced probe. With just a twist of the MULTI-PROBE tip you can set it to do any one of many time-saving jobs. A special holder on side of case keeps MULTI-PROBE firmly in place ready for use.

SPECIAL HANDLING

DC VOLTMETER

Will measure D.C. down to 1.5 volts full scale with minimum circuit loading as low as .025 volts. Will measure low AC and oscillator bias voltages from .1 volts or less up to 1900 volts with consistent laboratory accuracy on all ranges. Zero center provided for all balancing measurements such as discriminator, ratio detector alignment and hi-fi amplifier balancing.

AC VOLTMETER

True Peak-to-Peak measurements as low as 3 volts of any wave form including TV sync, deflection voltage, video pulses, distortion in hi-fi amplifiers, AGC and color TV. Scale divisions are easily read down to .1 volts. Measures RMS at 1/200th the circuit loading of a V.O.M. Unlike most other V.T.V.M.'s there is no loss in accuracy on the lowest AC range.

ELECTRONIC OHMMETER

Measures from 0 down to 2 ohms. Scale divisions are easily read from .2 ohms to one billion ohms. Will detect high resistance leakage in electrolytic and bypass condensers.

RF AND LO-CAP MEASUREMENTS

With these extra VT-1 functions you can measure voltages in extremely high impedance circuits such as color TV gating pulses, mixer output levels, I.F. stage-by-stage gain and detector inputs.

OUTSTANDING FEATURES

- Completely portable — self powered with long life batteries — permits use everywhere
- New advanced pentode amplifier circuit assures amazingly low battery drain
- Large 6" 100-microampere meter, many times more sensitive than meters used in most V.T.V.M.'s
- Laboratory accuracy performance — 2% of full scale on DC, 3% of full scale on AC
- Simplified multi-color easy-to-read 4-scale meter
- No heat operation assures rigid stability and accuracy
- Immune to power line fluctuations
- Amplifier rectifier circuit with frequency compensated attenuator — a feature found only in costly laboratory instruments
- Meter completely isolated — practically burn-out proof
- Hand-crafted circuitry — 1% resistors used for permanent accuracy
- Separate phone type coaxial connector
- Matching cover protects instrument face — snaps on and off instantly.



Moused in hammer-tone steel case — complete with MULTI-PROBE

SPECIFICATIONS

- DC Volts — 0 to 1.5/6.30/150/300/600/1500 volts
- AC Volts (RMS and Peak-to-Peak) — 0 to 1/2/10/100/200/1200 volts
- Ohms — 0 to a billion ohms, 10 ohms center scale — R1/10/100/1K/10K/100K
- RF — Peak reading demodulator supplied for use on all DC ranges
- Zero Center — available on all DC volt ranges with zero at mid-scale
- Decibels — from -10 Db to +10/22/36/50/62 based on the 0db unit: 0db 1mw in 600 ohms
- Impedance — 11 megohms DC, 1 megohm AC, 10 megohms Lo-Cap
- Input Capacity — 130 mmfd. RMS, 250 mmfd. Peak-to-Peak, 25 mmfd. Lo-Cap

Model VT-1
\$58.50
Net

TERMS: \$14.50 within 10 days. Balance \$11 monthly for 4 months.

FAST-CHECK TUBE TESTER Model FC-2

Simply set two controls... insert tube... and press quality button to test any of over 700 tube types completely, accurately... IN JUST SECONDS!

Over 20,000 servicemen are now using the FAST-CHECK in their every day work and are cutting by selling more tubes with very little effort. See for yourself at no risk why so many servicemen chose the FAST-CHECK above all other tube testers.

PICTURE TUBE TEST ADAPTER INCLUDED WITH FAST-CHECK

Enables you to check all picture tubes (including the new short-neck 110 degree type) for cathode emission, shorts and life expectancy... also to rejuvenate weak picture tubes.

RANGE OF OPERATION

- Checks quality of over 700 tube types, employing the time proven dynamic cathode emission test. This covers more than 95% of all tubes in use today, including the newest series-string TV tubes, auto 1/2 plate-volt tubes, OZ4s, magic eye tubes, gas regulators, special purpose hi-fi tubes and even foreign tubes.
- Checks for inter-element shorts and leakage.
- Checks for gas content.
- Checks for life-expectancy.

SPECIFICATIONS

- No time consuming multiple switching... only two settings are required instead of banks of switches on conventional testers
- No annoying roll chart checking... tube chart listing over 700 tube types is located inside cover. New listings are added without costly roll chart replacement
- 41 phosphor bronze beryllium tube sockets never need replacement
- Checks each tube mounted on panel
- Large 4 1/2" D'Arsonval type meter is the most sensitive available, yet rugged — fully protected against accidental burn-out
- Special scale on meter for low current tubes
- Compensation for no shock hazards
- Long lasting etched aluminum panel
- Separate gas and short jewel indicators
- Line isolated — all future tube types as they come out. New tube listings are furnished periodically at no cost.

NOTE:

CONVENIENT TIME PAYMENT PLAN — NO FINANCING CHARGES

ALL CENTURY INSTRUMENTS ARE GUARANTEED FOR ONE FULL YEAR. The extremely low prices are made possible because you are buying direct from the manufacturer.

CENTURY ELECTRONICS CO., INC.

CHECK INSTRUMENTS DESIRED

- Model CRT-2 CRT TESTER REACTIVATOR \$57.50 \$13.50 within 10 days. Balance \$11 monthly for 4 months.
- Model CT-1 In-Circuit Condenser Tester \$34.50 \$9.50 within 10 days. Balance \$5 monthly for 5 months.
- Model VT-1 Battery Vacuum Tube Volt Meter \$58.50 \$14.50 within 10 days. Balance \$11 monthly for 4 months.
- Model FC-2 Fast-Check Tube Tester \$69.50 \$14.50 within 10 days. Balance \$11 monthly for 5 months.

Prices Net F.O.B. Mineola, N. Y.

111 Roosevelt Avenue, Dept. 401, Mineola, New York

Please rush the instruments checked for a 10 day free trial. If satisfied I agree to pay the down payment within 10 days and the monthly installments as shown. If not completely satisfied I will return the instruments within 10 days and there is no further obligation. It is understood there will be NO INTEREST or FINANCING charges added.

Name _____ Please print clearly
Address _____
City _____ State _____

Transistor Car Ignition

Continued from page 58

for the life of your car and which will get the most power and mileage from your engine at all times?

Such a system is not only possible, it has already been designed and built! And it will soon be available for every American car. The secret of this wonder ignition is none other than the wonder of electronics, the transistor.

A transistorized ignition system works on a simple principle: A transistor is used to switch the heavy current through the primary of the spark coil. A small current through the distributor contact "points" times the firing to the engine by triggering the base circuit of the transistor.

To understand why this simple idea should cause an automotive revolution, let's look at today's far-from-perfect ignition system.

Auto engineers have long recognized that your standard ignition system is inadequate on two counts. First, it fails to give a hot spark at high speeds and second, it will have periodic breakdowns.

Your present ignition system works well at low speeds, because that's what it was originally designed to do (some fifty years ago). At low speeds the distributor contact points remain closed or "dwell" for a sufficiently long time, allowing a strong surge of current to pass through the primary of the ignition coil. That means a nice hot spark at the plugs. As the engine and distributor speed up, however, the contact points do not remain closed long enough to allow the current to build up to its full value. The result is a weak spark, or no spark at all at high speeds. The energy output at the spark gap may actually fall off as much as 50% as the engine revs up.

A twelve-volt system and a condenser may help push a sufficient surge of current through the points at high speeds, but this only aggravates the second problem—erosion and breakdown of the contact points.

Your car's contact points make and break about 12,000 times in one mile. At every break, a little spark erodes the

surface of the points. The bigger the current through the points, the greater the spark and the resultant erosion. Normal erosion usually ruins a set of points after 10,000 miles.

But more important is the fact that the best conventional tungsten contact points can't carry more than five amperes without excessive arcing and rapid breakdown. Yet modern high-compression, high-speed engines using high-octane gasoline may require as much as eight amperes through the points in order to provide sufficient voltage at the spark plug. This problem is solved only by a transistorized system.

What will your new ignition system look like? It will consist of a transistor and a special coil to replace the standard ignition coil. All other parts of the ignition system will remain pretty much the same, except for the removal of the usual condenser across the points.

The big difference will be in the system's operation. The distributor contact points, instead of carrying five amps or more, will carry only $\frac{1}{4}$ ampere. This $\frac{1}{4}$ ampere will trigger the transistor to pass as much as eight amperes through the ignition coil—enough to meet the needs of today's and tomorrow's engines. Tests have shown that with such small current through the distributor, erosion is negligible, and the contact points will easily last for more than 100,000 miles. Since transistors don't wear out too readily, and the coil won't deteriorate under normal conditions, you have a lifetime ignition system.

For cold weather starting, the transistor system should prove a boon since it will operate effectively to 65 below zero. The new system will be priced between \$50 and \$75, and will be available as special equipment in the near future. By 1961 it should be available as optional equipment on all new cars. If that's not soon enough for you, you can spend your time thinking about a transistorized automobile voltage regulator. It's also in the works. ●

(Editor's note: Watch for it soon in Electronics Illustrated—how YOU can construct a low-cost transistorized ignition system for your car!)



"best 35¢ I ever spent"...

From every corner of the electronics world comes this unanimous report: Radio Shack's new "king size" 312-page Guide to Electronic Buying is the most comprehensive, most exciting publishing achievement in electronics history. Send for your copy today — it's a typical Radio Shack bargain!

"Outstanding in the industry . . .", comments a Pennsylvania hi-fi enthusiast. "Tops! . . .", says a Michigan radio amateur. A University Professor asks, ". . . is it available in quantities for our students as a supplement to our textbook?" A hi-fi manufacturer writes, ". . . congratulations . . . excels all others I have ever seen". A laboratory notes, ". . . and we were pleased with the fine illustrations and informative listings".

50,000 copies of this valuable new Radio Shack Guide have already been sold in the two short months since its publication! By phone, letter and wire, hundreds of unsolicited "testimonials" tell us that we've published not merely another "free catalog", but literally an electronics education worth many dollars. Everything new, everything you need to know — everything that represents *value* — in today's wide world of electronics is yours in its 312 rotogravure 8½ x 11 pages.

Over 40,000 products are listed — test equipment, laboratory supplies, stereo and high fidelity components and accessories, products for industry, public address, ham gear, optical goods, electronic textbooks, records, tape, tools — with lowest net prices, clearly written specifications, fine quality halftone illustrations. There's not only a complete Product Index, but a Manufacturer Index that amounts to practically a "Who's Who" of Electronics.

You'll find stimulating articles and helpful engineering data, too. On pages 8-9, for example, is an article entitled "Selecting Your Stereo System" written by an expert in the field. On pages 41-42 the internationally known authority G. A. Briggs explains his latest theories on "Room Acoustics". And beginning on page 301 you'll see Radio Shack's quick-reference "Handbook" of electronic specifications, symbols, schematic diagrams and formulas for students, experimenters, laboratories and engineers.

Fill out the coupon right now. You'll agree it's the best 35¢ YOU ever spent.



RADIO SHACK CORPORATION, Dept. 1P, 730 Commonwealth Avenue, Boston 17, Mass.

Please send **POSTPAID** the new 1960 Radio Shack Guide to Electronic Buying. I enclose 35¢
 cash check money order

Name.....
 Address.....
 City..... Zone..... State.....

New Guide also on sale in our 3 stores: 167 Washington St., Boston 8, Mass. 730 Commonwealth Ave., Boston 17, Mass. • 230 Crown St., New Haven 10, Conn.



Superior's New Model 77

VACUUM TUBE VOLTMETER WITH NEW 6" FULL-VIEW METER

Compare it to any peak-to-peak V. T. V. M.
made by any other manufacturer at any price!

- ✓ Model 77 completely wired and calibrated with accessories (including probe, test leads and portable carrying case) sells for only \$42.50.
- ✓ Model 77 employs a sensitive six inch meter. Extra large meter scale enables us to print all calibrations in large easy-to-read type.
- ✓ Model 77 uses new improved SICO printed circuitry.
- ✓ Model 77 employs a 12AU7 as D.C. amplifier and two 9006's as peak-to-peak voltage rectifiers to assure maximum stability.
- ✓ Model 77 uses a selenium-rectified power supply resulting in less heat and thus reducing possibility of damage or value changes of delicate components.
- ✓ Model 77 meter is virtually burn-out proof. The sensitive 400 microampere meter is isolated from the measuring circuit by a balanced push-pull amplifier.
- ✓ Model 77 uses selected 1% zero temperature coefficient resistors as multipliers. This assures unchanging accurate readings on all ranges.

Model 77—VACUUM TUBE VOLTMETER. Total Price . . . \$42.50
Terms: \$12.50 after 10 day trial, then \$6.00 monthly for 5 months if satisfactory. Otherwise return, no explanation necessary.

AS A DC VOLTMETER:

The Model 77 is indispensable in Hi-Fi Amplifier servicing and a must for Black and White and color TV Receiver servicing where circuit loading cannot be tolerated.

AS AN ELECTRONIC OHMMETER:

Because of its wide range of measurement leaky capacitors show up glaringly. Because of its sensitivity and low loading, intermittents are easily found, isolated and repaired.

AS AN AC VOLTMETER:

Measures RMS values if sine wave, and peak-to-peak value if complex wave. Pedestal voltages that determine the "black" level in TV receivers are easily read.

Comes complete with operating instructions, probe leads, and streamlined carrying case. Operates on 110-120 volt 60 cycle. Only . . .

\$42⁵⁰

Specifications

• DC VOLTS — 0 to 3/15/75/150/300/750/1,500 volts at 11 megohms input resistance.
• AC VOLTS (RMS) — 0 to 3/15/75/150/300/750/1,500 volts. • AC VOLTS (Peak to Peak) — 0 to 8/40/200/400/800/2,000 volts. • ELECTRONIC OHMMETER—0 to 1,000 ohms/10,000 ohms/100,000 ohms/1 megohm/10 megohms/100 megohms/1,000 megohms. • DECIBELS: —10 db to + 18 db + 10 db to + 38 db. + 30 db to + 58 db. All based on 0 db = .006 watts (6 mw) into a 500 ohm line (1.73v). • ZERO CENTER METER — For discriminator alignment with full scale range of 0 to 1.5/7.5/37.5/75/150/375/750 volts at 11 megohms input resistance.

SUPERIOR'S NEW MODEL 83



C.R.T. TESTER

Tests and Rejuvenates **ALL** PICTURE TUBES

ALL BLACK AND WHITE TUBES

From 50 degree to 110 degree types
—from 8" to 30" types.

ALL COLOR TUBES

Test **ALL** picture tubes—in the carton—out of the carton—in the set!

Model 83—C.R.T. Tube Tester
Total Price . . . \$38.50
Terms: \$8.50 after 10 day trial, then \$6.00 monthly for 5 months if satisfactory. Otherwise return, no explanation necessary.

• Rejuvenation of picture tubes is not simply a matter of applying a high voltage to the filament. Such voltages improperly applied can strip the cathode of the oxide coating essential for proper emission. The Model 83 applies a selective low voltage uniformly to assure increased life with no danger of cathode damage.

• Model 83 is not simply a rehashed black and white C.R.T. Tester with a color adapter added. Model 83 employs a new improved circuit designed specifically to test the older type black and white tubes, the newer type black and white tubes and all color picture tubes.

• Model 83 provides separate filament operating voltages for the older 6.3 types and the newer 8.4 types.

• Model 83 employs a 4" air-damped meter with quality and calibrated scales.

• Model 83 properly tests the red, green and blue sections of color tubes individu-

ally—for each section of a color tube contains its own filament, plate, grid and cathode.

• Model 83 will detect tubes which are apparently good but require rejuvenation. Such tubes will provide a picture seemingly good but lacking in proper definition, contrast and focus. To test for such malfunction, you simply press the rej. switch of Model 83. If the tube is weakening, the meter reading will indicate the condition.

Model 83 comes housed in handsome portable Saddle Stitched Texon case — complete with sockets for all black and white tubes and all color tubes. Only

\$38⁵⁰

EXAMINE BEFORE YOU BUY!
USE APPROVAL FORM ON NEXT PAGE

Superior's New Model 70 UTILITY TESTER® FOR REPAIRING ALL ELECTRICAL APPLIANCES and AUTOMOBILE CIRCUITS



Model 70—UTILITY TESTER
Total Price...\$15.85 —
Terms: \$3.85 after 10 day
trial, then \$4.00 monthly for
3 months, if satisfactory.
Otherwise return, no ex-
planation necessary.

As an electrical trouble shooter the Model 70:

- Will test Toasters, Irons, Broilers, Heating Pads, Clocks, Fans, Vacuum Cleaners, Refrigerators, Lamps, Fluorescents, Switches, Thermostats, etc.
- Measures A.C. and D.C. Voltage, A.C. and D.C. Current, Resistances, Leakages, etc.
- Will measure current consumption while the appliance under test is in operation.
- Incorporates a sensitive direct-reading resistance range which will measure all resistances commonly used in electrical appliances, motors, etc.
- Leakage detecting circuit will indicate continuity from zero ohms to 5 megohms (5,000,000 ohms).

As an Automotive Tester the Model 70 will test:

- Both 6 Volt and 12 Volt Storage Batteries • Generators • Starters • Distributors
- Ignition Coils • Regulators • Relays • Circuit Breakers • Cigarette Lighters • Stop Lights • Condensers • Directional Signal Systems • All Lamps and Bulbs • Fuses
- Heating Systems • Horns • Also will locate poor grounds, breaks in wiring, poor connections, etc.

INCLUDED FREE This 64-page book—practically a condensed course in electricity. Learn by doing.

Just read the following partial list of contents: What is electricity? • Simplified version of Ohms Law • What is wattage? • Simplified wattage charts • How to measure voltage, current, resistance and leakage • How to test all electrical appliances and motors using a simplified trouble-shooting technique. • How to trace trouble in the electrical circuits and parts in automobiles and trucks.

Model 70 comes complete with 64 page book and test leads

\$15⁸⁵
Only

Superior's New Model 82A A truly do-it-yourself type

TUBE TESTER

TEST ANY TUBE IN 10 SECONDS FLAT!



Model 82A—Tube Tester
Total Price\$36.50
Terms: \$6.50 after 10 day trial,
then \$6.00 monthly for 5 months
if satisfactory. Otherwise re-
turn, no explanation necessary.

- 1 Turn the filament selector switch to position specified.
- 2 Insert it into a numbered socket as designated on our chart (over 600 types included).
- 3 Press down the quality button—

THAT'S ALL! Read emission quality direct on bad-good meter scale.

FEATURES:

- Tests over 300 tube types. • Tests OZA and other gas-filled tubes. • Employs new 4" meter with sealed air-damping chamber resulting in accurate vibrationless readings. • Use of 22 sockets permits testing all popular tube types and prevents possible observation. • Dual Scale meter permits testing of low current tubes. • 7 and 9 pin straighteners mounted on panel. • All sections of multi-element tubes tested simultaneously. • Ultra-sensitive leakage test circuit will indicate leakage up to 5 megohms.

Production of this Model was delayed a full year pending careful study by Superior's engineering staff of this new method of testing tubes. Don't let the low price mislead you! We claim Model 82A will outperform similar looking units which sell for much more—and as proof, we offer to ship it on our examine before you buy policy.

Model 82A comes housed in handsome, portable Saddle-Stitched Texon case

Only **\$36⁵⁰**

SHIPPED ON APPROVAL NO MONEY WITH ORDER—NO C. O. D.

Try any of the Instruments on this or the facing page for 10 days before you buy. If completely satisfied then send down payment and pay balance as indicated on coupon. **No Interest or Finance Charges Added!** If not completely satisfied return unit to us, no explanation necessary.

MOSS ELECTRONIC, INC.

Dept. D-694, 3849 Tenth Ave., New York 34, N. Y.

Please send me the units checked on approval. If completely satisfied I will pay on the terms specified with no interest or finance charges added. Otherwise, I will return after a 10 day trial positively cancelling all further obligation.

Name

Address

City Zone State

All prices net. F.O.B. N. Y. C.

- Model 77..... Total Price \$42.50
\$12.50 within 10 days. Balance \$30.00
monthly for 5 months.
- Model 83..... Total Price \$38.50
\$8.50 within 10 days. Balance \$30.00
monthly for 5 months.
- Model 70..... Total Price \$15.85
\$3.85 within 10 days. Balance \$4.00
monthly for 3 months.
- Model 82A..... Total Price \$36.50
\$6.50 within 10 days. Balance \$6.00
monthly for 5 months.

Prepare For Tomorrow

Continued from page 81

high school level dedicated to the advancement of engineering and science.

JETS was set up to offer teenagers as many different practical and stimulating scientific experiences as possible. With help from scientists and engineers in industry, students would be able to design and actually build their own projects.

The first JETS group was formed at East Lansing High School in 1950 with 20 members. Soon there were ten clubs in Michigan and one in New York. By 1959, the total had reached 550 chapters scattered through 41 states, Puerto Rico, Canada, New Zealand and Switzerland!

A project contest held annually at Michigan State U. is the climax of the year's work. Here JETS members and groups compete with each other for substantial prizes of equipment and college scholarships. Last year more than 100 projects were exhibited; including a fully instrumented nose cone, a cloud chamber, a turbo-jet engine and an electronic digital computer.

Since industry has such an important stake in the success of the JETS program, more and more industrial leaders are lending their support. Republic Aviation, Convair, Heath, GE, General Motors and Chrysler are but a few of the companies offering financial, professional and technical help, and the use of their production and test facilities.

Republic Aviation, for example, sponsors 12 JETS chapters on Long Island, N. Y. They undertook promotion of the program in 1957, a wild year to begin.

Because of the race to orbit an earth satellite, just about all JETS members seemed to want the same projects: rockets and missiles.

While some rocket projects were approved, the advisors and engineers succeeded in getting across the fact that just about all the scientific data they desired on their rockets could be gotten from a static firing test rather than from an actual launch.

Projects may be individual or group and are laid out to include the study, research and planning that must precede actual construction. Chapters usually meet weekly to continue project work, hear research reports, discuss problems and plan ahead. The consulting engineer meets with the group regularly and is always on call for special problems. If the problem lies outside his special field, he calls upon some other member of the engineering staff. This is all done on the engineers' own time.

The success of JETS has been overwhelming. Some 91 percent of JETS members enter college and about 64 percent of this total enroll as engineering students! Couple these figures with the tremendous enthusiasm of the students themselves for the JETS educational and industrial help program, and we have more than just a workable solution to the shortage of engineers and scientists. If more schools and more industries will back the program, we can forge the most potent weapon in the future arsenal of democracy. For further information on organizing a JETS chapter in your community, write to: JETS Inc., Box 589, East Lansing, Michigan.—
by W. A. Gregory

.22 CAL. NEW 7 SHOT REPEATER AUTOMATIC

The skilled hand of the German gunsmith is responsible for this .22 caliber 7 shot repeater automatic with self-ejecting empty shells. Just 4 inches long, fits easily into pocket or purse. Ideal for sporting events, stage use (not available to Calif. residents). Not a lethal weapon. Comes for \$6.95 from

BEST VALUES CO.

Dept. F-60, 403 Market St., Newark, New Jersey





HEATHKIT

WORLD'S LARGEST
MANUFACTURER OF
easy-to-build
do-it-yourself
ELECTRONIC KITS

"bookshelf" 12 watt amplifier kit COMBINES BEAUTY, STYLE AND QUALITY

Build this high quality amplifier in a few hours of your spare time and enjoy true high fidelity performance for years to come. Provides full range frequency response from 20 to 20,000 CPS within ± 1 db, and has less than 1% harmonic distortion at full 12 watt output over the entire range (20—20,000 CPS). Miniature tubes are used throughout the advanced circuitry, including EL84 output tubes in a push-pull tapped-screen output circuit. The special design output transformer has taps for 4, 8 and 16 ohm speakers. The model EA-2 has its own built-in preamplifier with provision for three separate inputs, mag phono, crystal phono and tuner. Features RIAA equalization, separate bass and treble tone controls, and a special hum-balance control. Complete with instructions for easy assembly.



Only

MODEL EA-2

\$28⁹⁵

SHPG. WT. 15 LBS.

Complete selection of Monophonic and Stereo Kits!



PREAMPLIFIERS



TUNERS

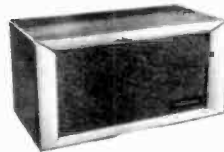

SPEAKER SYSTEMS

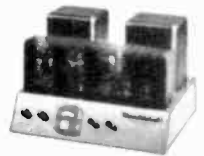

AMPLIFIERS

Send for FREE catalog

listing over
100 high quality
dependable
Heathkits for you
to choose from.

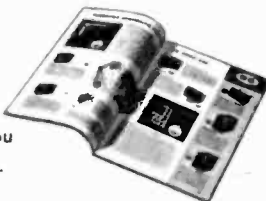

All Prices F.O.B. Benton Harbor, Mich. Prices and Specifications Are Subject To Change Without Notice.

HEATH

*pioneer in
"do-it-yourself"
electronics*

COMPANY

BENTON HARBOR 39, MICH.



a subsidiary of Daystrom, Inc.

Please send your latest Free Catalog.

name _____

address _____

city & state _____

Pre-Record Hi-Fi Tape

Continued from page 94

suggests that your home machine heads be checked by a competent technician periodically, depending upon how often you use your tape deck. It should be done at least once a year.

The alignment procedure is to feed a test tape with a tone output past the head and into an output meter. The azimuth adjustment screw on the head is manipulated until the meter reads maximum output.—by Ed Nanas

Label Your Equipment

Continued from page 99

3"x5", a few "Q" tips, some acetone (or nail polish remover), and a pair of tweezers. Wrap a rubber band around the tweezers so the tips stay closed.

First, clean the panel of dirt and grease. Select the rubber type that will form the desired labels. It's a good idea to have all the required letters on hand since the ink dries in two or three minutes. With the "Q" tip, smear some ink on the glass plate, just thick enough so the type may be wetted without clogging. Successively put the letters in the tweezers and carefully apply the printing to the panel using the ruler guide where necessary. Before applying the letter, check to see if it's the correct one by first printing it on the glass plate. This also reveals if the letter being applied is right side up. After imprinting each letter, immediately blot the excess ink on a paper towel.

HELP

yourself to better service from your postal service by including postal zone numbers on all correspondence.

Don't forget to include your own postal zone number in your own return address.

Postal zoning helps your post office give you better service.



STATEMENT REQUIRED BY THE ACT OF AUGUST 24, 1912, AS AMENDED BY THE ACTS OF MARCH 3, 1933, AND JULY 2, 1946 (Title 39, United States Code, Section 233) SHOWING THE OWNERSHIP, MANAGEMENT, AND CIRCULATION OF

ELECTRONICS ILLUSTRATED published monthly at Greenwich, Conn., for October 1, 1959.

1. The names and addresses of the publisher, editor, managing editor, and business managers are: Publisher, Fawcett Publications, Inc., Greenwich, Conn.; Editor, Charles Tepper, Chappaqua, N. Y.; Managing Editor, Larry Eisenger, Staten Island, N. Y.; Business Manager, Gordon Fawcett, Greenwich, Conn.

2. The owner is: (If owned by a corporation, its name and address must be stated and also immediately thereunder the names and addresses of stockholders owning or holding 1 percent or more of total amount of stock. If not owned by a corporation, the names and addresses of the individual owners must be given. If owned by a partnership or other unincorporated firm, its name and address, as well as that of each individual member, must be given.) Fawcett Publications, Inc., Greenwich, Conn.; W. H. Fawcett, Jr., Norwalk, Conn.; Marion Bagg, Overland Park, Kansas; Roger Fawcett, New York, N. Y.; V. D. Fawcett, Greenwich, Conn.; M. B. Fawcett, Norwalk, Conn.; Gordon W. Fawcett, Greenwich, Conn.; Gloria Leary, Santa Monica, Cal.; V. F. Kerr, Bakersfield, Cal.; Allan M. Adams and Jack R. Adams as trustees under the trust agreement with Eva F. Roberts, dated July 3, 1959, Greenwich, Conn.; W. A. Fawcett, New York, N. Y.; Roscoe Kent Fawcett, Reno, Nevada; M. F. Fawcett, Greenwich, Conn.

3. The known bondholders, mortgagees, and other security holders owning or holding 1 percent or more of total amount of bonds, mortgages, or other securities are: (If there are none, so state.) None.

4. Paragraphs 2 and 3 include, in cases where the stockholder or security holder appears upon the books of the company as trustee or in any other fiduciary relation, the name of the person or corporation for whom such trustee is acting; also the statements in the two paragraphs show the affiant's full knowledge and belief as to the circumstances and conditions under which stockholders and security holders who do not appear upon the books of the company as trustees, hold stock and securities in a capacity other than that of a bona fide owner.

5. The average number of copies of each issue of this publication sold or distributed, through the mails or otherwise, to paid subscribers during the 12 months preceding the date shown above was: (This information is required from daily, weekly, semi-weekly, and triweekly newspapers only.)

GORDON FAWCETT,
Business Manager

Sworn to and subscribed before me this 30th day of September, 1959.

[SEAL] LILLIAN M. KLEIN

(My commission expires April 1, 1963)



"BUCK STRETCHER"

HI-FI VALUES!

Expand the buying power of your Hi-Fi dollar at Sun Radio with substantial savings on new and fully guaranteed name brand Hi-Fi components!

Dept. D9,

SUN Radio & Electronics Co., Inc.

650 6th Ave., New York 11, N. Y.

Phone: OREGON 5-8600

I am interested in your special price quotations and your Hi-Fi package specials! Please send data at once.

Name _____

Address _____

City _____ Zone _____ State _____

Continued from page 116

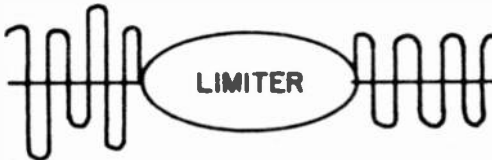

Fig. 2

grid reaches cutoff. This levelling effect is shown in Fig. 2.

The signal pathways through the ratio detector are shown in the full-page theory diagram on how the FM tuner works. Generally, the signal is introduced into the ratio detector transformer primary winding. Splitting takes place in the secondary which has a center tap connection. At a given instant one end of the transformer will become negative, the other positive. This happens as the signal enters the two halves of the secondary.

The diode rectifiers (crystal type used here though a 6AL5 tube is often used) are connected in such a way as to pass only negative signal pulses at the top and positive ones at the bottom. This configuration, plus the stabilizing capacitor rejects the amplitude changes.

The stabilizing capacitor is actually a reservoir. It is initially charged up from signals passing through the diodes. Its large capacity enables it to maintain a reference voltage that remains constant. As long as the signal amplitude does not change, the capacitor current is zero. But, if signal strength rises (amplitude modulation interference) the capacitor will absorb the overflow. Conversely, a temporary drop in signal level is accompanied by a discharge of the capacitor into the circuit. This is why the ratio detector requires no limiter. The output voltage is held at a constant self-levelling value.

The designation "ratio" in this type of detector arises from the manner in which the audio is produced. Voltage at the diode rectifiers differs due to frequency shifting of the carrier in the transformer. It is the ratio between these two voltages that produces audio.

A noteworthy aspect of the detector

SHOOT TV TROUBLE FAST

With H. G. Cisin's Copyrighted RAPID "TV TROUBLE SHOOTING METHOD"

Without experience or knowledge this guaranteed new method of servicing TV sets enables you to DIAGNOSE TV troubles as rapidly as an expert. NO THEORY—NO MATH—you can locate all faults in record-breaking time regardless of make or model. "TV TROUBLE SHOOTING METHOD" is the most valuable aid to TV servicing ever written. Be a TV Trouble Diagnostician. Increase your present earnings. Open your own Profitable Business or get a high-paying skilled job.

It's all in this book . . .

Nothing more to Pay—Nothing else to Buy

Alphabetically listed are 85 picture troubles, over 58 raster and 17 sound troubles. By this unique copyrighted method you know EXACTLY WHERE the trouble is; plus step-by-step instructions. Including 69 RAPID CHECKS, help to find faulty part. IS IMPORTANT PRELIMINARY CHECKS NEED NO INSTRUMENTS! Of the 69 Rapid Checks, OVER 45 ALSO REQUIRE NO INSTRUMENTS! Rapid checks include emergency checks for distorted pictures, defective tubes including PIX tube, plus 57 others. ALL EXPLAINED IN SIMPLE LANGUAGE. PERFORMED WITHOUT INSTRUMENTS. MANY CHECKS USE THE PICTURE TUBE AS A GUIDE.

H. G. Cisin, the author, is the inventor of the AC/DC midget radio. He licenses RCA, AT&T, etc. He has also trained thousands of technicians now owning their own prosperous TV service organizations or holding highly paid TV positions. His years of experience are embodied in this remarkable new book.

Guaranteed Money Back in 5 Days If Not Satisfied!

ABSOLUTELY FREE with each order: Your choice of Cisin's newest books: BASIC ELECTRICITY—Vol. 1 or TV-RADIO TUBE SUBSTITUTION GUIDE. These sell for 50¢ ea. ACT NOW—get 2 books postpaid at cost of only one!

\$1 Post-paid

RUSH COUPON NOW!

H. G. CISIN, Consulting Engineer—Dept. EL-10
Amagansett, N. Y.
Enclosed find \$1. Rush Trouble Shooting Method and free book marked above. (If not marked Basic Elec. will be sent.)
 Send all 3 books. Enclosed find \$1.50

Name _____
Address _____
City _____ Zone _____ State _____

ONE CENT SALE

BUY ONE AT OUR REGULAR LOW PRICE AND GET THE SECOND FOR ONLY 1¢ MORE

CITIZENS BAND TRANSMITTER (27MC) 5 watt chassis, complete with crystal \$14.99 each; two for \$15.00

CITIZENS BAND RECEIVER chassis tunable through all 22 channels. Complete with audio amplifier. \$9.99 ea. two for \$10.00.

AMATEUR BAND TRANSCEIVER (144-148 MC) chassis with dual VHF triodes for walkie-talkie radiophone. \$9.99 ea. two for \$10.00.

MICROPHONE High output 200 ohm carbon with terminal lugs. \$1.49 ea. two for \$1.50.

COILED CORD 4 conductor 11" telephone cord. Extends to over 4 ft. .99 ea. two for \$1.00.

KIT OF PARTS for AM-FM VHF radio receiver. Tunable from 80-200 mc. which includes U. S. satellite frequencies. \$6.99 ea. two for \$7.00.

TRANSISTOR AUDIO AMPLIFIER gives 50X voltage gain on low level signals Operates on 1½ volts. \$3.99 each, 2 for \$4.00.

CONVERTER (Crystal controlled) for 27 MC Citizens Band. Adapts any standard broadcast radio to 27 MC band. Tunes all 22 channels. Complete with tubes and crystal. \$14.99 each, 2 for \$15.00

LIMITED QUANTITY—NO LITERATURE OR CATALOG

Remit in full. Include sufficient postage. No C.O.D.'s.

VANGUARD ELECTRONIC LABS. Box 12-EL-1
Hollis 23, N. Y.

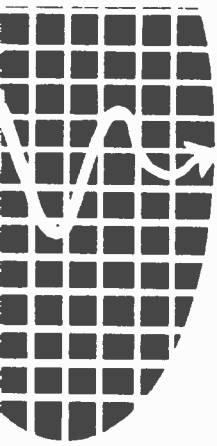

ELECTRONICS ILLUSTRATED

Classified Ads

Your advertisement can reach this mail-buying audience for only 35¢ per word . . . payable in advance (Check or M.O. please) . . . minimum 10 words. Closing dates are the 20th of 3rd preceding month i.e. copy for the April issue must be in our office by January 20th. Mail to ELECTRONICS ILLUSTRATED, 67 West 44th St., New York 36, N. Y. Word count: Zone number free. Figure one word: Name of state (New Jersey), name of city (New York); sets of characters as in key (I4-D); also abbreviations as 35MM, 8x10, D.C., A.C.

SAVE MONEY • ORDER BY MAIL

• • • FOR SALE

MONEY SAVING Prices on tubes. TV, Radio, Transmitting and Industrial Types. New, 1st quality, guaranteed. Top name brands only. Government surplus and commercial test, lab and communications equipment in stock. Sell us your excess tubes and equipment. Unused, clean tubes of all types wanted. Send specific details in first letter. Write for "Green Sheet" catalog 25¢. Barry Electronics Corp., 512 Broadway, (Dept. E1.), WA 5-7000, New York 12, N. Y.

GOVERNMENT SELLS: Surplus Electronics; Test Equipment; Oscilloscopes; Transceivers; Jeeps; Boats; Aircrafts; Misc.—Send for U. S. Depot Directory & Procedure \$1.00. "Government Surplus Sales," Box 425-EL, Nanuet, N. Y.

78 R.P.M. RECORDINGS. Many types. Free lists. Collections bought, P.O.B. 155(EL), Verona, N. J.

• • • PRINTING, MULTIGRAPHING, MIMEOGRAPHING

RUBBER STAMP Printer, self-inking, 3 lines \$1.00. Villani, Box 674, Cresskill, N. J.

• • • EMPLOYMENT OPPORTUNITIES

PRINTING - ADVERTISING SALESMEN. Excellent moneymaking sideline selling Decalcomania Name Plates. Advertising Specialties. Sign letters, Automobile initials. Free Samples. "Ralco"-E1, Box L, Boston 19, Mass.

• • • BUSINESS OPPORTUNITIES

MAKE \$5,000-\$10,000 YEARLY at home, in respectable field. Future growth unlimited! No experience necessary, no public contact, nothing to grow or make. Free expert guidance helps you achieve financial success. Rush name for Free, Complete Plan! Columbia Enterprises, 9268-EL Piney Branch Road, Silver Spring, Maryland.

VENDING MACHINES—No selling. Operate a route of coin machines and earn high profits. 32-page catalog free! Parkway Machine Corp., Dept. 33, 715 Ensor St., Baltimore 2, Md.

GROW MUSHROOMS. Cellar, shed and outdoors. Spare, full time, year round. We pay \$4.50 lb. dried. We have 29,000 customers. Free Book. Mushrooms, Dept. 315, 2954 Admiral Way, Seattle, Wash.

• • • HI-FI

HI-FI CONVERTER. Console sound from your radio, television, tape recorder, phonograph, with new speaker and enclosure kit. Free folder. Windhaven Radio, Box 16N-74, Baroda, Michigan.

PHONOGRAPH RECORDS cheap, post-paid. Catalogue. Paramount, Box 2026-K, Pine Castle, Fla.

• • • TAPE RECORDERS

TAPE RECORDERS, recording tape, Ball tape decks, Hi-Fi equipment, Norelco speakers. We Will Not Be Undersold! Send for our discount catalog and see why! Commissioned Electronics, 1776 Columbia Road, Washington, D. C.

RENT STEREO Tapes—over 900 different — all major labels — free catalog. Stereo-Parti, 1608-J Centinela Ave., Inglewood 3, California.

TAPE RECORDERS, Hi-Fi components, Sleep Learning Equipment, tapes. Unusual values. Free catalog. Dressner 69-02 Z 174 St., Flushing 65, N. Y.

HI-FI, RECORDERS. Free Wholesale Catalogue. Carston, 125-G East 88, N. Y. C. 28.

• • • RADIO & TV

DIAGRAMS FOR radios, phonos, recorders, \$1.00; television \$2.00. Give make, model. Diagram Service, Box 672-E1, Coral Gables, Fla.

DIAGRAMS FOR repairing radios, amplifiers, \$1.00; television \$2.00. Give make, model. Diagram Service, Box 672-E1, Hartford 1, Conn.

15 TESTED ONE-TUBE circuits—25¢ with Transistor experiments, catalog. Laboratories, 1131-K Valota, Redwood City, California.

NEW BOOK (Mobile Hi-Fi) Tape Recorders, Stereo, F-M, etc. \$5.00. Ekeradio, 650 N. Fair Oaks, Pasadena, California.

RADIO, AMPLIFIER diagrams 75¢. Television \$1.50. Raybon, 150 Rockyford Rd. NE, Atlanta 17, Ga.

• • • EDUCATION & INSTRUCTION

"LEARN CODE"—Instructions, 33 RPM record \$1.00. Olsen's School of Science, Iona, Idaho.

• • • BUILD-IT-YOURSELF

BUILD BATTERYLESS, Light-Powered Radio . . . Project Sound on a Light Beam! One International Rectifier 82M Sun Battery—enough to power radio—plus instruction sheet for both projects—only \$2.25! Solar Products, Box 221, Pacific Palisades, Calif.

• • • MISCELLANEOUS

HAVE FUN: comic postcards. 25 different \$1.00. Bradleys Variety, P. O. Box 281, McGregor, Iowa.

• • • STAMPS & COINS

THREE BRILLIANT uncirculated Mexican silver dollars \$1.00. Universal Services, Box 675, San Antonio 6-P1, Texas.

• • • DETECTIVES

DETECTIVES—WORK Home—Travel. Experience unnecessary. Detective Particulars free. Write, Wagner, B-125 West 86th, New York 24.

• • • MUSIC

SONGPOEMS AND Lyrics Wanted! Mail to: Tin Pan Alley, Inc., 1650 Broadway, New York 19, N. Y.

• • • ROCKETS

ROCKET AMATEURS Guidebook. New, valuable guide to sources of rocket kits, plans, supplies, free instruction manuals, safety rules, legal regulations, university courses. Includes list of rocket clubs, big bibliography. Only \$1.00. Space Products, Dept. E1-3, 38 East 57th St., New York, N. Y.

circuit is the de-emphasis resistor and capacitor. Its origin traces back to the FM transmitter. The higher audio tones tend to be far lower in level than those in the mid and low ranges. During transmission they tend to get lost in atmospheric noise. To compensate for this they are purposely boosted (pre-emphasized) before modulation onto the FM carrier. The net effect is an improved "signal-to-noise" ratio. Once the audio is detected in the receiver, the de-emphasis network tapers off the highs, restoring the original audio balance.

Construction

Through use of the factory-made FM tuning unit, construction of the tuner is greatly simplified. Follow the layout of components shown in the illustrations. As with the AM tuner, short leads to and from the IF transformers are essential to avoid feedback, oscillation.

Alignment should present little problem and could be done by ear. The Granco tuning unit tracked over the band so well that its trimmer capacitors were not touched.

If a sensitive meter (at least 20,000 ohms per volt) is available, follow this procedure: Place the negative probe of the meter to the negative side of C37. The positive probe is grounded. Now, tune in a station. Tune the top slug of IF3 (bottom slug should have little or no effect), top and bottom of IF4, and bottom of IF5. Adjust for maximum voltage. If the meter needle suddenly jumps to a very high or off-scale value, the stage has probably broken into oscillation. Back off *slightly* on the slug adjustments to bring the needle into range. If this condition persists, try shortening the wires to and from the IF transformers or redressing them.

Shift the meter probe to the audio output which appears at R49. Turn the slug on top of IF5 for zero voltage. When the needle hits zero, the sound should be the clearest.

In a good signal area, a short piece of wire should bring in all the major FM stations. Better sensitivity could be achieved with a 52" dipole. The antenna terminals are the tube lug (shown in the photo) and the chassis ground.

FREE!
H. H. Scott Helps You
PLAN FOR STEREO
With New Hi Fi Guide
and Catalog



H.H. Scott Inc., 111 Powdermill Road, Dept. E1-1, Maynard, Mass.
Rush me your **FREE** Hi Fi Guide and catalog to help me plan my stereo system.

Name

Address

CityState.....

 **YOU NEED THIS**

FREE GIANT 1960 B-A CATALOG



BURSTEIN-APPLEBEE CO.

Dept. E1, 1012 McGee St., Kansas City 6, Mo.

Send Free 1960 E-A Catalog No. 601.

Name

Address

CityState.....

SEND FOR IT TODAY

NEW! *Lafayette* 50 Watt Complete Stereo Phono System



LAFAYETTE LA-250

COMPLETE STEREO SYSTEM
174.50



LAFAYETTE SK-58



GARRARD RC121/11 WOOD BASE



NEW GE VR-22

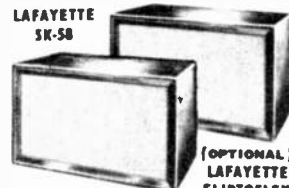

(OPTIONAL) LAFAYETTE ELIOTFLEX

This superb system will add a new dimension in living to your home with all the excitement and realism of a live concert. The new Lafayette LA-250, 50-watt stereo amplifier (25 watts each channel) forms the heart of this outstanding stereo hi-fi phonograph music system—the features, versatility and advanced circuitry of this unit are second to none. Also included is the famous Garrard RC121/11 intermix 4-speed automatic record changer with full manual or automatic operation supplied with your choice of stereo cartridges—the new GE VR-22 (.7 Mil) diamond stereo cartridge, Pickering 371-7D (.7 Mil) diamond stereo cartridge, Shure M7D (.7 Mil) diamond stereo cartridge or the new Electro-Voice 31 MD7 (.7 Mil) diamond stereo cartridge. Supplied with the Lafayette wood base cut for the RC121 in your choice of finishes. These outstanding components are coupled

COMPONENTS

- LAFAYETTE LA-250 50-WATT AMPLIFIER 89.50
- NEW GE VR-22 (.7 MIL) DIAMOND STEREO CARTRIDGE 24.45
- GARRARD RC 121/11 STEREO CHANGER 41.65
- LAFAYETTE WOOD CHANGER BASE 3.95
- 2- LAFAYETTE SK-58 FAMOUS FREE EDGE 59.00
- 12" COAXIAL SPEAKERS @ 29.50 59.00

REGULAR CATALOG PRICE ~~219.95~~

YOUR GUARANTEED BEST STEREO SYSTEM BUY!
You Save 44.05

with the 2 famous free edge Lafayette SK-58 12" Coaxial speakers with built-in crossover network and brilliance level control. System supplied with plugs, cables and simple instructions. Shpg. wt., 67 lbs.

HF-681 HI-FI STEREO PHONO SYSTEM with choice of cartridge and mahogany, walnut or blond changer base (please specify) 17.45 down 12.00 Monthly Net 174.50

HF-683 Same as HF-681, but with 2 Lafayette ElioTflex Series Bookshelf Enclosures (please specify finish). Shpg. wt., 143 lbs. 22.99 Down, 15.00 Monthly Net 229.95

HF-682. Stereo AM-FM-Phono System. Same as HF-681 but including the new Lafayette LT-50 stereo tuner. Shpg. wt., 85 lbs. 28.75 Down, 17.00 Monthly Net 287.50

LAFAYETTE'S FREE CATALOG!

308 GIANT SIZED PAGES

The Complete Catalog Featuring
"The Best Buys In The Business"



FOR THE NEWEST AND FINEST IN

STEREOPHONIC HI-FI EQUIPMENT AND SYSTEMS

- TAPE RECORDERS ● PUBLIC ADDRESS SYSTEMS
- AMATEUR EQUIPMENT ● INDUSTRIAL SUPPLIES
- MINIATURE COMPONENTS ● RADIO & TV TUBES AND PARTS
- EXCLUSIVE LAFAYETTE TRANSISTOR & HI-FI KITS

Send for Lafayette's FREE Catalog—the most complete, up-to-the-minute electronic supply catalog crammed full of everything in electronics at our customary down-to-earth money-saving prices.

Leaders in Hi-Fi

The most complete selection and largest stocks of hi-fi components and systems—available for immediate delivery at the lowest possible prices. Save even more on Lafayette endorsed "best-buy" complete systems.

NEW YORK
100 SIXTH AVENUE
NEW YORK 13, N. Y.

JAMAICA
165-08 LIBERTY AVE.
JAMAICA 33, N. Y.

BOSTON
110 FEDERAL ST.
BOSTON 10, MASS.

NEWARK
24 CENTRAL AVE.
NEWARK 2, N. J.

PLAINFIELD
139 W. 2nd ST.
PLAINFIELD, N. J.

FREE!
1960
CATALOG

CUT OUT
AND PASTE
ON POST
CARD

LAFAYETTE RADIO
P.O. BOX 222
JAMAICA 31, N. Y.
DEPT. E1A-6

Name

Address

City..... Zone..... State.....





IT'S EASY TO LEARN

You train in your own home—keep your present job while learning. Well illustrated NRI lessons teach Radio-TV-Electronic principles. You build, test, experiment with Radio-TV circuits, get actual practice with kits NRI gives you. Graduate Vagnoni, at right, knew nothing about Radio when he enrolled.



NO EXPERIENCE NEEDED

You don't have to know anything about electricity or Radio to understand and succeed with NRI courses. Many successful NRI men did not finish high school. NRI trained men have been accepted for responsible positions throughout the United States and Canada. Graduate Barnett, for instance, is Chief Engineer with station KGCU.



NRI HAS TRAINED THOUSANDS

For over 40 years, NRI has been training men for success in Radio-TV. Start now on your road to success, get training you need for good pay and a bright future. You can get the training you need, at home in your spare time. NRI can provide it for you.

FOR GOOD Learn Ra

MAIL POSTAGE-FREE CARD
for SAMPLE LESSON and
64-PAGE **FREE**
CATALOG

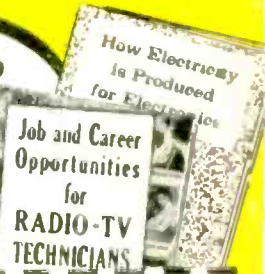

Broadcasting offers satisfying careers. Hundreds of Radio and Television stations on the air offer interesting jobs for Broadcasters and Technicians. Police, Aviation, Two-Way Comms are expanding. Men with Radio-TV training are in demand.



A solid, proven field of opportunity for good pay in the millions of Radio and TV sets now in use. Government, guided missile manufacturers, industry, and home Technicians. Color-TV, Hi-Fi are increasing the opportunities.

National Washington

POSTAGE WILL BE PAID BY
NATIONAL RADIO INSTITUTE
3939 Wisconsin Ave.
Washington 16, D.C.

BUSINESS REPLY CARD
NO POSTAGE STAMP NECESSARY IF MAILED IN THE UNITED STATES

FIRST CLASS
PERMIT NO. 20-R
(Sec. 368 PL&R)
WASHINGTON, D. C.



America's best TWO-IN-ONE magazine!

best in how-to-do

best in science

read

**MECHANIX
ILLUSTRATED**

25¢ at all newsstands