

By the Publishers of
**MECHANIX
ILLUSTRATED**

**THERMOELECTRICITY:
A Look Into The Future**

ELECTRONICS ILLUSTRATED

25¢
SEPTEMBER



Build This Metal Locator



**You Can Make
This Stereo Cabinet**

**A 6-Meter Rig For Your Car
Cracking the SWL Taboo!
Metal Etcher**

EUROPE...OR THE FAR EAST?

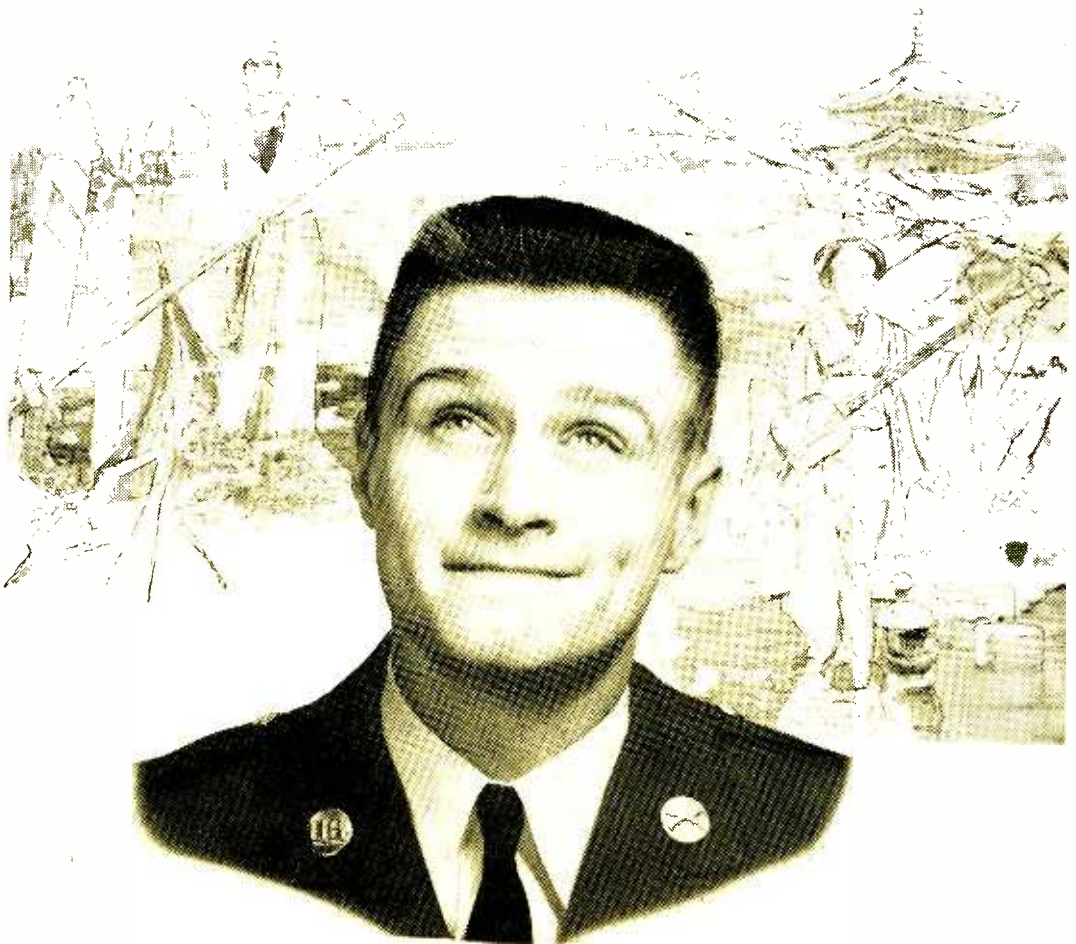

choose your travel before you enlist

Ever had the itch to travel? To explore Paris at night? To hunt wild boar in the forests of Japan? To try surfboarding at Waikiki? Skiing in the Swiss Alps? Swimming on the Italian Riviera?

Every year, thousands of American soldiers experience the thrill of foreign adventure. Roaming far-away corners of the world that most folks at home can never hope to see. Storing up exciting memories that'll last a lifetime.

Many of these Army men *chose* their own travel. And they made their choice *before* enlistment.

Sound interesting? Your Army recruiter can tell you all about Army travel opportunities. This week, drop in and talk it over.

P.S.

You may enlist in the Army for only three years.

CHOICE, NOT CHANCE **U.S. ARMY**



**A HIGHLY
RESPECTED TRADE—
START SOON TO
EARN EXTRA MONEY
IN SPARE TIME**

Learn at Home IN YOUR SPARE TIME to Fix Electrical Appliances

To build a better future, get into a field where there's much important work and the security that comes from knowing a good trade. Servicing electrical appliances offers that OPPORTUNITY. Every wired home has many electrical appliances and millions and millions of new appliances are sold every year. Owners pay well to keep them in repair. That's making a fast-growing need for trained men.

Add To Your Income Starting Soon Need For Service Technicians Increasing

Make extra money in your spare time. Start soon to fix electric toasters, fans, clocks, vacuum cleaners, and other electric appliances for your neighbors and friends. Work in your basement, garage or spare room. It's easy to increase your earning power—to pay for your training many times over—to have extra money to buy things you need.

Learn and Earn with Multi-Use Tester Built with Parts We Send

This course includes the parts to build a portable, sturdy Appliance Tester that helps you locate electrical defects quickly and easily. You use it to learn and do actual electrical appliance repair jobs. If you want better pay learn this good trade. No need to give up your present

job. You can train at home in your spare time for only \$3.00 down and \$6.00 a month. A small price to pay for increased earnings, a more secure future. Paste coupon below on a postal or mail in envelope for free book and sample lesson. Address **National Radio Institute, Dept. KJ9, Washington 16, D. C.**

**MAILING THIS
COUPON MAY START
YOU TO SUCCESS**

**LESSON AND BOOK
FREE**



NATIONAL RADIO INSTITUTE, Dept. KJ9, Washington 16, D. C.

Please send me Electric Appliance Training lesson and book free. (No salesman will call.)

Name Age

Address

City Zone State

ACCREDITED MEMBER NATIONAL HOME STUDY COUNCIL



ELECTRONICS ILLUSTRATED

SEPT. 1959

Vol. 2, No. 9

A FAWCETT PUBLICATION



CONTENTS

A Message From The Editor	4
Electronics In The News	10
Thermoelectricity	27
Hamming Is A Family Affair	31
A Metal Locator	32
Make Your Ideas Pay Off	36
El Build-It Course—1	40
Meters	44
How To Use Meters—2	48
Electronic Brain	52
You Can Make This Stereo Cabinet	54

Fight Against Hay Fever	58
Cracking Short Wave's Taboo	60
A Modulator-Driver Kit	63
Metal Etcher	66
Hi-Fi Clinic	69
A Six Meter Rig For Your Car	70
Improve Your Radio With A Loopstick	73
Radioactive Fallout	74
Try These	77
UHF Tells Us The Weather	78
Wire Your House For An Intercom	79
Make Sound Movies At Home	82
TV Top Hat	86



CHARLES TEPPER Editor

Leonard Buckwalter Associate Editor

Edward Nanas Feature Editor

Murray Cooper Art Editor

John M. Kane Art Associate

Elaine Jaffe Editorial Assistant

Larry Eisinger Editor-in-Chief

Phyllis Bendremer Production Editor

Nancy Kay Assistant Production Editor

John F. Webster Advertising Manager

Ralph Doigh Editorial Director

James Boynton Advertising Director

Al Allard Art Director

Ralph Mollison Associate Art Director

George H. Carl Production Director

ELECTRONICS ILLUSTRATED is published monthly by Fawcett Publications, Inc., Fawcett Place, Greenwich, Conn. W. H. Fawcett, Jr., President; Gordon Fawcett, Secretary and Treasurer; Roger Fawcett, General Manager; Roscoe K. Fawcett, Circulation Director.

EDITORIAL AND ADVERTISING OFFICES: 67 West 44th Street, New York 36, N. Y. ADDRESS ALL MAIL: Subscriptions, change of address, Form 3579 to Circulation Dept., Fawcett Bldg., Greenwich, Conn.; and all editorial and advertising to Fawcett Publications, Inc., 67 W. 44th St., New York 36, N. Y.

Second-class postage paid at Greenwich, Conn., and at additional mailing offices. Subscription price \$3.00 per year in the U. S. and possessions and Canada. All other countries \$6.00 per year. Foreign subscriptions and sales should be remitted by International Money Order in U. S. funds payable at Greenwich, Conn.

Printed in U.S.A. Copyright 1959 by Fawcett Publications, Inc.

Permission hereby granted to quote from this issue of this magazine on radio or television provided a total of not more than 1,000 words is quoted and credit is given to the title of the magazine and issue, as well as the statement, copyright 1959, by Fawcett Publications, Inc.

Train in New Coyne Shop-Labs for Today's Top OPPORTUNITY FIELDS!

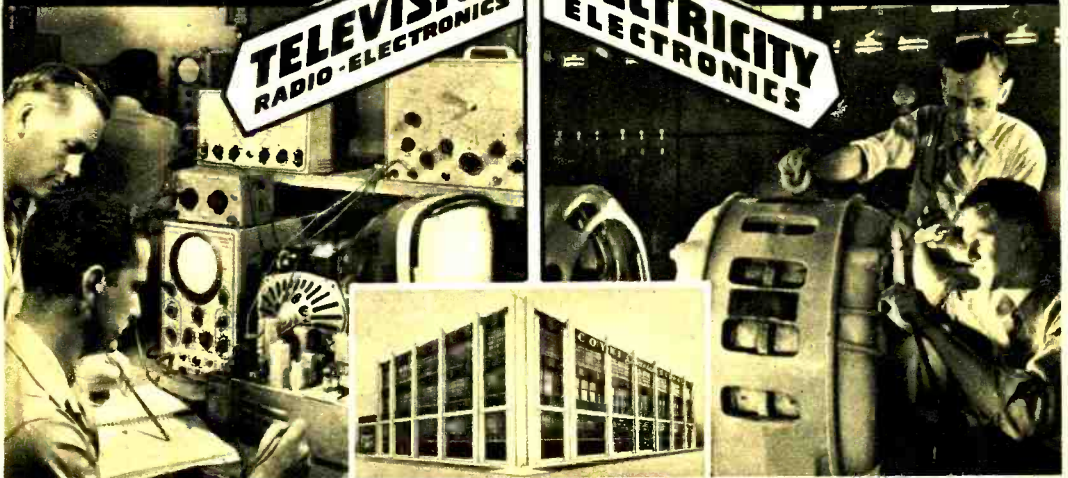

Instructor helping students check the wiring and trace the circuits of television receivers.

This modern fire-proof building which is occupied entirely by Coyne, houses the NEW COYNE SHOP-LABS.

Instructor explaining operation and testing of a large Motor Generator.

TELEVISION-RADIO ELECTRONICS

Here at COYNE you're trained for Testing, Trouble-Shooting and Servicing on AM and FM Radio, Auto Radio, Television, Color TV, etc. Thousands of COYNE trained men in good jobs or own well paying TV-Radio businesses.

ELECTRICITY ELECTRONICS

Big opportunities everywhere—city, town and country, in Power Plant Work, Motors, Industrial Electronics, Armature Winding, Home and Factory Wiring, Appliances, Refrigeration, Maintenance, Illumination, etc.

OLDEST AND BEST EQUIPPED SCHOOL OF ITS KIND IN THE U. S.

Send Coupon or Write for

FREE BOOK

"GUIDE to CAREERS"

Whether you prefer Electricity—Television—Radio or Combined Electronics Training this book describes all training offered.

Information comes by mail and no salesman will call.



To get Free Book and information, mail this Coupon in envelope or Paste on Postal Card, or write to address below.

WE TRAIN YOU IN CHICAGO

Our famous Practical-Technical method gives you practical experience on a massive outlay of equipment—over a quarter of a million dollars worth—plus necessary technical training right here in the NEW COYNE Shop-Labs.

Training in Refrigeration and Electric Appliances can be included.

Training offered to **VETERANS and NON-VETS alike**

START NOW—PAY LATER

Enroll now, pay most of tuition after Graduation. Part time employment help for students. Lifetime employment service to Graduates. Starting dates, every six weeks.

B. W. COOKE, JR., President

COYNE
ELECTRICAL SCHOOL

FOUNDED 1899

CHARTERED AS AN EDUCATIONAL INSTITUTION NOT FOR PROFIT
1501 W. Congress Parkway, CHICAGO, Dept. 69-8C

ELECTRICITY • RADIO • TELEVISION • REFRIGERATION • ELECTRONICS

COYNE ELECTRICAL SCHOOL, Dept. 69-8C, 1501 W. Congress Pkwy., Chicago 7, Ill.

At no obligation to me send FREE book "Guide to Careers" and details of all the training you offer. However, I am especially interested in:

ELECTRICITY TELEVISION BOTH FIELDS

Name _____

Address _____

City _____ State _____

(I understand no Salesman will call.)

A Message From the Editor

FEW licensed radio amateurs and potential hams realize the great potential of the frequency bands that have been assigned to them by the FCC. Listen in on any ham band and you will hear plenty of rag chewing and informal exchange of technical information, but have you ever heard a good scientific talk on an up-to-date topic by an authority with questions and answers "from the floor?" If you have tuned in on an informational net then you know what I'm talking about. These thoughts were brought to mind recently by some comments made by Mr. S. Edwin Piller, president of the Single Sideband Amateur Radio Association and a net director, on the subject of technical and scientific nets. These

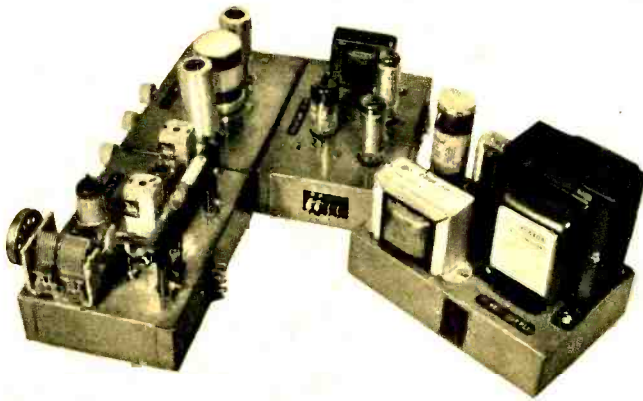

are voluntary organizations of interested hams who periodically go on the air using one or two frequencies for traffic handling, scientific forums, etc. One of the most interesting of these nets is the one which links 21 hospitals with

the Albany Medical College in Albany, N. Y. This was started with the help of over 70 radio amateurs and regularly carries talks and forums for doctors on the latest advances in medical techniques, etc. At a time when the free interchange of scientific information is so important and when it is becoming more and more expensive for individual technicians and engineers to attend all of the specialized conventions which are almost necessary these days, it would seem that technical information nets operated by hams could serve an important function. This is something I think which perhaps would bear looking into by more community-minded licensed amateurs. We plan to present an article on nets very shortly, discussing their potential, how they are used right now, and how more of them could be set up.

I'm sure you've noticed the metal locator on our cover this month. There's a story behind the development of this item for us. We originally desired to present an all-transistor metal locator on the theory that such a device could be made very small, easily portable and would be a "first." We assigned this idea to some of our regular contributors and some of them came up with working designs. But, after our typical "in-use" tests, none of them could operate with the sensitivity and accuracy that could be obtained from a vacuum tube model.

These test results disappointed us but rather than try for a publicity stunt and give our readers a transistor metal locator

THIS FREE DeVRY TECH BOOKLET WILL HELP YOU
CHART YOUR WAY TO REAL JOB OPPORTUNITIES IN...

TELEVISION • RADIO
ELECTRONICS

PREPARE IN SPARE TIME AT HOME,
OR IN DEVRY TECH'S
MODERN LABORATORIES
IN CHICAGO OR TORONTO

Let us Tell You how to
Prepare for, and **PROSPER**
in this Growing Field!

Here are short cuts, money-making tips, all found in one remarkable booklet that can show you a way toward your goal: a profitable career in **ELECTRONICS**, one of today's most exciting industries. DeVry has trained many men 17-25 for a start toward fine jobs . . . real earnings in this fast-growing, billion-dollar field. Let us give YOU these same facts! Send the coupon now.

HOME OR RESIDENT TRAINING

In modern training centers at Chicago or Toronto, you get thorough, practical day or evening training—the kind needed to earn real money. Or, you can learn at home in your spare time without quitting your present job. DeVry movies show you . . . clear texts tell you . . . practical experiments on real Electronic equipment help to sharpen your skill. You even build and keep your own test instruments! And when you complete the training, DeVry's **EMPLOYMENT SERVICE** helps you find a job or start your own servicing business. Get the facts. Send for this booklet. No obligation.

EXTRA: Just for mailing the coupon now, you will also receive a copy of DeVry's opportunity booklet, "ELECTRONICS IN SPACE TRAVEL." This, too, is a fascinating story of opportunities in a new field for trained men.

Accredited Member of National Home Study Council



DEVRY TECHNICAL INSTITUTE
4141 Belmont Avenue • Chicago 41, Illinois
Formerly DeForest's Training, Inc.

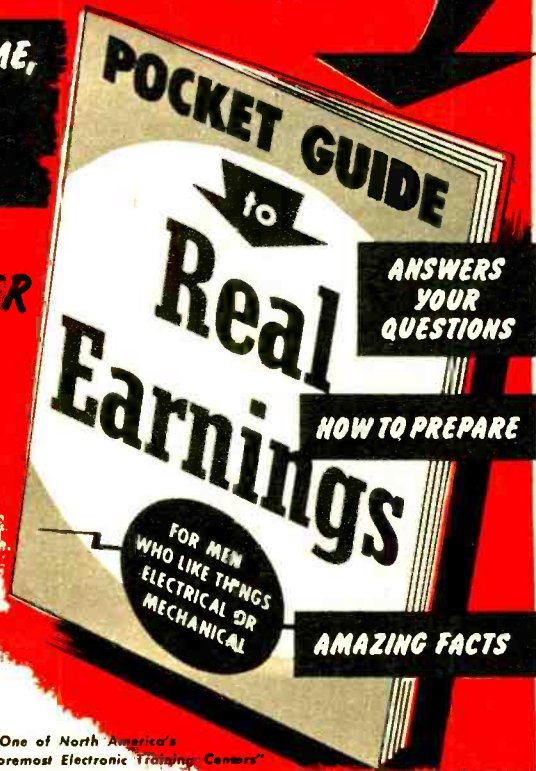

"One of North America's
Foremost Electronic Training Centers"

MAIL COUPON TODAY

DEVRY TECHNICAL INSTITUTE
4141 Belmont Ave., Chicago 41, Ill., Dept. EI-9-P
Please give me your FREE booklets, "Pocket Guide to Real Earnings" and "Electronics in Space Travel," and tell me how to prepare to enter one or more branches of Electronics.

NAME _____ AGE _____

STREET _____ PLEASE PRINT _____ APT. _____

CITY _____ ZONE _____ STATE _____

Check here if subject to military training.
DeVry Tech's Canadian Training Center is located at
2061 626 Roselawn Avenue, Toronto 12, Ontario.

It's easy to master
BASIC TELEVISION
 THE RIDER 'PICTURE-BOOK' WAY

The whole world of black and white television is before you for only \$10.00

NOW AVAILABLE

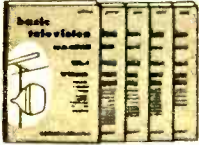

New 5-volume Rider 'picture book' course by Dr. Alexander Schure teaches the complete basic principles and practices of black and white television easily, quickly and understandably. You can master the basics of television easily, rapidly and thoroughly with this "learn by pictures" training course.

No experience, education needed

BASIC TELEVISION uses the same methods that have proven so successful in the famous Rider 'picture books' on electricity and electronics. This comprehensive course presents Basic Television in simple, down-to-earth language that everyone can understand—regardless of previous education. All that is assumed is that you have a knowledge of radio. Every phase of television is made instantly clear—explained in plain English supported by carefully prepared, large and exciting drawings that make every idea crystal-clear.

5 complete volumes

It starts with the transmitter and discusses in detail the following subjects: Volume 1 deals with the transmitter; the handling and the operation of the camera; formation of the picture signal and the general content of the transmitter. Volume 2 covers the organization of the entire TV receiver treating each section individually from antenna to picture tube. Volumes 3, 4 and 5 contain the TV receiver circuit explanations. Each volume covers a specific number of sections in the receiver.

Learn at home—no correspondence

This course is so complete, so different—there's no need for the usual letter writing, question and correspondence. You learn in the comfort of your home, in your spare time . . . at your own pace.

HOW TO KNOW MORE—EARN MORE WITH THESE RIDER 'HOW TO' BOOKS

HOW TO READ SCHEMATIC DIAGRAMS

by David Mark

Teaching theory and the recognition of symbols, this book is an ideal way to start a career or an electronic hobby. Covering the symbols and abbreviations used in schematic diagrams related to the electronics field, this book starts with the individual components and carries through to receivers and similar equipment. Components and circuits are identified and explained. #208, \$3.50.

HOW TO TROUBLESHOOT A TV RECEIVER (2nd Edition) by J. Richard Johnson, #152, \$2.50

HOW TO USE METERS by John F. Rider, #144, \$2.40

HOW TO USE TEST PROBES by A. Ghirardi and R. Middleton, #165, \$2.90

HOW TO USE SIGNAL & SWEEP GENERATORS by J. Richard Johnson, #147, \$2.10

ORDER TODAY!

Available at electronic parts jobbers or use coupon—



10-DAY UNCONDITIONAL MONEY-BACK GUARANTEE—
 JOHN F. RIDER PUBLISHER, INC., Dept. E1-9
 116 West 14th St., New York 11, N. Y.

I have enclosed \$..... Please send me:

- BASIC TELEVISION, 5 vol. SOFT COVER SET, \$10
- CLOTH BOUND, \$11.50
- #152, \$2.50
- #144, \$2.40
- #165, \$2.90
- #147, \$2.10

Name

Address

City Zone State

In Canada 5% higher; add state and city sales taxes where applicable.

GUARANTEE: Satisfaction guaranteed. All books returnable within 10-days for full refund.

that would do nothing, we have engineered the tube model on page 32 and this one EI will guarantee!

Up until last month every issue of EI carried a series called the "ABC's of Electronics." We have been gratified by the response from the readers on this course in electronic fundamentals. If you've read all the ABC's you should now be eager to learn how actual circuits work and how to build projects. The EI Build-It Course starting in this issue will serve this purpose. Each of the units described for the reader to build has been designed so that it may be plugged into another to make more advanced and usable electronic devices. For example, in this issue we present a power supply. In the subsequent articles the reader will be shown how to build the other sections needed to make an AM radio, a phono amplifier and preamplifier, an FM radio and so on.

Our June issue which contained a special section on the new two-way radio band opened to all citizens over 18 years of age was a bigger hit than we thought it would be. It was one of our best newsstand sellers and has also brought us many commendations from the manufacturers who are making the new low priced units. We are very gratified at this response and will continue to present to our readers at least one article on this topic every issue. Next month we will show you how to install some of these new two-way radios in your car so that you can talk with home, your shop, your business or any other place you desire. I'd like to remind you this 2-way radio band needs no operators license. Our one-transistor FM pocket radio project in February was so successful that we thought we should follow up with a one-transistor AM pocket radio which would operate without an external antenna. Be sure to be with us next month.

Charles Tupper

"HOW A 'CRAZY RUMOR' GOT ME PROMOTED!"



What I overheard one morning shook me right out of a rut!

"Company's getting ready to cut back . . . bound to be layoffs," I heard them say. "Just another crazy rumor," I told myself.

Just the same, I took quick stock of myself that night. Came up with four good reasons why the company would keep me on:

- Three years' experience*
- Getting along with foreman*
- Turning out acceptable work*
- Prompt and dependable*

And four just-as-good reasons why they might let me go:

- Making no real headway*
- Others better qualified*
- Still rated "semi-skilled"*
- Needs special training*

I wasn't in trouble. But I sure wasn't "in solid" like I should be. That's when I made up my mind to enroll for training with I.C.S.

I picked I.C.S. because it's the oldest and largest with 259 courses. The training is quick and thorough. It's recognized by my company and accredited by the National Home Study Council. You study in your spare time and get personalized, practical instruction—know-how you can apply next day on the job.

That was a year ago. There have been two layoffs since then. While some of the others were just hanging on or being released, I was moving up. My I.C.S. training started something. Not only did it get me promoted (with a fat pay hike), but it put me in line for real advancement.

Don't wait for a "crazy rumor" to set you straight. Take out your "job insurance" right now. Mail the coupon and get full, free details on how I.C.S. has helped thousands, how it can help you. No obligation—and you get three valuable books *free!* (1) How to Succeed; (2) Catalog of opportunities in the field of your choice; (3) Sample lesson (math).

For Real Job Security—Get an I. C. S. Diploma!

I. C. S., Scranton 15, Penna.

Accredited Member,
National Home Study Council

INTERNATIONAL CORRESPONDENCE SCHOOLS



BOX 73423H, SCRANTON 15, PENNA.

Without cost or obligation, send me "HOW TO SUCCEED" and the opportunity booklet about the field BEFORE which I have marked X (plus sample lesson):

- | | | | | |
|--|---|--|---|--|
| <p>ARCHITECTURE and BUILDING CONSTRUCTION</p> <ul style="list-style-type: none"> <input type="checkbox"/> Air Conditioning <input type="checkbox"/> Architecture <input type="checkbox"/> Arch. Drawing and Designing <input type="checkbox"/> Building Contractor <input type="checkbox"/> Building Estimator <input type="checkbox"/> Carpenter Builder <input type="checkbox"/> Carpentry and Millwork <input type="checkbox"/> Carpenter Foreman <input type="checkbox"/> Heating <input type="checkbox"/> Painting Contractor <input type="checkbox"/> Plumbing <input type="checkbox"/> Reading Arch. Blueprints <p>ART</p> <ul style="list-style-type: none"> <input type="checkbox"/> Commercial Art <input type="checkbox"/> Magazine Illus. <input type="checkbox"/> Show Card and Sign Lettering <input type="checkbox"/> Sketching and Painting <p>AUTOMOTIVE</p> <ul style="list-style-type: none"> <input type="checkbox"/> Automobile <input type="checkbox"/> Auto Body Rebuilding and Refinishing <input type="checkbox"/> Auto Engine Tuneup <input type="checkbox"/> Auto Technician | <p>AVIATION</p> <ul style="list-style-type: none"> <input type="checkbox"/> Aero-Engineering Technology <input type="checkbox"/> Aircraft & Engine Mechanic <p>BUSINESS</p> <ul style="list-style-type: none"> <input type="checkbox"/> Accounting <input type="checkbox"/> Advertising <input type="checkbox"/> Business Administration <input type="checkbox"/> Business Management <input type="checkbox"/> Cost Accounting <input type="checkbox"/> Creative Salesmanship <input type="checkbox"/> Managing a Small Business <input type="checkbox"/> Professional Secretary <input type="checkbox"/> Public Accounting <input type="checkbox"/> Purchasing Agent <input type="checkbox"/> Salesmanship <input type="checkbox"/> Salesmanship and Management <input type="checkbox"/> Traffic Management <p>CHEMICAL</p> <ul style="list-style-type: none"> <input type="checkbox"/> Analytical Chemistry <input type="checkbox"/> Chemical Engineering <input type="checkbox"/> Chem. Lab. Technician <input type="checkbox"/> Elements of Nuclear Energy <input type="checkbox"/> General Chemistry <input type="checkbox"/> Natural Gas Prod. and Trans. <input type="checkbox"/> Petroleum Prod. and Eng. <input type="checkbox"/> Professional Engineer (Chem) <input type="checkbox"/> Pulp and Paper Making | <p>CIVIL ENGINEERING</p> <ul style="list-style-type: none"> <input type="checkbox"/> Civil Engineering <input type="checkbox"/> Construction Engineering <input type="checkbox"/> Highway Engineering <input type="checkbox"/> Professional Engineer (Civil) <input type="checkbox"/> Reading Struc. Blueprints <input type="checkbox"/> Sanitary Engineer <input type="checkbox"/> Structural Engineering <input type="checkbox"/> Surveying and Mapping <p>DRAFTING</p> <ul style="list-style-type: none"> <input type="checkbox"/> Aircraft Drafting <input type="checkbox"/> Architectural Drafting <input type="checkbox"/> Drafting & Machine Design <input type="checkbox"/> Electrical Drafting <input type="checkbox"/> Mechanical Drafting <input type="checkbox"/> Sheet Metal Drafting <input type="checkbox"/> Structural Drafting <p>ELECTRICAL</p> <ul style="list-style-type: none"> <input type="checkbox"/> Electrical Engineering <input type="checkbox"/> Elec. Engr. Technician <input type="checkbox"/> Elec. Light and Power <input type="checkbox"/> Practical Electrician <input type="checkbox"/> Practical Lineman <input type="checkbox"/> Professional Engineer (Elec) <p>HIGH SCHOOL</p> <ul style="list-style-type: none"> <input type="checkbox"/> High School Diploma | <ul style="list-style-type: none"> <input type="checkbox"/> Good English <input type="checkbox"/> High School Mathematics <input type="checkbox"/> High School Science <input type="checkbox"/> Short Story Writing <p>LEADERSHIP</p> <ul style="list-style-type: none"> <input type="checkbox"/> Industrial Foremanship <input type="checkbox"/> Industrial Supervision <input type="checkbox"/> Personnel-Labor Relations <input type="checkbox"/> Supervision <p>MECHANICAL and SHOP</p> <ul style="list-style-type: none"> <input type="checkbox"/> Diesel Engines <input type="checkbox"/> Gas-Elec. Welding <input type="checkbox"/> Industrial Engineering <input type="checkbox"/> Industrial Instrumentation <input type="checkbox"/> Industrial Metallurgy <input type="checkbox"/> Industrial Safety <input type="checkbox"/> Industrial Drafting <input type="checkbox"/> Machine Shop Practice <input type="checkbox"/> Mechanical Engineering <input type="checkbox"/> Professional Engineer (Mech) <input type="checkbox"/> Quality Control <input type="checkbox"/> Reading Shop Blueprints <input type="checkbox"/> Refrigeration and Air Conditioning <input type="checkbox"/> Tool Design <input type="checkbox"/> Tool Making <p>RADIO, TELEVISION</p> <ul style="list-style-type: none"> <input type="checkbox"/> General Electronics Tech. | <ul style="list-style-type: none"> <input type="checkbox"/> Industrial Electronics <input type="checkbox"/> Practical Radio-TV Engr'g <input type="checkbox"/> Practical Telephony <input type="checkbox"/> Radio-TV Servicing <p>RAILROAD</p> <ul style="list-style-type: none"> <input type="checkbox"/> Car Inspector and Air Brake <input type="checkbox"/> Diesel Electrician <input type="checkbox"/> Diesel Engr. and Fireman <input type="checkbox"/> Diesel Locomotive <p>STEAM and DIESEL POWER</p> <ul style="list-style-type: none"> <input type="checkbox"/> Combustion Engineering <input type="checkbox"/> Power Plant Engineer <input type="checkbox"/> Stationary Diesel Engr. <input type="checkbox"/> Stationary Fireman <p>TEXTILE</p> <ul style="list-style-type: none"> <input type="checkbox"/> Carding and Spinning <input type="checkbox"/> Cotton Manufacture <input type="checkbox"/> Cotton Warping and Weaving <input type="checkbox"/> Loom Fixing Technician <input type="checkbox"/> Textile Designing <input type="checkbox"/> Textile Finishing & Dyeing <input type="checkbox"/> Throwing <input type="checkbox"/> Warping and Weaving <input type="checkbox"/> Worsted Manufacturing |
|--|---|--|---|--|

Name _____ Age _____ Home Address _____
 City _____ Zone _____ State _____ Working Hours _____ A.M. to P.M. _____
 Occupation _____

Canadian residents send coupon to International Correspondence Schools, Canadian, Ltd., Montreal, Canada. . . . Special low monthly tuition rates to members of the U. S. Armed Forces.

The COLUMBIA RECORD CLUB

to demonstrate how you can acquire, at great

REGULAR LONG PLAY

Symphonies



17. A "must" for any record library



6. Lovely "musical portrait of nature"



15. High-spirited, gay symphonies



12. Berlioz' most popular work



13. An heroic work, superbly performed



18. Brahms' most beloved symphony



25. "... it is a marvel"—Atlantic



3. Prokofiev's greatest work



31. A melodious and moving score



23. "given like a tornado"—NY Times

Concertos



9. Two romantic piano works



32. Has "intensity, power"—H. Taubman



24. "Powerful performances"—Hi-Fi



30. Bernstein at his greatest

ORCHESTRAL FAVORITES



14. Three brilliant hi-fi showpieces



2. A beloved American classic



10. Four dashing, fiery rhapsodies



1. Two electrifying tone poems



5. The ballet that "rocked the world"

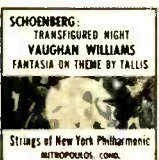

4. 2 passionate and poetic works



28. Also works by Leroy Anderson, etc.

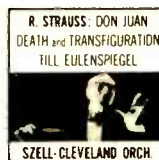

19. Strauss' loveliest tone poems



8. More thrilling than ever in stereo



22. Music from this popular opera



27. "record of rare beauty" Sat. Review



11. Also: Sylvia, Coppelia, etc.

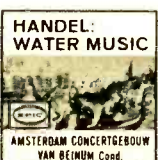

29. "Finest version"—NY Times

Choral Works



16. "Hallelujah", "Finlandia", etc.

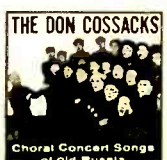

7. "A standout ensemble"—Variety

offers you a **TRIAL MEMBERSHIP** savings, a superb classical record library on

or **STEREO RECORDS**

any six

regular (Lp) FOR ONLY **\$3⁹⁸** retail value, \$29⁸⁸
or stereo (Lp) FOR ONLY **\$5⁹⁸** retail value, \$35⁸⁸

if you join the Club now—and agree to purchase as few as 5 selections from the more than 150 to be made available during the coming 12 months

All 31 of the Columbia and Epic high-fidelity records shown here are available in both regular long play and stereo! You may have ANY 6 of these records — at an amazingly low price — simply by agreeing to accept a Trial Membership in the Columbia (Lp) Record Club.

If you have a standard phonograph you may join the Club's Regular Classical Division, and receive the regular high-fidelity versions of any 6 of these records — a \$29.88 retail value — ALL 6 for only \$3.98!

If you have a stereo phonograph you may join the Club's Stereo Classical Division, and receive the stereo high-fidelity versions of any 6 of these records — a \$35.88 retail value — ALL 6 for only \$5.98!

Each month the Club's staff of music experts selects outstanding high-fidelity recordings — both regular and stereo — from every field of music. These selections are described

in the Club's entertaining Music Magazine, which you receive free each month.

You may accept the monthly Classical Selection . . . take any of the other records offered, both classical and popular . . . or take NO record in any particular month.

Your only obligation is to purchase five selections during the coming 12 months . . . and you may discontinue your Trial Membership at any time thereafter.

On the other hand, if you should choose to continue as a regular member, you will have earned the right to receive a Columbia or Epic Bonus record of your choice FREE for every two additional selections you buy.

The records you want are mailed and billed to you at the usual list price: regular long-play records at \$3.98 (Popular) and \$4.98 (Classical); stereo records at \$4.98 (Popular) and \$5.98 (Classical) — plus a small mailing charge. So mail the coupon today!

Broadway Shows



21. Complete score of this hit musical



20. Broadway's newest smash hit

NOTE: Stereo records must be played only on a stereo record player. If you do not now own a stereo phonograph, by all means continue to acquire regular long-play high-fidelity records. They will play with true-to-life fidelity on your present phonograph, and will sound even more brilliant on a stereo record player if you purchase one in the future.

SEND NO MONEY — Mail Coupon Now to Receive 6 Records

COLUMBIA (Lp) RECORD CLUB, Dept. 271-2
Terre Haute, Indiana

I accept your Trial Membership offer and have circled at the right the numbers of the six records I wish to receive. Bill me for \$3.98 for six regular long-play records OR \$5.98 for six stereo records — plus small mailing charge. Enroll me in the following Division of the Club:

(check one box only) Regular Classical Stereo Classical

As a Trial Member I agree to purchase five selections from the more than 150 regular long-play and stereo records to be offered during the coming 12 months, at usual list price plus small mailing charge. If I continue as a regular member, I will receive a Columbia or Epic Bonus record FREE for every two additional selections I buy.

Name.....
 (Please Print)

Address.....

City..... ZONE..... State.....

ALASKA and HAWAII: write for special membership offer
 CANADA: prices slightly higher; 11-13 Soho St., Toronto 2B
 To credit this membership to an established Columbia or Epic record dealer, authorized to accept subscriptions, fill in:

Dealer's Name.....

Dealer's Address..... 298

CIRCLE SIX NUMBERS BELOW:

(If you enroll in the Regular Classical Division, you receive your 6 records in regular high-fidelity. If you enroll in the Stereo Classical Division, you receive your 6 records in stereo-fidelity)

- 1 9 17 25
- 2 10 18 27
- 3 11 19 28
- 4 12 20 29
- 5 13 21 30
- 6 14 22 31
- 7 15 23 32
- 8 16 24

K-64 (REG.) F-62 (STER)

© "Columbia," (Lp), "Epic," (Lp) Marcas Reg. © Columbia Records Sales Corp., 1959

Electronics in the News

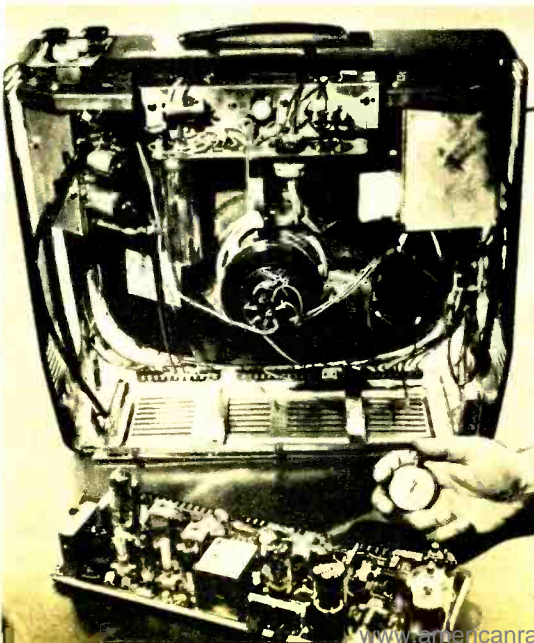

What's new in TV sets this year? Stylewise, greater use of TV sets as tables, room dividers, even part of pole lamps. Shown above is RCA's new "Hillsborough" 21-inch television set that converts from a console TV into a deceiving living room table. The stopwatch in the picture to the left was stopped at 33 seconds—the time it took to completely disengage the plated circuit board from the Motorola 17-inch portable TV set. Thirty electrical connections to the board are opened simultaneously. This board, which contains over 80% of the wiring and components of the set shows, on the same side as the components, all of the wiring, carefully color coded for ease in troubleshooting. Also, all components can be tested by simply removing the back cover of the TV set, loosening some screws and sliding the board forward. All connections and voltages remain intact.

Electronics Illustrated

NOW!
at a price
you can afford!

MAKE MORE MONEY in TELEVISION RADIO-ELECTRONICS

**BETTER...MORE COMPLETE...LOWER COST...
WITH NATIONAL SCHOOLS SHOP-METHOD
HOME TRAINING!**

BETTER... Training that is proved and tested in Resident School shops and laboratories, by a School that is the **OLDEST** and **LARGEST** of its kind in the world.

MORE COMPLETE... You learn **ALL PHASES** of *Television-Radio-Electronics*.

LOWER COST... Other schools make several courses out of the material in our **ONE MASTER COURSE** . . . and you pay more for less training than you get in our course at **ONE LOW TUITION!**



These two **FREE** books will show you how!

You get all information by mail . . . You make your own decision . . . at home! **NO SALESMAN WILL CALL**

TOP PAY... UNLIMITED OPPORTUNITIES LIFETIME SECURITY CAN BE YOURS!

You are needed in the Television, Radio, and Electronics industry! Trained technicians are in growing demand at excellent pay—in ALL PHASES, including Servicing, Manufacturing, Broadcasting, and Communications, Automation, Radar, Government Missile Projects.

NATIONAL SCHOOLS SHOP-METHOD HOME TRAINING, with newly added lessons and equipment, trains you in your spare time at home, for these unlimited opportunities, including many technical jobs leading to supervisory positions.

YOU LEARN BY BUILDING EQUIPMENT WITH KITS AND PARTS WE SEND YOU. Your National Schools course includes thorough *Practical* training—**YOU LEARN BY DOING!** We send you complete standard equipment of professional quality for building various experimental and test units. You advance step by step, perform more than 100 experiments, and you build a complete TV set from the ground up, that is yours to keep! A big, new TV picture tube is included at no extra charge.

EARN AS YOU LEARN. We'll show you how to earn extra money right from the start. Many of our students pay for their course—and more—while studying. So can you!

RESIDENT TRAINING AT LOS ANGELES

If you wish to take your training in our Resident School at Los Angeles, the world's TV capital, start NOW in our big, modern Shops, Labs and Radio-TV Studios. Here you work with latest Electronic equipment—professionally installed—finest, most complete facilities offered by any school. Expert, friendly instructors. Personal attention. Graduate Employment Service. Help in finding home near school. . . and part time job while you learn. Check box in coupon for full information.

LESSONS AND INSTRUCTION MATERIAL ARE UP-TO-DATE, PRACTICAL, INTERESTING. Every National Schools Shop-Method lesson is made easy to understand by numerous illustrations and diagrams. All instruction material has been developed and tested in our own Resident School Shops, Laboratories and Studios.

SEND FOR INFORMATION TODAY . . . it can mean the difference between **SUCCESS** and failure for you! Send for your **FREE BOOK** "Your Future in Television-Radio-Electronics" and **FREE Sample Lesson**. Do it **TODAY**, while you are thinking about your future. It doesn't cost you anything to investigate!

GET THE BENEFITS OF OUR OVER 50 YEARS EXPERIENCE

Approved for
GI Training



NATIONAL SCHOOLS

Los Angeles 37, Calif.

YOU GET...

- 19 Big Kits—YOURS TO KEEP!
- Friendly Instruction and Guidance
- Job Placement Service
- Unlimited Consultation
- Diploma—Recognized by Industry
- EVERYTHING YOU NEED FOR SUCCESS!

SHOP-METHOD HOME TRAINING COVERS ALL PHASES OF INDUSTRY

1. Television, including Color TV
2. Radio AM & FM
3. Electronics for Guided Missiles
4. Sound Recording and Hi-Fidelity
5. FCC License
6. Automation and Computers
7. Radar & Micro-Waves.
8. Broadcasting and Communications

NATIONAL TECHNICAL SCHOOLS

WORLD-WIDE TRAINING SINCE 1905

MAIL NOW TO
NATIONAL SCHOOLS, Dept R4Y-89
4000 S FIGUEROA ST LOS ANGELES 37, CALIF.

Rush free TV-Radio "Opportunity" Book and sample lesson. No salesman will call.

NAME _____ AGE _____
ADDRESS _____
CITY _____ ZONE _____ STATE _____
 Check if interested ONLY in Resident School training at Los Angeles
VETERANS Give date of Discharge _____

RESIDENT SCHOOL COURSES

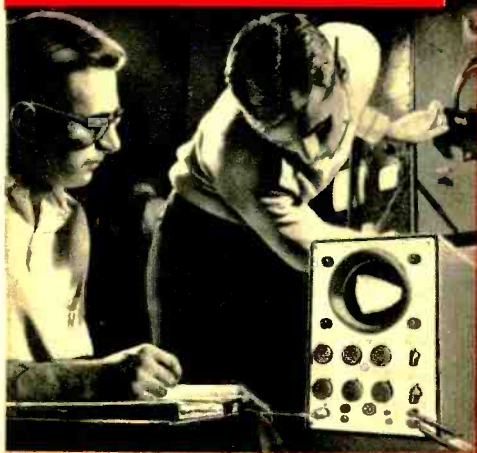

Industry needs Electronic Technicians!

Let RCA train you in Advanced Electronics

This is the college-level training you need to work with professional engineers on research, development or production projects in such fields as: automation, guided missiles, radar, television, computers and other advanced electronic applications.

RCA Institutes Resident School in New York City offers this comprehensive course that prepares you for any field of electronics you may choose. Other courses in TV & General Electronics, Radio & TV Servicing, and Radio Telegraph Operating.

Classes start four times each year. Applications now being accepted. Approved for Veterans.



RCA INSTITUTES, INC.
SCHOOL OF TELEVISION
AND ELECTRONIC TECHNOLOGY
A Service of Radio Corporation of America



RCA INSTITUTES, DEPT. EIR-99
350 W. Fourth St., N.Y. 14, N.Y.

Please send me your FREE catalog of Resident School courses in New York.

NAME _____ please print
ADDRESS _____
CITY _____ ZONE _____ STATE _____

For Home Study Courses see ad on opposite page

...News



For the do-it-yourselfer, the Heath Company is now shipping its new 2-way radio kit for the Citizens Band. It can cover distances from one to ten miles depending on the location and type of installation. The receiver is a superregenerative detector with RF stage and can be tuned to any of 23 assigned channels. The transmitter has a power input of 5 watts to plate of final RF amplifier. Kit comes complete with microphone, station identification card which fits in plastic window at end of cabinet, all pertinent FCC regulations and application forms, and crystal for one channel. Heath will supply crystal for the frequency of buyer's choice. The CB-1 requires a power supply of 117V 50/60 cycle AC for home use or 6V or 12V DC for mobile. Unit may be used with fixed or mobile antenna. Three different types of antennas are also available from the Heath Company in Benton Harbor, Michigan. The two-way radio kit is priced at \$42.95. 6- and 12-volt DC power supply kits are also available.



Desk-top analog computers may become as familiar an engineer's tool as the slide rule in the not too distant future. A new transistorized model, about the size of a standard electric typewriter and weighing only 80 pounds, was displayed recently by Electronic Associates. The basic analog computer can handle five second-order differential equations simultaneously with an accuracy of 0.1 percent. Price of the new computer, PACE TR-10, starts below \$4,000.



LET RCA TRAIN YOU IN ELECTRONICS

RCA Institutes celebrates Fifty Years of Electronic Training by introducing its newest Home Study Course . . .
ELECTRONICS FOR AUTOMATION

. . . Now you have *four* comprehensive courses for your electronic training . . . from basic electronic theory to the more advanced principles of color TV and Automation.

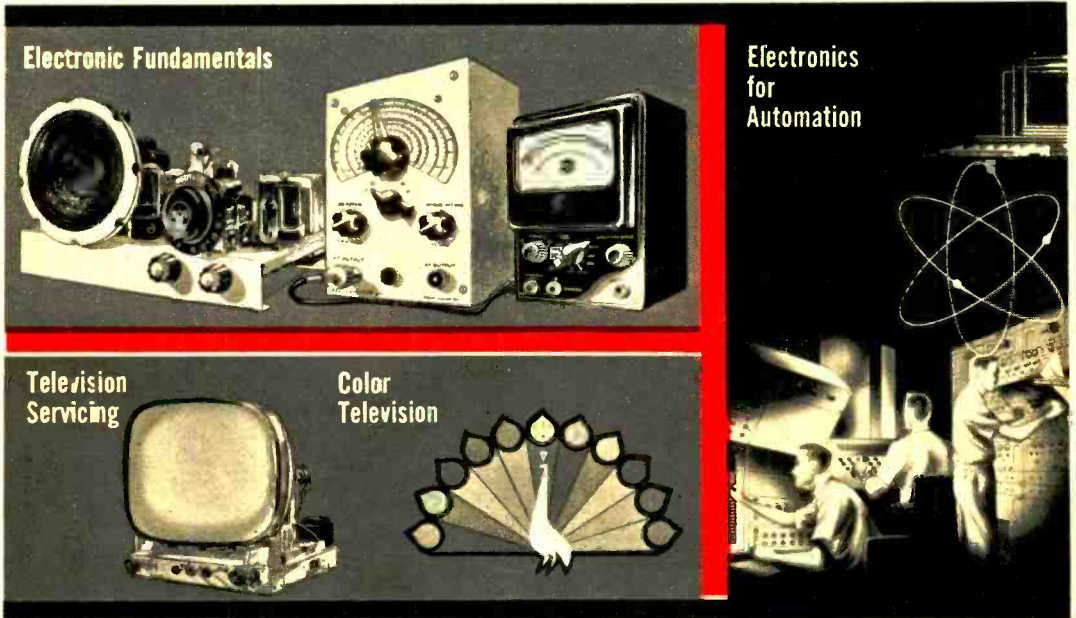

Send for our
64 page Home
Study Catalog
FREE!

For Resident
School Courses
see ad on opposite
page.

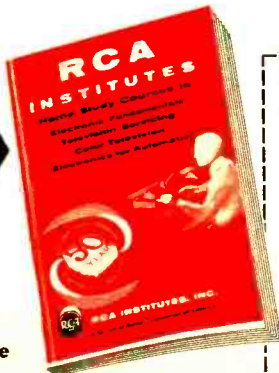

Practical work with the very first lesson. Pay-as-you-learn. You need pay for only one study group at a time.

RCA INSTITUTES, Inc. Home Study School, Dept. E1-99

A Service of Radio Corporation of America

350 West Fourth Street, New York 14, N. Y.

Without obligation, send me the FREE catalog of Home Study Courses. No salesman will call.

Name Please print

Address

City Zone State

Korean Vets! Enter Discharge Date

CANADIANS — Take advantage of these same RCA courses at no additional cost. No postage, no customs, no delay. Send coupon to: RCA Victor Company, Ltd., 5001 Cote de Liesse Rd., Montreal 9, Quebec
To save time, paste coupon on postcard.

DON'T BE HALF-TRAINED!

Be A Master Technician

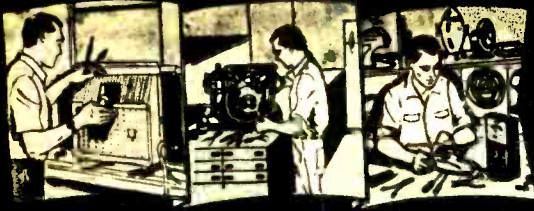

AIR CONDITIONING-REFRIGERATION ELECTRICAL APPLIANCES

**NOW ONE Modern Master
Home Training Course
IN ALL 3 PHASES
ALL AT ONE
LOW TUITION**

Only National Technical
Schools gives you this
complete training
at no extra cost!

YOU GET AND KEEP ALL THIS EQUIPMENT

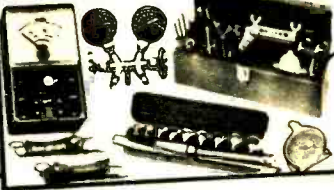

Incomplete training limits your earning power, even disqualifies you for top-pay jobs. The big service companies require complete, all-phase training. If you open your own shop, you'll be called upon to service and repair all types of refrigerators, air conditioners and appliances. With complete training — as only N.T.S. gives you — you can accept every job, make big profits all year round.

Future Bright For Trained Master Technicians

Over 30,000 new technicians must be trained annually. You are needed to help service and repair the 50 million air conditioners, refrigerators and electrical appliances that will need fixing this year alone. No wonder the Master Technician has steady work, at high pay, year after year. He can go places in his own business or with a manufacturer, dealer, distributor or department store. Armed with all-phase training, his earning power is unlimited.

The Most For Less

We give you illustrated Shop-Tested Lessons and Manuals . . . many other training aids . . . privilege of CONSULTATION with our instructors and engineers. Every lesson, every manual has been SHOP tested and approved.

Job Training At Home

You get Professional Tools, Precision Instruments, PLUS a Factory-Made APPLIANCE TESTER! A shop-full of PRACTICAL, professional equipment. Use them to conduct over 100 experiments . . . also in Spare Time Work and ON THE JOB. It is all yours to keep . . . no EXTRA MONEY DEPOSITS . . . no EXTRA COST on your equipment kits.

Earn As You Learn

We show you how. Many of our students pay for their entire course — and more — in Spare Time while learning. So can you. Graduate Advisory Service, too.

FREE!



**ILLUSTRATED
FACT BOOK
and
ACTUAL
LESSON**
Clip Coupon now

NATIONAL TECHNICAL SCHOOLS
WORLD-WIDE TRAINING SINCE 1905
4000 SO FIGUEROA ST., LOS ANGELES 37, CALIF., U.S.A.

N.T.S. also offers training in
**TV - RADIO - ELECTRONICS
and AUTO MECHANICS - DIESEL**

NATIONAL TECHNICAL SCHOOLS

WORLD-WIDE TRAINING SINCE 1905

MAIL NOW TO

National Technical Schools, Dept. C4Y-89
4000 S. Figueroa St., Los Angeles 37, Calif.

Rush **FREE** Air Conditioning-Refrigeration-Electrical
Appliances "Opportunity" Book and Actual Lesson. No
Salesman will call.

NAME _____ AGE _____

ADDRESS _____

CITY _____ ZONE _____ STATE _____

Check here if interested ONLY in Resident Training at Los Angeles.

GET THE
BENEFIT
OF OUR OVER
50 YEARS
EXPERIENCE



. . . News

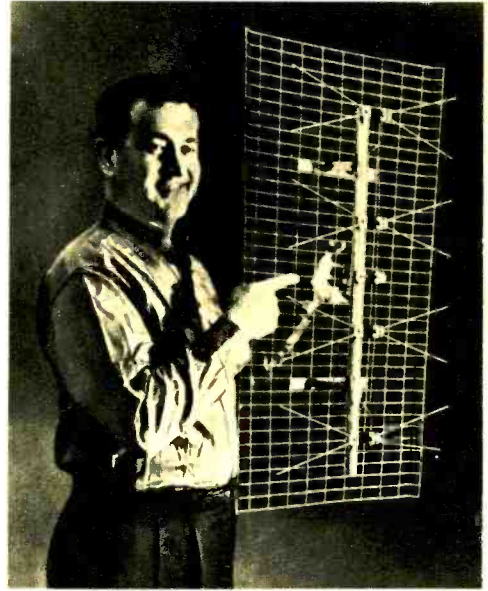

Channel Master of Ellenville, New York has announced its new four-way bowtie and screen combination for fringe area UHF reception. The antenna can be mounted with a U-bolt to the mast, or with the Channel Master Adapter, model 4221 which permits it to be inserted into the top of the existing mast. Model 4220A is supersembled and is ready for installation by snapping open. \$10.95. Available from local electronic parts stores.

Top government officials will now be able to keep in touch with any point on earth while in the air if they fly in Boeing's new VC137 jet airliner equipped with a long range communications system using single sideband radio. This system, the AN/ARC-65 converts incoming radio messages to teletypes on a teletypewriter in the plane and conversely, adapts outgoing teletype messages for radio transmission. All messages will be relayed via teletype although voice communication is available when needed. The normal radio channel will be through the Pentagon communications center, which can "patch in" messages of the other communications facilities. Developed by RCA.

Electronics Illustrated

build this great new **knight-kit** A PRODUCT OF ALLIED RADIO

stereo hi-fi amplifier... save up to 50%

COMPARABLE IN EVERY WAY TO WIRED AMPLIFIERS COSTING TWICE AS MUCH



tremendous value at only

\$44.50

only \$4.45 down

never before such performance...
such styling... such quality
at so low a price...

knight-kit 20-watt stereo hi-fi amplifier

Newest complete Stereo high-fidelity amplifier at an amazing low \$44.50. Incomparable value: Includes two built-in preamps for magnetic cartridges. Single switch selects phono, tuner or auxiliary stereo inputs, plus stereo reverse on each; also switches monophonic input to both amplifier channels. Bass and treble controls boost and attenuate. Special clutch-type concentric volume control permits individual channel balancing, plus overall volume control. Total output is 20 watts (10 watts per channel at less than 1½% distortion). Response, 20-20,000 cps, ± 1.5 db. Hum and noise better than 85 db below full output. Has four pairs of stereo inputs: magnetic cartridge, ceramic cartridge, tuner, auxiliary. RIAA equalized for stereo discs. Expertly designed push-pull output circuitry. Beautiful custom-styled case, 4¼ x 13¼ x 9". With case, tubes, all parts, wire, solder and instructions. Shpg. wt., 27 lbs.

Model Y-773. Knight-Kit Stereo Amplifier, F.O.B. Chicago... **\$44.50**

EXCLUSIVE **knight-kit** **MONEY-BACK GUARANTEE**

Every KNIGHT-KIT meets or exceeds published specifications, or we refund your money.

ONLY **knight-kits** ARE **CONVENIENCE ENGINEERED**

for easiest building—no previous electronic experience needed...

see over 50 other fine **knight-kits**... write for catalog

HI-FI KITS

Stereo Amplifiers
Stereo Preamp
Stereo Control
Hi-Fi Tuners
Hi-Fi Amplifiers
Speaker Systems,
and others

HOBBY KITS

Short-Wave Radios
AC-DC Table Radios
Clock-Radio
Radio-Intercom
Transistor Radios
Electronic Lab Kits
and many others

INSTRUMENT KITS

VTVM
VOM's
Tube Checkers
Oscilloscopes
Signal Tracer
Audio Generator
Sweep Generator

Cap. Checker
R/C Tester, etc.

HAM KITS

Receiver
Transmitter
VFO, etc.

EASY TERMS ON ORDERS AS LOW AS \$20

1959 ALLIED **FREE** CATALOG

Send for this value-packed catalog featuring the complete KNIGHT-KIT line, as well as the world's largest stocks of everything in Electronics.

WRITE FOR YOUR COPY TODAY

Registered Trade Mark
Allied Radio Corporation

ALLIED RADIO Dept. 133-J9 100 N. Western Ave., Chicago 80, Ill.

- Ship Model Y-773 Knight-Kit Stereo Amplifier. \$_____encl.
 Send FREE ALLIED 1959 Catalog

Name _____

Address _____

City _____ Zone _____ State _____

COMPLETE TRAINING IN RADIO-TV SERVICING



Helps you repair
any Radio or TV
ever made!

RADIO & TV TROUBLESHOOTING AND REPAIR by Ghirardi and Johnson is a complete, easily understood 820-page guide to modern professional service methods. Every phase of radio and television service—from circuits to components—is fully explained. You learn to locate troubles quickly. Then you learn to fix them fast and right. Tough jobs like realignment are explained

so you can really understand them. Shows what instruments to use—how to use them. Step by step troubleshooting charts save you loads of time. Helps you "brush up" on specific jobs; develop better methods and short cuts; or to find quick answers to any service procedure that "stumps" you. Over 400 pictures, diagrams and charts. Practice from it for 10 days at our RISK!

10-DAY FREE EXAMINATION

Dept. PR-99, RINEHART & CO., Inc.

232 Madison Avenue, New York 16, N. Y.

Send Radio & TV TROUBLESHOOTING AND REPAIR HAND-BOOK for 10-day examination. If I decide to keep book, I will then send \$7.50 plus postage. Otherwise, I will return book promptly and owe you nothing. (SAVE! Send \$7.50 with order and we pay postage. Same 10-day return privilege with money refunded.)

Name

Address

City, Zone, State

OUTSIDE U.S.A.—Price \$8.00 cash with order only. Money back if you return book in 10 days.



only 27 months for engineering degree

Unlock your talents. Start to realize your dream of becoming a graduate Electronics Engineer. Then promotion will not pass you by. You will share rewards awaiting college graduates. Important firms visit Tri-State campus to interview seniors. Approved for vets. Bachelor of Science Degree in 27 months in Electrical Engineering with either Electronics or Power major also in Mechanical, Civil, Chemical, Aeronautical Engineering. In 36 months a B. S. in Business Administration (General Business, Accounting, Motor Transport Management majors). Mature students. Enrollment limited. Small classes. More professional class hours. Beautiful campus. Well-equipped, new and modernized buildings and labs. Modest costs. Enter Jan., March, June, September. Mail coupon today for information.



TRI-STATE COLLEGE

J. A. McCarthy, Director of Admissions
4899 College Avenue, Angola, Indiana

Please send me Your Career Book and Catalog with full information on Electronics Engineering and other degree courses. I am especially interested in courses checked:

- Electrical (Radio, TV, Electronics option)
 Electrical (Power option) Chemical Aeronautical
 Civil Mechanical General Business
 Accounting Motor Transport Management General Education

Name

Street Address

City Zone State

... News



Globe Electronics has announced production of their two-way radio for the newly opened 11 meter Citizens Band. This model can be used in the home on 115V AC or as a mobile unit on 12V DC. Three channels may be used for transmitting and receiving. The CB-100 has a 7-tube crystal controlled superheterodyne circuit with 3-channel selectivity. A crystal for channel 11 is included with set. The transceiver features a squelch circuit, noise limiter and low AC hum level. It comes complete with external speaker jack, and ceramic microphone. Antenna accessories are available. \$129.95 from Globe Electronics, Inc., 3417 West Broadway, Council Bluffs, Iowa.

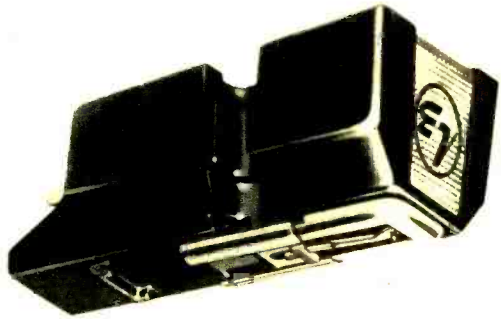

A new compatible stereo-monaural cartridge has been designed by Electro-Voice. The Magneramic 31 is a ceramic-type cartridge modified for direct use in magnetic phono inputs. This is done by means of a special printed circuit that is an integral part of the cartridge. It is available with either a .5 or .7-mil diamond stylus. The former is recommended for use in transcription arms, with 2-4 tracking force. \$24 from Electro-Voice, Buchanan, Michigan. Same cartridge for ceramic phono inputs, \$22.

**AT
LAST!**

RADIO-TV and ELECTRONICS TRAINING

**... AT A PRICE
YOU CAN AFFORD!**



***21 INCH**
Receiver Kit included

Yes, this great course costs *far less* than *any* training of its kind given by other major schools! Radio-Television Training School will train you for a good job in Television or Industrial Electronics — **AT HOME IN YOUR SPARE TIME.**

Think of it — a complete training program including over 120 lessons, Fourteen Big Radio-Television Kits, Complete Color-TV Instruction, Unlimited Consultation Service... **ALL at a really big saving to you.** How can we do this? Write to us today... and find out!

And what's more — you can (if you wish) **OPEN YOUR OWN RTS-APPROVED AND FINANCED RADIO-TV SERVICE SHOP**

We Want Many More Shops This Year

This 37 year old training organization — called RTS, that's Radio-Television Training School — wants to establish a string of Radio-TV Repair Shops in principal cities throughout the U. S. So far, a great many such shops are **NOW IN BUSINESS AND PROSPERING.** We are helping and training ambitious men to become future owners and operators of these shops in all areas.

**FOR UNSKILLED
INEXPERIENCED MEN ONLY —
WE TRAIN YOU OUR WAY!**

We must insist that the men we sign up be trained in Radio-TV Repair, Merchandising and Sales by our training methods—because **WE KNOW** the requirements of the industry. Therefore, we will **TRAIN YOU**... we will show you how to earn **EXTRA CASH**, during the first month or two of your training period. **YOU KEEP YOUR PRESENT JOB. TRAINING TAKES PLACE IN YOUR OWN HOME, IN YOUR SPARE TIME!**

**COMPLETE
COLOR
INSTRUCTION
INCLUDED**

*you build these
and other units*

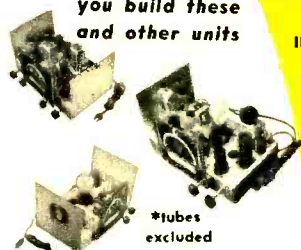

*tubes
excluded

**RADIO-TELEVISION
TRAINING SCHOOL**

5100 S. VERMONT AVENUE
LOS ANGELES 37, CALIFORNIA

Est. 1922

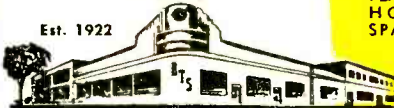

**ACT
NOW!**

RTS
APPROVED
REPAIR
SHOP

Get your free book on the
FAMOUS RTS BUSINESS PLAN
find out how you can open
A REPAIR SHOP OF YOUR OWN

We supply and finance your equipment

When you are ready and qualified to operate one of our RTS-Approved TV Repair Shops **WE WILL SUPPLY AND FINANCE EVERY BIT OF EQUIPMENT YOU NEED TO GET STARTED** plus an inventory of parts and supplies. In other words **we will stake you AN OFFER NEVER MADE BEFORE BY ANY TRAINING ORGANIZATION.** Under the RTS Business Plan you receive:

1. An electric sign for the shop front.
2. Complete laboratory of test equipment.
3. Letterheads, calling cards, repair tickets, etc.
4. Basic inventory of tubes, parts, supplies.
5. Complete advertising and promotional material.
6. Plans for shop arrangement.
7. Instructions on how to go into business.
8. Continuous consultation and help.
9. The right to use RTS Seal of Approval, and the RTS Crest.
10. The right to use the Famous Trade Mark.



RTS' Membership in The Association of Home Study Schools is your assurance of Reliability, Integrity, and Quality of Training

**ALL
THESE
FREE!**



CUT OUT AND MAIL — TODAY!

RADIO-TELEVISION TRAINING SCHOOL
5100 S. Vermont Avenue, Dept. E1-99
Los Angeles 37, California

SEND ME FREE — all of these big opportunity books — "Good Jobs in TV-Electronics," "A Repair Shop of Your Own" and "Sample Lesson." I am interested in:

- Radio-Television Industrial Electronics (Automation)

Name _____ Age _____
please print

Address _____

City & State _____
300

DIAGNYZER

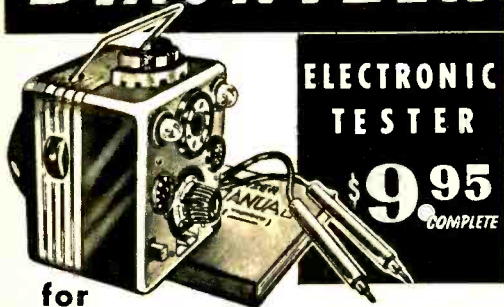

**ELECTRONIC
TESTER**

\$9.95
COMPLETE

for DO-IT-YOURSELF SERVICING

INDISPENSABLE—FOR TV, RADIO, HI-FI

Appliances, Autos, Electrical Tools. Used in Home, Shop and Farm, Checks Radio and TV Tubes, Components, Voltages and Circuits, etc.

INEXPENSIVE TO OWN. EASY TO USE

Anyone can do servicing with this wonderful instrument, pays for itself the first time you use it. Best value for money, nothing else like it.

**COMPLETE TRAINING COURSE AND SERVICE MANUAL
INCLUDED FREE WITH EACH INSTRUMENT**

- Send "Diagnyzer" postpaid. I enclose full payment of \$9.95
- Send "Diagnyzer" C.O.D. I will pay \$9.95 plus postage.
- Rush me FREE descriptive literature concerning "Diagnyzer."

Name

Address

APPARATUS DEVELOPMENT CO.
Dept. E1, Wethersfield, Conn.

ONE CENT SALE

**BUY ONE AT OUR REGULAR LOW PRICE AND
GET THE SECOND FOR ONLY 1¢ MORE**

CITIZENS BAND TRANSMITTER (27 MC) chassis complete with crystal. \$9.99 ea. two for \$10.00.

TRANSMITTER similar to above but with 5 watt RF stage instead of 1 watt. \$12.49 ea. two for \$12.50.

CITIZENS BAND RECEIVER chassis tunable through all 22 channels. Complete with audio amplifier. \$9.99 ea. two for \$10.00.

AMATEUR BAND TRANSCEIVER (144-148 MC) chassis with dual VHF triodes for walkie-talkie radiophone. \$9.99 ea. two for \$10.00.

MICROPHONE High output 200 ohm carbon with terminal lugs. \$1.49 ea. two for \$1.50.

COILED CORD 4 conductor 11" telephone cord. Extends to over 4 ft. .99 ea. two for \$1.00.

KIT OF PARTS for AM-FM VHF radio receiver. Tunable from 80-200 mc. which includes U. S. satellite frequencies. \$6.99 ea. two for \$7.00.

TRANSISTOR AUDIO AMPLIFIER gives 50X voltage gain on low level signals. Operates on 1½ volts. \$3.99 each, 2 for \$4.00.

SUPER SPECIAL: 25 watt, 30 to 40 mc. crystal controlled FM radiophone mobile transmitter with 8 tubes and dynamotor power supply. Orig. cost over \$300.00. Can be converted to Citizens Band. Used good condition \$24.99 ea. two for \$25.00 F.O.B. Hollis, N. Y.

LIMITED QUANTITY—NO LITERATURE OR CATALOG

Remit in full. Include sufficient postage. No C.O.D.'s.

VANGUARD ELECTRONIC LABS. Box 12-EL9
Hollis 23, N.Y.

...News

Age is no barrier when it comes to hamming. This statement is particularly true in the case of the Alessi family. Patrick and Frank, age nine, hold General Class tickets while Robert, a mere five and a half years old, is the holder of a Novice ticket.

"Stereo is big business," said Mr. Schwartzman of the Music Operators of America. And because of this statement, possibly the next time you drop a dime into a juke box, the trumpets will blare out in stereophonic sound. The Music Operators of America are waging a campaign to extend the realm of stereo high fidelity to the world of juke boxes.



The PACO Electronics Company known for their test equipment kits, has entered the field of stereo hi-fi with a new stereo preamp-amplifier kit. Model SA-40 features 20 watts per channel, 40 watts on peaks, balance and equalization controls and rumble and contour switches. It is priced at \$79.95. The model ST-45, a stereo AM-FM tuner kit will shortly be available. Complete specifications available from PACO, 7031 84th St., Glendale 27, L.I.

Grantham School of Electronics announced the opening of a new division of the school in Kansas City, Mo. Specializing in FCC license training, the School offers resident classes or home study courses. For complete information write to the school at 3123 Gillham Road, Kansas City, Missouri or phone Jefferson 1-6320.

BUILD YOUR OWN RADIO CIRCUITS AT HOME

with the New Deluxe
PROGRESSIVE RADIO "EDU-KIT"®

A Practical Home Radio Course

Now Includes

- ★ TRANSMITTER
- ★ SIGNAL TRACER
- ★ SIGNAL INJECTOR
- ★ CODE OSCILLATOR
- ★ No Knowledge of Radio Necessary
- ★ No Additional Parts or Tools Needed
- ★ EXCELLENT BACKGROUND FOR TV
- ★ School Inquiries Invited
- ★ SOLD IN 79 COUNTRIES

**YOU DON'T HAVE TO SPEND
HUNDREDS OF DOLLARS FOR A RADIO COURSE**

The "Edu-Kit" offers you an outstanding PRACTICAL HOME RADIO COURSE at a rock-bottom price. Our Kit is designed to train Radio & Electronics Technicians, making use of the most modern methods of home training. You will learn radio theory, construction Practice and servicing. THIS IS A COMPLETE RADIO COURSE IN EVERY DETAIL. You will learn how to build radios, using regular schematics; how to wire and solder in a professional manner; how to service radios. You will work with the standard type of punched metal chassis as well as the latest development of Printed Circuit chassis. You will learn the basic principles of radio. You will construct, study and work with RF and AF amplifiers and oscillators, detectors, rectifiers, test equipment. You will learn and practice code, using the Progressive Code Oscillator. You will learn and practice trouble-shooting, using the Progressive Signal Tracer, Progressive Signal Injector, Progressive Dynamic Radio, and the accompanying instructional material. You will receive training for the Novice, Technician and General Classes of F.C.C. Radio Amateur Licenses. You will build 16 Receiver, Transmitter, Code Oscillator, Signal Tracer and Signal Injector circuits, and learn how to operate them. You will receive an excellent background for Television, Hi-Fi and Electronics. Absolutely no previous knowledge of radio or science is required. The "Edu-Kit" is the product of many years of teaching and engineering experience. The "Edu-Kit" will provide you with practical education in Electronic and Radio, worth many times the complete price of \$22.95. The Signal Tracer alone is worth more than the price of the entire Kit.

THE KIT FOR EVERYONE

You do not need the slightest background in radio or science. Whether you are interested in Radio & Electronics because you want an interesting hobby, a well paying business or a job with a future, you will find the "Edu-Kit" a worthwhile investment. Many thousands of individuals of all

ages and backgrounds have successfully used the "Edu-Kit" in more than 79 countries of the world. The "Edu-Kit" has been carefully designed, step by step, so that you cannot make a mistake. The "Edu-Kit" allows you to teach yourself at your own rate. No instructor is necessary.

PROGRESSIVE TEACHING METHOD

The Progressive Radio "Edu-Kit" is the foremost educational radio kit in the world, and is universally accepted as the standard in the field of electronics training. The "Edu-Kit" uses the modern educational principle of "Learn by Doing." Therefore you construct, learn schematics, study theory, practice trouble-shooting—all in a closely integrated program designed to provide an easily-learned, thorough and interesting background in radio. You begin by examining the various radio parts of the "Edu-Kit." You then learn the function, theory and use of these parts. Then you build a simple radio. With this first set you will enjoy listening to regular broadcast stations, learn theory, practice testing and trouble-shooting. Then you build a more advanced radio, learn more advanced theory and techniques. Gradually, in a progressive manner, and at your own rate, you will find yourself constructing more advanced multi-tube radio circuits, and doing work like a professional Radio Technician.

Included in the "Edu-Kit" course are sixteen Receiver, Transmitter, Code Oscillator, Signal Tracer, and Signal Injector circuits. These are not unprofessional "breadboard" experiments, but genuine radio circuits, constructed by means of professional wiring and soldering on metal chassis, plus the new method of radio construction known as "Printed Circuitry." These circuits operate on your regular AC or DC house current.

THE "EDU-KIT" IS COMPLETE

You will receive all parts and instructions necessary to build 16 different radio and electronics circuits, each guaranteed to operate. Our Kits contain tubes, tube sockets, variable, electrolytic, mica, ceramic and paper dielectric condensers, resistors, tie strips, coils, hardware, and a printed, punched metal chassis. Instruction Manuals, hook-up wire, solder, etc.

In addition, you receive Printed Circuit materials, including Printed Circuit chassis, special tube sockets, hardware and instructions. You also receive a useful set of tools, a professional electric soldering iron, and a self-powered Dynamic Radio & Electronics Tester. The "Edu-Kit" also includes Code instructions and the Progressive Code Oscillator, in addition to F.C.C. type Questions and Answers for Radio Amateur License training. You will also receive lessons for servicing with the Progressive Signal Tracer and the Progressive Signal Injector. High Quality and a Quiz Book. You receive Membership in Radio-TV Club, Free Consultation Service, Certificate of Merit and Discount Privileges. You receive all parts, tools, instructions, etc. Everything is yours to keep.

UNCONDITIONAL MONEY-BACK GUARANTEE

The Progressive Radio "Edu-Kit" has been sold to many thousands of individuals, schools, and organizations, public and private, throughout the world. It is recognized internationally as the ideal radio course. By popular demand, the Progressive Radio "Edu-Kit" is now available in Spanish as well as English.

It is understood and agreed that should the Progressive Radio "Edu-Kit" be returned to Progressive "Edu-Kits" Inc., for any reason whatever, the purchase price will be refunded in full, without quibble or question, and without delay.

The high recognition which Progressive "Edu-Kits" Inc. has earned through its many years of service to the public is due to its unconditional insistence upon the maintenance of perfect engineering, the highest industry standards, and 100% adherence to its Unconditional Money-Back Guarantee. As a result, we do not have a single dissatisfied customer throughout the entire world.

ORDER DIRECT FROM AD—RECEIVE FREE BONUS RESISTOR AND CONDENSER KITS WORTH \$7

- Send "Edu-Kit" Postpaid. I enclose full payment of \$22.95.
- Send "Edu-Kit" C.O.D. I will pay \$22.95 plus postage.
- Send me FREE additional information describing "Edu-Kit."

Name

Address

PROGRESSIVE "EDU-KITS" INC.

1186 BROADWAY, DEPT. 515AE, HEWLETT, N. Y.

Reg. U.S.
Pat. Off.



FREE EXTRAS

● SET OF TOOLS

- SOLDERING IRON
- ELECTRONICS TESTER
- PLIERS-CUTTERS ● ALIGNMENT TOOL
- WRENCH SET
- VALUABLE DISCOUNT CARD
- CERTIFICATE OF MERIT
- TESTER INSTRUCTION MANUAL
- HIGH FIDELITY GUIDE ● QUIZZES
- TELEVISION BOOK ● RADIO TROUBLE-SHOOTING BOOK
- MEMBERSHIP IN RADIO-TV CLUB: CONSULTATION SERVICE ● FCC AMATEUR LICENSE TRAINING
- PRINTED CIRCUITRY

SERVICING LESSONS

You will learn trouble-shooting and servicing in a progressive manner. You will practice repairs on the sets that you construct. You will learn symptoms and causes of troubles in home, portable and car radios. You will learn how to use the professional Signal Tracer, the unique Signal Injector and the Dynamic Radio & Electronics Tester. While you are learning in this practical way, you will be able to do many a repair job for your friends and neighbors, and charge fees which will far exceed the price of the "Edu-Kit." Our Consultation Service will help you with any technical problems you may have.

J. Statarski, of 25 Poplar Pl., Waterbury, Conn., writes: "I have repaired several sets for my friends, and made money. The "Edu-Kit" paid for itself. I was ready to spend \$240 for a Course, but I found your ad and sent for your Kit."

FROM OUR MAIL BAG

Ben Valerio, P. O. Box 21, Magna, Utah: "The Edu-Kits are wonderful. Here I am sending you the questions and also the answers for them. I have been in Radio for the last seven years, but like to work with Radio Kits, and like to build Radio Testing Equipment. I enjoyed every minute I worked with the different kits: the Signal Tracer works fine. Also, like to let you know that I feel proud of becoming a member of your Radio-TV Club."

Robert L. Shuff, 1534 Monroe Ave., Huntington, W. Va.: "Thought I would drop you a few lines to say that I received my Edu-Kit, and was really amazed that such a bargain can be had at such a low price. I have already started repairing radios and phonographs. My friends were really surprised to see me get into the swing of it so quickly. The Trouble-shooting Tester that comes with the Kit is really swell, and finds the trouble, if there is any to be found."

**LEARN
RADAR MICROWAVES
COMPUTERS
TRANSMITTERS
CODE • TV • RADIO**

Phila. Wireless Technical Institute

1533 Pine St. Philadelphia 2, Penna.

A Non-Profit Corp. Founded in 1908

Write for Free Catalog to Dept. EI-99

...News



Matching the EICO Model HFT90 FM tuner in size and appearance, the new HFT94 AM tuner features a choice of wide bandpass to 14 kc or narrow bandpass to 7 kc for weaker or distant stations; tuned RF stage for high selectivity and sensitivity; pre-aligned RF and IF coils; built-in ferrite loop; and prewired "eye-tronic" tuning with the traveling DM-70 tube. Kit is priced at \$39.95, factory wired \$65.95. EICO 33-00 Northern Boulevard, Long Island City, New York.

**NEW
DIFFERENT**

For hi-fi fans and collectors of unique recordings, here is a great adventure . . . music arranged for piano and harp. A real first in hi-fi! Great old tunes played on this unusual combination of instruments by Will and Helen Irwin. And on the reverse side, a fascinating demonstration of piano-and-harp artistry, with special commentary written and narrated by hi-fi authority Don Hoefler.



EXCITING

TO ORDER: Send \$4.98 for each copy of "Hi-Fi Harp" to FAWCETT RECORDS, Box EI, Greenwich, Conn.

This is the first in a new series of exciting adventures in listening . . . records of exceptional interest that are brought to you on the FAWCETT FABULOUS FIDELITY label.



**"BUCK
STRETCHER"
HI-FI
VALUES!**

Expand the buying power of your Hi-Fi dollar at Sun Radio with substantial savings on new and fully guaranteed name brand Hi-Fi components!

Dept. D9,
SUN Radio & Electronics Co., Inc.
650 6th Ave., New York 11, N. Y.
Phone: ORegon 5-8600

I am interested in your special price quotations and your Hi-Fi package specials! Please send data at once.

Name _____

Address _____

City _____ Zone _____ State _____

**WE'RE MAKING IT EASIER THAN EVER TO BECOME A WELL PAID
RADIO-TELEVISION SERVICE TECHNICIAN**

**NOW - Just \$6 Starts You Training in
RADIO-TELEVISION**

the SPRAYBERRY "Learn-by-Doing" Way . . .

**25 BIG, COMPLETE KITS
of PARTS & EQUIPMENT**

To help you learn *fast* the practical side of Radio-Television, we send you expertly engineered training kits to test and assemble for interesting, valuable shop-bench practice!

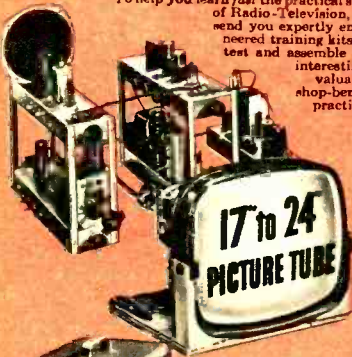

• The new Sprayberry Training Television Receiver, built and tested in 5 sections.

• Now offered . . . this fine modern oscilloscope.

• You build this powerful two-band superheterodyne radio receiver.

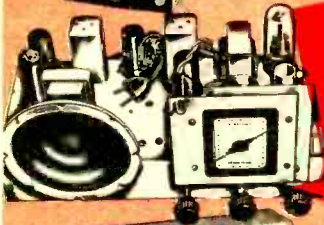

**Big New
CATALOG
AND
Sample Lesson
FREE!**



You build the new Sprayberry tester—a complete 18-range Volt-Ohm-Milliammeter test meter.

★ ★ ★ ★ This great industry is begging for trained men . . . to step into good paying jobs or a profitable business of their own! Our new plan opens the doors of Radio-Television wide to every ambitious man who is ready to act at once!

Men by the thousands . . . trained Radio-Television Service Technicians . . . are needed at once! Perhaps you've thought about entering this interesting, top paying field, but lack of ready money held you back. Now—just \$6 enrolls you for America's finest, most up to date home study training in Radio-Television! Unbelievable? No, the explanation is simple! We believe Radio-Television *must* have the additional men it needs as quickly as possible. We are willing to do our part by making Sprayberry Training available for less money down and on easier terms than ever before. This is your big opportunity to get the training you need . . . to step into a fine job or your own Radio-Television Service Business.

Complete Facts Free—Act Now; Offer Limited

Only a limited number of students may be accepted on this liberal and unusual basis. We urge you to act at once . . . mail the coupon below and get complete details plus our big new catalog and an actual sample lesson—all free. No obligation . . . no salesman will bother you.

HOME STUDY TRAINING IN SPARE TIME

Under world-famous 27-year old Sprayberry Plan, you learn entirely at home in spare time. You keep on with your present job and income. You train as fast or as slowly as you wish. You get valuable kits of parts and equipment for priceless shop-bench practice. And everything you receive, lessons and equipment alike, is all yours to keep.

LET US PROVE HOW EASILY YOU CAN LEARN!

Radio-Television needs YOU! And Sprayberry is ready to train you on better, easier terms, that any ambitious man can afford. *Just \$6 starts you!* Mail coupon today . . . let the facts speak for themselves. You have everything to gain. Let us prove the kind of opportunity in store for you!

SPRAYBERRY Academy of Radio-Television
1512 Jarvis Avenue, Dept. 120-B, Chicago 26, Illinois

Mail This Coupon Now—No Salesman Will Call

Sprayberry Academy of Radio-Television
Dept. 120-B, 1512 W. Jarvis Ave., Chicago 26, Ill.

Please rush all information on your ALL-NEW Radio-Television Training Plan. I understand this does not obligate me and that no salesman will call upon me. Include New Catalog and Sample Lesson FREE.

NAME..... Age.....

ADDRESS.....

CITY..... ZONE..... STATE.....



UNIVERSITY ANNOUNCES...
the new way to high fidelity
stereophonic sound from ultra-
compact speaker systems

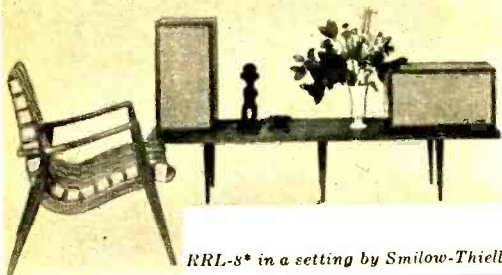

RRL-8 in a setting by Smilow-Thielle*

Three new systems of highest quality . . . priced to fit the tight budget . . . styled to match the wife's decor. For maximum flexibility and convenience, each is fine-furniture finished on four sides . . . for use as highboy or lowboy on bookshelf, bench, or built-in. Full details are in new edition of "Informative guide to high fidelity stereo and monophonic speaker systems and components." Write to Desk E-9, University Loudspeakers, Inc., White Plains, N. Y.

*RRL, Radiation Resistance Lending to give outstanding bass reproduction from ultra-compact cabinets.



The experts show you
how to build a rocket safely!

THE ROCKET HANDBOOK for AMATEURS

An Illustrated Guide to the Safe Construction, Testing and Launching of Model Rockets

Edited by LT. COL. CHARLES M. PARKIN, Jr., Army Engineer Corps. Foreword by WERNHER VON BRAUN. Written by eleven contributors professionally engaged in rocket development, this book—the first of its kind—gives amateurs of all ages the basic knowledge essential for rocket-building. It includes chapters on organizing a rocket club, satellite orbit geometry, human factors in space flight, safety precautions, solid and liquid propellants, design, fuel pumps, cryogenics, test instruments and the building of a safe rocket. Thoroughly illustrated. The editor is President, National Capital Section, American Rocket Society. \$5.95 at your bookstore or order from

THE JOHN DAY COMPANY

Sales Office: 210 Madison Avenue, New York 16, N. Y.

. . . News

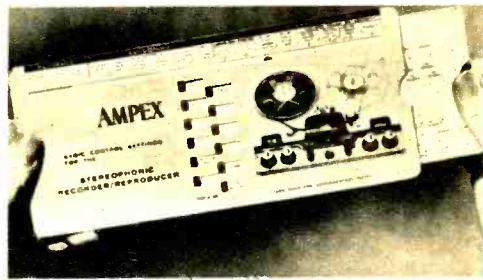

This unique slide rule giving directions for recording and playback operations is available free from Ampex Audio dealers. The "Stereo-graph" shows basic control settings, and directions for playback, recording and special effects. A tape footage playing time indicator is on the reverse side, specifying playing time for standard speeds with any tape.

New Booklets and Catalogs. . .

An illustrated catalog describing the Atlas Sound Corporation's line of sound equipment is available from 1449 39th Street, Brooklyn, New York. Catalog #559 gives information regarding loudspeakers, transformers, driver units and speaker and microphone mounting accessories.

Owners of CBS Transistor Home Study Course can obtain a 14 page supplement consisting of additional projects and circuit descriptions from CBS Electronics, Dept. TC, Danvers, Massachusetts for \$1.00.

A bulletin giving formulae for designing transformers for use in transistorized power supplies is also available from CBS Electronics. Bulletin E285 is available for the asking from Parker St., Newburyport, Mass.

Electro-Voice has announced publication of a guide to their high fidelity speakers, enclosures and systems. Catalog 134 available free from Electro-Voice, Buchanan, Michigan.

The "Signet Sound" booklet from Stromberg Carlson describes their speaker and amplifier kits. 1400 North Goodman St., Rochester, N. Y.

announcing

TRU-VAC®

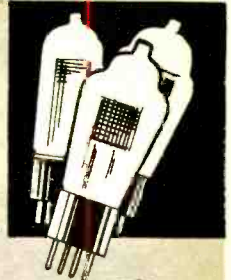

REMARKABLE TUBE VALUES AT 1950 PRICES

ALL TUBES INDIVIDUALLY BOXED, CODE DATED AND BRANDED "TRU-VAC®"

Typical TRU-VAC® Bargains!

THIS IS A PARTIAL LIST
Thousands More Always In Stock

0Y4	3AU6	6A6	6BB	6CH8	657	784	12A16	12SA7	36
0Z4	3BC5	6AB4	6BA6	6CL6	658GT	785	12A17	12S17	38
1A7GT	3BN6	6AC7	6BC5	6CM6	65A7	786	12AU6	12SK7	39/44
1B3GT	3B7A	6AF4	6BC9	6CH7	657GT	787	12A07	12SN7GT	41
1C6	3C8A	6AG5	6BD4	6CN7	65F5	788	12AV6	12S07	42
1CF	3Q4	6AH4GT	6RE4	6COR	65F7	7C4	12AV7	12V6GT	43
1F4	354	6AH6	6RT5	6CR6	65G7	7C5	12AX4GT	12W6GT	45
1F5	3V4	6AK5	6DG6G	6CS6	65H7	7C6	12AX7	12X4	50A5
1G4	4BQ7A	6AL5	6BH6	6CU5	65J7	7C7	12A27	14A7/17B7	50B5
1H5GT	4B55	6AM8	6H46	6CU6	65K7	7E5	12B4	14B6	50CS5
1I4	4B27	6AN8	6KX5	6D6	65J7	7E6	12BA6	14Q7	50L6
1I6	4C86	6AO5	6BI7	6DE6	65O7	7E7	12BA7	19	56
1NSGT	5AM8	6AQ6	6BI7GT	6DG6GT	65R7	7E7	12B06	19AU4GT	57
1R5	5AN8	6AQ7	6B46	6D06	674	7F8	12B66	19B6G6	58
1S5	5AT8	6AR5	6B26GT	6F5	6U8	7G7	12B76	19J6	71A
1T4	5AV8	6AS5	6B27	6F6	6V6GT	7H7	12B87	19I8	75
1U4	5AZ4	6AT6	6B18	6H6	6W6GT	7H7	12B06	24A	76
1U5	5BF8	6AUGT	6B58	6J4	6X4	7Q7	12B87	25Z6GT	77
1V2	5J6	6AUSGT	6BY5G	6J5	6X5GT	757	12B77	26	78
1X2	5R4	6AUG	6B16	6J6	6X8	7X6	12CA5	27	80
2AF4	5U4	6AUB	6B17	6J7	6Y6G	7X7	12CN5	35	84/624
2BN4	5U8	6AV3GT	6C4	6K6GT	7A4/XXL	7Y4	12D4	35A3	11723
2CY5	5V4G	6AV6	6C86	6K7	7A5	7Z4	12F5	35B5	
3A4	5V6GT	6AW8	6C06G	6M7	7A6	12AB	12K7	35C5	
3A5	5X8	6AX4GT	6C76	6O7	7A7	12AB5	12L6	35W4	
3AL5	5Y3	6AX5GT	6C57	654	7A8	12A05	12Q7	35Z5	



1 YEAR GUARANTEED PICTURE TUBES

Brand New* Allied A-1 Tubes Brand New
Below Listed prices do not include dud. Add Additional \$5.00 Deposit on tube sizes to 20"; an 21" and 24" tubes - \$7.50. Deposit refunded immediately when dud is returned prepaid. Aluminized tubes - \$4.00 extra.

Picture tubes shipped only to continental USA and Canada - All Tubes F.O.B. Harrison, N. J.

10BP4	7-99	10BP4	12-19	12CP4	16-99	19AP4	18-39	21AP4	18-79	21PP4	18-39	21YP4	18-39
12BP4	10-49	18BP4	11-99	12CP4	17-99	20CP4	15-89	21AP4	17-99	21AP4	18-39	21PP4	17-49
14B/CP4	11-99	18BP4	12-19	19MP4	16-99	20DP4	15-89	21AP4	18-79	21MP4	22-39	24AP4	28-49
16AD4	16-09	18BP4	11-99	19AP4	16-99	20MP4	17-89	21AP4	18-79	21PP4	18-39	24CP4	27-79
16DP4	12-19	17AP4	15-49	17DP4	11-89	21AP4	21-89	21AP4	17-39	21MP4	17-49	24DP4	29-79
16GP4	16-09	17BP4	13-49	17CP4	16-99	21AP4	18-79	21PP4	17-39	21PP4	17-49		

\$33
PER HUNDRED

For any used or factory second tube!

SENSATIONAL \$100,000 GIVE-AWAY
We want 100,000 new customers by Nov. 1st. For every new order of \$25 or more received by that date, we will send you a crisp, new dollar bill.

FREE FUSE CLIP!
Sent With Any Order Of \$5 Or More

GUARANTEE
Only TRU-VAC guarantees to replace free any tube which becomes defective in use within one year of date of purchase.

USED TV CONSOLES GUARANTEED TO Work
When You Receive Them

10" & 12"	\$29
14" & 16"	\$37
17"	\$45
19"	\$59
20" & 21"	\$70

All sets shipped in two cartons to avoid breakage. Sets shipped express to continental U.S.A. and Canada only. F.O.B. Harrison, New Jersey.

FREE BONUS—RABBIT EARS
\$7.95 Value
FREE with each set purchased

ATTENTION QUANTITY USERS!
Big Discounts Are Yours . . . Call or Write For Our 1000 Tube "Private Label" Special Attention Branding Dept. MGR.

MONEY CHEERFULLY REFUNDED WITHIN FIVE (5) DAYS, IF NOT COMPLETELY SATISFIED!

TRU-VAC® PAYS YOUR POSTAGE
On orders of \$5 or more in U.S.A. and Territories. Send approximate postage on Canadian and foreign orders. Any order less than \$5 requires 25¢ handling charge. Send 25% on C.O.D.'s. All orders subject to prior sale.

Complying with Federal regulations, the following statement appears in all Tru-Vac advertising: Tubes appearing in this ad may be FACTORY SECONDS or USED tubes and are clearly marked.

TRU-VAC® Electric Company

Harrison Avenue Box 107-A Harrison, New Jersey
Humboldt 4-9770

Write Dept. I For FREE LIST Of Other Tube Types and Products Sold By TRU-VAC®

Visit Our Huge Testing Dept. In The Heart Of Harrison, N. J.'s Electronics Industry



Build the Best Portable... **EICO**

6-TRANSISTOR RADIO RA-6

Kit \$29.95 Wired \$49.95

INCLUDES P.C.T. LESS BY BATTERY

Easy creative fun to build... a lifetime of big-set entertainment wherever you go... designed so that even the novice can build it & obtain a handsome professional assembly & outstanding performance. American-made, modern super-heterodyne all-transistor circuitry, plus finest quality parts throughout, assure you of highest durability & stability.

- high sensitivity & selectivity • big-set volume & tone quality with 4" x 6" PM speaker & 250 mw push-pull audio output stage • built-in Ferrite rod antenna for good reception in any location • pre-aligned RF & IF transformers
- planetary vernier tuning (7:1 reduction) for easy station selection & tuning • high-impedance earphone jack for private listening; eliminates drain of output stage when using earphone • attractive tan leatherette case, retractable handle
- compact: 8 1/2" w, 4 1/2" h, 2 1/2" d. Only 3 lbs.

Build the BEST BUYS in "HAM" gear...



* U.S. Pat. No. D-184,778

90-WATT CW TRANSMITTER* #720

Kit \$79.95 Wired \$119.95

"Ideal for veteran or novice" • **ELECTRONIC NITS GUIDE**, "Top quality" • **POPULAR ELECTRONICS**, "Well designed" • **ELECTRONICS WORLD**, 80 thru 10 meters with one-knob band-switching. Full "clean" 90W input, 65W external plate mod. Matches loads 50 to 1000 ohms. May be used as basic exciter unit. TVI shielded. Tubes: 6146, 6CL6, 2-6AQ5, 6Z34. Attractive "living room" low-silhouette design. 15" w, 5" h, 9" d.



UNIVERSAL MODULATOR-DRIVER #730

Kit \$49.95 Wired \$79.95

Cover E-5 \$4.50

Delivers 50W undistorted audio. Modulates transmitters having r.f. inputs up to 100W. Output transformer matches 500-10,000 ohms. Low-level speech clipping & filtering. Inputs for xtal or dynamic mikes, phone patch, etc. 7 tubes. 6" h, 14" w, 8" d.

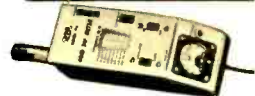

GRID DIP METER #710

Kit \$29.95 Wired \$49.95

Includes complete set of coils for full band coverage. 400 kc-230 mc in 8 overlapping ranges. 500 us meter. Plug-in coils are pre-wound, pre-calibrated to 0.5% accuracy. Transformer-operated power supply. 2 1/4" h, 2 1/4" w, 6 7/8" l.

Compare - judge for yourself - at your neighborhood EICO distributor. For free catalog on 65 models of EICO test instruments, hi-fi & "ham" gear, fill out coupon on Page 26. Add 5% in the West.

ELECTRONIC INSTRUMENT CO., Inc., 33-00 N. Blvd., L. I. C. 1, N. Y.

VIDEO ELECTRIC COMPANY says: DOWN WITH RISING COSTS OF ELECTRON TUBES

OVER ONE MILLION USED TUBES TO SELECT FROM

only **40¢** each FOR ANY TUBE

Each and every tube is tested by our supplier under actual operating conditions in Radio, F.M., Hi-Fi, Industrial Equipment and Television Chassis or Intricate Testing Equipment for Mutual Conductance and Life Test.

Below is a Partial List of Over Three Hundred Popular Types!

Write for Free Complete List and Order Blank!

6AV5GT	0A2	5A12CT	6BC5	6L7	7J7	19
6AW6	0A4	5A2Z	6BC6	6B7	7N7	19AUGGT
6B4C	1A3CY	5B8B	6BD4	6E6	7D7	19BGG
6B4CCT	1B3CT	5CQ1	6BE6	6E8	7E7/XTFM	19C
6B4C	1B3GT	5C9	6BE8	6E9	7E8	19D
6B4C	1B3GT	5C9	6BE8	6E9	7E8	19E
6B4C	1B3GT	5C9	6BE8	6E9	7E8	19F
6B4C	1B3GT	5C9	6BE8	6E9	7E8	19G
6B4C	1B3GT	5C9	6BE8	6E9	7E8	19H
6B4C	1B3GT	5C9	6BE8	6E9	7E8	19I
6B4C	1B3GT	5C9	6BE8	6E9	7E8	19J
6B4C	1B3GT	5C9	6BE8	6E9	7E8	19K
6B4C	1B3GT	5C9	6BE8	6E9	7E8	19L
6B4C	1B3GT	5C9	6BE8	6E9	7E8	19M
6B4C	1B3GT	5C9	6BE8	6E9	7E8	19N
6B4C	1B3GT	5C9	6BE8	6E9	7E8	19O
6B4C	1B3GT	5C9	6BE8	6E9	7E8	19P
6B4C	1B3GT	5C9	6BE8	6E9	7E8	19Q
6B4C	1B3GT	5C9	6BE8	6E9	7E8	19R
6B4C	1B3GT	5C9	6BE8	6E9	7E8	19S
6B4C	1B3GT	5C9	6BE8	6E9	7E8	19T
6B4C	1B3GT	5C9	6BE8	6E9	7E8	19U
6B4C	1B3GT	5C9	6BE8	6E9	7E8	19V
6B4C	1B3GT	5C9	6BE8	6E9	7E8	19W
6B4C	1B3GT	5C9	6BE8	6E9	7E8	19X
6B4C	1B3GT	5C9	6BE8	6E9	7E8	19Y
6B4C	1B3GT	5C9	6BE8	6E9	7E8	19Z

WE HAVE OVER 1000 USED TV SETS

At All Times In Our Huge Warehouse

Buy one or more of these WORKING TVs to sell or use as your own second set! All sets in GOOD WORKING condition!

Your Choice—Console or Table Model

10"	\$23.00	17"	\$46.00
12"	\$28.00	19"	\$58.00
14"	\$32.00	20"	\$64.00
14"	\$40.00	21"	\$72.00
	24"	\$99.00	

\$37.00 PER HUNDRED

FREE Bonus Antenna Given With Any TV Set Order!!

FREE RCA "Cheater" Cord Given With Any Tube Order of \$7.00 or More!!

When ordering TVs, state whether table model or console is desired. Also, preference on make of set. All TVs sent rail way express F.O.B. Newark. On any quantity, WIRE or CALL today!

SEND for our FREE complete TUBE & PARTS LIST and order blank.

GUARANTEE: We guarantee to replace FREE for one (1) year any tube purchased from us which fails to function efficiently under actual operating conditions. Refunds will be made promptly for any defective merchandise within 5 days of receipt.

VIDEO

FREE POSTAGE in U.S.A. and Territories on orders over \$5.00. 25c handling charge on orders under \$5. 25% deposit required on C.O.D.'s. Please send approximate postage or freight on Canadian and foreign orders. Subject to prior sale.

Phone **HUMBOLDT 4-9848**

ELECTRIC COMPANY
9-15 Sixth St., Harrison, N. J.

Learn Electronics

PREPARE FOR YOUR F. C. C. LICENSE—YOUR TICKET TO A BETTER JOB AND HIGHER PAY!

F.C.C. LICENSE—THE KEY TO BETTER JOBS

An F.C.C. *commercial* (not amateur) license is your ticket to higher pay and more interesting employment. This license is Federal Government evidence of your qualifications in electronics. Employers are eager to hire *licensed* technicians.

WHICH LICENSE FOR WHICH JOB?

The **THIRD CLASS** radiotelephone license is of value primarily in that it qualifies you to take the second class examination. The scope of authority covered by a third class license is extremely limited.

The **SECOND CLASS** radiotelephone license qualifies you to install, maintain and operate most all radiotelephone equipment except commercial broadcast station equipment.

The **FIRST CLASS** radiotelephone license qualifies you to install, maintain and operate every type of radiotelephone equipment (except amateur) including all radio and television stations in the United States, its territories and possessions. This is the highest class of radiotelephone license available.

GRANTHAM TRAINING PREPARES YOU

The Grantham Communications Electronics Course prepares you for a **FIRST CLASS** F.C.C. license, and it does this by **TEACHING** you electronics. Each point is covered simply and in detail, with emphasis on making the subject easy to understand. The organization of the subject matter is such that you progress, step-by-step, to your specific objective—a first class F.C.C. license.

CORRESPONDENCE OR RESIDENCE CLASSES

Grantham training is available by correspondence or in resident classes. Either way (residence or correspondence), we train you quickly and well—no previous training required. Even a beginner may qualify for his first class license in a relatively short time.

FOUR COMPLETE SCHOOLS: *To better serve our many students throughout the entire country, Grantham School of Electronics maintains four complete Divisions—located in Hollywood, Calif., Seattle, Wash., Kansas City, Mo., and Washington, D.C. All Divisions of Grantham School of Electronics offer the same rapid courses in F.C.C. license preparation, either by home study or in resident classes.*

This booklet
FREE!



This free booklet gives details of our training and explains what an F.C.C. license can do for your future.

Upgrade Your Income with a First Class F. C. C. LICENSE

HERE'S PROOF...

that Grantham students prepare for F.C.C. examinations in a minimum of time. Here is a list of a few of our recent graduates, the class of license they got, and how long it took them:

	License	Weeks
Donald E. Mason, 2659 Centinella, Santa Monica, Calif.	1st	12
Everett T. Bezard, 411 N. Wash. St., Alexandria, Va.	1st	12
Henry M. Best, 1003 Vermont St., Fremont, N. C.	1st	11
Harold V. Jones, P.O. Box 705, Alamogordo, N. M.	1st	13
Michael F. Aperia, 916 Townsend St., Chester, Pa.	1st	12
Earl A. Stewart, 3918 Modesto Dr., San Bernardino, Calif.	1st	14
Donald L. Leeberg, Box 1075, Anchorage, Alaska	1st	12
J. Milton Condit, 1312 N. 78th Street, Seattle, Wash.	1st	8
John R. Bahrs, 72 Hazelton St., Ridgefield Park, N. J.	1st	12
Richard Baden, 4226 - 37th St., N.W., Washington, D.C.	1st	12
James F. Stewart, 2618 1/2 Prospect Ave., La Crescenta, Calif.	1st	12
Norman R. Cook, 130 Olive Street, Needeska, Kans.	1st	12

GRANTHAM SCHOOL OF ELECTRONICS

HOLLYWOOD
CALIF.

1505 N. Western Ave. (HO 7-7727)
Hollywood, Calif.

SEATTLE
WASH.

408 Marion Street (MA 2-7227)
Seattle, Wash.

KANSAS CITY
MO.

3123 Gillham Road (JE 1-6220)
Kansas City, Mo.

WASHINGTON
D. C.

821 - 19th Street, N. W. (ST 2-3614)
Washington, D. C.

MAIL COUPON TO SCHOOL NEAREST YOU

(Mail in envelope or paste on postal card)

To: GRANTHAM SCHOOL OF ELECTRONICS

1505 N. Western • 408 Marion • 3123 Gillham Rd. • 821-19th, NW
Hollywood • Seattle • Kansas City • Washington



Gentlemen:

Please send me your free booklet telling how I can get my commercial F.C.C. license quickly. I understand there is no obligation and no salesman will call.

Name _____ Age _____

Address _____

City _____ State _____

I am interested in: Home Study, Resident Classes 98-P

the experts say
your BEST BUY
 is **EICO**...

EICO, 33-00 Northern Blvd., L. I. C. 1, N. Y. E1-9
 Show me HOW TO SAVE 50% on 65 models of top-quality:

HI-FI TEST INSTRUMENTS "HAM" GEAR
 Send FREE catalog & name of neighborhood EICO dealer.

NAME.....
 ADDRESS.....
 CITY..... ZONE..... STATE.....

ADD 5% IN THE WEST

...in
STEREO and MONO HI-FI



STEREO Dual Amplifier-Preamplifier HF81
 Kit \$69.95. Wired \$109.95.
 "Excellent" — SATURDAY REVIEW; HI-FI MUSIC AT HOME.



Mono Preamplifier HF65A:
 Kit \$29.95. Wired \$44.95.
 With Power Supply HF65:
 Kit \$33.95. Wired \$49.95.



FM Tuner HFT90
 Kit \$39.95*. Wired \$65.95*. Cover \$3.95.

*"One of the best buys you can get in high fidelity kits" — AUDIOCRAFT Kit Report.
 "Less Cover, F.E.T. incl. AM Tuner HFT94
 Kit \$39.95. Wired \$65.95, incl. Cover & F.E.T.



STEREO Dual Preamplifier HF85
 Kit \$39.95. Wired \$64.95.
 "Extreme flexibility a bargain" — HI-FI REVIEW



Mono Power Amplifiers (60, 50, 35, 30, 22, 14-Watt; use 2 for Stereo) from Kit \$23.50. Wired \$41.50.



2-Way Bookshelf Speaker System HFS1 complete with factory-built cabinet: \$39.95.



STEREO Dual Power Amplifier HF86
 Kit \$43.95. Wired \$74.95.



Mono Integrated Amplifiers: (50, 30, 20, 12-Watt; use 2 for Stereo) from Kit \$34.95. Wired \$57.95.



NEW! COMPLETE STEREO DUAL AMPLIFIER AF-4
 Kit \$38.95. Wired \$64.95.
 TRUE Hi-Fi quality to drive hi efficiency speakers to concert volume.

... and in
TEST INSTRUMENTS



New Power & Bias Supply for Transistorized Eqpt. #1020
 Kit \$19.95. Wired \$27.95.



Miniaturized Multi-Signal Tracer #145A
 Kit \$19.95. Wired \$28.95.



Vacuum Tube Voltmeter #221
 Kit \$25.95. Wired \$39.95.



Peak-to-Peak VTVM #232 & Uni-Probe (pat. pend.)
 Kit \$29.95. Wired \$49.95.



New TUBE & CRT FIL. Tester #612
 Kit \$3.95. Wired \$5.95.
 Fast-checks radio/TV tubes, pilot lamps, etc.



1000 Ohms/Volt V-O-M-#536
 Kit \$12.90. Wired \$14.90.



5" Push-Pull Scope #425
 Kit \$44.95. Wired \$79.95.



Tube Tester #625
 Kit \$34.95. Wired \$49.95.



RF Signal Generator #324
 Kit \$26.95. Wired \$39.95.



Series/Parallel R-C Combination Box #1140
 Kit \$13.95. Wired \$19.95.
 1350 Combinations!



6V & 12V Battery Eliminator & Charger #1050
 Kit \$29.95. Wired \$38.95.
 Extra-filtered for transistor eqpt. #1060
 Kit \$38.95. Wired \$47.95.



R-C Bridge & R-C-L Comparator #950B
 Kit \$19.95. Wired \$29.95.

IN STOCK! Compare, take them home — right "off the shelf" — from 2000 neighborhood dealers. Over 1 MILLION EICO instruments in use throughout the world.

© 1959, ELECTRONIC INSTRUMENT CO., INC., 33-00 N. BLVD., L. I. C. 1, N. Y.

See Page 24 for EICO'S BEST BUYS in "HAM" GEAR and TRANSISTOR RADIOS.

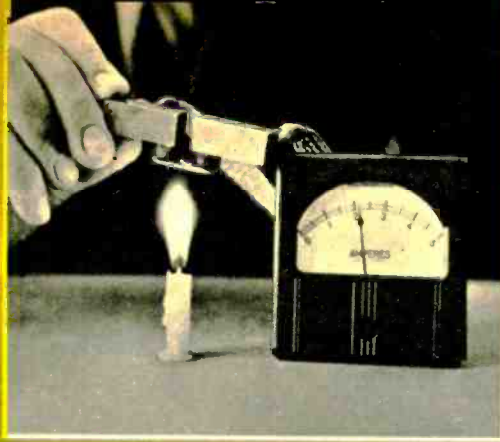

Over two amps of current from a candle flame! No moving parts! This is thermoelectricity, the working principle behind the unique appliance below and other exciting new devices. Wires connect junction of two dissimilar metals to meter.

thermoelectricity

A Look Into The Future

By E. M. Delman

NOBODY knows just why, but when the junction between two different materials is heated, electricity flows. Turn this around and run a current through the junction and, oddly enough, it becomes hot or cold, depending on the direction of current. Both of these long-neglected phenomena are two sides of what scientists call "thermoelectricity."

Because it can provide "pinpoint refrigeration," thermoelectricity may be the best answer yet to beating the heat problem in electronics. Heat and moisture are the leading enemies of elec-



Refrigeration unit on bottom and oven on top of this Westinghouse hostess cart are both powered by devices that take the thermoelectric principle out of the lab and put it in the home.

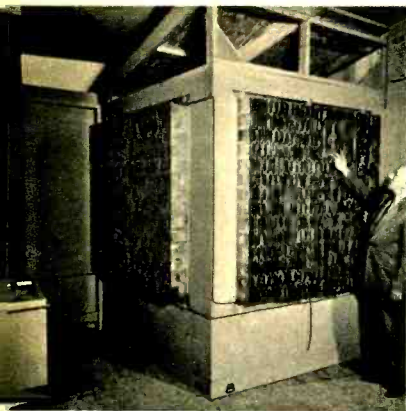

First thermoelectric air conditioner (rear view) by RCA can both heat, cool.



Automatic hot-or-cold unit by Westinghouse is designed for portable use, has timer.



Operating from car cigar lighter, this unit keeps bottle cool or warms it.

tronic equipment. Hermetic sealing, new plastic coatings and "potting" compounds have pretty well licked the moisture problem. But high temperatures remain the elusive "gremlin" in many electronic devices, especially the crucial ones in missiles.

In addition to countering destructive heat in electronic gear, the belated boom in thermoelectricity could also mean:

- airconditioning and refrigeration without moving parts (therefore silent)
- the return of the electric car
- noiseless outboard motors and lawnmowers
- cheaper electric bills

Intense thermoelectric experimentation at dozens of leading labs could easily lead one to think that the activity is based on recent discoveries. Actually, one thermoelectric effect was first discovered back in 1822 by the German scientist Thomas Seebeck. He found that when a loop was made of two lengths of dissimilar metals, a voltage was developed in the loop if the two junctions were kept at different temperatures. Seebeck's work attracted very little attention at first. Then a dozen years later, the French physicist Peltier found that a junction between two dissimilar metals was cooled or heated depending on the direction of current through it.

Recently, Westinghouse engineers demonstrated a baby bottle heater-cooler based on thermoelectricity, along with several other thermoelectric devices. Plugged into the cigarette lighter outlet in a car dashboard, it keeps the bottle cool and fresh. When the time comes to feed baby, the plug is reversed, and the same thermocouples quickly heat the bottle to the right temperature. General Electric, RCA, and Westinghouse have also built "Peltier" refrigerators, and marketing dates might not be more than a year or two off. Russia has exhibited a large thermoelectric refrigerator and a recent visit to the Soviet Union saw over 200 more such refrigerators, although the workmanship left something to be desired. In addition, the Russians have built thousands of radios powered by thermoelectric generators. Designed for use in remote parts of Russia where no electric utilities exist, these thermoelectric generators are operated simply by burning small amounts of kerosene, coal, or even dung inside a special chamber below the thermocouple.

Thermoelectric generators would be a wonderful source of main or auxiliary power for all sorts of vehicles: cars, trucks, trains, ships, submarines and planes. Made powerful enough and compactly, they could advance space travel by years. The most powerful thermoelectric generator was recently an-



Thermoelectric pellets, resistant to high temperatures, are made of ceramics.

Futuristic A. O. Smith welder would have thermoelectric unit, "floating" housing.

Decorative panels in home of future, says Westinghouse, will both heat and cool rooms via thermoelectricity. The panels will also provide lighting through new electroluminescence.

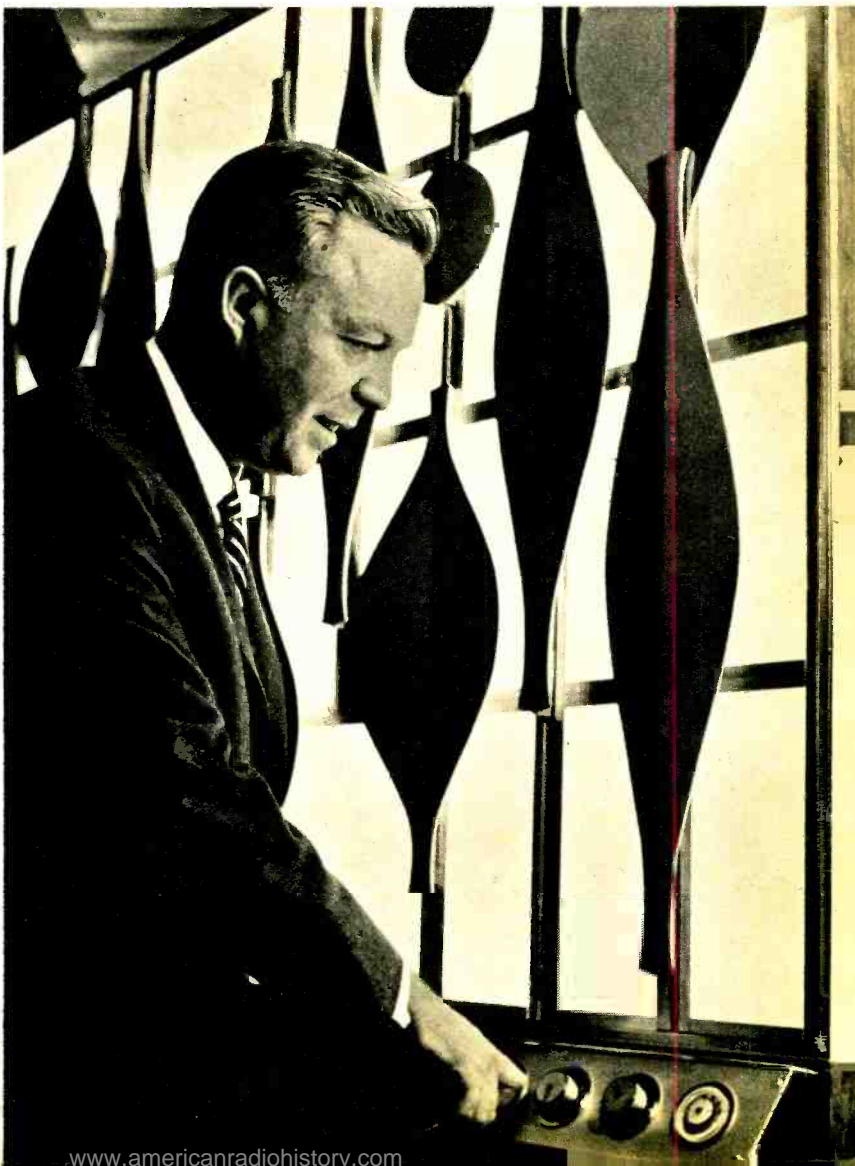



Full size, practical thermoelectric refrigerator was demonstrated by Westinghouse, but is not yet on the market. No moving parts, no noise.

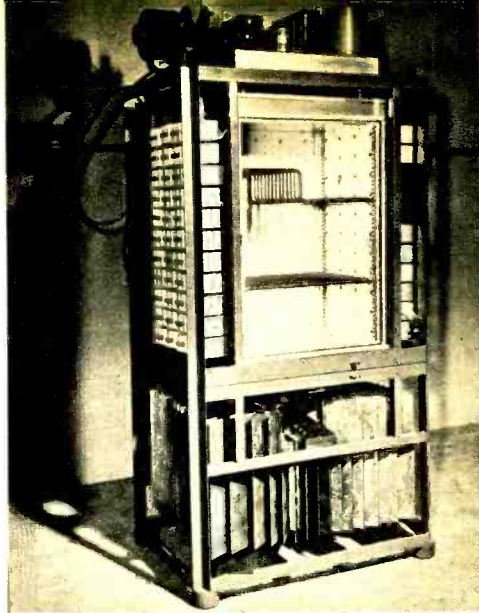

Here is RCA stripped-down electronic refrigerator demonstrated three years ago. Fins are for heat dissipation. Cooling unit is at top.

nounced by Westinghouse, who developed it for the Air Force. It converts the heat of burning fuel directly into electricity on a scale large enough to brightly light a large room. The unit, called TAP-100, is small enough for table-top operation and is scheduled for use in isolated Air Force outposts.

Thermoelectric devices have a particular significance to the development of electronics. Small thermoelectric generators are now being designed to power the electronic equipment in missiles and rockets. The "Snap III," made by the Martin Company in cooperation with Minnesota Mining and Manufacturing Co. (see the May 1959 issue of *Electronics Illustrated*) is actually the best known of a group of thermoelectric generators heated by atomic decay. The first was constructed in 1954 at the Mound Laboratory in St. Louis. This lab is run for the Atomic Energy Commission by Monsanto Chemical Co.

While we have seen large thermoelectric refrigerators, tiny ones could be imbedded in miniaturized electronic equipment to cool heat-sensitive components such as transistors. Where temperature stability is needed, the thermoelectric element could be reversible, providing heat when needed, then cooling under abnormally hot situations.

Remote TV relay and radar stations could obtain electricity from small thermoelectric generators, perhaps with long-lived radioactive fuel replacing noisy motor-generators.

Home and boat owners should be interested in the family of useful machines that could be run by the electricity generated by a single compact, standard-size generator. In the home, the thermoelectric generator could be connected to the home electric system, ready to go on automatically any time the electricity failed. It could also be mounted on a power lawnmower—a noiseless one! In the summer, the generator could be disconnected and thrown into the trunk of the car to provide power for a summer cottage, camp site, trailer, or a noiseless outboard motor.

On the farm, similar generators could run a variety of handy machines such as saws, well drills, and irrigation pumps. If the machine called for more juice than a single generator could provide, two or more generators could be tied in parallel.

If a recent experiment pays off at Los Alamos, the place where the atomic bomb was born, we should see a revolution in the large-scale generation of electric power because of thermoelectricity. [Continued on page 106]



When business takes Dad on the road, mobile rig provides him with a personal hookup to ...



... the wife and children at home. Of course, the lady of the house must have her license.

Hamming Is A Family Affair

By Carole Hoover, K9AMD

WITH interest in hamming on the increase, husband and wife teams aren't unusual by any means. But a surprisingly large number of such twosomes is putting the small Midwestern towns of Litchfield and Hillsboro on the Illinois map. Within a radius of ten miles, there are more than a dozen husbands and wives with ham licenses and more getting started every day.

What's the reason? Why have so many gals taken up a hobby that can only lead them, as it has their OM (Old Men), to stuffy attics and damp basements? Why are they scaling rooftops to erect antennas?

[Continued on page 104]



With hubby Gene, K9JFE, smiling over her shoulder, Nita, K9JFD, transmits CQ on 'phone. Like other hamming couples, they belong to local radio club where they can compare QSL's.

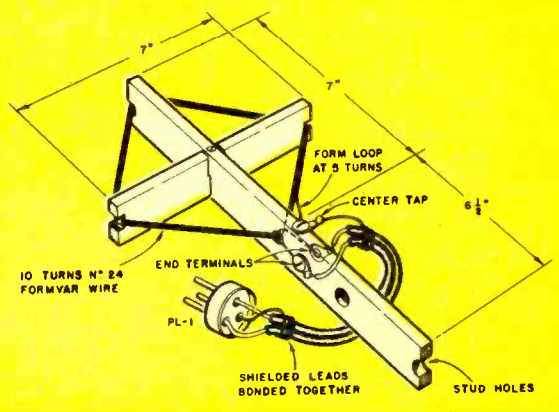
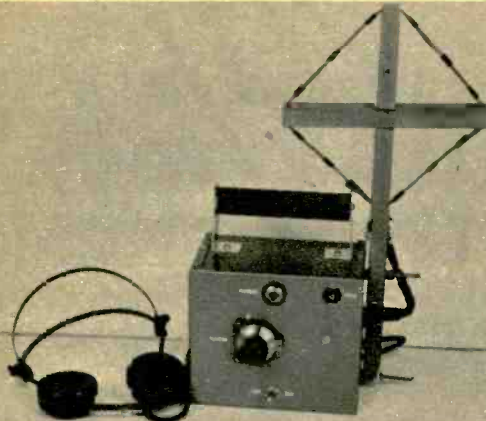

Tone in earphones changes as the large search coil passes over pipe buried in ground.

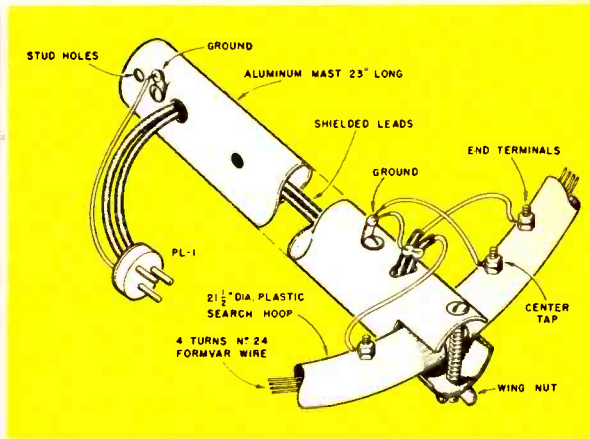
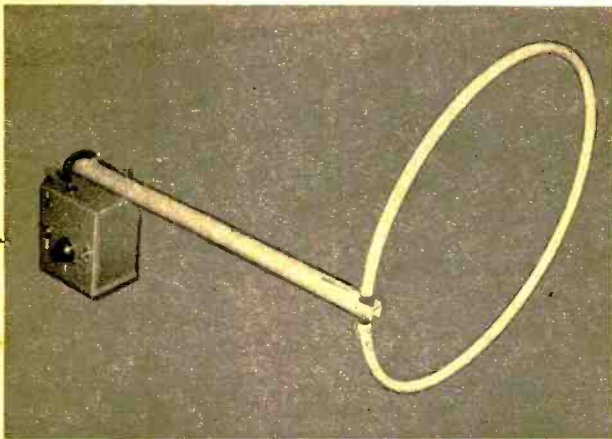

Top of facing page shows locator with the smaller search coil attached. Drawing gives detail for this coil, used for locating small metallic objects.

Above, large search coil built from a "hula hoop," with detail at right. It is used for larger masses of metal. Aluminum mast is TV antenna type.

build this

Metal Locator

By Harvey Pollack

Detect hidden metal of any size with this unit.

Its two search coils are quickly interchangeable.

HAVE you ever wanted to install an additional wall switch but were stymied because you didn't know where the BX cable or conduit was? Perhaps you have wanted to determine the exact path of electric wiring that goes from your house to your garage through an underground conduit, or maybe your sewer cleanout cover had been inadvertently buried and needed locating. Possibilities for using a consistent metal locator in such applications are almost unlimited.

It is important at the outset, however, that you recognize its limitations. The utility of a metal locator depends upon its depth of penetration through the masking material to the metal mass; this in turn is determined by several factors, all of them of unquestionable importance. Of greatest significance is the electrical state of the intervening substance; if it is electrically conductive due to the presence of chemical salts and moisture, the detector will not perform satisfactorily. Wet soil invariably creates false responses making it difficult to pinpoint the metal being sought. Depth of penetration varies with the area of the metal exposed to the search coil. If the area is large, the metal can be located at greater distances. Finally, the kind of metal and its condition influences the results. Ferrous metals provide more easily de-

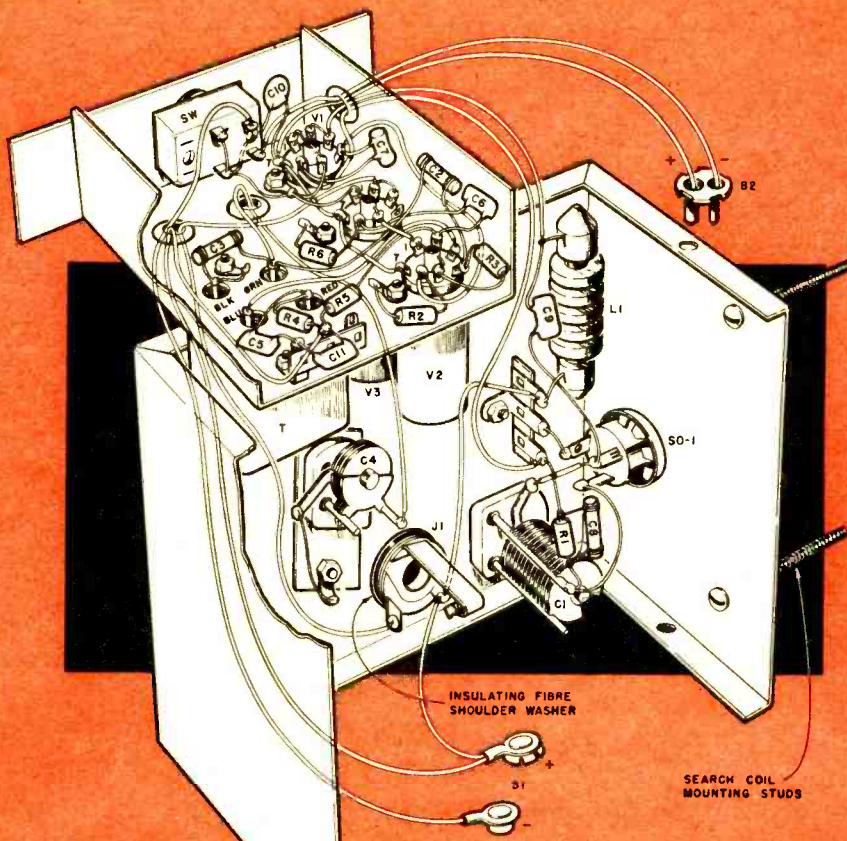

In wiring guide above, small chassis has been raised for clarity. J1 is insulated from case—it carries 90 volts from B1.

Inside view of case shows small chassis in position. It is between 90V battery B1 at left, 1.5V battery B2 to the right.

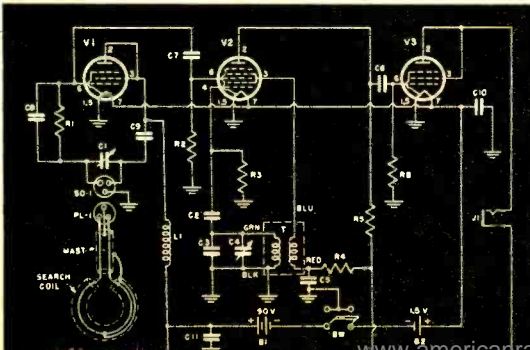

At lower left of diagram, large coil is shown. Small search coil is schematically the same, only physically different.

tectable signals, although non-ferrous materials—as long as they are electrically conductive—also can be spotted if they are close enough.

Tests conducted by the author have shown that this metal locator can be relied upon for detecting cables, conduit, pipes, and similar objects inside a plaster or concrete wall up to 10 inches thick. For this kind of operation, you would use the small search coil. A copper plate of one square foot area gave significant results when buried 2 feet under dry sand; from this, you can correctly conclude that metal objects of larger area could be successfully found at greater depths. Better depth is realized by using the large search coil when working outdoors in search of ore deposits or large buried masses of metal.

The detector is completely portable and easily stowed away for transportation or storage; it can be set up for use in a matter of a few minutes. Since the cost of construction is far less than any comparable commercial unit (about \$15.00), it is well worth having around the house for use on the occasions when nothing else will do the job quite as well.

Before beginning construction, we want to emphasize two key words: *rigidity* and *shielding*. You can use any layout you please, you can vary the me-

chanical details at will, you can even make reasonable parts substitutions if
[Continued on page 88]

PARTS LIST

- B1—90 volt battery (RCA VS090)
- B2—1.5 volt battery (RCA VS049)
- (All capacitors at least 200 working volts DC)
- C1—100 mmfd miniature variable capacitor (Hammarlund MAPC-100)
- C2, C3, C8—100 mmfd ceramic capacitor
- C4—15 mmfd, miniature variable capacitor (Hammarlund air padder MAPC-15)
- C5, C11—.01 mfd disc ceramic capacitor
- C6—.005 mfd disc ceramic capacitor
- C7—50 mmfd disc ceramic capacitor
- C9, C10—.001 mfd disc ceramic capacitor
- L1—Radio frequency choke, 10 millihenry
- R1, R3—100,000 ohm resistor (all resistors 1/2 watt)
- R2, R6—2.2 megohm resistor
- R4, R5—22,000 ohm resistor
- SW—Double-pole, single-throw toggle switch
- T—Oscillator transformer, Meissner 14-4243, shielded
- V1—1T4 tube
- V2—1R5 tube
- V3—1U4 tube
- SO-1, P1, I—3-pin socket with two matching plugs
- J1—Phone jack for headphone plug
- Small search coil: Vertical member 1/2"x1"x13 1/2"
Horizontal member 1/2"x1"x7"
Mortised 3/4" from top of vertical member to form crossed frame. The three end legs are V-notched 1/4" deep; mast leg drilled 7/8" hole to take coil winding.
- Large search coil: Medium size hula hoop 2 1/2" diameter hollow plastic
Mast is 2 3/4" section of standard TV aluminum mast
- Both coils require appropriate lengths of microphone cable
- Misc.—Three 7-pin miniature sockets with shields.
One aluminum case 6"x5"x4" (Bud CU-2107), vernier dial (Lafayette F-348), hardware, battery clips, terminal strips, scrap aluminum, high impedance headphones, about 30 feet of No. 24 Formvar wire



Shield-type tube sockets are used on small chassis. Can see oscillator transformer T.

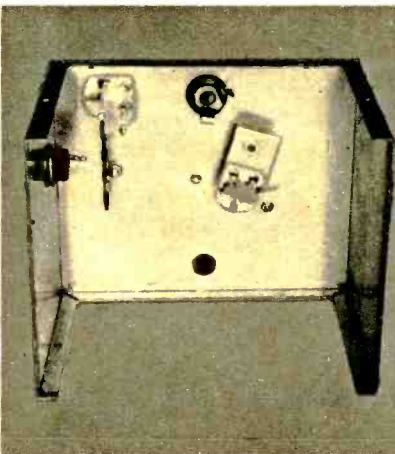

C4, right of center, is held on a small metal plate to allow use with vernier dial.

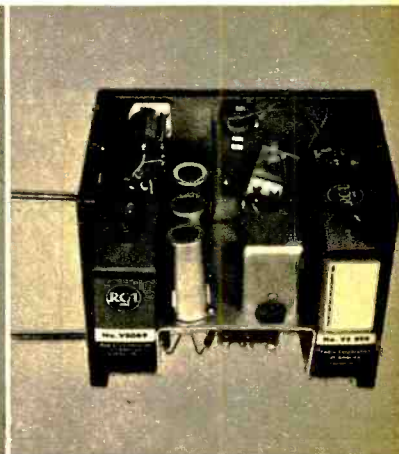

Topside of wired unit with the cover removed. Note coil mounting studs at left.

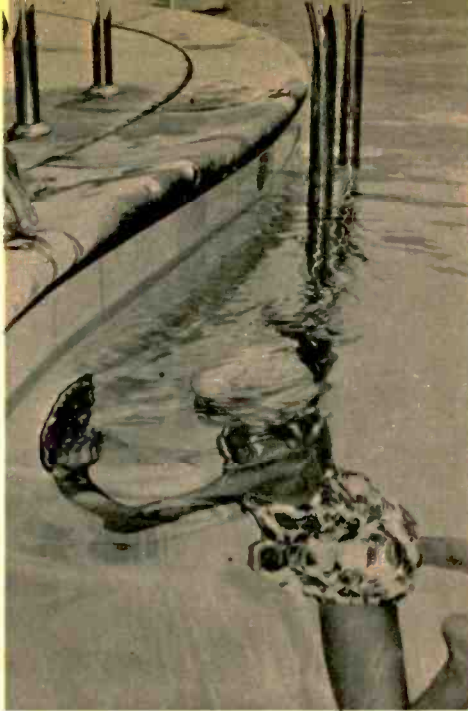

Music to dive by is specialty of audio engineer Frank O'Brien. He has installed sound systems in many pools, including one at Las Vegas' swank Tropicana Hotel. The speaker is submerged, audible only underwater.

Make Your Ideas Pay Off

By James Joseph

Do you see a need for a specialized electronics service? A good idea can finance you for life.

Transistorized transmitter kit and mike are held by Ferrell Burton. He sells demonstrator board to schools, students buy the kits.

Young Conway Chester, 25, has installed very expensive hi-fidelity and intercom systems in more than 1000 homes in the past five years.





Calibration and record-keeping to meet military specs for industry is business of Gerald Grounds.

IF you're hankering for a business all your own, now's the time to dip into the electronics industry's huge \$10 billion annual gross. You don't necessarily have to be a circuit connoisseur to do it. For everywhere electronic opportunity beckons, as rewarding to the in-business-for-himself technician as for the fellow who, though lost in even the simplest of circuits, can turn the engineers' doodles to dollars.

That \$10-billion figure, based on the latest available labor, components and sales figures can be sliced many different ways, all of them profitable. For instance photographer Joseph Jasgur makes upwards of \$30,000 a year taking shadowless photos of complex electronic circuits. Gerald Grounds plays electronic doctor to sick industrial instruments and has built up a plant clientele that reads like *Who's Who in Electronics*. Eyeing the burgeoning enrollment in high school and college radio-elec-

tronics classes, Ferrell Burton, Jr., and electronics teacher Paul S. Light launched Electronic Kits Supply Co. in 1956. This year will gross well over \$100,000 selling radio kits to eager students in 6000 U. S. high schools.

At 39 and almost ready to retire, Charles Vincent has reaped a fortune from TV rentals. He has 4000 video sets profitably placed in hospital rooms, motels, etc. Vincent's starting capital—a slim \$1500.

With a thousand dollar grubstake five years ago, 25-year-old Conway E. Chester will probably gross \$100,000 this year by customizing swank homes with

intercoms, wall mounted video and hi-fi.

Although their electronic specialties are circuits apart, all have something in common. Each has perceived a need, latched onto opportunity and pioneered an electronics business all his own.

Your business future in electronics? Statistics help to put the profit potential in perspective: 63,500 service shops last year grossed \$2.6-billion more than did all the lawyers in the United States. Nearly 850,000 new homes went up last year and most were prospects for hi-fi, electronic garage door openers and intercoms. Several hundred thousand

[Continued on page 102]

Here Joseph Jasgur employs his "light painting" technique to eliminate shadow. He has expanded his business to cover the photographing of miniaturized electronic components and parts.



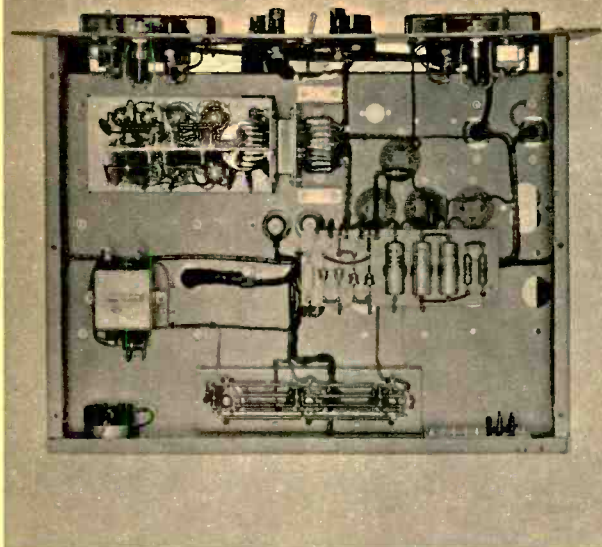

As nearly free of shadows as a circuit can be, this photo, with clearly visible components, is typical of Jasgur's specialized photography.



Starting from scratch, Charles Vincent now rents TV sets to hospitals, motels, etc. Note remote unit with set he makes in own shop.

WHAT YOU NEED TO KNOW

KITS FOR STUDENTS

Capital Needed—\$3,000-\$10,000.

Possible Gross—Upwards of \$100,000.

Required Technical Level—Technician or engineer for design work; or hire one.

Contacts—Radio-electronics or science instructors at high schools, colleges, trade schools. They'll suggest kits most needed.

Market—All schools.

INSTRUMENT CALIBRATION

Capital Needed—A few thousand to get started with rental or used equipment, but eventually you'll need \$20,000 investment in test gear.

Possible Gross—\$100,000 per year, up.

Required Technical Level—High level of testing proficiency.

Contacts—Plants' quality control managers and chief engineers.

Special Requirements—Your key test gear must be certified accurate by National Bureau of Standards. Cost: About \$50 per instrument. Must be done yearly.

Market—More than 300,000 industrial plants, plus thousands of labs.

SHADOWLESS PHOTOGRAPHY

Capital Needed—A few hundred dollars.

Possible Gross—\$20,000-\$35,000 per year.

Required Technical Level—No electronics.

Contacts—Chief engineers, publications directors of electronics manufacturers.

Special Requirements—Because of confidential nature of many assignments, government security clearance. Client obtains this for you. Again for security reasons, you must process film in dark-room rigged with security devices.

Market—4,100 firms engaged in manufacturing and research.

TELEVISION RENTALS

Capital Needed—A few hundred dollars to start.

Possible Gross—No limit.

Required Technical Level—None.

Contacts—Hospital superintendents or purchasing agents; hotel and motel owners and managers.

Market—More than 3,000 non-profit and corporate hospitals; thousands of motels, hotels and other institutions.

HOME SOUND

Capital Needed—About \$1,000 to start.

Possible Gross—Up to \$100,000 annually.

Required Technical Level—TV or radio serviceman.

Contacts—Architects, contractors, restaurant owners and homeowners.

Market—All new homes, medical and dental offices, institutions, plants, apartment or office buildings.

the EI Build-it Course-1

Learn while building! A power supply is the first "plug-in" project to be described in this series.

WITH this article, *EI* begins a new series. Its purpose—to combine the theoretical with the practical. Pleasure (or profit) from electronics appears to grow with the amount of understanding. For example, if you can trace the pathways of an oscillator circuit, in due course you might troubleshoot, build or even attempt to design one.

The very practical side of this series appears in the photos. It



The first four units at left plug together to form an operating AM tuner, lower right section, preamp lower left, with power amp behind it. Below, power supply is unplugged from other units.

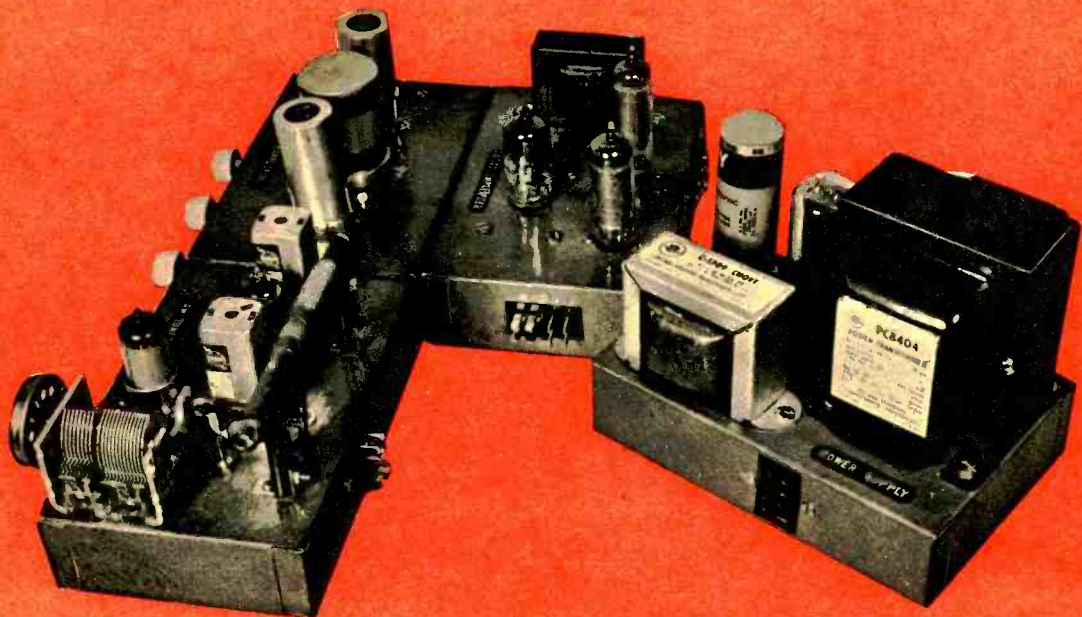

Power supply schematic. Socket SO-4 at right has the same leads as SO-1. Page 42 explains theory.

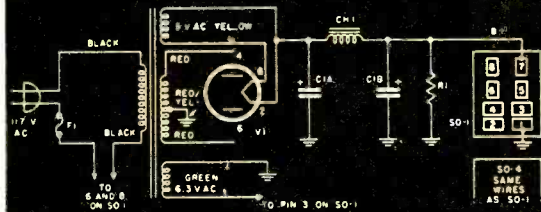

Underside view of wired chassis for power supply. The 25,000 ohm bleeder resistor (R1) is at center.

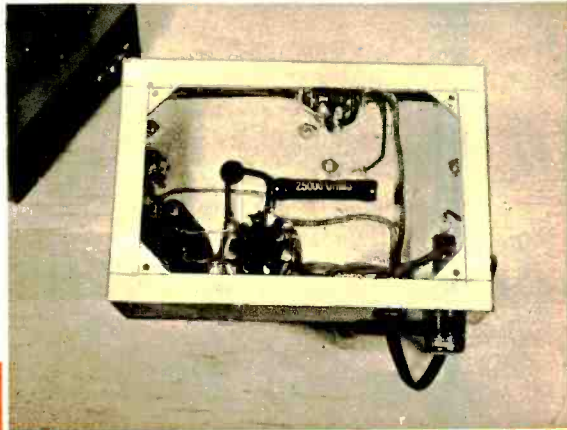

Follow wiring guide while building and observe the color code on leads from the power transformer T1.

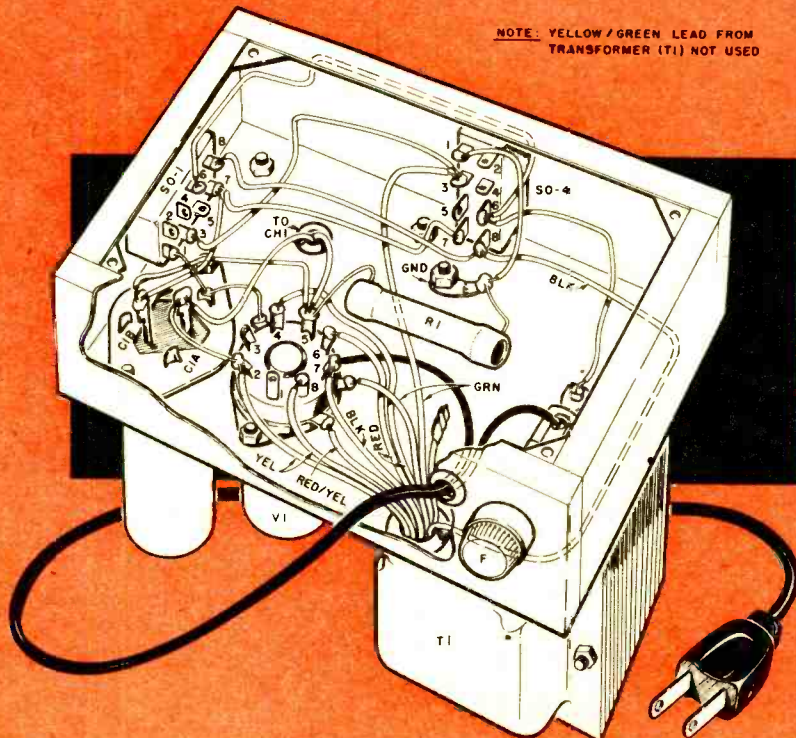

HOW THE POWER SUPPLY WORKS

117 VOLT AC
FROM WALL OUTLET

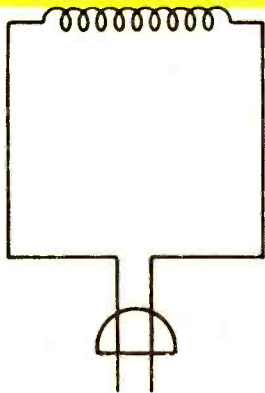

WAVE FORMS

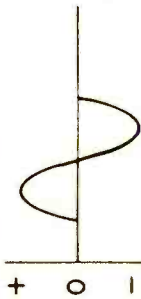

Primary winding of power transformer plugs into 117 volts AC which fluctuates at 60 times per second. The simple waveform diagram indicates how it rises and falls between the plus and minus side of the zero line. A corresponding magnetic field is created in the primary winding. This field is conducted through the iron core of the transformer, represented by two vertical lines. Thus far the voltage is still at the 117 volt AC value. In effect this voltage is transferred to the secondary wiring by the magnetic field.

TRANSFORMER
SECONDARY & RECTIFIER

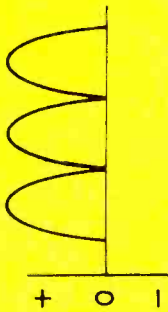
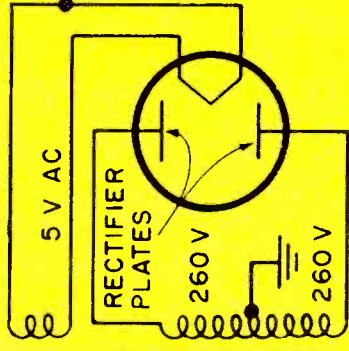

Two secondary windings are shown here. The upper one, marked 5 volts AC has far fewer turns of wire than the primary. The result is a stepdown effect as the magnetic field from the primary cuts across the turns. The other secondary steps up the voltage to more than double the primary value. The rectifier acts to change the 260 volts AC to DC. Each half of the secondary alternately causes the rectifier plates to conduct. This is full-wave rectification, plus and minus sides of secondary voltage are used.

BLEEDER RESISTOR
AND DC OUTPUT

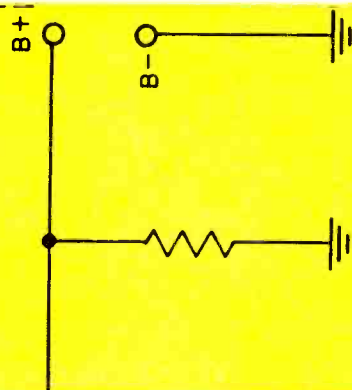

Smooth DC appears at the output. The power supply load in the form of the various tubes in the tuner, amplifier, etc., connects across B+ and B-. In many circuits the B- is actually the metal chassis itself. The bleeder resistor, as detailed in the text, is designed to discharge the filter capacitors when the supply is turned off. It also improves voltage regulation by acting as a constant load. Some power supplies use the bleeder as a voltage divider. This is done by a tapping down on the resistor at lower voltage points.

FILTER SECTION

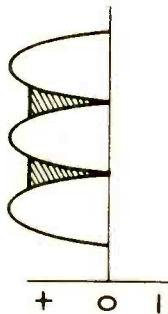
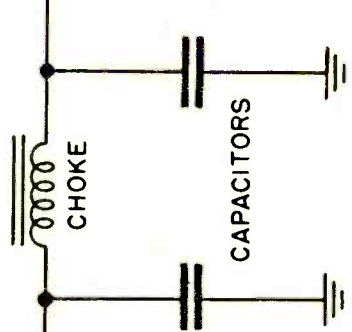

Filter section utilizes a capacitor-input type circuit. Pulsating DC from the rectifier (picked up from its filament) flows into the first capacitor. Examine the waveform and note how the valleys between the pulses are filled in. This results from the capacitor's ability to store electrons and discharge them when the applied voltage subsides. The choke aids in the smoothing action by virtue of its inductance. It opposes any change in the direction, or amplitude, of current passing through. Output capacitor completes filter.

is a "building block" approach. A fundamental circuit is built into each of the plug-together sections. These circuits will not only serve as a model around which the theory is discussed, but will function and operate usefully.

Each plug-in unit can stand alone. This feature was incorporated since some may not have the need or desire to construct every section. Tailor these projects according to your particular needs. The hobbyist who already has a power supply, for example, might choose the AM tuner and amplifier only. The suitable connections should become apparent from the wiring guides and diagrams.

The technical level of the theory will assume some knowledge of how such components as resistors, capacitors, etc., work. This was treated at length in *EI's* recent series "ABC's of Electronics." We are now continuing with the next step—putting the parts together to perform useful jobs. But, even the rank beginner should profit from these simple circuit descriptions.

A Basic Power Supply

The usual source of power for electronic gear is the wall outlet. It provides

117 volts, more or less, of alternating current. To be useful in our project it must be modified in several ways. The vacuum tube filaments in the circuits are heated by 6.3 volts AC, their plates require smooth DC of 250 volts. One tube, the rectifier, operates with 5 volts on its filament and 260 volts AC on its two plates. The power supply alters the 117 volt AC line to provide these voltages.

Although the major pathways through the power supply are shown and described on page 42, we'll detail the function of the individual components here.

The 117 volt AC line is applied to the
[Continued on page 93]

PARTS LIST

C1A,C1B—Dual-section electrolytic capacitor, each section 20 mfd @ 450 volts (Mallory FP 234)
R1—25,000 ohm 10 watt resistor
T1—Power transformer 117 volt primary, 260-0-260 volt secondary @ 90 ma, 5 volts @ 2 amps, 6.3 volts @ 3 amps. (Stancor PC8404)
CH1—Choke, 8 henries @ 85 ma (Stancor C-1709)
VI—5Y3GT rectifier tube
SO-1,SO-4—8-pin chassis mount socket (Cinch-Jones S308AB)
Chassis—4"x6"x1 1/2" aluminum (Premier ACH-436)
F1—Cartridge type fuse receptacle with 1 ampere fuse
Misc.—Line cord with AC plug, octal tube socket with four ground lugs

Photo at left shows method of making the hole for the sockets. An outline is marked by holding the socket against the chassis. A series of holes is drilled, then filed smooth. One socket hole may serve as a template for marking the adjacent chassis. Right shows rear view of the power supply.

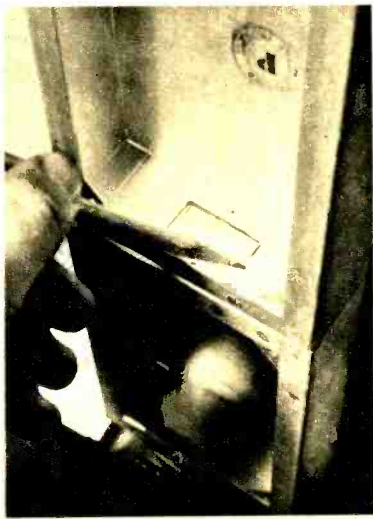
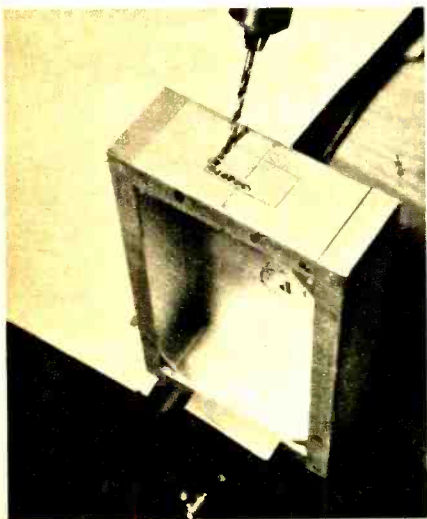

VTVM



Century

Heath



Precise



EICO

Superior Instruments Co.

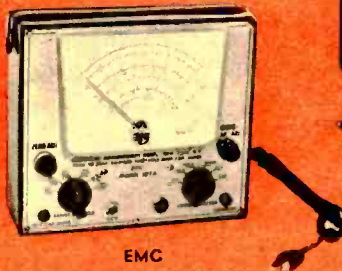

EMC



Measuring high impedance circuits is no challenge if you are equipped with the versatile VTVM—vacuum tube voltmeter. Accessories, such as probes, can expand this instrument's usefulness to cover wide variety of tests.

Meters

what they do, what they cost, how to buy!

OCCASIONALLY you may run into an old-time lineman or electrical technician who holds up a work-worn forefinger and says, with a twinkle in his eye:

"Test gear? This is my tester—I lick the tip and touch it to the spot. If it tingles, I know the line is hot. If not, it's dead and I look somewhere else."

This episode of the old man and the DC has little that the technician, experimenter, or home handyman can take seriously. To begin with, most of us never have developed this uncanny immunity to electrical shock. What's more, fingers aren't calibrated into convenient markings for current, voltage, resistance, decibels, microfarads, watts, or what-have-you.

The design and production of test gear is an industry in itself, with dozens of makes and models. Much is available in kit, or ready-made, form.

Prices and usefulness of meters, etc., vary from delicate instruments used to calibrate computers down to simple testers with which you might hunt for a break in wiring. The variety of test equipment available is great, and a person with a non-profes-

Truly portable, the VOM—volt-ohm-millicammeter—does not require an external power source. Many consider it to be the basic test instrument.

VOM

EICO



Knight (Allied Radio)



Lafayette

Simpson

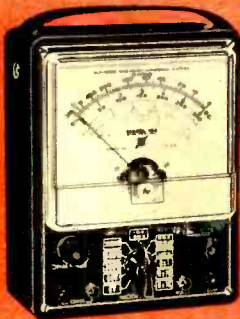

EMC



Heath



Shield



Usually limited in range, the general class of "pocket testers," (mostly VOM's) are small. Handy for checking appliances and tool kit inclusion.

Faulty tubes cause about 80% of all circuit failures; if you have a radio, TV or hi-fi set a tube tester is a handy thing to own. There are many types.

sional interest in electronics, like the professional, usually can use some sort of test gear.

There are two main classes of test equipment. One is the huge family of "indicating devices" that furnish information about a circuit or component. Some, like ammeters, voltmeters, and scopes, measure what's going on while the circuit is in operation. These devices are said to measure *dynamic* conditions. Others, like ohmmeters, measure the "at rest" conditions or *constants* of a circuit or component. They indicate what may happen if it is turned on.

The other family of test gear includes "input devices," such as signal generators. These instruments test a circuit by feeding it a predetermined signal, selected and controlled by the user.

Input devices will be covered next month.

The most basic information you could want about any circuit is whether it actually is a circuit. A normal circuit has continuity and is a closed path for current from the source through a specific load or resistance, and then back to the source. When a circuit is "open," it has no continuity (infinite resistance). When a circuit is "short," the wiring bypasses or shunts the normal load, resulting in not enough resistance.

Either of these conditions can cause trouble. In an open circuit nothing happens; the device is inoperative. In a short circuit, things happen too fast. Short circuits can damage equipment, to say nothing of creating shock and fire hazards. [Continued on page 94]

SCOPES



Heath



Knight



Simpson



EICO



Paco



Precise

The oscilloscope is fast becoming a favorite test instrument because of its high degree of accuracy and its ability to display complete information about a signal.



Knight



Precise



Century



EICO



EICO



Superior Instruments Co.



Heath

TUBE TESTERS



Fig. 1. This VTVM is set up to read resistance—RX10,000.

Milt Kiver on How to Use Meters-2

Part 2 of this series describes how to interpret all the scales and divisions found on meter faces.

TO know how to hook up a VOM or VTVM to make a measurement is the first step in the use of such devices. The second, and equally important, step is to be able to correctly read the meter scale. While this may, at first glance, appear to be the easier of the two, it often turns out to be the more difficult.

Three actions are involved in correctly reading a meter scale. These are: (1) To locate the proper scale to read (2) To determine the value of the individual markings on that scale (3) To know the right value by which the scale reading should be multiplied or divided.

Here, then, is the secret of correct scale reading. By following the rules given below, you will be able to avoid the pitfalls that many fall into.

The proper scale to read depends on how the VOM or VTVM is set up. Look at the FUNCTION switch, the one that indicates whether voltage, current or resistance is being measured. If it is set on resistance, then all scales dealing with voltage or current can be disregarded. Conversely, if it is set on voltage, disregard those scales dealing with resistance or current.

Next, look at the RANGE switch, the one that indicates how

much voltage or how much resistance can be measured. In the case of resistance, the RANGE switch will have positions marked $R \times 1$, $R \times 10$, $R \times 1000$, etc. These mean that whatever value is indicated on the ohms scale is to be multiplied by the factor specified. For example, in Fig. 1, the FUNCTION switch is set to OHMS, while the RANGE switch is pointing to $R \times 10,000$. Therefore, any value indicated on the OHMS scale when a resistor is being measured will be multiplied by 10,000.

In the case of voltage, the procedure is just a little different. Here, the RANGE switch indicates the maximum value that can be read on the meter. For example, if this control is set to 150V, then *no more* than 150 volts should be applied to the instrument, otherwise the needle will be driven off scale. The next step is to locate the appropriate voltage scale. A typical example will reveal how this is done. The VOM in Fig. 2 has, on the left side of its RANGE switch, the following voltage values listed: 1.5V, 6V, 30V, 150V,

and 600V. (For the moment, let us disregard the 3000V marked at the 600V position.)

Examining the scales of this VOM, we see that the one marked DC and positioned just below the top OHMS scale is the appropriate one for this purpose. Three sets of figures are given for this scale: 0-150, 0-30, and 0-6. If the RANGE switch is set for 150V, we would use the 0-150V scale.

Note that while the RANGE control has five separate voltage positions, the meter dial face has only three voltage scales. If we match up the RANGE positions with the meter scales, we find that the 1.5V and the 600V points do not apparently have any scales on the dial face.

This dilemma is resolved by noting that if we take every value on the 0-150 scale and divide it by 100, we obtain a suitable scale for voltages from 0 to 1.5V. By the same token, if the 0-6 scale is taken and multiplied by 100, we obtain an appropriate set of markings for the 600V position of the RANGE

Fig. 2. Knob marked AC DC is Function selector. Range switch is at the right.

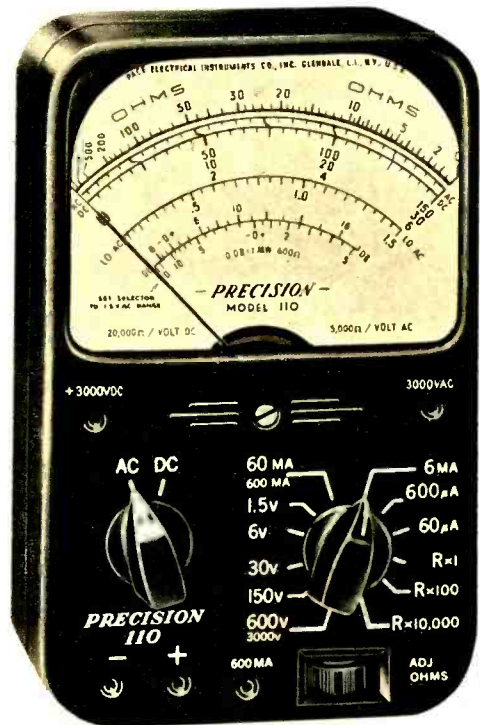

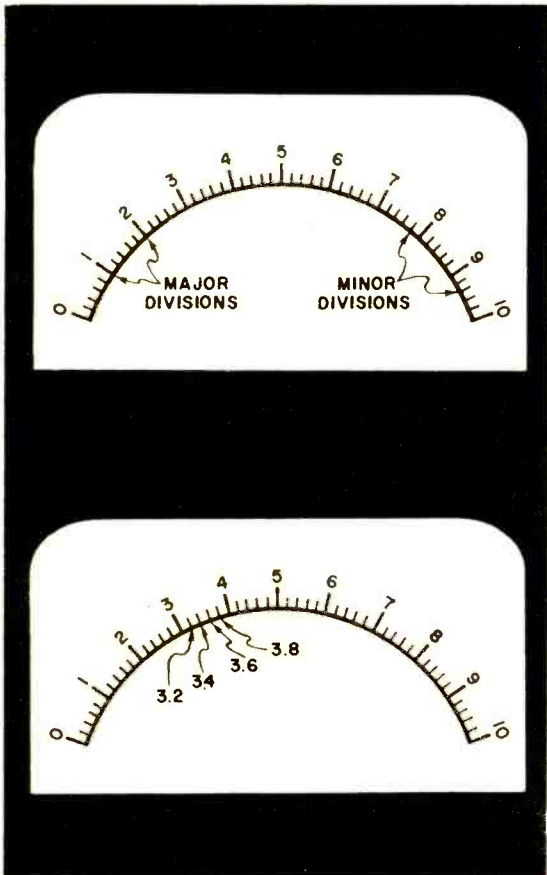

Fig. 3. A simple meter scale with major and minor divisions.

Fig. 4. Each minor division pointed out on this scale is equal to .2.

Fig. 5. Below, spaces vary between divisions on top scale (Ohms).

control knob that is seen in Fig. 1.

If voltages to 3000V are to be measured, the RANGE switch would be set to the position marked 600V, 3000V and all readings would be made on the 0-30V scale. The multiplying factor to use would be 100.

Another interesting thing about this meter face is that AC voltages use a separate set of markings. These markings are positioned just above the DC markings, and slightly displaced to the left. This is done to take into account the slightly different behavior of the meter movement for these two types of voltages. Note, too, that when low AC voltages (up to 1.5V) are being measured, that a separate scale is to be read. This is the one marked "LO AC."

Once the proper scale has been located, the next step is the actual reading itself. The greatest obstacle here stems from the difficulty in determining the



Fig. 6. On this VTVM meter scale DC and R.M.S. refer to DC and AC voltages. The Zero Center DC scale permits positive and negative DC voltage readings to be made without lead reversal or switching from DC to -DC. Peak-to-Peak scale indicates the plus-to-minus value of AC sine waves. It is 2.83 times the AC R.M.S.

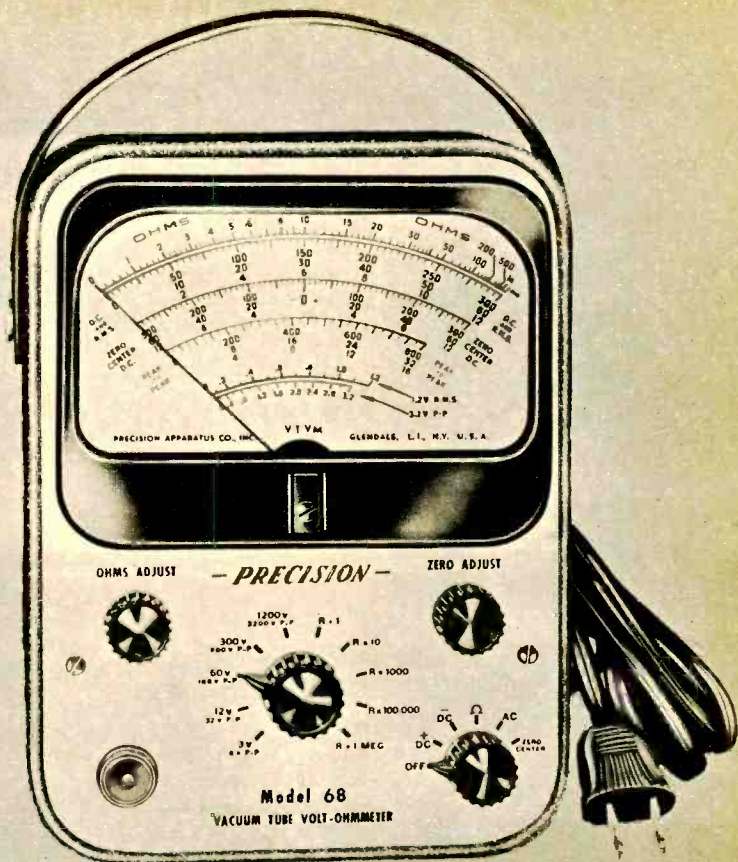

value of each marking. As a start, consider the simple scale shown in Fig. 3. The numbers here extend from zero at the left to 10 at the right. Each number is placed over a dark line which is longer and heavier than the lines immediately to the right or left of it. The darker lines are the major scale divisions while the smaller, lighter lines are the minor scale divisions. **RULE:** In reading a scale, you start with the major division closest to the meter needle and progress from here to the closest minor division.

On the scale of Fig. 3, there are four minor lines between each two consecutive major numbers. These four lines divide this space into five equal divisions. In the present case, this means that the difference between the two major numbers, which is one, is divided into five parts. Thus, each minor line is equal to $1/5$ or $.2$. Between 3 and 4,

then, we have 3.2, 3.4, 3.6, and 3.8. See Fig. 4.

RULE: To find the value of each minor scale division, count the number of minor lines between two adjacent major markings, add one, and then divide this number into the difference between the values of the two major indications.

If the meter needle should come to a stop between two minor lines, then you will have to estimate the value. For example, if it should come to a stop between 3.2 and 3.4 in Fig. 4, the answer might be 3.3. Actually, it is seldom necessary to obtain a precise value in such instances and a rough guess is sufficient.

A commercial VOM scale is shown in Fig. 5. This contains Ohms, DC volts, AC volts and DB scales. On the DC volts scale there are three sets of figures, 0-300, 0-60, and 0-12. If we study the

[Continued on page 91]

The Electronic Brain

Have you any question on electronics? Send it in and the Electronic Brain will provide the answer.

Adding Bandsread

How can I add a bandsread capacitor to an old superheterodyne radio receiver?

Robert Tisdall, Aylmer, Ontario, Canada

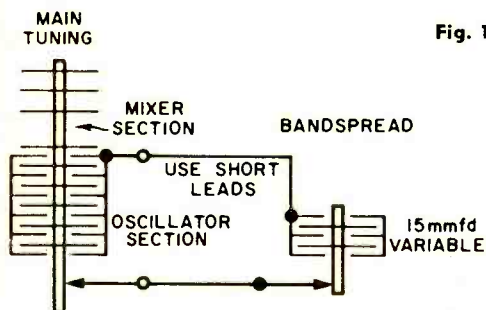

Fig. 1

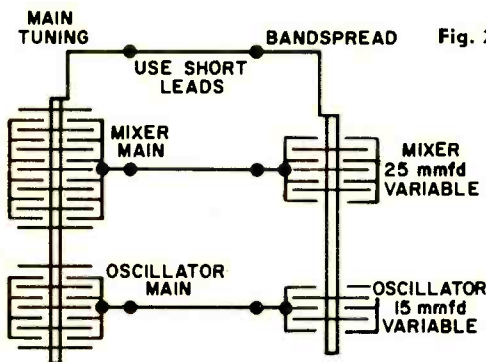

Fig. 2

If you merely want to use it for fine tuning as a short-wave listener, then the simplest and least expensive way to do it is to connect a 15 mmfd variable capacitor in parallel with the stator and rotor of the oscillator tuning capacitor. (See Fig. 1.) You can determine which of the main variable's sections is the oscillator control in most cases by noting which one has the fewest plates or smallest capacitance. Be certain that, in paralleling the two units, you connect rotor to rotor and stator to stator, keeping the leads extremely short.

On the other hand, true bandsread as the name implies, is expected to track from one section of the band to another section some distance away. This can

be accomplished properly only by using a bandsread variable having as many sections as the main tuning capacitor. Assuming that the main variable has two sections, as would be true for a radio of the type you mention in your letter, then you would need to connect a 15 mmfd oscillator bandsread variable in parallel with the main tuning oscillator and a 20-25 mmfd variable in parallel with the RF or mixer section. Furthermore, these bandsread capacitors must be ganged for ease of tuning. (See Figure 2.)

Receiver RF and IF Circuits

(1) If a superheterodyne were to receive a commercial broadcast station at the same time as it receives a strong CW carrier of identical frequency, what effect would be noticed?

(2) What would happen if a .01 mfd capacitor were to be bridged across the windings of a 455 kc IF transformer from the primary to the secondary?

James L. Sorgen, Kenton, Ohio

(1) If the two received frequencies were absolutely identical, there would be no beat note heard but the audio level of the broadcast station would be reduced. This would occur because the AVC system of the receiver would "see" a much more powerful carrier than the broadcast station alone and would then develop a high AVC voltage that would diminish the gain of the receiver. This is the equivalent of much less than 100% modulation.

(2) A large capacitor such as a .01 mfd unit connected as you describe might have several different effects, depending upon the alignment of the IF transformer. Assuming perfect alignment, this capacitor would cause severe detuning of the IF coils in most circuits. A second likely outcome would be a severe and undesirable broadening of the response of the IF system, spoiling the selectivity of the stage.

RF Amplifier

I would like to add a transistorized RF amplifier ahead of my Heathkit AR-3 receiver. Can you provide a circuit for this?

Kurt Theoret,
Blind River, Ont., Canada

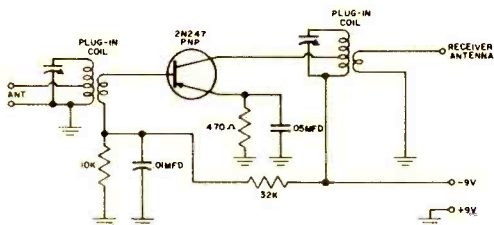

The availability of high frequency transistors, such as the RCA 2N247, makes it possible to design reasonably high gain amplifiers up to 30 mc or better. Since the AR-3 receiver has a high-frequency limit of 30 mc, one of these transistors set up in a circuit like that shown in the accompanying diagram should provide an appreciable amount of additional gain, an improvement in the signal-to-noise ratio, and some increase in selectivity.

We suggest that the coils shown be plug-in types wound on standard commercial, low-loss coil forms. Although coil data to correspond with the tuning ranges of the four bands in the AR-3 may be approximated by using the data tables in the ARRL handbook (Amateur Radio Relay League), you will have to do a considerable amount of experimentation to get them just right. The circuit values given in the diagram were obtained by using design equations and must also be considered close approximations, necessitating some further experimentation along these lines.

External Antenna

How can I add an external antenna to an all-transistor broadcast radio?

Roland Roy, Jr., Derby Line, Vermont

The addition of an external antenna to a transistor receiver is not a difficult task provided that you can locate the necessary point of connection.

Probably the simplest method consists of connecting a 20 or 30-foot length of wire to the *ungrounded* terminal of

the antenna tuning capacitor or the antenna tuning coil through a 10 mmfd capacitor. To locate the proper connecting terminal, first find the lead that goes from the loopstick antenna now in the receiver to one section of the tuning capacitor. Then be sure this point is not a common "ground" by inspecting the leads that come from it and tracing their paths.

Due to the miniaturized construction used in these tiny receivers, it is often difficult to trace leads. In this eventuality, you can try connecting your antenna through the 10 mmfd capacitor to both leads of both sections of the tuning capacitor, leaving it permanently connected to the one that gives you the loudest signal without detuning the receiver.

Hidden Microphone

I would like to know how to hook up a crystal microphone with an output level of about 55db as a hidden microphone for special investigation.

C. Ben Johnson, Detroit, Mich.

For sensitive pickup, as would be required by a special investigator, the crystal microphone would have to be equipped with a one or two stage amplifier, preferably the latter. In addition, for distances of 25 feet or more between microphone and amplifier, a matching transformer and a 400-ohm low-loss transmission system would have to be used.

It is always possible for the ambitious detective to build his own amplifier system but since commercial units are readily available at comparatively low cost, we would suggest the purchase of one of these in this particular case.

Here are some suggestions: the Ampec Corporation manufactures a tiny, pocket-sized battery operated unit having a gain of 4500 at 1,000 cps that would be ideal for your purposes. This is retailed by Allied Radio Corp., 100 N. Western Ave., Chicago 80, Illinois as type PC-201 for \$14.70. Another excellent possibility is the use of a wireless broadcaster where the microphone and broadcaster are hidden in the room to be observed and pickup is accomplished by an ordinary radio!

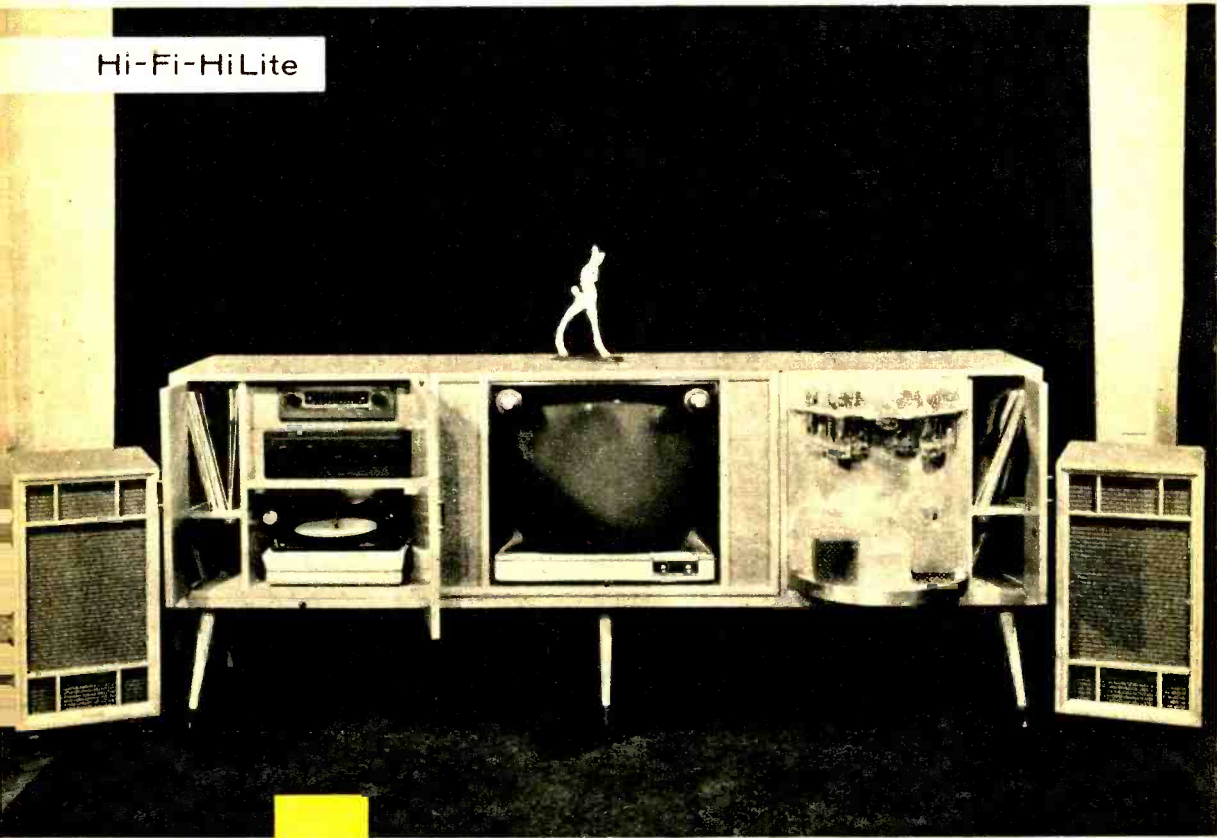

To the left and right of the cabinet are University S-IOHS speaker systems.

you can make this
Stereo Cabinet

By Earl McIntosh

Three movable sections are combined into one unit to contain stereo equipment, TV set and tape deck.

USING a TV set as a starting point this complete cabinet was made at a fraction of the cost of a factory-made unit. Oak-veneered plywood of $\frac{3}{4}$ " thickness is used, though the builder has a choice of other finishes. This combination offers good rigidity and appearance.

The dimensions given here are only suggested and serve to convey the central idea—three separate sections that appear as one cabinet. If it ever has to be moved to smaller quarters, the sections may be used individually on legs of their own.

The bar arrangement is shown as an alternate for the tape equipment, which may be installed at a future date. ♦



A Glaser-Steers changer is installed in left section. Note 45 RPM spindle, adapter and spare fuse on side wall. Above is EICO stereo amplifier and FM tuner mounted in upper panel. Bar is in right section, shown rotated to about half-open position revealing shelves in rear.

If desired, the bar in the right section may be eliminated and tape gear mounted instead.

Rear view of Viking tape equipment. Transport is on top, 2 preamps below feed stereo amp.

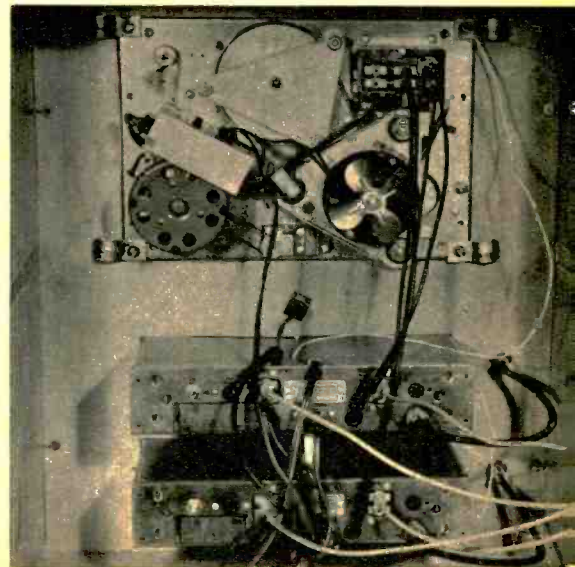
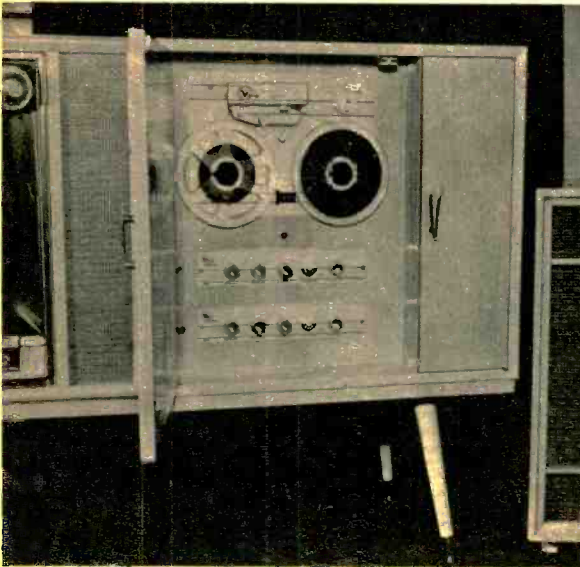

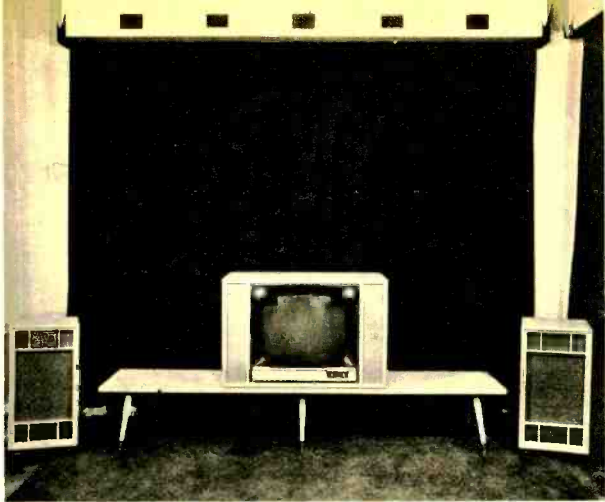

The two end cabinet sections have been removed to reveal the table.

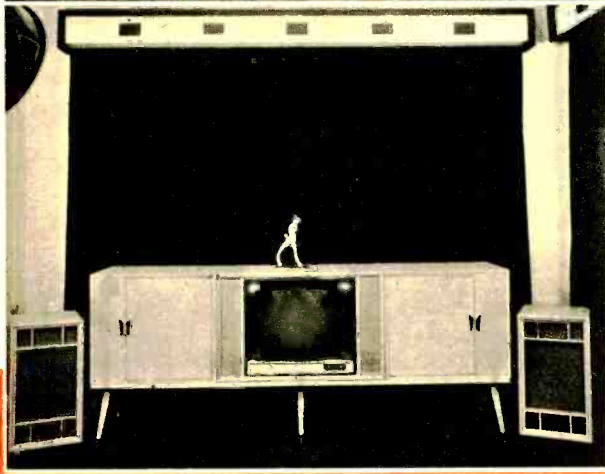

Completed unit showing door arrangement. Uses magnetic latches.

Detail of bar is given in drawing (top right) if tape equipment is not used.

- (A) RECORDS
- (B) SHELF IN BACK OF REVOLVING BAR
- (C) REVOLVING BAR
- (D) SWITCH ON WHEN DOOR OPENS
- (E) LIGHT
- (F) MAGNET LOCKS

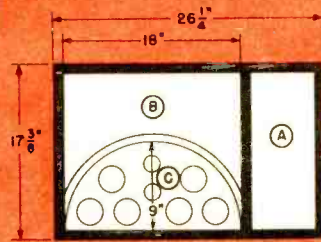

TOP VIEW OF BAR

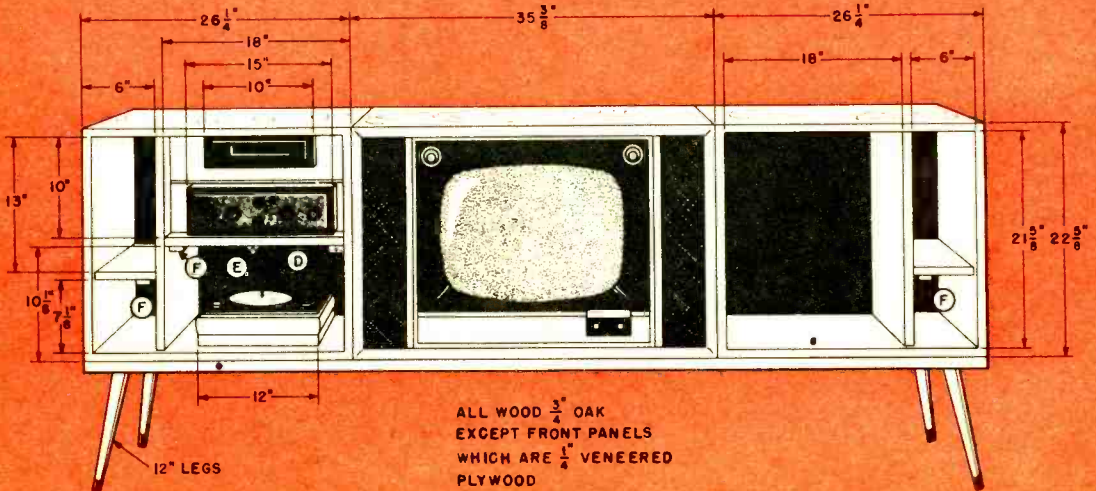

ALL WOOD $\frac{3}{4}$ " OAK
EXCEPT FRONT PANELS
WHICH ARE $\frac{1}{4}$ " VENEERED
PLYWOOD

The four edges of the table should be trimmed with solid wood having a veneer surface. Finished legs, brackets are available at hardware stores.

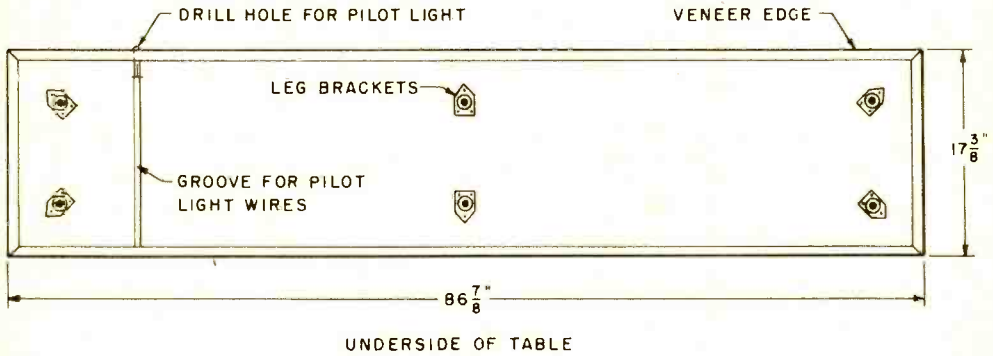

If grooves cannot easily be cut into panels as in top left photo, use screws and glue alone. Fit everything together before fastening (top right photo).

Door hinges are fastened in bottom left photo. The complete left section, being sanded, is pictured at lower right. Note slots for record storage.

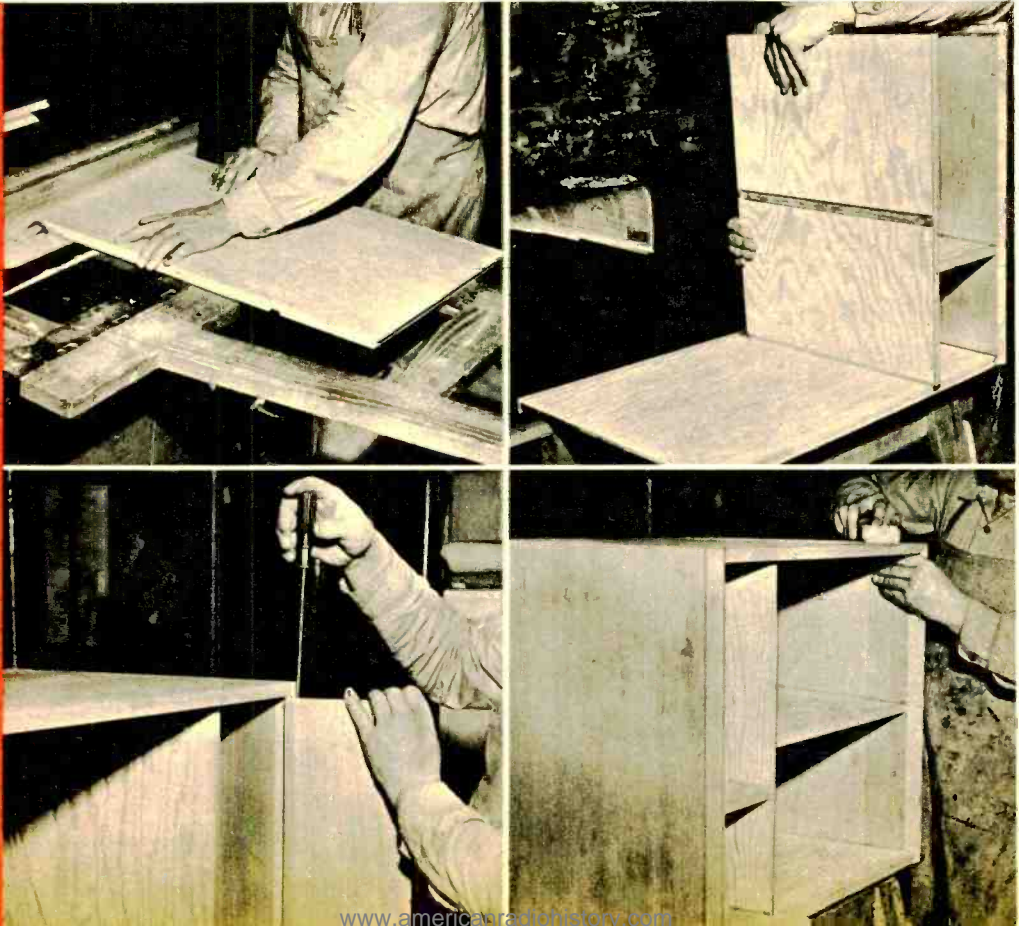



New York State Museum Photos

Radioactive phosphorus is injected into giant ragweed plant at Brookhaven National Lab. Pollen will be traced with geiger counters.



Here a geiger counter is passed over *Ambrosia trifida* (better known as ragweed). It is carefully cultivated on unique "isotope farm."

electronics is in the . . .

Fight Against Hayfever

By R. E. Atkinson

ELECTRONICS is the ally of some 17-million people in the United States who suffer from allergy—an abnormal sensitivity to substances that are ordinarily harmless or even helpful. One of the most common offenders is the pollen of the ragweed, the bugaboo of millions with hayfever and asthma.

Electronics is being employed in a number of ways against ragweed pollen and the discomfort it causes. Electrostatic precipitators capture pollen particles from the air, and radioactive isotopes help scientists spy on the battle tactics of these tiny enemies. Electro-chemical devices check on hundreds of other suspect substances so that relief-producing vaccines can be prepared. Electronics is aiding in research and treatment of a Pandora's Box of allergic diseases, including food allergies, skin allergies, shock from drug treatment, and the like.

If you are not one, try to imagine the predicament of the hayfever sufferer. Tons of the ragweed pollen are in the air during August and September in many areas of the United States. Yet each ragweed pollen particle measures only 18 or 20 microns (a micron is about 1/25,000 of an inch). That means about 2-billion pollen particles to a cubic inch! More than enough to make eyes red and swollen, noses sore, and heads ache.

Electrostatic principles have gone a long way toward the removal of pollen in the air and hayfever victims should seek out such environments. Airborne [Continued on page 90]

Electronic thermometer gives instantaneous temperature of lab animals. Rise in temperature indicates allergy.

Public Health Service photo



Caught in the act of an electronic flash is a ragweed flowerette ejecting pollen, the nemesis of hayfever sufferers.

A. H. Robins Co. photo



As solution of allergenic substance flows down paper, electrodes sort out elements of differing electric properties.

National Institutes of Health photo

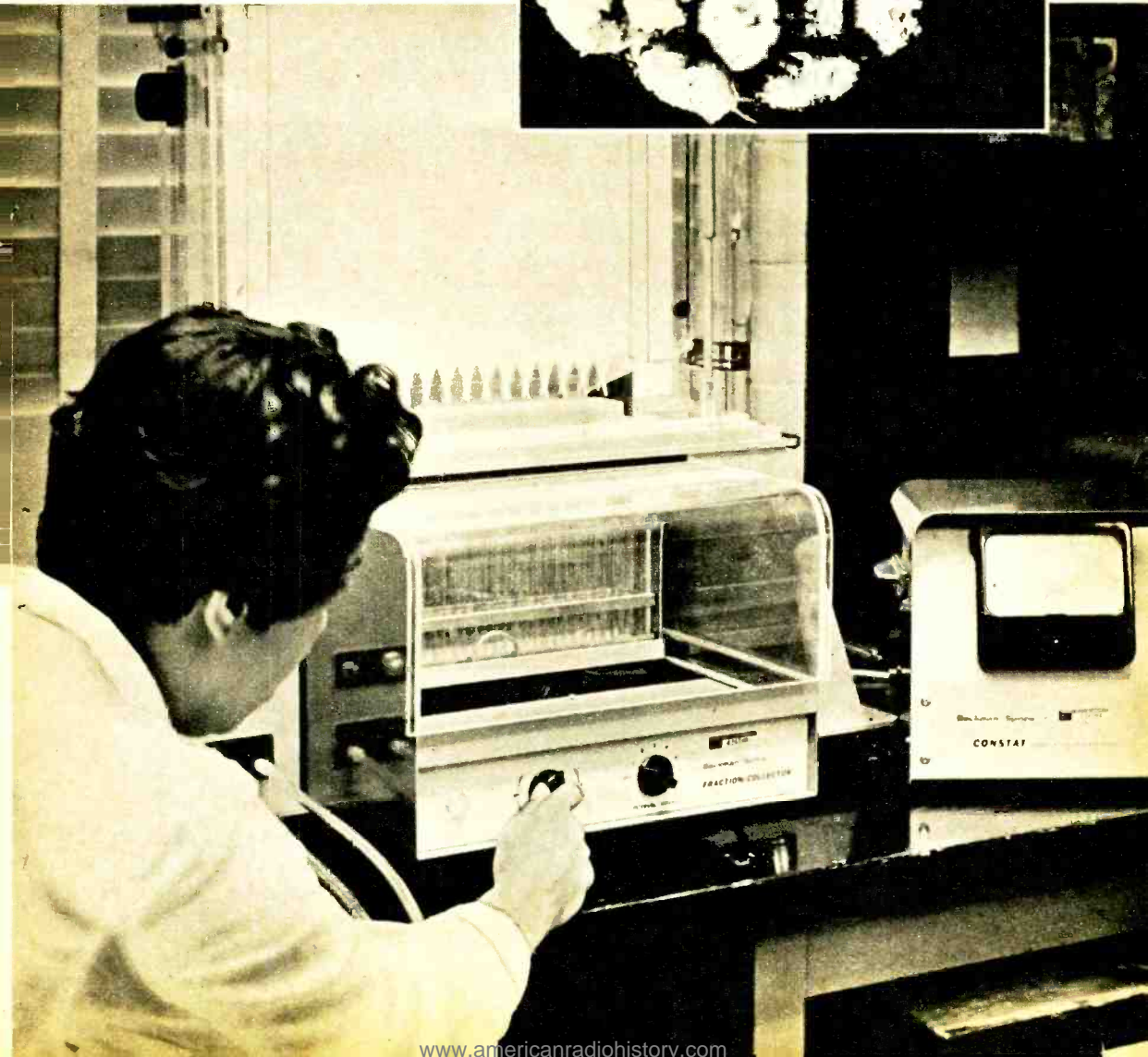

Cracking Short-Wave's Taboo

By C. M. Stanbury II

Here's how the short-wave listener can crack an untapped QSL bonanza—marine radiotelephone.

THE following is a first class brushoff.

"The transmission you received did not come from a 'Broadcasting' station but instead was test speech transmitted from a Bell System station used in providing public radiotelephone service with foreign countries and ships at sea. In view of the private nature of this public telephone service, we feel sure you will understand why we cannot verify your reception or discuss transmissions that you have heard over your facilities."

The above stone wall is nothing new to short-wave listeners who have the fascinating hobby of collecting QSL cards. Many countries and territories not having short-wave stations on the air do have a number of short-wave telephone stations. But as any veteran listener will tell you, not only do they refuse to verify, 95% of their transmissions are in unintelligible "scrambled" speech.

A sensitive communications receiver, such as this Hammerlund HQ120, is a big help when trying to pull in DX stations. But careful tuning and logging of frequency are still necessary if you wish to receive a QSL for your collection.



Scared off? Take a look at the postal cards on the next page. That's right, verification cards from radio telephone stations, and from the Radio Corporation of Puerto Rico, which usually doesn't answer reception reports at all!

Look at the letters below. More telephone stations verified. And some of these have been signed by the same company (Bell) quoted above.

How's it done? No magic. No bribery. Just find the *right* telephone station and use the *right method*.

Listen for These

Every major telephone company provides a very special service, namely telephone facilities for *direct* contact with ships at sea. You probably know it as ship-to-shore telephone. These transmissions differ greatly from the more frequently heard transoceanic stations. They must accommodate everything from the liner *Queen Mary* to tiny shrimp trawlers. Therefore the setup

Brushhoff letters, below, stressing private nature of radiotelephone traffic, are very easy to come by if you don't know the ropes.

must be both simple and inexpensive. This usually rules out scrambled speech, thus it is a cinch for the short-wave listener to pick up a clear identification—no time wasted hunting for test periods.

At the same time, these stations must maintain complete coverage over a broad area. The broader an area, the more complete the coverage, and this determines the success of a marine service. As a business operation, it must pay off. Theoretically, such stations fall into one of two categories. "High Seas," such as the widely heard one at Cairo, U.A.R., operating on 8811.5 kc, or VIS Sydney, Australia. Then there are the "Coastal" stations like WCT San Juan, P. R., and VPN2 Nassau, Bahamas. Neither country has a short-wave broadcasting service.

The DX listener will find both have plus and minus features. High Seas stations can be heard much further and you'll be able to bag stations from every part of the globe. However, these will

Lengthy, interesting confirmation letters from radiotelephone operators, such as these, can be yours if you observe a few ground rules.

.... Brushhoff

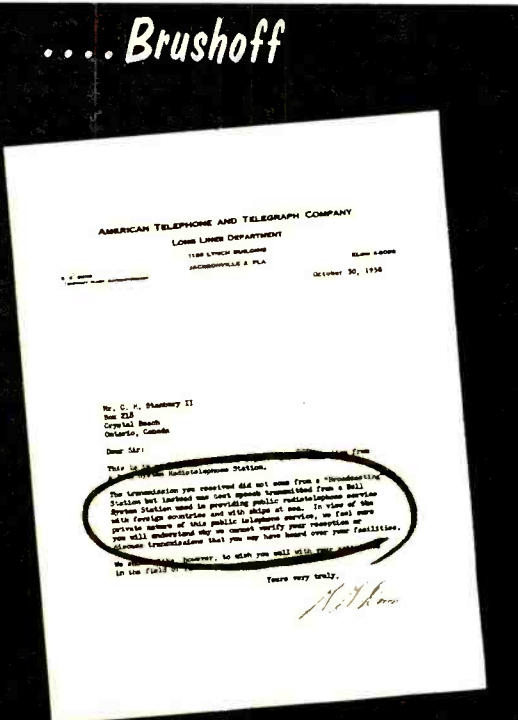

.... Success

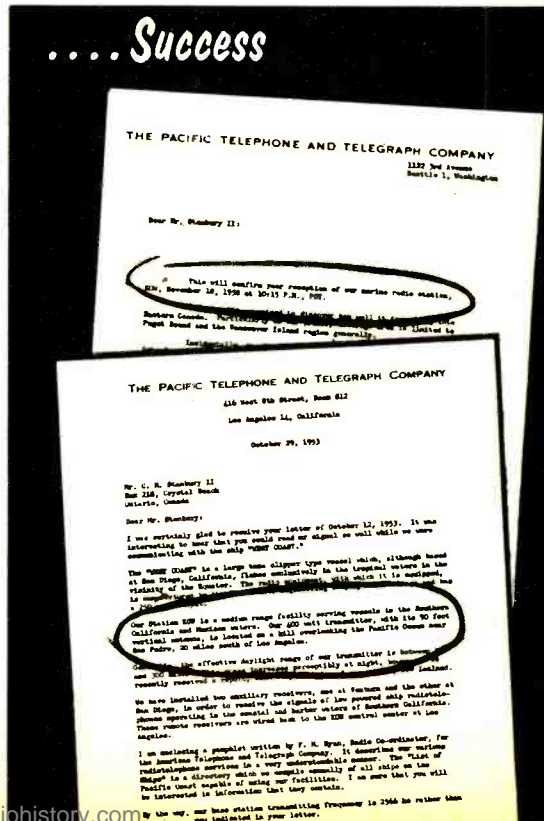

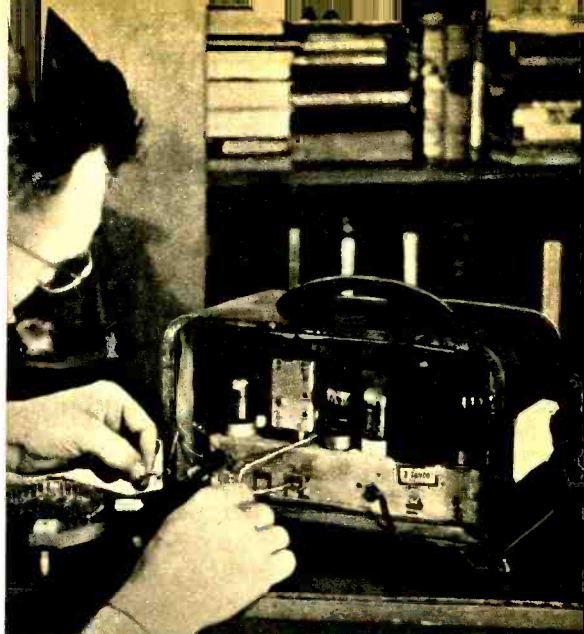

Here are three examples of a typewriter and postal cards can result in QSL's from stations that normally do not send QSL's.

External antenna coupled to old "police band" radio via .05 mfd capacitor makes for good DX. Capacitor prevents detuning, risky ground.

not always be countries lacking an international broadcasting service, and you might be able to get a printed QSL card from the regular broadcasting service. Also, High Seas operations are the only ones using scrambled speech. No real problem here since most initial contacts between ship and station are made via normal voice. Special modulation and scrambling are usually added after the call has been placed.

Dropping down to the lower frequencies, distant coastal stations are more difficult to pick up. You will have to tune around sunset and during the hours of darkness. Skill and patience are required, however the payoff will more than match your efforts. Areas such as Puerto Rico, the Bahamas, the Palmyra Islands are on these frequencies. These are places that couldn't possibly be heard on the regular short-wave broadcast bands.

If you want to try your hand at both types, concentrate on High Seas stations during the daytime and in late spring and summer nights, and the low frequency DX during the hours of darkness in fall, winter and early spring.

Many marine telephone stations have weather broadcasts twice a day. If there

[Continued on page 90]

A MARINE SWL CHART

Frequencies most commonly used by marine radio-telephone stations are indicated in **HEAVY TYPE**. Those above 7000 kc are generally used for high seas operation. A few of the more widely heard stations are listed here with their specific frequencies. Stations may occasionally be subject to interference from others in the United States and Canada.

FREQ IN KCS	DX STATION
22720	
↓	
22650	
17360	
↓	17340.5 DAN Narddeich, West Germany (P)
17290	
13200	{ 13180.6 LPL9 General Pacheco, Argentina
↓	{ 13165 Rome, Italy
13130	{ 13142.1 VIS Sydney, Australia
8815	{ 8811.5 Cairo, U.A.R.
↓	{ 8804.5 GCN3 Rugby, England (P)
7846	{ 8790.2 PCH Scheveningen, Netherlands
4438	
↓	4177.5 KQM Honolulu, Hawaii (1, 3)
4170	
2602	{ 2582 KSV Hilo, Hawaii (1, 4)
	{ 2558 VPN2 Nassau, Bahamas (2)
↓	{ 2530 WCT San Juan, P. R. (2, 5)
	{ 2530 KQM Honolulu, Hawaii (1, 3)
2462	{ 2530 Palmyra Islands (1)

- NOTES:**
1. Best reception after 0300 EST.
 2. Best reception sunset and early evening.
 3. Operated by Mutual Tel. Co., 1128 Alakea St.
 4. Operated by Hilo Fisheries.
 5. Operated by Radio Corp. of Puerto Rico
 - P. Operated by country's Postal-Telegraph Bureau

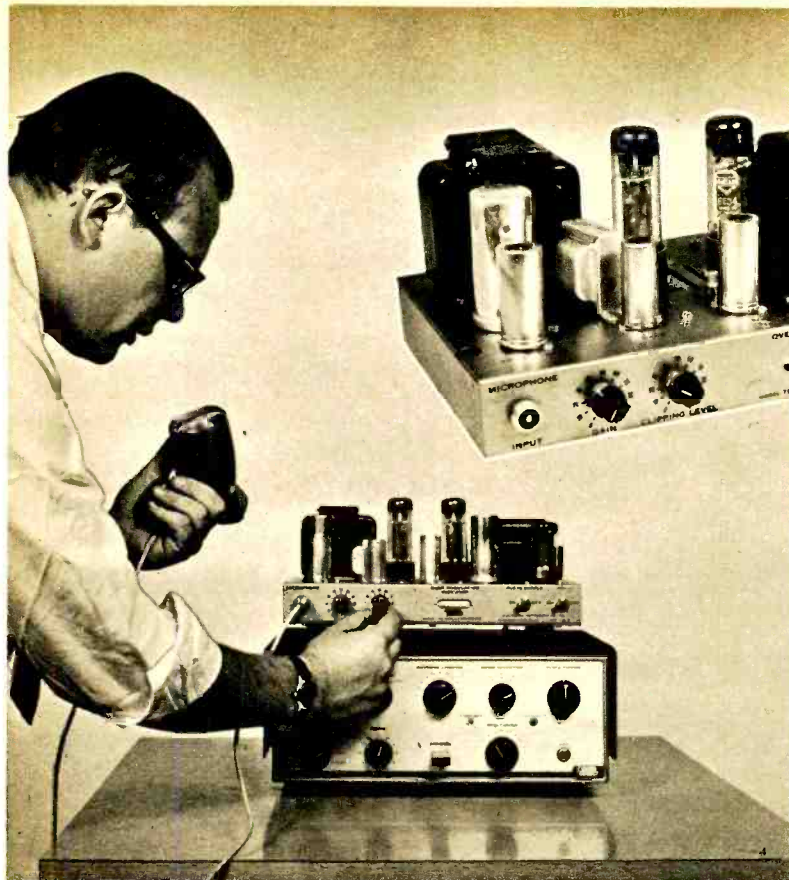

Along front apron of chassis, from left to right are mike input (for crystal or dynamic), gain, clipping level, the overmodulation eye, plate and AC power switches.

Modulator sits atop the 90 watt CW transmitter that it is connected into. Clipping, being adjusted, raises power without overmodulation.

EI assembles A Modulator-Driver Kit

The EICO Model 730 modulator will convert a ham CW transmitter of up to 90 watts to phone operation.

ADD a modulator to a simple code transmitter and it will be equipped for voice operation. This is a logical progression for the Novice ham, especially if he is on a limited budget. When a higher grade license is secured, the add-on modulator will upgrade the CW rig for use in the General Class phone bands.

EICO has designed the Model 730 modulator kit as a companion to their 90 watt CW transmitter, but sufficient flexibility has been incorporated into the unit to permit it to be used for virtually any transmitter up to 90 watts.

The modulator is a 50 watt audio amplifier with several particular features. Its output transformer is tapped with values ranging from 500 to 10,000 ohms for matching into a transmitter's final RF amplifier tube (s). Frequency response is limited to those voice tones that contribute most to intelligibility. A speech clipping circuit enables the percentage of modulation to be kept high without exceeding the 100 percent legal maximum.

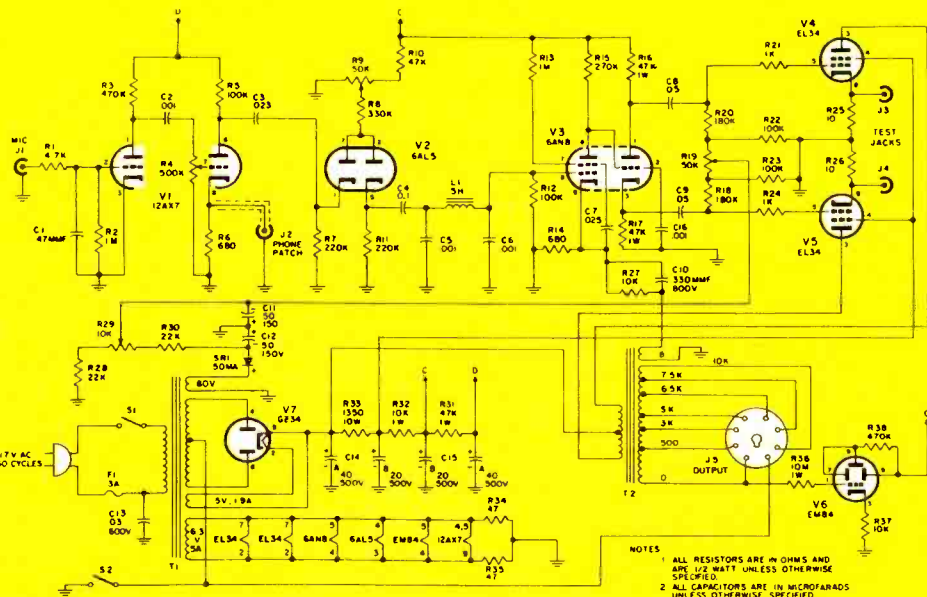

Layout of parts after kit is unpacked. Large chassis is made of steel plated with copper.

Chance of error is reduced if each component number is marked directly on the chassis.

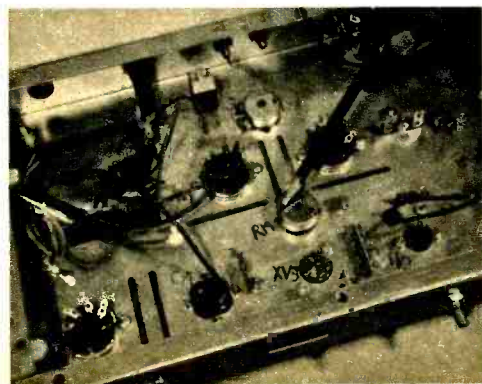

Push-pull output tubes V4, V5 deliver 50 watts. V2 clips and restricts the audio bandwidth.

Assembling the kit is about a nine hour job, plus a few moments devoted to adjustments. As seen in the photos, the chassis is uncrowded and presents little problem in the way of wiring. However, one simplification could have been made in the instruction manual. The tube socket for the overmodulation indicator is mounted on a bracket inside the chassis and presents a cramped corner for soldering. Its components and leads could have been attached before actually mounting the socket in place. Take care not to scorch any parts or insulation while poking in here with a hot iron.

After the final step was checked off, the chassis was firmly grasped, lifted and given some vigorous shaking. All manner of debris fell out—wire clippings, solder splashes, bits of insulation and one misplaced lockwasher. Don't omit this final step before plugging into the AC power.

Adjustments require a simple voltmeter. They include balancing the power tubes and bringing their negative

bias voltage to the correct value. No difficulty encountered here so the octal plugs were wired for the proper match and the two chassis strapped together with a ground lead.

Never operate a modulator (or any amplifier, for that matter) without a load on its output. Voltages in the output transformer will soar to dangerous values and often break down and ruin the insulation. Here, a properly tuned transmitter loads the modulator. If a transmitter is not available, a resistor of adequate power and resistance may serve as a dummy load for checking purposes.

A novel overmodulation indicator is used in the modulator. A fluorescent green stripe, broken at the center, appears in the front panel slot. While speaking into the mike the audio gain control is turned up until the edges of the stripe begin to overlap. The Clipping control is then increased so additional audio may be applied without in-

creasing the overlap on the indicator.

During an on-the-air trial hooked into the EICO transmitter the unit performed well. Four different signal reports on the ten meter phone band revealed that audio quality was crisp and highly intelligible.

Since EICO has designated this unit a "Modulator-Driver" it is worth noting that it may be used to drive a much larger modulator. This, of course, is necessary for plate modulation of transmitters running considerably more than 100 watts. But, with the surge in popularity of single sideband transmission it would be wise for the beginner to carefully weigh the situation before investing heavily in higher power AM modulation of the conventional type. The audio power used in SSB is extremely low.

Considering simplicity and ease of adjustment, the EICO 730 is a Good Buy at \$49.95 in kit form. A cover is available at \$4.50.

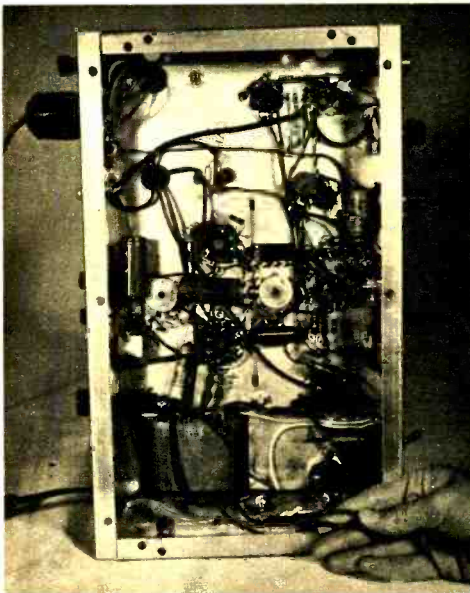

Above, the chassis wiring complete. Hand holds a transformer lead which may be wired in to boost line voltage if it is low in your area. Top chassis view at upper right shows Bias and Balancing points at center. Cable in right photo carries audio to transmitter.

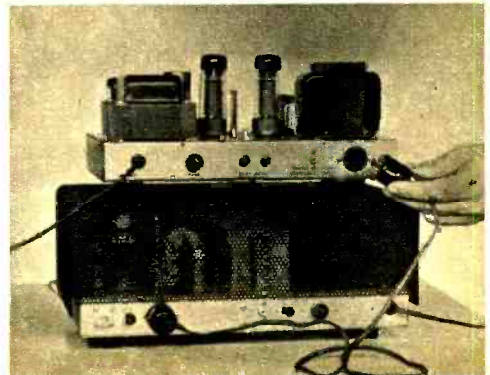
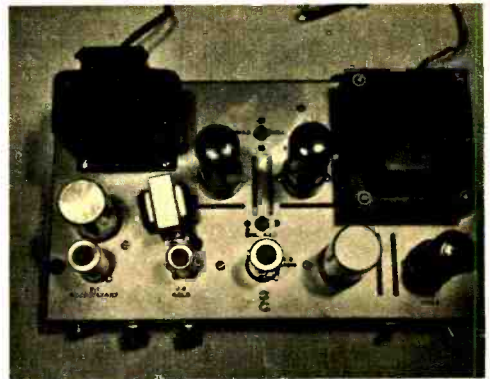

A Metal Etcher

By Marshall Anderson

Salvage a burned-out TV transformer and build this unit. It will mark tools or other metal objects.

HERE is an electric etching pencil with which you can permanently identify tools, mark the timing on gears and do other metal marking jobs. In fact, the pencil will write on any smooth ferrous-metal surface and will etch hardened steel as fast as you can write. Four heats of 150, 250, 300 and 400 watts output provide for a variety of etching requirements.

Basis of the tool is an old TV power transformer which was discarded by a repair shop. Any large transformer will serve, since size and type aren't too important, except that the iron core should have a total cross-sectional area of about two square inches.

Begin disassembly of the transformer by removing the clamp bolts that hold the iron core and removing the laminations, as shown. Spool off the wire onto a temporary reel. If the wire is

During operation the tool or other metal object is placed on the unit's flat plate and etched with "pencil." There is no shock hazard from the low voltage.

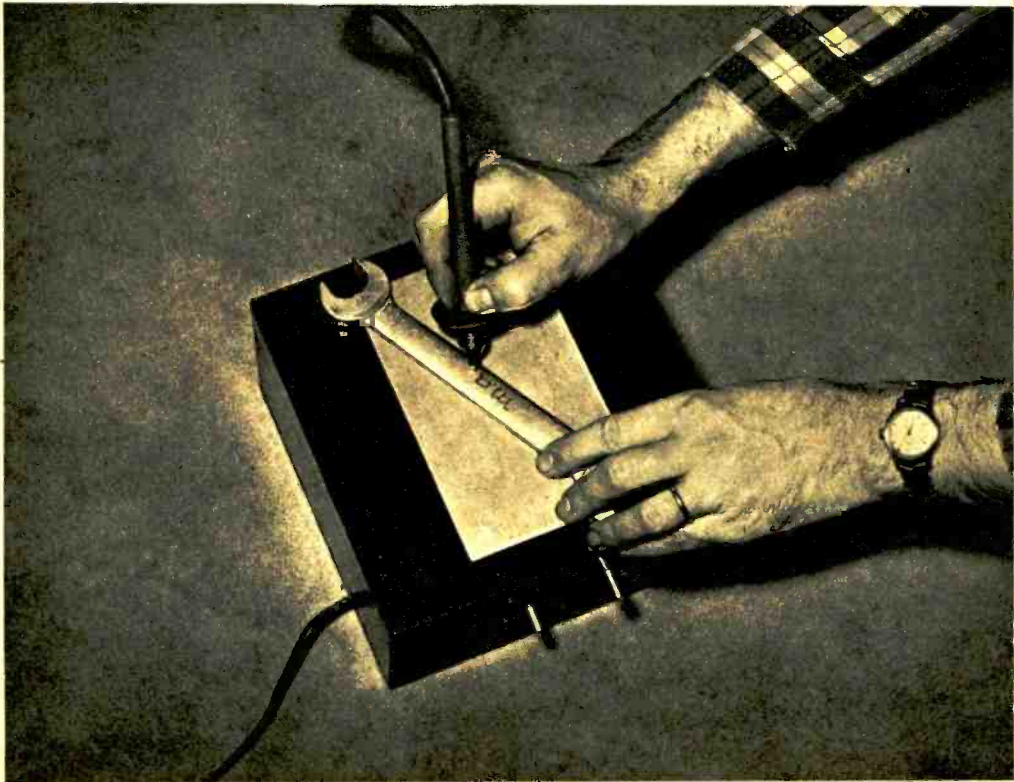

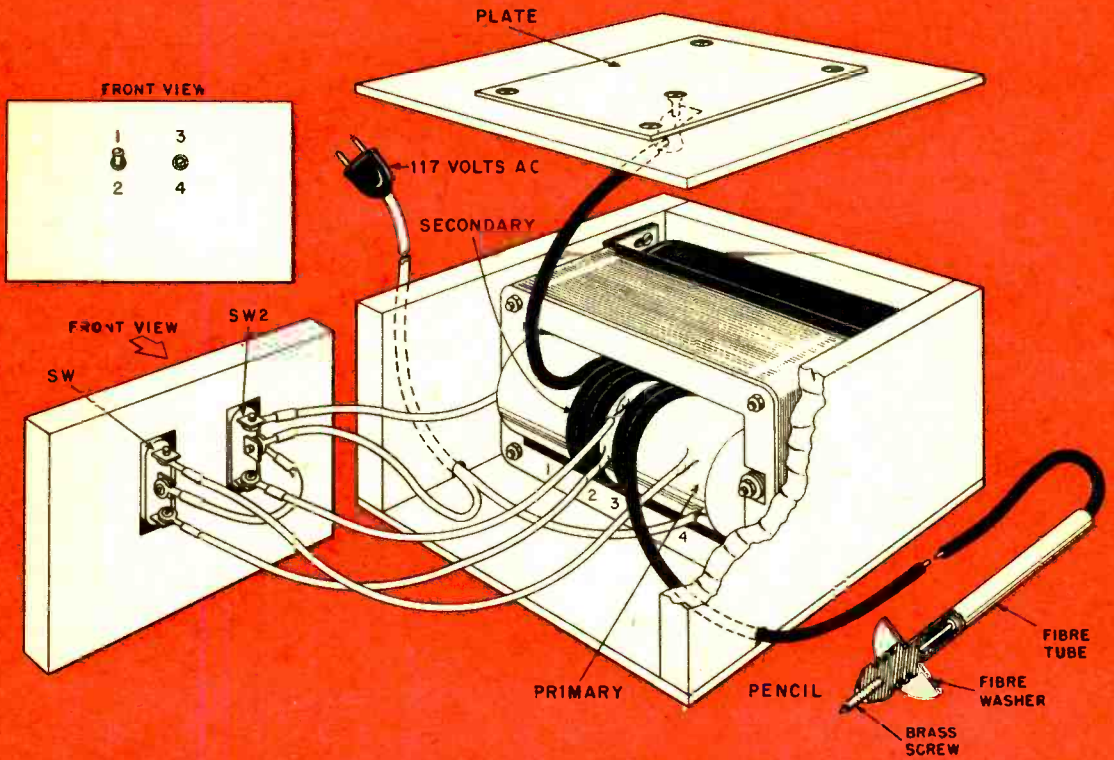

Four numbers at upper left indicate degree of heat only, numbers at center (on core) show taps.

Old transformer is opened and laminations are removed individually by prying with a knife.

As primary is wound, loops are formed at the prescribed number of turns to form the taps.

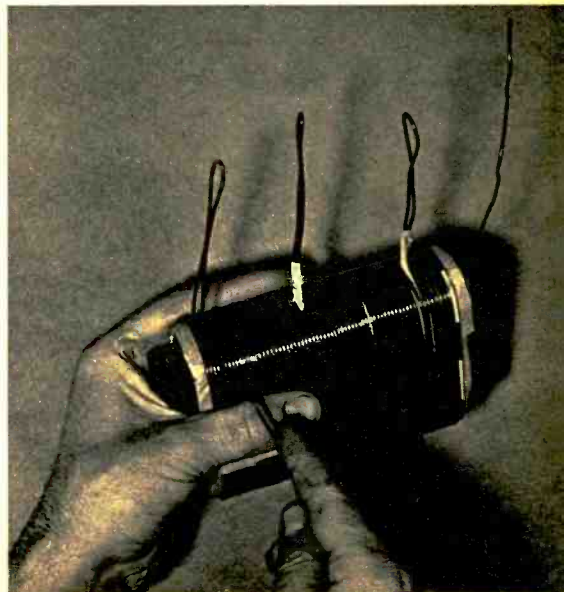

Schematic. Secondary circuit is completed when pencil touches metal lying on plate.

Secondary coil is wound from very heavy cable which also forms lead going to the pencil.

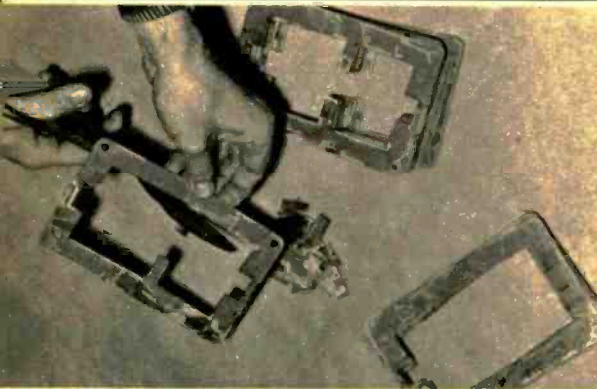
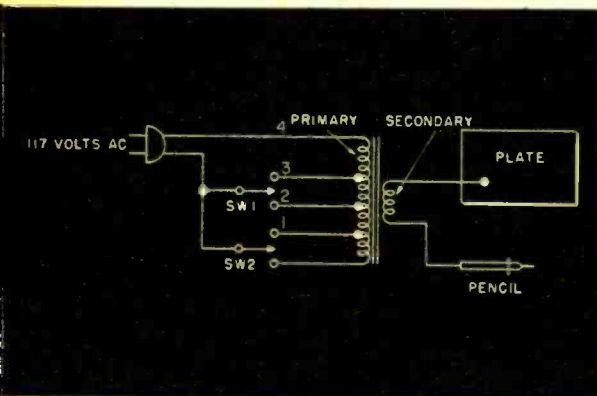

Center tabs of the core laminations may be trimmed to provide more space for the coils.

Insert coils and laminations into transformer case which is fastened with original bolts.

of a useable size and is in good condition, it may be re-used in winding the etcher. The table included in this article gives the equivalent of the required wire gauges in smaller sizes, which are wound in parallel. If winding space for the coil is limited, however, it is preferable to use new Formvar or plastic-coated magnet wire. About 350 feet or 4 lbs. will be required, depending upon the particular core used. Cost is about 70 cents per lb.

The primary is wound directly on the core. Wrap the core piece with several layers of heavy brown wrapping paper, for insulation. Leave a 6" lead and begin winding. Keep the turns tight and closely spaced, and insulate between layers with paper. Ordinary masking tape will hold the paper in place, and

may also be used to keep end coils from spilling out of the end of the winding. At 265 turns, take off a tap by forming a large loop, as shown, and keep winding. Mark this tap No. 1.

Take off tap No. 2 at 310 turns and No. 3 at 340 turns, marking these also. When the full 440 turns are on the coil, cut off the excess, leaving a 6" lead, and
[Continued on page 98]

WIRE SIZE EQUIVALENTS

Primary Wire			
#14	2 of #17	4 of #20	
Secondary Wire			
#3	2 of #6	4 of #9	

If #3 and #14 wire are not available, use equivalents (in parallel) in columns at right.



Hi-Fi Clinic

Send in your questions on hi-fi, the clinic answers each one by mail. If of general interest, they will appear in this column.

Stylus Wear

How often should diamond stylus in an LP or stereo cartridge be changed?

L. S. Sumner, Akron, Ohio

It is difficult to provide a quick answer to this question as a large number of factors enter into the problem. Aside from the matter of hours the stylus has been used, there are the considerations of how well polished the stylus was when new, the compliance of the cartridge and stylus assembly, the tracking force (weight) on the stylus tip, and the mass of the arm. The best advice that can be given, is to have your stylus checked under a microscope at least once a year. And if you use your machine regularly, a semi-annual check would be preferred.

Everything applying to LP stylus is that much more important when considering stereo. Since the stereo stylus has a smaller tip diameter (.7 mil as opposed to 1 mil) a twice-a-year check is mandatory.

Shorted Capacitor

When I first turn on my amplifier the 5Y3 rectifier tube gets very red and hot. A lot of noise is heard from the speaker. What do you believe would be the cause of this?

Michael Lebbano, Trafford, Penn.

The trouble you are experiencing is probably due to a shorted input filter capacitor. If no other component in your amplifier overheats then the filter is at fault. If any resistors heat up excessively look for the short on the side of the filter resistor farthest away from the 5Y3 tube.

If the input filter is shorted and is part of a multi-section can type capacitor, it's a good idea to replace the entire can, not just the defective section.

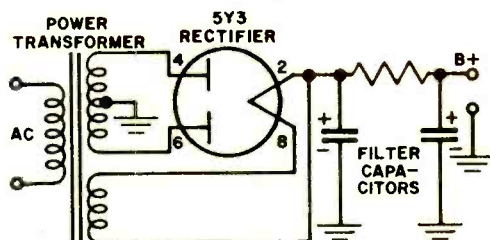

Note the diagram above and also refer to the article elsewhere in this issue that traces and explains the theory and operation of power supply circuits.

Needle Talk

It may be my imagination, but my LP stylus seems to be producing a lot of noise when playing a record. It seems to be far louder than when I bought the cartridge about two years ago. I've had the stylus checked and it shows very little sign of wear. My tone arm weight is correct also.

Carl Groves, Wayne, Pa.

Assuming that the stylus and tracking pressure are okay, your trouble might very well be due to problems in your stylus assembly. If your stylus is the type that uses small rubber damping blocks make sure that they are both attached properly and they have not stiffened up. Comparison with a new stylus assembly will tell you quick enough if anything is wrong. If one of the damping blocks has worked loose, but otherwise seems in good condition, you can set it back in place using a minimum amount of Duco cement. Make sure that the Duco *only* touches the spot where the metal meets the rubber.

If your cartridge is one of the types using a silicon grease for damping, the grease may have run out after two years. In that case return cartridge to factory for proper servicing.



Author depresses button on carbon microphone to activate transmitter located in the trunk of the automobile.

A Six Meter Rig For Your Car

By Don A. Smith, W3UZN

Build this printed circuit transmitter, then add the car receiver converter described next month.

GOING mobile brings to mind difficulties. Where do I get the power to operate the rig? Will my battery stand the extra load? How about the cost? How difficult is it to construct? I know the little woman won't go for drilling holes in the car.

The little rig described here overcomes most of these problems. Power can come from the auto radio power supply if desired. The RF power input is 3 watts.

One of the nice things about six meter operation is little trouble with high power stations or crowded band conditions. This rig has bounced along in the trunk of the car for several months

The section of the schematic at upper left is the printed circuit, enclosed in dotted lines. Modulator is below.

Underside of the chassis contains few components, most are topside, on the board. Relay is visible at the left.

Wiring guide. On the printed board, at upper right, only connecting points to the rest of the circuit are shown.

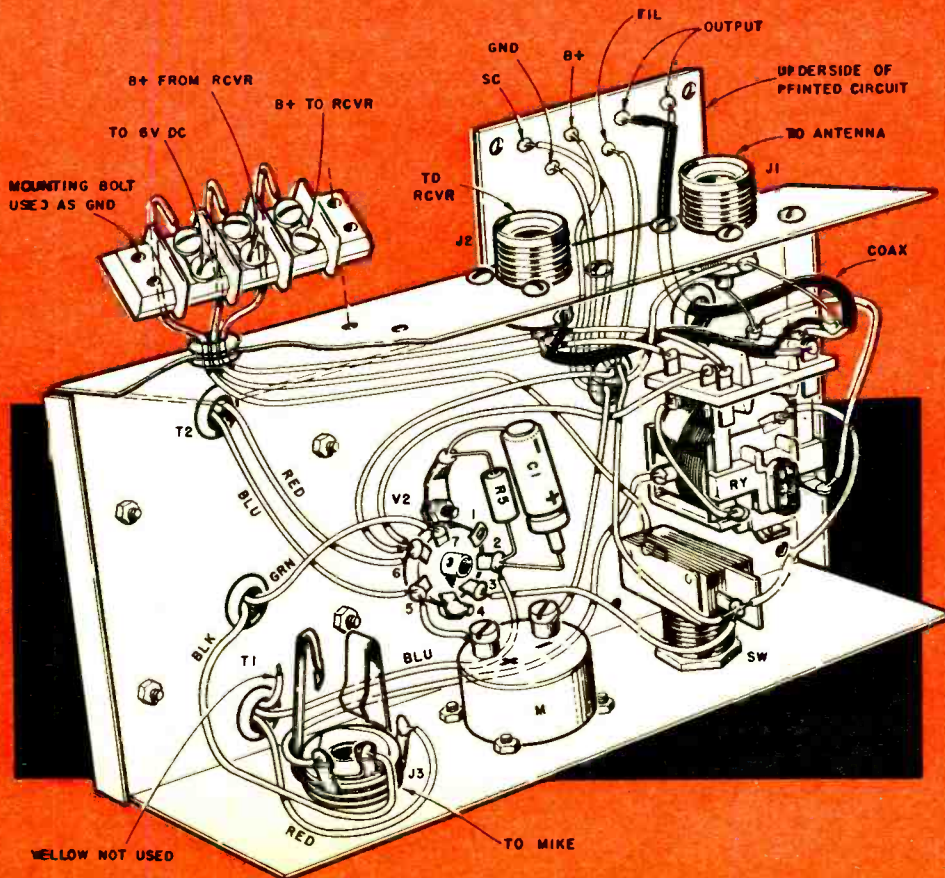
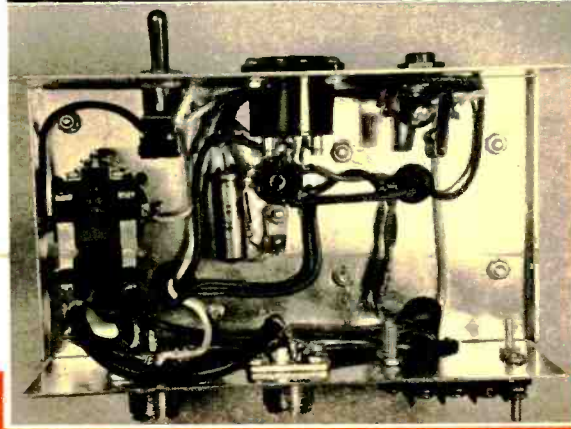
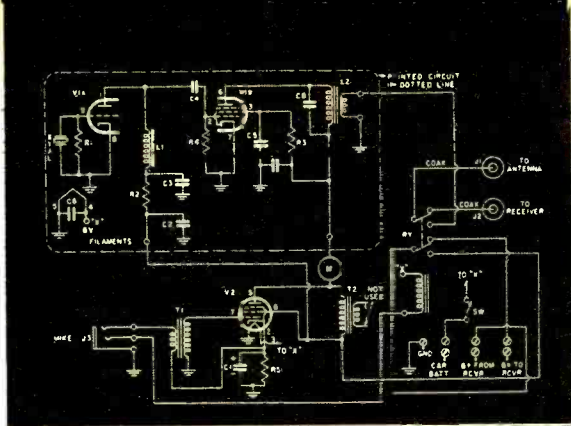

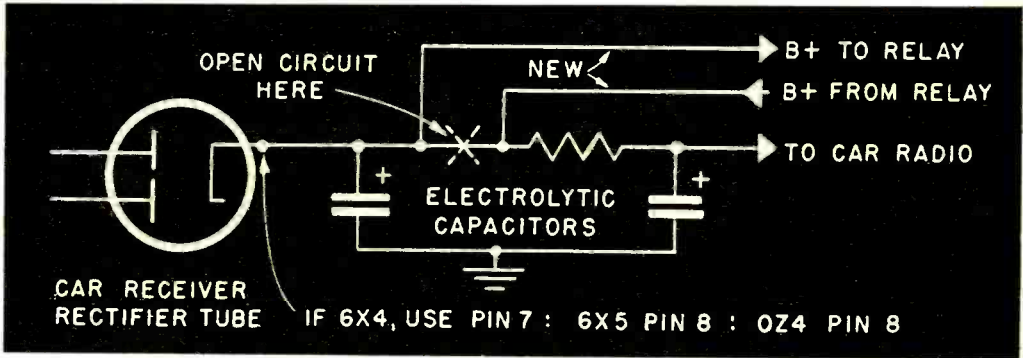

Power for the high voltage B+ in the transmitter is taken from the car receiver power supply.

and has been most amazing in its performance. Operation has been mostly in the Hagerstown, Maryland area, in the Cumberland Valley, with many hills and valleys. This makes VHF operation a little extra difficult, however regular communications are held with stations in Pen-Mar, Penna., while driving around in downtown Hagerstown!

The heart of the rig is a printed circuit board manufactured by International Crystal Co. All the wiring for the oscillator and RF amplifier is contained on this board. It comes drilled and ready for the mounting of parts, which are also included with the board. A single 6U8 tube is used for the oscillator and RF amplifier.

The printed circuit board is mounted above the chassis as shown in the pictures using the small stand-offs supplied with the printed circuit board. The location of the 6AQ5 modulator tube is [Continued on page 108]

- PARTS LIST**
- C1—25 mfd 25 volt electrolytic capacitor
 - R5—220 ohm 1 watt resistor
 - RY—6 volt DC DPDT relay (Potter & Brumfield KA11D)
 - T1—Single button to single grid carbon mike transformer (Stancor A4705)
 - T2—Audio output transformer, 50L6 or 50B5 type
 - J1, J2—Co-ax connectors (Amphenol 83-1R)
 - J3—Phone jack (Switchcraft 12B)
 - SW—SPST toggle switch
 - M—0-50 milliampere DC meter, 1" diameter
 - V1—6U8 tube
 - V2—6AQ5 tube
 - Printed Circuit Board—Kit # FO-6 (International Crystal Co., 18 N. Lee, Oklahoma City, Okla.)
 - Misc.—Chassis 6 1/4"x3 1/2"x2 1/2" (LMB # 138), 3-terminal barrier strip, rubber grommets

Commercial halo antenna is mounted on bumper, transmitter (circle) in trunk.

Top view shows printed board at left. It is available either in kit or wired form.

Left to right in rear view are power supply terminals, receiver and antenna jacks.

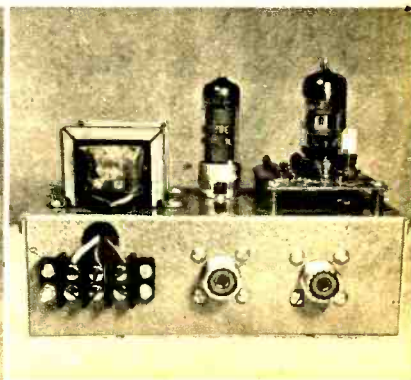
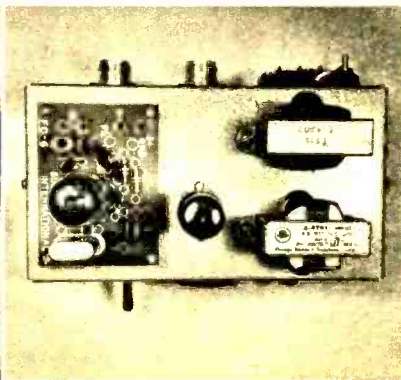

improve your radio with **A Loopstick**

By Joe W. Rocke

Replace the antenna in your AM broadcast set with a ferrite rod loopstick to increase its sensitivity.

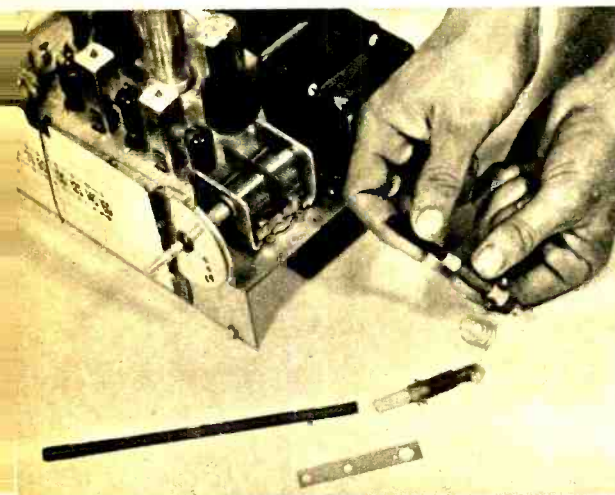

Three different length loopsticks are shown. The largest is most sensitive. Note bracket.

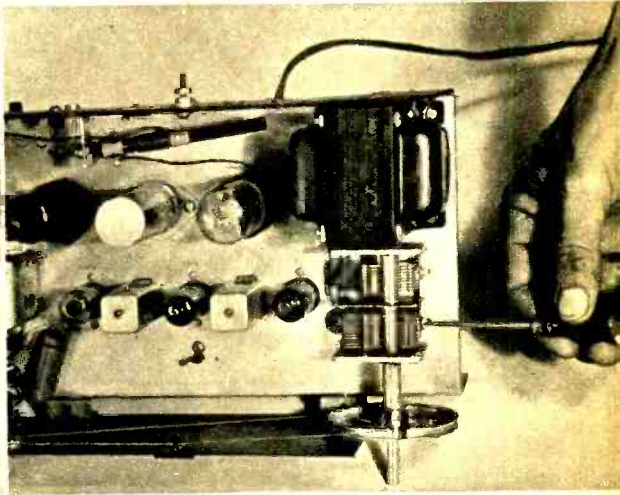

Loopstick is bracket-mounted at upper left. Trimmer capacitor is adjusted for best volume.

ASIDE from improved performance, a loopstick eliminates the tangles of wire and some of the directional characteristics common to the old-style loop antenna.

These midget antennas may be installed in any convenient location on the radio chassis or cabinet. The small mounting bracket supplied with the loopstick is bent as required for convenient mounting. This bracket can usually be fastened beneath an existing chassis screw.

If the radio is equipped with an old-style loop antenna note the location of the wires connecting the loop to the chassis. The wire running from the loop to the larger section of the variable capacitor is the antenna lead. Connect this wire to the antenna terminal of the new loopstick.

The second lead connected to the old loop is either a ground wire or connects to the automatic volume control circuit. In either case connect this lead to the ground or remaining terminal of the loopstick.

The loose length of wire coiled about the loopstick serves as an antenna. Uncoil this wire and stretch it away from the radio chassis. It may be taped around the inside of the radio cabinet as long as it does not contact the chassis.

To adjust the loopstick turn the radio [*Continued on page 98*]

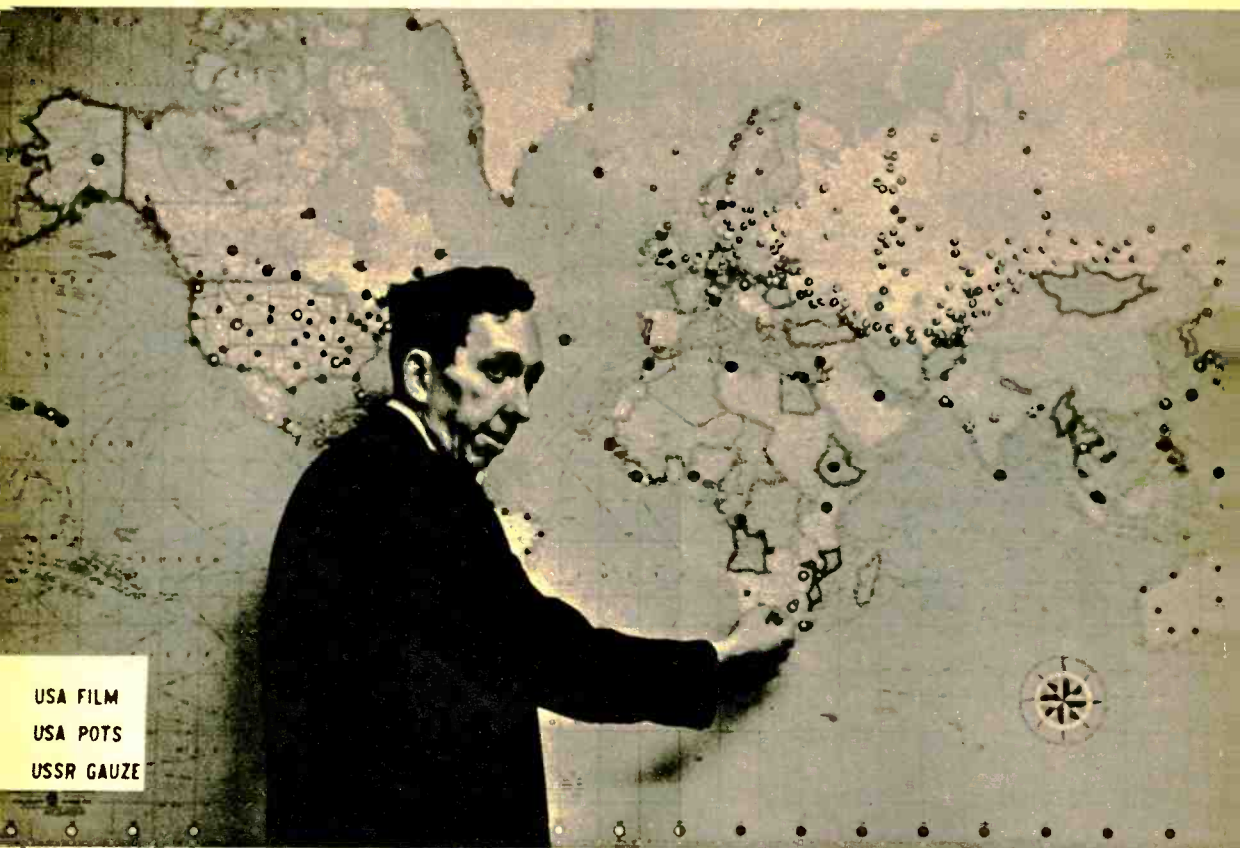

Radiation report is pinpointed by Dr. John Harley, AEC lab's director. Legend indicates how fallout is gathered—by gummed film, dust pots, gauze.

Radioactive **Fallout**

We are all anxious about fallout. Gathering data on radiation is the job of this unique laboratory.

FALLOUT! Strontium-90! What is it? Will we all suffer from the effects of unwanted radiation? What will fallout do to the human race? Is there a threshold—a specific amount of radiation that we can absorb without harmful effects?

These are not easy questions to answer, yet they are being asked daily all over the world. There is almost universal concern about fallout now that man has found the dubious means by which he can more than double the natural radiation level. The means, of course, is the nuclear explosion.

Scientists are relatively sure that natural radiation has some influence on the development of the human race, and it is logical to assume that if man doubles the amount of radiation through fallout, then the influence on man, whatever it is, will also double. Everyone may not agree on how or how much radiation produces

Gummed film is exposed out-of-doors for 24 hours to collect the fallout in many locations throughout the United States. All samples are sent to the central lab.



Carefully logged, film samples are folded and placed in metal cups. Then cups are put into thermoelectric oven where both film and fallout are reduced to ashes.



Ashes are then emptied into small plastic dishes (planchets). The planchets are sealed between two ribbons of vinyl and fed to electronic radiation counter.

Only one of its kind, this automatic beta counter measures the radiation of each sample as it passes over a Geiger counter. Reading is sent to recorder.



Photos by Carsten of Three Lions

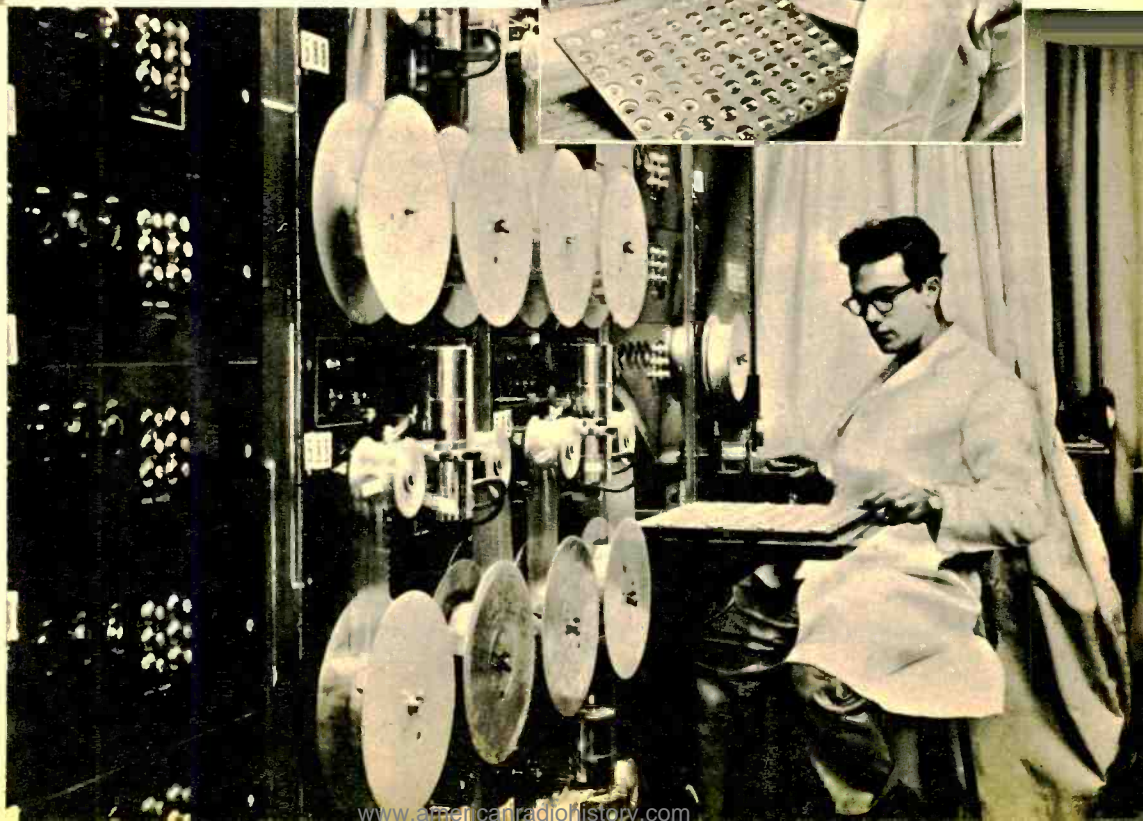

Samples in planchets are heat-sealed automatically in vinyl tape and rolled onto spool.

Radiation readings are recorded for all samples by this unit. Data punched on tape, cards.

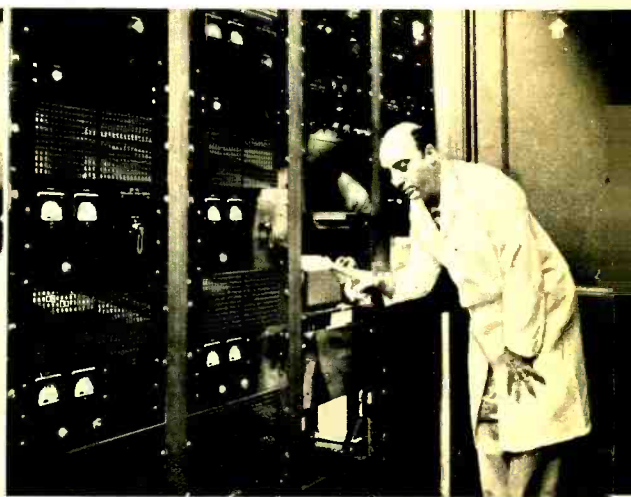
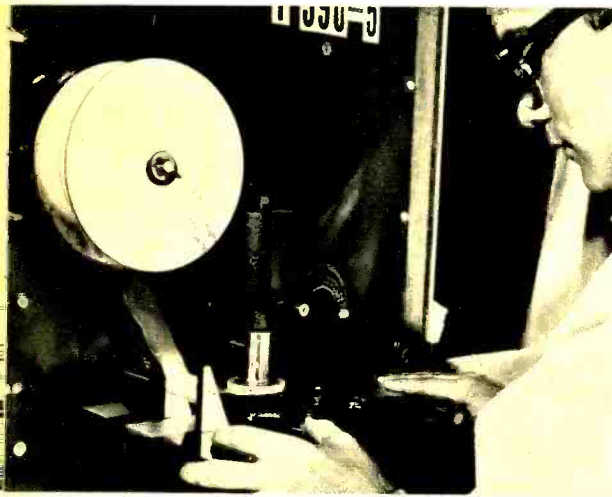

genetic damage or leukemia, but all agree there is a pressing need for more scientific data, more documentation on fallout.

The Atomic Energy Commission's unique Health and Safety Laboratory in New York City is gathering and recording that information, and distributing data to a select group of scientists deeply concerned with the radiation problem. From all over the free world come regularly submitted samples of atmospheric dust, soil, milk, plant roots, foodstuffs, etc. With the help of modern electronics, the percentages of radiation elements in these items are quickly checked and recorded, as shown on these pages. Any significant rise in the fallout level in a particular area shows up in a comprehensive quarterly report and other more frequent abstracts issued by the Health and Safety Lab. These reports are sent to scientists for study and interpretation.

Effects on Children

It has been found, for instance, that the average young child in 1966 will have about four micromicrocuries of strontium-90 per gram of calcium in his body. Strontium-90 is a long-lived isotope that produces ionizing radiation, radiation that has been broken down into its component parts. In general,

it is felt that any amount of radiation is undesirable. The big question is: Will four micromicrocuries of strontium-90 in a child produce a dread cancer? How about those 10 percent of the world's children who might end up with as much or more than eight micromicrocuries by 1966?

In 1958, the average amount of strontium-90 in adults' skeletons was only 0.19 micromicrocuries—about 1/20th the amount predicted for young children in 1966. How does one absorb the strontium-90? There are many ways, but mainly by way of mouth. Radioactive fallout containing strontium-90 settles on the earth, gets into the soil, is absorbed by the plants, which are eaten by animals which are in turn eaten by the human population. This is only one possible exposure, but a common progression.

It is only through more information on fallout that the scientists of the world can determine the patterns of fallout, its effects, and then learn what might be a safe radiation level. Then they will be in a position to advise the world how to keep radiation below that level. The work of the AEC's Health and Safety Lab, pictured on these pages, is a big first step in better understanding the radiation dangers surrounding us.

—E.N.

Try These

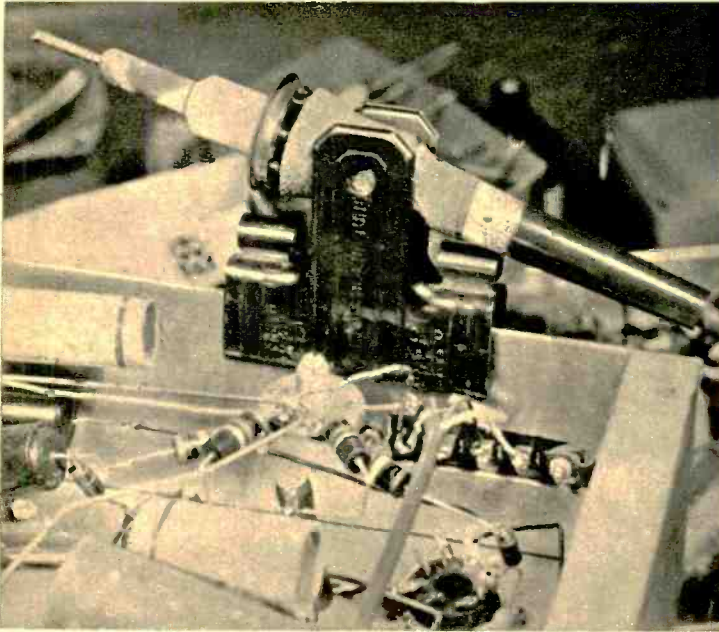

Handy Rack

A 3-inch paper clip will serve as a rack for a small soldering iron. It acts as a "third hand" for many soldering jobs.

Straightening Leads

To take kinks out of leads, lay the wire on a wood block and rub it gently with a second block rotating the part.

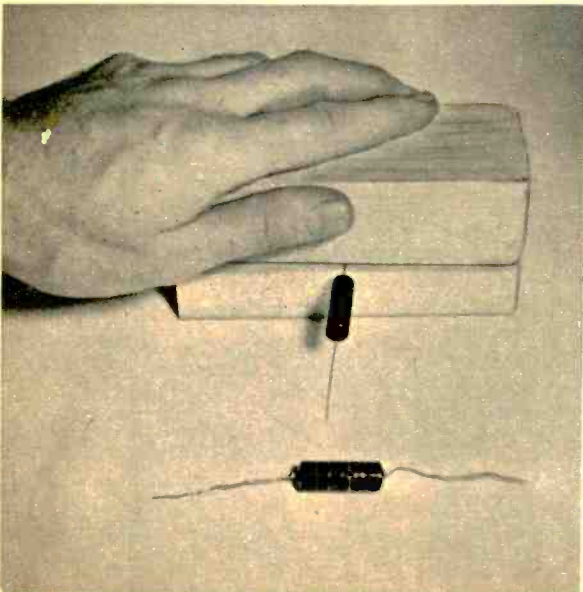

Bulb Removal

Removing a recessed pilot bulb from a panel may be simplified with a length of rubber tubing. It acts as a wrench.





Operator tunes receiver and checks graph read-out of humidity, air pressure and temperature as relayed via UHF radio.

Photos by George Pickow of Three Lions

UHF in a balloon

Tells Us The Weather

RADIO waves in the ultra high frequency (UHF) part of the spectrum not only bring us television, but some very valuable information about weather we haven't seen yet.

All over the world, every hour of the day, helium-filled balloons soar skyward toting small but valuable payloads—radiosonde transmitters. These transmitters have the touchy job of telemetering changes in air pressure, humidity and temperature to the receiving station on the ground.

Decked out with three special weather recording devices, the balloon rises and goes into action. The first signals telemetered to the ground are those indicating the changes in barometric pressure as measured by special pressure-sensitive cells that feed small voltage changes to the transmitter. Humidity is determined by an ordinary hair which expands and contracts with varying amounts of moisture. A tiny thermistor detects changes in temperature. All three are converted into radio signals.

This measuring and reporting process is repeated again and again until finally the balloon bursts at 20,000 feet.

Meanwhile, at the ground receiving station, UHF signals are picked up by a ground antenna and fed to an FM receiver. A taperbar activated by the receiver swings back and forth drawing thin lines on weather-calibrated graph paper.

By noting angle and speed at which directional antenna must be moved to keep transmitter tuned in, wind velocity and direction are determined. This weather station is in Nantucket, R. I.

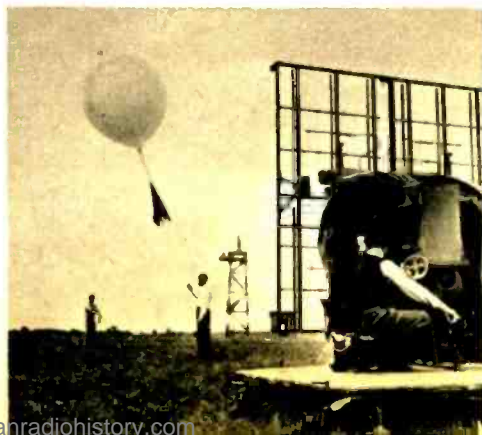

The master unit may contact any remote. It is being used to relay a message received on the telephone.



wire your home for
An Intercom In Every Room

By Paul Hertzberg

This system features voice communication, baby tending and music distribution throughout a home.

IF YOU'RE buying a new home or having one constructed, consider installing a complete intercom and music system. Any initial expense for the units will more than pay for itself in convenience. You won't have to walk from room to room to talk to another person, go up or down stairs to answer the door bell, and have the pleasure of music heard throughout the house.

The heart of the system is an intercom master, remote stations, superhet radio and switching arrangement. A Masco "Wife Saver" unit was used in this particular installation. The most practical place to mount the master unit is in the kitchen where most of the housewife's activities take place. The wall mounting box is designed to fasten between standard wall studs. Heavy nails will secure the box to the studs quite adequately. The box must extend out into the room a distance equal to the thickness of the plasterboard that will form the walls. It is wise to mount the master box at mouth level for the person who will use the

Master unit will fit into this plaster box, nailed between studs before wall is installed.

Rear view shows BX power cable entering the box to supply AC voltage for the master unit.



intercom most often. A good average height is about five feet above floor level. The only power line connection to the system is made to the nearest AC outlet box using BX cable that enters a gem box on top of the wall mounting box. This connects to a TV type interlock that automatically disconnects the unit from the power line when it is removed to be serviced. Clearly written instructions and labeled leads indicate which wire is to be connected to the ground side of the AC line. This will insure you against any shock hazard in the system.

Individual room speakers and their controls can be mounted at the discrimination of the installer. The remote speakers used in the system shown were mounted by the room light switches in

the case of the bedrooms and within reach of a person who might be caught in the bath when the door bell rings. The speaker boxes are nailed to the wall studs and additional support is furnished by horizontal pieces of wood. Since the speakers are very sensitive when they act as microphones, the control box could be mounted anywhere in the room. The two-conductor cable is the only connection between the room speaker and its individual control.

Each remote unit is connected to the master control unit by means of a four conductor plastic sheathed cable. Shielding is unnecessary unless the lead lengths are in excess of 100 feet each. It is still wise not to run the cable near sources of noise such as fluorescent
[Continued on page 106]

Wall has been installed, hole cut for master. Each of the cables from the remotes is tagged.

Excess cable is trimmed and ends of wires are stripped, soldered to terminals, then taped.

Hand holds cable inside plaster ring used for remote speaker. Switches mount in box below.

All cable is stapled to studs and centered to avoid damage by future nailing into the stud.

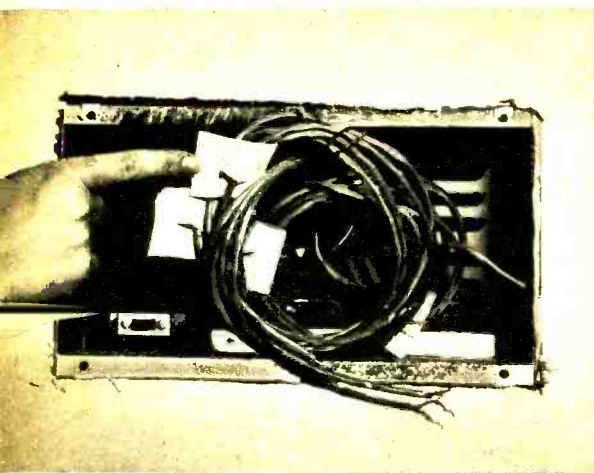

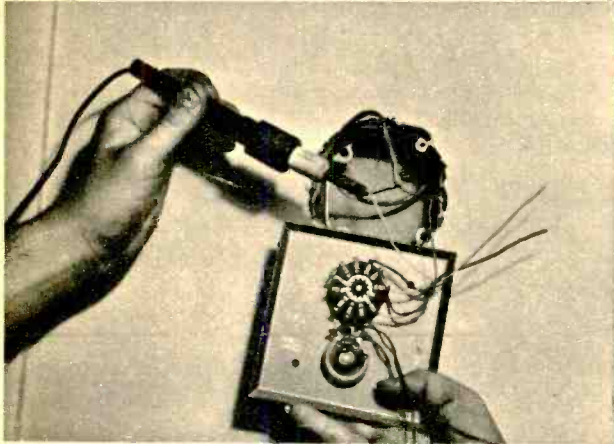
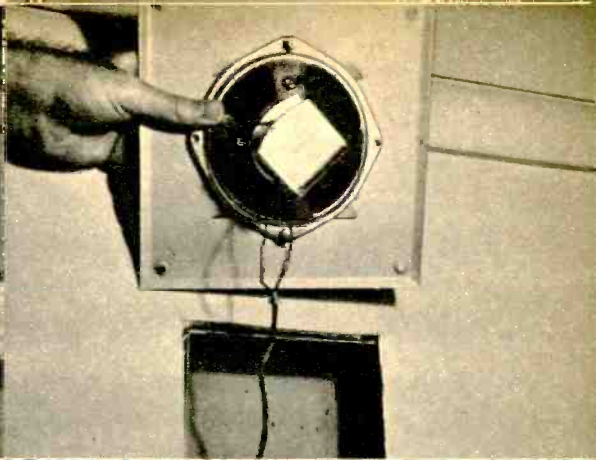
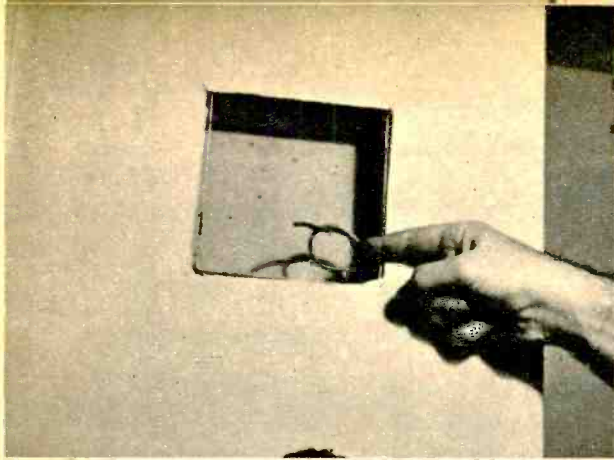

Hole is cut in wall board to reveal speaker box and its connecting cable from switch.

Speaker is bolted to grille, wires soldered. Slack wire will permit removal for servicing.

Control panel wires are soldered to the cable that leads to the master unit and the speaker.

The completed remote assembly for one room. Volume control at right is for music level.

A remote speaker is located under the porch roof where it is protected from the weather. It enables conversation with callers without opening the door.

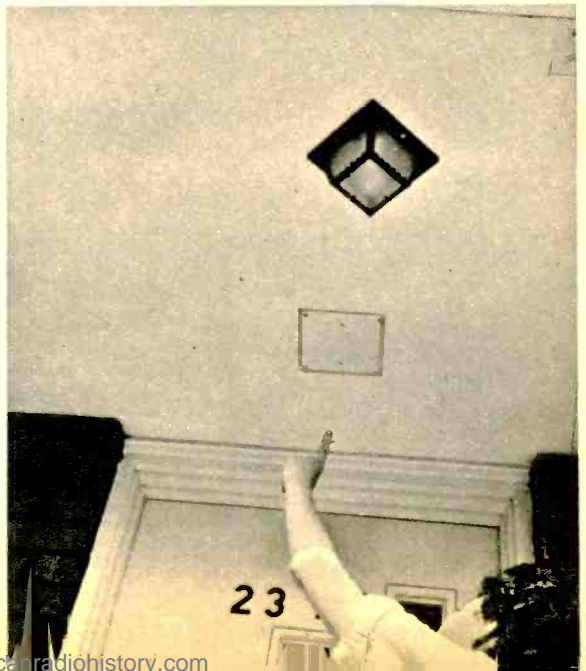

EI checks new tape equipment to Make Sound Movies at Home

By Art Zuckerman

You can lick synchronization, background noise and audio mixing problems with ingenious new equipment

SYNCHRONIZATION, the old bugaboo of the amateur sound movie maker, is finally on its way out, thanks to the inventiveness of audio and photographic equipment manufacturers. You can now buy projection equipment that synchronizes precisely with your tape recorder, or you can record your sound track directly onto an oxide stripe coated on your movie film, just as many professionals do.

If you're good at matching lip movements, you can even "lip sync" dialogue or singing, and one camera and attachment actually permits you to make a film-synchronized tape recording *while* you're filming the scene!

Audio mixing devices simplify the job of blending musical background with narration. Still easier, two German tape recorders and one American sound-on-film device permit you to record your music, then start from [Continued on page 93]

more photos on next two pages



Eumig P-8 8-mm projector (about \$130) has built-in, self-regulating electro-mechanical sync that links film transport to tape transport. Sliding switch with roller is held in off position by tape tension. As tape begins to feed from recorder, tension is relaxed and switch drops down. The lower the switch falls, the higher the projector speed. Lip synchronization is also possible.



Bauer coupler model S (about \$175), attached to tape recorder, can be plugged into special Bauer camera to obtain lip synchronization at time of shooting. It may also be used for synchronizing movie projector.

Cine-Sone adapter (about \$130) converts silent 8- and 16-mm projectors to magnetic sound synchronized with 16 or 24 frames per second. Record-playback amplifier, remote speaker, phono input and directional mike are included. See text for list of labs that apply oxide stripe to film. Switch on head assembly overrides erase head to permit recording of narration over background music.

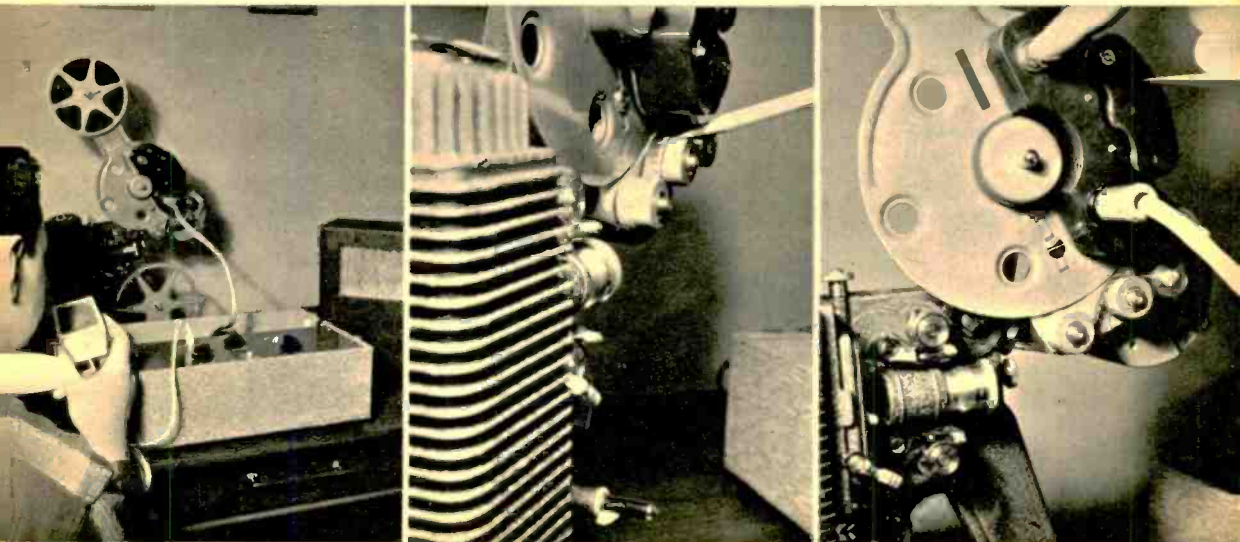



Saja recorder above (about \$130), uses 5" reels, has trick button for over-recording. This can be used for quick-spotting of narration and to blend several sound effects into one.



Directional cardioid mikes, upper left, such as Electro-Voice 951 (left) and Shure 737A (about \$30-\$40) allow recording during film screening without pickup of the projector noise.

Grundig TK-830 recorder, at left with Bauer coupler, mutes background music as voice is added, then returns music to full volume between voice inserts. Unit has hysteresis motor.

Sound Effects You Can Create

Sound effects, together with music and narration, add up to good amateur sound movies. For greater realism, couple sound effects. For instance, the rustling of leaves should be joined

by the chirping of birds. Here's how you can create some basic effects:

Steam Engine—Put mike in shoe box, tape vegetable grater to box and brush rhythmically with stiff brush.

Rain—Form trough with wax paper from top

Steam Engine

Rain

Fire

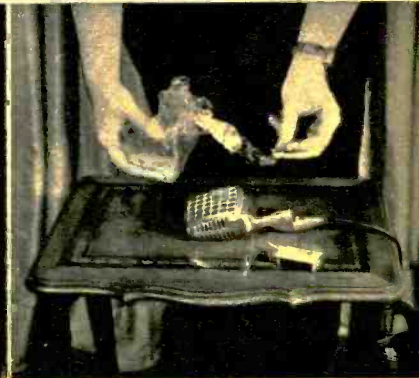
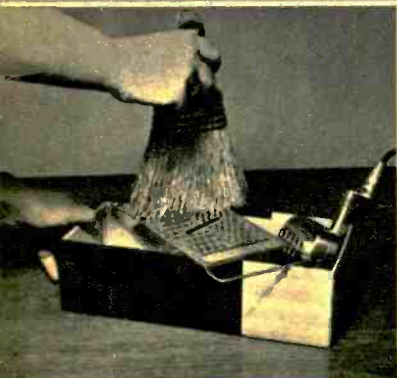

Right: Elite Eight projector by Tandberg (about \$400) has built-in magnetic record-playback amplifier and heads for use with sound-striped film. Provision is made for auxiliary speaker.



Professional quality sound movies are not difficult to make if you have the right equipment. Screening and narration, below, can be done in living room, but plan recording carefully.

Mixers, below right, permit blending of several mike or phono inputs. Larger Pentron electronic unit (about \$40) handles up to four inputs. The Switchcraft Mini-Mix (\$8) handles two.



of box to soup plate. Place mike under trough and pour sugar as shown.
Fire—Crumple cellophane, break matchsticks to simulate crackling.
Frying—Pour salt onto aluminum foil, or dip tip of hot soldering iron into plate of water.

Waves—Swirl rice in baking tin.
Thunder—Place BB shot inside balloon. Inflate balloon and shake.
Walking in Rain—Press both hands alternately against wet newspaper in sink. Have mike, wrapped in handkerchief, held close.

Frying

Waves and Water



Walking in Snow—Fill handkerchief with cornstarch and knead with both hands in walking rhythm.

Walking in Woods—Simulate leaves by crumpling paper towel—ing 6 inches from mike; twigs by snapping matchsticks.

Diving into Water—Invert full jar in tub or bucket. Hold mike just above and to one side of jar. Pull jar sharply out of water.

Steamboat Whistle—Blow across mouth of partially-filled jug. The higher the jug's water level, the higher the whistle pitch.

This photo-diagram of new combination television camera and periscope shows how doctor's apparent eye-level is the same as that of the camera's lens. System is big boon to medical schools.

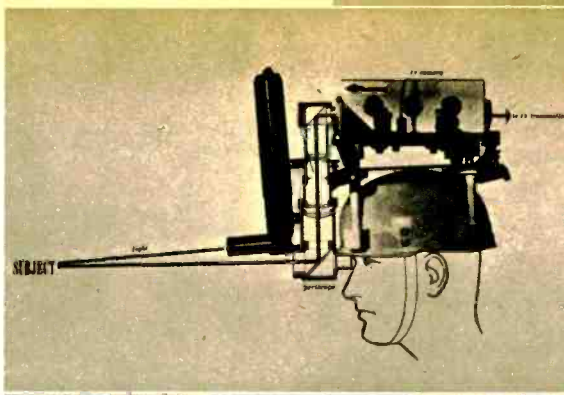

While physician proceeds with his examination of the tympanic membrane of patient, left, cluster of student doctors gathers around television set. They get magnified view.



TV Top Hat for the Doctor

CLINICS, operating rooms and medical schools have overcome the knotty problem of trying to let more than one person at a time peer into small, critical organs such as the ear, nose, throat and other body cavities while the areas are being treated or operated upon. Now a small, closed-circuit television camera and a special periscopic optical system allows the examining doctor and a room full of student doctors to view the exact same image while the patient is being treated.

The main units are a lightweight vidicon tube and a periscopic system with front-surfaced mirror, peep-sight, lens and prism. The heavy helmet is counterpoised. A small but bright light may be attached to the periscope and directed at the critical area. Developed by Drs. Paul Moore and Hans von Leden of Chicago, this unique camera is possibly the forerunner of a similar unit capable of transmitting color images.

Delicate nose operation is followed simultaneously by the surgeon, TV camera and observers at stand-around television set.



Photos courtesy Gould Foundation and Northwestern U. Medical School

Henry and Me

El will pay \$10 for each practical electronic idea used for Henry and Me. Send them to Electronics Illustrated, 67 W. 44th St., NY 36, NY.

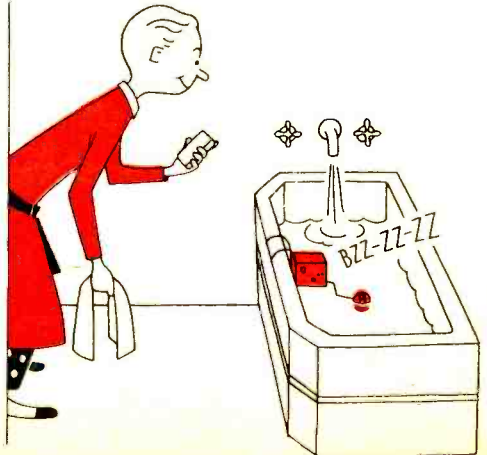
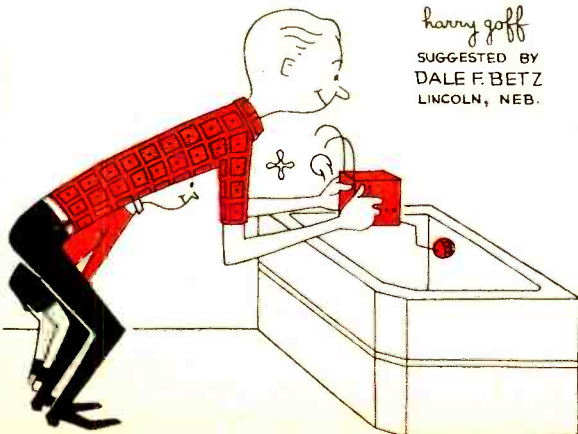
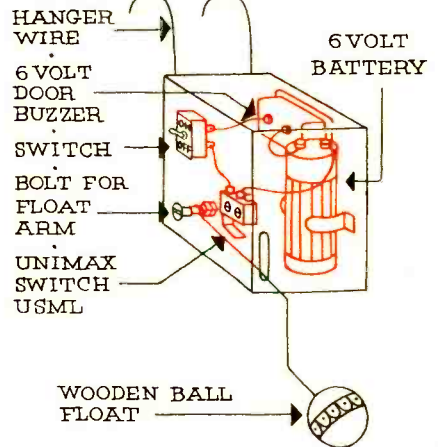
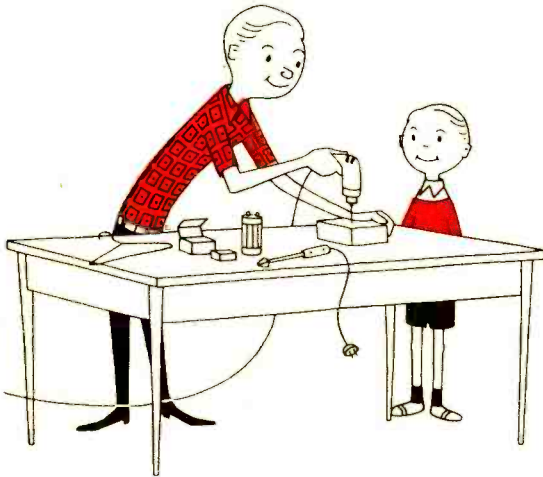
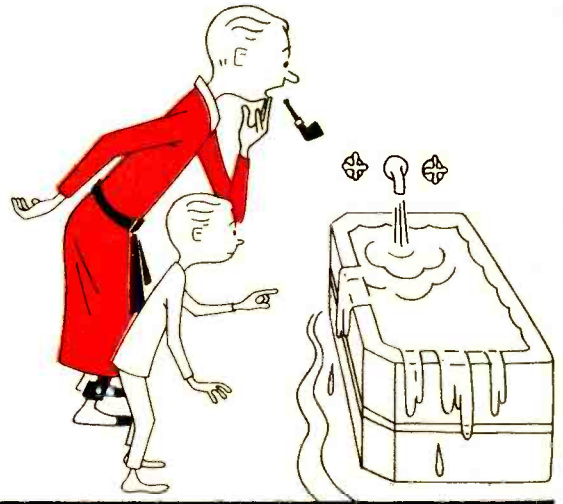

Metal Locator

Continued from page 35

necessary just as long as everything is rigidly mounted and well shielded.

If you decide to follow the model exactly, start by bending a sheet of scrap aluminum measuring 6"x5" into the shape of a chassis that fits into the metal housing. The two batteries that power the finished unit must be used as guides in the bending process because these are held securely in place between the sides of the case and the side aprons of the chassis. The chassis should come out to be close to 3 $\frac{3}{8}$ " wide, 3 $\frac{3}{4}$ " deep, with approximately 1 $\frac{1}{4}$ " aprons at the front and sides so that the batteries will fit snugly but without undue pressure on each side. The chassis is held to the front panel of the minibox by SW.

The tube sockets are punched along one side, equally spaced; on the other side, and to the rear is the shielded oscillator transformer T, leaving ample space to secure the 15 mmfd main tuning capacitor to the panel in front of it. It was found that a small, inexpensive vernier dial was extremely helpful in keeping the unit "on the beam" during use; this necessitated mounting the capacitor on a small metal plate separated from the panel by a $\frac{1}{2}$ " brass spacer rather than directly on the panel itself. The phone jack *must be insulated from the panel* by means of fibre or phenolic "shoulder" washers and may be placed near the tuning capacitor as shown in the photographs. If you wish to avoid the annoyance of the battery voltage appearing on the front panel simply cut a circle of tape and press it on the exposed metal portion of the jack. Position the 100 mmfd variable capacitor (C1) as far from C4 as possible to minimize any possible interaction.

In working the layout, bear in mind the need for *rigidity* and *shielding* at all times. It is particularly important to keep all components that belong in the tuned circuit of the search oscillator (V1 — 1T4) well shielded from the tuned circuit parts of the reference oscillator (V2 — 1R5). Unless this is carefully observed, there may be a ten-

dency for the oscillators to lock in with each other over a large tuning range. A certain amount of lock-in is normal, and even helpful, but if it is excessive, the sensitivity of the instrument will be destroyed. Secure all parts to terminal strips or unused socket lugs, otherwise there will be vibration that will tend to cause instability of tone. During use, the instrument is adjusted so that the two oscillators heterodyne each other to produce an audible tone; in the proximity of metal, the search oscillator shifts frequency with an attendant change in pitch of headphone signal.

It is strongly urged that you build the small search coil first because its construction is far simpler than the large "hula hoop" coil and because you can familiarize yourself with the performance of the whole system more readily.

The wire used on both coils is No. 24 Formvar coated copper. This is not a "must," however. You can wind the coils with ordinary enamel-covered or double-cotton covered wire just as well; also, any gauge wire from No. 20 up through No. 28 will do just as well.

Wind five turns of wire, then bring a center-tap out to a solder lug screwed to the vertical member of the wood frame. Be sure to clean the insulation off well. Then proceed to wind the second five turns to complete the coil. Connection to the electronic unit is made through a pair of shielded leads bonded together as illustrated in the diagram. A three-prong plug completes the assembly after the two shields have been well bonded together by soldering at each end. At this point, it is a good idea to test the coil with a good low range ohmmeter if you have one. The total coil resistance should be close to 0.5 ohm while each half to the center-tap should read about 0.25 ohm. At the same time, make certain that neither end of the coil is grounded out to the shield. Wrap some vinyl tape around the connecting cable and the small coil is complete.

Two studs consisting of 2" machine screws are fastened to the right side of the metal case, about 4" apart. Two matching holes are drilled in the vertical member of the small search coil so that the assembly may be secured to the case

with wing nuts. When everything is in place, but before connecting the batteries, check to be sure that you have no short circuits in the power leads that might ruin the batteries in short order. Connect the batteries; adjust the main tuning control to midscale on the vernier dial, then adjust the search oscillator capacitor (C1) until you hear a very loud beat note. While doing this, you will hear other, unstable signals; ignore these and find one that is really *loud*. It is best to use a nonmetallic tool.

Now adjust the main tuning control for a low pitched beat note and bring a metal object about the size of a half-dollar coin near the coil. The pitch of the note will either rise or fall, depending upon which side of zero beat you have the tuner set. Try walking around the room approaching other metallic objects and note the range of response. For example, you should be able to spot a 4" electrical junction box at a distance of 10 inches or better and a 9" pie tin at about 1½ feet. If the beat note warbles or is otherwise unstable, check for vibrating wires or components. The metal detector will tend to drift for about 3 minutes, then stabilize.

There are two equally satisfactory ways to use the detector: (1) by adjusting the tuning control so that an approach to metal results in a lowering

of the pitch and (2) by adjusting so that metal causes a rise in pitch. In both cases, however, it is important to keep the initial tone as low-pitched as possible without the oscillators locking in. Never attempt to use the instrument by starting in the locked-in condition.

A hula hoop is used to construct the large search coil. The hoop is held together by a cylinder of wood or nylon stapled in at the butt joint. Remove the staples and the cylinder. In most cases, you will find the cylinder drilled axially with a 3/8" hole, but if it is not, you will have to drill it out yourself. The hoop coil contains 4 turns, center tapped as before. The first turn is made with the drilled cylinder removed, but the succeeding turns all pass through the hole with the cylinder inserted in one end of the butt joint. Number 24 wire is easily fed through the hoop by pushing it around, much as you would snake a wire through a pipe. The center tap and both ends of the coil are held firmly to the hoop by connecting to machine screws previously inserted.

The connecting cable is much longer this time and calls for extreme care in making up. Two single conductor shielded wires are used in the same fashion as before but the bonding of shields and the connection to the hollow mast must be exceptionally good to prevent "ground noises."

The mast should be cut to a length that suits you. As you walk along with the handle in your grasp, the hoop should be about 4" from the ground.

As an experiment, the author tried the locator outdoors without any shielding on the hoop at all. Although metal could be spotted without too much trouble, there was some instability of the beat note due to variations in capacitance between the loop and the ground. An open loop shield made of aluminum foil (kitchen wrap) and vinyl tape (see diagram) did a good job in minimizing this capacitance but also had the adverse effect of reducing the sensitivity. If you do shield the hoop, it is necessary to be certain that you have no closed loops in which absorptive eddy currents can flow. A closed shield does not permit much radiation to occur.

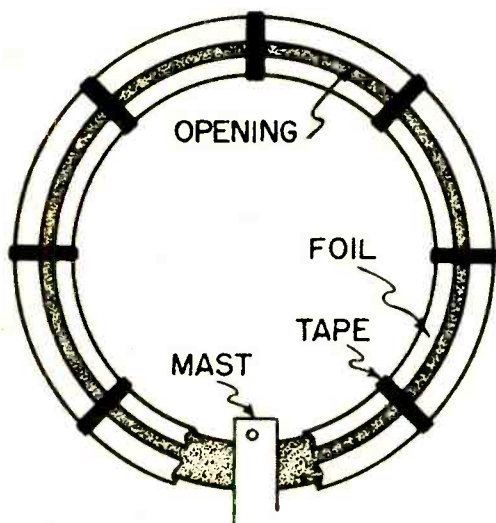

Optional foil shield on large coil reduces capacitance effects, as described in text.

Fight Against Hayfever

Continued from page 58

particles that may cause allergy, such as pollen, mold spores, dust, etc., can be barred from a room by an electrostatic precipitator in the window. The pollen particles, etc., enter a chamber in which there is an electrostatic field intense enough to break down air into free ions. The *positively* charged ions attach themselves to the allergy-causing particles by impaction. These charged particles are then drawn into a second, less intense electrostatic field where they are attracted out of the air stream by *negative* electrodes.

The principle of electromagnetism which functions in the precipitator is also used in the search for biochemical compounds that are responsible for the allergy-causing properties of pollens and other substances. A solution containing fragmented ragweed pollen, for example, is allowed to flow down a bit of blotter-like paper. At each side of this is a charged metal bar—positive current on one side, negative on the other. Different parts of the ragweed pollen in solution have varying attractions to these electrodes, either toward the positive or toward the negative. Thus, at the bottom of the flow, entirely different components are collected in test tubes. These are injected into animals to observe which fraction stimulates allergy, and to select the very essence of the pollen's allergy-causing chemicals. Purified allergens are thus obtained.



"Microaire" electrostatic precipitator pulls pollen out of air to relief of asthma sufferer.

In the research to find out how allergy may persist in the body, scientists at the California Institute of Technology injected rabbits with radioactive-sulfur tagged particles comparable to the pollen bits that cause allergy in humans. The investigators then used sensitive radiation counters to detect the by-products of the resulting reaction. They found that trouble-causing materials formed with the injected radioactive substance still remained in the rabbit's livers 500 days after the injection. The scientists believe that some method soon may be developed to flush out such "hibernating" reactors.

Isotopes are helping track ragweed pollen flight in the fight on hayfever. At Brookhaven National Laboratory, Long Island, New York, radioactive ragweed plants are being cultivated. The scientists jab a hypodermic needle into the stem of the plant, feeding it radioactive phosphorus that will eventually be incorporated into the plant pollen.

The flight patterns of "hot" pollen trapped at various distances and heights and detected with geiger counters are compared with meteorological data. The information provides a scientific basis for researchers and health officials to warn allergy sufferers.

As a result of all this research, perhaps the time will come when every hayfever and allergy victim will be able to carry with him a miniaturized electronic device that will set up an invisible protective shield around him to knock out his allergy-causing enemy. ●

Cracking Short-Wave's Taboo

Continued from page 62

is a special danger to mariners, such as a hurricane, a notice will be broadcast every hour or two. Obviously, if you log one of these, you're home free.

However you certainly can't count on being this lucky. Especially with the tougher stations which will be heard only for a few minutes. You will have to know what information to note from regular telephone transmissions. This information **MUST** be nonconfidential. To repeat confidential communications,

such as parts of the conversations, is unethical and furthermore, it's illegal.

So what's left to authenticate your reception? Most stations will permit you to name the vessel called or contacted. But if you want to be absolutely sure of not stepping on anybody's toes, describe the busy signal. This is a series of beeps sent by the station during the vessel's portion of the conversation. Count the number of beeps per minute. State whether it was high or low pitched. Should the station lack a busy signal, of course mention that fact.

There are other items which will help verify your report. Sex of operator, use of call letters (some stations identify only by location), and exact time the transmitter was turned on or off.

DX reports are frequently almost as valuable to a marine telephone facility as they are to a short-wave broadcaster.

Here is the reply from one PT&T station: "We are quite surprised to discover how well it is getting into Eastern Canada. . . . Incidentally, it also helps to explain some of our problems of interference from other stations during October, November and December."

The manner in which they verify, prepared card or individual letter, depends largely upon you. Nearly every station will verify via a postal card prepared by the DXer, signed and mailed back by the station. There are a number of ways to make these attractive. A toy printing set can do wonders. Or use your own typewriter and the method described in the book *Fun with Your Typewriter* by Madge Roemer. A prepared card should of course be self-addressed and affixed with sufficient postage. Uncancelled foreign stamps can be obtained at most stamp dealers.

If you prefer an individual letter, or live in an area not served by a stamp dealer, you should not use a report form or an SWL card, but write an individual letter yourself. Make it as interesting as possible by including all *pertinent* facts. List your equipment and, if possible, identify any source of interference. And if you can't obtain foreign stamps, always enclose return postage via International Reply Coupons on sale at your post office.

If you follow these methods, you'll not only add to your collection of countries and stations, but your hobby will become a real aid to long distance radio communications.

Most marine telephone stations outside the U. S., American possessions and Canada, are operated by government telecommunications departments. When the specific address is unknown, the following often gets your letter to the correct place:

Officer in Charge

Marine Radiotelephone Station (call letters)

Telecommunications Department

Government of (name of country)

(city) (country)

How To Use Meters

Continued from page 51

0-300 markings first, we see that the following values are indicated: 0, 50, 100, 150, 200, 250, and 300. Each number is positioned underneath a major line. There are, however, other major lines midway between each set of indicated figures. These unmarked major lines possess a value midway between the indicated values on either side of it.

As further proof of this, count the number of minor lines between each unmarked major marker and the figure above and below it. In all cases, there are four such minor lines. This, coupled with the fact that the scale appears to be linear, verifies that the mid major lines are indeed halfway between each successive set of numbers. Thus, mentally, we can insert the following values: 25, 75, 125, 175, 225, and 275 for the mid major lines.

Furthermore, since there are four minor lines between successive major lines, each major interval is divided by five. In other words, each minor line has a value of 25/5 or five more than the line just to the left of it. If the meter needle stops three minor lines above 150, the meter reading will be: 150 + 3 (5) or 165.

On the 0-60 scale, each minor division has a value of 1. This can be computed, using the procedure just given. It can be verified by noting that every line

(minor and major) on the 0-60 scale has one-fifth the value of every line on the 0-300 scale.

On the 0-12 scale, every minor line possesses a value of 0.2. Another way of looking at this is to note that the difference between two successive indicated figures (like 10 and 12) is 2 and there are 10 spaces between them. Two divided by 10 equals .2.

On the 0-3 scale near the bottom of the meter dial, we not only find major and minor divisions, but even smaller markings between the minor lines. These are sub-divisions and they should cause no more trouble than the preceding scales. RULE: Start with the major divisions (which are marked), then proceed to the minor divisions and, finally, to the smaller subdivisions.

On the Ohms scale, we encounter a non-linear set of markings. In addition, the scale is numbered from right to left. This direction will be found to be peculiar to VOM's. On VTVM's, the Ohm's scale figures increase from left to right. (The difference stems from the way in which the circuit is hooked up.) On such nonlinear scales, several things should be noted. First, the physical distance between major lines is not uniform.

Second, the difference between consecutive numbers changes. In Fig. 5, from the extreme right-hand side of the Ohms scale to the center, the difference between successive numbers is 1. This then changes rapidly, first to 5 (10 minus five), then to 10 (20 minus 10), then to 30, then to 150 (200 minus 50) and, at the extreme left-hand edge, to 800 (1,000 minus 200). This variation means that any minor markings found along the scale will likewise change in value and here is where the user must be most careful. However, in spite of all this variation, the method of determining the value of each minor and unmarked major marking still follows the procedure outlined above.

At the right-hand side of the Ohms scale in Fig. 5, between 0 and 1, there is a central major line which would possess a value of 0.5. Each minor line then can be seen to have a value of .1 higher than the line to the right of it.

This sequence is followed up to 4. Between 4 and 5 there are only four minor lines, each with a value of .2 higher than the line to its right.

Between 5 and 10, there are four minor lines and, between each of these, a subdivision line. The minor lines each have a value of 1 while the subdivision lines have a value of half this, or 0.5.

The interval between 10 and 20 is fairly straightforward, but between 20 and 50 the spacing changes within the interval. Here the values rise quite rapidly. The two minor lines here each have a value of 10 in order to maintain the proper scale sequence. Thus, the first minor line after 20 is 30 while the second minor line is 40. Between these minor lines are subdivisions and since there is only one such sub line between 20 and 30, its value must be 25. By the same token, the one between 30 and 40 has a value of 35, while the next sub line is 45.

Between 50 and 200 there are two minor lines and all we can assume these to be are 100 and 150. In other words, we must assume that they carry the same values within this interval. This is the only logical approach. As a matter of fact, whenever a reading occurs at the high, crowded end of the scale, it is desirable to switch to a higher scale (say from $R \times 1$ to $R \times 10$) in order to have the needle move down to the less crowded end.

One scale is employed usually for resistance measurements. Different values of resistance are then accommodated by shifting the RANGE switch to an appropriate range, such as $R \times 1$, $R \times 10$, $R \times 100$, $R \times 1$ meg, etc. Whatever value is then read on the scale is multiplied by the appropriate factor.

To conserve space, especially at the crowded end of the scale where large numbers are found, 1,000 (and higher values in the thousands) is shortened by the use of the letters K or M. Thus, most manufacturers prefer K, writing 1,000 as 1K, 10,000 as 10K, etc. A few manufacturers use M for this purpose. Finally, the infinity symbol, ∞ , is frequently placed at the very end of the scale to signify an open resistor (i.e., which possesses infinite resistance).

Build-It Course — 1

Continued from page 43

primary winding of the power transformer and produces a fluctuating magnetic field. This field, conducted by the transformer's iron core, "cuts" the various secondary windings. Where a secondary has more turns of wire than the primary, a higher voltage results at the output—where less turns are encountered, the voltage is lowered. The three secondaries on the transformer used in this case provide 5, 6.3 and 260 volts AC. The designer selected the "turns ratio" of the transformer to produce these specific voltages. The 5 volts heats the rectifier and the 6.3 volts heats the other tubes. It soon becomes apparent why rectifier operates on own winding.

The rectifier tube changes AC to DC, the first step in supplying smooth, high voltage DC to the plates of the other tubes. This voltage is commonly called the B+. The rectifier plates receive the 260 volts AC from that transformer secondary winding with the most turns. As each plate successively becomes positive, electrons are attracted to it. The direction of the electron flow causes the rectifier filament to acquire a pulsating charge (see diagram) close to 260 volts DC.

The pulsations are smoothed out by the filter consisting of two capacitors and a choke coil. Electrons surge into the first capacitor on the first pulse. As the pulse subsides (before the next one comes along) the capacitor discharges some of its electrons. This partially fills in gap between pulses. Added smoothing effect is accomplished by the choke.

The pulsating electron flow in the choke's single winding sets up a magnetic field which opposes a change in flow. The net effect of the choke and capacitors therefore is to produce a steady DC flow at the output. The value here is 250 volts B+.

Across the output of the power supply is the bleeder resistor. The name is derived from its effect of "bleeding" off, or discharging the voltage stored on the filter capacitors after the supply is turned off. This can prevent a nasty

shock while the unit is being serviced. Important, too, is the bleeder's voltage regulating influence. It always draws a small amount of current that lessens the wide swing from maximum to minimum current that some circuits draw.

As a building block the power supply is of extreme utility to the experimenter. It will operate a wide variety of circuits with moderate voltage and current requirements.

Construction is straightforward. The 8-pin output sockets should be positioned as shown in the illustrations. They are mounted so future sections will plug together only in the correct way. Be sure to twist the filament leads of the transformer to reduce radiation of hum. This is common to wires carrying high alternating currents.

Use ground wires where shown; sometimes the chassis itself serves as a ground return, but not completely in this case. A ground "bus" is used extensively in chassis to create a low resistance path for various return currents.

Next month the basic audio amplifier will be described—in theory and practice.

Make Sound Movies At Home

Continued from page 85

scratch and superimpose the narration without erasing musical background.

For a final professional touch, an extension speaker for the tape recorder placed under the screen completes the illusion of theater viewing.

SOUND STRIPING LABS

ANSCO
2299 Baux Hall Rd.
Union, New Jersey

BAY STATE FILM LAB.
35 Springfield St.
Agawan, Massachusetts

THE CALVIN COMPANY
1105 Truman Road
Kansas City, Mo.

CAPITAL FILM LAB.
1905 Fairview Ave. N.E.
Washington, D. C.

COLOR REPRO. CO.
7936 Santa Monica Blvd.
Hollywood, California

CONSOLIDATED FILMS
Ft. Lee, New Jersey

SOJA FILM STRIPING CO.
P. O. Box 994
Pawtucket, Rhode Island

F. WATSON CO.
141 East 44th Street
New York, New York

BYRON PICTURE LABS
1226 Wisconsin Ave., N.W.
Washington, D. C.

W. COLBURN LAB.
164 W. Wacker Drive
Chicago 6, Illinois

STRIPING COMPANY
Box 1191, G.P.O.
New York 1, N. Y.

SOUND STRIPING CO.
1472 Broadway
New York 36, N. Y.

Meters

Continued from page 46

SPECIAL
METERS



Knight

Argonne (Lafayette)



Heath



Aerovox



Century

Top: Capacitor checker, VU meter, wattmeter. Bottom: Coil/capacitor checker, capacitor tester.

Of the many types of indicators used today, one of the simplest to use and least costly is the combination meter that reads volts, resistance (ohms), and current (amperes and milliamperes). It is known as the VOM; the initials stand for "volt-ohm-milliammeter." These devices also are known by some catchy trade-names, depending on their manufacture.

The sensitivity of a VOM is stated as so many ohms-per-volt—a key to the amount of current needed to deflect the needle. There are several different degrees of sensitivity, the two most common being 1,000 ohms-per-volt and 20,000 ohms-per-volt. The former is usually a compact, rugged device and measures AC or DC voltages, direct currents, and resistances.

The more sensitive 20,000 ohms-per-volt type provides more detailed information over wider ranges and may be considered a full-fledged professional

tester. Neither requires external power.

Similar, yet different in some important applications, is the vacuum-tube-voltmeter or VTVM. This meter uses one or more tubes and must be plugged into an AC line. The big advantage of the VTVM over the VOM is its relatively high and constant input impedance, which means greater accuracy in measuring high impedance circuits, such as the resistance-coupled stages of a hi-fi amplifier, or the automatic volume control (AVC) networks in receivers, or the oscillator grid circuits in transmitters.

In addition to the basic VTVM there are some fancier refinements. A "peak-to-peak" VTVM, for example, does all that a plain VTVM does, plus a few tricks that are especially useful in TV work. "Peak-to-peak" means that the VTVM can measure the difference in amplitude between the positive and

negative peaks of complex AC waveforms. Then there is the "audio VTVM" which is ideal for measuring low voltages over a wide frequency range. It also indicates decibels more clearly than the other VTVM's, which also do the job, but require some extra meter-reading-translation effort on the user's part.

Obviously, these meters overlap somewhat in function, and they all are multi-purpose devices. Which one or two types to get depends on your particular interest or need. You might want a meter to do only one more or less permanent job, like getting a DC reading in the plate circuits of the output stages of a high-powered amplifier. A simple DC ammeter (of suitable range) could be wired right into the set for this purpose. Another specialized meter would be a wattmeter for getting direct power readings, important if you're operating a transmitter. You can, of course, use a VOM or VTVM to do this, but you'd have to translate what the meter says into wattage by some simple math.

Once confined to the laboratory, the oscilloscope is now gaining wide acceptance among home experimenters. The scope gives a graphic picture of dynamic circuit conditions. The main difference between a meter and a scope is that the oscilloscope presents a point-by-point display of a signal rather than one fleeting instant of that signal. If a meter reading is like a still photo, a scope display is like a moving picture.

A big advantage of a scope is that it can enlarge desired portions of a signal for close-up study. Of course, knowing what to look for enables you to analyze the signal and pin-point what's wrong.

There are a few different types of scopes. Generally, a scope designed for wide-band color TV also makes an excellent "all purpose" scope since its range and sensitivity will be wide and high enough for most tasks. The very best type of scope is the "DC coupled" variety which permits observation of DC up to high frequencies.

Closely associated with scopes and meters is a group of accessories known as probes. A probe is a pencil-like device, one end of which makes contact with whatever is to be measured. The

other end connects to the meter or scope. The probe contains tiny circuit elements housed inside its insulated handle. These circuit elements extend the versatility of the meter or scope being used, preparing it to receive signals which it otherwise would not be able to handle. Thus, a high voltage probe for a VTVM permits measurements as high as 50 kv.

Again, an RF probe enables you to use a VTVM for high frequency measurements that otherwise would require a highly specialized instrument. This probe houses a small diode detector which feeds a signal to the meter that enables the meter scale to furnish a usable reading. If you're planning to do any receiver alignment, you'll find the RF probe quite handy.

The VOM and VTVM are resistance indicators and are used, of course, for checking resistors. They also can be used for an approximate test of capacitors, but not always accurately and never in terms of the actual value of capacitance. When dealing with electrolytics, which change in value over time, precise information regarding value can be important, so there are capacitor testers on the market. Some units also indicate leakage. They are not very costly, and the serious hobbyist will find them quite handy.

Tube testers are in a special class. There are many devices that are called by this name. Small, inexpensive units test only the continuity of the tube filaments. A VOM or VTVM can do the same job. But open filaments are not the only thing that can go wrong with tubes. There may be shorts, leakage and, of course, faulty emission. For these tests, the full-size professional tube tester is needed. The most inexpensive of these is the "cathode emission" type which tests each tube as if it were a diode, uses low voltage and measures the emission of the cathode. A more accurate instrument is the "dynamic conductance" type which sets up more normal operating voltages for each tube element. This type generally features finer adjustments and a more sensitive meter. Newer models also test transistors.

SHIPPED ON APPROVAL

IN-CIRCUIT CONDENSER TESTER

Model CT-1

AN ABSOLUTE 'MUST' FOR EVERY SERVICEMAN!

Here is an in-circuit condenser tester that does the whole job. The CT-1 actually steps in and takes over where all other in-circuit condenser testers fail. The ingenious application of a dual bridge principle gives the CT-1 a tremendous range of operation. . . .



Model CT-1 housed in sturdy hammer-tone finish steel case complete with test leads
\$34.50 Net
 SIZE: W-6" H-7" D-3 1/4"

in-circuit checks:

- ✓ Quality of over 80% of all condensers even with circuit shunt resistance present. . . (leakage, shorts, opens, intermittents)
- ✓ Value of all condensers from 200 mmfd. to .5 mfd.
- ✓ Quality of all electrolytic condensers (the ability to hold a charge)
- ✓ Transformer, socket and wiring leakage capacity

out-of-circuit checks:

- ✓ Quality of 100% of all condensers . . . (leakage, shorts, opens and intermittents)
- ✓ Value of all condensers from 50 mmfd. to .5 mfd.
- ✓ Quality of all electrolytic condensers (the ability to hold a charge)
- ✓ High resistance leakage up to 300 megohms
- ✓ New or unknown condensers . . . transformer, socket, component and wiring leakage capacity

SPECIFICATIONS

- Ultra-sensitive 2 tube drift-free circuitry • Multi-color direct scale precision readings for both quality and value . . . (in-circuit or out of circuit) • Simultaneous readings of circuit capacity and circuit resistance • Built-in hi-leakage indicator sensitive to over 300 megohms • Cannot damage circuit components • Electronic eye megohms • Balance indicator for even greater accuracy • Isolated power line

IN-CIRCUIT RECTIFIER TESTER

Model SRT-1

Checks all power rectifiers in-circuit whether SELENIUM, GERMANIUM, SILICON, etc.

With the growing trend towards compactness, portability and low price, TV manufacturers are resorting more and more to producing series-string TV sets employing selenium, germanium or silicon power rectifiers. Now the need for an in-circuit rectifier tester is greater than ever.

THE SRT-1 CHECKS ALL POWER RECTIFIERS IN-CIRCUIT AND OUT-OF-CIRCUIT WITH 100% EFFECTIVE-NESS FOR:

- ✓ Quality ✓ Fading ✓ Shorts ✓ Opens
- ✓ Arcing ✓ Life Expectancy

SIZE: W-6" H-7" D-3 1/4"



Model SRT-1—housed in sturdy hammer-tone finish steel case complete with test leads
\$29.50 Net

SPECIFICATIONS

- Checks all types of power rectifiers rated from 10 ma. to 500 ma. (selenium, germanium, silicon, etc.) both in-circuit or out-of-circuit.
- Will not blow fuses even when connected to a dead short.
- Large 3" highly accurate multi-color meter . . . sensitive yet rugged.
- Separate meter scales for in-circuit and out-of-circuit tests.
- Cannot damage or over heat rectifier being tested.

SIMPLE TO OPERATE

Just clip SRT-1 test leads across rectifier under test right in the circuit without disconnecting rectifier from circuit. Press test switch and get an instant indication on the easy-to-read three-color meter scales. . . .

MINI-CHECK TUBE TESTER

Model MC-1

A Real ECONOMY MULTIPLE SOCKET TUBE TESTER without sacrifice in ACCURACY, SPEED or VERSATILITY

Here is a multiple socket tube tester designed to meet limited budgets. Although low in price it boasts a unique circuitry that enables you to check over 600 tube types — and has a range of operation that far exceeds others in its price class.



Model MC-1 — housed in sturdy wrinkle finish steel case
\$39.50 Net
 SIZE: W-9" H-8 1/2" D-2 1/4"

SPECIFICATIONS

- Checks emission, inter-element shorts and leakage of over 600 tube types. This covers 024s, series-string TV tubes, gas regulators, auto 12 plate volt, hi-fi and foreign tubes • 3 settings enable a test of any tube in less than 10 seconds • Employs dynamic cathode emission test principles • 3 1/2" D'Arsonval tube meter — most accurate type available . . . its greater sensitivity means more accuracy . . . its jewel bearing means longer life • 17 long lasting phosphor bronze tube sockets • Combination gas and short jewel compartment • 9 filament positions • Handy tube chart contained in special back compartment • New tube listings furnished periodically at no cost • Detachable line cord

plus these BONUS FEATURES . . . found in no other low price tube tester

- ✓ Checks for cathode to heater shorts ✓ Checks for gas content
- ✓ Checks all sections of multiple purpose tubes . . . will pickup tubes with one "Bad" section ✓ Line isolated — no shock hazard ✓ Variable load control enables you to get accurate results on all tubes
- ✓ Positively cannot become obsolete as new tubes are introduced.

TRANSISTOR TESTER

Model TT-2

AN INEXPENSIVE QUALITY INSTRUMENT DESIGNED FOR ACCURATE AND DEPENDABLE TESTS OF ALL TRANSISTORS AND DIODES QUICKLY AND ACCURATELY

Every day more and more manufacturers are using transistors in home portable and car radios . . . in hearing aids, intercoms, amplifiers, industrial devices, etc. Since transistors can develop excessive leakage, poor gain, shorts or opens, the need for TRANSISTOR TESTER is great.



Model TT-2 — housed in sturdy hammer-tone finish steel case complete with test leads
\$24.50 Net

SPECIFICATIONS

- Checks all transistors, including car radio, power output, triode, tetrode and unijunction types for cutoff current • Checks all diodes for forward to reverse current gain • All tests can be made even if manufacturer's rated gain is not available. Less than half a minute required for yet rugged . . . with multi-color scales designed for quick easy readings so small, Service life almost equal to shelf life. Battery cannot be drained due to accidental shorting of test leads • Cannot burn-out its own meter or clips enable tests without entirely removing transistor from circuit • Test terminal is secured by E.I.A. color code so that connection to the correct chart that fits into a special rear compartment.

IMPORTANT FEATURE: The TT-2 cannot become obsolete as you to check all new type transistors as they are introduced. New listings will be furnished periodically at no cost.

EASY TO BUY IF SATISFIED see order form on facing page

INSTRUMENTS ARE ALL GUARANTEED FOR ONE FULL YEAR

All CENTURY instruments are so brilliantly engineered and so durably constructed of top quality components that all carry an ironclad guarantee against defective parts and workmanship for one full year.

CENTURY

www.americanradiohistory.com

FOR 10 DAY FREE TRIAL

Convince yourself at no risk that CENTURY instruments are indispensable in your every day work. Send for instruments of your choice without obligation... try them for 10 days before your buy... only then, when satisfied pay in easy-to-buy monthly installments — without any financing or carrying charges added.

NEW Battery Operated **VACUUM TUBE VOLT METER** Model VT-1
Peak-to-Peak WITH LARGE EASY-TO-READ 6" METER —

featuring the sensational new **MULTI-PROBE** * Patent Pending

No extra probes to buy! The versatile MULTI-PROBE does the work of 4 probes

- ① DC Probe ② AC-Ohms Probe ③ Lo-Cap Probe ④ RF Probe

The VT-1 is a tremendous achievement in test equipment. With its unique MULTI-PROBE it will do all the jobs a V.T.V.M. should do without the expense of buying additional probes. No longer do you have to cart around a maze of entangled cables, lose time alternating cables or hunting for a misplaced probe. With just a twist of the MULTI-PROBE tip you can set it to do any one of many time-saving jobs. A special holder on side of case keeps MULTI-PROBE firmly in place ready for use.

FUNCTIONS

DC VOLTMETER... Will measure D.C. down to 1.5 volts full scale with minimum circuit loading, and give accurate readings of scale divisions as low as .025 volts... Will measure low AGC and oscillator bias voltages from .1 volts or less up to 1500 volts with consistent laboratory accuracy on all ranges... Zero center provided for all balancing measurements such as discriminator, ratio detector alignment and hi-fi amplifier balancing.

AC VOLTMETER... True Peak-to-Peak measurements as low as 3 volts of any wave form including TV sync, deflection voltages, video pulses, distortion in hi-fi amplifiers, AGC and color TV gating pulses... Scale divisions are easily read down to .1 volts... Measures RMS at 1/20th the circuit loading of a V.O.M.... Unlike most other V.T.V.M.'s there is no loss in accuracy on the lowest AC range.

ELECTRONIC OHMETER... Measures from 0 to 1000 megohms... Scale divisions are easily read down to .2 ohms... Will measure resistance values from .2 ohms to one billion ohms... Will detect high resistance leakage in electrolytic and by-pass condensers.

RF AND LO-CAP MEASUREMENTS... With these extra VT-1 functions you can measure voltages in extremely high-impedance circuits such as sync and AGC pulses, drawing saw tooth voltages, color TV gating pulses, mixer output levels, I.F. stage-by-stage gain and detector inputs.

OUTSTANDING FEATURES

- Completely portable — self powered with long life batteries — permits use everywhere
- New advanced pentode amplifier circuit assures amazingly low battery drain
- Large 6" 100-microampere meter, many times more sensitive than meters used in most V.T.V.M.'s
- Laboratory accuracy performance — 2% of full scale on DC, 5% of full scale on AC
- Simplified multi-color easy-to-read 4-scale meter
- No heat operation assures rigid stability and accuracy
- Immune to power line fluctuations
- Amplifier rectifier circuit with frequency compensated attenuator — a feature found only in costly laboratory instruments
- Meter completely isolated — practically burn-out proof
- Hand-crafted circuitry eliminates the service headaches of printed circuitry
- 1% resistor used for permanent accuracy
- Separate RF ground return for low-loss RF measurement
- Micro-telephone type co-axial connector
- Matching color protects instrument face — snaps on and off instantly



SIZE: W-7 1/2" H-9" L-4 1/4"

Model VT-1 — fully wired and calibrated, housed in handsome hammer-tone finish steel case, complete with MULTI-PROBE, and thorough instruction manual covering all the applications in detail.

SPECIFICATIONS

- DC Volts — 0 to 1.5/6/30/150/300/600/1500 volts
- AC Volts (RMS and Peak-to-Peak) — 0 to 3/12/60/300/1200 volt
- Ohms — 0 to a billion ohms, 10 ohms center scale — Rx1/10, 100/1K/10K/100K/1M
- RF — Peak reading demodulator supplied for use on all DC ranges
- Zero Center — available on all DC volt ranges with zero at mid-scale
- Decibels — from -10 Db to +10/22/36/50/62 based on the 0db unit. 0db-1MW in 600 ohms
- Impedance — 11 megohms DC, 1 megohm AC, 10 megohms Lo-Cap
- Input Capacity — 130 mmfd. RMS, 250 mmfd. Peak-to-Peak, 25 mmfd. Lo-Cap

\$58.50 Net

CENTURY'S extremely low prices are made possible because you are buying direct from the manufacturer.

FAST-CHECK TUBE TESTER Model FC-2

Simply set two controls... insert tube... and press quality button to test any of over 700 tube types completely, accurately... IN JUST SECONDS!

Over 20,000 servicemen are now using the FAST-CHECK in their every day work and are cutting servicing time way down, eliminating unprofitable call-backs and increasing their dollar earnings by selling more tubes with very little effort. See for yourself at no risk why so many servicemen chose the FAST-CHECK above all other tube testers.

PICTURE TUBE TEST ADAPTER INCLUDED WITH FAST-CHECK

Enables you to check all picture tubes (including the new short-neck 110 degree type) for cathode emission, shorts and life expectancy... also to rejuvenate weak picture tubes.

RANGE OF OPERATION

- ✓ Checks quality of over 700 tubes types, employing the time proven dynamic cathode emission test. This covers more than 99% of all tubes in use today, including the newest series-string TV tubes, auto 2 plate-volt tubes, OZ4s, magic eye tubes, gas regulators, special purpose hi-fi tubes and even foreign tubes.
- ✓ Checks for inter-element shorts and leakage.
- ✓ Checks for gas content.
- ✓ Checks for life-expectancy.

SPECIFICATIONS

- No time consuming multiple switching... only two settings are required instead of banks of switches on conventional testers
- No annoying roll chart checking... tube chart listing over 700 tube types is located inside cover. New listings are added without costly roll chart replacement
- Checks each section of multi-section tubes and if only one section is defective the tube will read "Bad" on the meter scale
- 41 phosphor bronze beryllium tube sockets never need replacement
- Checks each section mounted on panel
- Large 1/2" D'Arsonval type meter is the most sensitive available, yet rugged — fully protected against accidental burn-out
- Special scale on meter for low current tubes
- Compensation for line voltage variation
- 12 filament positions
- Separate gas and short jewel indicators
- Line isolated — no shock hazards
- Long lasting etched aluminum panel

NOTE: The Fast-Check positively cannot become obsolete... circuitry is engineered to accommodate all future tube types as they come out. New tube listings are furnished periodically at no cost.



SIZE: W-14 1/2" H-11 1/4" D-4 3/4"

Model FC-2 — housed in hand-rubbed oak carrying case complete with CRT adapter

\$69.50 Net

CONVENIENT TIME PAYMENT PLAN — NO FINANCING CHARGES

CENTURY ELECTRONICS CO., INC.

CHECK INSTRUMENTS DESIRED

- Model CT-4 In-Circuit Condenser Tester \$34.50 \$9.50 within 10 days. Balance \$5 monthly for 5 months.
- Model MC-1 Mini-Check Tube Tester \$39.50 \$9.50 within 10 days. Balance \$6 monthly for 5 months.
- Model SRT-1 In-Circuit Rectifier Tester \$29.50 \$4.50 within 10 days. Balance \$5 monthly for 5 months.
- Model TT-2 Transistor Tester \$24.50 \$4.50 within 10 days. Balance \$5 monthly for 4 months.
- Model VT-1 Battery Vacuum Tube Volt Meter \$58.50 \$14.50 within 10 days. Balance \$11 monthly for 4 months.
- Model FC-2 Fast-Check Tube Tester \$69.50 \$14.50 within 10 days. Balance \$11 monthly for 5 months.

Prices Net F.O.B. Mineola, N. Y.

111 Roosevelt Avenue, Dept. 409, Mineola, New York

Please rush the instruments checked for a 10 day free trial. If satisfied I agree to pay the down payment within 10 days and the monthly installments as shown. If not completely satisfied I will return the instruments within 10 days and there is no further obligation. It is understood there will be NO INTEREST or FINANCING charges added.

Name _____ Please print clearly
 Address _____
 City _____ State _____

Prices for all instruments vary. Equipment in the same price range generally are about the same in quality and give about the same performance. The higher price tags usually denote instruments that perform more accurately, or can perform more tests, or do them faster.

In buying a meter, the most important question you might ask yourself is, "Will it do what I want it to do?" In other words, if you want to check out a hi-fi circuit, will it do the trick? Do you also want to use it on your ham gear? If you're a ham, you'll find it convenient to have a meter with milliamperes scales, but if you plan on setting up a part-time service shop, you'll probably hardly ever use current scales.

What frequencies will you want your meter to work with? Can the meter you have in mind be extended in use by accessories such as probes? What about physical size and weight? Are they important? If you plan to use the meter in the field, they will be important. Perhaps a battery operated meter would best suit your purpose.

Understand the meter *before* you buy it, and know the differences between meters. Price is often the deciding factor in a meter purchase, but if you have to make some concessions, be sure the ones you make do not limit the instrument's use for *you*.

Radio Loopstick

Continued from page 73

on and tune in a station at approximately the center of the dial. Slowly slide the core of the loopstick back and forth to find the position that produces maximum volume.

Without disturbing the loopstick tune in a station around 1400 kc on the dial. Using a small screw driver, preferably nonmetallic, adjust the trimmer capacitor on the RF section of the variable capacitor. Adjust for maximum volume.

It may be necessary to repeat the tuning steps to find the combination that will produce the best results.

A Metal Etcher

Continued from page 68

bind the coil tightly with masking tape.

Lay on more brown paper insulation and begin wrapping the 6-turn secondary. The secondary coil wire should be as heavy as the remaining core space will permit, but in no case smaller than called for in the table.

This completes the coil, and the core may be reassembled by restacking the laminations as they were removed. On the core shown, the laminations were modified with tin snips to gain more winding space. The original transformer carried two coils on one core. Clamp the core with the original bolts. One side of the outer shell is best left off to provide access to the coil leads.

The transformer is connected as shown in the wiring guide. Two double-throw, center-off switches control the heats. Label for identification. Tap No. 1 gives highest output, No. 4 lowest.

The transformer is housed in a wood case, cut to fit. Mount a steel or aluminum contact plate, about $\frac{1}{16}$ " thick, on top the box and connect the short end of the secondary to it. Make certain that this connection is adequate to carry the high amperage. For most marking jobs, the work is simply placed on the contact plate while writing with the pencil. A length of flexible lead equipped with a husky battery clamp will provide a ground for working on surfaces that can't be placed on top the cabinet.

The working tips of the pencil are made from brass machine screws and are easily replaced when they wear out. A high-voltage probe, available at radio supply stores, can be modified to serve.

The etcher marks by creating a tiny arc which melts the surface of the work. The etcher will mark on any metal, but a machined steel surface etches best. Hold the pencil firmly against the work and write by sliding the point. The result should be a continuous etched line. If the point arcs and tends to stick to the work, too much heat is being used. Try a lower setting. Rusty or coated metal must be cleaned with sandpaper to provide a good contact.

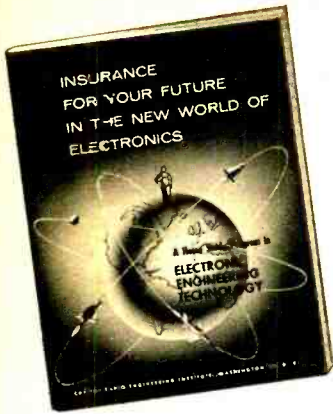

The data that Launched Thousands of Careers is yours *FREE*

Tells how you can be successful in **ELECTRONICS**

Send for your Free Copy today!

This a brand new 54-page edition of the book which has launched thousands of men on good-paying careers in electronics.

It brings you completely up to date—answers important questions on newest career developments in electronics, including Automation, Instrumentation, Industrial Electronics, Aeronautical Electronics, Guided Missiles, Radar, Servo-Mechanisms, Computers, Astronautics, Telemetering, Communications, Manufacturing.

Since its founding in 1927, CREI has provided thousands of professional electronics men with technical education. During World War II, CREI trained thousands for the Armed Services. Leading firms recommend CREI home study courses for their own personnel. Among them: All America Cables and Radio, Inc.; Canadian Broadcasting Corporation; Columbia Broadcasting System; Gates Radio Company; Federal Electric Corp.; The Martin Company; Douglas Aircraft Co.; U. S. Information Agency (Voice of America); Canadair Limited; Trans-Canada Air Lines; United Air Lines. Their choice of training for their own personnel is a good cue for your choice of a school.

You don't have to be a college graduate. You do have to be willing to study—at home. You can do it while holding down a full-time job. Thousands have. Since 1927 CREI has provided alert young men with the technical

knowledge that leads to more responsibility, more job security, more money. And CREI has constantly kept pace with the rapid expansion and progress in electronic achievement. Remember this: CREI starts with a review of the fundamentals and takes you along at your own speed. You are not held back by a class, not pushed to keep up with others. You set your own pace. CREI instructors guide you through the lesson material and grade your written work personally. You master the fundamentals, then get into more advanced phases of electronics engineering principles and practice.

Brand-New Course Added: Automation and Industrial Electronics Engineering Technology: Complete course, covers all electronic phases of automation. Special emphasis on theory, functioning and applications of servomechanisms and computers. Also note-worthy: Lessons on machine control, instrumentation, data processing and telemetry.

CREI ALSO OFFERS residence training in Washington, D. C. ...at the same high technical level. Day and evening classes start at regular intervals. Qualified residence school graduates earn degree as "Associate in Applied Science." You can qualify for CREI home study education if you have had electronic training, or experience in electronics—and realize the need of a high level technical knowledge to make good in the better electronic jobs. (Electronics experience is not required for admission to CREI Residence School.)

What's the next step! Certainly to get more information than we can cram into one page. Fill out and mail coupon today, or write Capitol Radio Engineering Institute, Dept. 179-F, 3224 - 16th St., N.W., Wash. 10, D. C.

MAIL THIS COUPON—TODAY!

CAPITOL RADIO ENGINEERING INSTITUTE

ECPD Accredited Technical Institute Curricula—Founded 1927
Dept. 179-F 3224 Sixteenth St., N.W., Washington 10, D. C.

Please send me your course outline and FREE (illustrated 54-Page Book "Insurance for Your Future in the New World of Electronics" . . . describing opportunities and CREI Home Study courses in Practical Electronic Engineering Technology.

- CHECK FIELD OF GREATEST INTEREST
- Radar, Servo and Computer Engineering Technology
 - Electronic Engineering Technology
 - Broadcast (AM, FM, TV) Engineering Technology
 - Television Engineering Technology
 - Aeronautical Electronic Engineering Technology
 - Automation and Industrial Electronics Engineering Technology

B³

Name _____ Age _____

Street _____

City _____ Zone _____ State _____

CHECK: Home Study Residence School Korean Veteran



To obtain fast, immediate service, and to avoid delay it is necessary that the following information be filled in:

Employed By _____

Type of Present Work _____

Education: Years High School _____

Other _____

Electronics Experience _____



Superior's New Model 77

VACUUM TUBE VOLTMETER WITH NEW 6" FULL-VIEW METER

Compare it to any peak-to-peak V. T. V. M.
made by any other manufacturer at any price!

- ✓ Model 77 completely wired and calibrated with accessories (including probe, test leads and portable carrying case) sells for only \$42.50.
- ✓ Model 77 uses a sensitive six inch meter. Extra large meter scale enables us to print all calibrations in large easy-to-read type.
- ✓ Model 77 uses new improved SICO printed circuitry.
- ✓ Model 77 employs a 12AU7 as D.C. amplifier and two 9006's as peak-to-peak voltage rectifiers to assure maximum stability.
- ✓ Model 77 uses a selenium-rectified power supply resulting in less heat and thus reducing possibility of damage or value changes of delicate components.
- ✓ Model 77 meter is virtually burn-out proof. The sensitive 400 microampere meter is isolated from the measuring circuit by a balanced push-pull amplifier.
- ✓ Model 77 uses selected 1% zero temperature coefficient resistors as multipliers. This assures unchanging accurate readings on all ranges.

Model 77—VACUUM TUBE VOLTMETER . . . Total Price \$42.50 —
Terms: \$12.50 after 10 day trial, then \$6.00 monthly for 5 months.

AS A DC VOLTMETER:

The Model 77 is indispensable in Hi-Fi Amplifier servicing and a must for Black and White and color TV Receiver servicing where circuit loading cannot be tolerated.

AS AN ELECTRONIC OHMMETER:

Because of its wide range of measurement leaky capacitors show up glaringly. Because of its sensitivity and low loading, intermittents are easily found, isolated and repaired.

AS AN AC VOLTMETER:

Measures RMS values if sine wave, and peak-to-peak value if complex wave. Pedestal voltages that determine the "black" level in TV receivers are easily read.

Comes complete with operating instructions, probe, leads, and streamlined carrying case. Operates on 110-120 volt 60 cycle. Only

\$42⁵⁰

Specifications

• DC VOLTS — 0 to 3/15/75/150/300/750/1,500 volts at 11 megohms input resistance.
• AC VOLTS (RMS) — 0 to 3/15/75/150/300/750/1,500 volts. • AC VOLTS (Peak to Peak) — 0 to 8/40/200/400/800/2,000 volts. • ELECTRONIC OHMMETER — 0 to 1,000 ohms/10,000 ohms/100,000 ohms/1 megohm/10 megohms/100 megohms/1,000 megohms. • DECIBELS: —10 db to +18 db to +10 db to +38 db. +30 db to +58 db. All based on 0 db = .006 watts (6 mw) into a 500 ohm load (1.73v). • ZERO CENTER METER — For discriminator alignment with full scale range of 0 to 1.5/7.5/37.5/75/150/375/750 volts at 11 megohms input resistance.

Superior's New Model TV-50A GENOMETER

7 Signal Generators in One!

- ✓ R.F. Signal Generator for A.M.
- ✓ R.F. Signal Generator for F.M.
- ✓ Audio Frequency Generator
- ✓ Bar Generator
- ✓ Cross Hatch Generator
- ✓ Color Dot Pattern Generator
- ✓ Marker Generator

This versatile All-Inclusive GENERATOR Provides ALL the Outputs for Servicing:

A.M. Radio • F.M. Radio • Amplifiers • Black and White TV Color TV



Model TV-50A GENOMETER . . .
Total Price \$47.50—Terms: \$11.50 after 10 day trial, then \$6.00 monthly for 6 months.

R. F. SIGNAL GENERATOR: The Model TV-50A Genometer provides complete coverage for A.M. and F.M. alignment. Generates Radio Frequencies from 100 Kilocycles to 60 Megacycles on fundamentals and from 60 Megacycles to 180 Megacycles on powerful harmonics.

VARIABLE AUDIO FREQUENCY GENERATOR: In addition to a fixed 400 cycle sine-wave audio, the Model TV-50A Genometer provides a variable 300 cycle to 20,000 cycle peaked wave audio signal.

BAR GENERATOR: The Model TV-50A projects an actual Bar Pattern on any TV Receiver Screen. Patterns will consist of 4 to 16 horizontal bars or 7 to 20 vertical bars.

CROSS HATCH GENERATOR: The Model TV-50A Genometer will project a cross-hatch pattern on any TV picture tube. The pattern will consist of non-shifting, horizontal and vertical lines interlaced to provide a stable cross-hatch effect.

DOT PATTERN GENERATOR (FOR COLOR TV) Although you will be able to use most of your regular standard equipment for servicing Color TV, the one addition which is a "must" is a Dot Pattern Generator. The Dot Pattern projected on any color TV Receiver tube by the Model TV-50A will enable you to adjust for proper color convergence.

MARKER GENERATOR: The Model TV-50A includes all the most frequently needed marker points. The following markers are provided: 189 Kc., 262.5 Kc., 456 Kc., 600 Kc., 1000 Kc., 1400 Kc., 1600 Kc., 2000 Kc., 2500 Kc., 3579 Kc., 4.5 Mc., 5 Mc., 10.7 Mc., (3579 Kc. is the color burst frequency).

The Model TV-50A comes absolutely complete with shielded leads and operating instructions. Only

\$47⁵⁰

EXAMINE BEFORE YOU BUY!
USE APPROVAL FORM ON NEXT PAGE

Superior's New Model 70 UTILITY TESTER® FOR REPAIRING ALL ELECTRICAL APPLIANCES and AUTOMOBILE CIRCUITS

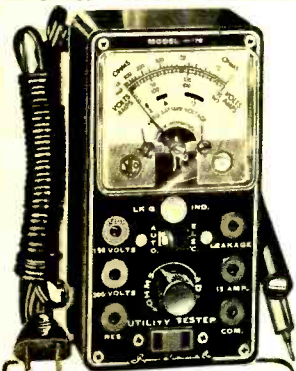

Model 70—UTILITY TESTER
Total Price...\$15.85—
Terms: \$3.85 after 10 day
trial, then \$4.00 monthly for
3 months, if satisfactory.
Otherwise return, no ex-
planation necessary.

As an electrical trouble shooter the Model 70:

- Will test Toasters, Irons, Broilers, Heating Pads, Clocks, Fans, Vacuum Cleaners, Refrigerators, Lamps, Fluorescents, Switches, Thermostats, etc.
- Measures A.C. and D.C. Voltages, A.C. and D.C. Current, Resistances, Leakages, etc.
- Will measure current consumption while the appliance under test is in operation.
- Incorporates a sensitive direct-reading resistance range which will measure all resistances commonly used in electrical appliances, motors, etc.
- Leakage detecting circuit will indicate continuity from zero ohms to 5 megohms (5,000,000 ohms).

As an Automotive Tester the Model 70 will test:

- Both 6 Volt and 12 Volt Storage Batteries • Generators • Starters • Distributors
- Ignition Coils • Regulators • Relays • Circuit Breakers • Cigarette Lighters • Stop Lights • Condensers • Directional Signal Systems • All Lamps and Bulbs • Fuses
- Heating Systems • Horns • Also will locate poor grounds, breaks in wiring, poor connections, etc.



INCLUDED FREE This 64-page book—practically a condensed course in electricity. Learn by doing.

Just read the following partial list of contents: What is electricity? • Simplified version of Ohms Law • What is wattage? • Simplified wattage charts • How to measure voltage, current, resistance and leakage • How to test all electrical appliances and motors using a simplified trouble-shooting technique. • How to trace trouble in the electrical circuits and parts in automobiles and trucks.

Model 70 comes complete with 64 page book and test leads

\$15.85
Only

Superior's New Model 82A A truly do-it-yourself type

TUBE TESTER

TEST ANY TUBE IN 10 SECONDS FLAT!



Model 82A—Tube Tester
Total Price...\$36.50
Terms: \$6.50 after 10 day trial, then \$6.00 monthly for 5 months if satisfactory. Otherwise return, no explanation necessary.

- 1 Turn the filament selector switch to position specified.
- 2 Insert it into a numbered socket as designated on our chart (over 600 types included).
- 3 Press down the quality button—

THAT'S ALL! Read emission quality direct on bad-good meter scale.

FEATURES:

• Tests over 600 tube types. • Tests OZ4 and other gas-filled tubes. • Employs new 4" meter with sealed air-damping chamber resulting in accurate vibrationless readings. • Use of 22 sockets permits testing all popular tube types and prevents possible obsolescence. • Dual Scale meter permits testing of low current tubes. • 7 and 9 pin straighteners mounted on panel. • All sections of multi-element tubes tested simultaneously. • Ultra-sensitive leakage test circuit will indicate leakage up to 5 megohms.

Production of this Model was delayed a full year pending careful study by Superior's engineering staff of this new method of testing tubes. **Don't let the low price mislead you!** We claim Model 82A will outperform similar looking units which sell for much more—and as proof, we offer to ship it on our examine before you buy policy.

Model 82A comes housed in handsome, portable Saddle-Stitched Texon case (Picture Tube Adapter available for \$5.50 additional)

Only **\$36.50**

SHIPPED ON APPROVAL NO MONEY WITH ORDER—NO C. O. D.

Try any of the instruments on this or the facing page for 10 days before you buy. If completely satisfied then send down payment and pay balance as indicated on coupon. **No Interest or Finance Charges Added** if not completely satisfied return unit to us, no explanation necessary.

MOSS ELECTRONIC, INC.

Dept. D-651, 3849 Tenth Ave., New York 34, N. Y.

Please send me the units checked on approval. If completely satisfied I will pay on the terms specified with no interest or finance charges added. Otherwise, I will return after a 10 day trial positively cancelling all further obligation.

Name
Address
City Zone State

All prices net, F.O.B., N. Y. C.

- Model 77 Total Price \$42.50 \$12.50 within 10 days. Balance \$6.00 monthly for 5 months.
- Model TV-50A Total Price \$47.50 \$11.50 within 10 days. Balance \$6.00 monthly for 6 months.
- Model 70 Total Price \$15.85 \$3.85 within 10 days. Balance \$4.00 monthly for 3 months.
- Model 82A Total Price \$36.50 \$6.50 within 10 days. Balance \$6.00 monthly for 5 months.
- Include Model 82A. Picture Tube Adapter at \$5.50

Make Your Ideas Pay Off

Continued from page 39

swimming pools in backyards are prospects for such items as electronic controls, novel systems, etc. Growing up around some 10,000 small boat berthing places is a whole new electronic service industry—whose “skippers” are pocketing many a buck (both salt water and fresh) from marine radios, direction finders and depth finders.

“Sure,” you may shrug, “I’ve always wanted the independence that comes with owning a business. And electronically, I’m tops as a technician. But I’ve just never had the breaks.”

Gerald Grounds was as down on his “breaks” until, literally, he made his own. After working ten years as a quality control engineer for a half-dozen big-time electronic firms, and fresh from 20 months as a government inspector with the Air Force’s electronic procurement branch, Grounds reached into his own backlog of experience for his “break.” He found it, oddly enough, in a government decree: Mil-Q-5923-C.

Simply stated, this government specification requires that companies making goods for Uncle Sam—whether a missile part or a radar console—must periodically recalibrate all electronic test equipment. Further, they must keep on file documentary proof of each recalibration.

Grounds saw a need for a calibration service which not only would regularly visit a plant and check-out its electronic test gear, but a service willing to shoulder the record-keeping chore as well.

Record-keeping—at no additional cost—was Grounds’ trump. And he played it to win, first as a part-time business, then full time as Epic Service Co. (which stands for Electronic Precision Instrument Calibration & Service).

Now, with seven technicians on his payroll and \$20,000 worth of precision equipment in his shop, Grounds’ calibration service grosses upwards of \$8000 a month.

Paradoxically, you can set-up an “electronics” business of your own with nothing more than a camera. That’s pre-

cisely what Joseph Jasgur did. A neophyte to circuitry, Jasgur one day read an electronic firm’s urgent ad for a photo retoucher.

“If they need retouching *that* badly,” reasoned Jasgur, “what they *really* need is good photography.”

Why the big demand for shadowless photos? The need goes back to the pictures’ purpose: the majority of circuitry photos either end up in a company’s engineering files or in a handbook destined for service technicians. Sharp and shadowless pictures are important.

Jasgur “paints” the circuits with an ever-moving photoflood (a #1 or #2 light). Working whenever possible in a blacked-out room, he effectively “erases” shadows, spending anywhere from 15 seconds to 2 minutes “light brushing” a chassis, while a 4x5 sheet of fast film is exposed in his bellows-type view camera.

Jasgur earns \$12.50 a shot, from \$50 to \$500 a day, annually grosses \$25,000-\$35,000 and has accumulated more than 20 lenses and almost as many cameras. Close-ups of miniaturized parts has opened a new door.

Almost at the other end of the service spectrum is 25-year-old Conway Chester, operator of Residential Electronics. Catering to well-heeled owners of \$30,000-up homes, Chester has, during the past five years, put in nearly 1000 intercom and home hi-fi systems.

Fresh from an electronics course at Pasadena City College, Chester grubstaked his venture with \$1000 and began knocking on architect’s doors.

“My credentials,” Conway concedes, “were pretty slim. I’d installed a few home systems locally, was a hi-fi fan myself, but I was pretty sure I knew what the owners of better homes wanted—top-rate quality and workmanship.”

Conway’s first few years were tough. But he gradually developed his contacts with architects and builders, submitted bids (most jobs require an itemized bid) while two commissioned salesmen and a crew of installers did the legwork.

Today, Residential Electronics steps as sure-footedly in the industrial-medical field as in home installations. It pipes pre-recorded background music (fee:



HEATHKIT

WORLD'S LARGEST
MANUFACTURER OF
easy-to-build
do-it-yourself
ELECTRONIC KITS

“bookshelf” 12 watt amplifier kit COMBINES BEAUTY, STYLE AND QUALITY

Build this high quality amplifier in a few hours of your spare time and enjoy true high fidelity performance for years to come. Provides full range frequency response from 20 to 20,000 CPS within ± 1 db, and has less than 1% harmonic distortion at full 12 watt output over the entire range (20—20,000 CPS). Miniature tubes are used throughout the advanced circuitry, including EL84 output tubes in a push-pull tapped-screen output circuit. The special design output transformer has taps for 4, 8 and 16 ohm speakers. The model EA-2 has its own built-in preamplifier with provision for three separate inputs, mag phono, crystal phono and tuner. Features RIAA equalization, separate bass and treble tone controls, and a special hum-balance control. Complete with instructions for easy assembly.



Only

MODEL EA-2
\$28⁹⁵

SHPG. WT. 15 LBS.

Complete selection of Monophonic and Stereo Kits!



PREAMPLIFIERS



TUNERS



SPEAKER SYSTEMS

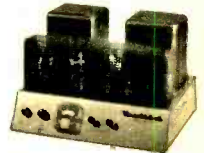

AMPLIFIERS

Send for FREE catalog

listing over
100 high quality
dependable
Heathkits for you
to choose from.

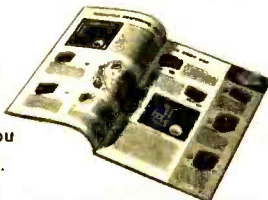

All Prices F.O.B. Benton Harbor, Mich. Prices and Specifications Are Subject To Change Without Notice.

HEATH COMPANY

BENTON HARBOR 39, MICH.

pioneer in
"do-it-yourself"
electronics

HD a subsidiary of Daystrom, Inc.

Please send your latest Free Catalog.

name _____

address _____

city & state _____

\$30 monthly) to medical buildings, restaurants and offices; rents intercoms (\$3 a month per master, plus installation charges, on a 3-year contract); leases battery-powered public address systems for corporate picnics and store openings.

Ferrell Burton, Jr., and high school electronics teacher Paul S. Light joined forces to supply instructional radio kits to high schools, trade schools and colleges.

Electronic Kits Supply Co. will gross more than \$100,000 this year, its third year in business. But, you might reason, there are plenty of other kit makers. There are, but few have concentrated on the school market where electronic enrollment has increased sharply in the missile age. To scale kit-costs down to student budgets, Burton and Light put their plans before Packard-Bell, a top radio-electronics maker.

Thus, in thousands of classrooms, students learn electronics on a Packard-Bell radio or hi-fi, mocked-up on a visual-aid demonstration board. And having seen, they buy the identical radio kit from Burton and Light.

Charles Vincent's capital was slim, less than \$1500. But his idea (TV rentals) was big. He put \$50 down on ten video sets and walked into a hospital superintendent's office. Vincent offered to make his ten sets available to the hospital. The hospital, in turn, would rent them to patients, charging \$1.50 to \$3.00 a day and pay Vincent \$1 a day.

It was the no-cost-to-hospitals kind of proposition which appealed to the administrators. Within a couple of years Vincent was signing 5-year contracts with big, 200-room hospitals. In the contract, Vincent agreed to install hook-ups to each room, provide late-model 17-inch TV sets on the carefully calculated bet that one-third of the sets would be rented daily, returning him \$67 a day, \$25,000 a year . . . and paying for themselves within two years. What of the remaining three years of the contract's run? Save for maintenance costs, they were pure profit.

A single inspired idea dealing with TV, hi-fi, stereo, industry—that's really all it takes to start you on the road to a successful business.

Hamming Is A Family Affair

Continued from page 31

Golde, K9AXS, explained it this way, "I was really an outsider in my own home before getting my ticket. Finally I just became tired of not knowing what my husband and son were talking about. All I heard was radio, and I decided to get in on the fun too."

The husband is usually the one who first becomes interested in radio. But the gals get just as enthusiastic when they learn that it isn't necessary to master Einstein's Theory of Relativity in order to get a license. For a happier home, however, experience has shown that a fellow shouldn't try to teach radio to his own wife. It's best for her to study with another gal or some ham friend who won't expect her to master every fundamental the first time around. The Hillsboro-Litchfield group went with manual in hand to Dan W9VEY, who probably spends more time instructing new hams than operating his own station. He has helped all the local XYL's (wives) except one—his own!

When a couple comes for help, the husband and wife are usually separated for a few sessions.

"Usually one makes the other nervous," he laughed. "Either the fellow is afraid he'll answer a question wrong in front of the little woman, or she's too timid to say a thing because he's listening."

After the Federal Communications Commission license examinations are water under the bridge, the household really gets lively. Around the clock XYL's trade recipes, chat locally about husbands, children and new equipment. Perhaps a DX station or two across the ocean is contacted. Radio clubs provide a chance to visit with other hamming couples and compare QSL's. During the warm weather months, hams and their families gather for picnics and "ham-fests." Mobile stations really come in handy when the bread-winner's business involves a great deal of out-of-town travel. If his wife is licensed too, they can set up regular check-the-homefront schedules.



**FORMER SERVICEMEN:
TAKE
A FRONT
ROW SEAT
IN THE
NEW AGE OF SPACE**



**AS A
SPECIALIST
IN THE
U.S. AIR FORCE**

If you have a technical skill, make the most of it, where the Age of Space is *now* — in the U.S. Air Force. You'll work with the latest equipment, learn the latest advances of your specialty. What's more, you'll hold down an *important*, responsible job, and you can look forward to a future that's guaranteed. But the time to act is now, while your skill is at peak value. See your local Air Force Recruiter, or mail the coupon.



**THE FUTURE BELONGS
TO THE AIRMAN**

PASTE ON POSTAL CARD AND MAIL TO:

Prior Service Information, Dept. ME-99
Box 7608, Washington 4, D. C.

Please send me more information on the Air Force Prior Service Program.

Name _____

Address _____ Age _____

City _____ Zone _____ State _____

A Look Into The Future

Continued from page 30

Until the time of this experiment in April of this year, thermoelectricity was based on the generation of current that occurs when the junction between two different materials is heated. At Los Alamos, three young physicists substituted a gas, hot ionized cesium, for one of the solids normally used. What they produced was a thermoelectric generator of far greater efficiency than ever before attained. The other partner in the thermocouple at Los Alamos was solid uranium, and the combination was lowered into the hot core of an atomic reactor to produce electricity. Since the thermoelectric generator needs no giant turbine or other expensive moving, wearing parts, it could conceivably convert the heat of an atomic reactor into electricity much cheaper than any atomic power plant now running or planned.

Although the new cesium gas-uranium thermocouple looks like a winner, thermoelectric combinations made out of semiconductors, the same type of material that goes into transistors, have been improved to such a great extent that they can't be counted out of the power race. And the solid thermoelectric materials are the only ones that can be used for refrigeration without moving parts—so far.

Thermoelectricity is not the only new way to produce electricity directly without moving parts. Of course, the



Brand new and biggest thermoelectric generator is Air Force's 100-watt unit by Westinghouse.

battery, which produces electricity directly, has been used for two centuries. Scientists at the General Electric Research Laboratory are hard at work on "thermionic converters," while many researchers here and abroad are plugging away at "electrochemical" converters. And, of course, you've heard of solar energy converters, which, unfortunately, can't be used for large-scale generation.

Thermoelectricity is one of a group of bright, seemingly new sciences that is competing for the pocketbooks of the military and industry. Based upon what is known already, plus the actual thermoelectric equipment that has been built, thermoelectricity is one of the best bets. The appliance stores of 1970 should be doing a land-office business in thermoelectric machines that will make life easier and better. 

An Intercom In Every Room

Continued from page 81

lights or motors. At the installation time there is usually no electric power available so you will have to resort to a hand brace and 5/16" bit for boring holes for the cable in any of the wood structure. Allow an extra foot of cable at every control box to take care of splices and joints. Try to figure the shortest path for the cable to follow. Use insulated staples to secure all cable in place and try to center the wires on the studs to avoid being damaged by future nailing. The entire initial installation can be done with a hammer, screwdriver, brace and bit and a pair of wire cutters. It is unlikely that you will break any of the wires in the cable but to be on the safe side check the cable for continuity.

After the wallboard has been installed repeat the continuity check before it is too late to remove any wall panels to change wires.

When the house is painted and you move in, you will undoubtedly be anxious to finish the wiring and the installation of the room speakers and switches. Follow all the instructions carefully. Solder and tape all electrical connections against short circuits. 

**Want To
Double
Your Pay**
Get into Radio—
TV-Electronics

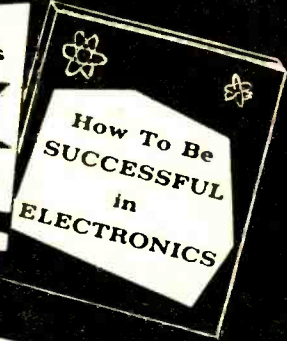
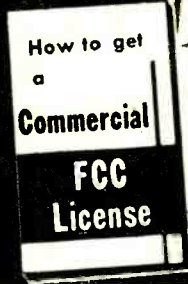

Get all 3 FREE

FIND OUT what the FCC license means

Your FCC license is recognized by employers as proof of your technical ability.

FIND OUT how the FCC license helps you get a better job or increase your pay on your present job

"License and \$25 raise due to Cleveland Institute training."
"I sat for and passed the FCC exam for my second class license. This meant a promotion to Senior Radio Technician with the Wyoming State Highway Department, a \$25 a month raise and a District of my own for all maintenance on the State's two-way communication system."

"I wish to sincerely thank you and the school for the wonderful radio knowledge you have passed on to me. I highly recommend the school to all acquaintances who might possibly be interested in radio. I am truly convinced I could never have passed the FCC exam without your wonderful help and consideration for anyone wishing to help themselves."
Charles C. Roberson
Cheyenne, Wyoming

FIND OUT how we guarantee your FCC license

The Master Course in Electronics will provide you with the mental tools of the electronics technician and prepare you for a First Class FCC License (Commercial) with a radar endorsement. When you successfully complete the Master Course, if you fail to pass the FCC examination, you will receive a full refund of all tuition payments.

FIND OUT how employers make job offers like this to our graduates every month

RADIO OPERATORS: TWA has opportunities for radio operators with a 2nd class license or better. Must be able to type at least 35 wpm. Free transportation for self and family. Vacation and many other benefits.

CLEVELAND INSTITUTE OF RADIO ELECTRONICS
Desk EI-12 4900 Euclid Avenue Cleveland 3, Ohio

September, 1959



good training doesn't cost . . . it pays!



Accredited by the National Home Study Council
Cleveland Institute of Radio Electronics

Desk EI-12 4900 Euclid Avenue Cleveland 3, Ohio

Please send Free Booklets prepared to help me get ahead in Electronics. I have had training or experience in Electronics as indicated below:

- | | |
|---|---|
| <input type="checkbox"/> Military | <input type="checkbox"/> Broadcasting |
| <input type="checkbox"/> Radio TV Servicing | <input type="checkbox"/> Home Experimenting |
| <input type="checkbox"/> Manufacturing | <input type="checkbox"/> Telephone Company |
| <input type="checkbox"/> Amateur Radio | <input type="checkbox"/> Other |

In what kind of work are you now engaged?

In what branch of Electronics are you interested?

Name..... Age.....
Address

City..... Zone..... State.....

Desk EI-12

U. S. MEDICAL CORPS STETHOSCOPE

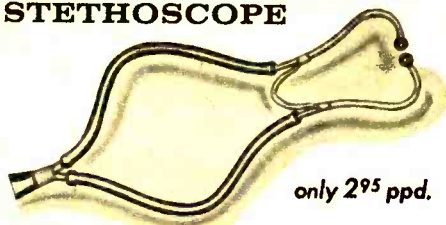

only 2⁹⁵ ppd.

Ever try to buy one of these? Hard to find, and usually expensive, this is a U.S. Medical Corps stethoscope. *Brand new surplus*, it's ideal for doctors, engineers and mechanics (to check trouble spots in motors, etc.), educational for kids and adults. Lots of fun, too. Handy in the country. An excellent buy for \$2.95 ppd. (half regular price). Moneyback guarantee. BANNER SUPPLY HOUSE, 1308-V Lincoln Bldg., N. Y. 17

TELEPHONE INTERCOM

ONLY
\$7.95



Recognize these? Probably the most durable phones ever made, these have been re-conditioned and refinished in gleaming black, and together make a good and cheap intercom system. Easy to hook up, they can be used over several miles, in effect duplicate a private telephone system. Fine for home, offices, garages, cabins, barns etc. (Fun for kids, too!) Pair, with surplus battery, 50 ft. of wire, \$7.95. Extra phones, \$3.95. Additional wire, 2c a ft. All ppd.

CHABON SCIENTIFIC CO., 411-B Lincoln Bldg., N. Y. 17

FOR THE WOULD-BE HAM AND THE NOVICE...

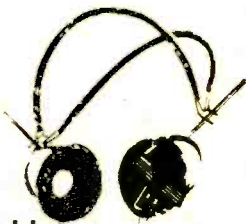

If you're interested in ham radio, this is the book for you.



75 cents

FB 415

on sale at local newsstands

to order direct: Send 75 cents to FAWCETT BOOKS, Dept. E1, Greenwich, Conn. Add 10 cents per copy for mailing. No Canadian orders.

A Six Meter Rig For Your Car

Continued from page 72

shown in the photographs along with the location of the carbon mike and modulator transformers.

The modulator transformer used is a regular audio output transformer such as used in table model radios. The type will not matter greatly, as adequate modulation will be available in any case.

A feature of any good mobile rig is push-to-talk operation. This rig is no exception. A relay, double pole-double throw, is used to switch the antenna and B+ from the receiver to the transmitter. The mike jack is a two-circuit type. When the mike button is depressed it connects the relay to ground, causing it to operate.

The auto receiver will in most cases supply the B+ required for the rig. Voltages from 150 to 300 volts may be used. Current drain from the supply will be 50 to 60 mils. The receiver power supply is easily adapted to this operation by opening up the B+ lead from the input filter capacitor and running a wire from it to the relay in the rig according to the diagrams.

The change-over relay is in series with the B+ supply of the auto radio after you have made the simple changes shown. When the relay is not energized, the B+ from the radio is connected through the relay, back to the receiver again. When the push-to-talk button on the mike is pressed, the relay is energized, connecting B+ to the transmitter and removing it from the receiver. The antenna is also switched, at this time, from the receiver to the transmitter.

This system prevents the receiver from operating during transmissions, eliminating feedback problems and gives the transmitter higher B+ voltage than would be available if both the receiver and transmitter drew current at the same time. Also, the power supply will not be overloaded this way.

An off-on switch for the "Hot" lead from the battery is on the front panel of the unit, so that the filaments and change-over relay will be disconnected when the rig is not being used. The

RADIO SHACK SHATTERS COST OF QUALITY STEREO AMPLIFIERS!!

REALISTIC

Stereolyne-7

only **\$29⁹⁵**

Factory Assembled In Cabinet 9 1/4" x 5 1/4" x 4 3/4"



The quality-built Stereolyne-7 puts sound reproduction first, delivers ample good clean wattage for most home hi-fi systems. The advanced tone control circuit provides a flat response curve, functions as a high-pass filter, cleaning out low frequency "rumble" — and as a low-pass filter eliminates high-frequency surface noise from your oldest records. Has extended frequency response, low distortion, low hum level. Connects to tuner, to crystal or ceramic cartridge, plays stereo or monaural. Has stereo-monaural switch, dual volume and tone controls, balance control, tuner-phono jack, off-on switch.

- Equal to \$60 amplifiers in reproduction quality!
 - Another audio engineering "first" by the creators of the fabulous ELECTROSTAT-3 tweeter!
- Order No. 90LX022 Sh. Wt. 11 lbs.

NOW! Immediate Delivery on

ELECTROSTAT-3

THE WORLD FAMOUS 25,000 CPS TWEETER **\$27⁵⁰**

Beware of imitations! Only the Realistic Electrostat-3 can give you the thrilling sound you pay for — the smooth, silky response from 5,000-25,000 cps acclaimed by the hi-fi test laboratories.

Order No. 36CX017Y Sh. Wt. 7 lbs.

Factory Assembled In 11 3/4" x 5 3/4" x 4 1/2" Cabinet



350 BIG PAGES OF BIG BARGAINS

FREE!

24-36 PAGES MONTH AFTER MONTH

Each jumbo page crammed with unduplicated savings on hi-fi, stereo, ham radio, LP records, tape, cameras, tools, sporting goods, appliances, etc. Printed in handsome rotogravure.



Out in September SAVE \$100's !

Radio Shack's new 1960 GUIDE TO ELECTRONIC BUYING lists lowest net prices on everything electronic — contains feature articles, charts, over 250 profusely illustrated pages, each a big 8 1/2 x 11"

FILL IN — CLIP — MAIL TODAY!

RADIO SHACK CORPORATION 9P

730 Commonwealth Avenue, Boston 17, Mass.

Please send me the following:

- Stereolyne-7 (#90LX022) \$29.95
 Electrostat-3 (#36CX017Y) 27.50
 8-Ohm Wired X-Over for above (#91L534) 6.95
 12 Months of Bargain Bulletins FREE
 1960 Guide to Electronic Buying 35c

Check Money C.O.D.

Name _____

Address _____

City _____ Zone _____ State _____

RADIO SHACK CORPORATION

177 Washington St., Boston 8, Mass.
 730 Commonwealth Ave., Boston 17, Mass.
 230-240 Crown St., New Haven 10, Conn.





ELECTRONICS ILLUSTRATED

Classified Ads

Your advertisement can reach this mail-buying audience for only 35¢ per word . . . payable in advance (Check or M.O. please) . . . minimum 10 words. Closing dates are the 20th of 3rd preceding month i.e. copy for the December issue must be in our office by September 20th. Mail to ELECTRONICS ILLUSTRATED, 67 West 44th St., New York 36, N. Y. Word count: Zone number free. Figure one word: Name of state (New Jersey), name of city (New York); sets of characters as in key (14-D); also abbreviations as 35MM, 8x10, D.C., A.C.

SAVE MONEY • ORDER BY MAIL

• • • FOR SALE

MONEY SAVING Prices on tubes. TV, Radio, Transmitting and Industrial Types. New, 1st quality, guaranteed. Top name brands only. Government surplus and commercial fast, lab and communications equipment in stock. Sell us your excess tubes and equipment. Unused, clean tubes of all types wanted. Send specific details in first letter. Write for "Green Sheet" catalog 25¢. Barry Electronics Corp., 512 Broadway, (Dept. E1.), WA 5-7000, New York 12, N. Y.

IMPORTS SHIPPED direct to you from all over the world. Black Forest clocks, Swiss watches, Egyptian hassocks and many others. Write The Newhart Company, P.O. Box 204, New Hartford, N. Y.

78 R.P.M. RECORDINGS. Many types. Free lists. Collections bought. P.O.B. 155(EL), Verona, N. J.

• • • EMPLOYMENT OPPORTUNITIES

PRINTING - ADVERTISING SALESMEN. Excellent moneymaking sideline selling Decalcomania Name Plates. Advertising Specialties. Sign letters, Automobile initials. Free Samples. "Ralco"-EI, Box L, Boston 19, Mass.

SALESMEN! PART Time Or Semi-Retired But Want To Keep Active? Earn Up To \$10,000 yearly selling shelving—parts bins—shop equipment. Write, BFC Corporation, 2938E. Hedley, Phila. 37, Pa.

• • • BUSINESS OPPORTUNITIES

WE PAY \$4.50 lb. dried. Grow Mushroom rooms, Cellar, shed and outdoors. Spare, full time, year round. We pay \$4.50 lb. Free Book. Mushroom, Dept. 315, 2954 Admiral Way, Seattle, Wash.

VENDING MACHINES—No selling. Operate a route of coin machines and earn high profits. 32-page catalog free! Parkway Machine Corp., Dept. 33, 715 Ensor St., Baltimore 2, Md.

OPERATE PROFITABLE mailorder business!! Write: Bond, T-1637 West Vernon, Phoenix, Arizona.

• • • AGENTS WANTED

RUN A spare-time Greeting Card and Gift Shop at home. Show friends samples of our new 1959 Christmas and All Occasion Greeting Cards and Gifts. Take their orders and earn to 100% profit. No experience necessary. Costs nothing to try. Write today for samples on approval. Regal Greetings, Dept. 44, Ferndale, Michigan.

• • • HI-FI

HI-FI CONVERTER. Console sound from your radio, television, tape recorder, phonograph, with new speaker and enclosure kit. Free folder. Windhavan Radio, Box 16J-74, Baroda, Michigan.

• • • TAPE RECORDERS

TAPE RECORDERS, Hi-Fi components, Sleep Learning Equipment, tapes. Unusual values. Free catalog. Dressner 69-02 Z, 174 St. Flushing 65, N. Y.

HI-FI, RECORDERS. Free Wholesale Catalogue. Carston, 125-G East 88, N. Y. C. 28.

• • • RADIO & TV

DIAGRAMS FOR repairing radios, amplifiers, \$1.00; television \$2.00. Give make, model. Diagram Service, Box 672-EI, Hartford 1, Conn.

15 TESTED ONE-TUBE circuits—25¢, with Transistor experiments, catalog. Laboratories, 1131-K Valota, Redwood City, California.

POCKET T-V with picture. Send stamped envelope for info. Ekeradio, 650 N. Fair Oaks, Pasadena, California.

CRYSTAL RADIO Experimenters. Write to Hulet, 305 Hope, Lakewood, N. J.

WORLD'S SMALLEST Radio \$1.00 and a stamped addressed envelope to Ekeradio, 650 N. Fair Oaks, Pasadena, Calif.

• • • ELECTRICAL SUPPLIES & EQUIPMENT

APPLIANCE PARTS—Accessories Wholesale. New Enlarged Catalogue 25¢. Seco, 26 South 20 Street, Birmingham 3, Alabama.

• • • INVENTIONS & INVENTORS

INVENTORS—SEND for free Patent Information book and Inventors Record. Registered Patent Attorney, Associate Examiner, Patent Office 1922-1929; Patent Attorney & Advisor, Navy Department 1930-1947. Gustave Miller, 99EI Warner Building, Washington 4, D. C.

• • • MISCELLANEOUS

KITS WIRED and tested. David Goldberg, 1708 N. Vine St., Chicago 14, Ill.

HELP WANTED With Math, Reply Post Office Box 856, San Pedro, Calif.

• • • STAMPS & COINS

INDIAN CENT plus Bargain Lists 10¢. Hutchinson's, Box 4747, Philadelphia 34, Penna.

• • • DETECTIVES

DETECTIVES—WORK Home—Travel. Experience unnecessary. Detective Particulars free. Write, Wagner, 8-125 West 86th, New York 24.

• • • MUSIC

SONGPOEMS AND Lyrics Wanted! Mail to: Tin Pan Alley, Inc., 1650 Broadway, New York 19, N. Y.

co-ax connectors are used for connecting to the antenna and the input of the receiver. Other connectors can be used, but they should be for VHF use. The lead running to the antenna should be 52 ohm co-ax and kept as short as convenient. Short lengths of co-ax are used to connect the relay to the RF section and to the co-ax jacks.

The wiring is not at all critical and will give no problems. A hole was drilled below the printed circuit board for the power leads and for the co-ax lead connecting the output of the RF amplifier to the change-over relay.

When the rig has been completely wired, carefully check over your work for any errors. Tune up is very easy. The triode oscillator ($\frac{1}{2}$ of the 6U8) covers 48 to 54 mc with third overtone crystals and requires no tuning. The pentode section of the 6U8A, which is used as the final RF amplifier, has a slug tuned final coil which must be dipped. Tune up the final in the usual manner for minimum plate current as read on the plate current meter. Talking into the mike will cause the needle to move slightly.

Final tuning should be done with the rig installed in the car. It may be installed in the trunk, as the model shown, or under the dash, front seat, or even in the glove compartment. Final tuning is best done using a signal strength meter. Set the meter so that you get an indication on it and tune the slug in the final coil for maximum indication on the meter. The final may have two locations which give an output. If this is true of yours, use the setting of the slug which gives maximum reading on the signal strength meter.

If the slug has a tendency to change its position in the coil due to vibration in the car, place a small amount of ordinary cotton into the coil from the top.

If no tuning meter, or signal strength meter is available, use the plate current meter to "dip" the RF amplifier. The indication of the dip on the meter will be small, so you will have to adjust the slug slowly.

Next month we'll describe the companion converter for receiving 6 meters on the car radio.

PACO

quality electronic equipment in KIT FORM

PACO is the only line of test instrument kits engineered and produced under the auspices of a leading test equipment and meter manufacturer.

and, you pay nothing extra for the convenience of buying PACO kits directly from your own local parts distributor.

COMPARE PACO against any other kits for performance, appearance, ruggedness, ease of operation and simplicity of assembly and wiring.

COMPARE PACO'S superbly detailed, step-by-step instruction manuals and giant size wiring diagrams, against any you have ever seen.

MODEL B-10
BATTERY ELIMINATOR KIT
KIT NET PRICE: \$41.95
FACTORY WIRED: 49.50

MODEL C-20
RES-CAP-RATIO BRIDGE KIT
KIT NET PRICE: \$20.95
FACTORY WIRED: 31.50

MODEL G-30
RF SIGNAL GENERATOR KIT
KIT NET PRICE: \$28.50
FACTORY WIRED: 39.95

MODEL M-40
HIGH SENSITIVITY V-O-M KIT
KIT NET PRICE: \$31.50
FACTORY WIRED: 37.50

MODEL S-50
5" OSCILLOSCOPE KIT
KIT NET PRICE: \$49.50
FACTORY WIRED: 84.50

MODEL S-55
WIDEBAND 5" OSCILLOSCOPE
KIT NET PRICE: \$87.50
FACTORY WIRED: 139.50

MODEL T-60
TUBE CHECKER KIT
KIT NET PRICE: \$38.75
FACTORY WIRED: 54.50

MODEL T-65
TRANSISTOR AND CRYSTAL
DIODE TESTER KIT
KIT NET PRICE: \$39.95
FACTORY WIRED: 59.50

MODEL V-70
VACUUM TUBE VOLTMETER KIT
KIT NET PRICE: \$31.50
FACTORY WIRED: 47.50

MODEL Z-80
RF-AF SIGNAL TRACER KIT
KIT NET PRICE: \$29.50
FACTORY WIRED: 42.50

MODEL SA-40
40-WATT STEREO
PREAMP-AMPLIFIER KIT
KIT NET PRICE: \$ 79.95
FACTORY-WIRED: 129.95

COMING SOON! MODEL ST-45
AM/FM STEREO TUNER KIT

▶ Write for latest, complete catalog.
▶ Available at leading electronic parts distributors.



B-10



C-20



G-30



M-40



S-50



S-55



T-60



T-65



V-70



Z-80



PACO

ELECTRONICS CO., INC.

70-31 84th Street, Glendale 27, L.I., N.Y.

Export: 458 B'way, N. Y. 13 • Canada: Atlas Radio Corp., Toronto 19

A DIVISION OF **PRECISION** Apparatus Company, Inc.

FREE

LAFAYETTE'S



1960 CATALOG 312 GIANT- SIZED PAGES

The Complete Catalog and Buyers Guide Featuring Quality

*Our
39th
Year*

**EASY PAY
TERMS**
Available on
orders
over \$20

at the Lowest Prices Anywhere

- INCLUDES THE LATEST IN STEREOGRAPHIC HI-FI EQUIPMENT AND SYSTEMS**
- PUBLIC ADDRESS SYSTEMS • TAPE RECORDERS • TOOLS • INDUSTRIAL SUPPLIES
 - AMATEUR EQUIPMENT • ELECTRONIC TUBES & PARTS • CAMERAS & OPTICAL GOODS
 - EXCLUSIVE LAFAYETTE HI-FI & TRANSISTOR KITS

The acknowledged leading buyer's guide for the economy minded audiophile, hobbyist, technician, student, engineer, serviceman or dealer.

JAMAICA 33, N. Y. 165-08 Liberty Ave. AXtel 1-7000	NEW YORK, N. Y. 100 6th Ave. Worth 6-5300	BOSTON, MASS. 110 Federal St. Hubbard 2-7850	BRONX, N. Y. 542 E. Fordham Rd. Fordham 7-8813	NEWARK, N. J. 24 Central Ave. Market 2-1661	PLAINFIELD, N. J. 139 W. 2nd St. Plainfield 6-4718
---	--	---	---	--	---

PLEASE INCLUDE POSTAGE WITH ORDER

FREE	LAFAYETTE RADIO, Dept. E11-9
CUT OUT AND PASTE ON POST CARD	P.O.Box 222, Jamaica 31, N. Y.
	SEND FOR THE WORLD'S LEADING ELECTRONICS, RADIO, T.V., INDUSTRIAL, AND HI-FI GUIDE
NAME _____	
ADDRESS _____	
CITY _____	
ZONE _____ STATE _____	
<input type="checkbox"/> Send FREE CATALOG 600	

Lafayette
Radio

"Everything in
Electronics"



FOR GOOD PAY TO Learn Radio-TV

AT

Start Soon a Week Ex

Many NRI students find friends and neighbors start. Use the Tester built with correct Radio-TV receiver more a week gives substantial who start in spare time soon sales and service businesses. faction in this fast growing



roadcasting offers satisfying careers. Hundreds of Radio and Television stations on the air offer interesting jobs for Operators Technicians. Police, Aviation, Two-Way Communications expanding. Men with Radio-TV training are in demand.

Benefit by NRI B Largest Home Study

NRI's more than 40 years experience—the outstanding record and reputation fits you in many ways. NRI methods successful graduates are everywhere, cities. Here is an investment that pays week, invest only a few hours spare time to be a Radio-TV-Electronic training to get ahead. NRI can provide

NRI Is The Tested Way

Technical know-how brings better pay. Radio-TV-Electronic opportunities are great. NRI has devoted over 40 years to develop practical training methods. Mailing the card a one of the most important acts of your life. Do it able tuition, on low monthly payments available you an actual Lesson and 64 page Catalog— BOTH FREE. Address: NATIONAL RADIO INSTITUTE, Dept. 9JK, Washington 16, D. C.



solid, proven field of opportunity for good pay, is servicing millions of Radio and TV sets now in use. Government, military, guided missile manufacturers, industry, all need technicians. Color-TV, Hi-Fi are increasing the opportunities.

National Radio Institute

Washington 16, D. C.

Est. 1914

SPECIAL

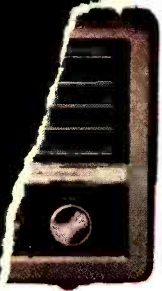

For the armchair adventurer to travel the world without leaving his living room. National's new NC-60 Special is the first all new, low priced shortwave receiver in over 10 years. Features continuous coverage of AM broadcast, amateur and world-wide shortwave bands with full electrical bandspread on all frequencies: 540-1600 kc to 31 mc in four bands. Giant, easy-to-read dial with standard broadcast, civil defense, WWV, marine, aircraft, amateur and foreign shortwave frequencies clearly marked.

Suggested list: \$59.95*

Only \$5.99 down

FOR SHORTWAVE LISTENERS—FOR HAM



NC-66

National's famed NC-66, portable shortwave receiver. Features 5 bands including marine and aircraft finding beacons, standard AM, amateur, and world-wide shortwave bands with battery pack. NC-66 at regular price: \$129.95; NC-66 direction finder at regular price: \$39.95; "Magnet Torch lite" including cells: \$2.49; and National's Handbook: \$3.95. Total value: \$176.34.

NOW only \$13.99 down

Special cash price: \$139.95*—a saving of \$36.39
NC-66 alone (\$129.95) now only \$99.95* full price



NC-188

National's NC-188—new general coverage receiver—a truly great value. Designed for Short Wave Listeners and for new Hams, it covers AM broadcast and all popular SWL and amateur bands. Continuous coverage: 540 kc to 40 mc in 4 bands, plus all the latest engineering features.

NOW only \$13.99 down

cash price: \$139.95*

*Slightly higher west of the Rockies and outside U.S.A.

NATIONAL

RADIO CO., INC. MELROSE 76, MASS.

A wholly owned subsidiary of National Co., Inc.