

The Coming World of Sun Power

ELECTRONICS ILLUSTRATED

25¢
APRIL



BOWLING!

How the Electronic
Pinsetter Works

Build a Hi-Fi Tester • Adapt for FM Multiplex
How to Buy a Ham Receiver and Transmitter

**Model EL 3516/G53
Technical Specifications**

Three Tape Speeds— $7\frac{1}{2}$, 3 $\frac{3}{4}$, and 1 $\frac{1}{2}$ inches per second

Tracks—Dual

Heads—Stacked

Head-Gap—0.0002 inches

Frequency Response—

at 7 $\frac{1}{2}$ ips; 50 to 16,000 cps

at 3 $\frac{3}{4}$ ips; 60 to 10,000 cps

at 1 $\frac{1}{2}$ ips; 60 to 5,000 cps

Wow and Flutter—0.15% at 7 $\frac{1}{2}$ ips

0.2% at 3 $\frac{3}{4}$ ips

0.35% at 1 $\frac{1}{2}$ ips



Volume Indicator—Magic Eye (Type EM-84)

Loudspeaker—Integrated, heavy magnet, wide range

Controls—Piano-key pushbutton

Fast Forward and Reverse—Less than 2 minutes for 1200 ft. of tape

Automatic Stop—At ends of reel (with metalized strips)

Program Indicator—Built-in, adjustable

Inputs—(1) radio/phono; (1) microphone (with mixing facilities)

Outputs—(1) for external speaker; (2) for external amplifiers with controls; (1) for external amplifier without controls; (1) for headphone monitoring recording circuit

Microphone—High-Impedance Dynamic

Tubes—EF-86 (2), ECC83 (2), ECL82 (1), EZ90 (1), EM84 (1)

Line Voltage—117 volts AC 60 cycles

Power Consumption—80 watts

Dimensions—15 $\frac{3}{4}$ " x 13" x 8"

Weight—32 lbs.

Case—Rugged, European-designed portable carrying case (internally designed for optimum acoustic baffling)

A matching companion piece, identical in appearance, containing a second amplifier and speaker, is available to those who seek the convenience of a complete portable stereo-tape playback system.

YOU
ARE LOOKING
AT A
Modern
Dutch
Masterpiece

The
STEREO
version of the
Norelco 'Continental'
TAPE RECORDER
Developed & Guild-Crafted
by
Philips
of the
Netherlands

We feel that the Stereo version of the Norelco 'Continental' is the ideal tape recorder for those recordists, high fidelity enthusiasts and music lovers who seek a professional quality machine at a truly modest price. The data listed here, represent painstaking, conservative and substantiated laboratory measurements. If you find that these data satisfy your technical requirements, and reflect those qualities that you consider mandatory in your stereo equipment, by all means listen to the Stereo version of the Norelco 'Continental' at your favorite HI-FI center or Camera store. There, we feel sure, you will agree with us that the Norelco Stereo 'Continental' is, indeed, a modern masterpiece . . .

Norelco

For further descriptive literature write to:
NORTH AMERICAN PHILIPS CO., INC.
Dept. 6K4, High Fidelity Products Division
230 Duffy Avenue, Hicksville, L. I., N. Y.



Make More Money Soon Fixing Electric Appliances



**Actual Lesson
FREE** Fast Growing
Field Offers
Good Pay, Security
Interesting Work

Learn at Home in Spare Time

Earn more money. Enjoy doing important, interesting work. Learn Electrical Appliance Servicing. This is a field of increasing opportunity. Today every wired home has many electrical appliances and millions and millions of new appliances are made and sold each year. Find out more about this great, growing field. Find out how NRI can train you, at home and in spare time to be an Appliance Service Technician. See how you can start soon to make extra money servicing appliances.

Add to Your Income Soon After Enrollment Opportunities Increasing for Service Technicians

NRI Training is practical, thorough. You get easy-to-understand lessons, and NRI supplies parts to build professional type Multi-Use Tester. Use it to get practical experience. Soon, you can add to your income by servicing appliances. Build a profitable *sideline* for your spare time—qualify for a good job—develop a business and be your own boss. As an Appliance Service Technician, your opportunities are broad—your services wanted, gladly paid for, highly regarded in your community.

Appliances are necessary to comfortable, convenient living. Owners pay well to keep them in repair. The field is amazingly big. In addition to major appliances such as electric ranges, air conditioners, refrigerators, there are over 40,000,000 electric irons, 5,000,000 electric blankets, 15,000,000 coffee makers, plus more millions of vacuum cleaners, fans, toasters, mixers, etc.

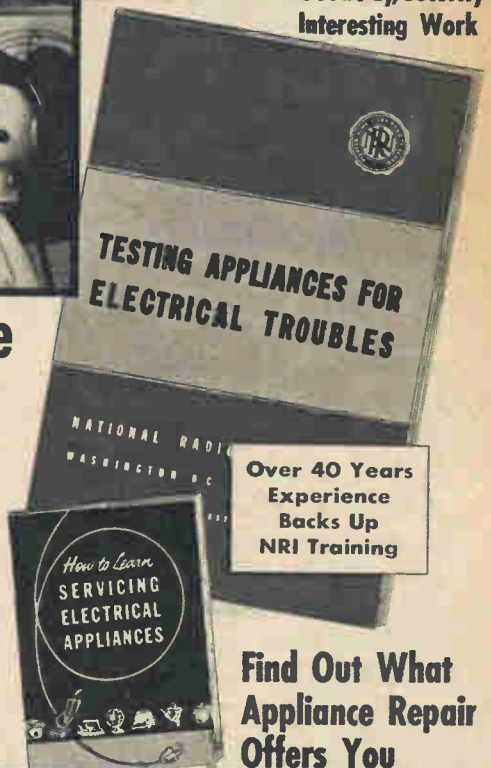

**Find Out What
Appliance Repair
Offers You**



Learn and Earn With Tester Diploma When You Finish

Locate appliance troubles easily with Portable Appliance Tester you build. You use it to learn and do actual electric appliance repair jobs. For only \$3.00 with enrollment and \$6 per month, get training including Tester—a small price to pay for increased earnings. Mail coupon for Sample Lesson and Book—your first step toward more interesting work, bigger earnings. **NATIONAL RADIO INSTITUTE, Dept. KD9, Washington 16, D. C.**

Mail Coupon FOR LESSON AND BOOK FREE

National Radio Institute
Dept. KD9, Washington 16, D. C.
Please send me Electric Appliance Servicing Lesson and Book FREE. (I understand no salesman will call.)

Name.....Age.....

Address.....

City.....Zone.....State.....

ACCREDITED MEMBER NATIONAL HOME STUDY COUNCIL

April, 1959

ELECTRONICS ILLUSTRATED

A Fawcett Publication

Vol. 2 No. 4

April 1959

Contents



A Message From The Editor	4
Electronics In The News	10
The Coming Age Of Sunpower	27
Adapt Your FM For Multiplex	32
All About Computers — 2	36
How To Buy Ham Equipment	40
Hi-Fi Sound From Your TV Set	43
A Stereo Adapter	46
Hi-Fi Clinic	49
Bowling With The Electronic Pinspotter	50
ABC's Of Electronics	52

An Auto Tachometer	55
How To Prepare A Chassis	58
Unique Electronic Clock	61
EI Picturescope	62
Hi-Fi Tester	64
Sell Her On Your Electronic Projects	68
VHF-Your Hometown Shortwave Radio	70
An Experimenter's Control Center	72
Add Years To Your Life	76
Precise 111-K Tube Tester Kit	79
Electronic Brain	82
Try This	85



CHARLES TEPPER.....Editor
Leonard Buckwaller.....Associate Editor
Edward Manas.....Feature Editor
Murray Cooper.....Art Editor
John H. Kane.....Art Associate
Elaine Jaffe.....Editorial Assistant

Larry Eisinger.....Editor-in-Chief
Phyllis Bendremer.....Production Editor
Nancy Kay.....Assistant Production Editor
John F. Webster.....Advertising Manager

Ralph Daigh.....Editorial Director
James Boynton.....Advertising Director
Al Allard.....Art Director
Ralph Mattison.....Associate Art Director
George H. Carl.....Production Director

ELECTRONICS ILLUSTRATED is published monthly by Fawcett Publications, Inc., Fawcett Place, Greenwich, Conn. W. H. Fawcett, Jr., President; Gordon Fawcett, Secretary and Treasurer; Rose Fawcett, General Manager; Roscoe K. Fawcett, Circulation Director.

EDITORIAL AND ADVERTISING OFFICES: 67 West 44th Street, New York 36, N. Y.
Entered as second class matter at the Post Office at Greenwich, Conn. under the Act of March 3, 1879 with additional entry at Louisville, Ky.

Subscription price \$3.00 per year in the U. S. and possessions and Canada. All other countries \$6.00 per year. Foreign subscriptions and sales should be remitted by International Money Order in U. S. funds payable at Greenwich, Conn.

Printed in U.S.A. Copyright 1959 by Fawcett Publications, Inc.
Permission hereby granted to quote from this issue of this magazine on radio or television provided a total of not more than 1,000 words is quoted and credit is given to the title of the magazine and issue, as well as the statement, copyright 1959, by Fawcett Publications, Inc.

Train in New
COYNE
Shops-Labs
for

ELECTRONICS

Today's Top Opportunity
Field!

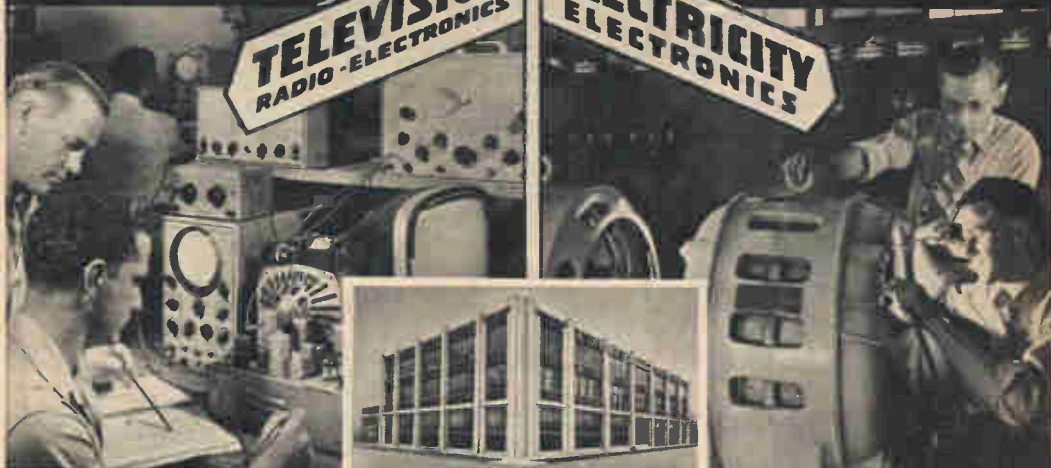

Instructor helping students check the wiring and trace the circuits of television receivers.

This modern fire-proof building which is occupied entirely by Coyne, houses the NEW COYNE SHOP-LABS.

Instructor explaining operation and testing of a large Motor Generator.

TELEVISION-RADIO ELECTRONICS

Here at COYNE you're trained for Testing, Trouble-Shooting and Servicing on AM and FM Radio, Auto Radio, Television, Color TV, etc. Thousands of COYNE trained men in good jobs or own well paying TV-Radio businesses.

WE TRAIN YOU IN CHICAGO

Our famous Practical-Technical method gives you practical experience on a massive outlay of equipment—over a quarter of a million dollars worth—plus necessary technical training right here in the *NEW COYNE Shop-Labs*.

Training in Refrigeration and Electric Appliances can be included.

Training offered
to **VETERANS** and
NON-VETS alike

ELECTRICITY ELECTRONICS

Big opportunities everywhere—city, town and country, in Power Plant Work, Motors, Industrial Electronics, Armature Winding, Home and Factory Wiring, Appliances, Refrigeration, Maintenance, Illumination, etc.

START NOW—PAY LATER

Enroll now, pay most of tuition after Graduation. Part time employment help for students. Lifetime employment service to Graduates. Starting dates, every six weeks.

**OLDEST AND BEST
EQUIPPED SCHOOL OF ITS
KIND IN THE U. S.**

Send Coupon or Write for

FREE BOOK

"GUIDE TO CAREERS"

Whether you prefer Electricity—Television—Radio or Combined Electronics Training this book describes all training offered.

Information comes by mail and no salesman will call.



To get Free Book and information, mail this Coupon in envelope or Paste on Postal Card, or write to address below.

COYNE ELECTRICAL SCHOOL
Dept. 49-8A, New Coyne Building
1501 W. Congress Pkwy., Chicago 7, Ill.

At no obligation to me send FREE book "Guide to Careers" and details of all the training you offer.

Name _____

Address _____

City _____ State _____

(I understand no Salesman will call.)

B. W. COOKE, JR., President

COYNE
ELECTRICAL SCHOOL

FOUNDED 1899

CHARTERED AS AN EDUCATIONAL INSTITUTION NOT FOR PROFIT
1501 W. Congress Parkway, CHICAGO, Dept. 49-8A
ELECTRICITY • RADIO • TELEVISION • REFRIGERATION • ELECTRONICS

April, 1959

A Message From the Editor



Blind radio hobbyist uses a braille-calibrated voltmeter to test electronic project he built. "Reading" is audible.

Next month we'll include the plans for radio-controlled ferryboat shown here. It's a sensation at local ponds.



ALMOST all TV manufacturers now use printed circuits in their receivers—yet one manufacturer loudly proclaims that his receivers do not contain any printed circuit boards. Are printed circuit boards bad, do sets using them require more service calls? The RCA Service Company recently undertook a study of this question and found that of 5000 service calls on equipment containing printed circuits less than one trouble call in 50 had anything to do with the circuit boards themselves. Another six month analysis of service calls throughout the country indicated that on the average, an active technician had to replace a circuit board in a TV set only once in 5000 calls. This factual study would seem to dispel the suspicion with which many people look on printed circuitry.

This seems to be the time for surveys and here are the results of another interesting one. Of 513 FM broadcasters contacted recently, 65 are now multiplexing commercial background music to restaurants, industrial buildings, etc., simultaneously with their regular programming and another 61 plan to be multiplexing by next year. Most of these stations are seriously contemplating stereo multiplexing when and if F. C. C. approval is obtained. Are you prepared to receive stereo on your FM tuner? If not, the article starting on page 32 of this issue will tell you how to adapt your present FM tuner to receive multiplex broadcasts.

In our January issue I asked for suggestions from readers for article topics for our 1959 issues. I was slightly overwhelmed by the response. So many of your suggestions are useable that it would be useless for me to mention them now, however, I intend very soon to give you a report on some of our work

Men 17 to 55—GET FREE FACTS!

See How **DeVry Tech** Can Prepare You For A Profitable Future In Many Fields

from **Communications** to **Guided Missiles, etc.**



No Previous Technical Experience Or Advanced Education Needed!





Laborers and bookkeepers, store clerks, shop men, farmers, salesmen — men of nearly every calling — have taken the DeVry Tech program and today have good jobs or service shops of their own in Electronics. You don't have to quit your present job. If you are 17 to 55, see how you may get yourself ready for a future in the fast-growing Electronics field.

Whether you prepare at home or in our well-equipped Chicago or Toronto Laboratories, you get sound, basic training in both principles and practice. At home, you use educational movies. You build actual circuits and test equipment. You read simple directions, follow clear illustrations. When you finish, you are prepared to step into a good job in this excitingly different field. You may even start a service shop of your own. Mail coupon for free facts today.

Get **FREE** Booklet!

We'll give you a free copy of an interesting booklet, "Electronics and YOU." See for yourself how you may take advantage of the opportunities in this fast-growing field.



	Radar
	Automation Electronics
	Television
	Micro-Waves
	Computers
	Broadcasting
	Your Own Service Shop



FREE EMPLOYMENT SERVICE

Put you in touch with job opportunities — we help you toward a better position in the plant where you are now employed.

Draft Age?

We have valuable information for every man of draft age, so if you are subject to military service, be sure to check the coupon.

DeVry Technical INSTITUTE

Chicago 41, Illinois

Formerly DeFOREST'S TRAINING, INC.

"One of North America's Foremost Electronics Training Centers"
Accredited Member of National Home Study Council



DeVry Technical Institute
4141 Belmont Ave., Chicago 41, Ill., Dept. EI-4-P
Please give me your FREE booklet, "Electronics and YOU," and tell me how I may prepare to enter one or more branches of Electronics as listed above.

Name _____ Age _____
Street _____ Apt. _____
City _____ Zone _____ State _____

Check here if subject to Military Training.
DeVry Tech's Canadian Training Center is located at 626 Roselawn Avenue, Toronto 12, Ontario

2040

GET MORE WORK OUT OF YOUR OSCILLOSCOPE



The book that
TELLS you how—SHOWS
you how!

Learn to service ANY radio
or TV faster . . . with the
handiest instrument of all!

Here, in a new 2nd edition, is
THE book that really shows you
how to use oscilloscopes!

Clearly as A-B-C, MODERN
OSCILLOSCOPES AND
THEIR USES tells you exactly
when, where and how. You learn
to locate either AM or FM radio
or television troubles in a jiffy.
Tough realignment jobs are
made easy. No involved mathe-
matics! Every detail is clearly
explained from making connec-
tions to adjusting circuit con-

ponents and setting oscilloscope controls. And you learn to
analyze patterns fast and RIGHT!

Includes latest data on quantitative measurements (the sick-
est method of handling many color TV troubles); using
'scopes in industrial electronics, teaching . . . even in atomic
energy work. Contains 326 pages and over 400 clear pictures.
Dozens of pattern photos make things doubly clear. Price only
\$6.50. Use coupon for 10-day free trial.

DON'T THROW OLD RADIOS AWAY!



This giant book shows
exactly how to fix them
. . . without a lot of
previous experience!

Just look up the how-to-do-it data on that
old radio you want to fix!

Four times out of 5, this giant, 3½-
pound, 744-page Ghirardi RADIO TROUBLESHOOTER'S
HANDBOOK gives exactly the information you need. Tells
what is likely to be causing the trouble . . . shows how to
fix it. Covers practically every radio receiver model made
by 202 manufacturers between 1925 and 1942. Using it, even
beginners can easily fix old sets which might otherwise be
thrown away because service information is lacking. With a
few simple repairs, most of these old sets can be made to
operate perfectly for years to come.

Included are common trouble symptoms and their remedies
for over 4,800 models of old home, auto radios and record
changers; Airline, Apex, Arvin, Atwater Kent, Belmont,
Bosch, Brunswick, Clarion, Crosley, Emerson, Fada, G-E,
Kolster, Majestic, Motorola, Philco, Pilot, RCA, Silvertone,
Sparton, Stromberg and dozens more. Includes hundreds of
pages of invaluable old time tube and component data, service
short cuts, etc. Price \$6.95—10-day free trial.

-----PRACTICE 10 DAYS FREE!-----

Dept. PR-49, RINEHART & CO., INC.,
232 Madison Ave., New York 16, N. Y.

Send book(s) checked below for free examination. In 10 days,
I will either send price shown (plus postage) or return books
postpaid and owe nothing.

MODERN OSCILLOSCOPES AND THEIR USES, \$6.50 RADIO TROUBLESHOOTER'S
HANDBOOK, \$6.95

SAVE! Send cash with order and we pay postage. Same 10-
day return privilege.

Name _____

Address _____

City, Zone, State _____

OUTSIDE U.S.A.—Add \$0c to each book, cash with order only.
Same 10-day return privilege with money refunded.

in progress which you will see published
this year. At the moment, however, I
would like to assure you that we will
continue to welcome your suggestions.

In this issue, on page 40, is our tape
recorded interview with Bob Gunderson
who answered our questions on how to
buy amateur radio equipment for both
the beginner and those who are ready
to progress past the novice stage. Bob
Gunderson is one of the most interest-
ing people we know both because of his
excellent knowledge of electronics and
amateur radio and because of the pion-
neering work he has done toward help-
ing blind youths develop a facility in
electronics. He has obtained jobs in the
electronics industry for over 200 of the
people he has trained. Standing in a
laboratory next to one of the techni-
cians is an inspiring experience. We
watched them cut out chassis holes,
mount components, solder in wiring and
perform tests on a circuit with braille-
calibrated meters. Bob is editor of a
monthly magazine called the Braille
Technical Press which he sends to blind
people all over the country. In it are
articles on electronics which he writes
as well as reprints of articles from maga-
zines such as this. He would like to
print and distribute more than the
seven or eight hundred he now pub-
lishes. However, he needs outside help
to do this because the amount that his
subscribers pay for this magazine is not
sufficient to cover the cost of publishing
it. We can't think of a more worthwhile
endeavor deserving of your support.
Bob points out that donations to the
Braille Technical Press are income tax
deductible. Checks should be made out
to the Braille Technical Press and sent
to the New York Institute for the Edu-
cation of the Blind, 999 Pelham Park-
way North, Bronx, New York.

Our May issue is full of interesting
items for you to build. These include a
specially designed radio-controlled
ferryboat, a bass reflex enclosure for
any size loudspeaker and a wind speed
indicator.

Charles Tupper

BIG JOB BOOM FORECAST!

Can You Get Ready in Time?

Right now job opportunities are tight all along the line. Economists now predict a period of mild ups and downs. Look for the "big break" to come in the next three years, they say. That's when good jobs will open up as never before. And men who are preparing themselves *now* will ride the crest of the boom.

DARK OUTLOOK FOR UNSKILLED WORKERS

Those with little or no training will find the going tough. Fewer openings. More competition for existing jobs. The tide is against the unskilled worker. It's getting stronger. Nor will the boom help. The new opportunities will go first to the skilled, next to the semi-skilled.

BIGGEST DEMAND IN THESE FIELDS

What's ahead? According to the best estimates, here are the industries due for the sharpest employment rise: Heavy transportation equipment. Mechanical, electrical, chemical, aeronautical and highway engineering. Industrial electronics.

All metals. Business services. Natural gas and oil. Paper products. On the other end of the scale, employment may lag in agriculture and leather. Check the trends in *your* field. Are you prepared to switch, if necessary?

GETTING YOURSELF READY—NOW

All the experts agree: Education, skill, specialized training will net the greatest rewards in the coming boom. The time you spend improving yourself is perhaps the wisest investment you can make *right now*. Your future success and happiness could hinge on your mastering a certain subject or acquiring a special skill. But there are obstacles. You may have a family to support. Or a job to hold down. You may feel you're too old to learn.

HOW I.C.S. CAN HELP YOU

For the man who can take his training hard and fast—without time off from his job or heavy expense—I.C.S. offers real advantages. A total of 259 courses to choose from (see partial list below). A spare-time

method that lets you progress as rapidly as you're able. Up-to-date, authoritative text material. Thorough, personalized instruction. Industry-recognized diploma to graduates. I.C.S. is the oldest and largest school accredited by the Accrediting Commission of the National Home Study Council. Its long list of successful graduates reads like "Who's Who."

Can you be ready for the next job boom? You can if you act quickly. Your first step: mark and mail the coupon below. What you do right this minute may determine how you make out in the coming boom!

THREE FREE BOOKS TELL HOW TO MEET NEXT JOB BOOM

Get the details on the fields that offer the best jobs in the immediate future. Get these three valuable books free—(1) "How to Succeed"—pocket-size guide to advancement, (2) Sample lesson (Math.) demonstrating the I.C.S. method, (3) Opportunity catalog on the subject you check in the coupon. Just mail the coupon.

For Real Job Security—Get an I. C. S. Diploma! I. C. S., Scranton 15, Penna.

Accredited Member,
National Home Study Council

INTERNATIONAL CORRESPONDENCE SCHOOLS



BOX 87423C, SCRANTON 15, PENNA.

(Partial list of 259 courses)

Without cost or obligation, send me "HOW TO SUCCEED" and the opportunity booklet about the field BEFORE which I have marked X (plus sample lesson):

ARCHITECTURE and BUILDING CONSTRUCTION

- Air Conditioning
- Architecture
- Arch. Drawing and Designing
- Building Contractor
- Building Estimator
- Carpenter Builder
- Carpentry and Millwork
- Carpenter Foreman
- Heating
- Painting Contractor
- Plumbing
- Reading Arch. Blueprints

ART

- Commercial Art
- Magazine Illus.
- Show Card and Sign Lettering
- Sketching and Painting

AUTOMOTIVE

- Automobile
- Auto Body Rebuilding and Refinishing
- Auto Engine Tuneup
- Auto Technician

AVIATION

- Aero-Engineering Technology
- Aircraft & Engine Mechanic

BUSINESS

- Accounting
- Advertising
- Business Administration
- Business Management
- Cost Accounting
- Creative Salesmanship
- Managing a Small Business
- Professional Secretary
- Public Accounting
- Purchasing Agent
- Salesmanship
- Salesmanship and Management
- Traffic Management

CHEMICAL

- Analytical Chemistry
- Chemical Engineering
- Chem. Lab. Technician
- Elements of Nuclear Energy
- General Chemistry
- Natural Gas Prod. and Trans.
- Petroleum Prod. and Engr.
- Professional Engineer (Chem)
- Pulp and Paper Making

CIVIL ENGINEERING

- Civil Engineering
- Construction Engineering
- Highway Engineering
- Professional Engineer (Civil)
- Reading Struc. Blueprints
- Sanitary Engineering
- Structural Engineering
- Surveying and Mapping

DRAFTING

- Aircraft Drafting
- Architectural Drafting
- Drafting & Machine Design
- Electrical Drafting
- Mechanical Drafting
- Sheet Metal Drafting
- Structural Drafting

ELECTRICAL

- Electrical Engineering
- Elec. Engr. Technician
- Elec. Light and Power
- Practical Electrician
- Practical Lineman
- Professional Engineer (Elec)
- High School Diploma

HIGH SCHOOL

- High School Diploma

- Good English
- High School Mathematics
- High School Science
- Short Story Writing

LEADERSHIP

- Industrial Foremanship
- Industrial Supervision
- Personnel-Labor Relations
- Supervision

MECHANICAL and SHOP

- Diesel Engines
- Gas-Elec. Welding
- Industrial Engineering
- Industrial Instrumentation
- Industrial Metallurgy
- Industrial Safety
- Machine Shop Practice
- Mechanical Engineering
- Professional Engineer (Mech)
- Quality Control
- Reading Shop Blueprints
- Refrigeration and Air Conditioning
- Tool Design Tool Making
- RADIO, TELEVISION
- General Electronics Tech.

INDUSTRIAL ELECTRONICS

- Industrial Electronics
- Practical Radio-TV Eng'g
- Practical Telephony
- Radio-TV Servicing

RAILROAD

- Car Inspector and Air Brake
- Diesel Electrician
- Diesel Engr. and Fireman
- Diesel Locomotive

STEAM and DIESEL POWER

- Combustion Engineering
- Power Plant Engineer
- Textile Diesel Engr.
- Stationary Fireman

TEXTILE

- Carding and Spinning
- Cotton Manufacture
- Cotton Warping and Weaving
- Loom Fixing Technician
- Textile Designing
- Textile Finishing & Dyeing
- Throwing
- Warping and Weaving
- Worsted Manufacturing

Name _____ Age _____ Home Address _____
 City _____ Zone _____ State _____ Working Hours _____ A.M. to P.M. _____
 Occupation _____

Canadian residents send coupon to International Correspondence Schools, Canadian, Ltd., Montreal, Canada. . . . Special tuition rates to members of the U. S. Armed Forces.

NOW the Columbia Record Club offers BOTH **STEREOPHONIC** *at Tremendous*



1. Johnny sings What'll I Do, Warm, White We're Young, 9 more



2. This vivid musical painting has become an American classic

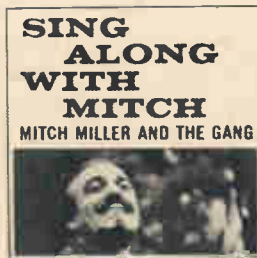

3. 16 favorites—Sweet Violets, Down by the Old Mill Stream, etc.



4. Pianistic fireworks abound in these two romantic scores

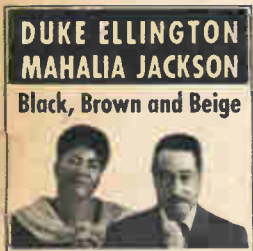

9. The finest performance ever of the Duke's masterpiece



14. Cugi's greatest hits—Besame Mucho, Tico-Tico, Brazil, 9 more



15. The most popular of Tchaikovsky's lovely, melodious symphonies

FREE ANY 3

OF THESE SUPERB

COLUMBIA and EPIC RECORDS (AVAILABLE IN STEREOPHONIC SOUND OR MONAURAL HIGH FIDELITY)

If you join the Columbia  Record Club now—and agree to purchase 4 selections during the coming 12 months

Yes, now you can acquire the world's finest stereophonic AND high-fidelity monaural recordings — at truly substantial savings! And as a dramatic demonstration of the Columbia  Record Club's money-saving Bonus Plan — you may have, at once, ANY 3 of the sixteen records shown here, FREE . . . available in your choice of stereophonic sound OR monaural high fidelity!

HOW THE CLUB SAVES YOU MONEY

Your only membership obligation is to purchase four selections from the almost 200 Columbia and Epic records to be offered in the coming 12 months. Thus you receive seven records for the price of four — a saving of more than one-third on your record purchases.

Furthermore, after buying four selections you receive your choice of a Columbia or Epic Bonus record (stereo or monaural) free for every two additional selections you buy.

HOW THE CLUB OPERATES

You enroll in any one of the six Club Divisions: If you have stereo equipment you enroll in either

the Stereo Classical or Stereo Popular Division.

If you have monaural equipment you enroll in any one of four Divisions: Classical; Listening and Dancing; Broadway, Movies, Television and Musical Comedies; Jazz.

Each month the Club's staff of musical experts selects outstanding recordings from every field of music. These selections are described in the Club Magazine, which you receive free each month.

You may accept or reject the selection for your Division, take any of the other records offered (stereo or monaural), or take NO record in any particular month. You may discontinue membership at any time after purchasing four records.

The records you want are mailed and billed to you at the regular list price: Popular Monaural Selections, \$3.98; Classical Monaural, \$4.98; all Stereo Records, \$5.98 — plus a small mailing charge.

To receive your three stereo or monaural records FREE, fill in and return the coupon today!

COLUMBIA  RECORD CLUB
 Terre Haute, Indiana

Electronics Illustrated

and MONAURAL RECORDS Savings!



5. Where or When, The Way You Look Tonight, Be My Love, 9 more



6. 43 hits for listening and dancing—in the smooth Lanin style



7. The ingratiating Miss Holliday in her biggest Broadway hit



8. Bernstein's exciting performances of two colorful scores



10. A truly magnificent performance of this majestic symphony



11. The great tunes from Rodgers and Hammerstein's fabulous hit



12. The two fiery Rumanian Rhapsodies—plus 2 more works

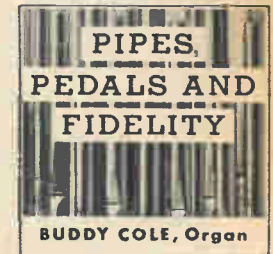

13. Organist Buddy Cole plays 11 tunes—Mine, Caravan, Carioca, etc.



16. Available in stereo only, 16 popular and classical selections

FREE — ANY 3 — MAIL COUPON NOW

COLUMBIA RECORD CLUB, Dept. 271-3
Terre Haute, Indiana

Please send me as my FREE gift the 3 records whose numbers I have circled at the right — and enroll me in the following Division of the Club: (check one box only)

MONAURAL DIVISIONS		STEREO DIVISIONS	
<input type="checkbox"/> Classical	<input type="checkbox"/> Broadway, Movies, Television and Musical Comedies	<input type="checkbox"/> Stereo Classical	<input type="checkbox"/> Stereo Popular
<input type="checkbox"/> Listening & Dancing			
<input type="checkbox"/> Jazz			

I agree to purchase four selections from the almost 200 stereophonic and monaural records to be offered during the coming 12 months, at regular list price plus small mailing charge. For every two additional selections I accept, I am to receive a Columbia or Epic Bonus record (stereo or monaural) of my choice FREE.

Name.....
(please print)

Address.....

City..... Zone..... State.....

CANADA: prices slightly higher, address 11-13 Soho St., Toronto 2E
If you want this membership credited to an established Columbia or Epic record dealer, authorized to accept subscriptions, fill in below:

Dealer's Name.....

Dealer's Address..... 215-1

© Columbia Records Sales Corp., 1959 "Columbia," "Epic,"

CIRCLE 3 NUMBERS BELOW:

(Indicate here whether you want your 3 records in Stereo or Monaural):

STEREO MONAURAL
L-50 L-49

1. Johnny Mathis — Warm
2. Grofe: Grand Canyon Suite
3. Sing Along With Mitch Miller
4. Grieg Piano Concerto; Rachmaninoff Rhapsody
5. 'S Marvelous — Ray Conniff
6. Lester Lanin at the Tiffany Ball
7. Bells Are Ringing — Original Broadway Cast
8. Firebird; Romeo and Juliet
9. Black, Brown and Beige
10. Beethoven: Eroica Symphony
11. Percy Faith Plays "South Pacific"
12. Rumanian Rhapsodies 1, 2; plus two more works
13. Pipes, Pedals and Fidelity
14. Cugat Cavalcade
15. Tchaikovsky: Pathetique Symphony
16. Listening in Depth (Available in stereo only)

Marcas Reg.



Electronics in the News

Television now commands the Tokyo skyline with the erection of a 1,092-foot Eiffel-like antenna tower. This Japanese skyscraper is 118 feet taller than the original French version. Atop the tower are the broadcast antennas of the Nippon Television City Company for telecasts to the greater Tokyo area. Studios are at the foot of the tower. The observation platform is open to visitors.

The two photos below compare some of the electronic equipment in the U.S. Atlas satellite (left) with that in the Russians' new artificial planet. In the hand at left is a 10-ounce transistor receiver which picks up messages from Earth. The unit behind it activates the magnetic tape recorder. The round unit in the front sends out the steady tracking signal. The Russian device at the right is used for measuring ion composition and density in the environment of the satellite.

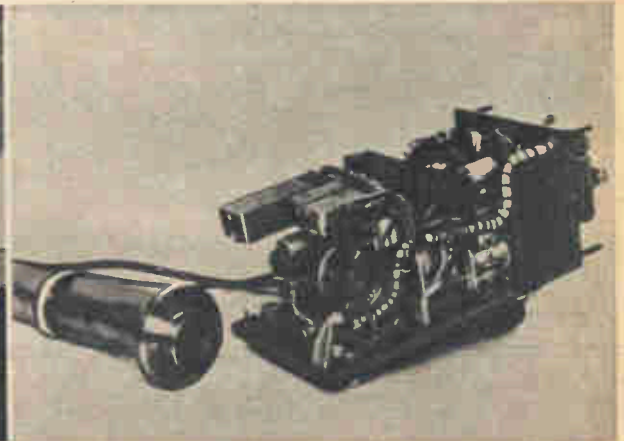
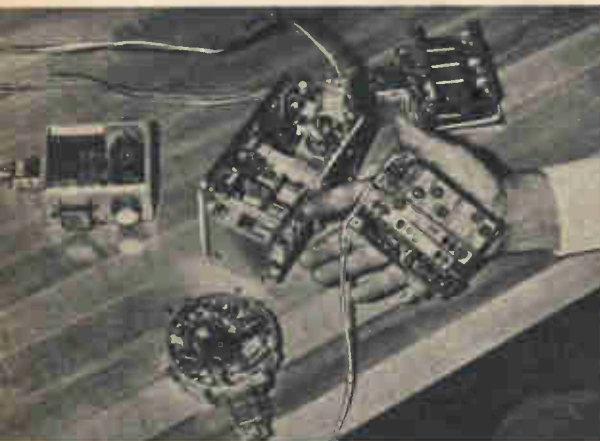

Get into

TELEVISION RADIO-ELECTRONICS



**LEARN ALL 8 PHASES
BY SHOP METHOD**

1. Television . . . including Color TV
2. Radio . . . AM, FM
3. Industrial Electronics
4. Communications

**OF THE INDUSTRY
HOME TRAINING**

5. Sound Recording & Hi-Fidelity
6. Automation
7. FCC License Preparation
8. Radar & Micro Waves

Let National Schools of Los Angeles, a Practical Resident Technical School for over 50 years, train you at home by Shop-Method for unlimited opportunities in All phases of TV, Electronics, Radio

**You get 19 big kits
of equipment!**

GOOD JOBS . . . MORE MONEY SECURITY . . . ALL CAN BE YOURS

YOU are needed in the great modern Television-Electronics industry. Trained technicians are in growing demand, at excellent pay, in sales and service, manufacturing, broadcasting, telecasting, communications, research, and many other important branches of the field. National Schools Master Shop-Method Training, with newly added lessons and equipment prepares you in your spare time right in your own home for these fascinating opportunities. **OUR OUTSTANDING METHOD IS PROVED BY THE SUCCESS OF GRADUATES ALL OVER THE WORLD!**

YOUR TRAINING IS ALL INCLUSIVE

We prepare you for a long list of job opportunities. Thousands of TV and Radio receivers are being sold every day—more than ever before. And, now, Color TV is here. Applications of Electronics in industry—**AUTOMATION**—are growing in tremendous strides. The whole field is alive—opening up new, important jobs rapidly. National Schools complete training program qualifies you in all phases of the industry.

YOU EARN WHILE YOU LEARN

Many students pay for their entire training— and more— with spare time earning. We'll show you how you can, too! Early in your course you receive material that shows you how to earn extra money servicing TV and Radio receivers, appliances, etc., for friends and acquaintances.

YOU GET EVERYTHING YOU NEED

Clear, profusely illustrated lessons, shop-tested manuals, modern circuit diagrams, practical job projects—all the valuable equipment shown above—many other materials and services—consultation privilege with our qualified staff, and Graduate Employment Service. **EVERYTHING YOU NEED** for outstanding success in Electronics.

INDUSTRY NEEDS YOU. NATIONAL SCHOOLS WILL TRAIN YOU. SEND FOR FACTS TODAY NO OBLIGATION.

YOU LEARN BY SHOP METHOD . . . you do servicing, circuit analysis, and do over 100 down-to-earth experiments. You build a Suphet Receiver and a modern TV Receiver, from the ground up, including a new, big screen picture tube. You also receive a professional, factory-made **MULTI-TESTER**. All of this standard equipment is yours to keep . . . at just one low tuition.

RESIDENT TRAINING AT LOS ANGELES

If you wish to take your training in our Resident School at Los Angeles, the world's TV capital, start NOW in our big modern Shops, Labs and Radio-TV Studios. Here you work with latest Electronic equipment - professionally installed Electronic equipment - finest, most complete facilities offered by any school. Expert, friendly instructors. Personal attention. Graduate Employment Service. Help in finding home near school - and part time job while you learn. Check box in coupon for full information.

Approved for
GI Training



NATIONAL SCHOOLS

LOS ANGELES 37, CALIF.

**FREE!
VALUABLE BOOK
& SAMPLE LESSON
- Just Send
Coupon!**



**YOUR FUTURE
IN RADIO
TELEVISION**

NATIONAL SCHOOLS

TECHNICAL TRADE TRAINING SINCE 1905
LOS ANGELES 37, CALIFORNIA

GET FAST SERVICE—MAIL NOW TO

NATIONAL SCHOOLS, DEPT. R4Y-39
4000 S. FIGUEROA ST. LOS ANGELES 37, CALIF.

Rush free TV-Radio "Opportunity" Book and sample lesson. No salesman will call.

NAME _____ AGE _____

ADDRESS _____

CITY _____ ZONE _____ STATE _____

Check if interested ONLY in Resident School training at Los Angeles. VETERANS. Give date of Discharge.

FREE CAREER BOOKLET



To guide you to a successful future in **ELECTRONICS RADIO-TV COMPUTERS ELECTRICAL ENGINEERING**

This interesting pictorial booklet tells you how you can prepare for a dynamic career as an Electrical Engineer or Engineering Technician in many exciting, growing fields:

**MISSILES • AVIONICS • AUTOMATION
SALES • DEVELOPMENT
ELECTRICAL POWER • ROCKETRY
RADAR • RESEARCH**

Get all the facts about job opportunities, length of study, courses offered, degrees you can earn, scholarships, part-time work — as well as pictures of the Milwaukee School of Engineering's educational and recreational facilities. No obligation — it's yours free.

MILWAUKEE SCHOOL OF ENGINEERING

MAIL COUPON TODAY!

Milwaukee School of Engineering
Dept. EI-459, 1025 N. Milwaukee St., Milwaukee, Wis.

Please send FREE "Your Career" booklet

I'm interested in

Electronics Radio-TV Computers
 Electrical Engineering Mechanical Engineering

Name..... Age.....
PLEASE PRINT

Address.....

City..... Zone..... State.....

I'm eligible for veterans education benefits.
Discharge date..... MS-117

...News



C & D Products of Old Marlboro Road, East Hampton, Conn., has announced a new dual function record cleaner—the "Stardust." It permits the record to be washed in running water without damage to either label or record and serves as an air-tight container for the sponge. The two plastic halves hold the record during washing and wiping to avoid prints on the playing surface. \$3.95. A descriptive circular is available from the manufacturer.



RCA is now marketing a line of factory-rebuilt TV picture tubes with a 1-year warranty. The "Monogram" line will sell for approximately 35% less than the all-new "Silverama" tubes with the return of an acceptable old picture tube.



LET RCA TRAIN YOU IN ELECTRONICS

RCA Institutes celebrates Fifty Years of Electronic Training by introducing its newest Home Study Course . . .

ELECTRONICS FOR AUTOMATION

. . . Now you have *four* comprehensive courses for your electronic training . . . from basic electronic theory to the more advanced principles of color TV and Automation.

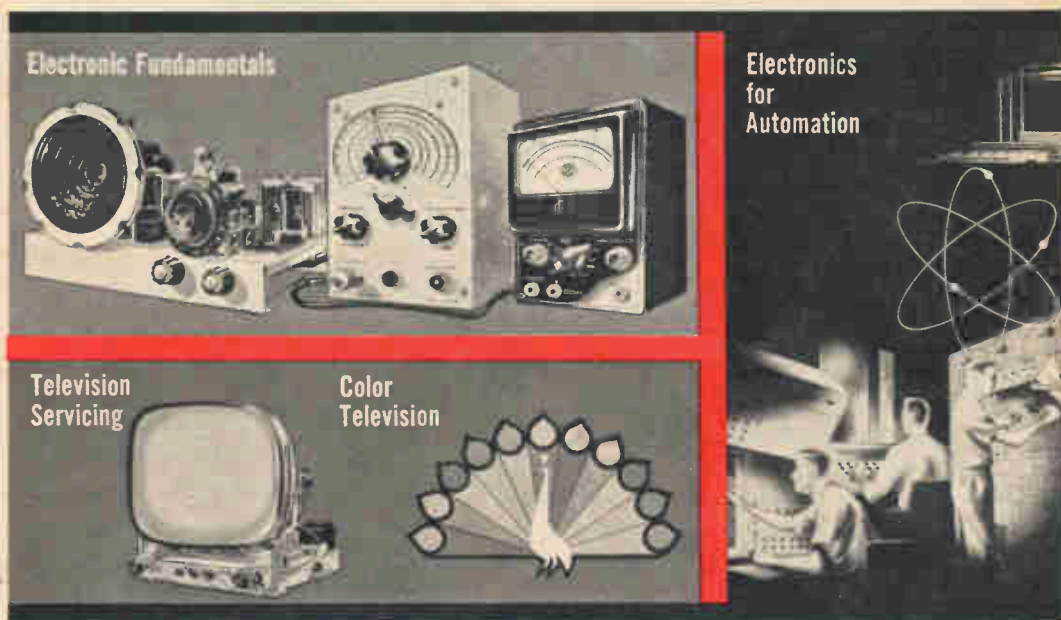

Send for our
64 page Home
Study Catalog

FREE!

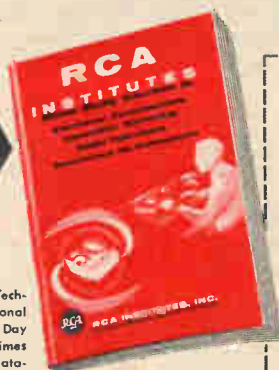

RESIDENT SCHOOL offers Technical Institute and Vocational School Courses in Electronics. Day and Evening classes start 4 times each year. Resident School Catalog sent free on request.

Practical work with the very first lesson. Pay-as-you-learn. You need pay for only one study group at a time.

RCA INSTITUTES, Inc. Home Study School, Dept. EI-49

A Service of Radio Corporation of America

350 West Fourth Street, New York 14, N. Y.

Without obligation, send me the FREE catalog of Home Study Courses. No salesman will call.

Name

Please print

Address

City..... Zone..... State.....

Korean Vets! Enter Discharge Date.....

CANADIANS — Take advantage of these same RCA courses at no additional cost. No postage, no customs, no delay. Send coupon to: RCA Victor Company, Ltd., 5001 Cote de Liesse Rd., Montreal 9, Quebec
To save time, paste coupon on postcard.



It's easy to master
BASIC ELECTRICITY
BASIC ELECTRONICS
The Rider 'picture-book' way

**Fabulous illustrated training course now used by
U. S. Navy—No Other Books Like Them!**

A Complete Idea on Every Page

Here's how this easy, illustrated course works: every page covers one complete idea! There's at least one big illustration on that same page to explain it! What's more, an imaginary instructor stands figuratively at your elbow, doing "demonstrations" that make it even easier for you to understand. Then, at the end of every section, you'll find review pages that highlight the important topics you've just covered. You build a thorough, step-by-step knowledge at your own pace—as fast as you yourself want to go! Sponsored by the Navy to turn out trained technicians in record time, this modern course presents Basic Electricity and Basic Electronics in a simple way that everyone can grasp—regardless of previous education!

10 Complete Volumes

BASIC ELECTRICITY—Volumes 1 and 2 cover DC components and circuits; Volumes 3 and 4 cover AC components and circuits; Volume 5 covers AC and DC motors and machinery.

BASIC ELECTRONICS—Volume 1 covers Diodes and Power Supplies; Volumes 2 and 3 cover Amplifiers and Oscillators; Volumes 4 and 5 cover Transmitters and Receivers.

Home Study Without Correspondence

This course is so different, so complete—there's no need for the usual letter writing, question and answer correspondence! Learn at home—at your own pace!

10 Day Examination — Money Back Guarantee

Send today for these exciting new training courses—*you risk nothing!* When you receive the volumes, examine them in your own home for 10 full days. If, at the end of that time, you're not completely satisfied, simply return the books to us and we'll gladly refund your full purchase price! Total cost for either 5-volume course is only \$10.00! In Canada, prices approximately 5% higher.

FOR A CAREER IN ELECTRONICS—MORE HOBBY FUN

HIGH FIDELITY SIMPLIFIED (3rd Edition) by Harold D. Weiler, #142, \$2.50

STEREOPHONIC SOUND by Norman H. Crowhurst, #209, \$2.25

HOME AIR CONDITIONING—Installation & Repair by J. Derman, F. Makstein, H. Seaman, #211, \$3.50

GETTING STARTED IN AMATEUR RADIO by Julius Berens, W2PIK, #199, \$2.40

HOW TO TROUBLESHOOT A TV RECEIVER (2nd Edition) by J. Richard Johnson, #152, \$2.50

HOW TO SELECT & USE YOUR TAPE RECORDER by David Mark, #179, \$2.95

ORDER TODAY!

Available at electronic parts jobbers, or use coupon.

10-DAY UNCONDITIONAL MONEY-BACK GUARANTEE

JOHN F. RIDER PUBLISHER, INC., Dept. EI-4
116 West 14th St., New York 11, N. Y.

I have enclosed \$..... Please send me:

- BASIC ELECTRICITY, 5 vol. soft cover set, \$10.00;
Cloth Bound \$11.50
- BASIC ELECTRONICS, 5 vol. soft cover, \$10.00;
Cloth Bound \$11.50
- #142, \$2.50 #209, \$2.25 #211, \$3.50
- #199, \$2.40 #152, \$2.50 #179, \$2.95

Name.....
Address.....
City.....Zone.....State.....

In Canada 5% higher; add city and state sales taxes where applicable.
GUARANTEE: Satisfaction guaranteed. All books returnable within 10-days for full refund.

...News

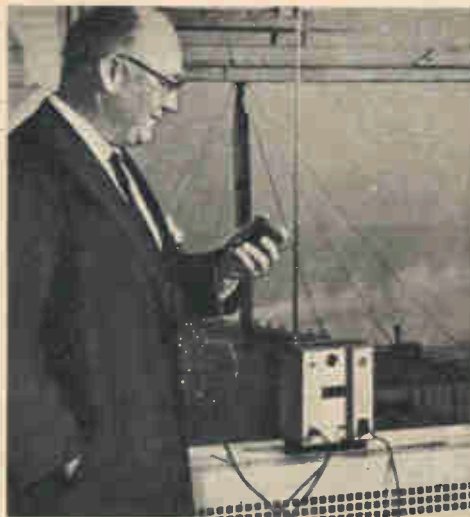

A two-way radio for the new citizens band on 27 mc has just been announced by RCA. The "Radio-Phone" operates on the citizens band frequencies recently set aside by the FCC for personal use. This band is open to all citizens of the U. S. over 18 years of age.

The "Radio-Phone" is capable of voice transmission over a distance of several miles. It sells for about \$100 per unit and two are needed for two-way conversation.

The unit weighs about 10 pounds and operates from a 6 or 12-volt battery or a 115-watt AC power source.



Stromberg-Carlson is now manufacturing and marketing high fidelity auto radios. The new radios feature transistor push-pull amplifiers, seven tuned circuits and an RF stage. The use of transistors in the audio amplifier reduces hum and noise pickup.

The radios are available in two models, one with a signal seeking tuner, the other with a standard manual tuner, shown above.

Build the best... build **knight-kits**

A PRODUCT OF ALLIED RADIO



Featured in
ALLIED'S
1959 Catalog

Free!



with exclusive **"CONVENIENCE ENGINEERING"**

Send for catalog describing in detail the complete KNIGHT-KIT line. See **everything** in Hi-Fi, Hobby, Test Instrument and Amateur kits. KNIGHT-KITS are lowest in cost, "convenience engineered" for easiest building, latest in design—the kits with guaranteed specifications that assure superior performance. Get the latest Allied Catalog—see the new, outstanding 1959 KNIGHT-KITS...

SAVE UP TO

50%

EASY TERMS
ON ORDERS
AS LOW AS \$20

send for it... **SEE DOZENS OF TYPICAL knight-kit VALUES LIKE THESE**



Top Value 12-Watt Complete Hi-Fi Amplifier Kit

Model Y-784

\$19.95

(less cover)
\$2.00 down

Never before has there been so much solid hi-fi value and quality performance at such low cost. **Guaranteed specifications:** frequency response, 30-15,000 cps $\pm 1\frac{1}{2}$ db at half power; less than 1% distortion at full power. **Has 15 db of inverse feedback.** With preamp stage equalized for magnetic cartridge; inputs for phono and tuner; separate bass and treble with boost and attenuation. 5 x 9 $\frac{1}{4}$ x 7" with cover (cover \$3.95 extra). 7 $\frac{1}{2}$ lbs.



Thrilling "Space Spanner" Receiver Kit

Model Y-259

\$18.95

Thrilling 2-band receiver, easy to build, fun to operate—a terrific value. Bandswitch selects exciting short-wave, including foreign broadcasts, amateur, aircraft, police and marine radio (6.5 to 17 mc), and standard broadcast. Highly sensitive regenerative circuit. Built-in 4" PM speaker and beam power output for strong volume. Headphone jacks and switch to cut out speaker. Handsome cabinet, 7 x 10 $\frac{1}{2}$ x 6". AC or DC operation. 7 $\frac{1}{2}$ lbs.

there is a money-saving **knight-kit** for every electronic need

HI-FI KITS

60-Watt Stereo Amplifier
Stereo Deluxe Preamp
Stereo Control
18-Watt Amplifier
25-Watt Basic Amplifier
30-Watt Amplifier
FM-AM Tuner
FM Tuner
Hi-Fi Preamplifier
Speaker Systems, etc.

HOBBY KITS

"Span Master" 4-Band Receiver
"Ranger" Radios
Clock-Radio
Radio-Intercom
"Ocean Hopper" Radio
5-Transistor Portable
2-Transistor Pocket Radio
1-Transistor Radio
Electronic Lab Kits
Photoelectric System, etc.

INSTRUMENT KITS

Tube Checkers
5" Oscilloscopes
VTVM
VOM's
RF Signal Generator
Signal Tracer
Audio Generator
Sweep Generator
Capacitor Checker
R/C Tester

Transistor Checker
Flyback Checker
Battery Eliminator, etc.

AMATEUR KITS

Communications Receiver
50-Watt Transmitter
Self-Powered VFO
100 kc Crystal Calibrator
RF "Z" Bridge
Code Practice Oscillator

**452 PAGE 1959
ALLIED CATALOG**

FREE

Send for this value-packed catalog featuring the complete KNIGHT-KIT line, as well as the world's largest stocks of **everything** in Electronics. It's the leading, money-saving Buying Guide.

WRITE FOR YOUR FREE COPY TODAY!



ALLIED RADIO

ALLIED RADIO CORP., Dept. 133-D9
100 N. Western Ave., Chicago 80, Ill.

Ship the following KNIGHT-KITS _____

\$ _____ Enclosed

Send FREE 1959 ALLIED 452-Page Catalog

Name _____

Address _____

City _____ Zone _____ State _____

Available from ORRadio Industries, Inc., Shamrock Circle, Opelika, Alabama. \$4.95.



As last, tape recorder fans now have a way to check the speed of their machine as easily as turntable owners. The manufacturers of Irish brand recording tape is now selling a stroboscope device for tape recorders.

The instrument is scaled and ruled in three concentric rings of radiating lines representing 3 3/4, 7 1/2 and 15 ips, the three most common recording speeds. When held against the surface of the moving tape, the disk will revolve at the same speed as the tape and indicate the speed at which the tape is moving.

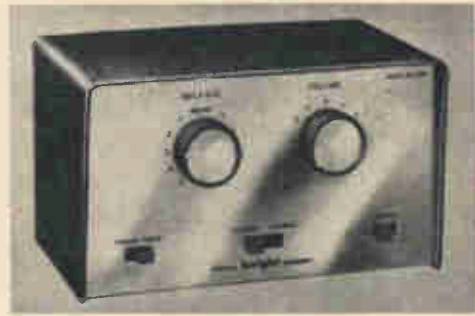

Allied Radio's new Knight Stereo Adapter is designed to provide centralized control for any stereo system using two separate amplifiers rated up to 12 watts each. The adapter, KN-750, is housed in a brown leathertone finished cabinet with white panel 3 3/4"x6"x3 1/2" and contains balance and volume controls, phasing, channel reverse and stereo-monoaural switches. It sells for \$14.95 net.

NOW YOU CAN SECURE A HIGH SALARIED • TOP PRESTIGE CAREER IN ELECTRONICS IN ONLY ONE YEAR!

ELECTRONICS is the fastest growing industry in America today, creating unlimited opportunities for high salaries, with rapid advancement in **INDUSTRY AND THE ARMED FORCES** for Bailey Trained electronic engineering technicians.

LARGE CORPORATIONS from coast to coast, and **BRANCHES OF THE ARMED FORCES** send recruiters to visit each graduating class at Bailey Tech, offering unusually high starting salaries.

BAILEY GRADUATES ARE BEING HIRED for such fascinating and interesting work as technical salesmen, research and development of guided missiles, electronic business machines and automatically controlled manufacturing plants, etc., also good **RATINGS IN THE ARMED FORCES**.

UP TO SEVEN TECHNICIANS are needed for every engineer . . . this, plus superior training is why Bailey Graduates are being paid more to start, and are advancing more rapidly than many men who have spent four years in training.

Resident training is easier and costs less than you may think! We provide housing and part-time jobs while in school, plus free nationwide employment service for graduates. If you want to quickly enter America's fastest growing and most exciting industry, write for free booklet . . . no obligation.

VETERAN APPROVED
BAILEY TECHNICAL SCHOOLS
1661 S. Grand • St. Louis 4, Mo.



This Minneapolis-Honeywell system controls hundreds of automatic manufacturing operations. Experience on live equipment is emphasized at Bailey and is another reason for the tremendous backlog of high pay positions waiting **BAILEY GRADUATES**.

MAIL TODAY

Please mail immediately this free booklet without obligation

Name _____
Address _____
City _____ State _____



Do you WISH you were EMPLOYED in ELECTRONICS?

F.C.C. LICENSE—THE KEY TO BETTER JOBS

An F.C.C. *commercial* (not amateur) license is your ticket to higher pay and more interesting employment. This license is Federal Government evidence of your qualifications in electronics. Employers are eager to hire *licensed* technicians.

WHICH LICENSE FOR WHICH JOB?

The **THIRD CLASS** radiotelephone license is of value primarily in that it qualifies you to take the second class examination. The scope of authority covered by a third class license is extremely limited.

The **SECOND CLASS** radiotelephone license qualifies you to install, maintain and operate most all radiotelephone equipment except commercial broadcast station equipment.

The **FIRST CLASS** radio telephone license qualifies you to install, maintain and operate every type of radiotelephone equipment (except amateur) including all radio and television stations in the United States, its territories and possessions. This is the highest class of radiotelephone license available.

GRANTHAM TRAINING PREPARES YOU

The Grantham course covers the required subject matter completely. Even though it is planned primarily to lead directly to a first class FCC license, it does this by **TEACHING** you electronics. Some of the subjects covered in detail are: Basic Electricity for Beginners, Basic Mathematics, Ohm's and Kirchoff's Laws, Alternating Current, Frequency and Wavelength, Inductance, Capacitance, Impedance, Resonance, Vacuum Tubes, Transistors, Basic Principles of Amplification, Classes of Amplifiers, Oscillators, Power Supplies, AM Transmitters and Receivers, FM Transmitters and Receivers, Antennas and Transmission Lines, Measuring Instruments, FCC Rules and Regulations, and extensive theory and mathematical calculations associated with all the above subjects explained simply and in detail.

OUR GUARANTEE

If you should fail the F. C. C. exam after finishing our course, we guarantee to give additional training at **NO ADDITIONAL COST**. Read details in our free booklet.

Get Your First Class Commercial F.C.C. LICENSE in 12 Weeks!

CORRESPONDENCE OR RESIDENCE CLASSES

Grantham School of Electronics *specializes* in F.C.C. license preparation. Correspondence training is conducted from Washington, Hollywood, and Seattle; also, resident **DAY** and **EVENING** classes are held in all three cities. Either way, by correspondence or in resident classes, we train you quickly and well.

This booklet **FREE!**

This free booklet gives details of our training and explains what an F. C. C. license can do for your future.



HERE'S PROOF...

that Grantham students prepare for F.C.C. examinations in a minimum of time. Here is a list of a few of our recent graduates, the class of license they got, and how long it took them:

	License	Weeks
Henry M. Best, 1003 Vermont St., Fremont, N.C.	1st	11
Harold V. Jones, P.O. Box 705, Alamogordo, N. Mex.	1st	13
Michael F. Aperia, 918 Townsend St., Chester, Pa.	1st	12
Norman R. Cook, 130 Olive St., Neodeska, Kan.	1st	12
Antane Mello, 68 Union Street, Nantucket, Mass.	1st	10
John Ward, 407 E. Cowden Ave., Midland, Texas	1st	10
F. T. Verga, 538 - 7th Street, Buffalo, N.Y.	1st	12
Philip J. Hooks, 4825 N. Capitol, N.W., Washington, D.C.	1st	12
Anthony Giacinta, 404 Dale Dr., Silver Springs, Md.	1st	12
J. Milton Condit, 1312 N. 78th Street, Seattle, Wash.	1st	8
James W. Reichard, 707 Arlington Street, Tamaqua, Pa.	1st	8
G. Carl Patschke, 3220 Conn. Ave., NW, Washington, D.C.	1st	12

Grantham School of Electronics

Hollywood Division

1505 N. Western Ave.
Hollywood 27, Calif.
(Phone: HO 7-7727)

Washington Division

821-19th Street, N.W.
Washington 6, D.C.
(Phone: ST 3-3614)

Seattle Division

408 Marion Street
Seattle 4, Wash.
(Phone: MA 2-7227)

MAIL COUPON TO SCHOOL NEAREST YOU

(Mail in envelope or poste on postal card)



To: **GRANTHAM SCHOOL OF ELECTRONICS**

821-19th, NW 1505 N. Western 408 Marion
Washington • Hollywood • Seattle

Gentlemen:

Please send me your free booklet telling how I can get my commercial F.C.C. license quickly. I understand there is no obligation and no salesman will call.

Name _____ Age _____

Address _____

City _____ State _____

I am interested in: Home Study, Resident Classes 98-D

Free!

ALLIED'S

MONEY-SAVING 1959

ELECTRONIC SUPPLY CATALOG



452

value-packed pages

send for it!

SAVE

ON EVERYTHING IN ELECTRONICS

EASY TERMS AVAILABLE

WORLD'S LARGEST STOCKS

Here is the complete guide to everything in Electronics for Experimenters, Builders, Amateurs, Servicemen, Engineers and Hi-Fi enthusiasts:

- Amazing Build-Your-Own KNIGHT-KITS
- Everything in STEREO Hi-Fi
- Hi-Fi Music Systems & Components
- Recorders & Phono Equipment
- Public Address & Paging Systems
- TV Tubes, Antennas, Accessories
- Amateur Station Equipment
- Latest Test & Lab Instruments
- Industrial Electronic Supplies
- Parts, Tubes, Transistors, Tools & Books

SAVE on everything in Electronics at ALLIED—get fast, dependable service, expert personal help, guaranteed satisfaction. Send today for your FREE 1959 ALLIED Catalog.

Everything in Electronics From One Reliable Source

OUR 38th YEAR

Send for FREE Catalog

ALLIED RADIO

• ALLIED RADIO, CORP., Dept. 86-D9
100 N. Western Ave., Chicago 80, Ill.

• Rush FREE 1959 ALLIED 452-Page Catalog

Name _____

Address _____

City _____ Zone _____ State _____

...News

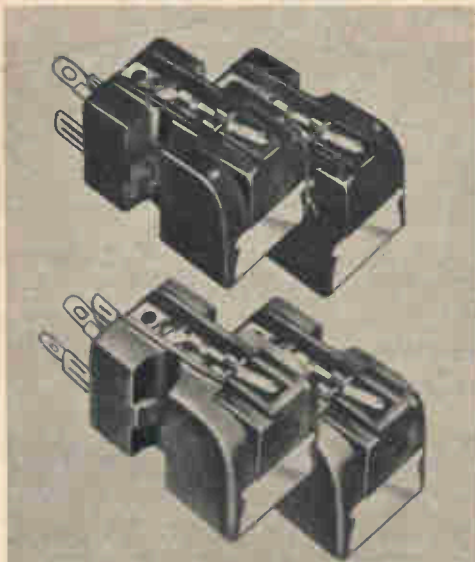

Four versions of the Columbia Constant Displacement Stereo Cartridge have been announced by CBS-Hytron. The basic twin-ceramic cartridge can be purchased with either a diamond or sapphire stylus and in either the "in-phase" or "out-of-phase" connection.

In-phase cartridges provide conventional phasing of the output signals for each channel or can be used in monaural systems by connecting the cartridge outputs in parallel. The out-of-phase cartridges have been specifically designed for the new "simplex" type stereo amplifiers which use one push-pull stage for two channel output. Such amplifiers are now used by Columbia Records in its latest phonographs. These amplifiers require opposite or out-of-phase polarity at the cartridge terminals.

The diamond cartridge, SC-1D, is priced at \$24.25 net and the sapphire cartridge, SC-1S, is \$17.00 net.

At the end of 1958 there were a total of 571 FM stations in the U. S. broadcasting good music to hi-fi fans. This was an increase of 34 over the previous year. The number of TV stations has mounted to 546.

**AT
LAST!**

RADIO-TV and ELECTRONICS TRAINING

**.... AT A PRICE
YOU CAN AFFORD!**

***21 INCH**
Receiver Kit included



Yes, this great course costs far less than any training of its kind given by other major schools! Radio-Television Training School will train you for a good job in Television or Industrial Electronics — **AT HOME IN YOUR SPARE TIME.**

Think of it — a complete training program including over 120 lessons, Fourteen Big Radio-Television Kits, Complete Color-TV Instruction, Unlimited Consultation Service... **ALL at a really big saving to you.** How can we do this? Write to us today... and find out!

And what's more — you can (if you wish)
**OPEN YOUR OWN RTS-APPROVED AND
FINANCED RADIO-TV SERVICE SHOP**

We Want Many More Shops This Year

This 37 year old training organization — called RTS, that's Radio-Television Training School — wants to establish a string of Radio-TV Repair Shops in principal cities throughout the U. S. So far, a great many such shops are **NOW IN BUSINESS AND PROSPERING.** We are helping and training ambitious men to become future owners and operators of these shops in all areas.

**FOR UNSKILLED
INEXPERIENCED MEN ONLY —
WE TRAIN YOU OUR WAY!**

We must insist that the men we sign up be trained in Radio-TV Repair, Merchandising and Sales by our training methods—because **WE KNOW** the requirements of the industry. Therefore, we will **TRAIN YOU** . . . we will show you how to earn **EXTRA CASH**, during the first month or two of your training period. **YOU KEEP YOUR PRESENT JOB. TRAINING TAKES PLACE IN YOUR OWN HOME, IN YOUR SPARE TIME!**

**COMPLETE
COLOR
INSTRUCTION
INCLUDED**

*you build these
and other units*



*tubes
excluded

RADIO-TELEVISION TRAINING SCHOOL

5100 S. VERMONT AVENUE
LOS ANGELES 37, CALIFORNIA

Est. 1922



**ACT
NOW!**

RTS
APPROVED
SERVICE
SHOP

Get your free book on the
FAMOUS RTS BUSINESS PLAN
find out how you can open
A REPAIR SHOP OF YOUR OWN

We supply and finance your equipment

When you are ready and qualified to operate one of our RTS-Approved TV Repair Shops **WE WILL SUPPLY AND FINANCE EVERY BIT OF EQUIPMENT YOU NEED TO GET STARTED** plus an inventory of parts and supplies. In other words we will stake you . . . **AN OFFER NEVER MADE BEFORE BY ANY TRAINING ORGANIZATION.** Under the RTS Business Plan you receive:

1. An electric sign for the shop front.
2. Complete laboratory of test equipment.
3. Letterheads, calling cards, repair tickets, etc.
4. Basic inventory of tubes, parts, supplies.
5. Complete advertising and promotional material.
6. Plans for shop arrangement.
7. Instructions on how to go into business.
8. Continuous consultation and help.
9. The right to use RTS Seal of Approval, and the RTS Credo.
10. The right to use the Famous Trade Mark.



RTS' Membership in The Association of Home Study Schools is your assurance of Reliability, Integrity, and Quality of Training.

**ALL
THESE
FREE!**



CUT OUT AND MAIL — TODAY!

RADIO-TELEVISION TRAINING SCHOOL

5100 S. Vermont Avenue, Dept. E1-49
Los Angeles 37, California

SEND ME FREE — all of these big opportunity books — "Good Jobs in TV-Electronics," "A Repair Shop of Your Own" and "Sample Lesson." I am interested in:

- Radio-Television Industrial Electronics (Automation)

Name _____ please print _____ Age _____

Address _____

City & State _____

300

The specs are the proof . . . now your
BEST BUY in
ham gear is

EICO



New

90-WATT CW TRANSMITTER . . . #720
KIT \$79.95 WIRED \$119.95

Conservative, highly efficient design plus stability, safety, and excellent parts quality. 80 thru 40, 20, 15, 11, 10 meters (popular operating bands) with one knob band-switching. 6146 final amplifier for full "clean" 90 W input, protected by clamper tube. 6CL6 Colpitts oscillator, 6AQ5 clamper, 6AQ5 buffer-multiplier, GZ34 rectifier. "Novice limit" calibration on meter keeps novice inside FCC-required 75W limit. No shock hazard at key. Wide range, hi-efficiency pi-network matches antennas 50-1000 ohms, minimizes harmonics. EXT plate mod. terminals for AM phone modulation with 65W input. Excellent as basic exciter to drive a power amplifier stage to max. allowable input of 1KW. Very effective TVI suppression. Ingenious new "low silhouette" design for complete shielding and "living room" attractiveness. Conservatively rated parts, copper-plated chassis, ceramic switch insulation. 5" H, 15" W, 9 1/2" D.



NEW UNIVERSAL MODULATOR-DRIVER #730
KIT \$49.95 WIRED \$79.95 Cover E-5 \$4.50

Superb, truly versatile modulator at low cost. Can deliver 50 W of undistorted audio signal for phone operation, more than sufficient to modulate 100% EICO #720 CW transmitter or any xmitter whose RF amplifier has plate input power of up to 100W. Multi-match output xmr matches most loads between 500-10,000 ohms. Unique over-modulation indicator permits easy monitoring, no need for plate meter. Lo-level speech clipping & filtering with peak speech freq. range circuitry. Low distortion feedback circuit, premium quality audio power pentodes, indirectly heated rectifier filament. Balance & bias adj. controls. Inputs for stat or dynamic mikes, phone patch, etc. Excellent deluxe driver for high-power class B modulation. ECC83/12AX7 speech ampli., 6AL5 speech clipper, 6AN8 ampli. driver, 2-EL34/6CA7 power output, EM84 over-mod. indicator, GZ34 rect. Finest quality, conservatively rated parts, copper-plated chassis. 8" H, 14" W, 8" D.

NEW GRID DIP METER #710
KIT \$29.95 WIRED \$49.95 including complete set of coils for full band coverage.

Exceptionally versatile. Basically a VFO with microammeter in grid; determines freq. of other osc. or tuned circuits; sens. control & phone jack facilitate "zero beat" listening. Excellent absorption wave meter. Ham uses: pre-tuning & neutralizing xmitters, power indication, localizing parasitic osc., antenna adj., correcting TVI, de-bugging with xmitter power off, determining C.L.Q. Servicing uses: alignment of filters, IF's; as sig. or marker gen. Easy to hold & thumb-tune with 1 hand. Continuous 400 kc-250 mc coverage in 7 ranges, pre-wound 0.5% accurate coils. 500 ua meter movement, 6AF4(A) or 614 Colpitts osc. Xmr-operated set. rect. 2 1/2" H, 2 1/4" W, 6 1/4" L. Satin deep-etched aluminum panel; grey wrinkle steel case.



NOW IN STOCK! Compare & take them home—right "off the shelf"—from 1000 neighborhood EICO dealers. For free catalog mail coupon in EICO ad 6 pages forward. In the West, add 5%. Over 1 MILLION EICO instruments in use throughout the world.

EICO

33-00 Northern Blvd., Copr. © 1958,
Long Island City 1, N.Y. Electronic Instr.
Co., Inc.

See EICO's other ad on page 26

. . . News

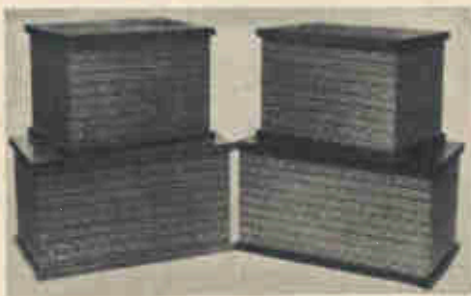

A new line of high fidelity speaker systems called the Mardis Gras is being marketed by the JFD Electronics Corp., 6101 Sixteenth Avenue, Brooklyn 4, New York. These low efficiency speakers combine specialized driver components with precision interior construction. The ALC acoustic loading principle used permits the enclosure to be small. Power handling capacity is 10 to 15 watts continuous; efficiency at 400 cps is 10%; power required is at least 5 watts.

One of the two versions of this speaker, the model ALC1, measures 18" x 10" x 10" and is priced at \$45 Net. The other, model ALC2, is 14" x 10" x 10" and sells for \$30 Net.

New Catalogs:

Catalogs containing listings of stereo and monophonic high-fidelity equipment, and related audio products are available from Leonard Radio, Inc., 60 Cortlandt Street and Terminal Radio Corporation, 85 Cortlandt Street both of New York City. Both catalogs contain the 1959 models available at publication date.

Do you have an old Atwater Kent radio in your attic that you would like to rehabilitate as an antique and conversation piece? To put it into working order, however, you'll need the schematic diagram of the receiver.

Diagrams for old time radios are available from Supreme Publications, 1760 Balsam Road, Highland Park, Ill. Individual schematic diagrams sell for 40¢ and a complete manual covering the years 1926 to 1938 is available for \$2.50.

**WE'RE MAKING IT EASIER THAN EVER TO BECOME A WELL PAID
RADIO-TELEVISION SERVICE TECHNICIAN**

**NOW - Just \$6 Starts You Training in
RADIO-TELEVISION**

the SPRAYBERRY "Learn-by-Doing" Way . . .

**25 BIG, COMPLETE KITS
of PARTS & EQUIPMENT**

To help you learn *fast* the practical side of Radio-Television, we send you expertly engineered training kits to test and assemble for interesting, valuable shop-bench practice!

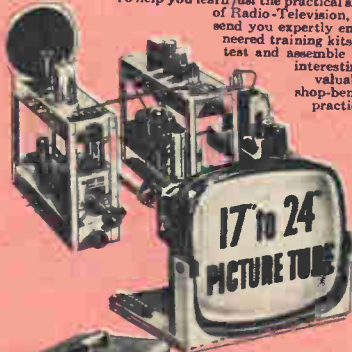

• The new Sprayberry Training Television Receiver, built and tested in 6 sections.

• Now offered . . . this fine modern oscilloscope.

• You build this powerful two-band superheterodyne radio receiver.

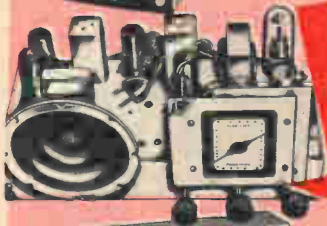

**Big New
CATALOG
+ 12
Sample Lesson
FREE!**



You build the new Sprayberry tester—a complete 19-range Volt-Ohm-Milliammeter test meter.

*** This great industry is begging for trained men . . . to step into good paying jobs or a profitable business of their own! Our new plan opens the doors of Radio-Television wide to every ambitious man who is ready to act at once!

Men by the thousands . . . trained Radio-Television Service Technicians . . . are needed at once! Perhaps you've thought about entering this interesting, top paying field, but lack of ready money held you back. Now—just \$6 enrolls you for America's finest, most up to date home study training in Radio-Television! Unbelievable? No, the explanation is simple! We believe Radio-Television *must* have the additional men it needs as quickly as possible. We are willing to do our part by making Sprayberry Training available for less money down and on easier terms than ever before. This is your big opportunity to get the training you need . . . to step into a fine job or your own Radio-Television Service Business.

Complete Facts Free—Act Now; Offer Limited

Only a limited number of students may be accepted on this liberal and unusual basis. We urge you to act at once . . . mail the coupon below and get complete details plus our big new catalog and an actual sample lesson—all free. No obligation . . . no salesman will bother you.

HOME STUDY TRAINING IN SPARE TIME

Under world-famous 27-year old Sprayberry Plan, you learn entirely at home in spare time. You keep on with your present job and income. You train as fast or as slowly as you wish. You get valuable kits of parts and equipment for priceless shop-bench practice. And everything you receive, lessons and equipment alike, is all yours to keep.

LET US PROVE HOW EASILY YOU CAN LEARN!

Radio-Television needs YOU! And Sprayberry is ready to train you on better, easier terms, that any ambitious man can afford. Just \$6 starts you! Mail coupon today . . . let the facts speak for themselves. You have everything to gain. Let us prove the kind of opportunity in store for you!

SPRAYBERRY Academy of Radio-Television
1512 Jarvis Avenue, Dept. 120-T, Chicago 26, Illinois

Mail This Coupon Now—No Salesman Will Call

Sprayberry Academy of Radio-Television
Dept. 120-T, 1512 W. Jarvis Ave., Chicago 26, Ill.

Please rush all information on your ALL-NEW Radio-Television Training Plan. I understand this does not obligate me and that no salesman will call upon me. Include New Catalog and Sample Lesson FREE.

NAME..... Age.....
ADDRESS.....
CITY..... ZONE..... STATE.....





Allied Radio's new Knight KN-130 "Bantam" Stereo FM-AM Tuner, permits separate FM and AM tuning for stereophonic reception. The AM and FM sections in this unit are independent of each other permitting reception of AM-FM stereo.

The tuner has dual outputs for stereo or monaural tape recording of programs and automatic frequency control. FM sensitivity is said to be 4 microvolts for 20 db quieting; on AM, 10 microvolts for 20 db signal-to-noise ratio. The unit has 8 tubes plus selenium rectifier. It measures 3 3/8" x 11 3/8" x 9", is finished in brown with a brushed brass panel and ebony trim. Price is \$79.50 net.

—O—

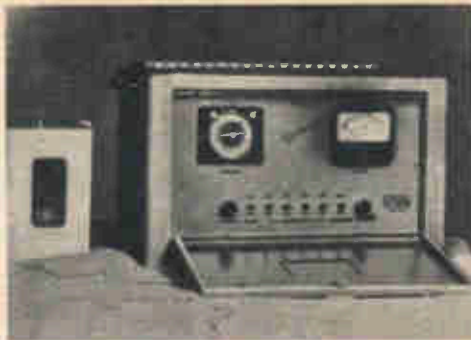

Naturally, when the better mouse-trap was to be built, it had to be electronic! But, instead of trapping the rodents, the new device chases them off in a frenzy. The generator produces an ultrasonic signal which is sent out of the accompanying tweeter. These signals are inaudible to humans and pets. The rats, however, simply cannot stand the sound and within 72 hours have run off or destroyed themselves.

This equipment is available through Supersonics Industry, Inc., 20510 Lorain Road, Cleveland 26, Ohio.

INVENTORS

WE recommend that you take the following preliminary steps toward patent protection. Make a disclosure of your invention; sign, date and have your disclosure witnessed by two people who understand your invention; authorize us to conduct a preliminary search among previously granted U. S. patents for similar types of invention. We give you a report on the probable patentability of your invention and our recommendation for further course of action.

Let us send you a copy of our instructive booklet, "Potent Protection for Inventors" and our convenient "Evidence of Invention" disclosure form. No obligation.

VICTOR J. EVANS & Co. *Merlin M. Evans*
REGISTERED PATENT ATTORNEY

555-DMERLIN BUILDING, WASHINGTON 6, D. C.

DEPENDABLE TV-RADIO TUBES



1-YEAR GUARANTEE

ZALYTRON Tubes for TV-Radio Servicemen, Dealers, Experimenters.

Nationally sold ZALYTRON Tubes are BRAND NEW Quality Tubes, priced low to help you meet competition in your area — and guaranteed to perform as well and as long as tubes much higher priced. Why pay more? Try them once, you'll buy them always. Every tube we ship is covered by our Full Refund Guarantee . . . YOU be the judge! Send today for new Price List "EI"

BE YOUR OWN BOSS

RUN A SELF-SERVICE TUBE BUSINESS

Get This Modern Sturdy Tube Tester **FREE**

with "Package Deal" order for nationally sold ZALYTRON Quality Brand Receiving Tubes. We'll show you how to start a successful Tube Tester Route, and get YOUR share of today's Big Profits in Self-Service Tube Sales! This is no "Get-Rich-Quick" scheme but a solid, proven business that will reward you well — if you WORK at it. But, INVESTIGATE before you INVEST! Get full details on the best "Deal" now being offered, send today for our booklet "I"



ZALYTRON TUBE CORPORATION
220 West 42nd St., N. Y. 36, N. Y.

BUILD YOUR OWN 16 RADIO CIRCUITS AT HOME

with the New Deluxe 1959 PROGRESSIVE RADIO "EDU-KIT"®

only \$22.95

Reg. U.S. Pat. Off.



A Practical Home Radio Course

- Now Includes**
- ★ 12 RECEIVERS
 - ★ TRANSMITTER
 - ★ SIGNAL TRACER
 - ★ SIGNAL INJECTOR
 - ★ CODE OSCILLATOR
 - ★ No Knowledge of Radio Necessary
 - ★ No Additional Parts or Tools Needed
 - ★ EXCELLENT BACKGROUND FOR TV
 - ★ School Inquiries Invited
 - ★ SOLD IN 79 COUNTRIES

YOU DON'T HAVE TO SPEND HUNDREDS OF DOLLARS FOR A RADIO COURSE

The "Edu-Kit" offers you an outstanding PRACTICAL HOME RADIO COURSE at a rock-bottom price. Our Kit is designed to train Radio & Electronics Technicians, making use of the most modern methods of home training. You will learn radio theory, construction practice and servicing. THIS IS A COMPLETE RADIO COURSE IN EVERY DETAIL. You will learn how to build radios, using regular schematics; how to wire and solder in a professional manner; how to service radios. You will work with the standard type of punched metal chassis as well as the latest development of Printed Circuit chassis. You will learn the basic principles of radio. You will construct, study and work with RF and AF amplifiers and oscillators, detectors, rectifiers, test equipment. You will learn trouble-shooting, using the Progressive Signal Tracer, Progressive Signal Injector, Progressive Dynamic Radio & Electronics Tester and the accompanying instructional material. You will receive training for the Novice, Technician and General Classes of F.C.C. Radio Amateur License. You will build 16 Receiver, Transmitter, Code Oscillator, Signal Tracer and Signal Injector circuits, and learn how to operate them. You will receive an excellent background for Television, Hi-Fi and Electronics. Absolutely no previous knowledge of radio or science is required. The "Edu-Kit" is the product of many years of teaching and engineering experience. The "Edu-Kit" will provide you with a basic education in Electronics and Radio, worth many times the complete price of \$22.95. The Signal Tracer alone is worth more than the price of the entire Kit.

THE KIT FOR EVERYONE

You do not need the slightest background in radio or science. Whether you are interested in Radio & Electronics because you want an interesting hobby, a well paying business or a job in a future you will find the "Edu-Kit" a worth-while investment. Many thousands of individuals of all

ages and backgrounds have successfully used the "Edu-Kit" in more than 79 countries of the world. The "Edu-Kit" has been carefully designed, step by step, so that you cannot make a mistake. The "Edu-Kit" allows you to teach yourself at your own rate. No instructor is necessary.

PROGRESSIVE TEACHING METHOD

The Progressive Radio "Edu-Kit" is the foremost educational radio kit in the world, and is universally accepted as the standard in the field of electronics training. The "Edu-Kit" uses the modern educational principle of "Learn by Doing." Therefore you construct, learn schematics, study theory, practice trouble-shooting—all in a closely integrated program designed to provide an easily-learned, thorough and interesting background in radio.

You begin by examining the various radio parts of the "Edu-Kit." You then learn the function, theory and wiring of these parts. Then you build a simple radio. With this first and trouble-shooting. Then you build a more advanced radio, learn more advanced theory and techniques. Gradually, in a progressive manner, and at your own rate, you will find yourself constructing more advanced multi-tube radio circuits, and doing work like a professional technician.

Included in the "Edu-Kit" course are sixteen Receiver, Transmitter, Code Oscillator, Signal Tracer, and Signal Injector circuits. These are not unprofessional "breadboard" experiments; genuine radio circuits, constructed by means of professional wiring and soldering on regular chassis, plus the new method of radio construction known as "Printed Circuitry." These circuits operate on your regular AC or DC house current.

THE "EDU-KIT" IS COMPLETE

You will receive all parts and instructions necessary to build 16 different radio and electronics circuits, each guaranteed to operate. Our Kits contain tubes, tube sockets, variable, electrolytic, mica, ceramic and paper dielectric condensers, resistors, tie strips, coils, hardware, tubing, punched metal chassis, instruction manuals, hook-up wire, solder, etc. In addition, you receive Printed Circuit materials, including Printed Circuit chassis, special tube sockets, hardware and instructions. You also receive a useful set of tools, a professional electric soldering iron, and a self-powered Dynamic Radio & Electronics Tester. The "Edu-Kit" also includes Code instructions and the Progressive Code Oscillator, in addition to F.C.C.-type Questions and Answers for Radio Amateur License training. You will also receive training with the Progressive Signal Tracer and the Progressive Signal Injector, a High Fidelity Guide, and a Quiz Book. You receive Membership in Radio-TV Club, Free Consultation Service, Certificate of Merit and Discount Privileges. You receive all parts, tools, instructions, etc. Everything is yours to keep.

FREE EXTRAS

- SET OF TOOLS
- SOLDERING IRON
- ELECTRONICS TESTER
- PLIERS-CUTTERS & ALIGNMENT TOOL
- WRENCH SET
- VALUABLE DISCOUNT CARD
- CERTIFICATE OF MERIT
- TESTER INSTRUCTION MANUAL
- HIGH FIDELITY GUIDE & QUIZZES
- TELEVISION SERVICE & RADIO TROUBLE-SHOOTING BOOK
- MEMBERSHIP IN RADIO-TV CLUB: CONSULTATION SERVICE & FCC AMATEUR LICENSE TRAINING
- PRINTED CIRCUITRY

SERVICING LESSONS

You will learn trouble-shooting and servicing in a progressive manner. You will practice repairs on the sets that you construct. You will learn symptoms and causes of troubles in home, portable and car radios. You will learn how to use the professional Signal Tracer, the unique Signal Injector and the Dynamic Radio & Electronics Tester. While you are learning in this practical way, you will be able to do many a repair job for your friends and neighbors, and charge fees which will far exceed the price of the "Edu-Kit." Our Consultation Service will help you with any technical problems you may have.

J. Stataitis, of 25 Poplar Pl., Waterbury, Conn., writes: "I have repaired several sets for my friends, and made money. The "Edu-Kit" paid for itself, I was ready to spend \$240 for a Course, but I found your ad and sent for your Kit."

FROM OUR MAIL BAG

Ben Valerio, P. O. Box 21, Magna, Utah: "The Edu-Kits are wonderful. Here I am sending you the questions and also the answers for them. I have been in Radio for the last seven years, but like to work with Radio Kits, and like to build radio Testing Equipment. I enjoyed every minute I worked with the different kits; the Signal Tracer works fine. Also like to let you know that I feel proud of becoming a member of your Radio-TV Club."

Robert L. Shuff, 1534 Monroe Ave., Huntington, W. Va.: "Thought I would drop you a few lines to say that I received my Edu-Kit, and was really amazed that such a bargain can be had at such a low price. I have already started repairing radios and phonographs. My friends were really surprised to see me get into the swing of it so quickly. The Troubleshooting Tester that comes with the Kit really swell, and finds the trouble, if there, any to be found."

UNCONDITIONAL MONEY-BACK GUARANTEE

The Progressive Radio "Edu-Kit" has been sold to many thousands of individuals, schools and organizations, public and private, throughout the world. It is recognized internationally as the ideal radio course.

By popular demand, the Progressive Radio "Edu-Kit" is now available in Spanish as well as English.

It is understood and agreed that should the Progressive Radio "Edu-Kit" be returned to Progressive "Edu-Kits" Inc. for any reason whatsoever, the purchase price will be refunded in full, without quibble or question, and without delay.

The high recognition which Progressive "Edu-Kits" Inc. has earned through its many years of service to the public is due to its unconditional insistence upon the maintenance of perfect engineering and the highest instructional standards, and 100% adherence to its Unconditional Money-Back Guarantee. As a result, we do not have a single dissatisfied customer throughout the entire world.

ORDER DIRECT FROM AD—RECEIVE FREE BONUS RESISTOR AND CONDENSER KITS WORTH \$7

- Send "Edu-Kit" Postpaid. I enclose full payment of \$22.95.
- Send "Edu-Kit" C.O.D. I will pay \$22.95 plus postage.
- Send me FREE additional information describing "Edu-Kit."

Name

Address

PROGRESSIVE "EDU-KITS" INC.
1186 Broadway, Dept. 510AE, Hewlett, N. Y.

ELECTRONIC COMPUTERS



SENSATIONAL MICROLOG

Solve advanced mathematics with "MICROLOG," a ready-built analog computer. Add, subtract, divide, solve calculus and advanced equations electronically. Perfect for training college students and engineers. For FREE information check MIC-2A.

REPLACES THE SLIDE RULE IN DYNAMIC PROBLEMS!

Three out of thirty home courses, kits in computers, automation, robots and electronics listed. For FREE catalog check 6-A.

C-14 COMPUTER MASTER: 50 lessons in relay, digital and analog computers, design and operation. Diploma credited.

C-61P ANALOG COMPUTER: 15 lessons in circuits, design and operation. Study and keep microlog computer.

TR-1 DIGITAL COMPUTER KIT: Completely transistorized. Work 100 interesting projects. You receive transistors, sensitive meter, instruction manual, full set of plans.

JOIN THE THOUSANDS OF EBEX STUDENTS IN U.S. AND FOREIGN COUNTRIES

EBEX TECHNICAL INSTITUTE

Largest Manufacturer Of Low Cost Electronic Computers
1015 Atkin Avenue, Salt Lake City, Utah

MIC-2A

6-A

Name

Street

City

SEND POSTCARD FOR FREE CATALOG TODAY! E1-7



GERMAN AUTOMATIC

6-SHOT REPEATER—22 CAL.

German Automatic, latest model 6 shot repeater, 22 caliber self ejecting clip, precision made by the finest West German Gunsmiths. Wonderful for sporting events, theatrical performances, would-be attackers, etc. 4" long, perfectly balanced. (Not available to residents of California.) Comes for \$6.95 ppd. from

BEST VALUES

Department G-988, 403 Market St., Newark, N. J.

...News



Republic Aviation Corporation of Farmingdale, L. I., N. Y. has published a glossary of space terms designed to help space enthusiasts understand the new vocabulary used by aeronautical pioneers. Designed to help the interested laymen to better understand news reports it defines such terms as "ablation," "doppler effect," "mach," etc. This 19-page booklet is available free.

A new moving-magnet stereo cartridge with a .6 mil diamond stylus is now available from the Heath Co. The frequency response is said to be within ± 4 db from 20 to 15,000 cycles. The output level of each channel is at least 3 millivolts and induced hum level about 55 db below recorded signal. Tracking force is 2 to 4 grams. This cartridge, the SF-1, has been designed for Heath by the Fairchild Recording Equipment Corp. It fits all tone arms. \$39.95.



FASTEST, EASIEST WAY TO LEARN CODE EVER DEVELOPED

NEW RIDER 'SOUND-N-SIGHT' CODE COURSE

by Lewis Robins & Reed Harris

W2R10

Combines sound and sight plus an imaginary instructor to speed code learning.

Now you can learn code faster, easier than ever before thanks to a scientific breakthrough in learning called REINFORCED LEARNING. The psychological principle behind this new method of learning code has already proved successful by the Armed Forces in teaching Morse and Blinker Code and typing.

REINFORCED LEARNING

... a dramatic step forward to faster learning

REINFORCED LEARNING is a form of training without memory—requiring no conscious effort to memorize. It teaches communications skills such as code by applying the psychological principle that people learn more quickly when the act they are trying to learn is immediately given some reinforcement or reward, like a pat on the back or a word of praise. It holds that a correct guess immediately followed by the instructor's approval will remain more firmly embedded in the student's memory than if he learned the signals by memory alone.

The 'Sound-N-Sight' course applies the REINFORCED LEARNING approach. It is the first code training course that combines sound and sight and actually puts an imaginary instructor at your side to speed your learning of three separate abilities necessary to learn code:

1. Hearing the signal correctly or sound perception—telling the difference between the dits and the dahs.
2. Identifying the correct letter for each signal pattern, or sight identification.
3. Combining sound and sight to recognize the signal and immediately identify it.

EXPERTS SAY ...

"REINFORCED LEARNING—AN OUTSTANDING SUCCESS"

In the Armed Forces and industry, the REINFORCED LEARNING method has produced astoundingly successful results:

From the Educational Review, November, 1953: "The Lewis Robins-Reed Harris reinforced learning system ... is achieving almost incredible results in shortening training time. The original tests conducted in the Navy ... showed that if the reinforced learning system were used, typing and code could be learned in about half the time formerly required. Tests then conducted by an unofficial organization, the staff of Navy Times in Washington, quickly proved the validity of the conclusions. Now IBM, RCA and the Chrysler Corporation are trying the method."

From William Haddad, The New York Post, November 14, 1957: "Dr. Harry J. Carman, world-famous historian, Dean Emeritus of Columbia College and Co-chairman of the President's Committee on the Arts & Sciences, said that Lewis Robins had adopted a 'brilliant approach' ... In a later article, November 22, Mr. Haddad reported: "... Captain Philip Winston, commander of the Fleet Training School ... said ... 'The group is learning faster than any other group we've ever had ...'"

From Richard M. Mansfield, military writer of the Norfolk Virginian-Pilot: "Professor Fred S. Keller ... one of the nation's top psychologists, has been quoted as citing Robins 'as one of the five or six persons who really have seen what the learning process is all about, and have really brought any fresh thought to bear upon it!'"

MOST COMPLETE, MOST UNIQUE COURSE EVER OFFERED

The course combines sound (clearly transmitted signal patterns on records with the instructor's voice immediately informing you if you are correct) with sight (47 identification cards with individual signal patterns and the letter, number or punctuation mark for which they stand). A clearly written book tells you how to apply the course, increase your speed, practice with someone else, transmit and provides charts to check your day-by-day progress.

The records start by giving signal patterns and an imaginary instructor at your side tells you immediately if you have recognized the correct pattern of dits and dahs, teaching you to hear and recognize signals correctly. Next, by using the identification cards you learn the correct letter associated with each signal pattern. Finally, the records tie together your ability to hear the signal correctly and identify the letter for which it stands. You can learn to receive as rapidly as you learn to send—proof positive of the effectiveness of this method. The instructor's voice is on hand at all times to give you the correct answer immediately. From this point on it's a matter of increasing speed. With the 'Sound-N-Sight' course many people have learned to receive 5 words per minute within 9½ hours!

THREE INDIVIDUAL COURSES

COMPLETE COURSE—covers all licenses up to commercial (0 to 20 words per minute)

Six 10" LP records (192 minutes of recording, 46 recordings), 47 identification cards and book train you to receive up to 20 words per minute. Also trains you to transmit. #REC-020, \$15.95.

NOVICE COURSE (0 to 8 words per minute)

Three 10" LP records (96 minutes of recording, 28 recordings), 47 identification cards and book train you to receive up to 8 words per minute and how to transmit. #REC-08, \$9.50.

ADVANCED COURSE for general, amateur extra or commercial license (9 to 20 words per minute)

Three 10" LP records (96 minutes of recording, 18 recordings) and the book train you to receive up to 20 words per minute and provide a firm foundation for receiving at even greater speeds. #REC-920, \$8.95.

These records have been prepared in collaboration with the New York Institute of Technology and manufactured by Decca Records.

BREAKS THROUGH YOUR CODE PLATEAU BARRIER

The "Sound-N-Sight" course has successfully eliminated the code plateau. Once this barrier to increasing receiving speed has been reached, you can progress as much as one word per minute, per day with this course.

This exciting code course plus many other titles that spell more amateur radio enjoyment (Getting Started In Amateur Radio; Building The Amateur Radio Station; Radio Operator's License Q & A Manual—6th edition—to name just a few) are available at book stores or electronic distributors. Use convenient coupon below to order direct.

----- Ten day unconditional money back guarantee -----

JOHN F. RIDER PUBLISHER, INC. 116 West 14th Street, N. Y. 11, N. Y.

EI-4

I have enclosed \$ _____ Please send me

REC-020 (0-20 words per minute) \$15.95

REC-08 (0-8 words per minute) \$9.50

REC-920 (9-20 words per minute) \$8.95

NAME.....

ADDRESS.....

CITY.....

ZONE..... STATE.....

In Canada 5% higher; add State & City Sales Taxes where applicable.

GUARANTEE: Satisfaction guaranteed.—returnable within ten days for full refund.

The experts say...
 in HI-FI and TEST
 INSTRUMENTS your best
 buy is **EICO**

EICO

33-00 Northern Blvd., L. I. C. 1, N. Y. EI-4

Show me HOW to SAVE 50% on 63 models of top-quality equipment (in box I have checked here:)

HI-FI TEST INSTRUMENTS HAM GEAR

Send FREE literature & name of neighborhood EICO dealer.

Name.....

Address.....

City..... Zone..... State.....

Add 5% in the West.



New!
 Miniaturized
 MULTI-SIGNAL
 TRACER #145A
 KIT \$19.95
 WIRED \$28.95



VACUUM TUBE
 VOLTMETER #221
 KIT \$25.95
 WIRED \$38.95



PEAK-TO-PEAK
 VTVM #232
 & UNI-PROBE
 (pat. pend.)
 KIT \$29.95
 WIRED \$49.95



New!
 1000 DHMS/VOLT
 V-O-M-#538
 KIT \$12.90
 WIRED \$14.90



5" PUSH-PULL
 SCOPE #425
 KIT \$44.95
 WIRED \$79.95
 DC-5 MC 5" SCOPE
 KIT \$79.95
 WIRED \$129.50



TUBE TESTER #625
 KIT \$34.95
 WIRED \$49.95



New!
 Series/Parallel
 R-C COMBINATION
 BDX #1140
 KIT \$13.95
 WIRED \$19.95
 1350 Combinations!



6V & 12V BATTERY
 ELIMINATOR
 & CHARGER #1050
 KIT \$29.95
 WIRED \$38.95
 Extra-filtered for
 transistor equipmt.
 #1060 KIT \$38.95 WIRED \$47.95



R-C BRIDGE & R-C-L
 COMPARATOR #950B
 KIT \$19.95
 WIRED \$29.95

IN TEST INSTRUMENTS
 IN HI-FI... STEREO and MONAURAL



New!
 STEREO DUAL
 AMPLIFIER-PREAMPLIFIER HF81
 Including cover:
 KIT \$69.95. WIRED \$109.95
 STEREO DUAL PREAMPLIFIER HF85
 KIT \$39.95, WIRED \$64.95



60-WATT
 ULTRA LINEAR
 POWER AMPLIFIER HF60
 with ACRO TO-330 Output Xfmr
 KIT \$72.95 WIRED \$99.95 "excellent
 buy" - Marshall, AUDIOCRAFT.



12-WATT
 WILLIAMSON-TYPE
 INTEGRATED AMPLIFIER HF12
 KIT \$34.95 WIRED \$57.95
 "Packs a wallop"—POPULAR ELECTRONICS
 "First rate"—MODERN HI-FI



MASTER CONTROL
 PREAMPLIFIER HF65A:
 KIT \$29.95 WIRED \$44.95
 with power supply HF65:
 KIT \$33.95 WIRED \$49.95 Superb
 new design... new "low silhouette" look.



50-WATT
 ULTRA-LINEAR
 INTEGRATED
 AMPLIFIER HF52
 KIT \$69.95 WIRED \$109.95
 "Excellent value"—Hirsch-Houck Labs.



2-WAY
 SPEAKER
 SYSTEM HFS1
 complete with
 factory-built
 cabinet: \$39.95



FM TUNER
 HFT90
 KIT, less cover \$39.95*
 WIRED, less cover \$65.95*
 COVER. \$3.95 *FET incl.



20-WATT
 ULTRA-LINEAR
 WILLIAMSON-TYPE
 INTEGRATED AMPLIFIER HF20
 KIT \$49.95 WIRED \$79.95
 "Well-engineered"
 — Stocklin, RADIO TV NEWS

STANDARD SPEAKER
 SYSTEM HFS2:
 Completely factory-built
 \$139.95 "Unusual
 suitability for stereo
 ... eminently musical"
 — Holt, HIGH FIDELITY
 "Fine for Stereo"—
 MODERN HI-FI



See
 EICO HAM
 Ad on page 20

Copyright 1958 by Electronic Instr. Co., Inc.



"One of the best buys in high fidelity kits."—AUDIOCRAFT Kit Report

IN STOCK!

Compare, take them home—right "off the shelf"—from 1900 neighborhood EICO dealers. Over 1 MILLION EICO instruments in use throughout the world.

Coming Age Of Sun Power

By James Joseph

From laboratory to practical electronics in five short years—Here's how we're harnessing Ol' Sol.

THE first man to reach the moon will look to the sun for survival. His space suit will be heated and air-conditioned by solar energy; his plastic-domed lunar home electrified by sunlight; his every breath purified by sunpower.

Solar floodlights will brighten the long lunar nights (as long as 14 earthdays). His heated space suit, powered by solar cells, will protect against nighttime temperatures down at the -250° F mark. By day, despite sizzling heat, he'll stalk the Sahara-hot lunar plains as comfortably as if he were lunching in earth's swankiest air-conditioned restaurant.

Sunpower will grow his food in lunar greenhouses whose solar-controlled lights will emit only wavelengths in the "growing spectrum." He'll cook on mirrored solar stoves, order his supplies by sun-powered telephone. And from deep lunar caves,

Electrical output of solar battery is compared with total energy available from sun. Bell Labs engineer makes measurements with a pyrheliometer.





Twenty solar cells soak up rays, convert them to current to power Palm Springs, Cal., clock.

sun-run factories, electrolysing oxygen from ice, will pump life-giving air to home and lab. Sunlight will be his salvation, incinerating his wastes, automatically focusing his research cameras and energizing the transmitters beaming his voice earthward.

Fiction? Not at all. Scores of moon-minded researchers are now preparing man for lunar life, grooming him to look toward the sun for survival. What's more, your survival here on earth is as inescapably tied to the sun. Mankind faces a survival deadline, the year 2000 AD. By then, less than half a century away, earthbound man will have depleted most of his natural sources of energy—oil, gas and coal. Controlled atomic fission will probably take over as the largest energy supplier, but a safer and more limitless source is the sun.

It is toward the sun and its everlasting power that scientists are reaching. Time is running out, but by 2000 AD we'll have harnessed the sun and made it our servant.

Right now, in fact, we are on the threshold of an energy breakthrough ushering in a new era: The Solar Age. Five short years ago, in April 1954, Bell



Water pumps using converted solar energy will be used to turn sunny deserts into fertile plains.

Telephone Laboratories unveiled the silicon solar battery, the first device to wring electricity from sunlight in an efficient manner. Today, silicon batteries power transistorized radios, hearing aids, navigational beacons and have in some way energized most of the satellites man has lobbed into space.

Slowly at first and now with increasing urgency, we are tapping the immense electrical reserve bottled up in the sun. It is a reserve of astounding potential; 9000-trillion kilowatt hours bathe the United States annually, only a small portion of the total that falls on the entire earth. If even a small fraction of this could be economically captured, we'd have more than enough power to run every home and factory.

SOLAR FURNACES

The problem: How to convert radiant power (light) to electrical energy cheaply and efficiently. One way is the solar furnace. The huge unit recently put into operation at Natick, Mass., by the Army's Quartermaster Research and Engineering Center, focuses solar energy to a fiery 5000°—twice the heat needed to wring electrical current (DC)

Big Bertha solar energy converter at right has 504 cells. Coast Guard has installed it atop lighthouse wall (arrow) to power flashing beacon over big light.

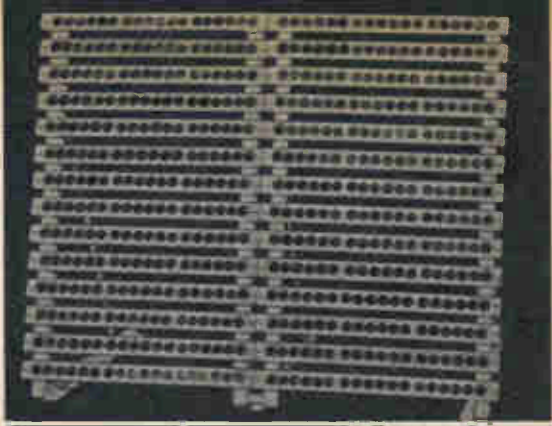

Transistorized mobile radio transmitter is powered by solar cells at Bell Labs. Man in distance with receiver gets clear signal. Effective range is several miles.



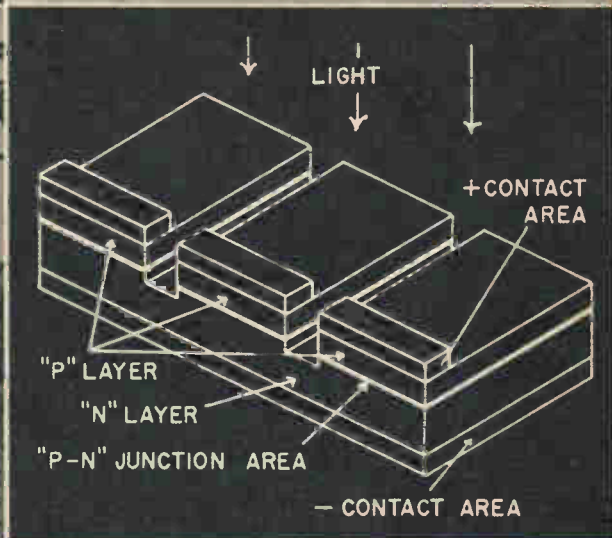
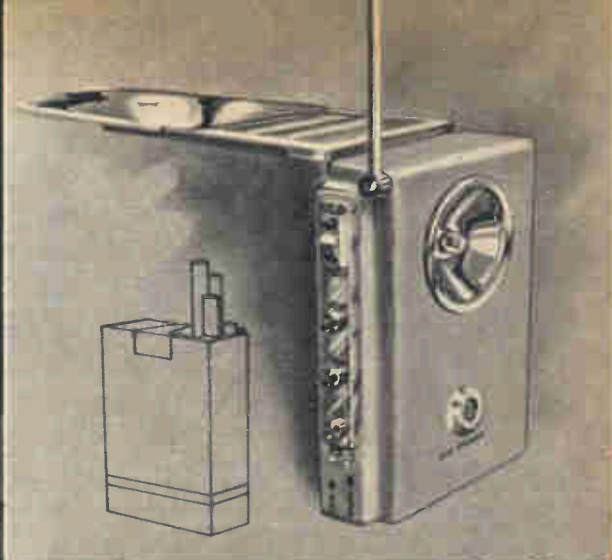

Silicon cells, 144 in all, are linked together to charge batteries rated from 6 to 48 volts.

Design for small rescue radio, with transmitter, receiver and lamp, would have cells in top.

Flat-type solar stills to purify sea water are under study by Dr. Maria Telkes of N. Y. U.

Diagram of new photovoltaic readout cell used in computers shows contacts, P-N junction.

from oxides of nickel, manganese and lithium-cobalt. Such *thermoelectric* materials are a promising new source of power.

most of their electricity from thermo-electric furnaces, stoked by earth-common metals and fueled by sunlight.

When thermoelectric compounds (oxides in pellet or powder form) are heated to about 2000° F, their electrons are disturbed. The result: Direct current produced simply, silently and without moving parts. Sunpower focused by parabolic mirrors in giant solar furnaces promises to fuel the conversion process. Our future factories may get

Solar furnaces themselves are not complex. In theory, they borrow the magnifying glass you used as a child, and for the very same purpose: To focus the sun's rays to fiery combustion.

One mirror, 147 feet high and 151 feet wide, with a flat mosaic of 1162 smaller mirrors, will ride along a rail as it automatically tracks the sun. This reflector is called the heliostat. It is designed to



Solar highway flasher can operate at night from power generated and stored during day.



Now on market is this transistorized portable radio. Solar cells are embedded in the handle.



Lens of camera is set automatically as International Rectifier cells react to light levels.



Eyeglass hearing aid by Zenith recharges miniature battery from silicon cells on temple bar.

reflect the solar energy to a dish-shaped collecting and focusing device called a concentrator, which features a 108-foot-wide parabolic face composed of 4800 precision-ground mirrors.

Concentrated, the sunlight can be focused down to a spot only four inches in diameter. This is the furnace's hearth, set atop an 80-foot tower. Here the heat will rise to within 50 percent of the sun's surface temperature.

SOLAR BATTERIES

Organic materials have become a new and exciting power source. University of California researchers recently announced the first successful solar battery concocted from organic materials.

The battery converts sunshine to energy as green plants, through photosynthesis, converts it to oxygen. Built of multi-colored layers of synthetic organic dyes, the wafer-thin battery ($\frac{3}{8}$ " wide, $\frac{1}{16}$ " thick) generates enough current in sunshine to trigger a low-powered transistorized relay.

Another sun-triggered current producer is the thermocouple—two different conductors joined at one end. A temperature difference at the juncture generates the current. Thermocouples now power circuits that keep our most sophisticated missiles on course. Although the direct current produced by thermocouples is modest, the device has

[Continued on page 92]

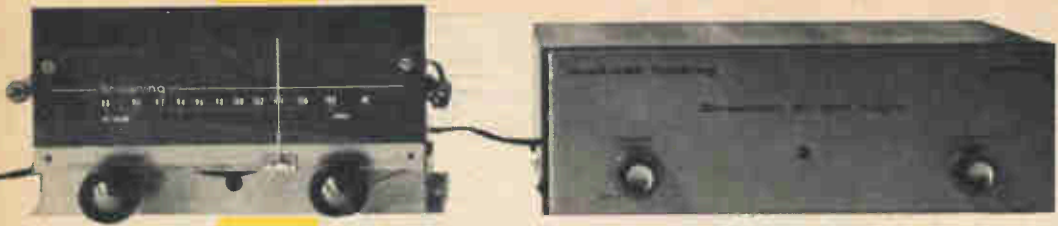

adapt your

FM For Multiplex

By Norm Eisenberg and Len Feldman

Prepare your tuner for the reception of stereo broadcasts by adding a multiplex output jack.

FOR some time now, many FM tuners have been featuring a "multiplex" output in addition to their normal signal output. The multiplex jack is for feeding the "second" signal that could be transmitted by an FM station along with the regular FM program. Up to fairly recently, that multiplex jack was of relatively little interest to home listeners. For one thing, they didn't have access to the required multiplex adapter into which this second signal must be fed. Equally important, there wasn't much worth listening to on multiplex: this "hidden signal" technique

Basic setup for receiving FM multiplex. The adapter (see Madisan Fielding unit at top of page, right) picks up signals from jacks on rear of FM tuner.

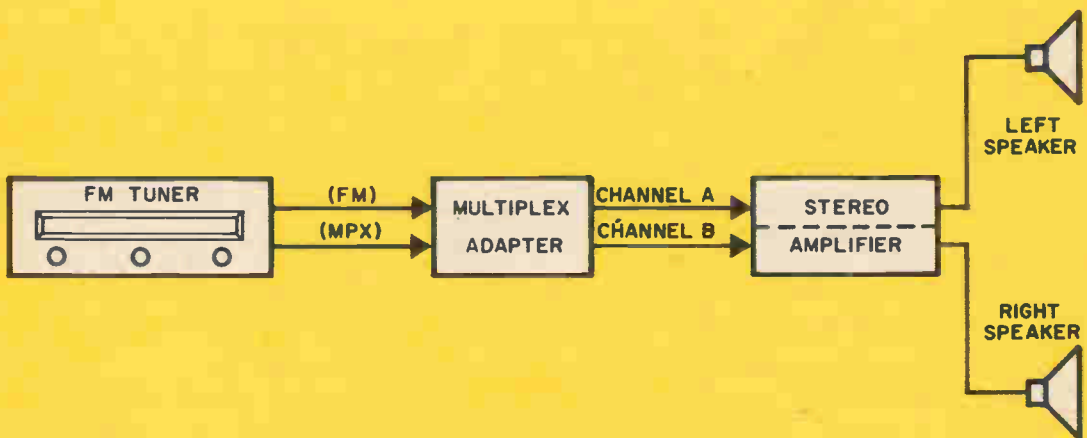

was being used largely for providing so-called background music (not very exciting to hi-fi enthusiasts) to business establishments on a private subscription basis.

The multiplex jack was being supplied, however, against the day when it would have importance for home listeners. In some areas, that day has arrived with the advent of stereo broadcasting by FM multiplexing. In New York City and in Wilmington, Delaware, at the time of writing, broadcasters are using a multiplex signal to transmit "compatible" FM stereo. These experimental broadcasts are transmitted by permission of the FCC. The listener with an ordinary FM set hears a full, monophonic version of these programs. Listeners who have a multiplex jack on their FM sets (plus a multiplex adapter and—of course—the second amplifier and speaker needed for any kind of stereo) can tune in to a thrilling stereo program in which all the depth and fullness of the new sound medium can be enjoyed via the noise-free, wide-range benefits of FM on both channels.

All right, you say. I'm sold on multiplex. I'm even willing to go out and buy the new adapter. I don't, however, happen to have anything on my present

FM tuner that resembles a "multiplex output." Does this mean that I must buy a new FM tuner as well?

The answer simply is that you can wire in your own multiplex jack very easily. Once installed, this new jack will provide a correct takeoff point for feeding multiplex to the adapter. It will not interfere with, or detract from regular FM quality; it will not prevent your FM set from being used in the normal manner as before.

Can such a jack be installed in any FM set? Will it work in any FM set? To both questions, the answer is yes. The multiplex signal (in the presently used Crosby system at least) rides in at 50 kc, high above the audio range. Even with that 50 kc modulated with the second channel there's enough electronic "space" in the average FM set for the signal to get through. In fact, each time you tune in your FM set, you are also admitting whatever "hidden signal" happens to be riding along. It rides on the multiplex carrier which itself rides along on the regular FM carrier frequency. In normal FM detection, the main signal is slipped out of its FM envelope; this envelope and any extraneous matter is filtered out and not heard. So, to nab that "hidden signal," you must get to it just after the entire

First step is finding the detector tube on FM set, usually a 6AL5, toward rear of chassis.

Although this tuner already has a spare jack, one may be added on the chassis' rear apron.

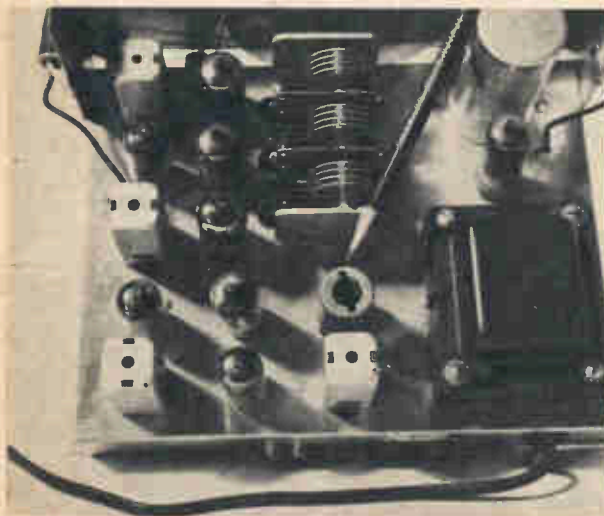

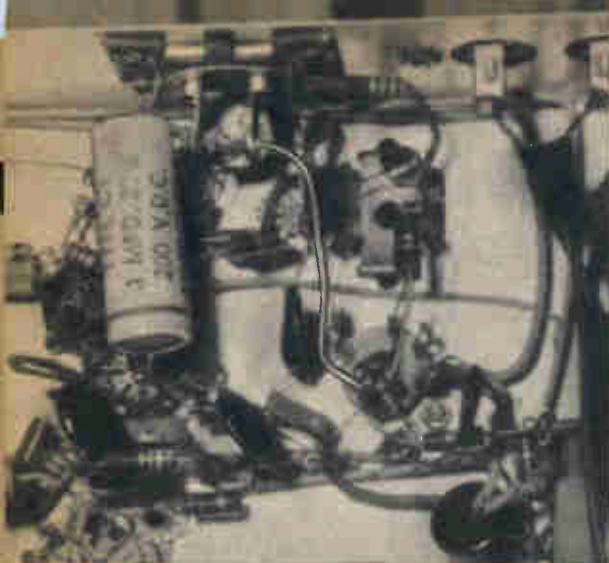

White wire, just right of center, runs from multiplex jack to "X" point on the detector.

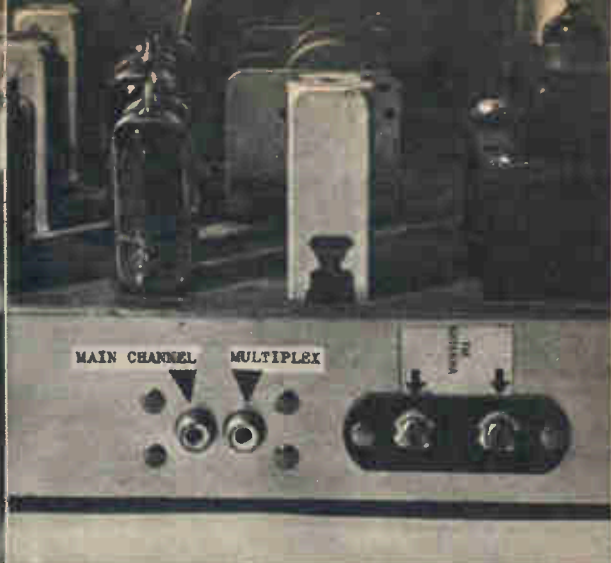

Label shows position of new multiplex output. Shielded cables will bring signals to adapter.

FM signal has been detected, but before filtering (de-emphasis) action has started.

In any FM receiver there is one—and only one—point in the circuit where you can pick off the multiplex signal. Just where it is in your own tuner depends on what kind of a tuner it is. So, before explaining how to add the multiplex output, we must first tell you how to find the spot in your set where it all begins.

There are two kinds of detector circuits commonly used in FM sets. One is the "limiter-discriminator" type; the other is the "ratio detector." Either works satisfactorily; either can be used for adding a multiplex output.

Both types of circuits are shown schematically. Compare these diagrams with the schematic for your own set to determine which circuit you have. If you don't have that schematic, a simple way to check which circuit is used in your tuner is to note the arrangement of the detector. Almost every tuner built in the last few years employs a type 6AL5 tube. This is a miniature double-diode. Sets of really ancient vintage may use an octal-socket type tube known as a 6H6. Some very recent tuners employ germanium diodes, rather than conventional tubes, but these most likely have multiplex jacks already.

In the discriminator circuit *both*

plates (pins 2 and 7) are connected to terminals of the discriminator transformer. This transformer is readily identified as the "can" nearest the detector tube. In the ratio detector, one plate of the double-diode is connected to a can terminal, and the cathode of the other diode section (pin 5) is connected to another terminal on the can.

Regardless of which circuit is used, installing a multiplex jack is easy.

The model chosen for this project was the Browning L-300 tuner. This set is fairly representative of many popular-priced reliable tuners bought a few years ago and still being used by thousands. The L-300 has a discriminator circuit, followed by a cathode follower for audio output.

The job turned out to be simpler than anticipated because two output jacks were already provided on the L-300 chassis. Both jacks were actually connected to the audio output of the cathode follower. Browning had "doubled up" on output jacks to enable the user to connect from one jack to his regular "listening" amplifier and from the other jack to a tape or disc recorder. Since most present-day amplifiers or preamps also are equipped with recorder feed jacks, we felt that nothing would be lost by reconnecting one of the two available jacks on the L-300 from its present circuit point to the point required for multiplex.

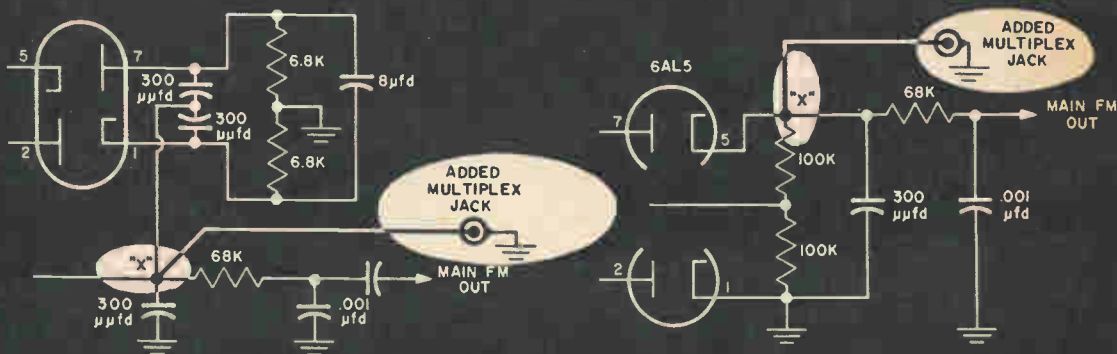

Two typical FM detector circuits; ratio detector at left, discriminator at right. Multiplex points are "X" and found by tracing back from main FM jack. 68K resistor is blue-gray-orange.

This point is at pin 5 of V7, the 6AL5 tube. Of the two jacks available, the one formerly labeled "audio output" happened to be closer to pin 5 of the tube. We gave it the new assignment. A short (two-inch) piece of wire was connected between pin 5 of the 6AL5 tube and the "audio output" jack. The connection between the "audio output" and "recorder" jacks was broken. The two ends of the new wire were soldered in place. This job took all of five minutes.

We then changed the labeling on the rear of the chassis to read correctly in accordance with the new connections: "Main Channel" for normal FM signal, and "Multiplex" for multiplex signal.

Using a Madison Fielding MX-100 multiplex adapter, we made the following interconnections: From the new multiplex output jack on the L-300 to the multiplex input on the adapter. From the "old" output jack on the L-300 (FM audio output) to the "FM IN" jack on the adapter. From the output jacks on the adapter to the "left" and "right" tuner inputs on a stereo amplifier.

At 11 a.m. we turned it all on and tuned to WBAI in New York for this station's daily multiplex broadcast. We caught the announcer as he opened with: "Station WBAI, also operating as KE2XXT, for stereo multiplex experimental purposes, brings you. . . ." We

turned up the "dimension" control on the adapter (this control provides stereo "spread" for such broadcasts) and the announcer suddenly moved to the right side of the living room. Then came the music. It didn't take long to realize that the faithful Browning had come through surgery unscathed—and with something new added, provisions for receiving multiplex.

The point at which to connect a multiplex output for both discriminator and ratio detector circuits is shown in the schematic diagrams. If your tuner does not happen to have two output jacks on its chassis, as did the L-300, you can install a new jack. Arrange it to be as near as possible to the detector tube so the wiring is kept short.

The input impedance on the adapter, at both its FM and multiplex receptacles, is 500,000 ohms. This is high enough to operate correctly with reference to the output impedances of tuners at their FM and multiplex takeoff points. In any case, keep interconnecting cables as short as possible for best results. You may find, too, that in certain areas reception of multiplex signals will require a good outside antenna.

Even if multiplex stereo hasn't reached your area yet, you can be reasonably sure that some form of multiplex will eventually arrive. So you may as well update your tuner now, and be ready for it —

All About Computers-2

By R. W. Yates

How computers work—what electronic "magic" enables machines to receive, store and process data.

NO discussion of how electronic computers work can proceed very far before a fundamental distinction is made: the distinction between analog and digital computing systems.

Both use electronic circuitry, vacuum tubes and/or transistors, magnetic amplifiers, etc., to perform complex mathematical calculations at millisecond speeds. Both work automatically on the basis of predetermined instructions or "programs," and both have had a revolutionary effect on the ability of human brains to deal with large amounts of factual information. Beyond that, they have nothing in common.

The automobile speedometer is a simple analog device. Without actually counting the revolutions of the wheel within a given time span and repeatedly dividing to determine the number of miles per hour, its mechanism senses the constantly varying rate of revolution and interprets that rate in terms of the constantly wavering needle on its miles-per-hour dial. In contrast, the ordinary desk calculator is a digital device. Its keys activate mechani-

At the Hanford atomic plant in Richland, Wash., two GE engineers set up a computer program designed to solve knotty heat transfer problems.

British computer by EMI Ltd. (left) has 2400 equipment racks to be assembled. It can absorb Encyclopedia Britannica's data in under 4 minutes.

Control circuits like one in Royal McBee's LGP-30, below, govern the signal gating so that everything happens at the right time in proper relationship.

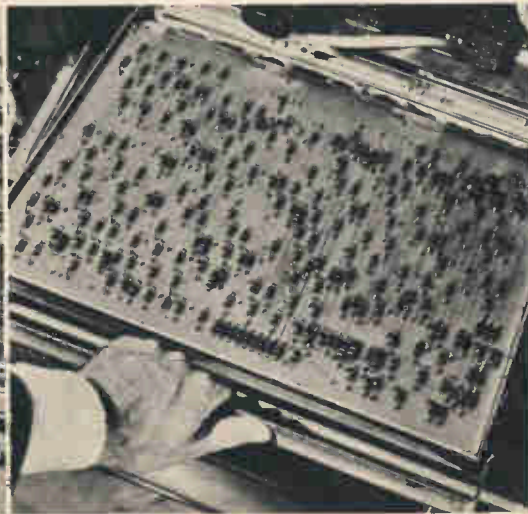
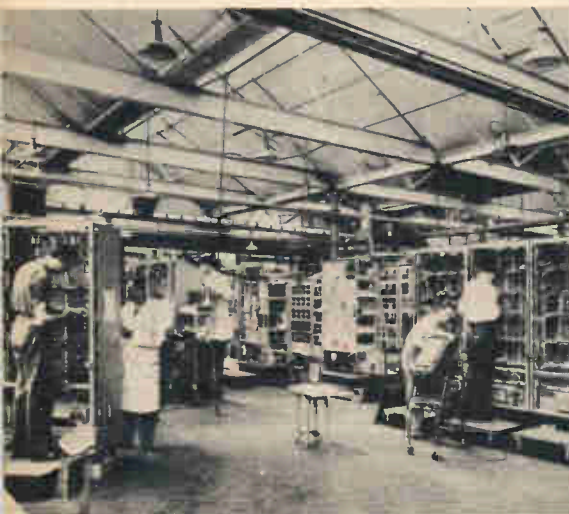

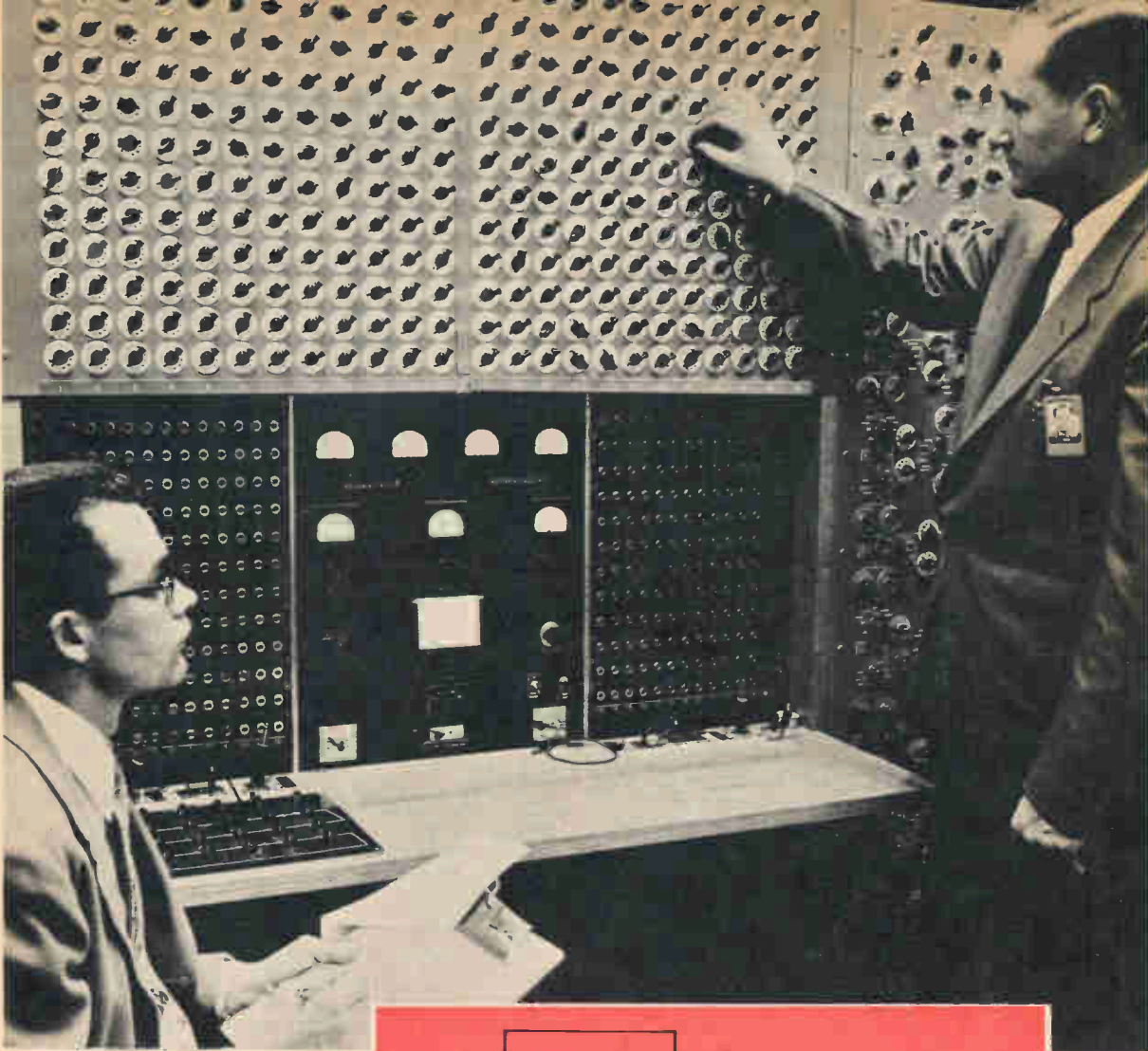

At right is diagram of simple analog computer. Problem: Multiply 5x5. Battery sends 10 volts through circuit. Dial A, controlling moveable arm linked to variable resistor A, is set at half-way point (5). Resistor B now receives only 5 volts. Halve this again and the meter reads 2.5. Rearrange decimal point and you have the answer. Setting of dials is "programming"; meter corresponds to "readout."

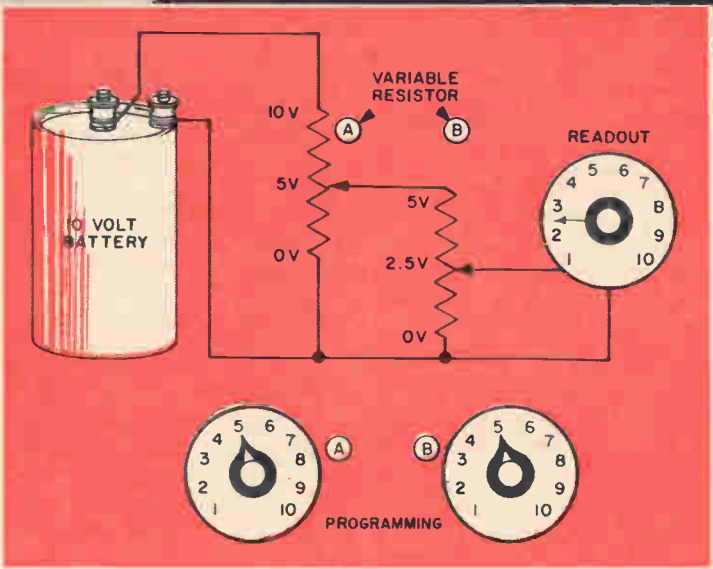

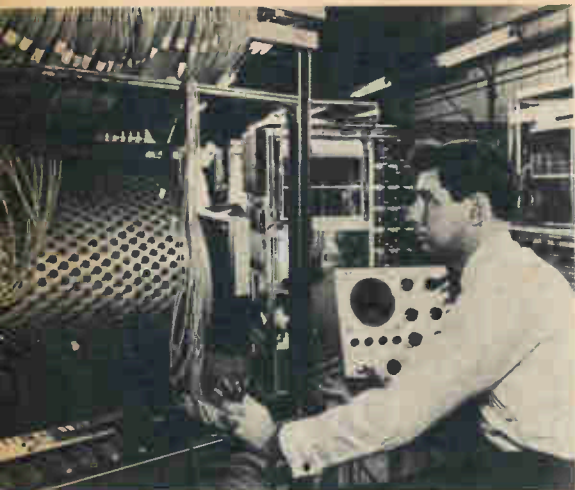

Univac memory drum, here being assembled, is a cylinder with sensitive surface. It spins inside jacket with magnetic reading heads.

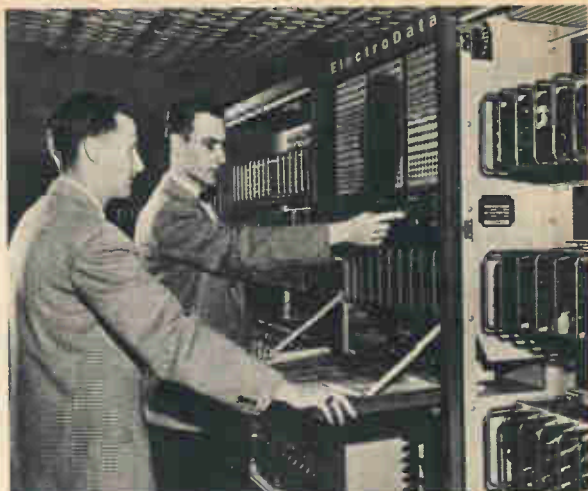

Programmers, most important element in computer operation, here trace through steps of insurance company's digital data problems.

cal parts representing the *actual* numerical quantities involved in arithmetic.

The same difference prevails in electronics. Analog computers use varying physical magnitudes (voltages, light intensities, shaft positions, and the like) as factors *analogous* (corresponding) to mathematical values. Digital computers work from pulses representing actual numerical (and alphabetical) symbols.

Within the category of analog computers, a further distinction must be made between special- and general-purpose systems. The small airborne computer used to guide an anti-aircraft missile is a special-purpose analog system, in that its program is unchanging. It solves the same problem over and over again.

The force that activates this computer—its "input"—is the missile's radar equipment. The radar signal supplies information on the constantly changing position of the enemy plane and enters this information, via a synchro-link, to the computing circuitry. Its "output"—the physical result of its analog computation—is the automatic control of machinery which makes constant, delicate readjustments of the missile's steering gear until the target is hit.

General-purpose analog computers

are generally used by engineers to test the value of their designs under theoretical conditions. They are capable of handling a great variety of problems. The terms of each problem assigned to it are wired into a removable program panel—a plugboard on which the *mathematical constants* of the problem have been translated into specific circuiting instructions.

The input of this computer is the engineer's hand, which adjusts a number of control dials to variable settings, each representing one of the *variable factors* of the problem and each applying an appropriate amount of current through the programmed circuits. Its output might be a series of readings on indicator dials, or it might be a wavering line drawn on graph paper—representing, say, the behavior of a theoretical airplane wing or tail assembly under the stress of supersonic flight.

Analog computers are perfectly accurate so long as the *physical* relationships it handles (voltages, etc.), are valid representations of the *mathematical* relationships in the problem. But, generally speaking, it is less *precise* as an instrument of calculation than a digital system, as well as slower. Another important distinction is that the memory capacity of an analog computer is static

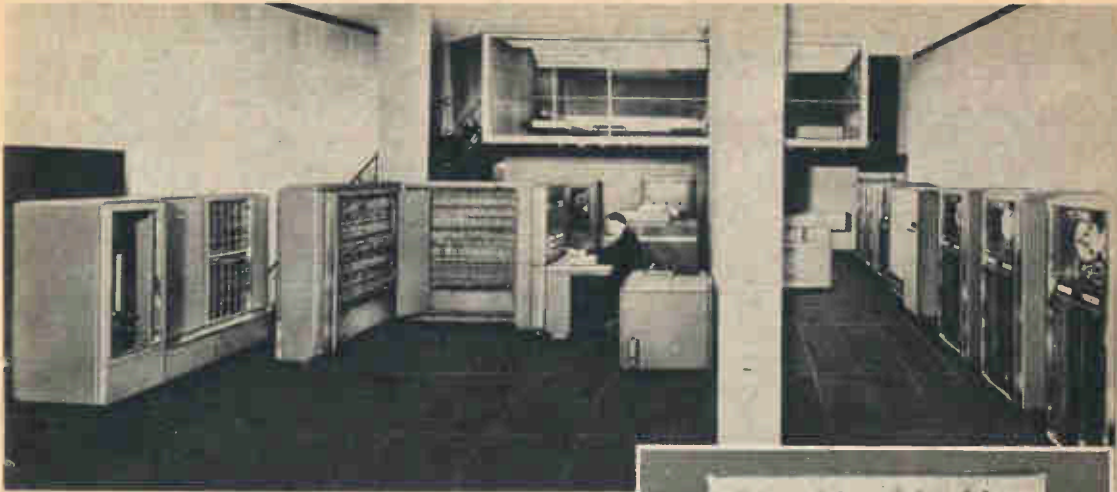

Part of this country's satellite computing center, IBM 704, above, calculates and predicts course of artificial moons and space rockets.

in nature. It can store information for later reference, but it can't automatically adapt itself to changes occurring within that stored data.

Chiefly for these reasons, the popular term "electronic brain" might be more appropriately applied to digital than to analog systems. A basic understanding of digital computers must begin with the knowledge of a traditional mathematical code called the binary digit system—a way of expressing an infinite variety of numbers through the use of only two symbols, "1" and "0", otherwise known as "on" and "off." In conventional binary digit coding, the ten numerals, 0-9, are expressed by varying combinations of 1 and 0 in a four-digit frame, as follows:

Zero is	0000
One is	0001
Two is	0010
Three is	0011
Four is	0100
Five is	0101
Six is	0110
Seven is	0111
Eight is	1000
Nine is	1001
Ten is	1010

The columns advance geometrically
 [Continued on page 87]

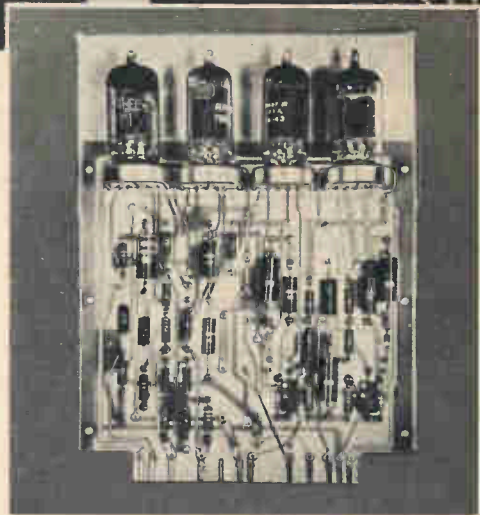

Plug-in circuit (for easy maintenance) is one of many in LGP-30 to set up math routing.

Memory grid shows magnetic cores which store data as patterns of magnetic fields.

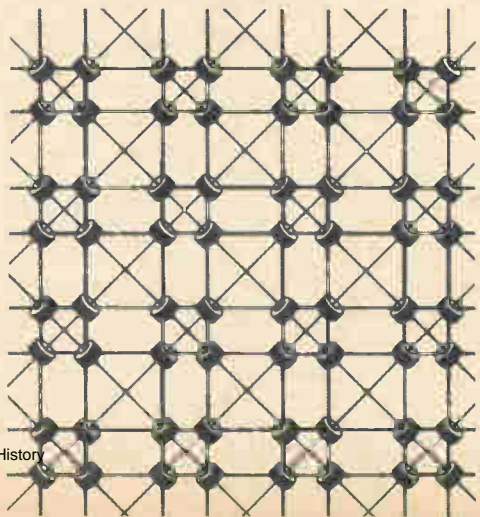



Above, Gunderson points out the basic features in ham receiver; band-spread, selectivity, stability. At left, *EI* editors tape record his comments.

how to buy

Ham Equipment

Tape interview with ham authority tells you how to get started, how to buy a receiver and transmitter.

BOB GUNDERSON, W2JIO, has been an active radio amateur for over twenty years. He has won the Edison Award, the highest commendation a ham can aspire to. He has taught ham radio to countless numbers of people, and has invented many electronic instruments and devices. He is totally blind!

Many beginning radio amateurs and short-wave listeners have met Bob at the New York City and Newark stores of Hudson Radio, a large retailer of ham equipment. Bob answers their questions on what to buy, and incidentally, may give them a brief course on hamming. Here he answers some typical questions.



Ques. *Bob, you've handled all kinds of ham equipment and have spoken to many people interested in amateur radio. How much does it cost to get started in amateur radio?*

Ans. Well, I guess anywhere from \$50 to \$1000. You can buy a transmitter and a receiver, put up the antenna, and plug the three units together and you're on the air; or you can buy a few well chosen parts and build up a very simple receiver and single tube transmitter and you're on the air.

Ques. *Bob, which way do you favor?*

Ans. So many of us today lose sight of the fact that when we become hams we not only do something in which we will enjoy ourselves, but in this way we have an opportunity to become trained technicians, yes and even engineers. For this reason, I would be in favor of the beginner's building his first transmitter and maybe even his receiver. I can remember my first transmitter, it used four oatmeal boxes as the coil forms, the coils were made of bell wire, and the tuning condensers were out of broadcast receivers. I couldn't afford electrolytic capacitors so I made them from aluminum and borax in cans or glass jars.

Ques. *Just what equipment does one need before going on the air?*

Ans. Well, the first thing that you need the minute you decide to become a ham is a buzzer or oscillator and a key to practice the morse code. Every ham must learn the code, whether he decides to stay with code or go on the air with voice transmission. Also, the beginner should build, as-

The relative merit of building or buying equipment is discussed. A National NC-303 receiver is shown, with a Viking transmitter, available in kit or wired form, above it.





Gunderson fires up rig by a unique telephone dialing system of his own design. It controls power, tuning, and band of homebrew transmitter.

Ques.

semble, or buy a receiver at the same time to become familiar with the way hams talk and behave. He can also get code practice from his receiver. I think the transmitter is last. One thing about the receiver that is very important is that if the beginner decides to buy rather than build, he should buy the best one he can afford.

Well now you say that a person should get the best receiver that he can afford. That is an interesting point. Why spend so much on a receiver—is it because the ham has to be able to hear a distant station first before he can contact it?

Ans.

Well, don't think of a receiver as useful only for listening to incoming signals, it is also an excellent piece of test equipment. For example, you can use it to monitor your own transmitter which, of course, is delivering a tremendous signal right next to the receiver. If the receiver has sufficiently good frequency stability you'll be able to check on the modulation and frequency of your transmitter. A good receiver will not be overloaded by the transmitter.

Ques.

What do you think are the important specifications, the minimum specs, that a good receiver should have?

Ans.

I think if it's going to be operated from the AC line there should be a transformer between the receiver and the power line for minimum noise pick-up. It should have a beat frequency oscillator with good stability and with sufficient signal injection so that you can hear the CW signals very well. It should have an RF stage and, of course, be mechanically stable so when you find W1AW on 3555 kc tonight it is still on 3555 tomorrow night. It should have adequate bandwidth so that you can separate stations, and a sensitivity control and audio gain control. Then you can go from there, the crystal filter or the Q multiplier or both, or the mechanical filter if you can get way up in price, single sideband provisions, etc.

Ques.

Bob, as you know, there are several inexpensive superregenerative receiver kits available. What do you think of these for the beginning ham?

Ans.

I think anything that a beginner can build or assemble and make work is wonderful. These kits have gotten people interested in ham

[Continued on page 84]

Hi-Fi Sound From Your TV Set

By Bob Wynn

Hear TV sound through your hi-fi with this plugin unit—no rewiring of the TV set is necessary.

THE range of sound capable of being transmitted by a TV station is excellent. A frequency modulation system is used that compares favorably to the regular FM stations, the main difference being in "deviation" rather than frequency response. The FM broadcast station has a greater deviation, which means that less noise will be received in deep fringe areas for a given signal strength. If you are receiving a reasonably good picture, the sound portion has hi-fi potentiality, especially during live shows.

A good deal of the distortion that is heard on TV sound is produced by the set itself; tiny speaker, inexpensive output transformer, and simple audio circuitry. Thus, if you pick off the signal from the voice coil leads of the TV set to feed your hi-fi, these distortions are amplified and heard.

The approach described here is to tap off the sound *ahead* of the point where this deterioration occurs. The most likely spot is just after the detector tube. Unfortunately, to do this, the chassis must be removed and modifications to the circuits be

The unit and its two plugs. Large octal plug goes to TV, small phono type to hi-fi set.

A likely mounting spot for the unit is behind the rear cover of TV. Note selector switch.

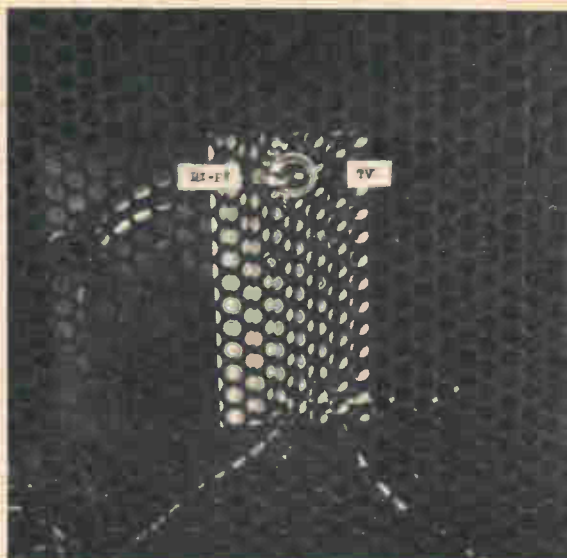
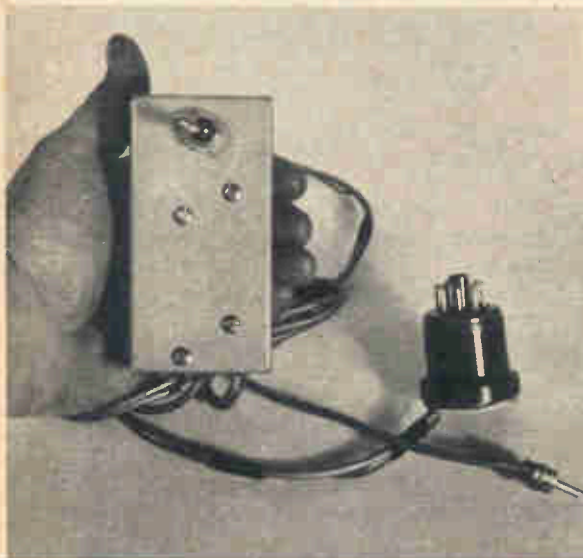



Components within the case are seen behind front cover. Transformer T is at lower right.

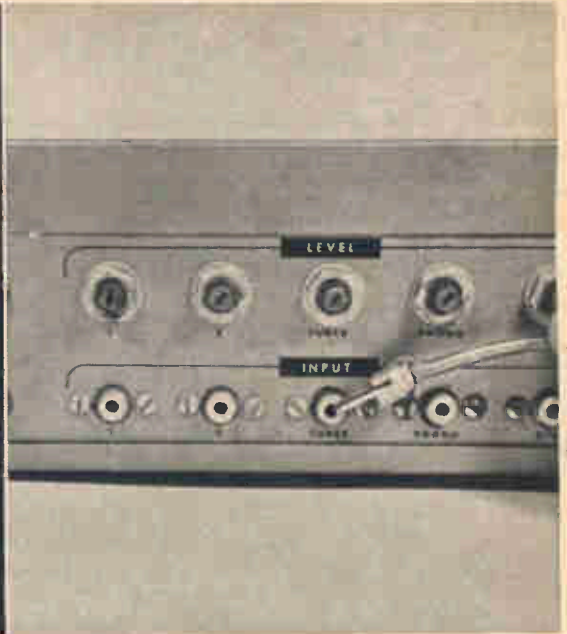

The unit's phono plug goes to a high level input on the hi-fi set—Tuner or Auxiliary.

made. But, with the unit described here, you simply pull the sound output tube from its socket, insert the Vector socket in its place, then plug the sound tube back in.

The phono plug emerging from the unit is inserted into the TV, TUNER, or AUXILIARY jack on your hi-fi set. An important feature is visible on the front panel of the unit—there is a switch that enables you to hear the sound in the TV speaker as before, or channel it to the hi-fi set.

After securing the necessary parts, locate the sound output tube in the TV set. There is usually a chart pasted inside the cabinet that indicates this, or better still, secure the schematic which is readily available from the manufacturer or electronic supply house.

Construction is simple. Carefully follow the diagram, grounding to the metal case of the unit only where shown. A transformer was incorporated in the circuit for two important reasons. First, the cable running to the hi-fi may be any desired length. Since the transformer changes the impedance from a high to a low value, hum and high fre-

quency losses are avoided. Second, the transformer acts as an isolation device, keeping the various chassis from direct contact with each other.

The Vector socket shown is an octal-type. It is originally intended for use as a test unit—bringing all the tube socket terminals above a TV chassis so meter readings may be taken without the need for pulling the chassis out of its cabinet. This feature makes this device possible since it provides a convenient takeoff point for audio, and a means of reducing the sound in the TV speaker while feeding the hi-fi. The various cables were easily soldered to the Vector unit after all the wires were

[Continued on page 110]

PARTS LIST

- C1—.1 mfd 600 volt paper capacitor
- C2—.25 mfd 400 volt paper capacitor
- T—200 ohms to 80,000 ohms audio transformer (Stancor A-4705)
- SW—Double-pole single-throw switch
- Vector Socket—Octal T-8-O or miniature 7-pin T-7-M
- P1—Phono plug, RCA type
- Case—4"x2 1/8"x1 1/2" aluminum (Premier PMC-1002)
- Misc.—4-lug terminal strip, shielded phono cable, two rubber grommets

View of TV chassis. Vector unit plugs into audio output socket. Audio tube then plugs into Vector.



In lower left of schematic, typical audio output tube is shown (6V6). Text gives several other examples.

Follow wiring guide below. Take care to ground wires to case only at the ground lug point shown.

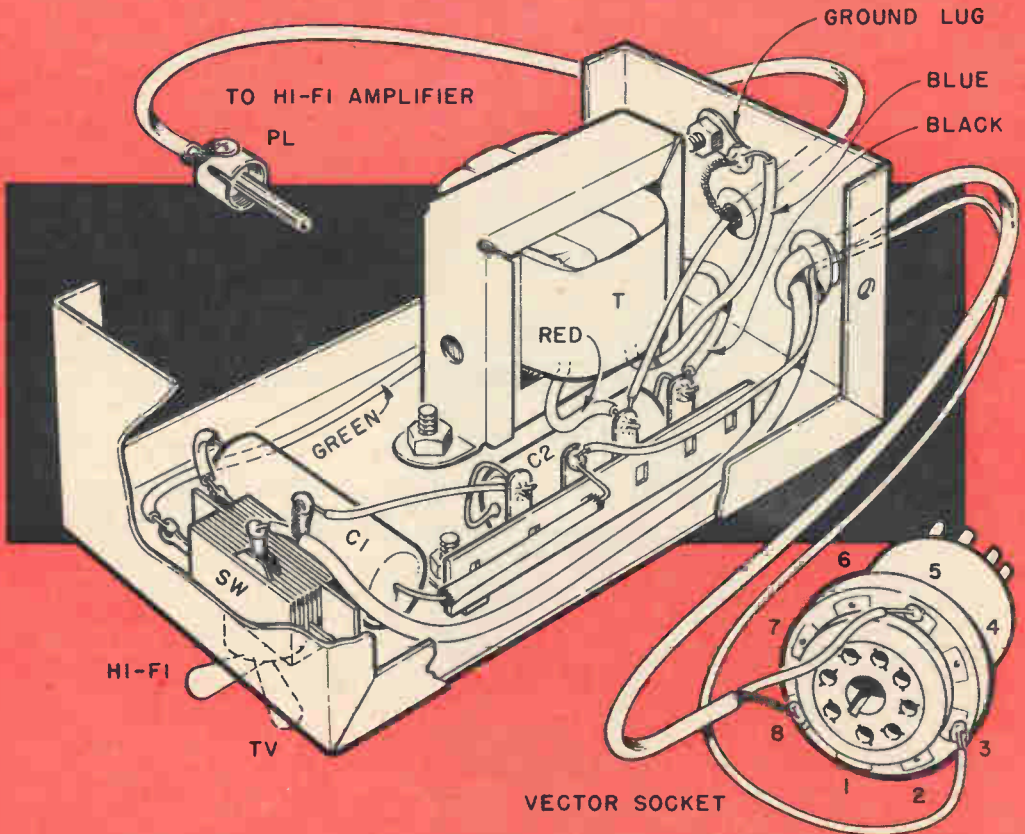
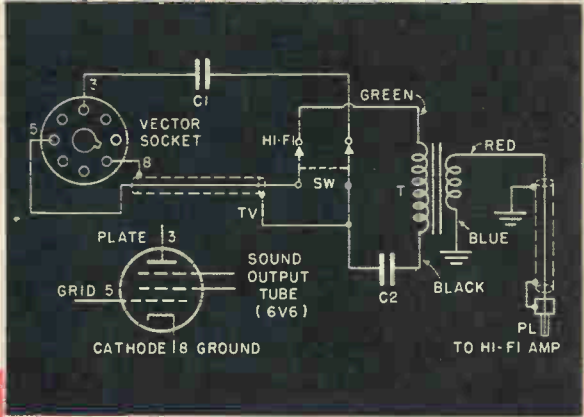

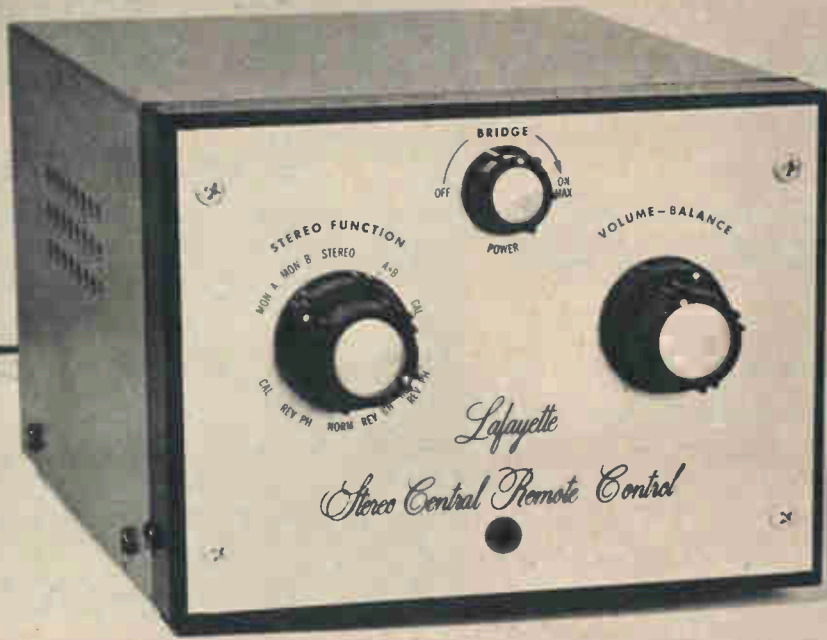

Completed kit is above. It may be used at a point remote from the stereo equipment. All knobs are explained in text.

Layout of parts supplied. The assembly manual includes templates, useful if the unit is to be mounted behind a panel.



The balance control, far left, and function selector, right, are both dual controls, wired before being bolted to panel.

46

EI assembles A Stereo Adapter

Remote control of two stereo amplifiers and third channel are features of Lafayette kit.

RECENT stereo amplifiers group their balance and speaker phasing controls conveniently on one panel. By use of ganged volume controls, the level of both channels is adjusted simultaneously. Such is not the case for the person who chooses to convert to stereo by adding another amplifier to his existing monophonic set-up. The Lafayette Stereo Remote Control, Model KT-315 should hold special appeal for him. Without a stereo adapter, he must jockey between separate units to make various adjustments.

Essentially, this unit ties together both amplifiers and centralizes the controls. In addition, it provides extreme switching flexibility and a unique balancing system.

Here's what it does, in detail. Channels A and B (right and left amplifiers) appear on an outer and inner volume control knob. When the inner knob is clicked in, the two are ganged and work together. Selector switches permit instant reversal of the channels so they may be heard in opposite speakers. Phasing of each channel may also be inverted so the speaker cones will move in unison. If monophonic material is being reproduced, either channel can be selected.

At below left two leads of a capacitor have been pushed through holes in the printed board. A low wattage iron is touched briefly to the foil as solder is applied to joint. Leads are then clipped. At right, top of board is seen.

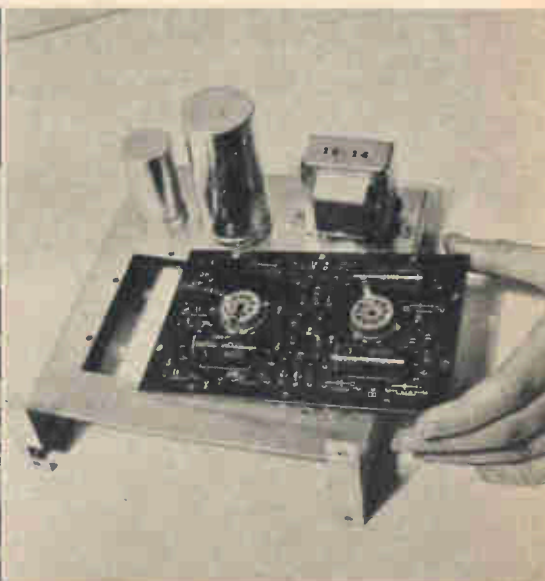
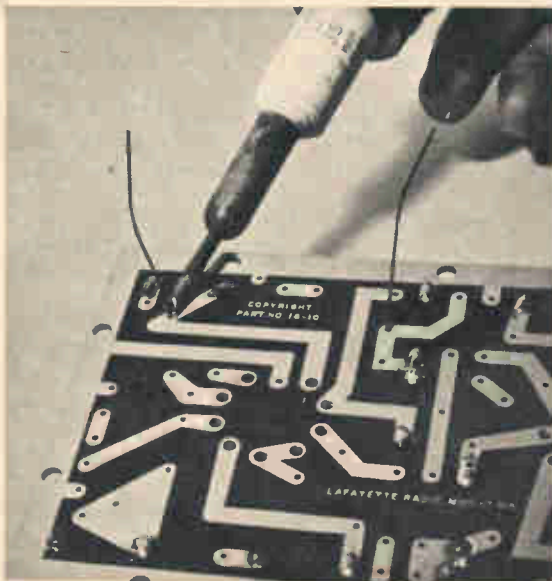

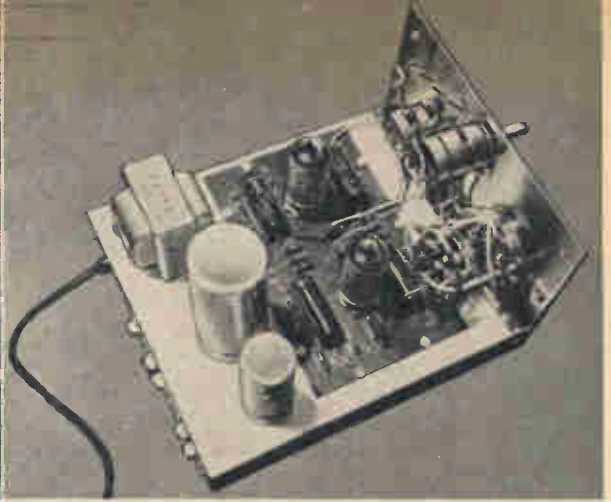
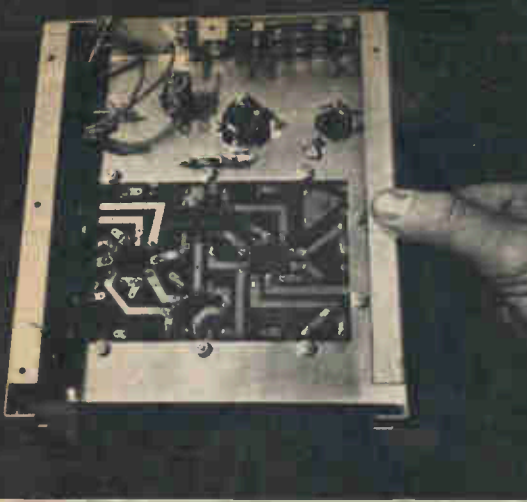

Top left shows underside of chassis, printed board in place. Parts just above board are in the power supply, to be wired to board.

Top right shows unit completed; controls on front panel have been wired to board, and two tubes (center) inserted in sockets.



Along rear of chassis, left, bridged output feeds third channel, AB output drives main amps, input gets signals from preamps.

Variable channel separation is another feature of this unit. If the program appears to have a "hole in the middle" effect, it is possible to crossfeed audio from one channel to the other.

For those who wish to use the more elaborate 3-channel stereo, with an additional amplifier and center speaker, a bridge output is supplied. A front panel control permits any mixture of the right and left channels to appear in this center amplifier and speaker.

The most singular feature about this unit is the balancing provision—for feeding equal level to both amplifiers. A selector is switched to a calibrate position and the volume control on one of the main amplifiers (or preamps) is set at a comfortable listening level. Then, the volume of the other amplifier is rotated until the sound in the speakers completely disappears! Switch

back to normal position and the volume controls are electronically equal. This "nulling" system is possible since the adapter uses tubes, as opposed to the passive types.

Installation of the unit may be done in several ways, depending on your equipment. In any case, it must be between the preamps and main amplifiers. This is simple when the preamp is on a chassis separate from the main amplifier—several shielded cables with phono plugs will do it. However, if the preamp is on the same chassis, it must have Tape input and output jacks for signal takeoff points. If there are none, jacks can be wired.

Construction of the unit went smoothly, taking about six hours.

At \$27.50 the KT-315 represents a Good Buy for those desiring flexibility in the use of their stereo equipment. —



Hi-Fi Clinic

Do you have any questions on the adjustment, installation, or repair of hi-fi equipment? The clinic provides an answer to each query.

Speaker Balance Controls

I would like to install separate volume controls on my midrange speaker and tweeter. What is the recommended way of doing this?

Nat Berkowitz, San Diego, Calif.

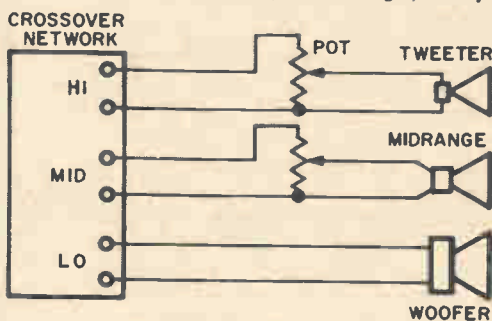

Ordinary two watt wirewound potentiometers may be used according to the circuits shown above. The resistance values of the pots should be three to five times the impedance of the speakers. They are installed between the speaker and the crossover.

Although they are somewhat more expensive, L-pads of the same impedance as the speaker may also be used. They provide a better match between the speaker and amplifier, and thus a more efficient transfer of power takes place. Instructions for wiring in these pads are customarily enclosed in the box they are packed in. The procedure is simple except for the manufacturer's use of terminology. Instead of speaker and amplifier, the words "Source" and "Sink" are sometimes used on the wiring diagram. Just consider the amplifier (or crossover) as the Source and the speaker as the Sink.

A somewhat better system for matching with a volume control is through use of a T-pad. Since this type has an additional section as compared to the L-pad, the price is higher. For the

simple setup that you require, the additional expense is not warranted since the difference is negligible.

Push-Pull Tubes

One of the push-pull output tubes in my amplifier seems to have an exceedingly short life in comparison to the other. Have you any idea of what might be causing this?

Claude Segall, Seattle, Wash.

The first thing to check is the grid voltage at the socket of the short-lived tube with a voltmeter. It is common that the coupling capacitor going to this pin has become partially shorted, causing a positive voltage to appear on the tube grid. The positively charged grid will cause the current to increase beyond a safe value in the tube and shorten its life.

Four Track Stereo Tape

I heard that four track stereo tape is shortly going to be available. Does this mean that it will be necessary to add two more speakers and amplifiers to my present stereo setup?

Robert Strom, Chapel Hill, N. C.

The new four track stereo was designed to increase playing time and not the number of sound channels. In order to play these tapes, the pickup head of the tape recorder must be changed to accommodate the new arrangement. The number of amplifiers and speakers remains the same as conventional stereo two channel sound.

The new tape permits you to run both sides of the tape through the transport, thereby doubling the playing time. Since stereo requires two channels in each direction, a total of four tracks is necessary to accomplish this. Conventional stereo tapes may only be run through the tape transport in one direction.

bowling with the Electronic Pinspotter

WHETHER you hook into the 1-3 pocket for a strike, or bounce the ball into the gutter, you can be sure the pinboy isn't making any nasty cracks under his breath—that is, providing you're bowling with one of those efficient automatic pinspotters.

With the AMF Automatic Pinspotter, a neat little electronic control box, affectionately called the "brain," sees to it that the pins are on spot when you want them on spot.

The whole unit, which stands 5' 2" tall, goes into action when the ball hits the cushion in the pit. Inside the cushion is a switch. Should the bowler be lucky enough, or skillful enough to roll a strike, a sweeper arm drops to the alley and waits while the respotting table descends. Finding no pins in the upright position, the table reascends to allow the sweeper arm to clear the deadwood into the pit. There the pins fall onto a conveyor belt which transports them to a wheel-like conveyor known as the "pinwheel." This unit lifts the wood to the top of the machine, and feeds them into the spotting table's cups as required.

Meanwhile, the spotting table has already spotted a new set of pins. There is little delay because there are two complete sets assigned to each alley, and while one set is being cleared, the other is in ready position for spotting.

This automatic pinspotter really shows its versatility when the first ball fails to knock down all the pins. The sweeper arm drops and waits. Then the

[Continued on page 113]

Left, ball leaves some pins erect. Upright pins (those extending well below respot table, center) are lifted as arm clears away deadwood, then set down again. Pinwheel, right, sends pins to top where they are reloaded.

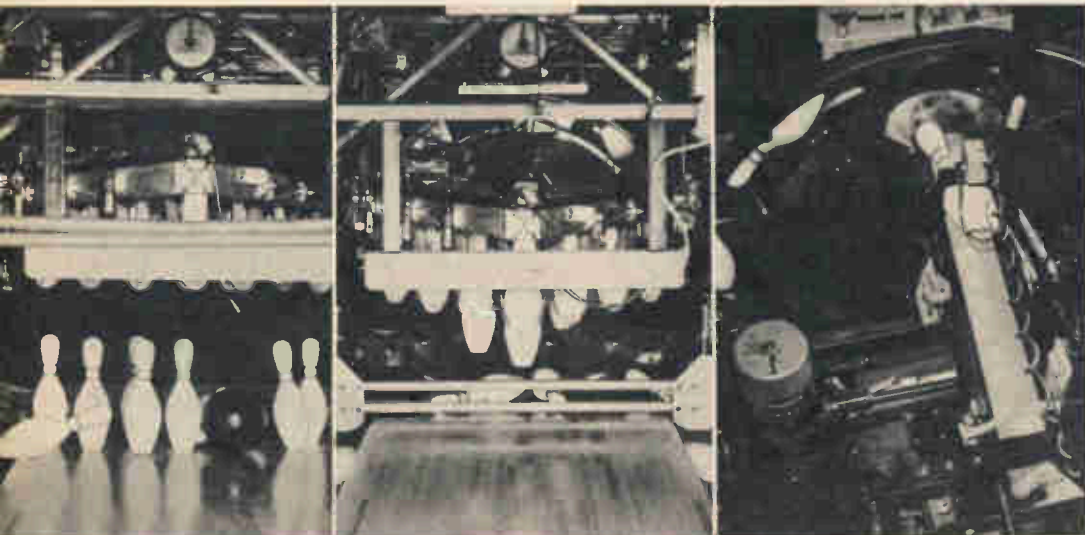



The only time a bowler must push a button is when he gets a spare in the tenth frame. Automatic pin-spotter can handle nine games an hour, returns ball very quickly.

This is the "brain" which guides the electro-mechanical unit through each game. The electronic control center is located over automated alley out of sight.

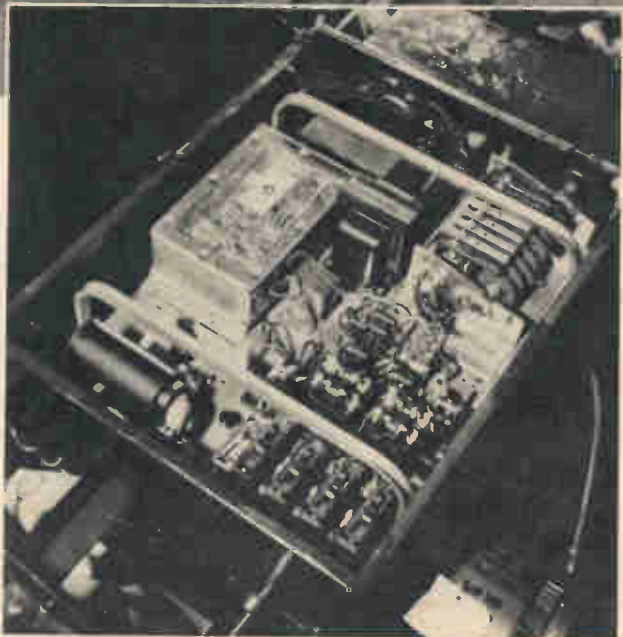

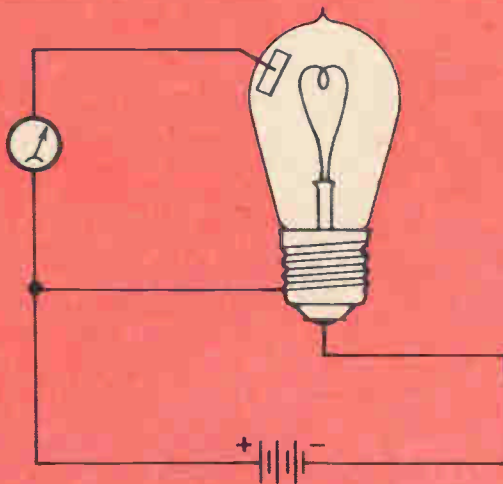

Fig. 1. A positive plate placed in a light bulb will attract electrons from the filament.

The ABC's of Electronics-10

By Donald Hoefler

How does an electron tube work? Part 10 explains the operation of the simplest type—the diode.

THOMAS A. EDISON made a most important contribution to the modern art of electronics in 1883, only he didn't know it. Twenty-two years passed before another man in another country suggested the possibility of applying Edison's discovery to the then infant art of radio communications.

Edison's momentous experiment is illustrated in Fig. 1. Using an ordinary carbon filament light bulb of the day, he added a metal plate inside the same bulb. When the plate was connected to the positive terminal of the filament battery as shown, the ammeter deflected. Apparently there was a flow of current right through the empty space, from the filament to the plate.

When the plate connection to the battery was removed, the current ceased. Also, when the plate circuit was connected to the negative battery terminal, there likewise was no current flow. Obviously, current could flow in one direction only in the bulb. From the heated filament to the positive plate, it was quite feasible, but from plate to filament it was impossible.

Edison duly recorded the phenomenon, but made no effort to explain or use it, nor did anyone else at the time. And there matters stood until 1905, when Prof. J. A. Fleming of London suggested a practical application. He proposed that a two-element

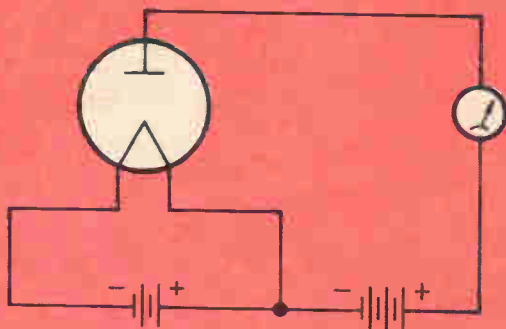

Fig. 2. Diode powered by 2 batteries; left one heats filament, right charges plate positively.

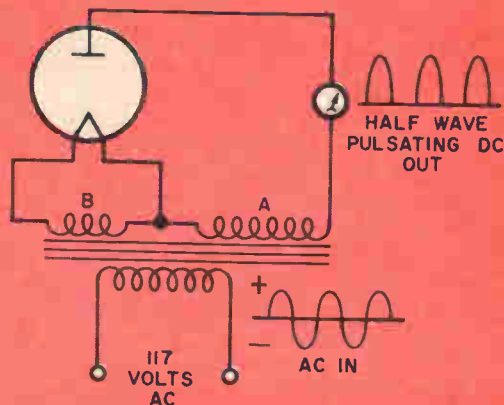

Fig. 3. When the batteries are replaced by a transformer, the 117 volt AC is rectified.

tube or valve, based on the "Edison Effect," might be better than the galena crystal then used for the detection of radio waves from spark transmitters.

Thus was born the "Fleming Valve," which is the basis of today's diode vacuum tube. Such a tube is shown schematically in Fig. 2, where we see it is very similar to the experimental Edison bulb in Fig. 1. The two elements are still commonly called the filament and plate, or more technically, the cathode and anode.

The filament may be simply a loop of tungsten wire within the evacuated tube. When a suitable voltage is impressed across the filament terminals, the wire heats up and begins to throw off electrons by a process known as *thermionic emission*. The usefulness of the vacuum tube depends upon the proper control of this electron cloud or *space charge*.

The emitted electrons are, as we know, elements of negative electricity. Consequently they will be attracted by a positive element, but repelled by a negative one. When the plate is made positive with respect to the filament, therefore, the free electrons will rush to the plate and ultimately return to the filament through the plate battery.

A very common application of the diode can be readily understood solely on the basis of principles just discussed. This is its use as a *rectifier* in power supplies, which permits the use of the AC house current for operating voltages in place of batteries. But in order to do this, the 117 volt AC must be converted to smooth DC.

If we removed the plate battery from the circuit of Fig. 2 and replaced it with an AC generator, current would flow only during the positive alternations of the AC cycle. And if we were to connect the plate line and the positive filament terminal into an AC outlet, this would in effect be connecting an AC generator across the plate circuit.

But the operating voltages required in electronic equipment often are greater than the 117 volts normally available from house circuits, so a transformer is usually used to step up the voltage. This results in the arrangement of Fig. 3. Notice that we are also using AC on the filament. This is perfectly all right, since the filament current is used solely for heat.

The voltage across plate winding A of the transformer, and hence the voltage on the plate, is several times the 117 volts impressed across the primary.

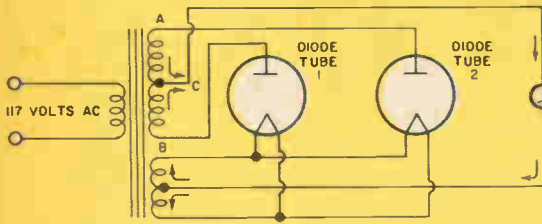

Fig. 4. Full wave rectifier uses 2 diodes; DC pulses are closer together than in Fig. 3.

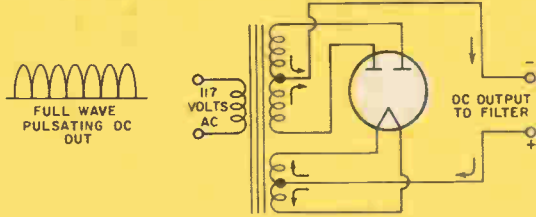

Fig. 5. Two diodes are commonly enclosed in a single tube. One filament serves both plates.

Whenever the plate end of winding A becomes positive, current will flow through the meter. But, when the pulse is negative there will be no current flow. The negative pulses are therefore effectively cut off, and the resulting output is pulsating DC as shown.

It would seem, however, that this scheme could be improved upon if we could somehow avoid wasting those negative halves of each cycle. And indeed we can, simply by using two tubes in the circuit shown in Fig. 4. This provides us with a *full wave* rectifier, as opposed to the half wave circuit in Fig. 3.

Let us begin by assuming a moment in time when the AC input tends to cause current flow from A to B in the transformer winding. This would mean that current would flow from the plate of tube 2 through the winding to the plate of tube 1. But this is impossible, for the electron flow would then have to continue across to the filament of tube 1.

There is another possible course for the current, however, from plate 2 to A to C. So far so good, but where does the current go from there? Continuing along, it can go through the meter and then into the center tap of the filament winding. From there it might go to the filament of tube 1, or of tube 2, or both. But the polarity of tube 1 is wrong at this time, tending to force current in just the opposite direction. And so all of the electrons go to filament 2, where they travel across to the plate and complete the circuit.

On the next alternation, all of the

polarities will be reversed. Tube 2 will now be cut off, but tube 1 will begin to conduct. Then current will flow from plate 1 to B, to C, and through the plate meter return circuit and into the filament winding.

Note that although the current in the transformer windings reverses, the current through the output meter is *always in the same direction*. The negative alternations have been flopped over and become positive, to fill in the gaps of the output waveform of Fig. 3.

Even the full waveform is still far from smooth and must be evened out to pure DC before it is useful for operation of other electronic equipment. This is done by means of a *filter* comprising chokes and condensers, or resistors and condensers.

The circuit of Fig. 4 can be simplified and improved if we consider that the filaments are both connected to the same point, and could therefore perhaps be reduced to one, common to both plates. This is quite possible if both plates are in the same envelope, to make up a twin diode as shown in Fig. 5. The operating principles are just the same as for the two single diodes just discussed.

This completes our coverage of the two-element diode. Its ability to change its input from AC to DC finds wide usage in electronic equipment. Next month we shall add an element and describe the triode tube and how it is capable of amplifying minute voltages.

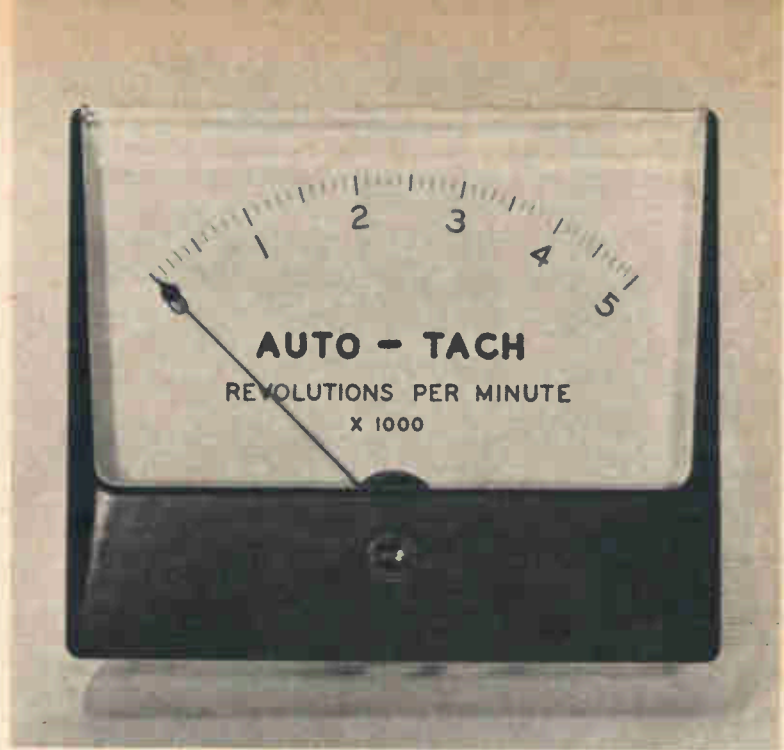

A half-circle of white paper was pasted on the face of a 0-1 millimeter. Numbers 1 through 5 were positioned just below original meter graduations.

An Auto Tachometer

By R. L. Winklepleck

One key to your car or boat engine performance is rpm. Check it with this all-electronic tachometer.

IF YOU are interested in your car's engine speed as well as road speed, perhaps the only thing that has kept you from adding a tachometer is the high price of a commercially made instrument.

Many good tachometers require an internal battery for accuracy since the auto battery may vary over a range of several volts due to voltage-regulator adjustments and variation in engine speed. The extra battery in such tachs increases the size of the instrument and requires regular maintenance. This tach is designed to use the automobile battery; but the supply voltage is regulated to a constant value through the use of one of the relatively new Zener or voltage-reference diodes, D2 in this unit.

The physical layout can take any convenient form. There is only one important point that must be watched carefully. In so compact a layout the leads are quite short. There are three diodes and one transistor that can be easily damaged by excess heat. In some instances there may be two or three heat-sensitive leads going to one solder point. Be very careful to use the minimum heat which will assure good connections and use needle-

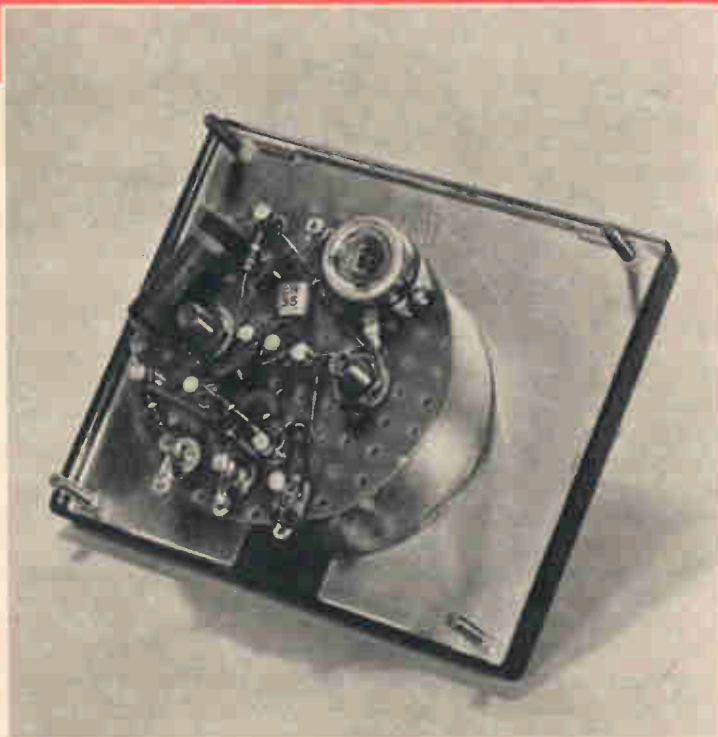
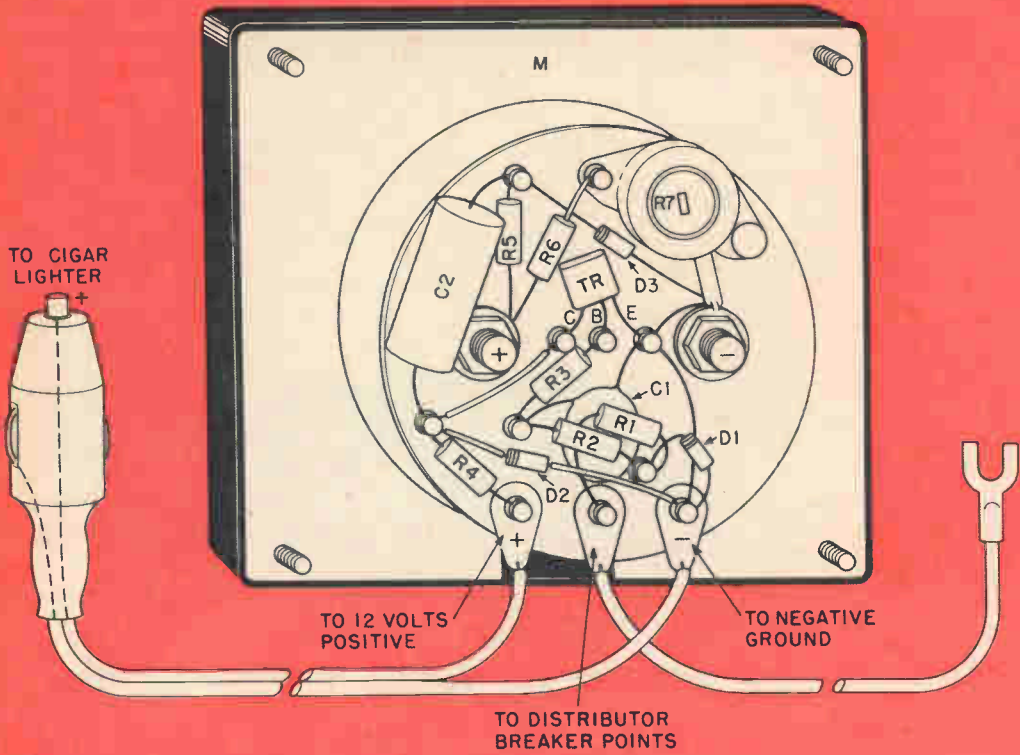

Wiring guide shows cigar lighter plug. However, if tach will be installed permanently, it is wired to ignition, as per text.

Circuit board with all the parts mounts directly onto the meter terminal posts. Calibrating pot R7 is at top of board.

nose pliers or some other type of heat sink on such lead, leaving it in place until the connection has cooled.

Small size and low value do not go hand in hand in potentiometers but this requirement is admirably met for R7 by one of the inexpensive hum reducing variable resistors used in the filament circuits of many amplifiers. The one in the illustration is called the Humdinger. The meter may be any size or shape. Any value under one milliampere may be used by reducing the value of R6 to shunt more of the current. The recommended meters are; 0-1 milliammeter for 12 volts and a 0-500 microammeter for 6-volt systems.

Installation consists of mounting the meter either through the instrument panel or in a small box which may be attached wherever convenient. The negative lead goes to any nearby ground point and the positive lead should be connected to the ignition switch terminal which is "hot" only when the ignition is on. The pulse terminal connects via a well insulated lead to the ungrounded side of the breaker points in the distributor. It is from this point that a lead goes to one of the low voltage

[Continued on page 113]

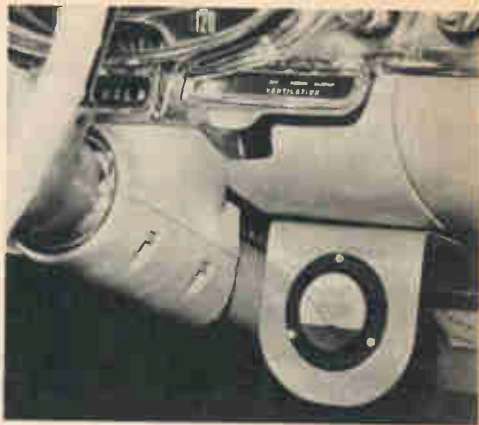

A smaller meter may more conveniently be mounted under dash. Circuit remains the same.

PARTS LIST

- R1—3300 ohm 1/2 w resistor
- R2,R3—2200 ohm 1/2 w
- R4—680 ohm 1/2 w
- R5—330 ohm 1/2 w
- R6—68 ohm 1/2 w
- R7—100 ohm potentiometer (see text)
- C1—.1 mfd 15 volt capacitor
- C2—5 mfd 15 volt
- D1,D3—Diode 1N90
- D2—For 12 volts use Zener diode 9 volt (Texas Instruments 1N757 or Transitoron 5V11). For 6 volts, Zener diode, 5 volt (Texas Instruments 1N751)
- TR—Transistor 2N35
- M—For 12 volts use 0-1 DC milliammeter. For 6 volts use 0-500 DC microammeter

12 volt connection is shown here. For operation on 6 volts, see parts list.

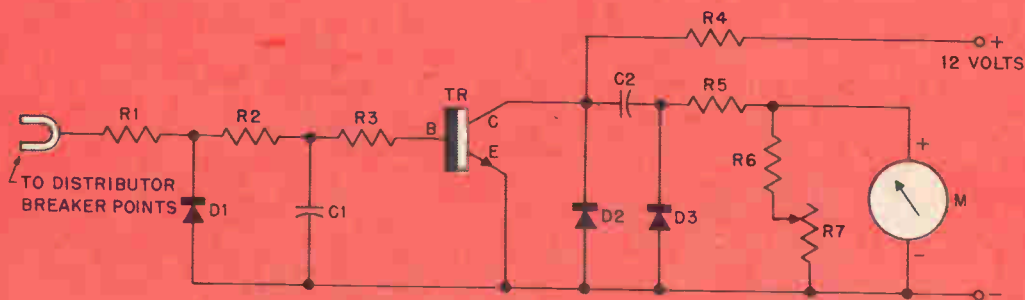

How To Prepare A Chassis

By Len Buckwalter

Associate Editor

Follow these tips. They'll speed the job and give your electronic projects a professional appearance.

QUITE often, about half the time spent in building a piece of equipment is devoted to readying the chassis for wiring. Several tools and techniques, available to the hobbyist, can go a long way toward reducing this period of time and give the device the appearance of a commercially manufactured unit.

Relatively inexpensive punches, as illustrated, should practically do away with the old method of making holes—drawing a circle, drilling a series of holes on it, then sawing them through. Certain odd shapes, of course, must be done this way, but count on the round or square punch for most of the cutting. If you require a somewhat larger hole than the punch will provide, a

[Continued on page 104]

If you don't want to mar the surface of the chassis, leave its wrapping on while working on it. Use the components themselves as marking templates.

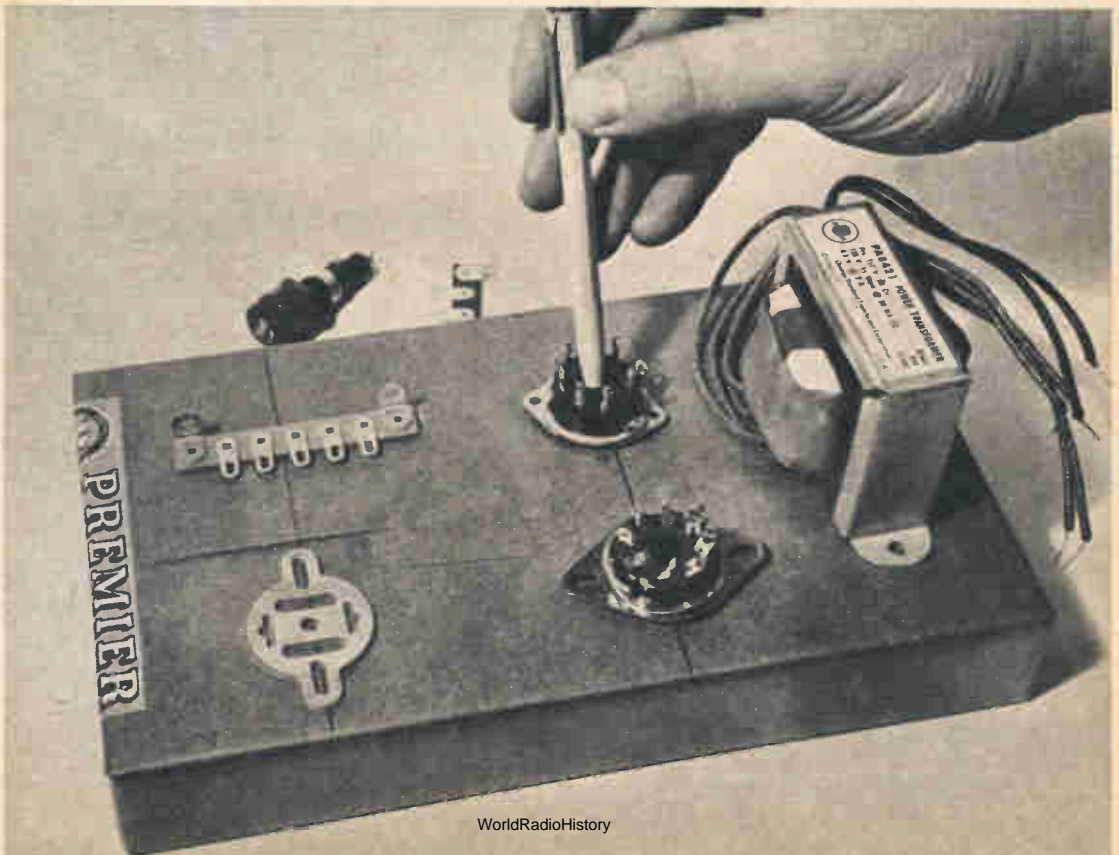

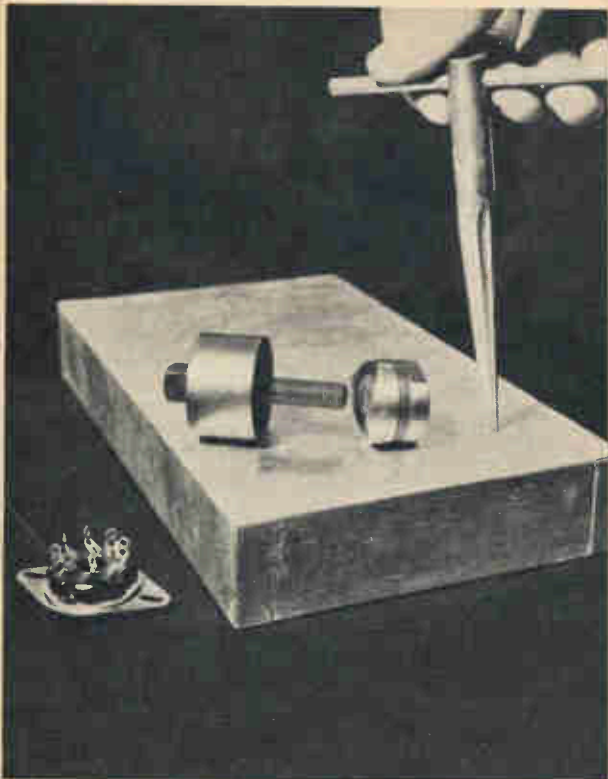

Perfect holes can be made with a variety of round or square punches. The Greenlee punch shown here is for the octal socket at left. First a hole is drilled, then widened with a hand reamer. The long bolt is inserted into the hole and the two halves of the punch are drawn together with a wrench.

Hole is ready to receive the octal socket. Note miniature transformer can and its adapter plate. This plate may also be used with the octal hole.

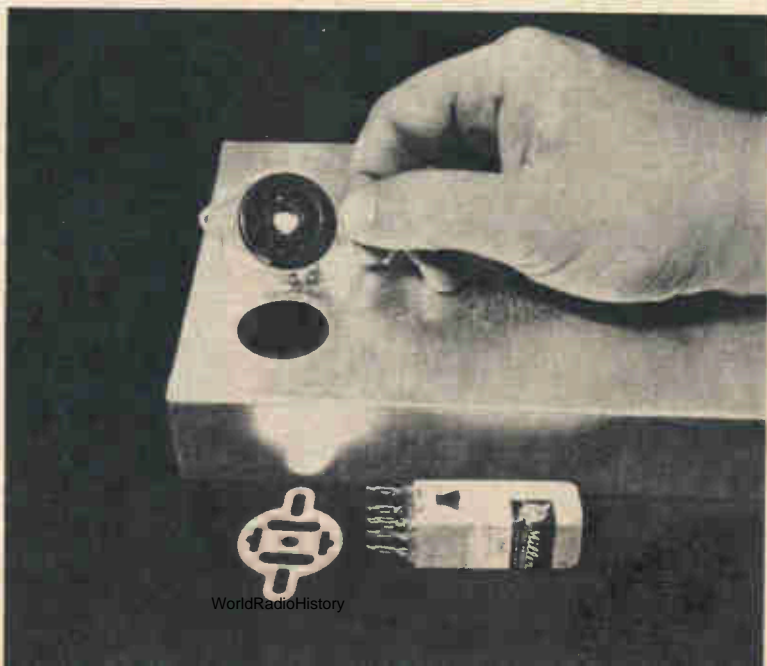

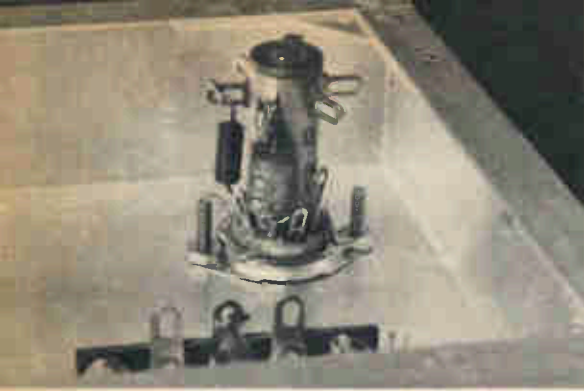

Parts can mount directly on this turret type socket (tube plugs in above chassis). It is useful where leads must be kept short.

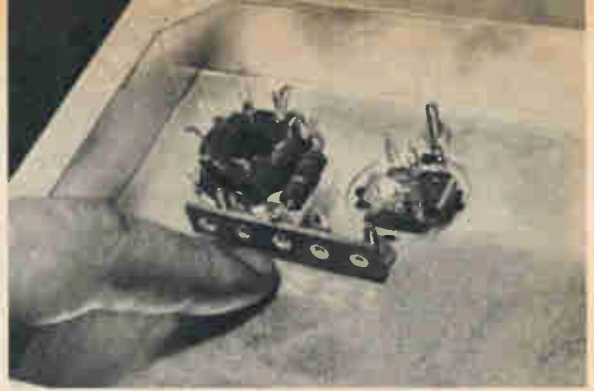

Terminal lug strips are often a necessity near sockets. They provide insulated anchor points for parts going to tube socket lugs.

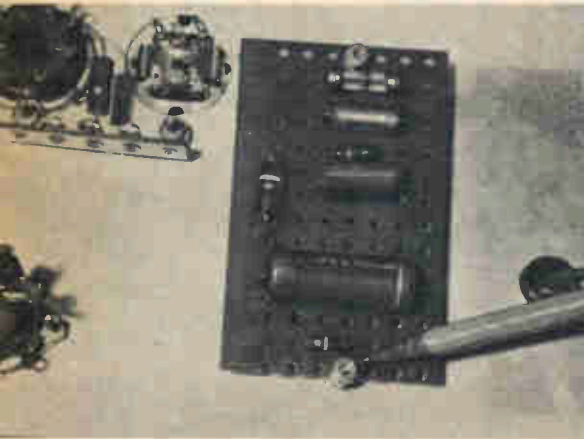

A perforated phenolic board makes a good subchassis. It is mounted with long screws. Space board from chassis by nuts or washers.

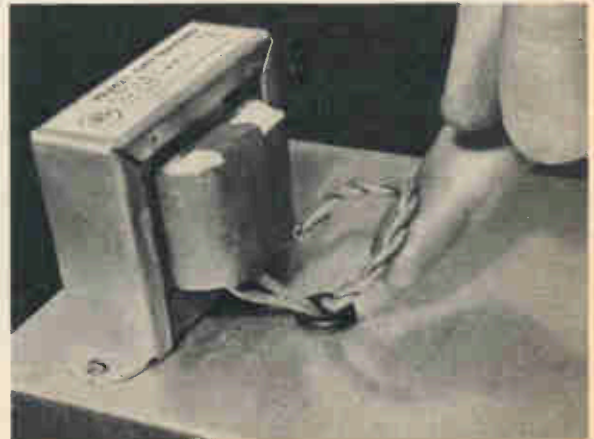

Always twist filament leads to reduce hum radiation. Use a rubber grommet for cables entering chassis to prevent chafing wire.

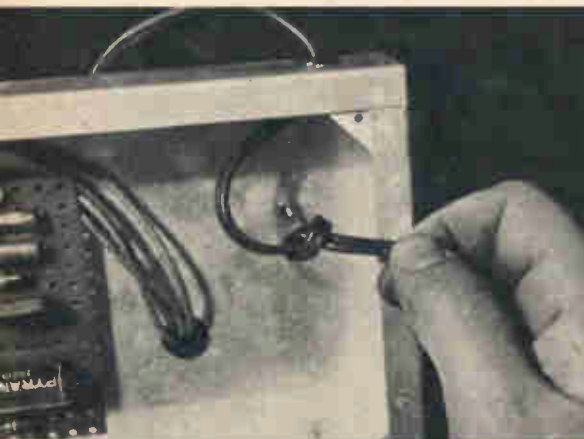

A knot in the AC line cord will provide strain relief in case the cord outside the chassis is pulled. Note the grommet at top.

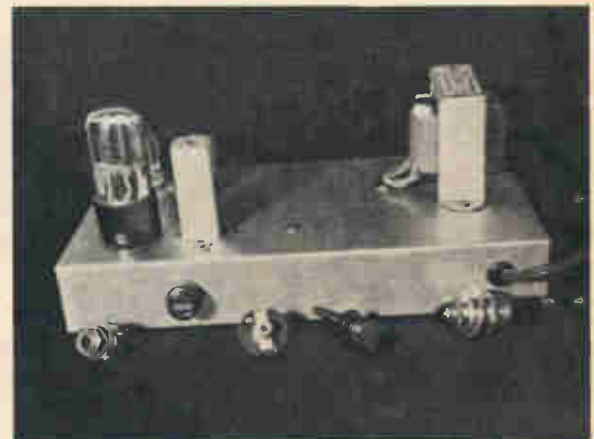

Some parts you may mount on the apron of the chassis are, left to right; phone jack, fuse, phono jack, binding post, pilot lamp.

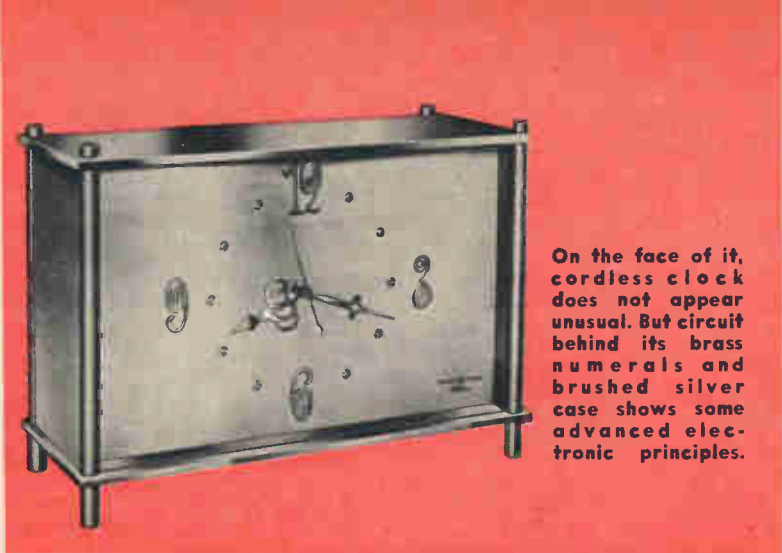

On the face of it, cordless clock does not appear unusual. But circuit behind its brass numerals and brushed silver case shows some advanced electronic principles.

Unique Electronic Clock

HERE'S an electronic clock that keeps accurate time without a cord or direct electrical attachment. It is synchronized through a circuit which takes advantage of the 60-cycle magnetic field radiating from power wiring in the home.

Alternating current in power lines throughout most buildings radiates a weak magnetic field at 60-cycles-per-second. This radiation is picked up by an inductive coil in the clock and fed through three stages of transistorized amplification to the motor. The motor's armature, geared to the clock's hands, synchronizes with the 60-cycle alternations of the field picked out of the air. Mercury batteries provide an extremely long-lived power supply for the transistors.

Designed to retail at \$195, this General Electric-Telechron appliance is said to be the first to operate on this principle.

Compact inner workings reveal an inductive coil, left, which picks 60-cycle magnetic field out of the air, feeds it to a transistorized amplifier, right.

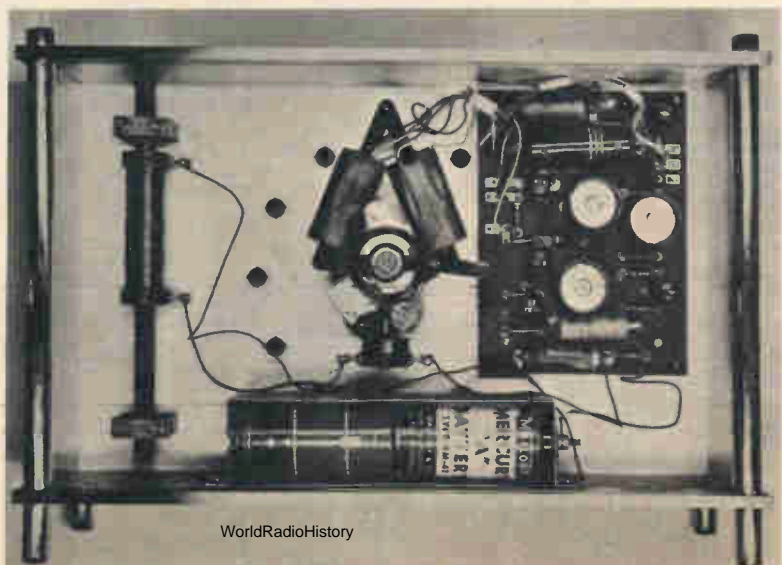



E I Picturescope

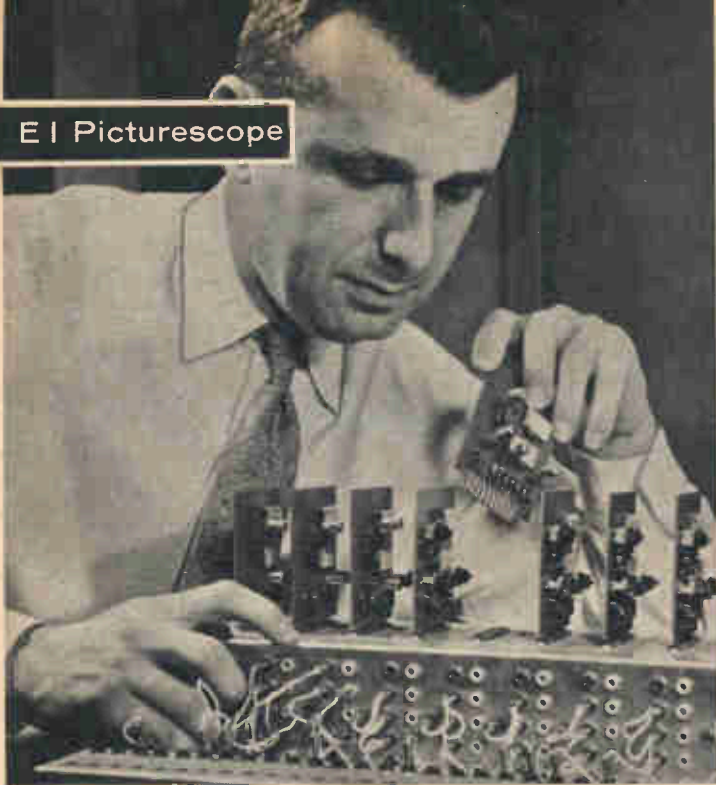

Nerve cells in the human eye and ear have been simulated at Bell Labs on an inexpensive printed circuit. These electronic "cells" can deliver a series of pulses when stimulated, and even show fatigue like a living cell by slowing down under prolonged stimulation. When combined with other "cells," systems which imitate some workings of human nerve networks are created, thus providing a new approach to medical study.

Here is a new triple-threat ultraviolet sensitive alarm that can detect and warn of smoke, fire and dangerous vapors separately, or all three at once. As the Minneapolis-Honeywell engineer lights his pipe, a four-inch tube detects the ultraviolet rays in the room and makes appropriate contacts which illuminate both fire and smoke indicators. Combustible gases in beaker also are detected, lighting the vapor warning slot in portable unit.





Walter Kidde installation for System Development Corp.

Above, secret documents of government contractor are guarded by ceiling-mounted ultrasonic transmitter which floods room with sound at 19,200 cps. Any movement in room disturbs sound waves, and the disturbance is picked up by monitor (right) which sounds audible alarm. Below, new color television projector called Eidophor, developed for Ciba Pharmaceuticals, projects sharp color picture onto theater screen. It is now being used in medical conventions.



On the front panel upper left to right, frequency selector, VU meter, output switch, jacks.



Hi-Fi Tester

By Harvey Pollack

This unit enables you to check amplifier frequency response and resonance of speaker and enclosure.

Top view of chassis shows power transformer, filter can C5 with tube sockets below—V2 (left) and V1. Shaft above V1 is R13, for waveform.

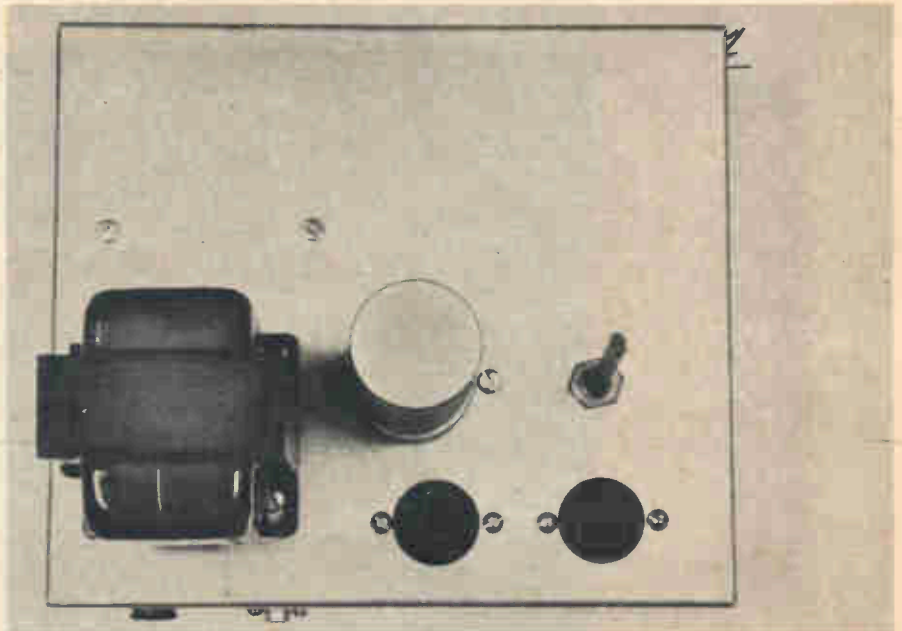

HERE'S a compact package with which you can check the frequency response and resonance characteristics of your hi-fi system.

The basic section of the tester is a stable Wien bridge oscillator that provides instantaneous selection of 10 different spot frequencies from 20 to 20,000 cycles per second. An additional control is provided to make available a continuously variable output signal from about 300 cycles per second down to 15 cycles per second for locating points at which the speaker system or the speaker enclosure resonates.

A great deal of effort is expended in modern hi-fi equipment to insure that the speaker and its enclosure resonate at different frequencies to avoid disastrous vibration. This tester, locates the resonant frequencies and provides the information required with regard to padding material, volume, or wood stiffening members.

The second principal section of the tester includes a Volume Unit (VU) meter, a dummy load, and a three position switch. By means of the latter, it is possible to measure and maintain a

constant input signal to the amplifier under test, measure the voltage drop across a dummy load, and measure the voltage applied to the speakers—all independently of one another.

Prepare the frequency selector switch in advance. A small piece of perforated bakelite or stiff fiber is mounted on the free end of the switch and a large solder lug secured to its center. Resistors R3A through R12A are then soldered to this lug, their opposite ends being joined to the appropriate switch terminals on the rear wafer. Two large hole solder lugs—the kind that are used around the bushing on standard volume controls—are then placed on the shaft of the rotary switch. These serve as the ground tie points for all the resistors from R3B through R12B. The remaining lead on each of these resistors is, of course, connected to the matching terminals on the front wafer. Prepare the output switch SW3 in advance, too. This is a 4-circuit, three-position key switch that is quite easy to wire and use.

Secure the panel to the chassis using the bushings of the on-off switch (SW1), the resonance dual potentiometer

Rear of front panel. Visible, left to right, are SW2, VU, R21, SW3 with jacks above.

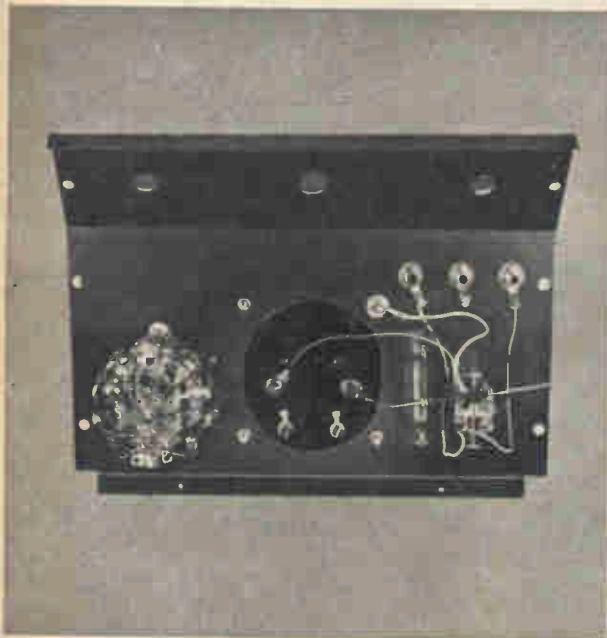

Follow this diagram for connecting tester to amplifier. Jacks at left are on the tester.

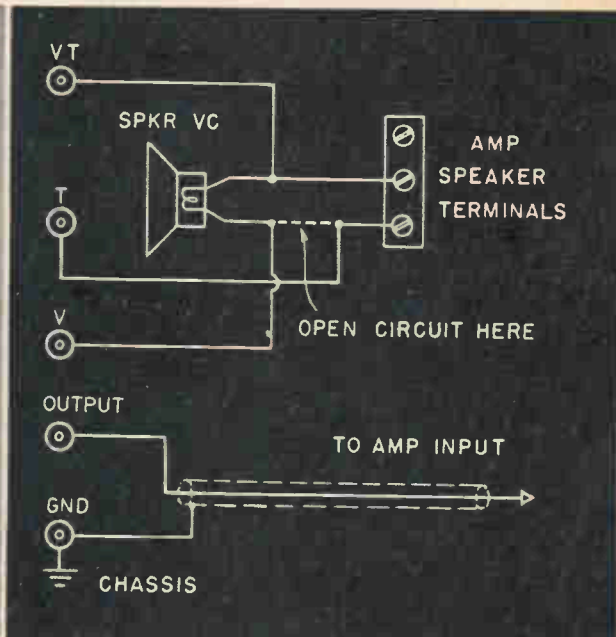

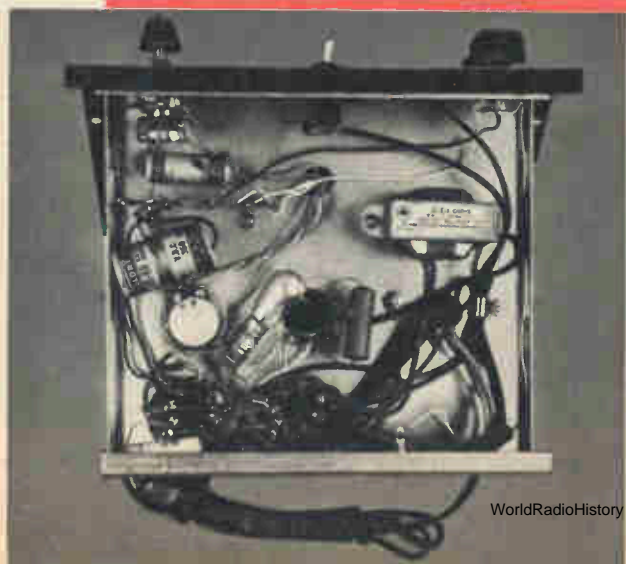
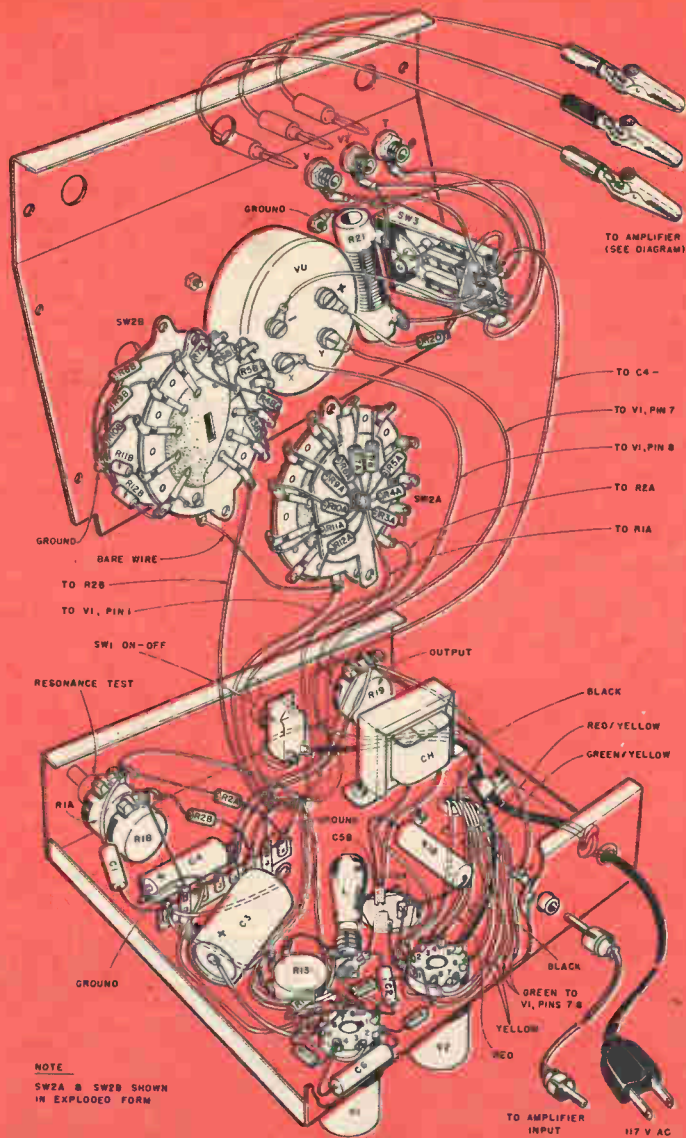

In wiring guide above, front panel has been raised and switch SW2 separated for reasons of clarity.

Underside view of chassis, front panel bolted on. Follow this recommended layout of components.

meter (R1A and R1B), and the output potentiometer (R19) as supporting elements. Use of sheet metal screws to hold panel to chassis is unnecessary.

Wire the 5 volt and 6.3 volt heaters, including the panel lamps of the VU meter first. Keeping the other transformer leads apart, test this wiring by plugging in the unit and turning it on. The heaters of the 6SN7GT and 5Y3GT, plus the panel lamps, should all come on.

Wire the power supply next. When fully wired—right through R18 of the filter network—test the DC output voltage without a load. This should be about 350 volts. *Discharge the capacitors by shorting the B+ to the chassis before continuing with the wiring.*

Mount and wire all other components, including both switches (SW2 and SW3). Before applying power, test for B+ to B— shorts with an ohmmeter.

R13, a 5K potentiometer, is mounted on the chassis rather than on the panel because this control is generally not touched after the initial adjustment is made.

The testing procedure is quite simple. Connect a pair of ordinary magnetic or dynamic headphones (or even a small speaker) to the output terminal. This is a phono jack of the standard variety on the rear apron of the chassis. Set R13 on about midscale and the wiper of R19 all the way to the ground end of the potentiometer. Position the rotary se-

[Continued on page 93]

PARTS LIST

All resistors 1/2 watt, 5% unless otherwise stated
 R1A, R1B—Dual potentiometer 5 megohms each section (IRC PQ 11-141 plus rear section M11-141)
 R2A, R2B—330,000 ohm
 R3A, R3B—3.9 megohm
 R4A, R4B—1.6 megohm
 R5A, R5B—820,000 ohm
 R6A, R6B—390,000 ohm
 R7A, R7B—160,000 ohm
 R8A, R8B—82,000 ohm
 R9A, R9B—39,000 ohm
 R10A, R10B—16,000 ohm
 R11A, R11B—8,200 ohm
 R12A, R12B—3,700 ohm
 R13—5,000 ohm potentiometer (IRC Q 11-114)
 R14—47,000 ohm
 R15—22,000 ohm
 R16—1,500 ohm
 R17—1 megohm
 R18—500 ohm 5 watt
 R19—1,000 ohm potentiometer (IRC Q 11-108)
 R20—3,900 ohm
 R21—7.5 ohm 10 watt (dummy load)
 C1, C2—.002 mfd 500 volt capacitor
 C3—20 mfd 350 volt electrolytic

C4—50 mfd 25 volt electrolytic
 C5A, C5B—30-60 mfd dual electrolytic, 350 volts each section
 C6—.02 mfd 600 volt
 V1—6SN7GT
 V2—5Y3GT
 SW1—Single-pole single-throw toggle switch
 SW2—11-position 2 deck rotary switch (Mallory 1321L)
 SW3—4-circuit 3-position lever switch (Lafayette type SW-20)
 T—Power transformer 240-0-240 volts @ 55 ma, 5 volts @ 2 amps, 6.3 volts @ 2 amps. (Stancor PC-8402)
 CH—Choke 9 henry @ 50 ma (Stancor C-1215)
 VU—Volume unit meter (Lafayette TM-80, —20 to +3 db, 0-100% @ 600 ohms)
 L—Lamp 117 volt 6 watt candelabra base
 Sockets—2 octal, 1 candelabra
 Chassis—7"x8"x2" open end (Bud CB-39)
 Cabinet—6 1/2"x9 1/16"x7 5/16" (Bud C-1585B)
 Terminals—3 insulated banana jacks with shoulder washers for panel mounting, 3 banana plugs, 1 phono jack, 1 phono plug
 Misc.—Line cord, decals, hardware, wire, alligator clips

The large group of resistors on left side of schematic (right), R3A through R12B, are mounted on the rotary switch.

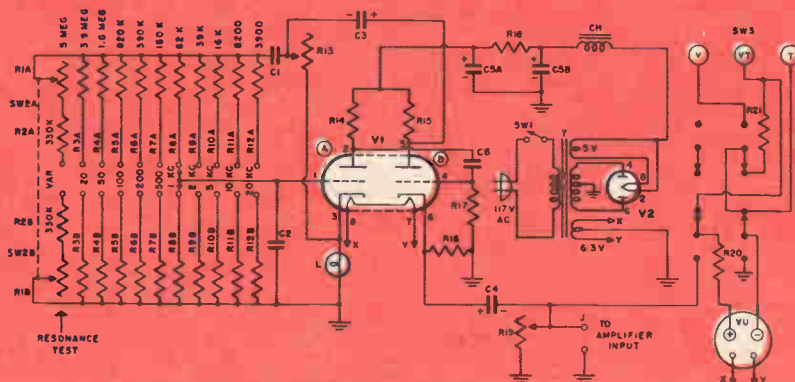

She may not know a sun battery from a superhet, but by following this schematic you may be able to . . .

Sell Her On Your Electronic Projects

By Carl Kohler

HERE is a practical home project which, if successfully completed, will insure many, many happy hours of electronic enjoyment without feminine static rankling your nerves. Although primarily of interest to married men, it behooves the bachelor to pay attention. A sudden change in marital status might otherwise catch him with his current turned off.

Most wives (and girl friends) are chronically incapable of

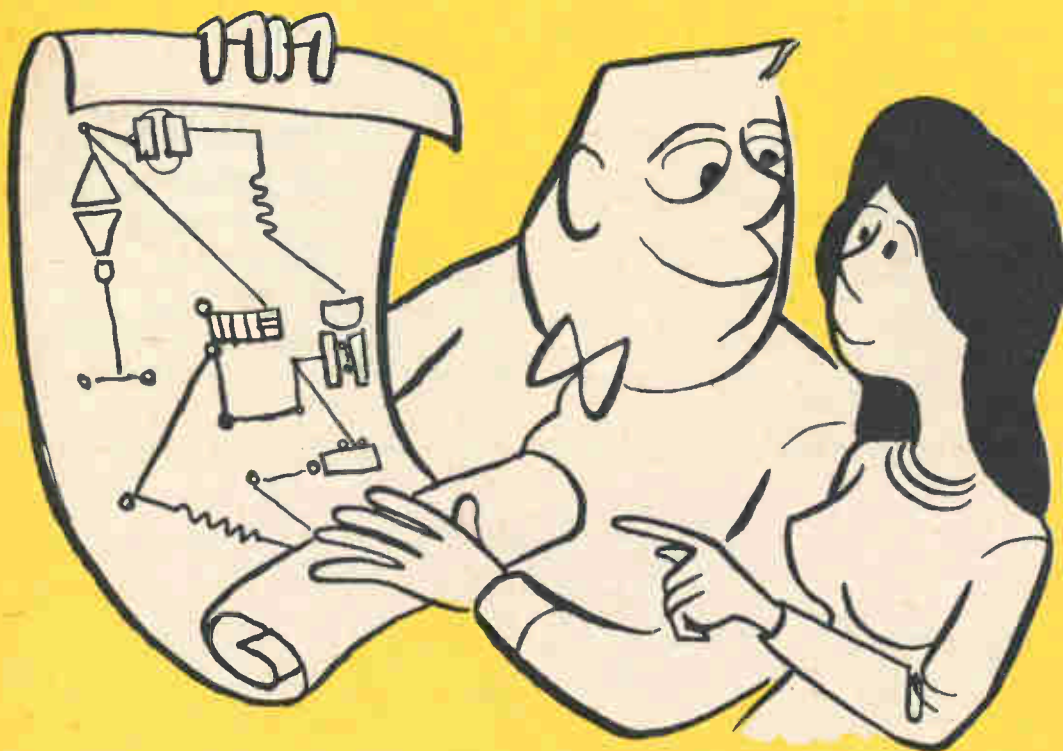

Drawings by the author

She must be made to believe that her interest is basically responsible for at least 60 percent (if not 90 percent) of your electronic achievements.



Arouse her "curiosity". Cunningly replace her women's magazines with ones on electronics.

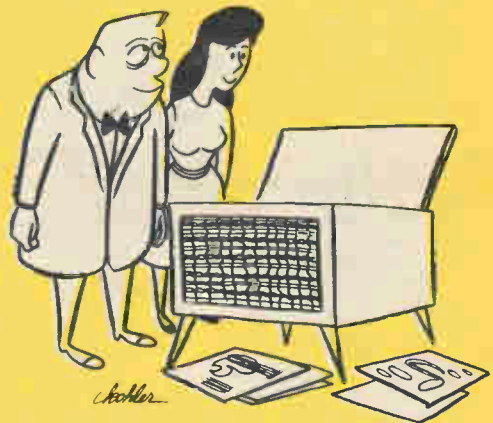

Lead her to appreciate the marvels of electronics with a "rigged" hi-fi demonstration.

ever becoming interested in electronic achievement beyond that of owning a television set or an automatic washing machine. Assuming that you are an electronics buff and that you would like the woman in your life (we'll call her "Wife") to develop a tolerant interest in your various electronic activities, we shall proceed with the campaign elements.

Advance Propaganda

Keeping in mind the fact that Wife is something of an outsider, electronically speaking, you should lead her gently to the threshold of this fascinating world. Remember, at this point she doesn't know an electron from an electric eel, so go slowly, man, slowly! Don't even try to expose her tender mind to the richness of Booberlinck's *Theories of Boolean Algebra*. If you do, you risk imparting a negative polarity to her personality that will never be reoriented.

Something lighter, but tinged with mystery and drama, both dear to the womanly heart, would be advisable. Cunningly and casually leave a copy of *Practical Magic in Electronics* in plain view on the coffee table. Women like to think they are practical, but nevertheless are fascinated by mysticism. You might see to it that a matched set of *The Romance of R/C Models* appears

about the house. It's rather regrettable that no one has yet written a tome entitled *Woman's Role in Modern Electronics*. Such a book would insure almost immediate interest. Until someone does write it, round up all the women's magazines in the house and replace them with bright, crisp copies of the magazine you now hold in your hands. This is to focus Wife's attention on the word "electronics." How you account for the missing women's magazines is a problem best handled by innocent silence. In short order Wife should be sufficiently curious to ask: "What's with this electronics jazz, anyhow?" This is your cue to launch Phase Two of the campaign.

Elementary Orientation (use restraint, man)

You must have something tangible to point to—or you will find yourself muddling around in an abstract lecture which, so far as Wife is concerned, makes less sense than last week's headlines. Avoid this at all costs. Arm yourself with some kind of electronic instrument, device or related components with which to illustrate your delightful explanation of electronics.

If you happen to be an introvert, you need more than one tangible instrument
[Continued on page 96]

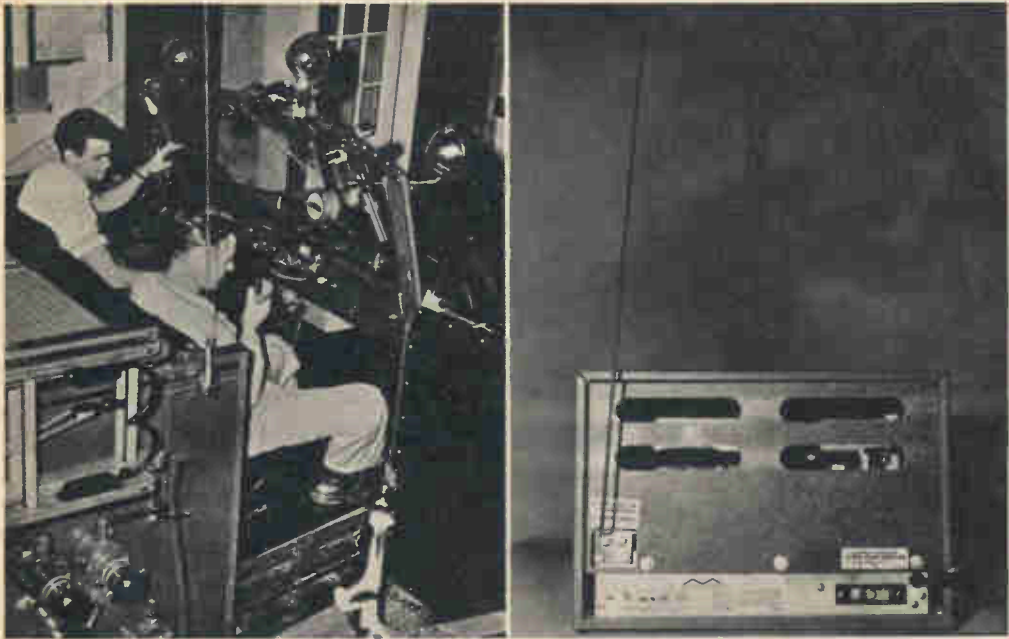

Fire trucks often are equipped with VHF. All you need to listen in is compact receiver, such as Monitoradio MR-10 (152-174 mc), 18' of wire as antenna.

In your home, car and boat, you can keep abreast of emergencies and disasters as they happen on . . .

VHF-Your Hometown Shortwave Radio

By Lee Craig

IN my New Jersey home on the morning of September 15, 1958, I tuned my FM communications receiver across the 152-174 megacycle band. In a few moments I learned that tragedy had struck very close to home: A commuter train bound for New York City had crashed through an open draw bridge and plunged into Newark Bay.

The news came over the VHF band long before it broke over the commercial and television stations and hours before it appeared in the newspapers. Dispatchers could be heard directing rescue squads to the disaster scene and for hours afterwards news bureau dispatchers and mobile units were heard relaying new information.

There are more than a million mobile and fixed radio stations authorized to operate at frequencies above 25 megacycles. About 243,600 police, fire and other public safety vehicles are equipped with two-way radio, and they report to [Continued on page 100]

Model railroad fans can learn a great deal about actual railroad procedure by eavesdropping on VHF transmissions from trains and operators at wayside signal towers.



If you live near a harbor or a major inland waterway, you will find that the airwaves offer many interesting conversations between men who live and work on the water.



WorldRadioHistory

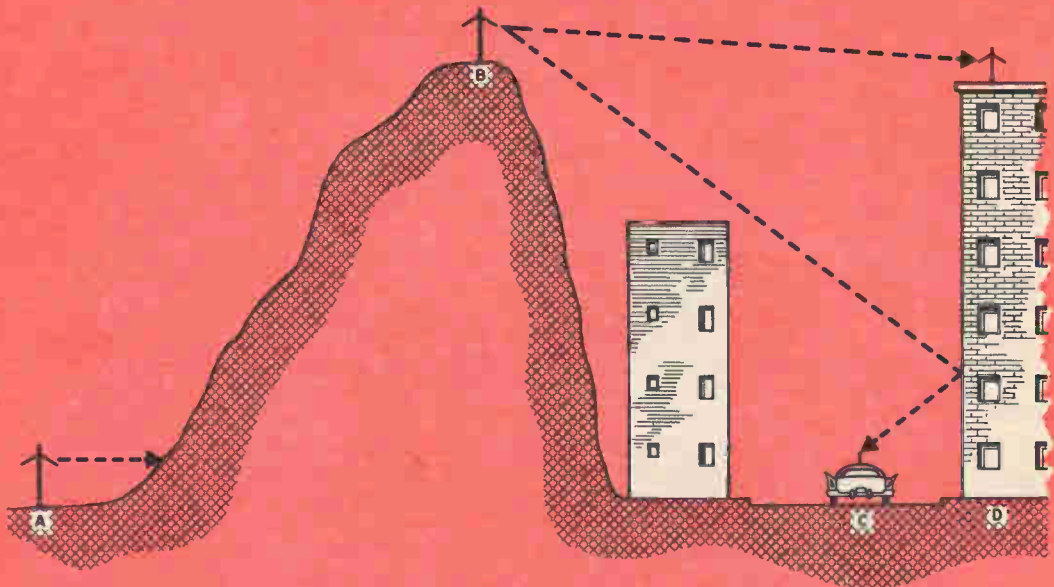
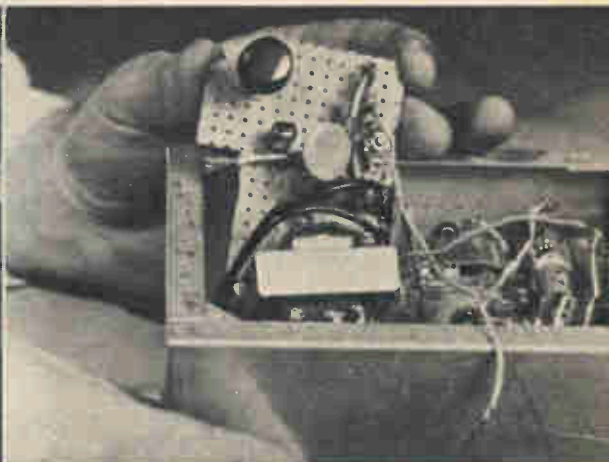

Diagram shows line-of-sight transmission characteristics of VHF. Station sending signal from point A cannot hope to reach mobile station C directly because hill is in the way. Station atop hill at point B can contact car even though smaller building is blocking direct path. VHF waves tend to be reflected by buildings. Height of transmitting antenna affects range of station.



With a meter added, the unit is able to check the operation of its own or other transistors.



Oscillator section is on its own subchassis. The knob seen at upper left controls the tone.

An Experimenter's Control Center

By Ronald Benrey

This amplifier-oscillator will act as the heart of countless alarm, control, or measuring systems.

HERE is a transistorized relay control system that's as versatile as it is easy to construct. Coupled with a few simple accessories, it can be quickly transformed into any of a multitude of useful devices covering controls, indicators, and alarms. These include photocell relays, fire and burglar alarms, and sound relays, just to mention a few. What's more, this unit has a bonus value. It can easily be converted into many different meter indicating devices such as electronic thermometers, field strength meters, and light meters. It will even test its own transistors! All operational controls and switches are mounted externally and connections to the unit are made via a 12-terminal barrier strip. All other components, with the exception of B1, are mounted on two perforated Bakelite subchassis: the internal oscillator on one, and the amplifier-relay subassembly consisting of TR1, the relay, and B2, on the other.

Begin construction by cutting both subchassis. Using the accompanying photographs as a location guide, and the major components themselves as templates, locate and drill all necessary mounting holes. Before mounting any components on the oscillator subchassis however, be sure to cut a small notch along the right hand $3\frac{1}{4}$ " dimension. The correct location with respect to the major components of this notch, which provides clearance for panel mounted switch 4, can be ascertained from the photo-

The amplifier-relay section is also on its own Bakelite subchassis. The relay is to the right, with B2 in the battery holder.

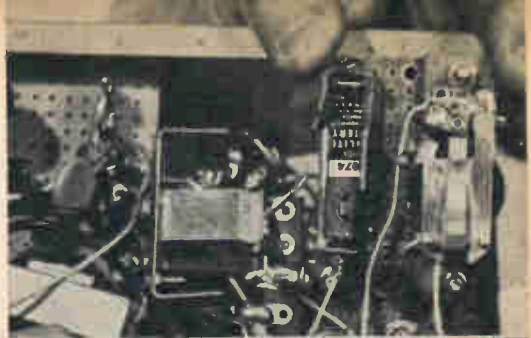

Slave photoflash. A photocell is wired to terminals 8 and 10 and picks up light from main flashgun. Slave gun goes to 5 and 6.



Front panel of the complete control unit. Various inputs and outputs are connected to 12-terminal barrier strip along top edge.

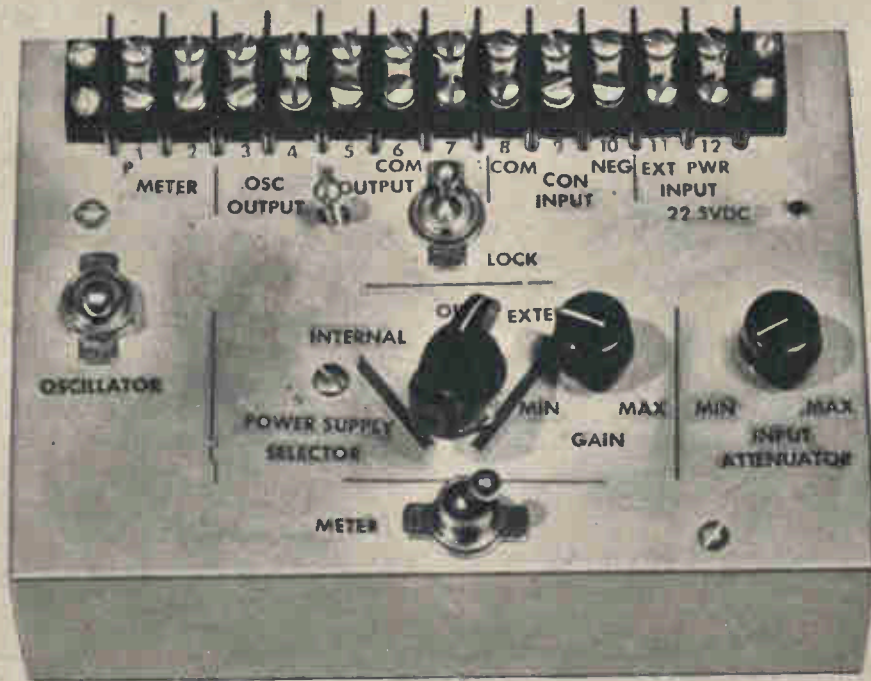



With a telegraph key and loudspeaker the unit is used for code practice. In this mode, the internal audio oscillator supplies the tone.

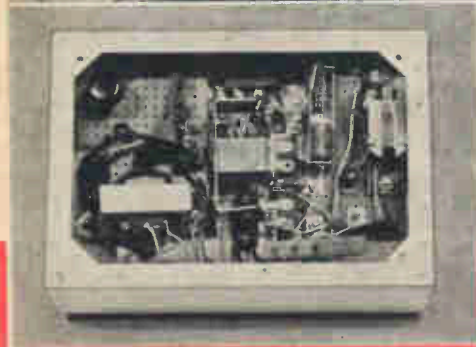

Underside view of wiring. To simplify assembly the two subchassis are wired before they are bolted to the inside of the metal chassis.

The guide below indicates all the wiring. Note that the amplifier section has been drawn outside the main chassis for clarity.

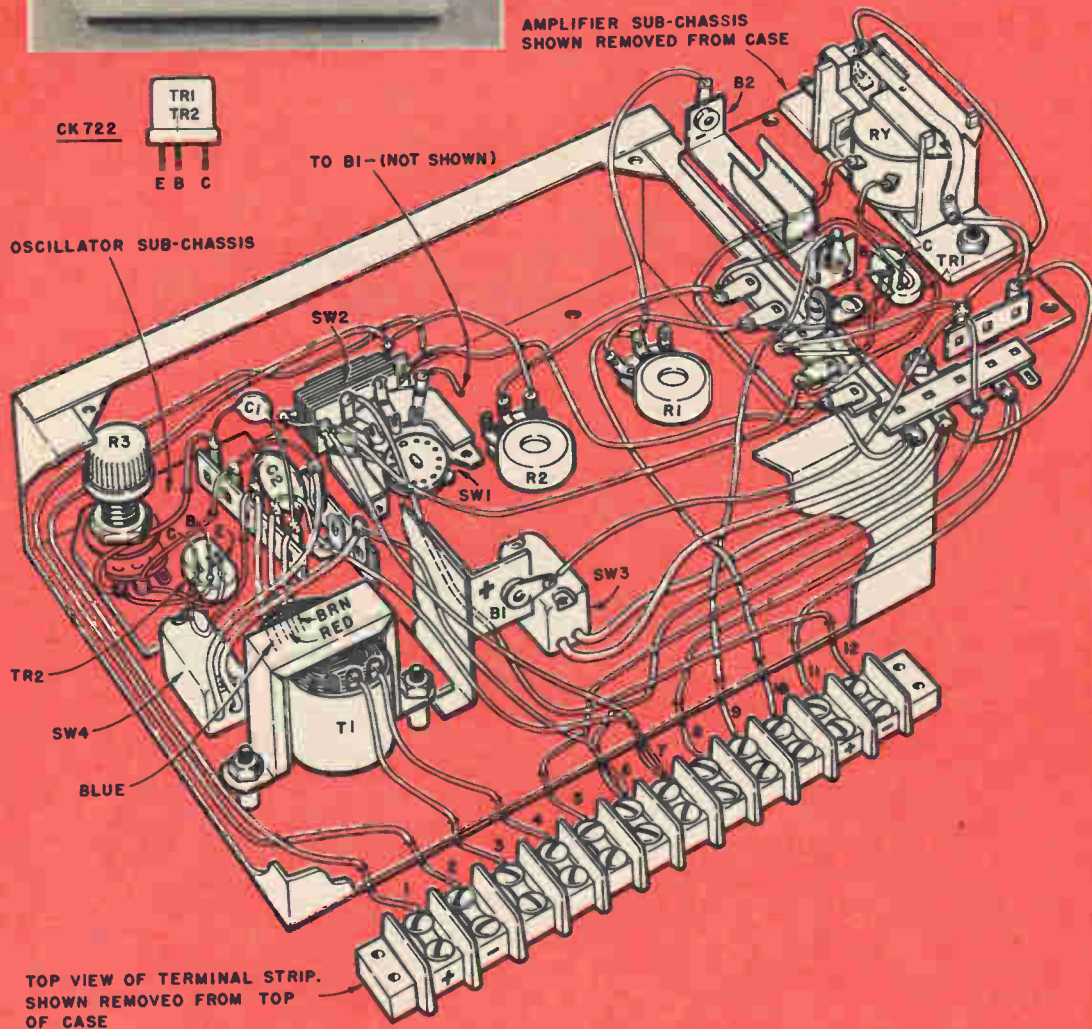

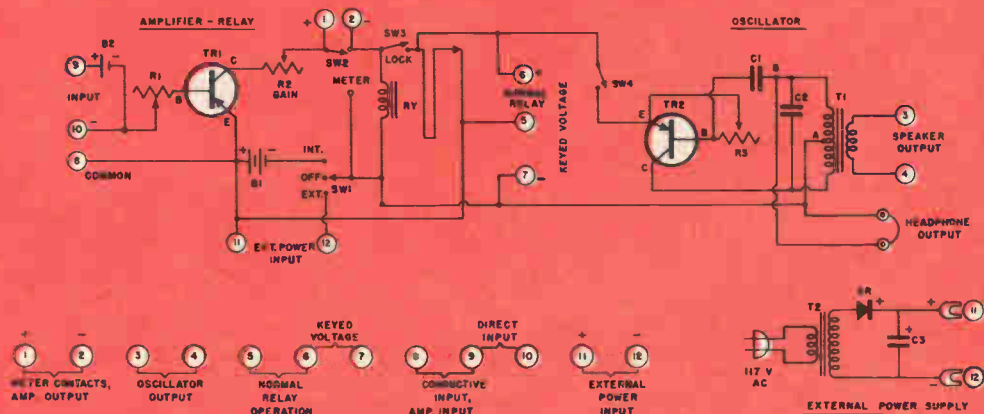

Circled numbers throughout schematic correspond to the 12 terminals on barrier strip (above).

graphs. Its proper size is of course determined by the size of switch 4 and may vary with the brand of switch used. However, in most cases the notch will measure about $1\frac{3}{8}$ " long by $\frac{5}{8}$ " deep.

Using scrap aluminum or tin can stock, fashion a bracket approximately $1\frac{7}{8}$ " long by 2" wide with a $\frac{1}{2}$ " flange. A commercially available battery holder used to secure B1 is attached to this bracket, which in turn is mounted in the aluminum housing with $\frac{3}{8}$ " 6-32 machine screws.

Position the completed subassemblies allowing approximately $\frac{1}{4}$ " clearance between the subchassis edges and the chassis walls. Three 1" 6-32 machine screws, spaced to form a "triangle" with its apex toward the panel bottom are used to mount each unit, support being provided by a $\frac{3}{8}$ " spacer on each screw.

After completing all wiring between panel components mount the amplifier-relay subassembly, employing two 5-lug tie strips attached to the subchassis to facilitate the task of hooking up the subassembly to the panel. Then, install the oscillator subassembly, checking to see that the polarities are correct when the power leads are connected.

It was found that for most purposes loudspeaker oscillator operation is desirable. However, if you prefer headphone operation, connect the oscillator output terminals to points A and B on

the diagram instead of to the transformer secondary as shown. In either case, adjust R3 (tone control), for the most audible tone.

The relay used in this device was chosen for its low cost, relatively small size, and large contact current carrying capabilities. However, it will be necessary to "sensitize" it before the circuit will operate properly. If you own a low range milliammeter (0-5 ma, 0-10 ma, etc.) the relay can be sensitized very quickly. Connect the meter to terminals 1 and 2; set SW1 to "Internal," SW2 on, SW3 "off," SW4 "off"; set both R1 and R2 to maximum re-

[Continued on page 106]

PARTS LIST

- C1—500 mmfd disc ceramic capacitor
- C2—3300 mmfd disc ceramic capacitor
- R1—25,000 ohm miniature potentiometer
- R2—5000 ohm miniature potentiometer
- R3—5 megohm miniature potentiometer
- TR1, TR2—CK722 transistor
- RY—5000 ohm plate circuit relay (Potter & Brumfield LB5 5000 ohms)
- T1—Audio output transformer, 3.2 ohm voice coil
- B1—22.5 volt battery (RCA V5-084)
- B2—1.5 volt penlite cell
- SW1—Single pole 3-position rotary switch (Centralab 1461)
- SW2, SW3, SW4—SPST switch
- Barrier strip—12 terminal (Cinch Jones 12-141)
- Misc.—Battery holders, knobs decals, flea clips, spacers, tie strips, aluminum chassis 7"x5"x2" (Bud AC-402) Bakelite subchassis—Amplifier-relay $3\frac{1}{4}$ "x2 $\frac{1}{2}$ ", oscillator $3\frac{1}{4}$ "x1 $\frac{3}{8}$ "

Parts for external power supply, if desired:

- T2—Power transformer 117 VAC to 24 VAC
- SR—Selenium rectifier 20 ma.
- C3—250 mfd electrolytic, 50 volt

Electronics and geriatrics (the study of old age and its diseases) have combined forces to . . .

Add Years To Your Life

By R. E. Atkinson

YOU'RE as old as your arteries" is a truism that bears special attention. The principal ravages of time are indeed evidenced in heart and blood vessel difficulties, which killed over 400,000 persons in the United States last year and disabled hundreds of thousands more. The need for research and progress is apparent against this bleak background.

Medical electronics is fighting a holding action by helping oldsters to stay alive in spite of heart and circulatory ailments. At the same time, the basic causes of these difficulties are under investigation.

A 76-year-old Brooklyn grandfather who survived a heart attack that nearly killed him went home from the hospital recently after depending 96 days upon an electronic heart stimulator. One of these stimulators was on hand at home when he arrived for Thanksgiving dinner and it stood by ready to mimic

Maimonides Hospital of Brooklyn

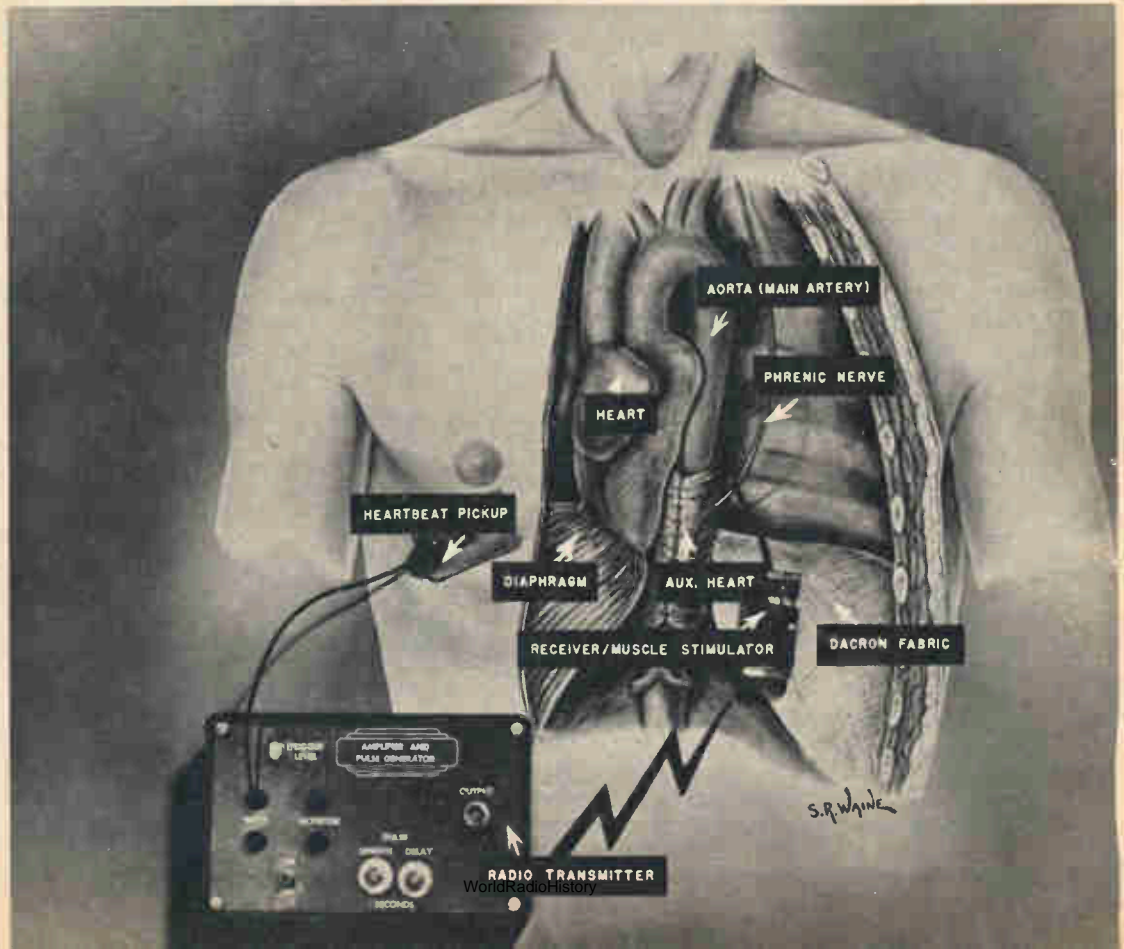



Left, auxiliary heart gets cadence from actual heart via radio wave. Dacron fabric replaces section of diaphragm used as muscle around the main artery.



Top: As electronic instruments, including oscilloscope, monitor oldster's pulse, device on arm sends pressure waves into artery to determine its elasticity.

National Heart Institute

In Framingham, Mass., many healthy persons, such as women on ballistocardiogram table, are being studied year after year to determine the effects of aging.

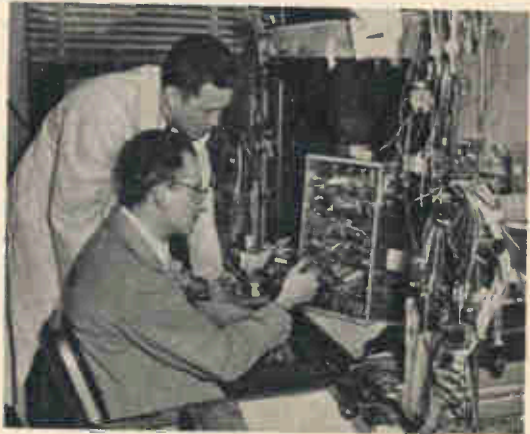

Combining medicine and electronics, Dr. Adam Denison uses surgical instrument (hemostat) to hold parts while soldering them into unique blood flow amplifier.

American Heart Association



National Institutes of Health photos

Studies of fats in blood are aided by precise analysis possible with mass spectrophotometer, which sorts out electrified particles, identifies foreign elements in a blood sample.

his heart rhythm while sending low voltage shocks to stimulate his heart to action.

Important advances in designing electronic equipment to stimulate the flow of blood in a patient have been made by Drs. Adrian Kantrowitz and William McKinnon at Maimonides Hospital of Brooklyn. A section of animal diaphragm, which may come from the patient himself, is wrapped around the aorta, the main blood supply line from the heart. It acts as a muscular booster and is made to contract in alternate rhythm with the heart by means of electronic stimulus.

The stimulus is applied to the phrenic nerve by a tiny, lucite-encased radio receiver which has no moving parts. Implanted in the body, it remains there permanently. This combination receiver and nerve stimulator gets signals from a transmitter. The transmitter, in the experimental stage, is now the size of a cigar box, but is subject to miniaturization. It must have contact with the patient's skin, where it picks up the natural heart beat and converts the signal into a radio wave. The wave is then



Electronic beams will look into this cartridge, here filled with human blood plasma, while it whirls in high velocity centrifuge that separates cholesterol molecules from the blood.

picked up by the in-body receiver, which passes it on to the stimulating nerve of the "man made" heart. The auxiliary heart is thereby synchronized with the regular heart, helping it to pump the blood throughout the body. Already capable of taking over as much as 25 percent of the work of the heart, it will eventually be improved to take over half the workload, or even more.

Artificial hearts, lungs, kidneys and other electronically maintained organs have been predicted, but they come under the heading of spare parts. They are only stop-gaps. Prevention of the woes of aging, not of aging itself, is the real goal toward which allied medical and electronics scientists are working.

Fundamental research in geriatrics, the branch of medicine that deals with aging, has made it known that blood fats are related to premature aging. The arteries harden and narrow with fatty cholesterol deposits. Cholesterol is a crystalline alcohol which is deposited in the body after certain fatty meats and other foods have been digested. Its effect is cumulative, and in later life may lead

[Continued on page 86]

Precise 111-K Tube Tester Kit

Seven different characteristics of a tube may be checked with this advanced type tube tester.

THE mutual transconductance tube checker actually supplies an operating circuit for the tube being checked. The usual, or emission type checker simply measures the current flow. This is a "static" test, with certain shortcomings. It does not reveal how the tube is acting "dynamically" with a varying signal passing through it. In many critical circuits, normal tube current is no guarantee of top performance. A more revealing test indicates how effectively the tube's grid is controlling its plate current flow.

Precise Development Corporation's Model 111-K (for Kit) will check Gm, the symbol for mutual transconductance, plus six other tube factors; plate emission, filament current, leakage

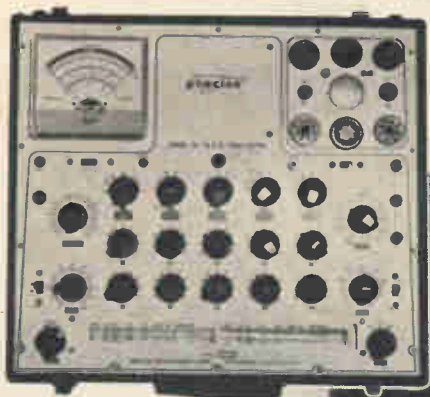

At left, the front panel of the 111-K. Though all 7 tests may be given a particular tube, the roll chart shows the most important single one by an asterisk.

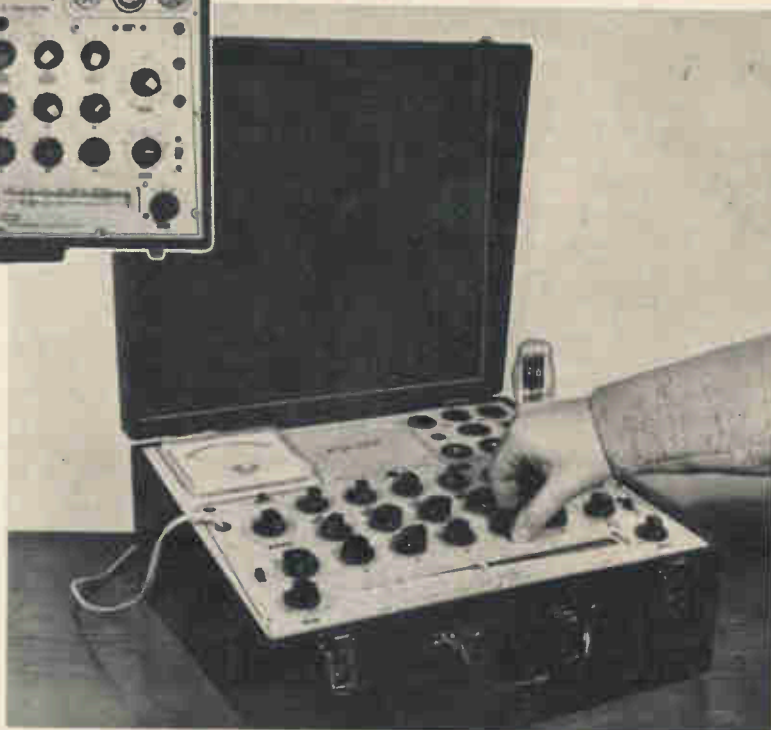



Major components supplied with kit. Many switches are stamped with their identifying numbers.

Use a 1/2-inch nut driver when mounting switches to avoid marring front panel.

Rear view of panel showing rows of rotary switches and tube sockets at upper left.

First, the parts on front panel are wired. Note spare tube socket at upper left.

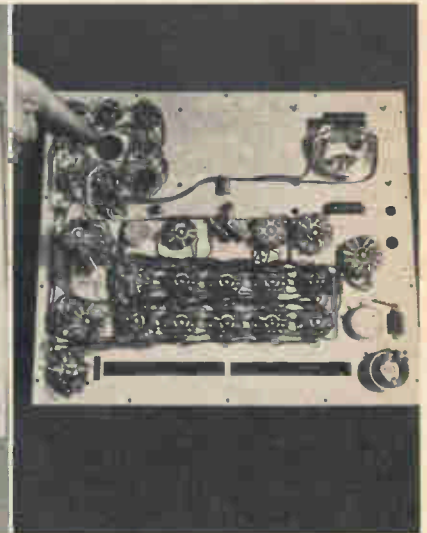
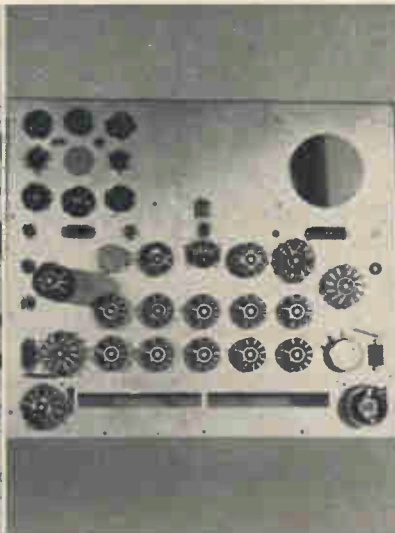
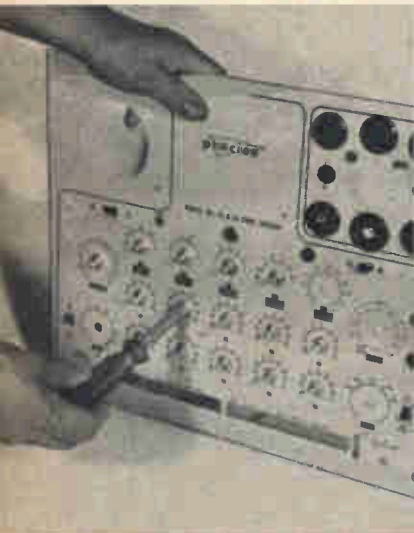

and shorts, gas, noise, and life. These features, plus its price tag of \$79.95, definitely places it in the laboratory and servicing category, but not too far out of reach of even the hobbyist and ham.

As apparent from the photos, construction is a lengthy process—it took over thirty hours to complete. The instruction manual departs from the customary format found in kit construction. Many individual steps are not represented by separate printed lines in the manual. Any time the steps are identical you are told to do the same to other components. After actually performing this type of wiring several times, relying heavily on the diagrams, it did not appear as difficult as originally thought to be.

The diagrams too are somewhat unconventional. Instead of the usual pictorial drawings, they are photographs, with the wires drawn on them in red ink. Their clarity was good, except for the orienting of the tube sockets. It took close examination of several photos to determine the direction of the tube socket keyways and pins.

A valuable feature in the instructions is the Wiring Check Chart. After com-

pletion of the kit, this 2-page list is used to quickly retrace all connections. It indicates what color lead should connect to each specific switch lug or terminal.

Since many of the switch and tube socket lugs are close together, care should be taken to keep adjacent bare wires from shorting. Quite often one lug is used for three or four leads.

Once the tester is complete, accidental shorts between its tube socket lugs are easy to detect. The Shorts switch is rotated, and, if the neon bulb lights on any of the numbered positions, you're informed of which lugs are shorting. This test will not pinpoint the exact socket that's at fault, just the pin numbers. Therefore, these numbers must be checked on each of the ten sockets. If shorts are in other parts of the circuit, the tester's fuse bulb protects the power supply.

After calibration of the completed instrument, the results were gratifying. Rather than to simply check the tube, this unit "evaluates" it. Considering the cost of a wired Gm checker, the 111-K is a Good Buy in that it places a professional instrument within the reach of many. —

Next, the components for the power supply are mounted on a subchassis.

The power supply subchassis is bolted to the front panel and wiring completed.

Pilot holes are drilled in carrying case to receive the panel wood screws.

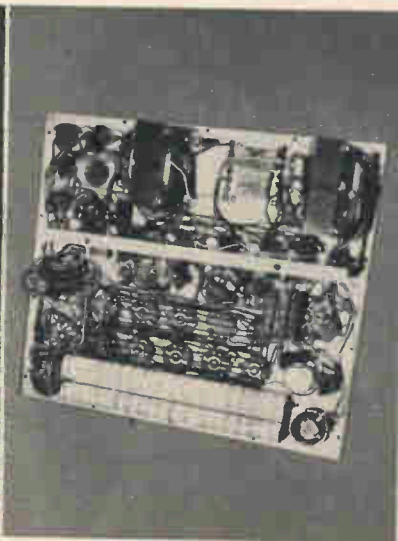
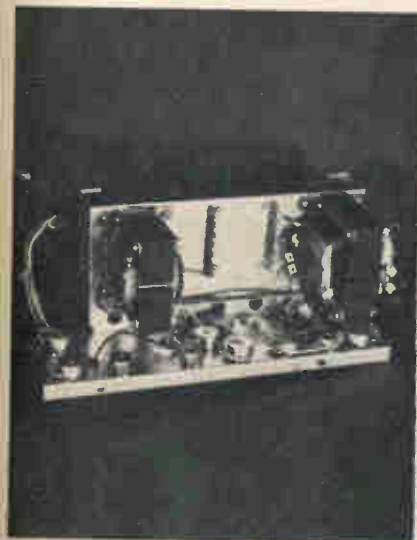

The Electronic Brain

Have you any question on electronics? Send it in and the Electronic Brain will provide the answer.

Silver Plating

Would it be possible for me to re-silver two small silver mirrors using the copper plating process described in the January 1959 issue of Electronics Illustrated?

Clarence Williams, Sylacauga, Alabama

Silver plating and copper plating are essentially the same processes. For the kind of silver plating one sees on tableware and other objects of this nature, commercial electro-plating plants use pure silver bars as the negative electrodes and the objects to be plated as the positive electrodes. The solution for the electrolytic action may be silver nitrate plus carefully controlled amounts of sodium or potassium cyanide. Since all of the cyanides are deadly poisons, we cannot recommend the use of this material in any home plating process.

If you are willing to experiment a bit, try this procedure: (Concentrations of chemicals will have to be determined separately for each plating operation).

1. In an aluminum pot, place about 1 teaspoonful of washing soda (sodium carbonate) and the object to be plated.

2. Boil for about 10 minutes. This will remove all the silver tarnish and other materials deposited on the old silver surface. **DO NOT USE VINEGAR AS WITH COPPER PLATING.**

3. Follow the instructions in the copper plating article, using a sterling silver spoon or fork as the negative electrode and a solution of silver nitrate as the electrolyte. **DO NOT ADD SULPHURIC ACID.** Use a somewhat higher voltage—6 volts or so—inspecting the deposition coat every 15 or 20 minutes. Keep the silver nitrate away from your hands and clothing.

Alarm For Scintillation Counter

How can I add an audible warning to a scintillation counter that is now

equipped only with a 0-50 microampere meter. This device should be adjustable and should call my attention to the meter reading when the current exceeds some predetermined value.

Bert Clemens, Seattle, Washington

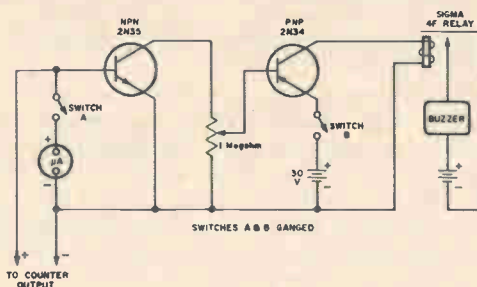

Since the output of your scintillation counter is evidently direct current, a good audible warning device can be built using two transistors and a relay in the form of a very sensitive DC amplifier circuit. When the output current exceeds a preset figure, the relay will pull in and cause a buzzer or bell to sound. Before constructing the amplifier-relay circuit, however, it is suggested that you measure the voltage that your counter can develop across a 7000 ohm resistor connected in place of the microammeter. If this voltage is in the vicinity of 30 millivolts (.030 volts), the circuit will provide positive action; if the voltage is less than this value, it would be necessary to add another amplifier stage prior to the output meter.

The voltage for the buzzer battery is not given in the diagram since it depends on the unit selected.

To set the relay for audible operation, open switch A to disconnect the meter from the circuit and adjust the potentiometer for the sensitivity desired. Once the alarm sounds, the switch is opened and a meter reading may then be taken.

Powering An Auto Radio

Can I run a 6.3 volt automobile radio by tapping off 6.3 volts from one of the tubes of an AC-DC home radio and using this to replace the storage battery?

Guy C. Milne, Cynwyd, Penna.

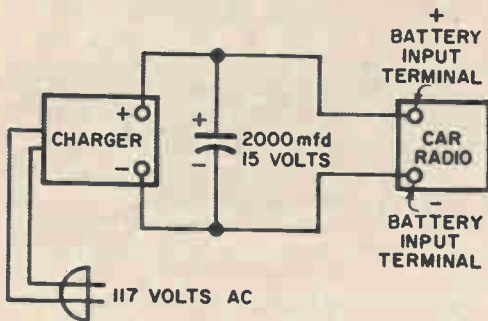

No, you cannot!

First of all, ordinary AC-DC radios do not have 6.3 volt tubes and there is no convenient place where this voltage can be obtained from such a radio. Even if the radio is of the AC type in which 6.3 volt tubes are used, this is AC, not DC; car radios are designed to be operated by pure DC from storage batteries. Furthermore, the 6.3 volt DC supply must be capable of delivering upwards of 8 amperes of current during operation of the radio. This is a lot of current!

What you can do is obtain a 6 volt battery charger of any type and add a filter capacitor as shown in the accompanying diagram. Be certain that the output voltage of the charger does not exceed 8 volts under load. Your radio, or TV serviceman can check this for you by connecting a 32 candlepower headlight lamp or a sealed beam unit across the terminals of the charger while the voltage is measured. Virtually all chargers of the old "Tungar" type can handle an auto radio without difficulty. A trickle charger will not do, however, since its current output is too small for this purpose.

TV Antenna Matching

How may several half-wave folded dipole antennas be connected to a single receiver without destroying the impedance

match? I would prefer information on a method using a matching stub or harness.

John Chalmers, Galeton, Pa.

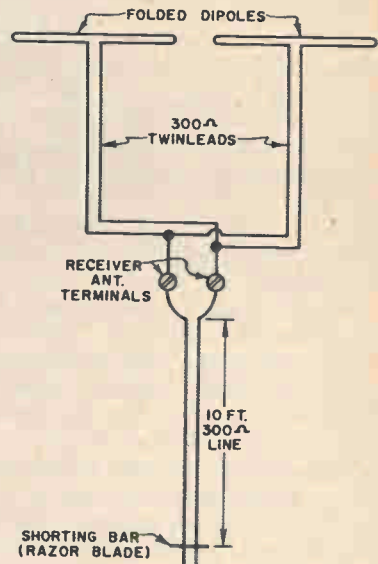

The principal reason for establishing the best impedance match between a transmission line and a television receiver is to avoid reflections and standing waves that cause multiple images and loss of signal.

If you don't mind a little experimentation, you can make an excellent matching stub or impedance transformer using a 10-foot length of ordinary twinlead transmission line as shown in the accompanying diagram. After making the connections as shown, tune in a channel and note the extent of multiple image display. Then, starting at the far end of the open stub, short-circuit the two conductors by means of a razor blade pressed through the insulation, repeating the process inch by inch. When you find the point at which the best match is obtained as evidenced by the display of minimum multiple images, mark the stub here and repeat the procedure for other TV channels. It is generally possible to find one shorting point where all receivable channels are vastly improved. At this point, cut the stub, splice and solder the two conductors together and tape joint. —●—

How To Buy Ham Equipment

Continued from page 42

radio who never heard of it before.

Ques. *Should the beginner go into single sideband immediately, or wait until he has had experience as an active ham?*

Ans. If he is going to buy his equipment I don't think it's going to make a bit of difference; if he's going to build it he shouldn't by any means fool with single sideband because it will be beyond him.

Ques. *Now as to the transmitter. What do you suggest to the beginner on this subject?*

Ans. I think he should build a CW transmitter, he can even make it out of triodes and learn how to neutralize it so that the final amplifier doesn't take off. He can get the plans from the magazines. It should be as simple as it can be. It's so easy to take a 6L6 and add it to a crystal oscillator and get on the air. Let the beginner get a handful of crystals and try different frequencies as the first part of his education. When I started out I used a receiving type 45 tube and it was harder to drive it on 40 meters than it was on 80 and it was much harder on 20; on 10 it was practically worthless unless I sawed the base off the tube.

Ques. *Now to sum up, you would say that after the beginner gets a code practice oscillator and learns his code and his radio theory, and then passes the test for his Novice or General class amateur radio license, you suggest that he buy the best ham receiver he can. You then suggest that he build the easiest transmitter he can to learn about transmitters and to get on the air. Now suppose he wants the refinements that a commercial transmitter can give him. How does he select a good transmitter?*

Ans. Well, the transmitter should be completely enclosed in a metal box with all incoming and outgoing lines for microphone, key, AC, etc., properly bypassed using high-pass capacitors. To assure that the harmonic output to the antenna is small, a low-pass filter should be at the antenna terminal. I think the amplifier in the transmitter

should be such that it can be made either class C or linear so that it can be used for single sideband. Good frequency stability is also necessary.

Ques. *How can the buyer determine the frequency stability of a particular transmitter?*

Ans. A lot of transmitters come with a built-in VFO, this is highly desirable for stability. But stability and some of the other important transmitter specs are best tested by use. If possible, the buyer of a transmitter should try to get one on a home trial basis, or else he should talk with other hams who have used the equipment he's interested in. One of the best sources of information on all ham gear is fellow hams.

Ques. *Bob, what accessory equipment does the beginning radio amateur need?*

Ans. Test equipment. I've contacted hams and asked them how much plate current they've got and they will answer that they don't know. This is crazy. If a ham is going to build or service his equipment, he's got to have test instruments; a multimeter, an oscillator and a grid dip meter at least. Then perhaps he can build an absorption type wavemeter using a lamp, condenser and a coil. And, oh yes, a frequency standard is mandatory. A 100 kc crystal oscillator will do for this.

Ques. *What kind of transmitter antenna do you recommend?*

Ans. It's got to be way up in the air, away from everything. A dipole is as good as anything, for example, about 65 feet for 40 meters.

Ques. *So many novices and beginners want to go to phone operation immediately, are there any advantages to staying with code?*

Ans. Well, of course, with code or CW you can talk farther for less power, and therefore for less dollars.

Ques. *What band should the beginner go on?*

Ans. I would start with the lowest frequency, 80 meters, because here there is the minimum interference to television and other services. He can work up gradually as he learns, trying 40 meters next and then 15 for CW and finally 2 meters for phone.

Thank you, Bob Gunderson, for this special interview for EI's readers.

Try This

Switching Cables

A compact and uncomplicated switch for high impedance leads can be constructed using an ordinary DPDT toggle switch and three RCA type phono jacks. The hookup is useful for testing and comparing audio equipment such as phono cartridges, preamps or amplifiers.

The center (hot) lug of each of the jacks should be shortened to the same length as the ground lug. Each jack is soldered to one pair of switch terminals. Make sure that all the ground lugs of the jacks are soldered to one side of the switch and the hot lugs to the other. By switching the ground leads, in addition to the signal carrying ones, ground loop hum problems are avoided.

In use, the signal lead to be switched is plugged into the middle jack and the leads from the two inputs are plugged into the end jacks.

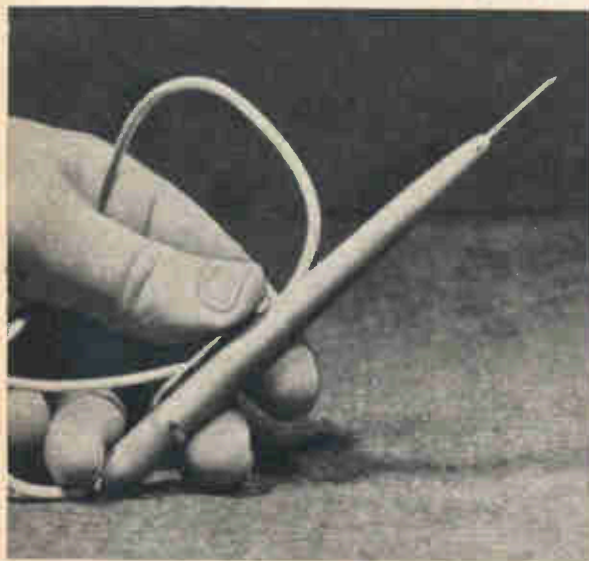
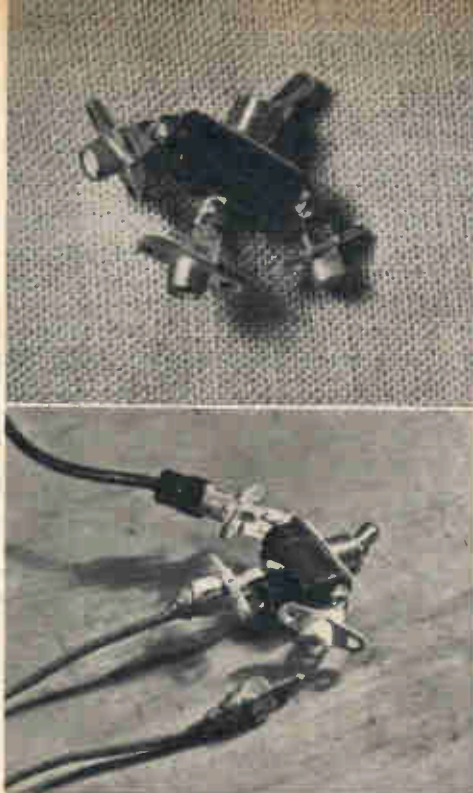

Ballpoint Pen Bushing

Insulating bushings or grommets of any length can be quickly devised by using the sleeve from a discarded plastic ballpoint pen. They are also useful as insulating sleeves for test prods. A thin nail (see photo) is the probe.

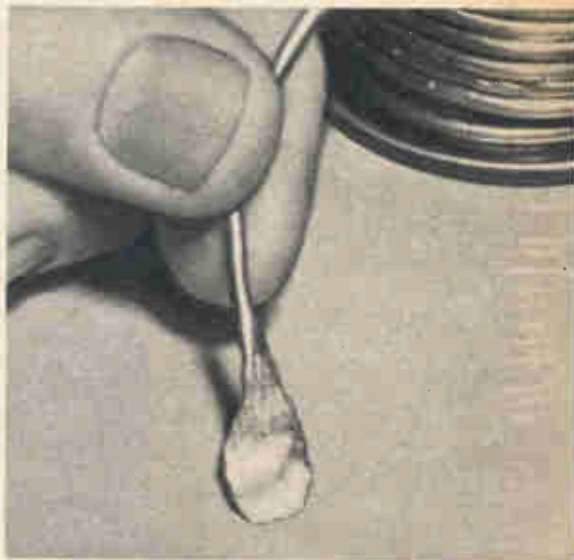

Lower Solder Melting Point

It is often necessary to apply as little heat as possible to transistors and other small components as they are soldered. The melting point of solder may be lowered by pinching or hammering the solder flat.

Continued from page 78

to strokes and heart attacks by choking off blood supplies to vital organs.

Scientists have separated and isolated certain giant fat molecules in blood plasma by whirling the plasma in an electronic ultra-centrifuge. This not only spins a blood sample at a velocity greater than the speed of a bullet, but also reports through an electronic optical system on the spectrum of fats in the whirling sample.

Blood fats have been notoriously difficult to separate and purify for study, but researchers have found that the spectrophotometer is also a good analytic instrument. It can sort out and identify streams of electrons in vaporized blood fats, and produces graphs that identify different components of human blood.

Some researchers have gone all-out in combining medical careers with electronics to design new, highly useful tools for medical measurements. Two such men are Drs. Merrill Spencer and Adam Denison of Bowman Gray Medical School in Winston-Salem, N. C. They have developed an experimental amplifier to measure the flow of blood through an intact artery. The device is called an electro-magnetic flowmeter. Blood to be metered flows through a magnetic field generated by a magnet applied to the outside of a blood vessel. The very small electrical potentials from the blood are picked up by tiny electrodes, which detect the voltage generated as the moving blood cuts the magnetic lines of force. This signal is transmitted to a special amplifier which raises it to a readable level. Studies with this instrument have revealed many hitherto unknown characteristics of blood vessels.

More ordinary electronic instruments, such as oscilloscopes, pulse generators, etc., have been adapted to examine aging arteries. Rebounding wave patterns in arteries studied electronically have provided valuable information on how arteries become less elastic with age and fail to expand and contract as blood surges from the heart.

Electronics is also playing an important part in a long term study of the

people of Framingham, Mass. They have become a "population in a test tube." Examinations of thousands of healthy volunteers over the last ten years will be continued for another ten years. The results may show just how heart disease develops as people grow older. Recording instruments attached to electrodes and amplifiers are useful in picking up electrical potentials that give clues to body function, locate scar tissue on the heart, etc. One such instrument, the ballistocardiograph, is based on Newton's law of motion that every action has a reaction. It measures the recoil when the heart rockets out a supply of blood into the arteries.

One finding from this Framingham study indicates that after 45 years of age and into the 60's men with any two of the three conditions of abnormally high blood pressure, overweight, or high fat content in the blood are about nine times as likely to develop coronary heart disease (cause of heart attacks) as men who are normal in those respects.

Basic research in solid state materials that have thermal-electric effects which electronically produce heat and cold, can be of considerable benefit to the aged. Air conditioning, for example, is a boon that many of us take for granted, but for the oldster with heart trouble it may mean the difference between life and death. It gives his heart a rest on hot, humid days when the demands of body-cooling blood circulation mechanisms might otherwise strain the heart.

Electronic air conditioners without moving parts are now on the drawing boards and some prototype models have been constructed. It may not be too far in the future when miniaturization will bring them down to a size that can be sewn right into an oldster's suit, enabling him to carry on normal activities outside his home in cool comfort.

With the indispensable aid of electronics, medical science is meeting some of the emergencies of aging. It is also trying to find out why some of us remain young and virile at 100, while others never make it past 50. Most important of all, electronics aids geriatrics research in the quest for the next best thing to the fountain of youth—a healthy, vital old age. —

All About Computers

Continued from page 39

from right to left. The far right column may be thought of as the one in which all the "1s" appear, the next all the "2s," then the "4s," "8s," "16s," etc. But the values only register if a 1 appears in the column. For instance, to represent the number 47 in binary coding you would have 101111 or, starting from the left, one 32, (no 16), plus one 8, one 4, one 2 and one 1. Add 32, 8, 4, 2 and 1 and you get 47.

When the frame is expanded, many additional combinations of 1 and 0 are possible—enough to represent all 26 letters of the alphabet as well as punctuation marks and Greek math symbols.

This is the language of digital computation. All the electronic elements inside a digital computer are bistable devices, capable of only two possible states of existence: The switches of its circuitry are either on or off (its tubes and transistors are either conducting or non-conducting; its *magnetic cores* are either charged or not) depending on the presence or absence of a pulse.

With these fundamentals in mind, we must now conceive of the digital computer not as a single machine, but as a system of five related components, each with a separate and simultaneous job to do. The five interdependent units are:

1. *Input*, which converts written facts and figures into the binary code;
2. *Storage*, which holds each incoming batch of facts to await its turn;
3. *Arithmetic*, which performs the actual calculations;
4. *Sequence control*, which directs the whole procedure;
5. *Output*, whose function is simply to re-translate the pulses back into the form of printed information.

In a typical large-scale digital system, the input mechanism consists of an electric typewriter equipped to translate every numeral and character it writes into a specific pattern of charged spots or "bits" on multi-channel magnetic tape. One channel represents each column of the expanded binary-digit coding system.

The storage unit consists of hundreds of thousands of separate magnetic cores

—tiny doughnut-shaped devices, each of which either become instantly charged on receiving a pulse, or remain uncharged to register a negative value.

The arithmetic section in early computers is based wholly on the use of vacuum tubes. These have been replaced in newer models by transistors. In either case, the action is the same: Electrons travel through circuits causing numerical values to be added, subtracted, multiplied, divided or compared.

The control circuits, meanwhile, operate as a timing mechanism to make sure that everything happens at the right time in relation to everything else—"reading" instructions from storage, interpreting them and making the necessary connections throughout the system. Thus, as soon as arithmetical results are achieved, they are assigned to output—flashed back in the form of pulses to charge new bits on a fresh spool of tape, which can then be fed to an automatic high-speed printing device and re-translated into human language.

The action of the entire system is monitored by a man who sits at a supervisory control console, a panel of buttons and lights by means of which the computer can be started, stopped and regulated. This man can send in new instructions or corrections, can test any portion of the memory and functional circuits, and can spot the occurrence and location of circuit failures. But he is not technically the master of the machine.

That role belongs exclusively to the programmer, a man without whom the most elaborate computer in the world is useless. It is the programmer's job to break the problem down into a series of logical arithmetical steps, to feed it to the computer in the right sequence, and literally tell the machine what to do and how to go about it every step of the way.

No computer, analog or digital, is anywhere near as smart as the man who programs it. But by freeing human minds from the drudgery of routine calculations, and by working at superhuman speed with superhuman accuracy, computers can be made to accomplish nearly incredible feats—some of which will be told next month. ●

**YOUR FUTURE MAY REST BETWEEN
THIS PAGE AND THE NEXT!**

use the
prepaid
post card
to send for
the data
that has
launched
thousands
of careers
in...

**This
Fact-
Packed
Booklet
FREE
on
request**



ELECTRONICS

INCLUDED: *information about CREI's*
BRAND-NEW home study course in
AUTOMATION
and industrial **ELECTRONICS** engineering technology

- Machine Control Systems ● Data Processing Systems
- Instrumentation Techniques ● Digital & Analogue Computers
- Servo-mechanism Systems ● Telemetry ● Industrial Processes

CREI prepares you quickly for success in ELECTRONICS including:

AUTOMATION • INSTRUMENTATION • INDUSTRIAL ELECTRONICS • COMMUNICATIONS • TELEVISION AERONAUTICAL ELECTRONICS • GUIDED MISSILES SERVOMECHANISMS • COMPUTERS • ASTRONAUTICS TELEMETERING • MANUFACTURING

Qualify for a secure career, not just another job. Enjoy the increased income, the job security and satisfaction that come only to trained men. *It takes just one \$10-a-week raise to repay your investment in CREI training, and leave you a substantial bonus the first year.* What you do in the next few months may well decide your success in the electronics field. The longer you delay, the longer you defer the sure rewards that come to trained electronics personnel.

CREI HOME STUDY—PROVED SINCE 1927—CREI has provided thousands of ambitious young men with the technical knowledge that leads to more money and better jobs. Once you start home study you feel the benefits of CREI training almost immediately. Your employer takes new interest in you and your future (we disclose your training only if you authorize it). You speak—and act—with more authority. Your associates gain new respect for your ability.

PRACTICAL COURSES—Your work is under the supervision of a regular staff instructor who knows and teaches what industry needs. Training is accomplished on your own time, during hours chosen by you. Lessons are prepared by experts, presented in easy-to-understand form, kept up to date.

INDUSTRY RECOGNIZED—As a graduate of CREI you'll find your diploma a door-opener to the electronics industry. The CREI Placement Bureau helps advanced students and graduates find positions. No jobs are guaranteed—but requests for CREI-trained personnel arrive regularly.

COLLEGE DEGREE NOT ESSENTIAL—This is professional training, but you don't have to be a college graduate to benefit. You can do it while holding down a full-time job. Thousands have. If you have had electronic education, or experience in electronics—and realize the need of a high-level technical knowledge to make good in the better electronic jobs—you can qualify for CREI home study training. Electronics experience is not required for admission to CREI Residence School offered in Washington, D. C. at the same high technical level. Day and evening classes start at regular intervals. Qualified graduates earn degree as "Associate in Applied Science."

This can be your big year. Write today for "Your Future in the New World of Electronics." Use post card at left. Tuition is reasonable, terms are easy. Available to veterans under GI bill.

CAPITOL RADIO ENGINEERING INSTITUTE

EOPD Accredited Technical Institute Curricula • Est. 1927
Dept. 174F, 3224 16th St., N.W., Washington 10, D. C.

April, 1959

WILL THIS BE YOU?



Mail card for free booklet



Decide on home study



Put knowledge to work as you go



Gain attention of management



Complete training



Enjoy secure future

Coming Age Of Sun Power

Continued from page 31

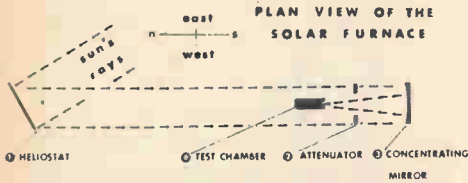

Photo and diagram show Army's massive solar furnace at Natick, Mass., where extremely high temperatures are used for thermal tests.

become a sun-energized switch essential to space navigation and guided missiles.

SILICON SOLAR CELLS

With today's most efficient silicon cells able to convert 14 percent of the sun's light to current, a square yard of cells would provide the moon mortal with fully 140 watts of useable electricity, enough to power his oxygen re-breathing gear, air-conditioning system, radio and heater. Now under development at International Rectifier Corporation is a solar suit, glass cloth woven with metallic threads, a kind of pre-wired circuit to which silicon cells are soldered.

Solar cells already power clocks, highway-warning flashers, and remotely located relay stations such as the repeater post atop Santiago Peak in California's Cleveland National Forest. There a 125 watt-hour sun battery composed of 504 silicon cells powers a transmitter which relays messages to a center 50 miles away.

Ingenious is the newly announced silicon photovoltaic "readout cell." This miniaturized, self-contained power plant can convert light directly to electricity (600 millivolts when bathed in 3000 foot-candles) and can actuate complex business machines. When, for ex-

ample, a punched card passes over a bed of readout cells, light shines through the holes in the card and falls in a pattern on the cells. The cells, in turn, are wired to the computer's circuits and the tiny dabs of trigger-quick energy strip the card of its data in microseconds.

But silicon cells are about two years away from sheathing the first moon man and decades distant from the day they'll supply your home with power. "The problem is to increase silicon's efficiency and cut its costs," concedes Norman Regnier of Hoffman Electronics Corporation, a leader in solar research. "Right now we tab 'good' a cell with 10 percent efficiency. That is, it converts 10 percent of available sunlight into current."

Recently, Hoffman began marketing a 5-watt solar battery composed of 144 separate silicon cells (price: \$500). That's \$100 per watt. Nor does the price include the nickel-cadmium battery (6-48 volts) charged by the 5-watt module. And almost always necessary is a storage battery—a sun-charged reservoir for cloudy days.

Typically, a solar cell (seldom more than 1" long and about 1/25" thick) is composed of two slices of super-refined silicon. One, the "N" (negative) layer, is covered with boron. The other, the "P" (positive) layer, contains arsenic. Bonded together, their area of meeting is called a "P-N" junction. And here is created an electrical field.

When light, solar or artificial, bathes the cell's surface, a voltage difference occurs across the P-N junction. Apply a load across the cell, and electric current flows, the result of a direct conversion of light to electrical energy.

But silicon cells are inefficient. They respond to but a small portion of the solar spectrum (to visible light only). Response to infrared or ultraviolet wavelengths is nil. Theoretically, silicon cells optimum efficiency is limited to about 23 percent.

But inefficient though the silicon cell is, it's a veritable power plant compared to some other photovoltaic materials. Selenium, for example, manages to convert no more than 2 percent of sunshine into electrical current. Silicon's greater efficiency tabs it as a comer in the space age, essential both to man's survival on earth and in space. —

Hi-Fi Tester

Continued from page 67

lector switch for 1000 cycle output (in contact with R8A and R8B) and the key switch to the INPUT position. This is up if your wiring follows that of the model.

Now apply power and give the equipment about 2 minutes for a warmup period. Slowly bring up the gain by rotating R19 clockwise. As sound begins to be heard in the headphones, the VU meter should show an increasing deflection. It should be possible to run the needle all the way up-scale to +3 db.

Next, rotate the selector switch from one frequency to the next to be sure that the bridge is oscillating freely at all points. If it fails to do so at the very low frequencies, try adjusting the setting of R13 slightly one way or the other. The test is conclusive if you can get oscillation on all 10 points of the spot frequencies.

To check the operation of the resonance section, rotate the selector switch to its last position at the low end (R2A and R2B contact point). As the setting of R1A-B is now changed, the frequency should vary smoothly from about 15 cycles per second to possibly 250 cycles per second.

The next step is to connect an amplifier to the test equipment as shown in the diagram.

Unsolder or otherwise disconnect one terminal of the voice coil from the secondary of the output transformer, leaving the other undisturbed. (In multiple speaker installations, the circuit should be opened between one terminal of the output transformer and the corresponding terminal of the crossover network.) This will provide three connection points:

VT—(stands for Voice coil and Transformer) where the transformer is still joined to the voice coil terminal

T—(Transformer only) where the transformer has been freed from the voice coil

V—(Voice coil only) where the voice coil has been disconnected from the transformer.

Join these points to those correspondingly labeled on the panel by means of banana plugs on one end of each lead and alligator clips at the other end.

The equipment is now ready for an amplifier frequency-response and resonance check. With the output control of the tester (R19) and the gain control of the amplifier both at zero, warm up both units for a few minutes. Set the tester key switch (up) to INPUT and, using R19, bring the meter pointer up to 0 db (100%) at 1000 cycles. Move the lever of the key switch to DUMMY and slowly bring up the amplifier gain until the meter again reads 0 db. No sound should be heard from the speakers in either of these two positions. If the key switch is now moved all the way down (SPKR position), the 1000 cycle tone should be heard from the speakers and the VU meter reading should be appreciably different from its former value when the dummy load was used.

A frequency response run of an amplifier into a dummy load serves to provide information as to the performance of the amplifier only, thus establishing a basis for judging the electronic equipment. A similar frequency response run into the amplifier's own speaker system will point out sharply just how much of the lack of flatness is due to the amplifier and how much is due to the speakers. As either type of run is carried on, the key switch should always be shuttled back and forth between INPUT and either DUMMY or SPKR to be sure that the input signal remains at a constant level. When drawing up response curves, use a semi-logarithmic paper having its frequency scale logarithmic and its db scale in linear divisions.

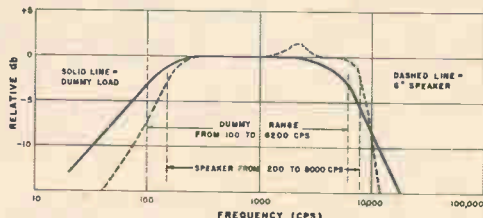

Frequency response curve on a small amplifier showed much high and low frequency drop-off.

SHIPPED ON APPROVAL

an IN-CIRCUIT CONDENSER TESTER THAT DOES THE WHOLE JOB!

The CT-1 actually steps in and takes over where all other in-circuit condenser testers fail. The ingenious application of a dual bridge principle gives the CT-1 a tremendous range of operation . . . and makes it an absolute 'must' for every serviceman.



IN-CIRCUIT CONDENSER TESTER Model CT-1

Model CT-1—housed in sturdy hammertone finish steel case complete with test leads only **\$34.50** Net

in-circuit checks:

- ✓ Quality of over 80% of all condensers even with circuit shunt resistance present . . . (leakage, shorts, opens, Intermittents)
- ✓ Value of all condensers from 200 mmd. to .5 mfd.
- ✓ Quality of all electrolytic condensers (the ability to hold a charge)
- ✓ Transformer, socket and wiring leakage capacity

out-of-circuit checks:

- ✓ Quality of 100% of all condensers . . . (leakage, shorts, opens and intermittents)
- ✓ Value of all condensers from 50 mmd. to .5 mfd.
- ✓ Quality of all electrolytic condensers (the ability to hold a charge)
- ✓ High resistance leakage up to 300 megohms
- ✓ New or unknown condensers . . . transformer, socket, component and wiring leakage capacity

OUTSTANDING FEATURES

- Ultra-sensitive 2 tube drift-free circuitry
- Multi-color direct scale precision readings for both quality and value . . . (in-circuit or out of circuit)
- Simultaneous readings of circuit capacity and circuit resistance
- Built-in hi-leakage indicator sensitive to over 300 megohms
- Cannot damage circuit components
- Electronic eye balance indicator for even greater accuracy
- Isolated power line

TRANSISTOR TESTER Model TT-2

Every day more and more manufacturers are using transistors in home portable and car radios . . . in hearing aids, intercoms, amplifiers, industrial devices, etc. Since transistors go bad the need for TRANSISTOR TESTER is great. They can

develop excessive leakage, poor gain, shorts or opens. The TT-2 is an inexpensive quality instrument designed for accurate and dependable tests of all transistors and diodes — quickly and accurately.

OUTSTANDING FEATURES

- Checks all transistors, including car radio, power output, triode, tetrode and unijunction types for current gain, leakage, opens, shorts, cut-off current
- Checks all diodes for forward to reverse current ratio
- All tests can be made even if manufacturers' rated gain is not available
- Less than half a minute required for tests of either transistors or diodes
- Large 3" meter is extremely sensitive - yet rugged . . . with multi-color scales designed for quick easy readings
- Power is supplied by an easy to replace 6-volt battery — current drain so small, service life almost equal to shelf life. Battery cannot be drained due to accidental shorting of test leads
- Cannot burn-out its own meter or damage transistor or diode under test
- Long test leads and insulated test clips enable tests without entirely removing transistor from circuit
- Test leads are identified by E.I.A. color code so that connection to the correct terminal is assured
- Comes complete with replaceable transistor set-up chart that fits into a special rear compartment.

IMPORTANT FEATURE: The TT-2 cannot become obsolete as the circuitry is engineered to enable you to check all new type transistors as they are introduced. New listings will be furnished at no cost.



Model TT-2 — housed in sturdy hammertone finish steel case complete with test leads . . . only **\$24.50** Net

Check all power rectifiers in-circuit

whether SELENIUM, GERMANIUM, SILICON, etc.

with the IN-CIRCUIT RECTIFIER TESTER Model SRT-1



Model SRT-1—housed in sturdy hammertone finish steel case complete with test leads . . . only **\$29.50** Net

With the growing trend towards compactness, portability and low price, TV manufacturers are resorting more and more to producing series-string TV sets employing selenium, germanium or silicon power rectifiers. Now the need for an in-circuit rectifier tester is greater than ever.

THE SRT-1 CHECKS ALL POWER RECTIFIERS IN-CIRCUIT AND OUT-OF-CIRCUIT WITH 100% EFFECTIVENESS FOR:

- ✓ Quality ✓ Fading ✓ Shorts ✓ Opens ✓ Arcing ✓ Life Expectancy

OUTSTANDING FEATURES

- Checks all types of power rectifiers rated from 10 ma. to 500 ma. (selenium, germanium, silicon, etc.) both in-circuit or out-of-circuit.
- Will not blow fuses even when connected to a dead short.
- Large 3" highly accurate multi-color meter . . . sensitive yet rugged.
- Separate meter scales for in-circuit and out-of-circuit tests.
- Cannot damage or over heat rectifier being tested.

SIMPLE TO OPERATE

Just clip SRT-1 test leads across rectifier under test right in the circuit without disconnecting rectifier from circuit. Press test switch and get an instant indication on the easy-to-read three-color meter scales . . .

ALL CENTURY INSTRUMENTS ARE GUARANTEED FOR ONE FULL YEAR

The extremely low prices are made possible because you are buying direct from the manufacturer.

EASY TO BUY IF SATISFIED see order form on facing page

FOR 10 DAY FREE TRIAL

try them for 10 days before you buy . . . only then, when satisfied, pay in easy-to-buy monthly installments — without any financing or carrying charges added.

Convince yourself at no risk that CENTURY instruments are indispensable in your every day work. Send for instruments of your choice without obligation . . . for instruments of your choice without obligation . . . without any financing or carrying charges added.

STILL THE BEST SELLING TUBE TESTER IN THE FIELD FAST-CHECK TUBE TESTER

Model FC-2



The greatest testimonial ever paid an instrument . . . over 20,000 sold in a little more than a year—and still selling as fast as we can produce them. See for yourself at no risk why so many servicemen choose the FAST-CHECK above all other tube testers—regardless of price.

Model FC-2 — housed in hand-rubbed oak carrying case complete with CRT adapter . . . only

\$69.50
Net

SIZE: W: 14 3/4" H: 11 1/4" D: 4 3/4"

Just 2 settings on the FAST-CHECK TUBE TESTER tests over 700 tube types completely, accurately — AND IN SECONDS!

PICTURE TUBE TEST ADAPTER INCLUDED WITH FAST-CHECK

Enables you to check all picture tubes (including the new short-neck 110 degree type) for cathode emission, shorts and life expectancy . . . also to rejuvenate weak picture tubes.

No other tube tester made at any price can match the value of the FAST-CHECK.

RANGE OF OPERATION

- ✓ Checks quality of over 700 tube types, employing the time proven dynamic cathode emission test. This covers more than 99% of all tubes in use today, including the newest series-string TV tubes, auto 12 plate-volt tubes, OZs, magic eye tubes, gas regulators, special purpose hi-fi tubes and even foreign tubes.
- ✓ Checks for inter-element shorts and leakage.
- ✓ Checks for gas content.
- ✓ Checks for life-expectancy.

IMPORTANT FEATURES

- No time consuming multiple switching . . . only two settings are required instead of banks of switches on conventional testers
- No annoying roll chart checking . . . tube chart listing over 700 tube types located inside cover. New listings are added without costly roll chart replacement
- Checks each section of multi-section tubes and if only one section is defective the tube will read "Bad" on the meter scale
- 41 phosphor bronze beryllium tube sockets never need replacement
- 7-pin and 9-pin straighteners mounted on panel
- Large 4 1/2" D'Arsonval type meter is the most sensitive available, yet rugged — fully protected against accidental burn-out
- Special scale on meter for low current tubes
- Compensation for line voltage variation
- 12 filament positions
- Separate gas and short jewel indicators
- Line isolated — no shock hazards
- Long lasting etched aluminum panel.

NOTE: The Fast-Check positively cannot become obsolete . . . as circuitry is engineered to accommodate all future tube types as they come out. New tube listings are furnished periodically at no cost.

NEW . . . For those looking for a real ECONOMY MULTIPLE SOCKET TUBE TESTER without sacrificing ACCURACY, SPEED and VERSATILITY MINI-CHECK TUBE TESTER

Model MC-1

Here is a multiple socket tube tester designed to meet limited budgets. Although low in price it boasts a unique circuitry that enables you to check over 600 tube types — and has a range of operation that far exceeds others in its price class.



Model MC-1 — housed in sturdy wrinkle finish steel case . . . only

\$39.50
Net

SIZE: W: 9" H: 8 1/2" D: 2 3/4"

OUTSTANDING FEATURES

- Checks emission, inter-element shorts and leakage of over 600 tube types. This covers OZs, series-string TV tubes, gas regulators, auto 12 plate volt, hi-fi and foreign tubes
- 3 settings enable a test of any tube in less than 10 seconds
- Employs dynamic cathode emission test principle
- 3 1/2" D'Arsonval type meter — most accurate type available . . . its greater sensitivity means more accuracy . . . its jewel bearing sockets
- 17 long lasting phosphor bronze tube filament positions
- Handy tube chart contained in special back compartment
- New tube listings furnished periodically at no cost
- Detachable line cord

plus these BONUS FEATURES . . . found in no other low price tube tester

- ✓ Checks for cathode to heater shorts
- ✓ Checks for gas content
- ✓ Checks all sections of multiple purpose tubes . . . will pickup tubes with one "Bad" section
- ✓ Line isolated — no shock hazard
- ✓ Variable load control enables you to get accurate results on all tubes
- ✓ Positively cannot become obsolete as new tube types are introduced.

CONVENIENT TIME PAYMENT PLAN — NO INTEREST OR FINANCING CHARGES

CENTURY ELECTRONICS CO., INC.

CHECK INSTRUMENTS DESIRED

- Model CT-1 In-Circuit Condenser Tester . . . \$34.50 \$9.50 within 10 days. Balance \$5 monthly for 5 months.
- Model SR-1 In-Circuit Rectifier Tester . . . \$29.50 \$4.50 within 10 days. Balance \$5 monthly for 5 months.
- Model TT-2 Transistor Tester . . . \$24.50 \$4.50 within 10 days. Balance \$5 monthly for 4 months.
- Model FC-2 Fast-Check Tube Tester . . . \$69.50 \$14.50 within 10 days. Balance \$11 monthly for 5 months.
- Model MC-1 Mini-Check Tube Tester . . . \$39.50 \$9.50 within 10 days. Balance \$6 monthly for 5 months.

Prices Net F.O.B. Mineola, N. Y.

111 Roosevelt Avenue, Dept. 404, Mineola, New York

Please rush the instruments checked for a 10 day free trial. If satisfied I agree to pay the down payment within 10 days and the monthly installments as shown. If not completely satisfied I will return the instruments within 10 days and there is no further obligation. It is understood there will be NO INTEREST or FINANCING charges added.

Name Please print clearly

Address

City State

Continued from page 69

A resonance check of a speaker is handled this way: Set the frequency selector switch on its VAR position and adjust the output and gain controls for comfortable volume in the speakers. Be sure that the VU meter is not off scale on this setting, however. Starting at the high frequency end of the resonance potentiometer (R1A-B) slowly reduce the frequency while you watch the meter. If speaker resonance exists, there will be a sharp rise in the reading at one point in the adjustment. Although it was not considered necessary to calibrate the resonance control, you may do so by zero beating the tester against any standard audio generator. Good approximations can be obtained, however, by aurally comparing the resonance frequency with the pitch of the 20, 50, 100, and 200 cycle spot pitches.

The waveform of the tester is controlled by the setting of the chassis potentiometer, R13. A pure sinusoidal wave having less than 2% distortion can be obtained when R13 is properly adjusted. The surest way to make this adjustment is to feed the signal to the vertical terminals of an oscilloscope and make the necessary adjustments visually. If a scope is not available, good waveform can still be obtained by setting R13 at that point where the tone *sounds* pure in the headphones; you would be surprised at the efficiency of the ear as a detector of waveform distortion.

Unless the resonance potentiometer (R1A-B) has equal tapers in front and back sections, some difficulty may be experienced in maintaining oscillation over its entire range when R13 is correctly adjusted for sinusoidal signal output. Should this occur, merely advance the resistance setting of R13 slightly so that the action is smooth throughout the rotation of the resonance control. This

Should you wish to build in the same degree of precision found in only expensive instruments, each of the bridge resistors might be made a potentiometer of suitable range. Then, when each potentiometer is individually adjusted, the output frequencies will be right on the nose! For the average hobbyist, however, this would involve needless expense. ●

to assist you. This is no time to lose the campaign for want of a gimmick. A good tape recorder is highly recommended. There is simply nothing like the sound of her own voice to instill Wife with considerable enthusiasm for the gadget that makes this wonderful phenomenon possible. Then you can ease her into how it operates, even the principles involved, providing you tell her she has a beautiful speaking voice (whether she has or not doesn't matter) and ought to be in show business.

Hi-fi is also endorsed as an invaluable aid in garnering Wife's interest. Here, however, you must proceed with great care. Say for instance, you want to add a full range electrostatic speaker to your rig. Now this speaker is probably priced to fit the pocket of any wealthy person.

But don't let that stop you. Go out and buy the speaker. Proceed to your present rig. Place an old, scratchy 78 rpm record on the turntable and turn it up full volume. The more "music" you can filter out, the better. When Wife storms into the room, calmly agree with her that it sounds terrible. Next, produce the speaker, hook it up, change the equalization settings on the preamp to provide optimum results, then play your finest laboratory hi-fi record (in stereo if possible), to show her the wisdom of her decision in your favor.

All right, let's assume you not only have skillfully introduced the little woman to the world of electronics and heightened her curiosity. Now you hope to guide her in to accepting the fact that your electronic projects take time—time which Wife would rather have you spend cutting grass, painting, shopping, cuddling, etc.

Closed-Circuit Psychology

No wife in her right mind is likely to become interested in her husband's projects unless she has been made to believe *her* interest is basically responsible for at least 60 percent of her husband's achievement.

Quite casually, begin dropping statements like, "I've got to hand it to you



*Prepare now
IN SPARE TIME
AT HOME
for great opportunity
field of...*

TELEVISION

**The future is YOURS in
TELEVISION—RADIO—COLOR-TV!**

A fabulous field—good pay—fascinating work—a prosperous future! Good jobs or independence in your own business!

**Modern Training by Coyne
RIGHT IN YOUR OWN HOME**

Coyne brings you the first truly lower cost, MODERN—QUALITY Television Home Training; training designed to meet Coyne standards. Not an old Radio Course with Television "tacked on." Here is MODERN TELEVISION TRAINING including RADIO, UHF and COLOR TV. No previous experience needed. Personal guidance by Coyne Staff.

The Institution Behind this Training
Famous for over a half century, COYNE occupies this entire building which is the new home of COYNE. COYNE'S modern resident training of men for Television, Radio, Electronics and Electricity has produced thousands of successful graduates.



B. W. COOKE, Jr., President

FOUNDED 1899

**COYNE
ELECTRICAL SCHOOL**
CHARTERED AS AN EDUCATIONAL INSTITUTION
NOT FOR PROFIT

1501 W. Congress Parkway, Chicago 7, Dept. 49-H8

MAIL COUPON NOW FOR DETAILS FREE

**LEARN TO
EARN IN SPARE TIME AT HOME**

COYNE offers a most practical, Home Television Training. Easy to follow step-by-step instructions, fully illustrated with 2150 photos and diagrams. **Practical Job Guides** to show you how to do actual servicing jobs—make money early in course. Keep your present job while training.

Low Cost—Easy Terms

We save you money because we don't send you—AND CHARGE FOR—a long list of parts or "put together kits," which you may not want or do not need. With Coyne Television Home Training you pay only for your training, no costly extras.

Let us show you that this is not only the newest, most up-to-the-minute Training in Television—but also it costs you much less than other leading home training courses. Send coupon today for details including Easy Payment Plan.

**SEND COUPON OR WRITE TO ADDRESS BELOW
FOR FREE BOOK**

and full details, including Easy Payment Plan. No obligation, no salesman will call.



COYNE Television Home Training Division
Dept. 49-H8 —New Coyne Building
1501 W. Congress Parkway, Chicago 7, Illinois
Send Free Book and details on Television Home Training. This does not obligate me in any way.

Name _____
Address _____
City _____ State _____
(It is understood no salesman will call.)

Superior's New Model 70 UTILITY TESTER® FOR REPAIRING ALL ELECTRICAL APPLIANCES and AUTOMOBILE CIRCUITS



Model 70—UTILITY TESTER
... Total Price \$15.85—
Terms: \$3.85 after 10 day
trial, then \$4.00 monthly for
3 months, if satisfactory.
Otherwise return, no ex-
planation necessary.

As an electrical trouble shooter the Model 70:

- Will test Toasters, Irons, Broilers, Heating Pads, Clocks, Fans, Vacuum Cleaners, Refrigerators, Lamps, Fluorescents, Switches, Thermostats, etc.
- Measures A.C. and D.C. Voltages, A.C. and D.C. Current, Resistances, Leakages, etc.
- Will measure current consumption while the appliance under test is in operation.
- Incorporates a sensitive direct-reading resistance range which will measure all resistances commonly used in electrical appliances, motors, etc.
- Leakage detecting circuit will indicate continuity from zero ohms to 5 megohms (5,000,000 ohms).

As an Automotive Tester the Model 70 will test:

- Both 6 Volt and 12 Volt Storage Batteries • Generators • Starters • Distributors
- Ignition Coils • Regulators • Relays • Circuit Breakers • Cigarette Lighters • Stop Lights • Condensers • Directional Signal Systems • All Lamps and Bulbs • Fuses
- Heating Systems • Horns • Also will locate poor grounds, breaks in wiring, poor connections, etc.



INCLUDED FREE This 64-page book—practically a condensed course in electricity. Learn by doing.

Just read the following partial list of contents:
What is electricity? • Simplified version of Ohms Law • What is wattage? • Simplified wattage charts • How to measure voltage, current, resistance and leakage • How to test all electrical appliances and motors using a simplified trouble-shooting technique.
• How to trace trouble in the electrical circuits and parts in automobiles and trucks.

Model 70 comes complete with 64 page book and test leads

Only
\$15⁸⁵

Superior's New Model 82A

A truly do-it-yourself type TUBE TESTER

TEST ANY TUBE IN 10 SECONDS FLAT!



Model 82A—TUBE TESTER ... Total Price \$36.50—Terms: \$6.50 after 10 day trial, then \$6.00 monthly for 5 months if satisfactory. Otherwise return, no explanation necessary

- 1 Turn the filament selector switch to position specified.
- 2 Insert tube into a numbered socket as designated on our chart (over 600 types included).
- 3 Press down the quality button—

THAT'S ALL!

Read emission quality direct on "BAD-GOOD" meter scale.

FEATURES:

- Tests over 600 tube types.
- Tests OZA and other gas-filled tubes.
- Employs new 4" meter with sealed air-damping chamber resulting in accurate vibrationless readings.
- Use of 22 sockets permits testing all popular tube types and prevents possible obsolescence.
- Dual Scale meter permits testing of low current tubes.
- 7 and 9 pin straighteners mounted on panel.
- All sections of multi-element tubes tested simultaneously.
- Ultra-sensitive leakage test circuit will indicate leakage up to 5 megohms.

Production of this Model was delayed a full year pending careful study by Superior's engineering staff of this new method of testing tubes. Don't let the low price mislead you! We claim Model 82A will outperform similar looking units which sell for much more—and as proof, we offer to ship it on our examine before you buy policy.

Model 82A comes housed in handsome, portable Saddle-Stitched Texon case. Only **\$36⁵⁰**
(Picture Tube Adapter available for \$5.50 additional)

EXAMINE BEFORE YOU BUY!
USE APPROVAL FORM ON NEXT PAGE

RCA RADIATION COUNTER

MADE TO SELL FOR \$160 - OFFERED FOR ONLY \$47.50 NET
(Much less than cost of Manufacture.)

**INDICATES
RADIOACTIVITY
IN 3 WAYS!**

- 1-BY NEON**
- 2-BY PHONE**
- 3-BY METER**



RADIOACTIVE SPECIMEN

Endless experiments and discoveries in the new exciting field of nuclear energy are made possible when you acquire this finely built and engineered device. In the past, a rugged counter which was suitable for the prospecting of radio-active ores such as uranium, thorium and radium, was unsuitable for laboratory work due to the inability of combining accuracy with ruggedness. Conversely, a laboratory counter, while being extremely sensitive, could not withstand use in the field where it would be subjected to abuse and abnormally hard knocks.

In the laboratory where determination of intensity (counts) of a reading are necessary, the WF-11AWB provides sensitivity for surpassing many laboratory counters.

Specifications

- Employs the extra sensitive 6306 Bismuth Type Geiger Counter Tube. Sensitivity is .015 Roentgens per hour (1 MR/HR = 6600 counts per minute).
- Three counting ranges: 0-200/2,000/20,000 counts per minute.
- Handy reset button.
- Ideal for survey work because the complete unit weighs only 5 1/2 lbs.
- Sight and sound indications by neon flashes and headphone. Then when an indication is obtained you switch to meter reading for exact measurements.
- Decantamination easy with damp cloth applied to the weather-proofed aluminum case.
- A radioactive specimen is included for instrument checking and experiments.
- Included at no extra charge—U. S. Atomic Energy Commission booklet titled "Prospecting with a Counter."
- R.C.A. Model WF-11AWB comes complete with self-contained batteries which provide over 200 hours of intermittent operation.

Model WF-11AWB RADIATION COUNTER . . . Total Price \$47.50—
Terms: \$11.50 after 10 day trial, then \$6.00 monthly for 6 months, if satisfactory. Otherwise return, no explanation necessary.

Comes with complete set of batteries, carrying strap, headphone, radioactive specimen and A.E.C. booklet. Only . . .

\$47.50 NET

SHIPPED ON APPROVAL NO MONEY WITH ORDER — NO C. O. D.

Try any of the instruments on this or the facing page for 10 days before you buy. If completely satisfied then send down payment and pay balance as indicated on coupon. **No Interest or Finance Charges Added!** If not completely satisfied return unit to us, no explanation necessary.

MOSS ELECTRONIC, INC.

Dept. D-577, 3849 Tenth Ave., New York 34, N. Y.

Please send me the units checked on approval. If completely satisfied I will pay on the terms specified with no interest or finance charges added. Otherwise, I will return after a 10 day trial positively cancelling all further obligations.

Name.....

Address.....

City.....Zone.....State.....

All prices net, F.O.B., N. Y. C.

Model 70.....Total Price \$15.85
\$3.85 within 10 days. Balance \$4.00
monthly for 3 months.

Model 82A.....Total Price \$36.50
\$6.50 within 10 days. Balance \$6.00
monthly for 5 months.

Include Model 82A Picture Tube,
Adapter at \$5.50.

Model WF-11AWB.....Total Price
\$47.50. \$11.50 within 10 days. Balance
\$6.00 monthly for 6 months.

FIRST TIME . . . a soldering kit with

DUAL HEAT GUN

FOR ONLY
\$7.95
LIST
Model 8200K



...and best of all,
it's a new

Weller®

Leave it to Weller to bring you greater soldering advances and values! Here's the newest and finest gun made . . . with the versatility of *Dual Heat*. Just touch the trigger for high (125 watt) or low (90 watt) heat as your job requires. Saves time, gives extra convenience for precision soldering. Tip life is also increased because you use high heat only when necessary. New high efficiency tip. Instant heat. Spotlight.



KIT INCLUDES:

- New Dual Heat Soldering Gun
- Wire Bristle Cleaning Brush
- Soldering Aid
- All-purpose Solder

On sale now at
your *Electronic
Parts Distributor*

WELLER ELECTRIC CORP. 601 Stone's Crossing Rd., Easton, Pa.

honey. There aren't many women who understand a man's need to own a really good voltmeter."

Or, "I sure feel sorry for the guys who can't discuss wavelength problems with their wives."

Naturally, she will wonder what the heck you are talking about but, being a woman she will recognize the gratitude in your statements, your "sincere" tone of admiration—and would sooner go to the supermarket without makeup than destroy these strange, wonderful expressions of appreciation.

When friends drop in, compound the effect by favoring Wife with one of those "secret" smiles across the room. Then say in a loud, clear voice for all to hear, "Jane (or whatever her name may be) certainly is getting savvy to the electronics game!"

Or, "Any day now, I wouldn't be surprised to find Alice reading those complicated schematics better than I can!"

She will not, of course, ever do any such thing. But these public pronouncements will make her feel obligated to keep the hot coffee coming while you're working on your projects, if only to pick your brains for enough electronics "talk" to be able to tell her friends, "Oh, I just wouldn't ever have the patience Harry has when it comes to wiring one of those cross-over systems, but I guess I know how to use a Philips screw driver if I have to!"

The first time you come home with an armload of boxes and she pleasantly inquires, "More components for the digital computer, dear?" you may safely assume you have magnificently carried off the campaign. ●

VHF—Your Hometown Short Wave

Continued from page 70

some 23,300 base stations. Thousands of railroad, bus, taxicab and truck offices communicate daily with radio equipped cars, trucks and trains.

Much of this activity takes place in the 152-174 megacycle VHF (very high frequency) band.

To listen in on this band, you need a suitable receiver. If you are interested in hearing the entire band, a tuneable receiver is required. However, if you

As a former serviceman, your skill could be valuable to the U.S. Air Force. If so, the Air Force has an important job and a guaranteed future waiting for you in this new Age of Space. You'll work with the most modern equipment and learn the newest techniques of your specialty. And don't forget: your previous service counts toward rank, pay and retirement income. Talk it over with your local Air Force Recruiter, or mail the coupon.

**FORMER SERVICEMEN:
YOUR EXPERIENCE
CAN MEAN A
GUARANTEED
FUTURE
IN THE
NEW AGE OF SPACE**



BE A SPECIALIST IN THE U.S. AIR FORCE



**THE FUTURE BELONGS
TO THE AIRMAN**

PASTE ON POSTAL CARD AND MAIL TO:

Prior Service Information, Dept. EI-13321
Box 7608, Washington 4, D. C.

Please send me more information on the Air Force Prior Service Program.

Name _____

Address _____ Age _____

City _____ Zone _____ State _____

are interested in monitoring only one or two specific stations, a fixed-tuned receiver can be used. The Monitoradio Models MC-40 and MC-160 are fixed-tuned sets for about \$100.

Among the tuneable FM receivers are the Monitoradio MR-10, which covers the 152-174 megacycle band, and the MR-33 for coverage between 30 and 50 mc. They are tuned in the same manner as a home broadcast radio, but also have a squelch control to cut down background noise. Monitoradio also builds a lower priced 5-tube set called the "Police Alarm."

Hallicrafters manufactures FM receivers for covering these bands. The model S-94 tunes from 30 to 50 mc and the S-95 covers from 152-173 mc. The SX-104 and SX-105 are nine-tube models for 30-50 mc and 152-173 mc coverage respectively and can be equipped with crystals for fixed-tuned operation. The several factory-made receivers range in price from \$50 to \$150.

Besides a receiver, you need an antenna. And, the better the antenna, the happier you will be with the results.

These FM sets can be used at home or

in your car or even in a boat. Ordinarily they operate from house current and when used in a car, a DC-to-AC converter is required.

Don't expect to hear distant stations, although this happens occasionally through skip transmission. Reception range depends upon the height of the transmitting antenna as well as the height of your own receiving antenna. Range is apt to be greater in winter than in summer because foliage tends to absorb VHF signals. The power of the transmitter also has a bearing on range, but not as much as antenna height.

You should be able to receive fixed stations up to 25 to 30 miles away and mobile units four or five miles away.

To identify the stations you hear, you need a call book. The Official Registry of Radio Systems in transportation, public safety, industrial, and telephone is available in four volumes from Communication Engineering Book Company, Radio Hill, Monterey, Mass.

So, to keep ahead of the news in your hometown, try tuning in on VHF. It is truly an unexplored vista for the short-wave listener.

MICRO
ELECTRON TUBE
INTRODUCES FOR THE FIRST TIME
ANYWHERE A SELECT STOCK OF USED
TUBES AT A FABULOUS LOW PRICE

37

¢
ea.

\$35

PER
HUNDRED
ASSTD.

FOR any TUBE LISTED

Jan Surplus Tubes!

ALL TUBES SENT POSTAGE PAID
Please send 25¢ handling for orders under \$5 Send 25¢
deposit on C.O.D. orders Send approximate postage on
Canadian and foreign orders

MICRO

ELECTRON TUBE CO.

P.O. BOX 55 Park Station, Paterson 3, N. J.

- Each and every tube is tested in our own laboratory for mutual conductance and life test.
- We guarantee FREE replacement for one year of any tube purchased from us which fails to function efficiently under any or all operating conditions. Prompt refunds are made on any defective merchandise.
- The advertised tubes are not necessarily new, but may be electrically perfect factory seconds or used tubes—each is clearly so marked.

0A2	6X6	6BM6	6SF5	724	13BC6G
024	6Y3GT	6BJ6	6SF7	12A8	13J6
1A7BT	6Y4G	6BK5	6S7	12AC5	13T8
1B3GT	6Y4G	6BK5	6S7	12A7S	13T8
1W4G	6A7	6BR7	6S7	12A7T	24A
1W4GT	6AB8	6B7GT	6S8	12A7T	24AV5
1L4	6AB4	6BL7GT	6S8	12A7T	25BQ6
1L6	6AC7	6BN6	6S9GT	12AU7	25DN6
1MGT	6AF7	6BQ6GT	6S9GT	12AV7	25L6GT
1Q8GT	6AQ5	6BQ7	6S9	12AV6	25W4GT
1R8	6AQ7	6B7	6T8	12AV6	25Z8
1S8	6A4GT	6BZ6	6V8	12A7	25Z8
174	6AH6	6BZ7	6V8	12A7	26
174	6AH6	6C6	6V8	12A7	26
1U4	6AN5	6C6	6W4GT	12B7	35A5
1U8	6AL3	6C6	6W4GT	12B7	35B5
1V2	6AL7	6C6	6W4GT	12B7	35C5
1X2	6AM5	6C6	6W4GT	12B7	35C5
2A2	6AN5	6C6	6W4GT	12B7	35C5
2AF4	6AQ5	6C7	6W4GT	12B7	35C5
3CB5	6AQ5	6C7	6W4GT	12B7	35C5
3BM6	6AQ5	6C7	6W4GT	12B7	35C5
3BZ6	6AR5	6C7	6W4GT	12B7	35C5
3CB6	6AR5	6C7	6W4GT	12B7	35C5
3CF8	6AT8	6C7	6W4GT	12B7	35C5
3CF8	6AT8	6C7	6W4GT	12B7	35C5
3C9G	6AT8	6C7	6W4GT	12B7	35C5
3L4	6AD4GT	6D6	7B4	12C5	39/44
304	6AUSGT	6D6	7B4	12C5	42
354	6AUS	6D6	7B4	12C5	43
3V4	6AV5GT	6H6	7B7	12C5	43
4B7A	6AV5	6J4	7B7	12C5	50A5
4B7B	6AV5	6J4	7B7	12C5	50B5
BA5B	6AX4GT	6J5	7C5	12C5	50C5
9AT8	6AX4GT	6J7	7C5	12C5	50L6GT
5AV8	6AX5GT	6K6GT	7C6	12C5	50X6
5AW4	6B8	6K7	7C7	12C5	57
5BK7	6B8	6K7	7C7	12C5	57
5J8	6B8	6K7	7C7	12C5	58
6T8	6B8	6K7	7C7	12C5	71A
6U4G	6B8	6K7	7C7	12C5	75
6U4G	6B8	6K7	7C7	12C5	76
6V4G	6B8	6K7	7C7	12C5	77
6V4GT	6B8	6K7	7C7	12C5	80
	6B8	6K7	7C7	12C5	84/624
	6B8	6K7	7C7	12C5	117Z3
	6B8	6K7	7C7	12C5	117Z6

WRITE DEPT. E-1 FOR FREE COMPLETE LIST OF
TUBES & SPECIAL PURPOSE TUBES



WORLD'S LARGEST
MANUFACTURER OF
easy-to-build
do-it-yourself
ELECTRONIC KITS

"bookshelf" 12 watt amplifier kit COMBINES BEAUTY, STYLE AND QUALITY

Build this high quality amplifier in a few hours of your spare time and enjoy true high fidelity performance for years to come. Provides full range frequency response from 20 to 20,000 CPS within ± 1 db, and has less than 1% harmonic distortion at full 12 watt output over the entire range (20—20,000 CPS). Miniature tubes are used throughout the advanced circuitry, including EL84 output tubes in a push-pull tapped-screen output circuit. The special design output transformer has taps for 4, 8 and 16 ohm speakers. The model EA-2 has its own built-in preamplifier with provision for three separate inputs, mag phono, crystal phono and tuner. Features RIAA equalization, separate bass and treble tone controls, and a special hum-balance control. Complete with instructions for easy assembly.



Only

MODEL EA-2

\$28⁹⁵

SHPG. WT. 15 LBS.

Complete selection of Monophonic and Stereo Kits!



PREAMPLIFIERS



TUNERS



SPEAKER SYSTEMS



AMPLIFIERS

Send for FREE catalog

Listing over
100 high quality
dependable
Heathkits for you
to choose from.



HEATH

COMPANY

BENTON HARBOR 39, MICH.

pioneer in
"do-it-yourself"
electronics



a subsidiary of Daystrom, Inc.

Please send your latest Free Catalog.

name _____

address _____

city & state _____

amazingly low cost!

**FIRST
MOBILE
FM receivers
TUNABLE
across the entire
EMERGENCY
communications band**



MODEL M-40 for 30-50 MC \$99.50 ••••• MODEL M-160 for 152-175 MC \$99.50

Ideal for monitoring the communications of all users of the 30-50 and 152-174 MC bands—Police and Fire departments, utilities, trucking and railroads, conservation departments, and other governmental, municipal, and industrial radio systems, the M-40 and M-160 are invaluable, of course, where two or more channels must be monitored.

These two fine receivers offer features ordinarily to be found only in much higher priced equipment—double conversion, for

example, for highest selectivity. Also featured are: built in 4" speaker, tuned RF stage, excellent sensitivity, built in squelch, adjustable from the front panel, and well illuminated slide rule dial, for easy and accurate tuning.

Housed in attractive cabinets, only 4½" x 6½" x 8¾", the receivers are readily installed, and the chassis are easily removed from the cabinets for ease of service.

monitoradio

Division of I.D.E.A., Inc.

7900 Pendleton Pike • Indianapolis 26, Indiana

	Model M-40	Model M-160
Frequency Range	30-50 MC	152-174 MC
Sensitivity (for 20 db quieting)	2 uv or less	4 uv or less
Selectivity	±40 kc at 20 db	±40 kc at 20 db
Squelch Operation	1 uv (adjustable)	1 uv (adjustable)
Power Output (for 10% distortion)	8 w	8 w

How To Prepare A Chassis

Continued from page 58

flat, semicircular, or rat-tail file will enable you to neatly enlarge it.

Unless your piece of equipment is destined for extremely rough usage, work with an aluminum chassis. It is far easier to cut than steel. Perhaps the only drawback to aluminum is that you can't solder to it easily—but, ground lugs under various mounting nuts overcomes this. These chassis are available in natural or painted finishes, gray hammertone seemingly the most popular. Otherwise, a variety of hammer-tone, wrinkle, or flat paints may be used, if desired. Consult the catalogs of electronic supply houses and you'll find a variety of types to house the completed chassis.

Here are some suggestions for under-chassis wiring. Run all leads except those carrying radio frequencies close to the metal chassis to utilize its shielding effect—and keep them short. When mounting resistors or capacitors make it a habit to orient any numbers, color dots, or other designations so they are visible after construction is complete. This makes troubleshooting much simpler.

In some of the projects appearing in *EI*, special wiring or construction methods may be recommended by the author. Follow them carefully since they usually contribute to the stability, proper heat dissipation, or other factor necessary for reliable operation of the device.



Chassis is finished with black wrinkle paint. Spray can, right, gives gray hammertone finish.

Want To Double Your Pay

Get into Radio-TV-Electronics

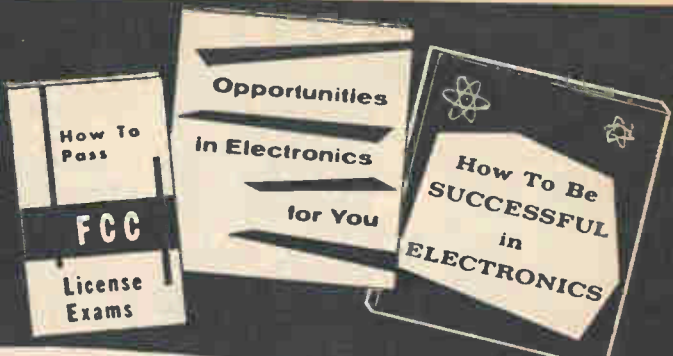

Get all 3 FREE

FIND OUT what the FCC license means

Your FCC license is recognized by employers as proof of your technical ability.

FIND OUT how the FCC license helps you get a better job or increase your pay on your present job

"License and \$25 raise due to Cleveland Institute training." "I sat for and passed the FCC exam for my second class license. This meant a promotion to Senior Radio Technician with the Wyoming State Highway Department, a \$25 a month raise and a District of my own for all maintenance on the State's two-way communication system.

"I wish to sincerely thank you and the school for the wonderful radio knowledge you have passed on to me. I highly recommend the school to all acquaintances who might possibly be interested in radio. I am truly convinced I could never have passed the FCC exam without your wonderful help and consideration for anyone wishing to help themselves." Charles C. Roberson Cheyenne, Wyoming

FIND OUT how we guarantee your FCC license

The Master Course in Electronics will provide you with the mental tools of the electronics technician and prepare you for a First Class FCC License (Commercial) with a radar endorsement. When you successfully complete the Master Course, if you fail to pass the FCC examination, you will receive a full refund of all tuition payments.

FIND OUT how employers make job offers like this to our graduates every month

RADIO OPERATOR: Capital Airlines (Ohio) is looking for a radio operator. A touch typing speed of 40 wpm is necessary. Must have at least a restricted operator's permit, but a radio-telephone 2nd or 1st class license is desirable.

CLEVELAND INSTITUTE OF RADIO ELECTRONICS
Desk EI-7 4900 Euclid Avenue Cleveland 3, Ohio

MAIL
COUPON
TODAY

You'll Be Glad You Did

good training doesn't cost . . . it pays!



Accredited by the National Home Study Council

Cleveland Institute of Radio Electronics

Desk EI-7 4900 Euclid Avenue Cleveland 3, Ohio

Please send Free Booklets prepared to help me get ahead in Electronics. I have had training or experience in Electronics as indicated below:

- | | |
|---|---|
| <input type="checkbox"/> Military | <input type="checkbox"/> Broadcasting |
| <input type="checkbox"/> Radio TV Servicing | <input type="checkbox"/> Home Experimenting |
| <input type="checkbox"/> Manufacturing | <input type="checkbox"/> Telephone Company |
| <input type="checkbox"/> Amateur Radio | <input type="checkbox"/> Other |

In what kind of work are you now engaged?

In what branch of Electronics are you interested?

Name..... Age.....

Address

City..... Zone..... State.....

Desk EI-7

DIAGNYZER



**ELECTRONIC
TESTER**

\$9.95
COMPLETE

for DO-IT-YOURSELF SERVICING

INDISPENSABLE—FOR TV, RADIO, HI-FI

Appliances, Autos, Electrical Tools. Used in Home, Shop and Farm, Checks Radio and TV Tubes, Components, Voltages and Circuits, etc.

INEXPENSIVE TO OWN, EASY TO USE

Anyone can do servicing with this wonderful instrument, pays for itself the first time you use it. Best value for money, nothing else like it.

**COMPLETE TRAINING COURSE AND SERVICE MANUAL
INCLUDED FREE WITH EACH INSTRUMENT**

- Send "Diagnyzer" postpaid. I enclose full payment of \$9.95
- Send "Diagnyzer" C.O.D. I will pay \$9.95 plus postage.
- Rush me FREE descriptive literature concerning "Diagnyzer."

Name

Address

APPARATUS DEVELOPMENT CO.
Dept. E1, Wethersfield, Conn.

Only University offers

4 WAYS TO STEREO

*for every space, budget and decor
requirement - or listening preference*

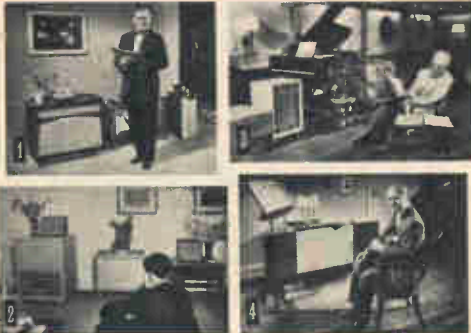

1. Leonard Warren converted his full-range "Troubadour" to stereo by using a compact Stereoflex-2 "add-on" speaker.
2. Enjoy magnificent stereo by connecting two University "add-ons" to a dual voice coil woofer in a suitable enclosure.
3. Fred Waring chose two Ultra Linear Response speakers for his stereo system.
4. Mischa Elman selected a completely integrated, single-cabinet system, the fabulous "Trimensional" TMS-2.

Which way to stereo is ideal for you? You'll find all the answers in University's FREE 16 page brochure, "An informative guide to high fidelity stereo and monophonic speaker systems and components." Write to Desk E-7, University Loudspeakers, Inc., White Plains, N. Y.



An Experimenter's Control Center

Continued from page 75

sistance. Short terminals 8 and 9, and back off on R1 until the meter reads 4 ma. Leaving all other controls alone, flip SW2 "off" and set R2 for minimum resistance. Adjust the relay until it pulls in by gently pressing the armature spring toward the relay frame just above the single machine screw, with needle-nose pliers. Reset R2 for maximum resistance as before and flip SW2 on, adjusting R1 until the meter reads 3.5 ma. Again adjust the relay as before, continuing the process until it operates dependably at 3 ma. If you do not have a meter, adjust the relay as described above until it pulls in when R1 is at about $\frac{3}{4}$ maximum resistance.

The meter terminals are used to connect a low range milliammeter into the circuit. When the meter switch (SW2) is flipped to ON the relay is shorted out and the meter terminals are connected in series with the transistor and power supply. When the meter is on, R1 becomes a current limiting resistance and should be set so as to prevent the meter from being pinned. In addition, when at maximum value, it "simulates" the relay and provides a means of fast and accurate calibration of the device.

The output circuit controls the mode of operation. Normal relay operation is provided at terminals 5 and 6. There is not enough space on the strip to provide every function, that's why normally closed relay operation, which does not find much use, was sacrificed. If you desire this type of operation however, bring out the normally closed lead to a binding post and use it, and terminal 6, to make contact. A keyed voltage, which can be used to power auxiliary equipment such as relays, is available at terminals 6 and 7, terminal 7 being positive. The "lock-in" feature, which is controlled by SW3 and used for alarm circuits, can be used *only* with the keyed voltage or oscillator. If normal relay contacts on a lock-in basis is desired, connect an external relay (a sensitized LB5 is a good choice) to terminals 6 and 7. Of course, the normal relay contacts (5 and 6) with SW3 off can control a latching relay for first

Shipped on... approval

**SEND NO MONEY —
NO C.O.D.**

Try them for 10 days at no risk!
Examine first, and then only if completely
satisfied, pay lowest prices for
highest quality units, in easy
monthly installments.



**MODEL 905
BATTERY ELIMINATOR and CHARGER**

Continuously variable voltage output. Automatic
overload relay self-resetting. Either 6 or 12 volt
operation. Heavy duty rectifier. Continuous opera-
tion 6V. at 10A. or 12V. at 6A. Intermittent
operation 6V. at 20A. or 12V. at 12A.

Model 905 (Wired) \$37.50



VOLOMETER, Model 104.

This 20,000 Ohms per volt in-
strument is the lowest priced,
domestic made, unit of its
kind in today's market. Uses
large 4½" D'Arsonval, 50 mi-

croampere meter, accurate to 2%. Housed in
polished, high impact, bakelite case . . . uses
a durable, etched aluminum panel. 3 AC Current
Ranges. Checks resistance accurately in 3 ranges
to 20 megohms. 5 DC and AC Ranges to 3000
volts. 5 DB Ranges. Model 104 (wired) \$26.95 Net



**MODEL 204 P
TUBE-BATTERY-OHM CAPACITY TESTER**

An Emission Tube Tester, with a completely flexi-
ble switching arrangement. Test all tubes. Checks
batteries under rated load on "reject-good" scale.
Uses 25W line voltage control. Checks condenser
leakage to 1 meg. Checks resistance up to 4 megs.
Checks capacity from .01 to 1 mfd.

Model 204P (illustrated) \$55.90
Cathode Ray Tube Adaptor available \$ 4.50

**MAIL THIS
COUPON
TODAY! NO
OBLIGATION
TO BUY—YOU
MUST BE
SATISFIED!**

TESTMASTER, INC.

Dept. El-4-9

192 Mercer Street, New York 12, N. Y.

Please send me for approval the units checked.
If completely satisfied, I will pay on terms specified,
with no interest or finance charges. Otherwise,
I will return after a 10 day trial, positively
cancelling all obligations.

Name _____

Address _____

City _____ Zone _____ State _____

All prices net, F.O.B. N. Y. C.

- MODEL 905 . . . \$37.50
\$11.50 within 10 days.
Balance \$6.50 for 4 mos.
- MODEL 905 KIT . . \$28.90
\$10.90 within 10 days.
Balance \$6.00 for 3 mos.
- MODEL 204 P . . . \$55.90
\$15.90 within 10 days.
Balance \$8.00 for 5 mos.
- MODEL 104 . . . \$26.95
\$6.95 within 10 days.
Balance \$5.00 for 4 mos.
- MODEL 104 KIT . . \$19.25
\$5.25 within 10 days.
Balance \$3.50 for 4 mos.

RADIO CONTROL HEADQUARTERS

For model airplanes, boats, cars, etc. FREE CATALOG T.
No operator's license required. FREE—send for FCC Form 50B.

HANDIE TALKIE Basic Transmitter & Receiver Chassis \$7.65
New, Wired, with Dual Tube

BEFORE YOU BUY COMPARE: (27.255 Mc.)
Most Powerful
Hand Held
R/C TRANSMITTER

- Greatest Power—up to 5 watts input
- Greatest Distance—Range up to 3 sq. miles
- Gyro Magic Tuning Indicator—simplest tuning
- Versatile—operates with as little as 90V "B"
- Complete & Guaranteed

Ready to operate (less battery) \$17.95 Complete Kit \$11.95

R/C RECEIVER 27 $\frac{1}{2}$ Mc. Complete
with Relay, Tube & Accessories,
Factory Tested, Small, approx. 3 Oz. \$9.61

"MITE" MINI RELAY 5000 ohm, 1 $\frac{1}{2}$ Ma Pullin. 2.50
NEW COMPOUND ESCAPEMENT \$3.95; SW ESCAPEMENT 2.95
STORAGE BATTERIES: B854, 2V, 3"x4"x $\frac{5}{8}$ " 27 Amp/Hr 4.25
NTE MINI 6 Volt, 4 Amp/Hr, 2 $\frac{1}{2}$ "x1 $\frac{1}{2}$ "x $\frac{1}{2}$ " 3.45
R/C TRANSMITTER & RECEIVER KIT: 27 $\frac{1}{2}$ Mc. 5 watt, 2-Tube
Simple Transm. & 2-Tube Rec. Incl. Drilled Bases, Wound
Coil. Res., Cond., SIGMA Relay, Instructions. \$9.95

SIGMA 4F RELAY: 8000 ohms \$5.95; G-REED-RELAY 14.95
R/C BOOKS: Model Control \$1; Radio Control \$1; Handbook 2.25
CRYSTALS: 27.255 Mc. \$2.85; BOLDER. .15
2" MEYERS: 0-1 Ma. \$3.65; 500 MicroA \$3.95; 3 Ma. 2.95

2-6V BATTERY CHARGER KIT. . . \$4.95; WIRED. . . 6.95
CHARGER for DRY BATTERIES will charge standard dry cells
(1 $\frac{1}{2}$ -90V) up to 5 times original life. . . 4.95
RELAY CONTROL UNIT Incl. Sensitive 10,000 ohm Sigma
Relay (1 $\frac{1}{2}$ Ma.) Thermal Bi-metal Strip, Heating Element
HI Z Audio Choke, Mini Alnico Magnet, Neon Lamp, Resistors
Capacitors. . . ONLY 99c
MINI STORAGE CELLS 2V 75c. . . ELECTRIC MOTOR 1 $\frac{1}{2}$ V .70
TUBES: XFG1, RK61, 3A4, 1A6, 3A5, 6AV6, TRANSISTOR .99
RELAYS: 10K ohm, 2 Ma DC or 110V AC SPDT 99c; SPST. . . 85c
Experimenters' SOLDERING IRON. . . 99c
EARPHONES: Plug-in Type \$1.95; Standard, Dual 2000 ohm 2.50
Experimental 3V DC MOTOR & GEARS 1.25
DYNAMOTORS: 6V-150V @ 100 Ma. 6.95
12/24V In. 250/500 V @ 50 Ma. 9.95
Mini TRANSMITTER—Radiosonde 390-410 Mc.
with 2 Tubes in small box 2 $\frac{1}{4}$ "x2 $\frac{1}{4}$ "x4 $\frac{3}{4}$ ". 1.50
Radiosonde MODULATOR Assembly Incl. Mini Sens. Relay.
Aneroid Barometer-operated Slide Element, in plastic case 1.50
Coiled PHONE CORD 4-Conductor, stretches to 6 ft. .95
Carbon MICROPHONE, Telephone Type. 2.45
TELEGRAPH KEY (Commercial Type) .95
Vert. Whip ANTENNA (Up to 32 ft.). . . 45c per 3 ft. Section
Push-Pull SOLENOID, 110 V., 80 Cycle. 2.45

GYRO ELECTRONICS CO. 36 WALKER STREET, T.
NEW YORK 13, N. Y.

NEW VOLT-OHM-MILLIAMMETER

By ALCO



MODEL TS-55A

- PORTABLE
- JUST 5" wide x 3 $\frac{1}{8}$ " high x 1 $\frac{1}{2}$ " deep
- HANDIEST TESTER YOU CAN OWN

D.C. VOLTAGE RANGES:
0-10, 50, 250, 500 & 1000
A.C. VOLTAGE RANGES:
0-10, 50, 250, 500 & 1000
D.C. CURRENT RANGES:
0-1 & 0-500ma
RESISTANCE: 0 — 100K Ω
DECIBEL:
20 dB 0 dB +36dB (2 ranges)

JUST
\$9.95 ea.

ORDER DIRECT OR
FROM YOUR
NEAREST
DISTRIBUTOR

ALCO ELECTRONICS MFG. CO.
Dept. C-1 3 Wolcott Ave., Lawrence, Mass.

pulse—make; second pulse—break operation.

The input circuit permits the use of all types of sensing elements. Elements that produce current such as selenium photocells should be connected between terminals 8 and 10, while those that change resistance upon the action of some outside phenomenon should be connected between terminals 8 and 9. An example of the latter is the thermistor used in fire alarms. Besides the photocell and thermistor, the partial list of sensing elements includes the following:

A tuned circuit for a field strength meter.

A small microphone and amplifying system with a rectified output for a sound relay.

A mercury switch for a change of position indicator.

A commercial moisture element for an electronic hydrometer or moisture alarm.

An AM tuner tuned to 1240 kc for automatic Conelrad alarm.

Terminals 11 and 12 are the external power supply connections. A small AC power supply can be used when a semi-permanent installation, such as a fan control for hot weather, is desired.

To test transistors with the device, set both R1 and R2 to maximum resistance; SW2 on and SW1 "Internal"; connect a 0 — 5 milliammeter across terminals 1 and 2 and note reading obtained as "Leakage." If this reading is almost full scale, the transistor is shorted and is worthless. For most transistors it should be under 1 ma. If it is, turn SW1 to "off"; place a 0 — 1 milliammeter across terminals 8 and 9; turn R1 until the meter reads 1/20 ma; leave the meter in the circuit or short out terminals 8 and 9; turn SW1 to "Internal" and note the reading on the 0 — 10 milliammeter. This reading divided by the bias (1/20 ma) is approximately equal to the beta gain of the transistor. The correct value can be found in many manuals. If no meter reading at all is detected, the transistor is "open" and worthless. The device is set up to test PNP transistors *only*. NPN units could be tested if the connections on both batteries are reversed. —

**VIDEO ELECTRIC COMPANY says: DOWN WITH RISING COSTS OF ELECTRON TUBES
OVER ONE MILLION USED TUBES TO SELECT FROM at only**

Each and every tube is tested by our supplier under actual operating conditions in Radio, FM, Hi-Fi, Industrial equipment and Television Chassis or Intricate Testing Equipment for Mutual Conductance and Life Test.

BELOW IS A PARTIAL LIST OF OVER THREE HUNDRED POPULAR TYPES! WRITE FOR FREE COMPLETE LIST AND ORDER BLANK!

0A2	5X8	68H6	65F5	7Z4	198GG
0Z4	5Y3GT	68J6	65F7	12A8	19J6
1A7GT	5Y4G	68K5	65J7	12AQ5	19TB
1B3GT	6A7	68L7GT	65K7	12AT6	24A
1H4G	6A8	68M6	65L7GT	12AU6	25AV5
1H5GT	6AB4	68N6	65N7GT	12AU7	25BQ6
1L4	6AC7	68Q6GT	65O7	12AV6	25DN6
1L6	6AF4	68Q7	65S7	12AV7	25L6GT
1N5GT	6AG5	68R5G	674	12AX7	25W4GT
1Q5GT	6AG7	68Z6	678	12B4	25Z5
1R5	6AH4GT	68Z7	6V6	12B8	25Z6
1S5	6AH6	6C4	6W4GT	12BA6	26
1T4	6AK5	6C5	6W6GT	12BA7	35A5
1U4	6AL5	6C6	6X4	12BE6	35B5
1U5	6AL7	6C8	6X5	12BF6	35C5
1V2	6AMB	6C8G	6X8	12BF7	35L6GT
1X2	6AN8	6C9	6Y6G	12BHT	35W4
2A3	6AQ5	6C9G	7A4/XXL	12BQ6	35Y4
2AF4	6AQ6	6CMB	7A5	12BR7	37
2BC5	6AQ7GT	6CM7	7A7	12BZ	39/44
2BN6	6AR5	6CN7	7AB	12CA5	42
2BZ6	6AS5	6CS6	784	12J5	43
2C86	6AT6	6CUB	785	12K7	45
2CF6	6AT8	6DE6	786	12L6	50A5
2CS6	6AU4GT	6DQ6	787	12Q7	50B5
2LF4	6AU5GT	6F6	788	12S7	50C5
3Q4	6AUB	6H6	7C4	12SK7	50L6GT
3V4	6AV5GT	6J4	7C5	12SN7GT	57
4BQ7A	6AV6	6J5	7C7	12SQ7	58
4BZ7	6AW6	6J7	7E7	12V6GT	71A
5AS8	6AX4GT	6K6GT	7E6	12W6GT	75
5AT8	6AX5GT	6K7	7E7	12X4	76
5AV8	6BB	6K8	7F7	12Z3	77
5AW4	6BA6	6L7	7F8	14A7/12B7	78
5BK7	6BC5	6N7	7H7	14B6	80
5B8	6BC8	6Q7	7N7	14Q7	84/6Z4
5J6	6BD6	654	7Q7	19	117Z3
5U4G	6BE6	658GT	7X7/XXFM	19AU4GT	117Z6
5V8	6BF5	65A7	7Y4		
5V4G	6BF6	65C7			
5V6GT	6BG6				



GUARANTEE: WE GUARANTEE TO REPLACE FREE FOR ONE (1) YEAR ANY TUBE PURCHASED FROM US WHICH FAILS TO FUNCTION EFFICIENTLY UNDER ACTUAL OPERATING CONDITIONS. REFUNDS WILL BE MADE PROMPTLY FOR ANY DEFECTIVE MERCHANDISE.
THE TUBES ADVERTISED HEREIN ARE NOT NECESSARILY NEW TUBES BUT MAY BE ELECTRICALLY PERFECT FACTORY SECONDS OR USED TUBES AND ARE SO MARKED.

WE HAVE OVER 1000 USED TV SETS

At All Times In Our Huge Warehouse, Buy one or more of these WORKING TVs to sell or use as your own second set! All sets in GOOD WORKING condition! Your Choice—Console or Table Model.
 10" ... \$23.00 19" ... \$58.00
 12" ... \$28.00 20" ... \$64.00
 14" ... \$33.00
 16" ... \$40.00 21" ... \$72.00
 17" ... \$46.00 24" ... \$99.00
 When ordering TVs, state whether Table model or console is desired. Also, preference on make of set. All TVs sent railway express F.O.B. Newark. On any quantity, WIRE or CALL today!

FREE RCA "Cheater" Cord Given with Any Tube Order of \$7.00 or More!!	FREE Bonus Antenna Given with Any TV Set Order!!
--	--

SEND for our **FREE** complete **TUBE & PARTS LIST** and order blank.

FREE POSTAGE
 in U.S.A. and Territories on orders over \$5.00. 25c handling charge on orders under \$5.00. 25% deposit required on C.O.D.'s. Please send approximate postage or freight on Canadian and foreign orders. Subject to prior sale.

VIDEO ELECTRIC COMPANY
 9-15 6TH ST., HARRISON, N. J.

Phone HUmboldt 4-9848

HOW & WHY OF HI-FI & STEREO



NEWEST AND BEST HI-FI STEREO BOOK

Has all the answers. Explains how HI-FI Stereo components work. Tells HOW and WHY to select amplifiers, preamps, record players, tuners, tape recorders, microphones, pickups, speakers & enclosures.

Tells how to read mfr's specs of HI-FI equipment. Shows how to adapt monaural systems to stereo. Contains easy way to use decibels. Also explains distortion and means of eliminating it. Explains feedback, Williamson & Ultra-Linear circuits, impedance matching, audio power needs, crossover networks, equalization, volume compression & expansion, bass and treble boost, pickups and cartridges, styl and many other subjects.

Includes latest stereo developments in record players, tuners and tape recorders.

EACH BOOK CONTAINS A STROBOSCOPE DISC.

Price Only \$1—BIGGEST HI-FI STEREO DOLLARS WORTH

Guaranteed Money Back in 5 Days If Not Satisfied

ABSOLUTELY FREE with each order: Your choice of Cisin's newest books: **BASIC ELECTRICITY—Vol. 1** or **TV-RADIO TUBE SUBSTITUTION GUIDE**. These sell for 50c ea. **ACT NOW—get 2 books postpaid at cost of only one!**

\$1 Post-paid

RUSH COUPON NOW!

H. G. CISIN, Consulting Engineer—Dept. E1-8
Amagansett, N. Y.

Enclosed find \$1. Rush HI-FI-STEREO book and free book marked above (if not marked Basic Elec. will be sent).

Send all 3 books. Enclosed find \$1.50

Name _____
Address _____
City _____ Zone _____ State _____

ASSEMBLE YOUR OWN WALKIE-TALKIE RADIOPHONES



New Model for Citizens Band

Electronic chassis ONLY \$18.98 post paid

- Meets FCC requirements for new class "D" citizens band radio-telephone.
- License easily obtained on application by any U.S. citizen 18 years or over. No tests to take.
- Transmits and receives one to several miles depending on obstructions and elevation.
- Assembled unit is completely portable and requires no external connections. Operates from self contained batteries obtainable at your local radio store.
- Electronic chassis is wired, tested, guaranteed and includes crystal controlled oscillator, R.F. power amplifier, audio modulator, receiver with R.F. stage, and a new transistorized audio booster stage for extra loud reception plus a complete set of tubes and transistor.
- Radio receiver is tunable to any of the 22 channels by a single control knob. Features ultra-high amplification, automatic volume control and noise clipping.
- Instructions and photographs are supplied with each chassis for completing the walkie-talkie as illustrated. Accessories are not included but are available at low cost.

FREE R.F. power indicator kit with each order. SEND YOUR ORDER TODAY. INCLUDE POSTAL MONEY ORDER FOR FAST DELIVERY. C.O.D.'S REQUIRE \$5.00 DEPOSIT.

SPRINGFIELD ENTERPRISES

BOX 54 EL 4

SPRINGFIELD GARDENS 13, N. Y.

Hi-Fi Sound From Your T.V. Set

Continued from page 44

inserted about a half-inch into proper holes. Though an 8-pin unit is shown here, 7-pin versions are also available if your TV set uses a miniature tube in the audio output. A 6AQ5 is a common example.

Notice that in the schematic three points of the sound tube are used; grid, ground, and plate. The correct pin numbers for the 6V6 tube used with the author's unit are 5, 8, and 3. A survey of TV schematics, going back about five years, revealed that the 6V6 is commonly used. Several others appeared which, incidentally, have the identical pin arrangement. They are 6W6, 6Y6, 6F6, 6K6, 6L6, 25L6—all octal, or 8-pin types. Two 7-pin miniature types also appeared; the 6AQ5, which uses pin 1 for grid, 2 for ground, and 5 for plate—and the 6AS5 that has pin 2 for grid, pin 1 for ground, and pin 7 for plate. Any variation in tube types for your particular set must be determined from a diagram.

Installation of the unit is outlined in the photos. A likely spot for the case is inside the rear cover of the TV set. Plug in the Vector socket as illustrated and run the phono cable to a high level input of the hi-fi set as described before. The TV set should be off.

Switch to the "Hi-Fi" position and adjust your amplifier volume control to its usual position. Bring up the TV volume control until a comfortable listening level is heard. If there is feed-through of sound in the TV speaker, reduce the TV volume control and raise the hi-fi amplifier volume. If hum is heard under the normal sound, reverse the AC plugs (one at a time) on the hi-fi or TV. One precaution to observe is not to use the magnetic or mike input on your hi-fi for use with this device. If you plug into one of these jacks, the signal levels will cause distortion.

While the unit is in hi-fi operation some very low level sound may barely be heard in the TV speaker. Since this should not prove annoying, no attempt was made to eliminate it entirely. However, it may be cut down even more by increasing capacitor C1. 

"COBRA, DEFENSIVE street-fighting tricks." Designed to help peaceful adults. \$2. Gaucho, 846-L9 Sunnyside, Chicago 40.

"WINEMAKING," \$1.00. "STOUT, Beer, Ale Brewing," \$1.00. Illustrated. Eaton Books, Box 1242-A, Santa Rosa, Calif.

1000 EMBOSSED BUSINESS Cards \$4.50 postpaid. Free chart, samples. Baker, 9244 Convent, Phila. 14, Penna.

"HYPNOTIZE . . . ONE word . . . One fingersnap," on stage. Satisfaction—or refund. \$2. Hypnomaster, 846-L9 Sunnyside, Chicago 40.

• • • STAMPS & COINS

UNITED NATIONS. Five different 10¢. Approvals. Anderson, 1112 Harrison, San Francisco 3, Calif.

1000 DIFFERENT WORLDWIDE with approvals only. A. B. Jacobsen, Crompond, N. Y.

INDIAN CENT plus Bargain Lists 10¢. Hutchinson's, Box 4747, Philadelphia 34, Penna.

• • • DETECTIVES

DETECTIVES—WORK Home—Travel. Experience unnecessary. Detective Particulars free. Write, Wagner, 8-125 West 86th, New York 24.

• • • MUSIC

SONGPOEMS AND Lyrics Wanted! Mail to: Tin Pan Alley, Inc., 1650 Broadway, New York 19, N. Y.

• • • PHOTOGRAPHY

SEND YOUR favorite snapshot or negative for professional quality prints at wholesale prices. 10 wallet size (silk finish)—\$1.00. 5x7—75¢ each, 3 for \$2.00. 8x10—\$1.25 each, 3 for \$3.25. Add 75¢ when sending snapshot without negative. No C.O.D.'s. Breiter, 229-03 Grand Central Pkwy., Flushing 64, N. Y.

• • • ROCKETS

ROCKET AMATEUR'S Guidebook. New, valuable guide to sources of rocket kits, plans, supplies, free instruction manuals, safety rules, legal regulations, university courses. Includes list of rocket clubs, big bibliography. Only \$1.00. Space Products, Dept. EI-2, 38 East 57th St., New York, N. Y.

NEW DIFFERENT

For hi-fi fans and collectors of unique recordings, here is a great adventure . . . music arranged for piano and harp. A real first in hi-fi! Great old tunes played on this unusual combination of instruments by Will and Helen Irwin. And on the reverse side, a fascinating demonstration of piano-and-harp artistry, with special commentary written and narrated by hi-fi authority Don Hoefler.



EXCITING

TO ORDER: Send \$4.98 for each copy of "Hi-Fi Harp" to FAWCETT RECORDS, Box EI, Greenwich, Conn.

This is the first in a new series of exciting adventures in listening . . . records of exceptional interest that are brought to you on the FAWCETT FABULOUS FIDELITY label.

Electronic Pinspotter

Continued from page 50

respotting table lowers and its gripper pads tighten around those pins that remain standing, lifting them out of the way. The sweeper arm quickly clears the deadwood, and the table replaces the standing pins to the exact locations from which they were taken, ready to be bowled over by the second ball. Pins offspotted by the first ball are put right back on their offspot position.

How? The gripper pads, over four inches in length, are each equipped with a respot cell connected to the "brain." They are also mounted on horizontal rolling tracks. As the gripper pads descend and brush ever-so-lightly over the standing pins, the respot cell's micro-switches and circuits sense the location of the pin, combine with the "brain" to move the gripper pad directly in line with the pin, and then lock it there until the pin has been respotted.

The only occasion a bowler would have to push a button is to get a new setup after the tenth frame. ●

An Auto Tachometer

Continued from page 57

terminals of the ignition coil and the connection can be made at either point.

Calibration can be carried out at the nearest garage. Have the mechanic attach his tachometer, rev up the engine and adjust R7 so the meter agrees with the garage instrument.

Variations in the value of the components may require a change in the value of R6 to place exact calibration within the range of R7. If, by adjusting R7, the tach reads too high, R6 should be reduced in value. Conversely, if the tach cannot be adjusted to read high enough, increase the value of R6.

Cost is about \$8 plus meter. ●



Pulses are picked up from distributor points.

The Greatest In Test Instruments

Precise Development Corp.
Oceanside, Long Island, N. Y.

Please send me information about Test Equipment.

Name _____
Address _____
City _____ Zone _____ State _____
My Dealer would like information too!

He is _____
Address _____
City _____ Zone _____ State _____

Mutual Conductance and Emission

TUBE TESTER

Here is a tester that actually checks a tube for its application, not whether it is just good or bad. GM and emission are checked separately. It is the first and only device that measures 600-mil tubes on a meter. Sweeps from 0 through the normal testing range when making measurements to give an average evaluation of the tube over an extended range of operation. Selected for use by the United States Department of Standards. MODEL 111K, Kit, \$79.95; MODEL 111W, Factory-wired.....\$139.95

... that's the opinion of leading electronic engineers, radio service people and amateur radio enthusiasts. And Precise has achieved this reputation, too, because of its efforts to bring you the best possible equipment at the lowest possible prices. You can depend on Precise for quality—based upon ingenuity, originality, and production "know-how."



precise DEVELOPMENT CORPORATION
OCEANSIDE, N. Y. Cable Address: CHURCHIN

CUT HOLES IN 1-1/2 MINUTES

(OR LESS)

with Greenlee
Chassis Punches



Many sizes . . . quickly make smooth, accurate holes in metal, hard rubber, or plastics . . . for sockets, plugs, controls, meters, panel lights, etc. Easy to use, simply turn with a wrench. Write today for free literature.



GREENLEE TOOL CO.
1783 Columbus Avenue, Rockford, Ill.



QUALITY CUT QUARTZ FOR EVERY SERVICE



All crystals made from Grade "A" imported quartz—ground and etched to exact frequencies. Unconditionally guaranteed! Supplied in:
FT-243 holders. Pin spacing 3/4". Pin diameter .093.
DC-34 holders. Pin spacing 3/4". Pin diameter .136.
MC-7 holders. Pin spacing 3/4". Pin diameter .125.
FT-171 holders. Pin spacing 3/4". Banana pins.
MADE TO ORDER CRYSTALS
100KC to 2500KC:
.01% Tolerance \$2.00 .005% Tolerance \$2.75
2501KC to 9000KC: .005% Tolerance \$2.50
9001KC to 12,000KC: .005% Tolerance \$3.00
Specify holder wanted.

ANY AMATEUR, NOVICE, TECHNICIAN BAND CRYSTALS
.01% Tolerance \$1.50 each—80 meters 3701-3749 KC, 40 meters 7152-7198 KC, 15 meters 7034-7082 KC, 6 meters 8335-8650 KC (within 1KC)

NEW CITIZEN BAND CLASS D CRYSTALS \$2.50
Following Frequencies in Stock. (Frequencies listed in megacycles)
26,965, 26,975, 26,985, 27,005, 27,015, 27,025, 27,035,
27,055, 27,065, 27,075, 27,085, 27,105, 27,115, 27,125,
27,135, 27,155, 27,165, 27,175, 27,185, 27,205, 27,215,
27,225.

ASK YOUR LOCAL PARTS DISTRIBUTOR FOR TEXAS CRYSTALS
LOOK FOR YELLOW & RED DISPLAY BOARD.

If He Does Not Stock Texas Crystals Order Direct From The Factory
SEALED OVERTONE CRYSTALS supplied in metal HC/6U holders
—pin spacing .486, diameter .050.
15 to 30 MC. .005 tolerance \$3.85 ea.
30 to 45 MC. .005 tolerance \$4.10 ea.
45 to 60 MC. .005 tolerance \$4.50 ea.

FUNDAMENTAL FREQ. SEALED CRYSTALS
In HC/6U holders from 1400KC-10,000KC any frequency
.005 tolerance \$3.50 ea.

MARINE FREQUENCY CRYSTALS
All marine frequencies from 2000-3200KC .005 tolerance \$2.50
(Supplied in either FT-243, MC-7, or FT-171 holders.)

RADIO CONTROL CRYSTALS
In Stock For Immediate Delivery. (Frequencies listed in megacycles) Sealed Crystals 26,995, 27,047, 27,095, 27,145, 27,195, 27,255.

(1/2" pin spacing . . . specify pin diameter .093 or .050) \$2.50 ea.
Stock crystals in FT-243 holders from 5875KC to 8650KC in 25KC steps . . . 75c or 3 for \$2.00

FT-241 lattice crystals in all frequencies from 370 KC to 540 KC (All except 455 KC and 800 KC) . . . 50c
Matched pairs ± 15 cycles \$2.50 per pair.

200 KC Crystals, \$2.00; 455 KC Crystals, \$1.50; 500 KC Crystals, \$1.50; 1000 KC Frequency Standard Crystals, \$3.50;
100 KC Frequency Standard Crystals, \$4.50; Dual Socket for FT-243 Crystals, 15c; Ceramic socket HC/6U Crystals, 15c.
(Add 5c per crystal for postage and handling.)

WRITE FOR FREE CRYSTAL CATALOG
COMPLETE WITH OSCILLATOR CIRCUITS

TEXAS CRYSTALS

8538 W. GRAND AVENUE • RIVER GROVE, ILL.
ALL PHONES—GLADSTONE 3-3555

Terms: All items subject to prior sale and change of price without notice. All crystal orders MUST be accompanied by check, cash or M.O. WITH PAYMENT IN FULL. NO C.O.D.'s. Postpaid shipments made in U.S. and possessions only. Add 5c per crystal for postage and handling charge.

Television

or Communications

Practicing at Home

in Spare Time

What NRI Graduates Do and Say



Chief Engineer with Station
"I am Chief Engineer with KGCU. Also have my own spare time servicing business." R. BARNETT, Bismarck, N. D.



Good Spare Time Earnings
"Am doing well in spare time Radio and TV. Sometimes have 3 TV jobs waiting." G. F. SEAMAN, New York, N. Y.



Has Own Radio-TV Business
"Have appliance store with TV Servicing. In Army, NRI helped get me top rated job." W. M. WEIDNER, Fairfax, S. D.

 **CUT OUT AND MAIL
POSTAGE-FREE CARD**

**SAMPLE LESSON
and 64-Pg. Catalog
Both FREE**

**NO STAMP NECESSARY
WE PAY POSTAGE**

**NATIONAL RADIO INSTITUTE
Dept. 9DK, Washington 16, D. C.**

Mail me Sample Lesson and 64-page Catalog. (No salesman will call. Please write plainly.)

NAME _____

AGE _____

ADDRESS _____

CITY _____ ZONE _____ STATE _____

Accredited Member National Home Study Council



Mail Postage-Free Card for

SAMPLE LESSON

FREE

Shows how easy it is to
Train at Home for Good

RADIO-TV JOBS

**Find Out What NRI—
Oldest, Largest Home
Study Radio-TV School
Can Do For You**

Since 1914—NRI has been training ambitious men at home. Thousands have found NRI's training the way to higher earnings.

The ABC's of
SERVICING

← **See Inside**

BUSINESS REPLY CARD

No Postage Stamp Necessary If Mailed In The United States

POSTAGE WILL BE PAID BY

NATIONAL RADIO INSTITUTE

Washington 16, D. C.

FIRST CLASS
Permit No. 20-R
(Sec. 34.9 P.L.&R.)
Washington, D.C.

Learn Radio-

Servicing by Pro



**Jobs Like These Go to the
Radio-Television Technician**



NRI Trained these Men



"I knew practically nothing about Electronics. After 15 lessons I started repairing sets. My future looks bright." D. B. ACKERMAN, Minneapolis, Minn.

"Thanks to NRI. I operated a successful Radio Repair shop. Then got a job with WPAQ; now I am an engineer for WHPE." V. W. WORKMAN, High Point, N. C.



"Have good job in a TV repair shop plus a small business in my home. In one year I went from lowest paid to head benchman." V. BARR, Toronto, Ohio.



J. E. SMITH
Founder

Fast Growing Field Offers You Good Pay, Success, Bright Future

Bigger than ever and still growing. That's why Radio has special appeal to men not satisfied with their earnings. More than 4,000 Radio and TV stations on the air. More than 150 million home and auto Radios. 40 million TV sets. Training PLUS OPPORTUNITY is the ideal combination for success. Plan now to get into Radio! National Radio can train you at home in your spare time. NRI is the oldest and largest home study Radio-school. Easy to understand, well illustrated lessons teach you basic principles. And you LEARN-BY-DOING, by practicing with kits of equipment NRI sends.

Start Soon to Make \$10—\$15 a Week in Spare Time

Soon after enrolling many NRI students start to earn \$10, \$15 a week extra fixing sets in spare time. You get the benefit of NRI more than 40 years' experience training men. Make a move toward becoming one of that select group—a Radio-TV Technician. Send Postage-Free card today for actual Lesson and 64-page Catalog BOTH FREE. NATIONAL RADIO INSTITUTE, Dept. 9DK, Washington 16, D. C.

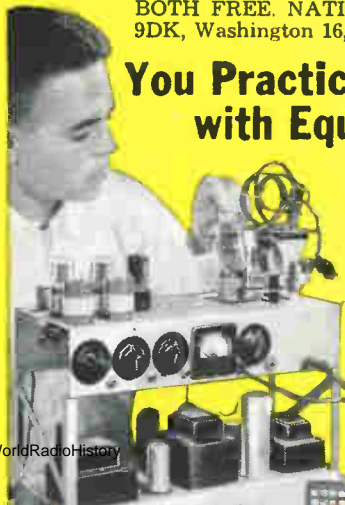

You Practice Communication with Equipment NRI Sends

Nothing takes the place of practical experience. As part of NRI Communications Course you build a Broadcasting Transmitter; train for FCC License.

You Practice Servicing with Equipment Sent

As part of NRI's Servicing Course you build AC-DC Superhet Receiver, Vacuum Tube Voltmeter, and other pieces of equipment for practical experience.

MAIL POSTAGE FREE CARD

another "first"... from the first name in high fidelity turntables—a RONDINE turntable with **hysteresis motor*** at



\$ **49** ⁹⁵ net

REK-O-KUT RONDINE K33H KIT

Rondine K-33H Specifications; powered by Rek-O-Kut hysteresis synchronous motor. Single-speed (33½ rpm) with Crown-Spindle belt drive; includes built-in strobe disc and on-off switch. Assembly: 30 minutes or less with ordinary tools. Complete instructions in each kit. Price: \$49.95 net, K-33H Turntable Kit only.

For ease of installation, handsome Rek-O-Kut bases and pre-drilled motor boards are available. Bases from \$10.95; Mounting Boards from \$4.95. Rek-O-Kut Tonearms from \$27.95. *Hysteresis motors are essential for the professional quality required by broadcast and recording studios.

REK-O-KUT
HIGH FIDELITY TURNTABLES
TURNTABLE ARMS

Expert: Morhan Exporting Corp., 458 Broadway, New York 13, N. Y.
Canada: Atlas Radio, 50 Wingold Ave., Toronto 10, Ontario

Rek-O-Kut Co., Inc.
Dept. E14
38-19 108th St. Corona 58, N.Y.

Please send complete information on the new Rondine K33H Kit with hysteresis motor.

Name _____
Address _____
City _____ Zone _____ State _____

RK-40

Rondine — the Hysteresis Line... Engineered for the Studio... designed for the home!