

Is TV The Answer To Better Teaching ?

ELECTRONICS ILLUSTRATED

25^c
JANUARY

**SCIENCE FAIR
WINNER—**
The Electronic Machine
That Follows
A White Line

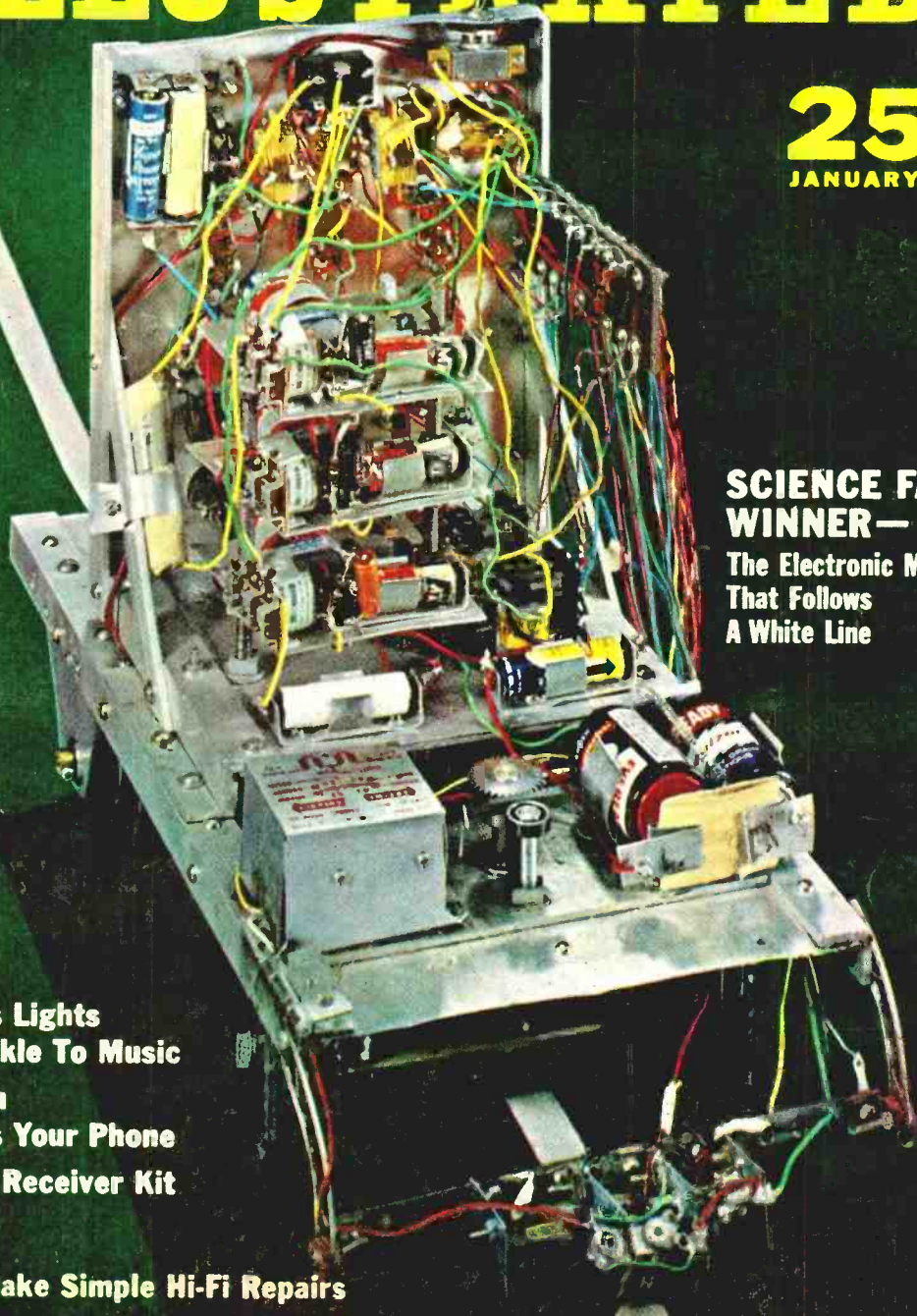

Build:

- Christmas Lights That Twinkle To Music
- Fire Alarm That Dials Your Phone
- New Ham Receiver Kit

Also:

- How To Make Simple Hi-Fi Repairs

National News Dial



Published periodically by the NATIONAL CO. INC., MALDEN 48, MASS.



FIRST ALL-NEW, LOW-PRICED SHORTWAVE RECEIVER IN OVER 10 YEARS!



New National NC-60 SPECIAL Breaks All Sales Records For Christmas

First reports from National Co. Distributors indicate that the new NC-60 SPECIAL is breaking all sales records for low-priced SWL receivers during the Christmas season. The manufacturer is scheduling overtime shifts to meet distributor orders. It's no wonder why you consider the smart, modern appearance and exclusive features which combine to make the NC-60 SPECIAL America's top value in standard broadcast/shortwave receivers.

The NC-60 SPECIAL covers .54 to 31 mc in 4 bands with full electri-

cal bandspread on all frequencies. Features exceptional sensitivity with separate tuning coils for each band. Has separate general coverage and bandspread tuning capacitors, front panel phone jack and built-in speaker. Standard broadcast, civil defense, WWV, marine, aircraft, amateur and world wide shortwave frequencies are clearly marked on dial. 110 volt AC/DC.

ONLY \$5.95 DOWN Suggested price \$59.95. Most National Co. Distributors offer budget terms.

NATIONAL CO. DISTRIBUTORS OFFER FREE \$17⁵⁰ SPEAKER WITH NC-109 OR NC-188 RECEIVER!

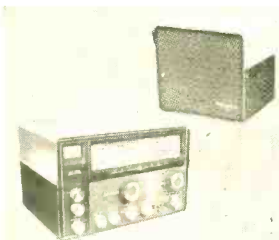

NC-109 PLUS NTS-1 SPEAKER
Regularly \$217.45
NOW ONLY \$19.95 DOWN
full suggested cash price \$199.95



NC-188 PLUS NTS-1 SPEAKER
Regularly \$177.45
NOW ONLY \$15.95 DOWN
full suggested cash price \$159.95

For a limited time only, most National Co. Distributors offer an opportunity to buy and save \$17.50 on the purchase of either the NC-109 or NC-188 receivers. You get the receiver PLUS speaker . . . BOTH FOR THE PRICE OF THE RECEIVER ALONE! See your National Co. Distributor now and save.

NC-109 . . . Covers 540 kc to 40 mc in 4 bands. Calibrated bandspread for 10-80 meter bands. Exclusive "MICROTOME" filter provides 5 degrees of super-sharp selectivity. Sensitivity 1-2 microvolts with 10 db signal/noise ratio. Separate high frequency oscillator with temperature compensated

ceramic coil forms reduces drift to .01% or less. Separate product detector for SSB makes the NC-109 America's lowest priced SSB receiver.

NC-188 . . . covers 540 kc to 40 mc. Directly calibrated for 4 general coverage ranges and 5 bandspread ranges for 10-80 meter bands. Has RF amplifier stages, two IF stages, and two audio stages. Has tone control, antenna trimmer, S-meter, separate RF and AF gain controls, automatic noise limiter. Has temperature compensated and ventilated high frequency oscillator for increased stability.

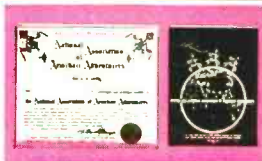

NAAA FORMED

New Organization To Stimulate
Interest in Shortwave Radio

The NAAA is the NATIONAL ASSOCIATION OF ARMCHAIR ADVENTURERS—a grand group of bold, dare-do-wells devoted to effortless world-wide travel and adventure through the medium of shortwave radio listening. Membership in the exclusive, international organization is limited to those with courage to risk 50c for a colorful membership certificate and a copy of an exciting new book on Shortwave Listening. Tells when, where and how to listen. Provides log for listing each exciting shortwave adventure. Send 50c to NATIONAL CO., INC., MALDEN 48, MASS.



**A HIGHLY
RESPECTED TRADE—
START SOON TO
EARN EXTRA MONEY
IN SPARE TIME**

Learn at Home IN YOUR SPARE TIME to Fix Electrical Appliances

To build a better future, get into a field where there's much important work and the security that comes from knowing a good trade. Servicing electrical appliances offers that OPPORTUNITY. Every wired home has many electrical appliances and millions and millions of new appliances are sold every year. Owners pay well to keep them in repair. That's making a fast-growing need for trained men.

Add To Your Income Starting Soon Need For Service Technicians Increasing

Make extra money in your spare time. Start soon to fix electric toasters, fans, clocks, vacuum cleaners, and other electric appliances for your neighbors and friends. Work in your basement, garage or spare room. It's easy to increase your earning power—to pay for your training many times over—to have extra money to buy things you need.

Learn and Earn with Multi-Use Tester Built with Parts We Send

This course includes the parts to build a portable, sturdy Appliance Tester that helps you locate electrical defects quickly and easily. You use it to learn and do actual electrical appliance repair jobs. If you want better pay learn this good trade. No need to give up your present

job. You can train at home in your spare time for only \$3.00 down and \$6.00 a month. A small price to pay for increased earnings, a more secure future. Paste coupon below on a postal or mail in envelope for free book and sample lesson. Address **National Radio Institute, Dept. KA9, Washington 16, D. C.**

**MAILING THIS
COUPON MAY START
YOU TO SUCCESS
LESSON AND BOOK
FREE**



NATIONAL RADIO INSTITUTE, Dept. KA9, Washington 16, D. C.

Please send me Electric Appliance Training lesson and book free. (No salesman will call.)

Name Age

Address

City Zone State

ACCREDITED MEMBER NATIONAL HOME STUDY COUNCIL

ELECTRONICS ILLUSTRATED

A Fawcett Publication

Vol. 2 No. 1

Jan. 1959

CONTENTS



A Message From The Editor	4
Electronics in the News	10
Why Don't We Have More Educational TV?	27
National Guard Air Arm Has Long Reach	32
Christmas Lights That Twinkle To Music	34
Is There A Job For You In Florida Electronics?	38
Our Amazing Teenagers	44
Too Smart To Add 2 + 2	48
A Timer Counter For Your Darkroom	49
A Fire Alarm That Dials Your Phone	52
El Assembles A Mohawk Ham Receiver	58
Electronic Brain	62
Inside Your Heart	63
Soviet Solar Switch	66

Henry and Me	67
Copper Plating At Home	68
All About Short-Wave Listening - 2	70
A 50¢ Mike Stand	74
Simple Hi-Fi Repairs	42
ABC's of Electronics	76
El Assembles A Hi-Fi Speaker System	78
Clean Your Records With This Record Bath	80
Hi-Fi Clinic	83
New Life For Weak Batteries	84
Assemble A Common Component Receiver	86
Report on Community TV	90
Color Film Processing	92



COVER PHOTO by JAY B. LEVITON

CHARLES TEPPER.....Editor
Leonard Buckwaller.....Associate Editor
Edward Nanas.....Feature Editor
Murray Cooper.....Art Editor
John M. Kane.....Art Associate
Lois Bianchi.....Editorial Assistant

Larry Eisinger.....Editor-in-Chief
Phyllis Goodman.....Production Editor
Nancy Kay.....Assistant Production Editor
John F. Webster.....Advertising Manager

Ralph Daigh.....Editorial Director
James Boynton.....Advertising Director
Al Allard.....Art Director
Ralph Mattison.....Associate Art Director
Annetta Packer.....Production Director

ELECTRONICS ILLUSTRATED is published monthly by Fawcett Publications, Inc., Fawcett Place, Greenwich, Conn. W. H. Fawcett, Jr., President; Gordon Fawcett, Secretary and Treasurer; Roger Fawcett, General Manager; Roscoe K. Fawcett, Circulation Director. Editorial and Advertising offices: 67 West 44th Street, New York 36, N. Y. Entered as second class matter at the Post Office at Greenwich, Conn. under the Act of March 3, 1879 with additional entry at Louisville, Ky. Price 25¢ a copy, Subscription price, 12 issues for \$3.00 in U. S. and Possessions and Canada. Copyright 1959 by Fawcett Publications, Inc. Printed in the U.S.A. Permission hereby granted to quote from this issue of this magazine on radio or television provided a total of not more than 1,000 words is quoted and credit is given to the title of the magazine and issue, as well as the statement, copyright 1959, by Fawcett Publications, Inc.

These men are getting practical training in... *Electronics*

ELECTRICITY ELECTRONICS



On Real:

**A. C. and D. C. Motors
Generators
Switchboards
Controllers
Modern Appliances
Automatic Electronic
Control Units**

(Shown at left—Instructor explaining operation and testing of a large Motor Generator in our A.C. Department.)

TELEVISION RADIO ELECTRONICS

On Real:

**Television Receivers
Black & White and Color
AM-FM and Auto Radios
Transistors—Printed
Circuits—Test Equipment**

(Right — Instructor helping students check the wiring and trace circuits of television receivers.)

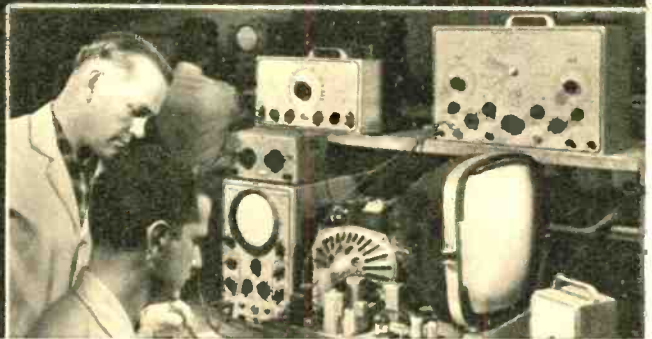

Train in the NEW SHOP-LABS of COYNE

Largest, Oldest, Best Equipped School of its Kind in the U.S.

Prepare for your future now in today's top opportunity field. Don't be satisfied with a "No Future" job. Train the Coyne way for a better job in a field that offers a world of opportunities in the years ahead. You train in Chicago—the Electronic Center of the World—on real equipment. Professional and experienced instructors show you how, then you do practical jobs yourself. No previous experience or advanced education is needed.

FINANCE PLAN: Enroll now, pay most of tuition after graduation. Part-time employment help for students.

Mail coupon or write to address below for free book—"Guide to Careers". Whether you prefer Electricity—Electronics, Television-Radio Electronics or Combined Electronics Training, this book describes all training offered and gives facts to Vets and Non-Vets.



**Mail Coupon or Write
for FREE Book**

Book comes by mail. No obligation and no salesman will call.

Mail coupon below in an Envelope or paste on a Postal Card or write Address given and free book, "Guide to Careers", with information will be sent to you by return mail.

COYNE ELECTRICAL SCHOOL
Dept. 19-8A, New Coyne Building
1501 W. Congress Pkwy., Chicago 7, Illinois

Send FREE Book, "Guide to Careers" and details of all training you offer.

NAME.....

ADDRESS.....

CITY.....STATE.....

(I understand no Salesman will call)

B. W. Cook, Jr., Pres. COYNE ELECTRICAL SCHOOL Founded 1899

CHARTERED AS AN EDUCATIONAL INSTITUTION NOT FOR PROFIT
1501 W. CONGRESS PARKWAY, CHICAGO 7 Dept. 19-8A
ELECTRICITY ★ RADIO ★ TELEVISION ★ REFRIGERATION ★ ELECTRONICS

A Message From the Editor

Strictly speaking, the subject of educational TV is not electronic. We'd probably classify it as cultural. However, you, our readers, are in an especially influential position in your communities, relative to this matter. Your neighbors and friends who know that you have some knowledge of electronics undoubtedly ask you about what hi-fi components or system to buy, which TV set is best, and what stereo is all about. Similarly, when your community considers educational TV your opinion will be sought about TV cameras and monitoring and broadcasting equipment—if you make yourself active in the drive. Our article in this issue is an attempt to fill you in on some of the problems involved. Educational TV is an advance that cries for action—you can do more than most.

Dr. Vladimir K. Zworykin, inventor of the TV camera, is closer in breadth of vision and depth of knowledge to Leonardo da Vinci's age than to the present. He refuses to be specialized. Now 70 and an honorary RCA vice president, he is devoting all of his energies to applying electronics to inventions for humanitarian purposes. One of his pet projects is the development of electronic highway and auto controls that will make driving absolutely safe. We spoke to him about this and the exclusive interview that resulted will appear in our next issue.

On page 63 of this issue we have an interesting story on a tiny microphone that fits into the human heart and is used to diagnose heart trouble. According to the author, it is entirely possible that this American invention was copied by the Russians and used to monitor Laika, the Sputnik dog. More details on this appear in the story.

Since starting the Electronic Brain and the Hi-Fi Clinic columns in EI we have received many letters from readers



Dr. V.K. Zworykin, developer of electronic road safety system is interviewed by EI's Editor.

Men 17 to 55—GET FREE FACTS!

See How **DeVry Tech** Can
Prepare You For A Profitable Future In Many Fields

from **Communications** to **Guided Missiles, etc.**



**No Previous Technical Experience
Or Advanced Education Needed!**

Laborers and bookkeepers, store clerks, shop men, farmers, salesmen—men of nearly every calling—have taken the DeVry Tech program and today have good jobs or service shops of their own in Electronics. You don't have to quit your present job. If you are 17 to 55, see how you may get yourself ready for a future in the fast-growing Electronics field.

Whether you prepare at home or in our well-equipped Chicago or Toronto Laboratories, you get sound, basic training in both principles and practice. At home, you use educational movies. You build actual circuits and test equipment. You read simple directions, follow clear illustrations. When you finish, you are prepared to step into a good job in this excitingly different field. You may even start a service shop of your own. Mail coupon for free facts today.

Get **FREE** Booklet!

We'll give you a free copy of an interesting booklet, "Electronics and YOU." See for yourself how you may take advantage of the opportunities in this fast-growing field.



**FREE
EMPLOYMENT
SERVICE**

Puts you in touch with job opportunities—or helps you toward a better position in the plant where you are now employed.

Draft Age?

We have valuable information for every man of draft age; so if you are subject to military service, be sure to check the coupon.

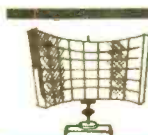

Radar



**Automation
Electronics**



Television



Micro-Waves



Computers



Broadcasting



**Your Own
Service Shop**

DeVry *Technical* INSTITUTE

Chicago 41, Illinois
Formerly DeFOREST'S TRAINING, INC.

"One of North America's Foremost Electronics Training Centers"
Accredited Member of National Home Study Council



DeVry Technical Institute
4141 Belmont Ave., Chicago 41, Ill., Dept. EI-1-P
Please give me your FREE booklet, "Electronics and YOU," and tell me how I may prepare to enter one or more branches of Electronics as listed above.

Name _____ Age _____
Street _____ Please Print _____ Apt. _____
City _____ Zone _____ State _____

Check here if subject to Military Training.

DeVry Tech's Canadian Training Center is located at 626 Roselawn Avenue, Toronto 12, Ontario

2040

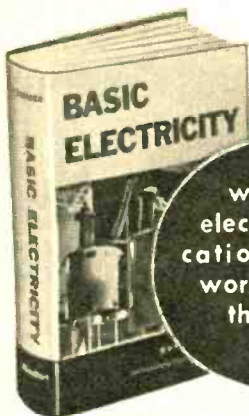

Brand New!

No matter what kind of radio, electronic, communications or electrical work you plan to do, this is the most important training of all!

BASIC ELECTRICITY

Your key to Success in Radio-Electronics

DON'T LET MODERN CIRCUITS AND EQUIPMENT "STUMP" YOU!

Think how often you've been stumped by a technical talk, magazine article or by some modern circuit or complicated piece of equipment . . . simply because you're not too clear about the basic principles involved. Think of the troubles you may have had with fundamentals such as reactance, power factor, phase relations, and others for the same reason!

That's why a complete knowledge of BASIC ELECTRICITY is so highly important. Then everything else in electronics, radio, TV, communications, hi-fi and all the rest comes 10 times as easy . . . for they're ALL based on these same fundamental electrical principles.

Actually, this new 396-page BASIC ELECTRICITY manual is a complete training course in the things you absolutely must know in order to get the most out of any form of radio-electronic activity.

Starting with a clear explanation of basic factors, the book progresses to every phase of electrical and electromagnet theory and operation. Included are dozens of electrical problems and their solutions. Essential elements such as motors, generators, transistors, polyphase and others—often neglected by ordinary text books are fully covered. Everything is explained as clearly as A-B-C by text and by over 300 illustrations.

Includes 61-page INTRODUCTION TO ELECTRONICS

also: Basic Circuits and Direct Currents; Switches and Controls; Current Flow in Liquids and Gases, Magnetism and Electromagnetism; Capacitors and Capacitance; Inductors and Inductance; Phase Relations and Impedance; Transformers; Generators and Motors; Polyphase Systems; Rectifiers; Wiring; Illumination; Telegraph and Telephone Fundamentals; Instruments and Measurements—and many more.

Try this complete new basic training now . . . at our risk. See how it clears up problems—helps you understand technical details more fully!

---10 DAY FREE EXAMINATION---

Dept. PR-19, RINEHART & CO., INC.
232 Madison Ave., New York 16, N. Y.

Send Turner's 396-page BASIC ELECTRICITY manual for 10-day FREE EXAMINATION. If book is satisfactory, I will then send you \$6.50 (plus postage) promptly in full payment. If not, I will return book within 10 days and owe nothing. (SAVE! Send \$6.50 with order and we pay postage. Same return privilege with money refunded.)

Name

Address

City, Zone, State

OUTSIDE U.S.A.—Price \$7.00 cash with order. Money back if you return book within 10 days.



Coming next month: a one-transistor FM receiver.

requesting help on circuits, equipment, installations, etc. We've answered every one. Now we in turn seek help from you. We are planning our 1959 issues and to serve you the best way we can, we'd like to know which of the articles in our past issues have made the best impression on you. What type of construction project do you like best? Which regular feature? What build-it-yourself items or subjects would you like us to present in a future issue? Send your answers to EI, Dep't. ED, 67 West 44th Street, New York 36, N.Y.

Our February issue, incidentally, should be especially exciting for do-it-yourselfers. We have an article on a complete FM pocket radio that measures 2" x 2 3/4" and uses only one transistor—no tubes, no crystals. Also, you will learn how to build a wireless intercom that uses the house current lines as a signal carrier. This means that you need only plug these units into the wall outlets in any room in your house, and you have two-way communications. If you'd like to add a stereo cartridge to your record player or changer, we'll describe how to do it.

One of the commonest jobs that must be done in kit building and all types of electronic construction is wire stripping. Yet many electronics handymen do not know how to properly strip and clean leads. We'll show you how. As usual, there will also be two factual kit reports and our other regular features.

Charles Tappan

Electronics Illustrated

BIG REWARDS

for the most-wanted men in Radio-TV-Electronics



General Electronics Technician



Radio-TV Engineer



Radio-TV Service Manager



Industrial Electronics Technician



Electrical Engineering Technician



Electrical Draftsman

That's right! There are big rewards for the most-wanted men in Radio-TV-Electronics.

You can be one of these men. With the right training you can qualify for a big-pay job in a vital industry. You can start yourself on an exciting, rewarding career in a field that offers unlimited opportunities.

But you must be thoroughly trained. You must know more than wires and tubes. You must think in electronic terms.

There's no short-cut to success in Radio-TV-Electronics. But there is a simple, sure way . . . the I.C.S. way.

I.C.S. is the world's oldest and largest technical training school. Sixty-seven years of experience in training 6½ million students have made the I.C.S. system a success-proven method

of home study. Today, there are more trained men from I.C.S. in supervisory and management jobs than from any other school.

Up-to-the-minute I.C.S. Courses make electronic fundamentals clear, easy-to-follow. Personalized guidance helps you through each step.

You study at home — in your spare time — at your own pace. Everything you learn is practical, usable. Courses are prepared by experts who know what you need to know to go places.

Join the ranks of the most-wanted men in Radio-TV-Electronics. Your first step is to send for your free I.C.S. Career Kit. You have nothing to lose. You can gain an exciting career in the fastest-growing industry of all time.

HOW WILL YOUR I.C.S. SUCCESS STORY SOUND ?

"I took my diploma from your school in Radio Operating in 1947. In 8 years I became chief engineer of WKOK in Sunbury, Pa. Then I came to California as Audio Engineer for ABC in Hollywood. I still hold this position. I will always be grateful for your help in getting me in the type of profession that has so much to look forward to."
William B. Dreece

"I had been in the radio-repair business for 30 years, when I enrolled in the I.C.S. Television Servicing Course.

"Now I am able to approach a television job in a systematic manner, while others are still operating on the hit-or-miss level."
Kelsey G. Cobb

"Up to the time I enrolled, my interest in electronics was purely a hobby, but before completing my course I was able to do a considerable amount of radio work. Now I have a good part-time business."
George A. Chase

Send the coupon below for your free I.C.S. Career Kit!

- 1 "How to Succeed," 36-page guide to advancement.
- 2 Opportunity handbook for the field of your choice.
- 3 Sample lesson (Math) to demonstrate I.C.S. method.



For Real Job Security—Get an I.C.S. Diploma!

I.C.S., Scranton 15, Penna.

Accredited Member,
National Home Study Council

INTERNATIONAL CORRESPONDENCE SCHOOLS



BOX 02313M, SCRANTON 15, PENNA.

(Partial list of 259 courses)

Without cost or obligation, send me "How to Succeed" and the opportunity booklet about the field BEFORE which I have marked X (plus sample lesson):

RADIO TELEVISION ELECTRONICS

- General Electronics Tech.
- Industrial Electronics
- Practical Radio-TV Eng'r'g
- Practical Telephony
- Radio-TV Servicing

BUSINESS

- Cost Accounting
- Managing a Small Business
- Purchasing Agent

DRAFTING

- Electrical Drafting

HIGH SCHOOL

- High School Diploma
- Good English
- High School Mathematics

ELECTRICAL

- Electrical Engineering
- Elec. Engr. Technician
- Elec. Light and Power
- Practical Electrician
- Professional Engineer (Elec.)

LEADERSHIP

- Industrial Foremanship
- Industrial Supervision
- Personnel-Labor Relations
- Supervision

Name _____ Age _____ Home Address _____

City _____ Zone _____ State _____ Working Hours _____ A.M. to _____ P.M. _____

Occupation _____

Canadian residents send coupon to International Correspondence Schools, Canadian, Ltd., Montreal, Canada. . . . Special tuition rates to members of the U. S. Armed Forces.

AN EXTRAORDINARY VALUE OFFERED TO NEW



13. 12 songs — Love Me or Leave Me, It's Magic, etc.



12. This musical painting has become an American classic

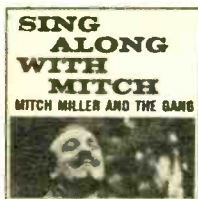

15. 16 favorites—You Are My Sunshine, Sweet Violets, etc.



62. Blue Skies, Mean to Me, Nearness of you, 9 more

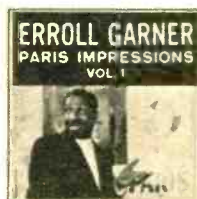

46. 8 numbers—Louise, Moulin Rouge, I Love Paris, etc.



60. Dream Girl, A Kiss in the Dark, Toyland, 9 more

ANY SIX

of these superb High-Fidelity

COLUMBIA and EPIC RECORDS

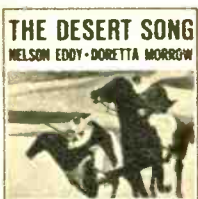

17. Romberg's romantic operetta is always a joy to hear



22. Mozart's last work—called "an opera for the angels"



1. Make the Man Love Me, Smoke Gets in Your Eyes, 10 more



48. Rain in Spain, I Could Have Danced All Night, etc.



28. Hauntingly lovely music—beautifully played

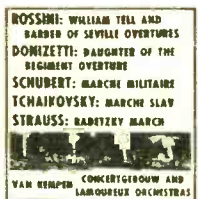

61. A hi-fi thriller. Six stirring overtures and marches



27. Orig. performances of 11 Goodman Classics in Swing



39. Exciting performances of two colorful scores



7. Jezebel, High Noon, I Believe, Jealousy, Granada, 8 more



10. Schweitzer's interpretations of three Bach organ works

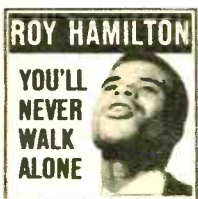

29. The "Big Voice" sings Ebb Tide, I Believe, 10 more



16. Two ever-popular classics—superbly performed



19. Duchin plays The Man I Love, April Showers, 13 more



49. "... lustrous sound!"—High Fidelity. 7 waltzes

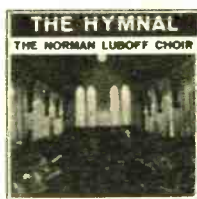

38. 12 beloved hymns—Let Him In, Sweet Hour of Prayer, etc.

MEMBERS OF THE COLUMBIA RECORD CLUB



30. "...superb...most sensuous of ensembles," N.Y. Times

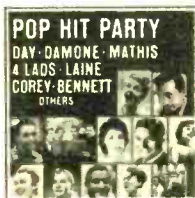

44. A dozen hit tunes — performed by 12 pop artists



18. The intense drama of this work is here fully realized



14. This great show album is the all-time best-seller



11. No Love, I Look at You, Warm and Tender, 12 in all

FOR ONLY **\$3.98**

RETAIL VALUE UP TO **\$29.88**

if you join the Columbia  Record Club now—and agree to purchase only 5 selections during the coming 12 months

- ★ You receive ANY 6 of the 12" high-fidelity long-playing records shown here for only \$3.98
- ★ Your only obligation as a member is to purchase five selections from the more than 100 Columbia and Epic records to be offered in the coming 12 months. Thus, you actually receive eleven records for the price of six—a saving of more than 40% on your record purchases
- ★ After purchasing only five records you receive a 12" Columbia or Epic Bonus record of your choice free for every two additional selections you buy
- ★ You enroll in any one of the four Club Divisions: Classical; Listening and Dancing; Broadway, Movies, Television and Musical Comedies; Jazz

- ★ Each month the Club's staff of musical experts selects outstanding recordings from every field of music . . . music that deserves a place in any well-planned library. These selections are described in the Club Magazine, which you receive free each month
- ★ You may accept or reject the selection for your Division, take any of the other records offered, or take NO record in any particular month
- ★ You may discontinue membership at any time after purchasing five records
- ★ The records you want are mailed and billed to you at the regular list price of \$3.98 (Classical Selections, \$4.98), plus small mailing charge
- ★ Mail the coupon today to receive your six records



26. 4 brilliant works—played by "World's Greatest Orch."



5. The Way You Look Tonight, Where or When, 10 more



21. 13 Jazz Greats perform Honeysuckle Rose, Laura, etc.



20. "Ravishingly performed," High Fidelity Magazine

SEND NO MONEY — Mail coupon to receive 6 records for \$3.98

COLUMBIA  RECORD CLUB, Dept. 271-1

Terre Haute, Indiana

I accept your offer and have indicated at the right the six records I wish to receive for \$3.98, plus small mailing charge. Enroll me in the following Division of the Club:

(check one box only)

- Classical Listening and Dancing Jazz
 Broadway, Movies, Television and Musical Comedies

I agree to purchase five selections from the more than 100 to be offered during the coming 12 months, at regular list price plus small mailing charge. For every two additional selections I accept, I am to receive a 12" Columbia or Epic Bonus record of my choice FREE.

Name.....
 (Please Print)

Address.....

City..... ZONE..... State.....

CANADA: Prices slightly higher, address 11-13 Soho St., Toronto 2B

If you wish to have this membership credited to an established Columbia or Epic record dealer, authorized to accept subscriptions, fill in below:

Dealer's Name.....

Dealer's Address..... 220

CIRCLE 6 NUMBERS:

- | | |
|----|----|
| 1 | 22 |
| 5 | 26 |
| 7 | 27 |
| 10 | 28 |
| 11 | 29 |
| 12 | 30 |
| 13 | 38 |
| 14 | 39 |
| 15 | 44 |
| 16 | 46 |
| 17 | 48 |
| 18 | 49 |
| 19 | 60 |
| 20 | 61 |
| 21 | 62 |

K-43



Electronics in the News

No longer limited to code and the spoken word, now hams can get into television too. From Electron Corp. comes the first amateur band TV transmitter, designed to operate on the 420-450 mc band at the maximum permissible power of 50 watts. With a proper antenna, TV signals can be transmitted 30 to 40 miles. Only video signals are transmitted. Audio contact will be made by the amateur with existing radio transmitting equipment. A complete TV station consisting of a Ling Spectator TV camera, the Ling-Mitter, video monitor, antenna and accessories costs \$2,495.

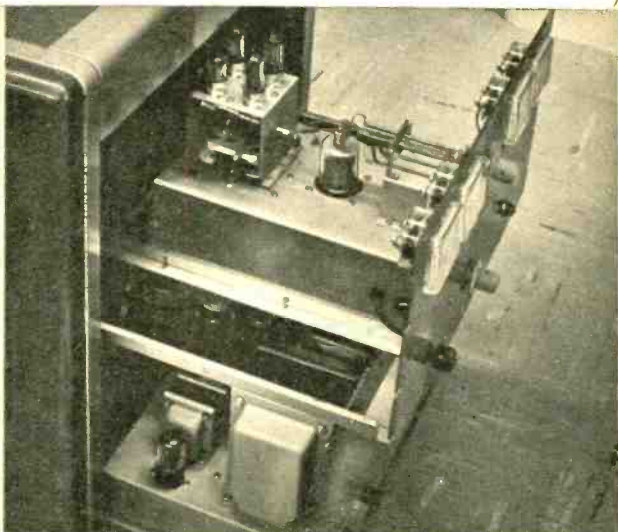

A ham record has been set by a conversation between amateur radio operators 2,000 miles apart, using a transmitter and receiver powered entirely by solar energy. The completely transistorized transmitter operates with an output between 60 and 75 milliwatts. The power supply was a bank of 72 silicon solar cells from Hoffman Electronics Corp.

EDU-KIT 16 RADIO

Reg. U.S.
Pat. Off.

CIRCUITS AT HOME
with the New Deluxe 1959
PROGRESSIVE RADIO "EDU-KIT"®

only
\$22.95



A Practical Home Radio Course

- Now Includes**
- ★ TRANSMITTER
 - ★ SIGNAL TRACER
 - ★ SIGNAL INJECTOR
 - ★ CODE OSCILLATOR
 - ★ No Knowledge of Radio Necessary
 - ★ No Additional Parts or Tools Needed
 - ★ EXCELLENT BACKGROUND FOR TV
 - ★ School Inquiries Invited
 - ★ SOLD IN 79 COUNTRIES

**YOU DON'T HAVE TO SPEND
HUNDREDS OF DOLLARS FOR A RADIO COURSE**

The "Edu-Kit" offers you an outstanding PRACTICAL HOME RADIO COURSE at a rock-bottom price. Our Kit is designed to train Radio & Electronics Technicians, making use of the most modern methods of home training. You will learn radio theory, construction practice and servicing. THIS IS A COMPLETE RADIO COURSE IN EVERY DETAIL. You will learn how to build radios, using regular schematics; how to wire and solder in a professional manner; how to service radios. You will work with the standard type of punched metal chassis as well as the latest development of Printed Circuit chassis.

You will learn the basic principles of radio. You will construct, study and work with RF and AF amplifiers and oscillators, detectors, receivers, test equipment. You will learn and practice code using the Progressive Code Oscillator. You will learn and practice trouble-shooting, using the Progressive Signal Tracer, Progressive Signal Injector, Progressive Dynamic Radio & Electronics Tester and the accompanying instructional material. You will also receive the Signal Tracer and Code Oscillator. You will receive FCC Radio Amateur Licenses. You will build 16 Receiver, Transmitter, Code Oscillator, Signal Tracer and Signal Injector circuits, and learn how to operate them. You will receive an excellent background for Television, Hi-Fi and Electronics.

Absolutely no previous knowledge of radio or science is required. The "Edu-Kit" is the product of many years of teaching and engineering experience. The "Edu-Kit" will provide you with a basic education in Electronics and Radio, worth many times the complete price of \$22.95. The Signal Tracer alone is worth more than the price of the entire Kit.

THE KIT FOR EVERYONE

You do not need the slightest background in radio or science. Whether you are interested in Radio & Electronics because you want an interesting hobby, a well paying business or a job with a future, you will find the "Edu-Kit" a worth-while investment. Many thousands of individuals of all

ages and backgrounds have successfully used the "Edu-Kit" in more than 79 countries of the world. The "Edu-Kit" has been carefully designed, step by step, so that you cannot make a mistake. The "Edu-Kit" allows you to teach yourself at your own rate. No instructor is necessary.

PROGRESSIVE TEACHING METHOD

The Progressive Radio "Edu-Kit" is the foremost educational radio kit in the world, and is universally accepted as the standard in the field of electronics training. The "Edu-Kit" uses the modern educational principle of "Learn by Doing." Therefore you construct, learn schematics, study theory, practice trouble-shooting—all in a closely integrated program designed to provide an easily-learned, thorough and interesting background in radio. You begin by examining various radio parts of the "Edu-Kit." You then learn the function, theory and wiring of these parts. Then you build a simple radio. With this first set you will enjoy listening to regular broadcast stations, learn theory, practice testing and trouble-shooting. Then you build a more advanced radio, learn more advanced theory and techniques. Gradually, in a progressive manner, and at your own rate, you will find yourself constructing more advanced multi-tube radio circuits, and doing work like a Professional Radio Technician.

Included in the "Edu-Kit" course are sixteen Receiver, Transmitter, Code Oscillator, Signal Tracer, and Signal Injector circuits. These are not unprofessional "breadboard" experiments, but genuine radio circuits, constructed by means of professional wiring and soldering in the modern class, plus the new method of radio construction known as "Printed Circuitry." These circuits operate on your regular AC or DC house current.

THE "EDU-KIT" IS COMPLETE

You will receive all parts and instructions necessary to build 16 different radio and electronics circuits, each guaranteed to operate. Our Kits contain tubes, tube sockets, variable, electrolytic, mica, ceramic and paper dielectric condensers, resistors, tie strips, coils, hardware, tubing, punched metal chassis, Instruction Manuals, hook-up wire, solder, etc. In addition you receive Printed Circuit materials, including Printed Circuit chassis, special tube sockets, hardware and instructions. You also receive a useful set of tools, a Professional electric soldering iron, and a self-powered Dynamic Radio & Electronics Tester. The "Edu-Kit" also includes Code instructions and the Progressive Code Oscillator, in addition to F.C.C.-type Questions and Answers for Radio Amateur License training. You will also receive lessons for servicing with the Progressive Signal Tracer and the Progressive Signal Injector, a High Fidelity Guide and a Quiz Book. You receive Membership in Radio-TV Club, Free Consultation Service, Certificate of Merit and Discount Privileges. You receive all parts, tools, instructions, etc. Everything is yours to keep.

UNCONDITIONAL MONEY-BACK GUARANTEE

The Progressive Radio "Edu-Kit" has been sold to many thousands of individuals, schools and organizations, public and private, throughout the world. It is recognized internationally as the ideal radio course. By popular demand, the Progressive Radio "Edu-Kit" is now available in Spanish as well as English.

It is understood and agreed that should the Progressive Radio "Edu-Kit" be returned to Progressive "Edu-Kits" Inc. for any reason whatever, the purchase price will be refunded in full, without quibble or question, and without delay.

The high recognition which Progressive "Edu-Kits" Inc. has earned through its many years of service to the public is due to its unconditional insistence upon the maintenance of perfect engineering, the highest instructional standards, and 100% adherence to its Unconditional Money-Back Guarantee. As a result, we do not have a single dissatisfied customer throughout the entire world.

ORDER DIRECT FROM AD—RECEIVE FREE BONUS RESISTOR AND CONDENSER KITS WORTH \$7

- Send "Edu-Kit" Postpaid. I enclose full payment of \$22.95.
- Send "Edu-Kit" C.O.D. I will pay \$22.95 plus postage.
- Send me FREE additional information describing "Edu-Kit."

Name

Address

PROGRESSIVE "EDU-KITS" INC.
1186 Broadway, Dept. 507AE, Hewlett, N. Y.

FREE EXTRAS

- SET OF TOOLS
- SOLDERING IRON
- ELECTRONICS TESTER
- PLIERS-CUTTERS • ALIGNMENT TOOL
- WRENCH SET
- VALUABLE DISCOUNT CARD
- CERTIFICATE OF MERIT
- TESTER INSTRUCTION MANUAL
- HIGH FIDELITY GUIDE • QUIZZES
- TELEVISION BOOK • RADIO TROUBLE-SHOOTING BOOK
- MEMBERSHIP IN RADIO-TV CLUB: CONSULTATION SERVICE • FCC AMATEUR LICENSE TRAINING
- PRINTED CIRCUITRY

SERVICING LESSONS

You will learn trouble-shooting and servicing in a progressive manner. You will practice repairs on the sets that you construct. You will learn symptoms and causes of troubles in home, portable and car radios. You will receive the unique Signal Tracer, the unique Signal Injector and the Dynamic Radio & Electronics Tester. While you are learning in this practical way, you will be able to do many a repair job for your friends and neighbors, and charge fees which will far exceed the price of the "Edu-Kit." Our Consultation Service will help you with any technical problems you may have.

J. Szalkis, of 25 Poplar Pl., Waterbury, Conn., writes: "I have repaired several sets for my friends, and made money. The "Edu-Kit" paid for itself. I was ready to spend \$240 for a Course, but I found your ad and sent for your Kit."

FROM OUR MAIL BAG

Ben Valerio, P. O. Box 21, Magna, Utah: "The Edu-Kits are wonderful. Have I am sending you the questions and also the answers for them. I have been in Radio for the last seven years, but like to work with Radio Kits, and like to build Radio Testing Equipment. I enjoyed every minute I worked with the different kits; the Signal Tracer works fine. Also like to let you know that I feel proud of becoming a member of your Radio-TV Club."

Robert L. Shuff, 1334 Monroe Ave., Huntington, W. Va.: "Thought I would drop you a few lines to say that I received my Edu-Kit, and was really amazed that such a bargain can be had at such a low price. I have already started repairing radios and phonographs. My friends were really surprised to see me get into the swing of it so quickly. The Trouble-shooting Tester that comes with the Kit is really swell, and finds the trouble, if there is any to be found."

RESIDENT SCHOOL COURSES

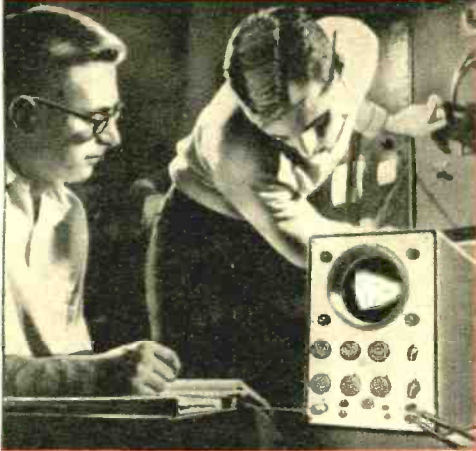

Industry needs Electronic Technicians!

Let RCA train you in Advanced Electronics

This is the college-level training you need to work with professional engineers on research, development or production projects in such fields as: automation, guided missiles, radar, television, computers and other advanced electronic applications.

RCA Institutes Resident School in New York City offers this comprehensive course that prepares you for any field of electronics you may choose. Other courses in TV & General Electronics, Radio & TV Servicing, and Radio Telegraph Operating.

Classes start four times each year. Applications now being accepted. Approved for Veterans.



RCA INSTITUTES, INC.

SCHOOL OF TELEVISION
AND ELECTRONIC TECHNOLOGY

A Service of Radio Corporation of America



RCA INSTITUTES, INC., DEPT. EIR-19
350 W. Fourth St., N. Y. 14, N. Y.

Please send me your FREE catalog of
Resident School courses in New York.

NAME please print

ADDRESS

CITY ZONE STATE

HOME STUDY COURSES

course I

Electronic Fundamentals



course II

Television Servicing

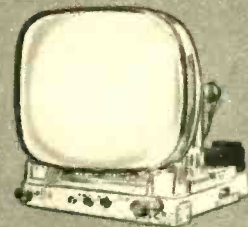

course III

Color Television

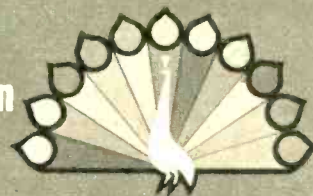

RCA Institutes offers you the finest of Home Study training. The equipment illustrated and text material you get with each course is yours to keep. Practical work with very first lesson. Courses for the beginner and the advanced student. Pay-as-you-learn. You need pay for only one study group at a time.

Send for Our
Complete Catalog **FREE**



RCA INSTITUTES proudly announces a new home study course... ELECTRONICS for AUTOMATION

Nucleonics, Photoelectronics, Digital Techniques, Synchros and Servomechanisms, Data Recorders, Automatic Process Controllers, Telemetry and Remote Control, Ultrasonics, and Automatic Control Systems . . . these are just a few of the many Industrial Electronics subjects covered in the new Electronics for Automation course.

RCA Institutes — now celebrating 50 years of electronic training — adds this new home study course to prepare you for a career as an electronic technician. Pay-as-you-learn. You need pay for only one study group at a time.



RCA INSTITUTES, INC., Home Study School EI-19

A Service of Radio Corporation of America • 350 West Fourth Street, New York 14, N. Y.

Without obligation, send me the FREE catalog of Home Study Courses. No salesman will call.

NAME.....
PLEASE PRINT

ADDRESS.....

CITY..... ZONE..... STATE.....

Korean Vets! Enter discharge date.....

CANADIANS Take advantage of these same RCA Courses at no additional cost. No postage, no customs, no delay. Send coupon to:

RCA VICTOR COMPANY, LTD. • 5001 Cote de Liesse Rd., Montreal 9, Que.

TO SAVE TIME, PASTE COUPON ON POSTCARD.



The Lockheed-built Kingfisher target missile can "impersonate" a supersonic enemy bomber many times its own size, with a ball-shaped lens that projects an enlarged phantom radar image. During

recent tests, it was this image, which the Army's Talos missile intercepted, rather than the actual Kingfisher.

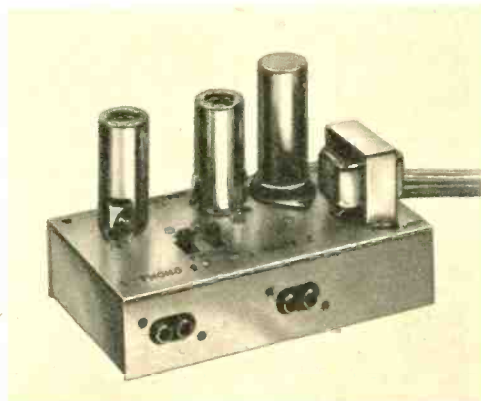

From General Electric comes a stereo hi-fi preamplifier, the Stereo Classic, featuring individual switching for each channel to select phono or tape input. With a minor circuit modification it may be used as a monaural or stereo tape recorder microphone preamp. \$24.95.

NOW YOU CAN SECURE A HIGH SALARIED • TOP PRESTIGE CAREER IN ELECTRONICS IN ONLY ONE YEAR!

ELECTRONICS is the fastest growing industry in America today, creating unlimited opportunities for high salaries, with rapid advancement in **INDUSTRY AND THE ARMED FORCES** for Bailey Trained electronic engineering technicians.

LARGE CORPORATIONS from coast to coast, and **BRANCHES OF THE ARMED FORCES** send recruiters to visit each graduating class at Bailey Tech, offering unusually high starting salaries.

BAILEY GRADUATES ARE BEING HIRED for such fascinating and interesting work as technical salesmen, research and development of guided missiles, electronic business machines and automatically controlled manufacturing plants, etc., also good **RATINGS IN THE ARMED FORCES.**

UP TO SEVEN TECHNICIANS are needed for every engineer... this, plus superior training is why Bailey Graduates are being paid more to start, and are advancing more rapidly than many men who have spent four years in training.

Resident training is easier and costs less than you may think! We provide housing and part-time jobs while in school, plus free nationwide employment service for graduates. If you want to quickly enter America's fastest growing and most exciting industry, write for free booklet... no obligation.

VETERAN APPROVED
BAILEY TECHNICAL SCHOOLS
1625a S. Grand • St. Louis 4, Mo.



This Minneapolis-Honeywell system controls hundreds of automatic manufacturing operations. Experience on live equipment is emphasized at Bailey and is another reason for the tremendous backlog of high pay positions waiting **BAILEY GRADUATES.**

MAIL TODAY

Please mail immediately this free booklet without obligation

Name _____
Address _____
City _____ State _____



Get into

TELEVISION RADIO-ELECTRONICS



LEARN ALL 8 PHASES OF THE INDUSTRY BY SHOP METHOD HOME TRAINING

1. Television . . . including Color TV
2. Radio . . . AM, FM
3. Industrial Electronics
4. Communications
5. Sound Recording & Hi-Fidelity
6. Automation
7. FCC License Preparation
8. Radar & Micro Waves

Let National Schools of Los Angeles, a Practical Resident Technical School for over 50 years, train you at home by Shop Method for unlimited opportunities in All phases of TV, Electronics, Radio.

You get 19 big kits of equipment!

GOOD JOBS . . . MORE MONEY SECURITY . . . ALL CAN BE YOURS

YOU are needed in the great modern Television-Electronics industry. Trained technicians are in growing demand, at excellent pay, in sales and service, manufacturing, broadcasting, telecasting, communications, research, and many other important branches of the field. National Schools Master Shop-Method Training, with newly added lessons and equipment prepares you in your spare time right in your own home for these fascinating opportunities. **OUR OUTSTANDING METHOD IS PROVED BY THE SUCCESS OF GRADUATES ALL OVER THE WORLD!**

YOUR TRAINING IS ALL INCLUSIVE

We prepare you for a long list of job opportunities. Thousands of TV and Radio receivers are being sold every day—more than ever before. And, now, Color TV is here. Applications of Electronics in industry—**AUTOMATION**—are growing in tremendous strides. The whole field is alive—opening up new, important jobs rapidly. National Schools complete training program qualifies you in all phases of the industry.

YOU EARN WHILE YOU LEARN

Many students pay for their entire training—and more—with spare time earning. We'll show you how you can, too! Early in your course you receive material that shows you how to earn extra money servicing TV and Radio receivers, appliances, etc., for friends and acquaintances.

YOU GET EVERYTHING YOU NEED

Clear, profusely illustrated lessons, shop-tested manuals, modern circuit diagrams, practical job projects—all the valuable equipment shown above—many other materials and services—consultation privilege with our qualified staff, and Graduate Employment Service. **EVERYTHING YOU NEED** for outstanding success in Electronics.

INDUSTRY NEEDS YOU. NATIONAL SCHOOLS WILL TRAIN YOU. SEND FOR FACTS TODAY NO OBLIGATION.

YOU LEARN BY SHOP METHOD . . . you do servicing, circuit analysis, and do over 100 down-to-earth experiments. You build a Superhet Receiver and a modern TV Receiver, from the ground up, including a new, big screen picture tube. You also receive a professional, factory-made **MULTI-TESTER**. All of this standard equipment is yours to keep . . . at just one low tuition.

RESIDENT TRAINING AT LOS ANGELES

If you wish to take your training in our Resident School at Los Angeles, the world's TV capital, start NOW in our big, modern Shops, Labs and Radio-TV Studios. Here you work with latest Electronic equipment—professionally installed—finest, most complete facilities offered by any school. Expert, friendly instructors. Personal attention. Graduate Employment Service. Help in finding home near school—and part time job while you learn. Check box in coupon for full information.

Approved for GI Training

NATIONAL SCHOOLS
LOS ANGELES 37, CALIF.

FREE!
VALUABLE BOOK & SAMPLE LESSON
—Just Send Coupon!



NATIONAL SCHOOLS
TECHNICAL TRADE TRAINING SINCE 1905
LOS ANGELES 37, CALIFORNIA

GET FAST SERVICE—MAIL NOW TO
NATIONAL SCHOOLS, DEPT. R4Y-128
4000 S. FIGUEROA ST. LOS ANGELES 37, CALIF.

Rush free TV-Radio "Opportunity" Book and sample lesson. No salesman will call.

NAME _____ AGE _____
ADDRESS _____
CITY _____ ZONE _____ STATE _____

Check if interested ONLY in Resident School training at Los Angeles.
VETERANS: Give date of Discharge _____

Free!

ALLIED'S

MONEY-
SAVING 1959

ELECTRONIC SUPPLY CATALOG

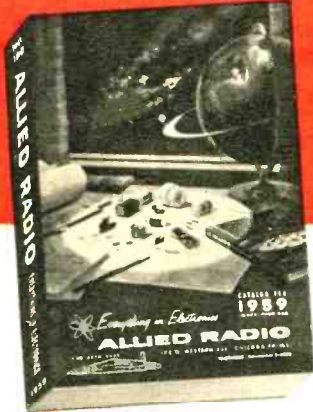

452

value-packed
pages

send for it!

SAVE

ON EVERYTHING
IN ELECTRONICS

EASY TERMS
AVAILABLE

WORLD'S LARGEST STOCKS

Here is the complete guide to everything in Electronics for Experimenters, Builders, Amateurs, Servicemen, Engineers and Hi-Fi enthusiasts:

- Amazing Build-Your-Own KNIGHT-KITS
- Everything in STEREO Hi-Fi
- Hi-Fi Music Systems & Components
- Recorders & Phono Equipment
- Public Address & Paging Systems
- TV Tubes, Antennas, Accessories
- Amateur Station Equipment
- Latest Test & Lab Instruments
- Industrial Electronic Supplies
- Parts, Tubes, Transistors, Tools & Books

SAVE on everything in Electronics at ALLIED—get fast, dependable service, expert personal help, guaranteed satisfaction. Send today for your FREE 1959 ALLIED Catalog.

Everything in Electronics
From One Reliable Source

Send for
FREE
Catalog

OUR 38th YEAR

ALLIED RADIO

ALLIED RADIO, CORP., Dept. 86-A9
100 N. Western Ave., Chicago 80, Ill.

Rush FREE 1959 ALLIED 452-Page Catalog

Name _____

Address _____

City _____ Zone _____ State _____

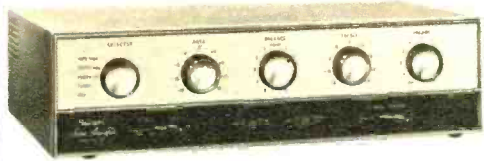

Allied Radio Corp. has released the Knight Stereo Ensemble, consisting of the KN-734 Deluxe 34-Watt Stereo Amplifier and the KN-120 Deluxe Stereo Basic FM-AM Tuner. Only two hi-fi speakers need be added for 3-dimensional reception. In addition, there is complete provision to accommodate stereo records and tapes. The amplifier, which may be used for stereo delivering 17 watts from each of its two sections, or monaurally as a 34-watt amplifier, features a low-impedance output jack for binaural headphone use and dual tone controls to provide independent setting for each of the two stereo speakers. Additional features include adjustable input load for magnetic cartridges; DC current on preamplifier heater filaments; loudness control; and rumble and scratch filters.

The KN-120 tuner features dynamic sideband regulation, a novel circuit which controls incoming FM signals and reduces distortion caused by weak or overmodulated broadcast signals. Other features are an extra long illuminated 9½" tuning scale, two new-type EM84 cathode ray tuning indicators, dual flywheels and individual factory sweep alignment. Sensitivity is 2.5 microvolts for 20 db quieting on FM, and 5 microvolts for a 20 db signal-to-noise ratio on AM.

The Knight Stereo Ensemble is in beige vinyl plastic, bonded to metal cases, with contrasting gold and smoky beige panels of solid extruded aluminum. It may be placed on tabletops, bookshelves, etc. \$244.

—O—

**WE'RE MAKING IT EASIER THAN EVER TO BECOME A WELL PAID
RADIO-TELEVISION SERVICE TECHNICIAN**

**NOW - Just \$6 Starts You Training in
RADIO-TELEVISION**

the SPRAYBERRY "Learn-by-Doing" Way . . .

**25 BIG, COMPLETE KITS
of PARTS & EQUIPMENT**

To help you learn fast the practical side of Radio-Television, we send you expertly engineered training kits to test and assemble for interesting, valuable shop-bench practice!

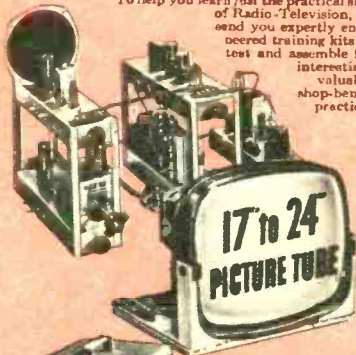

- The new Sprayberry Training Television Receiver, built and tested in 5 sections.
- Now offered . . . this fine modern oscilloscope.
- You build this powerful two-band superheterodyne radio receiver.

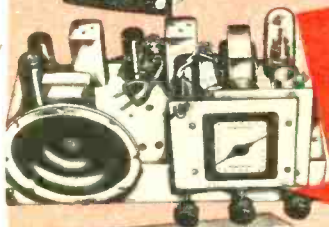

**Big New
CATALOG
AND
Sample Lesson
FREE!**



You build the new Sprayberry tester—a complete 18-range Volt-Ohm-Milliammeter test meter.

*** This great industry is begging for trained men . . . to step into good paying jobs or a profitable business of their own! Our new plan opens the doors of Radio-Television wide to every ambitious man who is ready to act at once!

Men by the thousands . . . trained Radio-Television Service Technicians . . . are needed at once! Perhaps you've thought about entering this interesting, top paying field, but lack of ready money held you back. Now—just \$6 enrolls you for America's finest, most up to date home study training in Radio-Television! Unbelievable? No, the explanation is simple! We believe Radio-Television *must* have the additional men it needs as quickly as possible. We are willing to do our part by making Sprayberry Training available for less money down and on easier terms than ever before. This is your big opportunity to get the training you need . . . to step into a fine job or your own Radio-Television Service Business.

Complete Facts Free—Act Now; Offer Limited

Only a limited number of students may be accepted on this liberal and unusual basis. We urge you to act at once . . . mail the coupon below and get complete details plus our big new catalog and an actual sample lesson—all free. No obligation . . . no salesman will bother you.

HOME STUDY TRAINING IN SPARE TIME

Under world-famous 27-year old Sprayberry Plan, you learn entirely at home in spare time. You keep on with your present job and income. You train as fast or as slowly as you wish. You get valuable kits of parts and equipment for priceless shop-bench practice. And everything you receive, lessons and equipment alike, is all yours to keep.

LET US PROVE HOW EASILY YOU CAN LEARN!

Radio-Television needs YOU! And Sprayberry is ready to train you on better, easier terms, that any ambitious man can afford. Just \$6 starts you! Mail coupon today . . . let the facts speak for themselves. You have everything to gain. Let us prove the kind of opportunity in store for you!

SPRAYBERRY Academy of Radio-Television
1512 Jarvis Avenue, Dept. 120-Q, Chicago 26, Illinois

Mail This Coupon Now—No Salesman Will Call

Sprayberry Academy of Radio-Television
Dept. 120-Q, 1512 W. Jarvis Ave., Chicago 26, Ill.

Please rush all information on your ALL-NEW Radio-Television Training Plan. I understand this does not obligate me and that no salesman will call upon me. Include New Catalog and Sample Lesson FREE.

NAME Age.....

ADDRESS.....

CITY ZONE STATE.....



Get
Your First Class Commercial
F.C.C. LICENSE
in
12 Weeks

F.C.C. LICENSE — THE KEY TO BETTER JOBS — An F.C.C. commercial (not amateur) license is your ticket to higher pay and more interesting employment. This license is Federal Government evidence of your qualifications in electronics. Employers are eager to hire licensed technicians.

GRANTHAM TRAINING PREPARES YOU — Grantham School of Electronics specializes in preparing students to pass F.C.C. examinations. Training is available either by correspondence or in resident classes—NO previous training required. A beginner may qualify for his first class F.C.C. license in as little as 12 weeks.

THREE COMPLETE SCHOOLS: To better serve our many students throughout the entire country, Grantham School of Electronics maintains three complete schools—one in Washington, D. C., one in Hollywood, Calif., and one in Seattle, Wash. All schools offer the same rapid courses in FCC license preparation, either home study or resident classes.

MAIL COUPON FOR FREE BOOKLET: Our free booklet, *Careers in Electronics*, gives details of how you can prepare quickly for your FCC license. For your free copy of this booklet, clip the coupon below and mail it to the Grantham School nearest you.

WASHINGTON D.C. Grantham School of Electronics
821-19th Street, N. W.
Washington 6, D. C.

HOLLYWOOD CALIF. Grantham School of Electronics
1505 N. Western Avenue
Hollywood 27, California

SEATTLE WASH. Grantham School of Electronics
408 Marion Street
Seattle, Washington

(Mail in envelope or paste on postal card)

To: **GRANTHAM SCHOOL OF ELECTRONICS**
Desk 98-A • Washington • Hollywood • Seattle

Gentlemen:

Please send me your free booklet telling how I can get my commercial F.C.C. license quickly. I understand there is no obligation and no salesman will call.

Name Age

Address

City State

I am interested in: Home Study, Resident Classes

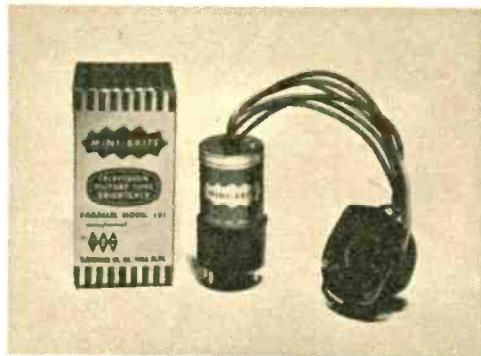

The Mini-Brite, a new TV picture tube brightener, has been introduced by CBC Electronics Co. Model 101 for parallel use and Model 102 for series sets are designed to restore brilliance to any duo-decal picture tube for several years. The units are easy to install and require no soldering.



An aural reading machine with which blind persons can read ordinary books and magazines, is being developed under the Veterans Administration. A probe on the portable machine contains two tiny lights and a lens which projects an image of the printed letter upon a row of photocells. Each photocell, when it "sees" black, turns on a transistorized oscillator in the chassis which generates a specific pitch proportional to the heights of the black part of the letter "seen." These pitches are translated to sound patterns by earphones. By interpreting these tones, trained users should attain a reading speed of up to 30 words per minute.

**AT
LAST!**

RADIO-TV and ELECTRONICS TRAINING

**... AT A PRICE
YOU CAN AFFORD!**



***21 INCH**
Receiver Kit included

Yes, this great course costs far less than any training of its kind given by other major schools! Radio-Television Training School will train you for a good job in Television or Industrial Electronics — **AT HOME IN YOUR SPARE TIME.**

Think of it — a complete training program including over 120 lessons, Eleven Big Radio-Television Kits, Complete Color-TV Instruction, Unlimited Consultation Service... **ALL at a really big saving to you.** How can we do this? Write to us today... and find out!

And what's more — you can (if you wish) **OPEN YOUR OWN RTS-APPROVED AND FINANCED RADIO-TV SERVICE SHOP**
We Want 100 More Shops This Year

This 37 year old training organization — called RTS, that's Radio-Television Training School — wants to establish a string of Radio-TV Repair Shops in principal cities throughout the U. S. So far, 36 such shops are **NOW IN BUSINESS AND PROSPERING.** We are signing contracts with ambitious men to become future owners and operators of these shops in all areas.

**FOR UNSKILLED
INEXPERIENCED MEN ONLY —
WE TRAIN YOU OUR WAY!**

We must insist that the men we sign up be trained in Radio-TV Repair, Merchandising and Sales by our training methods—because **WE KNOW** the requirements of the industry. Therefore, we will **TRAIN YOU**... we will show you how to earn **EXTRA CASH**, during the first month or two of your training period. **YOU KEEP YOUR PRESENT JOB.** TRAINING TAKES PLACE IN YOUR OWN HOME, IN YOUR SPARE TIME!



Get your free book on the **FAMOUS RTS BUSINESS PLAN**
find out how you can open
A REPAIR SHOP OF YOUR OWN

We supply and finance your equipment

When you are ready and qualified to operate one of our RTS-Approved TV Repair Shops **WE WILL SUPPLY AND FINANCE EVERY BIT OF EQUIPMENT YOU NEED TO GET STARTED** plus an inventory of parts and supplies. In other words: we will stake you **AN OFFER NEVER MADE BEFORE BY ANY TRAINING ORGANIZATION.** Under the RTS Business Plan you receive:

1. An electric sign for the shop front.
2. Complete laboratory of test equipment.
3. Letterheads, calling cards, repair tickets, etc.
4. Basic inventory of tubes, parts, supplies.
5. Complete advertising and promotional material.
6. Plans for shop arrangement.
7. Instructions on how to go into business.
8. Continuous consultation and help.
9. The right to use RTS Seal of Approval, and the RTS Creed.
10. The right to use the Famous Trade Mark.

*you build
all these units*

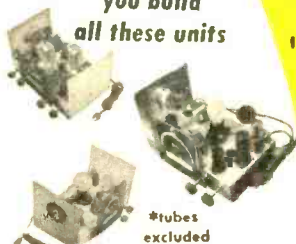

*tubes excluded

**RADIO-TELEVISION
TRAINING SCHOOL**
5100 S. VERMONT AVENUE
LOS ANGELES 37, CALIFORNIA

Est. 1922



**ACT
NOW!**

CUT OUT AND MAIL — TODAY!

RADIO-TELEVISION TRAINING SCHOOL

5100 S. Vermont Avenue, Dept. E1-19
Los Angeles 37, California

SEND ME FREE — all of these big opportunity books — "Good Jobs in TV-Electronics," "A Repair Shop of Your Own" and "Sample Lesson." I am interested in:

Radio-Television Industrial Electronics (Automation)

Name _____ Age _____

Address _____

City & State _____

300



RTS' Membership in The Association of Home Study Schools is your assurance of Reliability, Integrity, and Quality of Training.





college graduates get ahead faster!

... have higher income ... advance more rapidly. Grasp your chance for a better life. Share rewards awaiting college men. Important firms visit campus regularly to employ Tri-State College graduates. Start any quarter. Approved for Vets.

Bachelor of Science Degree in 27 months

Electrical Engineering with either an Electronics or Power major. Also Mechanical, Civil, Chemical, Aeronautical Engineering. In 36 months a B. S. in Business Administration (General Business, Accounting, Motor Transport Management Majors). Superior students faster. More professional class hours. Small classes. Enrollment limited. Beautiful campus. Well-equipped labs. Prep courses. Mature students. Modest costs. Enter March, June, September, January. Mail coupon now to Jean McCarthy, Director of Admissions, for Catalog, View Book and book "Your Career in Engineering and Commerce."



TRI-STATE COLLEGE

4819 College Avenue, Angola, Indiana

Please send me your catalog with full information on Radio Engineering and other courses. I am especially interested in courses checked:

- Electrical Engineering (Radio, TV, Electronics option)
 Electrical Engineering (Power option) Chemical
 Civil Mechanical General Business
 Accounting Motor Transport Management Drafting

Name

Street Address

City Zone State

INVENTORS

Learn how to protect your invention. The U. S. patent laws were enacted for the benefit of the inventor to give him protection for the features of his invention which are patentable.

Unless the inventor is familiar with patent matters, he should engage a competent registered patent attorney or agent to represent him. We are registered to practice before the U. S. Patent Office and are prepared to serve you in the handling of your patent matters.

A specially prepared booklet entitled "Patent Guide for the Inventor," containing detailed information with respect to patent protection and procedure, together with a "Record of Invention" form, will be promptly forwarded to you without obligation upon request.

CLARENCE A. O'BRIEN & HARVEY JACOBSON

Registered Patent Attorneys

910-A DISTRICT NATIONAL BUILDING
WASHINGTON 5, D. C.

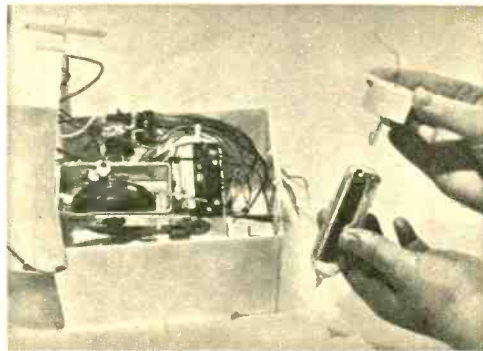

This tiny vacuum bottle, developed by General Instrument Corp. is the key to discovering secrets of weather 15 to 25 miles above ballistic missile launching sites. The hyposometer provides extremely accurate barometric measurements when sent up in a balloon. The fish-hook-like thermistor in the cap of the flask, takes continuous readings of temperatures of vapor inside the flask and sends them to the radiosonde's electronic circuitry, which translates them into radio signals for transmission to ground stations. Instrumentation of the radiosonde includes sensing elements to measure humidity and air temperature, and a metal bellows to record atmospheric pressure.

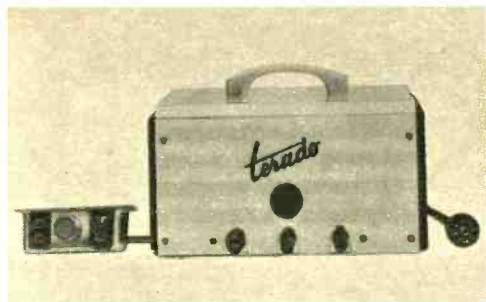

This Terado Trav-Electric Supreme converter transforms 12 volt battery current to 110 volts AC with a capacity of 200 watts. On this, tape recorders, portable TV, phonographs, dictation machines, radios and other electrical devices can be operated. Complete with remote control for under automobile dashboard installation, the Supreme has an AC outlet, 5-position switch and indicator light.



see what's new in electronic kits... see the outstanding 1959 **knight®-kits**

AN ALLIED RADIO PRODUCT



featured in **ALLIED'S**
1959 CATALOG

free! send for it

SEE TYPICAL **knight-kit** VALUES LIKE THESE



There's a **knight-kit** for every need

- LOWEST COST • EASIEST TO BUILD
- LATEST DESIGN • FINEST QUALITY

Do-It-Yourself: **SAVE UP TO 50%**



knight-kit Stereo Adapter Control Kit
Y-776 \$9⁹⁵



knight-kit Stereo Deluxe Preamp Kit
Y-776 \$62⁵⁰



knight-kit "Space Spanner" 2-Band Receiver Kit
Y-259 \$18⁹⁵

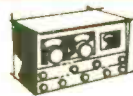

knight-kit Amateur Communications Receiver Kit
Y-726 \$104⁵⁰



knight-kit Dual 30-Watt Stereo Hi-Fi Amplifier Kit
Y-777 \$84⁵⁰ (less case)



knight-kit 12-Watt Hi-Fi Amplifier Kit
Y-784 \$19⁹⁵ (less case)



knight-kit "Ranger III" AC-DC Radio Kit
Y-736 \$16⁹⁵



knight-kit "400" Tube Checker Kit
Y-707 \$19⁹⁵



knight-kit "Span-Master" 4-Band Receiver Kit
Y-258 \$24⁹⁵



knight-kit "Ranger" Clock-Radio Kit
Y-737 \$24⁹⁵



knight-kit "Ranger" Radio-Intercom Kit
Y-739 \$27⁵⁰



knight-kit 12-In-1 Electronic Lab Kit
Y-272 \$14⁹⁵

Plus DOZENS OF OTHER **BEST BUY** knight-kits

EASY TERMS AVAILABLE
on orders of \$20 or more, only 10% down

HI-FI KITS

- 18-Watt Amplifier
- 25-Watt Basic Amplifier
- 30-Watt Amplifier
- FM-AM Tuner
- FM Tuner
- Hi-Fi Preamplifier
- 2-Way Speaker Systems
- 3-Way Speaker Systems

HOBBY KITS

- Printed Circuit Radio

"Ocean-Hopper" Radio

- 5-Transistor Portable
- 2-Transistor Pocket Radio
- Transistor Lab Kit
- 1-Transistor Radio
- 2-Way Intercom
- Wireless Broadcaster
- Photoelectronic System
- Electronic Photoflash
- Crystal Set

INSTRUMENT KITS

- 5" Oscilloscopes
- VTVM
- Tube Testers
- VOM's
- RF Signal Generator
- Signal Tracer
- Audio Generator
- Sweep Generator
- R/C Sub Boxes
- Capacitor Checker

R/C Tester

- Transistor Checker
- Flyback Checker
- Battery Eliminator
- Voltage Calibrator
- AMATEUR KITS**
- 50-Watt Transmitter
- Self-Powered VFO
- 100 kc Crystal Calibrator
- RF "Z" Bridge
- Code Practice Oscillator

FREE

452-PAGE 1959 ALLIED CATALOG

Send for this value-packed catalog featuring the complete KNIGHT-KIT line, as well as the world's largest stocks of *everything* in Electronics. You'll want this money-saving Buying Guide.

WRITE FOR YOUR FREE COPY TODAY!



ALLIED RADIO

ALLIED RADIO CORP., Dept. 133-A9,
100 N. Western Ave., Chicago 80, Ill.

Send FREE 1959 ALLIED 452-Page Catalog

Name _____

Address _____

City _____ Zone _____ State _____

FAST WAY TO TOP PAY

Train Yourself To Level Of ENGINEERING TECHNICIAN

with Radio College of Canada

Nowhere is there a greater need for skilled men than in the fabulously expanding field of electronics. And, it's easy to get started fast toward the high-paying jobs that are open in radar, microwave, television, aviation electronics. Enrol now in R.C.C.'s **ELECTRONIC COMMUNICATIONS** course . . . home study, day or night. No previous experience needed.

Radio College, now in its 30th successful year, has the facilities and the staff to give you the know-how it takes. Hundreds of graduates now employed in dozens of firms and Government agencies—some earning as much as \$10,000 a year within 2 years of graduating.

Act now . . . don't delay your future in electronics another day. Write stating age, education.

RADIO COLLEGE OF CANADA

write to

86 Bathurst St.,
Toronto, Canada

or

P.O. Box 164,
North Wales, Pa., U.S.A.

ELECTRONIC COMPUTERS



**OWN YOUR OWN COMPUTER!!!
SEND NO MONEY.**

Solve advanced mathematics with the "Microlog", a complete ready-built analog computer. Can add, subtract, divide, solve algebra, calculus and advanced equations.

Perfect for college students and engineers. For **FREE** information on "Microlog" check MIC-2A.

Three in over thirty home courses, kits and plans in computers, automation, robots and electronics listed below!!!

C-14 Computer Master: 50 lessons in circuits, design and operation. Diploma received upon completion of course.

C-6R Electronic Analog Computers: 15 lessons in circuits, design and operation. Diploma received upon completion of course.

TR-1 Digital Computer Kit: This kit is completely transistorized. Work 100 interesting projects. You receive transistors, sensitive meter, instruction manual, all parts and full set of plans.

For **FREE** information on courses, kits and plans on computers, automation, robots and electronics, check 6-A.

EBEX TECHNICAL INSTITUTE

Division of Electronic Brain Enterprises
1015 Atkin Ave., Salt Lake City 6, Utah

MIC-2A

6-A

Name

Street

City

send for your free catalog today

E1-4



A truly automatic still camera is the Infallible by Bell and Howell. A photocell or electric eye computes the light reading, sets the lens opening and requires no focusing. A solenium plate photocell converts solar or light energy to an electric current which sets the lens opening. After passing through a resistor and thermistor to compensate for temperature variations, the current activates a meter which opens or closes the iris blades or the lens aperture. Housed in aluminum, the camera retails for \$79.95, which includes a flash gun.

—○—
Peninsula TV and Radio Supply, 656 S. First St., San Jose 10, Calif., has released its first general catalog: 240 pages listing electronic components and equipment for industrial, service, hi-fi and commercial sound applications.

—○—
RCA has installed a closed circuit TV system for briefing jet pilots at the Sioux City Air Base in Iowa, thus linking the alert hangar with the weather station, two miles away.

—○—
A new radar set, developed by Bendix Aviation Corp., now makes sharp, TV-like scope images possible even in strong sunlight. The Bright-Line Daylight Radar Indicator will be used in Air Force troop-cargo aircraft and jet tankers, eliminating the need for light-proof hoods over radar screens.

The experts say...
in HI-FI and TEST
INSTRUMENTS your best
buy is **EICO**



33-00 Northern Blvd., L.I.C. 1, N. Y. EI-1

Show me HOW TO SAVE 50% on 63 models of top-quality equipment (in box I have checked here:)

HI-FI TEST INSTRUMENTS HAM GEAR
Send FREE literature & name of neighborhood EICO dealer.

Name.....

Address.....

City.....Zone.....State.....

Add 5% in the West.



New!
Miniaturized
MULTI-SIGNAL
TRACER #145A
KIT \$19.95
WIRED \$28.95



New!
1000 OHMS/VOLT
V-O-M #536
KIT \$12.90
WIRED \$14.90



New!
Series/Parallel
R-C COMBINATION
BOX #1140
KIT \$13.95
WIRED \$19.95
1350 Combinations!



VACUUM TUBE
VOLTMETER #221
KIT \$25.95
WIRED \$39.95



5" PUSH-PULL
SCOPE #425
KIT \$44.95
WIRED \$79.95
Lowest-priced
professional Scope

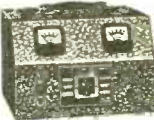

6V & 12V BATTERY
ELIMINATOR
& CHARGER #1050
KIT \$29.95
WIRED \$38.95
Extra-filtered for
transistor equipmt.
#1060 KIT \$38.95 WIRED \$47.95



PEAK-TO-PEAK
VTVM #232
& UNI-PROBE
(pat. pend.)
KIT \$29.95
WIRED \$49.95

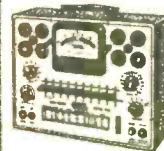

TUBE TESTER #625
KIT \$34.95
WIRED \$49.95

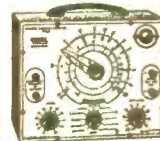

R-C BRIDGE & R-C-L
COMPARATOR #950B
KIT \$19.95
WIRED \$29.95

IN TEST INSTRUMENTS
IN HI-FI... STEREO and MONAURAL



New!
STEREO DUAL
AMPLIFIER-PREAMPLIFIER HF81
Including cover:
KIT \$69.95. WIRED \$109.95
STEREO DUAL PREAMPLIFIER HF85
KIT \$39.95, WIRED \$64.95



MASTER CONTROL
PREAMPLIFIER HF65A:
KIT \$29.95 WIRED \$44.95
with power supply HF65:
KIT 33.95 WIRED \$49.95 Superb
new design . . . new "low sil-
houette" look.



FM TUNER
HFT90
KIT, less cover \$39.95*
WIRED, less cover \$65.95*
COVER. \$3.95 *FET Incl.
"Drift absolutely absent; audio
quality excellent."
— Electronics Illustrated



60-WATT
ULTRA LINEAR
POWER AMPLIFIER HF60
with ACRO TO-330 Output Xfmr
KIT \$72.95 WIRED \$99.95 "excellent
buy" — Marshall, AUDIOCRAFT.

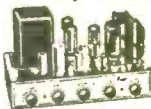

50-WATT
ULTRA-LINEAR
INTEGRATED
AMPLIFIER HF52
KIT \$69.95 WIRED \$109.95
"Excellent value"—Hirsch-Houck Labs.



20-WATT
ULTRA-LINEAR
WILLIAMSON-TYPE
INTEGRATED AMPLIFIER HF20
KIT \$49.95 WIRED \$79.95
"Well-engineered"
— Stocklin, RADIO TV NEWS



12-WATT
WILLIAMSON-TYPE
INTEGRATED AMPLIFIER HF12
KIT \$34.95 WIRED \$57.95
"Packs a wallop"—POPULAR ELECTRONICS
"First rate"—MODERN HI-FI



2-WAY
SPEAKER
SYSTEM HFS1
complete with
factory-built cabinet:
\$39.95



STANDARD SPEAKER
SYSTEM HFS2:
Completely factory-built
\$139.95 "Unusual
suitability for stereo
. . . eminently musical!"
— Holt. HIGH FIDELITY
"Fine for Stereo"—
MODERN HI-FI.

Copyright 1958 by Electronic Instr. Co., Inc.

IN STOCK! Compare, take them home—right "off the shelf"—from 1900 neighborhood EICO dealers. Over 1 MILLION EICO instruments in use throughout the world.

INVENTORS

WE recommend that you take the following preliminary steps toward patent protection. Make a disclosure of your invention; sign, date and have your disclosure witnessed by two people who understand your invention; authorize us to conduct a preliminary search among previously granted U. S. patents for similar types of invention. We give you a report on the probable patentability of your invention and our recommendation for further course of action.

Let us send you a copy of our instructive booklet, "Patent Protection for Inventors" and our convenient "Evidence of Invention" disclosure form. No obligation.

VICTOR J.
EVANS & Co. *Merlin M. Evans*
REGISTERED PATENT ATTORNEY
555-A MERLIN BUILDING, WASHINGTON 6, D. C.

DEPENDABLE TV-RADIO TUBES



ZALYTRON Tubes for TV-Radio Servicemen, Dealers, Experimenters.

Nationally sold ZALYTRON Tubes are BRAND NEW Quality Tubes, priced low to help you meet competition in your area — and guaranteed to perform as well and as long as tubes much higher priced. Why pay more? Try them once, you'll buy them always. Every Tube we ship is covered by our Full Refund Guarantee . . . YOU be the judge! Send today for new Price List "E1"

1-YEAR GUARANTEE

BE YOUR OWN BOSS RUN A SELF-SERVICE TUBE BUSINESS Get This Modern Sturdy Tube Tester **FREE**

with "Package Deal" order for nationally sold ZALYTRON Quality Brand Receiving Tubes. We'll show you how to start a successful Tube Tester Route, and get YOUR share of today's Big Profits in Self-Service Tube Sales! This is no "Get-Rich-Quick" scheme but a solid, proven business that will reward you well — if you WORK at it. But, INVESTIGATE before you INVEST! Get full details on the best "Deal" now being offered, send today for our booklet "I"



ZALYTRON TUBE CORPORATION
220 West 42nd St., N. Y. 36, N. Y.



A simple item from Audio Devices may prove a great boon to tape recording fans. The Echoraser removes print-through from magnetic tapes by means of a small upright chromium-plated energized bar which fits over a 3/4" base plate permanently installed on the tape deck. The moving tape passes in front of this small permanent magnet. One

eraser removes up to 9 db print-through, the second as much as 18 db. \$12.50.

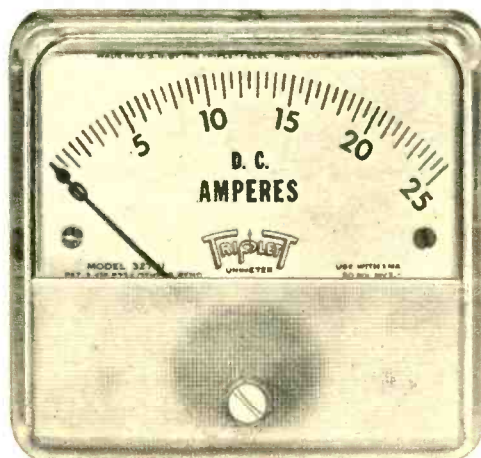

Triplet Electrical Instrument Co. has devised a low-cost method of combining any number of dial component sections with a separate basic movement section. Besides permitting a more flexible inventory, the assembly process itself requires only five or six seconds.

Opportunities in Electronics

- Radar
- Guided Missiles
- Broadcasting
- Aeronautical Electronics
- Computers
- Automation
- Industrial Electronics
- Home Electronics

Are you interested in learning how you can have a profitable career in any or all of the above fields?

Find out how modern technical training and a Government License (FCC) can lead to profitable employment in any branch of electronics.

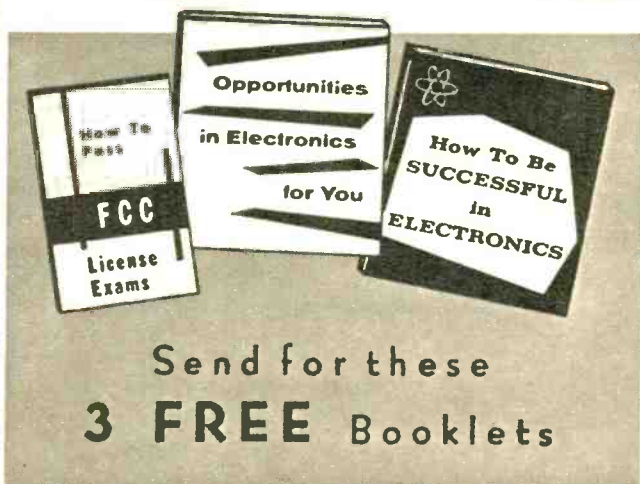

Send for these
3 FREE Booklets

Thousands of interesting well-paid jobs in electronics must be filled. To fill such jobs, you need sound technical training. An FCC license is convincing proof of technical skill. Send for the three Cleveland Institute booklets offered here. They explain how you can prepare for an interesting and profitable career in electronics. Mail the coupon today—no obligation.

good training doesn't cost—it pays!

Cleveland Institute of Radio Electronics

Desk EI-4 4900 Euclid Ave. Cleveland 3, Ohio

Accredited by
the National
Home Study
Council



Please send FREE Booklets prepared to help me get ahead in Electronics. I have had training or experience in Electronics as indicated below:

- | | |
|---|---|
| <input type="checkbox"/> Military | <input type="checkbox"/> Broadcasting |
| <input type="checkbox"/> Radio-TV Servicing | <input type="checkbox"/> Home Experimenting |
| <input type="checkbox"/> Manufacturing | <input type="checkbox"/> Telephone Company |
| <input type="checkbox"/> Amateur Radio | <input type="checkbox"/> Other..... |

In what kind of work are you now engaged?.....

In what branch of Electronics are you interested?.....

Name..... Age.....

Address.....

City..... Zone..... State.....

Desk EI-4

**FORMER SERVICEMEN:
MAKE
YOUR
SKILLS
PAY OFF
WHERE THE
AGE OF SPACE
IS REAL**



**AS
A SPECIALIST
IN THE
U.S. AIR FORCE**



**THE FUTURE BELONGS
TO THE AIRMAN**

With the new Age of Space, more and more men are finding that their previous military training can really pay off in the U.S. Air Force. If *you* have a skill the Air Force needs, you, too, can step into an important job. You'll work with the latest equipment, learn the newest techniques of your specialty — and look to a future that's guaranteed. Find out if there is a place for you, where the Age of Space is *real*. See your local Air Force Recruiter, or mail the coupon.

PASTE ON POSTAL CARD AND MAIL TO:

Prior Service Information, Dept. EI-9321
Box 7608, Washington 4, D. C.

Please send me more information on the Air Force Prior Service Program.

Name _____

Address _____ Age _____

City _____ Zone _____ State _____



Need for educational TV in New York City is met in part by arrangement with commercial station (WPIX-Ch. 11). Left, Board of Regents teacher discusses math at ninth grade level for teens in class, adults at home.

why don't we have

More Educational TV?

By Worthington A. Gregory

Producer, New York State Board of Regents
TV Consultant-Producer, Hofstra College

Adult or child, you're missing plenty if ETV isn't in your town. You ought to know why it's lagging.

BACK in 1952, with great fanfare, and no little controversy, the Federal Communications Commission set aside 242 television channels for educational use. This number was later increased to 256. Now, over six years later, a look at the score indicates that progress has been painfully slow.

If you happen to live in one of only 38 communities scattered across the country from Atlanta, Ga., to Corvallis, Ore., that has its own educational television station (ETV), you are lucky indeed. If you are a supporter of ETV in an area that has been fighting for a station and still doesn't have one, you



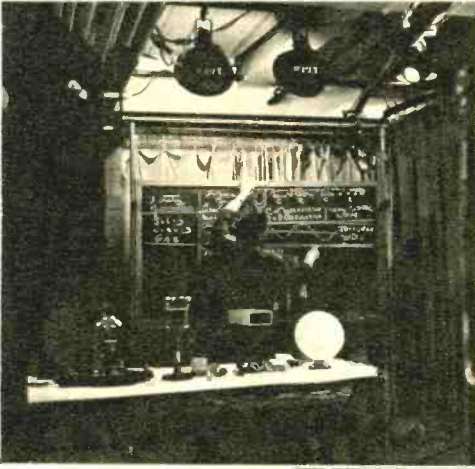

Boston's WGBH, a leader in educational television programming, regularly schedules shows of timely interest from exhibits at Museum of Science.

TV is good medium for subjects such as physics which require close-up viewing of demonstrations. Best teachers reach more pupils through TV.

Alabama youngsters, right, make up studio audience for in-school "Music Time" where they hear and see instruments and can ask questions.



know the obstacles. If you don't, you should. For without ETV in your community, you and your children are being cheated out of something that can make your life rich and full, and stimulate your imagination to new high levels.

When only 38 of 256 allotted channels have been taken up, when rich states such as Texas and California have only one station each, and when heavily populated northeastern states have but one station in Boston, we feel that progress is far behind what it should be. New York, the world's largest city, has no ETV station of its own. It does make some amends to its citizens by leasing large blocks of time during the daylight hours from a commercial station, WPIX (Channel 11), for educational broadcasting.

Closed circuit, open circuit and community television all have held the news spotlight at one time or another. The terms get confusing. When we talk about educational television, we are concerned only with non-commercial educational television stations broad-

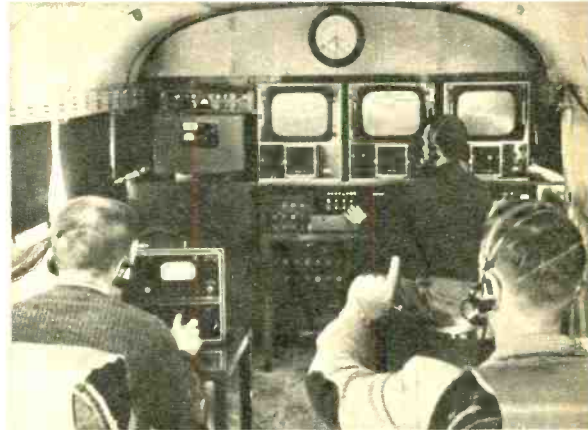

ETV stations at universities, such as Ohio State, are manned by students who direct shows (top left), check transmitter (top right), and put special events on air from TV controls in bus.

casting to the general public, as well as to children in school, on a regular channel reserved for education. Programs on commercial stations, such as *Omnibus*, good plays, symphonies, etc., are very welcome. Only they are too few and too far between, and don't get into the schools. The many very fine closed circuit experiments, such as that underway in the Hagerstown, Md., schools, are confined to the sets directly connected to them by coaxial cable. They have proved a valuable, though limited aid to in-class teaching, but are outside the scope of this report.

Just where do we stand in bringing ETV to all? At the moment, over \$70-million has been invested in educational television. In addition to the 38 stations now on the air, six more are under construction. For the most part, these are fairly evenly distributed over the country, with the South and Midwest leading the nation. Alabama alone

has an effective statewide network. Pittsburgh is the only city with *two* ETV stations.

Whatever progress has been made in the last six years can be attributed to grants from philanthropic foundations, notably the Ford Foundation, the Fund for Adult Education, and the Fund for the Advancement of Education. In most cases, however, such grants are on a "matching" basis—the foundation will match whatever money is raised locally. This has proved to be the stumbling block in many areas. Not realizing what they are missing by not having ETV, some citizens are reluctant to "help themselves," even though foundations have offered assistance.

But no one thing is retarding the progress of ETV. There is no longer a question as to its value or effectiveness. As long ago as 1952 experiments by both the Navy and the Army showed educators and the public that students learn

Public can invite great minds into their homes. Harvard Prof. I. A. Richards talks on "Iliad."



Wisconsin art instructor turns to crafts construction for Christmas decorations program.



equally as well, if not better, via TV as opposed to the straight classroom situation. Subsequent research provided a mounting pile of supporting evidence, in training, in direct teaching and in influencing attitudes.

Basically, there are three factors responsible for ETV's slow growth. First, human inertia. It's easier for most of us to go on doing things as we always have rather than adopt something new. Those familiar with schools know that it takes a long time for new ideas and methods to be accepted—especially if they cost money. School trustees and boards of education are reluctant to spend public funds for any new device or method until it has been proven over a number of years.

It wasn't until the armed services achieved remarkable results in training World War II fighters that motion pictures won any measure of acceptance in our schools. Television? Very entertaining, but hadn't we better wait and see how the other fellow makes out?

Also, among educators there has been

(unfortunately) considerable lack of agreement on ETV's role in the community, resulting in the ridiculous spectacle of two or more groups of ETV adherents squabbling as to whether this "new" medium is best for direct teaching and enrichment in the classroom, or whether it is more suited for cultural programs in the home. This squabbling does nothing to raise public confidence. When it results in an open split between factions, with each wanting to go it alone, the public often shrugs and decides to wait until those on the warpath (those supposedly "in the know") make up their minds.

But the most important factor holding back the progress of ETV has been money, or rather the lack of it. Television of any kind is expensive. The lump sum required to construct a station, and the yearly operating expenses always sound huge. A million dollars, a yearly operating budget of \$500,000, etc., are figures that make men shrink. But in reality, such sums are less than the cost of one medium-sized school

building—but with the capacity for hundreds of thousands, even millions of “students” a day!

In many cases, ETV plans were presented as a multi-million dollars statewide network to be paid for by public funds. Unfortunately, these proposals came at a time of rapidly rising costs. We were forced to match tempo—and funds—with other nations in a race for arms supremacy and survival. School buildings were springing up overnight and still we couldn't build them fast enough to keep up with the swelling tide of youngsters waiting to occupy them.

In short, we were all screaming about our taxes—school, local, state and federal. ETV often appeared to be an expensive luxury that we could not afford.

Also, in the matter of financing, there again was some confusion in high places. On one hand we had—and still have—the earnest efforts of top educators to keep the estimated costs of an ETV project at the lowest level. In practice this overlooked the highly complex operation involved in running and ade-

quately staffing a station. This paradox results in either going back to the taxpayer for more money, or living within an inadequate budget, putting out poor programs. Either way, the public loses.

The reverse situation occasionally exists where educators all for ETV have a network appetite on a shoestring income, resulting, in some cases, in the over-staffing of a station in relation to total program output. This has led several stations to the brink of bankruptcy.

One way for ETV to cut down on operating expenses has been found by some states which have located the main ETV station on the campus of the state university. Eager and competent college students and teachers staff the stations, providing all the technical assistance the station requires, all the script writing, all the on-camera talent, all the publicity, etc. Their programs are of a highly acceptable, often exceptional quality, providing a great service to the local community and the school children in the classrooms as well. At

[Continued on page 95]



On only statewide ETV network in nation, Alabama teacher gives daily lesson in biology.



Adults, out of school for many years, have found 12th grade English literature stimulating.

National Guard... Air Arm Has Long Reach

By Art Zuckerman

Tactical control units of Air Guard train in field to give electronic aid to planes, troops on ground.

In upper photos (left to right) A/2C Carl Eckman, a bakery worker in civilian life, gets briefing from commander of B-57 tactical bomber, which makes combat-like training runs as directed by ground air controllers. Next, he learns about field radar, which operates on gasoline generators.



Communications equipment must be reliable. Its maintenance and calibration are the partial responsibility of A/1C Hubert Kessel, a customer service engineer with IBM in civilian life. In first photo he checks gasoline generator, only source of power in combat, then gets info on FM radio relay.

HIGHLY mobile tactical control groups of the Air National Guard, with portable radar, portable power sources, tracking boards and radio, have two major jobs to do in time of war. The reservists attached to these units can move into a combat zone in a matter of days where they (1) direct Air Force planes, via radar and radio, against the enemy in support of our own infantry, and (2) detect approaching enemy aircraft, alert the proper air interceptor units—and even guide them to the tar-

get via radar. These tactical control units could prove to be the winning margin in a non-nuclear, conventional war such as the recent conflict in Korea or trouble in other overseas areas.

How well these jobs are done depends on the men behind the electronics equipment. *EI* followed two typical airmen as they went about 15 days training with their Guard unit, the 106th Tactical Control Squadron, White Plains, N.Y. Each had to learn many different tasks, leading to competence, versatility. —

In his duties as aircraft control and warning operator, Airman Eckman lays out the day's bombing mission at the control center under sergeant's watchful eye. In order to advance in rank, he must become familiar with radar console. Information received via radar is relayed to portable plotting board (far right) which displays data (written on board from behind) for controllers.



High frequency radio-tele-type gear, used by control center for quick distribution of operational and administrative messages, is tuned by Airman Kessel, who listens to signal via headset. Center, he performs maintenance on UHF air-to-ground transmitter, then extends troubleshooting to installation (far right) of UHF radio direction finder. Gear is then checked by actual operator.

Christmas Lights That Twinkle To Music

By Leon Wortman

Clip this unit to any speaker and multicolor lights will change their brightness in step with the music.



The string of lights may be used to decorate a Christmas tree, mantelpiece, or front door.

The black cabinet, readily available, gives the completed unit a professional appearance.

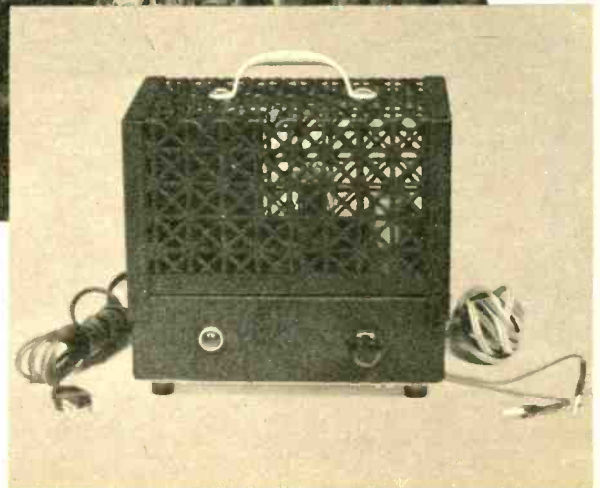

IF you decorate your tree at Christmas time, you've probably tried different sets of lights. Some just light up. Others blink on and off for more interesting effects. But, here is something entirely novel for your Christmas tree, a set of colored lights that literally twinkle to music!

It is used in conjunction with your record player or hi-fi system and you don't have to make a single modification. You just clip two wires onto the voice coil of the set's speaker and play a record of your favorite Christmas music. Turn on the power switch of the unit and the colored lights twinkle to the music. They follow the sounds on the record, glowing brightly with each crescendo, softly with pianissimo, going out when the music or caroling stops. It's all done electronically.

There are two parts to be constructed. One is an electronic unit, the other is the string of lights that decorates your tree. The unit uses 3 tubes, a twin-triode 12AU7A, a power-pentode 6CL6, and a 5Y3GT rectifier. A power transformer isolates the equipment from the house power lines. The entire unit is built on a "miniature amplifier foundation," but any chassis that measures at least 5"x7"x2" can be used. The "foundation" assembly makes a neat appearance with its attractive perforated metal cover.

The string of lights is made in half an hour's time. The string shown in this construction uses 24 bulbs. Up to 45 bulbs have been used for this effect, but 24 seems to be a popular number in commercially produced Christmas light strings. Obtain about 36 feet of wire, the kind used for appliances and lamps. The sockets for the individual lights are easily attached to this cord. They must be connected in series. A "house" plug terminates at one end of the power cord. This is inserted into a receptacle at the back of the chassis.

When the record player is idle and no sound is coming from the loudspeaker to which the lights are connected, the lights would be inactive. However, a toggle switch at the back of the

Alligator clips attached to any speaker voice coil will bring audio signals to the unit.

All the bulbs are tinted with colored lacquer and each is then wired in series as shown here.

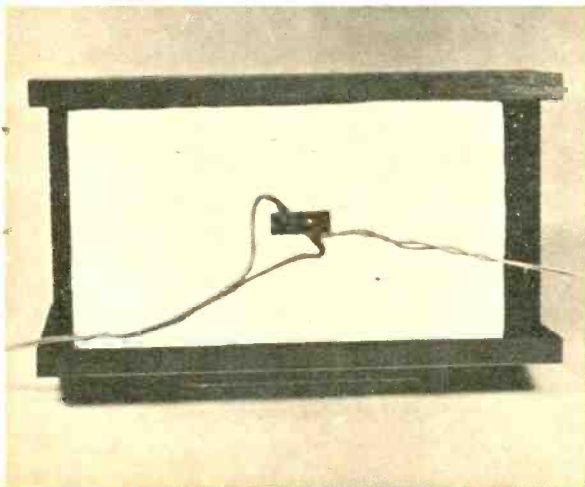

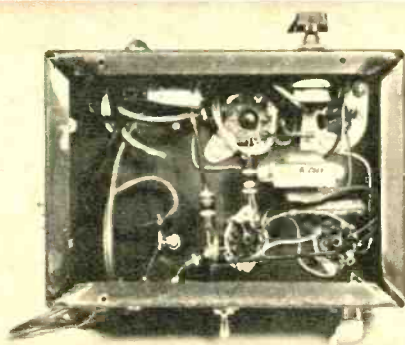
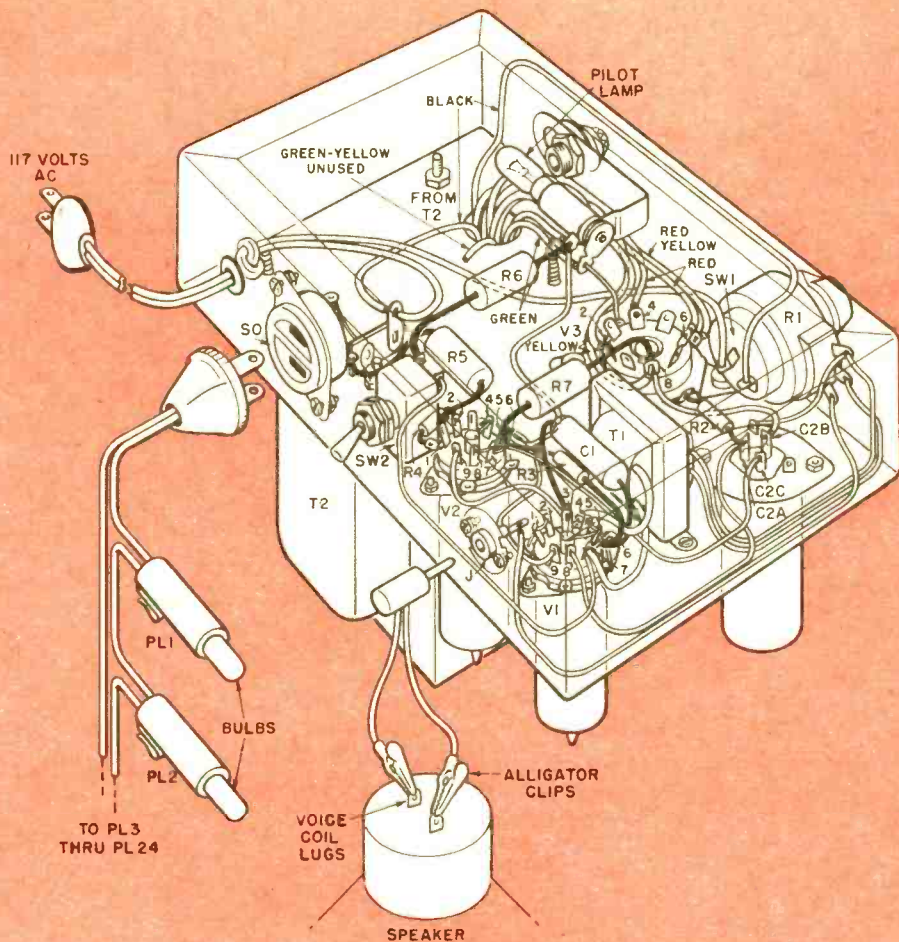

Various holes in the steel chassis above were made with commercial tube punches, electric drill.

Underside view. To insure a good ground, scrape black paint from area where V3 and J are mounted.

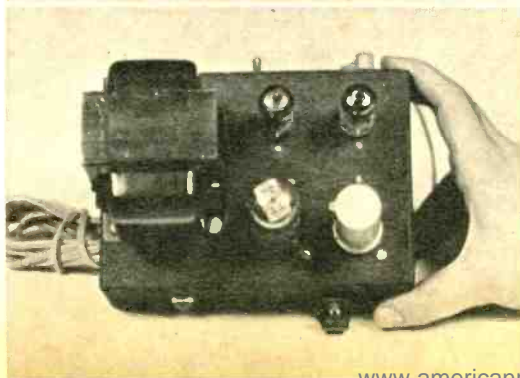

Top view. Power transformer T2 is at left with filter capacitor C2A,B,C on lower right of chassis.

chassis makes it possible to keep the lights aglow when no record is playing. In one position of the toggle switch the music has no effect on the glow and the lights remain constantly illuminated. In the other position, the lights are made to "twinkle" by the sound at the loudspeaker to which they are connected. Potentiometer R1 is wired the way a volume control usually is in a sound amplifier. However, instead of controlling volume, it controls the brilliance of the lights. The lights are quite sensitive and, with R1 at its maximum clockwise position which corresponds to full "on," it requires no more than a fraction of a watt of sound power to make the lights glow brightly.

The theory of operation is really quite simple. The string of bulbs are series wired from the cathode of the 6CL6 tube to ground, represented by the chassis. The current that flows through the 6CL6 passes, therefore, through the string of lights. If we change the voltage on the control grid (grid No. 1) of this tube, making it more positive for example, the current through the 6CL6 increases and the bulbs glow more brightly. If we make the grid voltage vary at a rate synchronous with the changing loudness of the sound, the bulbs change their glow accordingly.

One section of the twin-triode 12AU7A operates as a preamplifier, stepping up the signal from T1 which connects across the loudspeaker of your record player. The output of this triode section is coupled to the cathode of the second section of the 12AU7A. The grid and plate of this section are wired together and connected to ground. This second section, then, operates as a diode to rectify the signal voltage output of the first section. That's how we obtain a varying DC voltage for the control grid of the 6CL6. Do not attempt to plug the lights directly into the house-current wall socket. This would burn out one or more of the bulbs in the string.

The first trial with the completed model was made with an ordinary table radio. First the alligator clips were put across the lugs of the speaker and a station tuned in. The bulbs glowed steadily until R1 was adjusted. It was found that the best effect was achieved in just a few moments of experimentation with the control.

The charming old custom of lighting the Christmas tree has gone electronic. And you'll find that this is one set of lights you can enjoy the rest of the year as an adjunct to your high fidelity music listening. —●—

Schematic and parts. The cost of this unit, including lights, using new parts, is about \$20.

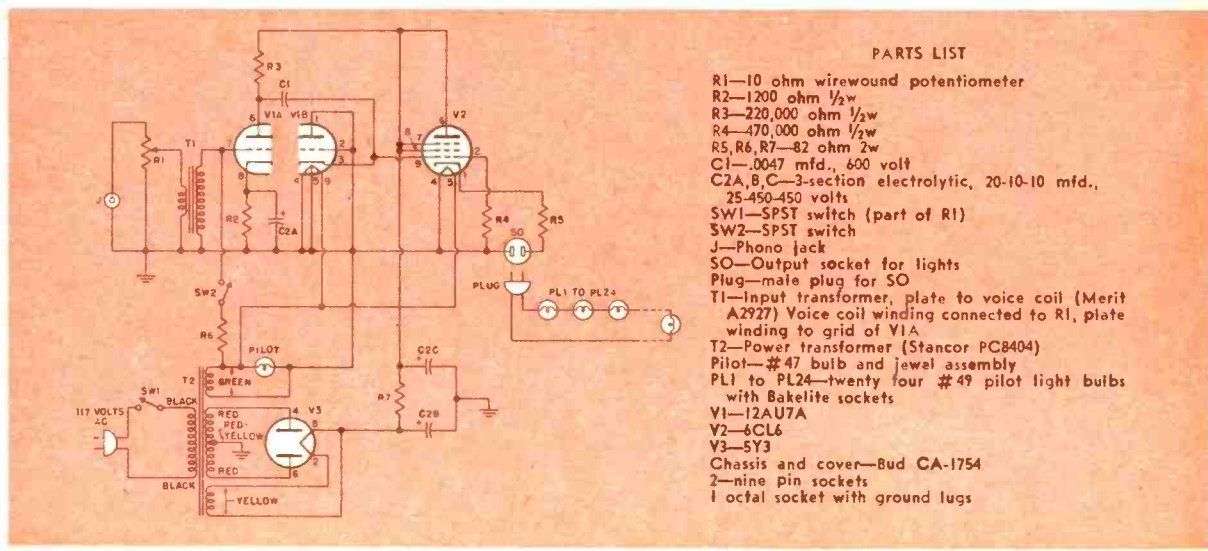

PARTS LIST

- R1—10 ohm wirewound potentiometer
- R2—1200 ohm 1/2w
- R3—220,000 ohm 1/2w
- R4—470,000 ohm 1/2w
- R5, R6, R7—82 ohm 2w
- C1—.0047 mfd., 600 volt
- C2A, B, C—3-section electrolytic, 20-10-10 mfd., 25-450-450 volts
- SW1—SPST switch (part of R1)
- SW2—SPST switch
- J—Phono jack
- SO—Output socket for lights
- Plug—male plug for SO
- T1—Input transformer, plate to voice coil (Merit A2927) Voice coil winding connected to R1, plate winding to grid of V1A
- T2—Power transformer (Stancor PC8404)
- Pilot—#47 bulb and jewel assembly
- PL1 to PL24—twenty four #49 pilot light bulbs with Bakelite sockets
- V1—12AU7A
- V2—6CL6
- V3—5Y3
- Chassis and cover—Bud CA-1754
- 2—nine pin sockets
- 1 octal socket with ground lugs

is there a job for you in . . .

Florida Electronics?

By Al Toffler

Envy those who work in Florida sun? This feature tells what to expect if you decide to join them.

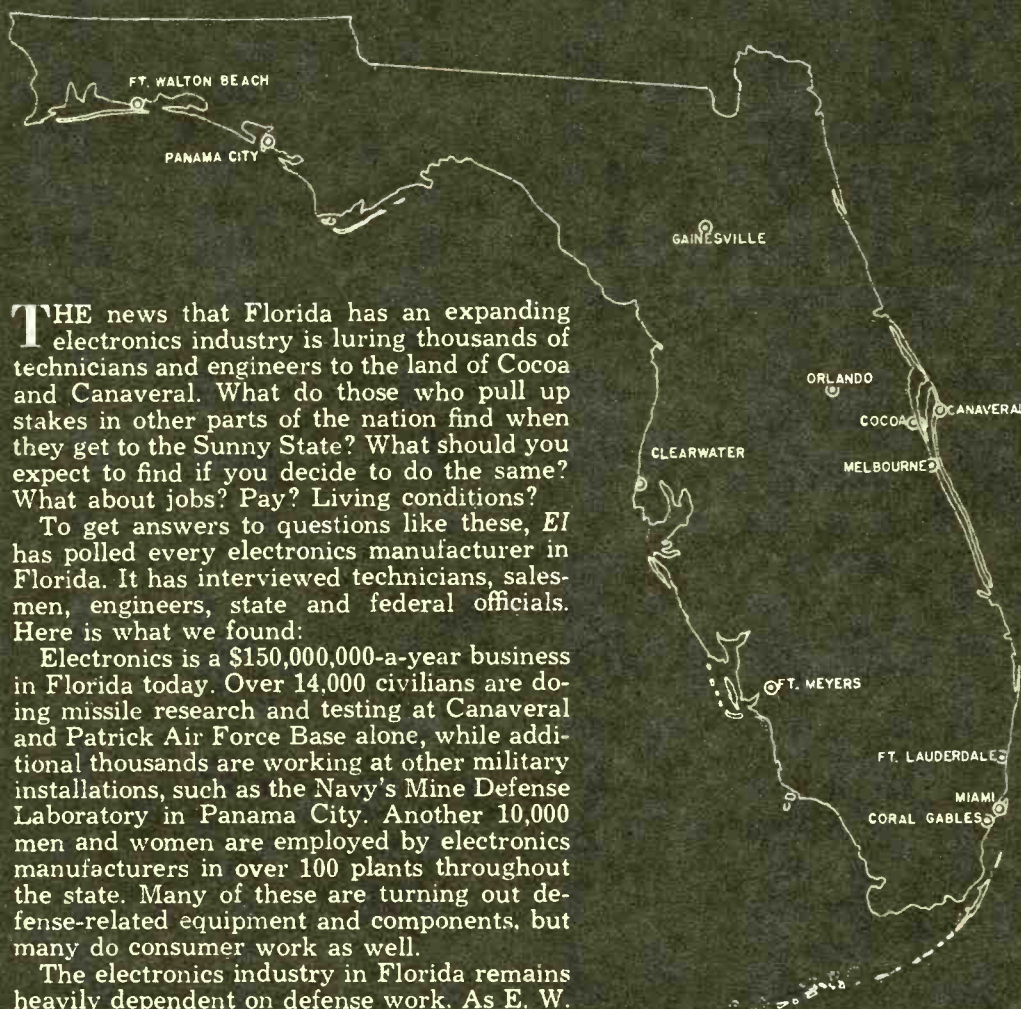

THE news that Florida has an expanding electronics industry is luring thousands of technicians and engineers to the land of Cocoa and Canaveral. What do those who pull up stakes in other parts of the nation find when they get to the Sunny State? What should you expect to find if you decide to do the same? What about jobs? Pay? Living conditions?

To get answers to questions like these, *EI* has polled every electronics manufacturer in Florida. It has interviewed technicians, salesmen, engineers, state and federal officials. Here is what we found:

Electronics is a \$150,000,000-a-year business in Florida today. Over 14,000 civilians are doing missile research and testing at Canaveral and Patrick Air Force Base alone, while additional thousands are working at other military installations, such as the Navy's Mine Defense Laboratory in Panama City. Another 10,000 men and women are employed by electronics manufacturers in over 100 plants throughout the state. Many of these are turning out defense-related equipment and components, but many do consumer work as well.

The electronics industry in Florida remains heavily dependent on defense work. As E. W. Kimball, of Kimball Electronics in Miami, puts it: "As long as the government defense program lasts, there will be plenty of work. After that, who knows?"



Here is one man who left the cold, northern winters forever when he sold his radio-TV repair shop in Brooklyn and migrated south. With a dream job as a marine radio technician, Frank Candela lives in 5-room stucco ranch in Palm Springs (left), and drives to work putting communications installations on pleasure craft. Was he just lucky?

Considering that a few years ago Florida had virtually no electronics industry, its growth to the \$150,000,000-a-year sales level is strikingly impressive. But the national electronic sales figure for 1958 was \$7.8 billion. Another \$2 billion was spent on servicing electronic equipment. This means that despite Florida's remarkable gains, it is still, relatively speaking, in the peanut class.

More important, so many technicians and engineers want to relocate under Florida's magnificent skies that employers can often take their pick and this abundance of skilled help has slashed the level of wages and salaries. Asked what advantages they have found in their Florida location, dozens of companies readily point to this ready supply of labor.

Actually, wages and salaries (except in the case of government employes), are more than just "slightly lower" than in the North and West. One electronics executive told *EI* bluntly: "We can get graduate engineers for \$100-a-week to start and that's more than our competition pays. Installation men start at \$75 or \$80. For many people the weather is so ideal that they're willing to take a pay cut to come. As a result, I'd say wages are a good 25% lower down here than in the North."

How about the possibilities of starting a service business of your own? Listen to Shan Desjardins, editor of the Radio and Television Technician's Guild Newsletter in Florida: "If you have hopes of coming to Miami and opening a service operation—don't. In this city alone," he says, "we have about 500 small independent repair shops. There are so many people in the business that it's rare for anyone to make even \$100 a week."

Does this mean that there is no opportunity in Florida? Not at all! Take the case of Frank Candela. In May 1956, 28-year-old



Technicians work on aircraft landing device in electrically-screened laboratory of Miami firm.



In Johnson Electronics' new plant, 90 out of 100 employees are women with skilled fingers.

Frank gave up a flourishing TV repair business in Brooklyn, N. Y., to try his luck in Florida. Frank and his wife, Gloria, rolled into Miami late one night, checked into a motel. The next morning they found a small efficiency apartment (unfurnished, \$75 a month in advance). The second day in town Frank asked his landlord for the name of the biggest TV store in town. Candela made a bee-line for the store, was hired on the spot, and went to work as a bench repairman. Pay: \$75 a week the first two weeks, then \$85, for a standard 40 hours. A few days later Gloria got a job, too.

Eight months later the store closed its service operation, so Frank again went job hunting. This time it took him three days to land a similar job. The pay and conditions were the same. In 60 days Frank was up to \$90 a week, and in line for foreman.

"It was during that time that I decided that television wasn't for me," Frank said. "I found TV repair even more cut-throat in Miami than in New York."

Candela visited the Miami office of the FCC and took the exam for a second class license qualifying him to work on communications equipment. He passed. With this he visited every airline in town "from Eastern down to the little free lancers" offering his services as a radio technician. He found that the pay and conditions were superior to those in the TV field.

Using his imagination, Frank took a

civil service exam, and applied for a job servicing police car radios. He passed, topping the list of eligibles. As it turned out, both Eastern and the Miami police came through with job offers. But, in the meantime, Frank saw an ad in a Miami paper calling for a man having a second class radio-telephone license. Frank applied. So did 17 others.

He got the job. It turned out to be what Frank now calls his "once in a lifetime." He works for Pearce-Simpson, Inc., installing and servicing marine radio and telephone equipment. He willingly took the job, even though it started at \$80 a week, \$10 less than he had been making.

On a typical day Frank drives to work and arrives at about 8:15. The day begins with an informal "conference" with the sales manager and the other serviceman. Together they work out a schedule for the day. By 9:00 Frank is on his way to change the frequencies on a 60-foot pleasure schooner radio-telephone, or convert a radio on a nearby yacht for operation by remote control. In the afternoon he may visit the boatyard, where a new vessel is under construction, to establish the location and layout for a radio installation. His day ends at 5:00.

How do the lower pay rates in Florida line up with living costs? A look at Candela's budget is revealing. Frank manages to take home \$80 a week.

[Continued on page 97]

Some recruiting government contract work at Cape Canaveral missile testing center is done periodically by big electronics companies in major cities up north. This man is operating an unusual spiral coil tracking antenna on the missile range.

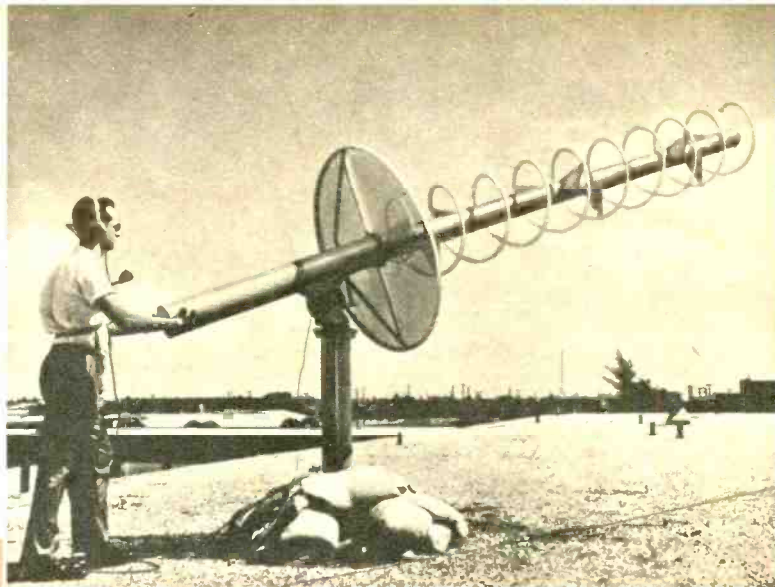

RESULTS OF EI POLL OF FLORIDA ELECTRONICS EMPLOYERS

SCOPE OF FLORIDA INDUSTRY:

Everything from research and development to servicing a wide variety of equipment. The output includes missile guidance systems, radar, underwater sound measurement devices, radio/telephone communications, television and vidicon components, facsimile equipment, computers and test apparatus. Most are in defense or defense-related production, but some companies are exclusively in the consumer products field.

HIRING OUTLOOK:

Sixty-five percent reported plans to hire technical personnel during the first quarter of 1959. Most will hire under five, although one firm plans to hire 120, another plans to hire 50. Ten percent of companies said they were in doubt about hiring new help, 25 percent said no hiring in early months of 1959.

PAY RANGE:

From \$2,600 up for technicians. Ceiling pay, \$8,230. Most technicians earn from \$3,224 to \$6,708 per year. For engineers, pay range is \$5,820 to \$15,000.

TRAINING AND EXPERIENCE:

Over 40 percent of companies demand 1 to 5 years experience for technicians, 2 to 7 years for engineers. Training must be relevant to job, not general.

AGE REQUIREMENTS:

Ninety percent say no age restrictions. Caution: Very few companies publicly admit they will not hire applicants over 45.

RESIDENCE REQUIREMENTS:

No "snowbirds"—transients who drift south for winter, then migrate back north. Seventy percent said they have no residence requirements. Others simply demand some evidence of good faith, such as purchase of a home. Government agencies hiring through Civil Service system give preference to applicants nearest jobs to be filled. Florida State agencies require six months residence.

OTHER RESTRICTIONS:

A high percentage of employers of electronics personnel are either federal agencies or firms having government contracts. This means that by law they must be open on a basis of equality to all qualified applicants, regardless of race, creed, color, or national origin.

Simple Hi-Fi Repair

By David Fidelman

Locating some of the more common hi-fi troubles is easy—Follow the simple procedures outlined here.



Switch inputs to isolate the trouble. Above, loud ringing occurred when using phonograph. The cabinet was sending vibrations back to pickup arm.

Insert a short bare wire into input jack. If loud hum is heard, amplifier and speaker are OK.

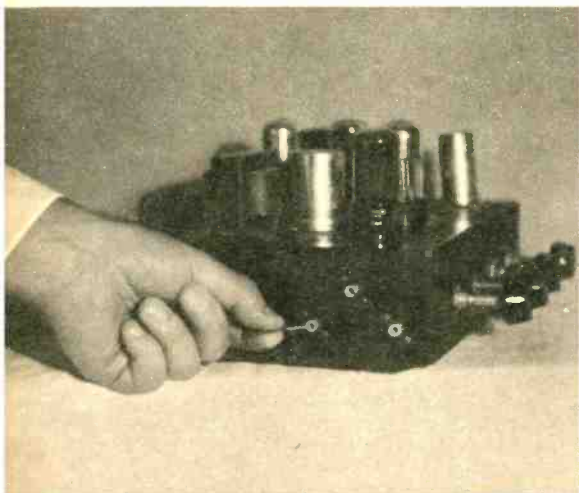

Cables may be checked for shorts or breaks by the hum method. Place finger on tip of plug.

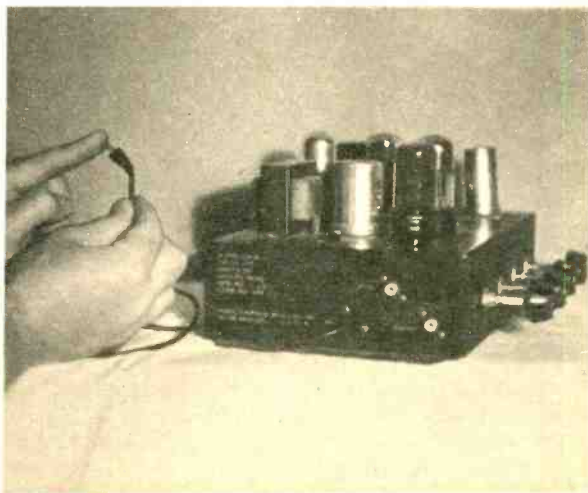

HI-FI systems usually begin to act up at the most inopportune moments; while listening to records or FM, or perhaps while demonstrating to friends. Fortunately, some of the worst sounding failures are the easiest to repair with these simple procedures. If the equipment *suddenly* develops trouble, the cause is likely to be easy to locate.

There are three main types of failures that you are most likely to encounter. No sound, loud hum or noise, and very distorted sound. A little detective work should aid in locating the specific spot where the disturbance originates.

The first step is to set all controls in the same positions as for normal operation. Switch the input selector (tape, tuner, phono, etc.) and see if the trouble is on one or all positions. If the tuner plays properly and the phono causes loud hum, we can be fairly certain the main amplifier is not the culprit.

If there is no sound from the loudspeaker, check the following: all plugs firmly seated in their sockets, blown fuse, selector switch on correct position, and wires that are broken or touching. Pinch and wiggle the speaker wires and shielded cables to determine if a lead might have opened up inside the insulation.

A very effective means of trouble-

If sound from the speaker is intermittent, try to find break by flexing cable along its length.

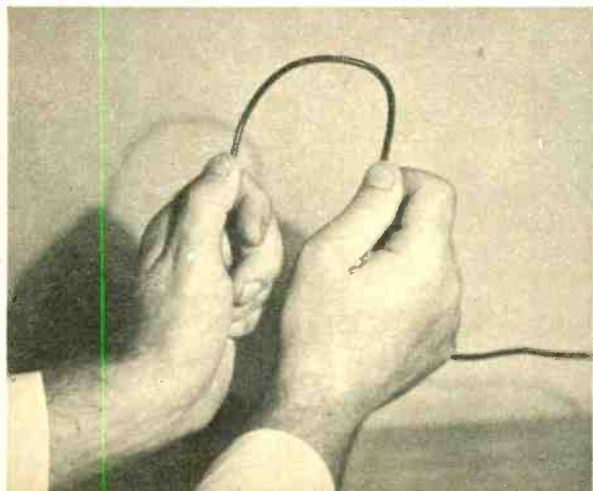

shooting is to introduce hum into the system at various points. This may be done by placing a finger on the amplifier inputs. Strong 60 cycle AC hum fields from the power lines in the room will be induced through your finger into the amplifier. You might have to use a short piece of bare wire to make the connection. Be careful not to touch any point inside the amplifier that might have high voltage on it.

Tubes are a common source of failure and hum. Here, it is advisable to keep a set of spares. Then, a simple substitution procedure will locate the bad one. To forestall future tube trouble it is a good idea to have them checked on a tester every six months. Tapping with a pencil will aid in finding microphonic (ringing noise) tubes. A tube that has a bluish glow throughout its interior is going gassy and should be replaced. However, new power tubes will often have *slight* tinges of blue which indicates a good vacuum.

Finally, the adventurous audiophile might choose to open the bottom plate of a unit and attempt to locate a faulty component. Look for burnt, charred, or discolored parts. A waxy substance oozing from a condenser is also a bad sign. If it is possible to identify the value of the component, replace it without altering the layout. 

Weak sounds accompanied by loud hum may be due to a wire disconnected from cartridge.

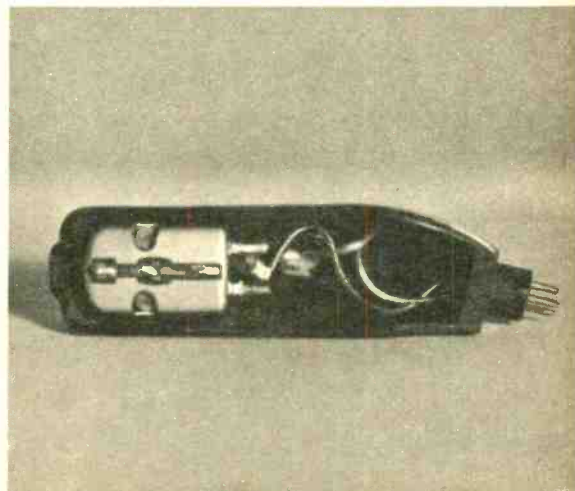

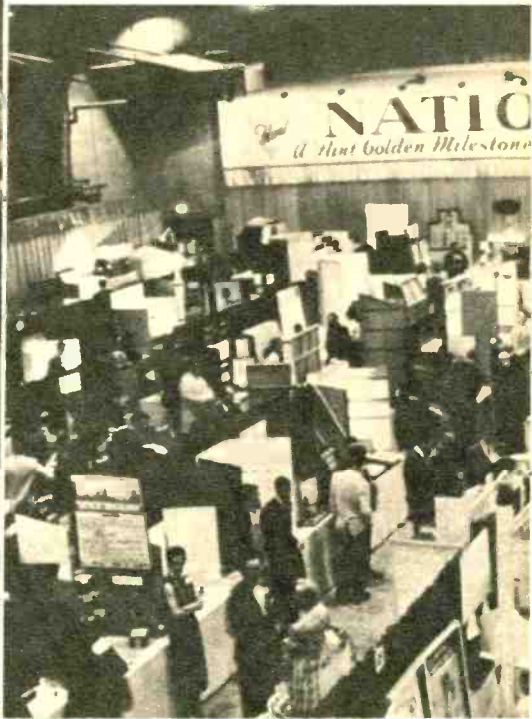
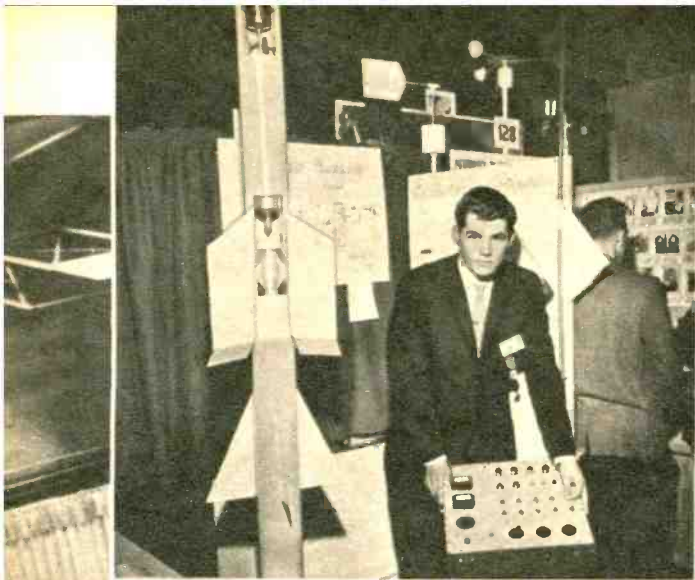

Complex two-stage liquid fuel rocket with built-in computer and guidance system was constructed by 17-year-old Marshall Kriesel, of Owatonna, Minn. He wants career in aviation.

Robert Arnell, 16, of Juneau, Alaska, combined his interest in math and music to design computer to compose music. It shows probability and statistics as applied to notes sequence.

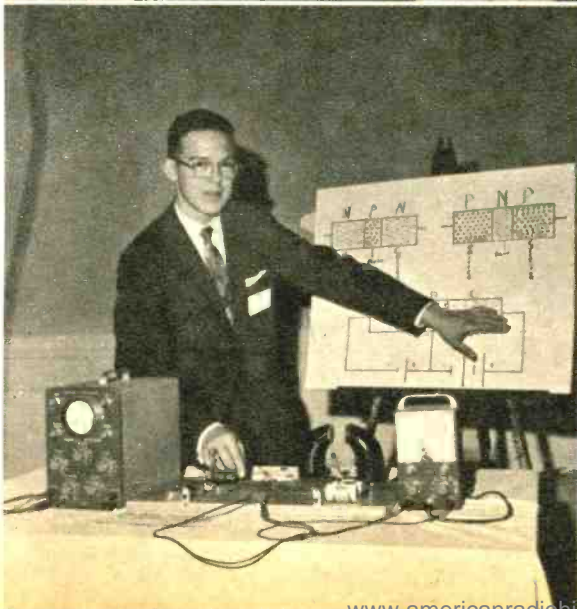

High school senior Matthew Fassett, of Penfield, N. Y., demonstrates the basic principles of junction transistors. Much of the equipment was donated by local businesses, school.

Electronics Illustrated



Some 250 teenagers, showing remarkable ingenuity and talent, show their projects at National Science Fair. Many more students exhibit at local fairs.

Our Amazing Teenagers!

By Mike Bienstock

Given a chance at Science Fairs, high school students show great promise with their electronic projects.

OVER a year has passed since Russia launched the first Sputnik and in spite of our own satellites and moon shots, the woeful gaps in our educational system revealed by being beaten into space remains partially unfilled. Aside from an occasional prod-ding editorial, the American public has been allowed to sink back into apathy, a state that has been the bane of scientific progress for scores of years. The stereotype of the absent-minded professor or "mad" scientist remains a part of the folk legend, and some of our teenagers still look upon scientists as strange and somehow threatening.

America's serious science students must be encouraged in every way to continue their interest if we are to keep pace with the various scientific ages—Atomic, Jet, Space. What's more, we must find new scientific talent and channel it into its most productive areas. One of the bright spots is a recent move by Columbia University School of Engineering to establish a science honors program for 60 highly rated high school students. The \$25,000

grant, small though it may be, will finance their attendance at university level science and engineering classes every Saturday. The courses will be taught by the school's faculty and will include math, physics, chemistry and engineering. The program will try to learn how fast and how far science education can advance with gifted high school students, and could possibly prove to be the prototype of the future science curriculum.

In a realistic move, the United States Office of Education set up on September 8, 1958, a new four-year, \$900,000,000 program of Federal aid to science education. The funds will be allocated to the states for teaching aids and laboratory equipment, for guidance, counseling and testing.

By far the brightest spot in America's science picture is the National Science Fair, held every year under the sponsorship of Science Service, a non-profit institution for the popularization of science. The first fair was held in 1950 with 30 exhibitors from 13 areas. If its present growth continues, it should draw 1,000 teen-age exhibitors from all over the country and territories by 1960. Since each exhibit represents the top entry out of some 250 boys and girls, we

may have as many as 250,000 of our high school youth competing in regional and state science fairs.

The State Science Teachers Associations also sponsor local science fairs, the winners of which participate in state-wide science fairs. These extraordinary exhibits of the scientific and engineering talent of today's teenagers are usually head and shoulders above what is normally considered "the high school level." Entries include computers, complete radio stations, particle accelerators, cloud chambers, and even a more esoteric project which will determine the charge of an electron by the Millikan-Stokes Method. This latter was by a 15-year-old girl.

The projects exhibited at the science fairs cover the entire range of scientific endeavor, including investigations of the new theory of the anti-universe, an ionic drive reaction motor, electroluminescence, and a method of producing oxygen from algae during space flight. Projects on solar energy and heat are not uncommon. Spectrographs, spectroscopes and spectrometers have been designed and built by teenagers, along with solar furnaces, and electron microscopes. Fairs have also included aero-

[Continued on page 100]

An analog computer, designed and built by Kenneth Hanson, 18, of Mamaroneck, N. Y., features a recorder to graph its results.

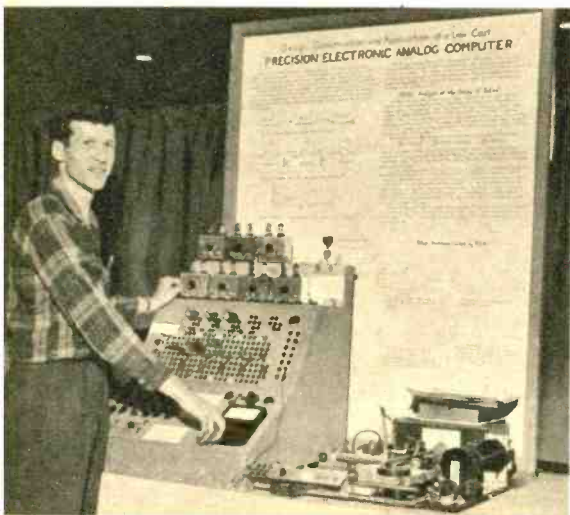

46

From an abstract idea, David Toback, 17, of Coral Gables, Fla., built practical electronic scale that weighs samples in a magnetic field.



Electronics Illustrated

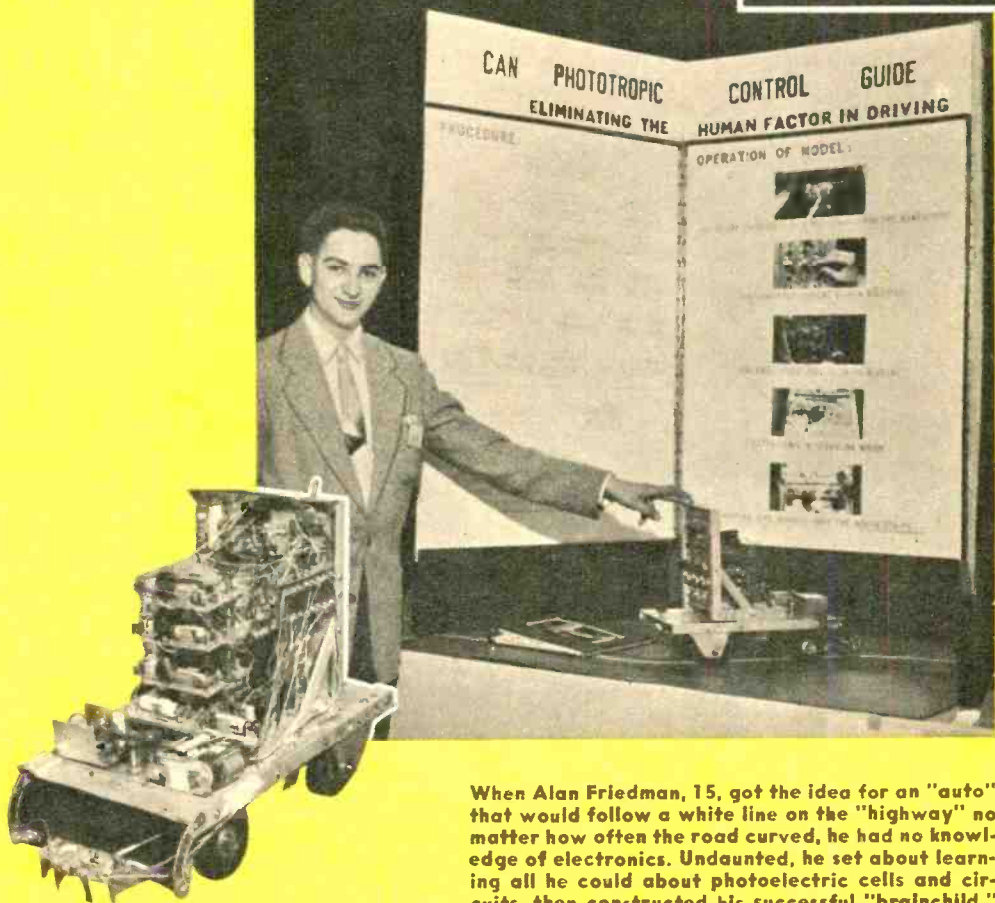

When Alan Friedman, 15, got the idea for an "auto" that would follow a white line on the "highway" no matter how often the road curved, he had no knowledge of electronics. Undaunted, he set about learning all he could about photoelectric cells and circuits, then constructed his successful "brainchild."

WHILE reading a book, 15-year-old Alan Friedman, of Atlanta, Ga., came upon the word "phototropism." Not knowing what it meant, he looked it up in the dictionary and found it described the movement of certain plants and insects toward a stimulus of light. Alan wondered if this movement might be duplicated and adapted in a manner useful to man. After briefly considering futuristic applications such as a spaceship that could follow a star, Alan hit upon the more feasible auto that would follow a white line. His research led him through popular magazines, introductions to electricity and electronics, and finally more advanced literature on circuit design and components.

After much research, Alan chose a

two-transistor circuit, built a volt-ohm-meter kit, then set about testing various components, relays, etc. Months later his device was complete. Three B2M photocells activate three two-transistor amplifiers. As the white line under the "car" moves beneath either right or left photocell as the road curves (deviating from the middle cell), the steering motor is automatically started to move the car in the direction of the activated cell. Circuit and motor operate on batteries, 20 in all, with 11 switches and 17 adjustments. It cost Alan a year's allowance. The electronic equipment was all obtained from mail order houses and parts jobbers and the project won for Alan top recognition in Georgia State Science Fair and a Navy cruise award.

this computer is . . .

Too Smart To Add 2+2

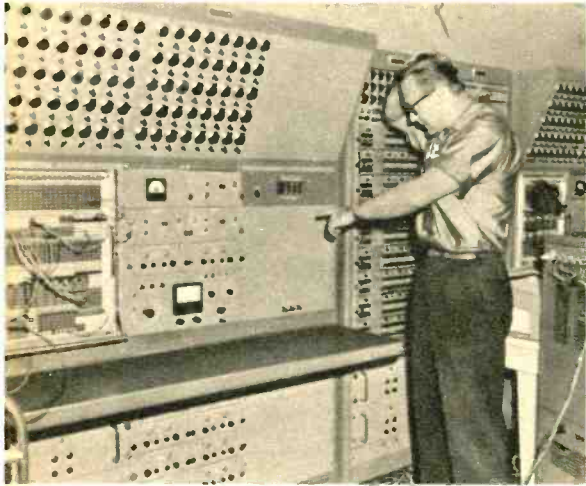

Complex computer has difficulty doing simple addition, as shown in puzzlement of engineer.

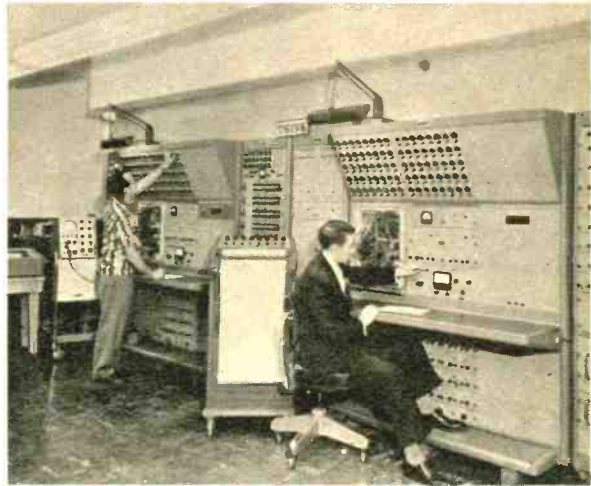

But when programmed correctly, it solves difficult analog problems, read out on graph.

IN a second grade classroom, this electronic "brain" would certainly wear the dunce cap. If asked the simple sum of two plus two, it would struggle for 15 minutes and come up with something like 3.998.

But before we call the junkman to haul away this \$130,000 machine, we might hastily explain that PACE, as the computer is called, is an analog computer (as opposed to a digital computer which specializes in numbers). Analogs just never get *exact* results. Engineers at AiResearch Manufacturing Division in Phoenix, Ariz., sing the praises of PACE's memory and "imagination," rather than its ability to add and subtract. PACE can retain in its electronic memory all specifications for a new part, then advise the engineers how long the part will last and how much heat, pressure and vibration it can take.

New gadgets are not made until PACE nods approval on graph paper. It is preferable to have PACE put a wet blanket on an imaginary rocket in the lab than to permit an expensive test model to disintegrate on the launching pad.

With its 96 amplifiers, 1,000 tubes and a host of variables and components, PACE can simulate everything from an airplane maneuvering at 50,000 feet to a turbine, rocket engine, or an automobile driving over a bumpy road. Its accurate answers on the future performance of proposed parts for almost any system saves thousands of dollars each year. It takes about two days to set up a difficult problem and five hours to warm up the machine, but then engineers can sit back and ask almost anything about materials, combinations, etc., and get quick, reliable answers. ●

A Timer-Counter For Your Darkroom

By Harvey Pollack

This unit controls an enlarger or contact printer
—and also has an audible counter for developing.

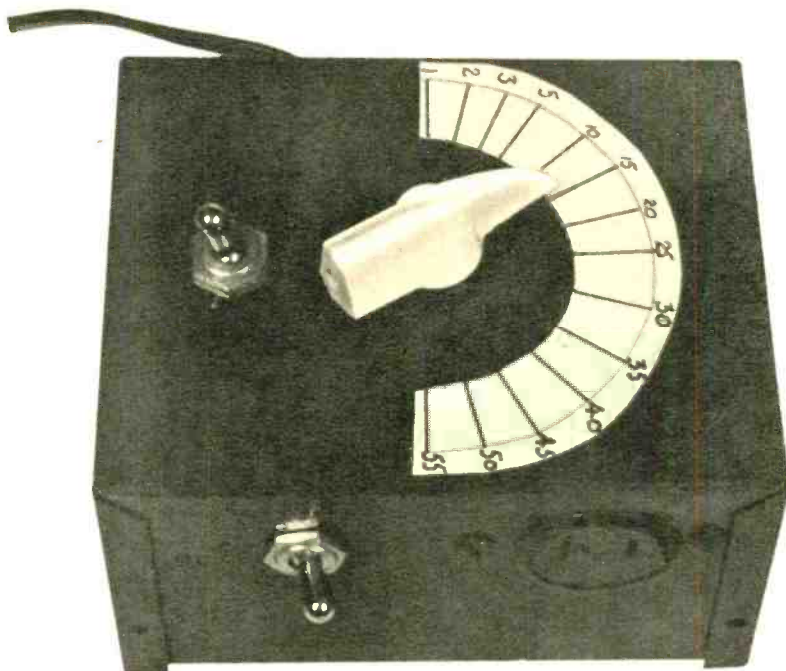

White knob selects time interval on dial, calibrated in seconds. Power switch is next to knob. Lower switch changes unit from timer to counter.

BESIDES photography where precise timing of enlarging and contact printing exposure is necessary, there are many other uses for this simple timer-counter. Among the many possibilities are service as a self-timer for a camera solenoid, X-ray exposure timer, seconds-counter for color developing processes in the home laboratory, ultraviolet exposure timer for experimental work with various kinds of irradiation effects, an advertising display flasher, and so forth. With a timing range from a fraction of a second up to fifty-five seconds, it can be used in any operation where dependability and repeatability are important factors.

Since no tubes of any kind are employed, both standby power and heating are absolutely *zero*! Even the transformer is completely disconnected from the line until a short timing period is required. At the end of the interval power is again removed.

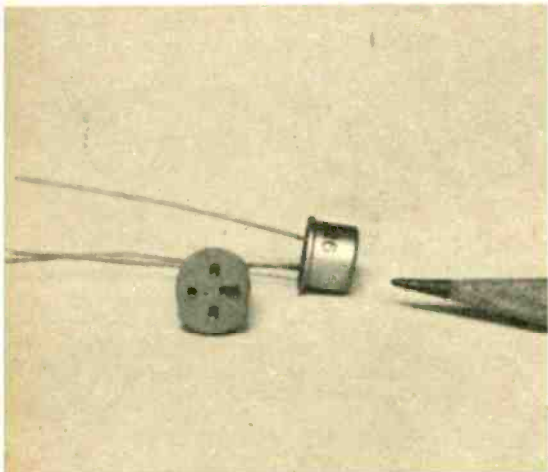

The new unijunction transistor (with socket) is like a thyratron, used to control relays.

Thus there is no gradual temperature rise such as one encounters with tube operated devices and even in some standard transistor timers.

The simplicity of the circuit is made possible by the relatively new *unijunction* transistor, in this case a GE 2N494. This transistor differs from standard types in that it behaves more like a gas thyratron rather than an amplifier tube. Under certain conditions of emitter to base 1 voltage, the resistance between base 2 and base 1 is quite high, hence very little current flows from one to the other. The relay, in series with the B2 to B1 connection, carries very little current in this situation and is not energized. As the positive voltage of the emitter is slowly raised, the B2 to B1 current *does not increase at all* until a certain critical voltage is reached; then the unijunction transistor "fires" just like a thyratron tube. "Firing" in this instance means a very sudden reduction of B2 to B1 resistance, an equally sudden increase of current and fast, positive relay action. This is very different from normal transistor behavior where gradual voltage buildup produces a slow rise in current. This gentle increase in current does not make for timing precision because the relay then tends to pull in at slightly different intervals in successive operations due to temperature changes, dust on the bearings, and so

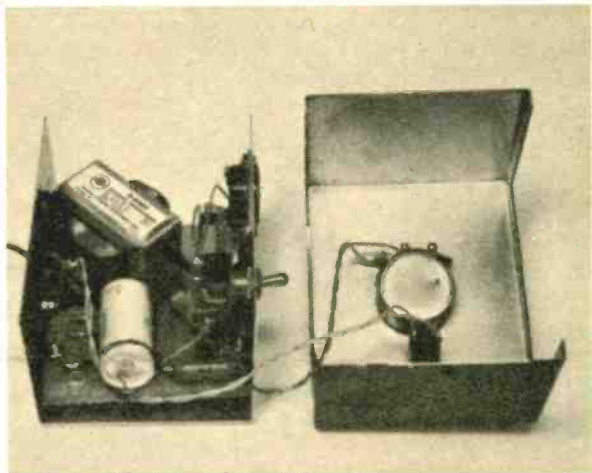

Wire placement is not critical but in no case is the metal chassis used as a common ground.

on. Thus, the unijunction transistor has received wide industrial acceptance for switching and triggering applications of all kinds.

In the construction of this unit, parts layout is not critical. Note that the metal case is *NOT* used as a common ground, thus wood or Bakelite will serve equally well.

It was found convenient to mount the following small parts on the Bakelite before starting to cut holes in the case: R2, R3, the unijunction transistor, C1, C2, and the selenium rectifier. Then, with all the parts self-supporting, the major portion of the wiring can be completed below this little subchassis before mounting it in the box. The two resistors and the two capacitors are secured by passing their pigtail leads through convenient perforations and bending them over sharply to hold them firmly in place. The selenium rectifier is supported by a machine screw through its core (or by its own stud as the case may be) while the transistor is mounted in a tiny socket fastened to the perforated Bakelite sheet. You will probably find it helpful to bring out color coded wires from the various points of connection under the Bakelite sheet for later soldering to the relay, switches, and output receptacle. Make each colored lead about 8" in length and note the color

[Continued on page 110]

PARTS LIST

- C1—8 mfd., 150 volt electrolytic, miniature
- C2—250 mfd., 50 volt electrolytic
- R1—250,000 ohm wirewound potentiometer
- R2—4700 ohm 1/2 w
- R3—100 ohm 1/2 w
- RY—2500 ohm plate relay (Potter & Brumfield LB-5, 2500)
- SW1, SW2—Single-pole single-throw toggle switches
- SO—117 volt chassis receptacle
- SR—Selenium rectifier 120 volt, 65 ma.
- T—Filament transformer, 117 volt primary, 25.2 volt secondary (Stancor P-6469)
- TR—Unijunction transistor, GE 2N494, with socket Perforated Bakelite sheet 2 1/4" x 3 1/4" Aluminum case 3" x 4" x 5" (Bud Minibox CU-3005)
- Misc.—3-lug terminal strip, two 3/4" brass spacers to hold subchassis, line cord and plug, 3/8" rubber grommet for line cord.

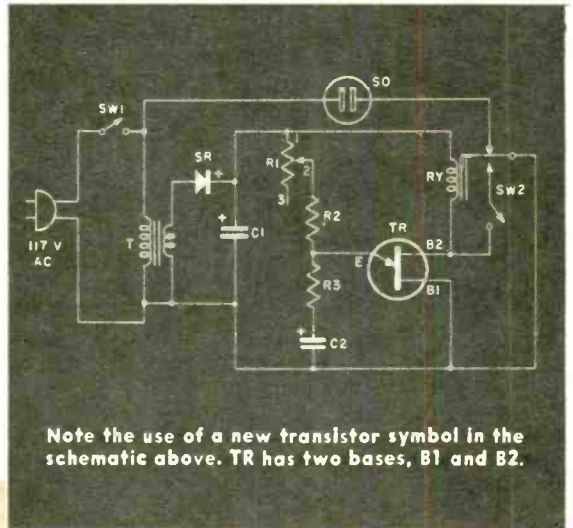

Note the use of a new transistor symbol in the schematic above. TR has two bases, B1 and B2.

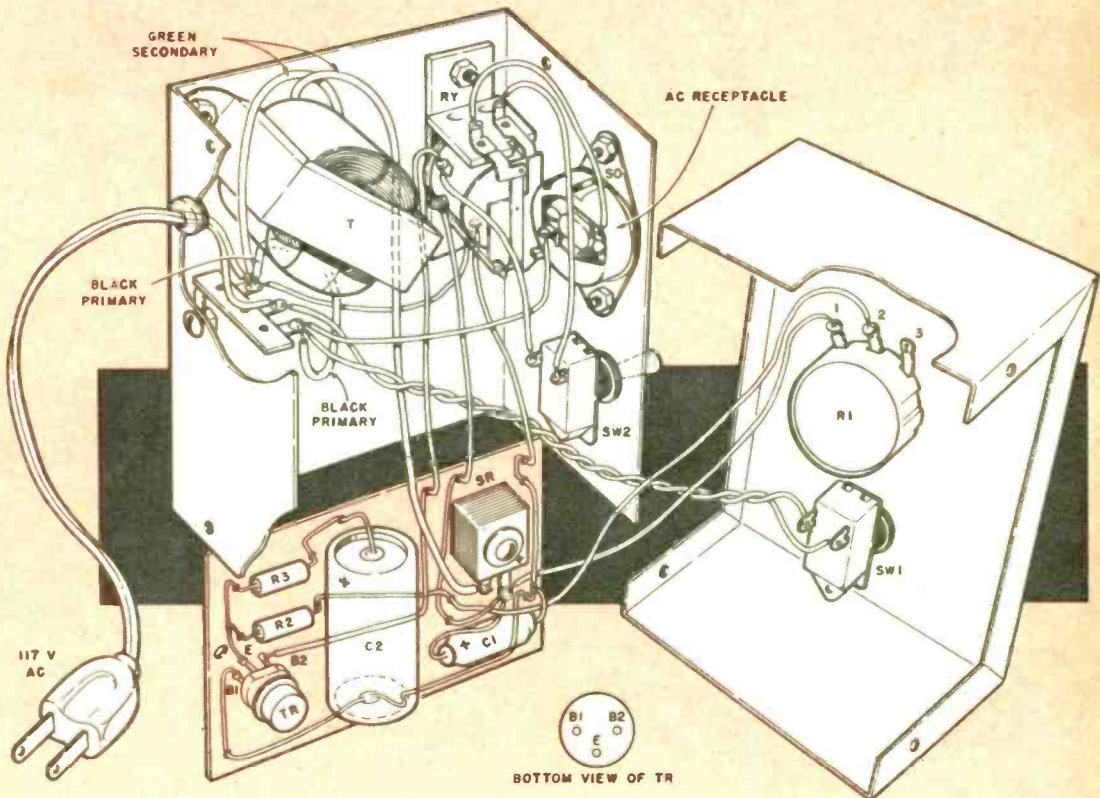

For clarity, the board where C2 is mounted is shown below main chassis. Photos show actual location.

A Fire Alarm That Dials Your Phone

By Tracy Diers

Protect your store or office with a unit that will dial your home number and buzz a warning.

IF you own a business, store, or home, you are concerned about the ever-present danger of fire. You can build a simple fire alarm that will work 24 hours a day for only a few cents worth of electricity, little enough, considering that it will telephone you and report a fire at the moment the trouble starts. However, you must have an alarm on the premises or construct one to use with this device. Such an alarm will appear soon in *EI*.

Also you must have a dial telephone at the place to be protected. You may be surprised to know that you don't need the

The telephone is placed on the wooden platform with "dialing arm" resting in the cradle. Handset remains atop cabinet and picks up the buzzer sound.

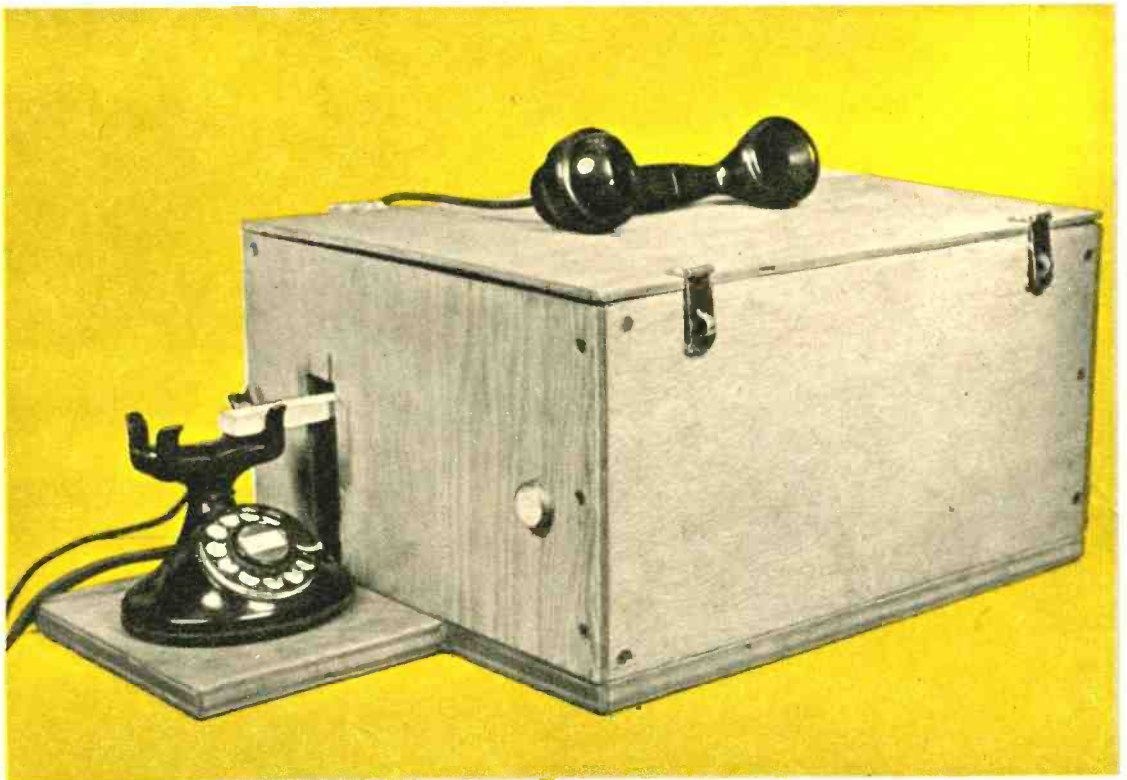

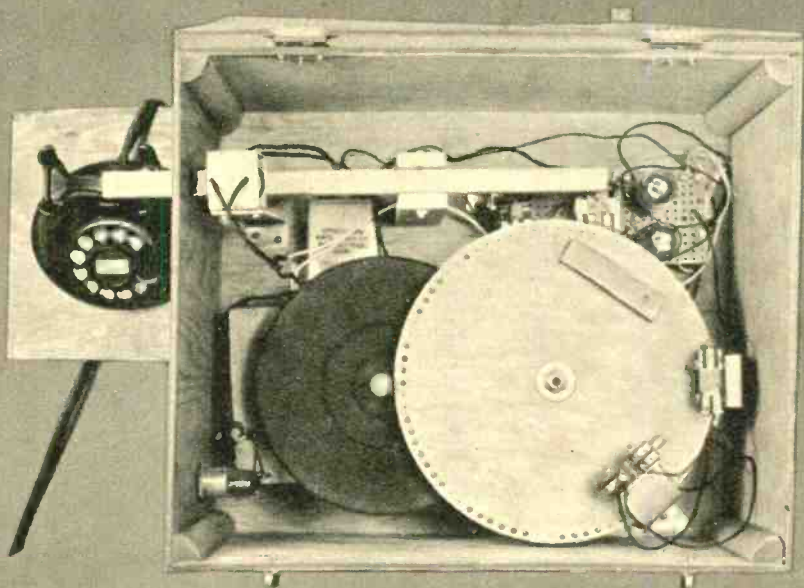

Above, the large code wheel may be seen. Brass screws along its circumference are arranged to correspond to phone number. See diagram p. 57.

A small hole is drilled through the end of the phono center post. It will receive a metal pin used to hold a wood dowel shown at lower right.

After the wood dowel has been prepared according to specifications it is slipped over the phono center post. The metal pin prevents any slippage.

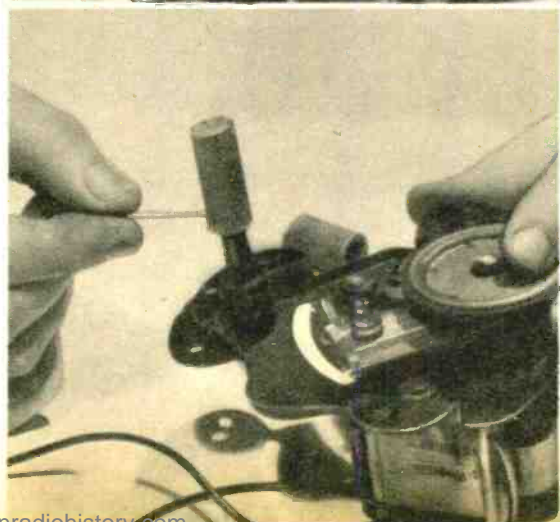
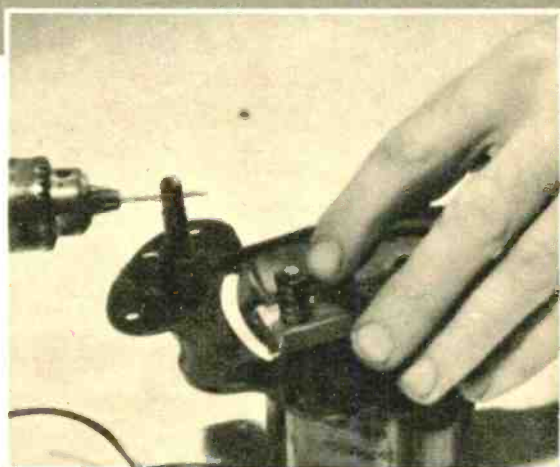

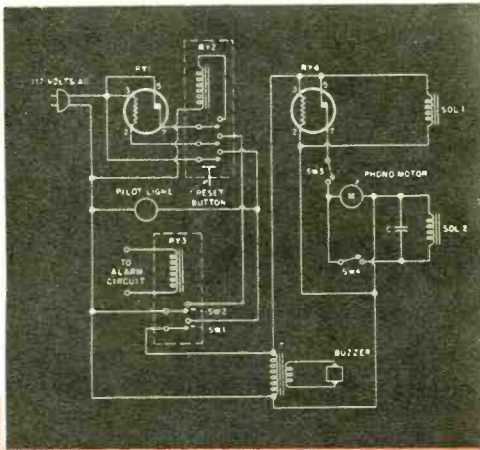

Locate "TO ALARM CIRCUIT" in schematic. Fire alarm must supply proper voltage to RY3.

The control subchassis containing RY1 and RY4 has been displaced to clarify the wiring guide.

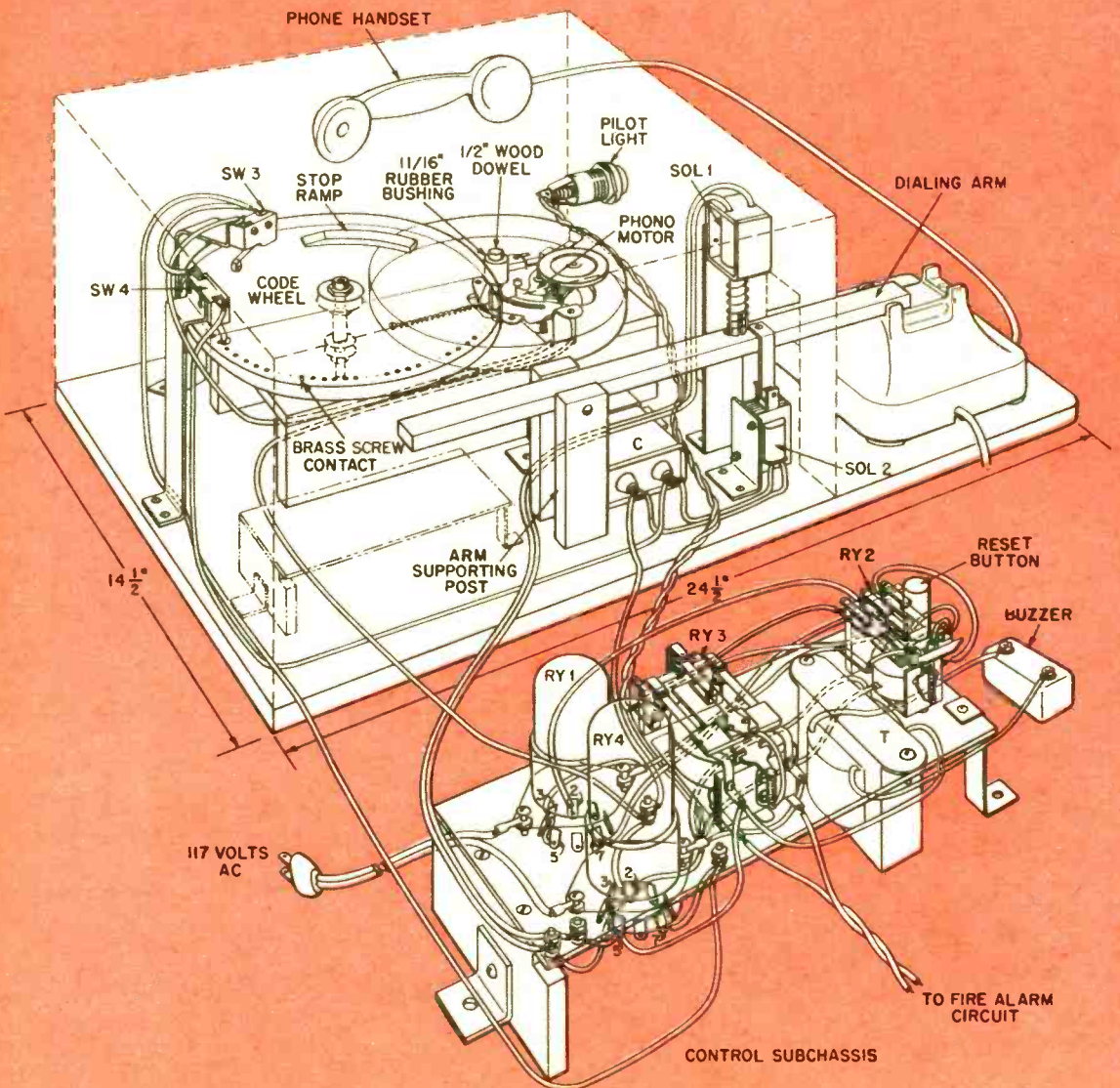

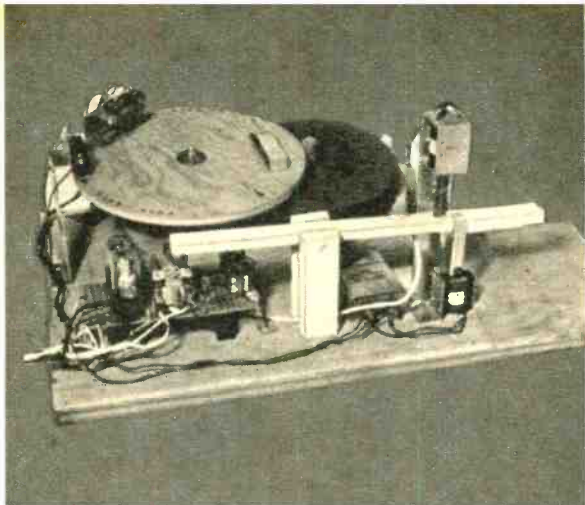

The cabinet has been removed to show location of the major components mounted on base.

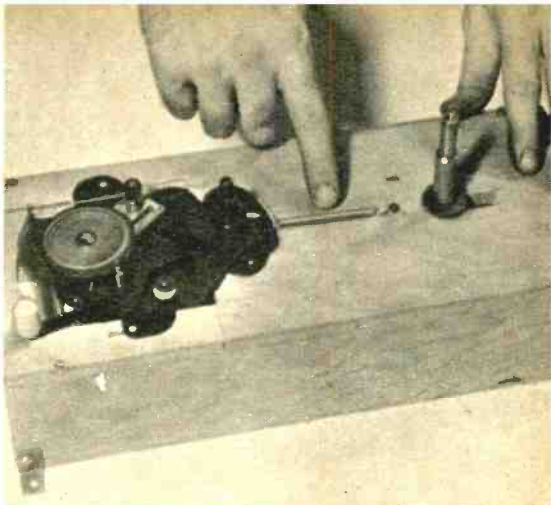

The spring keeps the turntable firmly pressed against the code wheel which is mounted later.

dial on your telephone to call. When you lift the handset two black buttons (or lever) pop up on the cradle. If you tap one of these buttons rapidly up and down with your finger at the right speed you will be doing the same thing that the dial does.

The "heart" of the device is a group of thermal relays, a slowed-down phono motor, and a microswitch adjusted to send pulses of current to a "dialing" solenoid.

Actual construction is begun with the baseboard. Study all the illustrations in this article since they give complete construction details and dimensions. The board is cut from $\frac{3}{4}$ " plywood and the phono timing mechanism is mounted first. The end of the turntable shaft must be cross drilled to receive the metal pin, to hold the wood dowels as shown in the photos. Then, slip a piece of rubber tubing over the dowel to provide a friction drive.

The motor assembly should be mounted on a piece of wood 13" by $5\frac{3}{4}$ ". Drill a hole about $\frac{3}{8}$ " in diameter in this piece. If you have facilities to turn metal on a lathe, prepare a brass shaft as shown. These dimensions were chosen to enable a piece of threaded brass nipple to fit snugly over the brass shaft. If you don't have lathe facilities use a threaded bolt $\frac{3}{8}$ " in diameter and about 3" long. The brass shaft or threaded bolt should be placed in its hole and firmly bolted to the board.

Still working on the same piece of

wood, you must now cut a hole in it for the motor assembly. Also cut slots in it to receive the motor assembly support screws. Mount the motor assembly on the board and arrange the holding bolts to be a "sliding fit." The motor assembly must be free at all times to slide about $\frac{3}{4}$ ". One end of a small spring should be connected to the motor assembly and the other end is attached to a fixed point.

To support this entire assembly cut two pieces of wood 13" by $5\frac{3}{4}$ " and attach one of these to each side of the assembly. All of this will become clear if you study the accompanying drawings.

Since the normal running speed of the motor is too fast to be used directly we must slow it down with a gear that also serves as the "code wheel." Cut a circular piece of plywood 10" in diameter. The center hole should be $\frac{1}{2}$ " in diameter to receive a $\frac{3}{8}$ " (I.D.) piece of threaded nipple. This size threaded nipple was chosen because of the brass shaft dimensions. If you are using a threaded bolt of a diameter different from the shaft, then select a piece of threaded nipple to fit this.

Slip the section of threaded nipple through the hole in the code wheel, place a washer on each end and a nut on each end.

The dialing is accomplished by placing $\frac{1}{2}$ " round head brass wood screws around the upper edge of the code wheel. The "stop ramp" is a piece of

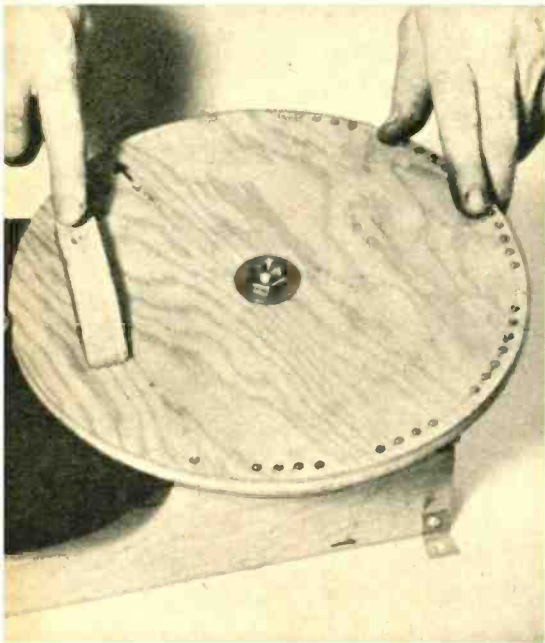

After one rotation of the code wheel, the stop ramp on the left operates microswitch SW3.

$\frac{3}{4}$ " by 4" with one end beveled. It is placed so that when the machine has dialed the number once it will shut the motor off by tripping a microswitch.

To install the code wheel, pull the motor assembly against the holding spring, drop the code wheel on its shaft and release the motor assembly. The holding spring should keep the rubber covered spindle in good contact with the code wheel at all positions of rotation. Test it once by putting power on the motor.

The "dialing arm" is a piece of wood about 15" long by $\frac{3}{4}$ " square. It is attached to the baseboard by means of two vertical posts. The "fulcrum" is a 2" No. 8 machine screw. This must be a loose fit so the dialing arm can move up and down easily. Reduce side play to a minimum.

Two solenoids must be attached to this arm. SOL2 is under the arm so that it will pull it down against the telephone button contacts on the cradle. The other solenoid, SOL1 is over the arm so that weight of its spring-loaded plunger will hold the cradle buttons down until the

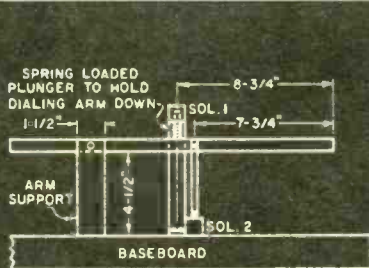

IF THREADED BOLT IS USED, 2 NUTS TO HOLD ON MOTOR BOARD

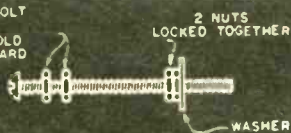

IF SHAFT IS TURNED ON LATHE -

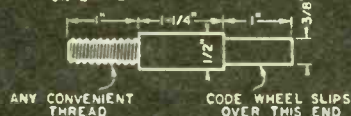

Dimensions for the dialing arm assembly. Code wheel is supported by this axle shaft.

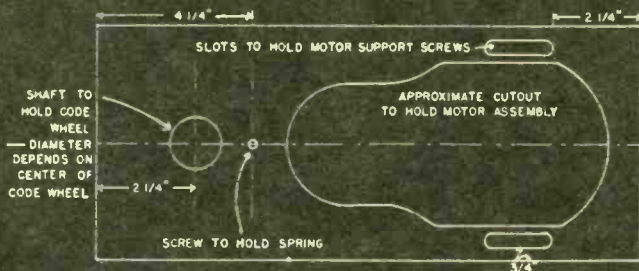

Top of motor board with location of cutouts.

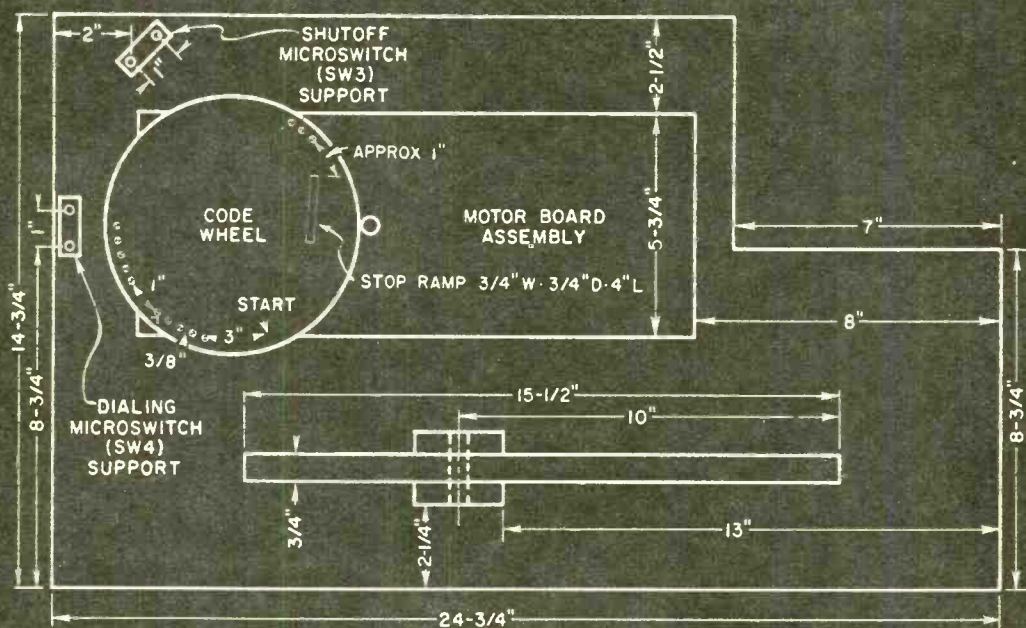

Overall top view of the baseboard. Position motor board and dialing arm using this guide.

moment when the whole unit goes into action.

After you have mounted the dialing arm and its associated solenoids you can begin wiring. Check carefully when you hook up the relays. There is a possibility here of making some time consuming mistakes.

The entire circuit can be put together on a piece of perforated phenolic board 3" by 7". Mount it on the baseboard with aluminum brackets in the location shown.

The buzzer is the ordinary 6-8 volt household variety. A bell works just as well. Any convenient spot on the baseboard will do.

Lastly you must mount the two microswitches. SW4 is the dialing microswitch and it should be mounted using a heavy piece of aluminum in such a position that its lever is pushed up and down by the small screw heads on the code wheel. SW3 is mounted in the same way but extends a bit further in on the code wheel. It will be pushed up when the stop ramp rides under it.

When you make the code wheel you can decide what number the unit is to call in an emergency. This is done by the arrangement of the small 1/4" screws mentioned before. However, for testing purposes it is a good idea to first set it up for the telephone number of the phone it will work with. In this way you will get a busy signal for checking out the circuit.

[Continued on page 96]

PARTS LIST

- RY1—Amperite thermal delay relay, normally closed, 115 volt, 180 seconds
- RY2—3-pole double-throw 115 volt AC relay (Potter & Brumfield KA14AY)
- RY3—Double-pole single-throw relay, normally open (Coil voltage selected to operate from voltage supplied by external fire or burglar alarm. Coil should be selected for continuous service)
- SW1, SW2—Part of RY3 (see text)
- SW3—Single-pole single-throw microswitch. Lever arm must have roller
- SW4—Single-pole single-throw microswitch with lever
- SOL1—Lift solenoid (Guardian 4AC-117-1)
- SOL2—Dialing solenoid (Guardian No. 12)
- T—Filament transformer, 117 volt AC to 6.3 volts
- M—78 rpm turntable motor (Lafayette ML-13)
- Pilot bulb—7 1/2 watt, 117 volt
- C—4 mfd. capacitor, 400 volt
- Buzzer—Household type 6-8 volt AC

EI assembles The Mohawk Ham Receiver

The most advanced receiver ever offered in kit form features a factory sealed and aligned tuning unit.

LET it be said immediately: the Heathkit "Mohawk" is a construction job that separates the men from the boys. This is a massive 15 tube, ham band only, double-conversion superheterodyne weighing more than 50 pounds without its external loudspeaker. It is definitely intended for experienced technicians who have spent a lot of previous time poking around electronic chassis of various kinds with soldering irons and voltmeter probes.

The Mohawk is a high-grade communications receiver and by its very nature is a complicated piece of equipment from both the electrical and mechanical standpoints. What makes it a practical kitchen table project is its clever electrical and mechanical

Complete stock of parts and instructions supplied with the kit. The wired tuning assembly (receiver front end) is at center, partially in cabinet.

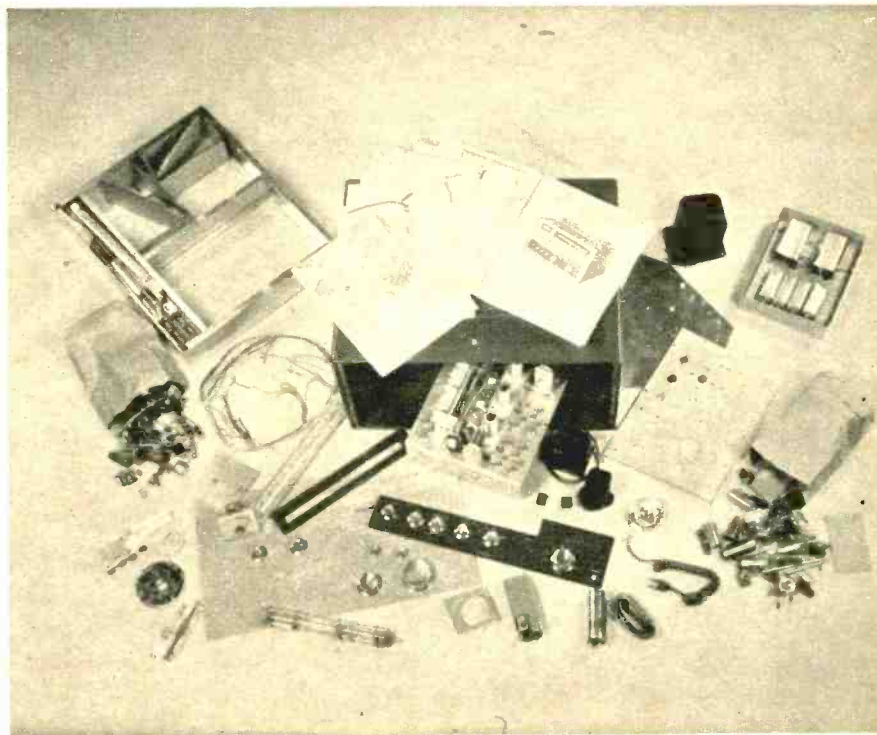



Receiver and matching speaker cabinet. As the bandswitch on the lower right is rotated each band appears in the window.

This rigid framework supports the 2 major subchassis. Long shaft with components is switch assembly for controlling selectivity.

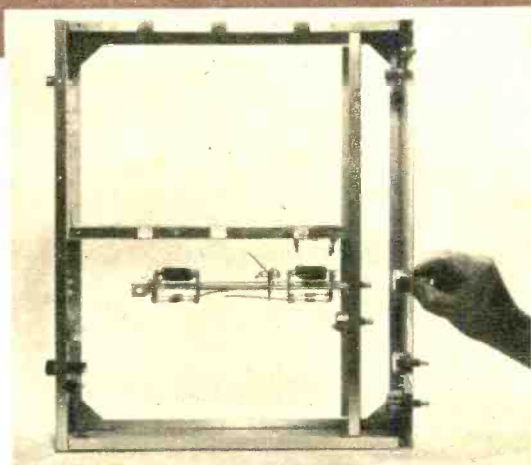

The major part of the assembly and wiring time is devoted to work on this subchassis. It contains both the IF and audio circuits.

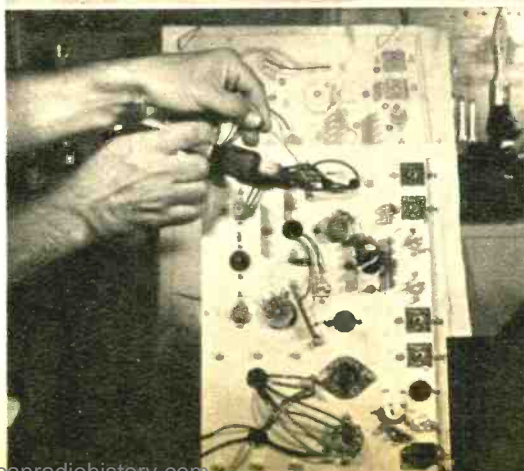

January, 1959

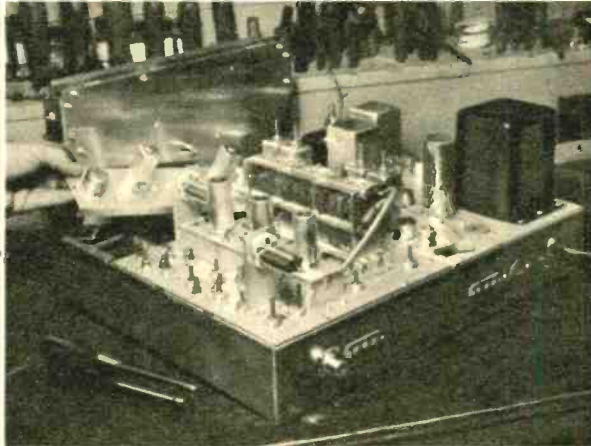
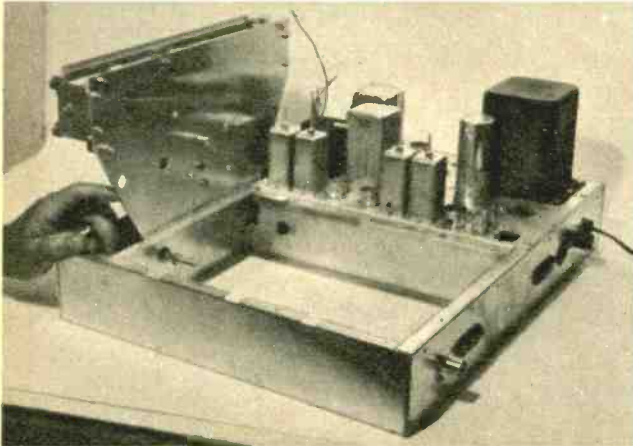
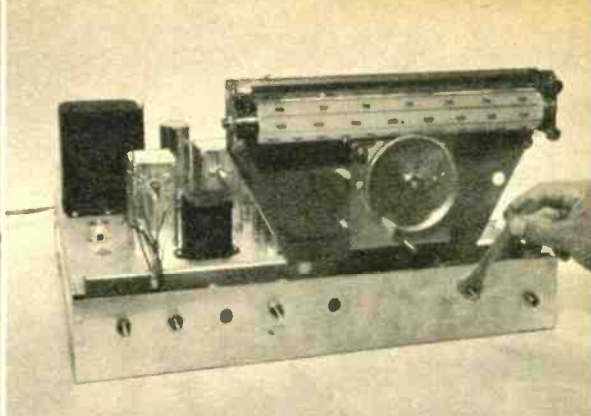
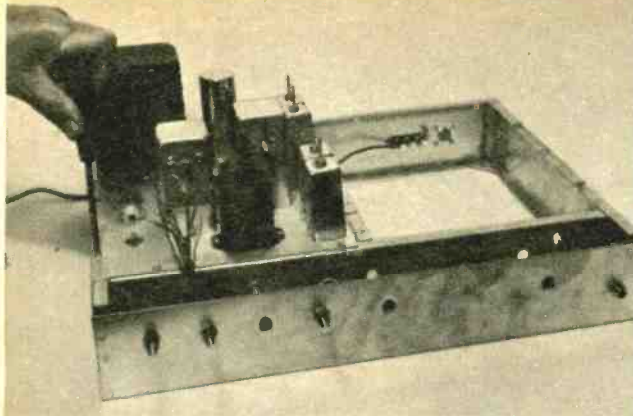

When the IF-audio subchassis is completed it is mounted and bolted to main chassis frame.

Top shows dial drum mechanism. Band selector (being tightened) rotates it through gears.

Chassis ready to receive front end. Antenna, speaker, control wires connect to rear apron.

Front end is now in place. The small chassis being slid into position is 1682 kc IF strip.

design. For the assembly operations you need only the usual screwdrivers, pliers, nut drivers, soldering iron with small points, large supply of solder, strong overhead light, good eyesight, and a reasonable amount of patience. For the alignment and other adjustment operations you don't need anything besides a loudspeaker or a pair of earphones.

That old bugaboo about alignment which has kept multiband ham receiver kits off the market until now is neatly erased in the Mohawk by two expedients. First, the entire "front end," consisting of RF amplifier stage, local oscillator and first mixer, and its associated tuning controls, is furnished as an assembled, wired, *prealigned*, and sealed unit. This merely drops into a big hole in the main chassis, picks up its heater

and plate voltages from the latter, and feeds the first IF signal, at 1682 kilocycles, into the IF section of the set.

Second, a built-in 100-kilocycle calibrating oscillator and the beat frequency oscillator, connected in the usual manner to the detector, function as signal generators for the alignment of two 1682 kc transformers and four 50 kc transformers. The latter is part of the second-conversion circuits. The alignment indicator is the signal strength meter integral with the receiver. With this arrangement, alignment is actually the simplest and quickest part of the entire construction effort.

Selection of upper or lower sideband mode of reception is by a two-position switch, which cuts in either of two crystal controlled oscillators. These do not

require adjustment. For best rejection of unwanted sidebands the 50 kc IF stages are tuned to 50.4 rather than to 50 kc. This signal is obtained from the BFO. First, the latter is adjusted precisely to 50 kc by zero-beating its second harmonic of 100 kc against the very conveniently available 100 kc signal of the crystal calibrator; the BFO pointer is then turned clockwise a hair to an index line on the front panel. This now represents the desired 50.4 kc.

The 100 kc calibrator itself is brought "on the nose" by trimming it against the well-known 10 megacycle signal of the Bureau of Standards station WWV. This frequency is quite separated from the ham bands, but the Mohawk is made to cover it via the 20 meter scale by the use of external, preset trimmers which are connected temporarily to the main tuning capacitor.

An entirely new dial mechanism, offering satin smooth tuning completely free of backlash, was designed for this receiver. It is something of a jigsaw puzzle to assemble, but once done it becomes a very interesting control.

A "slide-rule" type rotating drum

bears the markings of the ham bands from 10 through 160 meters, and an additional 2 and 6 meter scale for use with an external converter. This drum is tied to the bandswitch, and when the latter is turned only, the corresponding scale pops into view. Stringing the dial pulleys together took your *EI* reviewer the best part of a whole day, but he could do a second job in half an hour.

Actual operation of the receiver immediately pointed up the value of some of its features. The dual conversion design contributed to excellent rejection of undesired "image" frequencies.

Annoying whistling (heterodynes) and overlapping signals could effectively be tuned out with the selectivity control. It's a T-notch type with five positions.

The finished Mohawk presents a stunning appearance. The panel is a cream gray, the cabinet and all the trim a contrasting blue green, and the special knobs bright aluminum. It's a real eye stopper, and what's more important, it works beautifully.

The kit costs \$275. A matching loudspeaker is available for a few dollars. ●

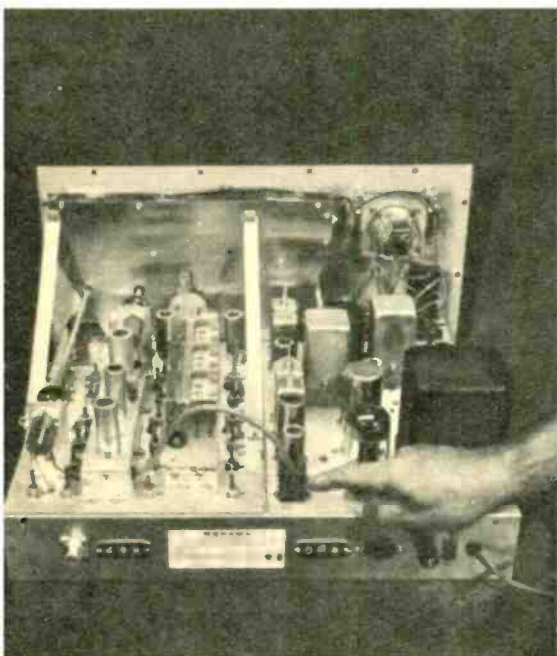

Rear view of completed chassis. Finger points to plug that carries power to RF deck at left.

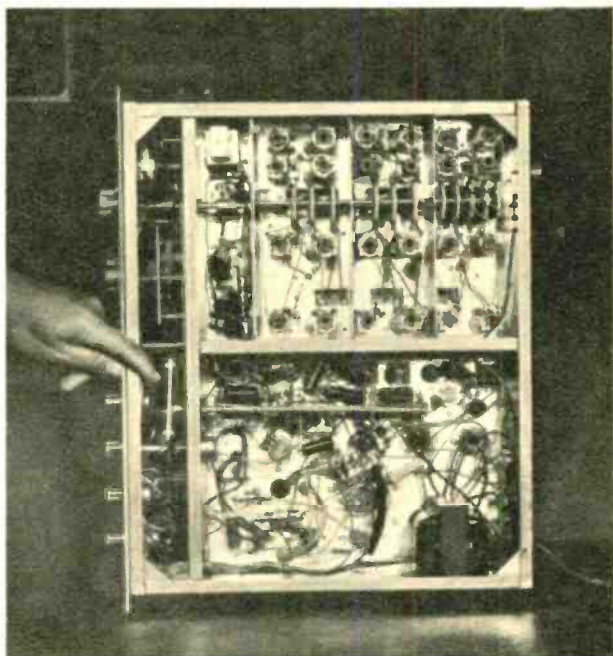

Underside view. Upper half (RF deck) is all factory wired. Below it is the IF-audio deck.

The Electronic Brain

The Brain will answer any questions dealing with the field of electronics. If your question is of general interest it may appear in a future column.

TV Antenna

Can you provide constructional details for a TV antenna that will perform well on Channels 3 through 5 inclusive?

C. W. Sweet, Ontario, Canada

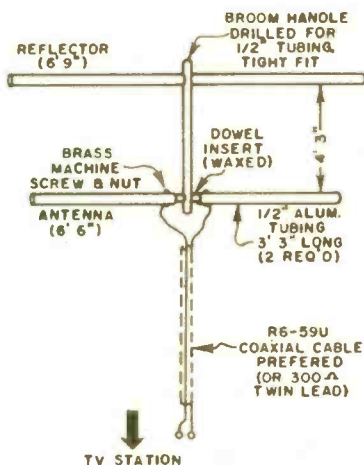

Although your letter does not state whether or not you are in a "fringe" area, we shall assume that the TV signals in your area are reasonably strong making it unnecessary for you to plan on a high-gain beam installation that might be too complex for your needs.

A single antenna for Channels 3 through 5 should be cut for best reception on 71 MC since this frequency is exactly midway between the ends of the range desired. Using the equation:

$$\text{Antenna length} = \frac{462}{f} = \frac{462}{71} = 6 \text{ feet, 6 inches}$$

The material used for the antenna should be aluminum tubing about 1/2" in diameter. Measure out a length exactly 6 feet, 6 inches in length and cut it through the exact center, giving you two pieces each 3 feet, 3 inches long. Support these on a piece of Bakelite rod (or wood, if the latter is wax impregnated

with paraffin) as shown in the diagram. The machine screws should be brass and are used to make connection to the transmission line.

The reflector should be proportioned and spaced behind the antenna as shown in the drawing, and should also be cut from 1/2" aluminum tubing stock. A well-varnished broom handle or other round insulating material is used to space the two elements as well as to serve as a support for the antenna and reflector.

Testing with a VTVM

Is there any way of testing either transistors or capacitors with a VTVM?

Tom Riggs, New York, N. Y.

Transistors cannot be tested accurately or safely with only a vacuum tube voltmeter. To be certain that a transistor will perform as it should in a circuit, it is necessary to determine the effect of changes in emitter and base current upon collector current at various frequencies. A VTVM cannot do this.

On the other hand, the condition of capacitors usually can be ascertained with a VTVM. A capacitor between 0.1 mfd and 1.0 mfd is good if it reads as an open circuit (very high resistance) when the meter is set up as an ohmmeter on the highest scale. Capacitors higher than 1.0 mfd in value are usually electrolytics and are in good condition if they give readings on the ohmmeter as follows: when the leads are first connected across the capacitor terminals, the ohmmeter will drop to a relatively low resistance reading on the scale. As the capacitor charges from the VTVM power supply, the resistance will increase until it has risen to one megohm or better. The larger the capacitance, the lower the final resistance reading will be. A bad capacitor will indicate zero resistance (short-circuit) or a stable low resistance. —

Heart trouble now can be diagnosed with an amazing little microphone that goes through your arm to get . . .

Inside Your Heart

By Donald C. Hoefler

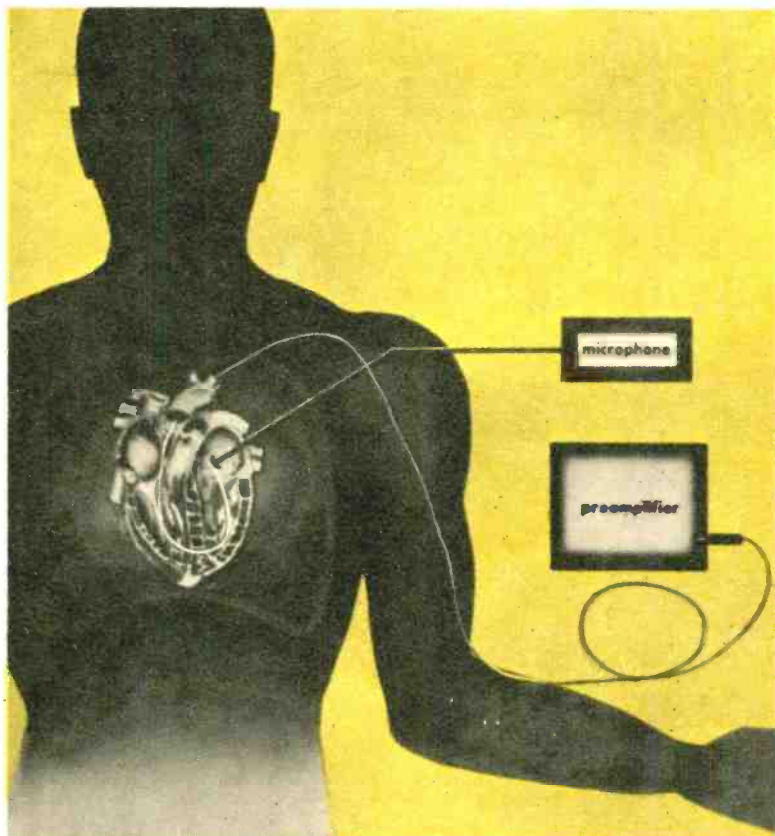

Tiny microphone and cable, connected to preamp, is placed in heart painlessly by maneuvering it through vein in arm, over shoulder, into auricle.

MEDICAL discoveries, from penicillin to the Salk polio vaccine, are great moments in history. But one advance just as important owes its existence to the science of electronics and to a devoted physicist at the Navy undersea warfare laboratory.

It is often jokingly said that all death is due to heart failure. When your heart stops, that's all. But the grim fact is that heart and circulatory breakdowns are by far the greatest killers known to man. At last there has been a scientific breakthrough which may change all that.

You have undoubtedly felt a doctor's cold stethoscope on your chest at one time or another while the doctor tried to figure out

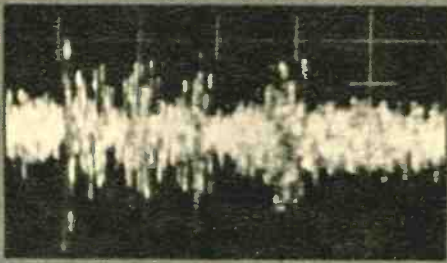

Top, Sputnik II (Laika) signal on oscillograph. Bottom, mike signal from heart of U. S. dog.

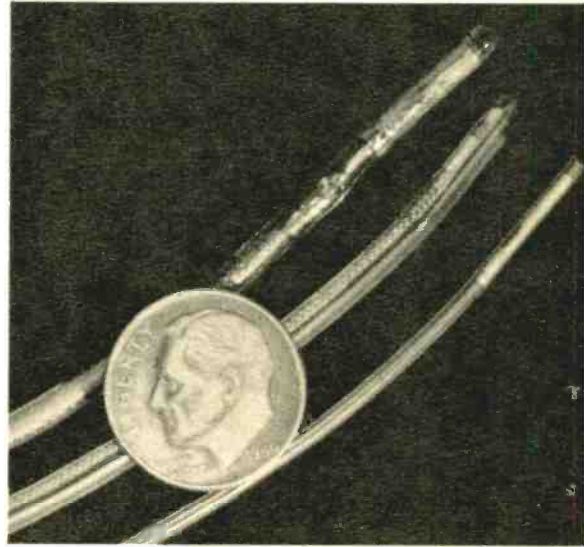

Three versions of small ceramic heart mike and thin cable are compared with enlarged dime.

Diagram below indicates main areas of human heart. Heart disease is number one killer.

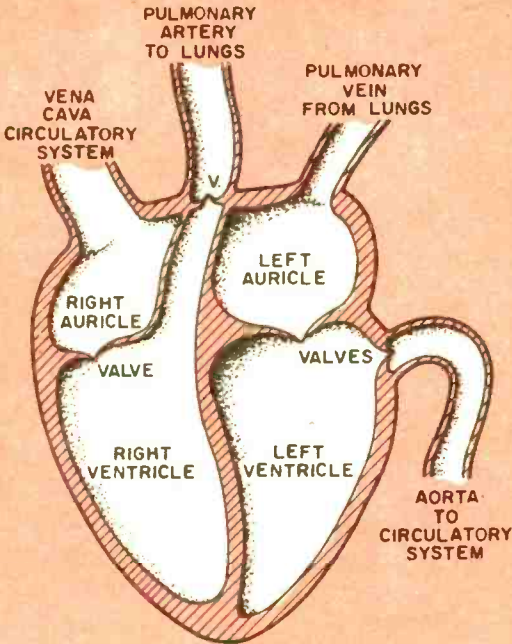

what your heart was doing. The stethoscope, with its curved ear pieces and rubber tubes, has been used by doctors for over 140 years. The only significant improvements on it have been the introduction of a contact microphone, electronic amplifier and earphones.

The stethoscope has one major disadvantage. Amplified or not, it still hears the heart from outside, after the sounds have traveled through the heart walls, through the chest, between or through the ribs, and finally through the skin. In getting through these acoustic barriers, the sounds are weakened about 80 decibels. Furthermore, all the various heart sounds merge together, regardless of where they originated. The result is something like listening to a dance band two doors down the hall, while each musician is playing a different arrangement of the same tune.

The only way we can really tell what the heart is doing is by listening to it from the inside of each one of its four chambers. But how? First you get a sensitive microphone smaller than a grain of rice. Then you enclose it with a pair of wires in a plastic tube hardly thicker than a piece of string. And then you work the mike and its cable right into the chambers of the heart.

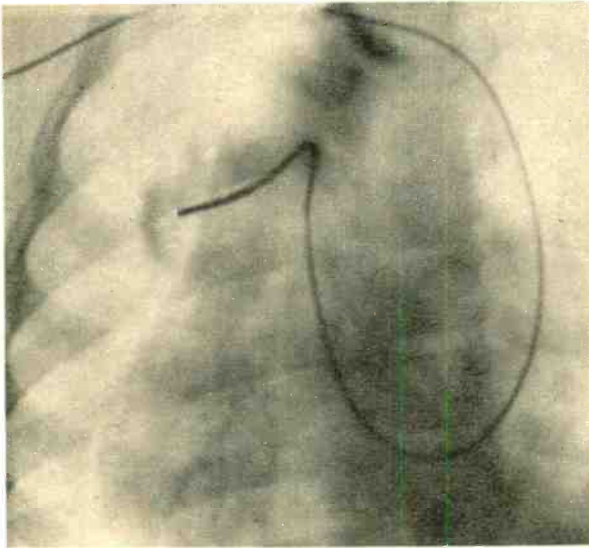

X-ray photo of mike in heart of 4-year-old girl, first human patient. Her trouble was cured.

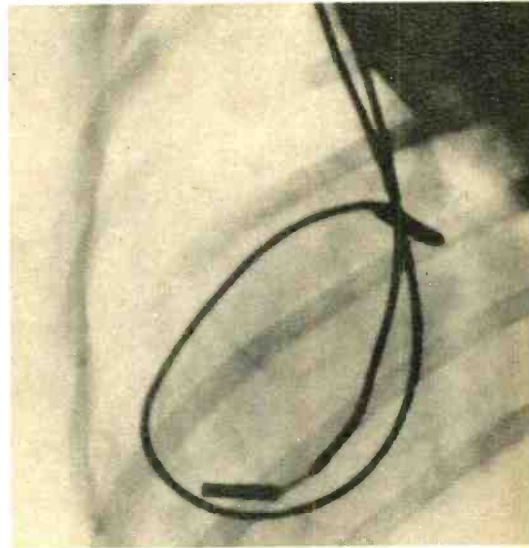

Two mikes in dog's heart, one used as speaker, measured sound isolation through heart wall.

The beauty of this phonocatheter, as it is called, is its simplicity of equipment, use, and the ease with which its signals can be interpreted. This development, which has already prolonged hundreds of lives, was originally the brain-child of John D. Wallace, a specialist in underwater sound at the Naval Air Development Center (NADC), Johnsville, Pa. In the course of sonar work, he developed and patented a new method of imparting piezoelectric properties to a ceramic. From this came a number of underwater microphones which are quite similar in principle to the familiar ceramic phonograph cartridge.

The heart microphone is very much smaller than the ceramic phono pickup, however. And while the output of the pickup is about a volt, the output of the heart mike is only about 10 microvolts.

Even having perfected the microphone, there was still the problem of miniature cable and tubing, which Wallace solved and for which he was presented a miniaturization award at the Institute of Radio Engineers 1958 convention.

Wallace enlisted the aid of James R. Brown, Jr., an electronic engineer, to design a preamplifier. The first circuit used all vacuum tubes, but later tran-

sistors took over, except in the first stage, which requires a tube to permit a sufficiently high input impedance. The system is truly hi-fi, with flat response from 3½ to 17,000 cps. The preamplifier can feed a variety of readouts, such as earphones, tape recorder, pen recorder, oscilloscope, or audio amplifier and loudspeaker.

To consider practical applications, Drs. David H. Lewis and George W. Deitz, both of Philadelphia General Hospital, joined the research team. They suggested two methods of getting the tiny mike into all heart chambers. In one method, the catheter is introduced into the vein in the arm, the same one used when you contribute to the Blood Bank. The process is practically painless, and no general anesthesia is needed. Local anesthetic may be applied at the small incision where the tube enters the arm. The microphone end of the tube is then threaded through the veins over the shoulder into the right side of the heart. Entering from the top (vena cava) the cable can get into both right chambers, through their valves, and even into the pulmonary artery which carries blood to the lungs.

To get to the left side of the heart by
[Continued on page 104]

Soviet Solar Switch

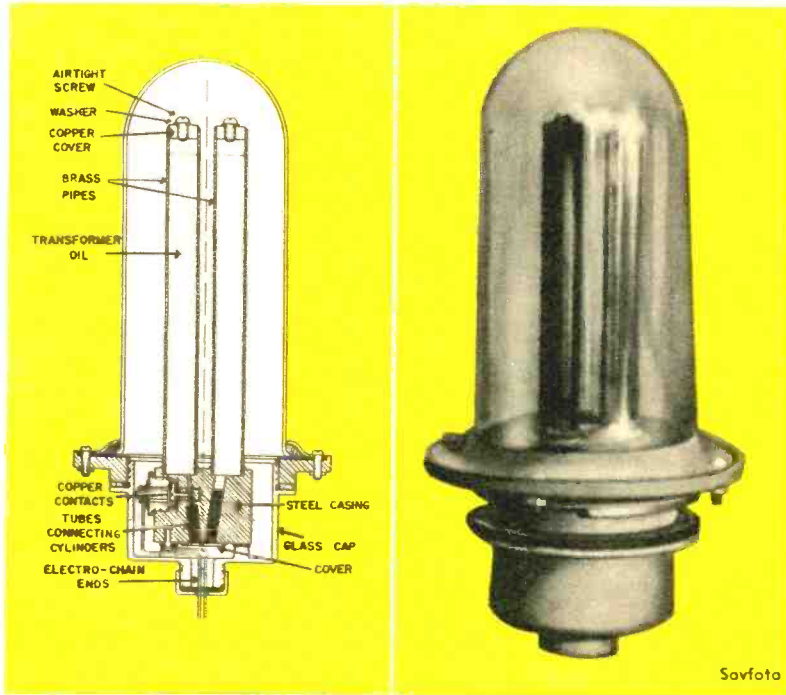

In sun switch, dark tube heats more intensely than white, expands oil which pushes mercury (heavy black in diagram) in narrow tube, breaking contact.

SHORE lights and channel buoy bulbs along Russia's busy Volga-Caspian seaway have been automated under sun control by use of a new sun-actuated switch termed a "solar hydraulic electroswitch." It has no photoelectric cell, no clock mechanism, requires no servicing, yet can always be relied upon to turn on the lights when the lights are needed.

Here is how it works: The switch has two tubes; one coated with lampblack, the other with a surface of white, shiny nickel. As the sun shines upon them, the dark tube heats up, while the shiny one remains relatively cool. This is the same principle that explains why people in the tropics wear white clothes to reflect and not absorb heat.

Inside the switch's two tubes, columns of oil expand and contract with changing temperatures of day and night. This motion operates a sliding switch (in this case mercury) to turn the buoy lights on and off at the proper time, depending on the actual amount of solar energy.

Heavy traffic of Baku oil tankers and grain boats continues at all hours, in fog and darkness, and this switch has been a reliable navigation aid. Oxidation and burning out of the contact are excluded because it breaks and closes the circuit not in the air, but in transformer oil. The unit is sealed under glass. ●

Henry and Me

Electronic Handymen

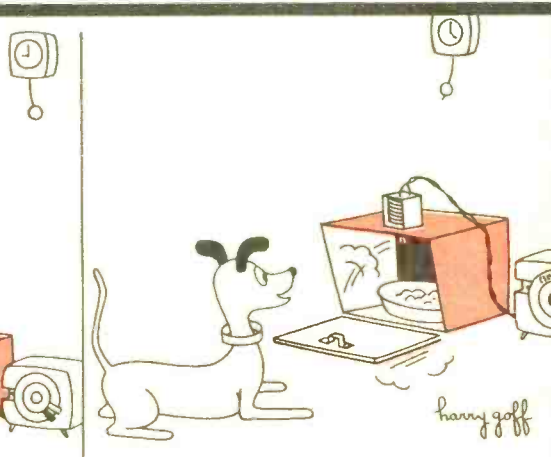
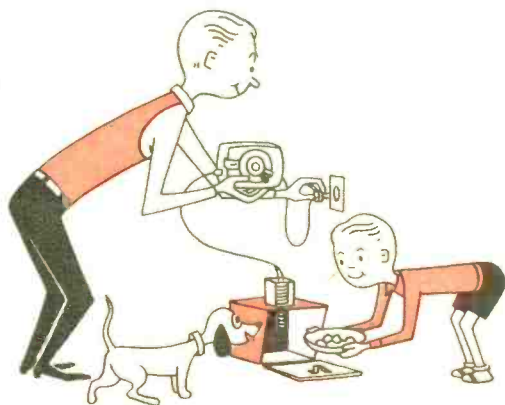
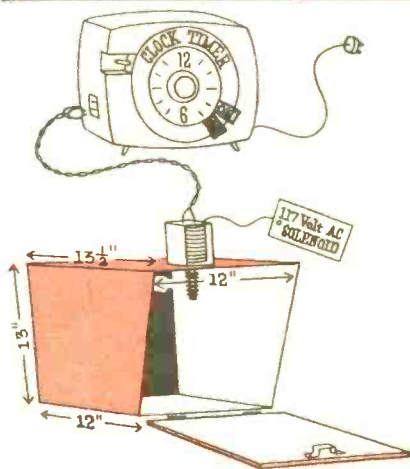



The basic materials required for plating the belt buckle and key are shown above. The only additional items necessary are vinegar and some acid from car battery.

The preparation of the plating solution. One tablespoonful of copper sulphate is mixed with one cup of water. Sulphuric acid is then added with an eyedropper.



Prior to plating, the buckle should be boiled in a mild acetic bath of vinegar and water. This is an important step to remove all traces of any dirt or grease.



Copper Plating at Home

By Paul Hertzberg

Protect and beautify metal, wood, leather, and clay articles with a coating of copper.

MANY items such as keys, costume jewelry and tools can easily be copper plated. The materials needed are simple to obtain. An ordinary drinking glass or jar makes a fine container for plating. One tablespoonful of copper sulphate (commonly called blue vitriol) should be thoroughly mixed with each cup of water used to make the plating solution. To this add a few drops of sulphuric acid. If you can't obtain the acid at your local pharmacy, "borrow" an eye-dropper full from your automobile car battery. Extreme care should be taken when handling acid because it can burn holes in your clothing and cause skin irritation. Wash your hands thoroughly with plenty of water if any acid spills on them.

The object to be plated must be thoroughly clean. Copper will not stick to a surface that has the smallest piece of dirt, oil or grease on it. Kitchen "Brillo" makes a fine job of the cleaning process. Fine grades of sandpaper also may be used. The next step is to carefully hook a stiff piece of wire onto the object to be plated and lower it into a boiling solution of about one pint of water and one ounce of vinegar. It is important not to touch the object because your fingers are naturally a little oily.

While the object is being boiled, connect one length of wire from the positive or center terminal of a dry cell to a piece of copper. Any scrap piece will be fine for the job, such as roof flashing. Hook the copper over the edge of the jar and into the copper sulphate solution. [Continued on page 104]

The negative terminal of the battery, lower left, is attached to the buckle. The positive center post is wired to the copper strip hooked on the side of jar. The plating action is permitted to continue until the desired effect is achieved. Wooden objects, center, are varnished and dusted with copper bronze powder. Use big container, lower right, and battery charger for larger objects.

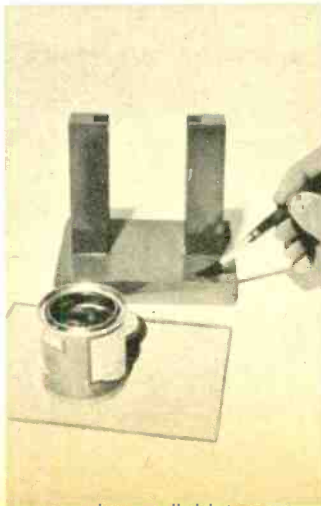

All About Short-wave Listening-2

By Jack Gould

Radio-TV critic, N.Y. Times

Your receiver will give you much pleasure, but like any instrument, you should learn to use it properly.

GETTING the most out of a short-wave radio receiver is like getting the most out of a car: it helps if you know how to run it.

With a regular broadcast set that picks up the familiar standard stations in one's locality it is common practice to whisk the dial across the range of transmitting outlets. Usually, the more powerful stations are spaced sufficiently apart so that it is no trick to find one's favorite program.

If the same method of tuning is followed in short-wave radio the set owner is apt to think he has eavesdropped on a convention of peanut vendors. The bedlam of whistles, squeals and howls may make him wish Marconi had taken up knitting rather than electronics.

In short-wave radio there is a basic admonition that governs tuning: take it easy. The main tuning dial should be turned with

Ham radio Red Cross volunteers often pitch in where needed to provide mobile communications at disasters. They can be heard on a home receiver.





Radio Japan's kimono-clad singer may get you a QSL card bearing ancestral counterpart if you acknowledge receiving the program.

Additional dials on face of short-wave receiver serve to capture weak signals and help minimize effects of static and interfering stations on the desired signal.

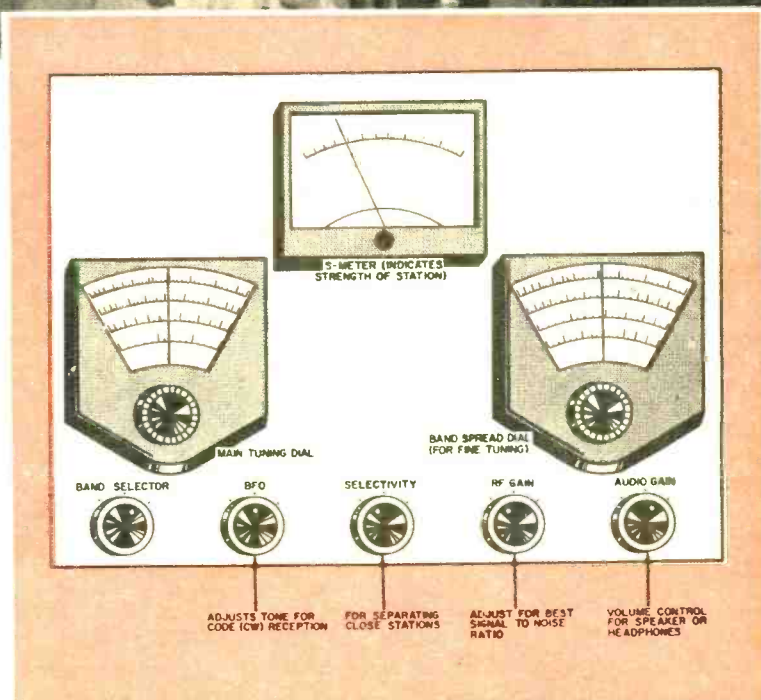

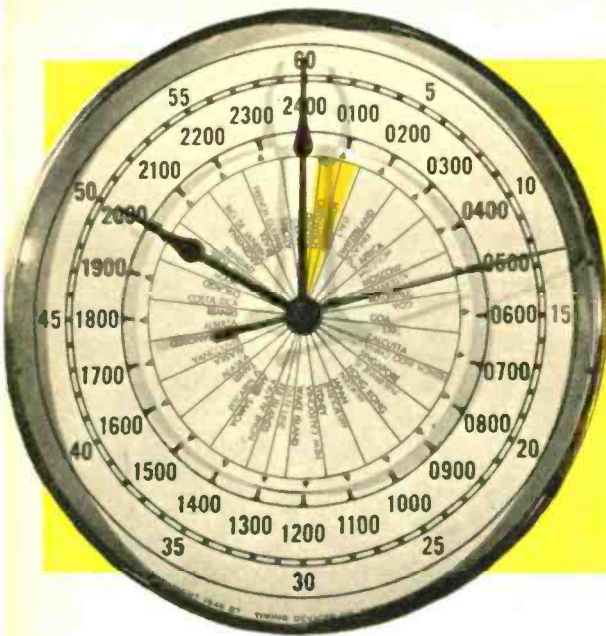

The 24-hour clock helps listener keep track of schedules, enables him to log programs accurately. Minute and second hands remain universally the same, but hour differs from zone to zone. International point of reference is Greenwich Mean Time (G.M.T.), the time at Greenwich, England. You should determine the difference between G.M.T. and your local time zone. International time-telling is based on 24 hours rather than 12. Instead of repeating cycle, 12 hours represent only half of clock face. One p.m. would be 1300, and time of 2000 (four hours short of 24) would be 8 p.m. local time in lay language.

infinite patience and deliberation. The dial marker itself—a mere fraction of an inch in width—may span two or three separate stations. Quite literally a broadcast from London may be removed by only a hair from a transmission from Moscow or Stockholm. Realistically, the main tuning dial should be considered as something of a precision instrument to be moved with great delicacy and care.

On short-wave radios designed primarily for reception of international broadcasts, as opposed to those which treat short wave as something of an added sales "gimmick" for a conventional set, engineers have substantially eased the tuning problem. This is done by a supplementary tuning dial known as the bandspread dial.

The main tuning dial may be set at a given frequency, say 10 megacycles. Then the bandspread dial may be employed to tune in stations immediately below that frequency. Not even the bandspread dial will guarantee complete freedom from overlapping of stations—the overcrowding of the short-wave spectrum in itself is a matter of international concern and often antagonism among nations. But the supplementary dial does aid enormously in providing reception pleasures.

There is another fundamental trick to

short-wave tuning. On a conventional set the channel on which a station broadcasts may be regarded as a letter "V." The station is properly tuned when the tuning dial hits the bottom of the "V." Rock the tuning dial of any set—slowly pass back and forth through a station—and a listener can tell by ear when he has hit the "notch." In short wave a measure of "cheating" may be both desirable and necessary. If interference from a second station is encountered when tuning to the "notch" adjust the tuning dial so that it is just a shade off center. This may cause the voices and music to sound a bit higher than normally but it can be a helpful way to avoid interference.

After a short-wave listener has had his first experience in hearing a voice from thousands of miles away he is almost certain to be bitten by the bug for "DX." This is the code abbreviation for the word "distance." Once a short-wave listener has his set in operation, he quickly becomes conscious that he is the possessor of an instrument that performs differently under different conditions and circumstances.

In this regard there are several factors worthy of mention: (1) The aerial for a short-wave receiver; (2) Knowing when and where to tune; (3) calculation of the global differences in time;



Israeli disk jockey spins platters of his nation's music. His equipment is newer than. . . .



. . . jury rig deep in once isolated Tibet. Short-wave radio brings nations closer together.

(4) How to prove to sceptical friends that, via radio at least, you know your way around the world.

The choice of an aerial for a short-wave receiver usually involves a certain amount of elementary experimentation for the attainment of maximum results. Not even the most gifted scientist can know in advance the precise location in which a set is to be used and its local electronic advantages or disadvantages. The embryo do-it-yourselfer, be he eight or eighty, should have no difficulty in fixing up a satisfactory antenna.

With the popular superheterodyne type of receiver it is often necessary to use only fifteen or twenty feet of wire to hear a good many countries. In fact, sometimes a short antenna may have an advantage in that it tends to cut down the volume of some near-by stations that either come in too loudly or tend to "splash" all over the dial.

But a longer straight wire often is helpful. If you can string up thirty to fifty feet of antenna wire from a tree to the side of the house—the wire should be "interrupted" by glass insulators at either end—and lead it to the aerial post on the receiver, distant stations generally will be heard more clearly.

The short-wave fan in due course may find different types of aerials fascinating to play around with but at the outset

there is a more important matter. In short-wave radio different frequencies are heard better at different hours of the day during different seasons. Similarly, different frequencies are employed to reach different parts of the world. For instance, the British Broadcasting Corporation, which conducts a round-the-clock short-wave service to all parts of the world, uses 177 different transmitting aerials on multiple frequencies to furnish the best signals everywhere.

After using a short-wave set for a few days a listener soon becomes acquainted with the virtues and defects of different frequencies. As a general rule, if you wish to hear distant stations between dawn and mid-afternoon you should tune to stations operating on such frequencies at 17 megacycles (16 meters) and 15 megacycles (20 meters). From mid-afternoon until after darkness you should move to lower frequencies—11 megacycles (25 meters) and 9 megacycles (30 meters). In mid-evening you find that 7 megacycles (41 meters) and 6 megacycles (49 meters) come "alive."

But these suggestions should not be regarded as inflexible. Short-wave radio has a habit of not following any set rules for too long and you should try different frequency bands at different hours of the day to become familiar with the

[Continued on page 108]

A 50¢ Mike Stand

By Art Trauffer

This versatile stand will hold a microphone three ways—on a desk, on a floor stand, or for hand use.

WHETHER you use a microphone with a tape recorder or public address system this streamlined and versatile stand will do it justice. As shown in the illustrations it is simple to build and should take no more than two hours of your time.

First make the paper template. Lay it on top of a piece of hardwood measuring about $5\frac{1}{2}$ " by $6\frac{1}{2}$ " by $\frac{7}{8}$ " thick. Trace around the template with a pencil, and saw out the base using a jigsaw or coping saw. Sand it smooth and round off the edges as shown.

Obtain a piece of wood dowel or broomstick handle of the correct diameter to fit the handlebar grip snugly. Referring to the drawing saw off a piece of dowel about $3\frac{1}{4}$ " long and make the cut at a slight angle, as shown. The dowel is mounted on the base about 2" back from the front edge with glue and a long flathead wood screw. Prebore the base and dowel with a small drill and

Lower left shows the completed model. Note handlebar grip used to support the mike.

The connector mounted on grip is for physical support, no wiring connection is made to it.



countersink for the screwhead before twisting in the wood screw. The writer gave his base two coats of flat brown paint that pleasantly contrasts the red handlebar grip. Glue a piece of felt on the bottom side of the base or use three rubber tack bumpers.

Use an "NTD" plastic handlebar grip from Sears Roebuck or Western Auto and fasten an Amphenol 75-PC1M male chassis microphone connector into the end with two washers and locknut. The $\frac{5}{8}$ "-27 threads on the connector fits the stand socket on the bottom of your mike.

You will find that the plastic handlebar grip already has a small hole in the end of it, you need only enlarge it a little with a rattail file or small knife blade to fasten the chassis unit into it.

Some microphones have their cord connections right through their stand sockets. In this case, simply bore a small hole near the top of the grip to pass the mike cord and connect the cord connector to the amplifier in the usual way.

If necessary, bore a small hole in the top of the grip to let out air pressure when pushing it onto the dowel. —●—

The microphone is screwed on the grip. This assembly is lifted from dowel for hand use.

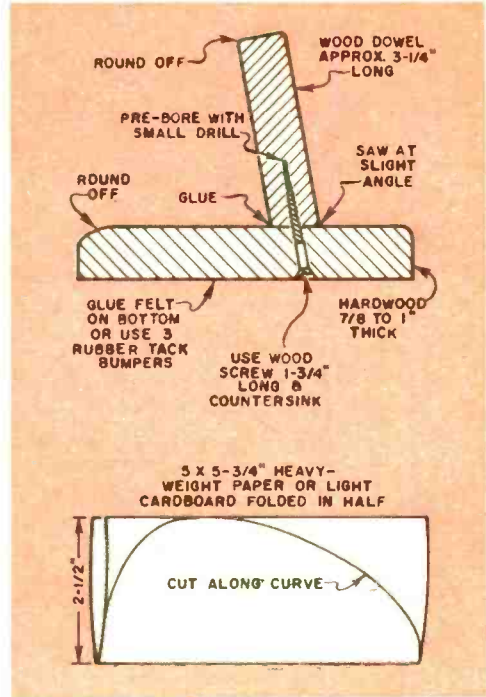

All the specifications appear in this diagram. Additional directions are found in the text.

To use the microphone on a floor stand simply slip the handlebar grip over a broom handle.



The ABC's of Electronics-7

By Donald Hoefler

Part seven in this series introduces alternating current, the most basic wave form in electronics.

UP to this point we have talked about the steady flow of direct current. A flow which periodically reverses itself is *alternating current* and finds wide application in power lines, audio and radio frequency oscillators, and transformers.

Although this flow is in many ways unlike the flow of water, a hydraulic analogy in this case will help in understanding the basic AC concept. In Fig. 1 we see how a piston, with a back and forth movement, could cause water in a closed circuit to reverse direction.

Suppose that initially the piston is at rest and the water is not moving. When the piston moves to the left from A to B, water will be pushed ahead of it and will close in behind it. The flow in the circuit will be around in the direction CDEF. When the piston reaches the end of its travel it will reverse direction. But note that momentarily, at the instant of reversal, both the piston motion and the water flow are stopped. Then the piston starts moving right from B to A, and the water now flows around FEDC. And so it is with AC.

Current starts at zero rate of flow and gradually increases in amplitude until it reaches a maximum in one direction. Then it gradually decreases until it stops altogether. Next it similarly increases to a maximum in the opposite direction, finally decreasing again back to zero.

This complete series of events is called a *cycle*, and the number of these cycles which occur in one second is said to be the *frequency* of a given AC current or voltage. Until now we have

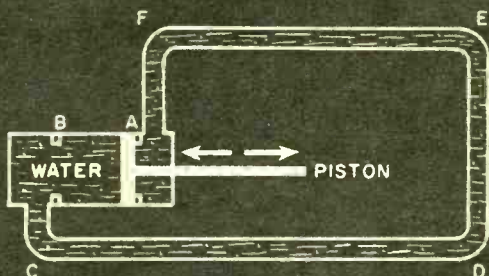

Fig. 1

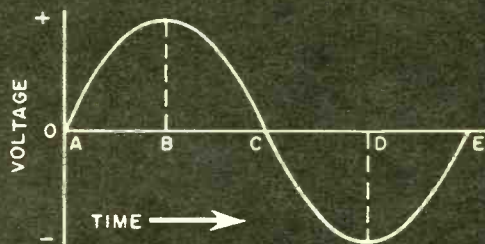

Fig. 2

been talking only about rate of current flow, but we already know that any such flow must have a propelling force to move it. This is the *voltage*.

The way in which an AC voltage changes with time is shown in Fig. 2. Beginning with that instant in time A, the voltage is zero, but begins increasing at once. By time B it has reached a maximum, and at C it has reached zero again and is ready to reverse direction. The opposite peak is reached at D, and the voltage is back to zero and ready to begin another cycle at E.

If the time from A to E is 1/60 second, then the frequency of this particular voltage would be 60 cycles. Ordinary power lines often use a frequency of 60 cps at a voltage of 110. But just what does this mean? We have seen that the voltage is constantly varying. At points A, C and E the voltage is zero, a far cry from 110. And at points B and D, as we shall see, the voltage is actually 154. Well then, where does the 110 come in?

This 110 volt figure is called the *effective voltage* because that is the amount of DC which would be required to do the same work. That is, an AC voltage which reaches momentary peaks of 154 volts won't get your toaster any hotter in the morning than 110 volts of DC. With a little simple arithmetic you can quickly prove that the effective voltage is only 70.7 percent of the peak, and that the peak is 1.414 times as great as the effective. It is important to remember that test instrument calibrations, as well as component ratings, are

normally given in terms of effective values.

An AC generator is basically a conductor moving through a magnetic field. This movement causes magnetic lines of force to be cut, and a voltage is generated within the conductor. In Fig. 3 we see the circular path which would be made by a single conductor rotating between the poles of a permanent magnet. When the conductor is moving at 90 degrees with respect to the magnet poles, the maximum lines of force are cut and the induced voltage is maximum. When the conductor is moving in line between the poles, or at zero degrees, the voltage is zero because no lines of force are cut.

All of the other values of voltage between zero and maximum must be generated elsewhere on the circle. We could determine from experiment that at 30 degrees of rotation the voltage is one-half the peak value, and at 45 degrees it is 0.707 times the peak. When we see this, the logic of the effective value becomes more obvious.

Now it happens that these fractional values turn out to be the trigonometric *sines* of the respective angles of generator rotation. For this reason the basic AC waveform is known as a *sine wave*. Waves which are not based on the sine are found to contain *harmonics*. In addition to the basic lowest frequency, there will also be present in the same wave multiples of the fundamental.

Next month we'll begin a discussion of inductance and capacitance and their place in AC circuits. —●—

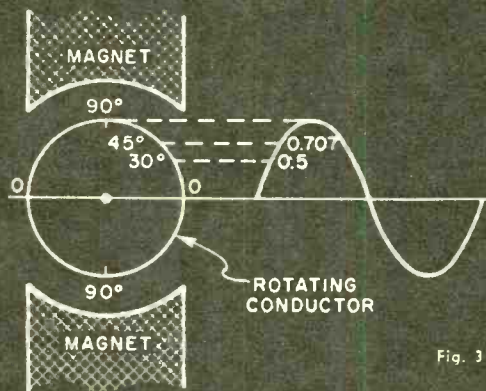

Fig. 3

Fig. 1. In this reciprocating pump analogy the current is represented by the water. The piston's pressure may be compared to voltage.

Fig. 2. The direction of current flow is indicated by the use of plus and minus signs. A complete alternation, or cycle, is shown here.

Fig. 3. An alternating current is induced in a coil when it rotates in a magnetic field. The resulting wave form is described in text.

EI assembles

A Hi-Fi Speaker System

This Knight-kit speaker enclosure includes 12-inch woofer, horn tweeter, and L-pad balance control.

IN the quest for a small, moderately priced speaker system with reasonably good bass response, manufacturers have come up with the "ducted port" enclosure. Simply stated, it leads the sound from the back of the woofer through a pathway that causes it to reinforce the sound issuing from the front of the cabinet.

This is the principle used in the Knight 2-way Speaker System (83YU789-C2) at \$49.95 net. It is called a system, rather than an enclosure since the speakers are supplied with the kit; a 12-inch Jensen woofer and horn tweeter.

Construction is very simple and the instructions are explicit. Work on a surface protected by soft material to protect the finish. Don't use staples for installing sound absorbing material, they will cut right through, instead use the flat head tacks provided in the kit.

Figuring price, appearance and pleasing sound, *EI* rates this system a good buy. —●—

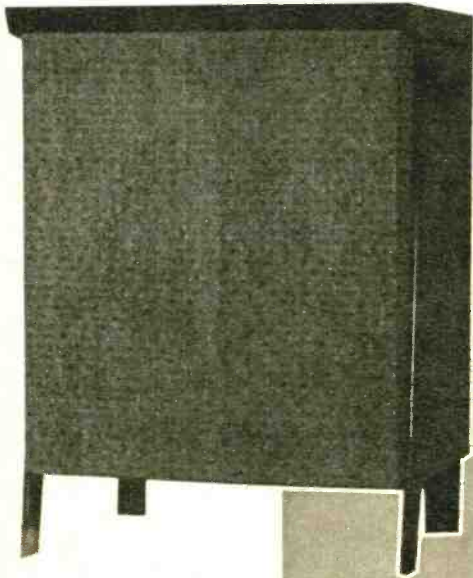

All the exterior wood surfaces are factory pre-finished. Below is a layout of all kit components.

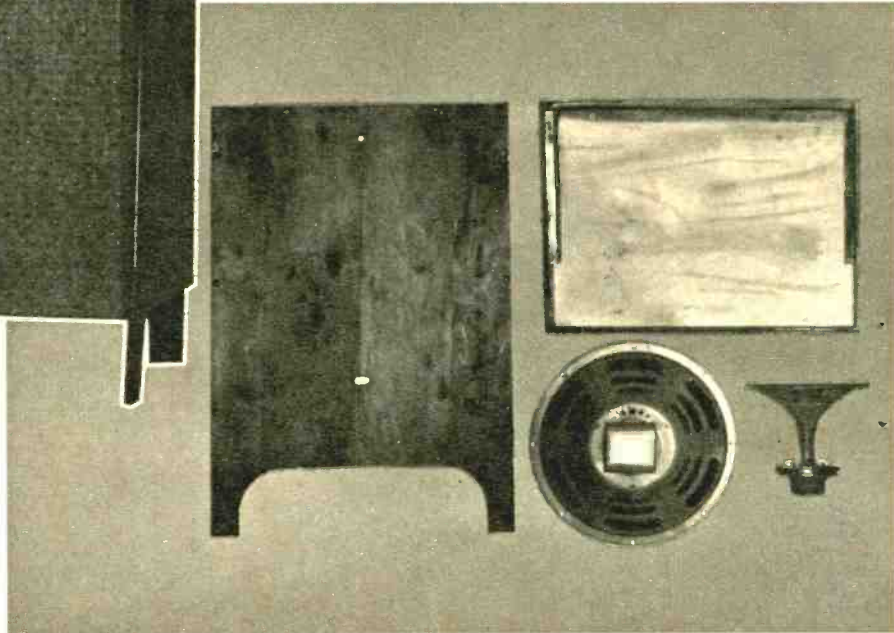

At right, cabinet sides are screwed to bottom.



This assembly is joined to top and front panels.



Then speakers are mounted on front panel and the L-pad is wired.



Far right. Mounting rear panel completes the kit.

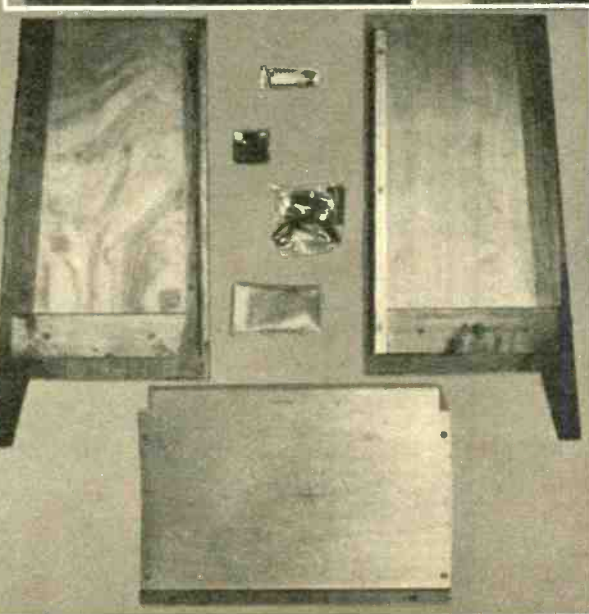
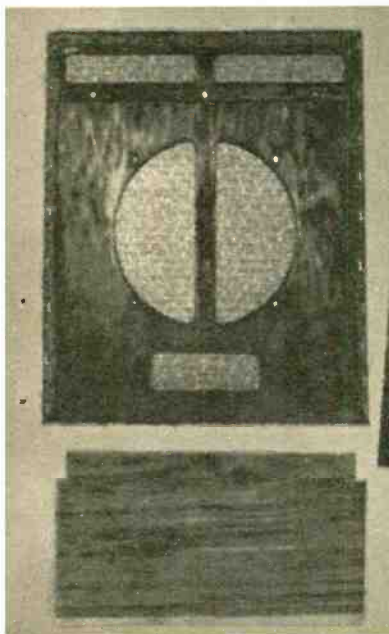

clean your records with this

Record Bath

By Paul Ross

THE finest hi-fi system can sound terrible if the disc being played through it is clotted with dust and grit. Most experts agree that the best cleaning agent for records is a water detergent mixture. The record bath shown here can be made with a rectangular watertight container, a piece of wood for the base, 2 wooden posts for uprights, 4 cuphooks, a curtain rod and a squeegee sponge. Construction, as pictured, is simple. To bathe your records fill the container with enough water and detergent to cover grooves when the record is suspended from the lower hooks. Spin the record gently. To dry, lift the bar to the upper hooks and, while turning the record, hold the sponge against the grooves. Clear sound is yours again, in seconds. —

Record bath frame is wood base with 2 uprights positioned so short curtain rod is centered over bath. When rod is on lower hooks record should be 1/4" off bottom of container for washing; on top hooks, over pan for drying.

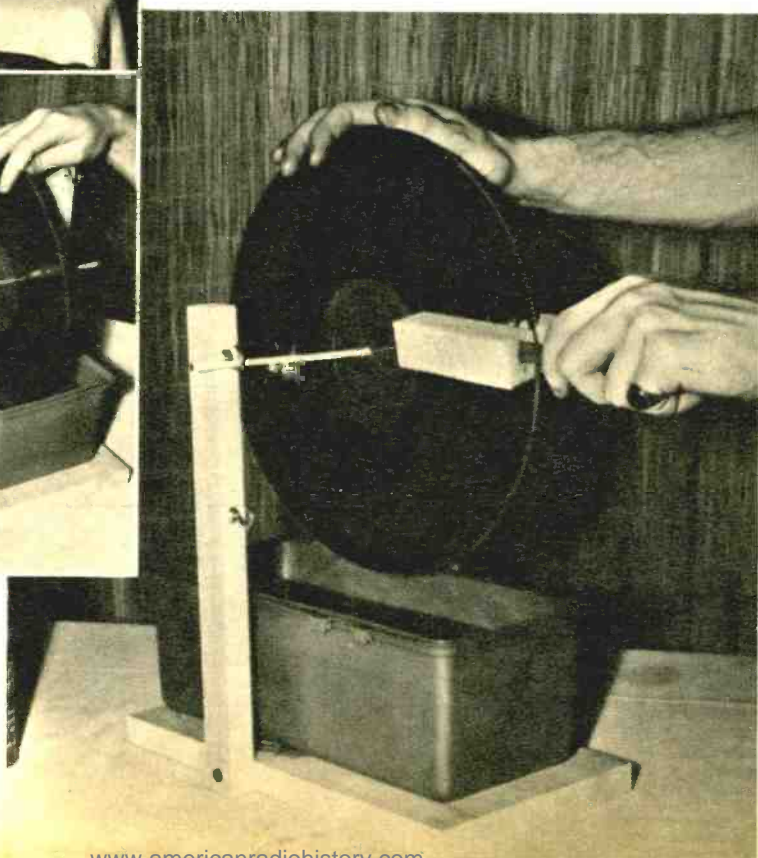
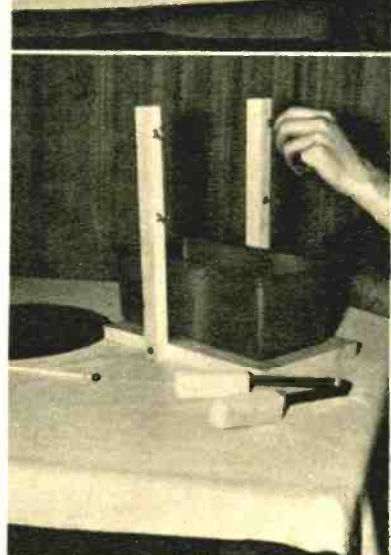
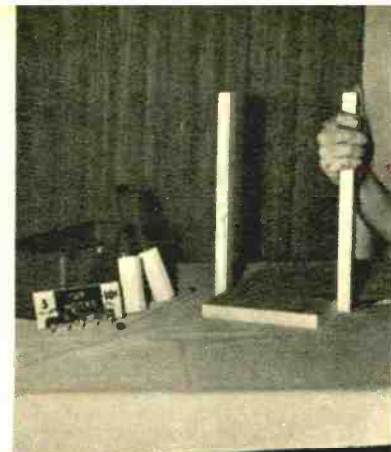

Just off the press... newly revised and up-to-date

Send for this FREE Booklet today!

• See what can be yours in the rapidly expanding field of...

ELECTRONICS

including:

- Guided Missiles • Radar • Instrumentation
- Computers • Automation • Astronautics
- Servomechanisms • Aeronautical Electronics
- Telemetry • Communications
- Manufacturing • Television
- Broadcasting • Industrial Electronics

Electronics offers you a

- Better Job • Better Pay
- Promotion • Greater Security
- Greater Confidence • Better Living for You and Your Family

All these benefits can be yours if you act now! Take that first step this minute—No obligation whatsoever! Write Capitol Radio Engineering Institute, Dept. 171-F, 3224 16th St., N.W., Washington 10, D.C.

If you have had a high school education, and experience in electronics—and realize the need of high-level technical knowledge to make good in the better electronic jobs—you can qualify for CREI home study training. (Electronic experience is not required for admission to CREI Residence School.)

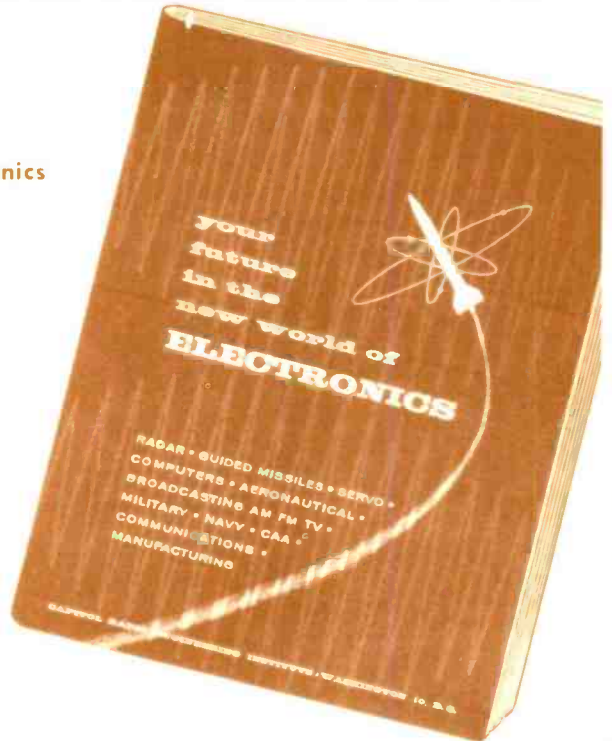

TAKE A MINUTE TO MAIL THIS CARD FOR FREE BOOKLET!

CAPITOL RADIO ENGINEERING INSTITUTE

ECPD Accredited Technical Institute Curricula • Founded 1927
Dept. 171-F, 3224 Sixteenth St., N.W., Washington 10, D.C.

Please send me your course outline and FREE illustrated Booklet "Your Future in the New World of Electronics"... describing opportunities and CREI home study courses in Practical Electronic Engineering Technology.

- CHECK FIELD OF GREATEST INTEREST
- Radar, Servo and Computer Engineering Technology
 - Electronic Engineering Technology
 - Broadcast (AM, FM, TV) Engineering Technology
 - Television Engineering Technology
 - Aeronautical Electronic Engineering Technology
 - Automation and Industrial Electronics Engineering Technology

HZ1

Name _____ Age _____

Street _____

City _____ Zone _____ State _____

CHECK: Home Study Residence School Korean Veteran

To help us answer your request intelligently, please give the following information:

Employed By _____

Type of Present Work _____

Education: Yrs. High School _____

Other _____

Electronics Experience _____

This book is a Gold Mine
Send for it immediately!

FREE



Reveals how you can gain quicker success
or turn your hobby into a well-paid career
in radio . . . television . . . electronics.

*Whether you're an amateur . . . a hobbyist . . . or already in
electronics . . . let us show you how to have a bright career in*

**Electronics — Television — Broadcasting — Guided Missiles — Aeronautical Electronics
Radar — Automation — Instrumentation — Computers — Industrial Electronics
Servomechanisms — Astronautics — Communications — Manufacturing — Telemetry**

TURN YOUR HOBBY INTO A HIGH-PAYING CAREER!

Today thousands of electronics hobbyists have an opportunity to turn their hobbies into profits. It's the "Age of Electronics!" *Trained* men are in crucial demand! You may be "outside" the electronics industries now, working on a job you enjoy far less than experimenting, building, transmitting, receiving; working for less money than is being paid to electronics engineering technicians. But your "true love" is electronics. Why not awaken to your opportunities—now?

ELECTRONICS HAS GOOD PAYING JOBS FOR TRAINED MEN!

And only *trained* men can fill them. You can get your share, if you take time now to gain that indispensable technical knowledge.

Many of the men currently on the street are there for a reason. "As many as 8 out of 10 are deadwood," estimates the chief engineer of a medium-sized Philadelphia firm; the problem is to find the live ones.

—From **ELECTRONICS MAGAZINE**

If you're interested in an honest-to-goodness career in the vigorous young electronics industry, here's how you can step ahead of job-competition, move up to a better job, earn more money, **AND BE SURE OF HOLDING YOUR TECHNICAL JOB, EVEN WHEN THE "DEADWOOD" IS BEING CLEANED OUT.**

Sure you have some experience. But the fellows with only partial technical knowledge move slowly, or stand still while you—the man with advanced technical training—plunge ahead in the golden world of electronics opportunities.

ACQUIRE NECESSARY TRAINING AT HOME

Use spare-time hobby hours for CREI Home Study as thousands of successful technicians have done since 1927. Get concentrated

training in minimum time, then step into a good job and enjoy good pay in the mushrooming electronics industry. CREI courses are being studied *today* on the DEW Line in the Antarctic—in Alamogordo and in Munich—by electronics experts in guided missile development and by telemetering technicians on the missile ranges.

CREI TRAINS YOU IN MINIMUM TIME AT HOME

Thousands of men *before* you have benefited quickly from CREI Home Study training. Thousands of CREI graduates are now employed in industry here and abroad. Here is what one graduate has to say:

"You can quote me as saying that it was the smartest money I ever invested in my life, and it has repaid me several hundred times in earnings, not to mention the confidence and security that accompanied mastery of radio and electronics, thanks to CREI."
—Joseph Zelle, W8FAZ; Radio Engineer, WERE, Cleveland, O.

**BRAND NEW COURSE
ADDED: AUTOMATION
AND INDUSTRIAL
ELECTRONICS ENGI-
NEERING TECHNOLOGY**
Complete course on automation. Special emphasis on theory, functioning, and applications of servomechanisms and computers. Lessons on machine control, instrumentation, data processing, telemetry, etc.

CREI OFFERS RESIDENCE TRAINING
at the same high technical level. Day and evening classes start at regular intervals. Qualified residence school graduates earn degree as "Associate in Applied Science."

If you have had electronic education, or experience in electronics—and realize the need of a high-level technical knowledge to make good in the better electronic jobs—you can qualify for CREI home study training. (Electronic experience is not required for admission to CREI Residence School.) Check coupon if you prefer residence or home study information . . . or write, Capitol Radio Engineering Institute, Dept. 171-F, 3224 16th St., N.W., Washington 10, D.C.

If eligible for training under the new G.I. Bill of Rights, check the coupon for full information.

FIRST CLASS

Permit No. 288-R

Washington, D. C.

BUSINESS REPLY CARD

No Postage Stamp Necessary If Mailed in United States

4c Postage Will Be Paid By

CAPITOL RADIO ENGINEERING INSTITUTE

3224 16th Street, N.W.

Washington 10, D. C.

Hi-Fi Clinic

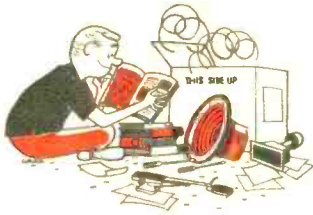

Do you have any questions on the adjustment, installation, or repair of hi-fi equipment? The clinic provides an answer to each query.

Half or Full Track

I've been offered the choice of half track or full track heads on a semi-professional tape recorder I'm going to buy. Are both types of tape available and which would give me the best frequency response? What are the advantages and disadvantages of each type?

James Farmer, St. Paul, Minn.

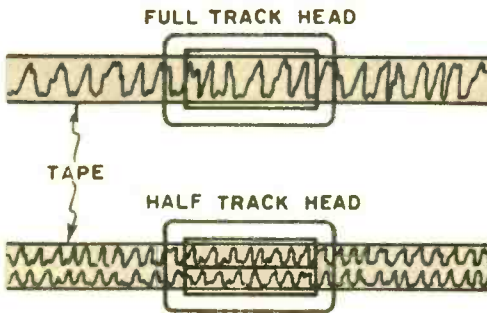

First of all, the frequency response of the recording will be the same, half or full track, and the same type of tape is used for both. A full-track head uses the full width of the tape at one time during recording; a half-track head uses half the width at one time and the other half when the reel is turned over and the tape sent through again. Full track recordings are easier to edit and have a better signal-to-noise ratio. It's almost impossible to edit half-track material when both tracks have important material on them. Full-track recording puts double the signal on the tape and results in less playback noise because the tape preamplifier and associate amplifier can be run with their gain controls at lower settings. The advantage of half track can be expressed in one word—economy; double the recording time and storage is available on the same size reel.

Homemade Stereo Tapes

I discovered a way to make stereo tapes in my own home. All I have to do is set up my stereo recorder to record a disc jockey program from my tuner. When the announcer gives the name of his next selection and I have a copy of that record in my collection, I place it on my turntable and synchronize it with the broadcast. Is there anything wrong with this idea?

Andrew Fernald, North Abington, Mass.

In order to achieve stereo reproduction it is necessary to have two completely separate channels from the point of origin of the original sound until the time the signal reaches the listener. This means in broadcast stereo there are at least two microphones, critically spaced, picking up the original program material. These two mikes feed two separate amplifiers, which in turn feed two transmitters. The two broadcasts are picked up by separate tuners or a single stereo tuner and fed through the two channels of your stereo hi-fi system. If at any one point the channels are mixed *previous* to their reproduction by the loudspeakers, the true stereo effect is lost.

Woofer and Tweeter Controls

I want to be able to set the balance of my mid-range speaker and tweeter with reference to my woofer. I've heard all sorts of conflicting opinions as to the sort of control I should use. My choices seem to be either a T-pad, an L-pad or a simple potentiometer. What do you suggest?

Chris Shumsky, Litchfield, Conn.

You have a choice between the L-pad and the less expensive potentiometer. The pad or pot, whichever is used, should be connected between the cross-over element and the speaker. —

New Life For Weak Batteries

By Paul Hertzberg

Hundreds of extra hours are possible with the new nickel-cadmium batteries and this simple charger.

TODAY'S transistor radios have very long battery life. To extend playing time many hundreds of hours battery manufacturers have made available rechargeable nickel-cadmium cells. The penlite size is the most popular in pocket transistor portables. When the volume gets weak or not all stations can be tuned in it is time to recharge the batteries. A simple and inexpensive charger can be constructed in a small aluminum box. Assemble the parts in the box using small machine nuts and bolts to hold the transformer. Be careful not to allow any of the leads to touch the metal box. The selenium rectifier can be mounted to the box.

Two cells are inserted in the holder for an overnight charge. These batteries are physically the same as penlite dry cells and produce 1.25 volts each.

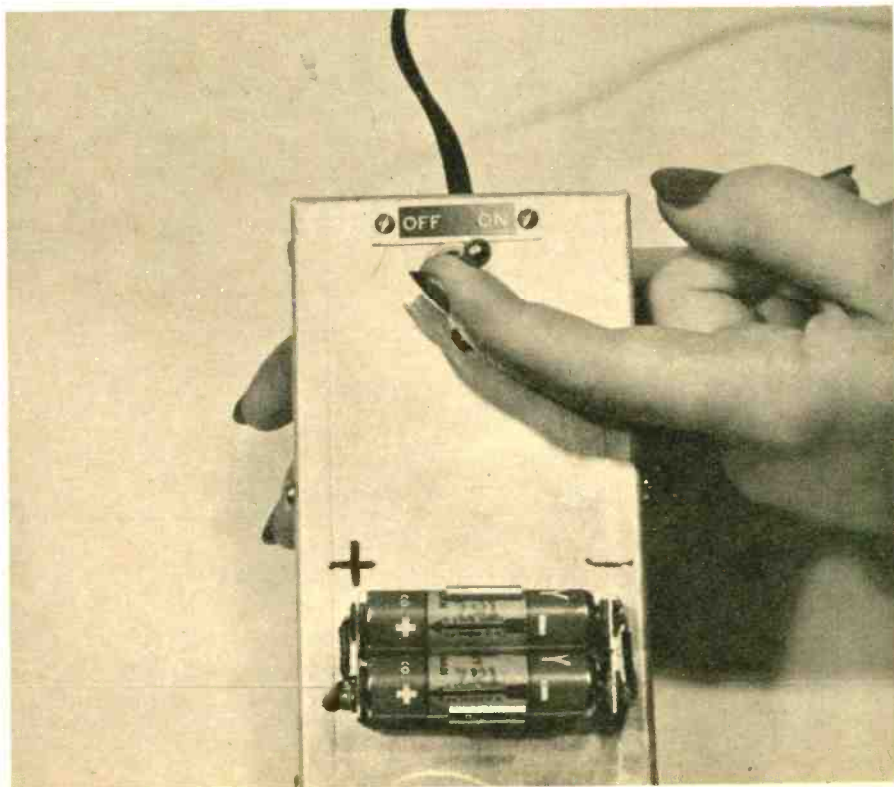

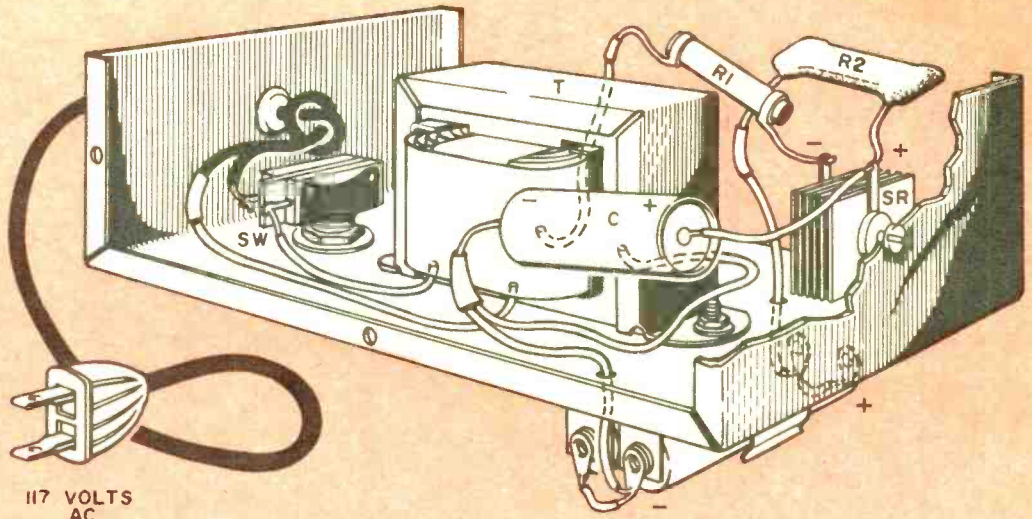

117 VOLTS
AC

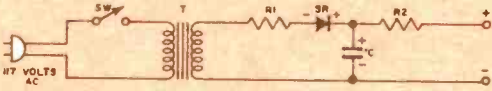

PARTS LIST

- R1—33 ohm, 5 w
- R2—47 ohm, 2 w
- C—100 mfd., 25 volt electrolytic
- SR—Selenium rectifier, 100 ma.
- SW—SPST toggle switch
- T—Filament transformer, 117 to 6.3 volts AC, 4 amps
- Battery holder (2 penlite cells)
- Aluminum case 5"x2"x3"
- Batteries—Nickel-cadmium type "AA"
(Gould National Batteries, Depew, N. Y.)

It works in the following way. The filament transformer steps down the alternating current from 117 volts to approximately 6.3 volts. The 47 ohm resistor absorbs any surges of current that might damage the selenium rectifier. The reduced voltage is rectified by the selenium rectifier to a rough direct current and further smoothed with the aid of the filter capacitor. The resistor R2 reduces the voltage at the output terminals to 1.4 volts direct current.

The batteries should be charged at approximately 1.4 volts. This rate can be controlled by changing the value of resistor R2. About 25 to 30 ohms will give the desired voltage.

An overnight charge will bring your weak batteries up to par.

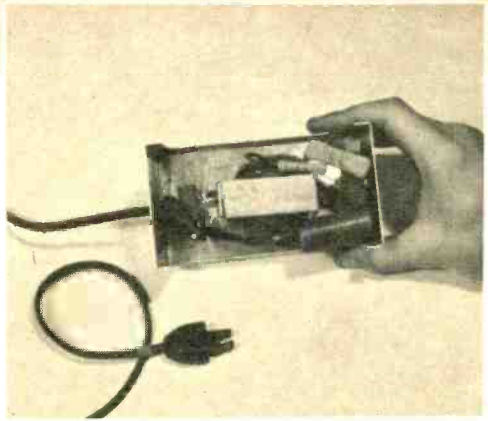

Underside view. At center is transformer with filter capacitor in the lower right corner.

The approximate cost of building the battery charger with the parts pictured below is \$4.

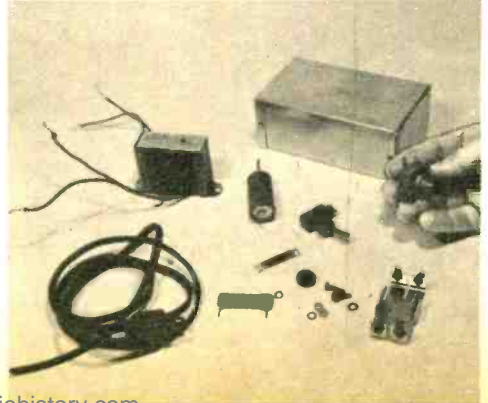

Assemble a Common Component Receiver

By Lou Garner

This begins a series on how to build a variety of useful projects using the same parts over again.

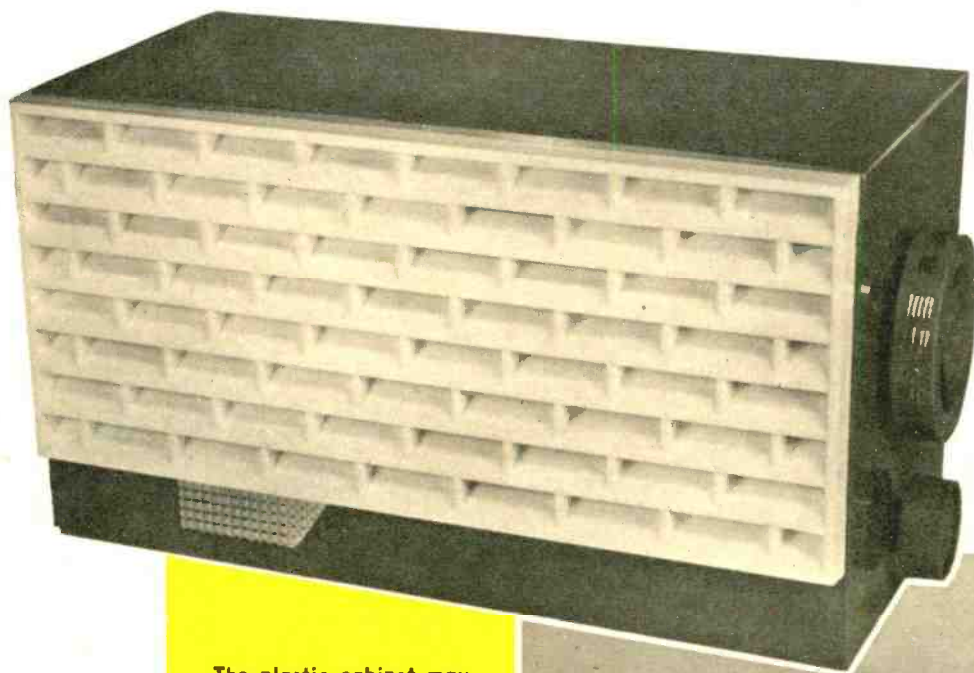

The plastic cabinet may be purchased if desired. The larger knob selects broadcast stations, the small one is for volume.

To keep construction time and metalwork at a minimum, a prepunched chassis may be used. Layout is like AC-DC sets.

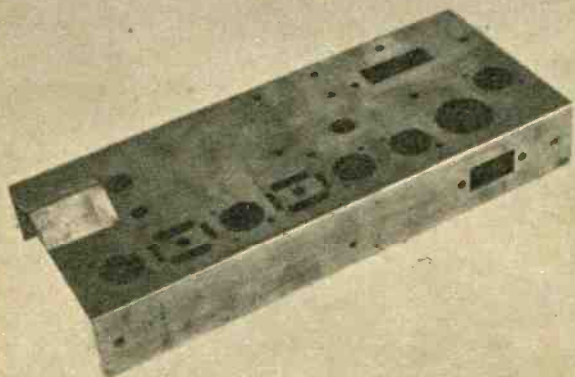

IN the early days of radio, when only a few types of vacuum tubes were manufactured, it was not unusual for an experimenter to assemble a six or seven tube receiver with the same type tube used in every stage. However, as more types were introduced and as electronic components were manufactured in a greater variety of styles and values, it became common practice to use a different tube for each function. A seven tube set used as many different tube types, as well as dozens of different sizes of resistors and capacitors.

Recently, our armed services have expressed a real interest in the common component concept. Applying this old principle, electronic equipment is designed using a minimum number of tube types as well as a limited variety of resistor and capacitor values. Where special component values are needed to obtain circuit operation, series and parallel combinations of the "standard" values are employed. To the home electronics builder, the common component approach offers an easy way to increase the variety of electronic projects he can assemble. He can minimize costs and reduce space in the workshop for parts storage and increase the salvage value of discarded projects.

An inexpensive and easy-to-assemble version of the "Common Component" superhet receiver is shown in the photographs. While only one type of tube is used in *all* stages, and the set requires only a few different values of resistors and capacitors, its performance is comparable to factory-built receivers requiring as many as four or five different types of tubes and a dozen or more different values of resistors and capacitors. This is the first of a series of Common Component construction projects

Mounting the loudspeaker. Small spacers are placed between the speaker frame and chassis.

Top view of receiver. Two large resistors on the right are R15 and R16 in heater circuit.

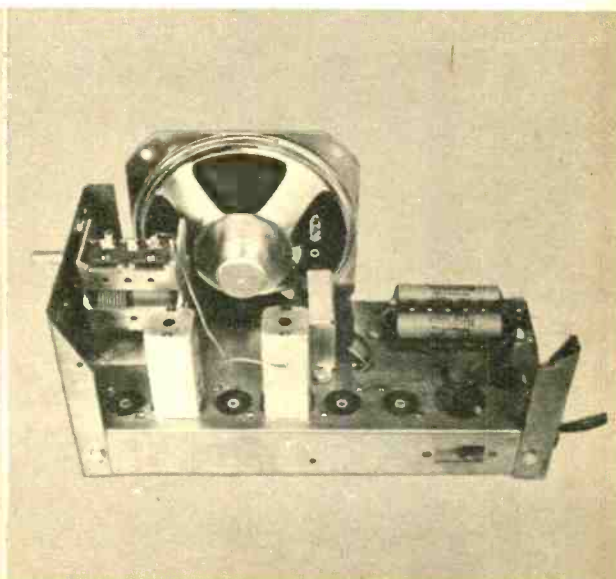
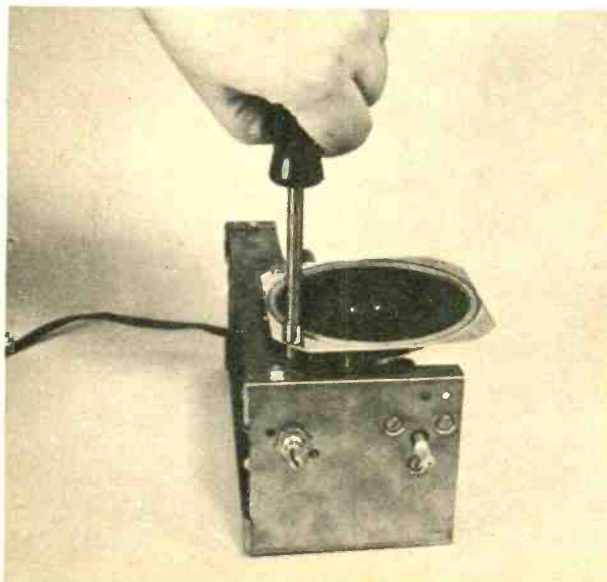

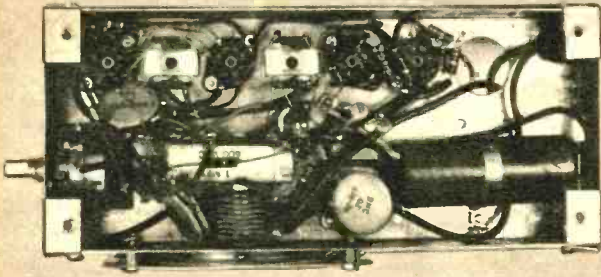

PARTS LIST

- R1,2,13—47,000 ohm, 1/2 w
- R3,4,5,6,14—1 megohm, 1/2 w
- R7,8,9,10,11,12—330 ohm, 1/2 w
- R15,16—900 ohm, 10 w wirewound
- R17—5 megohm volume control, audio taper, with switch
- C1,2—Two-gang superhet tuning capacitor (Lafayette SP-115)
- C3,8,9,11—220 mmfd. disc, 200 v
- C4—.1 mfd. paper tubular, 200 v
- C5,6,7,10,12,13—.02 disc, 200 v
- C14,15—20-40 mfd., 150 volt dual electrolytic (C15 is 20 mfd.)
- L1—Loop antenna coil (for BC band)
- L2—Oscillator coil (Lafayette SP-117)
- IF1,IF2—455 kc IF transformers
- SR—65 ma selenium rectifier
- T1—Audio output transformer (Lafayette SP-119)
- Speaker—4" PM, 3.2 ohm
- V1,2,3,4—12BE6
- Misc.—prepunched chassis with end brackets (Lafayette SP-121), cabinet and knobs (Lafayette SP-122), four 7 pin miniature tube sockets, hardware, line cord and plug.

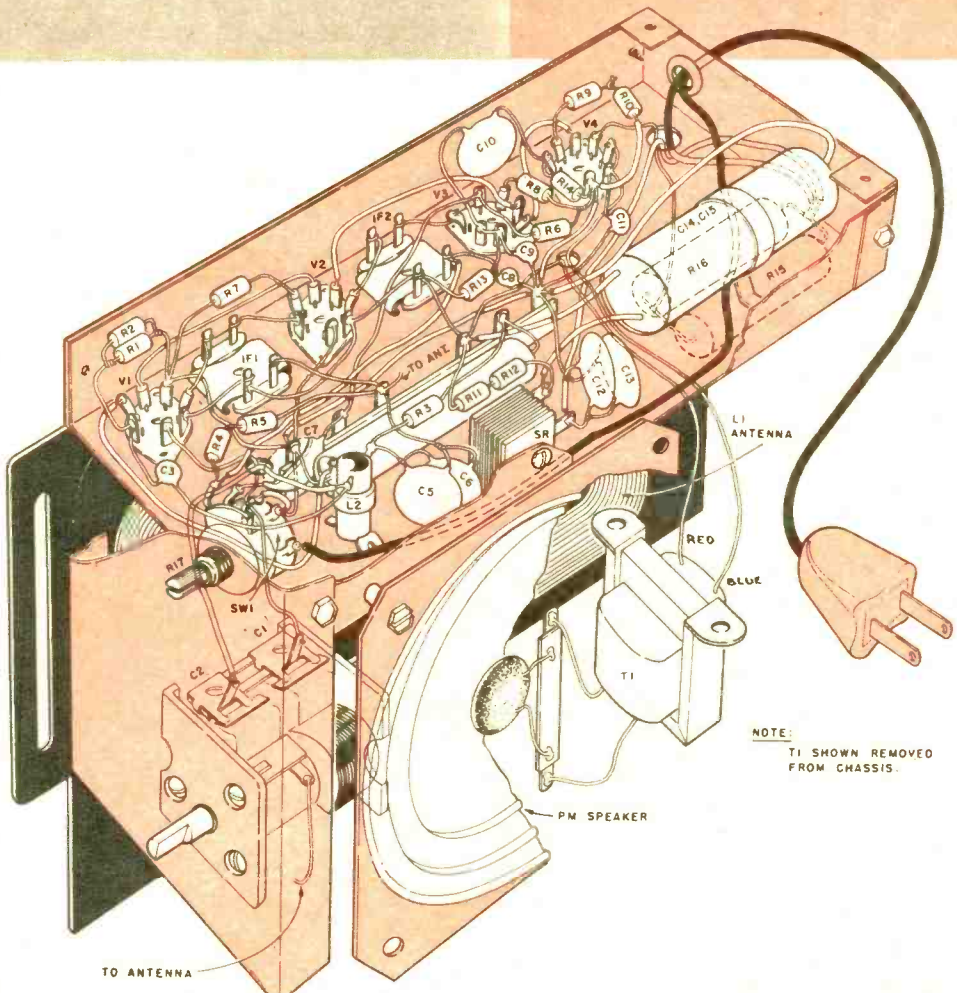

NOTE:
T1 SHOWN REMOVED
FROM CHASSIS.

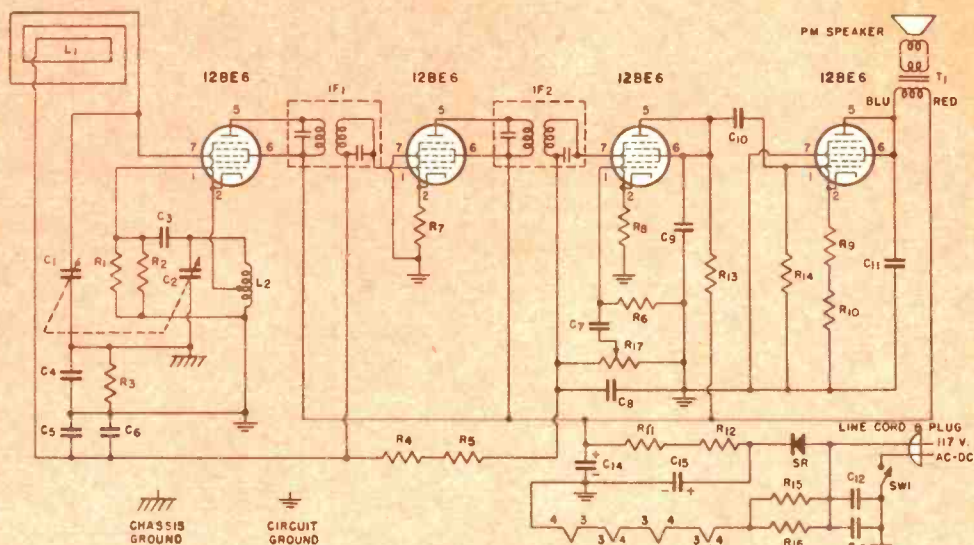

Follow wiring guide on facing page being certain not to connect any "circuit ground" to chassis.

to be featured. In future issues we'll describe amplifiers, controls, and other projects you can build at home, all using the same tube type and essentially the same values of resistors and capacitors.

Full construction details are given in the diagrams and photographs. Since a superhet circuit is used, the Common Component receiver is not recommended as a project for the rank beginner. But the hobbyist who has assembled two or three simpler receivers, an amplifier or two, or a few kits, should have little or no difficulty with the project.

The commercially available prepunched chassis specified in the parts list was used for assembling the author's model, with the completed receiver mounted in a standard cabinet. You can make up your own chassis from "scratch," or use one salvaged from a discarded AC-DC receiver. All components are standard and are readily available through electronic parts distributors. The exact electrical characteristics of the coils and transformers used are not too critical as long as the parts match each other. For example, make sure that the loop antenna (L1), oscillator coil (L2), and two-gang su-

perhet tuning condenser (C1, C2) all match and are designed to furnish a 455 kc IF. Standard "replacement" components may be used here, as well as for the IF transformers (IF1, IF2), the output transformer (T1), and the PM loudspeaker. If you wish, you can use parts salvaged from a second-hand AC-DC receiver. Just make sure that a tapped oscillator coil is used (rather than the two-winding type) and that all items are in good condition.

Following the illustrations, mount the output transformer, tube sockets, terminal strips, filter capacitor, and similar components. The IF transformers, depending on their design, may be mounted with spring clips or spade bolts and nuts. The oscillator coil, in general, simply snaps into an appropriate chassis hole. Do not mount the loudspeaker or loop antenna (L1) until all chassis wiring is completed.

Series filament resistors R15 and R16 are mounted on a terminal strip above the chassis to permit good air circulation and improved heat dissipation, insuring minimum heating of other components.

If you use the prepunched chassis
[Continued on page 102]

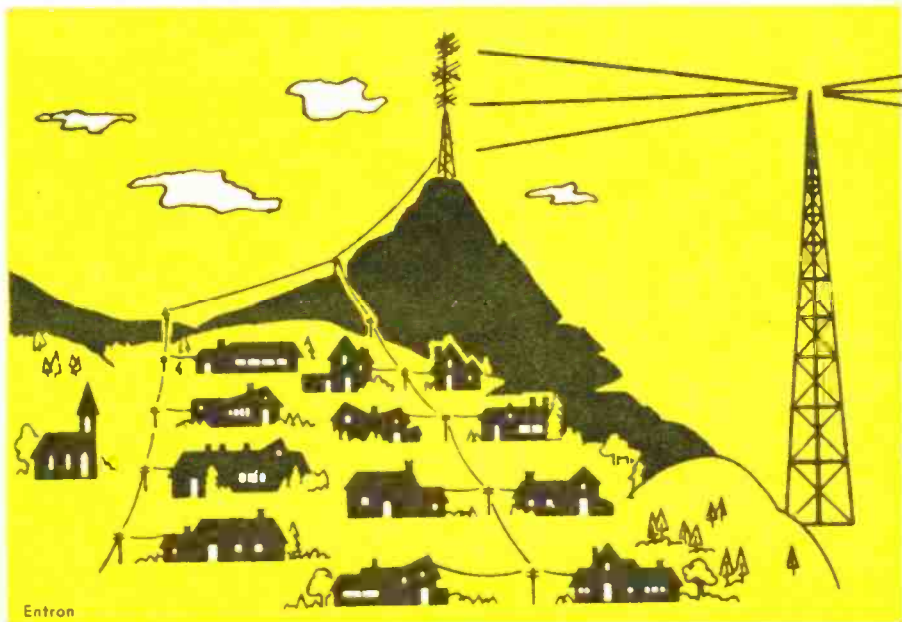

Community antenna is more sensitive than private antenna, occupies best spot, and delivers pictures via cable directly into the subscribers' homes.

Report On Community TV

Outside big city reception areas, one antenna for an entire town brings big city TV into the home.

MENTION CATV to the man in the street and he probably will think you are referring to a new television station's call letters. Mention CATV to a TV station owner, and you'll probably get a dirty look. But despite certain objections to community antenna television (CATV), about 500,000 families receive service from cables coming into their homes like telephone lines.

The technical aspects of all CATV systems are similar. Required are (1) a master antenna, located near the community to be served, but usually on a high point; and (2) a signal transportation system consisting of coaxial cable, line amplifiers, line splitting devices and customer connection equipment. Without CATV some 2,000,000 persons in small towns and mountainous areas would not be able to see TV, or perhaps only snowy pictures or second rate local programming.

In the West, over 250 CATV installations attest to the popularity and need for this service. Oregon has over 50 installations, only exceeded by Pennsylvania, which has more than twice as many. After World War II there were few regular TV stations and their power was low. Villages on the fringe of a station's coverage area had poor reception. Pennsylvania, with its rolling hills and numerous small settlements, was a natural place to try the idea of picking up a TV station's signal with a high antenna, and feeding it



Microwave technician checks frequency tuning on receiver at master antenna site of a system that requires long distance relays.

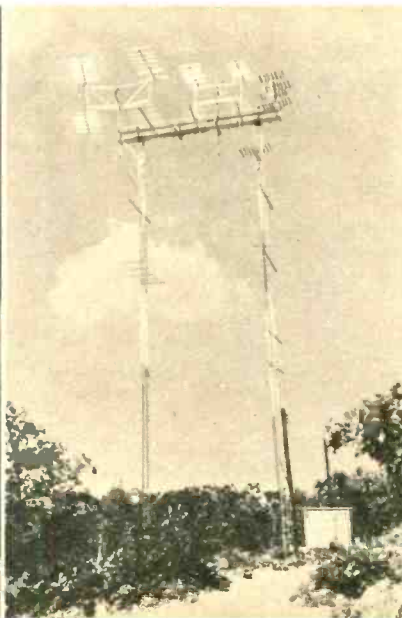

Unusual multi-element VHF high gain antenna of Yagi design is adaptable for use with some of the more elaborate CATV in fringe TV areas.

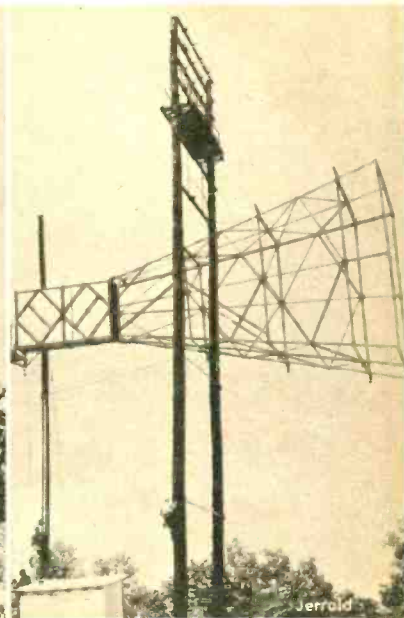

This equally unusual horn antenna is also designed for high gain directional reception. It is sturdy, with amplifier housed at far left.

to viewers by means of a cable into each house. More rugged country in the Far West, with its sparse population in small settlements also was a ripe area.

Most of the western CATV systems (Arizona and Oregon leading the field) use high gain antennas placed on the highest possible ground location free from static. In Reno, Nev., for example, the receiving antennas for San Francisco signals are on Mount Rose. The elevation is 10,000 feet, the distance about 250 miles, and the received signal extremely clean. After amplification, the signal is fed via cables strung from poles to the City of Reno where it is distributed by more coaxial cables to the subscribers' homes.

This type of CATV system is relatively simple because it is little more than a superior antenna system connected to one or more high gain VHF amplifiers. In most installations the distribution amplifiers convert the high band VHF signals to unused low band channels (2 through 6).

A variation of the direct off-the-air

pickup and distribution system involves use of microwave relay of one or more hops. One of the newest is designed to bring Houston TV to Lufkin, Tex., and has a 110-mile run with four hops. Local stations are complaining of unfair competition from this CATV system. The microwave relay system involves much more than the simple antenna and distribution cables, like an FCC license.

Another borderline class of CATV operation is the "translator." A typical translator will pick up a weak signal, say Channel 6, and rebroadcast it on one of the top UHF channels. Thus people who live outside normal VHF signal areas can receive a station on a UHF receiver, or a VHF receiver with a UHF converter. A translator's power is seldom as high as one watt, and is often closer to 1/2 watt. This is low but adequate. There are about 200 licensed translators in operation.

A variation of the translator is the "booster." This is generally an "on-channel" rebroadcast station which

[Continued on page 113]

new fields for electronics

Color Film Processing

By Simon Nathan

Big color labs don't take chances with your film; they can be sure because of electronic sentries.

TIME was when large photo processing laboratories were nothing more than small darkrooms multiplied many times. Films were developed in trays or tanks much like those used by you or me in our homes. Now, however, especially in the processing of color film, special high-speed equipment, precisely regulated and automatically controlled, has taken over. Electronic controls keep the chemicals just right and adjust many steps in the process to insure correct color balance and exposure for each negative. Here is how this is done at the labs of Technicolor New York. —

Ansochrome and Super Ansochrome color transparency film are processed in the machine shown below. The electronic control panel in the center monitors every step.

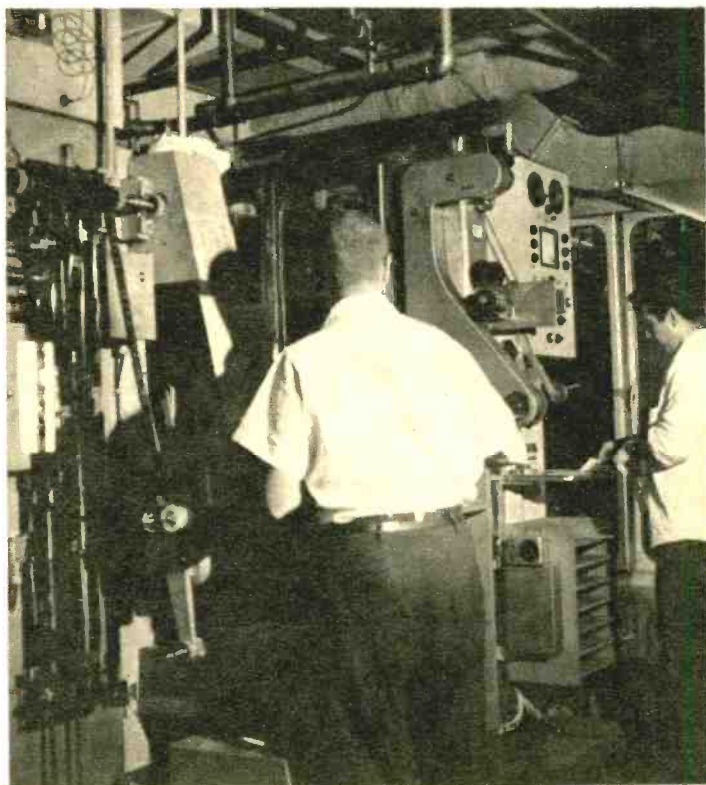

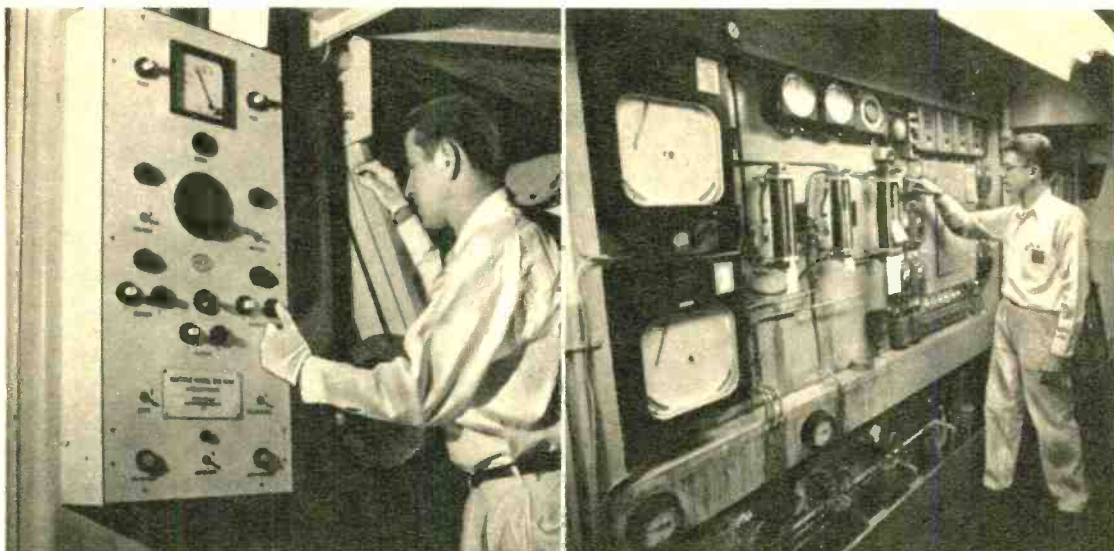

Above left is a closeup of the control panel for the Kodachrome processing machine. Once this is adjusted, the film runs through automatically; if however the temperature of the developing solution, for example, should change, this will be detected electronically and displayed on the board at the right. The operator will then use the various pushbuttons.

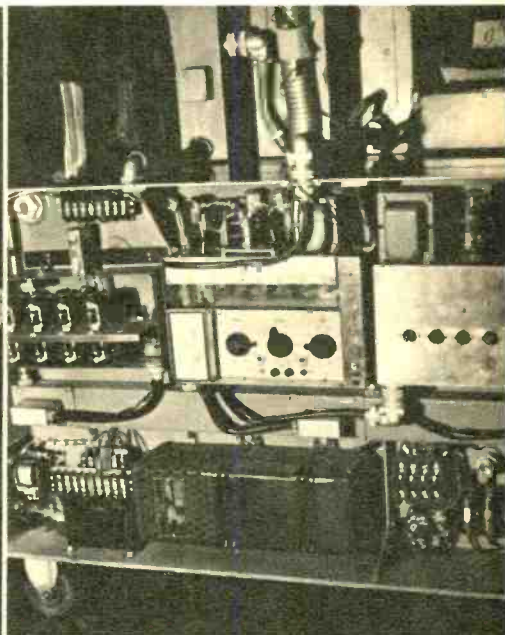

All photos by the author

Print-making machine for Ektacolor. Here electronics takes over where human judgment may err in the determination of proper exposure time and color balance for different color negatives. By using the panel on the machine the operator can change the speed and color response of the electronic circuits shown on the right which are under the special console.

Individual color prints are cut from continuous roll by blade actuated by electronic pulse conducted by a pencil mark on back of print.

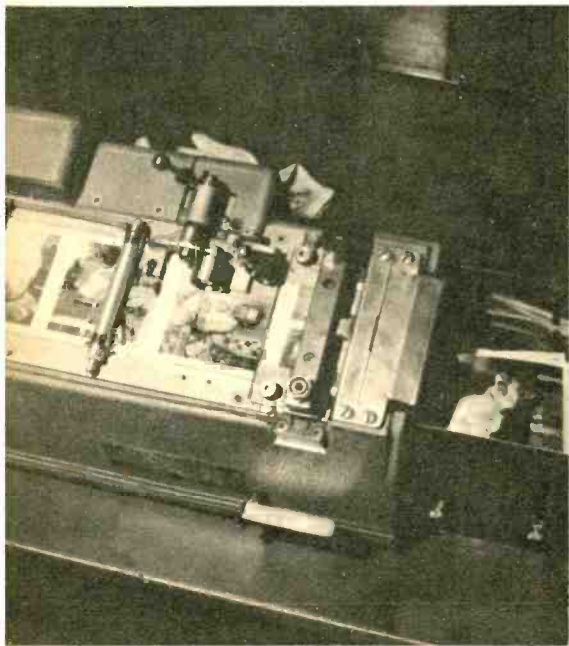

This is the pencil marking device that makes the conductive graphite line between prints. Sensing unit picks up pulse, activates blade.

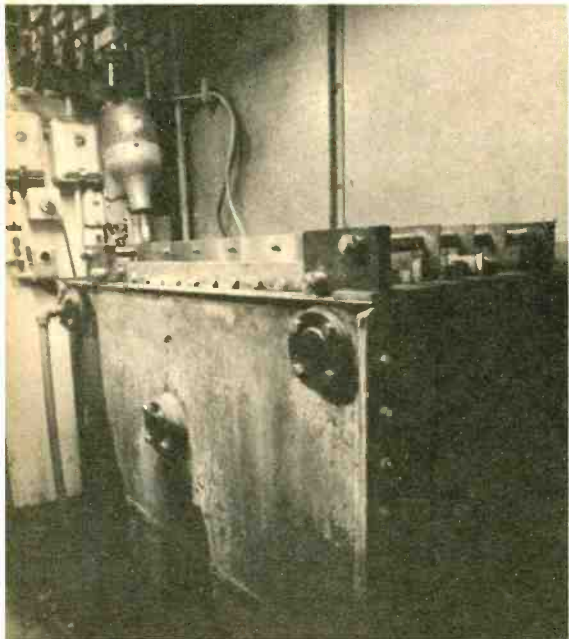
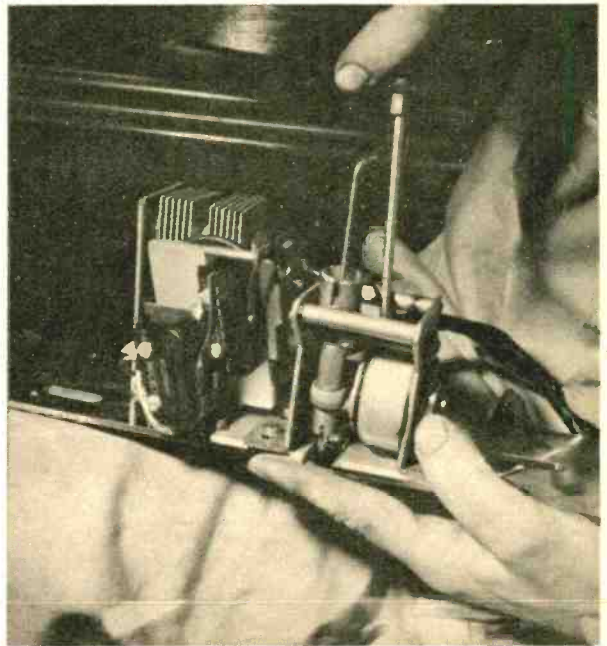

This machine earns thousands of dollars, does not develop single roll of film. It recovers, electrolytically, lost silver from hypo solution.

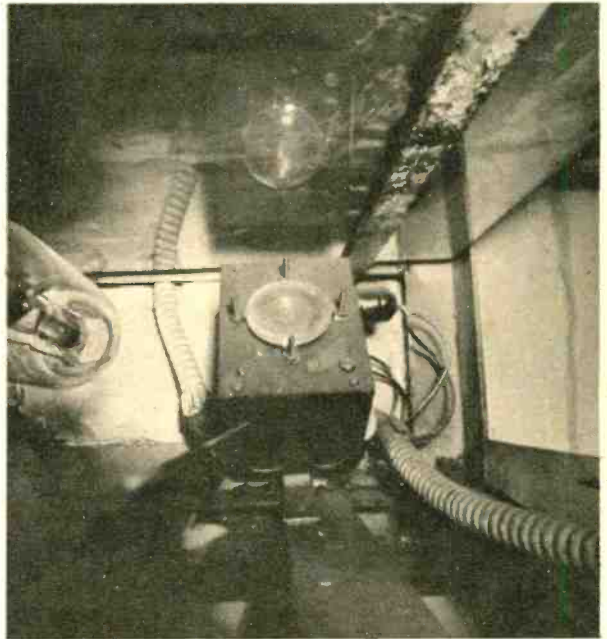

This emergency photoelectric switch is used to trigger a bank of 500 watt bulbs to properly expose film if the mercury lamp at left fails.

More Educational TV

Continued from page 31

the same time, the university students receive valuable training in an industry that has yet to realize its full potential.

Aware of the many difficulties facing them, those working in and for ETV feel that progress thus far has been fair. The general public, however—especially in areas where there is little or no progress toward establishing an ETV station, feel that things could be speeded up. But how?

We must accept the fact that ETV is a very effective tool for education at all levels, pre-school through adult. It is a proven instrument, no longer a fad or whim. It reaches more people with both picture and sound than any other medium. The number of subjects that can be taught via TV is limited only by the imagination of the programmers and the public. It is the planning, the content and the presentation that is most important to proper education—the technical equipment of the station cannot control this.

ETV people themselves must close ranks and avoid disagreement. They must view ETV as one big picture in which their narrow interests are merely a part. At times it may be necessary to subordinate one piece of the total picture in order to achieve something larger, more urgently needed. If the total picture is healthy, the parts will thrive.

A better and sounder means of financing ETV *must* be found. Foundations have helped in the initial stages of getting a station on the air, but they rightly assume these stations should become self-supporting in time. Public donations and subscriptions put the station at the mercy of the economic barometer; if there is a slump, the station is liable to find itself off the air. Similarly, a station that depends for its financial support upon a legislature that must re-approve its appropriation each year could, conceivably, have a life of only one year, even though the public wants and supports its station.

Some adult education groups are advocating a form of toll or pay ETV, believing such a system would place the

responsibility for good programming squarely on the station. The public will not pay for what it does not want. A well-known foundation has recently made a substantial grant for a complete study of this problem of financing ETV and perhaps from this will come a solution that will remove the major obstacle in the path of an ETV station in your community.

But what can you, as an individual and good citizen do to bring about an ETV station in your town? There are several courses of action: Join a civic group such as Rotary, Kiwanis, Lions, PTA, church organizations, etc., and insist that one of the group's major projects is bringing about ETV in your community. Have the group look into all the possibilities, consult with local educators, school boards, teachers' organizations. Query established ETV stations and their supporting organizations in other communities. Compare problems, talk them out, create public interest and overcome any local human inertia. Keep abreast of what is going on in the state legislature and the local college or university toward the establishment of ETV—and make your desires known to those who might be able to do something about them!

Once you have ETV, you will have the opportunity to tune out those cowboy epics and rock n' roll singers in favor of programs having more substance. Meanwhile, if you happen to be among the lucky ones already having ETV, sit back and be educated and entertained—and occasionally let your station know you support it. ●

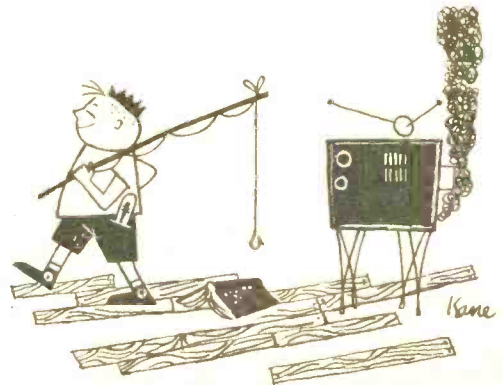

Fire Alarm Phone Dialer

Continued from page 57

Let us say we want to call Hickory 6-7441. Spelled out in numbers this is 4-4-6-7-4-4-1. Put a group of 4 screws in the code wheel, followed by a space and then a group of 4 followed by another space and then a group of 6 screws, etc. The drawing shows the proper spacing.

When you have set up the code wheel with the proper amount of screws, place it in position. You should allow about 3 inches for the wheel to pick up speed before the first screw hits the micro-switch.

Place the telephone in the proper position so the dialing arm can press down on one of the cradle buttons. When the handset is removed the dialing arm should take its place and press the button fully down so no dial tone is heard. Lay the handset on top of the cabinet so that it can pick up the sound of the buzzer.

Plug the unit into a 117 volt AC outlet and manually close the armature of RY2. This is the reset button in the wiring guide and made from a plastic or Lucite rod. This rod is then cemented to the armature of RY2. It should stay closed and the red "ON" light will go on.

To simulate a fire or burglary close RY3 manually and keep it closed. The instant you close RY3 the lift solenoid SOL1 should lift the weight off the dialing arm and the cradle buttons on the phone should then pop up. Also, at the same time, the buzzer should start sounding.

Keep RY3 closed. At the end of ten seconds the code wheel should start to turn and the dialing arm will move up and down as it counts out the number on the code wheel. Immediately after completion of dialing the code wheel must stop automatically. Listen to the telephone, you should get a "busy signal." Assuming you have it, keep RY3 manually closed. At the end of 3 minutes RY1 should open and shut the entire works off.

Set up the code wheel for the number you want to dial. Connect the fire (or

burglar) alarm to RY3. When you close up for the night just press RY2 closed, slip the phone under the dialing arm and place the handset on top of the box.

In the morning replace the handset on the cradle and then pull the plug out of the wall. This will shut everything off.

An understanding of how your unit works will help you trace trouble if any is encountered.

When you press the armature of RY2 closed you will notice that current flows into the holding coil through a set of contacts on RY2. When switch 1 and 2 on RY3 close, then the heater of R1 warms up. When 3 minutes have passed the contacts of RY1 will be forced open. The heater of RY4 has also started to warm up, and current is going to SW1 and to the buzzer.

After 15 seconds RY4 closes and sends current to the phono motor through SW3 which is normally closed. Now SW4 permits pulses of current to go to SOL2, the dialing solenoid. When dialing is completed SW3 will be opened by the stop ramp attached to the code wheel and the motor stops. At this point your telephone at home is ringing.

Meanwhile, the proper temperature is reached to make RY1 open at the end of three minutes. When it opens, RY2 does so also, and the unit shuts off. However, current may still be going to RY3 holding coil. It should be able to carry current continuously. At the end of the above sequence the phone "hangs up." This is important for you because you will probably want to make some calls.

Earlier we mentioned our choice for a phono motor. This type is not absolutely essential. Any other motor will do as long as your code wheel will run at the right speed. The "right speed" will pass 10 screws under the dialing microswitch SW4 in one second. Some variation can be tolerated as long as it will fit in with the timing cycles set up at your telephone center.

The 15 second delay was put in to be sure that the dial tone is present when the dialing starts. If your home number is busy you will not get the call.

Some individual adjustment may be

necessary to get your unit to work. If the springs on the telephone cradle buttons are not strong enough to lift the dialing arm you can correct this by putting a small counterweight on the other end of the dialing arm. —

Florida Electronics

Continued from page 41

Gloria, who is assistant bookkeeper in a shoe concern, takes home an additional \$47.40. This makes a total weekly income of \$127.40.

Out of this they must meet the normal expenses of all young couples. A few months after they settled they bought their present house in Palm Springs—five rooms, stucco, three bedrooms, two baths and a modern, well-equipped kitchen. No basement. Price: \$13,250. Property taxes are relatively low. Other home expenses and utilities (no heating necessary) total about \$18 to \$20 a month. Food costs \$30 to \$35 a week. “That’s a lot,” Gloria explains, “because we both work and I buy things we can cook up quickly, like steak.” Sample food prices: Milk, 28c qt.; butter, 81c lb.; roast beef, \$1.09. Other expenses: Cigarettes, 28c a pack. Gas for the car, \$4.50 a week. Frank claims his car needs less care than it did in New York, aside from never needing any antifreeze or chains.

Where the Candelas believe they save money is on clothing. Prices are about the same as in New York, they say, but they buy less. Around the house they wear shorts. Suits are saved for rare occasions.

How does all this add up economically? “We just manage,” Frank asserts. “If Gloria didn’t work, we’d have to scrimp a bit. And don’t forget, we have no kids.”

On the other hand, there are certain intangible assets in Florida living. There is, of course, the climate, the relative informality. Candela insists he wouldn’t leave Miami.

What about advice to technicians who may be thinking of making the same break? “That,” says Candela, “is like asking a man who’s just won a pot at poker whether he thinks other people ought to play. I consider myself lucky.

Whether someone else can make a go of it depends on two things: His qualifications and the breaks.”

As this is written, openings exist for electronics technicians in Cocoa, Gainesville, Orlando. *EI*’s poll showed that dozens of Florida electronics firms plan to hire additional technicians during the first quarter of 1959. These include firms in Melbourne, Fort Walton Beach, Miami, Coral Gables, Fort Myers, and Fort Lauderdale.

However, there may be only one or two openings at a time. They may be for very specialized occupations requiring previous specialized training. Moreover, at the big missile installations, housing is a severe problem. At Cocoa, for example, incoming personnel will find houses for sale, but rental space is tight. Furnished rooms range from \$18 to \$25 a week.

Before You Make the Move

How, then, can one make the big move? Men who have done it all advise against heading for Florida “cold”—that is, without contacts. Try to line up a job by mail or phone in advance. One way to do this is to take stock of your skills and experience. Then write, describing them to the Florida State Employment Service in Tallahassee. Another way is to contact the state Chamber of Commerce or its local affiliates asking for the names and addresses of companies that hire people with your specific skills.

Other aids: The Florida Development Commission in Tallahassee publishes a list of all electronics manufacturers and related firms in the state. The list gives nutshell descriptions of what each firm does. From this you can narrow down your hunt to a few companies, then contact them directly by mail.

If you decide to “plunge in” the way Candela did, without prior contacts, it may take as much as several months to get located. Don’t move without an adequate stake. Candela had over \$5,000 from the sale of his business. He didn’t need it. But every individual interviewed advised the technician who comes “cold” to have at least \$750 to \$1,000 over and above his moving expenses—just in case. —



Superior's New Model 77

VACUUM TUBE VOLTMETER

WITH NEW 6" FULL-VIEW METER

Compare it to any peak-to-peak V. T. V. M.
made by any other manufacturer at any price!

- ✓ Model 77 completely wired and calibrated with accessories (including probe, test leads and portable carrying case) sells for only \$42.50.
- ✓ Model 77 employs a sensitive six inch meter. Extra large meter scale enables us to print all calibrations in large easy-to-read type.
- ✓ Model 77 uses new improved SICO printed circuitry.
- ✓ Model 77 employs a 12AU7 as D.C. amplifier and two 9006's as peak-to-peak voltage rectifiers to assure maximum stability.
- ✓ Model 77 uses a selenium-rectifier power supply resulting in less heat and thus reducing possibility of damage or value changes of delicate components.
- ✓ Model 77 meter is virtually burn-out proof. The sensitive 400 microampere meter is isolated from the measuring circuit by a balanced push-pull amplifier.
- ✓ Model 77 uses selected 1% zero temperature coefficient resistors as multipliers. This assures unchanging accurate readings on all ranges.

AS A DC VOLTMETER:

The Model 77 is indispensable in Hi-Fi Amplifier servicing and a must for Black and White and color TV Receiver servicing where circuit loading cannot be tolerated.

AS AN ELECTRONIC OHMMETER:

Because of its wide range of measurement leaky capacitors show up glaringly. Because of its sensitivity and low loading, intermittents are easily found, isolated and repaired.

AS AN AC VOLTMETER:

Measures RMS values if sine wave, and peak-to-peak value if complex wave. Pedestal voltages that determine the "black" level in TV receivers are easily read.

Specifications

• DC VOLTS — 0 to 3/15/75/150/300/750/1,500 volts at 11 megohms input resistance.
• AC VOLTS (RMS) — 0 to 3/15/75/150/300/750/1,500 volts. • AC VOLTS (Peak to Peak)—0 to 8/40/200/400/800/2,000 volts. • ELECTRONIC OHMMETER—0 to 1,000 ohms/10,000 ohms/100,000 ohms/1 megohm/10 megohms/100 megohms/1,000 megohms. • DECIBELS: —10 db to + 18 db to + 38 db. + 30 db to + 58 db. All based on 0 db = .006 watts (6 mw) into a 500 ohm line (1.73v). • ZERO CENTER METER — For discriminator alignment with full scale range of 0 to 1.5/7.5/37.5/75/150/375/750 volts at 11 megohms input resistance.

Model 77 comes complete with operating instructions, probe and leads. Use it on the bench—use it on calls. A streamlined carrying case, included at no extra charge, accommodates the tester, instruction book, probe and leads. Operates on 110-120 volt 60 cycle. Only

\$42⁵⁰

The Most Versatile All-Purpose Multi-Range Tester Ever Designed!

Superior's New Model 79



Model 79 completely wired and calibrated with test leads and portable carrying case sells for only \$38.50. Positively no extras to buy.

but in addition includes those services the ever-increasing number of new components used in all phases of today's electronic production. For example with the Model 79 SUPER-METER you can measure the quality of selenium and silicon rectifiers and all types of diodes—components which have come into common use only within the past five years, and because this latest SUPER-METER necessarily required extra meter scale, SICO used its new full-view 6-inch meter.

SUPER-METER

WITH NEW 6" FULL-VIEW METER

A Combination VOLT-OHM MILLIAMMETER.

Plus CAPACITY, REACTANCE, INDUCTANCE AND DECIBEL MEASUREMENTS.

Also Tests SELENIUM AND SILICON RECTIFIERS, SILICON AND GERMANIUM DIODES.

The Model 79 represents 20 years of continuous experience in the design and production of SUPER-METERS, an exclusive SICO development. In 1938 Superior Instruments Co. designed its first SUPER-METER, Model 1150. In 1940 it followed with Model 1250 and in succeeding years with others including Models 670 and 670-A. All were basically V.O.M.'s with extra services provided to meet changing requirements.

Now, Model 79, the latest SUPER-METER includes not only every circuit improvement perfected in 20 years of specialization, which are "musts" for properly servicing the following components are all tested for QUALITY at appropriate test potentials. Two separate BAD-GOOD scales on the meter are used for direct readings.

• D.C. VOLTS: 0 to 7.5/15/75/150/750/1,500.
• A.C. VOLTS: 0 to 15/30/150/300/1,500/3,000. • D.C. CURRENT: 0 to 1.5/15/150 Ma. 0 to 1.5/15 Amperes. • RESISTANCE: 0 to 1,000/100,000 Ohms. 0 to 10 Megohms. • CAPACITY: .001 to 1 Mfd. 1 to 50 Mfd. • REACTANCE: 50 to 2,500 Ohms. 2,500 Ohms to 2.5 Megohms. • INDUCTANCE: .15 to 7 Henries. 7 to 7,000 Henries. • DECIBELS: —6 to + 18, + 14 to + 38, + 34 to + 58.

The following components are all tested for QUALITY at appropriate test potentials. Two separate BAD-GOOD scales on the meter are used for direct readings.

• All Electrolytic Condensers from 1 Mfd. to 1000 Mfd. • All Selenium Rectifiers. • All Germanium Diodes. • All Silicon Rectifiers. • All Silicon Diodes.

Model 79 comes complete with operating instructions and test leads. Use it on the bench—use it on calls. Only

\$38⁵⁰

EXAMINE BEFORE YOU BUY!
USE APPROVAL FORM ON NEXT PAGE

Superior's New Model 70 UTILITY TESTER®

FOR REPAIRING ALL ELECTRICAL APPLIANCES and AUTOMOBILE CIRCUITS

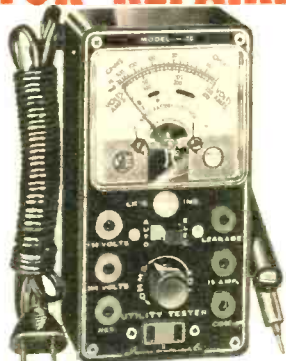

As an electrical trouble shooter the Model 70:

- Will test Toasters, Irons, Broilers, Heating Pads, Clocks, Fans, Vacuum Cleaners, Refrigerators, Lamps, Fluorescents, Switches, Thermostats, etc.
- Measures A.C. and D.C. Voltages, A.C. and D.C. Current, Resistances, Leakages, etc.
- Will measure current consumption while the appliance under test is in operation.
- Incorporates a sensitive direct-reading resistance range which will measure all resistances commonly used in electrical appliances, motors, etc.
- Leakage detecting circuit will indicate continuity from zero ohms to 5 megohms (5,000,000 ohms).

As an Automotive Tester the Model 70 will test:

- Both 6 Volt and 12 Volt Storage Batteries • Generators • Starters • Distributors
- Ignition Coils • Regulators • Relays • Circuit Breakers • Cigarette Lighters • Stop Lights • Condensers • Directional Signal Systems • All Lamps and Bulbs • Fuses
- Heating Systems • Horns • Also will locate poor grounds, breaks in wiring, poor connections, etc.



INCLUDED FREE This 64-page book—practically a condensed course in electricity. Learn by doing.

Just read the following partial list of contents: What is electricity? • Simplified version of Ohms Law • What is wattage? • Simplified wattage charts • How to measure voltage, current, resistance and leakage • How to test all electrical

appliances and motors using a simplified trouble-shooting technique.

- How to trace trouble in the electrical circuits and ports in automobiles and trucks.

Model 70 comes complete with 64 page book and test leads.

Only **\$15⁸⁵**

Superior's New Model 82



A truly do-it-yourself type TUBE TESTER

TEST ANY TUBE IN 10 SECONDS FLAT!

- 1 Turn the filament selector switch to position specified.
- 2 Insert it into a numbered socket as designated on our chart (over 600 types included).
- 3 Press down the quality button—

THAT'S ALL! Read emission quality direct on bad-good meter scale.

FEATURES:

- Tests over 600 tube types.
- Tests OZ4 and other gas-filled tubes.
- Employs new 4" meter with sealed air-damping chamber resulting in accurate vibrationless readings.
- Use of 22 sockets permits testing all popular tube types and prevents possible obsolescence.
- Dual Scale meter permits testing of low current tubes.
- 7 and 9 pin straighteners mounted on panel.
- All sections of multi-element tubes tested simultaneously.
- Ultra-sensitive leakage test circuit will indicate leakage up to 5 megohms.

Production of this Model was delayed a full year pending careful study by Superior's engineering staff of this new method of testing tubes. Don't let the low price mislead you! We claim Model 82 will outperform similar looking units which sell for much more—and as proof, we offer to ship it on our examine before you buy policy.

Model 82 comes complete, housed in portable, hand-rubbed oak cabinet with removable cover. Only

\$36⁵⁰

SHIPPED ON APPROVAL NO MONEY WITH ORDER — NO C. O. D.

Try any of the instruments on this or the facing page for 10 days before you buy. If completely satisfied then send down payment and pay balance as indicated on coupon. **No Interest or Finance Charges Added!** If not completely satisfied return unit to us, no explanation necessary.

MOSS ELECTRONIC, INC.

Dept. D-544, 3849 Tenth Ave., New York 34, N. Y.

Please send me the units checked on approval. If completely satisfied I will pay on the terms specified with no interest or finance charges added. Otherwise, I will return after a 10 day trial positively cancelling all further obligation.

Name.....

Address.....

City..... Zone..... State.....

All prices net, F.O.B., N. Y. C.

- Model 77 Total Price \$42.50
\$12.50 within 10 days. Balance \$6.00
monthly for 5 months.
- Model 79 Total Price \$38.50
\$8.50 within 10 days. Balance \$6.00
monthly for 5 months.
- Model 70 Total Price \$15.85
\$3.85 within 10 days. Balance \$4.00
monthly for 3 months.
- Model 82 Total Price \$36.50
\$6.50 within 10 days. Balance \$6.00
monthly for 5 months.

Our Amazing Teenagers

Continued from page 46

dynamics and weather study exhibits, projects on the upper air and deep into the earth with seismology. Rockets, missiles and satellites are also favorite topics of teenage exploration.

There are more than 19,500 Science Clubs of America operating in every state except Kentucky, Nevada, Oregon and Wyoming. In addition to sponsoring local and regional science fairs, the SCA also promotes the National Science Fair. The 10th fair will be held in Hartford, Conn., from May 6 through May 9, 1959. In 1960 it will be held in Indianapolis, Ind., May 11-14.

Another important science event for teenagers sponsored by the SCA is the annual Science Talent Search held in cooperation with the Westinghouse Educational Foundation. The Search distributes a total of \$34,250 in scholarships to the 40 top winners and distributes 260 certificates of honorable mention. In addition, recommendations to the schools of their choice are available to all 300, which usually result in acceptance of the students by the college as well as scholarships and other financial aid.

As an indication and tie-in to the wide interest in the National Science Fair, four other organizations present awards in specialized categories:

The American Medical Association for the best exhibits in medical science and health; the Navy for exhibits in Navy-oriented sciences; the Air Force in the field of air power and rocketry; the Army in missiles, satellites, electronics, computers and mathematics.

If you are a teenager, teacher or parent interested in more information relating to the Science Clubs of America, the National Science Fair, the National Science Talent Search, communicate with Science Clubs of America, 1719 N Street, N.W., Washington 6, D. C.

For local and regional organizations contact your school science teacher, city or state Science Teachers Association, the National Science Teachers Association, 1201 16th Street, Washington 6, D. C., or your local or state board of education.

It is quite evident that this country

has a wealth of young talent, but lacks a comprehensive, over-all program to develop that talent. Science fairs are excellent, but go just so far, and no further. Only two alternatives are open to us. We may continue as we are now, trusting to luck that our schools, with a tea-cupful of private aid and Federal aid can develop the scientists and mathematicians we desperately need. Or we can push for a full-blown, government-sponsored program of *heavy*, comprehensive aid to education—all education.

EI advocates the latter course, which leaves us open to critics shouting "Regimentation!" "Socialism!"

Not so. In this era of continual crisis, we face an opponent with a firm grasp on reality. The Soviet Union knows that whoever can make the greatest technological advance in the next decade will control the earth and outer space. We must face that fact and prepare for it.

We can prepare for it with no loss of the freedoms we enjoy today. We must realize that government aid to education is necessary to build the physical plants we so sorely lack today. To those who fear government intervention, we might point out that many phases of our lives today are government-subsidized without any loss of freedom. The government builds roads for autos and trucks; it subsidizes transportation, develops atomic energy and supplies power. We are no less free because of that.

In the same way the United States could aid in building schools without intruding on the academic freedom we prize—with one exception: Certain high standards of teaching must be maintained. These standards, of course, would not be set by the government, but rather by educators in cooperation with private foundations already doing pioneer work in curriculum studies, such as the Ford Foundation.

You can help by writing your congressmen now to vote for a comprehensive aid-to-education measure in the next session of Congress. If the public shows enough interest in such a bill, it will not be long before we will be able to catch and surpass Russia in the quantity and quality of our scientists and engineers, as well as artists, writers, doctors and the other "eggheads" we need for a full, productive America. —



Prepare now
**IN SPARE TIME
 AT HOME**
 for great opportunity
 field of...

TELEVISION

The future is **YOURS** in
TELEVISION—RADIO—COLOR-TV!

A fabulous field—good pay—fascinating work—a prosperous future! Good jobs or independence in your own business!

**Modern Training by Coyne
 RIGHT IN YOUR OWN HOME**

Coyne brings you the first truly lower cost, MODERN—QUALITY Television Home Training; training designed to meet Coyne standards. Not an old Radio Course with Television "tacked on." Here is MODERN TELEVISION TRAINING including RADIO, UHF and COLOR TV. No previous experience needed. Personal guidance by Coyne Staff.

The Institution Behind this Training

Famous for over a half century, COYNE occupies this entire building which is the new home of COYNE. COYNE'S modern resident training of men for Television, Radio, Electronics and Electricity has produced thousands of successful graduates.



D. W. COOKE, Jr., President

FOUNDED 1899

COYNE
ELECTRICAL SCHOOL
 CHARTERED AS AN EDUCATIONAL INSTITUTION
 NOT FOR PROFIT

1501 W. Congress Parkway, Chicago 7, Dept. 19-H8

MAIL COUPON NOW FOR DETAILS FREE

LEARN TO

EARN IN SPARE TIME AT HOME

COYNE offers a most practical, Home Television Training. Easy to follow step-by-step instructions, fully illustrated with 2150 photos and diagrams. Practical Job Guides to show you how to do actual servicing jobs—make money early in course. Keep your present job while training.

Low Cost—Easy Terms

We save you money because we don't send you—AND CHARGE FOR—a long list of parts or "put together kits," which you may not want or do not need. With Coyne Television Home Training you pay only for your training, no costly extras.

Let us show you that this is not only the newest, most up-to-the-minute Training in Television—but also it costs you much less than other leading home training courses. Send coupon today for details including Easy Payment Plan.

**SEND COUPON OR WRITE TO ADDRESS BELOW
 FOR FREE BOOK**

and full details, including Easy Payment Plan. No obligation, no salesman will call.

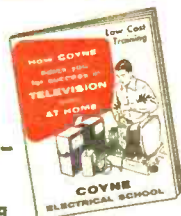

COYNE Television Home Training Division
 Dept. 19-H8 — New Coyne Building
 1501 W. Congress Parkway, Chicago 7, Illinois
 Send Free Book and details on Television Home Training. This does not obligate me in any way.

Name _____

Address _____

City _____ State _____

(It is understood no salesmen will call.)

Common Component Receiver

Continued from page 89

specified, you'll find that a pair of end brackets are provided. These serve to support the loop antenna, with the larger one serving as a support for the volume control (R17) and tuning capacitor (C1, C2). These are attached to the main chassis with sheet metal screws.

Complete all filament and "ground" wiring first. Then connect all permanently mounted components. . . IF transformers, output transformer, oscillator coil, and so on. Finish by wiring the power supply circuit and installing smaller electrical parts. The oscillator section (C2) of a standard superhet tuning capacitor may be identified by its *smaller* rotor plates.

Note that a "floating ground" is used. Thus, only the rotor sections (frame) of tuning capacitor C1-C2 and R3 and R4 are connected to the receiver's chassis. All other ground connections are to *insulated* terminals.

Once you've completed all circuit wiring, double-check each connection for errors, poor soldering, accidental shorts, and similar defects. With these visual checks completed, mount and connect the loudspeaker, install the vacuum tubes, and mount and wire the loop antenna (L1).

For preliminary tests, insert the line plug in a wall receptacle and turn the receiver on, allowing ample time for warmup. All the tubes should light to about normal brightness. If the tubes glow, but dimly, check R15 and R16 for possible opens. If the tubes remain dark, check the entire series filament circuit for possible opens; have the tubes tested. If several of the tubes light, but one remains dark, there may be an internal short in that tube, or a short across its tube socket or filament wiring.

Next, turn the volume control to its maximum position and touch its center arm lightly with *one* finger. Make sure that no part of your body is grounded when you do this. You should hear a definite noise, hum, or buzz in the loudspeaker. This indicates that the audio and power supply circuits are working.

Try adjusting the tuning control. If the IF transformers are not too far out of adjustment, you may be able to pick up one or more local AM broadcast stations. As in any superhet receiver, the tuned circuits must be *aligned* for peak performance and proper dial "tracking." You'll need a standard RF signal generator for this job. If you don't own such an instrument or can't borrow one from a friend, turn the completed receiver over to a competent radio serviceman for this final operation.

Connect the signal generator's ground lead to the chassis and its "hot" lead through a small (10-25 mmfd.) ceramic or mica capacitor to pin 7 of V1. Turn volume control to its maximum volume position and apply a modulated RF signal at 455 kc, adjusting the generator's *Output Level* controls for the *minimum* signal necessary to hear a tone in the loudspeaker.

Next, using a standard alignment tool, adjust IF transformers IF1 and IF2 for a peak in the loudness of the signal heard through the loudspeaker. Reduce the generator's output as alignment proceeds so that loudspeaker volume remains at a low to moderate level.

Depending on the exact components you've used, layout, lead dress, and other factors, you may find that the receiver breaks into oscillation as you approach peak alignment. You can tell when this happens by a sudden change in the audio tone heard in the loudspeaker and, in some cases, by the presence of squeals. If this occurs, readjust the IF transformers for maximum output before oscillation occurs.

Next, set the signal generator to supply a 1600 kc modulated RF signal and adjust the tuning control until the rotor plates are fully open. Next, adjust the oscillator trimmer capacitor (on C2) until an audio tone can be heard in the loudspeaker, peaking this adjustment.

Shift the signal generator's frequency to about 1200 kc and adjust receiver tuning until the audio tone can be heard again. At this point, adjust the RF trimmer capacitor (on C1) for peak audio output. Finally, repeat the oscillator and RF trimmer adjustments.

When these adjustments are done, the receiver is complete and may be installed in its cabinet. ●

easy to build

do it yourself



COMBINES BEAUTY, STYLE AND QUALITY

"bookshelf" 12 watt amplifier kit

Build this high quality amplifier in a few hours of your spare time and enjoy true high fidelity performance for years to come. Provides full range frequency response from 20 to 20,000 CPS within ± 1 db, and has less than 1% harmonic distortion at full 12 watt output over the entire range (20—20,000 CPS). Miniature tubes are used throughout the advanced circuitry, including EL84 output tubes in a push-pull tapped-screen output circuit. The special design output transformer has taps for 4, 8 and 16 ohm speakers. The model EA-2 has its own built-in preamplifier with provision for three separate inputs, mag phono, crystal phono and tuner. Features RIAA equalization, separate bass and treble tone controls, and a special hum-balance control. Complete with instructions for easy assembly.



MODEL EA-2
\$27⁹⁵



Whatever your hobby there is a HEATHKIT for you!



TEST
Model V-7A
VTVM, \$24.50



HI-FI
Model SS-2 "Basic Range"
Speaker System, \$39.95.



HAM
Model DX-20
CW Transmitter, \$35.95



MARINE
Model FD-1 Fuel
Vapor Detector, \$35.95

Send for FREE catalog

listing nearly
100 high quality
dependable
Heathkits for you
to choose from.



HEATH COMPANY BENTON HARBOR 39, MICH.

*pioneer in
"do-it-yourself"
electronics*

D a subsidiary of Daystrom, Inc.

I'm interested in the following type of equipment:
 TEST, HI-FI, HAM GEAR, MARINE.

name _____

address _____

city & state _____

Inside Your Heart

Continued from page 65

this method, however, would require going into the arteries, against the blood flow and against the valve action. So the doctors devised a second method of introduction. A long, hollow needle is inserted between the ribs in the back, directly into the left auricle. The mike and cable pass inside the needle, and from the left auricle can drop down to the left ventricle and even into the aorta.

The first patient to prove the usefulness of the heart mike was an unsung mongrel dog at the NADC. Doctors heard the actual sounds of a living heart from inside the heart, sounds that had never been heard before. Since that day three years ago, more than 600 human beings, including a five-pound premature infant, have had their hearts sounded electronically, and many have had their lives prolonged as a direct result.

Continuing his research, Wallace later introduced *two* microphones into the heart of a dog, one into each side. One of the microphones was converted into a miniature loudspeaker, and Wallace discovered the amazing fact that there are 60 decibels of sound isolation through the thin wall between the two sides of the heart. "If I knew how Nature does that one," he said, "I could completely revolutionize the soundproofing business."

Another more famous canine may very well have been carrying a heart mike on the last days of her life. This was Laika, the occupant of Russia's Sputnik II. Long before she took her ride into outer space, the Russians had all the information necessary.

On July 12, 1956, a letter was written in Moscow by Prof. A. N. Bakulev, head of the Academy of Medical Sciences of the U.S.S.R. It was addressed to the doctors at Philadelphia General and requested complete information concerning the heart mike. Everything asked for was freely given. Then nothing else was heard from behind the Iron Curtain.

But when Sputnik II's radio was transmitting, its signal, as analyzed by an oscilloscope, discounting noise from outer space, looked suspiciously like an

oscillographic recording made of a dog's heartbeat by Jack Wallace using his heart mike.

If the Russians were using the phonocatheter, they had complete information on Laika's heart action, pulse and respiration. When asked point blank whether they had appropriated Wallace's idea, the Russian Embassy asked for time to investigate. Finally the answer came back: "No comment."

The first human patient was a very ill four-year-old girl. The mike moved into her heart through her arm and quickly sent back the information that there was a rupture in the walls between her right and left auricles. As soon as doctors had the information, an operation was ordered and today the young girl is in perfect health.

Preparations are now being made to measure the size of the heart chambers, as well as the stiffness of certain arteries. The research team expects in this way to probe the mysteries of hardening of the arteries, perhaps even detect the condition of coronary thrombosis, the largest killer of all. If they succeed in doing this, they will have realized a dream as old as the history of medicine, and there'll be no award big enough to represent the gratitude of all mankind. —

Copper Plating At Home

Continued from page 69

Now remove the piece from the boiling cleaning bath and immerse it completely in the plating solution on the side of the jar opposite the copper strip. The plating action is started when you connect another piece of wire from the negative or outside terminal of the dry cell to the stiff wire holding the object being plated.

After a few minutes you will see the object start to change color as pure copper is deposited on its surface. A very tiny amount of electric current is all that is necessary. I used an old cell and obtained a reading of only $\frac{1}{2}$ volt and a current drain of 50 milliamperes. This was more than sufficient for very good copper coating. If you want to obtain different plating effects such as a heavy layer of small lumps (dull finish), increase the current by using a new cell

*Shipped on...
approval*

**SEND NO MONEY —
NO C.O.D.**

Try them for 10 days at no risk!
Examine first, and then only if completely
satisfied, pay lowest prices for
highest quality units, in easy
monthly installments.

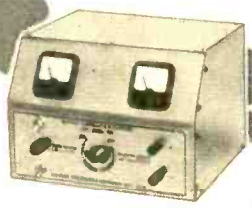

**MODEL 204 P
TUBE-BATTERY-OHM CAPACITY TESTER**

An Emission Tube Tester, with a completely flexible switching arrangement. Test all tubes. Checks batteries under rated load on "reject-good" scale. Uses 25W line voltage control. Checks condenser leakage to 1 meg. Checks resistance up to 4 megs. Checks capacity from .01 to 1 mfd.

Model 204P (illustrated) \$55.90
Cathode Ray Tube Adaptor available \$ 4.50

**MODEL 905
BATTERY ELIMINATOR and CHARGER**

Continuously variable voltage output. Automatic overload relay self-resetting. Either 6 or 12 volt operation. Heavy duty rectifier. Continuous operation 6V. at 10A. or 12V. at 6A. Intermittent operation 6V. at 20A. or 12V. at 12A.

Model 905 (Wired) \$37.50

VOLOMETER, Model 104.
This 20,000 Ohms per volt instrument is the lowest priced, domestic made, unit of its kind in today's market. Uses large 4½" D'Arsonval, 50 mi-



croampere meter, accurate to 2%. Housed in polished, high impact, bakelite case . . . uses a durable, etched aluminum panel. 3 AC Current Ranges. Checks resistance accurately in 3 ranges to 20 megohms. 5 DC and AC Ranges to 3000 volts. 5 DB Ranges. Model 104 (wired) \$26.95 Net

TESTMASTER, INC. Dept. EI-1-59

192 Mercer Street, New York 12, N. Y.
Please send me for approval the units checked. If completely satisfied, I will pay on terms specified, with no interest or finance charges. Otherwise, I will return after a 10 day trial, positively cancelling all obligations.

Name _____
Address _____
City _____ Zone _____ State _____

All prices net, F.O.B. N. Y. C.

- MODEL 905 — \$37.50**
KIT . . . \$28.90
\$10.90 within 10 days.
Balance \$6.00 for 3 mos.
- MODEL 204 P**
Total Price \$55.90
\$15.90 within 10 days.
Balance \$8.00 for 5 mos.
- MODEL 104 — \$26.95**
KIT . . . \$19.25
\$5.25 within 10 days.
Balance \$3.50 for 4 mos.



FREE

GIANT NEW 1959 B-A CATALOG

A COMPLETE BUYING GUIDE FOR EVERYTHING IN

RADIO TV

ELECTRONICS

BA 1959
ANNUAL CATALOG '59

SINCE 1927

BURSTEIN-APPLEBEE CO.

Dept. E1, 1012 McGee St., Kansas City 6, Mo.

Send Free 1959 B-A Catalog No. 591.

Name _____

Address _____

City _____ State _____

180 KING-SIZED PAGES

EVERYTHING IN RADIO TV AND ELECTRONICS

100'S OF NEW ITEMS LISTED HERE FOR 1st TIME

21 PAGES OF BARGAINS NOT IN ANY OTHER CATALOG

SEND FOR IT TODAY

See the Stars, Moon, Planets Close Up!

3 1/4" ASTRONOMICAL REFLECTING TELESCOPE

60 to 160 Power—An Unusual Buy!

FAMOUS MT. PALOMAR TYPE!

Assembled—ready to use! You'll see the Rings of Saturn, the fascinating planet Mars, huge craters on the Moon, Star

Clusters, Moons of Jupiter in detail, Galaxies! Equatorial mount with lock on both axes. Aluminized with overcoated 3" diameter highspeed f/10 mirror. Telescope comes equipped with a 60X eyepiece and a mounted Barlow Lens, giving you 60 to 160 power. An Optical Finder Telescope, always so essential, is also included. Sturdy hardwood, portable tripod. Free with scope: Valuable STAR CHART and 272 page "Astronomy Book."

Stock No. 85,050-EB \$29.95 Postpaid
Send check or M.O.—money back guarantee.

MECHANICAL DRAWING SET

Regular Price \$18.00 Our Price Only \$6.00 Pstpd.

10 handsome pieces in velvet-lined case. Nickel plated brass—precision American-made. Set contains 5 1/2" Swedish Etching Pen, 5 1/2" Compass, Lengthening Bar for Compass, 3/4" Interchangeable Pen for Compass, 3/4" Dividers with straightening device, Center Wheel 3" Bow Pen, Center Wheel 3" Bow Pencil, Center Wheel 3" Bow Divider, Adjusting Screw Driver, Spare Parts Container with Leads and

Points. We guarantee you will be satisfied or money refunded.
Stock No. 50,200-EB \$6.00 Postpaid
Quantity Price: 5 Sets for \$5.50 each Postpaid
10 Sets for \$5.00 each Postpaid

SPECIAL INFRARED IP25A IMAGE TUBE

Stock No. 70,127-EB \$9.95 pstpd.

WRITE FOR FREE CATALOG "EB"!

Complete Line of Astronomical Telescope Parts and Assembled Telescopes, Satellite-telescopes. Also huge selection of lenses, prisms, war surplus optical instruments, parts and accessories. Telescopes, microscopes, binoculars, etc. Request Catalog "EB"!



ORDER BY STOCK NUMBER SEND CHECK OR MONEY ORDER. SATISFACTION GUARANTEED!
EDMUND SCIENTIFIC CO., BARRINGTON, N. J.

or increase the voltage by using two cells in a series hookup.

If you want to plate larger objects such as tools and baby shoes it will be necessary to use a container such as an earthenware crock and a battery charger. Adjust the output for approximately 2 volts and, if necessary, use a series dropping resistor or rheostat to reduce the voltage of a 6 or 12 volt charger.

Book ends, clay objects and other non-metallic pieces may also be copper plated. The surface of these objects are covered with a coating that conducts electricity. First, with wooden objects, the surface must be made 'waterproof' with several coats of shellac or varnish. After thorough drying, apply another coat of varnish and before it dries dust copper bronze powder over the area you wish to be plated. Put the powder on as heavily as you can. Any excess that did not stick can be brushed off when the varnish is dry.

Remember, as before, not to allow your fingers, which may be greasy, to touch the work. Treat the job as before, connecting the object to the negative side of the charger and the copper sheet to the positive lead. Plating will take from a few minutes to several hours depending upon how thick you wish the copper coating. In order to insure an even coat, rotate the object every few minutes while in the solution. The plating methods described can be used on baby shoes with equal success.

It is only necessary to remember that cleanliness is the biggest secret. Shoes should be cleaned thoroughly with a solvent such as lacquer thinner to remove all dirt, grease and oil, but ordinary soap and water will do the job.

The entire shoe, after it is dry, can be completely dipped in clear lacquer to make it waterproof. Allow the lacquer to soak into the leather and sprinkle copper bronze powder onto the surface before the lacquer dries. This must be done rather quickly because of the drying speed of the lacquer. After being thoroughly dried, the shoe is attached to the negative electrical terminal.

The finished job will be an everlasting reminder of the baby's first days of walking.

FREE Lafayette 1959 CATALOG

260 GIANT-SIZED PAGES!

The Complete Catalog Featuring "The Best Buys In The Business"

Send for Lafayette's 1959 Catalog—the most complete, up-to-the-minute electronic supply catalog crammed full of everything in electronics at our customary down-to-earth money-saving prices.

LEADERS IN HI-FI—The most complete selection and largest stocks of hi-fi components and systems—available for immediate delivery at the lowest possible prices. Save even more on Lafayette endorsed "best-buy" complete systems.

FOR THE NEWEST AND FINEST IN STEREPHONIC HI-FI EQUIPMENT AND SYSTEMS

- TAPE RECORDERS
- PUBLIC ADDRESS SYSTEMS
- AMATEUR EQUIPMENT
- INDUSTRIAL SUPPLIES
- MICROSCOPES & TELESCOPES
- RADIO AND TV TUBES & PARTS
- EXCLUSIVE LAFAYETTE TRANSISTOR AND HI-FI KITS

"Everything in Electronics"

CONTAINS HUNDREDS OF EXCLUSIVE LAFAYETTE ITEMS NOT AVAILABLE IN ANY OTHER CATALOG OR FROM ANY OTHER SOURCE — SEND FOR YOUR COPY NOW!

A "must" for the economy-minded hi-fi enthusiast, experimenter, hobbyist, engineer, technician, student, serviceman and dealer.

EASY PAY TERMS

Only 10% down—Up to 18 months to pay

COMPLETE STEREO PHONO SYSTEM KIT

- ASSEMBLE THE STEREO AMPLIFIER AND SAVE REAL MONEY
- PLAYS STEREO AND MONAURAL RECORDS

REGULAR	ONLY
76.53	59.95

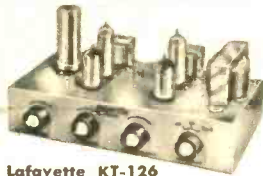

Lafayette KT-126

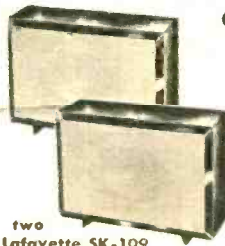

two Lafayette SK-109



Collaro TSC-640



Ronette "OV" Turnover Stereo Cartridge

Enjoy fine stereo performance with this "easy-to-assemble" exclusive Lafayette package. The complete system consists of Lafayette KT-126 basic stereo phono amplifier kit, the renowned Collaro TSC-640 4-speed automatic record changer, the new Ronette "OV" Turnover Stereo cartridge with dual sapphire styli for stereo and monaural records, and two Lafayette SK-109 Miniature Hi-Fi Speakers and Enclosures. The amplifier kit has many fine features including 2 watts per channel with separate volume control, "stereo-reversal-monaural operation" switch, and isolation transformer to eliminate shock hazard. The 4" x 6" 5 watt speakers are housed in beautiful mahogany wood cabinets, work from either 4 or 8 ohm outputs and are supplied with 25 ft. of cable for hookup. You save 16.58 over regular catalog prices!

PK-299 Stereo Phono Kit System Net 59.95
 KT-126 Stereo Amplifier Kit Only. Complete with all tubes, parts and instructions. Shpg. wt., 7 lbs. Net 18.95

COMBINATION MONEY SAVER

The KT-126 Stereo Amplifier Kit and Ronette "OV" Stereo Turnover Cartridge with dual sapphire styli. Net 24.90



NEW! STEREO BALANCE VU METER

8.95

Removes guesswork in providing perfect balance of the 2 amplifier or preamplifier channels in any stereo system. Can be used as record-level indicator with stereo tape recorders, and for balancing stereo tuners. Impedance 10,000 ohms; calibrated 20 db attenuators, capacitors for blocking DC. Calibrated in Volume Units and percent; highly damped, reads average voltage of voice or music signals. Sensitivity 1.4 volts for 0 VU. Shpg. wt., 1 lb.

LAFAYETTE TM-40 Stereo Balance Meter Net 8.95

Lafayette Radio P. O. BOX 511
 Dept. EIA JAMAICA 31, N. Y.

Send FREE CATALOG 590

Name _____

Address _____

City _____

Zone _____ State _____

CUT OUT AND PASTE ON POSTCARD

SHOOT TV TROUBLE FAST

With H. G. Cisin's Copyrighted RAPID "TV TROUBLE SHOOTING METHOD"

Without experience or knowledge, this guaranteed new method of servicing TV sets enables you to **DIAGNOSE TV TROUBLES** as rapidly as an expert. **NO THEORY—NO MATH**—you can locate all faults in record-breaking time regardless of make or model. "TV TROUBLE SHOOTING METHOD" is the most valuable aid to TV servicing ever written. Be a TV Trouble Diagnostician. Increase your present earnings. Open your own Profitable Business or get a high-paying skilled job.

It's all in this book . . .

Nothing more to Pay—Nothing else to Buy

Alphabetically listed are 85 picture troubles, over 58 raster and 17 sound troubles. By this unique copyrighted method you know **EXACTLY WHERE** the trouble is: plus step-by-step instructions, including 69 RAPID CHECKS, help to find faulty parts. **13 IMPORTANT PRELIMINARY CHECKS NEED NO INSTRUMENTS!** Of the 69 Rapid Checks, **OVER 65 ALSO REQUIRE NO INSTRUMENTS!** Rapid checks include emergency checks for distorted pictures, defective tubes including PIX tube, plus 37 others. **ALL EXPLAINED IN SIMPLE LANGUAGE PERFORMED WITHOUT INSTRUMENTS. MANY CHECKS USE THE PICTURE TUBE AS A GUIDE.**

H. G. Cisin, the author, is the inventor of the AC/DC midjet radio. He licenses RCA, AT&T, etc. He has also trained thousands of technicians now owning their own prosperous TV service organizations or holding highly paid TV positions. His years of experience are embodied in this remarkable new book.

Guaranteed Money Back in 5 Days If Not Satisfied!

ABSOLUTELY FREE with each order: Your choice of Cisin's newest books: **BASIC ELECTRICITY**, Vol. 1 or **TV-RADIO TUBE SUBSTITUTION GUIDE**. These sell for 50c ea. **ACT NOW—get 2 books postpaid at cost of only one!**

\$1 Post. paid

RUSH COUPON NOW!

H. G. CISIN, Consulting Engineer—Dept. E1-5
Amagansett, N. Y.
Enclosed find \$1. Rush Trouble Shooting Method and free book marked above (if not marked Basic Elec. will be sent).
 Send all 3 books. Enclosed find \$1.50

Name _____
Address _____
City _____ Zone _____ State _____

ASSEMBLE YOUR OWN

WALKIE-TALKIE RADIOPHONES



New Model for Citizens Band Electronic chassis ONLY \$18.98 post paid

- Meets FCC requirements for new class "D" citizens band radio-telephone.
- License easily obtained on application by any U.S. citizen 18 years or over. No tests to take.
- Transmits and receives one to several miles depending on obstructions and elevation.
- Assembled unit is completely portable and requires no external connections. Operates from self contained batteries obtainable at your local radio store.
- Electronic chassis is wired, tested, guaranteed and includes crystal controlled oscillator, R.F. power amplifier, audio modulator, receiver with R.F. stage, and a new transistorized audio booster stage for extra loud reception plus a complete set of tubes and transistor.
- Radio receiver is tunable to any of the 22 channels by a single control knob. Features ultra-high amplification, automatic volume control and noise clipping.
- Instructions and photographs are supplied with each chassis for completing the walkie-talkie as illustrated. Accessories are not included but are available at low cost.

FREE R.F. power indicator kit with each order. **SEND YOUR ORDER TODAY. INCLUDE POSTAL MONEY ORDER FOR FAST DELIVERY. C.O.D.'S REQUIRE \$5.00 DEPOSIT.**

SPRINGFIELD ENTERPRISES

BOX 54EL

SPRINGFIELD GARDENS 13, N.Y.

Short-wave Listening

Continued from page 73

vagaries of short-wave transmission. It may be nighttime where you live, but daylight where a station is; so try the higher frequencies when in the mood.

Enjoyment of short-wave radio can be enhanced if a listener keeps his own personal log. This can be divided into two parts. One part may list every new station heard; it's wise to note the time, the day, the month, the approximate frequency on which the station was heard, and some indication of the individual dial settings. The second part—divided into the seven days of a week—can be used for jotting down different programs worthy of rehearing.

An important point to remember in connection with short-wave reception, however, is that it does not have the same reliability as normal radio. There are days when almost all stations are "blacked out" for several hours or even days; this condition is due to atmospheric conditions and affects the most

STATEMENT REQUIRED BY THE ACT OF AUGUST 24, 1912, AS AMENDED BY THE ACTS OF MARCH 3, 1933, AND JULY 2, 1946 (Title 39, United States Code, Section 233) SHOWING THE OWNERSHIP, MANAGEMENT, AND CIRCULATION OF

ELECTRONICS ILLUSTRATED published Monthly at Greenwich, Conn., for October 1, 1958.

1. The names and addresses of the publisher, editor, managing editor, and business managers are: Publisher, Fawcett Publications, Inc., Greenwich, Conn.; Editor, Charles Tepfer, Ridgefield Park, N. J.; Managing Editor, Larry Elisinger, Staten Island, N. Y.; Business Manager, Gordon Fawcett, Greenwich, Conn.

2. The owner is: (If owned by a corporation, its name and address must be stated and also immediately thereunder the names and addresses of stockholders owning or holding 1 percent or more of total amount of stock. If not owned by a corporation, the names and addresses of the individual owners must be given. If owned by a partnership or other unincorporated firm, its name and address, as well as that of each individual member, must be given.) Fawcett Publications, Inc., Greenwich, Conn.; W. H. Fawcett, Jr., Norwalk, Conn.; Marion Bagge, Overland Park, Kansas; Roger Fawcett, New York, N. Y.; V. J. Fawcett, Greenwich, Conn.; M. B. Fawcett, Norwalk, Conn.; Gordon W. Fawcett, Greenwich, Conn.; Gloria Leary, Santa Monica, Cal.; V. F. Kerr, Bakersfield, Cal.; Mrs. Eva Roberts, Seattle, Wash.; H. A. Fawcett, New York, N. Y.; Hoscoe Kent Fawcett, Reno, Nevada; M. E. Fawcett, Greenwich, Conn.

3. The known bondholders, mortgagees, and other security holders owning or holding 1 percent or more of total amount of bonds, mortgages, or other securities are: (If there are none, so state.) NONE.

4. Paragraphs 2 and 3 include, in cases where the stockholder or security holder appears upon the books of the company as trustee or in any other fiduciary relation, the name of the person or corporation for whom such trustee is acting; also the statements in the two paragraphs show the affiant's full knowledge and belief as to the circumstances and conditions under which stockholders and security holders who do not appear upon the books of the company as trustees, hold stock and securities in a capacity other than that of a bona fide owner.

5. The average number of copies of each issue of this publication sold or distributed, through the mails or otherwise, to paid subscribers during the 12 months preceding the date shown above was: (This information is required from daily, weekly, semi-weekly, and triweekly newspapers only.)

GORDON FAWCETT,
Business Manager

Sworn to and subscribed before me this 30th day of September, 1958.

[SEAL] ILLIAN M. KLEIN

(My commission expires April 1, 1963)

costly receivers as well as the least expensive. Don't assume your set is broken just because only a few stations are heard or distant outlets have poor volume. Conditions can change for better or worse rather quickly; sometimes you need only switch frequencies.

If the taste of a short-wave listener does not lean to international broadcast stations, there are always the radio amateurs, better known as "hams." These hobbyists seemingly seldom go to bed and can be heard chatting on one band or another practically around the clock. Others communicate through the international Morse code. Among the bands assigned to "hams" in the United States are 3.5 to 4 megacycles (80 meters); 7 to 7.3 (40 meters); 14-14.35 (20 meters); 21-21.45 (15 meters); and 28-29.7 (10 meters).

Some short-wave listeners enjoy collecting cards verifying reception of foreign stations. To obtain cards it is up to the "SWL" to be as helpful as he can to the station. First, he should list exactly what he heard, the name of a speaker, the title of a song during a reasonable portion of the program. He should indicate the exact time—in Greenwich Mean Time (G.M.T.), incidentally—when he was listening. He should list the model of his receiver, the number of tubes it contains, the type of aerial, etc. Most important, he should report whether the station was heard loudly or softly in comparison to other broadcasts, whether it was steady or erratic in strength, whether there was much interference, and any other information of assistance to an engineer.

In the case of some short-wave stations verification cards are mailed out at the broadcaster's expense. But in other instances the listener must include an international reply coupon, obtainable from the post office. Return postage and a self-addressed envelope always should be included if a listener seeks a verification card from a radio amateur; the hams live on a budget, too. Some countries are very indifferent to reception reports and may not send out cards even after repeated pleas. But enough countries follow the practice so that a short-wave listener may decorate his den with many souvenirs of hearing the faraway reaches of the globe.

Leading Editors Say:

"NEWCOMER, OR OLD 'PRO' YOU CAN LEARN ALL ABOUT TELEVISION WITH . . . BASIC TELEVISION

Editors of leading electronic magazines, service technician publications and industrial magazines—the experts—unanimously acclaim Basic Television, new five volume "picture-book" training course as the easiest possible way of learning all about black and white television.

Electronic Technician, April 1958

"One picture is worth 10,000 words," so you can imagine the information contained in the more than 700 figures included here. Each of these drawings is illustrated in the manner which makes the most difficult concept readily understandable. Text is very clear. . . . If you are a relative newcomer to TV, this work will be a most valuable "Bible"; if you are an old pro, you will be surprised at how much you can learn."

Radio Television News, May 1958

"For those who have thought about studying television but have been intimidated by the complexity of the average engineering text, this easy-to-take introduction to the subject should be encouraging. . . . There is no reason why the student with an elementary radio and electronics background couldn't use this 'course' as a springboard to a career as a service technician in the television field."

Telephony, April 1958

"This is undoubtedly the most understandable presentation of the basic theory, operation and circuitry of black and white television ever published. Everything from the transmitter to the picture on the screen is explained with utmost clarity in words as well as illustrations that 'visualize' each concept discussed."

Signal, April 1958

"Only a knowledge of basic electronics and radio is presupposed. The coverage, ranging from the creation of the TV image in the studio to its appearance on the receiver screen, contains many topics absent in the more traditional text."

Navy News, April 1958

"Here is an excellent encyclopedia on television from A to Z. . . . this is, indeed, the most complete work of its kind. . . . suitable for the beginner as well as the advanced technician, and anyone interested in TV."

If you want to learn all about black and white television, quickly, easily and economically, this 5 volume "picture-book" course BASIC TELEVISION is the answer. Now available at your local bookstore or electronic parts distributor. If your dealer does not have this book, order direct.

10 day unconditional money-back guarantee.



John F. Rider Publisher, Inc.
116 West 14th Street
New York 11, N. Y.

EI-1

I have enclosed \$ _____ Please send me:
 | _____ 5 vol. Basic Television set (soft cover) \$10.00
 | _____ per set
 | _____ Deluxe cloth bound edition, all 5 vols. in single
 | _____ binding, \$11.50

I understand I may return the books in 10 days for
 | complete refund of full purchase price if I am not
 | satisfied.

| NAME _____
 | Address _____
 | City _____ Zone _____ State _____

Grammes Little Genie HIGH FIDELITY KITS

• LAYER BUILT • COLOR GUIDE

"So simple . . . it's like magic"

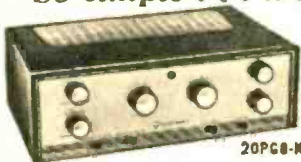

20PC8-K

Before you build another kit, see this new method of kit assembly. Each kit complete with all parts and instructions.

- 20PC8-K 20 Watt Amplifier with built-in pre-amplifier and all controls. Net \$9.50
 LJ-6K 10 Watt Amplifier (Little Jewel). Has built-in preamplifier and record compensator on phono channel. Net \$4.95
 207A-K Hi-Fi Preamplifier (Self-Powered). Feedback circuit with 10 controls. Net \$4.50
 250-K 60 Watt Basic Hi-Fi Amplifier. For use with a preamplifier (such as 207A-K). Net \$9.50

Grammes—Div. of Precision Electronics, Inc.
 Dept. EL 12 9101 King St., Franklin Park, Ill.

Name of Dealer _____

Send complete Kit details.

Kit

Check or M.O. enclosed

C.O.D. \$5 enclosed

Name _____

Address _____

City _____

Zone _____

State _____

IF IT'S EXTRA MONEY

YOU NEED—

Start A Spare Time Business With a 3¢ Postal Card As Your Only Investment

Hundreds of men and women of all ages are earning extra money as part time subscription sales representatives for **ELECTRONICS ILLUSTRATED** and other leading publications.

You need no experience to earn steady profits and you keep a cash commission on every sale. You operate in your own community by phone or personal calls. You will be authorized to sell new and renewal subscriptions along with special offers made by the publishers.

To get started immediately—send us your name (on a 3¢ postal card) requesting free supplies and selling materials. You're under no obligation and you'll be your own boss.

Write to: Electronics Illustrated Subscription Dept. DE
 Fawcett Bldg., Greenwich, Conn.

A Timer - Counter For Darkroom

Continued from page 51

you use on both the wiring diagram and a separate sheet of paper for easy identification when you are ready for final connections.

Transformer (T) is mounted at an angle to provide ample room for the relay and terminal strip to which the incoming AC leads are soldered. We want to repeat one important warning at this point: the metal case is *NOT* used as a common ground. Do not permit any bare wires to come in contact with it at the risk of making the case "hot" as far as the 117 volt AC line is concerned.

When the wiring is finished you should perform a few simple tests to be certain that no errors have been made and that all components are working as they should. Without applying power, connect an ohmmeter (or a continuity checker consisting of a single dry cell and pilot lamp in series) across the terminals of C1. With R1 rotated fully counterclockwise to the zero resistance position, the resistance reading should be no greater than 10,000 ohms nor less than 5,000 ohms. If you use a battery and lamp checker, the lamp should not light at all. This tells you that there are no short-circuits to damage any of your components. It is also advisable to use the ohmmeter to detect possible short-circuits in the 117 volt AC leads and to make certain that neither AC wire is touching the case.

Before plugging in, set both switches in the OFF position and rotate R1 fully counterclockwise to zero resistance. Plug an ordinary lamp (or you may use your enlarger or contact-printer) into the AC socket you have provided for power output. Now throw SW1 on and listen for the clicking of the relay. When SW2 is off the relay should pull in and release about every half-second with R1 in the position specified. As the timing knob is rotated about 1/4 of the way around, the spacing between clicks should get longer so that the period between successive clicks is very close to one second. As the relay clicks on and off, your indicator lamp should light and go out to show that proper relay contact is being made.

Now move SW2 to its ON position. Set R1 at about half-scale (SW1 OFF). Now turn SW1 on and begin to time the "on" period of the lamp. If everything is wired correctly and all the parts have the values specified, you will find that the indicator lamp will extinguish after approximately 30 seconds. The instrument is now ready for calibration.

Note that the calibration scale shown in the photographs is non-linear *only at the very beginning*. This feature was intentionally designed into the timer to make precise settings of small intervals possible; that is, the lower part of the scale is spread out. Beyond the 5-second mark, the scale is very nearly perfectly linear. Because of the slight differences that may exist between different transistors and other parts, it will be necessary to calibrate your particular instrument. Use a sweep-second hand on the kitchen clock or your wristwatch and calibrate according to your needs. The arrangement used in this model is ideal for photographic enlarging, but then you might want to change it some-

what for other specialized applications.

Here are some suggestions for special modifications. If you want a timer specifically for contact printing or X-ray exposures you won't need more than a 10-second range. Thus, by changing R1 to a 25,000 ohm potentiometer (wire-wound for stability) you can make up a 0-10 second timer or counter that will be very precise because there will be wide spaces between scale divisions. For longer timing periods, up to several minutes, both C2 and R1 should be *increased* in value. A three-minute timer-counter, for instance, can be built using a 500 mfd. capacitor for C2 and a 500,000 ohm potentiometer for R1. The values of the fixed resistors R2 and R3 should not be changed, however.

The timing accuracy of this unit was found to be excellent. When adjusted for exactly one-second intervals it maintained a precise rhythmic beat over as long an interval as it was checked—something over three hours. There is no reason to believe that there would be any change for any timing interval.

VIDEO ELECTRIC COMPANY says: DOWN WITH RISING COSTS OF ELECTRON TUBES OVER ONE MILLION USED TUBES TO SELECT FROM

only **40¢** each FOR ANY TUBE

WE HAVE OVER 1000 USED TV SETS

At All Times In Our Huge Warehouse

Buy one or more of these WORKING TV's to sell or use at your own second set! All sets in GOOD WORKING condition!

Your Choice—Console or Table Model

10" . . . \$23.00	17" . . . \$46.00
12" . . . \$28.00	19" . . . \$58.00
14" . . . \$33.00	20" . . . \$64.00
16" . . . \$40.00	21" . . . \$72.00
	24" . . . \$99.00

When ordering TV's, state whether table model or console is desired. Also, preference on make of set. All TV's sent railway express F.O.B. Newark. On any quantity, WIRE or CALL today!

\$37.00 PER HUNDRED

FREE Bonus Antenna Given with Any TV Set Order!

FREE RCA "Cheater" Cord Given with Any Tube Order of \$7.00 or More!!

Each and every tube is tested by our supplier under actual operating conditions in Radio, FM, Hi-Fi, Industrial Equipment and Television Chassis or Intricate Testing Equipment for Mutual Conductance and Life Test.

Below is a Partial List of Over Three Hundred Popular Types!

Write for Free Complete List and Order Blank!

6AV5GT	6B2	5AK5CT	6BC5	6L7	711	1B
6AW4	6Z2	5AZ1	6BC7	6R7	717	1B9AUGT
6B4C	1ASCT	5BR2	6BC8	6Q7	7M7	1B9BGGT
6B4C	1B7GT	5BR3	6BD6	6E4	7D7	1B9
6B4C	1B8GT	5BR4	6BE6	6E4	7X7/XKFM	1976
6B4C	1B9GT	5BR5	6BE6	6E4	7Z7	20A
6B4C	1B9GT	5BR6	6BE6	6E4	7Z7	20AV6
6B4C	1B9GT	5BR7	6BE6	6E4	7Z7	20B4
6B4C	1B9GT	5BR8	6BE6	6E4	7Z7	20B6
6B4C	1B9GT	5BR9	6BE6	6E4	7Z7	20B8
6B4C	1B9GT	5BR10	6BE6	6E4	7Z7	20B9
6B4C	1B9GT	5BR11	6BE6	6E4	7Z7	20C4
6B4C	1B9GT	5BR12	6BE6	6E4	7Z7	20C6
6B4C	1B9GT	5BR13	6BE6	6E4	7Z7	20C8
6B4C	1B9GT	5BR14	6BE6	6E4	7Z7	20C9
6B4C	1B9GT	5BR15	6BE6	6E4	7Z7	20D4
6B4C	1B9GT	5BR16	6BE6	6E4	7Z7	20D6
6B4C	1B9GT	5BR17	6BE6	6E4	7Z7	20D8
6B4C	1B9GT	5BR18	6BE6	6E4	7Z7	20D9
6B4C	1B9GT	5BR19	6BE6	6E4	7Z7	20E4
6B4C	1B9GT	5BR20	6BE6	6E4	7Z7	20E6
6B4C	1B9GT	5BR21	6BE6	6E4	7Z7	20E8
6B4C	1B9GT	5BR22	6BE6	6E4	7Z7	20E9
6B4C	1B9GT	5BR23	6BE6	6E4	7Z7	20F4
6B4C	1B9GT	5BR24	6BE6	6E4	7Z7	20F6
6B4C	1B9GT	5BR25	6BE6	6E4	7Z7	20F8
6B4C	1B9GT	5BR26	6BE6	6E4	7Z7	20F9
6B4C	1B9GT	5BR27	6BE6	6E4	7Z7	20G4
6B4C	1B9GT	5BR28	6BE6	6E4	7Z7	20G6
6B4C	1B9GT	5BR29	6BE6	6E4	7Z7	20G8
6B4C	1B9GT	5BR30	6BE6	6E4	7Z7	20G9
6B4C	1B9GT	5BR31	6BE6	6E4	7Z7	20H4
6B4C	1B9GT	5BR32	6BE6	6E4	7Z7	20H6
6B4C	1B9GT	5BR33	6BE6	6E4	7Z7	20H8
6B4C	1B9GT	5BR34	6BE6	6E4	7Z7	20H9
6B4C	1B9GT	5BR35	6BE6	6E4	7Z7	20I4
6B4C	1B9GT	5BR36	6BE6	6E4	7Z7	20I6
6B4C	1B9GT	5BR37	6BE6	6E4	7Z7	20I8
6B4C	1B9GT	5BR38	6BE6	6E4	7Z7	20I9
6B4C	1B9GT	5BR39	6BE6	6E4	7Z7	20J4
6B4C	1B9GT	5BR40	6BE6	6E4	7Z7	20J6
6B4C	1B9GT	5BR41	6BE6	6E4	7Z7	20J8
6B4C	1B9GT	5BR42	6BE6	6E4	7Z7	20J9
6B4C	1B9GT	5BR43	6BE6	6E4	7Z7	20K4
6B4C	1B9GT	5BR44	6BE6	6E4	7Z7	20K6
6B4C	1B9GT	5BR45	6BE6	6E4	7Z7	20K8
6B4C	1B9GT	5BR46	6BE6	6E4	7Z7	20K9
6B4C	1B9GT	5BR47	6BE6	6E4	7Z7	20L4
6B4C	1B9GT	5BR48	6BE6	6E4	7Z7	20L6
6B4C	1B9GT	5BR49	6BE6	6E4	7Z7	20L8
6B4C	1B9GT	5BR50	6BE6	6E4	7Z7	20L9
6B4C	1B9GT	5BR51	6BE6	6E4	7Z7	20M4
6B4C	1B9GT	5BR52	6BE6	6E4	7Z7	20M6
6B4C	1B9GT	5BR53	6BE6	6E4	7Z7	20M8
6B4C	1B9GT	5BR54	6BE6	6E4	7Z7	20M9
6B4C	1B9GT	5BR55	6BE6	6E4	7Z7	20N4
6B4C	1B9GT	5BR56	6BE6	6E4	7Z7	20N6
6B4C	1B9GT	5BR57	6BE6	6E4	7Z7	20N8
6B4C	1B9GT	5BR58	6BE6	6E4	7Z7	20N9
6B4C	1B9GT	5BR59	6BE6	6E4	7Z7	20O4
6B4C	1B9GT	5BR60	6BE6	6E4	7Z7	20O6
6B4C	1B9GT	5BR61	6BE6	6E4	7Z7	20O8
6B4C	1B9GT	5BR62	6BE6	6E4	7Z7	20O9
6B4C	1B9GT	5BR63	6BE6	6E4	7Z7	20P4
6B4C	1B9GT	5BR64	6BE6	6E4	7Z7	20P6
6B4C	1B9GT	5BR65	6BE6	6E4	7Z7	20P8
6B4C	1B9GT	5BR66	6BE6	6E4	7Z7	20P9
6B4C	1B9GT	5BR67	6BE6	6E4	7Z7	20Q4
6B4C	1B9GT	5BR68	6BE6	6E4	7Z7	20Q6
6B4C	1B9GT	5BR69	6BE6	6E4	7Z7	20Q8
6B4C	1B9GT	5BR70	6BE6	6E4	7Z7	20Q9
6B4C	1B9GT	5BR71	6BE6	6E4	7Z7	20R4
6B4C	1B9GT	5BR72	6BE6	6E4	7Z7	20R6
6B4C	1B9GT	5BR73	6BE6	6E4	7Z7	20R8
6B4C	1B9GT	5BR74	6BE6	6E4	7Z7	20R9
6B4C	1B9GT	5BR75	6BE6	6E4	7Z7	20S4
6B4C	1B9GT	5BR76	6BE6	6E4	7Z7	20S6
6B4C	1B9GT	5BR77	6BE6	6E4	7Z7	20S8
6B4C	1B9GT	5BR78	6BE6	6E4	7Z7	20S9
6B4C	1B9GT	5BR79	6BE6	6E4	7Z7	20T4
6B4C	1B9GT	5BR80	6BE6	6E4	7Z7	20T6
6B4C	1B9GT	5BR81	6BE6	6E4	7Z7	20T8
6B4C	1B9GT	5BR82	6BE6	6E4	7Z7	20T9
6B4C	1B9GT	5BR83	6BE6	6E4	7Z7	20U4
6B4C	1B9GT	5BR84	6BE6	6E4	7Z7	20U6
6B4C	1B9GT	5BR85	6BE6	6E4	7Z7	20U8
6B4C	1B9GT	5BR86	6BE6	6E4	7Z7	20U9
6B4C	1B9GT	5BR87	6BE6	6E4	7Z7	20V4
6B4C	1B9GT	5BR88	6BE6	6E4	7Z7	20V6
6B4C	1B9GT	5BR89	6BE6	6E4	7Z7	20V8
6B4C	1B9GT	5BR90	6BE6	6E4	7Z7	20V9
6B4C	1B9GT	5BR91	6BE6	6E4	7Z7	20W4
6B4C	1B9GT	5BR92	6BE6	6E4	7Z7	20W6
6B4C	1B9GT	5BR93	6BE6	6E4	7Z7	20W8
6B4C	1B9GT	5BR94	6BE6	6E4	7Z7	20W9
6B4C	1B9GT	5BR95	6BE6	6E4	7Z7	20X4
6B4C	1B9GT	5BR96	6BE6	6E4	7Z7	20X6
6B4C	1B9GT	5BR97	6BE6	6E4	7Z7	20X8
6B4C	1B9GT	5BR98	6BE6	6E4	7Z7	20X9
6B4C	1B9GT	5BR99	6BE6	6E4	7Z7	20Y4
6B4C	1B9GT	5BR100	6BE6	6E4	7Z7	20Y6

THE TUBES ADVERTISED HEREIN ARE NOT NECESSARILY NEW TUBES BUT MAY BE ELECTRICALLY PERFECT FACTORY SECONDS OR USED TUBES AND ARE SO MARKED.

SEND for our FREE complete TUBE & PARTS LIST and order blank.

GUARANTEE:

We guarantee to replace FREE for one (1) year any tube purchased from us which fails to function efficiently under actual operating conditions. Refunds will be made promptly for any defective merchandise within 5 days of receipt.

VIDEO

FREE POSTAGE in U.S.A. and Territories on orders over \$5.00. 25c handling charge on orders under \$5.00. 25% deposit required on C.O.D.'s. Please send approximate postage or freight on Canadian and foreign orders. Subject to prior sale.

Phone **HUmboldt 4-9348**

ELECTRIC COMPANY
9.15 Sixth St., Harrison, N. J.

ELECTRONICS ILLUSTRATED

Classified Ads

Your advertisement can reach this mail-buying audience for only 25¢ per word . . . payable in advance (Check or M.O. please) . . . minimum 10 words. Copy to be inserted in February issue must be in the office November 20th. Mail to ELECTRONICS ILLUSTRATED, 67 West 44th St., New York 36, N.Y. Word count: Zone number free. Figure one word: Name of state (New Jersey), name of city (New York); sets of characters as in key (14-D); also abbreviations as 35MM, 8x10, D.C., A.C.

SAVE MONEY • ORDER BY MAIL

• • • FOR SALE

MONEY SAVING Prices on tubes, TV, Radio, Transmitting and Industrial Types. New, 1st quality, guaranteed. Top name brands only. Government surplus and commercial test, lab and communications equipment in stock. Sell us your excess tubes and equipment. Unused, clean tubes of all types wanted. Send specific details in first letter. Write for "Green Sheet" catalog 25¢. Barry Electronics Corp., 512 Broadway, (Dept. E.I.), WA 5-7000, New York 12, N. Y.

NEON WINDOW signs, borders, trim. Any size, shape, color. Write Murray Neon, 217 North Poplar Street, Dept. EL-4, Elizabethtown, Penna.

15 ASSORTED COMIC business cards. Ideal pin ups for home or shop. Only 25¢. Goodrich Press, Box 4917, Station B, Columbus 2, Ohio.

RADIO WORKBENCH is truly a builder-experimenter's publication. Each issue is jam-packed with practical projects, articles, hints, etc. Latest issue—25¢. Radio Workbench Magazine, Carlsbad, N. M.

GOLD-SILVER DETECTORS. Geiger Counters. Violites for tungsten, etc. Best available. Guaranteed. Information Free. Defectron, 5528 Vineland Ave., Dept. 149, North Hollywood, Calif.

RING-VALVE JOB while driving, \$6.00. Literature. Motaloy, Grantham 8, Penna.

• • • BUSINESS OPPORTUNITIES

GROW MUSHROOMS. We buy mushrooms and pay high prices. Use cellar, shed and outdoors. Spare, full time, year round. We sell 100% pure Cultured Mushroom Spawn. Free Book. Mushroomers. Dept. 315, 2954 Admiral Way, Seattle, Wash.

VENDING MACHINES—No selling. Operate a route of coin machines and earn high profits. 32-page catalog free! Parkway Machine Corp., Dept. 33, 715 Ensor St., Baltimore 2, Md.

\$200. MONTHLY POSSIBLE, Sewing Baby-wear! No house selling! Information Free. Send name to Cuties, Warsaw 168, Ind.

FREE "FRANCHISE Profit Letter" describes nationwide opportunities. Exclusive distributorships, dealerships, agency operations. Write today. National Franchise Reports, EI-528, 333 North Michigan, Chicago 1.

\$30-\$60 WEEKLY ADDRESSING envelopes at home. Instruction \$1.00, refundable. Reiss, 210 Fifth Avenue, Suite 1102-EB, New York 10.

609 ODD SPARE-TIME Businesses. Institute, Box 1001-ELA, Evanston, Ill.

MAIL TRADE Magazine has moneymaking opportunities galore. Sample 25¢. Donovan, 79-E Greenbelt, Levittown, N. Y.

\$1,000. MONTHLY POSSIBLE, raising Earthworms—African Giants. Backyard, Garage, Basement. Complete Illustrated Booklet, explains raising, feeding, packing, marketing. Only 25¢! Ozark Worm Farm-E, Willow Springs, Mo.

MAKE MONEY mailing. Literature Free. 8007-E SE 65th Ave., Portland 6, Ore.

• • • HI-FI

TRANSISTORIZED POCKET Stereophonic Radio, AM-FM Short Wave. Information. Send stamped self-addressed envelope. Ekeradio, 650 N. Fair Oaks, Pasadena, Calif.

• • • EMPLOYMENT OPPORTUNITIES

COPYRIGHTED REPORTS. Best paying jobs with travel, adventure, promotions. Construction, aviation, shipping, oilfields, laborers, clerical, trades, supervisory, factory, unusual opportunities. Skilled — unskilled. Foreign — stateside. Men-Women. Only \$2.00 (\$2.25 Airmail) (COD'S Accepted), including registration-advisory service. Satisfaction guaranteed. Included free: Special reports on Alaska—Venezuela—South American opportunities—husband & wife foreign jobs. Research Services, Suite 514-EI, Meramec Building, St. Louis 5, Mo.

JOB—HIGH Pay; USA, So. America, The Islands. All trades. Many companies pay fare. Write Dept. 725, National Employment Information, 1020 Broad, Newark, N. J.

EARN BIG Money. Be A Success. Tremendous Opportunities. Don't dream of success. Be one. Grasp your opportunity now by sending \$1.00 for U.S.A. Overseas Job List and Guide Book aiding you to get the job you want. Futures Unlimited, Dept. E, 222 West 33 Street, New York City 1.

PRINTING - ADVERTISING SALESMEN. Excellent moneymaking sideline selling Decalcomania Name Plates. Advertising Specialties. Sign letters, Automobile initials. Free Samples. "Ralco"—EI, Box 1, Boston 19, Mass.

HOMEWORKERS! \$130 MONTHLY possible sorting our product. Numisales, 328-F Eleventh, West Bend, Wisc.

JOB'S OVERSEAS! Janeczek Development Co., 1092 Hub Station, New York 55, N. Y.

GUARANTEED HOMEWORK! Cash Commissions! Free Outfits! Hirsch, 1301-25 Hoe, New York City 59.

HIGH EARNINGS in electronic, electro-mechanical drafting, designing. Degree unnecessary. Technical Guidance, Box 1653, Boston 5, Mass.

• • • TAPE RECORDERS

THE AMAZING Electronic Educator offers exciting new concept in education. Free details. Sleep-Learning Research Association, Box 24-EI, Olympia, Wash.

• • • RADIO & TV

WE BELIEVE we have the most interesting illustrated catalog of Government surplus electronics, parabolic reflectors, snooperscopes, mine detectors, receivers, transmitters, and just plain junk. Absolutely crazy prices. Send 10¢ for our fantastic, amazing, surplus electronic catalog and get ready to spend your money on our junk. Meshna, 580a Lynn, Malden 48, Mass.

TRANSISTORIZED POCKET Stereophonic Radio, AM-FM Short Wave. Information. Send stamped self-addressed envelope. Ekeradio, 650 N. Fair Oaks, Pasadena, Calif.

DIAGRAMS FOR repairing radios, amplifiers, \$1.00; television \$2.00. Give make, model. Diagram Service, Box 672-EI, Hartford 1, Conn.

GIANT REPAIR Kit! For Radio and TV. Terrific for Servicemen, Experimenters, etc. Includes 5FP7 Test Tube, Service Hints, Schematics, Huge Parts Assortment, etc. Fabulous Buy At Only \$6.99. Allkit, Box 98, Midwood Station, Brooklyn 30, N. Y.

BECOME A Radio Amateur. Free Information on how to pass Code and Theory FCC examinations. American Electronics, 1203B Bryant Ave., New York 59, N. Y.

"15 TESTED ONE-TUBE Circuits," Transistor experiments and catalog—25¢. Laboratories, 1131-K Valota, Redwood City, Calif.

• • • EDUCATION & INSTRUCTION

LEARN WHILE Asleep. Exciting details free. Sleep-Learning Research Association, Box 24-EI, Olympia, Wash.

COMPLETE YOUR High School at home in spare time with 62-year-old school. Texts furnished. No classes. Diploma. Information booklet free. American School, Dept. X137, Drexel at 58th, Chicago 37, Ill.

ATOMIC ENERGY Career—Home study, small monthly cost. Organize school club, 50¢ weekly per member. Atomic Energy Institute, (Signal Mtn. 2.) Tenn.

THRILLING ENTERTAINMENT. Success Home Study Courses. Amazing professional popular piano. Rapid songwriting course. Special personality courses. Free booklet. Weidner System, 423 E. 7th St., Boston 27, Mass.

ENGINEERING DEGREES earned through Home Study. Electronics, Electrical, Mechanical, Civil, Physics. When writing, specify course desired. Residence classes also available. Pacific International University, 5719-E Santa Monica Boulevard, Hollywood 38, Calif.

"HYPNOTIZE . . . ONE word . . . One fingersnap," on stage. Satisfaction—or refund. \$2. Hypnomaster, 846-L9 Sunnyside, Chicago 40.

• • • **ELECTRICAL SUPPLIES & EQUIPMENT**

ELECTRIC PENCIL: Engraves all Metals, \$2.00. Beyer Mfg., 10511-El Springfield, Chicago 43.

• • • **ROCKETS**

ROCKET AMATEURS Guidebook. New, valuable guide to sources of rocket kits, plans, supplies, free instruction manuals, safety rules, legal regulations, university courses. Includes list of rocket clubs, big bibliography. Only \$1.00. Space Products, Dept. El, 38 East 57th St., New York, N. Y.

• • • **MISCELLANEOUS**

"RULE OTHERS with thoughts." (Telepathy.) Details—stamp. Clarion, 846-L9 Sunnyside, Chicago 40.

SAVE 50% ON Vitamins. New, free catalogue lists all brands, formulas, prices. Compare and save. State vitamins now using. Vitamin Specialties, Box 4435-E, Philadelphia 40, Penna.

"COBRA. DEFENSIVE street-fighting tricks." Designed to help peaceful adults. \$2. Gaucho, 846-L9 Sunnyside, Chicago 40.

ELECTRONIC INTERESTED, Student, Inventor: Nat'l non-profit ass'n now forming. Details, 4¢ stamp. Jeff Heim, Box 19704, Los Angeles 19, Calif.

FREE CATALOG, postpaid printing, rubber stamps. DM Press, Sebastopol, Calif.

• • • **PLASTICS**

PLASTICS! NEW, do-it-yourself Casting and Molding materials. Crystal Clear for Embedding Specimens. Ivory, Ebony, Marble, and Colors for Jewelry, Novelties and Industrial Castings. Send 25¢ for Instructive, Illustrated Catalog listing over 200 materials and accessories. Castacraft Corp., Dept. E-11, P.O. Box 555, Palo Alto, Calif.

• • • **STAMPS & COINS**

TERRIFIC STAMP Bargain! Israel—Iceland—Vatican Assortment—Plus Exotic Triangle Set—Also Fabulous British Colonial Accumulation—Plus Large Stamp Book—All Four Offers Free—Send 10¢ to cover postage. Empire Stamp Corp., Dept. E2, Toronto, Can.

BEAUTIFUL STAMP albums and stamps. Send 20¢ for catalogue. New-Way Stamp, Lawrence 6, Mass.

TERRIFIC U.S. Price List Free! Bailey, 45 Bromfield, Boston 8-X, Mass.

FREE POSTAL Zool U. S., Australian Animal Stamps. Approvals. Barnes, 920 SW 28, Oklahoma City 9, Okla.

200 DIFFERENT ARGENTINA, \$1.00, approvals. Doc Shoenfelt, 259 Tower, Mansfield, Ohio.

INDIAN CENT plus Bargain Lists 10¢. Hutchinson's, Box 4747, Philadelphia 34, Penna.

UNITED NATIONS. Five different 10¢. Approvals. Anderson, 1112 Harrison, San Francisco 3, Calif.

1000 DIFFERENT WORLDWIDE with approvals only. A. B. Jacobsen, Crompond, N. Y.

COMPASSIONATE CHRIST set 15¢. Approvals. Barricks, 1600 Seward, Detroit 6, Mich.

• • • **DETECTIVES**

DETECTIVES—WORK Home—Travel. Experience unnecessary. Detective Particulars free. Write, Wagner, B-125 West 86th, New York 24.

• • • **MUSIC**

SONGPOEMS AND Lyrics Wanted! Mail to: Tin Pan Alley, Inc., 1650 Broadway, New York 19, N. Y.

Community TV

Continued from page 91

picks up the distant station and rebroadcasts on the same channel with power of a few hundred milliwatts. Many of these so-called booster amplifiers are nothing more than ordinary pre-amplifiers arranged to pick up the best possible signal, and then feed it to an antenna oriented in the direction of the viewers. This operation is not legal in most cases, and often produces intolerable adjacent channel interference through spurious radiation.

In the early days of television, CATV was looked upon as providing a welcome bonus audience for the big city broadcaster. But broadcasters have since changed their tune. They now believe that CATV cable systems offer a threat to commercial TV because of the ease with which a CATV operator can insert commercials into his cable circuit, using free programming. Also CATV, which brings programs in from afar, has made it hard sledding for some newly established local TV stations. It stands to reason that if the local viewer has his

choice between a network program from a distant big city, and a more modest local offering, he will choose the network, thereby reducing the audience watching the local station.

There is a strong possibility that the FCC will decide to regulate CATV systems, but in the meantime CATV offers, in many cases, good return on a comparatively small investment for local businessmen or syndicates. For example, in a city of about 30,000 people unable to receive good outside signals about 4,500 subscribers are likely to pay for CATV at the rate of \$3.50 each per month. This amounts to \$170,000 yearly, and with expenses of about \$100,000 leaves \$70,000 before taxes. This is good business, but the monthly charge may be eliminated entirely if the initial cable connection charge runs as high as \$150.

As CATV becomes big business (more than 600 regular systems in operation) it is more and more under attack from organizations such as ASCAP, BMI and SESAC, who feel that their material is being used free of charge. If you get your television through CATV, it's a situation worth watching. ●

NO OTHER TUBE TESTER MADE- AT ANY PRICE - can MATCH the VALUE of the CENTURY FAST-CHECK



Dimensions: Width: 14 1/4" Height: 11 1/4" Depth: 4 3/8"

Special compartment accommodates line cord and Picture Tube Test Adapter

Picture Tube Test Adapter Included With Fast-Check

Enables you to check all picture tubes (including the new short-neck 110 degree type) for cathode emission, shorts and life expectancy... also to rejuvenate weak picture tubes. This feature eliminates the need of carrying extra instruments and makes the FC-2 truly an all-around tube tester.

FAST-CHECK'S low price is made possible because you are buying direct from the manufacturer.

Model FC-2—housed in sturdy wood carrying case complete with CRT adapter...

Guaranteed for One Full Year

\$ 69⁵⁰
Net

20,000 SERVICEMEN CAN'T BE WRONG!

See for yourself—AT NO RISK—why over 20,000 servicemen selected the FAST-CHECK above all other tube testers—regardless of price. With the FAST-CHECK you will make every call pay extra dividends by merely showing your customer the actual condition and life expectancy of the tube. The extra tubes you will sell each day will pay for the FAST-CHECK in a very short time.

Just 2 settings on the **FAST-CHECK TUBE TESTER** tests over 650 tube types completely, accurately — **AND IN SECONDS!**

- **POSITIVELY CANNOT BECOME OBSOLETE**
Circuitry is engineered to accommodate all future tube types as they come out. New tube listings are furnished periodically at no cost.
- **NO TIME CONSUMING MULTIPLE SWITCHING**
Only two settings are required instead of banks of switches on conventional testers.
- **NO ANNOYING ROLL CHART CHECKING**
Tube chart listing over 650 tube types is conveniently located inside FAST-CHECK cover. New tube listings are easily added without costly roll chart replacement.

COMPARE FAST-CHECK WITH OTHER TESTERS RANGING FROM \$40 TO \$200

RANGE OF OPERATION

- Checks quality of over 650 tube types, which cover more than 99% of all tubes in use today, including the newest series-string TV tubes, auto 12 plate-volt tubes, OZ4s, magic eye tubes, gas regulators, special purpose hi-fi tubes and even foreign tubes.
- ✓ Checks for inter-element shorts and leakage.
 - ✓ Checks for gas content.
 - ✓ Checks for life-expectancy.

IMPORTANT FEATURES

- Checks each section of multi-section tubes and if only one section is defective the tube will read "Bad" on the meter scale ● Less than 10 seconds required to test any tube ● 41 long lasting phosphor-bronze tube sockets accommodate all present and future tube types... cannot become obsolete ● 7-pin and 9-pin straighteners mounted on panel ● Large D'Arsonval type meter is extremely sensitive yet rugged — fully protected against accidental burn-out ● Special scale on meter for low current tubes ● New tube listings furnished periodically at no cost ● Compensation for line voltage variation.

Other testers may have some of the above features... but only the **FAST-CHECK has them all!**

SHIPPED ON APPROVAL FOR 10 DAY FREE TRIAL

Try the FC-2 before you buy it! No obligation to buy.

PAY IN SMALL MONTHLY PAYMENTS

Easy to buy if you're satisfied. Pay at net cash price... no financing charges.

NO MONEY REQUIRED WITH ORDER...

CENTURY ELECTRONICS CO., Inc., 111 ROOSEVELT AVENUE Dept. 401, Mineola, N. Y.

Rush the FAST-CHECK for a 10 day trial period. If not completely satisfied I will return the instrument within 10 days without further obligation. If fully satisfied I agree to pay the down payment within 10 days and the monthly installments as shown. No financing charges are to be added.

MODEL FC-2... \$69.50 — Pay \$14.50 within 10 days.
Balance \$11.00 monthly for 5 months.

Name.....

Address.....

City..... State.....

F.O.B., Mineola, N.Y.

Learn Radio-

Servicing by Pro



Fast Growing Field Offers You Good Pay, Success, Bright Future

**Jobs Like These Go to the
Radio-Television Technician**



J. E. SMITH
Founder

Bigger than ever and still growing. That's why Radio-TV has special appeal to men not satisfied with their earnings. More than 4,000 Radio and TV stations on the air. More than 150 million home and auto Radios. 40 million TV sets. Training PLUS OPPORTUNITY is the ideal combination for success. Plan now to get into Radio-TV. National Radio can train you at home in your spare time. NRI is the oldest and largest home study Radio-TV school. Easy to understand, well illustrated lessons teach you basic principles. And you LEARN-BY-DOING, by practicing with kits of equipment NRI sends.



Start Soon to Make \$10—\$15 a Week in Spare Time

Soon after enrolling many NRI students start to earn \$10, \$15 a week extra fixing sets in spare time. You get the benefit of NRI's more than 40 years' experience training men. Make a move toward becoming one of that select group—a Radio-TV Technician. Send Postage-Free card today for actual Lesson and 64-page Catalog BOTH FREE. NATIONAL RADIO INSTITUTE, Dept. 9AK, Washington 16, D. C.

NRI Trained these Men



"I knew practically nothing about Electronics. After 15 lessons I started repairing sets. My future looks bright." **D. B. ACKERMAN**, Minneapolis, Minn.

"Thanks to NRI, I operated a successful Radio Repair shop. Then got a job with WPAQ; now I am an engineer for WHPE." **V. W. WORKMAN**, High Point, N. C.



"Have good job in a TV repair shop plus a small business in my home. In one year I went from lowest paid to head technician." **V. BARR**, Toronto, Ohio.

You Practice Communication with Equipment NRI Send



Nothing takes the place of practical experience. As part of NRI Communications Course you build the Broadcasting Transmitter; train for FCC License.

You Practice Servicing with Equipment Sent

As part of NRI's Servicing Course you build AC-DC Superhet Receiver, Vacuum Tube Voltmeter, and other pieces of equipment for practical experience.

MAIL POSTAGE FREE CARD

now... a **NEW** improved Electro-Voice Stereo Cartridge

FOR MAGNETIC INPUTS

E-V MAGNERAMIC STEREO CARTRIDGE

From E-V, first with a stereo cartridge, comes a new improved stereo cartridge design. Just like E-V's first cartridge... only better... and, BY ACTUAL TEST, superior to any other stereo cartridge.

HERE'S WHY: THE E-V MAGNERAMIC HAS THE

HIGHEST

VERTICAL & HORIZONTAL COMPLIANCE

gives you better tracking... longer record wear

BEST

CHANNEL SEPARATION

gives you over 25 db between channels

FLATTEST RESPONSE

gives you full range frequency response flat from 20 cps to beyond audibility

Lowest

HUM AND RUMBLE

far below other stereo cartridges



THE E-V MAGNERAMIC STEREO CARTRIDGE

plugs into any magnetic input; PZT Ceramic elements deliver flat response to RIAA Standards. Step up to the excitement of stereo... step up to Electro-Voice Stereo... the industry's standard. Over a half-million in use, *more than the total of all other stereo cartridges combined*, attest to its acceptance as stereo's standard. Choose either the E-V MAGNERAMIC or the standard Electro-Voice Stereo Cartridge for non-magnetic inputs.

21 MD Stereo Cartridge, with 0.7 Mil Diamond Stylus, net \$19.50... 26 MDST Sterea Turnunder Cartridge, with 0.7 Mil Diamond (Stereo) Stylus, and 3-Mil Sapphire (Monaural) Stylus for 78 R.P.M.'s, net \$22.50... 21 MS Stereo Cartridge, with 0.7 Mil Sapphire Stylus, net \$9.90... 26 MST Stereo Turnunder Cartridge, Linear Velocity, with 0.7 Mil Sapphire (Stereo) Stylus, and 3-Mil Sapphire (Monaural) Stylus for 78 R.P.M.'s, net \$12.90

GOOD STEREO DEPENDS ON THESE VITAL FEATURES:

FREQUENCY RESPONSE	15-20,000 cps flat [Westrex LA]
ELEMENTS	2 PZT Ceramic
OUTPUT VOLTS	20 mv. Nominal
COMPLIANCE	2 x 10 ⁻⁶ cm/dyne
WEIGHT	3.4 Grams
TRACKING FORCE	4.6 Grams
CHANNEL SEPARATION	25 db @ 1 KC
MOUNTING	EIA (RETMA) Standard 1/2" 7/16" Center
STYLUS	7 MIL (Diamond or Sapphire)
OUTPUT TERMINALS	STD. .050 Connectors
IMPEDANCE OR LOAD	22,000 ohm or higher magnetic input

See your high fidelity specialist or write Dept. EI

Electro-Voice INC., BUCHANAN, MICHIGAN

Over 1/2 Million in Use... More Than All Others Combined

www.americanradiohistory.com

