

By the Publishers of
**MECHANIX
ILLUSTRATED**

25^c
MAY

ELECTRONICS ILLUSTRATED

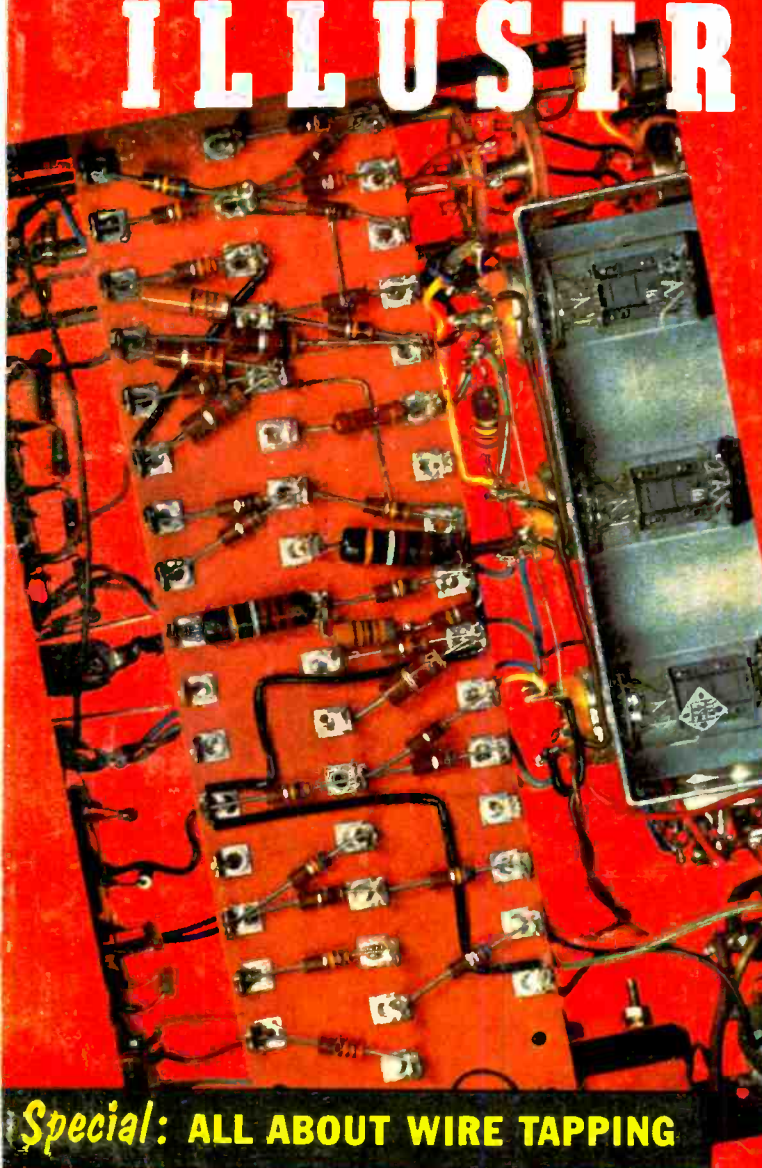

Stores Sound — Disc or Tape?



New Radio Control Developments



Kit Assembly Techniques

Special: ALL ABOUT WIRE TAPPING

HAM RADIO • HI-FI • SHORT WAVE LISTENING • HOME EXPERIMENTS
PROJECTS YOU CAN MAKE
Low Cost Electric Garage Door Opener • Electric Eye Driveway Floodlight System
Transistor Tester • Automatic Music System • Novice Transmitter • Code Oscillator



FOR SALE

Practically new ranch house with 200-foot, poured-concrete, spirally curled, exponential bass horn; 12-foot multicellular midrange horn (24 cells); large inventory of assorted dynamic and electrostatic tweeters; three 2,000-watt water-cooled amplifiers; infinite-attenuation electronic crossover networks; master control-mixer-preamplifier console; two 1,500-lb. belt-driven turntables suspended in mercury bath; vacuum-sealed record-positioning chamber with servo-controlled record lifters and nuclear-reactor record deionizer; foam-rubber base-

ment for acoustical feedback isolation; also complete blueprints for construction of identical house for stereo.

Will sacrifice, or trade for NORELCO speaker, which owner of house has discovered to be ideal for delightful hi-fi listening without electronic anxiety neuroses or showdowns with the loan company. For detailed and convincing confirmation of latter viewpoint, write to North American Philips Co., Inc., High Fidelity Products Division, 230 Duffy Avenue, Hicksville 1, Long Island, N. Y.



NORELCO loudspeakers

a complete line of 5" to 12" high-fidelity speakers and acoustically engineered enclosures

NOW—A Faster Way to Reach the Top in TV SERVICING

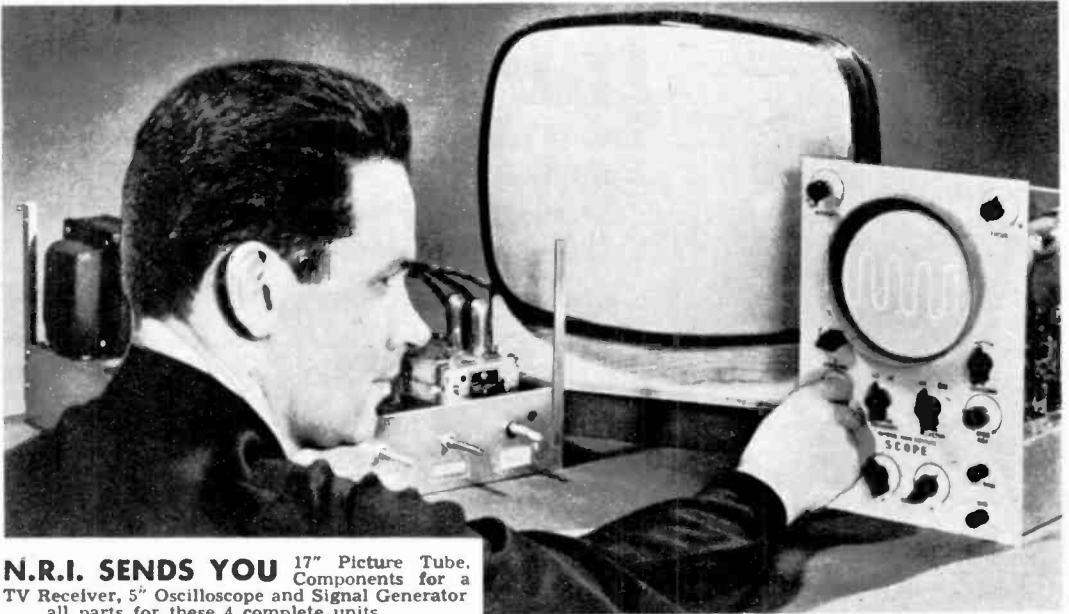

N.R.I. SENDS YOU 17" Picture Tube, TV Receiver, 5" Oscilloscope and Signal Generator . . . all parts for these 4 complete units.

N.R.I. All-Practice Method Trains You at Home in Spare Time to Fix TV Sets Quickly, with Confidence

The man who knows the answers—the Professional TV Technician enjoys the prestige, gets the better jobs, the higher pay. Here is the learn-by-practice training to be a Professional TV Technician. It shows you the way to be the boss, to earn top pay. Television Servicing needs more well trained men. If you have a basic knowledge of radio and electronics you can make some Television repairs simply by trial and error. But sooner or later you will face TV Service problems you can not solve. And you can't get the training you need while customers wait.

N. R. I. is Oldest and Largest Home Study Radio-TV School

Over forty years experience and the record and reputation of N.R.I. back up this learn-by-doing Professional TV Servicing Course. Instead of just reading about TV problems, you build and conduct experiments on circuits in a TV receiver. You learn methods. "Tricks of the trade" proved by top TV Servicemen. You learn to fix any set, any model with confidence.

You Get COLOR TV Textbooks Early The day you enroll, N.R.I. sends you special Color-TV books to speed your knowledge and understanding of this vast, growing phase of Television. Many full color pictures and diagrams help you recognize defects and help you learn how to correct them quickly and properly. To cash in on the coming Color TV boom.

you'll need the kind of knowledge and experience this N.R.I. training gives.

This is 100% learn-by-doing, practical training. Here is a course for men who know basic theory, either from Radio or TV Servicing experience or planned training but realize the need for more knowledge to forge ahead. Here is what one graduate, G. G. Stethem of Belpre, Ohio, says, "I can not praise N.R.I.'s Professional TV Course highly enough. I have my own spare time shop and all the Radio-TV work I can handle."

Another graduate, Edward Ravitsky of Northumberland, Pa., says, "I have taken your course in Professional TV Servicing. It takes the kind of experience you offer to really learn." If you want to go places faster in TV Servicing, make your future more secure as the industry develops, we invite you to find out what you get, what you practice, what you learn from N.R.I.'s Course in Professional TV Servicing. Mail the coupon now. There is no obligation. NATIONAL RADIO INSTITUTE, Dept. 8EKT, Washington 16, D. C.



Send for FREE BOOK ➔

NATIONAL RADIO INSTITUTE

Dept. 8EKT, Washington 16, D. C.

Please send FREE copy of "How to Reach the Top in TV Servicing." I understand no salesman will call.

Name Age.....

Address

City Zone..... State.....

ACCREDITED MEMBER NATIONAL HOME STUDY COUNCIL

May 1958

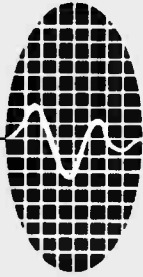

ELECTRONICS ILLUSTRATED

A Fawcett Publication
Contents

Vol. 1 No. 1



Special Project



Hi-Fi HiLite



An EI Exclusive

A Message From The Editor	4
Electronics In The News	8
New Ion Fuel For Rockets	23
Electronics Tracks Ills	27
The EI Radio Garage Door Opener	44
Radio Control—Hobby Extraordinary	34
World's Smallest TV Station	40
Code Practice Oscillator	54
A First Transmitter For The Novice	57
Small Rectifier—Big Current	61
Driveway Floodlight Control	64
Power Pack For HO Trains	69
The ABC's of Electronics	72
Careers In Electronics	76
Build A Stereo Speaker	50
Movie Camera With Electronic Brain	81
Transistor Tester	82
How To Solder	84
Stereo Makes News	88
Automatic Music System	92
All About Wiretapping	28

Larry Eisinger Editor-in-Chief

George Tilton Executive Editor

CHARLES TEPPER Editor

Phyllis Goodman Production Editor

Nancy Kay Assistant Production Editor

John F. Webster Advertising Manager

Ralph Daigh Editorial Director

James Boynton Advertising Director

Al Allord Art Director

Ralph Mattison Associate Art Director

Annette Packer Production Director

Harold Kelly Art Editor

Silvio Lembo Associate Art Editor

Murray Cooper Assistant Art Editor

Nick Carlucci Art Associate

John Selvaggio Art Associate

Mike Eastman Art Associate

David Weiss Art Associate

ELECTRONICS ILLUSTRATED is published bi-monthly by Fawcett Publications, Inc., Fawcett Place, Greenwich, Conn. W. H. Fawcett, Jr., President; Gordon Fawcett, Secretary and Treasurer; Roger Fawcett, General Manager; Roscoe K. Fawcett, Circulation Director. Editorial and Advertising offices: 67 West 44th Street, New York 36, N. Y. Application for second class mail privileges pending at Greenwich, Conn. Price 25¢ a copy. Subscription price, 12 issues for \$3.00 in U. S. and Possessions and Canada. Copyright 1958 by Fawcett Publications, Inc. Printed in the U. S. A.

Permission hereby granted to quote from this issue of this magazine on radio or television provided a total of not more than 1,000 words is quoted and credit is given to the title of the magazine and issue, as well as the statement, copyright 1958, by Fawcett Publications, Inc.

THESE MEN ARE GETTING PRACTICAL TRAINING IN **ELECTRICITY**

—**ELECTRONICS**

On Real:

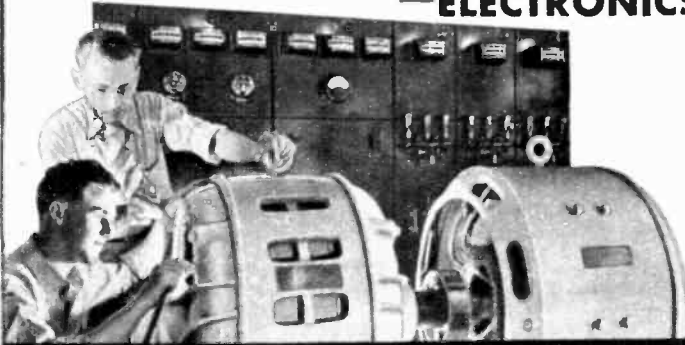

**A.C. and D.C. MOTORS
GENERATORS
SWITCHBOARDS
CONTROLLERS
WIRING JOBS
APPLIANCES
ELECTRONIC UNITS**

(Shown at left—Instructor explaining operation and testing of a large Motor Generator in our A.C. Department.)

AND **TELEVISION-RADIO**

On Real:

**TELEVISION
RECEIVING SETS
Including Color TV
AM and FM RADIO
RECEIVERS including
AUTO RADIOS
TELEVISION TEST
EQUIPMENT**

(Right — Instructor helping students check the wiring and trace circuits of television receivers.)

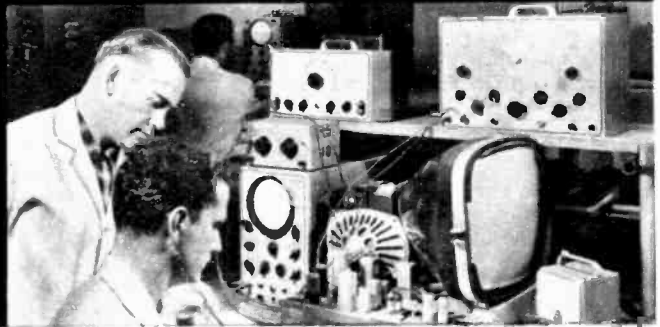

Train in the great **SHOPS** of **COYNE**

Largest, Oldest, Best Equipped School Of Its Kind In The U. S.

Whether 17 or up to 45 years of age, prepare for your future now. Don't be satisfied with a "No Future" job. Train the Coyne way for a better job in a field that offers a world of opportunities in the years ahead.

FINANCE PLAN Enroll now, pay most of tuition later. Part-time employment help for students. **WE TRAIN YOU IN CHICAGO** on real equipment. Trained instructors show you how, then you do practical jobs yourself. No previous experience or advanced education needed.

CLIP COUPON NOW for big new illustrated Coyne book "Guide to Careers in ELECTRICITY and TELEVISION-RADIO". No obligation; no salesman will call. Get vital facts now! **Training in Refrigeration and Electric Appliances can be Included.**



*Mail Coupon for
Big Free Book*

Training Offered
to **VETERANS**
and
NON-VETERANS
Alike

**B. W. COOKE, Jr., President
COYNE ELECTRICAL SCHOOL**

500 S. Paulina St., Chicago 12, Ill. Dept. 58-8C
Send **FREE** book and details of all the training you offer. This does not obligate me and no salesman will call. I am especially interested in:

- ELECTRICITY-ELECTRONICS**
 TELEVISION-RADIO

NAME.....

ADDRESS.....

CITY.....STATE.....

B. W. COOKE, Jr., Pres. **COYNE** FOUNDED 1899
ELECTRICAL SCHOOL

A TECHNICAL TRADE INSTITUTE OPERATED NOT FOR PROFIT
500 S. PAULINA STREET, CHICAGO Dept. 58-8C
ELECTRICITY ★ RADIO ★ TELEVISION ★ REFRIGERATION ★ ELECTRONICS

A Message from the Editor



The first issue of a new magazine is usually launched with a weighty and platitudinous statement from the editor advising the reader of the reasons for the new publication. But the obvious way in which electronics affects our life really makes a justification for our magazine unnecessary. However, let us say this: If you are interested in the world in which you live; if you want to know about electronics as a force that vitally affects your life today; if you want to use it in your home, your hobby and your work; and if you want to read a spritely, interesting, and highly pictorial magazine, then **ELECTRONICS ILLUSTRATED** is for you!

During this period of high interest in *space travel* we tell you about a new electronic fuel that may make space travel a reality. *Wiretapping* is in the news and we tell you how it is done and how *you* can do it for legitimate purposes. Stereo is the big news in high fidelity — we tell you about the newly developed *stereo records*.

This is the do-it-yourself era. Whether you live in a house or apartment you are building more, repairing more, and installing more than ever before. We'll show you how to build things, electronic things, for your children, your wife and yourself. Each of these projects will be built by an editor and operated before it is published. In this way you

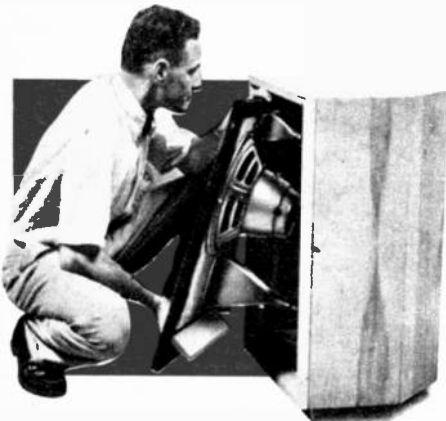

FREE FACTS FOR MEN 17-55!

Prepare In Spare Time For Profitable Jobs In . . .

ELECTRONICS

AS USED IN

GUIDED MISSILES

TELEVISION — RADAR — MICRO-WAVES, ETC.

No Advanced Education or Previous Technical Experience Required!

A man doesn't even have to know how to splice a lamp cord or use a soldering iron to be eligible to prepare in his spare time at home to enter the big opportunity field of Electronics. As a result, many laborers and bookkeepers, store clerks, shop men, farmers, and men of nearly every calling—have taken the DeVry Tech program, and today have good jobs or service shops of their own in Electronics.

Marvels of Electronics

Satellites, guided missiles, and other marvels made possible by Electronics bring us into a new era of wanderment and opportunity!

Employment Service



Puts you in touch with job opportunities—or helps you toward a better position in the plant where you are now employed.

Draft Age?

We have valuable information for every man of draft age; so if you are subject to military service, be sure to check the coupon.

KEEP YOUR JOB!

As you train for a good opportunity that pays real money in Electronics, you won't have to interfere with your present job. Your chances of preparing to enter Electronics need not be held back because of the job you hold today. Send coupon for full facts!

Prepare NOW

At Home or at our Chicago or Toronto Laboratories!

Use part of the income from the job you have today to prepare at home for a highly interesting and profitable career tomorrow! Or, come to Chicago or Toronto and train full time in well-equipped laboratories. It is probably easier than you think. Send coupon for FREE FACTS!

"One of North America's foremost Electronics Training Centers"

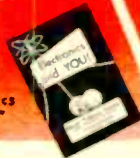

Sample Booklet FREE!

We'll give you a free copy of an interesting booklet, "Electronics and YOU." See for yourself how you may take advantage of the opportunities in this fast-growing field.

Accredited Member of National Home Study Council



DeVRY TECHNICAL INSTITUTE

CHICAGO 41, ILLINOIS

Formerly DeFOREST'S TRAINING, INC.



DeVRY TECHNICAL INSTITUTE

4141 Belmont Ave., Chicago 41, Ill., Dept. EI-5-0

Please give me your FREE booklet, "Electronics and YOU," and tell me how I may prepare to enter one or more branches of Electronics.

Name _____ Age _____

PLEASE PRINT

Street _____ Apt. _____

City _____ Zone _____ State _____

Check here if subject to Military Training.

DeVry Tech's Canadian Training Center is located at
2033 626 Roselawn Avenue, Toronto 12, Ontario

Complete Training

FOR BETTER RADIO-TV SERVICE JOBS



Let these two great Ghirardi training books teach you to handle all types of AM, FM and TV service jobs by approved professional methods—and watch your efficiency and earnings soar!

Each book is a complete service training guide. Each contains complete data on modern methods and equipment—NOT a re-hash of old, out-of-date material. Each is co-authored by A. A. Ghirardi whose famous RADIO PHYSICS COURSE and MODERN RADIO SERVICING were, for 20 years, more widely used for military, school and home study training than any other books of their type!

THE NEW Ghirardi RADIO-TV SERVICE LIBRARY

Almost 1500 pages and over 800 clear illustrations show step-by-step how to handle every phase of troubleshooting and servicing.

1—Radio and Television Receiver TROUBLESHOOTING AND REPAIR

A complete guide to profitable professional methods. For the beginner, it is a comprehensive training course. For the experienced serviceman, it is a quick way to "brush up" on specific jobs, to develop improved techniques or to find fast answers to puzzling service problems. Includes invaluable "step-by-step" service charts. 820 pages, 417 illus., price \$7.50 separately.

2—Radio and Television Receiver CIRCUITRY AND OPERATION

This 600-page volume is the ideal guide for servicemen who realize it pays to know what really makes modern radio-TV receivers "tick" and why. Gives a complete understanding of basic circuits and circuit variations; how to recognize them at a glance; how to eliminate guesswork and useless testing in servicing them, 417 illus. Price separately \$6.75.

Special low price . . . you save \$1.25

If broken into lesson form and sent to you as a "course," you'd regard these two great books as a bargain at \$50 or more! Under this new offer, you save \$1.25 on the price of the two books—and have the privilege of paying in easy installments while you use them! No lessons to wait for. You learn fast—and right!

STUDY 10 DAYS FREE

Dept. PR-58, RINEHART & CO., Inc.
232 Madison Ave., New York 16, N. Y.

Send books below for 10-day FREE EXAMINATION. In 10 days I will either remit price indicated (plus postage) or return books postpaid and owe you nothing.

Radio & TV Receiver TROUBLESHOOTING & REPAIR (Price \$7.50 separately)

Radio & TV CIRCUITRY & OPERATION (Price \$6.75)

Check here for MONEY-SAVING COMBINATION OFFER . . . Save \$1.25. Send both of above big books at special price of only \$13.00 for the two. (Regular price \$14.25 . . . you save \$1.25) Payable at rate of \$4 plus postage after 10 days if you decide to keep books and \$3 a month for 3 months until the total of \$13.00 has been paid.

Name _____

Address _____

City, Zone, State _____

Outside U.S.A.—\$8.00 for TROUBLESHOOTING & REPAIR; \$7.25 for CIRCUITRY & OPERATION; \$14.00 for both. Cash only, but money refunded if you return books in 10 days.

will know that ELECTRONICS ILLUSTRATED projects work and can be put together without any trouble. Large clear wiring guides will accompany every construction article—you will not have to read a schematic diagram, although these will be furnished. Large photos will show the step-by-step building process.

Our first issue contains a project that has been especially designed for us; this is the EI Radio Garage Door Opener. We know it works, we've had it on two garages! We describe a simple-to-build code practice oscillator for would-be radio amateurs (Hams), a DC power supply for model trains, a hi-fi system that records radio broadcasts automatically, and more.

Everyone has an old table model radio around the house; next month, we'll show you how to convert it to an intercom and still use it as a radio. There will be articles for transistor fans, short wave listeners, and more.

If we encourage you to install your hi-fi system we feel that we should also answer your installation questions. Therefore, the next issue will introduce a new department: *Hi-Fi Clinic*. Also, look for the feature called *The Electronic Brain* in which an expert will answer your questions regarding circuits, equipment, etc.

Our next issue will attempt to answer a question that is close to home for all of us: Is the defense setup of our country adequate in this age of missiles and electronic warfare? You will read about our anti-missile program and other developments that have been kept under wraps. We will also continue our survey of career opportunities in electronics.

ELECTRONICS ILLUSTRATED will score a major scoop in its next issue with the beginning of a "how-to" series on building and launching small rockets. We will show you how to build a safe rocket, how to launch it, how to put test instruments in it to follow its flight and how to bring it back to Earth. The writer of this series is a nationally prominent rocket expert. We'll also have a special announcement for all interested in rockets and space travel—watch for it.

The whole exciting world of electronics is our subject—come explore it with us!

Charles Tupper

Electronics Illustrated

HOW WOULD YOU LIKE TO BREAK INTO ENGINEERING STARTING NEXT MONTH?

Your start in Engineering could mean higher pay, more interesting work, a real chance for advancement. Here's how to do it—fast!

A career in Engineering may be closer than you think, whatever your age or education or present job.

You know about the tremendous demand for engineers and technicians. But do you know how easy it is to get the training that will qualify you for this vital work, and how quickly you can advance?

First Step Wins Job Consideration

The moment you enroll for a course in Engineering you're in a position to change your job. I.C.S. Engineering Courses, for example, start you off with Basic Mathematics and Drafting. Most employers are quick to accept men who start technical training.

Your Advancement Is Rapid

Your interest, your determination, your willingness to spend free hours improving your-

self all work in your favor. But your mastery of engineering subjects is what wins you the biggest boosts.

The I. C. S. method makes it possible for you to learn while you earn, to qualify yourself for upgrading step by step—from Draftsman to Detail Designer to Engineering Technician to full-fledged Engineer. It's a plan fitted to your needs, with personalized instruction and guidance, and, if you like, regular progress reports to your employer.

Mail Coupon for Free Books

If you are seriously interested in a fresh start in an opportunity-packed field, then mark and mail the coupon today. We'll send you *three* free books—(1) the 36-page career guide "How to Succeed," (2) Opportunity outlooks in your field of interest, (3) sample lesson (Math) demonstrating I. C. S. method.

For Real Job Security—Get an I. C. S. Diploma! I. C. S., Scranton 15, Penna. Accredited Member, National Home Study Council

INTERNATIONAL CORRESPONDENCE SCHOOLS



BOX 14313C, SCRANTON 15, PENNA.

(Partial list of 257 courses)

Without cost or obligation, send me "HOW TO SUCCEED" and the opportunity booklet about the field BEFORE which I have marked Z (plus sample lesson):

ARCHITECTURE and BUILDING CONSTRUCTION

- Air Conditioning
- Architecture
- Arch. Drawing and Designing
- Building Contractor
- Building Estimator
- Carpentry and Millwork
- Carpenter Foreman
- Heating
- Interior Decoration
- Painting Contractor
- Plumbing
- Reading Arch. Blueprints

ART

- Commercial Art
- Magazine & Book Illus.
- Show Card and Sign Lettering
- Sketching and Painting

AUTOMOTIVE

- Automobiles
- Auto Body Rebuilding and Refinishing
- Auto Engine Tuning
- Auto Technician

AVIATION

- Aero-Engineering Technology
- Aircraft & Engine Mechanic

BUSINESS

- Accounting
- Advertising
- Business Administration
- Business Management
- Cost Accounting
- Creative Salesmanship
- Managing a Small Business
- Professional Secretary
- Public Accounting
- Purchasing Agent
- Salesmanship
- Salesmanship and Management
- Traffic Management

CHEMICAL

- Analytical Chemistry
- Chemical Engineering
- Chem. Lab. Technician
- Elements of Nuclear Energy
- General Chemistry
- Natural Gas Prod. and Trans.
- Petroleum Prod. and Engr.
- Professional Engineer (Chem)
- Pulp and Paper Making

CIVIL ENGINEERING

- Civil Engineering
- Construction Engineering
- Highway Engineering
- Professional Engineer (Civil)
- Reading Struc. Blueprints
- Structural Engineering
- Surveying and Mapping

DRAFTING

- Aircraft Drafting
- Architectural Drafting
- Drafting Machine Design
- Electrical Drafting
- Mechanical Drafting
- Sheet Metal Drafting
- Structural Drafting

ELECTRICAL

- Electrical Engineering
- Elec. Engr. Technician
- Elec. Light and Power
- Practical Electrician
- Practical Lineman
- Professional Engineer (Elec)

HIGH SCHOOL

- High School Diploma

LEADERSHIP

- Good English
- High School Mathematics
- Short Story Writing
- Industrial Foremanship
- Industrial Supervision
- Personnel-Labor Relations
- Supervision

MECHANICAL and SHOP

- Diesel Engines
- Gas-Elec. Welding
- Mechanical Engineering
- Industrial Instrumentation
- Industrial Metallurgy
- Industrial Safety
- Machine Design
- Machine Shop Practice
- Mechanical Engineering
- Professional Engineer (Mech)
- Quality Control
- Reading Shop Blueprints
- Refrigeration and Air Conditioning
- Tool Design
- Tool Making

RADIO, TELEVISION

- General Electronics Tech.

INDUSTRIAL ELECTRONICS

- Industrial Electronics
- Practical Radio-TV Eng'g
- Practical Telephony
- Radio-TV Servicing

RAILROAD

- Car Inspector and Air Brake
- Diesel Electrician
- Diesel Engr. and Fireman
- Diesel Locomotive

STEAM and DIESEL POWER

- Combustion Engineering
- Power Plant Engineer
- Stationary Diesel Engr.
- Stationary Fireman

TEXTILE

- Carding and Spinning
- Cotton Manufacture
- Cotton Warping and Weaving
- Loom Fixing Technician
- Textile Designing
- Textile Finishing & Dyeing
- Throwing
- Warping and Weaving
- Worsted Manufacturing

Name _____ Age _____ Home Address _____
 City _____ Zone _____ State _____ Working Hours _____ A.M. to P.M. _____
 Occupation _____

Canadian residents send coupon to International Correspondence Schools, Canadian, Ltd., Montreal, Canada. . . . Special tuition rates to members of the U. S. Armed Forces.

Electronics in the news



PHYSICISTS of the U.S. Army Signal Engineering Laboratories at Fort Monmouth, N.J. have explored the weather to an altitude of 60 miles. The readings were taken during a series of Aerobee rocket launchings which were made in connection with the International Geophysical Year. High explosive "firecrackers" built into the rocket nosecones were used to sound out temperature and winds simultaneously for the first time at such altitudes. The special Aerobees were loaded with 19 high-explosive grenades which were ejected from the nosecone at pre-timed altitudes. The blasts were picked up by delicate sound ranging devices on the ground.

—○—

The Navy has released a guide to construction of the Mark II Minitrack for the benefit of amateur radio groups which are willing to help plot the course of the Vanguard earth satellites. The guide, which is available from the Office of Technical Services, U.S. Department of Commerce, Washington 25, D.C. for \$1.00, describes two relatively inexpensive designs for the Mark II. One system merely records the passage of the satellite while the more elaborate version contains tracking and data recording modifications which provide computational material valuable to the Navy Vanguard Computing Center.



RCA INSTITUTES offers you the finest of home study training. The equipment illustrated and text material you get with each course is yours to keep. Practical work with very first lesson. Courses for the beginner and the advanced student. Pay-as-you-learn. You need pay for only one study group at a time.

**Send for this
FREE Book Now** ▶

RESIDENT SCHOOL courses in New York City offer comprehensive training in Television and Electronics. Day and evening classes start four times each year.
Detailed information on request.

RCA INSTITUTES, Inc. Home Study Dept. EI-58
350 West Fourth Street, New York 14, N. Y.

Without obligation, send me FREE 52 page CATALOG on Home Study Courses in Radio, Television and Color TV. No salesman will call.

Name..... please print

Address.....

City..... Zone..... State.....

Korean Vets! Enter discharge date.....

In Canada — RCA Victor Co., Ltd.
5001 Cote de Liesse Rd., Montreal 9, Que.

To save time, paste coupon on postcard.

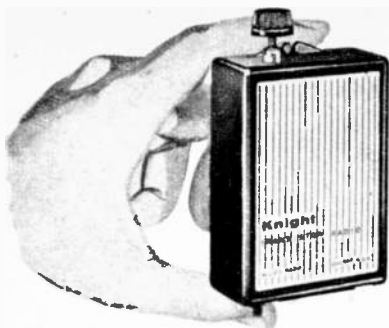

Here is an evening's homework for Pop so that Junior can have his own transistorized pocket radio receiver. Allied Radio of Chicago is offering a low cost 1-transistor kit, the "Trans-Midge" which is only slightly larger than a cigarette pack. When used with a headphone and an external antenna, the set is said to provide good sensitivity and selectivity over the standard broadcast band. The radio will operate for months on a single penlite battery which, when it needs replacing, won't dent the small fry budget too seriously as they sell at from 10¢ to 15¢.

After over a year of intensive design effort, the Electronic Instrument Co., Inc. (EICO) of Long Island City, N.Y., has marketed an FM tuner available as a kit or completely wired. This unit uses a unique pre-wired r.f. (front end) section which is virtually drift-free and completely prealigned. Thus, even novices can assemble the model HFT 90 FM tuner and be assured of good results. The unit also includes a traveling neon tuning indicator and multiplex output. This attractively-styled low-silhouette tuner is available as a kit for \$39.95, or completely wired for \$65.95.

Abraham Marcus, co-author of famous best-seller "Elements of Radio" makes amazing offer!



TRY MY TV and RADIO REPAIR COURSE FREE FOR 1 MONTH

"If you haven't earned at least \$100 in spare time during that period you pay not a cent."

Here it is! The most amazing guarantee offered on any radio-TV course anywhere! We'll send you Abraham Marcus' course to use FREE for one full month! If in that time you haven't actually made \$100 fixing radios and TV sets, just return the books to us and pay not a penny!

Why do we make this sensational offer? First, because these books are so easy to use. They are written in the same clear, easy-to-understand language that made the author's "Elements of Radio" a 1,000,000-copy best-seller. Second, because these books get right to the point—tell you what to do in 1-2-3 fashion. For example, once you master the first few chapters of the TV book you are ready for business—ready to do service jobs in the field—jobs that account for over 80% of all service calls.

DON'T WAIT! You risk nothing when you send the coupon at right. You don't have to keep the books and pay for them unless you actually make extra money fixing radios and TV sets. Even when you decide to keep them, you pay on easy terms. Mail the coupon now.

WHAT YOU GET IN THESE 3 GIANT VOLUMES

ELEMENTS OF TELEVISION SERVICING. Analyzes and illustrates more TV defects than any other book, and provides complete, step-by-step procedure for correcting each. You can actually SEE what to do by looking at the pictures. Reveals for the first time all details, theory and servicing procedures for the RCA 28-tube color television receiver, the CBS-Columbia Model 205 color set, and the Motorola 18-inch color-receiver.

RADIO PROJECTS. Build your own receivers! Gives you 10 easy-to-follow projects, including crystal detector receiver—diode detector receiver—regenerative receiver—audio-frequency amplifier—tuned-radio-frequency tuner—AC-DC superheterodyne receiver—etc.

RADIO SERVICING Theory and Practice. Here is everything you need to know about radio repair, replacement, and readjustment. Easy-to-understand, step-by-step self-training handbook shows you how to locate and remedy defects quickly. Covers TRF receivers; superheterodyne receivers; shortwave, portable, automobile receivers, etc. Explains how to use testing instruments such as meter, vacuum-tube voltmeters, tube checker, etc., etc.



MAIL THIS COUPON

Prentice-Hall, Inc., Dep. 5215-G1
Englewood Cliffs, New Jersey

Please send me Abraham Marcus' TV & RADIO REPAIR COURSE (3 volumes) for 10 days FREE examination. Within 10 days I will either return it and owe nothing, or send my first payment of \$3.60 plus a few cents postage. Then, after I have used the course for a FULL MONTH, if I am not satisfied I may return it and you will refund my first payment. Or I will keep the course and send you two more payments of \$3.60 a month for two months.

Name

Address

City..... Zone..... State.....

Get into

TELEVISION RADIO-ELECTRONICS



**LEARN ALL 8 PHASES
BY SHOP METHOD**

1. Television . . . including Color TV
2. Radio . . . AM, FM
3. Industrial Electronics
4. Communications

**OF THE INDUSTRY
HOME TRAINING**

5. Sound Recording & H-Fidelity
6. Automation
7. FCC License Preparation
8. Radar & Micro Waves

Let National Schools of Los Angeles, a Practical Resident Technical School for over 50 years, train you at home by Shop-Method for unlimited opportunities in All phases of TV, Electronics, Radio

**You get 19 big kits
of equipment!**

**GOOD JOBS . . . MORE MONEY
SECURITY . . . ALL CAN BE YOURS**

YOU are needed in the great modern Television-Electronics industry. Trained technicians are in growing demand, at excellent pay, in sales and service, manufacturing, broadcasting, telecasting, communications, research, and many other important branches of the field. National Schools Master Shop-Method Training, with newly added lessons and equipment prepares you in your spare time right in your own home for these fascinating opportunities. **OUR OUTSTANDING METHOD IS PROVED BY THE SUCCESS OF GRADUATES ALL OVER THE WORLD!**

YOUR TRAINING IS ALL INCLUSIVE

"We prepare you for a long list of job opportunities. Thousands of TV and Radio receivers are being sold every day—more than ever before. And, now, Color TV is here. Applications of Electronics in industry—**AUTOMATION**—are growing in tremendous strides. The whole field is alive—opening up new, important jobs rapidly. National Schools complete training program qualifies you in all phases of the industry.

YOU EARN WHILE YOU LEARN

Many students pay for their entire training — and more — with spare time earning. We'll show you how you can, too! Early in your course you receive material that shows you how to earn extra money servicing TV and Radio receivers, appliances, etc., for friends and acquaintances.

YOU GET EVERYTHING YOU NEED

Clear, profusely illustrated lessons, photostated manuals, modern circuit diagrams, practical job projects—all the valuable equipment shown above—many other materials and services—consultation privilege with our qualified staff, and Graduate Employment Service. **EVERYTHING YOU NEED** for outstanding success in Electronics.

INDUSTRY NEEDS YOU. NATIONAL SCHOOLS WILL TRAIN YOU. SEND FOR FACTS TODAY NO OBLIGATION.

YOU LEARN BY SHOP METHOD . . . you do servicing, circuit analysis, and do over 100 down-to-earth experiments. You build a Superhet Receiver and a modern TV Receiver, from the ground up, including a new, big screen picture tube. You also receive a professional, factory-made **MULTI-TESTER**. All of this standard equipment is yours to keep . . . at just one low tuition.

RESIDENT TRAINING AT LOS ANGELES

If you wish to take your training in our Resident School at Los Angeles, the world's TV capital, start NOW in our big, modern Shops, Labs and Radio-TV Studios. Here you work with latest Electronic equipment — professionally installed — finest, most complete facilities offered by any school. Expert, friendly instructors. Personal attention. Graduate Employment Service. Help in finding home near school — and part time job while you learn. Check box in coupon for full information.

Approved for
GI Training



NATIONAL SCHOOLS
LOS ANGELES 37, CALIF.

**FREE!
VALUABLE BOOK
& SAMPLE LESSON
—Just Send
Coupon!**



NATIONAL SCHOOLS
TECHNICAL TRADE TRAINING SINCE 1905
LOS ANGELES 37, CALIFORNIA

GET FAST SERVICE—MAIL NOW TO
NATIONAL SCHOOLS, DEPT. R4Y-38
4000 S. FIGUEROA ST. LOS ANGELES 37, CALIF

Rush free TV-Radio "Opportunity" Book and sample lesson. No salesman will call.

NAME _____ AGE _____
ADDRESS _____
CITY _____ ZONE _____ STATE _____

Check if interested ONLY in Resident School training at Los Angeles.
VETERANS Give date of Discharge _____

see the amazing new
EASY-TO-BUILD ELECTRONIC
ALLIED knight-kits

in **ALLIED'S 1958**

ELECTRONIC SUPPLY CATALOG

FREE!

**BUILD YOUR OWN!
SAVE MONEY—HAVE FUN**



HI-FI KITS



HOBBY KITS



INSTRUMENT KITS



HAM KITS

404 value-packed pages

SAVE on Everything in Electronics

WORLD'S LARGEST STOCKS

Everything for Experimenters, Builders, Amateurs, Servicemen, Engineers and Hi-Fi Hobbyists. Get more for your money in Hi-Fi systems and components; build-your-own KNIGHT-KITS; recorders and phono equipment; TV tubes, antennas, accessories; Amateur station equipment; test instruments; industrial electronic equipment—plus the world's largest stocks of parts, tubes, transistors, tools and books. Send today for your **FREE** 1958 ALLIED Catalog!

Everything in Electronics From One Reliable Source
our 37th year **EASY TERMS AVAILABLE**

ALLIED RADIO

send for
FREE
Catalog

ALLIED RADIO CORP., Dept. 86-E8
100 N. Western Ave., Chicago 80, Ill.

Rush **FREE** 1958 ALLIED 404-Page Catalog

Name _____

Address _____

City _____ Zone _____ State _____

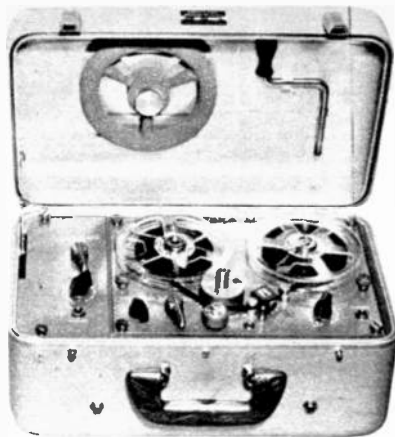

Amplifier Corp. of America, 398 Broadway, New York 13, N.Y. has designed a new, self-contained stereophonic tape recorder for field use. Three single speed models are available for either 3.75, 7.5 or 15 inches per second. Measuring 8½" x 11" x 10", the "Stereo-Magnemite" weighs only 17 pounds. Its high gain recording-playback amplifiers are powered by drycells and one "B" battery which last 100 hours. Constant tape speed is achieved by means of a patented centrifugal ball-bearinged, triple compensated flyball governor on the spring motor. Tapes made on this machine can be played back on any standard stereo playback unit.

General Transistor Corporation, 91-27 138th Place, Jamaica, N.Y. has issued a "How Not To Do It" instruction book as a switch on the tackle-it-yourself trend. The booklet of real "mad" cartoons tells how not to use transistors and will be sent without charge on request to those eager beavers who want to improve each minute of the coffee break.

In a more serious vein, Shure Brothers, Inc. of Evanston has come out with a "do-it-yourself" kit which makes stereophonic playback available at low cost to fans with Revere or Wollensak tape recorders. The kit includes an in-line stereophonic magnetic tape head which is designed to replace the monaural head with which the recorder is equipped. Camera stores, record shops, and appliance stores carry the kit.

Learn **PRACTICAL RADIO-TV**
with **25 BIG KITS**

of equipment I send you while you train with me for valuable shop bench experience . . .

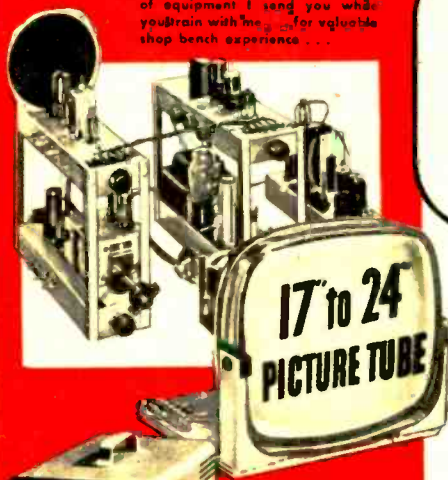

The new Sprayberry Training Television receiver, built and tested in sections.

I now offer this fine modern oscilloscope.

You build this powerful 2 Band superhet radio receiver.

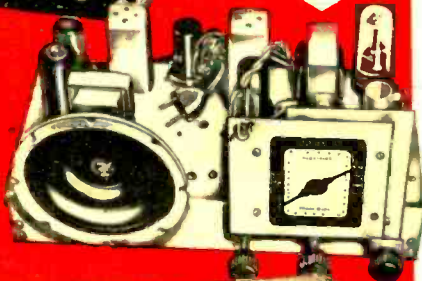

You build the new Sprayberry Tester . . . 18-range Volt-Ohm-Milliammeter 220 volts.

AVERAGE COST OF LESSONS

ONLY \$3.42

Including Kits and Equipment

Clip and Mail the Coupon Below—Now!

**Train in Spare Hours at Home
for the Best Jobs and Big Pay in**

Radio-Television

—my new, faster way!

Want Proof? Send for my big FREE CATALOG and Sample Lesson. Let the facts speak for themselves!



Frank L. Sprayberry
Educational Director

Why wait—get into Radio-Television fast! I will train you in as little as 10 months to step into the top paying Radio-Television field as a much-needed Service Technician! You will train entirely at home in your spare time . . . which means you can train as fast or as slowly as you like. You have a choice of **THREE** Sprayberry Training Plans . . . one *exactly* suited to your needs. My *easier-than-ever* payment terms make it possible for you to get set for the good jobs in Radio-Television without the slightest strain on your budget! Get the true facts . . . just mail the coupon for my big new 56 page fact-filled catalog plus actual sample lesson—both **FREE**.

REALLY PRACTICAL TRAINING—NO PREVIOUS EXPERIENCE NEEDED

My students do better because I train both the mind and the hands. Sprayberry Training is offered in 25 individual training units, each includes a practice giving kit of parts and equipment . . . all yours to keep. You will gain priceless practical experience building the specially engineered Sprayberry Television Training Receiver, Two-Band Radio Set, Signal Generator, Audio Tester and the new Sprayberry 18 range Multi-Tester, plus other test units. You will have a complete set of Radio-TV test equipment to start your own shop. My lessons are regularly revised and every important new development is covered. My graduates are completely trained Radio-Television Service Technicians.

NEWEST DEVELOPMENTS

Your training covers U H F, Color Television, F.M., Oscilloscope Servicing, High Fidelity Sound and Transistors.

MAIL THE COUPON—See what's ahead in Radio-TV . . . No Salesman Will Call On You!

The coupon below brings you my big new catalog plus an actual sample Sprayberry Lesson. I invite you to read the facts . . . to see that I actually illustrate every item in my training. With the facts in your hands, you will be able to decide. No salesman will call on you. The coupon places you under no obligation. Mail it now, today, and get ready for your place in Radio-Television.

SPRAYBERRY ACADEMY OF RADIO-TELEVISION

1512 Jarvis Ave., Dept. 120-G, Chicago 26, Illinois

Mail This Coupon For Free Facts and Sample Lesson



SPRAYBERRY ACADEMY OF RADIO-TELEVISION
Dept. 120-G, 1512 Jarvis Ave., Chicago 26, Ill.

Please rush all information on your ALL-NEW Radio-Television Training Plan. I understand this does not obligate me and that no salesman will call upon me. Include New Catalog and Sample Lesson **FREE**.

Name _____ Age _____

Address _____

City _____ Zone _____ State _____

BIG MONEY IN THE 4 CORNERS OF THE WORLD!

in TELEVISION, RADIO,
ELECTRONICS, RADAR, SONAR
ONLY CHRISTY OFFERS
COMPLETE TRAINING!

Investigate the Christy Complete Course. Why be satisfied with less? CTS Shop Method, Home Training makes learning easy. You learn by working with actual equipment. You receive Comprehensive training from the start. Can EARN AS YOU LEARN. You become qualified to open your own Electronics Repair business or to gain high pay as a TV, Radio, Electronics, etc., Technician.



19 TRAINING KITS INCLUDED!
You receive a Multi-Tester, Oscillator, Signal Tracer, Oscilloscope, Signal Generator, Electronic Timer, Regenerative Radio, 24" TV set (optional) and other valuable testing equipment. **FREE BOOK** and **TWO FREE LESSONS** yours for the asking! No obligation.



CHRISTY TRADES SCHOOL
Dept. T-113, 4804 N. Kedzie Ave.,
Chicago 25, Ill.

**CHRISTY TRADES SCHOOL, Dept. T-113
4804 N. Kedzie Ave., Chicago 25, Ill.**
Please send me the 3 FREE BOOKS and Special Form for
PAYING LATER from EARNINGS MADE WHILE LEARNING.

NAME..... AGE.....
ADDRESS.....
CITY..... ZONE..... STATE.....

**Can you think faster
than this Machine?**

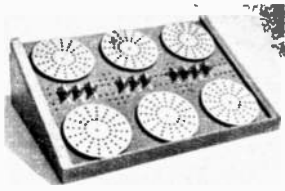

GENIAC set up to do a problem in check valve research
Be careful before you answer. **GENIAC** the first electrical brain construction kit is equipped to play tic-tac-toe, cipher and encipher codes, convert from binary to decimal reason (in syllogisms) as well as add, subtract, multiply and divide. Specific problems in a variety of fields—actuarial, policy claim settlement, physics, etc.—can be set up and solved with the components. Connections are solderless and are completely explained with templates in the manual. This covers 33 circuits and shows how new ones can be designed.

You will find building and using **GENIAC**'s a wonderful experience; one kit user wrote us: "this kit has opened up a new world of thinking to me." You actually see how computing, problem solving, and game play (Tic-tac-toe, nlm, etc.) can be analyzed with Boolean Algebra and the algebraic solutions transformed directly into circuit diagrams. You create from over 400 specially designed and manufactured components a machine that solves problems faster than you can express them.

MAIL THIS COUPON
**SCIENCE KITS, Dept. ELS8, Oliver Garfield Company
128 Lexington Avenue, New York 16, N. Y.**
Please send me:
1 **GENIAC** Electrical Brain Construction Kit and Manual.
\$19.95 (East of Mississippi)
\$20.95 (Elsewhere in United States)
\$21.95 (Outside the United States)

Returnable in seven days for full refund if not satisfied.
I enclose \$..... in full payment.
My name and address are attached.



Mohawk Business Machines Corporation of Brooklyn 33, N.Y. has brought out a transistorized version of its battery operated pocket-size tape recorder as the "Midgetape" #300. The space saved by replacing the vacuum tubes by the tinier transistors makes room in the case to include a self-contained loud-speaker for high volume playback.

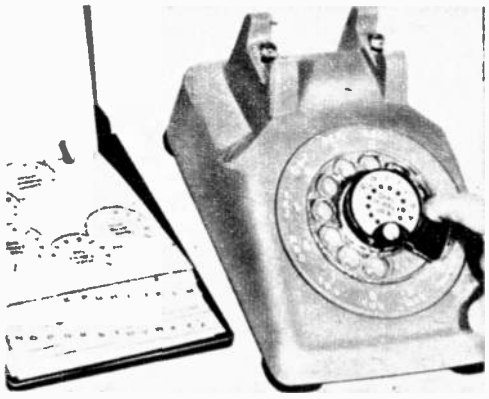

A California inventor, Carl Tilden, has come up with a "Phone-O-Matic" phone-number selector which automatically "remembers" phone numbers, exchanges, and area codes for long-distance dialings. Each digit is dialed as it appears in the lens of the convenient little gadget which fits over your regular phone dial. An index box holds over 180 numbers. The indexed number disc is placed in the center of the ring on the phone and the figures are dialed. For the absent-minded... a real boon. The product is being marketed by Dial Direct Dex, 209 Los Molinos, San Clemente, California.

BUILD 16 RADIO

Reg. U.S.
Pat. Off.

CIRCUITS A HOME

with the New Deluxe 1958
PROGRESSIVE RADIO "EDU-KIT"

only
\$22.95



A Practical Home Radio Course

- Now Includes**
- ★ TRANSMITTER
 - ★ SIGNAL TRACER
 - ★ SIGNAL INJECTOR
 - ★ CODE OSCILLATOR
- ★ No Knowledge of Radio Necessary
 - ★ No Additional Parts or Tools Needed
 - ★ Excellent Background for TV
 - ★ School Inquiries Invited
 - ★ Attractively Gift Packed

WHAT THE "EDU-KIT" OFFERS YOU

The "Edu-Kit" offers you an outstanding PRACTICAL HOME RADIO COURSE at a rock-bottom price. Our Kit is designed to train Radio & Electronics Technicians, making use of the most modern methods of home training. You will learn radio theory, construction practice and servicing.

You will learn how to build radios, using regular schematic; how to wire and solder in a professional manner; how to service radios. You will work with the standard type of punched metal chassis as well as the latest development of Printed Circuit chassis.

You will learn the basic principles of radio. You will construct, study and work with RF and AF amplifiers and oscillators; detectors, rectifiers, test equipment. You will learn and practice code, using the Progressive Code Oscillator. You will learn and practice trouble-shooting, using the Progressive Signal Tracer, Progressive Signal Injector, Progressive Dynamic Radio & Electronics Tester & the accompanying instructional material.

You will receive training for the Novice, Technician and General Classes of F.C.C. Radio Amateur Licenses. You will build 16 Receiver, Transmitter, Code Oscillator, Signal Tracer and Signal Injector circuits, and learn how to operate them. You will receive an excellent background for Television.

Absolutely no previous knowledge of radio or science is required. The "Edu-Kit" is the product of many years of teaching and engineering experience. The "Edu-Kit" will provide you with a basic education in Electronics and Radio, worth many times the complete price of \$22.95. The Signal Tracer alone is worth more than the price of the entire Kit.

THE KIT FOR EVERYONE

You do not need the slightest background in radio or science. Whether you are interested in Radio & Electronics because you want an interesting hobby, a well paying business or a job with a future, you will find the "Edu-Kit" a worth-while investment. Many thousands of individuals of all

ages and backgrounds have successfully used the "Edu-Kit" in more than 79 countries of the world. The "Edu-Kit" has been carefully designed, step by step, so that you cannot make a mistake. The "Edu-Kit" allows you to teach yourself at your own rate. No instructor is necessary.

PROGRESSIVE TEACHING METHOD

The Progressive Radio "Edu-Kit" is the foremost educational radio kit in the world, and is universally accepted as the standard in the field of electronics training. The "Edu-Kit" uses the modern educational principle of "Learn by Doing." Therefore you construct, learn schematics, study theory, practice trouble-shooting—all in a closely integrated program designed to provide an easily-learned, thorough and interesting background in radio.

You begin by examining the various radio parts of the "Edu-Kit." You then learn the function, theory and wiring of these parts. Then you build a simple radio. With this first set you will enjoy listening to regular broadcast stations, learn theory, practice testing and trouble-shooting. Then you build a more advanced radio, learn more advanced theory and techniques. Gradually, in a progressive manner, and at your own rate, you will find yourself constructing more advanced multi-tube radio circuits, and doing work like a professional Radio Technician.

Included in the "Edu-Kit" course are sixteen Receiver, Transmitter, Code, Oscillator, Signal Tracer, and Signal Injector circuits. These are not unprofessional "breadboard" experiments, but genuine radio circuits, constructed by means of professional wiring and soldering on metal chassis, plus the new method of radio construction known as "Printed Circuitry." These circuits operate on your regular AC or DC house current.

THE "EDU-KIT" IS COMPLETE

You will receive all parts and instructions necessary to build 16 different radio and electronics circuits, each guaranteed to operate. Our Kits contain tubes, tube sockets, variable, electrolytic and paper dielectric condensers, resistors, tie strips, coils, hardware, tubing, punched metal chassis, Instruction Manuals, wire, solder, etc.

In addition, you receive Printed Circuit materials, including Printed Circuit chassis, special tube sockets, hardware and instructions. You also receive a useful set of tools, a professional electric soldering iron, and a self-powered Dynamic Radio & Electronics Tester. The "Edu-Kit" also includes Code instructions and the Progressive Code Oscillator, in addition to F.C.C.-type Questions and Answers for Radio Amateur License training. You will also receive lessons for servicing with the Progressive Signal Tracer and the Progressive Signal Injector, a High Fidelity Guide and a Quiz Book. You receive all parts, tools, instructions, etc. Everything is yours to keep.

PRINTED CIRCUITRY

At no increase in price, the "Edu-Kit" now includes Printed Circuitry. You build a Printed Circuit Signal Injector, a unique servicing instrument that can detect many Radio and TV troubles. This revolutionary new technique of radio construction is now becoming popular in commercial radio and TV sets.

A Printed Circuit is a special insulated chassis on which has been deposited a conducting material which takes the place of wiring. The various parts are merely plugged in and soldered to terminals.

FREE EXTRAS

- SET OF TOOLS
- SOLDERING IRON
- ELECTRONIC TESTER
- PLIERS-CUTTERS • ALIGNMENT TOOL
- WRENCH SET
- TESTER INSTRUCTION MANUAL
- HIGH FIDELITY GUIDE • QUIZZES
- TELEVISION BOOK • RADIO TROUBLE-SHOOTING BOOK
- MEMBERSHIP IN RADIO-TV CLUB: CONSULTATION SERVICE • FCC AMATEUR LICENSE TRAINING
- PRINTED CIRCUITRY
- VALUABLE DISCOUNT CARD
- CERTIFICATE OF MERIT

SERVICING LESSONS

You will learn trouble-shooting and servicing in a progressive manner. You will practice repairs on the sets that you construct. You will learn symptoms and causes of trouble in home, portable and car radios. You will learn how to use the professional Signal Tracer, the unique Signal Injector and the dynamic Radio & Electronics Tester. While you are learning in this practical way, you will be able to do many a repair job for your friends and neighbors, and charge fees which will far exceed the price of the "Edu-Kit." Our Consultation Service will help you with any technical problems you may have.

J. Statalis, of 25 Poplar Pl., Waterbury, Conn., writes: "I have repaired several sets for my friends, and made money. This "Edu-Kit" paid for itself. I was ready to spend \$240 for a Course, but found your ad and sent for your Kit."

FROM OUR MAIL BAG

Ben Valerio, P. O. Box 21, Magna, Utah: "The Edu-Kits are wonderful. Here I am sending you the questions and also the answers for them. I have been in Radio for the last seven years, but like to work with Radio Kits, and like to build Radio Testing Equipment. I enjoyed every minute I worked with the different kits the Signal Tracer works fine. Also like to let you know that I feel proud of becoming a member of your Radio-TV Club."

Robert L. Shum, 1534 Monroe Ave., Huntington, W. Va.: "Thought I would drop you a few lines to say that I received my Edu-Kit, and was really amazed that such a bargain can be had at such a low price. I have already started repairing radios and phonographs. My friends were really surprised to see me get into the swing of it so quickly. The Troubleshooting Tester that comes with the Kit is really swell, and finds the trouble, if there is any to be found."

UNCONDITIONAL MONEY-BACK GUARANTEE

ORDER DIRECT FROM AD—RECEIVE FREE BONUS RESISTOR AND CONDENSER KITS WORTH \$7

- Send "Edu-Kit" Postpaid. I enclose full payment of \$22.95.
- Send "Edu-Kit" C.O.D. I will pay \$22.95 plus postage.
- Send me FREE additional information describing "Edu-Kit."

Name _____

Address _____

PROGRESSIVE "EDU-KITS" INC.

497 Union Ave., Dept. 501 AE, Brooklyn 11, N. Y.

INVENTORS

Learn how to protect your invention. The U. S. patent laws were enacted for the benefit of the inventor to give him protection for the features of his invention which are patentable.

Unless the inventor is familiar with patent matters, he should engage a competent registered patent attorney or agent to represent him. We are registered to practice before the U. S. Patent Office and are prepared to serve you in the handling of your patent matters.

A specially prepared booklet entitled "Patent Guide for the Inventor," containing detailed information with respect to patent protection and procedure, together with a "Record of Invention" form, will be promptly forwarded to you without obligation upon request.

CLARENCE A. O'BRIEN & HARVEY JACOBSON

Registered Patent Attorneys
810-E DISTRICT NATIONAL BUILDING
WASHINGTON 5, D. C.

INFRARED SNIPERSCOPE TELESCOPE and PARTS

See in the dark—without being observed. War surplus Sniperscope M-2. Gov't cost about \$1200. Used for industrial plant security; research lab experiments; infrared photography; spectroscopy, etc. Instrument complete, ready to use. Includes Power Pack, infrared light source. Will operate from 6 V auto battery. Battery or transformer available.

Stock No. 85,053-EB \$150.00

Shipping weight approx. 12 lbs., f.o.b. Barrington, N. J.



Save still more money! Build your own Sniperscope! We will furnish instructions—parts, including: Power Pack, 1P25A image tubes, light units, filters, etc. For details—request FREE Catalog "EB."

NEW! STATIC ELECTRICITY GENERATOR

See a thrilling spark display as you set off a miniature bolt of lightning. Absolutely safe and harmless. Stands 14" high. Turn the handle and two 9" plastic discs rotate in opposite directions. Metal collector brushes pick up the static electricity, store it in the Leyden jar type condenser until discharged by the jumping spark. Countless tricks and experiments. 24 page instruction booklet included.

Stock No. 70,070-EB \$10.95 Postpaid



SPECIAL! SPECIAL! INFRARED 1P25A IMAGE TUBE

Stock No. 70,127-EB \$9.95 pstpd.

COLOR TV TUBESCOPE

Saves time, effort in alignment of color dot pattern.
Stock No. 50,139-EB . . . 22 power \$24.50 pstpd.

WRITE FOR FREE CATALOG "EB"!

Complete Line of Astronomical Telescope Parts and Assembled Telescopes, Satellitescopes. Also huge selection of lenses, prisms, war surplus optical instruments, parts and accessories. Telescopes, microscopes, binoculars, etc. Request Catalog "EB!"

ORDER BY STOCK NUMBER. SEND CHECK OR MONEY ORDER. SATISFACTION GUARANTEED!
EDMUND SCIENTIFIC CO., BARRINGTON, N. J.

Texas Instruments Incorporated of Dallas, Texas has developed a new light-weight transistorized land mine detector for the U.S. Army. The use of transistors has permitted miniaturization of the device to the point where all parts, except the antenna, can be carried under the operator's clothing. This is of special importance where the detector is to be used in the Arctic regions. Just to be on the safe side, the company has also fungus-proofed the unit for tropical use.

Dr. V. K. Zworykin, honorary vice-president of RCA, told a group of 1000 highway engineers and administrators attending the Highway Research Board meeting in Washington that the ultimate solution to the problem of traffic accidents that now claim more than 100 lives daily is an electronic system that provides automatic control of vehicles on the highway. He called for cooperation among highway engineers, administrators, and the electronics industry in bringing such a system to practical reality in the near future.

American Machine & Foundry Co. has built a fully automated shell-filling line for the Joliet Illinois Arsenal of the U.S. Army Ordnance Department. The unit will handle either 75 or 90 mm. shells. The fully automated line is divided into twelve stations, all of which are monitored by a single operator sitting at a control console. In addition to elaborate instrumentation, the operator watches five television monitors that tie in with cameras focused on critical operations in the process. Any malfunctioning will be caught immediately and rectifying steps taken to prevent a shutdown of the assembly line.

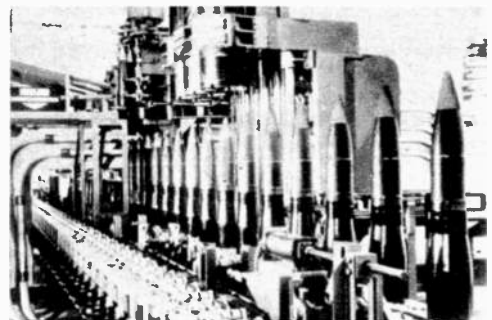

MAKE MORE MONEY

in

ELECTRONICS

with an

COMMUNICATIONS

F.C.C. LICENSE

The Key to Better Jobs

An F. C. C. commercial (not amateur) license is your ticket to higher pay and more interesting employment. This license is Federal Government evidence of your qualifications in electronics. Employers are eager to hire licensed technicians.

Learn by Mail or in Resident Classes

Grantham School of Electronics specializes in preparing students to pass F. C. C. examinations. Correspondence training is conducted from Washington and Hollywood; resident DAY and EVENING classes are held in both cities. Either way, we train you quickly and well — NO previous training required. A beginner may qualify for his first class F. C. C. license in as little as 12 weeks.

This booklet
FREE!

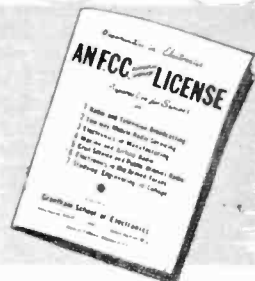

This free booklet gives details of our training and explains what an F. C. C. license can do for your future. Send for your copy today.

Here's Proof...

that Grantham Students prepare for F. C. C. examinations in a minimum of time. Here is a list of a few of our recent graduates, the class of license they got, and how long it took them:

	License	Wks.
Douglas Moore, 5102 Flambeau Rd., Madison, Wis.	1st	11
Bernard Kirschner, 504 E. 5th, New York, N.Y.	1st	12
Albert D. Meeleib, Box 136, Elrama, Pa.	1st	12
Dan Breece, Station KOVE, Lander, Wyo.	1st	12
Richard Meelan, 166 Jerome St., Brooklyn, N.Y.	1st	10
Leo Bishop, 37 Calle Contenta, Flagstaff, Ariz.	1st	12
Carl Deare, Jr., P. O. Box 467, Jeanerette, La.	1st	11
Jackson York, 1029 N. Quincy St., Arlington, Va.	1st	15

Grantham School OF ELECTRONICS

Hollywood
Division

1505 N. Western Ave.
Hollywood 27, Calif.
Phone: HO 2-1411

Washington D. C.
Division

821 - 19th Street, N.W.
Washington 6, D. C.
Phone: ST 3-3614

for **FREE** Booklet **CLIP COUPON** and
mail in envelope or paste on postal card.

MAIL COUPON TO SCHOOL NEAREST YOU

Grantham Schools, Desk 88-E

821 - 19th Street N.W. OR 1505 N. Western Ave.
Washington 6, D. C. Hollywood 27, Calif.

Please send me your free booklet telling how I can get my commercial F. C. C. license quickly. I understand there is no obligation and no salesman will call.

Name _____ Age _____

Address _____

City _____ State _____

I am interested in: Home Study, Resident Classes

INVENTORS

Send for

PATENT INFORMATION BOOK and INVENTOR'S RECORD

Without Obligation

REGISTERED PATENT ATTORNEY

Associate Examiner
U. S. PAT. OFF. 1922-1929

Patent Attorney & Advisor
U. S. NAVY DEPT. 1930-1947

PATENT LAWYER

Gustave Miller

58 El Warner Bldg., Washington 4, D. C.



college graduates get ahead faster!

... have higher income ... advance more rapidly. Grasp your chance for a better life. Share rewards awaiting college-trained men. Important firms visit campus regularly to employ Tri-State College graduates. Start any quarter. Approved for Vets.

Bachelor of Science Degree in 27 months

Electrical Engineering with either an Electronics or Power major. Also Mechanical, Civil, Chemical, Aeronautical Engineering. In 36 months a B. S. in Business Administration (General Business, Accounting, Motor Transport Management Majors). Superior students faster. More professional class hours. Small classes. Enrollment limited. Beautiful campus. Well-equipped labs. Prep courses. Mature students. Modest costs. Enter June, September, January, March. Mail coupon now to Jean McCarthy, Director of Admissions for Catalog, View Book and book "Your Career in Engineering and Commerce."



TRI-STATE COLLEGE

3858 College Avenue, Angola, Indiana

Please send me your catalog with full information on Radio Engineering and other courses. I am especially interested in courses checked:

- Electrical Engineering (Radio, TV, Electronics option)
 Electrical Engineering (Power option) Chemical
 Civil Mechanical General Business
 Accounting Motor Transport Management Drafting

Name

Street Address

City Zone State.....



The Scouting world's first Science Explorers post has been established in Newport Beach, California. Sponsored by the Helipot Division of Beckman Instruments, the Scouts have already begun a series of individual projects, ranging from the construction of a small-scale cyclotron to solid state diffusion research! Science Explorers Posts are planned for other areas.



An oldtime specialized radio products manufacturer that has only recently entered the high-fidelity equipment market, the J. W. Miller Company of Los Angeles California, has just announced a new FM tuner for \$59.95. This unit offers AFC, a tuning indicator, Foster-Seeley discriminator, grounded-grid r.f. amplifier and two outputs. The drift is said to be negligible with the automatic frequency control in operation and the sensitivity is quoted as 3 microvolts with 20 db quieting. This tuner is self powered. The model 560 FM tuner is of the "pancake" design and is quite stylish. Altogether it seems to be a worthy product at a moderate price.

It is designed to be stacked with other units, or can be mounted as a built-in as part of a Hi-Fi system.

**AT
LAST!**

RADIO-TV and ELECTRONICS TRAINING

**... AT A PRICE
YOU CAN AFFORD!**



***21 INCH**
Receiver Kit included

Yes, this great course costs far less than any training of its kind given by other major schools! Radio-Television Training School will train you for a good job in Television or Industrial Electronics — **AT HOME IN YOUR SPARE TIME.**

Think of it — a complete training program including over 120 lessons, Eleven Big Radio-Television Kits, Complete Color-TV Instruction, Unlimited Consultation Service... **ALL at a really big saving to you.** How can we do this? Write to us today... and find out!

And what's more — you can (if you wish)
**OPEN YOUR OWN RTS-APPROVED AND
FINANCED RADIO-TV SERVICE SHOP**

We Want 100 More Shops This Year

This 35 year old training organization — called RTS, that's Radio-Television Training School — wants to establish a string of Radio-TV Repair Shops in principal cities throughout the U. S. So far, 36 such shops are **NOW IN BUSINESS AND PROSPERING.** We are signing contracts with ambitious men to become future owners and operators of these shops in all areas.

**COMPLETE
COLOR
INSTRUCTION
INCLUDED**

*you build
all these units*



**FOR UNSKILLED
INEXPERIENCED MEN ONLY —
WE TRAIN YOU OUR WAY!**

We must insist that the men we sign up be trained in Radio-TV Repair, Merchandising and Sales by our training methods—because **WE KNOW** the requirements of the industry. Therefore, we will **TRAIN YOU**... we will show you how to earn **EXTRA CASH**, during the first month or two of your training period. **YOU KEEP YOUR PRESENT JOB. TRAINING TAKES PLACE IN YOUR OWN HOME, IN YOUR SPARE TIME!**

**RADIO-TELEVISION
TRAINING SCHOOL**
5100 S. VERMONT AVENUE
LOS ANGELES 37, CALIFORNIA

Est. 1922



**ACT
NOW!**

**RTS
APPROVED
SERVICE
SHOP**

Get your free book on the
FAMOUS RTS BUSINESS PLAN
find out how you can open
A REPAIR SHOP OF YOUR OWN

We supply and finance your equipment

When you are ready and qualified to operate one of our RTS-Approved TV Repair Shops **WE WILL SUPPLY AND FINANCE EVERY BIT OF EQUIPMENT YOU NEED TO GET STARTED** plus an inventory of parts and supplies. In other words we will stake you **AN OFFER NEVER MADE BEFORE BY ANY TRAINING ORGANIZATION.** Under the RTS Business Plan you receive:

1. An electric sign for the shop front.
2. Complete laboratory of test equipment.
3. Letterheads, calling cards, repair tickets, etc.
4. Basic inventory of tubes, parts, supplies.
5. Complete advertising and promotional material.
6. Plans for shop arrangement.
7. Instructions on how to go into business.
8. Continuous consultation and help.
9. The right to use RTS Seal of Approval, and the RTS Credo.
10. The right to use the Famous Trade Mark.



RTS' Membership in The Association of Home Study Schools is your assurance of Reliability, Integrity, and Quality of Training.

**ALL
THESE
FREE!**



CUT OUT AND MAIL — TODAY!

RADIO-TELEVISION TRAINING SCHOOL
5100 S. Vermont Avenue, Dept. PF58
Los Angeles 37, California

SEND ME FREE — all of these big opportunity books — "Good Jobs in TV-Electronics," "A Repair Shop of Your Own" and "Sample Lesson." I am interested in:

- Radio-Television Industrial Electronics (Automation)

Name _____ Age _____

Address _____

City & State _____
300

SHOOT TV TROUBLE FAST

With H. G. Cisin's Copyrighted RAPID "TV TROUBLE SHOOTING METHOD"

Without experience or knowledge, this guaranteed new method of servicing TV sets enables you to DIAGNOSE TV troubles as rapidly as an expert. NO THEORY—NO MATH—you can locate all faults in record-breaking time regardless of make or model.

"TV TROUBLE SHOOTING METHOD" is the most valuable aid to TV servicing ever written. Be a TV Trouble Diagnostician. Increase your present earnings. Open your own Profitable Business or get a high-paying skilled job.

It's all in this book . . .

Nothing more to Pay—Nothing else to Buy

Alphabetically listed are 85 picture troubles, over 58 raster and 17 sound troubles. By this unique copyrighted method you know EXACTLY WHERE the trouble is; plus step-by-step instructions. Including 69 RAPID CHECKS, enabling you to find the faulty part.

13 IMPORTANT PRELIMINARY CHECKS NEED, NO INSTRUMENTS! Of the 69 Rapid Checks, OVER 65 ALSO REQUIRE NO INSTRUMENTS! Rapid checks include emergency checks for distorted pictures, defective tubes including PIX tube, plus 57 others. ALL EXPLAINED IN SIMPLE LANGUAGE, PERFORMED WITHOUT INSTRUMENTS. MANY CHECKS USE THE PICTURE TUBE AS A GUIDE.

H. G. Cisin, the author, is the inventor of the AC/DC midjet radio. He licenses RCA, AT&T, etc. He has also trained thousands of technicians now owning their own prosperous TV service organizations or holding highly paid TV positions. His years of experience are embodied in this remarkable new book.

Guaranteed Money Back in 5 Days If Not Satisfied!

ABSOLUTELY FREE with each order: H. G. Cisin's newest book "TV & RADIO TUBE SUBSTITUTION GUIDE." Gives direct replacements of set and picture tubes. Most valuable servicing aid! ACT NOW—get both books postpaid at cost of only one!

\$1 Post-paid

RUSH COUPON NOW!

H. G. CISIN, CONSULTING ENGINEER,
Amagansett, L. I., N. Y.

Dept. E1-1

Enclosed find \$1. Rush both books.

Name

Address

City

Zone

State

LOOK! FAMOUS Regency



ALL-TRANSISTOR VEST POCKET RADIO

READY TO PLAY!

Includes 1000-hour batteries and ultra-sensitive phone

ONLY \$14.95 POSTPAID

Lektron scoops the field with the "hottest" pocket transistor radio since the advent of the transistor! Designed and built by one of America's great names... Regency. Uses an exclusive circuit with RF, DET and AMP stages. SMALLER THAN A PACK OF CIGARETTES—only 3x2x1". NO EXTERNAL ANTENNA OR GROUND or any hanging wires. Amazing sensitivity, volume and selectivity! Attractively designed two-tone styrene case. Variable tuning covers 540 to 1500 kc. READY TO PLAY when you receive it. 1000-hour batteries and ultra-sensitive phone included in this fabulously low price! Gift packed. SATISFACTION GUARANTEED! Wt. 1.5 oz.

3-TUBE AC/DC AMPLIFIER

Fully wired. Separate volume, tone controls. Reg. \$5. Now at lowest price ever! \$2.99

TUBES, \$1.91 EXTRA

Please include estimated postage with order for this item. Any excess returned. SHIP WT. 2 lbs.

SEND CHECK OR M.O.

POCKET MULTI-TESTER



3 1/2 x 2 x 1 1/2" bakelite case. 100 ohms/V. Zero adj. 0/15/150/1000 AC & DC V. 0/150 ma; 0/100,000 ohms. W test leads and battery... In orig. pack \$13. Estimated postage with order for this item. Any excess returned. SHIP WT. 2 lbs. \$6.99

Please include estimated postage with order for this item. Any excess returned. SHIP WT. 2 lbs.

C.O.D. ORDERS, 25% DOWN.

FREE! 12-PAGE BARGAIN CATALOG!

LEKTRON

131-135 EVERETT AVE.

CHELSEA 50, MASS.

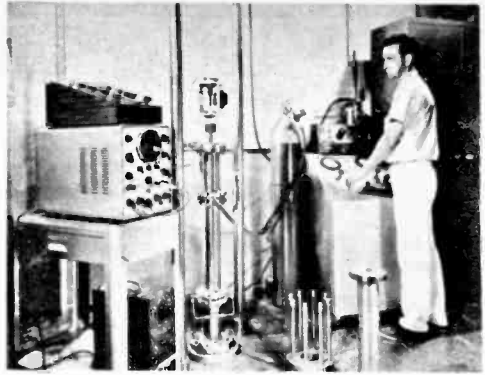

The Micronics Division of Elgin National Watch Company tests its delicate electromechanical and mechanical devices by means of this pneumatically operated shock tester. Here a laboratory technician observes the oscilloscope reading of "g" forces induced on the timing device mounted on the tester (center). Standing vertical from its heavy floor mounting, the tester induces thrust up to 10,000 pounds and develops loads as high as 300 g's.

The National Bureau of Standards in Washington reports that the standard ampere maintained by the Bureau has drifted no more than a few parts per million in the last 15 years. The standard was recently measured in absolute amperes using two different sets of apparatus. One was the current balance used in the 1942 evaluation and the other was a Pellat-type electro-dynamometer which was introduced to reduce the possibility of systemic errors. So, what is all this about inflation?

The Electronic Industries Association, trade group for equipment and set manufacturers, has reported that through November 1957 some 5,636,881 TV and 7,689,841 radio receivers were sold to the public. Compared with 1956, TV set sales are down but radio sets are going over the counters at top speed. The same group revealed that almost 26 million transistors were sold during the first eleven months of 1957 as compared with 11.2 million a year earlier. Through November, transistor sales made manufacturers happy to the tune of \$63,120,000!

If there is any doubt that transistors are revolutionizing the electronics industry, these figures should prove it. •

Technicians
will run
the

NEW AGE OF SPACE

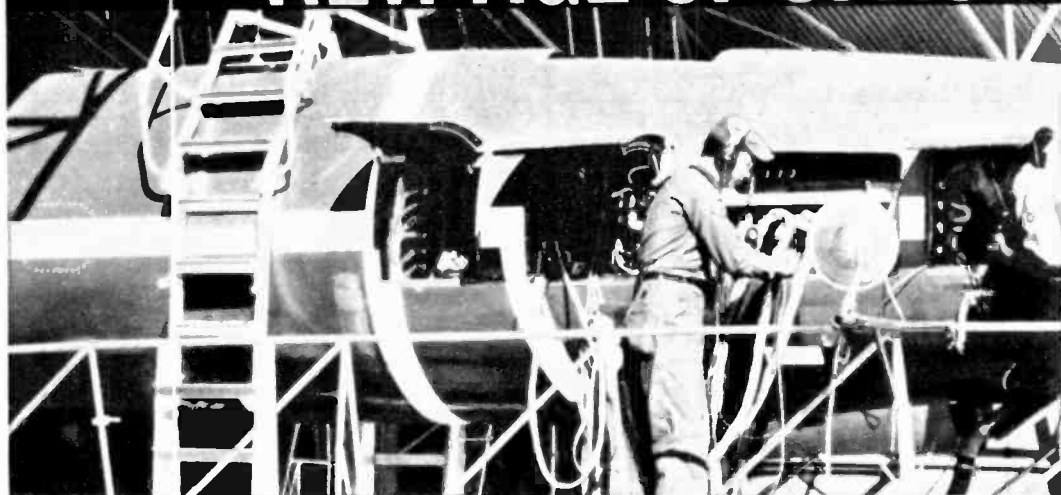

train now for your future in the

U.S. AIR FORCE

As a man of mechanical ability, you have a bright future. For in the new Age of Space, it is the technician trained in rocketry, jet propulsion, electronics, or allied fields, who will be the important, sought-after man. And, remember, nowhere else can you get so broad and complete a training for these Space Age specialties than as an Airman in the U.S. Air Force. See your Air Force Recruiter today—or mail coupon.

The future belongs to the Airman

You'll go places
faster in the **U.S.**
AIR FORCE

PASTE COUPON ON POSTCARD AND MAIL TO:

Airman Information, Dept. E I-5321
Box 7608, Washington 4, D. C.

Please send me information on my opportunities in the U.S. Air Force.
I am between the ages of 17-34 and reside in U.S.A. or possessions.

Name _____

Address _____

City _____ Zone _____ State _____

Garrard models change. Garrard ideals do not. Meaningful new features are added. Time-proven features are carefully retained. Gadgets, for the sake of gadgetry, are sternly rejected. The all-important fact to remember is that thirty-five years of experience in designing, testing, and building fine record players, guide us in offering you the present Garrard models.

Garrard

**WORLD'S FINEST
RECORD PLAYING
EQUIPMENT**



**B. I. C.
ENDORSED
QUALITY**

*There's a Garrard for
Every High Fidelity System*

A quality endorsed
product of the
British Industries Group:

Garrard, Leak
Wharfedale, RJ
River Edge, Genalex
S. G. Brown, Multicore



**Model 301 PROFESSIONAL
TRANSCRIPTION TURNTABLE**
Each speed variable!
Each unit with its own
performance test report. \$89.00



**Model RC98 4-SPEED SUPER
AUTO-MANUAL CHANGER**
Continuous + or - variable
control on all speeds. \$67.50

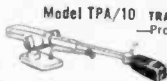

Model TPA/10 TRANSCRIPTION TONE ARM
—Professional performance,
Jewel-like construction
and exceptional
versatility. \$24.50



**Model RC88 4-SPEED DELUXE
AUTO-MANUAL CHANGER**
Exclusive pusher platform
protects your records. \$54.50



**Model T Mark II
4-SPEED MANUAL PLAYER**
A superior unit for quality
budget systems. \$32.50



**Model RC121 Mark II 4-SPEED
MIXER AUTO-MANUAL CHANGER**
Fine performance with economy
and compactness. \$42.50

**Mail this
Coupon for
Descriptive
Literature**

**GARRARD SALES CORPORATION, DEPT. GE-438
PORT WASHINGTON, NEW YORK**

Please send literature on Garrard.

Name _____

Address _____

City _____

Zone _____ State _____

New Ion Fuel For Rockets

By Paul Beame

How will our space ships of the future store enough fuel to navigate between planets?

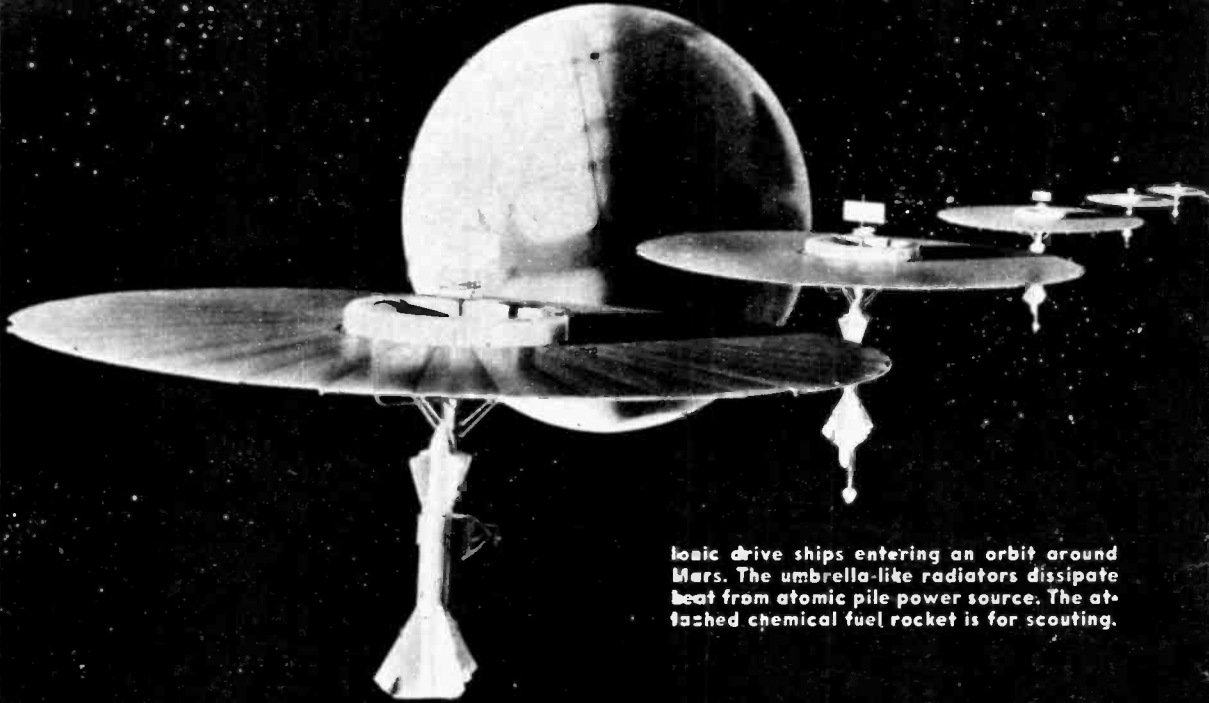

Ion drive ships entering an orbit around Mars. The umbrella-like radiators dissipate heat from atomic pile power source. The attached chemical fuel rocket is for scouting.

WHILE the eyes of the world are still focused on the flame-belching rockets spurting skyward from Florida, there's a quiet little revolution in the works which may steal their thunder. Even before man sets foot on the moon, his costly, monster chemical-propelled rockets may be relegated to the obscurity of shuttle runs from Earth to orbiting space stations.

The real work—bridging the gap between the planets—may fall to a vehicle far more suited to the huge distances involved. That next step is expected to be the ion drive space ship, using a concept once the exclusive property of science fiction writers, but today the object of intense study in the United States,

Russia, and in laboratories elsewhere.

Ion propulsion, rocket engineers believe, is not only feasible, but highly practical. Far more practical for interplanetary space, as a matter of fact, than chemical drive. All that's required, they believe, is enough concentration of research and development funds to bring it from the drawing board to actuality.

Any physics classroom can demonstrate how the ionic drive works. Ions, of course, are atoms which have been stripped of one or more electrons, thus gaining a positive charge. In a classroom, if we build up a sufficient positive charge on a freely rotating arm whose ends are bent at right angles, we find it will be sent spinning as the ions leak off

the ends. Were we able to accelerate these ions, the arm would spin much faster. Basically, this is the ion drive.

Action and Reaction

The ion motor works on the same principle as the chemical rocket motor: every action has an equal and opposite reaction. In other words, when a chemical rocket is fired, the mass of gases rushing out of the motor in one direction causes the rocket to "react," and move in the opposite direction. A gun, for instance, acts in exactly the same manner. When the bullet explodes from the muzzle (action), the stock kicks against your arm (reaction).

So with the ionic drive. In this case the reaction is supplied by the charged particles rushing out from the rear of the ship, kicking the ship forward.

It has been found that, in a chemical rocket, the faster the gases escape, the faster the ship will travel. In the ion rocket, the same principle holds true—

the faster the ions escape, the faster the ion rocket will move. And fortunately, there is a rather simple way to speed up ions. This is the electric field. If we pass a stream of ions through a properly oriented electric field, their speed will be boosted. The more intense the field, the greater the speed imparted. This is somewhat analogous to the way the electron beam in a television picture tube gets a "shot in the arm."

Therefore, in its simplest terms, all we need for an ion motor are two things: fuel to be ionized and a source of power to ionize the fuel and energize the electric field. We have these basics today, but the problem we face is in putting them together properly, and in the right place.

Before we examine the workings of an ion ship, let's find out why we need it.

The Fuel Problem

The chemical rocket, we know, is

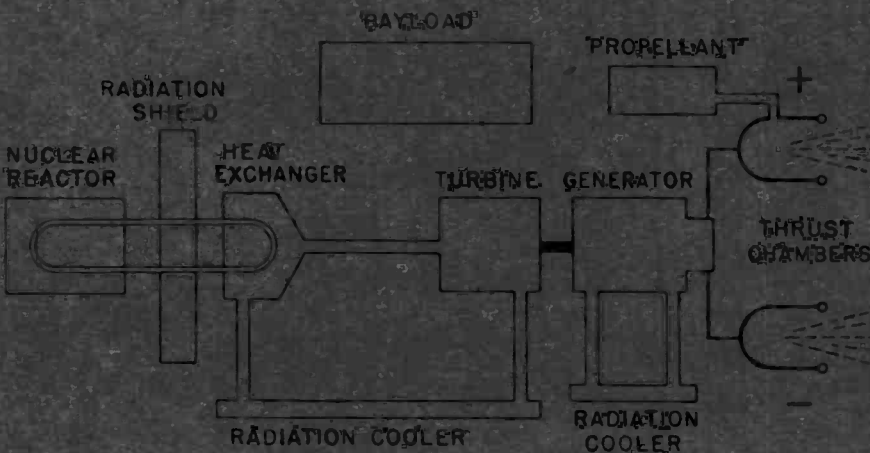

American Rocket Society

Block diagram of Dr. Ernst Stuhlinger's ionic space ship is shown above. Note that both positive ions as well as negative electrons have to be expelled to keep the ship's charge neutral. The electric field used to accelerate the particles is generated in the thrust chambers. At right is shown the Walt Disney conception of the interior of an ionic space ship's control center. Living quarters are atop the umbrella radiators.

highly inefficient. It eats up tremendous quantities of fuel in its drive to space. So much fuel, as a matter of fact, that we have as yet been unable to pack enough into such a rocket to kick it up to 25,000 miles an hour, which would allow it to escape the Earth's gravitational pull and push its way into empty space.

Even if we got the ship into an orbit about the Earth and were prepared to refuel it from a space station, we would find that it would need so much fuel for a trip to Mars that there would be little room for a payload such as crew, food, water, air and equipment.

But here is where the ionic drive ship would come into its own. Such a ship could carry enough fuel for perhaps a year's constant operation, and this supply would take an area of only a few square yards. We would then have licked our biggest problem. We could get to Mars and back, and later, with more efficient design, we could push our

cruising radius out to much of the rest of the Solar System.

There are drawbacks, of course. The ion motor does not have the thrust necessary to enable such a ship to escape the heavy gravity of Earth. But since we would have to refuel a chemical rocket via a space station, we could just as easily do the same with an ion rocket. It could be sent into an orbit as the third stage of the chemical rocket, from whence it could be fueled and sent on its way by ionic drive.

Another drawback is the speed of such a ship. It has been calculated that a chemical rocket could get to Mars in about 260 days. It would take about 400 for the ion ship. This is not felt to be of sufficient consequence since space travelers would have to expect to spend long periods of time in accomplishing such journeys.

Weighing these pros and cons, proponents of the ionic drive feel such a ship holds the key to opening up the

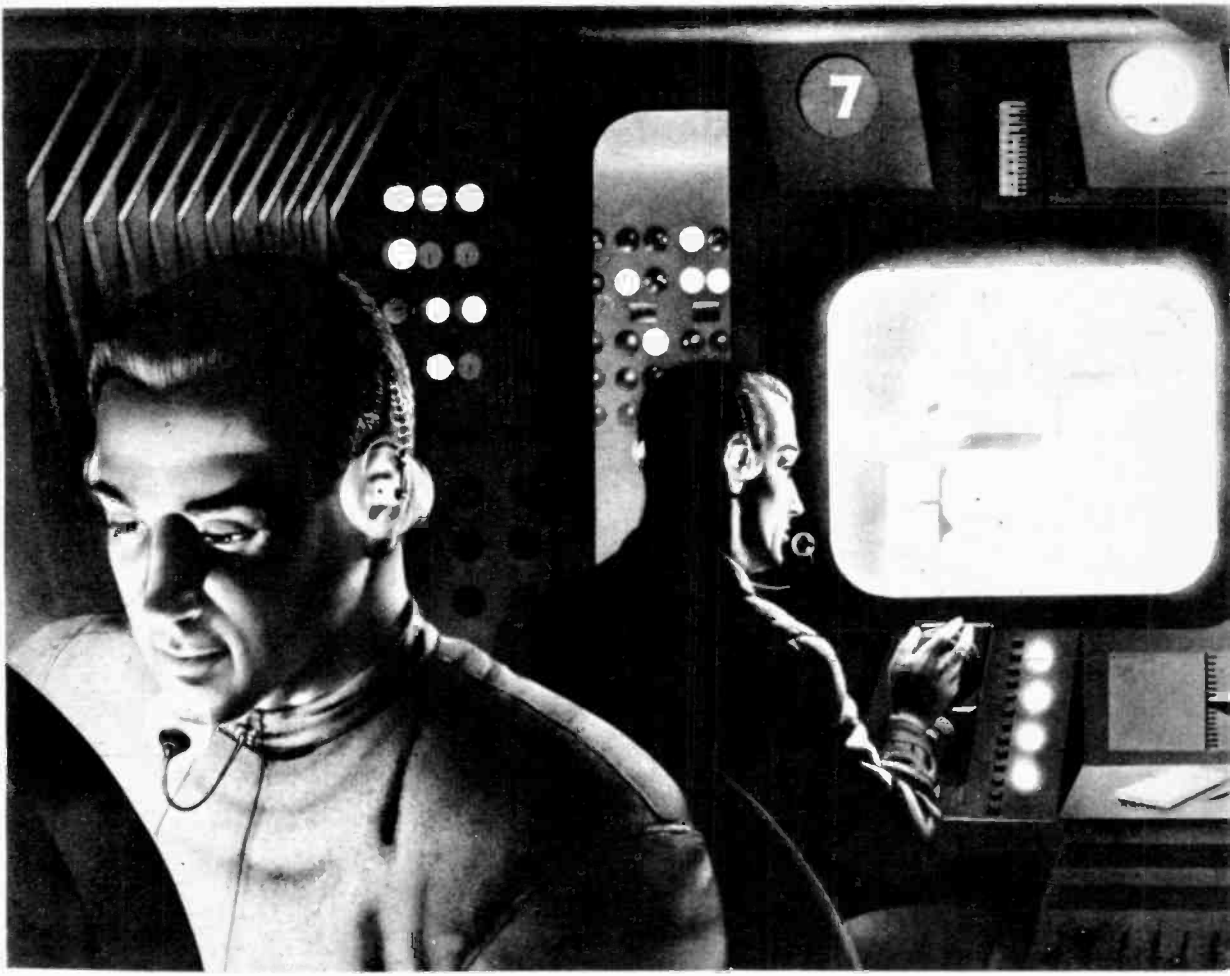

Solar System to spacemen from Earth.

Atomic Reactor Makes Ions

There have been several plans advanced for ion space ships. One of this country's top rocket experts, Dr. Ernst Stuhlinger, one of wartime Germany's foremost V2 designers and now at the Army's Redstone Arsenal at Huntsville, Alabama, is certain ion propulsion is the coming thing.

His plans call for an atomic reactor as the source of power. It would run a generator through a heat exchanger coupled to a steam turbine. The generator would heat to incandescence platinum ionizing grids, against which the fuel, cesium, would be sprayed. Cesium has the property of shedding electrons and ionizing easily upon contact with sufficient heat. These ions would be passed through an intense electric field, built up by the generator, which would accelerate them tremendously and expel them from the rear. The greater

the intensity of the field, the greater the speed of the ions and the greater the thrust. At the same time, the electrons which have been stripped from the cesium atoms would be sent through a similar field and expelled, so that the ship would remain electrically neutral.

M. I. Willinski and E. C. Orr, engineers at *Rocketdyne*, a division of *North American Aviation*, have gone one step further. They have outlined "Project Snooper," a program for reconnaissance of the Solar System using unmanned ion ships of a design somewhat similar to Dr. Stuhlinger's. These "Snooper" ships would be guided by preset instructions and would be powered for flights of a year or more. They would record everything they "saw" in orbits about Mars and the other planets, then head back for Earth and "report."

Ships using such a system of heat exchange would of necessity have to cool the hot steam so it could be recycled. The "Snooper" [Continued on page 106]

Dr. Werner von Braun (right) checks with a Disney specialist on construction details of the ionic space ship. Von Braun is the U. S. Army's top rocket expert and designer.

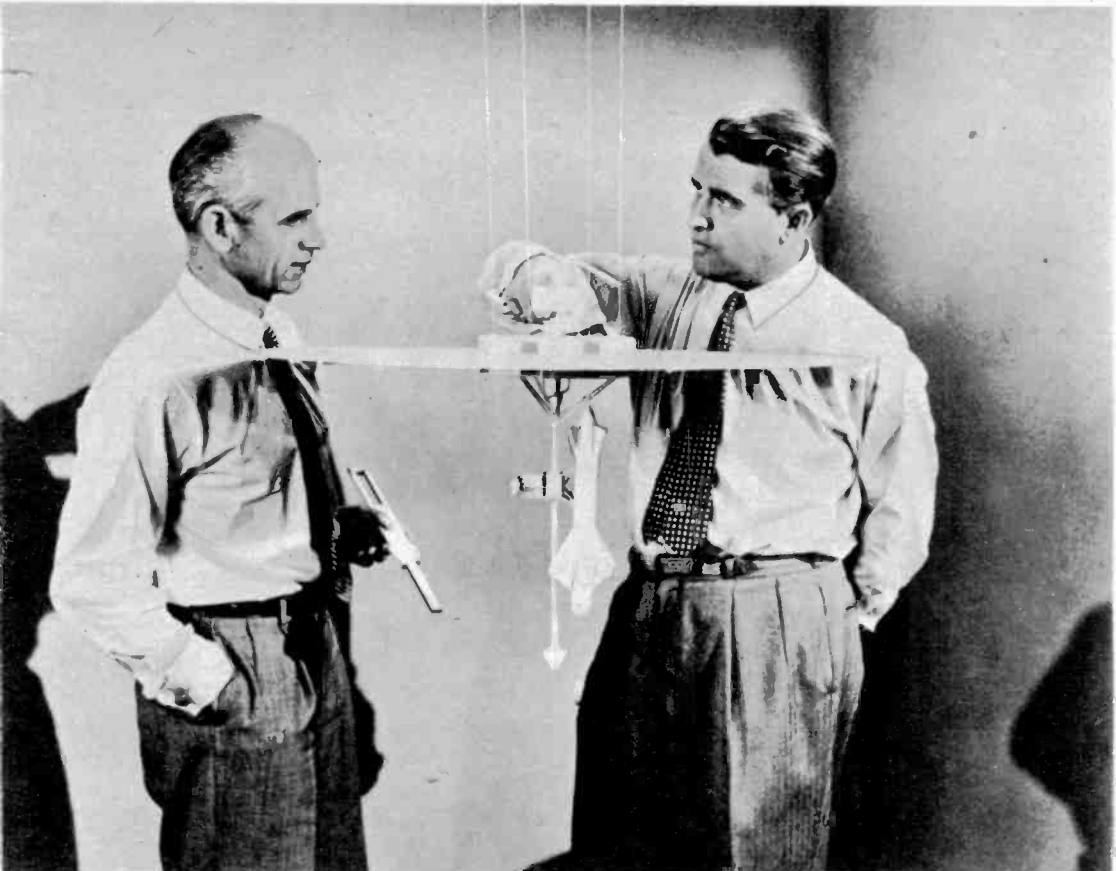

Electronics Tracks Ills

MORE and more the frontiers of medicine are being pushed into the land of the minute, the smallest of the small. The basis of scientific investigation, measurement, would be almost impossible in this region were it not for the techniques and instruments developed by electronics. The advances shown on this page are fruits of the increasing application of electronics to medical research and clinical diagnosis. •



Radio Corporation of America

Small capacitance pickup on patient's chest detects and records heart murmurs that may reveal heart defects at a very early stage.



General Motors Corp., Medical College of South Carolina



Arthur Schatz, Black Star

Electrogastrograph developed by research team at Columbia-Presbyterian Medical Center detects ulcers in stomach electronically.

Left, two scientists demonstrate a "radio pill," a small FM transmitter which is sent through the intestinal tract and followed externally.

The capacity pickup on the left is used in a soundproof room; the instruments for recording murmurs are located outside, below.



All About Wiretapping

Modern pickups are so sensitive that detection is almost impossible.

Article describes how "bugs" are made and tells what to guard against.

By Miguel Vega

PRVACY of the American individual in his person, his home, his papers, and his communications has been an established principle of our way of life, at least on paper. By the far and the large the various law enforcement agencies and private detectives do not and have not invaded these rights. However, the news has been full recently of cases where wiretapping has been used by both government agencies and private individuals. Just as electric chairs and nooses do not deter murderers so will recent strict laws fail to prevent telephone taps or their equivalent. This article is written primarily to acquaint the reader with how easy it is to gain knowledge of your telephone talks by showing how it is done so that you can be on your guard. It may be too late to call a policeman after damage to your business or your reputation.

First, though, we mention the old style

tap. It consisted of a lineman's test phone or other portable telephone instrument connected across the two line wires to a telephone, called a "pair." (Below.) This was actually a tap. The telephone company could easily locate such a job and remove it. Whenever a call came over the line the "tap" phone would ring too and so would the phone on the line tapped although more weakly than normal. And the conversation over a tapped wire was weaker than normal. Hence such could be detected rather readily. *Modern electronic "taps" do not cause this characteristic lowering of the signal, a common fallacy.*

Modern tapping devices do not make a physical connection with the phone wires. All operate on the principle that they intercept the invisible and inaudible magnetic or capacitative field around telephone wires created by

Old method of wiretapping bridged telephone lines making a noticeable reduction in sound.

Modern induction pickup coil can be slipped under a telephone and does not affect sound.

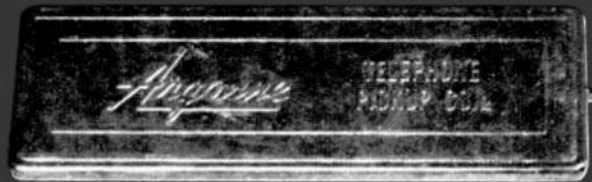
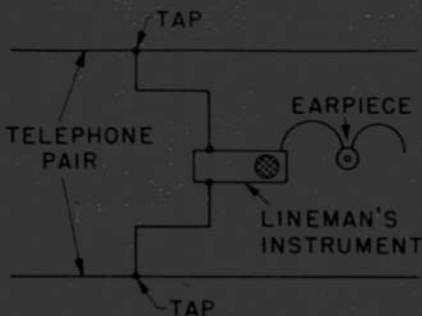



TELEPHONES

Homemade induction coil used with a miniature wire recorder for wiretapping public phone.

Typical small portable amplifier for wiretapping. Others use transistors instead of tubes.

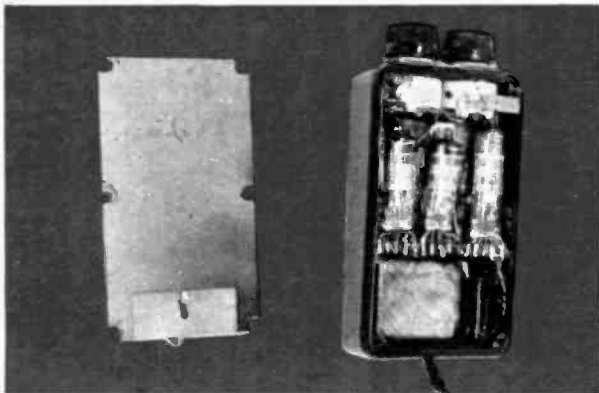

telephone currents: voice, ringing and dialing currents. An amplifier builds up the weak signal into an audible one or feeds a recorder for a permanent record.

Quite legal almost everywhere is a common practice in business of tapping your own phone with an induction pick-up as shown at left, center. A variety of these units for different phone types can be obtained from mail order and other electronic distributors. Such a unit is placed near the phone, its cradle, or ringer box. The output feeds an amplifier so that several can hear both sides of the conversation through a loud-

speaker, or several headsets or individual earphones.

Not always so legal is the *recording* of a phone conversation. A high pitched "beep" note is ordinarily required to apprise the distant talker that his remarks are being recorded. Check your local laws before attempting this. Almost all the various induction pickups can be fed directly into one of the input circuits of a tape or wire recorder. Some may require a matching transformer if the impedances are too different. Consult the pickup dealer or manufacturer if trouble is experienced so he can suggest the proper matching device.

Unauthorized Interceptions

It is easy to see taps like those just mentioned. You can disconnect or move the induction coil away from the phone and the tap is broken. But a blackmailer or extortionist, etc., is certainly not that obvious. He would use another phone. Nor is an individual safe in foregoing a private phone for a public phone booth. They, too, can be "bugged" temporarily as we shall see.

A knowledge of the methods employed and types of equipment used enable you to safeguard your telephone talks.

Let's start with a simple type of capacity "bug" to illustrate what can be accomplished. A piece of wire may be strung along an exposed telephone pair of wires as shown at right. This wire forms a small capacity with the telephone wires like a condenser. With a very high gain amplifier both sides of the conversation become audible. This method is so effective that some private detectives have picked up telephone conversations on their hidden microphone lines when these were adjacent to phone wires. The phone conversation interfered!

On page 29 is a portable hearing aid amplifier that is often used with such a pickup. The conversation may be recorded on a tape recorder (below left). Most tape recorders require an auxiliary preamplifier to boost the signal from a capacity wire pickup unless the length of the pickup wire is over about 10 feet. The output of the tape recorder or amplifier is monitored.

Construction details of typical induction pickup coil used for wiretapping.

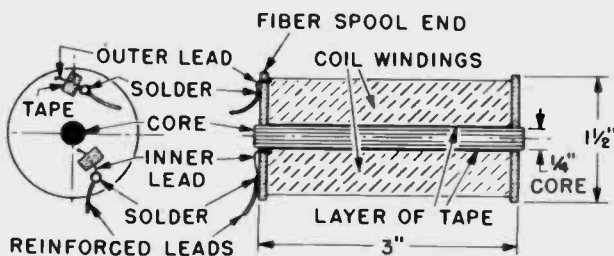

ONE POUND NO. 36 "FORMVAR" INSULATED MAGNET WIRE. FERRITE ROD FROM A LOOPSTICK.

Matching a recorder to pickup amplifier.

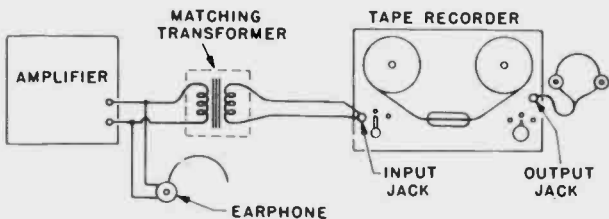

Finished pickup coil covered with black plastic tape and with microphone cable.

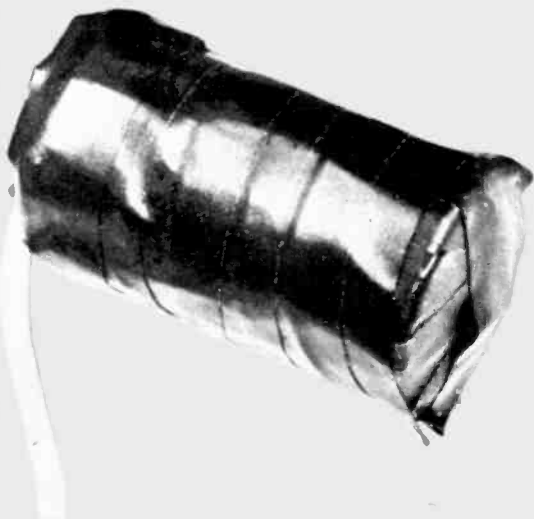



Core and semifinished pickup coil covered with Scotch tape; note reinforced leads.

Simple wire slipped between twisted pair of phone leads picks up sound, must be amplified.

Induction Pickup

Due to the low sensitivity of the capacity-wire type pickup some form of induction pickup is most commonly used. A smaller and less sensitive amplifier is required with this device than for the capacity "bug." Page 33 has a pictorial sketch of how one type is hooked up. The matching transformer may be deleted if the impedances of the pickup coil and the amplifier input are approximately the same. A tape recorder may be substituted for the amplifier.

A simple induction tap is shown on



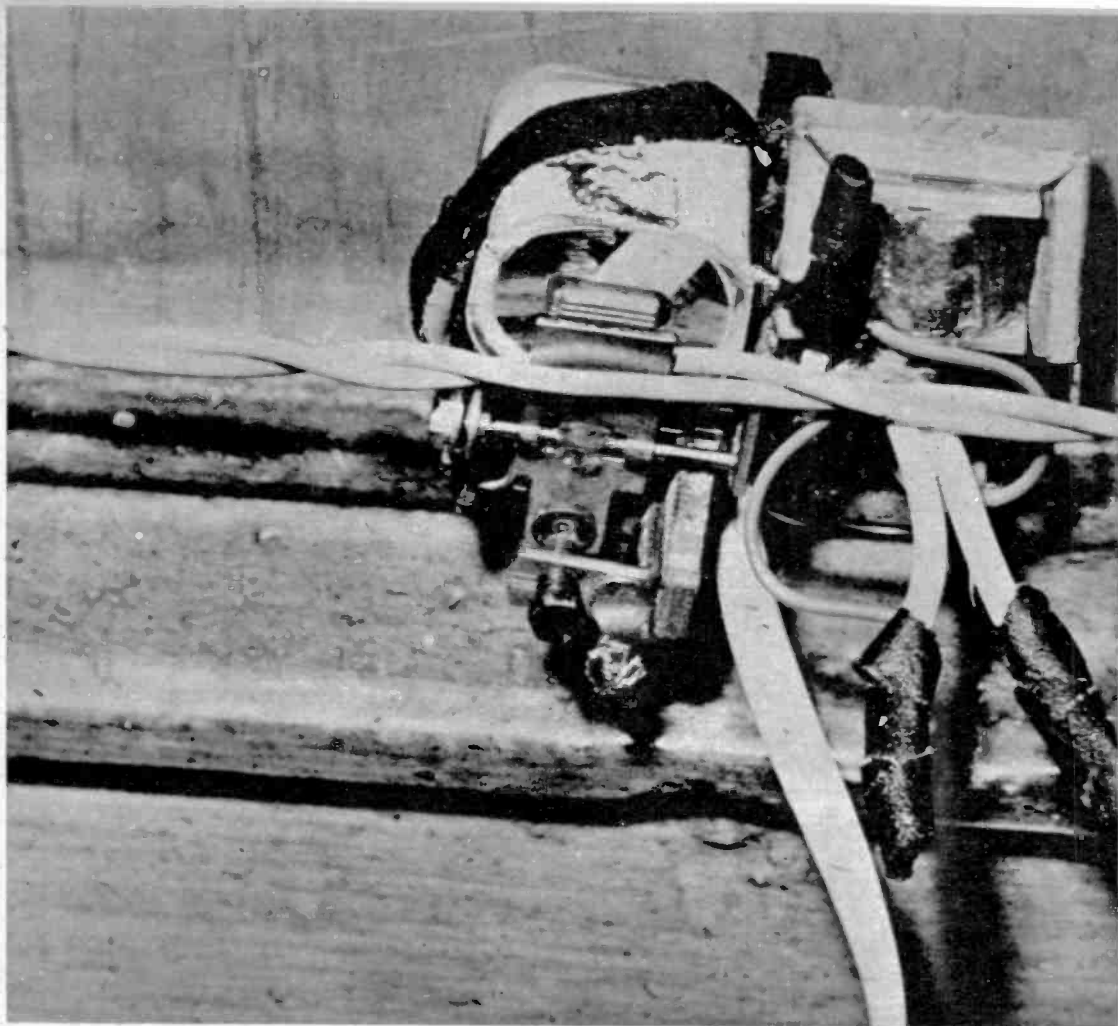

above. Here, a common sensitive radio relay, a *Sigma* "4F," is used as the induction pickup. One of its contacts is unscrewed enough so the armature will open sufficiently for a telephone wire to enter the gap between armature and pole piece. The telephone wire acts as one turn of a transformer winding while the coil on the relay is the other winding. (This particular relay coil has an a.c. impedance of about 25,000 ohms, so a matching transformer must be used to step down the impedance to about 1000 to 1500 ohms to match the input of a transistor amplifier or to step up the impedance to about 100,000 ohms for a vacuum tube amplifier. Small transformers for this purpose are readily

available; *Argonne* models AR 104 or AR 100 are two examples.)

Now these methods work if the telephone wires are exposed. If not, then a junction box is opened and the induction pickup is slipped onto the wire. Or the line may be tapped by inserting a small capacitor from each wire (there are two) to the two input terminals of the amplifier. The capacitor used is always less than about 0.001 mfd. This direct tap cannot be found except by visual inspection.

Tapping Pay Phones

So you think you are safe to go to a phone booth and make a call? Maybe. You go to a phone booth. Somebody



Small inexpensive relay used as an induction pickup on a twisted pair of telephone leads. Note one telephone lead in gap between relay armature and pole piece. Matching transformer goes with relay.

Schematic diagram of the setup in the photo above. Note how matching transformer is used between pickup and amplifier or tape recorder.

enters the adjacent booth and you hear them drop a coin in the slot and dial—maybe even talk. Can they hear what goes on over your line? Yes! Or maybe someone is looking up a number in a nearby directory while you're making your call. Beware!

Page 29 shows the use of a powerful induction coil near the ringer box in a phone booth. The unseen magnetic field around the ringer box is picked up by the coil and fed to a hearing-aid type amplifier and earphone. Or the talk may be taken down on a portable tape recorder. Even the dial impulses from a dial phone can be recorded in this way, and deciphered later to tell just what number you dialed.

You avoid such possible intrusion of your privacy by assuring yourself that no one loiters near the phone you are using—within 10 feet of the handset, the phone proper, or its ringer box. Furthermore, do not employ the same phone habitually. Habit is noticed by criminals like those who "case" a payroll.

The oversize induction coils used for these pickups are simple to make. In-
[Continued on page 111]

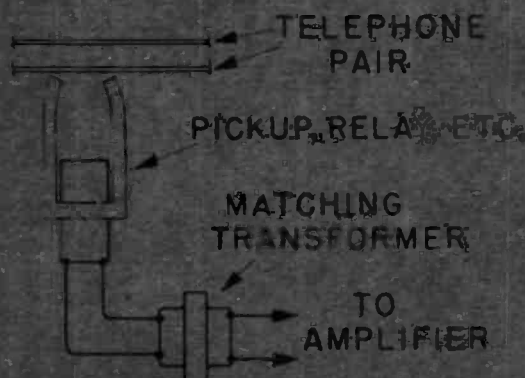

Radio Control—Hobby Extraordinary

By William Winter

Get the thrill of flying or sailing
with models and simple electronics.

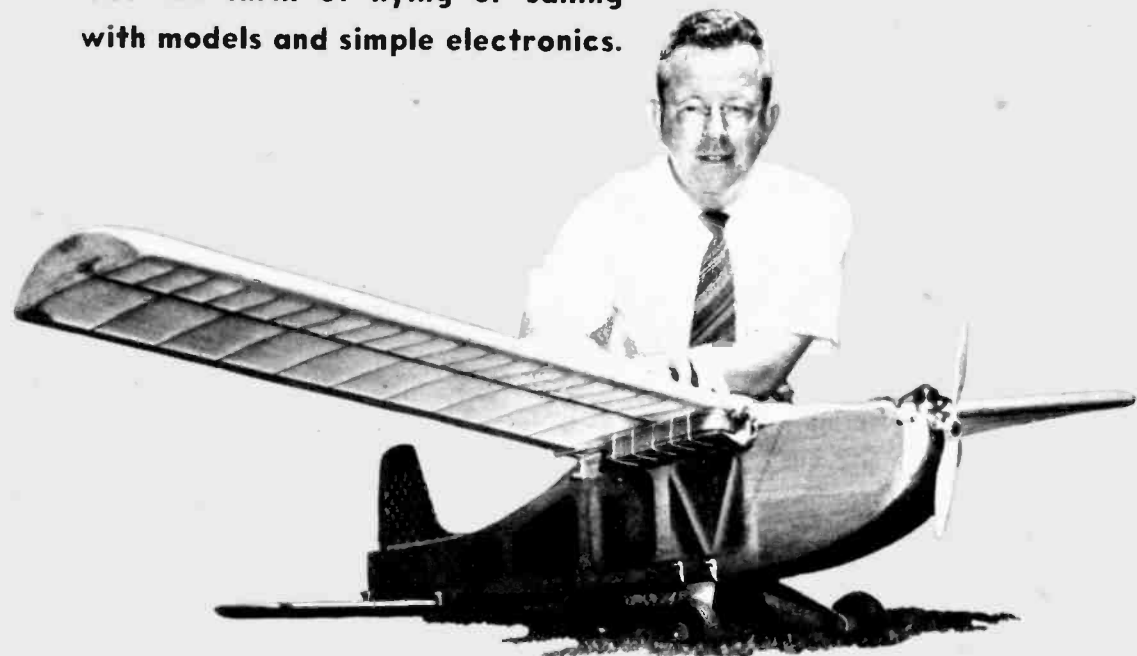

This model winged over water from Catalina to L.A. via radio control.

IN the short 13 years since VJ Day, no division of electronics has made more spectacular gains than the tight little industry that produces equipment for the hobbyist who goes in for radio-controlled model airplanes, boats, and cars. It's quite a business.

In the all-out competitive battle to increase reliability and degree of control, to reduce weight and current drain, perhaps a dozen manufacturers wage war against each other with printed circuitry, transistorization, subminiaturization, and all of the latest "secret weaponry" of electronics. Guided missiles and drones may be the major interest of some of these people—Babcock and CG Electronics, for instance—but victory in this "side line" battle

seemingly is for survival. The hobbyist loves it.

At the 1957 National Model Airplane Meet, held at Willow Grove Naval Air Station, near Philadelphia, 367 people entered the "RC" event. Throughout the week of July 29—August 3, miniature planes spun, looped, flew inverted, snap rolled and slow rolled, did Cuban eights, touch-and-go landings and many other "air show" maneuvers. When it was all over, Bob Dunham of California held a half-point lead over Harold deBolt, of Buffalo, N. Y. Both flew eight-channel equipment capable of operating every control you can find on a real plane. Eight-channel receivers were commonplace. Truly remarkable, was the fact that almost all this exotic

Right, typical rubber-band powered escapement with built-in relay. Arm turns when radio-controlled receiver "pulls in" relay.

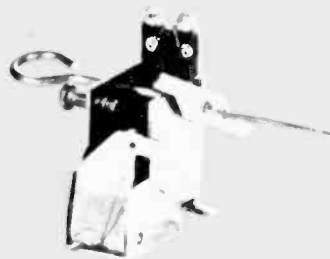

Below, this 3 1/2" scale model yacht is one of a number of kits designed for radio control.

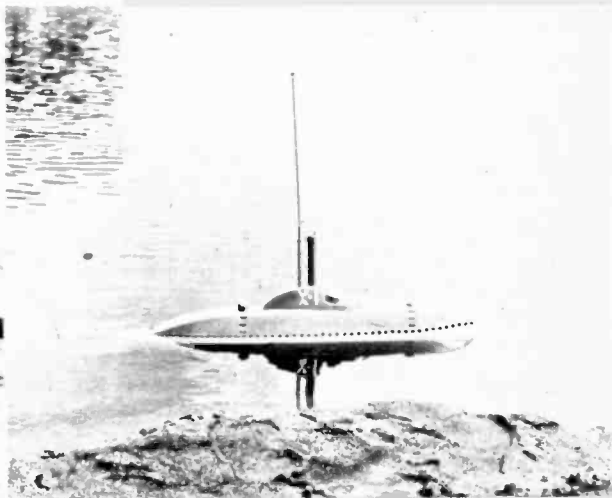

Above right, electric motor powered submarine model dives, steers under water, and surfaces all in response to radio control.

Right, various radio control parts. The 5-reed relay is activated by tones and controls five circuits—compare its size with the nickel! Below it is a servo and its boat control unit.



equipment was right off the dealers' shelves. And most of the fliers barely knew the difference between a transistor and a resistor. Anyone can do it!

Gone are the days when the hobbyist had to team with a "ham." When a day's outing involved diddle sticks and earphones, test sets and meters, car-battery soldering irons and rabbit's feet. Now you put in the batteries, turn on the switch, and burn up the sky—or skim the waves if boats are your pleasure. The only tough problem is deciding what system and equipment to use. For a pair of ten spots—or C notes, there's something for everyone—school kid or bank president.

The Orbit eight-channel that won the Nationals (CG Electronics, Bramco and

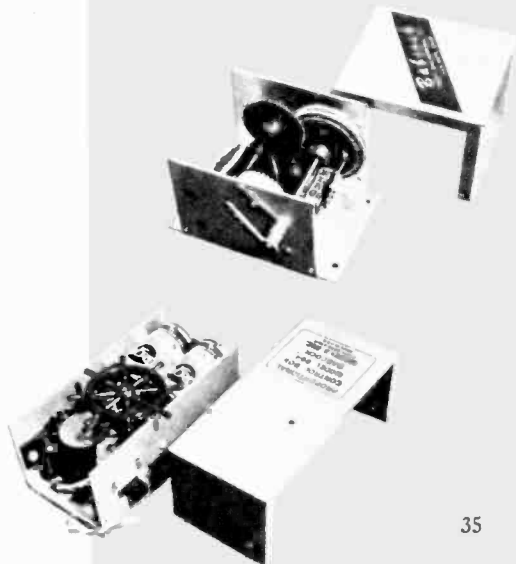

CG Electronics' 8-channel transmitter, left, and receiver, right. The flight of a model airplane is completely controlled by the two sticks on the front of the transmitter. The receiver is all transistorized with a reed relay and eight operator relays in a compact, shockproof package.

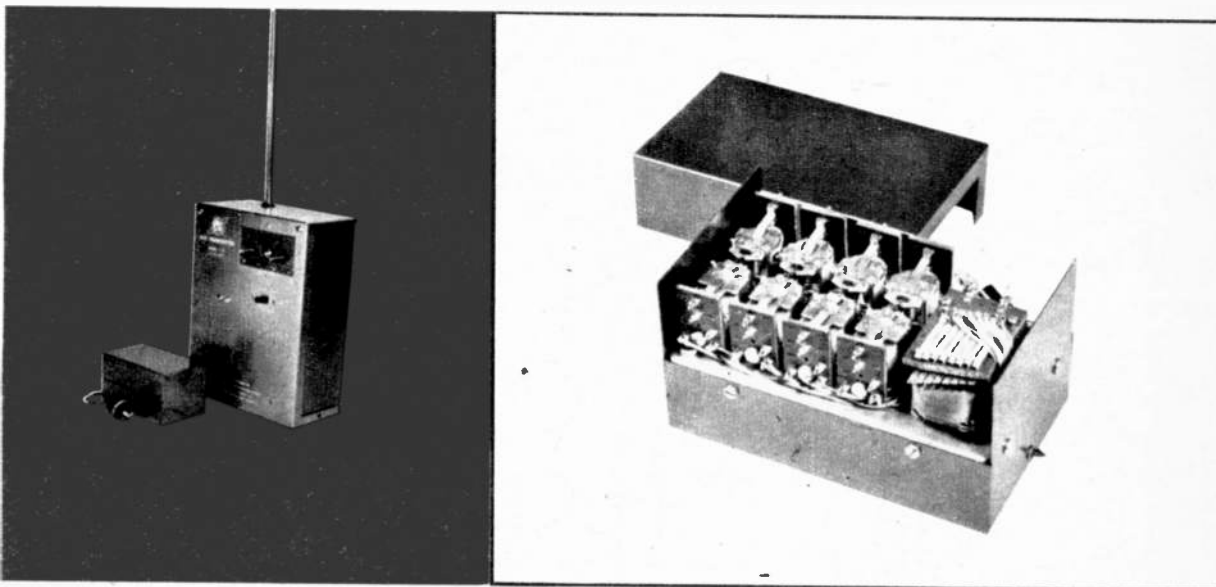

others have similar equipment) weighs only nine ounces and fits in a "can" $2\frac{1}{16} \times 2\frac{1}{4} \times 3\frac{3}{4}$ —and that includes eight miniature relays and a reed bank. Operating on the Citizens frequency of 27.255 megacycles, Orbit equipment, like all the others, requires no code test or written examinations for a "ham" license. The frequencies of 465 and 27.255 mc are examination-free. You fill out, and file with FCC, the form 505 which comes with the equipment. This gets you a "station license."

Small size and low weight and versatility, however amazing, only suggest the story.

The Orbit receiver uses a 1AG4 sub-miniature tube and two transistors in its circuits (the remarkable CG doesn't even use a tube!). A lightweight hearing aide battery (such as a Burgess 30-volt U20), and a single pencil for filament is the power supply. In fact, one firm, B & S Products, produces a tiny transistorized power supply for receivers. This is correct—for receivers!

How They Work

Basically, the "RC" system consists of the transmitter which puts out the

signals; the receiver, which picks up the signals and puts them to work; and the actuator(s) which moves the control surfaces on a plane, rudder on a boat, or steering mechanism of a car or truck. Equipment is distinguished by the number of channels, or different control orders that can be transmitted and picked up independently of each other. The popular single channel sets may be either carrier wave- or modulated tone-operated; multi-channel sets are invariably tone modulated. What means this Buck Rogers' gibberish?

In the carrier wave (CW) job, the transmitter sends out a steady signal as long as the control switch is closed. Reception of this signal at the receiver causes a significant change in the idling current, and this change in current through the relay of the receiver in turn, causes the relay to open or close, as the case may be. Everything exists just to work that relay—and a relay is nothing but a switch to close a second electrical circuit to the actuator. The actuator is either an escapement (powered by a rubber loop) which is released by a built-in magnet to move the control surface one position, or an electric motor-

Typical 8-channel RC installation in a model airplane. The receiver, servo actuators, and batteries are on trays.

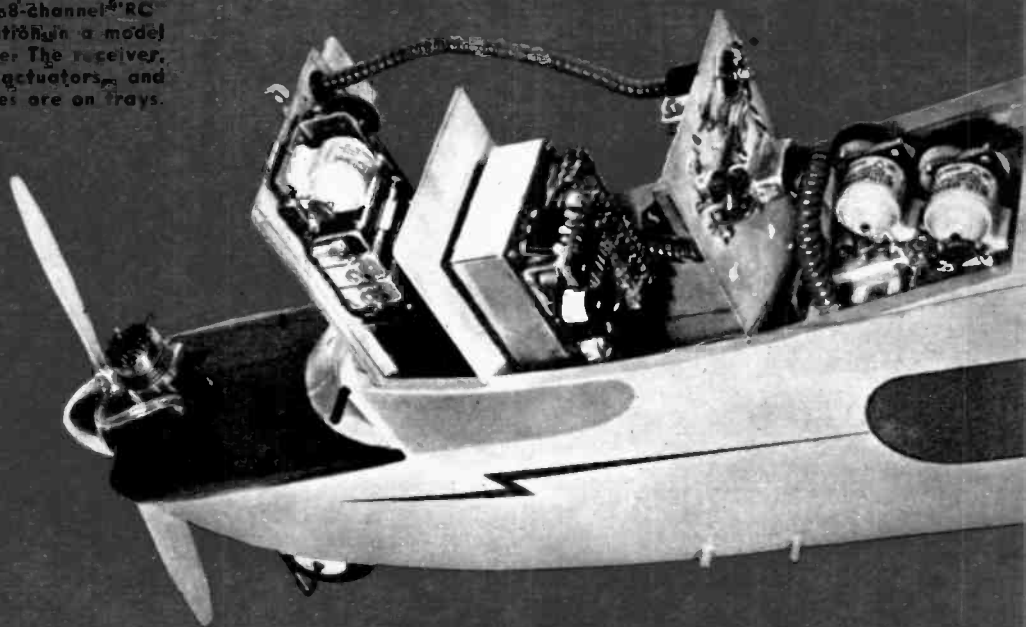

driven servo with the same function. In any single-channel set, all additional controls must be achieved by Rube Goldberg variations on the actuator—you can vary the number, the length or the spacing of the signals to select auxiliary motions of the actuator.

The tone-modulated rig functions much like a household radio. The carrier wave generally is transmitted steadily. Upon the CW a tone may be imposed, just as sound is carried on the CW to the household radio. In the receiver this tone evokes a response, again used to change the current through a relay.

Additional channels are easily had with tone-modulated rigs. Each tone is sorted out in the receiver and directed to its particular actuator by means of either a reed bank or a filter block. The reed bank consists of a magnet and a set of vibrating reeds of various lengths, usually thin strips of metal. The lengths of the reeds govern the resonant frequency at which the given reed will vibrate madly. The idea, of course, is to have each reed vibrate when its tone is sent out by the transmitter. When it vibrates the reed causes a relay to close.

A filter block is nothing but a network of condensers and resistors that do the same job as a reed bank but entirely electronically. Either reed bank or filter block operates as many as ten relays (one for each channel). Filter blocks are heavy and usually are limited to two or three channels.

As in the single channel sets, the relay(s) close additional circuits to actuators—almost always servos in this case. For example, movement of a control stick at the transmitter for "up elevator" will vibrate one reed, close one relay, and supply "juice" thereby to one side of the motor in the servo. To move the servo in the other direction, the stick would be pushed to "down," vibrating a different reed in the receiver, closing another relay, hence sending current to the other side of the servo motor, causing it to run in the reverse direction.

Any of the better eight-channel receivers and transmitters provide simultaneous action of controls. Two channels may be connected for left and right rudder, two for up and down elevator, two for proportional engine throttle, and two for ailerons. Some modelers connect a fifth servo to operate landing

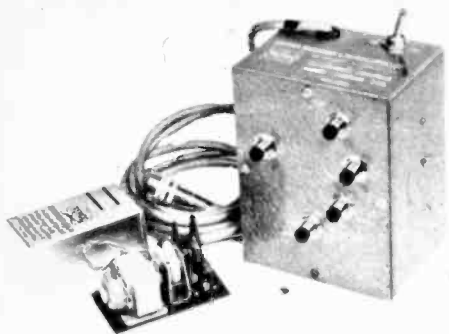

Pushbuttons on this transmitter control different model plane functions through servo shown.

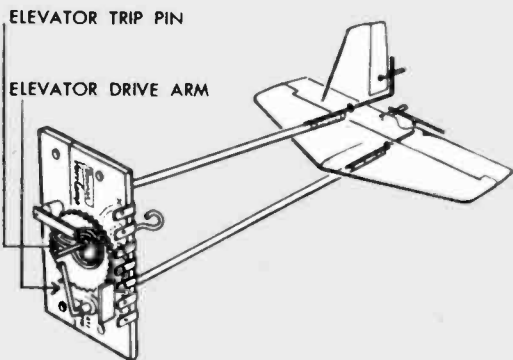
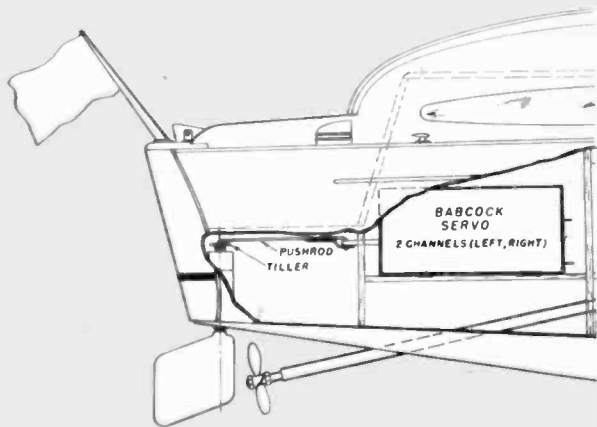

Drawing shows how an escapement controls more than one function on a model plane with but a single-channel radio.

Typical single-channel receiver operates on pencil and 2 hearing-aid batteries.

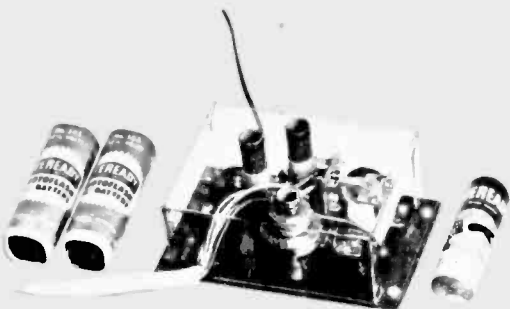

flaps. Wheel brakes operate by magnetic clutch systems, or mechanically from the extreme up elevator control on the ground.

Model planes taxi out slowly, swing into the take-off position, lock their brakes and rev up their engines before "climbing out." They land with motor throttled back, roll down the runway and, by brakes and steerable tail wheel (works with the rudder), taxi back to the pilot, threading their way through people, cars, and other obstacles. If boats are your weakness, flags unfurl, gun turrets swivel (one mad genius fires blanks!), while the boat speeds along, or slows down, and even reverses. The writer has seen an incredibly detailed Mississippi stern wheeler belching smoke to the strains of Dixie coming from its gadget-filled hold.

With his high-powered rig, it isn't surprising that the "ham" looks down his nose at the tiny-power transmitters used by hobbyists. But the hobbyist does things with his "peashooter" that make the "ham" mumble in his beard. For example, the CG tone transmitters use an antenna one-eighth wave length long and deliver to it only $\frac{1}{4}$ watt of power. This won't cause Arthur Godfrey to talk from the fillings in your teeth. Yet, one of CG's standard transistorized receivers was attached to the wing of a

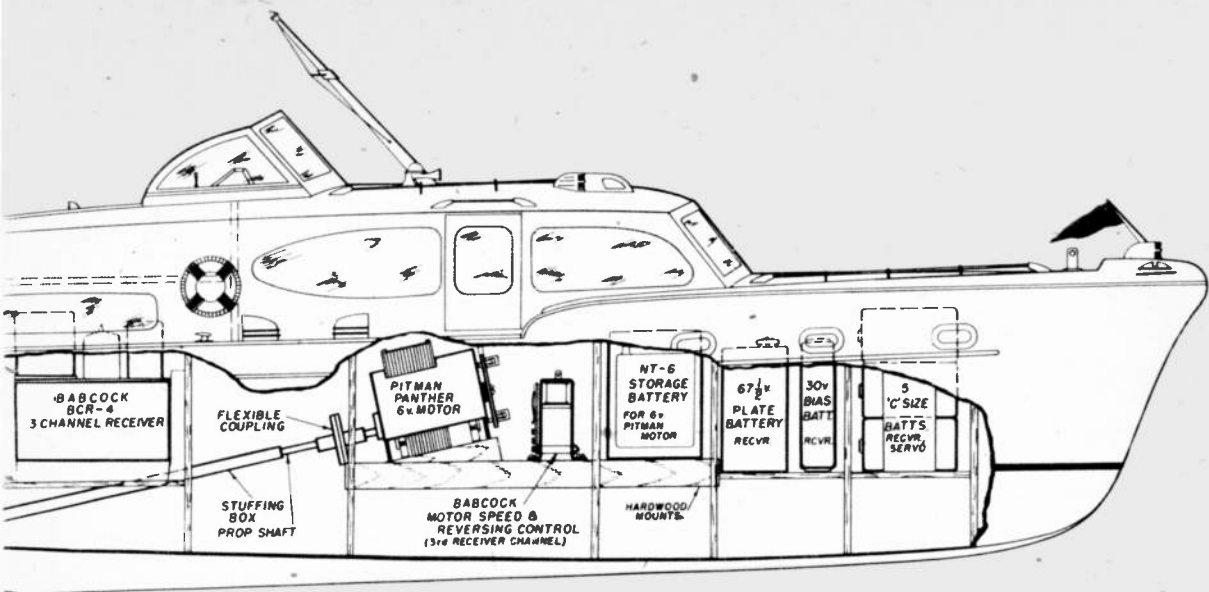

Typical Chris-Craft cabin cruiser (Sterling) showing installation of 3-channel receiver. Boats are becoming more and more popular for "RC," they are less risky than planes; easier to work.

New Mexico National Guard F-80 jet trainer, with an 18-inch antenna. At an altitude of 1,000 feet, the ground range was in excess of four miles. At 25,000 feet, the equivalent ground range was 15 miles, not considering the five miles above the ground. The tiny RT-1 single-channel receiver was then tuned to 20 mc and Sputnik I came in loud and clear on a four-foot antenna. 'Nuf said, (At 1/2 mile, a six-foot model plane is a black dot, at 1/4 mile it is extremely difficult to control properly. Visual limitations, therefore, prevent practical operation beyond these distances.)

Though this might convince the "ham" that low output does have range, it would be almost impossible to convince him that such gimmickry is reliable. It is.

For the benefit of the technically minded, the following statement might be of interest:

"A powerhouse transmitter is not necessary for reliable range," states Frank Hoover of CG. "Weight is of no consideration in a transmitter but battery economy is a major factor, especially where B batteries are concerned. Battery drain is eight to 10 ma for the

plate batteries. Under normal use one set of batteries will provide six months' reliable operation.

"Reliability? The modulator in the transmitter must modulate the carrier at least 90% for reliable operation. The audio tone generators must stay within two cycles to give reliable reed-relay operation. The reed relay has a band width of approximately three cycles at the center frequency of 300 cycles per second." This requires stability of 1% or better over a range of 1 to 1 1/2 volts and a plate voltage of 100 to 135 at any temperature from zero to 150 degrees F."

All CG receivers have surface barrier transistor detectors. This front end is not a crystal detector, as one might suspect, but is true super-regenerative detector with a sensitivity of six to 10 microvolts. This sensitivity compares to the tube detectors and is temperature compensated.

Buying Your Equipment

To make heads and tails out of the raft of RC equipment at the hobby shop, one must think in terms of the kinds of
 [Continued on page 102]

World's Smallest TV Station

This Port Jervis, N. Y., studio operates without need of FCC license.

By Robert Hertzberg



The "studio" is a converted 19- by 20-foot garage.



A CONVERTED two-car garage is the studio. The staff numbers two men. The technical equipment consists of a single camera and four photoflood lights. The station does not have and does not need an FCC license, but it operates on Channel 6. Viewers get perfect reception all the time. From its start, the enterprise has been self-sustaining, and local business people are clamoring for more commercial time.

Here in a paragraph is a description of what is probably the smallest but most unique television service in the world. It calls itself PJ-TV, the first part representing the initials of Port Jervis, New York.

Port Jervis is a thriving town of 10,000 inhabitants, located about 60 air miles from New York City at a point where the states of New York, New Jersey and Pennsylvania form a corner. This is definitely an unsatisfactory "fringe area" as far as reception from New York or any other television center is concerned. Some residents have their own big antenna arrays and sometimes obtain passable programs from two or three of the Empire State stations. Most set owners, however, have found it better to subscribe to a community service called Port TV. This organization maintains an elaborate "farm" of seven antennas on a nearby hill. These funnel



Station PJ-TV's one camera handles all programs and commercials. Organ provides live music.

Outdoor features are shot in front of the garage with camera pointed out door.

strong signals from all the New York City stations into a cable network that honeycombs Port Jervis.

Any family can avail itself of the Port TV facilities for an initial installation charge of \$125 and a monthly fee of \$3.00. In return, the company guarantees perfect 24-hour-a-day reception. The deal is a very good one.

Last summer it occurred to three local business men that while Port Jervis was enjoying better television reception than do many sections of New York City, the town itself had no TV representation. The men were Ernest Winkler, an insurance executive, Jerome Cohen, a lawyer, and Robert Shevlin, a radio



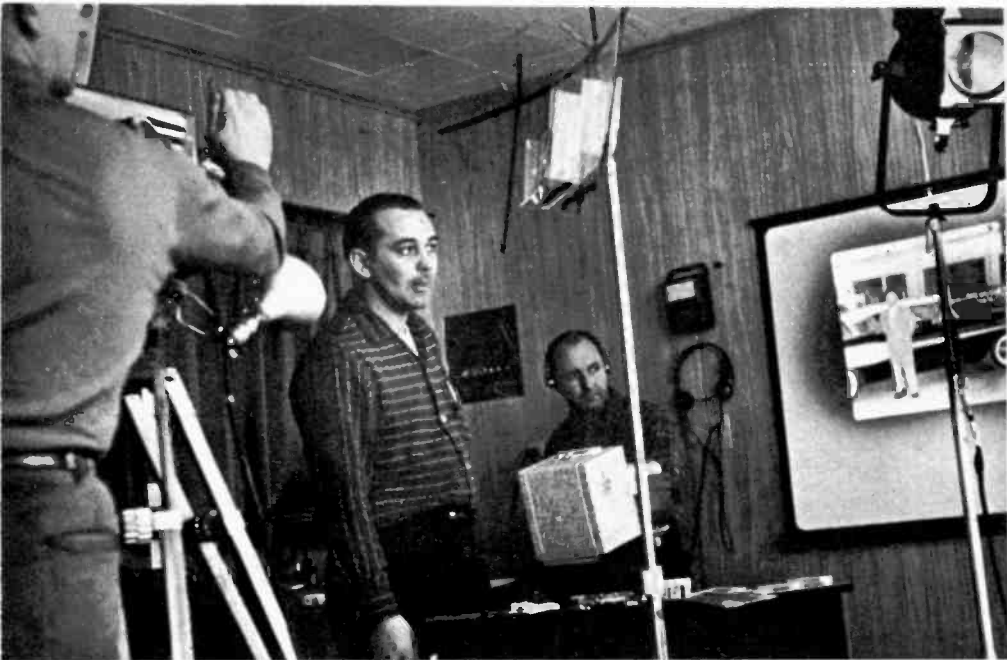

Slide and movie projector plus still photographs are used to cover local news stories.

station personality. They knew that it would be prohibitively expensive to apply for an FCC station license and then buy and install a TV transmitter and its necessary high antenna.

"Port TV already has pipe lines into several thousand homes. Why go on the air at all? Why not just pipe local programs into the existing system?" This was their general reasoning.

The idea was so simple that it created its own misgivings. But the three-man team went ahead. It formed a company called PJ-TV, Inc., made arrangements with Port TV as a fee-paying subscriber in reverse, rented a 19-by-20 foot garage on the grounds of a motel on the edge of town, and bought one solitary television camera, associated equipment to feed the video signals into the Port TV cables, and some bright lights. The signals were adjusted to correspond to Channel 6, which is not used by any Station in the vicinity.

Note carefully here that PJ-TV does not "broadcast" over the air at all, but sends its programs only through a closed wire circuit to viewers' homes. People using regular outdoor antennas with their sets cannot pick up PJ-TV, for the

simple reason there's nothing to pick up. However, Port TV subscribers can flip their channel selectors to 6 and see pictures fully as good as anything on the New-York channels.

With an investment of only about \$18,000 in a midget "station," the PJ-TV boys never dreamed of competing with NBC, CBS, ABC and the other giant television interests. Instead, they concentrated from the start on Port Jervis, and Port Jervis only. The first program went into the cable on October 18, 1957, and overnight PJ-TV became part of Port Jervis life.

PJ-TV provides strictly local news, with still pictures secured from local sources. Its live programs, all originating in the garage-studio, are folksy, friendly, personal and regional. Practically all the performers and staff double in brass at something else. A tape recorder provides sound effects, a small organ the only live music.

What the station lacks in production facilities it makes up in ingenuity and improvisation. For example, when an unexpected blizzard hit Port Jervis shortly after PJ-TV opened, commercial-manager Shevlin had a local auto-



Programs are informal and folksy. Nearly everyone on the staff performs several duties.



Corner of studio holds all the equipment used to operate the world's smallest TV station.

mobile dealer bring a new car up the driveway to the garage to show how well it performed in snow; the lone camera was merely wheeled to the door and caught the whole performance perfectly.

The staff is looking forward eagerly to the summer because also on the motel grounds, just within convenient camera range, is a swimming pool. The boys envision swimming and diving competitions, fashion shows, and of course a little interesting swim-suit cheesecake. What big-time television station has a swimming pool in its back yard?

When calling on active or prospective sponsors, Shevlin carries a Polaroid camera, does a lot of fast shooting with flash, and has approved program pictures in hand before he leaves.

The best indication of PJ-TV's success is its waiting list of sponsors. Plenty of camera-time is available, but the small staff just can't work up non-conflicting programs fast enough. Less than two months after inception, the client list includes three car agencies, two banks, and one each hotel, men's clothing store, appliance dealer, liquor shop and toy store. •

The staff consists of local residents. Here, one enters studio after a morning's hunting.



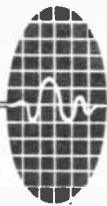

Special Project

the **EI** radio garage door opener

By E. J. Lorenz

**Press a button on your dash and your garage door opens
—rain or snow won't bother you. This unit is foolproof.**

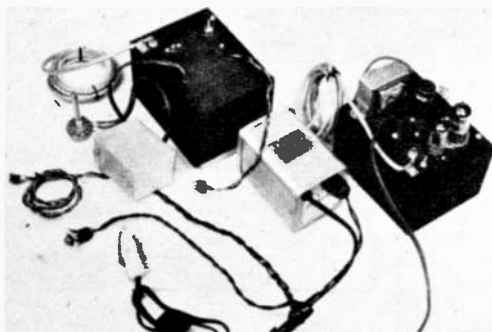

All of the units of the garage door opener are shown on the left, the receiver alone is shown below. The receiver is mounted anywhere in the garage where it can conveniently turn on the electric motor which actually lifts door. Note its simplicity.

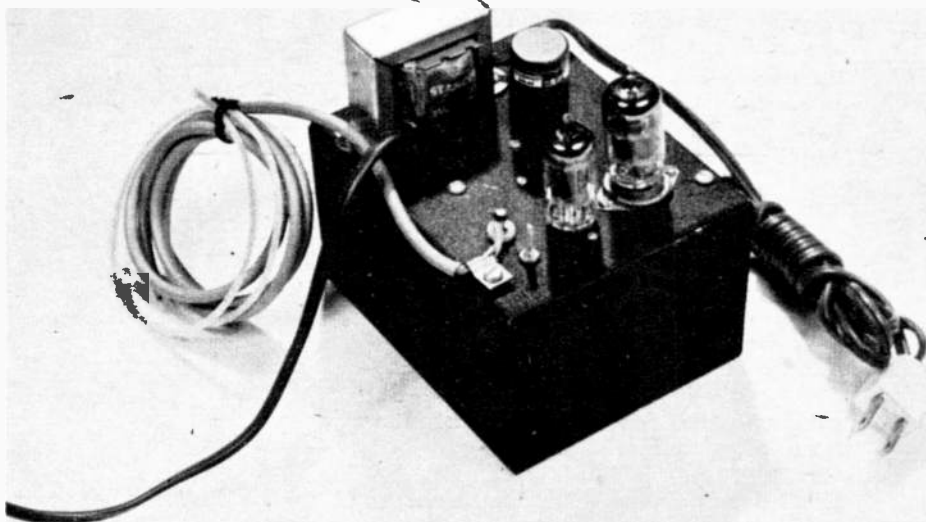

THIS radio-controlled garage door opener is the result of over one year's design and testing. It is as fool-proof and as simple to build as such a circuit can be.

Now let's see what happens when we wish to open our garage door, turn on the garage or house lights or operate some other mechanism from our car. A conveniently located push-button on the dash of the car, is held closed for about two seconds. This turns on the power supply which actuates the transmitter in the trunk, or some other out of the way spot in the car. The transmitter operates on the license-free frequency (be sure to fill out an FCC form #505, obtainable from local FCC offices or most hobby shops) of 27.255 mc. and is modulated by a 190 to 510 cycle tone. Total transmitter power requirement is about 2.9 watts. The signal is picked up by the receiver (detected by the 6C4 tube, with the audio tone being ampli-

fied by the pentode section of the 6U8 and then fed to the triode section of the 6U8), for operation of a reed coil. The resonant-reed relay (in the plate circuit of the 6U8 triode section) responds only to the desired audio frequency. Total receiver power consumption is about 3 watts.

Before getting into the construction of this unit, it should be pointed out that a multi-channel unit for remote operation of as many mechanisms as desired can be made with no change in the electronic circuit. Reed relays may be had with up to 8 reeds per relay. Single reed relays are obtainable from *CG Electronics*, as are 2 and 3 reed units. 5 and 8 reed units can be obtained from *W. S. Deans & Company*, Downey, California. Single reeds may also be obtained from some model hobby shops.

The range of this system has been checked well in excess of 300 feet, the exact range depending upon the trans-

Underchassis view of the receiver. If a larger chassis is used the parts may be spread out.

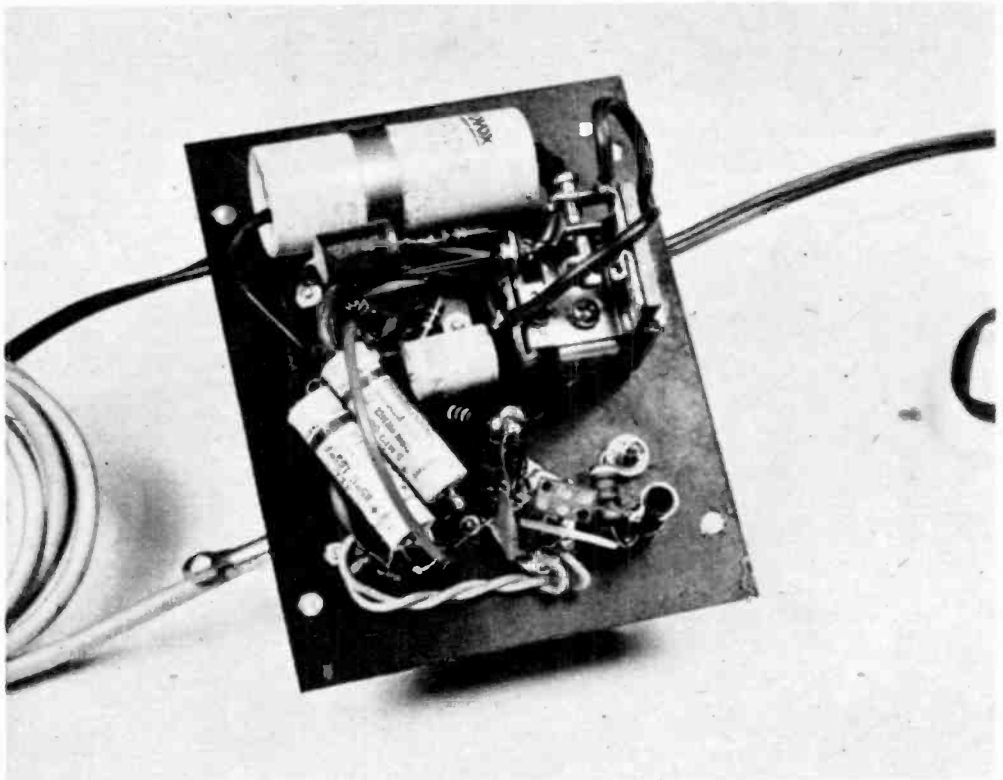

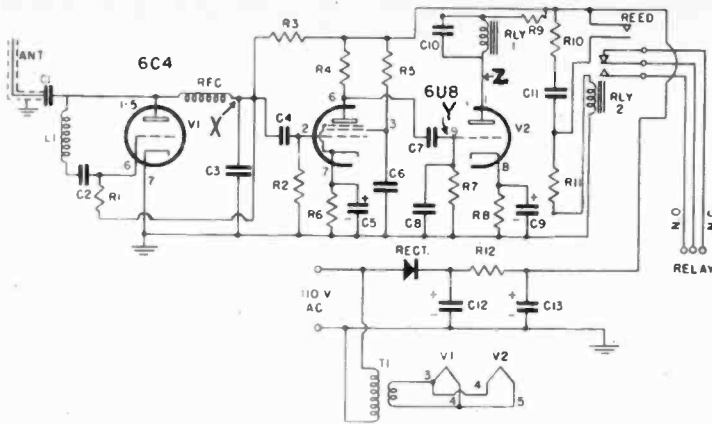

Above, schematic diagram of the receiver unit; the point-to-point wiring guide is shown below. For the best results use components exactly as specified on the parts list on the facing page.

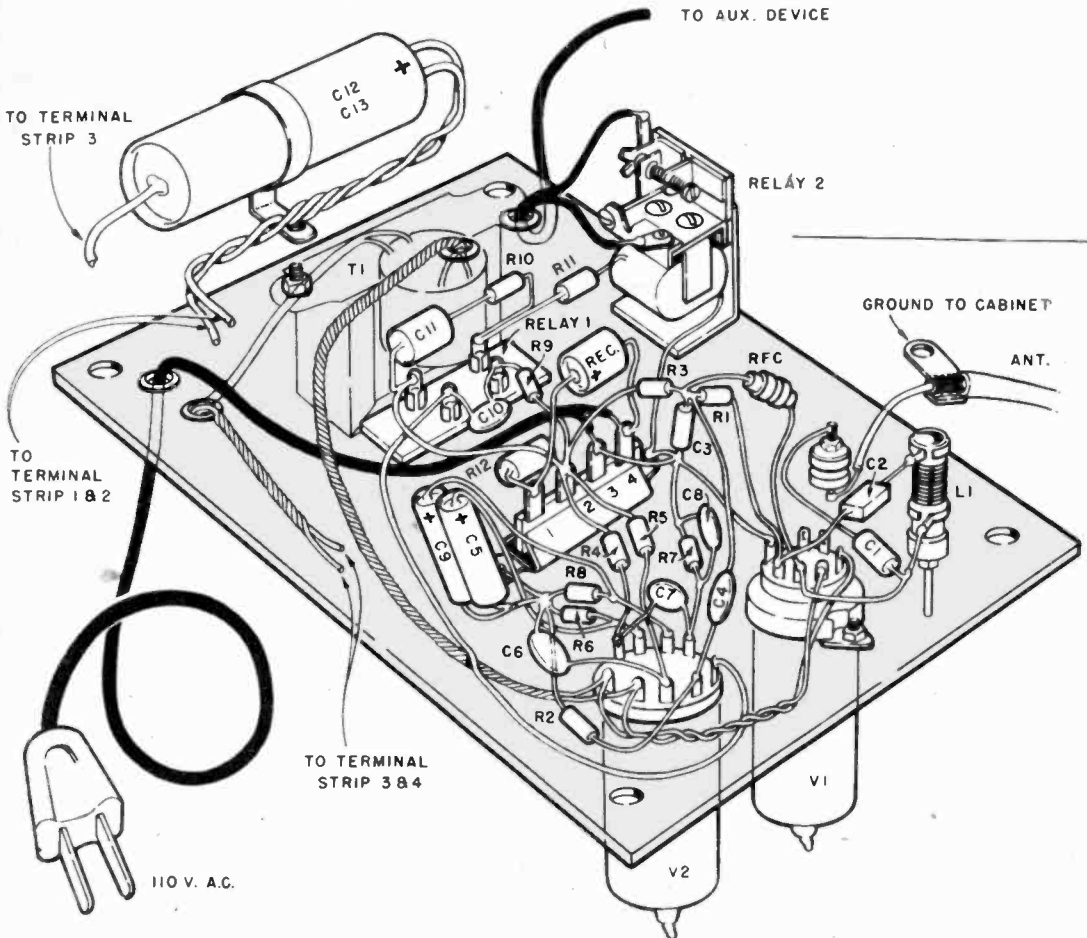

Capacitors.

C1—5 mmfd. TC (Erie NPOA-050 or silver mica)
C2—33 mmfd. TC (Erie NPOL-330 or silver mica)
C3, C8—.001 mfd.
C4, C6, C7, C10—.01 mfd. disc (Erie 811-01)
C5, C9—5 mfd., 50 v. electrolytic (Sprague TVA-1303)
C11—.25 mfd., 200 v. (Aerovox P82Z)
C12/13—20/20 mfd., 250 v. dual electrolytic (Aerovox PR5)

Resistors:

R1—2 megohm, 1/2 w.
R2—3 megohm, 1/2 w.
R3—47,000 ohm, 1/2 w.
R4—75,000 ohm, 1/2 w.
R5, R7—270,000 ohm, 1/2 w.
R6, R8—3000 ohm, 1/2 w.
R9—4800 ohm, 1/2 w.
R10—100 ohm, 1/2 w.
R11—39,000 ohm, 1/2 w.
R12—2700 ohm, 1 w.

Misc.:

RFC—50 microhenry choke (National R-33)
Rect.—selenium, 20 ma., 130 v.
L1—40 turns No. 32 wire closewound on 1/4" dia. CTC form LSM
T1—filament transformer, 6.3 v. sec. (Stancor P-6134)
RY1—reed relay 200 to

500 cps (see text) CG Electronics, Albuquerque, New Mexico
RY2—Sigma 4F relay (Sigma 11F or equiv. may be used if switching load is light)
V1—6C4 tube
V2—6U8 tube
Cabinet 4"x5"x3" (Bud # CU-7288)
7-pin miniature tube socket
9-pin miniature tube socket
4 position terminal strip (Cinch # 2004)
Antenna feed-through insulator (National XS-9)
6' microphone/hi-fi cable (Alpha # 1704)
Small piece of aluminum for relay mounting bracket
3 rubber grommets (5/16" mounting hole)
Lamp cord of suitable length
Short lengths of insulated hookup wire and spaghetti
Small machine screws for mounting parts (#4—5/16" or 3/8" long)
Small cable clamp and several small soldering lugs

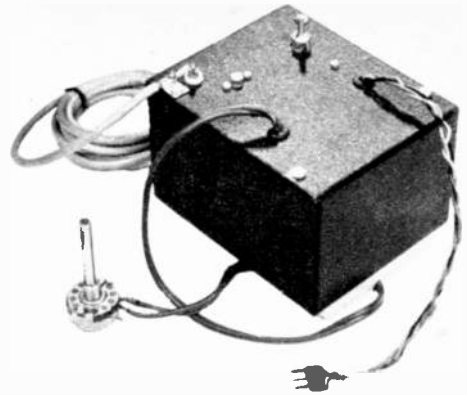

The transmitter is completely enclosed in this chassis. Potentiometer varies tone frequency.

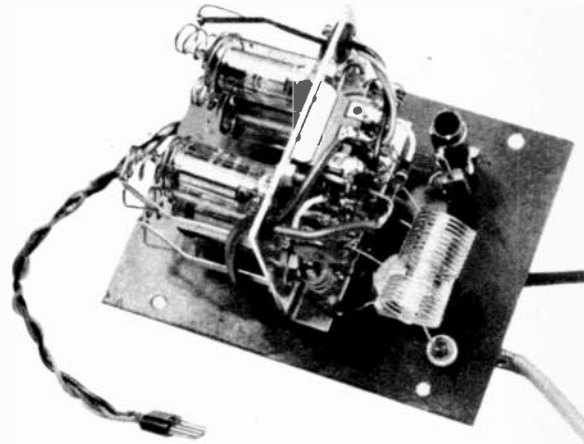

All of the transmitter parts are affixed to underside of top plate. Note the tube clamps.

mitter antenna installation, terrain and location of the receiver antenna. Construction of the receiver and transmitter is straight forward and should present no difficulties if the schematics, wiring guides and photographs are followed.

Receiver Construction

The receiver shown is built into a 3" x 4" x 5" case, as is the transmitter, but may be built into a larger case or chassis if additional channels are desired.

Lay out the receiver chassis panel and drill or punch mounting holes as indicated. Note that the receiver is built entirely on one panel, the case serving only as a support and dirt shield. Mount tube sockets, making sure the pin numbers are properly located as per the sketch. Mount transformer, rectifier, reed relay socket and terminal mounting strips as shown. Place a soldering lug and lockwasher under each nut



Glue a piece of foam rubber or plastic to bottom of transmitter to ease vibration.

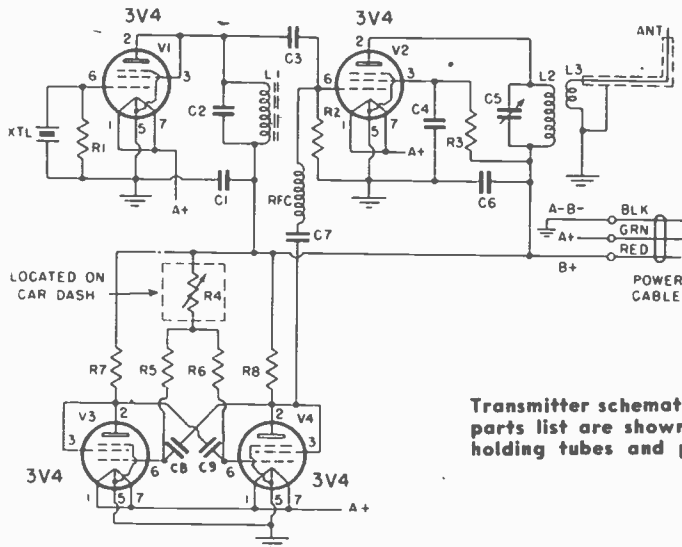

Transmitter schematic diagram, wiring guide and parts list are shown here. Note how subchassis holding tubes and parts is fixed to top plate.

Capacitors:

- C1, C4, C6—.005 mfd., disc
- C2—20 mmfd. TC silver mica
- C3—48 mmfd.
- C5—35 mmfd. variable (Hammarlund MAPC-35)
- C7—.01 mfd. disc
- C8—.03 mfd., 200 v. (Aerovox F8Z)
- C9—.02 mfd., 200 v. (Aerovox P8Z)

Misc.:

- XTL—13.627 mc. crystal (Available from Ace Radio Control, Higginsville, Mo., or Polk's Modelcraft Hobbies, 314 Fifth Av., N.Y.C.)
- RFC—750 microhenry choke (National R-33)
- L1—22 turns No. 26 enameled copper wire on $\frac{3}{8}$ " slug form (CTC L53)
- L2—10 turns B&W No. 3007 Miniductor
- L3—5 turns B&W No. 3007 Miniductor
- Cabinet: 4"x5"x3"
- 4—7-pin miniature tube sockets, flange mounting
- 4 tube retainers
- Feed-through insulator (National XS-9)
- 3 position terminal strip
- 6' microphone/hi-fi cable
- 3' No. 26 enameled copper wire
- Short lengths of insulated hookup wire and spaghetti
- No. 16 stranded plastic coated wire for hookup between transmitter and power supply/battery.
- 4 rubber grommets to fit $\frac{5}{16}$ " mounting hole
- 2' length lamp cord
- Small machine screws for mounting parts (#4— $\frac{5}{16}$ " or $\frac{3}{8}$ " long)
- Small cable clamp and several small soldering lugs
- Piece $\frac{3}{4}$ "-1" thick foam plastic 3"x5"
- Small piece .040" or $\frac{1}{16}$ " aluminum, brass or steel for chassis

Resistors:

- R1—75,000 ohm, $\frac{1}{2}$ w.
- R2—2 megohm, $\frac{1}{2}$ w.
- R3—5600 ohm, $\frac{1}{2}$ w.
- R4—250,000 ohm potentiometer, linear taper (Ohmite AB)
- R5, R6—200,000 ohm, $\frac{1}{2}$ w.
- R7, R8—18,000 ohm, $\frac{1}{2}$ w.

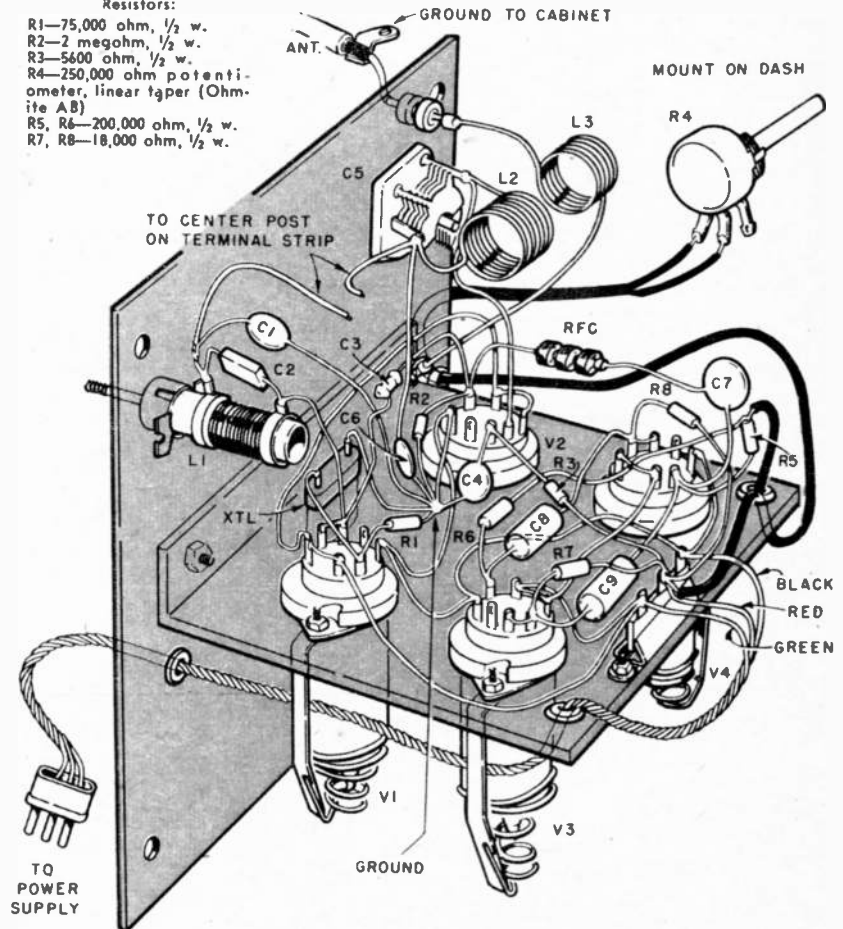

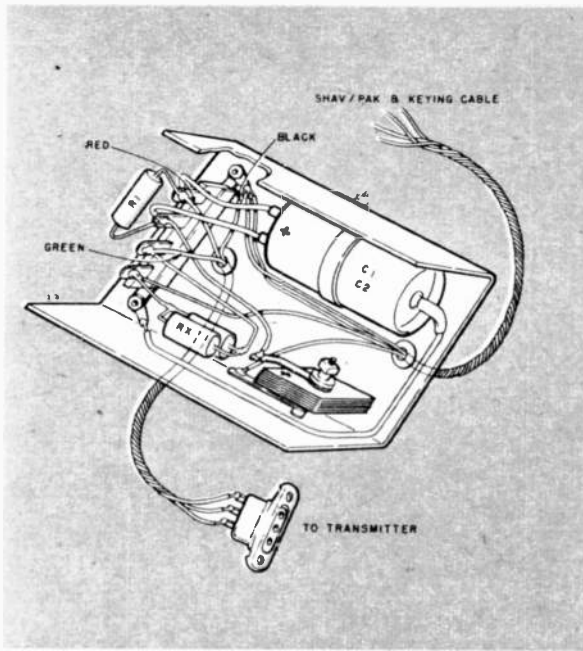
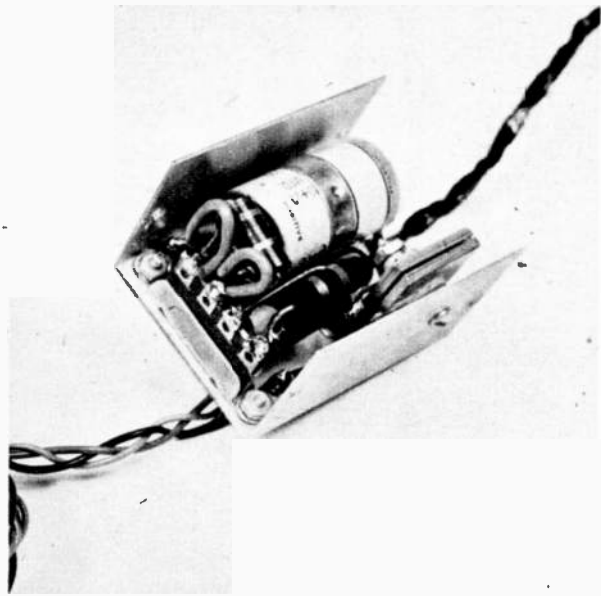

The small transmitter power supply unit is shown here. This may be fitted behind dash.

Wiring guide for the power supply; the parts list and schematic diagram are shown below.

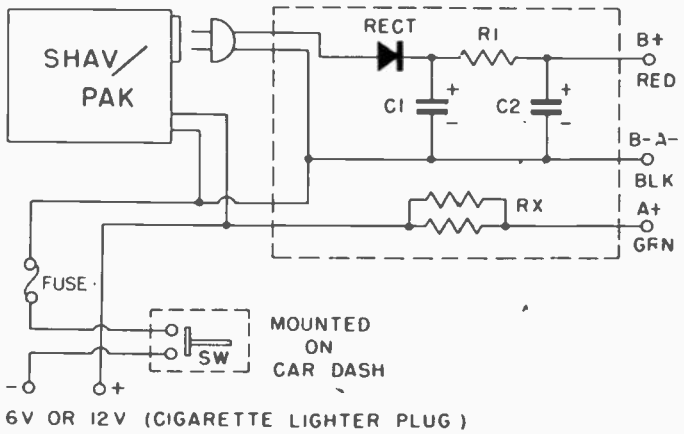

- C1/C2—20/20 mfd., 150 v. electrolytic capacitor
- R1—2700 ohm, 2 w. resistor
- RX—for 12 v. operation: 2—56 ohm resistors, 2 w., 5% in parallel
- 6 v. operation: 2—22 ohm resistors, 1 w. 5% in parallel
- Rect.—selenium rectifier, 65 ma., 130 v.
- Shav-Pak made by ATR, 15 w. or equiv., specify for 6 or 12 v. operation
- SW—momentary contact, normally open pushbutton switch

- Box: Bud # 3000 Minibox
- 1—4 position terminal strip (Cinch # 2004)
- 2—rubber grommets for 5/16" mounting hole
- 1—#6-32 screw 1" long w/nut and lockwasher
- 3—4-40 screws 5/16" long with nuts and lockwashers
- Necessary No. 16 stranded wire for hookup
- 2 soldering lugs

holding the terminal strips in place. Wire in the filament circuit for both tubes and mount the tuning coil, L1. Do not substitute values or type of parts unless you are sure they are the exact equivalent. Since this receiver will remain on at all times and may be exposed to changes in temperature, high quality parts with an adequate safety rating are specified.

[continued on page 103]

Build A Stereo Speaker

By Ernest Wayland

Stereo Hi-Fi need not be costly —this complete second speaker system costs you less than \$30.

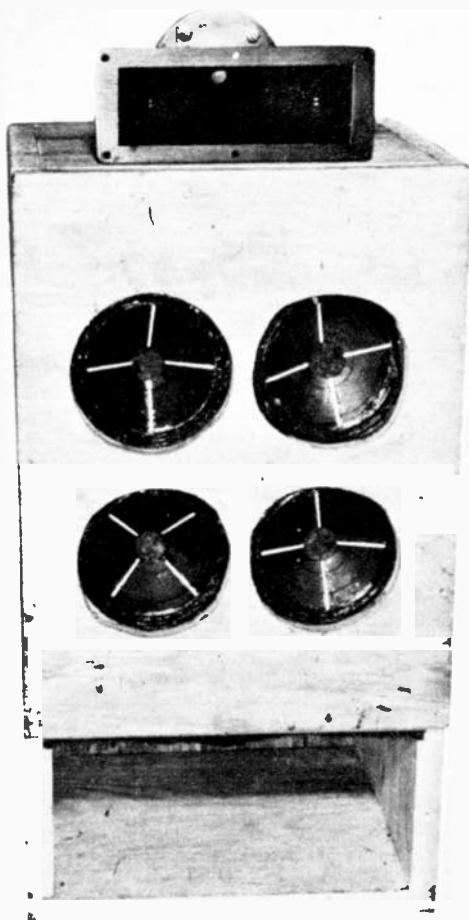

Four inexpensive replacement type 5" speakers make up the bass unit of this system. The speakers are modified to improve their bass response as described in the text. The photo above shows slits being cut along the rim of the speaker. The next step is to stiffen the speaker cone by adding toothpicks to the cone itself. All tools needed to modify the speakers are shown in photo.

The complete speaker system is shown at the left. This unit may be inserted into a piece of furniture already in the room or it may be covered with grill cloth and Contact paper. The horn tweeter may be positioned in opening at bottom.

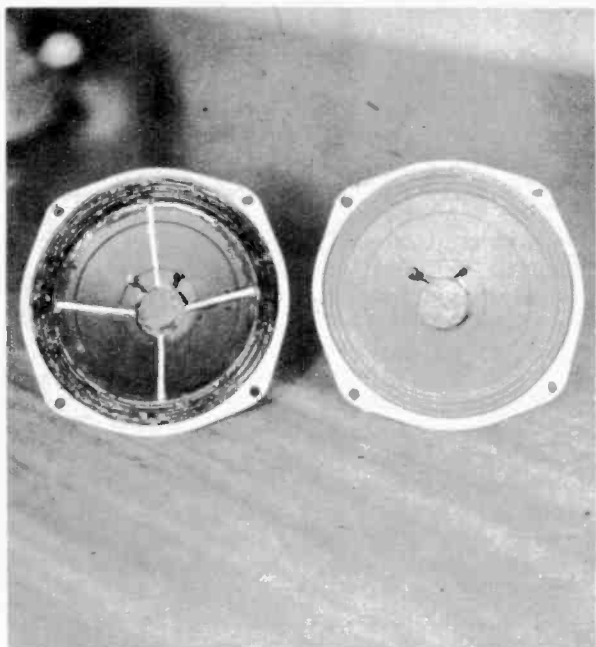

Inexpensive speaker on the right has its rim loosened and its cone stiffened as on left to improve its frequency response for system.

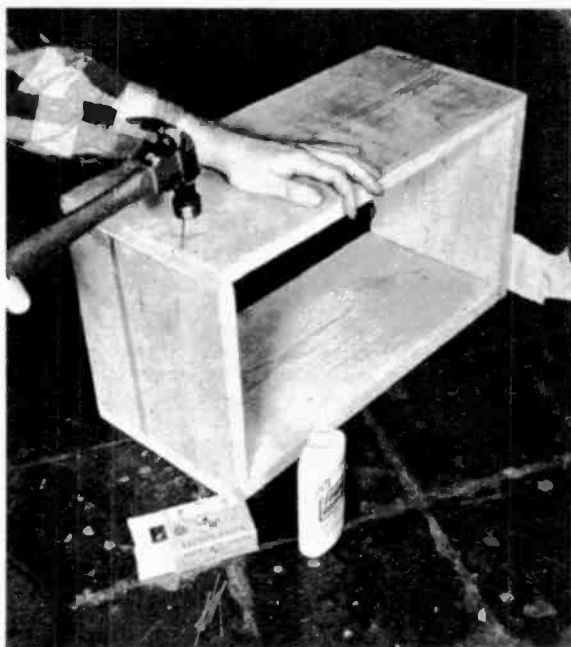

The sides of the speaker enclosure should be glued first and then nailed together to furnish a stiff, rattle-proof speaker box.

IF you've been swayed by recent pronouncements that stereophonic hi-fi is here and you'd like to add it to your present hi-fi system, it needn't cost too much if you build the second speaker system you'll need. The opinion is widely held by many who know that the second channel speaker need not equal in quality the first, if it balances the first and does not introduce distortion.

The little speaker system described here can be built for a minimum outlay of cash. Yet, it will give audio reproduction far beyond what you would expect. Basically, it consists of a 4-speaker woofer and a horn tweeter.

The Bass End

The problems encountered in the selection or construction of a stereo bass reproducer are not overly difficult. The lower audio frequencies tend to spread out and hence their point source is not apparent to the ear. The low rumble of the kettle drum, if well reproduced by the master speaker, will not suffer much in stereo if the smaller second speaker does not do it full justice. Real econo-

mies therefore can be realized at the bass end of your second channel without excessive sacrifice of quality.

It's been found that four inexpensive 5" speakers, if properly modified and assembled in a small enclosure, can provide surprisingly good sound considering their cost and size. The problem is to lower the resonant frequency of the speakers and by doing so *not* introduce distortion.

The tools needed to adapt the 5" speakers to function efficiently as woofers are a razor blade, a bottle of glue, a jar of Vaseline, a can of light machine oil, sixteen toothpicks, and a can of acrylic spray. The toothpicks should be the flat type. Follow this procedure in the order given with reference to the chemical treatment of the cone as a step out of turn may ruin the speaker.

First, considering the speaker as a clock face, make twelve cuts with a sharp razor blade in the edge suspension of the speaker; each cut should be on an hour position. These cuts should run from the innermost suspension corru-

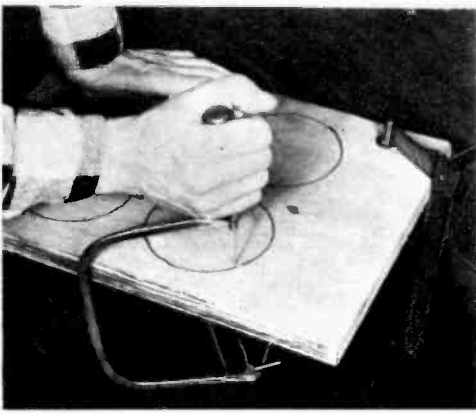

The front of the enclosure should be made from $\frac{3}{4}$ " plywood so that it will not split when the four speaker holes are cut into it.



Tack Fibreglas insulation, old towels, etc., to the inside of the back and sides of the enclosure to absorb undesirable sound waves.

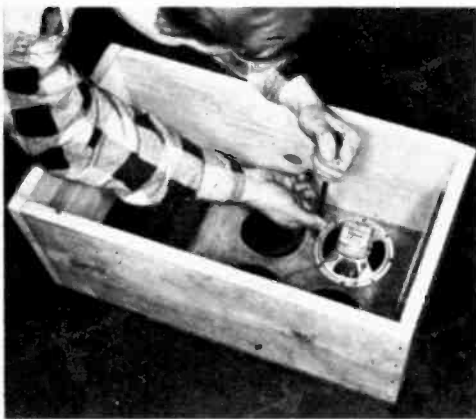

Screw the speakers to the inside of the front panel. When all are installed, they are wired in series as explained in text.

gation (C) to the outer rim (D).

Now break each toothpick to a length which will extend from the edge of the voice coil of the speaker (A) to the point where the first ripple of the rim suspension is encountered (C). Cement four toothpicks into place with the glue as per the photograph. (The glue used should be of the type which does not contract on drying. A Borden's product, "Elmer's Glue-All," proved to be ideal.) Now form a complete circle of glue along the inner edge (C) of the same rim ripple. The purpose of the glue is to prevent the edge slits from extending themselves and to act as a barrier to the spread of the oil, which is next applied.

A light machine oil should be spread lightly on the rim suspension between the glue barrier at (C) and the outer edge of the speaker (B). Immediately after the oil, a moderately heavy coating of Vaseline should be applied over the same area, taking care that neither substance is allowed to leak by the glue barrier. The acrylic spray is now brought into action and two coats are applied to the front and rear of the speaker cone. It doesn't matter if the frame of the speaker interferes with a thorough rear spraying. Now with the aid of a pipe cleaner or swab, remove the excess Vaseline, leaving a thin layer, and the modification is complete. Each of the four speakers should be treated similarly.

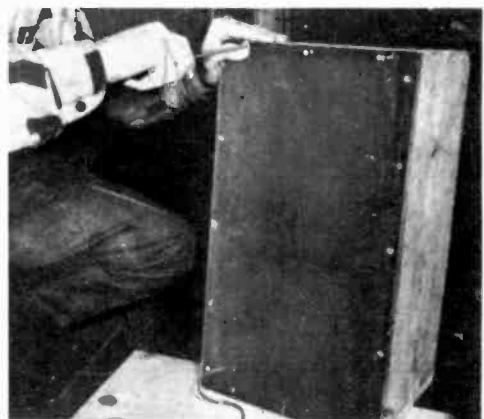

The back is screwed tightly to the sides of the box to prevent rattles and sound leaks. First drill pilot holes for screws. Note the cable.

Building the Cabinet

The construction of the cabinet is simplicity itself. Since butt joints are used throughout, no difficult mitering or other fancy woodworking is required. A 6' pine board of 10" width and 1" finished thickness will provide the top, bottom, and side pieces. The front and back sections of the cabinet are made of $\frac{1}{2}$ " or $\frac{3}{4}$ " plywood. Note that the cabinet dimensions are only accurate for 5" replacement type speakers modified as suggested. Drill a $\frac{3}{16}$ " hole in the back panel for the leads to the amplifier, and a series of $\frac{3}{16}$ " pilot holes $\frac{3}{8}$ " deep along the back panel edge for screws. The panel is mounted with 2" No. 8 flathead screws. Fiberglass insulation, rug backing, old towels or any other handy coarse material can be used for cabinet damping. Tack it to the back panel and walls of the cabinet. If the bass sound when the speaker is tried out seems "wooden" or "hollow," add an extra layer or two.

After the four modified 5" speakers are installed in the cabinet, they'll have to be connected *in series, in phase*. Simply connect the right hand terminal of each speaker to the left hand terminal of its neighbor, leaving the left hand terminal of the first speaker and right hand terminal of the last speaker open. Connect a 2" length of wire to each of

[Continued on page 100]



Wind the coil for the crossover network fairly tight. Make certain that you fill up evenly the coil form with 250 turns of wire.

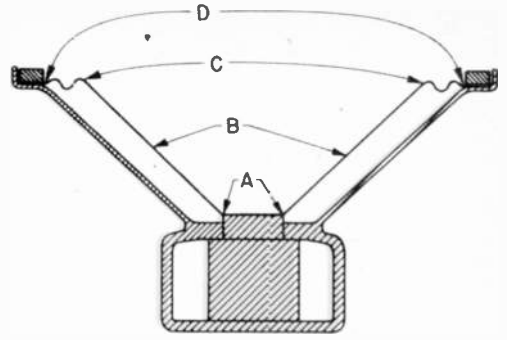

Cross section of a typical replacement type speaker. The letters refer to parts modified.

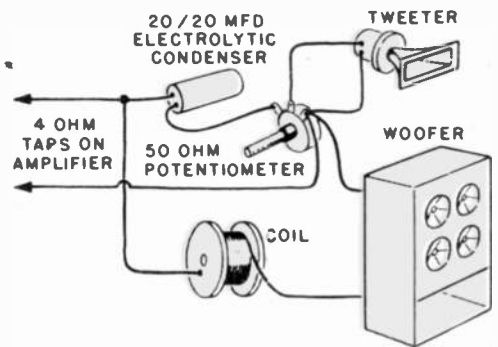

Wiring diagram showing how the tweeter and bass unit (woofer) are connected together through the homemade crossover network.

SPEAKER ENCLOSURE PARTS

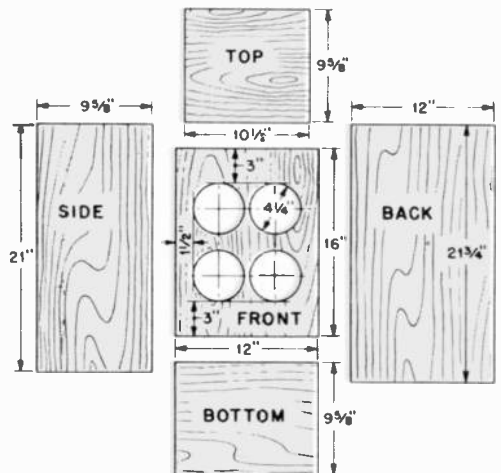

Dimensions of the various parts of the enclosure. Don't change these sizes since they have been carefully determined for 5" speakers.

Code Practice Oscillator

By Paul Hertzberg

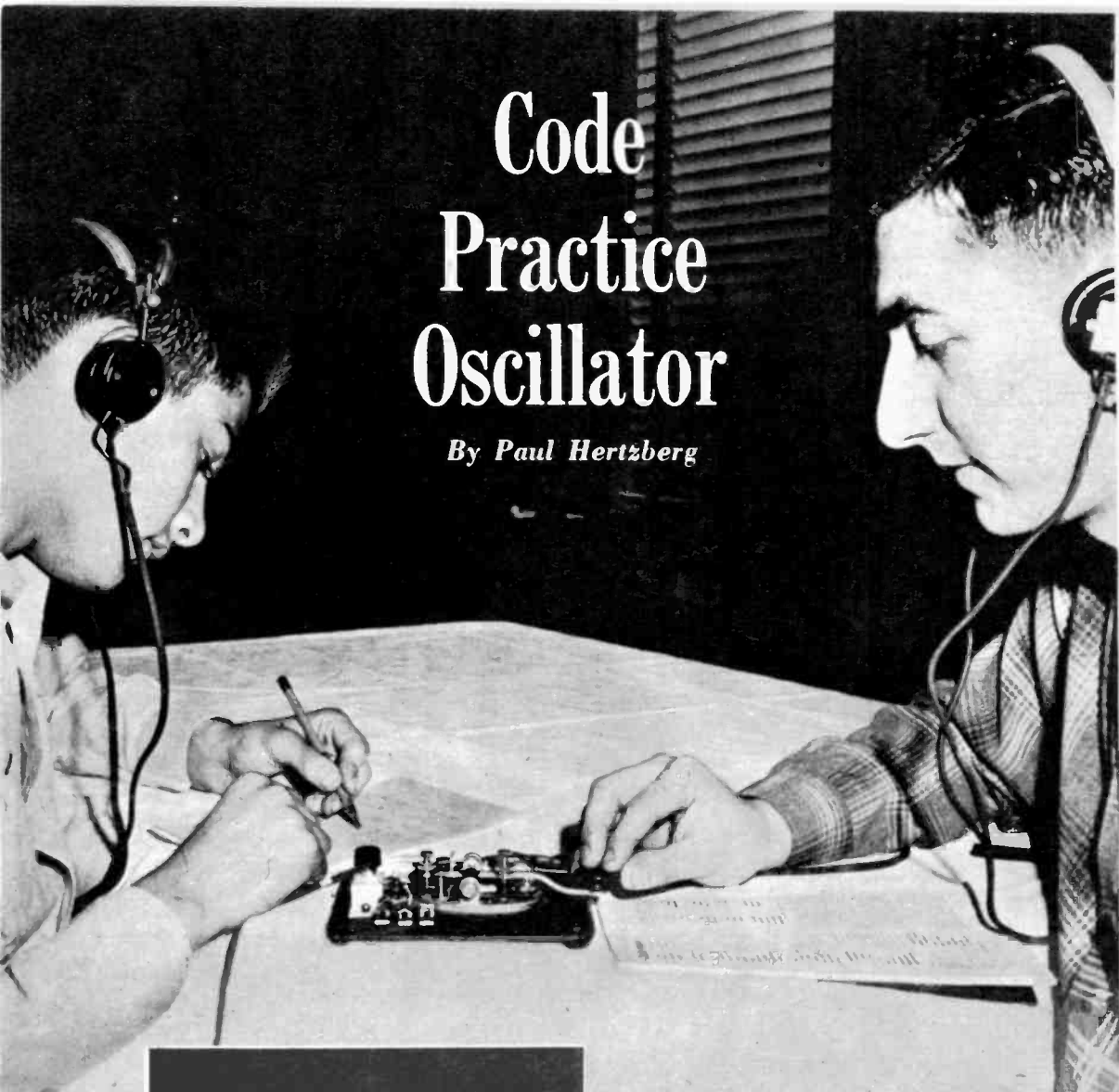

—2N007 transistor
2—01 mica paper capacitors
1—50k potentiometer
1—2.7k $\frac{1}{2}$ w resistor
1—22k $\frac{1}{2}$ w resistor
1—1.8k $\frac{1}{2}$ w resistor
5—faststock clips
5— $\frac{1}{8}$ " #32 Phillips machine screws
5—32 nuts
2— $\frac{1}{32}$ " volt penlight cells
1—two-cell holder
1—small knob $\frac{1}{4}$ " hole
1—telegraph key
1—pair more pairs of 2000 Ohm ear phones
Strip of metal $3\frac{1}{2}$ " \times " $\frac{3}{4}$ " for mounting on
Masonite pegboard $5\frac{1}{4}$ " \times " $6\frac{1}{2}$ "
2 feet of insulated hookup wire

Two potential amateur radio operators, are shown practicing the Morse code by means of the code practice oscillator described in this article. The complete device is only slightly larger than the telegraph key itself. The bottom view of the oscillator, on the right, shows how simple the wiring is. The schematic diagram is on the far right.

Be a HAM! But first, learn the code with this simple device.

PRACTICE makes perfect. Constant practice of the code is the way to pass your ham license requirements.

You can use a simple buzzer and key combination but very often the sound is annoying to those not interested in your practice. Also, the buzzer does not sound like CW (continuous wave, radio telegraphy) as you would hear it on a receiver. The solution is to build a private listening device.

A very good, variable tone, code practice oscillator can be made with a few easily obtained parts. It uses a 2N107 transistor in a feedback oscillator circuit. Two paper capacitors and four resistors comprise the remainder of the circuit.

The entire code practice set is just a little larger than the telegraph key itself. This has been designed specifically for space-conscious apartment dwellers who may want to tuck this item out of the way when not in use. After the ham ticket has been won, the key itself can be removed and used separately with the complete transmitter; the parts may be used for some other devices.

Arrange the parts as shown in the photos. The potentiometer for the tone

A --	S ...
B	T -
C	U ...
L ...	V
E .	W ...
F	X
G ...	Y
H	Z
I ..	1
J	2
K --	3
L	4
M --	5
N ..	6
O ---	7
P	8
Q	9
R ...	0

Period

Comma

Question mark

Error

Double dash

End of message

Invitation to transmit ---

End of work

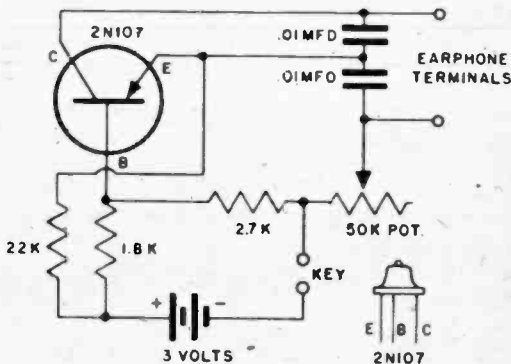
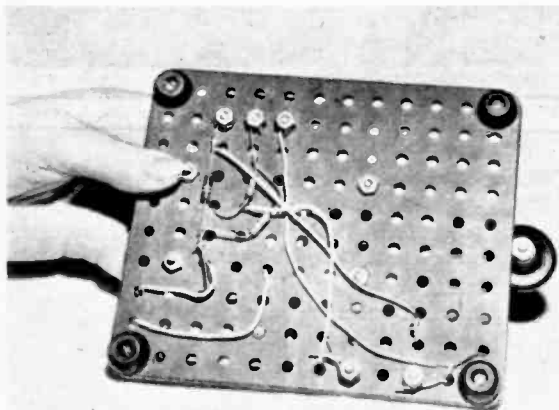

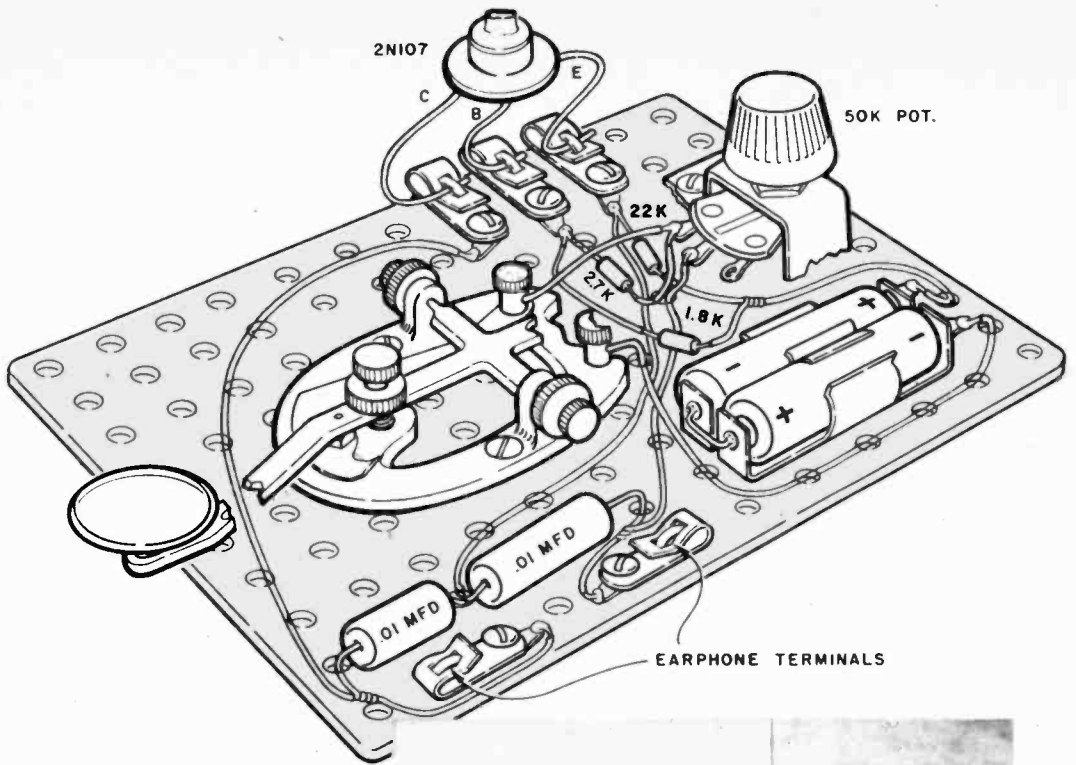

The pictorial diagram above shows how to wire the oscillator and where to place the various parts. Note the transistor near the top edge of the device in the top view, right.

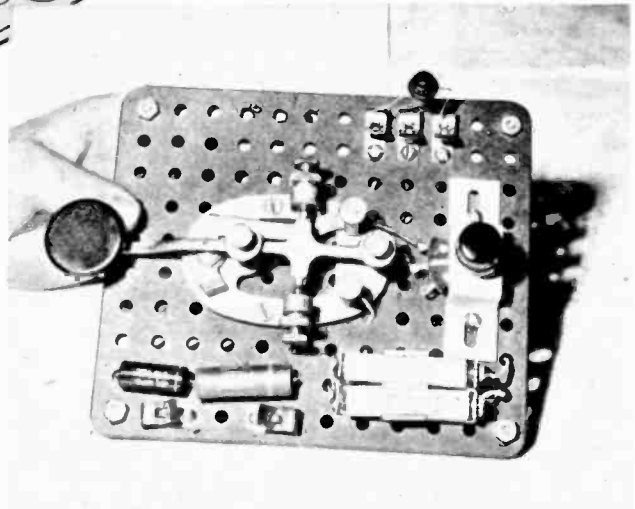

control, key, batteries, transistor and two capacitors are mounted on the top of the masonite board. The resistors and other wiring are on the underside. Note that the transistor is not soldered into the circuit. It is held by three fahnestock clips and can be easily removed and used for other experiments. A small bracket to support the pot can be made from a scrap piece of tin or brass. Solder all connections except the transistor leads.

Assembly time should be about one hour.

Attach a pair of the earphones to the two earphone clips and adjust the potentiometer for the most pleasant tone to your ears as you close the key.

It is advisable to practice the code with another person. Use two sets of earphones connected in parallel to the phone clips. The more you practice the easier it will be to pass your code examination. •

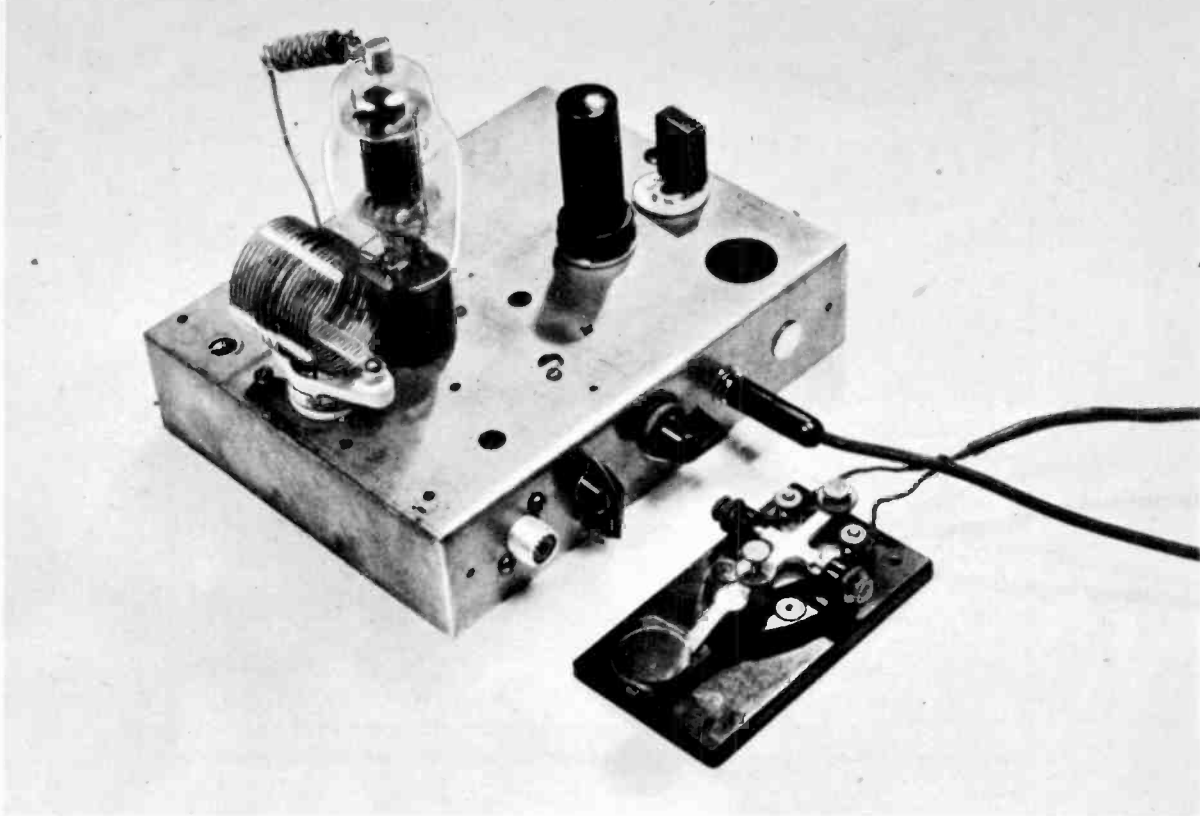

The complete transmitter contains two tubes and requires only a simple power supply.

A First Transmitter for the Novice

By Joseph Warren

This 40-meter rig is easy to build, foolproof, and inexpensive. It is also flexible so that advance features may be added later.

A RADIO transmitter designed for the novice's first attempt should be simple, easy to build, foolproof and inexpensive, involving no complicated circuitry or tuning procedures. It must also be adaptable, enabling the builder to add to its serviceability later on as he becomes more familiar with the amateur operation in general and wants to expand his facilities.

Many novice rigs are designed to provide advanced features from the start, such as bandswitching and crystal

switching which are desirable in themselves for the more advanced novice. However, for the beginner who may have very little electronic background and a limited budget, such features may prove cumbersome.

The transmitter described here is designed to avoid complications and to incorporate the desirable features described above. So, if you are a beginner, the fellow who has perhaps never before attempted to build a radio transmitter and has to start from scratch, this

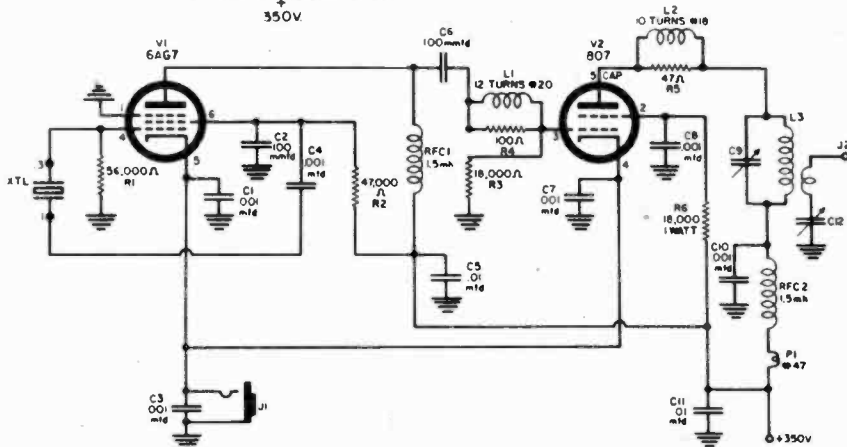
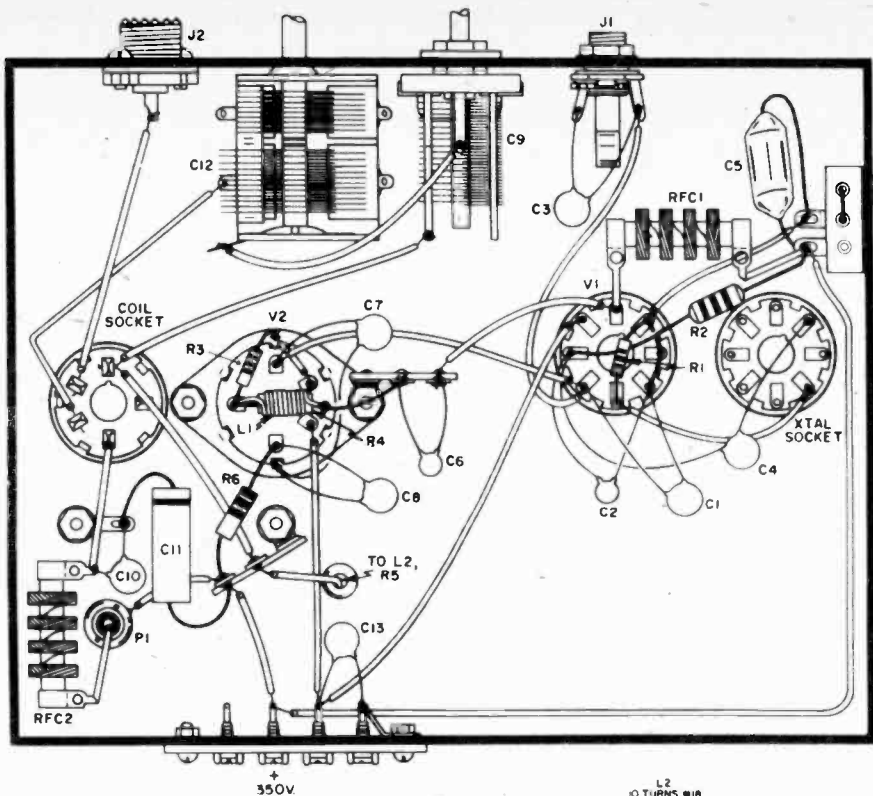

Wiring guide and schematic diagram for transmitter are shown above; parts list is below.

Capacitors:

- C1, C3, C4, C7, C8, C10—.001 mfd. ceramic disc
- C2, C6—100 mmfd. ceramic disc
- C5, C11—.01 mfd. plastic
- C9—75 mmfd. variable air padder
- C12—360 mmfd. broadcast type

Resistors:

- R1—56,000 ohms, 1/2 w.
- R2—47,000 ohms, 1/2 w.
- R3—18,000 ohms, 1/2 w.
- R4—100 ohms, 1/2 w., see L1
- R5—47 ohms, 1 w., see L2
- R6—18,000 ohms, 1 w.

Misc.:

- L1—12 turns No. 20 enamelled wire wound on R4, in parallel with it.

- L2—10 turns No. 18 enamelled wire wound on R5, in parallel with it.

- L3—B&W # 3111 40 JCL coil for 40 meters or B&W # 3112 80JCL for 80 meters

- RFC1, RFC2—1.5 millihenry r.f. chokes

- V1—6AG7 tube

- V2—807 tube

- XTL—40 or 80 meter novice band crystal

- PI—# 47 pilot lamp

- J1—open circuit phone jack

- J2—coaxial chassis mount connector

- 2 sockets, 5 contact ceramic

- 2 knobs

- 1 terminal strip

- 2 octal sockets, ceramic

- asst. terminal strips

Power from any handy source (even a table radio) is fed to transmitter by clip leads.

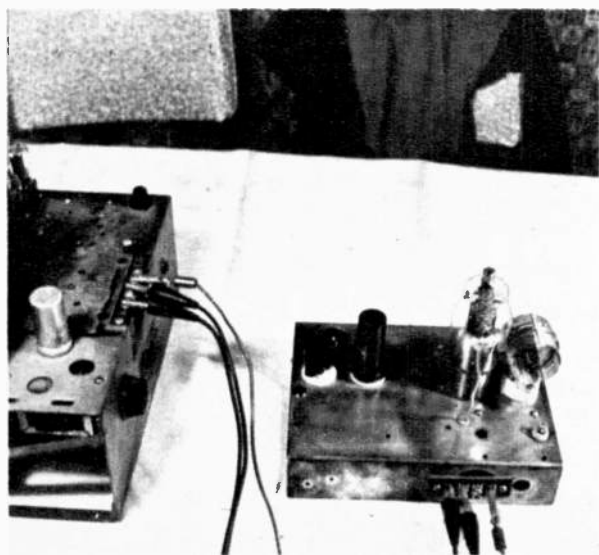

The rig is shown here being used with a key. An audio modulator may be added for voice.



rig is a natural for you. The more advanced novice, too, might well take note for this rig is capable of 60 watts input, it can be easily modulated, it can be used with a VFO and it can be easily converted for bandswitching. It may also be kept in readiness as a standby auxiliary rig in case of failure of your present rig, or it can be used as a driver or exciter, for a high power final amplifier.

The forty meter band was chosen as the preferred novice band after consideration of the following factors. First of all, medium to long range DX is available most all year round on this band and high power is not a prerequisite. Next, TVI—the bugbear of many an oldtimer, is not as difficult to eliminate as it is on the 15 meter band. Antenna space requirements are the third consideration, a forty meter wire should be just about half as long as an 80 meter wire and can easily fit in the average-backyard. The output circuit is designed to feed a center-fed 40 meter dipole antenna via a length of 50 or 72 ohm transmission line. The antenna should be about 67 feet long overall.

If 80 meter operation is desired it is only necessary to change the output coil (see parts list). Be sure you are

using an 80 meter crystal and, of course, an 80 meter antenna—137 feet overall, fed at the center. For forty meter operation either an 80 or 40 meter crystal may be used. The 6AG7 provides adequate drive for operation of the 807 final on either band.

The 807 was chosen for the final amplifier tube because it is easily obtainable, inexpensive and will operate satisfactorily over a wide range of plate voltages. For economy's sake, power can be supplied from an old receiver or a utility supply and any voltage ranging from 250 to 600 DC will suffice. It is advisable to use a DC milliammeter in series with the power supply when tuning the rig, especially if over 400 volts DC is used for the plate supply. If desired, the meter could be mounted on the chassis of either the transmitter or the power supply. If the meter is mounted on the transmitter it should be connected in place of the resonance indicator *PK*. The filaments require 6.3 volts, readily available from almost any power supply chassis.

The 6AG7-crystal oscillator is designed to provide stable operation without any necessity for adjustment. With any crystal of average activity and stability this circuit will prove to be

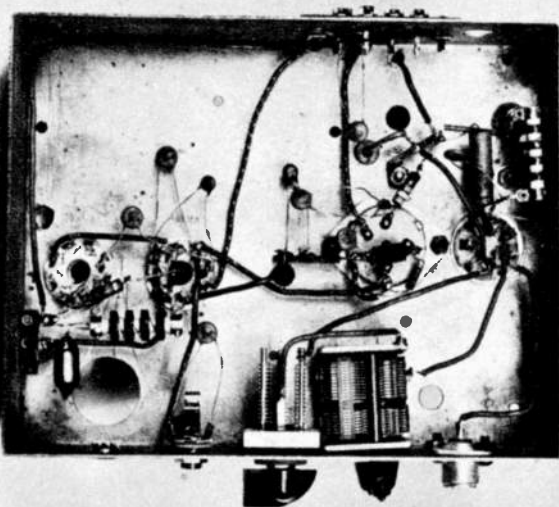

Underchassis view of transmitter. To help the reader follow the wiring, the components' long leads were left on. These are shortened in wiring.

thoroughly reliable. An octal socket is used as the crystal socket for three reasons. First, the operating crystal can be mounted in the operating position, holes 1 & 3. Second, a spare crystal can be mounted and stored in holes 5 & 7, ready for instant use when the occasion arises and you want to pick a different operating frequency. The third purpose of the octal socket is to provide a convenient means of connecting a VFO later on (holes 3 & 8), after the General class license has been won.

The output circuit is the standard link-coupled type and is straight forward in operation. Band changing is accomplished as explained before. Note that the power supply must be turned off before changing the coil in order to avoid shock. Both the 807 plate cap and the 807 coil carry the DC plate voltage on them whether the key is closed or open.

The telegraph key, through its jack, keys both the oscillator and final amplifier cathodes and no difficulty should be encountered with key clicks or chirps if the schematic diagram is followed and any layout similar to that shown in the accompanying photographs is used. The entire rig is quite adequately bypassed and it is recommended that all the by-

pass condensers shown in the schematic be used. Another very important component, sometimes sacrificed, is the parasitic suppressor *R4-L1* in the 807 grid circuit. *This item is a must.* Remember, don't cut costs. All the parts are necessary, and each has its own definite function. One more thing—all power supply leads should be bypassed at the point where they leave the transmitter chassis.

To operate the transmitter, first connect the power supply leads, B+ for the plates, 6 volts for the filaments, and ground. Place a crystal in the crystal socket (holes 1 & 3) and insert the key plug in the key jack. A DC milliammeter range 0-200 ma., should be placed in series with the B+ lead from the power supply, but if none is available use the resonance indicator lamp *P1* to indicate resonance. Turn on the power supply and wait about a minute for the filaments to warm up. After this interval, depress the code key and immediately adjust *C9* for minimum deflection of the meter, or a decrease in brightness of *P1*. Now connect a length of transmission line to the coaxial connector, and connect a 40 watt light bulb to the other end of the coaxial line. Once again de-
[Continued on page 98]

Small Rectifier— Big Current

By Robert Hertzberg

One of the most important developments of recent times is this silicon rectifier which operates at 300 degree temperatures

HIGH current-handling capacity, very small size, good heat resistance and sealed construction are features of the silicon rectifier that make it one of the important electronic developments of recent times. Used in very simple circuits, a rectifier equivalent in size to a $\frac{5}{16}$ - $1\frac{1}{4}$ -inch bolt can handle up to 20 amperes at 6 volts or 10 amperes at 12 volts, *continuously*; or 50% more intermittently. Other types of dry-disc rectifiers capable of doing the same job are actually scores of times larger and much less efficient.

Any device carrying 20 amperes is bound to get warm. The silicon diode does too, but it is designed to operate safely at temperatures slightly in excess of 300 degrees Fahrenheit. In practice this temperature is never encountered, unless the equipment is burning up for some other reason!

The sealed construction makes the silicon rectifier especially suitable for marine devices, which are normally exposed to considerable moisture. Salt water spray is particularly wicked, as

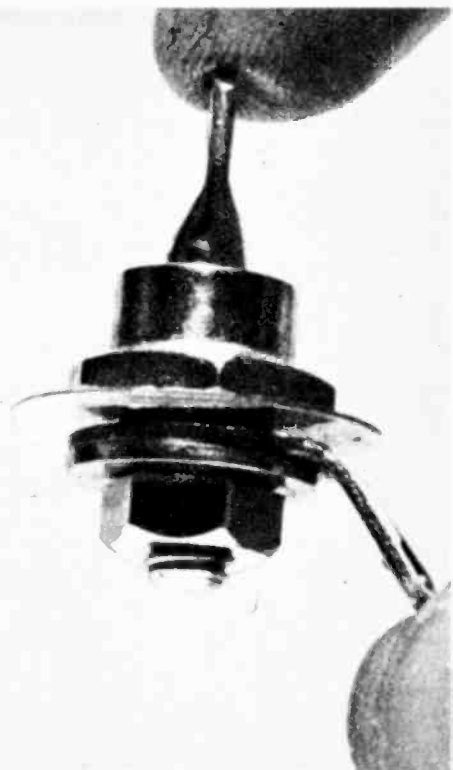

The bolt-like device shown above is the new type silicon rectifier, able to handle 20 amperes. The illustration is larger than full size. This rectifier mounts in tight spots.

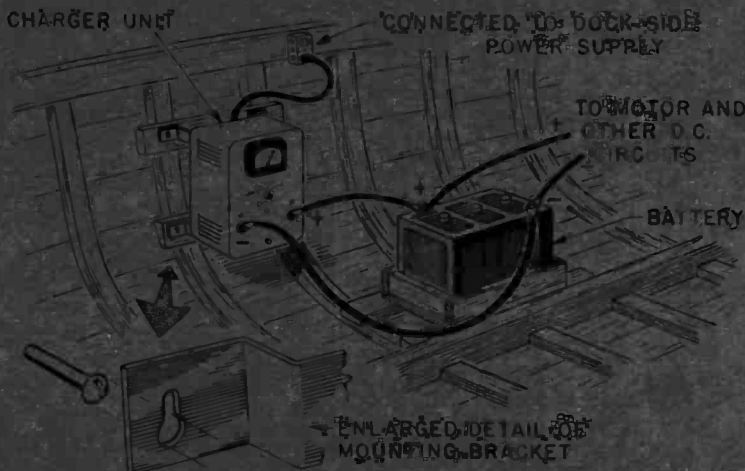

any tidewater sailor knows only too well.

The Heath people have put this rectifier to work in a new "Marine Converter and Battery Charger" kit, which is of interest to any boat or car owner who is concerned with keeping storage batteries in top condition. This is a very rugged, heavy-duty appliance. It consists of a step-down power transformer having moisture- and fungus-proof insulation, a 1N248A silicon rectifier, a control switch, and a 0-25 ampere meter to show the charging rate.

The transformer has two 6-volt secondaries, which are connected in parallel for 6-volt service and in series for 12-volt service. Changeover from one type of operation to the other is a matter of shifting two small wire links on a terminal board on the chassis. The transformer's primary is tapped, to provide three-step adjustment of the charging rate. It is also fused as protection against overloads or accidental shorting of the output wires.

The assembly of the parts to the chassis and the front panel takes only about 20 minutes. The wiring, as the schematic diagram indicates, is very simple, and takes another half hour. The completed unit measures 9½ by 8 by 5½ inches overall and weighs 12 pounds. The back of the case is fitted with slotted feet to permit the charger to be mounted vertically on a bulkhead or a garage wall.

For marine applications this "con-

verting" can be used only when a boat is tied up to a dock having nearby AC power outlets. To facilitate connection to the latter, the unit is provided with a 15-foot line cord instead of the usual 6-foot length.

Two days after I finished the sample charger shown in the accompanying pictures, the battery in my car went dead because I inadvertently had left the radio going overnight. I hooked the charger up, cranked the output to the

verter" can be used only when a boat is tied up to a dock having nearby AC power outlets. To facilitate connection to the latter, the unit is provided with a 15-foot line cord instead of the usual 6-foot length.

Two days after I finished the sample charger shown in the accompanying pictures, the battery in my car went dead because I inadvertently had left the radio going overnight. I hooked the charger up, cranked the output to the

Chassis view of Heath Model MC-1 charger. The power transformer is below subchassis.

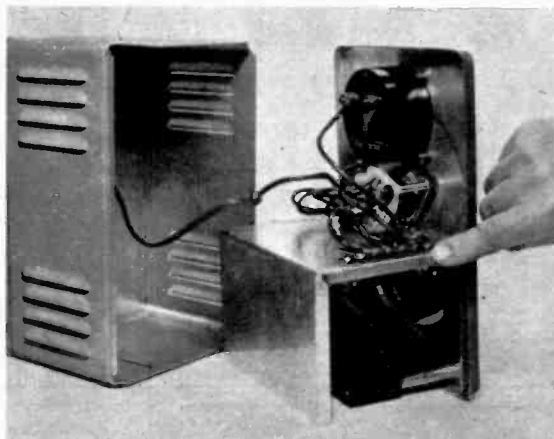

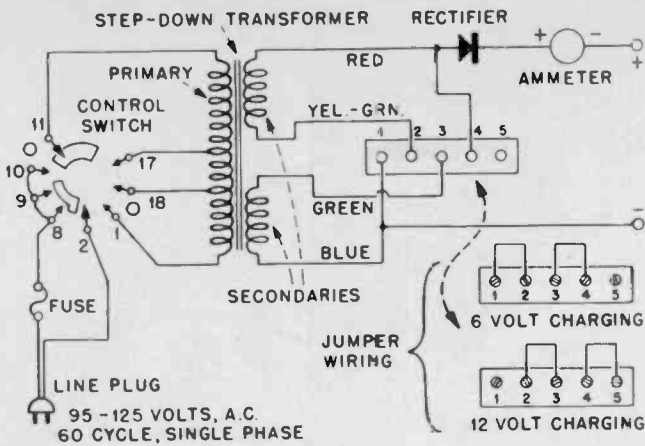

Wiring of charger is shown here. Secondaries are jumped in parallel for 6-volts, in series for 12-volts on terminal board.

Identify output voltages by putting a sticker on the panel between the output binding posts.

maximum of 10 amperes (for a 12-volt battery), and let it run. Five hours later the battery had recuperated sufficiently to kick the engine over. I have installed the charger in a place of honor on the garage wall and have fitted the output wires with a plug that fits the cigarette lighter. Any time the temperature goes below freezing, I give the battery an overnight "trickle" charge of a couple of amps, and in the morning it responds with vim and vigor! •

Heavy power transformer mounts to front panel by four studs. Fuse is easy to replace.



In typical garage, charger mounts conveniently on wall near power, as shown below.

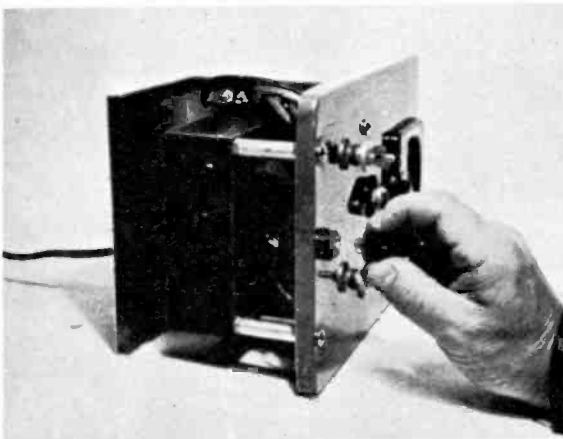

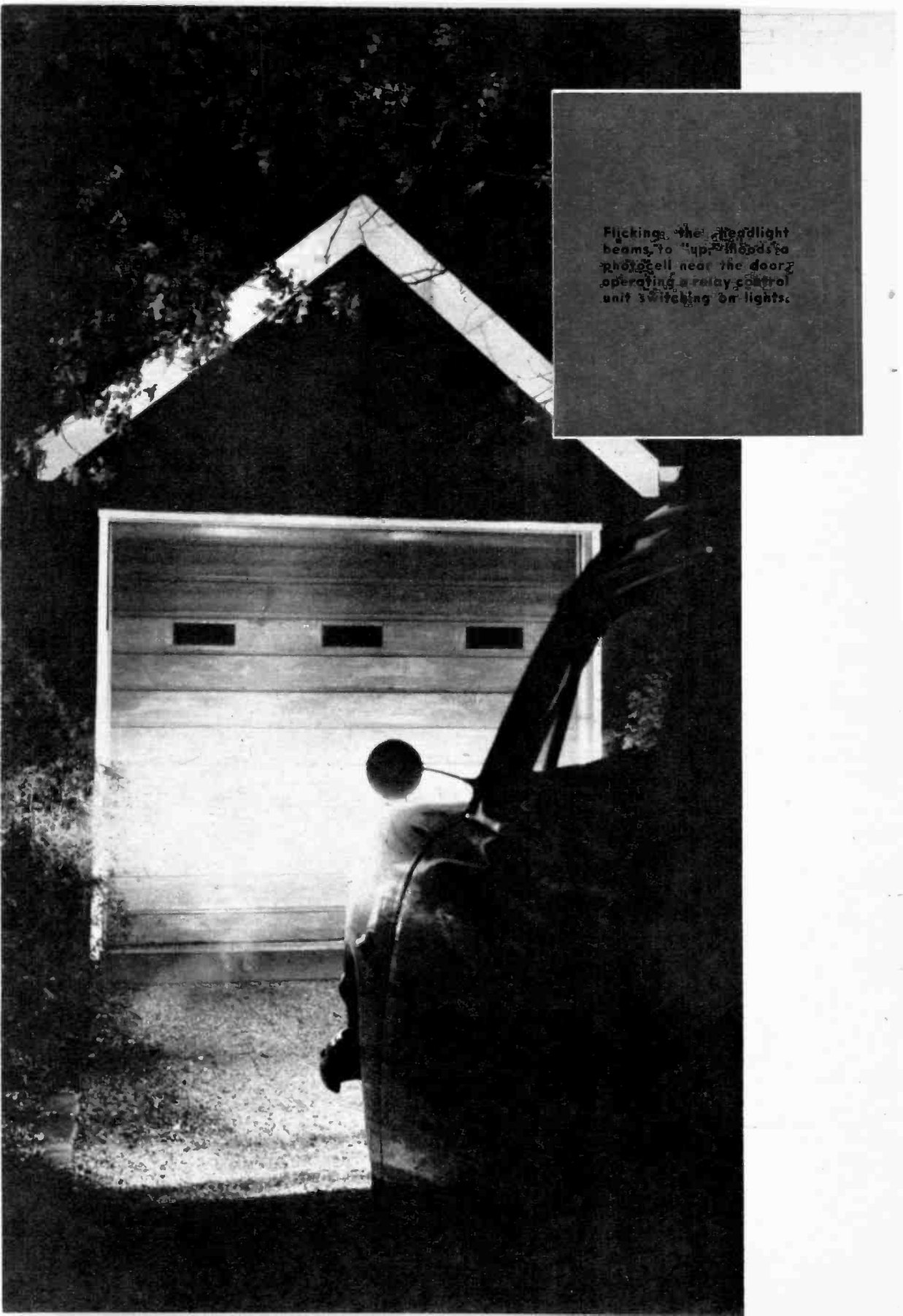

Flicking the headlight
beams to "up" in order to
photo cell near the door
operating a relay control
unit switching on lights.

Driveway Floodlight Control

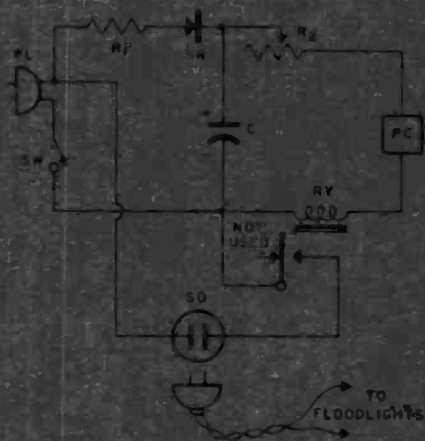

By Harvey Pollack

Light up your driveway, garage—without getting out of your car!

MORE than ever before, the family automobile is now a "His and Hers" vehicle. Modern automatic transmissions have placed the wheel into the hands of the ladies and do they love it! But ask your wife or daughter what scares her most about driving and chances are she will answer, "Pulling into the garage alone when I come home after dark."

Here's your opportunity to kill two of those proverbial birds with one stone. Build this simple photoelectric automatic driveway floodlight control. Not only will you make late homecomings safe for the women of your house but you can prove to them once and for all that electronics works for them as well as for you!

The design of this interesting project is based upon an extremely sensitive cadmium sulfide photocell of vastly improved performance. This cell is so responsive to light of even low intensity, that it can operate a sturdy, inexpensive relay with no amplification of any kind. The absence of vacuum tubes and transistors in the circuit reduces the initial expenditure for parts substantially and makes the control unit extremely easy to assemble in a night or two.

The sequence of "operations" goes something like this: when the car is taken out for the evening, the driver

turns the system on by throwing the switch on the control unit. The little box containing the photocell is mounted within easy reach, sheltered from rain or snow but located in such a manner that your car's headlight beam can reach the photocell when you approach the driveway. Thus, as the car enters the driveway, the light from the headlamp beams reaches the cadmium sulfide cell through the aperture at the front of the case, triggers the relay which in turn turns on the floodlight. For extremely sensitive response, a 49¢ magnifying glass is used as an intensifying lens. With this lens in place, the relay will be triggered at distances up to 100 feet. If your driveway is shorter, or if you want to limit the range of operation to 50 feet or so, the lens may be omitted.

The relay contacts are rated at a maximum of 5 amperes, which means that you can use up to 500 watts of floodlighting without fear of damaging the contacts provided that the auxiliary wiring is heavy enough for the job.

How It Operates

Alternating current from the AC lines is converted into direct current by the circuit comprising R1, SR, C, and SW. The selenium rectifier SR produces pulsating DC; capacitor C smooths out much of this pulsation to

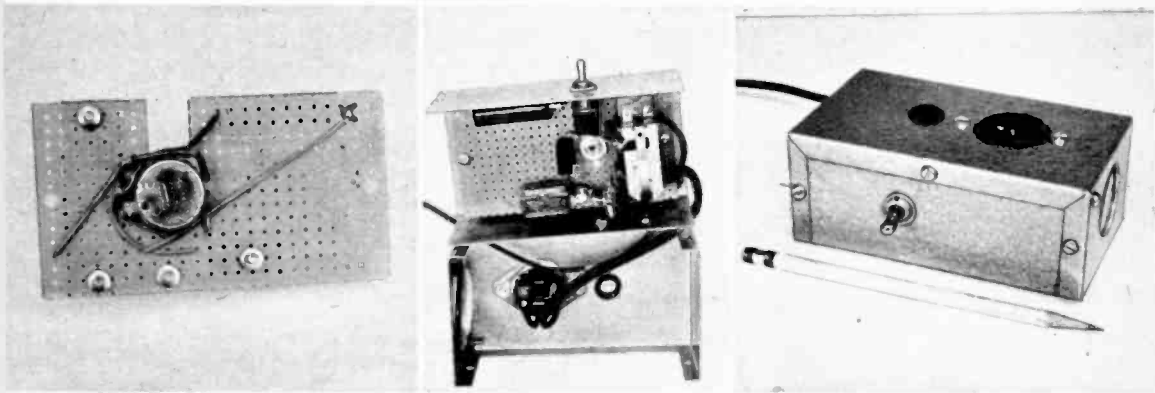

Various views of the complete control unit are shown above. At the left is the underside of the bakelite panel with the sensitivity control; the rectangular notch is for the switch. The other side of the bakelite and the components mounted on it are shown in the center photo. The complete unit, closed, is on the right.

PARTS LIST

Electrical

- C - Capacitor, electrolytic, 20 mfd @ 150 volts.
- PC - Photocell, cadmium sulfide, Hupp Manufacturing Co.; type CDS-10 (available from Lafayette Radio Corp., 165-08 Liberty Ave., Jamaica, N. Y. Listed as CDS-10 Powermaster).
- PL - AC line cord and plug.
- R1 - 37 ohms, 1/2 watt resistor.
- R2 - Potentiometer, 25K ohms linear taper, small size.
- RY - Relay, 10,000 ohm coil, spst, 5 ampere contacts such as Potter and Brumfield type LB-5.
- SO - Receptacle, chassis-mounting type, for standard AC plug.
- SW - Switch, spst toggle, bat-handled type.
- SR - Selenium rectifier, 120 volt, 75 ma rating.

Mechanical and Optical

- CABINET - aluminum, grey hammertone miniature case, 5 1/4" x 3" x 2 1/8".
- BAKELITE, PERFORATED - One sheet, 3 1/8" x 6 3/4", 1/16" thick.
- LENS - Focal length 3 1/2", diameter 1 1/4". Lens used in this model is Lafayette =F-46 and sells for 49c.
- SPACERS - BRASS, 1/2" in length to pass 4-46 screw, 2 required.
- MISCELLANEOUS - Hardware, hookup wire, solder, etc.

yield more-or-less pure DC at its terminals. Resistor R1 is a surge resistor that prevents damage to the rectifier when SW is first turned on and capacitor C charges. Without R1, the capacitor would take an initial surge of current that might be large enough to overheat the rectifier.

PC is a photo-resistive cell whose resistance is very high when there is little illumination on its sensitive surface (well over a megohm). Light causes the resistance of PC to drop substantially. In the high resistance condition, the current through the series circuit consisting of R2, PC, and the relay RY is too small to pull down the relay armature. As the resistance of PC drops due to incident light, the relay current rises and the armature drops in, closing the contacts and feeding line voltage to the output receptacle SO.

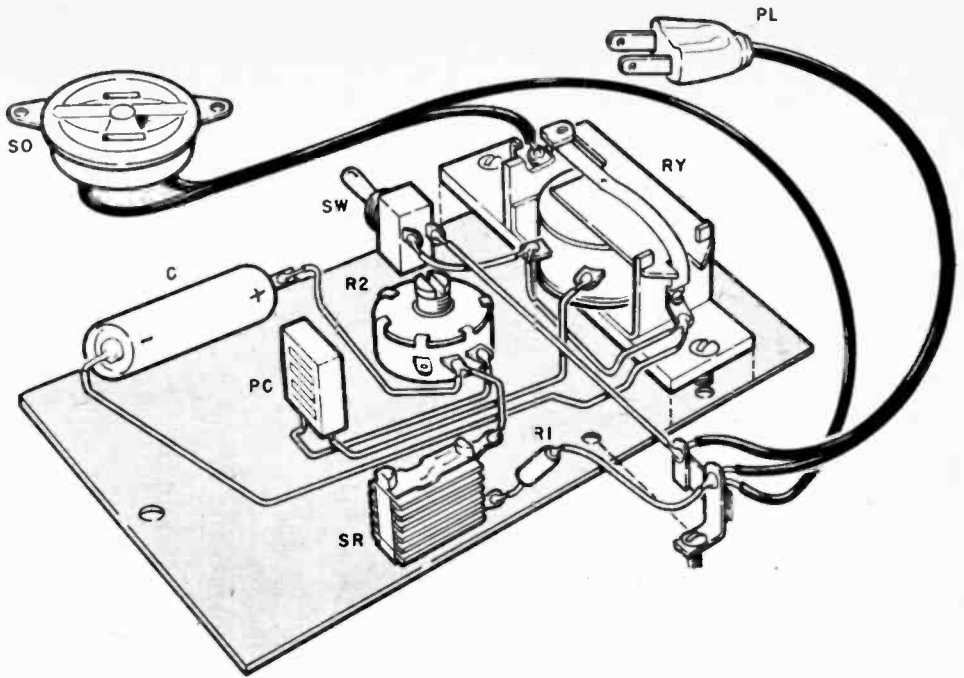

Follow the pictorial diagram shown above to avoid mistakes in wiring, use parts specified. The control box is secured to the inside of the garage wall, facing out, as shown below.

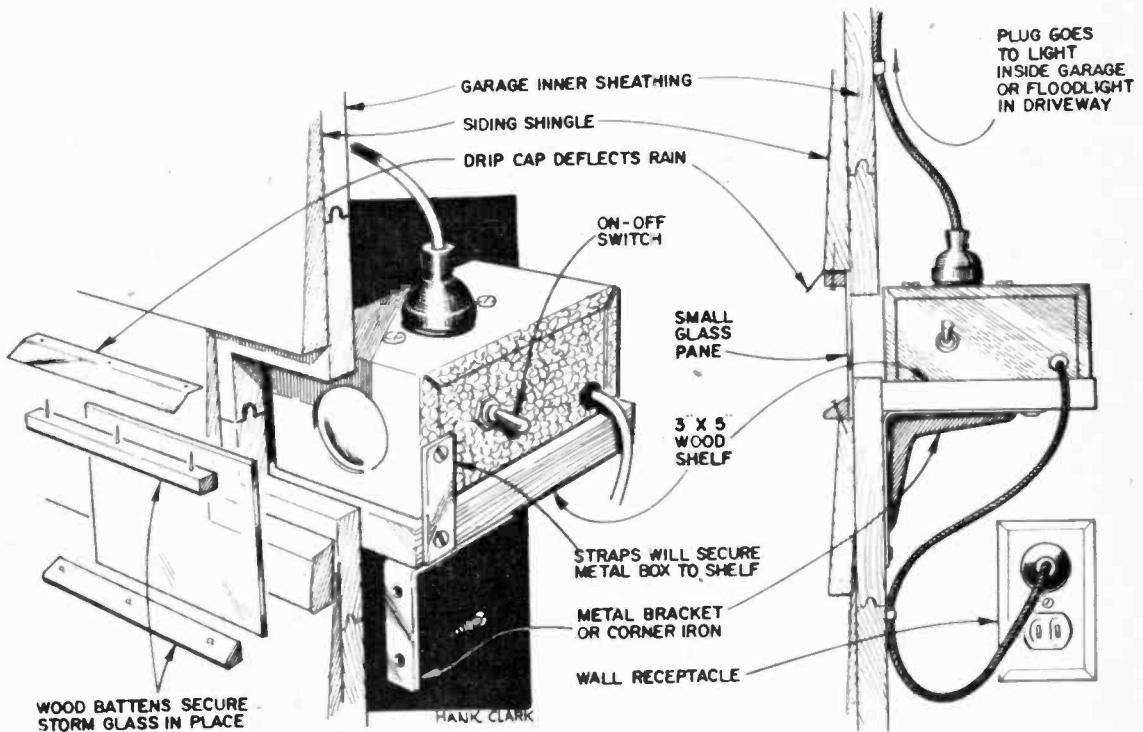

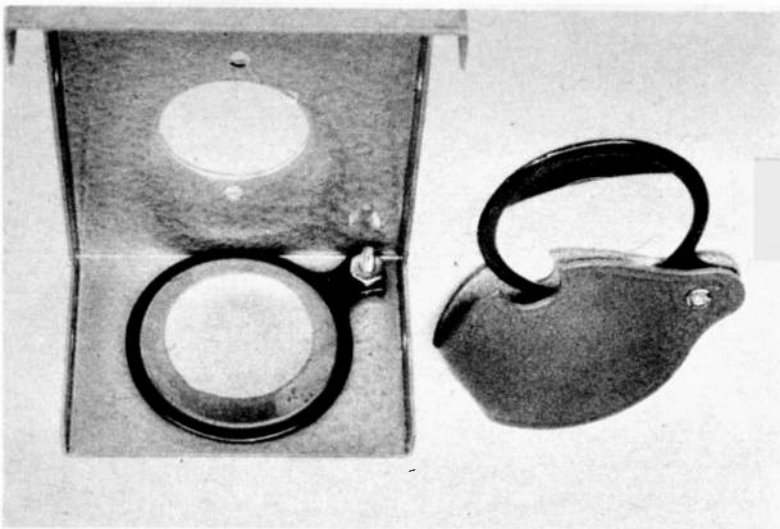

The lens is sold with a leather cover secured to the lens handle by a rivet. Cut the rivet off with a saw, etc., and use the hole in the handle for mounting the lens. The control unit may be mounted at the side or above the garage door as shown below. Make sure to angle the unit so it "sees" car headlights.

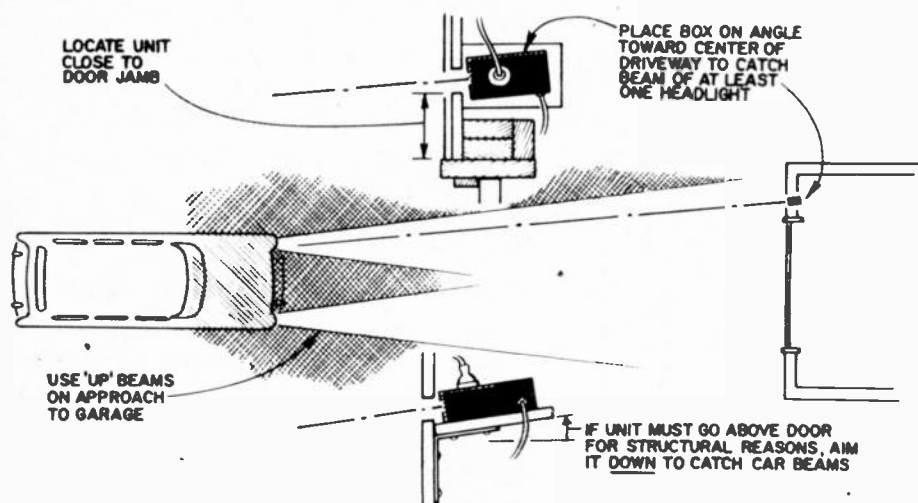

Construction

All the components of the Floodlighter, except for the On-Off switch and the output power receptacle, are mounted and wired on a piece of perforated bakelite cut to fit into the lower section of the miniature case. This thin, sheet phenolic may be cut very easily with an ordinary pair of metal shears. The perforated sheet is held away from the bottom of the case by means of two 1/2-inch brass spacers through which two 4-36 machine screws are passed. The spacers are just long enough to permit the potentiometer to clear the case; the latter is mounted underneath the perforated sheet so that its short shaft projects above the bakelite and can be

reached through a hole in the top of the cabinet.

The placement of the parts is critical in only one respect: the cadmium sulfide photocell should be mounted on the bakelite sub-chassis so that its sensitive face (glass window) is 2 3/8 inches back from the front or aperture side of the case, just in the event that you decide to use a lens. At this distance, the easily available lens described in the parts list focuses an excellent concentration of light on the photocell. Even if no lens is used the photocell should be placed far behind the aperture to minimize the chance of light other than that from the headlamps reaching the sensitive element.

[Continued on page 108]



Complete new DC power supply for new model trains of HO type is shown above. Old AC transformer from larger model train set is basis of the power pack. Meters are useful accessory, not needed for successful operation.

A Power Pack for HO Trains

Use your old transformer plus few parts for new DC supply.

ONE of the biggest problems the model railroad fan faces is that of room—living room, bedroom or playroom, you name it, and it's too small. Too small, that is, for the conventional O and S gauge systems which are scaled at one-quarter and three-sixteenths of an inch to the foot respectively. All of us who started with these sizes at one time or another have found that any sort of track layout beyond a simple oval or figure eight forced the family to move out of the room. And reluctantly, most of us put these trains away, to be pulled out only at Christmas time to amuse the children. But some fans have discovered HO, a

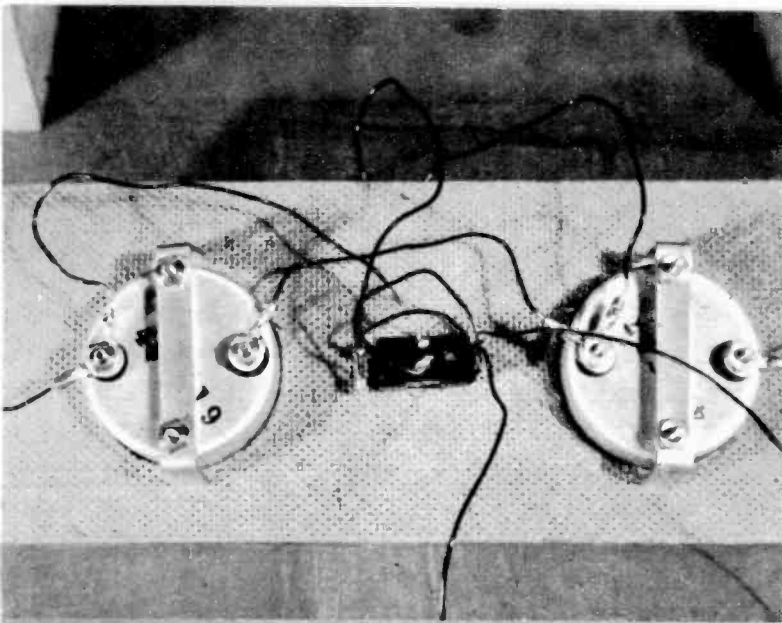

Rear view of meter panel showing how meters and reversing switch are mounted and wired on Masonite panel board.

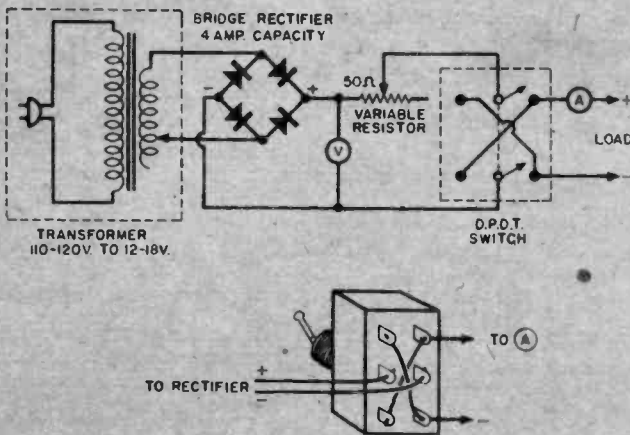

Schematic diagram shows how to wire up power pack. "V" is voltmeter, "A" is ammeter, both are optional. Details of wiring switch are also shown at left.

relatively new railroad system scaled 3.5 mm to the foot, a far more workable size, since it is slightly more than half that of the O gauge.

With HO, large track systems can be laid out on a simple four by seven piece of plywood, which can be hinged to the wall or suspended from the ceiling by pulleys, allowing the complete works to be put away in a matter of moments. Unfortunately, although HO is generally less expensive than the larger sizes, many hesitate to buy them because of the previous investment in larger trains. However, by building a power pack yourself, you can save anywhere from \$8 to \$15 or \$20. The commercial

packs run anywhere from \$10 to \$30, but if you have a transformer which came with the larger trains, you can build your pack for a minimum of cash.

The power pack is a simple project. Since the HO trains use tiny, powerful, direct current motors compared to the alternating current jobs in larger trains, we must supply our new system with DC. The trains draw about eight-tenths to one ampere at about 12 volts, and fortunately the transformers supplied with most of the O and S gauge systems have a working AC voltage of 12 to 18 volts.

If you have no transformer, you can buy used models of the proper size at many hobby shops. It would be advis-

able to buy one with a built-in circuit breaker, which is a must for the power supply. Most transformers built in the past five years which have a rating of above 50 watts, have such safety features. The cost shouldn't be more than \$3 to \$5 tops, although if you're interested in a really high-powered job at a reasonable price, you may find a 150-watt model, new, selling at about \$8.50.

The secret to getting direct current out of a transformer is to use a selenium rectifier. The current rating of a rectifier is for continuous output, but normally in HO use it wouldn't be called upon for steady high current. Mostly it will work at well below its rated capacity, with short stretches of full load. The selenium rectifier can stand high-current overloads for short periods—say two or three minutes—providing it's allowed to cool down afterward. You can take advantage of this to buy a smaller rectifier than you'd normally consider. Since one train draws about one ampere or slightly less, you could consider using a rectifier rated at about an amp and costing about \$5 but this may be uneconomical for you, since you would have to change later if you add trains. For the purposes of this project, the author used a Sarkes-Tarzian rated at 4 amps. It costs about \$10.

Normally, we might consider filtering the output with a 1000 mfd. capacitor to obtain smooth current, but in the case of HO equipment, that's just what we don't want. It's a fact that these small trains start easier if they're subjected to the pulses of unfiltered current.

Commercial power packs are generally controlled by a rheostat to supply the needs of the engine, but since we already have a built-in means of control in our transformer, we can bypass that expense. However, it might be a good idea to insert a variable resistor—much cheaper than a rheostat—in the line if the output of your power pack is high.

It may be advantageous to use a voltmeter and an ammeter in the circuit to allow for precise control, and to eliminate the possibility of overload. These Shurite models are very inexpensive—about \$2 each—and should be purchased with a 0-5 DC ampere scale for the ammeter and, say, 0-25 DC volts for

the full-scale reading of the voltmeter.

There is only one other control necessary before we start building. Most, if not all, HO engines have no reverse relay. Therefore, if we put a double pole, double throw switch in the line, we can reverse polarity—and the train—at the flick of the switch.

The author found it simple to use a small board rather than a metal chassis, simply because of price. You can use a chassis if you wish, but by using a board to mount the parts, it is extremely simple to cut openings for the meters and the switch in a narrow length of Masonite or other composition material. This assembly can then be fastened to two pieces of one inch board cut at a slant, at the far end of the chassis. The transformer can be mounted at the front of the board, and the rectifier next to it. Put the resistor somewhere between to make wiring easy.

One point: Don't fasten down your control panel until it is completely wired and checked out, or it will be difficult to get at. It would be best to use spade lugs for connection to the meters and the transformer, for firm seating. One other thing you may wish to do, which the author didn't. You can add an on-off light to the panel—a 110-volt miniature bulb wired in parallel to the primary of the transformer will do. That, however, is incidental.

The power pack is now ready to go into operation. Check all connections; see that there aren't any shorts. Make sure the rectifier gets plenty of air, so there'll be no overheating, then turn it on. Put a load across it. (A couple of alligator clamps attached to the output wires are perfect for attaching to the track terminals, by the way.) The train motor will check out at about eight or ten ohms, so a resistor of that size, at 15 watts, should be used as a test load.

Without such a load, your voltmeter should read about 10 to 14 volts, and the ammeter will barely budge. With the load, the voltmeter will drop down to, say, six or eight volts, and the ammeter will skip up to a half or eight-tenths of an amp. If you find your output more than this, adjust your variable resistor (more resistance) until you get readings of the above nature. •

The ABC's of Electronics

by Donald Hoefler

This dynamic new force touches the lives of all in our jobs, our recreation, our homes, in medicine, in defense.

WHAT is electronics? This question is asked hundreds of times each day, and yet electronics engineers and scientists themselves are still grappling with the problem of answering it. The vastness of this rapidly-growing art is so great that a description which was accurate yesterday may be out of date tomorrow.

For electronics is a science serving all of the other sciences, and most of the arts as well. Unlike other modern discoveries, such as atomic and nuclear energy, or jet and rocket propulsion, electronics affects each one of us in hundreds of ways every single day.

It is the telephone through which we hear from a friend or call the doctor. It is the radio we listen to and the television we watch. It is the eyes of the pilot, both on the sea and in the air, when no human eye can see.

It is the remote control for our model airplanes, or full-scale drone planes, or guided missiles, or a farmer's tractor. It opens garage doors, operates drinking fountains, turns on street lights at sundown, and tunes up cars.

It is medical radiology, diathermy and physiotherapy, and the unseen net around our continent protecting us against military attack. It is an automatic bread wrapper, a radio telescope, a color matcher for cans of paint. It is phonograph records and

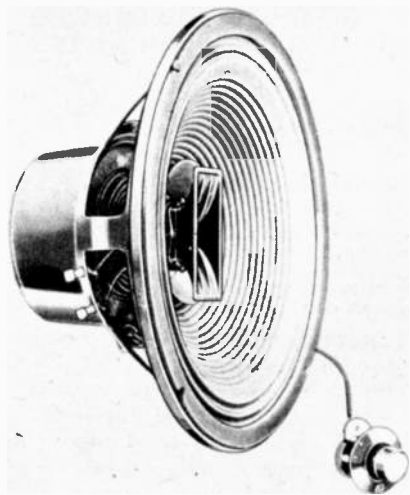

sound movies and a super-human mathematical wizard. And this doesn't begin to tell the story.

What is electronics, did we ask? What, indeed, *isn't* it?

It is staggering to realize that electronics, this huge factor in our daily lives, depends upon man's knowledge of the electron, the *tiniest* known particle of matter.

At one time we could have said that an electronic device was one using a vacuum tube, so familiar in radio sets, but this is no longer true. Many electron tubes now contain gasses instead of a vacuum, and the transistor is no tube at all. The magnetic amplifier in fact uses neither tubes nor transistors. Yet all of these are electronic devices.

Electronics was once confined to very small electrical currents, but now it is being used more and more in the field of electric power, not only for control systems, but for the actual generation of the power itself.

No, this wonderful world of electronics is revolving too fast for any of us to say precisely what it is. The best we can do is tell what it does and how it does it.

Electronic Circuits

Every electronic device comprises one

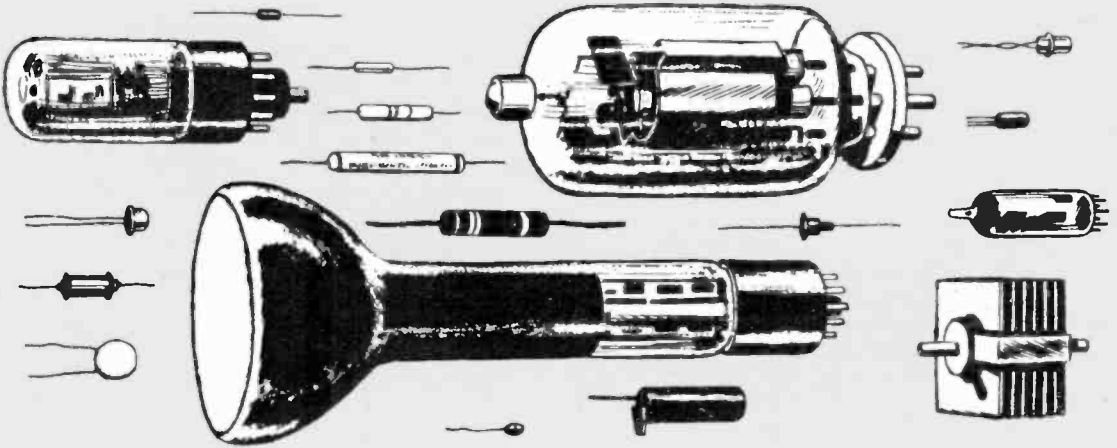

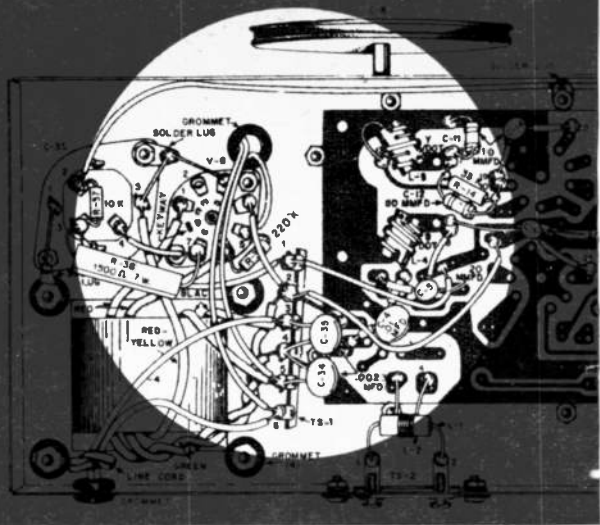
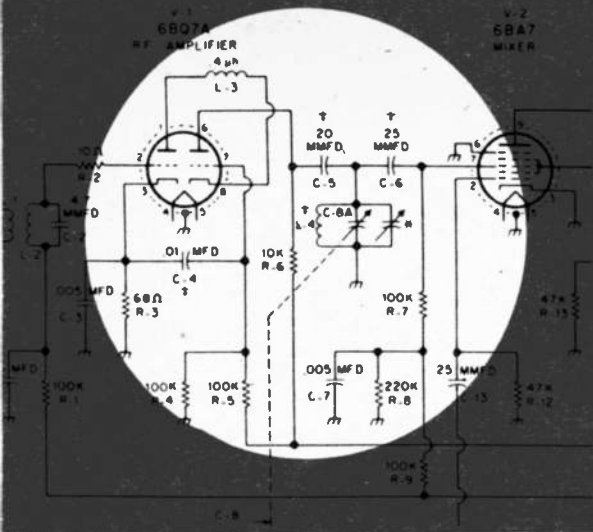

On the left is shown a schematic diagram, the specialized blueprint used by the electronic engineer or technician for a particular circuit or piece of equipment. Each part of this diagram symbolizes a component such as those shown in the wiring diagram on the right.

or more *circuits*, the heart of which is usually a tube or transistor. The complete circuit also has other electrical components, such as coils, condensers, resistors and connecting wire. Thus the electronic circuit can be roughly compared to a mechanical system in which the tube represents a motor and the other components act as the belts, chains pulleys, gears and shafts.

Not long ago engineers used to go through a mental "shifting of gears," thinking of an electronic circuit in terms of an equivalent mechanical system, in order to understand its operation. For example, it was common to compare the flow of current in a wire with the movement of water through a pipe.

This practice led to some bad guesses, however, and only a few unreconstructed old-timers still hold to it. Electronic advances have been so rapid, furthermore, that now it's more common to find the mechanical engineer using electronic concepts in analyzing his systems.

The ties between electronics and mechanics are still strong, however. One of the fundamental ideas in practical electronics is the varying voltage which stands for some changing physical value. Sound becomes an electrical voltage, for example, through the medium of the microphone. Light is converted into electricity by a photocell or video

camera. Even changing temperatures can result in varying voltages.

Electronic Signals

Electrical voltages of this type are called *signals*, and the device that generates them after stimulation by an outside source is known as a *transducer*. In addition to the microphone and tv camera, other transducers include the phono pickup and tape reproducer.

It will be noted that all of these appear at the *input* of the electronic circuit. That is, they convert some other physical quantity into a signal which is then fed into the electronic circuit. Another family of devices which is equally important is the *output* transducers. These have the job of converting the electronic signals back into physical form, either the same as or different from the original. Examples in this group are tv picture tubes, loudspeakers, meters and various types of recorders.

All of the signal movement we have discussed so far is of the *closed-circuit* variety. The signal, that is, has remained at all times confined within the circuits of the electronic devices. But this doesn't have to be so, for there is a way in which these signals can escape the bounds of electronic circuitry and shoot out in every direction in space.

For this to happen, the electronic sig-

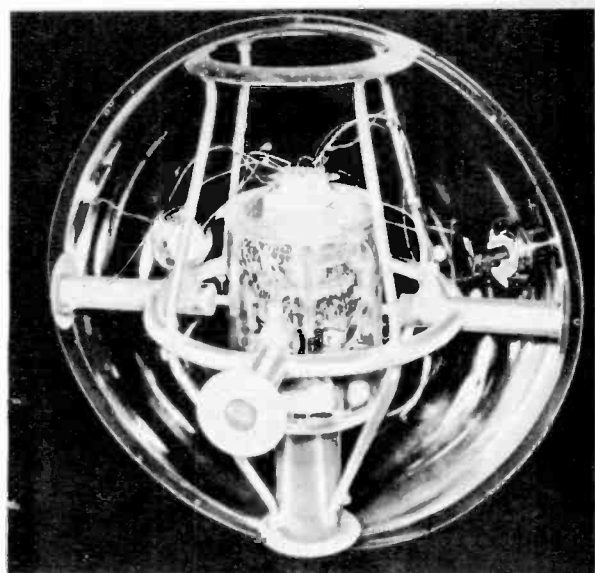

Transparent model of the U. S. satellite. The core consists of several round printed circuit boards for data transmission.

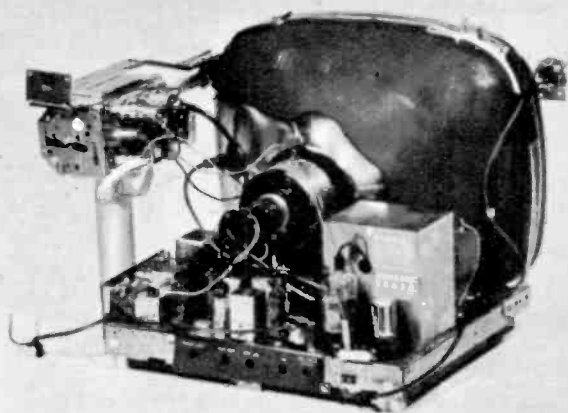

Internal view of new Zenith portable TV. Most of components are on the horizontal "chassis," no larger than the picture tube.

nals must be converted again, this time into electromagnetic waves. This conversion, as well as the reconversion from electromagnetic waves back into electronic signals, is the basis of radio, television and radar. The transducers in this case are transmitters, antennas and receivers. But the wondrous thing is that between the transmitting and receiving antennas, even though they may be miles apart, there need be absolutely nothing but empty space.

Electronic Communication

One important branch of electronics, then, is communications. Its purpose is to send intelligence or information of some sort from place to place: a telephone call, TV show, police call or instructions from an airport control tower. In every case the information is converted into an electronic signal by a transducer such as a telegraph key, microphone, TV camera or teletypewriter.

The signal is then carried by wire line, radio waves, or both. Depending on the nature of the signals, electronic communication is called telegraphy, telephony, television or telemetry. The first three are quite familiar, but the fourth, the baby of the family, is still showing off its great potential.

Telemetry is also known as data transmission, which means the sending
[Continued on page 96]



Electron microscopes are being produced in smaller and smaller versions for more rapid utilization for fighting disease.

Careers in Electronics

By Harry Kursh

**Electronics will control the age of space—
learn it, and great opportunities will be yours!**

A COUPLE of years after World War II, three young Boeing Aircraft engineers—Martin K. Lilleberg, Howard H. Suskin, and Louis P. Hanson—were trying to develop some control devices for the new Stratocruiser. Something besides ordinary electrical and mechanical devices was needed. They decided to take a crack at electronic controls.

Within a year, encouraged by Boeing Aircraft, they started gathering after working hours in the basement of Louis Hanson's home and it wasn't long before they saw the handwriting on the wall—electronic control was the key to their futures. In 1948 they formed a corporation, United Control Corp. of Seattle, and borrowed \$2,000 to start producing electronic temperature control units for aircraft windshields. But it remained strictly a sparetime business until one by one they left their jobs at Boeing, and by 1950 all were working fulltime for their own company, United Control.

The cynics said they were nuts. It seemed that way, too. Their total sales in 1950 went to \$47,000, not much to split three ways. Today, the three sole stockholders of United Control can afford to have the last laugh. They employ a staff of more than 600 and their last year's sales figures were zipping along at a \$10,000,000-a-year clip.

Unusual? Not at all. The story of United Control and its three young engineers is typical of the entire electronics industry. At the time these three were starting out, electronics was still a strange word associated mostly with radio, television, radar and screwy gadgets to open garage doors.

Since that time electronics has blazed its way from 40th on the list of American businesses to the fifth largest industry in the nation. From only a handful of companies in electronics, there are

now 4,000. From sales totaling only a few hundred million dollars, the annual take for the industry already exceeds eight billion dollars—and this does not include the radio and television industry. While the three bosses of United Control were carving themselves a chunk of the booming pie, employment in the industry, says the Bureau of Labor Statistics, doubled.

Yet this is only the beginning. Thanks to the transistor, the printed circuit, and the mushrooming needs of defense, research, science, and industry, experts everywhere are predicting that electronics will vie only with aircraft and automobiles for first place in the economic spotlight.

Says one of the nation's leading business voices, *Business Week*: "In the United States today, a handful of industries has an inherent growth capacity greater than the economy as a whole: electronics, chemicals, oil, power supply, possibly some of the rare metals. Of these, the brightest is electronics."

Once again the handwriting is on the wall. For whom? For the 1,200,000 young Americans to be graduated from high school this year. For the 190,000 getting set to pick up college degrees. For the countless thousands of employed Americans who'd give anything to switch their jobs or find new careers. For those restless and hardy souls who want to build quick fortunes in business or invention.

It would take a veritable encyclopedia to catalog the scores of occupations and opportunities opening up in electronics. Even now there is scarcely a business or industry that is not or will not be affected by electronics, ranging from the two-by-four TV service station to the miracles of automation, rockets, missiles, and nuclear energy. Electronics has begun to revolutionize

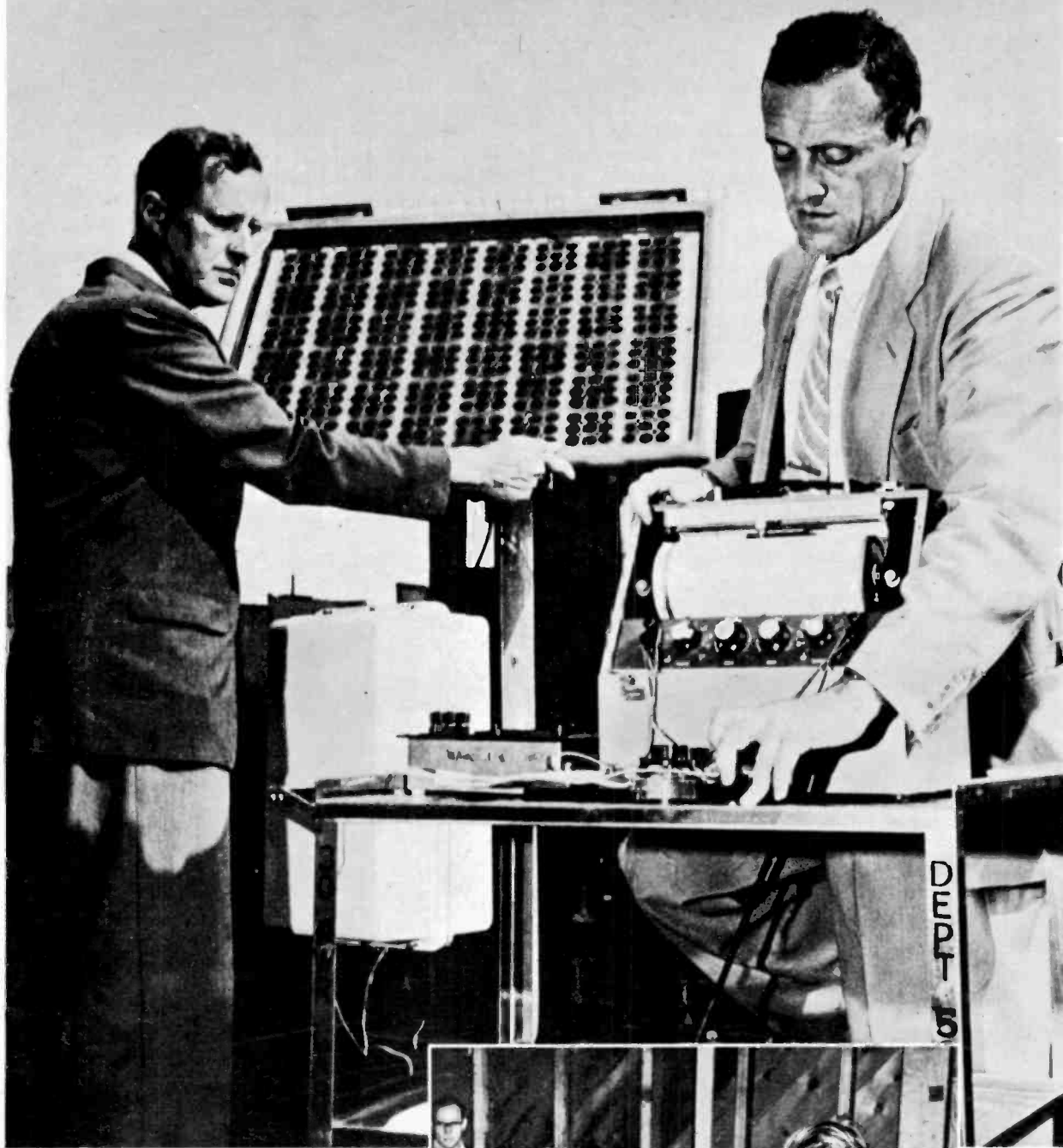

Above, two engineers make tests on the Bell Telephone Labs. sun battery, the first successful device to convert the sun's energy directly and efficiently into electricity. Right, service technician repairing a two-way radio of type used in trucks, cars, other vehicles.



chemistry, and it has already established a solid beachhead in medicine. As Dr. C. Guy Suits, vice-president and research director of General Electric puts it: "In the next decade we will be completely saturated with electronics."

Everyone knows this calls for more engineering brains. But it will also call for a wide variety of skills, from the technician who has been trained on the job, to the junior engineer or sub-professional with only a year or two of technical school education behind him.

How can you hop on the gravy train and ride electronics to a brighter future?

Let's face it. You'll need more than just inspiration. You'll need specific advice on training and qualifications and where and how to look for the job you want. You'll want to know something

about present-day wages, future earning potentials, working conditions, chances for advancement, and chances for self-employment. Forthcoming issues of **ELECTRONICS ILLUSTRATED** will delve into all these details, to bring you a step-by-step, blow-by-blow account for a career in just about every occupation imaginable in electronics.

Meanwhile, if you've been nudged up to the starting line, don't just sit back and wait for someone to blow the whistle. Start investigating the whole picture, the background and the future. See where you fit in now or may fit in for the future. Let's consider this point by point:

1. *Look for specific vocational guidance.* This means check into the opportunities in your hometown area, and

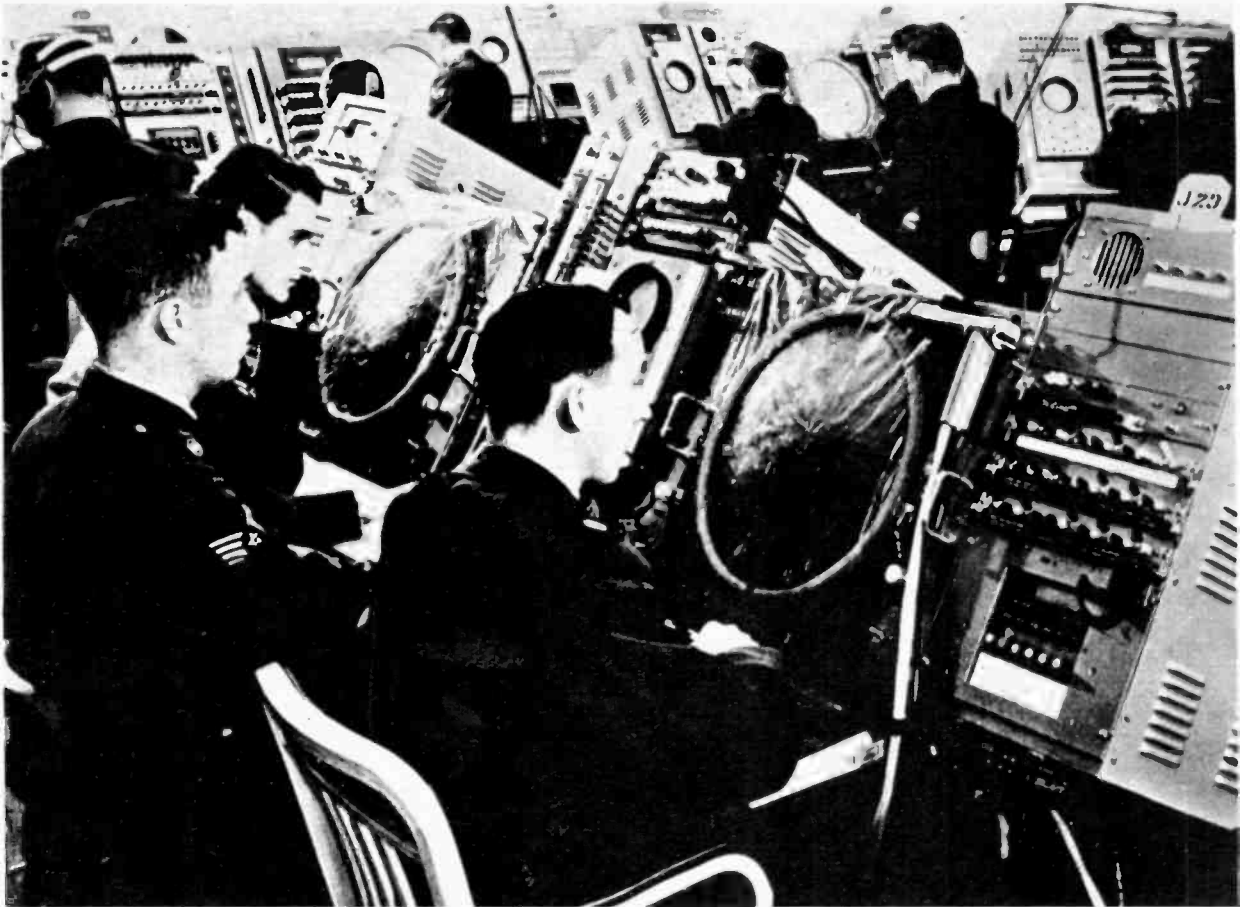



U. S. Air Force technicians observe radar scopes of the early warning air defense system of the continental U. S. in the photo on the facing page. On the left, a complete community or factory television broadcasting unit is shown being operated by one man.

get a fresh look at your own aptitudes. Your best source of information is your local state employment service. There are more than 1,800 such offices scattered throughout the 48 states, and most of them have free professional guidance-counseling and aptitude-testing services. You can also receive advice and assistance by writing to the *American Personnel and Guidance Association*, 1534 O St., NW, Washington, D. C.

2. *Look into trade and industrial education courses.* Many communities today are providing free or low-cost training designed to help produce more trained technicians and sub-professionals. You can get detailed information from your own state supervisor of industrial education. There's one in every state. If you don't happen to know where to write in your own state—or perhaps in some other state that may interest you—write to the *U.S. Office of Education, Division of Vocational Education, Washington 25, D. C.*, and ask for the list of “supervisors of trade and industrial education by states.”

3. *Check on-the-job training opportunities.* Some fourteen percent of the nation's work force consists of skilled workers and technicians. But there aren't enough to go around now, and there won't be enough in the foreseeable future. Heavy unemployment, if any, in

the future will be largely among unskilled and untrained workers. These are the conclusions of recent studies published by the U.S. Department of Labor. And because of this many companies today have launched their own on-the-job training programs. It's earn-while-you-learn. A number of major corporations are even paying their on-the-job trainees to go to outside technical schools and colleges in order to develop them into junior and professional engineers, with comparable pay. Once again your best overall source of information for on-the-job training programs is your own state employment service. If you have trouble locating the information you want, write to the *U.S. Department of Labor, Bureau of Employment Security, Washington 25, D. C.*

4. *Investigate apprenticeship opportunities.* The electronics industry has yet to develop a widespread system of recognized apprenticeship training, which is considered the best means of developing top-notch craftsmen. But a number of apprenticeable skills in other industries fit into electronics, and the idea of setting up apprenticeships in electronics itself is catching on. For guidance along these lines, write to the *U.S. Bureau of Apprenticeship and Training, Office of Information, Washington 25, D. C.*

5. *Can't go to school? Can't leave your job? How about correspondence school courses?* The list of successful correspondence-school graduates in the electronics industry would fill a library shelf. Some of the most famous men in the business possess nothing more in the way of education than a correspondence school diploma. For information about accredited schools or courses in electronics, write to the *National Home Study Council, 1420 New York Ave., NW, Washington, D. C.* You may also obtain a free list of home-study schools by mailing a request to *ELECTRONICS ILLUSTRATED, 67 West 44th Street, N.Y. 36, N.Y.*

6. *Read all you can about the business outlook and career opportunities in electronics.* You can obtain some of the best and most accurate information at low cost directly from Uncle Sam's own reports, booklets and pamphlets. Here's how: Write to the *U.S. Government Printing Office, Division of Public Documents, Washington 25, D. C.*, and ask for "price lists on occupations and careers." This will tell you exactly what is available, and the price. You order accordingly. Also have your local librarian show you the way to the shelves containing publications on vocational information.

7. *Opportunities in government service.* Three major branches of the armed forces—Army, Navy and Air Force—

employ tens of thousands of skilled men and technicians. Many have been trained directly on government payrolls. This is especially true in the field of electronics. It is estimated that half the electronics output of the nation today goes to the armed forces. Most of these training opportunities are announced through Civil Service bulletins. Watch for these at post offices, state employment offices, and Civil Service field offices. As a matter of fact, if there happens to be a Civil Service field office near you it would be a good idea to drop in and look around and have a chat with any of the officials there. Look in the telephone book under "United States Government" to locate the nearest field office, or write to the *U.S. Civil Service Commission, Washington 25, D. C.*

If you want to know more about civilian employment and electronics training opportunities in the armed forces, write to the *U.S. Department of Defense, Pentagon, Washington, D. C.* But make your information request specific, that is, ask for *civilian employment* opportunities with either the Army, Navy, or Air Force, so that your letter will get sent around to the proper office without delay.

Remember, this is only the beginning for electronics, and perhaps for you. Future issues of *ELECTRONICS ILLUSTRATED* will show you which way is up, step-by-step. •



The electronic circuits responsible for the gathering and coding of space information obtained by the Vanguard satellite are contained in the cylindrical unit shown being lowered into the satellite. This unit consists of printed circuits of the type on the table. Antenna elements are also shown in the foreground on the table.

Movie Camera With Electronic Brain



Light-operated photocell adjusts lens automatically

THE energy from solar or light rays has been harnessed to set the lens of a new automatic 8mm movie camera introduced recently by Bell & Howell Company. The new camera is the first in the world in which light energy alone supplies the power to generate the electric current which adjusts the lens. No batteries, motors or springs are used for the exposure setting. The movie maker winds the camera, sights and shoots. The electric eye, which adjusts to changing light faster than the human eye, sets the lens for proper exposure before the starting button is touched. It can operate the lens through its full range of stops from $f/1.9$ to $f/16$ in less than one second.

The automatic control is intended primarily for color film having an ASA speed rating of 10 or 16. A slide under the photocell adjusts the mechanism for either value. Black and white film, which is generally much faster than color, can be used if a knob above the lens is turned from "Auto" to "Manual"; the lens must then be adjusted in the conventional manner.

No focusing is necessary and the camera can be used with indoor or outdoor color film. This means that without knowing what an f /stop is, the movie novice can now be sure of properly exposed film every time, a result not consistently achieved by experts. He can also follow a subject from light to shadow, confident that the electric eye is accurately computing the light changes and automatically adjusting the lens. With an ordinary camera he would have to interrupt shooting to change the exposure setting.

An amber exposure beacon in the camera's viewfinder glows as long as the available illumination is adequate. It turns black to signal

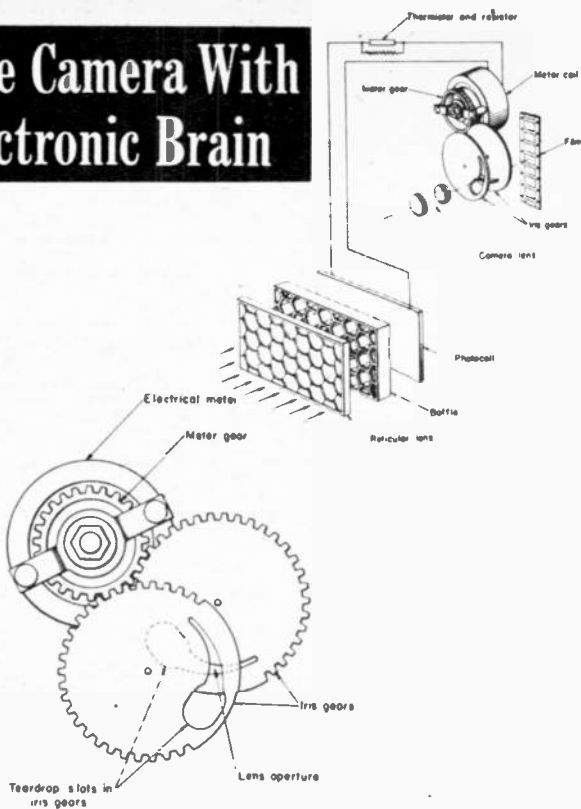

that there is insufficient light for movie making.

Like the human eye, which continually adapts to the brightness of its surroundings, the electric eye works continuously as long as light reaches the photocell. It "rests" only in darkness or when there is insufficient light for movie making. It never wears out or weakens under normal conditions.

To make feasible the design approach of the electric eye, Bell & Howell engineers developed a new type of lens iris so sensitive that it moves at the touch of a human hair. Yet it is sturdy and shockproof and has withstood the most vigorous environmental and field tests.

Light reflected from the subject enters a reticular honeycomb lens which controls the angular coverage to match that of the camera lens. Upon reaching the photocell, the light generates an electric current which is fed to the meter mechanism. The meter computes the correct exposure and opens or closes the lens as required.

The use of a thermistor in the circuit compensates for temperature variations. The photocell generates more current at low temperatures, less at high temperatures. The thermistor has high resistance to current when cold, low resistance when warm. Thus at low temperatures the thermistor "slows down" the increased current from the photocell. At high temperatures the thermistor takes the current from the cell and gives it an easier path to the meter mechanism.

Linked to the control mechanism is a needle pointer which moves back and forth along a visible scale, indicating the opening at which the lens is set. The scale is marked in f /stops of 1.9, 2.8, 4, 5.6, 8, 11 and 16. •

Transistor tester

Check that transistor or crystal diode before you discard it!

Here's how to use a typical tester to pick out the good ones.

OUT of the laboratory and into practical use the transistor has come full tilt. Its progress has been so rapid that many technicians and experimenters have been caught by surprise. A transistorized set goes bad. Where does one begin his service procedure? As with a vacuum-tube set, the obvious start is with a check of the transistors. Transistor testers comparable to the ordinary tube checker are widely available. No technician, serviceman and experimenter should be without one.

It will indicate leakage and current gain for all types of both P-N-P and N-P-N transistors: junction, point-contact and surface-barrier. It will also test germanium and silicon diodes, and selenium and copper-oxide rectifiers.

This checker will enable the experimenter to determine quickly the general fact of whether the transistor under test is good or bad, and the specific information concerning its current gain. In the case of diodes and rectifiers, their value depends upon their inherent ability to conduct current in one direction. The transistor-diode checker reads both their forward and reverse currents, and therefore indicates positively whether or not the unit is satisfactory.

Most transistor checkers operate by placing the unit under test into an actual amplifier circuit which has a DC milliammeter acting as the collector load.

In the typical tester shown here, a LEAKAGE-GAIN selector switch determines the function being tested. When testing leakage, the base circuit is open, and the only current indicated by the meter will be the leakage across the base-emitter and base-collector junctions. In the case of a defective unit, this leakage current will be considerable.

When testing for gain, a DC signal is

applied to the transistor base element and the meter reads the amplifier collector current. This figure is easily converted into the value of current gain and compared with manufacturers' published data.

Operation of the transistor-diode checker is quite simple. With the power switch off, a junction type or point-contact transistor may be inserted in the socket. (Testing of surface-barrier transistors is identical, except that the 15-volt battery must be replaced with one of 4.5 volts.)

The type selector switch is set to either P-N-P or N-P-N as required. The LEAKAGE-GAIN switch is set for leakage first, the power turned on, and the meter read directly as GOOD, FAIR or POOR. The switch is then turned to whichever of the GAIN positions gives the maximum meter reading without the needle going off scale. There are three such positions, with range multipliers of 20, 50 or 100. This multiple range switch permits readings of up to 300 without throwing the meter off scale.

Then to find the base current amplification, first subtract the LEAKAGE reading from the GAIN reading. Then multiply this difference by the appropriate range multiplier (20, 50, or 100). This is the base current amplification to be compared with the manufacturer's published data for the transistor under test.

In circuits where absolute minimum noise level is important, it is possible to try a batch of the same type transistor, giving them an aural check for noise. A pair of jacks is provided on the tester, into which a pair of crystal headphones may be connected directly, or a pair of sensitive magnetic phones with a 0.05 mfd. condenser in one lead.

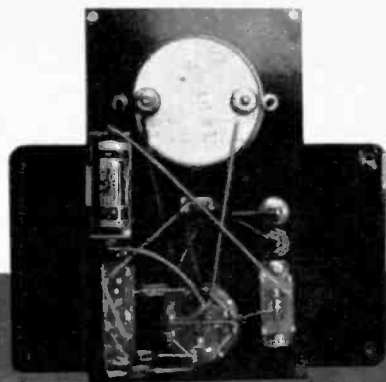

Inside view of tester. 15 v. battery is changed to 4½ v. to test surface barrier units.

To test a point contact or junction transistor, plug it into the socket under the meter and find the leakage first and then gain.

Diodes are plugged into the terminals on the left of panel; the switch is thrown from PNP to NPN, allowing meter to indicate crystals forward and back currents.

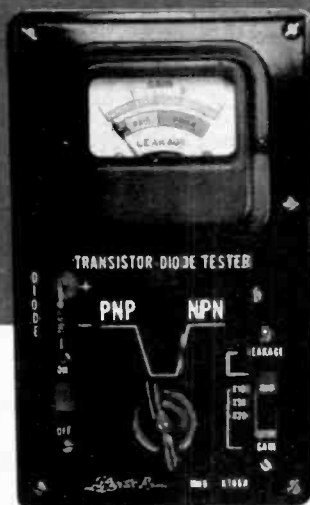

Diodes and rectifiers are tested by reading the amounts of current they pass in each direction. In one direction the current should be negligible, while in the other it should be about equal to the short-circuit battery current. With the power switch off, test leads from the jacks are connected to the appropriate terminals on the diode or rectifier. Then with the power on and the selector switches set to P-N-P and LEAKAGE, the reverse current is indicated. This

should never exceed 3 subdivisions on the scale. Then the selector switch is turned to N-P-N to read the forward current, which should not be less than 2 milliamperes. In the case of rectifiers, which operate at much higher voltages than that in the checker, a unit which tests OK at this low voltage may not perform satisfactorily at normal working voltage. If the test is NG, however, the suspected rectifier must be replaced. •

Solder with a clean tip! Use a piece of canvas or toweling rag.

How To Solder

By Art Craig

Learn to solder as well as the "pro's" and avoid mistakes when assembling kits or making repairs—just follow these instructions.

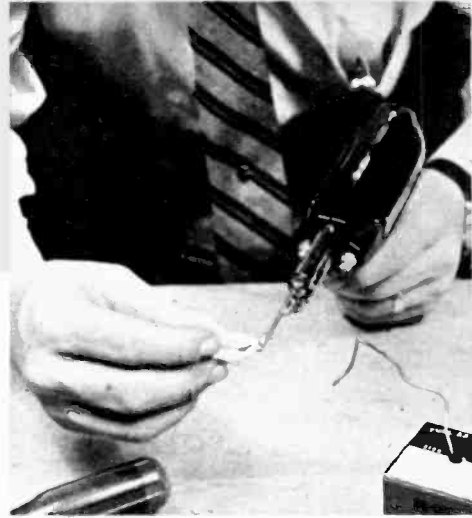

LOOK at the underside of any radio or amplifier chassis and you will agree that the *solder joint* is about the most important element in the circuit. It is a bond that securely terminates component leads and circuit wiring at strategic points in the mechanical design of the chassis. In the construction of an oscilloscope kit, I recently made no less than 375 solder joints!

Technicians servicing TV, radio or hi-fi equipment have found, after spending much time checking voltages and measuring resistances, that the source of trouble was often a poorly-soldered connection. After spending much time and effort in constructing an electronic kit many a home builder has had to recheck his solder joints to get the unit into operation. This should not be necessary because once the proper techniques of soldering are learned, this part of construction or repair becomes the easiest part of the job.

What Is Solder

Solder is an alloy of tin and lead that has a melting point much lower than

the metal it bonds. Soft solder as generally used in radio and electronics is available in a variety of gauges (thicknesses) and alloys. The alloy most widely used in radio work is 60/40 (60% pure tin and 40% lead). 60/40 has a lower melting point than 50/50 or 40/60 alloys, and it melts rapidly with the standard soldering irons and guns used today.

In contrast to bar solder and the can of rosin flux of yesterday, modern solder is manufactured in wire form and contains a center core or cores of rosin flux. Most metals (especially copper) tend to oxidize unless they are coated with nickel or tin. And, when heat is applied to a terminal lug, further oxidation tends to form on the lug and the wires or leads connected to it. The purposes of flux are to remove the oxidation, if any, on the leads and terminal lugs and prevent further oxidation during the soldering operation as well as reduce the surface tension of the molten solder as it flows through the joint.

A good grade of solder containing a non-corrosive rosin flux should only be

Remove a component from a wiring board by applying heat to its solder lug, using the notched end of a solder aid to lift the lead (left). For printed wiring use a low wattage iron (right).

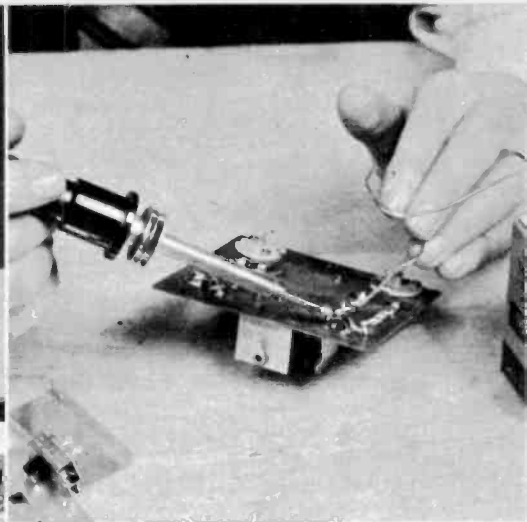
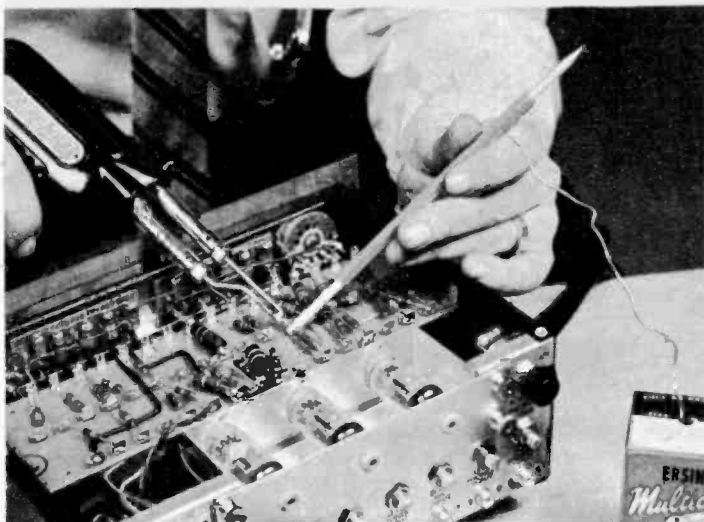

used in radio and electronic construction. Never use *acid-core* solder or an *acid flux* for this work! Acid flux will eventually corrode wires or leads in the circuit. More important, it is extremely hazardous to use acid flux when soldering delicate crystal diodes, coils, transformers, etc.

What Gauge To Use

Selection of solder gauge should be determined by the work being done. For work on printed circuits use thin gauge solder such as 18 S.W.G. (about $\frac{1}{16}$ " diameter). Such solder instantly melts on contact with the soldering tip, permitting "touch soldering" to avoid the excessive heat not recommended for printed circuits. In general work, especially where there are large areas at connecting terminals, 16 gauge (about $\frac{3}{32}$ " diameter) or heavier solder may be used. In all cases, it is a good idea to follow this rule: A thinner gauge in any alloy will melt more rapidly and should be used where small areas must be "touch-soldered" and excessive heat avoided at the terminal.

The Soldering Tool

The modern soldering gun is almost standard equipment with the service technician and has gained favor with the home constructor and hobbyist. Of course, when there is a good deal of bench work involved, the service technician keeps a hot "iron" going all day by means of a thermostat device so the heating element in the iron will not burn out. Such a device, when home-made, usually consists of a low wattage lamp in series with the soldering iron; the lamp is bridged by a switch. When the lamp is in the circuit, it maintains a predetermined temperature at the iron tip. When the soldering iron is to be used for a period of time, a flick of the switch bypasses the lamp and the soldering iron quickly reaches operating temperature.

In modern radio and electronic work incorporating miniature components, printed circuits and transistors, a large high wattage soldering tool is quite unnecessary and can prove to be cumbersome and unwieldy. For this type of work, a good quality "pencil iron" or an instantaneous-heating solder gun is

more efficient and safer for the parts.

A solder gun uses a step down transformer with a trigger-type switch. When the line voltage of 110 to 120 volts is reduced, the current increases and the solder tip, which is part of the secondary of the transformer, quickly develops heat. When the switch is released, the tip cools quickly and the solder gun can be placed on the table without any danger of damage.

Regardless of what type of soldering tool you use, the tip should always be clean and free from oxidation and pitting. It's a good idea to keep an old piece of toweling or canvass handy and to wipe the tip as often as required. Constant filing of a tip in a pencil or bench iron is not advisable. By keeping it clean with an occasional wipe of the towel or canvass rag, you avoid the necessity of filing and wearing the tip down. It is not recommended to carry solder on the iron tip to the joint. However, the tip should be "wet" so that it will not oxidize from the heat. A dirty or oxidized tip will not efficiently transfer heat to the solder lug and the soldering operation becomes difficult.

All soldering operations should be rapid and the flux should "sizzle" as it touches the heated solder lug. Always heat the connection or lug to which a wire or part is to be soldered, not the wire or part itself. Solder should flow freely and penetrate the wires of leads in the lug, forming a permanent bond.

Keep Work And Wires Clean

A good job of soldering requires more than a good soldering tip and a good grade of solder. The connecting lug, the wires, and the leads should be free of oxidation. Therefore, a certain amount of preparation must be done to assure a trouble-free solder joint. Here are a few good rules to follow:

1. Keep a ball of fine steel wool or emory cloth in the tool box or near the work bench.
2. Make it a practice to "tin" wires or leads as you cut them to size and remove insulation. This is done by heating the exposed wire ends and apply a thin layer of solder.
3. When a good ground to chassis is necessary, one of two methods may

When soldering new wires to a previously used part, such as the transformer shown below, the solder lugs should be cleaned with a wire brush and hot soldering tip before making the new connection. Open the hole in the lug by inserting the tip of a soldering aid, then tin leads.

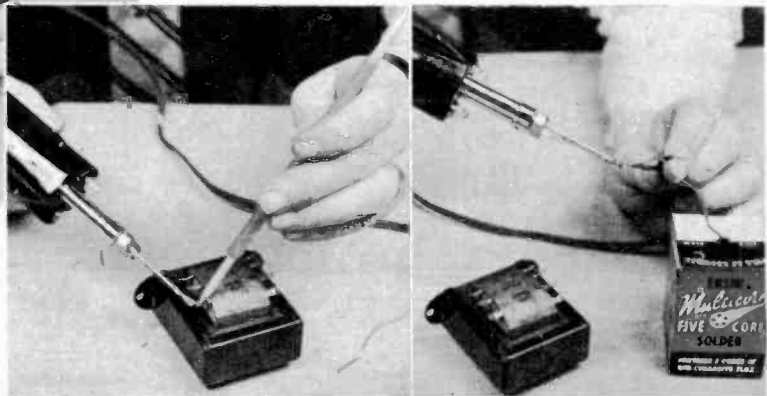
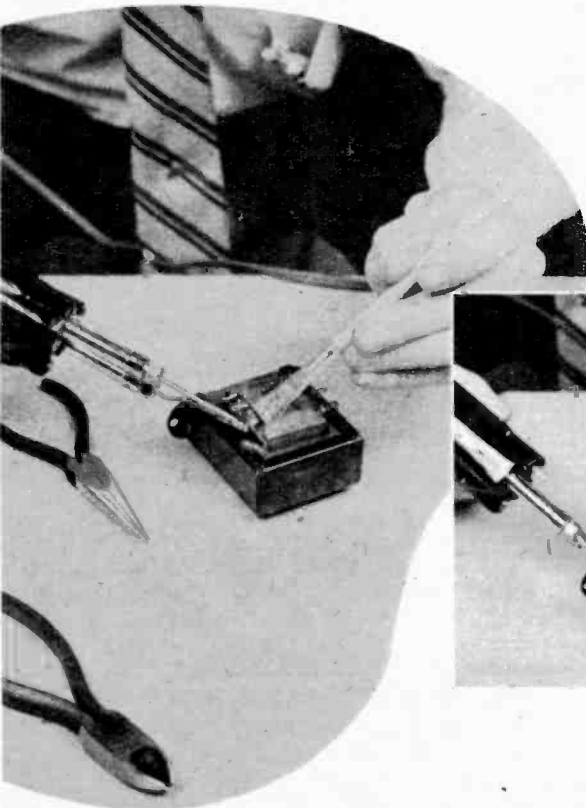

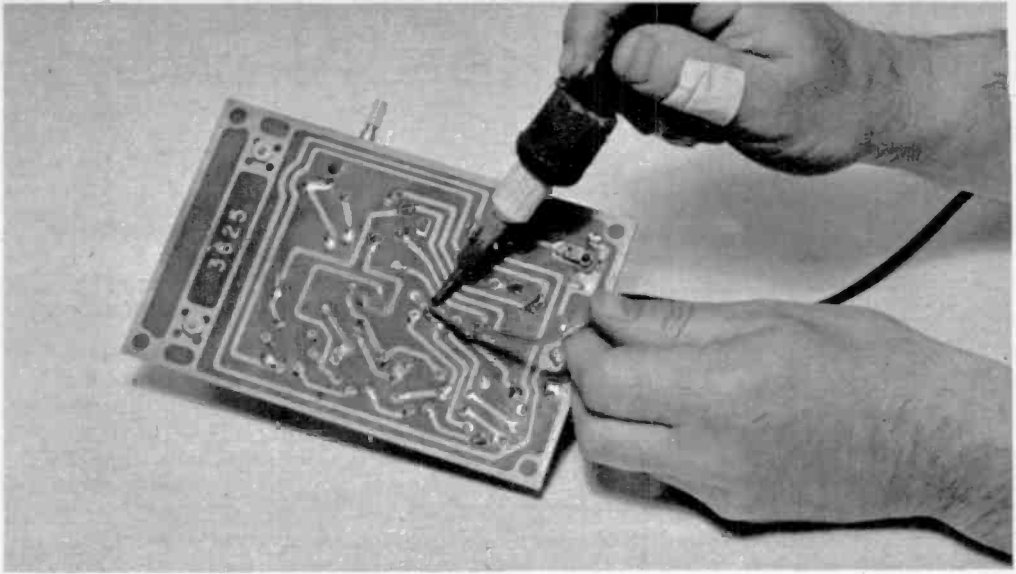

When using a printed wiring board, use a minimum of solder to avoid spillover on adjacent wires.

be used. The first is to scrape part of the chassis where the ground connection will be located with emery cloth and heat it with the tip of the iron, at the same time, "tin" the area with a film of solder. The second method is to drill a small hole in that part of the chassis. A solder lug is then fitted with a screw and nut and

heated and "tinned" thoroughly. The hole in the solder lug can be kept open by inserting the tip of a solder tool or awl.

4. When soldering wires or leads to terminals of a transformer, loudspeaker, etc., care must be taken to see that the solder lugs are free of wax, grease, and insulating varnish. •

Insert the new lead into the solder lug on the transformer and heat the lug until the solder flows onto the wire and into lug making strong bond.

When checking a piece of equipment for cold solder joints, dab with nail polish those joints which pass inspection. When done, resolder only unpolished joints.

Sometimes a third hand would be useful when tinning a lead or soldering a component. A spring clip can be used at such times to hold the soldering iron, leaving the hands free.

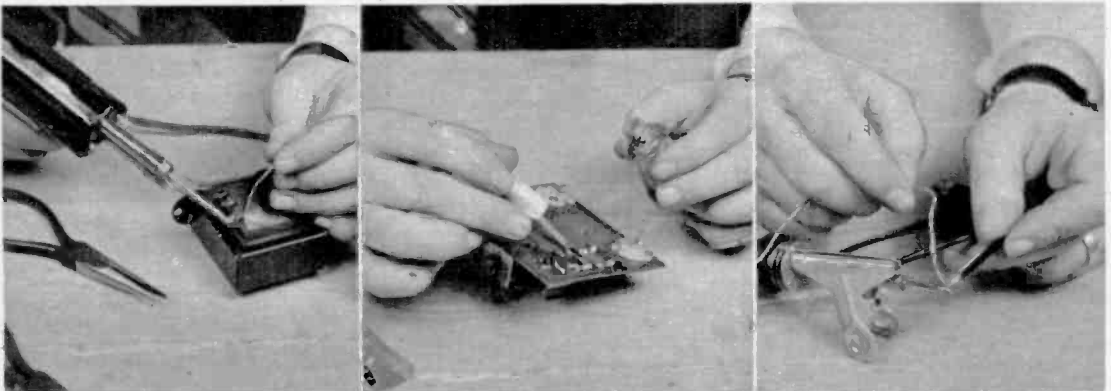

Stereo Makes News

By Donald Hoefler

The big hi-fi news of the year is stereo on records, but it has long been available on tape and broadcasts.

STEREO sound, the most exciting audio development since hi-fi itself, will be made available to hobbyists and music lovers this year as never before. Every medium of sound transmission—tape, records, radio broadcasts and soundfilm—have all successfully been used for stereo reproduction, and it is almost a certainty that all of them will soon be enjoyed at almost any time the listener wishes.

Stereo sound, like stereo pictures, gives a greater sense of presence, depth and direction. And just as stereo pictures are a possibility because we see with two eyes, so stereo sound is realized because we have two ears.

But stereo is *not* achieved simply by putting two microphones in front of an orchestra or two loudspeakers in a living room. Multiple mike setups have been used in broadcast and recording for years, and while they often provide better balance they don't

New cartridge developed to play stereo discs is shown below left. This ceramic pickup of Electro-Voice, Inc. plays stereo records and conventional discs and costs only \$19.50. One of the first stereo records offered to the hi-fi listener is shown below right. It utilizes the Westrex "45-45" system.

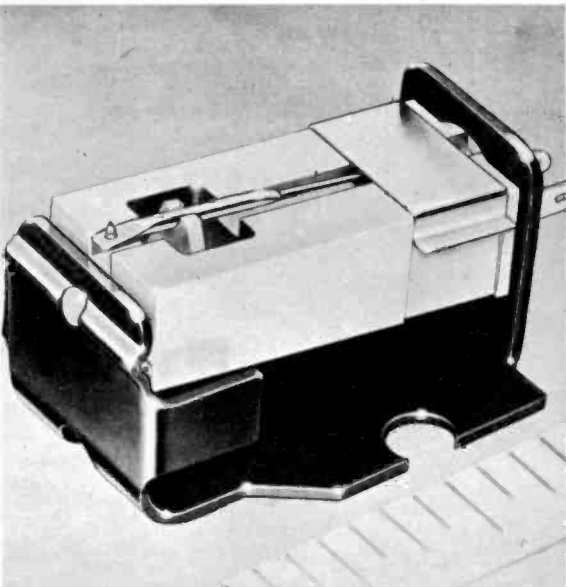



The JBL Ranger "Paragon" integrated stereo reproducer containing two multi-speaker systems.

provide stereo. Multiple speakers placed some distance apart often present a very pleasing spatial effect, but this isn't stereo either.

Stereo sound requires two or more completely separate transmission channels all the way from the original sound source right up to the loudspeakers. Although as many as 10 or more channels have been used in some experimental systems, program material for home use is all of the two-channel type.

By far the most popular source of stereo sound today is prerecorded magnetic tape. This has become possible through rapid advances in tape quality, which now permit using less than half the width of the tape for each recorded

channel. Not too long ago the idea of recording a signal on anything less than the full quarter-inch width of the tape would have been unthinkable.

The stereo tape reproducer has two separate playback heads, one to scan channel 1 and another simultaneously to scan channel 2. The rest of the stereo system involves two separate playback preamplifiers, two sets of cables, two audio power amplifiers and two complete and independent loudspeaker systems. Such a setup is obviously more complex and expensive than ordinary monaural hi-fi, but there are many who think that the outstanding results more than justify the investment.

Stereo sound in motion pictures is

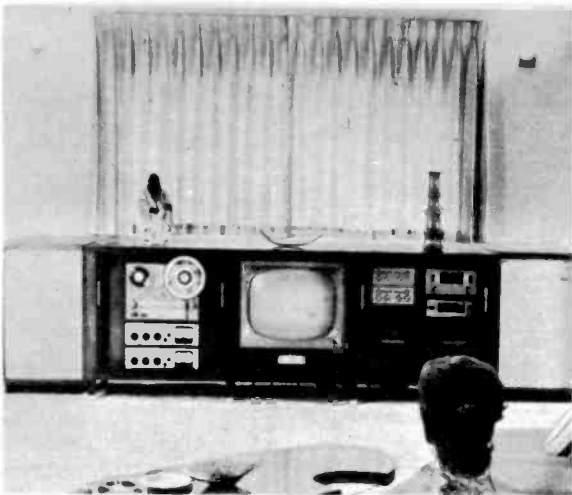

Complete home installation for stereo tape and radio. Equipment need not be so costly.



Stereo tape test and evaluation setup at the Minnesota Mining and Manufacturing Co.

now commonly heard in many leading theatres, but the first production of any importance to use the process had to carry its own sound equipment around from place to place. This was the Fantastone system employed in the original version of Walt Disney's *Fantasia*, which first appeared about twenty years ago. Today, of course, processes such as Cinerama, Cinemascope and others employ very elaborate stereo setups.

Several methods of broadcasting stereo have been used. One system involves co-operation between two separate FM stations, with each station carrying one of the channels. At the receiving point two receivers feed two amplifier and speaker systems. Another approach uses both an AM and an FM station in the same way. This is a little easier on the hi-fi fan's budget as several current AM-FM tuners are designed to receive two signals simultaneously, and thus constitute an all-in-one stereo receiving unit.

The newest method of stereo broadcasting, and one which shows great promise, uses only one FM station in a system known as multiplexing. In this arrangement a conventional modulator superimposes an audio signal on the FM carrier in the usual way. At the same time a supersonic frequency is imposed on the FM carrier and audio superimposed on that as well. Thus the supersonic signal acts as a sub-carrier for the second audio signal, which really makes the system FM within FM.

Since there is absolutely no inter-

action between the two signals noticeable at the receiver, it is of course possible to present two completely separate programs on the same carrier. But it is also possible to present both channels of the same program in stereo. Stereo multiplex program transmissions for the home are still experimental, but they are on the increase.

There are also a number of possible ways of achieving stereo sound on a disc. The earliest attempts were made in the Bell Telephone Laboratories in the early 1930's. Since the earliest days of recording, when the Edison cylinders had an up-and-down motion impressed on their grooves and the disc records had a side-to-side motion in theirs, there have been two basic methods of cutting a record.

The Bell system simply combined the two motions in a single groove, with the lateral part representing one channel and the vertical movement representing the other. The trouble was that it was exceedingly difficult to separate the two signals coming out of the pickup, and it was equally difficult to turn out quality discs on a mass-production basis. Consequently the idea was dropped.

But at the London audio show last year Arnold Sugden demonstrated his "Connoisseur" stereo disc and reproducer, and quite a sensation was created. The basic principle was the old vertical-lateral system of Bell Labs. The difference is that Sugden has shown that he can reproduce without objectionable cross-talk between channels.

Another stereo disc method is the Cook system, in which the first half of

the grooves are engraved with one channel and the inner half with the second channel. Then a Y-shaped tone arm with two pickups drops a stylus into the lead-in groove of each band.

At the New York hi-fi show in October of last year, there was demonstrated still another type of stereo disc which in many ways is the simplest and most direct yet. The basic notion of the system, which has been dubbed the 45-45, is simplicity in itself. Since every record groove has *two* walls, why not modulate each one separately for each of the stereo channels?

The 45-45 system does just that, with a special cutter with two styli at right angles to one another and each making about a 45° angle with the record surface. The first pickups were hand made in the laboratories of the developer, Westrex, but trade reaction to this system has been so favorable that already several pickup manufacturers have completed development work and are ready to get into mass production on 45-45 pickups as soon as records appear on the market.

Just which stereo disc system will become the standard is still not a closed issue. Recently another entry, this one from Components Corporation, was demonstrated to the trade and press. This is somewhat similar in principle to the FM multiplex system for stereo broadcasting. This method engraves first a conventional lateral groove. In addition there is an FM carrier on which a "difference" signal is modulated. Because of the high frequencies involved,

the second signal is not really the other "ear" of a complete stereo system, but rather only enough information to establish a distinct difference between the two reproducers. Development work on this system is continuing, and it shows distinct promise.

Reproducing systems for stereo, regardless of the program source, will require two loudspeakers, two power amplifiers, and in most cases two preamplifiers. The transducer at the input end will depend upon program source.

For tape the reproducing machine must have stereo playback heads, but is, conventional in every other way. Stereo home movie equipment is not yet being made, but there is no technical reason why it could not be, and if a demand develops the equipment will most certainly become available.

Stereo broadcasts require two FM tuners, an AM and an FM tuner, or an FM multiplex tuner, depending upon the method of transmission. As for stereo discs, most record manufacturers are setting up to make stereo records depending upon customer demand. Both the Record Industry Association of America and the Electronic Industries Association have urged adoption of the Westrex 45-45 system as the standard. But still other competing systems are now in the laboratories, and which one will take the brass ring is a matter for some conjecture.

The only thing which can be said for a certainty is that the next few months are going to be mighty interesting stereo-wise! •

Westrex "45-45" stereo head cutting a disc.

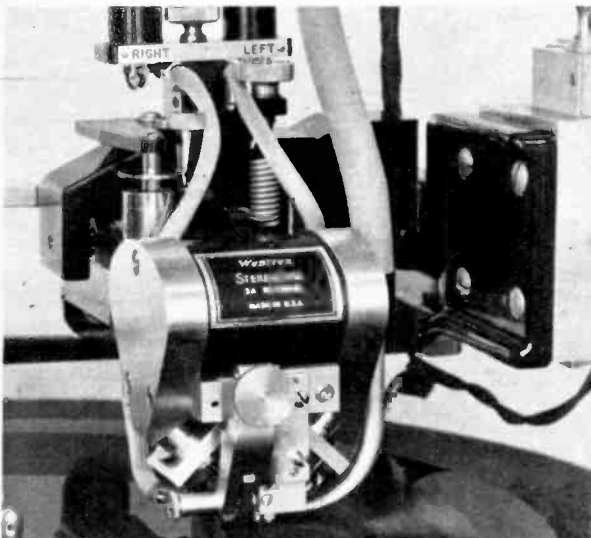

Microphotograph of "45-45" stereo grooves.

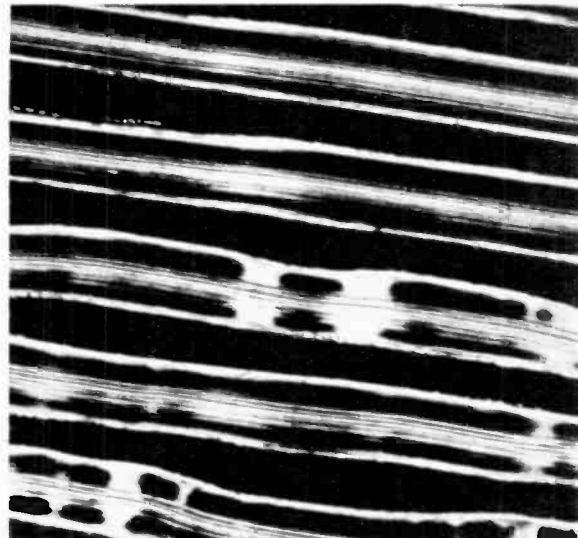



Set your automatic timer to wake you to hi-fi music from your tuner.

Automatic Music System

Don't miss important music broadcasts when you're busy—use an automatic timer to record them and, incidentally, to wake you to music.

IT'S three minutes away from the time of the Maestro's farewell performance broadcast from Carnegie Hall.

In your living room there's a sudden *click!* An FM tuner dial lights up; the tuning meter swings wildly for a moment and then locks in.

Tape recorder reels start to revolve; a recording level eye winks greenly. Your hi-fi speaker tells an empty living room—"We now take you to Carnegie Hall." And every thrilling moment of the concert is captured on tape—at the same time you were out on that important date or business conference.



Automatic control of factory machines have been making the news for many months. Drill presses and lathes turn on and off without human hands at the switches. The wheels of industry go round controlled by punched tapes, clockwork timers and many other types of programming devices. By using the same techniques, you can adapt your hi-fi set and/or tape recorder to catch once-in-a-lifetime broadcasts—automatically.

The "brain" of the operation is an Intermatic time switch Model T675. Although not as clever as those employing feedback principles, it has a number of special features. The Intermatic can be adjusted to turn equipment on or off at two hour intervals over a twenty-four hour period. Furthermore, it can be set to determine at each interval how long it will remain on. Other timers that are useable are the Tork Model 801 and the Reliance Model W33.

The three or four button timers found in clock radios have a disadvantage in that the period during which the unit remains "on" is not adjustable. If you try and set up an automatic taping system with one of these types, the chances are that you'll come home to find either the recorder has been shut off prema-

turely or the last few feet of tape have been beaten to shreds because the tape reel ran out and the recorder kept going.

The adjustable "on" interval type avoids these problems and can be set to tape a number of programs of different length at different times. As a low-fi example of the Intermatic timers' flexibility; Mother can set it up to record her favorite fifteen minute soap operas at 3¾ ips each day, all week, while she's away on vacation. She can then return home and get a full week's dose in one sitting.

Other uses of timers such as providing morning awakening to Brubeck or Brahms, depending upon your mood and taste, are obvious. Your morning program can either be set up in advance on your tape or record player, or be left to the discretion of your tuner.

Connecting the timer to the equipment to be controlled is simplicity itself, merely follow the directions and diagram on the timer cover.

The adaptability of these timers is amazing. They will find use in the kitchen, bedroom or living room. The day of automation is upon us and your ingenuity is the only limitation placed upon the how, when and where of time switches in your home. •

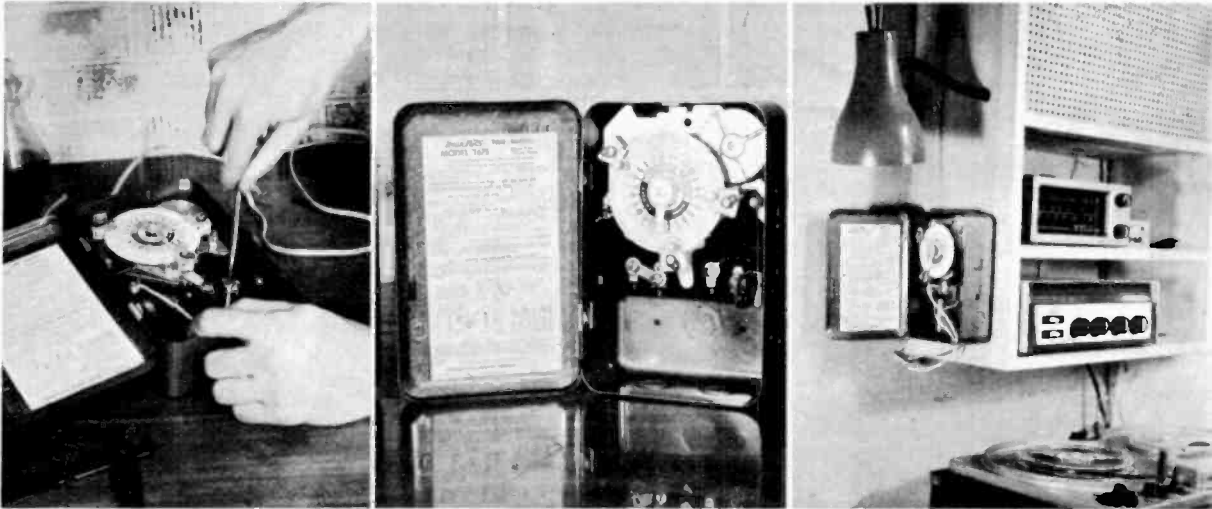

The Intermatic timer above and at left contains, on the front cover, full instructions and necessary diagrams for connecting the timer to your hi-fi set, etc. The timer is shown at the right controlling an FM-AM tuner, tape recorder and amplifier. The unit need not be exposed, it can be hidden.

transistor electronic flash

Lightweight and powerful, this unit operates off inexpensive flashlight batteries and uses a single power transistor.

ELECTRONIC flash guns have long suffered from the disadvantage of excessive weight. This feature has been more or less unavoidable because of the nature of the high-voltage supplies used to energize the xenon-filled flash tubes. These consist generally of either of the following: 1) A single large dry battery developing several hundred volts; very expensive, and becomes useless when its voltage falls off only slightly. 2) The equivalent of an automobile radio's "B" section, comprising a small storage battery, a vibrator and a rectifier; the battery is full of lead, and the vibrator generally is unreliable.

The advent of the power transistor has changed the situation radically, and for the better. A West German manufacturer has hit the market with the first transistorized electronic flash, the Mecablitz 100, which is sold in the United States by *Burleigh Brooks, Inc.*, of New York, the well-known importers of the Rolleiflex cameras.

The technical concept of this unit is entirely different from that of its predecessors. A single large transistor is employed in a simple audio oscillator circuit, the frequency of which is not critical and lies between 5,000 and 10,000 cycles. The output of the oscillator is stepped up to about 500 volts by a small



Top, inside of Mecablitz 100 flash unit. Finger indicates transistor, oscillator is under shield. The complete unit as shown above is book size, note position of convenient on-off switch.

transformer, and then turned into pulsating DC by a dry rectifier. From here on the operation is conventional. The DC, at a low value in the order of milli-amperes, dribbles into a large electrolytic capacitor, and when this is fully charged the camera shutter discharges it into the flash tube.

The transistor being essentially a low-voltage device, the source of energy for the oscillator can be obtained effectively and economically from six ordinary "D" size flashlight cells, available everywhere. One set of batteries is good for more than 700 flashes. The time required for the capacitor to charge up, between flashes, is about ten seconds. With batteries, the entire shoulder-slung unit weighs only four pounds.

I tried a stock sample of the Mecablitz 100 with a Rolleiflex and a Leica M3, and was delighted with its reliable, foolproof operation. A guide number of 110 (that is, 110 divided by distance to subject equals lens opening) gave fine, clear negatives on Verichrome Pan in the Rollei and Plus-X in the Leica, with normal development in D-76 and with prints on No. 2 paper. The flash duration is 1/800 second, which is more than fast enough for the shooting of such active subjects as children and pets.

—R. H.



MR. ELECTRONICS MAN:
If you're willing to go
just half-way in electronics
TURN THIS PAGE!

But if you're interested in an honest-to-goodness *career* in *electronics*, here's how to step ahead of job-competition, get a better job, earn more money, and be sure of *holding* your technical job, even when the brass starts "laying off."

The "how" is CREI home-study training. CREI offers you recognized advanced, professional home study training in Electronic Engineering Technology, including **SERVO-MECHANISMS; COMPUTERS; RADAR; AUTOMATION; AERONAUTICAL ELECTRONICS; BROADCASTING; COMMUNICATIONS and MANUFACTURING, and the ELECTRONIC PRINCIPLES ASSOCIATED WITH GUIDED MISSILES, TELE-METERING, ASTRONAUTICS and INSTRUMENTATION.** You can choose your preferred course of training. You don't have to be a college graduate. You *do* have to be willing to study—at home. You can do it while holding down a full-time job. Thousands have. Remember this: CREI starts with fundamentals and takes you along at *your own speed*. You are not held back by a class, not pushed to keep up with others who have more experience or education. Your instructors guide your study and *grade* your written work personally. You master the fundamentals, then get into more advanced phases of electronic engineering principles and practice.

Since 1927 CREI has provided alert young men with the technical knowledge that leads to more responsibility, more job security, more money. And CREI has constantly kept pace with the rapid expansion and progress

in electronics. More than 30 years' experience qualifies CREI to train you.

How good is CREI training? CREI home study courses are accredited by the Engineers' Council for Professional Development; CREI is an approved member of the National Council of Technical Schools. Ask personnel managers how they regard a man with a CREI "ticket." Many organizations recommend CREI training for their own personnel. These are but a few examples: United Air Lines, Canadian Broadcasting Corp., The Martin Co., Federal Electric Corp

CREI ALSO OFFERS RESIDENCE TRAINING at the same high technical level, in Washington, D. C. Classes start at regular intervals. Qualified residence school graduates earn degree, "Associate in Applied Science." Check coupon if you prefer residence study. **VETERANS:** If eligible for training under the new G. I. Bill of Rights, check the coupon for full information.

NOT FOR BEGINNERS. If you have the equivalent of a high school education, and are good at mathematics, if you have some electronics experience (advanced amateur, industrial or military),—and realize the need of high-level technical knowledge to make good in the better electronic jobs—you can qualify for CREI home study training. (Electronic experience is not required for admission to CREI Residence School.)

What's the next step? The logical one is to get more information than we can cram into this page. The coupon below, *completely* filled out, will bring you a fact-packed booklet, "Your Future in the New World of Electronics." It includes outlines of courses offered, a resume of career opportunities, and tuition details. It's free.

Mail coupon today, or write Capitol Radio Engineering Institute, Dept. 175-E, 3224 16th St., N. W., Washington 10, D. C.

MAIL COUPON FOR FREE BOOKLET

CAPITOL RADIO ENGINEERING INSTITUTE

ECPD Accredited Technical Institute Curricula — Founded 1927

Dept. 175-E 3224 16th St., N. W., Washington 10, D. C.

Please send me your course outline and **FREE** illustrated Booklet, "Your Future in the New World of Electronics"... describing opportunities and CREI home study courses in Practical Electronic Engineering Technology.

- CHECK** Radar, Servo and Computer Engineering Technology
FIELD OF Electronic Engineering Technology
GREATEST Broadcast (AM, FM, TV) Engineering Technology **12**
INTEREST Television Engineering Technology
 Aeronautical Electronic Engineering Technology

Name.....Age.....

Street.....

City.....Zone.....State.....

Check: Home Study Residence School Korean Veteran

To help us answer your request intelligently, please give the following information:

EMPLOYED BY

TYPE OF PRESENT WORK.....

EDUCATION: YEARS HIGH SCHOOL.....

YEARS COLLEGE.....

ELECTRONICS EXPERIENCE.....

The ABC's of Electronics

[continued from page 75]

of information gathered by instruments from an unmanned point. One of the first devices to telemeter information back to a control station was the radio-sonde weather balloon. Now when we want to know how high or how fast our last guided missile went, or what conditions are aboard an artificial satellite or inside an atomic reactor, telemetering gives us the answers.

Electronic Instrumentation

This leads us to a closely related branch of electronics. As we implied earlier, almost any physical effect such as heat, light, sound, vibration, infra-red and X-rays, can produce an electronic signal if a suitable transducer exists. One of the advantages of electronic systems is the ability to *amplify*, that is to strengthen very feeble signals. Thus the transducer needn't be very sensitive, nor must it upset the physical condition it is attempting to measure.

At the output of the electronic circuit we have a *readout* device, which gives us the information we want. In the engine ignition analyzer the indicator is usually a cathode ray tube. On a Geiger counter it is an ordinary meter. The electrocardiograph provides a permanent photographic record.

Other electronic instruments include the photographic exposure meter and colorimeter, the electron clock and the ionization gauge used in physics laboratories. The chemist uses a *pH* meter to determine the acid or alkaline state of a solution, the engineer uses an electronic strain gauge, the doctor an electroencephalograph, the astronomer a radio telescope, and the weekend sailor an electronic fume detector to warn him of an explosive condition in the bilge of his boat. All of these are electronic instruments, and there are many, many more.

Electronic Controls

In any system involving the use of power, there is also a need for controlling this energy accurately and rapidly. The hydraulic brakes on a car, or the switches on an electric stove, are just

two examples of low power devices which control high powered ones. It doesn't take much work to depress a brake pedal, yet this will stop a car weighing well over a ton. And little effort is required for turning on a stove, yet the voltages and temperatures controlled are powerful enough to kill a person.

The idea of using a low power device to control a high power system is the basis of the *servo* principle, and the devices themselves are called *servomechanisms*. Since they are in effect amplifiers of power, they can be at least partly electronic in nature. Electronic servomechanisms are widely used in automatic pilots, artillery fire control systems, and in many factory production and assembly processes.

Since even the best servo system is inanimate, it is still a slave to mankind and must be told what to do. It can have a "master" in constant attendance, pushing buttons, throwing switches or turning rheostat knobs. In this case the system is called an *open cycle* control.

But in many cases the instructions are prepared in advance, and recorded in some way, such as on a punched or magnetic tape. Or the system may be self-correcting, such as the automatic pilot which senses when the airplane is going off the set course and automatically makes correction. This type of operation, in which a human starts it off but then leaves the system to take care of itself, is known as *closed cycle* control and the process is called *automation*.

Electronic Switching

Many electron tubes and circuits can be adjusted so as to act as on-off devices. That is, instead of passing varying currents as an amplifier does, they will pass either a fixed amount of current or no current at all. Thus they are in effect electronic switches. They don't wear out mechanically, and when they do fail, usually plugging in a new tube will make the repair.

A huge number of electromechanical switches and relays are employed in automatic telephone dialing systems, but

ONE PRICE FOR EVERY TYPE OF TUBE

DON'T PAY MORE FOR SET TESTED LONG LIFE
DEPENDABLE HI-FI RADIO AND TV TUBES • BUY
VIDEO • INDIVIDUALLY BOXED—ALL GUARAN-
TEED FOR ONE YEAR OR YOUR MONEY BACK
WITHIN 5 DAYS.

Some	Standard	Brand—Others	with Famous	VIDEO	Brand
0A2	5U4G	6H6GT	12AT7		
0A3	5U8	6J4	12AU6		
0A4	5V4G	6J5GT	12AU7		
0B2	5Y3	6K6GT	12AV6		
0C3	5Y4G	6L6	12AV7		
0Z4	6AB4	6L6	12AX7		
1A7GT	6AC7	6N7GT	12AZ7		
1B3GT	6AG5	6S4	12B4		
1C7G	6AF4	6S7G	12BA6		
1F4	6AH4GT	6SA7	12BE6		
1H4	6AK5	6SB7Y	12BH7		
1H5GT	6AL5	6SC7	12BH7		
1J6GT	6AM8	6SF5	12CU6		
1L4	6AN4	6SF7	12SA7		
1L6	6B8	6SG7	12S67		
1LA6	6AQ5	6SH7	12SH7		
1LC5	6AQ7GT	6S17GT	12S17GT		
1LM4	6AS5	6SK7GT	12SK7		
1LN5	6AS7G	6SL7GT	12SN7GT		
1N5GT	6AT6	6SN7GT	12SQ7		
1S4	6AU4GT	6SQ7	12V6GT		
1S5	6AUSGT	6SV7	12X4		
1T4	6AU6	6SS7	14A7		
1U4	6BV5GT	6T8	14B6		
1U5	6AV6	6U4GT	14D7		
1V2	6AX4GT	6U7G	19B6G6		
1X2	6BA6	6U8	19T8		
2A7	6AX5GT	6V3	24A		
2D21	6BC5	6V6GT	25AV5GT		
2X2	6BC7	6W4GT	25B06GT		
3A4	6BE6	6W6GT	25CD6G		
3A5	6BF5	6X4	25CUB		
3AL5	6BG6G	6X5GT	25L6GT		
3AU6	6BH6	6X6	25W4GT		
3RC5	6B16	6Y5G	25Z6GT		
3CB6	6BK5	7A5	35L6GT		
3Q4	6BK7	7A7	35W4		
3Q5GT	6BN6	7B5	35Y4		
3S4	6BL7GT	7C5	35Z3		
3V4	6B06GT	7C6	35Z5GT		
4B27	6BQ7	7C7	50A5		
4B97	6BY5G	7F7	50B5		
5AM8	6BZ7	7F8	50C5		
5AN8	6C4	7N7	50L6GT		
5AQ5	6CB6	7Q7	80		
5AT8	6CD6G	7Y4	117N7GT		
5AW4	6CF6	7Z4	117P7GT		
5A24	6CS6	12A6	117Z3		
5J6	6CS6	12AH7GT			
5T4	6CUBGT	12AT6			
5T8	6E5				

FREE RCA "CHEATER" CORD GIVEN WITH ANY TUBE ORDER
OF \$7.00 OR MORE! PROMPT SHIPMENT OF ALL ORDERS.
Brand New Factory Seconds! Electrically Perfect Factory Seconds!
Used Tubes! New and Used Job Surplus Tubes!

40¢
FOR ANY
TUBE
\$37.00
PER HUNDRED

We Have OVER 1000 USED TV SETS

At All Times in Our Huge Warehouse. Buy one or more of these WORKING TV's to sell or use as your own second set! All sets in GOOD WORKING condition. Your choice—Console or Table Model.

10"	\$23.00	19"	\$58.00
12"	\$28.00	20"	\$64.00
14"	\$33.00	21"	\$72.00
16"	\$40.00	24"	\$99.00
17"	\$46.00		

When ordering TV's state whether table model or console is desired. Also preference on make of set. All TV's sent railway express F.O.B. Newark. On any quantity WIRE or CALL today!

WHY PAY MORE FOR TUBES . . . ORDER TODAY!

FREE BONUS ANTENNA GIVEN WITH ANY TV SET ORDER!

SEND for our FREE complete TUBE AND PARTS LIST and order blank.

FREE POSTAGE in U.S.A. and Territories on orders over \$5.00. 25c handling charge on orders under \$5.00. 25% deposit required on C.O.D.'s. Please send approximate postage or freight on Canadian and foreign orders. Subject to prior sale.

VIDEO

ELECTRIC COMPANY Phone
79 CLINTON PL. NEWARK, N. J. HUmboldt 4 9348

**THIS IS THE WAY
A GREAT TAPE RECORDER
IS BUILT...**

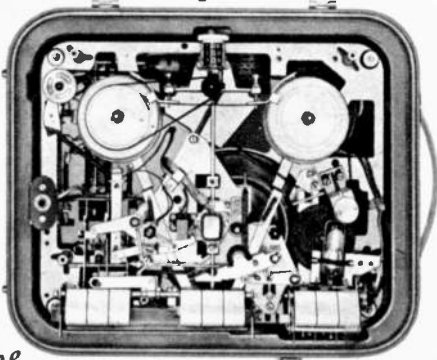

the **NORELCO®**

'CONTINENTAL'

world's most advanced all-in-one portable

TAPE RECORDER

Engineered by Philips of the Netherlands, world pioneers in electronics
Precision-crafted by Dutch master technicians

Styled by the Continent's top designers
Three speeds (7½, 3¼ and 1½ ips) ... twin tracks ... push-button controlled

Special narrow-gap (0.0002 in.) head for extended frequency response

Built-in, wide-range Norelco speaker
Also plays through external hi-fi set

For the name and address of your nearest Norelco dealer, write to Dept. E



NORTH AMERICAN PHILIPS CO., INC.
High Fidelity Products Division
230 DUFFY AVENUE, HICKSVILLE, L.I., N.Y.

the handwriting on the wall says that they are doomed for replacement by electronic switching circuits. Electronic data processing equipment, better known as computers or "electronic brains," also depend for their operation upon hundreds of electronic switches.

Now that we know just a few of the things this amazing art of electronics embraces, in the next issue we can begin exploring some of the habits of the tiny electron, which has been harnessed for the benefit of mankind. •

First Novice Transmitter

[continued from page 60]

press the key and adjust C9 again for resonance, indicated by a sharp decrease in plate current. Now adjust C12, the loading control, for maximum brilliance of the 40 watt lamp, while at the same time keeping the output circuit resonance by alternately adjusting C9 and C12. The purpose of these adjustments is to obtain maximum brilliance of the 40 watt lamp, and adjustment of one condenser will affect the other. Go through these adjustments several times until you get the feel of it. Incidentally do not allow the plate current to rise above 120 ma. during these adjustments.

In making these adjustments you have been substituting the 40 watt lamp for your antenna. Now you are ready to go on the air so you can disconnect the lamp from the transmission line and connect your antenna to it in its place. When this has been done, once again, turn on the power supply and after warm-up, depress the key and adjust C9 for resonance. Touch up the loading condenser C12 until the plate-current reads about the same figure you read before when you lit the 40 watt lamp to maximum brilliance, at the same time keeping C9 (plate tuning condenser) adjusted for resonance. Once again do not exceed 120 ma. plate current.

One word of caution—check your crystal frequency and make sure you operate your transmitter within the confines of the novice bands. An on air check with a friend who has a reliable

[continued on page 108]

Superior's New Model 70 UTILITY TESTER®

FOR REPAIRING ALL ELECTRICAL APPLIANCES MOTORS • AUTOMOBILES • TV TUBES

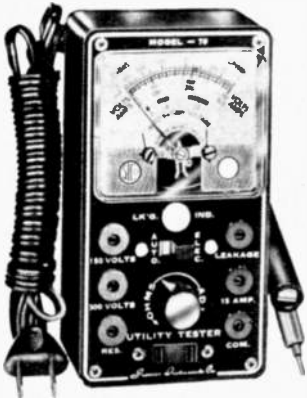

As an electrical trouble shooter the Model 70:

- Will test Toasters, Irons, Broilers, Heating Pads, Clocks, Fans, Vacuum Cleaners, Refrigerators, Lamps, Fluorescents, Switches, Thermostats, etc.
- Will test all TV tubes for open filaments, inter-element shorts, burned out tubes, etc.
- Measures A.C. and D.C. Voltages, A.C. and D.C. Current, Resistances, Leakage, etc.
- Will measure current consumption while the appliance under test is in operation.
- Incorporates a sensitive direct-reading resistance range which will measure all resistances commonly used in electrical appliances, motors, etc.
- Leakage detecting circuit will indicate continuity from zero ohms to 5 megohms (5,000,000 ohms).

As an Automotive Tester the Model 70 will test:

- Both 6 Volt and 12 Volt Storage Batteries • Generators • Starters • Distributors • Ignition Coils • Regulators • Relays • Circuit Breakers • Cigarette Lighters • Stop Lights • Condensers • Directional Signal Systems • All Lamps and Bulbs • Fuses • Heating Systems • Horns • Also will locate poor grounds, breaks in wiring, poor connections, etc.

IT'S SO EASY!!



With tester's cord in outlet, current consumption of appliance is read direct on meter when line cord is connected to receptacle on panel. This typical iron takes 7 amperes (Good).



Small electric fan motor indicates 50 ohms (normal resistance).



Control circuits of most furnaces use 24 volts obtained from step-down transformer. Here's how to check room thermostat to see if wires to it are alive.



Manual supplied with Model 70 shows meter needle should move to right when test leads are connected to pins 3 and 4 of this 6AU6 tube. Procedure for testing all tubes used in TV are detailed in manual.

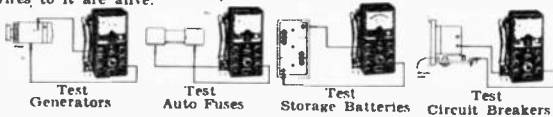

READ THIS!

READ THIS!

READ THIS!

You don't pay for the Model 70 until AFTER you have examined it in the privacy of your home! Model 70 is

SHIPPED ON APPROVAL NO MONEY WITH ORDER — NO C. O. D.

Try it for 10 days before you buy. If completely satisfied then send \$3.85 and pay balance at rate of \$4.00 per month for 3 months — No Interest or Finance Charges Added! If not completely satisfied, return to us, no explanation necessary.



INCLUDED FREE!!

This 64-page book—practically a condensed course in electricity. Learn by doing.

Just read the following partial list of contents:

- What is electricity? • Simplified version of Ohms Law • What is wattage? • Simplified wattage charts • How to measure voltage, current, resistance and leakage • How to test all electrical appliances and motors using a simplified trouble-shooting technique.
- How to test all TV tubes; also simple procedure for determining which specific tube (or tubes) is causing the trouble.
- How to trace trouble in the electrical circuits and parts in automobiles and trucks.

Model 70 comes complete with above \$15⁸⁵ book and test leads. Only ...

MOSS ELECTRONIC DIST. CO.

Dept. D-443 3849 Tenth Ave., New York 34, N. Y.

Please rush me one Model 70. If satisfactory I agree to pay \$3.85 within 10 days and balance at rate of \$4 per month until total price of \$15 85 plus postage is paid. If not satisfactory, I may return for cancellation of account.

Name _____

Address _____

City _____ Zone _____ State _____

 **YOU NEED THIS**

FREE GIANT 1958 B-A CATALOG

A COMPLETE BUYING GUIDE FOR EVERYTHING IN
RADIO · TV ELECTRONICS
B-A 1958
 ANNUAL CATALOG SET
 SINCE 1927

BURSTEIN-APPLEBEE CO.
 Dept. IE, 1012 McGee St., Kansas City 6, Mo.
 Send Free 1958 B-A Catalog No. 581.

Name _____
 Address _____
 City _____ State _____

SEND FOR IT TODAY

172 KING-SIZED PAGES

EVERYTHING IN RADIO TV AND ELECTRONICS

100'S OF NEW ITEMS LISTED HERE FOR 1st TIME

21 PAGES OF BARGAINS NOT IN ANY OTHER CATALOG

Build A Stereo Speaker

[continued from page 53]

these two terminals and touch the other end of each wire to one side of a flashlight battery. Watch the speaker cones at the moment of contact, you'll notice that they all either move in or out. If one speaker does not move in the same direction as the others, reverse the leads going to the terminals of that particular speaker. Then make the flashlight battery test again until all speaker cones move in same direction at same time.

Crossover

A simple coil and condenser combination will serve to separate the high frequencies from the lows and feed the former to the separate tweeter used in this speaker system. For another dollar you can add a "brilliance" control. Any 8 to 16 ohm tweeter will work with the woofer described here provided it has a crossover of 2000 cps or under. Select one which matches, soundwise, the tweeter in your first speaker system.

The capacitor is a dual 20 mfd, 150-volt electrolytic. Simply cut off its negative lead and use the remaining two positive leads as terminals. Its effective capacity is now equal to *one half* of one section—or 10 mfd.

The coil is wound on a 1½" length of 1" wooden dowel. The end pieces can be made of Masonite, plywood or any nonmetallic flat material. Wind 250 turns of No. 18 enameled copper wire on this form. It is not necessary that the wire be accurately layer-wound, provided that the coil form is evenly filled.

The "brilliance" control, needed for balancing the higher frequencies, is a 50- to 100-ohm, 2 watt wirewound potentiometer.

The bass power packed in this little job will amaze you. Since the individual speakers used were rated at only 2 watts each, no more than a 10 to 15 watt amplifier should be used in driving it. For a modest investment, you've built yourself a speaker system that not only is a "stereo-mate" for your living room, but will be a welcome guest in a solo role as an extension speaker in any room in your house. •

Learn ELECTRIC APPLIANCE REPAIR IN YOUR SPARE TIME AT HOME

START YOUR OWN BUSINESS

WITH A POTENTIAL MARKET OF 50,000,000 CUSTOMERS

New shop-method, home-training system gives you electrical know-how that used to take years to learn. Learn at home by building valuable testing kits, repairing your own and neighbors' appliances. It is charge on the basis of \$5.00-\$8.00 an hour.

FREE ILLUSTRATED BOOK
 Shows you how you learn every phase of electrical appliance. How to make money while you learn. Write today for your FREE copy.

CHRISTY TRADES SCHOOL
 Dept. D-162
 4804 North Kedzie Ave., Chicago 25

ONE BUSINESS THAT IS NOT AFFECTED BY STRIKES, DEPRESSIONS OR POLITICS

FREE!
LAFAYETTE
CATALOG



NEW 180 PAGE ELECTRONIC CATALOG FEATURING THE BEST BUYS IN THE BUSINESS

The newest and largest assortment of Electronic, Radio and TV parts, Hi-Fi and Public Address Components and systems, Test Equipment, tubes, Transistor Kits and miniaturized components for transistor circuitry, Ham Equipment, Builders Kits, Tools, Books, Microscopes, Binoculars, Telescopes, Cameras, and Drafting Equipment—**ALL AT LOWEST PRICES**—Catering to the economy minded dealer, serviceman, engineer, technician, experimenter and hobbyist. **CRAMMED FULL OF MONEY SAVING BUYS. SEND FOR YOUR FREE COPY TODAY.**

Lafayette - ELECTRONIC PROJECT HEADQUARTERS FOR THE EXPERIMENTER AND HOBBYIST

6 TRANSISTOR SUPERHET RECEIVER KIT with LATEST NPN-PNP COMPLEMENTARY

- GE 2N188A AUDIO TRANSISTORS IN PUSH-PULL OUTPUT
- 100% SUBMINIATURIZED
- NEW 28 PAGE INSTRUCTION MANUAL



This transistor set provides superior commercial quality. Circuitry features 6 transistors and diode, matched loop, oscillator coil and IF's and transformer coupled push-pull audio. Speaker and earphone jack for private listening. Complete kit includes detailed instructions. 6 1/2 x 3 1/2 x 1 1/2". Shpg. wt., 3 lbs.

NEW	KT-119A—Complete Kit—Less Battery and Case.....	Net 29.95
29.95	Less Case and Battery	
	BATTERY — BURGESS 2N6.....	Net 1.30
MS-339A—Brown leather case with carrying strap.....		Net 2.95
MS-368—Sensitive Matching earphone.....		Net 1.29

3 TRANSISTOR SUPERHET POCKET RADIO KIT

- A TRUE POCKET SUPERHET RECEIVER—NO EXTERNAL ANTENNA
- NO EXTERNAL GROUND



A truly sensitive, super-selective pocket superhet receiver. Features matched components, built-in ferrite antenna, compact circuitry and commercial appearance. Complete kit with detailed instructions. 1 3/4 x 2 3/4 x 1-1/16". Shpg. wt., 1 lb.

KT-116—Complete Kit, less earphone.....

MS-260—Super Power Dynamic Earphone.....	Net 3.95
or MS-368—Sensitive Economy Dynamic Earphone.....	Net 1.44

4 TRANSISTOR TELEPHONE PICKUP AMPLIFIER KIT

- FOR GROUP LISTENING OF PHONE CONVERSATIONS

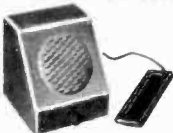

Extra-sensitive 4 transistor telephone pickup amplifier with "class B" push-pull output for efficient speaker operation. Merely requires pickup coil under or near phone. Also may be used as high gain amplifier for phono and mike.

Easy-to-follow instructions. Size 4 1/2 x 4 1/4 x 1 1/4". Shpg. wt., 3 lbs.

KT-131—Complete Kit Less Battery & Pickup Coil.....	Net 17.95
BATTERY RCA VS305 (9V).....	Net 1.30
MS-16—Telephone Pickup Coil.....	Net 2.95

AUDIO CONTROL CENTER

HI-FI PREAMP KIT

- EXTRA CHANNEL FOR CONTROL OF STEREO TUNER



Highly flexible preamp which cannot become obsolete. Features DC on all filaments, 2 cathode follower outputs, 24 positions of equalization, tape head input and printed circuit construction. Complete with all parts and detailed instructions. Size 12 3/4 x 9 1/4 x 3 3/4". Shpg. wt., 10 1/2 lbs.

MODEL KT-300—KIT.....	Net 39.50
-----------------------	-----------

FM-AM STEREO TUNER KIT



Highly sensitive and flexible hi-fi tuner for stereophonic or standard reception of FM and AM broadcasts. Outstanding design and circuitry assure noise-free, distortion-free, drift-free operation and also protects you against interference. Size 13 1/2 x 10 1/2 x 4 1/2". Shpg. wt., 18 lbs. Supplied complete with 2 printed circuit boards for easy construction, all parts plus metal cover, step-by-step instruction manual with schematic and pictorial diagrams.

KT-500—FM-AM STEREO TUNER KIT.....	Net 74.50
------------------------------------	-----------

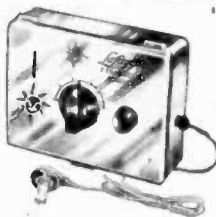

"SUNFLEX" 2 TRANSISTOR REFLEX RADIO RECEIVER KIT

- FOR SOLAR OR FLASHLIGHT BATTERY OPERATION
- NPN-PNP CIRCUIT REFLEXED FOR 3 TRANSISTOR PERFORMANCE

An efficient miniature receiver kit for earphone operation. Works on 2 inexpensive penlight cells (3 volts) or in sunlight using solar batteries (not supplied). 1 mil current drain. Complete kit with detailed instructions. Size 4 x 3 x 1 1/2". Shpg. wt., 1 lb.

KT-132—"SUNFLEX" KIT (less earphones).....	Net 11.95
MS-260—Super Power Dynamic Earphone.....	Net 3.95



"HELIODYNE" SUBMINIATURE SOLAR SILICON BATTERY

- MOST EFFICIENT TYPE OF SUN BATTERY

Generates electrical energy from sunlight or other light source. Rated 3.2 volts at 2 millamps. Ideal for "Sunflex" receiver, 1-1/16 x 3/32".

MS-420—"HELIODYNE" SILICON SOLAR BATTERY.....	Net 6.65
---	----------



TRANSISTOR DIODE CHECKER KIT

- QUALITATIVE CHECK OF P-N-P and N-P-N TRANSISTORS FOR LEAKAGE AND GAIN
- CHECKS DIODES
- CHECKS SELENIUM RECTIFIERS

Checks P-N-P and P-N-P transistors for leakage and shorts on a multi-colored scale and indicates at once whether transistor is good or bad. Provides direct GAIN readings on a calibrated GAIN scale. Permits rapid check of diodes and selenium rectifiers by indicating forward and reverse current characteristics. Sturdy black bakelite case and aluminum panel. Complete with detailed assembly and operation instructions.

KT-86A—Transistor-Diode Checker Kit.....	Net 7.95
--	----------

Lafayette Radio
DEPT. EI-C
P. O. BOX 511 JAMAICA 31, N. Y.

Send FREE LAFAYETTE Catalog 305

Name

Address

City..... Zone..... State.....

CUT OUT AND MAIL TODAY

Locations JAMAICA, N. Y.—163-08 Liberty Ave. NEW YORK, N. Y.—100 South Ave. BRONX, N. Y.—343 E. Fordham Rd. NEWARK, N. J.—26 Central Ave. PLAINFIELD, N. J.—126 West 2nd St. BOSTON, MASS.—110 Federal St.



...because **ERSIN MULTICORE** 5-core solder is designed specifically for quality radio and electronic applications, it is sold only through radio parts distributors.

The world's finest cored solder—yet, at popular prices. Available in 1 lb. dispenser cartons and 7 lb. bench reels.

For information write to Dept. ME438

MULTICORE SALES CORPORATION • PORT WASHINGTON, NEW YORK

Radio Control—Hobby Extraordinary

[continued from page 39]

flying and the types of controls, from the "poor man's" rudder-only to the plush "multi-channel" sets.

Nine out of ten sets purchased today, regardless of make, are single channel. Three out of four airplanes fitted with these sets are "rudder only." Rudder-only planes are capable of loops, spirals, and, of course, any desired turns. They are ideal for sport and for beginners. By various means, additional controls can be worked with the "building block" single-channel receiver, including elevators and engine throttle.

Proportional rudder control can be had by substituting a magnetic type of actuator for the familiar escapement, and an electronic or mechanical pulser unit for the normal transmitter micro-switch control button. The relay, and hence the rudder, slaves to every minute movement of the stick control of the pulser.

As a general rule, single-channel radio operates one escapement. As made by Babcock, Bonner, and others, many of these escapements are capable of several functions. They give left and right rudder, high and low motor, and, in many cases, can operate a second escapement for other controls. Bonner's Vari-comp escapements feature printed wiring and can be hooked up in series, or "cascaded" so that closing and holding the transmitter control button or switch once gives right rudder; twice, left rudder; three times, up elevator;

four times, down elevator. One quick blip of the control button triggers the engine throttle control. So equipped, the single-channel plane can perform outside loops and fly inverted. To boil it down, competition falls in three classes: rudder only, intermediate (when gimmicks are added for more controls), and true multi (more than one channel) control. Equipment comes in single, two, three, five, six, eight and, soon to be, 10 channels. The operator's wits are the limiting factor!

Where real "muscle" is required, servos are preferred to escapements—deBolt (DMECO), Bonner, and Babcock mass produce a varied line of servos that do everything but think.

What are the costs? You can put a single-channel set into the air (or in a boat) for about \$50 to \$60. At this figure, Babcock Models, for example, offer a combination deal including the plane or boat kit, the receiver and transmitter, and the escapement or actuator. The electronic gear may be a kit (the lower figure) or assembled. You do have to buy glue, dope, and engine and tank. Figure another ten spot max. Low cost parts kits for many types of receivers are offered by many people, such as Lafayette Radio, and Essco. Imported single-channel receivers run from \$8.95 up, \$14.95 and up for transmitters. What you get for your money is roughly comparable to the investment. •

The EI Radio Garage Door Opener

[continued from page 49]

It is suggested that the power supply and the detector be wired first, keeping all leads to a minimum length and neatly soldered in place. Use #22 standard plastic covered wire. The power supply delivers approximately 135-140v. DC with no load. Current drain of the detector is .5 to .7 ma.

Check output of the power supply with a 20,000 ohms-per-volt meter for proper operation. The receiver is checked by using a pair of headphones connected between ground and point "X". (NOTE: Connect a .01 mfd. capacitor in series with the headphones at point "X". This allows passage of the audio signal and prevents the DC voltage being applied to the phones.) With the headphones connected, a hissing or rushing noise will be heard. This is the characteristic super-regenerative hiss. If this noise is not heard, check the following: tube, short circuit in wiring, open connections, incorrect components. Rotate tuning slug in and out, using an insulated tuning wand. When tuned to a signal of from 26 to 30 mc. this rushing noise will disappear.

With the detector operating properly, wire in the pentode audio amplifier section of the 6U8. The amplifier should have all lead lengths as short as possible. Operation may be checked in the same manner as the detector, placing the headphones between ground and point "Y". At this point the audio level, or rushing noise should be greatly increased. If no signal, or a weak signal is noted at point "Y" check for the same faults listed for the detector circuit. In addition, check for a signal at the grid of the pentode section of the 6U8. This signal level should be the same as at point "X". If not, C4 is defective or there is a poor connection.

With the pentode amplifier operating, wire in the triode power output section of the 6U8. A 10,000 ohm, $\frac{1}{2}$ w. resistor may be substituted for the reed relay coil and R9 for test purposes. Repeat the check for a signal on the triode section, checking at point "Z". The same symptoms and possible causes for no signal are the same as for the pentode

section. When the rushing noise feeds through the receiver and is progressively amplified up to point "Z", the reed relay connections may be made, along with the reed contacts and the secondary relay, RLY2:

The antenna is connected as shown in the photo and wiring guide. Since the receiver may be located in the garage or house, it is desirable to run the antenna to a point where signal pickup is better. This is done by using a 4 to 6 foot length of shielded cable, prepared as shown in the pictorial sketch. Remove the outer braid conductor for about 16" to 18" from one end. The other end should be stripped back about $\frac{3}{4}$ to 1 inch. The inner conductor from this end is soldered to the antenna post and the outer braid is secured under a solder-lug, as shown in the photo, spot soldered. A small cable clamp may be used to further secure the cable to the case and thus act as a strain relief.

The receiver is now ready for operation, however, the transmitter must be built before the receiver is placed in operation.

Transmitter Construction

The mobile transmitter is built on one cover of a 3" x 4" x 5" case. Four filament type tubes, 3V4's are used. One is for the crystal oscillator on 13.627mc, one for the doubler output stage on 27.255mc. and two are used for the tone generating circuit. Drill or punch the front panel and chassis bracket as shown in the drawing. Assemble these pieces and add the tube sockets, tube clamps, grommets, terminal strip and final tuning capacitor. Use small lock washers under each nut and/or screw head. Be sure sockets are mounted with pins located as shown. Place a soldering lug and lockwasher under the nut holding the amplifier socket in place and the screw holding the chassis to the front panel. Wire in the filaments using #22 stranded plastic cover wire. All filaments are wired in parallel, thus requiring 1.5v. at .4 amp. for proper operation. Mount the oscillator coil form and then add balance of components to com-

A BOX IS NOT A MUSICAL INSTRUMENT!

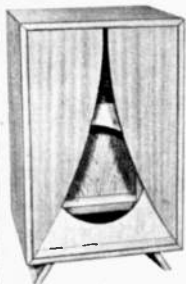

No skilled musical instrument maker, including even those in aboriginal tribes, has ever found a rectangular box satisfactory. IN SPITE OF THIS, today many HI-FI speaker systems proclaim the ultimate in high fidelity, yet they employ nothing more than the most elementary boxes to perform the complicated function of transforming the vibrations of the loudspeaker into sound.

In the PATENTED • KARLSON ENCLOSURES, specially curved internal and external structures are used to provide you with the highest performance capabilities available in the industry today. Actually the Karlson Enclosure is one of the most fabulous musical instruments ever created and is capable of reproducing every sound from a baby's breath to the mighty roar of thunder. After long and rigorous tests, we know

definitely that the Karlson Enclosures can outperform all other units now available on the market at any price.

Despite their fantastic performance characteristics these units are available to you in 20 different models in KIT, UNFINISHED AND FINISHED FORMS, at prices you can afford, ranging from \$14.00 to \$174.00.

SEND FOR OUR COMPLETE CATALOG TODAY AND LEARN HOW THE KARLSON ENCLOSURE CAN BE FITTED TO YOUR SPECIFIC NEEDS.

* 2,816,610

KARLSON ASSOCIATES, INC., Dept. E18
1610 Neck Road
Brooklyn 29, N. Y.

Please send catalog.

Name _____

Address _____

City _____

State _____

ONE MILLION DOLLARS CASH

IN CONFEDERATE MONEY
Yours only \$298

Be a deep south millionaire! Have money to burn! We'll send you exactly one million bucks in honest-to-goodness Confederate money—and all you pay is \$298! You can do everything with this money but spend it. Amaze and amuse your cotton-pickin' friends. Win bar bets by the barrel! Light your cigars and cigarettes with \$10.00 bills! Live it up! It's a million dollars worth of laughs and fun—all for only \$298. You get one million bucks in \$10's, \$20's, \$50's, \$100's etc. denominations—enough to keep your friends laughing and happy for months—This offer is limited. Only \$4 million dollars to a customer. Our supply of this loot is limited—so rush your order. . . . One Million dollars only \$298. Four Million dollars only \$10.00. If not delighted keep \$100,000 for your trouble and return the rest of the money for a full and prompt refund. Send to—BEST VALUES CO., Dept. M-273, 403 Market St., Newark, N. J.

GERMAN AUTOMATIC

6-SHOT REPEATER—22 CAL.

- Blank Cartridges
- No Permit Required
- Latest Model
- Fully Automatic

Self ejecting clip. Firing spring adjustable! Precision made by the Finest West German Gunsmiths—Wonderful for sporting events, theatrical performances, to scare would-be attackers, etc. 4" long, perfectly balanced. Sold on a money back guarantee—Send \$6.95 Cash, check or Money order to:

BEST VALUES COMPANY

Dept. G-56, 403 Market St., Newark, N. J.



\$6.95

Postpaid

plete the oscillator. Add the power lead-in wires to the terminal strip, leaving them about 2 feet long. Use #18 standard plastic covered wire.

It is desirable to bench check the transmitter in the same manner as the receiver was checked, stage by stage. A single dry cell, or two size D flashlight cells in parallel, will supply the 1.5v. for the filament. A 67½v. or 90v. portable radio B battery will suffice for the high voltage. The radio frequency output may be checked by using a 60ma., pink bead, flashlight bulb connected to 2 loops of insulated wire, having a diameter of about ⅝" to ¾". Insert the crystal and oscillator tube and connect the filament supply. Place a 0-25ma. DC meter in series with the B supply. Make sure polarity is correct.

Until properly tuned, the plate current of the oscillator will be fairly high, in the order of 15ma. for 67½v. and about 22ma. for 90v. Rotate the tuning slug in or out until a current dip is indicated on the meter. This should be a drop to about 5-8ma. Note, that as the slug is moved into the coil area, the current reading will gradually decrease until it reaches minimum, whereupon further turning in a clockwise direction will cause a sudden increase to maximum reading. At this point, rotate slug counterclockwise, or out of the coil area, about 1 turn. Locating the loop on the flashlight bulb near the end of the coil will cause the bulb to glow. If the oscillator has been tuned for minimum dip and the bulb does not glow, check the following: defective bulb, circuit peaked too sharp (placing loop near coil knocks circuit out of oscillation, move slug out of winding about ½ to 1 turn); or more B voltage is required. A ham friend, serviceman, or local radio station operator can help you make the necessary adjustments.

When the oscillator is working properly, wire in the components for the doubler-amplifier. The tank coil consists of 10 turns of a B & W #3007 Miniductor. Cut a length of coil about ⅛" longer than the 10 turns and unwind turns from one end so as to leave about ⅛" of plastic supports exposed. This will allow for mounting of the antenna coil. If desired, L2 may be made from #16 enamelled copper wire. 9 turns on

a $\frac{3}{4}$ " diameter form are required, with the length being about 11/16".

When the amplifier is completed it is checked in the following manner: insert amplifier tube and turn on filaments, apply B plus to oscillator and check to be sure the current remains at a minimum, place loop of bulb at end of amplifier coil and with B plus connected to the amplifier, rotate amplifier tuning capacitor slowly until bulb glows. The oscillator plate current must remain at a low level when the amplifier circuit is brought into resonance. Adjust the oscillator slug and amplifier tuning capacitor for maximum brilliance of the bulb.

The antenna pickup coil is made from 6 turns of the #3007 B & W Miniductor. Leave about $\frac{1}{8}$ " of the plastic supports to protrude from one end. Allow about 2" of wire at each end of the coil for connections. The coil is positioned as shown in the photograph at the plate end of the tank coil. One end of the coil is soldered to the antenna feed-through terminal and the other end to a ground lug which is held in place by the screw holding the chassis to the front panel. The plastic supports should be cemented together or fused together by a hot soldering iron. Distance between the coil windings should be about $\frac{1}{4}$ ".

Now assemble the two 3V4's for the audio frequency multivibrator circuit. Keep leads short and place components as shown in the photograph. Note that R4 is located external to the transmitter case. Conventional lamp cord or hookup wire may be used for lengths up to 2 to 3 feet. Over 3 feet it may be advisable to use a shielded cable for protection against ignition noise. R4 is a variable potentiometer used to tune the transmitter audio frequency, and should be mounted as close to the transmitter box as possible and also in a convenient spot for making adjustments. With the audio section completed, the transmitter is now ready for use and the receiver may be actuated. This may be done on the bench for familiarizing yourself with the system and then it may be necessary to check it out again when the final installation has been made.

Turn on the receiver and insert the headphones between ground and point "Z" using the .01 mfd. condenser in

series. A rushing noise should now be heard. Turn on the transmitter and then adjust the receiver tuning coil slug until the rushing noise disappears. This may be done with the multivibrator tubes removed or left in their sockets. If they are removed, the rushing noise will disappear. If they are left in place, an audio note will be heard. It will be noted that the audio frequency from the transmitter will vary somewhat with changes in B voltage. This is normal and will be held to a minimum when the transmitter power supply is operated from the car battery.

The transmitter power supply as shown in the photograph is a combination device. A 15-watt "Shav-Pak," which may be plugged or wired into the cigarette lighter, serves to supply 110v., 60 cps., AC to the rectifier. The rectifier circuit is built into a #CU-3000 Minibox, along with the dropping resistors for the filaments. The two units now supply 130v. DC at about 20ma. and 1 $\frac{1}{2}$ v. for the filament supply, from either a 6 or 12v. car battery. (Note: the voltage at the filament leads will not be 1 $\frac{1}{2}$ volts unless the tube filaments are in the circuit.) BE SURE that you use the proper voltage "Shav-Pak" to suit your car and that the filament dropping resistor is selected for either 6 or 12 volts. The input line to the "Shav-Pak" contains the momentary push button actuator switch. This switch should be located at a convenient place on the dash of your car.

Following are a few notes on installation and tuning of the system.

The receiver is self contained and should be housed in a sheltered spot. The basement of the house is satisfactory, with the antenna being run to the outside for better pickup. The relay contacts merely act as a remote switch to operate the door raising actuator or turn on lights. Thus the line between the relay and the remote-controlled device may consist of up to about 100 feet of lamp cord. This will of course depend upon the current drawn by the device and if you are in doubt it would be wise to check with your local electrician.

The transmitter wiring should be checked carefully against the schematic
[continued on page 107]

Grommes Little Genie HIGH FIDELITY KITS

• LAYER BUILT • COLOR GUIDE

"So simple . . . it's like magic"



LJ-6K

Before you build another kit see this new method of kit assembly. Each kit complete with all parts and instructions.

LJ-6K 10 Watt Amplifier (Little Jewel). Has built-in pre-amplifier and record compensator on phono channel. Highest value in its field. Net 24.95

207A-K-Hi-Fi Pre-amplifier (Self-Powered). Feedback circuit with 10 controls. Net 44.50

250-K-60 Watt Basic Hi-Fi Amplifier. For use with a pre-amplifier (such as 207A-K). Net 79.50

61PG-K—20 Watt Amplifier. With built-in preamplifier and all controls. Net 59.50

Grommes Division of Precision Electronics, Inc.
Dept. EL-5, 9101 King Street, Franklin Park, Illinois
Send complete KIT Details

Name _____
Address _____
City _____ Zone _____ State _____

ACME BATTERY HOLDERS

WORLD'S LARGEST PRODUCER OF BATTERY HOLDERS

- Positive electrical contact at all times
- Batteries can be replaced without removal of any parts
- Standardized for continued use in production jobs
- Made of spring tempered aircraft aluminum
- Pretinned copper soldering terminals
- Approved fibre insulation
- Brass contacts at all terminals
- Mounting holes provided and standardized in every holder
- Batteries cannot spin from vibration



2 cell holder 50c
specify battery

Over 100 styles to choose from—a holder to fit every dry or mercury cell. ACME BATTERY HOLDERS are used the world over by Manufacturers—Universities—Experimenters—Hobbyists and many others.

When you need a battery holder—insist on ACME the dependable Battery Holder.



Specify batteries

MANUFACTURERS—If you need a holder for your product, write for quantity prices. Specify style and quantity.

ACME BATTERY HOLDERS are available in most electronic supply houses and hobby departments.

SEND FOR FREE COMPLETE LIST OF OVER 100 BATTERY HOLDERS. FREE CROSS REFERENCE GUIDE.

If you cannot buy our battery holders in your area you may order direct from us. Add 5c for each holder.

ACME MODEL ENGINEERING CO.
4703-L Third Avenue, Brooklyn 20, N. Y.

New Ion Fuel For Rockets

[continued from page 26]

ships would use a rather strange pair of batlike "wings" which would radiate this heat into space, since radiation is the only way to lose heat in a vacuum..

Fantasy and Fact

In Walt Disney's newest space film, "Mars and Beyond," ionic ships are used to get to Mars, where they enter an orbit. Then small chemical rockets, which hang from the umbrella-like heat radiators, are used to descend to the surface. Dr. Wernher von Braun, the U. S. Army's top rocket expert, was design consultant for this ship. Dr. von Braun is also a former V2 designer.

There are several firms known to be at work on ionic drive research. In addition to the aforementioned *Rocketdyne*, which has a modest-sized Air Force Office of Scientific Research contract, *General Electric* has been doing work in the field. G. M. Giannini, a West Coast instrumentation manufacturer, has also shown interest, as has the National Advisory Committee on Aeronautics, which has been working on a form of ion gun.

On the other hand, there have been reports from Moscow that Russian rocket scientists have been working on "advanced propulsion systems," which are believed to be the ionic drive as well as an even more advanced idea, the photon drive. However, this latter is little more than a concept at this time, and it is felt that the main Soviet emphasis is on ionic propulsion. Photonic drive, which makes use of the propulsive power of particles of light, may come much later.

There can be little doubt, however, that the Russians have been pouring money and talent into all phases of rocketry. If they beat us to a workable ion ship, we may well expect to receive the first message from Mars in a Russian accent. We will, truly, have lost the race for space. •

The El Radio Garage Door Opener

[continued from page 105]

and pictorial drawings to make certain all wires are connected properly. It is preferred that the transmitter be mounted in the trunk of the car, along with the power supply. Use #16 wire to connect the battery to the equipment, especially if it is a trunk installation. The prime concern is to eliminate as much voltage drop as possible due to the filament circuit being only 1.5 volts. The transmitter antenna may be a 4 to 6 foot length of #24 stranded microphone hi-fi cable (Alpha #494B). Prepare one end about 1½" back as per the wiring guide and remove 16-18 inches of outer covering and shielded braid from the other end, leaving the center conductor encased in the inner plastic insulation. This cable may be run through a grommet in the firewall or body of the car so that the exposed end is in the clear. The free end may be anchored and placed away from the car body by cementing a block or two of Styrofoam (obtainable in 10 cent stores), about 1" x 2" x 2", to the frame or body of the car. Use contact cement or Pliobond, making sure the metal surfaces are free of caked mud, grease or dirt. When these blocks have dried, sandwich the free end of the cable between similar blocks.

Place the antenna near the front of the car or in the open grill work. Do not locate it in such a manner as to shield the signal by the car chassis. If the transmitter is placed in the trunk, it would also be convenient to use a regular whip antenna. This antenna should be mounted in the normal manner, insulating it from the car body, and should be 3 to 4 feet long. If this is done, use a piece of shielded cable to connect the antenna and transmitter box connections to the antenna itself. This type of installation will greatly increase the useable range of the system.

Final tuning should be done with the component parts in place. Check the radio frequency section of the transmitter for proper operation, although if properly bench checked it should not

EVERYBODY'S TALKING ABOUT ELECTRONICS ILLUSTRATED

... AND SO ARE WE!



MECHANIX ILLUSTRATED,
the How-To-Do Magazine, always
brings its readers (more
than a million) the very latest
news of exciting developments in
electronics... PLUS step-by-step,
easy-to-follow instructions for
building radio transmitters and
receivers, hi-fi players, television
sets, Geiger counters, home
sentry systems, public address
units, lie detectors, unique family
telephone hook-ups, radio-
controlled models and many other
fascinating projects. For the
best in electronics plans and
projects always buy...

**MECHANIX
ILLUSTRATED**

Another Great FAWCETT Publication

25c / a copy

\$3 a year

need retuning. The pushbutton is depressed and potentiometer R4 is rotated until the reed relay in the receiver is actuated. It will be noted that the reed will increase in amplitude of vibration as the pot. is turned from maximum to minimum resistance. DO NOT set for maximum amplitude or strength of vibration, but rather back off toward the maximum resistance side of the pot. The reed relay should be chosen so that its frequency is not a multiple of the 60 cycle line frequency by closer than 10 cycles, i.e., omit frequencies between 230 and 250, 290 and 310, 350 and 370 cps., etc.

The transmitter rectifier section of the power supply could be built into the 3" x 4" x 5" box if you prefer, however, a tighter packaging of components will result, a feature which was avoided in laying out the present design for ease of assembly.

The mechanical section of a door opening actuator is not given due to the variation in doors, actuators and installation problems. The actuator mechanism can be obtained from the P. E. Hawkins Company, 631 Prospect, Dept. EI, Kansas City 24, Missouri; Alliance Manufacturing Co. Inc., Alliance, Ohio; the Perma Power Co., 4727 N. Damen, Chicago 25, Illinois; among others. Or, check with your local electronic parts distributor. You could also get information from your local garage door dealer on the type of mechanical actuator best suited to your door. •

First Novice Transmitter

[continued from page 98]

receiver will reassure you that your signal is clean and on frequency. Incidentally you can check your crystal oscillator frequency without overloading your receiver by merely removing the 807 from its socket and keying just the 6AG7 oscillator tube, and listening for the signal on your own receiver. Of course, the calibration on the receiver must be accurate to give you a correct indication.

So there you are—for approximately fifteen dollars and a few hours labor, the exciting world of amateur radio will be open to you. We wish you 73's and many hours of successful DX hunting. •

Driveway Floodlight Control

[continued from page 68]

Once all the parts are mounted on the bakelite sheet, most of the wiring may be completed before mounting the little sub-chassis in the box. If you use sufficiently thin hook-up wire, you will find that it passes through the perforations nicely, thereby permitting much of the wiring to be located under the sheet.

Some additional precautions to reduce the hazards of short circuits and possible shock from live metal parts are:

(1) The photocell is mounted by pushing its brass leads through a suitable pair of perforations and then bending the leads over sharply to insure firmness of positioning. One of the leads is wired directly to the proper potentiometer lug as a further support; *be sure you cover all bare leads with insulated tubing (spaghetti) to avoid having them touch the case or each other.*

(2) Both wires of the AC line cord are brought into the box through a grommeted hole and terminated securely at a two-lug terminal strip. *Neither AC lead must be permitted to touch the case!* All power leads that are fed from the AC are then brought to the lugs on the terminal strip.

(3) *Observe the polarity of the electrolytic capacitor carefully!* Note that the positive pigtail of the capacitor connects to the selenium rectifier.

(4) Install the selenium rectifier so that you know which terminal is the "plus" or "K" end. All good rectifiers are marked either "+" or "K" at this terminal. For chassis mounting types, such as the one in this model, the plus terminal is usually the one furthest from the chassis after mounting.

(5) Three holes are required in the top section of the case. A ½-inch hole which takes a ½-inch o.d., ⅜-inch i.d. rubber grommet is located directly over the slotted shaft of the sensitivity control potentiometer to permit sensitivity adjustments *in situ* should it be necessary to do so. This is best handled by a short length of ¼-inch dowel stick cut to a screwdriver shape at one end. (It is not advisable to use a metal screwdriver

Popping With Electronic Ideas?



Spilling over with plans for electronic garage door gimmicks, TV commercial killers, hi-fi amplifiers, tuners and the like—but stumped by theory? Stymied because you don't know what circuits to use? RADIO-ELECTRONICS magazine can help you. Here's an easy-reading but thorough magazine which tells you everything you want to know about electronics from Amplifiers to Zero beat. Covers radio, TV, hi-fi, and electronic construction, servicing, and operation—plus occasional off-beat articles on out-of-this-world electronic applications. If you want to know more about electronics—in all its phases—read RADIO-ELECTRONICS regularly.

Get a copy at your newsstand or parts distributor—35¢ a copy. APRIL issue on sale March 25. MAY SPECIAL TRANSISTOR ISSUE on sale April 24

SUBSCRIBE NOW

3 years \$9 2 years \$7 1 year \$4
 Save up to \$3.60 over the newsstand price

Radio-Electronics

May, 1958

SOME ARTICLES TO BE PUBLISHED SOON

- Amplifier for Your Hi-Fi Tweeter
- Automatic Fan Thermostat Uses Transistors
- Build This All-Transistor All-Wave Radio
- Facts and Fallacies in Color TV
- Servicing Transistor Radios
- Designing a Hi-Fi 12-Watt Amplifier
- Tube Changers—Good Service Technicians?
- Servicing Horizontal Oscillator Circuits
- What's with Characteristic Impedance
- Special Audio Amplifier Circuits

Sound interesting? Then RADIO-ELECTRONICS is for you

RADIO-ELECTRONICS, Dept. E1
 154 West 14th Street, New York 11, N. Y.

OK—you've convinced me. Enter my subscription to RADIO-ELECTRONICS as checked below.

3 years \$9 2 years \$7 1 year \$4
 Remittance enclosed I'll pay when billed

Name
 please print

Street

City..... Zone..... State.....



HAM RADIO

is a
fascinating
hobby.

You can learn to operate your own radio station and speak to other electronic-conscious people all over the world.

For more than 12 years CQ, The Radio Amateurs' Journal has been publishing all the latest doings in the amateur radio market. A single issue contains articles on transmitters, receivers, sideband operations, mobile radio, DX contests, VHF, novice activity, propagation, transistor news, radio-teletype, short wave, and many others.

CQ teaches the beginner how to plan his shack, build his first equipment, and takes him right on up the ladder to experienced ham activity. CQ features hundreds of articles each year on construction of interesting radio and electronic devices.

If you're interested in electronics as a hobby, you can't afford to miss another single issue. Fill in the coupon below and fly, don't run, to the nearest post office.

CQ MAGAZINE

EI-1

300 West 43 Street, New York 36, N. Y.

Sirs: Here is my remittance for \$..... Enter my subscription order to "CQ" for the next issues.

Subscription Rates: 36 issues—\$10.00; 24 issues—\$7.00; 12 issues—\$4.00*

*The above rates apply to U.S. Possessions, APO, FPO, Canada & Mexico, Pan-America and foreign: 1 year \$6.00; 2 years \$11.00; 3 years \$16.00.

Name..... Call.....

Address

City..... Zone..... State.....

since you may approach one of the lugs on the AC terminal strips too closely). Two 1¼-inch holes in this section are also required: one is the aperture for light entry and the other is fitted with the output AC receptacle. The aperture is centered in the small front panel of the case; the receptacle opening is placed above and somewhat in front of the photocell. Use No. 16 zip-cord or other AC wire for the connections between the receptacle, the relay contacts, and the AC line, especially if you intend to have over 200 watts of lighting.

Testing and Adjustment

After the wiring has been completed, and before power is applied, you would be well-advised to carry out a few resistance or continuity checks to make certain that there are no short-circuits. These are suggested, using either an ohmmeter or a flashlight battery and lamp in series if the meter is not available. First check across the prongs of the AC plug and at the terminals of the output receptacle. The resistance should be quite high between these points with the switch either open or closed. Next, check across the filter capacitor C with R2 at both extremes successively. Again the resistance should be high. Advance the sensitivity control fully clockwise to its most sensitive position and darken the room. Apply power. The relay should not pull in. Allow some light to enter the aperture and listen for the relay as it triggers. Once this action is established, plug a lamp into the output receptacle and re-test the unit with several different light sources. The plugged in lamp should, of course, respond to abrupt changes in incident illumination. The sensitivity control should be left at its maximum position. Further adjustment, if necessary at all, should be made when the unit is in its final position.

In selecting the location of the Floodlighter in the garage, you will need to place your car in the position where you want triggering to take place. Mount the control box so that the aperture is in the center of the most intense part of the headlamp beam. Final adjustment of sensitivity is made after you have established reliable and consistent operation. Use as little sensitivity as is consistent with good performance. In this

way, you reduce the likelihood of a chance beam from a passing car spuriously triggering the relay. If this should happen despite the reduced sensitivity, no harm will be done since the floodlight will extinguish when the car passes on anyway.

All About Wiretapping

[continued from page 33]

variably they consist of about a pound or two of fine wire (about No. 40) wound on a ferrite core and enclosed in a nonmagnetic case of brass or aluminum. Several coils of this nature may be hooked up in series. The complete coil can be enclosed in a discarded vibrator, brass, aluminum, or fiber case. The coil may be taped for convenience. An old TV flyback transformer may be used for this purpose.

The coil feeds to an amplifier as in the preceding instances. It may feed a recorder too. A matching transformer may or may not be needed, depending on the amplifier and the coil impedances.

Such a coil can easily be carried in a pocket and oriented with one hand. It need not be exposed to sight so that even in your own office or home you may not be safe from some unfriendly person listening to the other side of a telephone conversation. And the big coil does the job ten feet away from a phone booth.

A preamplifier of the hearing-aid type—either tube or transistor—may require matching to the tape recorder if one is used. Ordinarily an earphone is used to monitor either the tape recorder output or the amplifier output simultaneously.

In conclusion, a caution about the phone booth. Even the single booth is not immune. A pickup against the booth wall will do the job, and it may remain concealed in the interloper's pocket during use. So beware of any invasion of your privacy—you do not know who has designs on your property or your person.

In the next issue we will show that even a talk on a park bench, or in a car is not necessarily private. The menace of the high powered "bug" microphone is ever present to pry into your secret talks.

TUBES "TAB" TESTED GUARANTEED

Our 12th Year in Business

DA2	.80	9LP7	1.00	6BQ6	2.00	7Q7	.79
OB2	.72	2C22	20/\$1	6BQ7	.99	12AT6	.59
OB3	.82	7193	20/\$1	6C4	.49	12AT7	.79
OC	3.40	434A	1.99	6C6	1.99	12AU6	.69
OD3	.80	1N34A	2/\$1	6CD6	1.49	12AV6	.59
OZ4	.80	CK722	.99	6E6	.59	12AX6	.59
1A2	.98	6AU6	.69	6E6	.69	12BA7	.79
1B3	.78	5V4	.89	6E6	.59	12BK7	.79
1L4	.82	5Y3	.59	6K6	.59	12BN7	.89
1R4	.78	6AR4	.59	6K7	2.79	12BY7	.89
1R5	.78	6B7	.79	6L6	1.19	12CA7	.89
1S4	.78	6AQ7	.97	6A7	.69	12SK7	.69
1S5	.68	6AH4	.89	6SA7	.79	12SN7	.69
1T4	.69	6AG6	.59	6SH7	.69	259Q6	1.29
1J5	.59	6AK5	.69	6SJ7	.69	14A7	.69
1K2	.66	6AL5	.59	6SK7	.69	19BQ6	1.69
2021	.68	6AQ5	.66	6SL7	.69	259Q6	1.29
2X2	.48	6A55	.75	6SN7	2/\$1	25Z6	.79
2V3	.48	6AT6	.49	6SQ7	.59	35C5	.59
3A5	.69	6AU4	.69	6T4	1.19	35L6	.59
954	10/\$1	6AU6	.69	6T8	.99	38W4	.59
955	.33	6AX4	.79	6U8	.99	35Z5	.55
1019	5/\$1	6BA6	.59	6V8	.59	50A5	.69
1019	5/\$1	6BA6	.59	6V8	.59	50A5	.69
1025	4/\$1	6BE6	.59	6X4	.39	50C5	.69
1026	3/\$1	6BF5	.79	7A8	.79	50L6	.69
1029	4/\$1	6BQ6	.49	7C5	.79	75	1.00
807	1.15	6BK5	.69	7F7	.79	76	5/\$1
808	.69	6BL7	.99	7F8	.79	77	5/\$1
8P1	\$3.98	6BN6	.69	7N7	.79	10Y	3/\$1

INFRARED SNOOPSCOPE

SEE IN DARK TUBE

Selected QTD. Image Converter Tube, Hi-sensitivity simplified design 2" dia. Willemite screen—Hi-Resolution Tube & Data. _____ \$9.95 @, 2 for \$9.95



Model #S2001K—4500VDC/35MA Supply using dual doubler ckt. Leak chassis & grill. _____ \$13.95

BATTERY CHARGER KIT 2 to 4 Amps. CHARGES 2-4-6 & 12 VOLT BATTERIES. KIT BCK-1 SPECIAL. _____ \$9.95

NEW "TABTRON" SELENIUM RECTIFIERS

FULL WAVE BRIDGE

Dated—One Year Guarantee



18VAC/14VDC—1 Amp \$1.40; 2A \$2.00; 3A \$2.90; 4A \$3.50; 6A \$3.95; 10A \$5.85; 12A \$7.20;

38VAC/30VDC—1 Amp \$2.80; 2A \$3.40; 3A \$4.10; 4A \$4.60; 6A \$6.40; 10A \$7.70; 12A \$11.30; 15A \$14.25;

18 VOLT @ 8 AMP DC PARTS PACKAGE, CONTAINS BRIDGE RECTIFIER & 18 to 24V/8A (2 lb) TRANS. 115 VAC INPUT, \$20 value. Delivers 14 to 20 VDC, Ideal R.R. _____ SPECIAL \$11

NEW POCKET AC-DC MULTITESTER

1000 Ohms Per Volt Postpaid 48 States

"TAB" 27E Only \$7.49 ea.



Finest precision Hi-accuracy VOM. Reads AC & DC Volts; 0-15-150-1000V. DCMA; 0-150 MA. OHMS: 0-100K. Size 1 1/2" D x 4 1/2" L x 3 1/4" W. Features: 176 Precision resistors. Extra long meter scales. Complete w/batteries & test leads. Ideal for Ham, Experimenter and Beginner.

NEW TEST EQUIPMENT KITS!

TIK VTVM KIT \$24; TSK SCOPE 5" KIT \$42
RES/CAP BRIDGE KIT \$19; T6K TUBE TESTER KIT \$34
TKM HI-FI 2 WAY SPEAKER KIT \$36; T7K SCOPE 7" KIT \$76
TKB DYNAMIC TUBE & TRANSISTOR TESTER KIT \$66

We stock parts for all "Electronics Illustrated" Circuits. Write "TAB" That's A Buy!

BATTERY CHARGER KIT 2 to 4 Amps. CHARGES 2-4-6 & 12 VOLT BATTERIES. KIT BCK-1 SPECIAL. _____ \$9.95

"TAB" FINEST HI-FI RECORDING TAPE

7" Reel—1200 Ft. Per Reel \$1.45 Lbs of 6 Sold on Money Back Guarantee

Highest quality Hi-Fi Precision Coated & Silt. "ERIN" MPGR & PROCESS, quality controlled, constant output Noise FREE, Splice FREE Plastic Tape. Prod. 7 1/2 IPN. 40-15KC Oxide. Wind-In. "TAB" @ \$1.50 ea.; 3/\$1.50 ea. New 1st Quality "MYLAR" 2400 Ft. 7" Reel "ERIN" MPGR & PROCESS RECORDING TAPE \$4.49 @ 3/\$12

Registered One Year Gtd. Replacement Needed Single Diamond \$8; Dual Dia \$15; Dia-Sapphire \$9 @ Please Send Cartridge Name & Number a Postpaid 48 States

KITS! Each "TAB" Kit Contains The Finest Selection

Kit 35 Precision Resistors	Kit 40 Insulators
Kit 10 Switches	Kit 35 Power Resistors
Kit 75 Resistors 1/2/1/2W	Kit 75 Mica Condensers
Kit 150 Carbon Resistors	Kit 5 Crystal Diodes
Kit 45 Panel Lamps	Kit 250 ft. Hook Up Wire, Ass't'd
Kit 12 Electrolytic Cond's	Kit 100 Fuses, ass't'd all types
Kit 15 Volume Controls	Kit 100 Ceramic Condensers
Kit 35 Tube Sockets	Kit 150 Coil Forms
Kit 65 Tubular Condensers	Kit 5 Crystals & Holders
Kit 500 Lugs & Eyelets	Kit 65 Inductors & Coils
Kit 10 Bath Tub Oil Cond's	Kit 5 Microswitches
Kit 5 lbs. Surprise Package	Kit 10 Wheat Lamps
Kit 10 Transmit Mica Cond's	Kit 3 Transistor Xfms

Order Ten Kits ONE EACH ABOVE \$99c We Ship Eleven!!! KIT ONLY

FREE! WRITE TODAY FOR OUR NEW CATALOG

"TAB" TERMS: Money Back Gtd. \$2 min. order F.O.B. N.Y.C. Add shp. charges or for C.O.D. 25%. Dep. Prices shown are subject to change.

111CF Liberty St., N. Y. 6, N. Y., Rector 2-6245

easy to build

do it yourself

HEATHKIT

NEW! TRANSISTOR RADIO

direction finder kit

Navigate by radio on land—on water—in the air. Sailors, campers, hunters, hikers, aviators—will delight in this light, compact, self-powered six-transistor radio direction finder which doubles as a high quality portable radio. Simply tune in two or more standard radio stations by rotating the front-driven directional antenna, take the reading from the compass rose and bearing indicator and plot your exact location on any map! Precise vernier dial tuning on a 540 to 1620 kc broadcast band facilitates locating and identifying numerous stations. The built in speaker in the handsome (7½" x 5⅝" x 5⅝") unit provides clean sound reproduction. Powered by a tiny nine-volt battery. A real buy for many uses at this low price. Shpg. wt. 5 lbs.



MODEL DF-1

only \$54⁹⁵

Whatever your hobby there is a HEATHKIT for you!



TEST
Model V-7A
VTVM, \$24.50



HI-FI
Model EA-2 HI-FI
Amplifier, \$25.95



HAM
Model DX-20
CW Transmitter, \$35.95



MARINE
Model FD-1 Fuel
Vapor Detector, \$35.95

Send for **FREE** catalog

listing nearly
100 high quality
dependable
Heathkits for you
to choose from.

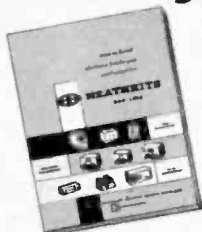

HEATH

pioneer in
"do-it-yourself"
electronics

COMPANY BENTON HARBOR 39, MICH

D
a subsidiary of Daystrom, Inc.

I'm Interested in the following type of equipment:
 TEST, HI-FI, HAM GEAR, MARINE.

name _____

address _____

city & state _____

Learn Radio-

Servicing by Prac



**Jobs Like These Go to the
Radio-Television Technician**



NRI Trained these Men



"I knew practically nothing about Electronics. After 13 lessons I started repairing sets. My future looks bright." **D. B. ACKERMAN**, Minneapolis, Minn.

"Thanks to NRI, I operated a successful Radio Repair shop. Then got a job with WPAQ; now I am an engineer for WHPE." **V. W. WORKMAN**, High Point, N. C.



"Have good job in a TV repair shop plus a small business in my home. In one year I went from lowest paid to head benchman." **V. BARR**, Toronto, Ohio.

**Fast Growing Field Offers You
Good Pay, Success, Bright Future**



**J. E. SMITH
Founder**

Bigger than ever and still growing. That's why Radio-TV has special appeal to men not satisfied with their earnings. More than 4,000 Radio and TV stations on the air. More than 150 million home and auto Radios. 40 million TV sets. Training PLUS OPPORTUNITY is the ideal combination for success. Plan now to get into Radio-TV. National Radio can train you at home in your spare time. NRI is the oldest and largest home study Radio-TV school. Easy to understand, well illustrated lessons teach you basic principles. And you LEARN-BY-DOING, by practicing with kits of equipment NRI sends.

Start Soon to Make \$10-\$15 a Week in Spare Time

Soon after enrolling many NRI students start to earn \$10, \$15 a week extra fixing sets in spare time. You get the benefit of NRI more than 40 years experience training men. Make a move today toward becoming one of that select group—a Radio-TV Technician. Send Postage-Free card today for actual Lesson and 64-page Catalog. **BOTH FREE. NATIONAL RADIO INSTITUTE, Dept 8EK, Washington 16, D. C.**



**You Practice Communications
with Equipment NRI Sends**

Nothing takes the place of practical experience. As part of NRI Communications Course you build this Broadcasting Transmitter; train for FCC License.

**You Practice Servicing
with Equipment Sent**

As part of NRI's Servicing Course you build AC-DC Superhet Receiver; Vacuum Tube Voltmeter; many other pieces of equipment for practical experience.

MAIL POSTAGE FREE CARD

**if you think
that all brands of
recording tape are alike ...**

**wait
till
you
try**

irish

BRAND



ferro-sheen

available wherever quality recording tape is sold

